



Durham E-Theses

The plasticity of human saccadic eye movements

Crawford, Trevor J.

How to cite:

Crawford, Trevor J. (1984) *The plasticity of human saccadic eye movements*, Durham theses, Durham University. Available at Durham E-Theses Online: <http://etheses.dur.ac.uk/7224/>

Use policy

The full-text may be used and/or reproduced, and given to third parties in any format or medium, without prior permission or charge, for personal research or study, educational, or not-for-profit purposes provided that:

- a full bibliographic reference is made to the original source
- a [link](#) is made to the metadata record in Durham E-Theses
- the full-text is not changed in any way

The full-text must not be sold in any format or medium without the formal permission of the copyright holders.

Please consult the [full Durham E-Theses policy](#) for further details.

The Plasticity of Human Saccadic Eye Movements

Trevor J. Crawford

The copyright of this thesis rests with the author.
No quotation from it should be published without
his prior written consent and information derived
from it should be acknowledged.

Thesis submitted for the degree of Doctor of Philosophy

University of Durham

Department of Psychology

1984



15. APR. 1986

The Plasticity of Human Saccadic Eye MovementsTrevor J. Crawford

The central purpose of this research has been to examine the possibility of the plasticity of individual saccadic parameters and to identify their patterns of covariation. Experiments using trial-by-trial feedback or continuous on-going feedback methods demonstrated that the saccadic generator can prolong the duration of a saccade above normal levels. However, slowed peak velocities were only evident with continuous feedback. The results showed that although continuous feedback was a more effective method for inducing modifications of saccade trajectories, the effects of trial-by-trial feedback schedules were enhanced by distributing the training over several days.

The instructions to produce slow saccades caused a 'staircase' pattern of eye movements in which a continuous sequence of hypometric saccades was manifested. These saccades had latencies 400-600 msec longer than normal visually controlled eye movements. Detailed measurements (chapter 4) of the latencies of the saccadic components indicated that each component was programmed independently.

In chapter 5 the Gurevich claim that a saccade velocity depends only on the spatial magnitude of the saccade was tested by measuring saccades of equivalent amplitudes to targets which varied in movement duration and velocity. The accuracy of saccades but not their peak velocities or durations was sensitive to manipulations in the temporal characteristics of the target.

Experiments in chapter 6 showed that the use of spatial signals in the aiming of a saccade can be systematically controlled. When subjects were trained for several days in a visual discrimination task the accuracy of the initial saccadic movement increased over time. The results of these experiments seriously question the Young and Stark (1963b) ballistic model and other formulations (Westheimer, 1954b, 1973; Yarbus, 1967) which assume that the saccadic system operates according to stereotyped mechanisms.

CONTENTS

CHAPTER 1 :A Brief Introduction to the Physiology of the Human Eye and Extraocular Muscle Actions	
1.1 The Eye	1
1.2 Extraocular Muscles	4
1.3 Peripheral Mechanisms in the Control of Eye Movements	7
1.4 The Innervation of Motorneurons	14
1.5 An Empirical Model	20
1.6 Conclusions	23
1.7 Saccade Parameters	25
1.7.1 Saccade Latency.	25
1.7.2 Saccade Duration	28
1.7.3 Saccade Peak Velocity	30
1.8 Efferent and Afferent Information on Eye Position	34
1.9 Motor Programming	47
1.10 Continuous Feedback Control of Saccades.	51
1.11 Plasticity of Saccades	54
1.12 Conclusions.	59
CHAPTER 2 : METHODS	
2.1 Methods:Eye Movement Recording	61
2.1.1 The Problem of Head Movements	61
2.1.2 Direct Visual Observation	63
2.1.3 After Image Methods.	64
2.1.4 Mechanical Methods	66
2.1.5 Reflected Beams Using Mirrors	67
2.1.6 Corneal Reflection Methods	68
2.1.7 Photo-Camera Methods	69
2.1.8 Electro-oculography.	70
2.1.9 Electromagnetic Recording	72
2.1.10 Photoelectric Methods	73
2.2 Methods and Apparatus of the Experiments.	74
2.2.1 The Computer	74
2.2.2 The Calibrations	77
2.2.3 The Eye Movement Recording Unit.	78
2.2.4 Data Processing.	83
CHAPTER 3:The Modification of Saccadic Trajectories	
3.1.1 Introduction	88
3.1.2 Overview of the Experiments.	93
3.2 Experiment 3.1	96
3.2.1 Method	96
3.2.2 Procedure	96
3.2.3 Analyses and Results	99
3.2.4 Summary.	110
3.2.5 Discussion	112
3.3 Experiment 3.2	116
3.3.1 Introduction	116
3.3.2 Method and Procedure	117
3.3.3 Results.	120

3.3.4 Summary.	128
3.4 Experiment 3.3	129
3.4.1 Introduction	129
3.4.2 Method and Procedure	129
3.4.3 Results.	130
3.4.4 Summary.	135
3.5 Experiment 3.4	136
3.5.1 Introduction	136
3.5.2 Method and Procedure	137
3.5.3 Results.	139
3.5.4 Discussion	142
3.6 General Discussion	144
3.6.1 The role of feedback	145
3.7 Conclusions	149
CHAPTER 4: Multiple Saccades and Saccade Latencies: Consequences of the BF-slow task	
4.1 Introduction.	152
4.1.2 Multiple Saccade Analysis	155
4.2 Experiment 4.1	163
4.2.1 Introduction	163
4.2.2 Method and Procedure	164
4.2.3 Results.	167
4.2.4 Discussion	172
4.3 Experiment 4.2	175
4.3.1 Introduction	175
4.3.2 Method and Procedure	175
4.3.3 Results.	176
4.4 Discussion	179
4.5 Summary	179
CHAPTER 5: The Effect of Temporal Parameters of the Stimulus Movement on the Saccade Trajectory	
5.1 Introduction.	181
5.2 Experiment 5.1	190
5.2.1 Method and Procedure	190
5.2.2 Results.	192
5.2.3 Discussion	199
5.3 Experiment 5.2	202
5.3.1 Method and Procedure	202
5.3.2 Results.	204
5.3.3 Discussion	211
5.4 Experiment 5.3	212
5.4.1 Introduction	212
5.4.2 Method and Procedure	213
5.4.3 Results.	215
5.4.4 Discussion	221
5.5 Experiment 5.4	224
5.5.1 Introduction	224
5.5.2 Method and Procedure	224
5.5.3 Results.	225

5.5.4 Discussion	229
5.6 Summary	232
CHAPTER 6: The Modification of Saccadic Amplitudes	
6.1.1 Introduction to the Control of Saccade Amplitudes	234
6.1.2 Pulse-Step Movements	236
6.1.3 Modification of Saccade 'Gains'.	241
6.1.4 The Hallet Amplitude Recalibration Experiments.	243
6.2 Introduction to the Experiments.	245
6.3 The Pilot Study	246
6.3.1 Method and Procedure	247
6.3.2 Results.	250
6.3.3 Discussion	252
6.4 Experiment 6.1	254
6.4.1 Method and Procedure	254
6.4.2 Results.	254
6.4.3 Discussion	259
6.4.4 Summary.	260
6.5 Experiment 6.2	261
6.5.1 Introduction	261
6.5.2 Method and Procedure	263
6.5.3 Results.	266
6.5.4 Discussion	269
6.6 Conclusion	271
CHAPTER 7: General Conclusions	
7.1 Review	273
7.2 Clinical Implications	289
Appendix A	294
Appendix B	300
References	303

STATEMENT OF COPYRIGHT

The copyright of this thesis rests with the author. No quotation from it should be published without his prior written consent and information derived from it should be acknowledged.

DECLARATION

I declare that the work in this thesis is my own and has not been submitted for any other degree. Part of the work reported in chapter 3 has been published (Crawford, 1984).

ACKNOWLEDGEMENTS

I would like to thank first my supervisor, Dr. John Findlay whose advice and encouragement was invaluable throughout this research.

I am grateful to Professor Michael Morgan and Professor Patrick Rabbitt for the kind provision of the research facilities in the vision and eye movement laboratory.

I would like to express my gratitude to Malcolm Rollings, Neil Corr, Arthur Perry and Ray Cookson for allowing me to draw upon their technical expertise in the design and construction of the apparatus. I thank Cathy Thompson for her considerable computing assistance. I also thank Dr. L. Harris and Sue Chivers for their helpful comments on earlier drafts.

I am deeply grateful to the following subjects: Pam Butterworth, Sue Chivers, Jocelyn Core, Ala Hola, Rosemary Ince, Amanda Innocent, Pete Hepper, Neil Morris, Martin Spencer, Georgia Testa and Chris Todd.

I acknowledge the support of the S.E.R.C.

CHAPTER 1

A Brief Introduction to the Physiology of the Human Eye and Extraocular Muscle Actions

1.1 The Eye

Each eyeball is suspended in its orbital socket by a complex matrix of check ligaments and extraocular muscle attachments. The check ligaments as their name implies, help to prevent instability or slackness during periods of fixation. Three pairs of muscles for each eye allow eye movements to be executed with horizontal, vertical and torsional components (see Fig. 1.1). Viewing from the front the outer coat of the eye, the sclera, is the white part of the eye surrounding the iris and the transparent, protruding cornea. The cornea is the first image forming surface of the eye and is responsible for 70% of the total refractive power of the eye (Moses, 1975). A watery substance called the aqueous humor, one of whose functions is to supply nutrients to the lens and cornea, fills the space between the cornea and the lens of the eye. The greater part of the inside of the eye, filling the cavity between the lens and the retina at the back of the eye contains a fluid called the vitreous humor (fig. 1.2). In front of the lens is the iris, which is a collection of muscles controlling the diameter of the eye's aperture, the pupil. At the rear of the eye the optic nerve spreads



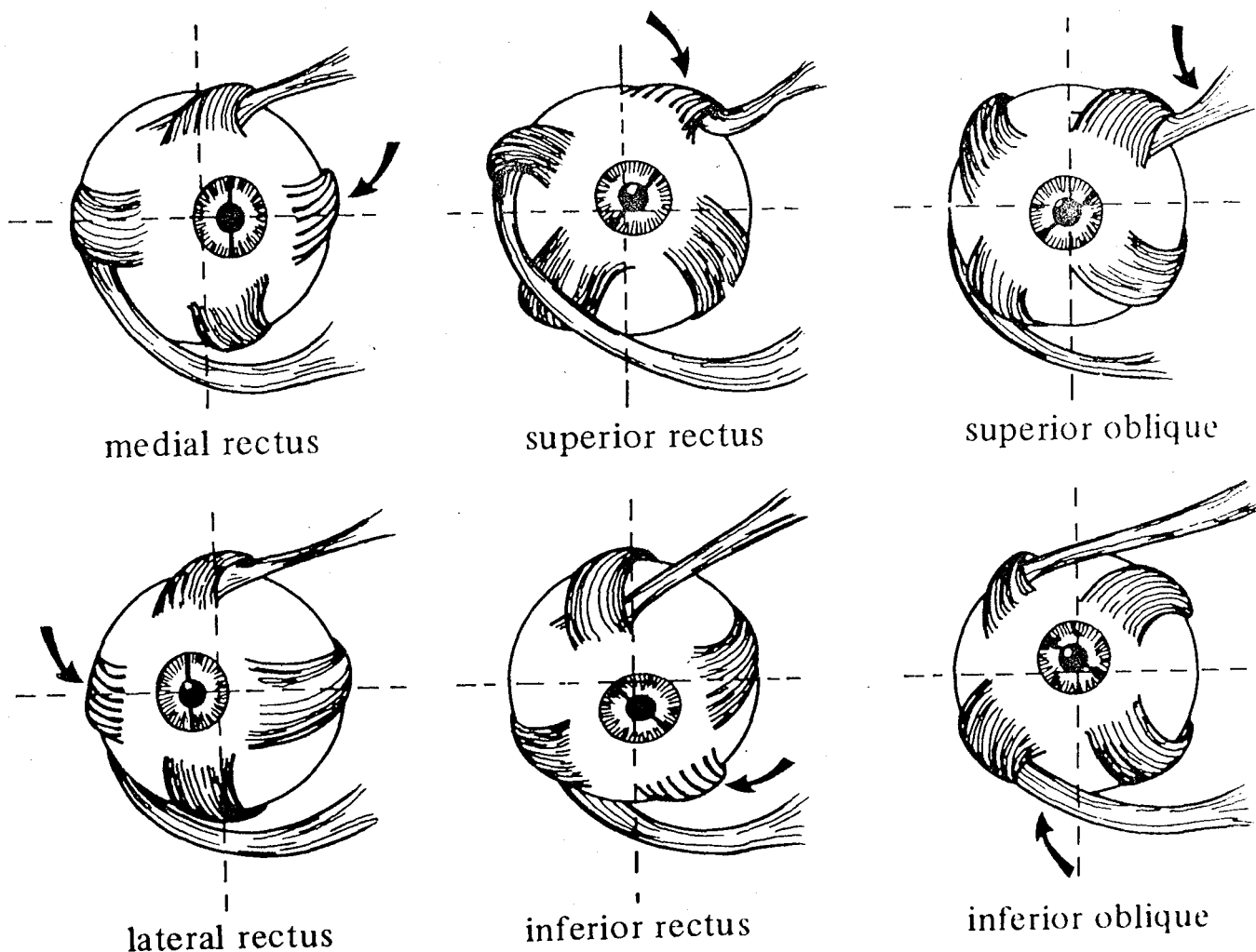

Fig. 1.1. Primary and secondary motor actions of extraocular muscles, (after Carpenter, 1977). Medial and lateral rectus muscles exert forces largely in the horizontal plane. Superior and inferior rectus, superior and inferior oblique muscles produce rotations which have both horizontal and vertical components. Note also the torsional effect of these muscles.

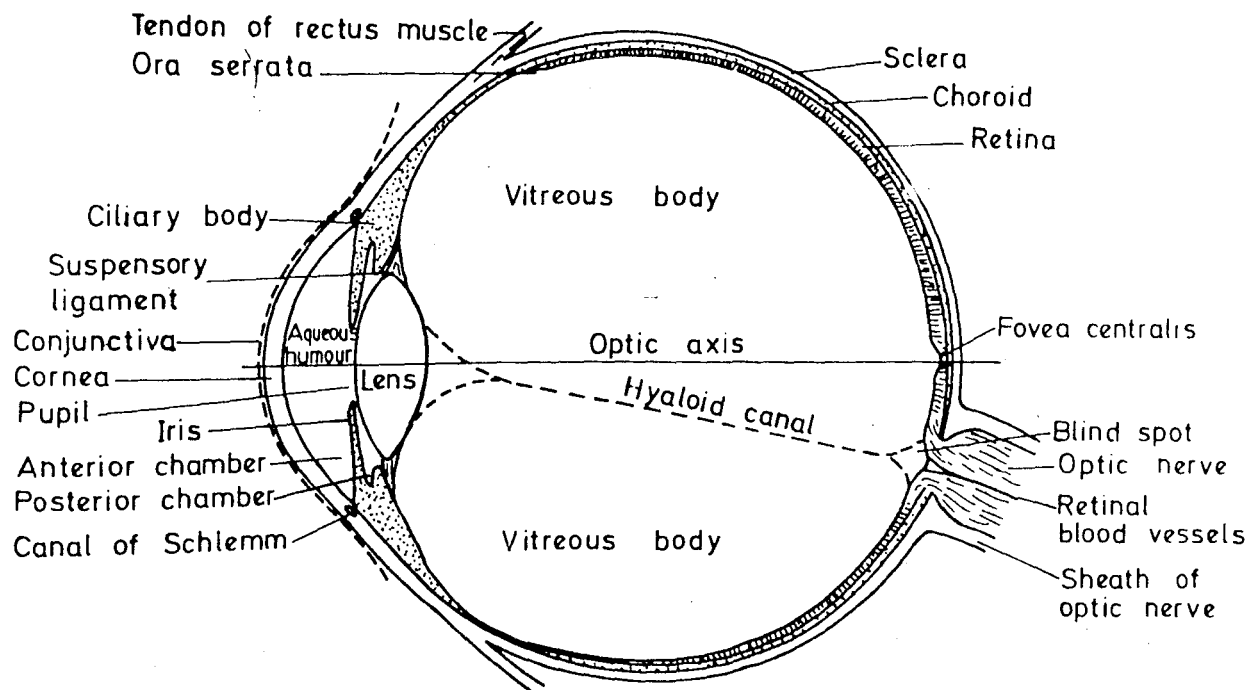

Fig. 1.2. Anatomy of the human eye, (after Laycock, 1978).

over the interior surface of the retina. The nerve fibres penetrate the surface of the retina to make connections with the photosensitive receptors of rods and cones. It is a curious phenomenon that light entering the eye must traverse the retina (including blood vessels) to reach the rods and cones. The cones are most densely distributed around the immediate foveal region. They function maximally in daylight (photopic) conditions, and are sensitive to colour. The cones provide a greater visual resolution than that of rods, which are particularly important in scotopic visual conditions. The region where the optic nerve enters the eye has no photoreceptors and is therefore insensitive to visual stimulation and is appropriately termed the blind spot. The fovea is approximately 0.3 mm in diameter (Osterberg, 1935), corresponding to a visual angle of about 1 deg. and is the region of highest visual acuity.

1.2 Extraocular Muscles

The eye's orientation in the orbit is determined by the six extraocular muscles. The muscles are arranged in three pairs, with one muscle in each pair acting as an agonist (contracting) or an antagonist ('relaxing') for any direction of conjugate eye movements, (for disconjugate movements when the two eyes move in opposite directions the relationship of agonist / antagonist muscle actions will be modified e.g for horizontal convergence the medial recti of both eyes will simultaneously

contract). Each connection is made to the sheath-like Capsule of Tenon, enveloping the eyeball. This capsule is firmly attached to the eyeball and therefore moves in unison with movements of the eye. Five of the muscles, the superior, inferior, medial and lateral recti and superior oblique, originate at the apex of the cone of the orbit. The superior oblique, however, passes through a pulley whose mechanical leverage is arranged such that the primary muscle action causes a torsional rotation (see fig. 1.1 top right). The inferior oblique is fastened to the forward end of the orbit while the other end is attached to the capsule. The lines of action of each muscle are such that the muscles have subsidiary or secondary actions as well as primary actions (Carpenter, 1977). However, the lateral and medial recti are primarily responsible for the horizontal eye movements when the eye is in the primary position (0 degs. visual angle). These rotations have been the most widely studied of eye movements.

The fact that each muscle is attached directly at the circumference of the eyeball means that their action has a mechanical advantage greater than that found in most other muscles. Thus although the eye movement energy requirements are minute compared to the demands of other body movements (for example the energy required to read a normal sized hardback of about 350 pages is roughly equivalent to the task of lifting a pint of beer to the mouth (Carpenter, 1977 pl47) the maximum muscle force is

calculated to be 100 times greater than that required to initiate a saccadic movement). Therefore only a proportion of the individual fibres need contract at one time; this reduces the likelihood of muscle fatigue.

The extraocular muscles have a number of different types of fibres which vary along several dimensions. These include their diameters, their extent of myelination, distribution within a fibre bundle and their neural innervation ratios in a motor unit. Within this spectrum Hess and Pilar (1963; see Moses, 1975) identified two categories of motor fibres with two distinct forms of contractile activity. These were twitch or fast contractions and tonic or slow activity. This suggested a possible neuromuscular basis for the fact that eye movements can be controlled from very slow velocities (less than 5 degs / sec) to the extremely rapid saccadic rates of 1000 degs / sec seen in primates (see 1.7.3). However, this distinction between twitch and tonic fibres does not cover the entire range of muscles fibres found in mammalian eye muscles. Four different classes of fibres that have twitch characteristics have been identified by Alvarodo and Van Horn (1975). These fibres differ in their size and position in the muscle as well as in terms of their mitochondrial and enzymatic content. The complexity of eye muscle actions is further increased by the dimensions of the individual muscles and their angles of insertion in the muscle.

question of how the eye was brought to rest at the end of a saccade. According to one account of a ballistic movement (see Alpern, 1962), these movements are characteristically stopped by the activation of antagonist muscles towards the end of the eye movement. Bjork (1955) reported that a mechanism of this kind was observed in his studies. However, other workers failed to find any evidence of such a braking mechanism (Miller, 1958; Tamler et al., 1959; Westheimer, 1954a). There is strong evidence that a saccade is in fact not terminated by an active braking mechanism but by the 'programming' of the exact muscular forces for a given eye movement amplitude (see below).

In 1954 Westheimer published some results and a theory derived from his studies of saccadic eye movements, whose dynamic parameters were obtained from records using an eye movement photo-camera recording device. Subjects (Ss) were asked in this study to make a single saccade between two sequentially illuminated targets. The visual angle for a saccade was varied between 2 and 30 degs. The individual records showed that saccades contained a rapid acceleration to a fast velocity for most of the saccade trajectory (fig. 1.3). It was also noted that when the eye arrived at the target there was some damped oscillation around this new baseline. Westheimer therefore calculated that the muscular mechanism in saccadic movements was equivalent to a system applying a step input force to an underdamped amplifier allowing a

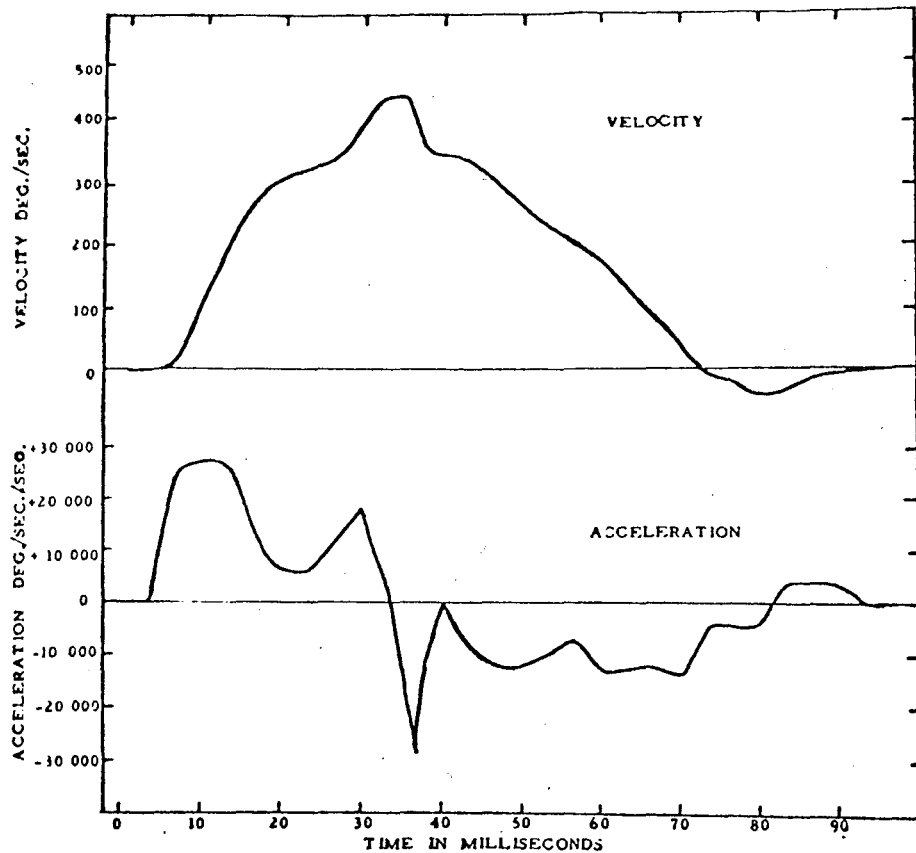

Fig. 1.3. Saccadic velocity and acceleration profiles across time as reported by Westheimer (1954). The saccade velocity rises to a peak of over 400 degs/sec and then gradually decelerates until the eye comes to rest. The negative velocity at the end of the movement represents dynamic overshoot.

resonance frequency of about 19 Hz. However, no direct recordings were obtained from the muscle activation itself and the oscillations mentioned by Westheimer were not clearly evident in the records he presented. The eye patterns can be better termed 'dynamic' overshoot.

Robinson's work 10 years later provided a good test of Westheimer's claims by investigating the nature of dynamic and isometric tensions associated with saccadic movements and different angles of fixation against the viscous and elastic forces of the orbital mechanics. Robinson's method used a suction contact lens, firmly attached to the eye, in a device which allowed given weights to be applied to the eye. The system was used to calibrate the required force (in grams) necessary to pull the eye through a wide range of angles of rotation. The results of this work revealed a number of important mechanical properties of the oculomotor plant.

Data obtained from isometric conditions, in which one eye was physically restrained while the other eye was allowed to move freely, demonstrated that as previously suspected, during a saccade the agonist muscle rises to a peak tension and then decays to a new resting muscle tension. This decay to the new tension had a time constant of about 250 msec. The resting tension was positively related to the final position of the eye in the orbit (cf Collins, 1971). The long time constant would suggest that the consequences of any extraocular innervation might be

influenced by its temporal onset relative to a previous innervation. Thus closely spaced saccades in time might be confounded with previous innervation making it difficult to gauge the correct force for a given saccade amplitude. This may partly explain why saccades are normally separated by intervals of approximately 200-250 msec. Collins (1975) showed that overshoot in the agonist activity was predominantly due to the large, fast conducting central fibres. The smaller fibres produced little overshoot during a saccade.

Robinson also observed that the peak force developed during a saccade and its duration increased with the amplitude of the movement, although the increase was not proportional to the increase in amplitude. The duration of the force therefore increases with the amplitude to compensate for this absence of proportionality. Contrary to Westheimer's (1954a) claim a step input produced a sluggish eye movement quite different from the fast saccadic actions. This result was clearly what would be expected from an overdamped rather than an underdamped system as originally proposed by Westheimer.

Experiments in which a detached cat lateral rectus was stimulated at different frequencies showed that muscle tension increased with frequency from 25 to 150 Hz (see also Collins, 1971). But for any given stimulation there was a normal muscle length-tension curve as found in previous classic studies of muscle activity (e.g Hill,

1938).

Further characteristics of the system were studied by Collins (1971) who separated out the viscoelastic forces of the globe, and passive and contractile elements of cat extraocular muscle. Although there were differences in the slopes and intercepts for each element, in general, it was found that there was a linear relationship between the viscoelastic forces and the level of muscle tension for the globe and passive elements. The viscosity of extraocular muscle during contraction was measured in one experiment by using the values for tensions developed by pulling the muscle at various velocities while stimulating the muscle at different frequencies. For any level of muscle innervation it was shown that when the rate of muscle change was in the range of saccadic velocities (e.g 90 - 600 degs / sec) the viscous forces of the globe and contractile components declined gradually as the velocity increased (the function was flat in the pursuit velocity range, fig. 1.4). This result showed that even if Robinson (1964) was correct in arguing that the excess force (i.e peak force minus steady state level) does not increase with a saccade amplitude, the saccade velocity would still be expected to increase with the saccade amplitude, as is known to be the case (see 1.7.3).

Collins' (1975) results support Robinson's finding that the eye is accelerated by an overshoot of muscle tension. This peak tension in the agonist occurs in phase with the

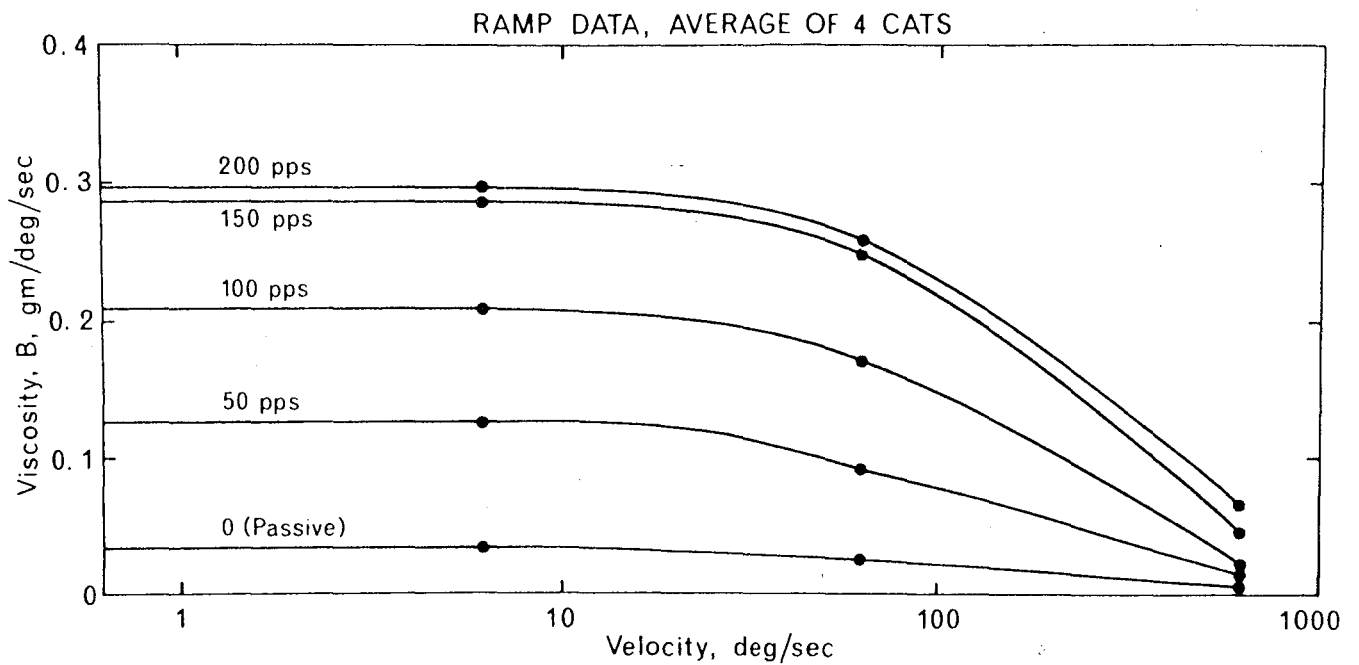

Fig. 1.4. Velocity / viscosity relationships in the medial rectus of the cat. Muscle viscosity was estimated from the length-tension characteristics as the muscle was pulled at different velocities. This was repeated over a series of external innervations (after Collins, 1971).

peak velocity of a saccade. The peak tension then falls to a new resting level. Interestingly at the same time, the stretching of the antagonist muscle causes a similar though reduced pattern of activity, even though there is no active innervation. The transient excess force of the agonist is therefore necessary to overcome the build up of the viscous forces of the globe and passive elements. When the excess force is withdrawn the eye gradually slows towards zero velocity and is then held in position at the new steady state.

1.4 The Innervation of Motorneurons

The research on mechanisms of extraocular muscle actions in the control of saccades showed that the neural input to saccades must satisfy at least three basic requirements:

1. The neural parameter(s) controlling the muscle force should vary with the amplitude of the saccade.

2. Two components of the neural input will be necessary. One providing the initial burst of force to accelerate the eye and a second component to provide the new baseline force to hold the eye at the new location.

3. There must also clearly be some mechanism for terminating the input to the agonist muscles.

Over the last two decades, with improved methods of single unit micro-electrode recording methods, neurophysiologists have located a number of cells or nuclei within the brain

stem region, particularly in the pontine paramedian reticular formation (PPRF), the IIIrd nucleus and the abducens. These seem to function as final outposts discharge stations to the oculomotor neurons. By precisely quantifying the patterns of neural firing while at the same time taking accurate measurements of the eye movement dynamics it has been possible to develop a generally agreed and testable model of the key components of this network.

Robinson (1970) reported the results of recordings taken from the IIIrd nucleus. Consistent with the findings on the development of muscle tension during a saccade units released a high frequency burst during the saccadic movement followed by a drop to a new steady firing rate when the saccade was completed. This seemed to confirm that the neural input to saccades was in effect a pulse-step of activation. For an eye movement which carried the eye in the opposite direction to that produced by the pulse-step response (the off-direction) a complete inhibition of activity occurred (fig. 1.5). The discharge frequency increased linearly as the position of the eye moved further into the field of action and decreased gradually for movements in the opposite direction. In addition a positive relationship was also observed between unit firing rates and the velocity of the eye.

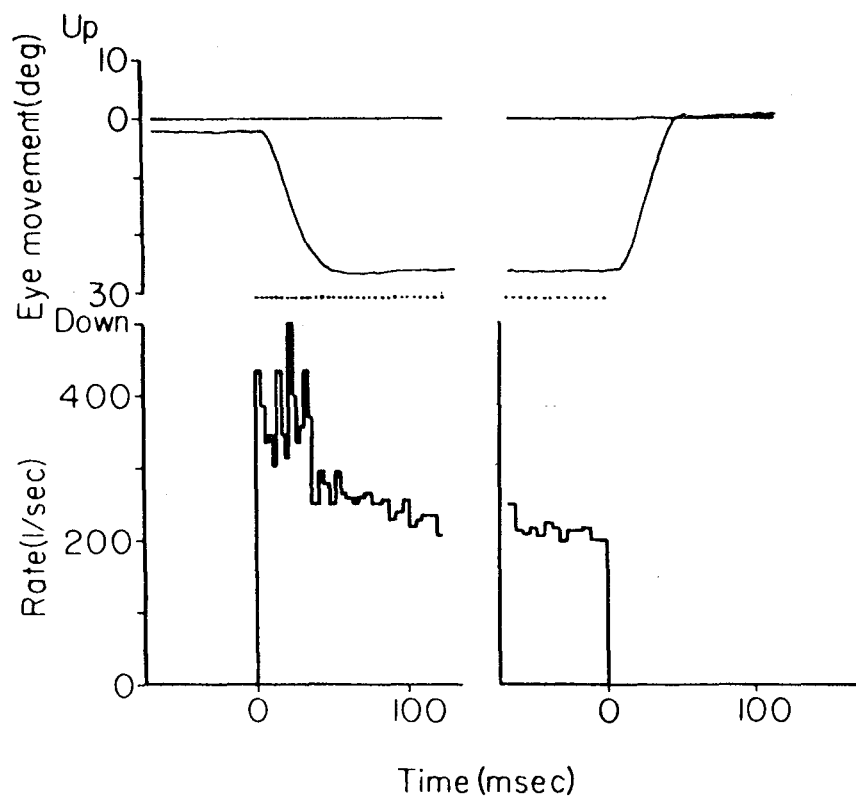

Fig. 1.5. The pulse-step firing pattern of an oculomotor unit during and following a saccade. The upper traces show the position of the eye in space, the lower graphs show the corresponding motor firing levels. The first response pattern is a record of motor unit firing as the saccade moves into the unit's field of action (on-saccade); the second record is that of an opposite saccade (after Robinson, 1975).

These two effects were restated in a simple differential equation:

$$R = k\theta + r d\theta/dt \quad (1)$$

R = discharge frequency

r & k = constants

θ = eye position

$d\theta/dt$ = saccadic velocity

The two factors on the right hand side of the equation were equivalent to the pulse and step components observed in the discharge of the oculomotor units and also reflected in the tension developed in the extraocular muscle. However, to get from the pulse signal to a step of the same neural origin an integration is necessary. Robinson therefore argued that some form of neural integration process must also be involved in the generation of saccadic eye movements.

Schiller (1970) obtained results that were consistent with Robinsons' data. In addition he found no correlation between the frequency of an oculomotor cell firing and the amplitude of the saccade ($r = 0.06$). The correlation of unit firing rate and saccade velocity was 0.38 ($p < 0.005$). The failure to find a higher correlation here may have been related to the problem of firing saturation at saccade amplitudes above 20 degs. The duration of the burst was linearly related to saccade amplitude. Fuchs and Luschei (1970) again recording in the abducens also

found that units responded to saccades with a pulse-step discharge. However, they found that, unlike Robinson's cells in the IIIrd nucleus abducens units do not fire towards the end of saccades for saccades in the off-direction, thus ruling out the possibility that these units may play a role in any braking mechanism.

Luschei and Fuchs (1972) distinguished between units in the abducens which differed in the form and timing of the activations relative to the onset of the saccade. The following describes four of the unit firing categories they identified:

- 1) Medium lead burst (MLB) units were described as units which released a pulse of activity whose frequency was related to the saccadic velocity. These units fired approximately 8-9 msec before a saccade and the burst duration was equal to the duration of the saccade.

- 2) Long lead burst (LLB) units had similar firing characteristics to MLB units, however they tended to have lower correlations with the parameters of the saccade. Increased activity in these units could be detected in some cases as early as 80 msec before a saccade.

- 3) Tonic units did not show the intense firing characteristics of burst units during a saccade but developed an increased discharge related to the position of the eye at the end of a saccade.

4) Pause (P) units: A number of units were identified which ceased firing shortly before and during a saccade, although during fixation and smooth pursuit they discharged at high frequencies. Some units paused for ipsilateral or contralateral movements only while other units paused for all saccades. The duration of the pause equalled the duration of the saccade. However the authors were unable to offer any proposals as to the functional significance of these curious units. Robinson (1970) had also observed a similar unit in his sample but on the grounds that it did not appear to be a motor unit discarded it from his results ! More recent research has shown that these units in fact play a critical role in the regulation of saccadic eye movements.

Keller (1974) showed that micro-stimulation of P units inhibited spontaneous saccades, although smooth eye movements were unaffected. In further studies Keller (1977) demonstrated that micro-stimulation of approximately 30 msec duration during a saccade would cause the eye to stop in mid-flight, the duration of the saccadic pause was dependent on the stimulus duration. When the micro pulse was switched off the eye continued the saccade from its present position to the target position in one single movement. This seemed to suggest that saccades are controlled by a continuous input to the motoneurons. The signal to terminate a saccade was determined not by a predefined pulse duration but by the cancellation of the error between the current eye position

and the goal position.

1.5 An Empirical Model

Following Luschei and Fuchs (1972) it has been suggested that the MLB units provide the direct input which governs the high frequency burst activity carried by oculomotor neurons for a saccade. This hypothesis is based on the relative time of onset of burst unit firing and the high correlation of their firing durations with duration of a saccade. The consistent relationship between saccadic velocity and burst frequency also argues in favour of direct connections to the motor neurons. Keller (1974) first raised the possibility that P units may serve an important function by inhibiting MLB units during fixation which is somehow also inhibited during a saccade. These and other concepts were brought together in a more comprehensive statement on the nature of this system by Robinson (1975), [only some aspects of the model will be described at this stage, further features will be discussed in subsequent sections as they become relevant].

The Bang-Bang Model

The model (see fig. 1.6) proposes that motor neurons are continuously controlled by MLB neurons during a saccadic eye movement. As suggested by Keller (1974), it is argued that the activity of MLB units are under total inhibition

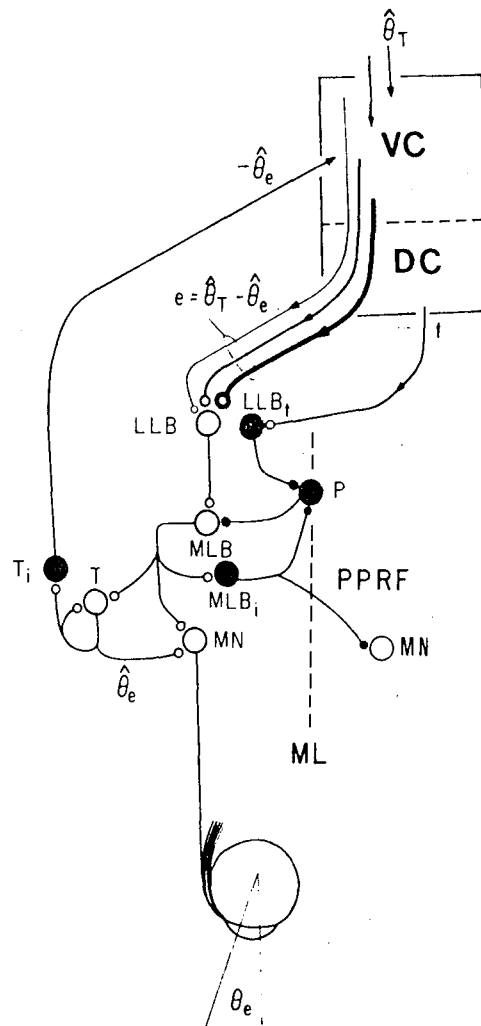

Fig. 1.6 Schematic representation of the neural organization of the saccadic eye movement system. See text for a discussion of the hypothesized operation of this model. Symbols: θ_e , eye position; ML, brain stem midline; MN, motoneuron; $\hat{\theta}_e$, internal copy of eye position; T, tonic-eye position neuron; T_i , inhibitory tonic neuron; MLB, medium-lead burst neuron; MLB_i , inhibitory medium-lead burst neuron; PPRF, paramedian pontine reticular formation; P, pause neuron; LLB, long-lead burst neuron; LLB_t , long-lead trigger neuron; $\hat{\theta}_T$, target position in orbital coordinates; VC, a visuomotor center; DC, associated saccadic decision center; t, saccadic trigger signal; e, motor error signal, i.e., the present difference between where the target is located and where the eye is located. (after Keller, 1974)

from P units during fixation and all eye movements which are not saccadic. When a saccade is signalled a brief pulse of inhibition is sent to the P units, this releases the MLB units to produce the high frequency discharge. When active the MLB neurons simultaneously inhibit P units through an inhibitory interneuron. Having obtained the necessary pulse to generate the saccade this can then be integrated to provide the step force component to hold the extraocular muscles at the new eye position. This integrated signal in fact serves two purposes. Firstly, it provides the control signal for the tonic units which discharge according to eye position. In addition a copy of the current eye position can be derived from this information and then used in a negative feedback circuit to evaluate the remaining target position error. When the eye position equals the target position the pulse generator is switched off.

The entire process is initiated by the crucial inhibitory signal to the P units. It has therefore been particularly disappointing that this signal has not been clearly identified (Fuchs, 1977). Keller (1981) has suggested that such a signal could be passed on from the LLB units (cf Henn and Cohen, 1976). LLB units (but not MLB) apparently receive monosynaptic inputs from the superior colliculus and some areas of the visual cortex.

The model is particularly weak in accounting for the control of antagonist activity during a saccade. The

implicit assumption appears to be that inhibitor MLB units may also connect to the antagonist muscle in addition to the ipsilateral connections to the P units (Keller, 1981).

1.6 Conclusions

Human saccadic eye movements are an important means by which the brain gathers visual information. The saccadic mechanism allows the eye to be moved very rapidly from one visual location to another, thus the fovea can register visual detail over a wide field. The high speed of these movements allows the the visual system to allocate proportionally more time to the processing carried out during periods of fixation. In trying to understand the saccadic control system it is important to take into consideration the mechanism for generating the dynamic and static forces in the extraocular muscles. Neurophysiological research over recent years has made it possible to determine with some precision the fundamental characteristics of the transfer functions relating the neurological discharge frequencies to the development of muscle tensions leading to a saccade. This research has shown that the firing patterns of the brain stem motor units are elegantly matched to the requirements imposed by the mechanical features of the oculomotor plant.

One exciting consequence of this work is that it is now possible to make inferences based on psychophysical

measurements (using non-invasive techniques) on the neurological state of the channels underlying the generation of a saccade.

1.7 Saccade Parameters

1.7.1 Saccade Latency

In a simple saccadic eye movement task a visual target is presented on a screen at a peripheral position to which a S has to make an accurate eye movement. The latency of the saccade is measured from the appearance of the peripheral target to the onset of the eye movement response. Two important kinds of processing take place during this delay interval. One stage involves the transfer of information from the retina to the visual cortex and the subsequent analysis of the visual information for use in the planning of an eye movement. At a second level the visual information is interpreted and used to stimulate a sequence of motor impulses in the brain stem area for the appropriate eye movement response. The study of saccade latencies therefore has potential value in reflecting the consequences of visual and motor processes in the preparation of the saccade.

The usual latency reported for a visually elicited saccadic movement was found to lie within the range 120-180 msec (Ginsborg, 1953; Westheimer 1954(a)) although values of up to 250 msec were reported by Johnson and Fleming (1963) and White, Eason and Bartlett (1962). Using monocular presentation Volkman and Volkman (1971) further reported slightly longer latencies for saccades in a nasal direction, than in a temporal direction. This result suggests that the ocular plant dynamics

may partially determine latencies, (although others e.g. Hyde (1959) have claimed that there is no latency difference between nasal and temporal saccades). Thus there are conflicting opinions on this issue. In the view of the author there is at present no convincing evidence that nasal and temporal saccades produce consistent or significant differences in saccade latencies.

Hackman (1940) reported that knowledge of the stimulus location was a major factor in determining latency, however, his results are difficult to interpret because of the combined effects of the visual stimulus and a paired auditory cue. More recent work (Michard et al., 1974; Posner, 1978) demonstrated that when the target position was known in advance this produced shorter saccade reaction times by 10-20 msec. On the other hand Saslow's (1967) results and Heywood and Churcher's (1981) experiment showed that the number of possible stimulus locations (1,4,8 or 16) had no effect on the saccade latency. The question of whether prior information about a subsequent target position has a facilitatory effect on saccade latencies is still unresolved.

Saccade latencies have also been found to vary as a function of the temporal and directional uncertainty of the target. Saccades to a regular, repetitive square wave input were very short and in some instances actually anticipated the target movement (Young and Stark, 1963b; Findlay, 1981; Michard, Tetard and Levy-Schoen, 1974; Cohen and Ross, 1977). Monkeys apparently do not make such predictive saccades (Fuchs 1967b).

Beyond 20 degs. target eccentricity, the saccade reaction time has been generally found to increase with the visual angle of the target (for a review see Findlay, 1982). For smaller target eccentricities the saccade reaction time is relatively independent of the amplitude of the movement both in man (Johnson and Fleming, 1963) and monkeys (Fuchs 1967a).

Lengthened reaction times have been observed in special visual conditions, such as when the target is dim (Cohen and Ross, 1977). However, when the target intensity was systematically varied increases in reaction times were only found at the extremely low intensity range (Wheless, Cohen and Boynton, 1967). This suggests that lengthened latencies may result from increased uncertainty of the S in the discrimination of the target rather than as a consequence of the luminance of the target per se.

Saccade latencies have been investigated in more complex visual search tasks. Gould (1973) investigated fixation durations in a task where Ss scanned a set of characters; the task was to respond to the detection of a target character if it was a member of a previously familiarized character set. The saccade latencies were found to be an approximately linear function of the size of the character set. Levy-Schoen (1981) has also shown that a current fixation duration is reduced when a S performs peripheral processing at the previous fixation location. Therefore in visual scanning tasks the delay between fixations is influenced by the memory load as well as the availability of useful peripheral information.

Summary and Conclusions

The timing of a saccade has been widely used as an index to the role of temporal and spatial factors in the control of saccadic eye movements. Apparently visual factors, such as the brightness and eccentricity of a visual target, only have an effect when extreme values are used. Non-visual factors such as the temporal uncertainty of the target movement have a clearer effect on saccade latencies. Saccade latencies are also shorter to an auditory stimulus than a visual stimulus (Zahn et al., 1978).

1.7.2 Saccade Duration

It has been shown that the duration of a saccade is dependent upon the amplitude of the movement (Robinson, 1964; Yarbus, 1967) and can be approximated by the equation:

$$T = 21 + 2.29a \text{ msecs (2)}$$

(Robinson, 1964)

where :

T = Saccade duration

a = Saccade amplitude in degs.

Yarbus (1967) reported that this duration was determined only by the amplitude of the movement and not by the point of ocular rotation from which the saccade is initiated.

However, there is evidence that saccade durations for nasally directed saccades are about 5 msec longer than temporal saccades (Fuchs, 1967b).

Saccade durations are affected not only by differences in saccade magnitude and direction but are also influenced by alcohol consumption (Wilkinson et al, 1974); intravenous injection of valium (Aschoff, 1968); sleep (Fuchs and Ron, 1968); diurnal states (Kris, 1960); disorders of the central nervous system (Zee and Robinson, 1979) and fatigue (Becker and Fuchs, 1969) but Fuchs and Binder (1983) now seriously question the validity of any effect of muscle fatigue. Becker and Fuchs (1969) found that ambient visual input also has a modifying influence on saccade durations. By depriving Ss of visible fixation targets the duration of a 40 deg. saccade increased by 19 msec. A homogenous visual field resulted in the same eye movement as occurred in the dark, suggesting that the visual input to the saccadic system can influence a dynamic component in the saccade (but see Gurevich, 1959). However, this effect was only demonstrated with large 40 deg. saccades.

Conclusions

There is some evidence that the duration of a saccade is not a fixed characteristic of a saccade but can be modified by manipulating arousal states with, for example, drugs and alcohol. Jurgens et al. (1981) found that the

high accuracy of a saccade to a visual target was maintained under these conditions. They argued from this finding that the duration of a saccade was the outcome of the operation of 'local' feedback loop controlling the amplitude of the saccade (see section 1.10). This of course means that equation (2) does not hold for all populations of saccades, although it may on average be valid under normal conditions.

1.7.3 Saccade Peak Velocity

Early descriptions of saccadic eye movements developed the idea that these movements were ballistic in nature. The conventional definition of this term implies that once a movement is initiated its trajectory cannot be modified. An earlier use of this term suggested that for a particular motor movement, there is a rapid build up to peak velocity which is maintained throughout the greater part of the trajectory, followed by a deceleration to zero velocity (fig. 1.3, Westheimer, 1954b). Hyde (1959) was able to demonstrate that the saccade was not 'ballistic' in this second sense. Further investigation revealed that for saccades up to 20 degs. the trajectory is a sinusoidal like function (Yarbus, 1967) that approximates the equation:

$$a = b/2(1 - \text{Cos}(3.14/T)t) \quad (3)$$

where :

t = time in seconds

a = angle of eye rotation

T = duration of saccade (secs)

b = amplitude of saccade (degs)

Saccades larger than 20 degs begin to appear less sinusoidal and more assymmetric with a longer deceleration phase. This assymetry becomes marked for saccades of the order of 50-60 degs. (Hyde, 1959 see fig. 1.7).

Investigations of the trajectories of small amplitude saccades shows that the average saccade attains peak velocity approximately mid-way through the movement (Baloh et al., 1975) and this velocity peak occurs later in time as the amplitude increases (Cook and Stark, 1965). There is some discrepancy in the time reported for the eye to accelerate from rest to maximum velocity (Thomas, 1961). Although the level of this maximum velocity is clearly dependent on the amplitude of the movement (Travis, 1936; Ginsborg, 1953; Hyde, 1959; Gurevich, 1961; Cook and Stark, 1965). The maximum angular velocity increases approximately linearly with the saccade amplitude at small amplitudes but shows a tendency to saturate with large amplitudes. A similar relationship has also been demonstrated for micro-saccades (Zuber, Cook and Stark, 1965), the fast phase of vestibular nystagmus (Ron, Robinson and Skavenski, 1972) and secondary saccade

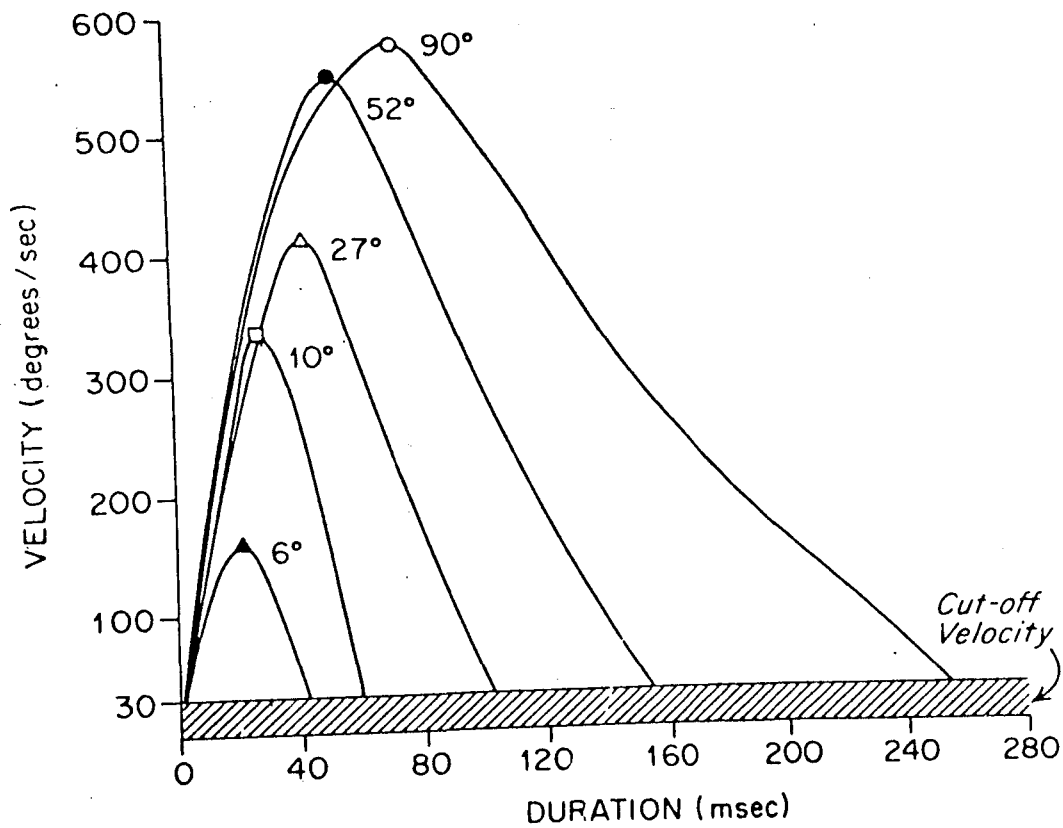

Fig. 1.7 The saccadic trajectory across time at different saccadic amplitudes. Note the increasing assymetry in the acceleration and deceleration regions of a saccade as a function of the saccadic amplitude (Baloh et al., 1975).

components (Gurevich, 1961).

Gurevich's (1961) experiments supported Westheimer's (1954b) results and showed that the average angular velocity for any given amplitude was fairly constant in the horizontal, vertical and diagonal planes irrespective of variations in the start position, direction of movement or whether fixation points were present and contrary to Becker and Fuchs (1969) even when the movement occurred in total darkness.

The finding that the velocities of micro-saccades, voluntary saccades and the quick phase of the vestibular nystagmus all have the same curvilinear relationship with respect to amplitude has led some workers (Zuber, Cook and Stark, 1965; Ron, Robinson and Skavenski, 1972) to propose that all saccadic movements are produced by a common physiological system. Ron et al. (1972) demonstrated that the temporal frequency of micro-saccades during fixation was similar to the rate of larger refixation saccades in normal visual scanning. Cunitz and Steinman (1969) consider all saccades to serve the single purpose of performing controlled visual search.

1.8 Efferent and Afferent Information on Eye Position

Behind the investigations of early workers on eye movements (e.g. Sherrington, 1918; Irvine and Ludvigh, 1936; Gurevich, 1959; 1961; Helmholtz, 1866) was the question of the source of information used in determining the position of the eye.

There is considerable evidence that there are stretch receptors in human extra-ocular muscles (Buzzard (1908); Whitteridge (1960)) and that these receptors and their afferents project to various parts of the brain, in particular the cerebellum (e.g. Fuchs and Kornhuber, 1969). Sherrington argued that information on eye movement activity, based on what he termed the 'muscle sense', was fed to the central nervous system from these stretch receptors located in the extra-ocular muscles. This channel of information could then provide direct and continuous feedback on the eye position to the motor control centers in the brain.

Helmholtz (1866) had argued that our knowledge of eye position comes from 'the effort of will put forth in moving the eye'. Helmholtz supported his theory with two observations on the perception of motion and stability. Firstly, when the eye is passively displaced the target rather than the eye is perceived as moving; secondly, if the eye is restrained during an attempted eye movement the target is seen as displaced in the direction of the

attempted eye movement. It was argued that if proprioceptive information was available it should be used to inform the perceptual system of the veridical motion of the eye in the passive displacement condition, and the fixation of the eye in the stabilized eye condition. However, if knowledge of the eye position was primarily derived from the motor efferent impulses sent to the eye muscles, then the perceived motion of the world during passive movement of the eye could result from the failure of this information to match the retinal movement. Collins (1971) has proposed a model in which oculomotor innervation is linearly related to eye position. Such a model makes it reasonable to suppose that central monitoring of innervation levels would provide reliable information on eye position.

The brain can derive information about the motions of the eye from several sources. Visual feedback from the retina on the discrepancy between the fovea and the visual target conveys information specifying the position of the eye relative to the visual array. This information is not used to control the trajectory of a saccade, as the saccade duration of 30-80 msec does not allow sufficient time for concurrent visual information to be used to modify a motor response. Keele and Posner (1968) have estimated the minimum time to be between 190 to 260 msec for the visual adjustment of manual movements. Becker and Jurgens (1979) showed that for saccade movements the minimum modification time is in the region of 80 msec.

One further problem which rules out this possibility is that the quality of visual information is degraded during saccades due to the retinal blurring of the image and visual masking.

Psychologists have long been aware of the fact that the quality of visual perception during a saccadic eye movement is significantly weakened relative to normal vision. Dodge (1900) showed that the probability of detecting a stimulus decreased substantially during a saccadic eye movement. He explained this result by arguing that as the retinal image during a saccade travels at high velocities, the resulting blurring of the retinal trace could account for the reduced visibility.

This theory has been tested by decreasing the duration of a stimulus presented during a saccade to a level which would eliminate any retinal blurr or smear during a saccade. Volkman (1962) measured visual thresholds to a 20 micro sec flash. He found that the threshold for detection of a flash, superimposed on a steady light fixation field, was raised by 0.5 log units for a moving eye relative to a fixating eye. Further evidence against the idea that simple retinal smearing could account for the reduced visual sensitivity during a saccade came from Latour (1962). In this experiment it was shown that the 'suppression' effect preceeded the saccadic movement by a mean time of 40 msec. Volkman et al. (1968) showed that the effect also continued well after the eye had come

to rest. Thus retinal smear alone cannot account for visual impairment during a saccade.

A different kind of theory was offered by Richards (1969). As the eye consist of different substances, during a saccade these parts will accelerate and decelerate at slightly different rates. The eye is not a solid mass but more like a pot of jelly. These factors mean that during fast eye movements shearing forces will be generated between the retina and the vitreous body. This resultant shear could cause the photoreceptors to be tilted away from the direction of the eye movement causing a decrease in sensitivity to light during a saccade. As Laycock (1978) stated, "The average shift in the Stiles-Crawford effect following a 5 deg eye movement is approximately equal to 0.6 mm which is equivalent to a 2 deg angular tilt on the retina. This plus the fact that up to 15 msec after the movement has been completed the position of the retina may still trail that of the sclera, could account for the suppression observed after a saccadic movement. Furthermore, because the neural effect of a light flash resides in the retina for several tens of milliseconds following the flash, it is possible that a saccade might affect the threshold for a flash delivered prior to the movement."

The theory predicts that the suppression should increase with the velocity of the movement, and therefore its amplitude. Unfortunately, Richards did not test this

prediction. However, Volkman et al. (1968) did and found that saccade size had no effect on the magnitude of suppression. In contrast Latour (1966) and Mitrani et al. (1970) found a positive effect of saccade amplitude on the amount of suppression. Thus the evidence is contradictory. Richards' view is an attractive one and it seems highly likely that eye movement shearing forces will contribute to the reduction in visibility during a saccade. However, at present there is insufficient direct evidence to support the theory.

One type of masking which might account for saccadic suppression is the so-called shift effect. The shift effect refers to the phenomenon where pattern movements in the periphery reduces the visual sensitivity in the central visual field. A typical display is one in which a grating of low (0.2 to 0.3 c/deg) is projected over a wide (30 - 40 degs rectangular) visual angle. The central circular area (about 20 degs diameter) of the grating is occluded and adjusted to a mean luminance equal to the space average luminance of the surrounding grating. The threshold for visibility of a central spot of light is then measured on trials on which the grating moves 1/2 a cycle simultaneously with the light stimulus flash; this is then compared to the visibility of the light with no movement. With the grating movement visual thresholds are increased by 0.2 to 0.4 log units (Breitmeyer et al., 1980).

Brooks and Impelman (1981) compared the loss in visual sensitivity in the following two tasks: in one task there was a surrounding grating movement with the eye stationary and in a second task saccades were generated across the grating display. The magnitude and time course of the change in visual thresholds was almost identical in these two tasks. This finding suggests that the reduction in sensitivity during a saccade may be due to the masking effect induced by luminance and contour shifts across the retina. Further evidence in support of this view comes from the findings that both the shift effect (Derrington, 1984) and saccadic suppression (Burr et al., 1982) are selective for targets of low spatial frequency. Nonetheless, there is strong evidence that in addition to the visual masking there is a specific eye movement component to the visual suppression (Riggs et al., 1974).

Given the problems in accessing visual feedback on eye position other channels of information will also be required. A further source of information comes from the record the brain has about its own output programs. This concept was re-introduced by Von Holst (1954) and has been variously described as 'outflow', 'efference copy' and 'corollary discharge'.

A further possible source is that of proprioceptive information. Evidence against a functional role of eye proprioception was provided by the work of Brindley and Merton (1960) and Irvine and Ludvigh (1936) which showed

that the stimulation of stretch receptors in human extra-ocular muscle failed to produce conscious sensations of eye position changes ('inflow'). However, Skavenski and Steinman (1970), Skavenski (1972), presented evidence suggesting that proprioceptive inflow also acts as an additional source of eye position information during passive eye displacements. They criticised Brindley and Merton (1960) and Irvine and Ludvigh's (1936) techniques arguing that proprioceptive information could be masked by the painful and arduous techniques employed and the interfering sensations on the eyelid in restraining the eye.

In a series of experiments Skavenski attempted to demonstrate the functional role of extra-retinal information in the control of eye movements (Skavenski, 1972). Extraretinal signals can be described as position information that does not arise from the relative location of a target image on the retina, which may include 'inflow' or 'outflow' information. In the first experiment each trial began with a 10 sec period of fixation on a visible target in either the primary or 10 deg. arc to the left or right of the central position. The target was then switched off and the S attempted to maintain fixation on the defined position for 38 secs in total darkness. The mean fixation error for both Ss was less than 1 deg. The fixation error was not markedly influenced by target position. Error increased throughout the dark interval but the rate of increase was slow, less

than 1 min arc/sec for the best S. Although the eyes of the Ss slowly moved further away from the target position, fixation stability about the short term (7.6 sec) showed no progressive changes.

The finding that fixation stability was a flat function throughout the dark interval suggested, according to Skavenski, that the progressive accumulation of error in the dark was caused by a deterioration of spatial memory rather than a loss of oculomotor control. This was a possible confounding factor in the comparisons because in the visual condition the position information is continuously present.

In a subsequent experiment Skavenski (1972) tried to demonstrate the functional significance of inflow in the control of eye position. The study was based on the assumption that by applying forces to the human eye in total darkness and requiring him to report the moment the force was perceived this would confirm the presence of proprioceptive inflow. If only outflow information was available Ss would not be able to respond correctly.

External forces on the eye were produced by loads silently applied to a moulded, tightly fitted scleral contact lens worn on one eye. Passive eye displacements were achieved by increasing the load applied to the left or right sides of the eye. Both Ss could detect the presence of a load and report the direction of the pull on their eyes.

There were at least two serious limitations with this experiment. Firstly, the loads required to produce an awareness of eye movement corresponded to eye deviations of 7 and 14 degs. This performance does not explain how in their previous experiment extraretinal information was used to maintain eye position within an mean error region of less 60 minutes over a 38 sec period. One interpretation of this is that proprioceptive information is more accessible for large eye movements and that inflow is not used to control precise fixation. A second limitation arises from the need to demonstrate directly the role of inflow in the control of eye position not simply an awareness of such stimulation. A third experiment attempted to show this.

In this experiment the spring / tension relationship was calculated for each S such that the amount of force required for a given eye deviation was evaluated. Known forces were then applied to one eye and the task was then to maintain eye position in the dark relative to a previous visual fixation stimulus. For one S the load corresponded to an eye displacement of 2.5 deg.; for another a load equivalent to 7 deg. was used. Both Ss were able to maintain eye position with mean fixation errors of 2 to 3 degs. (But it should be noted that both Ss had had several years experience by this time (Matin, 1976a)). By using only experienced Ss the applicability of the conclusions to a wider population is somewhat tenuous. In order to determine the generality of the

finding it is necessary to use experimentally naive or inexperienced Ss.

Stevens et al. (1976) tested visual judgements of movement with Ss whose eyes were paralyzed using various paralytic drugs. According to Helmholtz, under these conditions when an eye movement was attempted although the eye could not move, the world should not appear stationary. This is because the absence of retinal movement fails to cancel the neural innervation to the eye muscles which should provide a phenomenological percept of movement. However, when the eyes were totally paralyzed no perception of movement was experienced when a S attempted to make an eye movement. Moreover, Brindley et al. (1976) also showed that when only one eye was paralyzed, movement was perceived in the non-paralyzed but not in the paralyzed eye when an eye movement was attempted. The strict conclusion to be drawn from this work is not necessarily that proprioception is used in visual judgements, but that efferent information alone is not sufficient to account for visual stability as argued by Helmholtz. Nonetheless, the results of these experiments are consistent with the former possibility. Yet efferent information is clearly of some significance since when subparalytic doses of curare are applied movement perception is associated with attempted eye movements (Stevens et al., 1976) which suggests that proprioception does not provide veridical information on the stability of the eyes in this case.

The work of Hallett and Lightstone (1976) has been taken to support the claim that the saccade generator has access to continuous information on the position of the eye during a saccade. In a typical trial the observer fixated a target which stepped randomly left or right by 3.8 degs. to elicit a saccade. The onset of a saccade triggered a second instantaneous target step to one of eight randomly selected positions in the range of + or - 11.5 degs. After a given period the target was blanked out for 150 - 350 msec before final re-illumination.

The results showed that a saccade of normal latency and correct amplitude was made to a brief target flashed during a previous saccade. Strangely, the duration of the target flash (1-300 msec) made no difference. Moreover, the saccade was directed to the true location of the target in space and not to its projection at the retina at the time of the flash. The eventual saccade amplitude also correctly compensated for any intervening change in eye position.

These data showed that the continuous eye position information signal can be used to direct the eyes to specific locations in space. This is consistent with the neurophysiological research which demonstrated that after interruption, by the electro-stimulation of pause units in the PPRf, the saccade resumes its flight to bring the eye accurately to the target (see 1.4). Hallett's result, however, should be regarded with a degree of caution in

the light of a recent unsuccessful attempt to replicate this result (Cummings, 1981). Cummings (1981) did not find that corrective saccades could be accurately directed to a target presented during a previous saccade. It is possible that this discrepancy can be explained in terms of the intensities of the stimulus sources. Hallett and Lightstone (1976) used sources 2 log units above threshold. Saccadic suppression is reported to have a magnitude of only 0.5 log units. Thus their stimuli would still be visible during a saccade. Unfortunately, Cummings (1981) did not report the intensities he used.

Experiments which have investigated the localization of visual targets during a saccade showed that there are important limitations on the use of extraretinal information in vision. Matin's (1976a) studies have shown unequivocally that targets presented just before, during or just after saccades are quite significantly mislocalised. Matin (1976a) argued that the eye position signal used in the perception of direction is sluggish and is not in phase with the actual eye position in space.

Summary and Conclusions

The availability of feedback information on the position of the eye is important for perception and the role it plays in the control of eye movements. The main forms of eye position information can be derived from three

separate sources: Firstly, the position of the retinal image, relative to the fovea: Secondly, from 'inflow' proprioceptive feedback via muscle spindles: And thirdly, from efference information within the control commands sent to the eye muscles. The presence of efference information was supported by observations on the perception of visual motion when the eye is passively displaced and when an attempt is made to move an immobilized or paralyzed eye. The question of the extent to which 'inflow' information contributes to the extraretinal signal is still unclear.

It is debatable whether this issue can ever be finally resolved. Matin (1976b) has suggested a hybrid mechanism in which efferent stimulation also produces sensitivity tuning of muscle spindles. The reverse of this had been suggested by Ludvigh (1952) who argued that muscle spindle information might be used to modify innervation to the muscle fibres ! But the question of the functional value of the extraretinal eye position information has centred around its role in the perception of motion, direction and visual stability. An important question concerns the role of this information in the control of the saccade motion itself.

1.9 Motor Programming

The view that a motor movement is controlled in terms of a motor 'program' has become increasingly popular in recent years (Stelmach, 1978; Stelmach and Requin, 1981). This implies that the parameters of the motor act are determined prior to the movement itself. A common definition of the motor program originally proposed by Keele (1968) is that 'a motor program may be viewed as a set of muscle commands that are structured before a movement sequence begins, and that allows the entire sequence to be carried out uninfluenced by peripheral feedback'. The motor program approach has been helpful in providing insight into the underlying components of a motor skill and much research has been directed at establishing its empirical value, (Stelmach, 1978; Stelmach and Requin, 1981).

The first clear statement of programmed saccadic eye movements came from an experiment by Westheimer (1954b). The experiment began with a S looking at a fixation target in the centre of the visual field. A peripheral LED light spot was then flashed for a period varying from 40 and 200 msec. The S moved his eyes to the illuminated target followed by a return saccade back to the central fixation position. It was observed that Ss made a precise eye movement to the peripheral stimulus followed some 200 msec later by a return eye movement to the centre. This behaviour was particularly interesting for target

pulses of short durations. In these cases saccades to the peripheral target occurred although at the time the eye movement was initiated the target was already back at the fovea. Recent research using double-step targets (cf chapter 6) have provided further information on how the eye behaves to a target which changes position at various times prior to a saccade (Becker and Jurgens, 1979; see 1.10).

The usefulness of the motor program concept for limb movements was inspired by an early study by Lashley (1917) in which the capacity of a spine injured patient to reproduce movement was studied. This patient showed that normal accurate control of movement was possible in the absence of sensory feedback. Lashley became a proponent of the centralist view of motor control. He argued that examples from many human skills supported the conclusion that the parameters of a motor movement can be preset and released independently of any sensory controls. Lashley's approach was supported by his observations on fast motor sequences such as those of a pianist's fingers which can move at a rate of 16/sec, a rate too fast for any closed-loop proprioceptive feedback to control the movement. Chernikoff and Taylor (1952) have estimated the kinesthetic reaction time to be about 119 msec. (This time is probably considerably shorter for the oculomotor system. Fuchs and Kornhuber (1969) found that stretch of the extra-ocular muscles of the cat produced a response in the cerebellum in 4 msec and a response in the brain stem

in 3-4 msec).

Assuming the human saccadic movement involves a structured sequence of motor commands, one can ask about the information carried in the motor signals and how these signals might be related to each other.

Extensive research has been carried out on the nature of the neural impulses for eye movement control. Robinson (1975) has shown that the neural information used to move the eye in a saccade is composed of step/pulse components, in systems analysis terms. The height of the pulse provides the impulse for acceleration; the duration of the pulse determines the duration of the response and the size of the saccade. A similar approach has been recently outlined for limb movements (Wallace, 1981). The step change in neural firing rate has to be appropriate to match the pulse to prevent either undershooting or overshooting of the saccade movement. This component is also necessary to hold the eye position.

However, there are further aspects of the motor preparation process of which we know very little.

1. How much time is required to specify the parameters of the movement? Does the increased antagonist muscular stretching and the greater recruitment of agonist muscle fibres for large, fast movements require more programming time than for small slower movements?

2. How much time is required to specify each of the program parameter values ?
3. Are different values specified independently of one another or are the identities of individual parameters affected by the identity of other values ?
4. Are the values specified in serial or parallel ?
5. What aspects of a motor act are open to modification ? Can a given parameter of a saccade be modified independently of other parameters ?
6. Do complex motor sequences require more time than simpler movements as predicted by the Henry and Rogers' (1960) 'memory-drum' theory for motor movements ?
7. Are small dimensions for amplitude, velocity and movement duration S to the same principles as for large dimensions ?

Research on such questions is particularly important because it promises to provide specific data on how the oculomotor skill is organized by the nervous system. Very little eye movement research has actually addressed any of these 7 issues.

However, workers on saccadic movements are faced with a

methodological difficulty somewhat unique to this system. An immediate problem lies in the fact that large saccades are extremely fast, with peak velocities of 700 degs / sec and durations of less than 100 msec for 20 deg. movements. In contrast to manual motor movements it is widely held that neither this velocity nor the saccade duration can be controlled voluntarily (Yarbus, 1967). One formidable problem therefore has been the problem that key parameters such as the peak velocity and duration cannot be independently controlled under normal conditions (although they can be manipulated artificially by drugs, alcohol and possibly fatigue: Carpenter, 1977).

1.10 Continuous Feedback Control of Saccades

There are several lines of research which suggest that any extreme claim that saccades are entirely preprogrammed, ballistic movements (Westheimer, 1954b) represents a grossly oversimplified view. Although Keele (1968) and others (see Stelmach, 1978) have argued convincingly for the validity of the motor program concept, the possibility that certain categories of movement may use information in a closed-loop manner was not ruled out. Also further research has begun to examine the possibility that different dimensions of a motor response may vary in their degree of programming. Klapp (1975) for example has argued that the extent to which a motor movement is programmed is a function of its amplitude. Schmidt and

Russell (1972) on the other hand have argued that the duration of the movement is the critical variable in the way a movement is regulated. But as amplitude and duration are highly correlated in saccadic eye movements these views are not for the present purposes incompatible.

Strong evidence for a local feedback loop in the control of saccade movements larger than 5 deg. comes from a recent study by Jurgens et al. (1981). In this study of human saccadic eye movements, certain relationships were observed in the variability of saccade velocities and durations for a given target eccentricity. At each target position there were a cluster of saccades possessing a range of different durations and velocities. However, although durations and velocities showed pronounced fluctuations, the accuracy of the saccade was largely unaffected by this variability. The authors argued that their results were best explained by the hypothesis that the duration of the pulse is modulated in a local eye movement feedback circuit, to balance the on-line level of the pulse intensity (see 1.2). Zee et al. (1976) argued that the pulse duration is based on an efference copy of the motor innervation. In both of these formulations the height of the pulse ('independent variable') drives the adjustments in the pulse duration ('dependent variable').

If the pulse is controlled in the on-line manner, as argued by Jurgens et al. (1981), certain effects on the trajectory of the saccade can be predicted. Hyde (1959)

and Baloh et al. (1975) discovered that there was an increase in the difference between the length of the deceleration phase and the acceleration phase as the amplitude of saccade increases (fig. 1.7). Baloh et al. (1975) have also found that the absolute time of the deceleration phase but not the acceleration phase increases with the size of the saccade, suggesting that the deceleration phase may be influenced by the duration of the pulse controlling the amplitude of the saccade. For saccades in which the pulse intensity is larger than necessary for a target eccentricity the local feedback loop should ensure that the duration of the pulse is adjusted appropriately on detection of the enhanced nerve impulses generating the peak velocity of the saccade. Therefore for saccades of equal accuracy the length of the deceleration region, from peak velocity for excessively high intensity pulses (when the pulse duration is shortened), would be less than for lower intensity pulses (when the pulse duration is increased). On the other hand the saccade deceleration would be independent of the pulse duration, if the deceleration of the saccade is entirely due to the viscosity of the orbital mechanics as originally suggested by Robinson (1964). Further work will be necessary before we can be certain whether the system operates in a continuous on-line fashion using the actual pulse firing or whether the saccade response is controlled on the basis of efference or predicted pulse activity.

Conclusion

It may be permissible to refer to a saccade as a 'programmed movement' in the sense that firstly, important decisions concerning the nature of the response (e.g. the specification and recruitment of muscle fibres) are initiated prior to the saccade, and secondly that the projection of a saccade to a visual stimulus must be based on visual information received before the release of the response. However, there is evidence that the dynamic parameters of the saccade movement is modulated in a continuous feedback loop.

1.11 Plasticity of Saccades

It has been widely assumed that saccadic eye movements are stereotyped responses. In an extensive series of studies Gurevich (1957,1959,1961) found that the saccade amplitude / velocity relationship was remarkably invariant. Harris and Cynader (1981) showed that the normal amplitude / peak velocity relationship was found even in cats who were visually deprived from birth. Yarbus (1967) argued that saccade velocities cannot be varied voluntarily by human Ss. Further research however has suggested that the control of saccades may in fact be open to a greater degree of modification than had previously been assumed.

In an experiment by McLaughlin (1967), Ss were asked to fixate on a light target. Upon hearing a tone cue, they made a rapid eye movement to a target 10 degs to the left. This initial movement was normally accurate within about 0.3 deg. Following some trials, the target light was switched after the start of the eye movement to a new position 9 degs. away from the fixation point. At first the eye tended to overshoot the 9 deg. position, but after 3 or 4 trials the 10 deg. signal came to initiate an accurate 9.1 deg. eye movement. When the trials were changed back to a simple 10 deg. target shift undershooting occurred for several trials, indicating that the motor program had indeed been modified. Cavicchio (1975) extended this work by showing that the phenomenon was a parametric effect, in that the recalibration adjustment was generalized proportionally to eye movements of different amplitudes. However, although Miller, Anstis and Templeton (1981) replicated the McLaughlin result, contrary to Cavicchio's finding, they found that the amplitude adjustments did not generalize strongly to other saccade amplitudes and was practically absent to targets in the opposite direction to the trained adjustment.

Adaptation of the central mechanisms subserving saccadic eye movement generation has been demonstrated in response to extraocular muscle paresis. Kommerall et al. (1976) reported on a patient who had developed a unilateral abducens nerve palsy in the visually dominant eye. When the paretic eye was patched it was found that the

non-paretic eye made overshooting saccades, suggesting that the oculomotor control centre was attempting to increase neural activity to the paretic eye, and that because both eyes receive equal muscular innervation (Hering's law, 1868), this was manifested in larger saccades in the good eye. Optican and Robinson (1980) detached the horizontal rectus muscle of one eye in monkeys and found that viewing with the good eye produced hypometric saccades in the weak eye that undershot the target by about 50%. When the normal eye was patched the hypometria of the weak eye was eventually eliminated after 3 days and replaced by saccades of normal gain (i.e the ratio of saccade amplitude to the target eccentricity).

Abel et al. (1978) have conducted the most detailed investigation on the plasticity changes in a patient with an oculomotor paresis and its effects on saccadic parameters. Their S was asked to wear an eye patch for ten days. From days 1 to 6 the patient wore the patch on the good non-paretic eye; from day 7 to day 9 the patch was placed on the paretic eye. On each day monocular and binocular eye movements were recorded in both the paretic and non-paretic fields. With paretic eye viewing saccade gain increased for saccades into the paretic field while leaving unchanged saccades into the non-paretic field. Although saccadic gain increased, peak velocity showed no real change. However, saccades did show an appreciable increase in duration time.

The authors argued that the changes in saccade gain reflected adaptive alterations in the neural mechanism responsible for saccadic eye movements. They concluded that the changes in saccade gain for movements into the paretic field and the simultaneously unaffected saccades in the opposite direction showed that plastic adaptation can be directionally selective in humans (see also Cavicchio, 1975). Since saccadic gain and duration increased while the peak velocities did not, they proposed that the central control mechanism responsible for saccades can 'selectively alter the operation of different aspects of the saccadic system'.

Some reports have suggested that the optokinetic nystagmus (OKN) can be brought under some degree of voluntary control. Zikmund (1973) reported that Ss could, by imagining an OKN inducing stimulus, simulate the OKN eye movement pattern. In a later study Guensberger and Zucha (1973) observed that individuals could suppress the OKN to moving striped bars if they were also provided with a fixation point and auditory feedback on the eye movements. For one S auditory feedback alone was sufficient to inhibit the OKN. This result is consistent with recent results on the use of continuous feedback in the attenuation of congenital nystagmus (Abadi et al. 1979, 1980; Ciuffreda et al. 1980).

There has however, been only one study which showed that the speed of the saccade trajectory can be controlled.

Viviani and Berthoz (1977) in a text scanning task asked Ss to detect a critical word embedded in the centre of a passage of text on the screen. Individuals were asked to saccade 40 deg. obliquely across a display while attempting to detect a critical word. After some training Ss were able to pick out the critical word during the saccade. On examination of the saccadic records all S's showed slowed components in the saccadic trajectories. Becker and Jurgens (1979) tested a S's response to a visual stimulus that stepped 60 deg. in one direction for a short period and then stepped back to the 30 deg. position (pulse-step) in the opposite direction. Saccadic patterns were occasionally observed in these conditions which showed that the initial saccade could be cut short in mid-flight by a second saccade which seemed to have zero latency and which carried the eye accurately onto the new target position. These data showed that the system must have access to information about the current position of the eye during a saccade in order to calculate the target position and to adjust the eye accurately to this location. It is also likely that the saccade is planned in terms of the position of the target in spatial coordinates and not retinal coordinates (see Robinson, 1975; ch. 7). Finally these data also support the hypothesis that the saccade can be modified under special conditions.

1.12 Conclusions

Research on the modified control of saccades has provided evidence that saccades are not simple stereotyped motor reflexes. They are open to short term adjustments and in common with other oculomotor eye movements (e.g vestibular) can be adapted to meet demands (experimental and neuromuscular impairments) imposed on the system. The modification of eye movements in cases of both human and animal oculomotor impairments is beginning to shed light on the mechanisms of repair. This is particularly important in the clinical treatment of oculomotor paresis. The study of the modification of saccades is also important theoretically, in particular for an understanding of how the eye movement system controls individual saccade parameters. This may also provide further insight into the general principles underlying the control of motor skills.

The experiments in the following chapters were designed to investigate the possible plasticity of the saccadic system in human Ss. By concentrating on the modification of saccades it was planned, as has been done in motor skills and biofeedback research (see Appendix A), to begin to determine the way in which saccade parameter relationships are regulated. Particular interest centered on the issues raised in section 1.8, where several questions on the control of a saccade were proposed. By investigating the

modification mechanisms it was possible to study the effect on the efficiency of movement control (e.g the saccade timing and precision) and its effects on other saccadic characteristics.

The first step in analyzing the control of saccadic parameters was aimed at developing a method to allow a controlled de-coupling of saccadic parameters. The experiments in chapter 3 were designed to test Yarbus' (1967) claim that saccadic velocity could not be independently modified. It is concluded that this research can be most suitably incorporated within a non-ballistic model of saccadic eye movement control (chapter 7).

CHAPTER 2

METHODS

2.1 Eye Movement Recording

This chapter is organized into 2 general sections. The first section briefly reviews the development of current eye movement recording techniques and provides a critique of their principles and some of their underlying assumptions. It is shown that judgements on a particular technology for recording eye movements must involve considerations based on the nature of the eye movement information required. The second section of the chapter describes the general methods and apparatus used in the experiments presented in the following chapters.

2.1.1 The Problem of Head Movements

Individuals normally execute eye movements together with head movements (Bizzi, Kalil and Tagliasco, 1971). This is often a serious irritation for eye movement work. The problem arises from the neurophysiological wiring of the compensatory eye / head feedforward relationship, whereby the eye is rotated in the opposite direction and to a corresponding extent to the angle of the head rotation. This is a reflex mechanism which cannot be entirely suppressed, although the gain of the relationship can be

modified (Melvill-Jones, 1976).

One approach to the problem is to try to stabilize the image relative to the motions of the eye. The eye signal is usually amplified and filtered so that the gain of the relationship can be reliably controlled by the investigator. This is then fed to the visual stimulus position input, which modulates the target position with the eye motion. Some compensation for pure head movement can be introduced by simply using the head oscillation information to drive the target.

The drawback with this solution is that it is difficult to determine what additional effect this extra compensatory loop may have on the main eye movement task. Any delay in the extra-feedback loop may introduce unstable delayed feedback effects into the tracking operation. In addition one needs a highly sensitive device to compensate properly for micro eye movements. However this principle has been successfully applied in image stabilization studies (Ditchburn, 1973).

Rather than attempting to stabilize the retinal image with respect to the head, a second option is to simply monitor the head movement simultaneously with the eye movement. The relative movement of the retinal image can then be estimated by subtracting the motions of the head from the eye position in the time domain. However, the method

increases the data processing demands on the system and by introducing a new stage of data analysis increases the margin for measurement errors.

A more direct solution to the head movement problem is to devise an apparatus to maintain the head in the required position. A number of workers therefore prefer to clamp the head in position with a combination of head rests, dental bite bars and chin rests (fig. 2.1b). Such measures cannot guarantee perfect head stability, but with a co-operative S significant head movements can be appreciably reduced. In any case for experiments in which absolute eye position information is not crucial a certain margin of DC shift caused by head movements can be tolerated. Perhaps the main obstacle to physical head stabilization devices is the possible discomfort to Ss caused particularly in long and tedious experiments. But the comfort of Ss can be improved substantially by ensuring that all the securing components of the apparatus can be adjusted to each individual S.

2.1.2 Direct Visual Observation

A general impression of the nature of an eye movement can be obtained from direct visual observations of the eye. Some authors (Javal, 1879) used a plane mirror for this purpose. Observations were made by simply noting the fluctuations of the reflected mirror image with the

unaided eye. Movements greater than 1-2 degs. could be reliably detected. The accuracy of visual observations was later increased by using optical instruments to provide a magnified image of the eye, or some part of it. Lenses giving the required magnification were used in the study of relatively large eye movements (Newhall, 1928) and a microscope was adapted for the study of small eye movements or micro movements during fixation (Gassovkii and Nikolskaya, 1941).

Park (1936a 1936b) recorded eye movements during fixation by measuring, using a galvanometer, the movements of a lens attached to the eye. Peckham (1934) and Ogle, Mussey and Prangen (1949) used a stereoscope and telescopes to study changes in convergence during fixation on an object.

Direct viewing methods are currently usually adopted in studies where only the occurrence of a lateral eye movement and its direction are required, with no measures of the extent of the movement as in studies on the use of eye movements as an index of lateralization in cognitive processes (Kinsbourne, 1972) and fixation preference in infants (e.g. Fantz, 1961).

2.1.3 After Image Methods

Several experimenters (Dodge, 1907; Helmholtz, 1925; Duke-Elder, 1932; Barlow 1952) have used after-images to

study eye movements. The method involved presenting to the eye a bright flash shortly before or during the course of an eye movement. A sharp high contrast source of light produced a negative after-image lasting some several seconds. As this after-image was fixed on the retina perceived motions of the image reflected the corresponding eye movements. Knowing the distance between the eye and the stimulus it was possible to calculate the size of the eye movements with a correctly calibrated reference, such as a screen graticule. Small, clear stimuli improved the precision of the method. Rough approximations of the eye velocity could be gained using after-image methods. The basic requirement was that the stimulus was of an appropriate alternating current type and of sufficient duration to produce a clear image on the retina. A large saccade across the light source resulted in a perceptible array of discrete points or flashes spread out across the retina. The inter-point distance was equivalent to a moment-to-moment sample of the average eye velocity along the saccade trajectory (see also Thomas, 1961 for an interesting suggested application of this principle).

One ingenious early version of this method used a bright source placed at the centre of a narrow slit. While the observer fixated this target a lamp was flashed behind the upper and lower halves of the slit. The lamps were switched on and off consecutively at a predetermined rate producing an after-image of each half of the slit. An eye movement during the interval between two flashes displaced

the two halves of the after-image relative to each other. Thus, when the source was of a frequency greater than the inter-fixation rate, the magnitude of the displacement corresponded to the magnitude of an eye movement.

One appealing feature of after-image methods, which tends to be entirely absent in modern eye movement recording systems is the direct awareness Ss have of the character of the motions of the eye. This may be particularly helpful in studies on questions of voluntary control of eye movements. The method is largely unaffected by head movements - a problem still faced by modern recording systems. However, as a general method it lacks the precision of, for example, the more recent photoelectric recording systems, and therefore is unsuitable for detailed measurements of saccadic parameters.

2.1.4 Mechanical Methods

In the past some workers have used mechanical principles in their attempts to obtain accurate measurements of human eye movements. One early method used a probe which rested directly on the apex of the surface of the cornea. The movement of the cornea was transmitted along a lever which was balanced at a fulcrum attached to the Ss head. The other end of the lever arm charted a record of the eye movements on a moving paper graph (cf Ohm, 1928; Cords, 1927). A second mechanical method used an aluminium or

plaster cup shaped contact lens, in which a small aperture was drilled in the center. A lever connected to the cup transmitted eye movements to the recording chart. In some experiments Orschansky (1899) fixed a small mirror to the cup: he was evidently the first to use a beam of light reflected and projected on a screen to study eye movements. Direct mechanical methods have never enjoyed wide popularity as a procedure for recording eye movements and are now more or less obsolete, although mechanical systems are still applied in producing passive eye rotations (e.g Skavenski, 1972, Collins, 1975).

2.1.5 Reflected Beams Using Mirrors

Mirror reflection methods have in common the use of a mirror attachment on a contact lens, placed over the corneal surface. A light source directed at the eye is reflected back and focused onto a photosensitive material or device. Ss eye lids are sometimes held open manually or with adhesive tape as the mirrors are usually mounted on a stalk attached to lens. The head is held in position by the use of a headrest. Haddad and Steinman (1973) have used such a mirror system in conjunction with an attenuated laser as the light source. The discomfort and inconvenience to Ss is an obvious drawback of this method. The possibility of contact lens slippage during fast eye movements must also to be considered when using this procedure.

2.1.6 Corneal Reflection Methods

The radius of curvature of the cornea is approximately 8 mm and that of the eye itself about 12 mm, the centre of curvature of the cornea is therefore displaced on average by 3-5 mm relative to the centre of rotation of the eye. The cornea being a clear, shiny surface, partly reflects any light source falling on its surface. And since the rotations of the eye and cornea do not coincide, the angle of reflection from the cornea during an eye movement moves with the eye. This principle has been used to estimate the angle displacement of the eye.

Dodge and Cline (1901) and Stratton (1902) were the first to recognise and apply this method to the recording of eye movements. Lord and Wright (1948) developed a photoelectric method for recording movements of the corneal reflex, as it has been called. In their experiments the head was restrained by a head strap and the use of a bite bar attached to the head rest. A beam of ultraviolet light was directed onto the cornea, whose reflection fell onto a semi-transparent mirror. The reflected beam was then divided into two parts to be picked up by two photodiodes which registered the horizontal and vertical components of an eye movement. The signals were then amplified and displayed on a cathode-ray oscilloscope.

Mackworth and Mackworth (1958) in a famous study, measured

the corneal reflex using a closed circuit television camera system. By magnifying the image 100 times and then projecting both the corneal reflex and the visual display onto a television tube the position of the corneal reflex was made to correspond directly to the point of fixation. The system was accurate to + or - 1 deg. over a 20 deg. range.

Corneal reflection methods can potentially provide eye movement resolution of up to 1 min. of arc. over a range of 10 to 20 degs. An important feature of the method is that the brightness and contrast of the image can be enhanced by simply increasing the intensity of the source.

2.1.7 Photo-Camera Methods

Several authors have developed photographic methods based on motion-picture or still photography methods to study eye movements. Dodge and Cline (1901) were the first to make photographic studies of the eye in motion.

Judd, Mcallister and Steel (1905) took sequential photographs of the eye at a rate of 9 per sec. Two high reflectance 'land marks' were attached to a fixed head rest and were included in the exposure field of a recording camera. A small spot of chinese white was placed on the cornea. The position of the white spot relative to the land marks was determined in each frame

and the measurements were used to provide a descriptive account of eye movements.

Barlow (1952) recorded eye and head movements by monitoring the displacements of two small drops of mercury placed on the cornea and forehead. Karlake (1940) made motion pictures of the image of the eye in a semi-transparent mirror, through which Ss looked at the object of perception.

Photographic methods can be used fairly effectively for recording large eye movements and accurately reflects movements in both horizontal and vertical orientations. However, a laborious analysis is often necessary before the data can be clearly interpreted. But a more serious handicap is the implicit limitations on details of the saccade dynamics that can be derived by photographic systems due to the low temporal resolution.

2.1.8 Electro-oculography (EOG)

An ocular electric potential is known to exist between the outer and inner sides of the retina (Mowrer, Ruch and Miller, 1936). The higher metabolic rate of the retina causes the cornea to be some 0.4 to 1.0 μ V positive with respect to the retina. During rotary movements of the eye in the horizontal plane there occurs a change in the potential difference with respect to the outer canthi of

the eyes. When the eyes rotate in a vertical plane these changes take place between points on the head above and below the eyes. The relative potential changes can be detected by two low impedance electrodes attached to the corresponding points on the skin. The signal is only a few millivolts and must therefore be amplified. The change in potential is linearly related to the visual angle of the eye with respect to the head, over a wide visual angle. This signal can be used to measure movements of the eye and is currently a popular and widely used procedure in many eye movement laboratories.

However, the EOG method has several serious problems. Miles (1939) investigated the effect of various conditions on the magnitude of the corneo-retinal potential difference. It was revealed that light adaptation causes an increase, while dark adaptation causes a decrease in the absolute eye potential. A further serious doubt concerning the EOG method has been caused by unresolved questions concerning the origin of the EOG potential, as this seems to be influenced by EEG, EMG and GSR artifacts. Furthermore, Lippold and Shaw (1971) apparently recorded a EOG potential synchronised with instructions to move the (absent) eyes from an enucleated S! Byford (1963) has also suggested that the velocity of the eye may contribute a confounding component to the EOG, causing a marked distortion in the registration of some saccades. By using the corneal reflection as a reference, it was shown that changes in the EOG measure can occur in the absence of an

eye movement and vice versa.

Notwithstanding many researchers have used the EOG method because it has a number of attractive features. The method can be used for recording eye movements in the dark and when the eyes are closed. EOG is simple to use and does not impede a S's vision. It also produces a linear output over a wide visual angle.

2.1.9 Electromagnetic Recording

A uniform alternating magnetic field induces a measurable current in an eye coil situated within that field. The amplitude of which is proportional to the angle between the plane of the eye coil and the lines of forces generated in the magnetic field. The signal is fed into a recording device for phase detection and amplification. The recording of vertical eye movement components requires a second orthogonal magnetic field. A second pair of parallel coils is placed around the S's head with a different frequency from the current generating the horizontal magnetic field. The S is fitted with a scleral coil carefully positioned to center around the cornea covering the scleral region (Robinson, 1963; Collewijn et al., 1975).

It has been claimed that this method is sensitive to 15" of arc. A further characteristic of the procedure is its

insensitivity to pure lateral displacements, but the recordings may still be contaminated by head rotations inducing compensatory eye torsion. It is therefore still necessary to ensure stabilization of the head.

2.1.10 Photoelectric Methods

Photoelectric methods take advantage of the fact that the iris and sclera of the eye reflect light by different amounts. A light source is directed towards the temporal side of the eye so that half of the signal is on the sclera and the other half on the iris. The different reflecting properties of the sclera and iris causes a modulation of the reflected light proportional to the ratio of sclera and iris surface area orthogonal with the light source. This signal is then reflected back to a photodiode and fed into an amplifier, before final storage on magnetic tape or computer disks.

A high signal to noise ratio of many photoelectric devices makes the system particularly appropriate for giving precise resolution of small saccades and have the additional advantage of requiring no direct attachments to the eye. The system is normally limited to horizontal eye movement, since the upper and lower limbus areas are obscured by the eye lids.

2.2 Methods and Apparatus of the Experiments

The experiments were conducted in a specially adapted room approximately 5.5m x 3.0m x 3.5m for the running of visual psychophysical experiments. The minicomputer controlling the experiments was placed in the same laboratory, except for two early experiments when it was located in a separate, adjoining room.

The experiments raised a number of issues concerning the operational characteristics of the saccadic motor system. Saccades are normally generated when the eye is attracted by a peripheral target that appears sufficiently into the peripheral field that detailed vision is poor in comparison to when the visual axis is aligned with the target. Thus the sudden movement of an object from the fovea to the parafovea or further peripheral retina provides an adequate stimulus for a saccade. The target displacements used in these experiments were generated by applying a step function to the target input with a rise time much smaller than 1 micro second.

2.2.1 The Computer

Central to the running of the experiments was a Computer Automations LSI alpha (CED) 2/20 minicomputer, using the 502 interface model. The computer performed three general functions:

a) The Eye Movement Displays

One function of the computer was to generate visual stimuli on an X-Y display. With the exception of Experiment 4.1, which used smooth target movements, all target movements were step functions. The processing time to display the screen targets was determined by the size and complexity of the stimulus matrix in addition to the on-line analytical operations in eye movement contingent experiments (further details are presented with each experiment) where the target presentation was determined by the timing of the saccade. This allowed the experiment to hold the duration of the target at the fovea constant for a saccade of any latency.

The display unit was a Tektronix model 602 phosphor 31 which produced very little after-image in normal ambient conditions. The screen surface area was 100mm x 80mm. The height of the scope was set to the S's eye level using an adjustable platform. This scope was used for recording 5 deg. saccades. Ss were situated 1145 mm from the display. A second Hewlett-Packard model 1327A X-Y screen was used for experiments in which both large (20 degs) and small (5 degs) eye movements were required. When using this larger scope Ss were seated 850 mm from the display. This scope had a frontal surface area of 430mm x 330mm. The average luminance of the display was 100 cd/m^2 .

By conducting the experiments in a semi-darkened lighting conditions any "glare" from the scopes was significantly

reduced. A pilot study revealed problems in attempting to make recordings completely in the dark. This tended for example to increase eye strain on the S. It also became difficult to make any adjustments to the settings of the eye movement apparatus at the calibration points during an experimental run, also scope after-effects became more noticeable.

The same display units were used to carry textual information and to signal the start and end of a run and to present the visual feedback of experiments 3.1 - 3.4.

b) Eye Movement Sampling

The frequency at which eye movement sampling could be achieved was related to the level of complexity of the stimulus display. This problem was approached in two ways. By keeping the display as simple as possible, thus holding the time display overheads to a minimum, it was possible to record eye position at up to 1000 Hz. However, sampling intervals at 500 Hz were found to be adequate for our purposes.

A different strategy was required for experiment 4.2 where the effect of a target velocity on the saccade trajectory was investigated. In this study it was necessary to manipulate the rate of movement of the target across the scope. Here the display refresh rate frequency was

separately controlled from the eye movement sampling stage by using a hierarchical timing system. This made it possible to move the target at fast or slow speeds while permitting the high frequency sampling of the eye position. Once the data was recorded this was written immediately and stored onto floppy disk.

c) Data Storage and Analysis

The third key function of the computer was in the filing and analysis of the data. However, before describing this the process of recording the eye data is described.

2.2.2 The Calibrations

Once a S was set up he/she was presented with three dot points at the left, central and right positions for that condition. A symmetrical eye position measure was obtained by a continuous process of resetting the photoelectric DC offset and amplifier gain while simultaneously monitoring a voltage meter reading. The calibration continued with a press from the S controlled button when the triple dot stimuli were replaced by a single target moving from the left peripheral eccentricity to the central and then right eccentricity at intervals of 512 or 1024 msec. The S was instructed to fixate accurately the target at each position, where continuous samples of the eye were recorded. The symmetry and

variability of the fixations was then analysed on-line and the results displayed on the computer terminal. The calibration was rejected and the procedure recommenced for assymetries in the order of 10% of the total left / right visual angle for that condition. The procedure was repeated every 20 trials.

The problem of head instability was reduced by using a combined head clamp, chin holder and a 1 cm diameter dowel bite board (see fig. 2.1).

2.2.3 The Eye Movement Recording Unit

The eye movement recording device operated on the photoelectric method. The set up used a fibre optic channel called a random Y-guide to transfer light from a light emitting infra-red diode (LED) to the limbus area between the iris and the sclera (fig. 2.2). One arm of the Y-guide transmitted the chopped incident source while the second arm returned the scattered signal from the eye back to a receiving diode in the recording box. The signal was then amplified by a standard DC amplifier.

The input-output function of the system was measured in the following way: A mid-grey contrast stimulus was placed across the incident surface of the fibre optic by operating a micro manipulator (see fig. 2.3). This provided the visual input to the photo diode. A dial



- 1 - Head rest
- 2 - Bite bar
- 3 - Fibre optic probe
- 4 - Chin rest
- 5 - Display screen
- 6 - Volt meter
- 7 - Eye movement monitor
- 8 - Alpha 2/20 minicomputer

Fig. 2.1 Subject setup and apparatus.

Positioning of the Fibre Optics

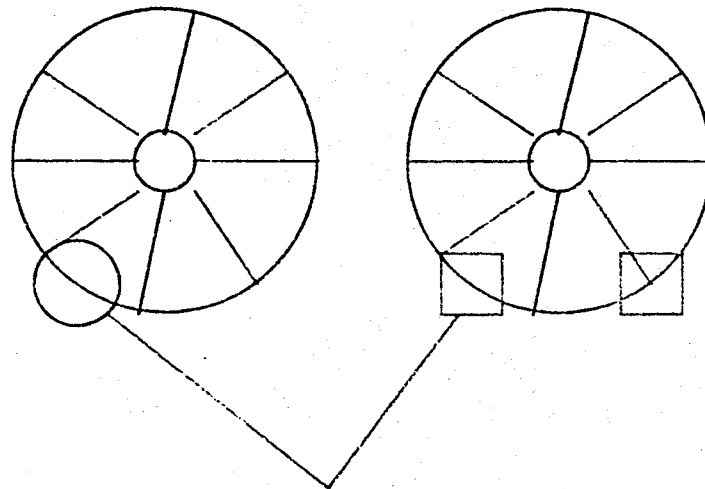

Fibre optic probes

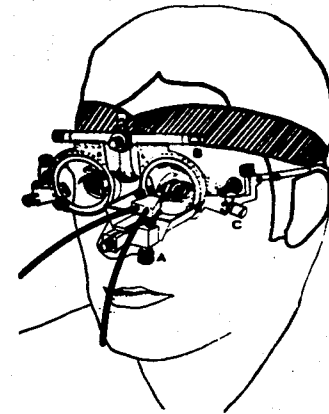

Fig. 2.2. Alignment of the fibre optic probes. The recording system allowed subjects to use binocular vision, but eye movements were recorded monocularly.

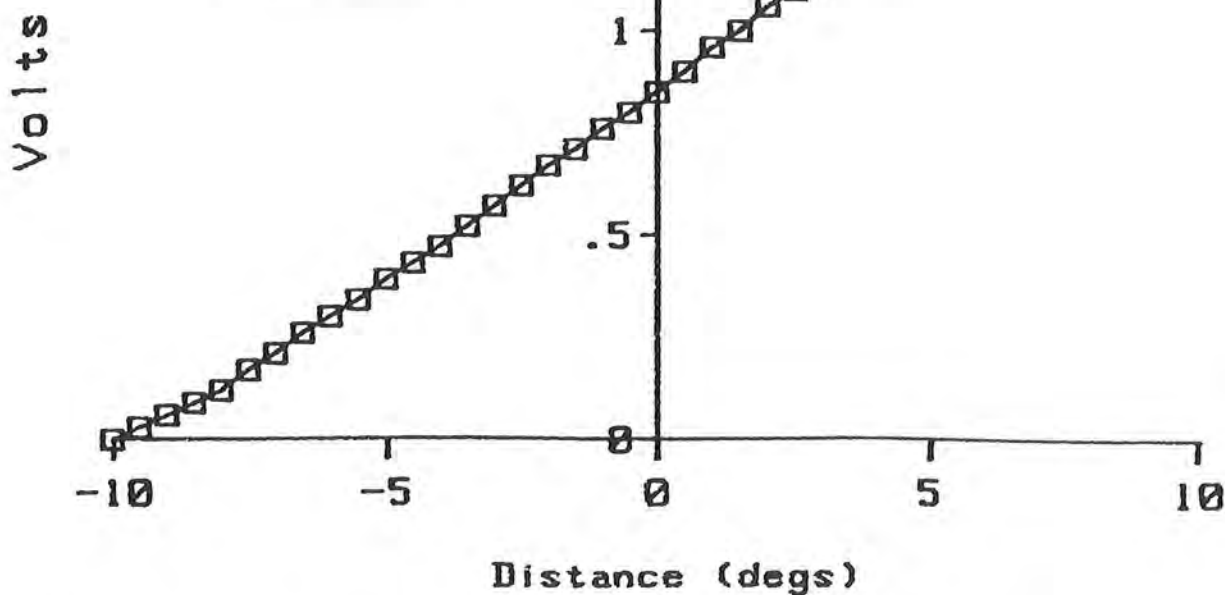
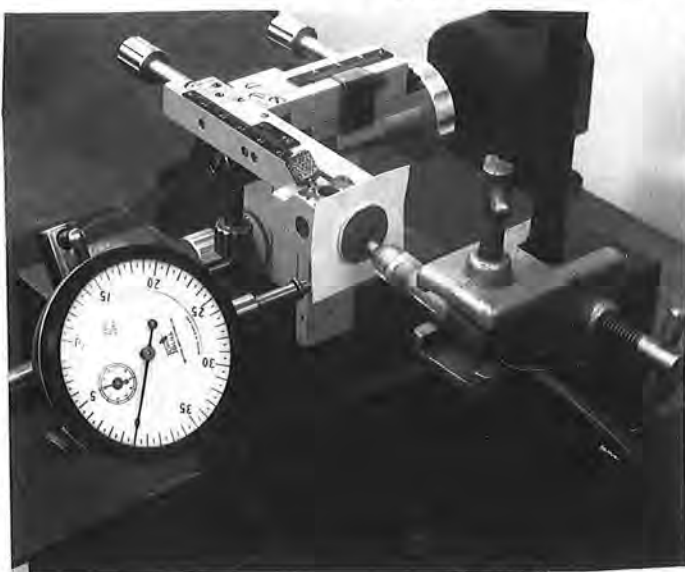
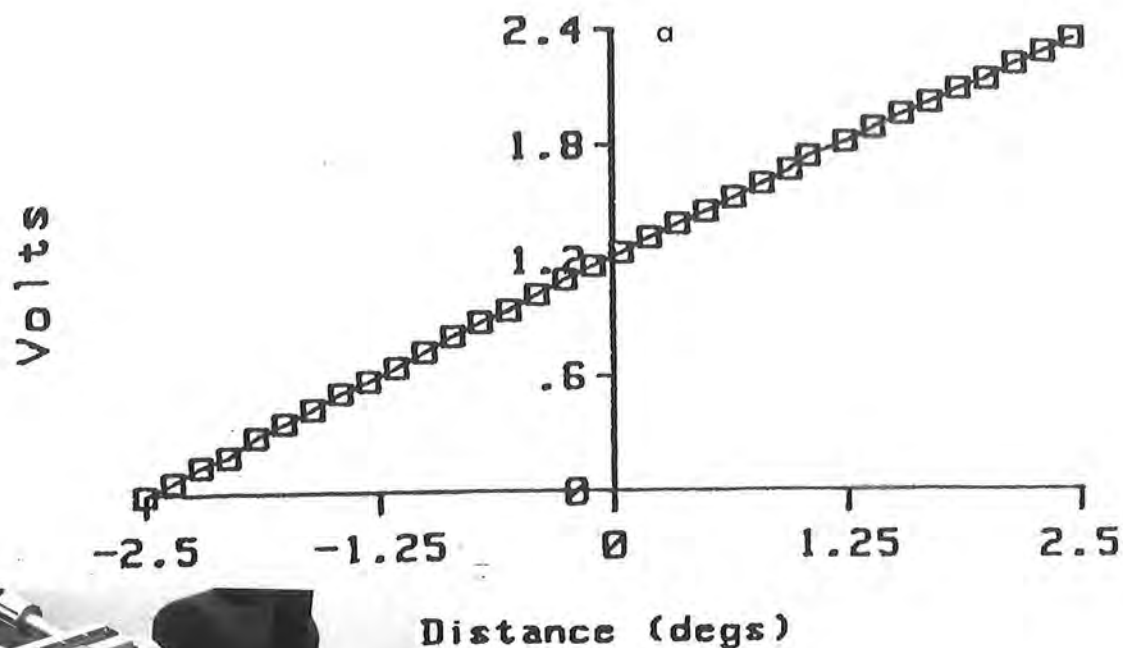

Fig. 2.3. Measurements of the linearity of the eye movement recording device using a single probe (a) and the double probe (b). These measurements were obtained by recording the input displacements of a mid-grey contrast stimulus with a micrometer dial. This was plotted as a function of the output voltage from the eye movement recording system. Measurements were taken at minimum gain.

micrometer was used to 'sense' the movement of the stimulus at increments of 0.0128 mm. This was equivalent to 0.073 degs. The angular displacements were plotted against the corresponding voltage output from the recording unit. Fig. 2.3a shows that this system was linear up to + or - 2.5 degs relative to the central fixation position.

A second device using similar principles was used to measure larger eye movements (20 degs). The device used two channels for each i.r source and second pair of channels for photodiode detection (fig. 2.2). A phase-locked oscillator was added to counter-act transient interference. Thus changes in ambient light did not affect the performance of the system, which was designed to register only mechanical displacements. The sensitivity of the system was improved by implementing an adjustable DC offset mechanism separately from the amplifier stage.

The probes were placed at the sides of the cornea and were held in position by perspex frames mounted on an aluminium stand. The mounting frame for the probes allowed movements in horizontal, vertical and depth planes. Eye movements were recorded monocularly.

The two probes were aligned such that a horizontal eye movement would produce a signal of increasing polarity in one probe and a decreasing signal in the second probe.

The respective signals were picked up by two photodiodes and treated electronically in the same way as in the previous system. The voltages were passed to a differential amplifier which generated the final analogue signal proportional to the angle of the eye rotation. This information was then transmitted to the digital computer and recorded onto floppy disk. Fig 2.3b shows that the system was linear over a central area of at least 20 degs. Fig 2.4 shows the results of the stability of the system centered around a DC of 0.01 volts at maximum gain. The drift over 30 minutes was less than 0.25%. The sensitivity of the system was better than 4 min. arc. Fig. 2.5 shows the frequency response of the system, which was good up to 125 Hz. The rise and fall time from 0 to 5 volts was 5 msecs.

2.2.4 Data Processing

The object of the analyses were directed at a number of saccadic parameters which included the latency, amplitude, peak velocity, duration and peak acceleration of a saccade. Of these the measures of peak velocity, acceleration and duration are most sensitive to the sampling frequency. Saccade latencies and amplitude can be reliably estimated at frequencies as low as 100 Hz. However a system operating at this level would be totally inadequate for someone interested in the details of the saccade dynamics. For example, if a 5 deg saccade lasts

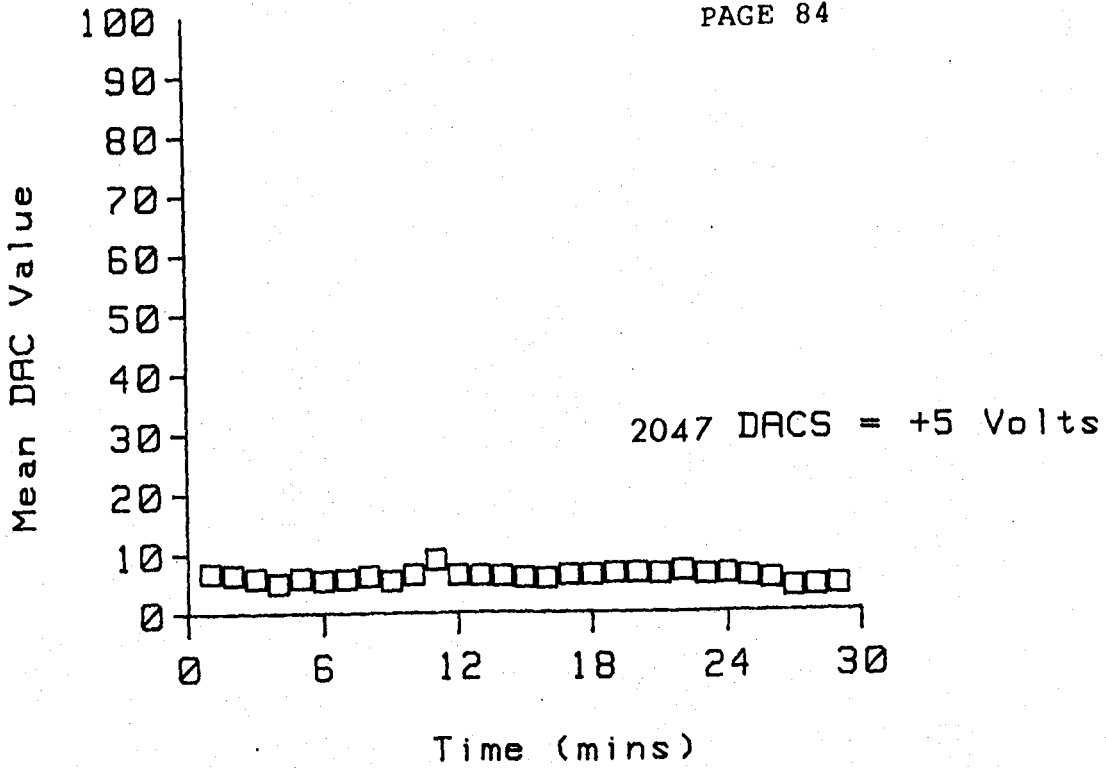

Fig. 2.4. Noise fluctuations of the system. Each square represents the average value of a 60 second sampling period. DAC - digital to analogue computer units. 2047 DACs = 5 volts.

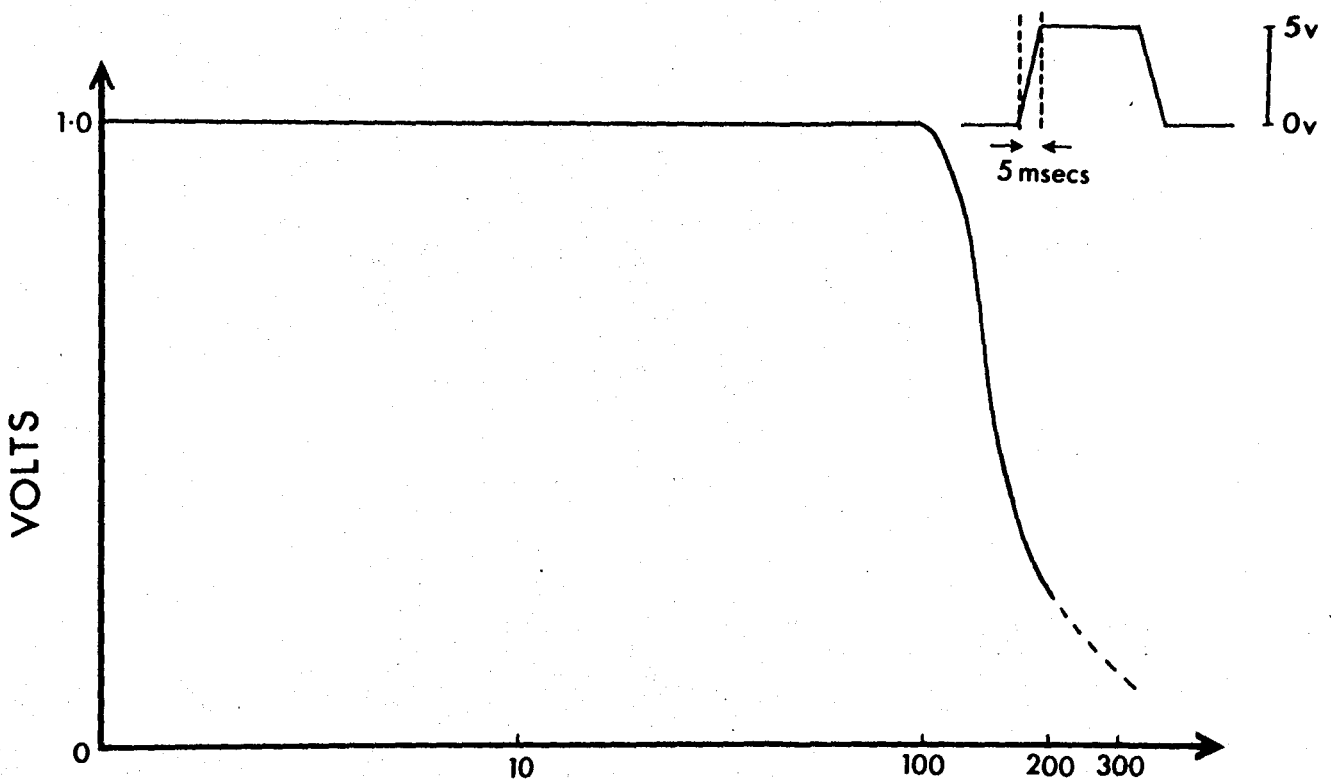

Fig. 2.5. Frequency response curve of the system. Also shown is the rise and fall time of the system between 0 to 5V(volts).

30 msec, such a system would provide a maximum of 3 points with which to calculate the saccade trajectory. These studies therefore used a sampling rate of 500 Hz, with the exception of experiment 3.5 which was based on samples at 250 Hz.

Sampling at such high frequencies however also introduced a problem. Even during so-called period of fixation the eye was never entirely stationary but was moving continuously in involuntary tremors and drifts (Ditchburn, 1973). A 500 Hz sampling rate picked up a significant proportion of these high frequency eye oscillations. A criterion therefore was used to distinguish between these irregular involuntary movements and the larger saccadic movements used in voluntary refixations. This criterion was then used to determine the amplitude and duration of a saccade. The criterion applied took the form of a 30 deg/sec velocity threshold. A sub-criterion specified that in addition a saccade also contained an acceleration component for three successive samples (Ditchburn pers. comm., 1981). A temporal gate was also specified by defining an anticipatory response as a saccade having a latency less than 80 msec (after Becker and Jurgens, 1979; Heywood and Churcher, 1981).

The analysis algorithm used an interactively operated CRT marker which indicated the estimated beginning, the end and the point of peak velocity for each saccade (fig. 2.6). Obvious miscalculations could therefore be

Saccade

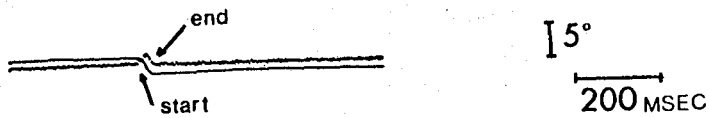

Eye Blink



Fig. 2.6. Top record, detection of onset and termination of a small saccade. Lower record, a typical blink artifact. Note the longer duration and distinctive profile of the artifact.

rectified by adjusting the position markers superimposed on the displayed eye records. Thus errors due to blinks and other artifacts could be clearly identified with this procedure.

During the course of experiment 3.3 a number of 'hard errors' were generated at random on some records. These sectors were unsuitable for proper analysis. Subsequent experiments circumvented this problem by (superstitiously) double-checking each sector for read and write eligibility prior to finally writing a record to disk. Further descriptions of the procedures will be presented with each study.

CHAPTER 3The Modification of Saccadic Trajectories3.1.1 Introduction

A report on experiments 3.1 and 3.2 in this chapter has previously been published in Crawford (1984).

When the point of visual regard is transferred with a saccadic eye movement the time course of the eye displacement has a characteristic form. The saccade begins with a gradually increasing velocity which reaches a peak approximately half way through the movement for small saccades (<10degs.) and then decreases once more (see example in fig. 3.1). For larger movements the point at which the saccade reaches its peak velocity falls proportionally nearer the beginning of the saccade as the amplitude of the saccade increases (Baloh et al., 1975, see fig. 1.7). This peak velocity can be seen in a record of the velocity time curve of the saccade in fig. 3.1.

It is now well established that the peak velocity and the saccade duration manifests a predictable relationship with the amplitude of the saccade (see fig. 3.2). Both the peak velocity and duration increase approximately linearly with the amplitude at small saccade amplitudes, but the peak velocity tends to saturate at amplitudes beyond 20

degs. This general relationship has been termed the 'main sequence' (Bahill and Stark, 1975).

Early descriptions of saccadic eye movements developed the view that saccades were largely stereotyped, preprogrammed movements. This conclusion was advanced from at least two lines of research. Westheimer (1954b), in a well known study, had a visual target which jumped from a central fixation position to a peripheral position for periods varying between 40 and 400 msec, and which then returned to the centre. Ss eye movement responses consisted of a saccade to the initial target displacement followed by a return eye movement to the centre. This response sequence persisted even when the target had returned back to the line of the visual axis before the onset of the initial saccade. This implied that saccades were controlled in a serial order with a minimum refractory period of 200-250 msec. It appeared that once a saccade was initiated it was no longer under direct visual or voluntary control. This work also encouraged the development of the Young and Stark (1963) sampled-data model which claimed that a saccade was triggered by a visual sampler receiving input at a rate of approximately 3-4 Hz.

Studies on saccade durations and peak velocities also seemed to support the view that saccades were produced in a stereotyped manner. Robinson (1964) demonstrated that the duration of the saccade was dependent on the amplitude of the movement. Yarbus (1967) claimed that this duration

could not be controlled voluntarily when Ss were directed to increase or decrease the speed of their saccades.

Subsequent research (e.g Becker and Jurgens, 1979) has undermined the original Westheimer (1954b) claim by showing that a saccade can in fact be modified by visual information received up to 80 msec. before the saccade is released and adjustments in the saccade can occur during the saccade flight (Van Gisbergen, Ottes and Eggermont, 1982; Findlay and Harris, 1984). However, the Yarbus' experiment has been taken by some workers as conclusive evidence that saccade velocities cannot be modified by human Ss. It also provided an important foundation for formulations in which the saccade was seen as a totally preprogrammed eye movement, (e.g Fuchs 1971, 1976; Shakhovich, 1977). There were a number of problems with the experiment, however, which casted doubt on the validity of deductions based on this result.

The absence of several important details in Yarbus' report meant that it was difficult to be certain about the precise nature of the conditions used in the experiment. From the data presented, it appeared that only between 8 and 10 trials were used in each condition. His Ss therefore had little time to become familiar with their tasks. The tasks were made more complicated by the use of a mixed rather than a blocked trials design which would have decreased the possibility of Ss developing a consistent strategy for the tasks. Yarbus also apparently

only investigated saccades within an amplitude range of 6 to 8 degs. It may be that there are important operational differences in the control of small and large saccadic eye movements (Frost and Poppel, 1976; Posner, 1978). Yarbus' apparatus for measuring eye movements, which only allowed saccade durations to be measured with a temporal resolution of 10 msec, would have left room for appreciable errors in the estimation of the durations of these small saccades, which usually only take 30-40 msec. Finally, other measures of the saccadic trajectory such as the peak velocity were not discussed in Yarbus' brief account.

Recent research has re-opened the idea that Ss may be able to influence directly the course of an individual saccadic eye movement. Viviani and Berthoz (1977) showed that the saccade trajectory could be slowed when individuals were asked to detect a key word during a large oblique saccade across a text display containing the word. Van Gisbergen, Ottes and Eggermont (1982) showed, in a double target step paradigm, that saccadic velocities can be modified in mid-flight. Also Jurgens et al. (1981) found that in a population of saccades to a given target location there was a wide range of peak velocity and duration values but the saccades still arrived accurately at the target. It should be noted, however, that the results reported by Viviani and Berthoz (1977) and Van Gisbergen et al. (1982) were obtained for saccades of approximately 30 and 40 degs which is well beyond the normal amplitude range for

naturally occurring saccades (Bahill et al., 1975).

Such observations suggested that the modification of saccades was certainly possible. Yet there has been no clear demonstration that the duration and peak velocity of horizontal saccades can be systematically modulated in the absence of direct manipulations of the nervous system (e.g. with drugs; Carpenter, 1977).

3.1.2 Overview of the Experiments

The series of experiments described in this chapter were designed to re-examine the assumption that the trajectory of a saccade cannot be systematically controlled as argued by Yarbus (1967) and others. Experiment 3.1 used a method of trial-by-trial feedback to examine the possible modification of saccades in two saccade motor tasks. This experiment used two biofeedback (BF) conditions. The 'BF-slow' task required Ss to reduce the speed of the saccade trajectory and a 'BF-fast' task asked Ss to increase the speed of their saccadic eye movement. In a further condition the effect of extended practice in the BF-slow task was investigated by training two Ss for 10 days in this paradigm. It was felt that the demonstration of the presence or absence of motor control provides important but limited information on the qualitative nature of the underlying motor system itself. The modification process would be more clearly understood if

one could also determine whether the modification of saccadic parameters approaches that of the systematic learning curve of normal human skills. The process of acquiring a motor skill or becoming more proficient in a movement task (as well as in many cognitive and perceptual skills) has a well known positive relationship with the extent of training (Newell, 1981) although single trial learning does occur in some tasks (Kay, 1965). Previous research on the modification of biological systems with feedback (cf Appendix A) have perhaps prematurely interpreted the evidence for acquired biological control in terms of a human skills acquisition model without going on to provide any evidence on the skilled characteristics of the target behaviour (see Appendix A). It was therefore considered important to determine whether saccade adjustments are all-or-nothing phenomena or whether they are sensitive to the fundamental practice effects in a similar way to other motor performance. The data demonstrated that modifications in the saccade trajectory increased by up to 40% with extended training. In experiment 3.2 individuals were tested at 5 degs. and 20 degs. target eccentricities for their ability to modify saccade velocities with continuous on-going feedback, since experiment 3.1 demonstrated that increases in saccade peak velocities were possible with the 5 deg. saccades used in that experiment. The extremely fast speeds attained during large saccades (approximately 500-700 degs/sec) suggested that further increases in the velocity of 20 deg. saccades would be unlikely. However,

there would be room for reductions in the peak velocities of large saccades in the BF-slow task. The results were generally consistent with the view that with practice the velocity of small saccades can be increased, while large saccades can be slowed. Experiment 3.3 then investigated the effects of extended practice in the BF-fast task over a period of 5 days at target movement eccentricities of 5 degs. and 10 degs. Saccadic peak velocities increased gradually for 3 out of 4 Ss during this period. Experiment 3.4 used a task which placed demands for processing a visual stimulus during the saccade execution, to determine whether the modification of saccade velocities can be adapted to the requirements of a visual task and to look in detail at the temporal region of a saccade in which modifications can occur. Thus the experiment attempted to determine whether modifications in the trajectory of the saccade are biased to one temporal vicinity or whether, as predicted by the Robinson bang-bang model, modifications are equally probable in different temporal regions. The results were consistent with Robinson's model.

3.2

Experiment 3.1

It was predicted that it should be possible, under certain conditions, for example as with highly informative feedback, to induce adjustments in the parameters of the saccadic trajectory; in particular, the duration and peak velocity. However, if saccades are the product of preprogrammed, stereotyped processes the modification of a saccade trajectory should not be possible.

3.2.1 MethodSubjects

Three post-graduate students participated in this experiment. The Ss were all naive concerning the detailed characteristics of eye movements. All Ss had emmetropic vision.

3.2.2 Procedure

This experiment used a method of trial by trial feedback to examine the modification of saccade speeds in two saccade motor tasks. In both tasks the Ss had to move their eyes to a 5 deg target jump. Two biofeedback (BF) conditions were used: 'BF-slow' and 'BF-fast'.

The BF-slow condition

In the BF-slow condition Ss were instructed to reduce the velocity of their saccadic trajectory on each trial with

respect to ten initial baseline control trials.

The BF-fast condition

In the BF-fast condition Ss were required to increase their saccade velocities. The distinction between the reaction time of a saccade and saccade velocities was first clearly explained to each subject.

Each condition consisted of 60 trials and commenced with calibration measures of the eye movement registration apparatus (see chapter 2). This calibration was repeated every 20 trials. The first ten trials in the feedback conditions were used as baseline trials. The Ss were instructed to follow the movement of the target accurately without attempting to adjust saccade velocities until the onset of the feedback information on trial 11. A trial was initiated by the subject who controlled a push button. At the start of the trial the target was positioned at the central fixation position of the oscilloscope. On the initiation of a trial a high contrast visual spot target was displaced 2.5 degs. to the left or right (this direction was randomised). Ss were required to fixate this target until it jumped 5 degs. across the display 3 secs later and remained there for 2048 msec. Ss were required to modify their saccade trajectory to this step. The end of the eye movement sampling and also the trial was signalled by the return of the target to the central fixation position. Ss were encouraged to proceed at their own pace, and to pause whenever necessary.

Each S also took part in a control session, with no feedback, in which they were instructed to track as accurately as possible the movement of a target step which occurred on that trial. As in the other two conditions Ss controlled the initiation of a trial by a start button. A trial began with the target for the eye movement in the central screen position. Following the start signal the target shifted 0.5 degs. to the left or right for 3 secs, after which the target jumped twice this distance to the opposite corresponding screen position. The size of the target jump was incremented by 1 deg. every ten trials for fifty trials. The only subject requirement was to follow the movement of the stimulus as accurately as possible.

Ss were told that this was not a reaction time experiment, but that the aim of the task should be to modify the speed of the eye trajectory once it was initiated. The Ss were informed that the purpose of these conditions was to determine whether they were able to adjust the speed of saccadic eye movements, and that to help them achieve this visual and auditory feedback on the peak velocity of their eye would be provided following each trial. Analogue information was provided in the form of a computerised DAC unit measure of the saccade peak velocity. This was presented on the screen approximately 1 sec after the eye movement for the duration of that trial. A visual binary feedback signal, an asterisk ('*') indicating a satisfactory level of performance, was based on a criterion of 0.5 standard deviation outside the mean of

the baseline control velocities obtained at the start of the feedback sessions. In addition, an auditory tone, whose frequency was related monotonically to the saccade peak velocity, was provided.

Extended Training Condition

Two further Ss took part in a condition in which they were given practice in the BF-slow paradigm for ten days. The details of the training procedure were identical to the BF-slow condition described above. On day 1 baseline control data on saccadic characteristics were obtained. Ss were given 40 practice trials only (to reduce any possible effects of fatigue) on each day for ten consecutive days. Eye movements were sampled at 500 Hz. The data presented here were taken from the initial saccades on a given trial.

3.2.3 Analyses and Results

Saccade Peak Velocity and Duration

The analysis of individual records revealed that Ss appeared to use a regular strategy in their efforts to reduce saccade speeds in the BF-slow task. On a large proportion of trials in this condition Ss produced a regular sequence of hypometric saccades (or 'multiple

saccades') which ultimately took the eye to the target position. Therefore, as saccade peak velocities and durations are a function of saccade amplitudes they were treated by using the amplitude of the saccade in the calculation of any differential velocity effects. The standard deviations showed that the variances of the control and feedback conditions were not homogeneous and this was confirmed by F-tests on the variances. The control and feedback data were therefore analysed in a t-test for data with unequal variances (Edwards, 1970). Plots of the data are shown in fig. 3.8 and fig. 3.9. The data from each session were also analysed in a linear least squares regression analysis of amplitudes against peak velocities and durations. The regressions were found to be highly significant ($p < 0.0001$ level for the slopes of amplitude / velocity and $p < 0.001$ for the amplitude / duration relationships). In experiment 3.1 the curves accounted for 70% to 98% of the variance in saccade velocities. More complex curves could have been developed to describe each individual trend, but this was not necessary as the prime object was to determine whether saccades in the feedback and control conditions were significantly different from each other. The velocity and duration of saccades produced in the feedback conditions were compared to the control values by calculating the duration and velocity of saccades of equivalent amplitudes obtained in the control condition.

Ss showed saccade duration increases in the BF-slow

condition of 5.7 msec (S1), 8.9 msec (S2) and 13.2 msec (S3); (S1:t=4.73, df(1/45), $p < 0.005$; S2:t=3.98, df(1/47), $p < 0.005$; S3:t=14.17, df(1/47), $p < 0.005$). Table 3.1 shows that no S successfully reduced peak velocities in the BF-slow condition. Velocities increased from mean levels by 9.3 degs/sec, 13.6 degs/sec and 30.2 degs/sec in the BF-fast conditions (S1:t=3.22, df(1/59), $p < 0.005$; S2:t = 5.82, df(1/52), $P < 0.005$; S3:t=4.21, df(1/46), $P < 0.005$). S1 also had increased velocities in the BF-slow session. Note that no S shortened a saccade duration from the control performance. One S showed longer durations in the BF-fast condition than in the control condition but this S showed the largest increase in saccade durations in the BF-slow task.

Correlations

Table 3.2 shows that the amplitude / peak velocity Pearson product-moment correlation coefficients are still very strong in each condition. In the control conditions correlations of approximately 0.9 and 0.8 are found for the amplitude / duration relationships. These correlations are clearly reduced in the BF-fast and BF-slow conditions, showing that in the feedback conditions there was an increased variability in this relationship. This result shows firstly, that a weakening in the saccade duration / amplitude relationship can occur independently of any overall changes in the baseline level of saccade durations as manifested in the BF-fast



Peak Velocities and Durations

	Ss	BF-slow	Control	DF	p	BF-fast	Control	DF	p
1	PV	122.1(67.7)	122.4(69.8)	1/45	>0.45	219(44.2)	209.7(40.1)	1/59	<0.005
	D	37.2(12.3)	31.5(10)	1/45	<0.005	46.7(15.5)	43.8(5.7)	1/59	>0.05
2	PV	164.3(80.3)	149.4(81.1)	1/47	<0.005	249(44.1)	235.4(40.9)	1/52	<0.005
	D	44.3(15.2)	35.4(5.7)	1/47	<0.005	44.5(8.1)	43.7(3.3)	1/52	>0.25
3	PV	178(65.6)	178.6(62.6)	1/47	>0.4	334(91.6)	303.8(70.2)	1/46	<0.005
	D	40.5(8.9)	27.3(5.6)	1/47	<0.005	49.4(17.6)	38.8(6.0)	1/46	<0.005

Table 3.1. Details of the t-tests (Edwards, 1970) statistical analyses of saccadic peak velocities and durations. The table shows the mean values and standard deviations (in parenthesis) in each experimental condition. Saccadic peak velocities are significantly increased in BF-fast condition and saccadic durations are increased in the BF-slow condition. BF - biofeedback, DF - degrees of freedom, p - probability level, PV - peak velocity, D - duration.

Correlations (r)

	Control	BF-fast	BF-slow
N	50	53	48
S1 A/PV	0.994	0.992	0.93
A/D	0.823	0.229	0.287
N	50	47	48
S2 A/PV	0.96	0.877	0.957
A/D	0.82	0.48	0.641
N	49	50	48
S3 A/PV	0.932	0.845	0.863
A/D	0.911	0.446	0.576

Table 3.2. Pearson product-moment correlation coefficient (r) of the amplitude / peak velocity (A/PV) and amplitude / duration (A/D) relationships. The A/PV correlations are close to 1.0. In contrast the A/D correlations are reduced in the BF-fast and BF-slow conditions from the control levels.

conditions. Secondly, the increased durations cannot have been the result of simply increasing saccade amplitudes.

The Multiple Saccade Response

An analysis of individual records revealed that Ss were frequently using a regular strategy in their efforts to reduce saccade speeds in the BF-slow task. On a large proportion of trials in this condition Ss produced a regular sequence of hypometric movements which ultimately took the eye accurately to the target location (fig. 3.3). These saccade sequences will be referred to as 'multiple saccades'. A multiple saccade is defined here as a sequence of hypometric movements in which the initial component is less than 60% of the final eye position. Further analysis of these saccade trajectories showed that they were partly responsible for an inverse relationship observed for saccade amplitude and saccade reaction times in the BF-slow condition. Multiple saccades will be discussed in more detail in chapter 4.

Saccade Latency

A dramatic effect of the BF-slow task on saccade reaction times is illustrated in fig 3.4. In a similar way to the effects on saccade velocities, saccade latencies in the BF-slow condition were modified, and in this case lengthened, within two or three trials following feedback onset. This increase was maintained for the duration of

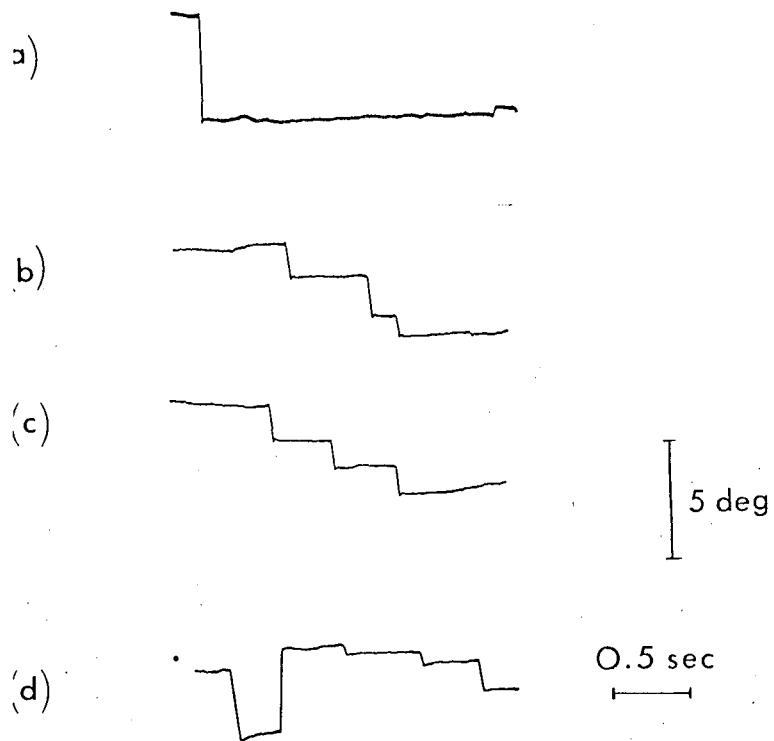

Fig. 3.3. Multiple saccades. (a) single component saccade, (b) and (c) multiple saccades, (d) multiple saccades preceded by a reflex single saccade to the target.

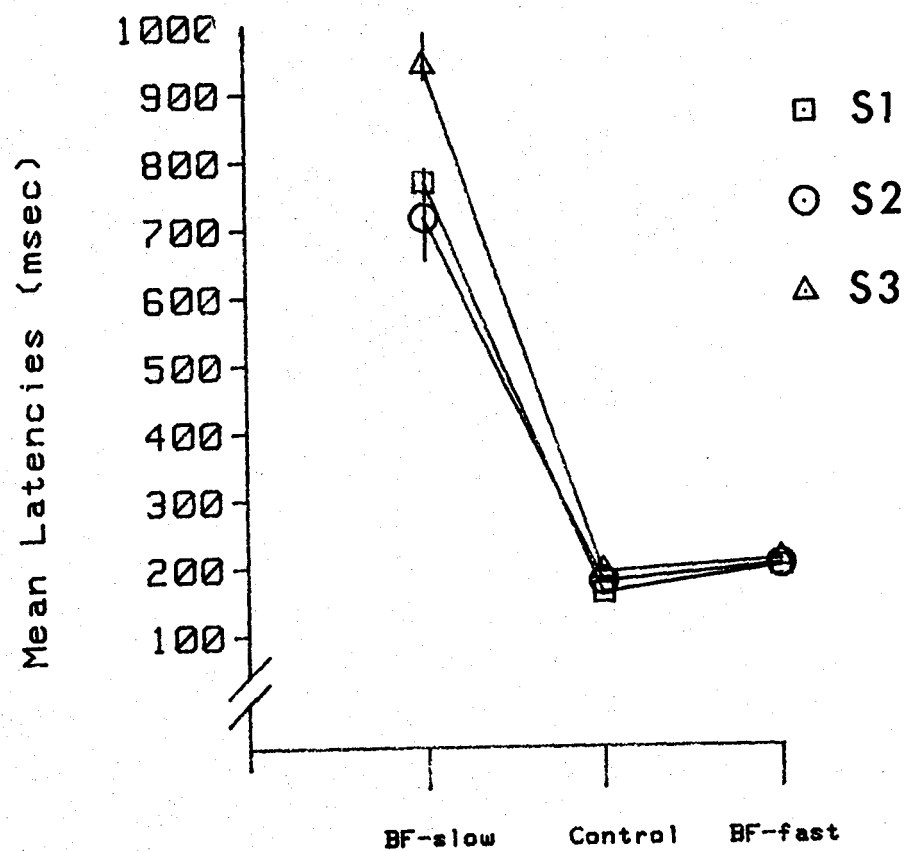

Fig. 3.4. Mean saccadic latencies. Saccadic latencies are markedly slowed in the BF-slow condition. Where standard error bars are not shown these were less than the diameter of the symbols. BF - biofeedback.

the sessions.

Enhanced saccade latencies occurred concomitantly with an increase in variability, as indicated by the standard error markers (fig. 3.4). However, if the variability is taken as a proportion of the absolute latency, the enhanced deviations found in the BF-slow condition become similar to those in other conditions.

Extended Training Condition

Peak Velocity

Fig. 3.5 show the changes in peak velocities relative to the initial velocities measured on day 1. No significant trend for peak velocities were observed over the training sessions. The mean changes in peak velocities across the entire training period were 1.14% for S1 and 7.93% for S2. The correlations for saccade amplitudes and peak velocities were also unchanged. There were reliable amplitude / velocity correlations on every day (fig. 3.6).

Saccade Duration

Fig. 3.5 also illustrates the changes in saccade durations. The change in saccade durations from the control levels increased from initial values of 8%(+) and 3.6%(-) on day 1 to final values of 49%(+) and 21%(+) on day 10. The modification of saccade durations increased,

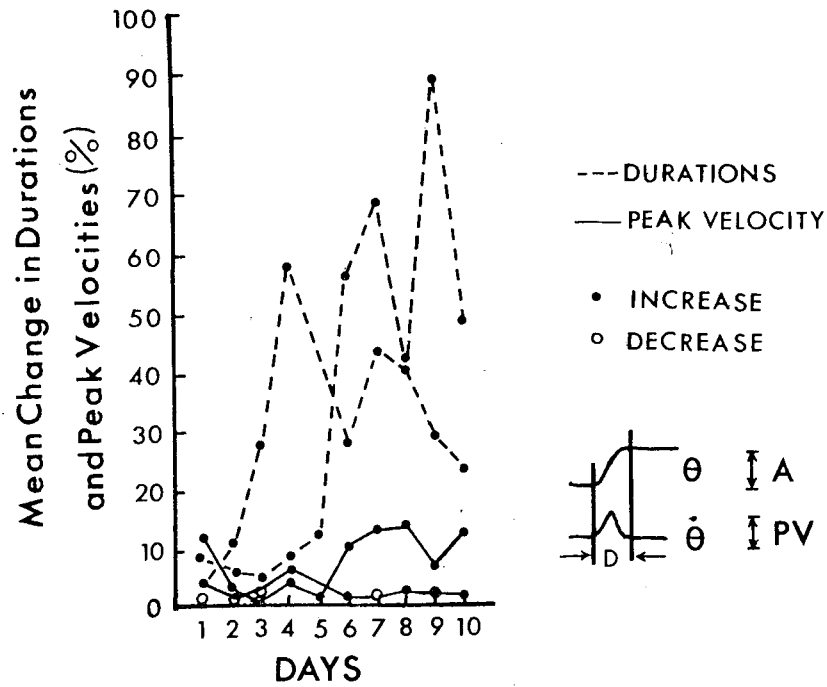

Fig. 3.5. Change in peak velocities (PV) and durations (D) of saccades over the 10 day training period. Saccade durations are modified to a much greater extent than peak velocities. A - Amplitude.

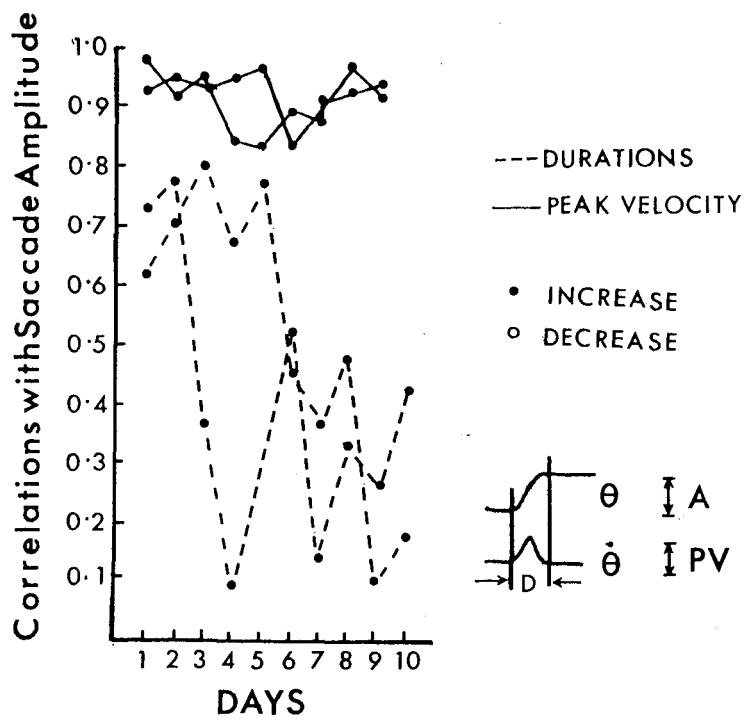

Fig. 3.6. Session by session change in Pearson's product-moment correlation coefficient (r) of peak velocities (PV) and durations (D) with saccade amplitude (A). D - duration.

although nonlinearly, with further training. The curve showing lengthening of saccade durations was largely isomorphic with that showing the fall in the amplitude / duration correlations, confirming that neither the within or the between session modulation of saccade durations can be adequately accounted for solely in terms of adjustments in the saccade amplitudes.

Saccade Latency

Fig. 3.7 shows the mean saccade latencies for both Ss. Clearly the BF-slow task induced large delays in the initial saccadic responses to the target movement. This effect occurred almost immediately, within the first 2 or 3 trials of the BF-slow task. Such lengthened reaction times persisted in all the sessions.

3.2.4 Summary

1. Trial-by-trial feedback training in the modification of saccade speeds can induced changes in saccade movement durations, such that saccade durations are increased in the BF-slow task relative to a control condition. This effect is enhanced when training is distributed over several days.
2. In feedback conditions saccade movement duration time and saccade amplitude are modified such that the strength of the relationship is reduced from the control condition.

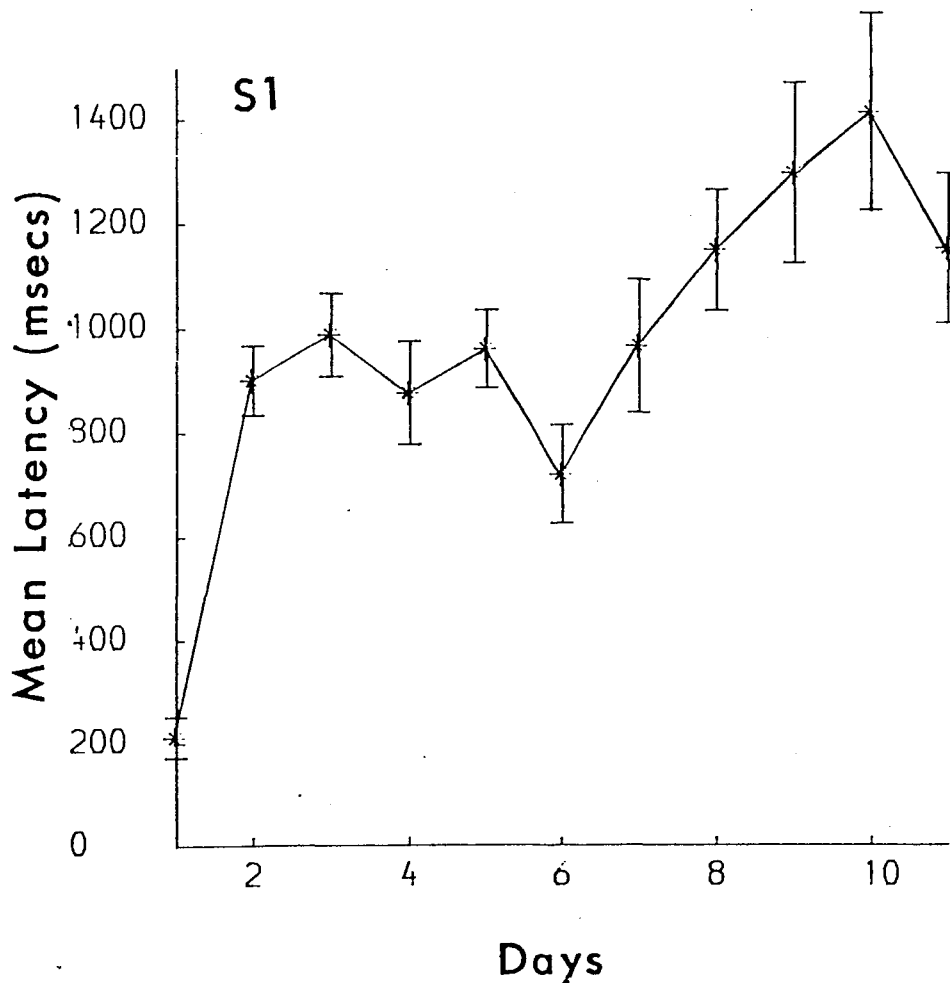
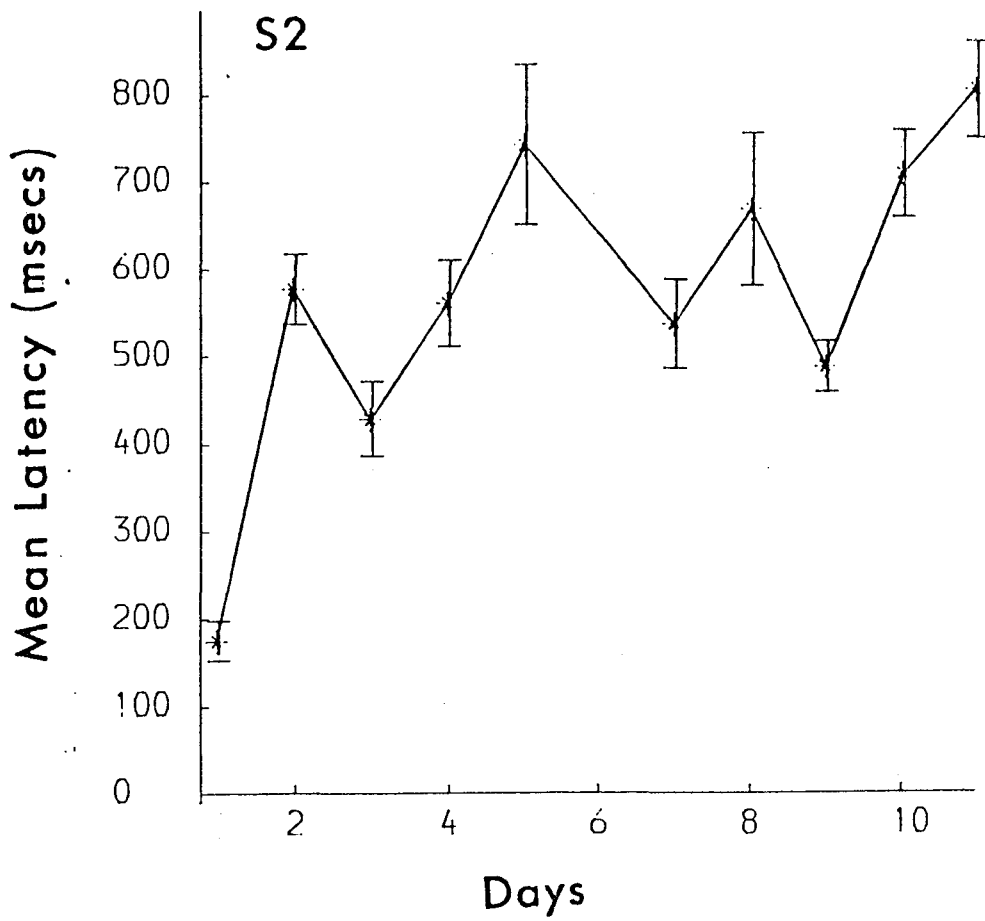

Fig. 3.7. Mean saccadic latencies and standard errors in the extended BF-slow task. Saccade latencies increase during the training period. Normal latencies are demonstrated in the control session at the beginning of the training period.

3. The usual high correlations for peak velocity and saccade amplitude is maintained in all conditions.

4. The limitations of modifications in this experiment were indicated by the moderate increase in peak velocities in the BF-fast condition and in the absence of any lowering of the peak velocities or saccade durations relative to the control conditions.

5. Performance in the BF-slow task revealed the 'programming' of multiple saccades. It was suggested that these multiple saccades were responsible for the grossly lengthened saccade latencies in this condition. This will be discussed separately in chapter 4.

3.2.5 Discussion

The results demonstrate that modifications in the dynamic components of 5 deg. saccades are possible and would therefore seem to be incompatible with the view that saccades are fundamentally stereotyped mechanisms.

The results show that the modification of one parameter relationship does not necessarily simultaneously affect the values of other saccade characteristics. This was shown by the velocity and duration correlations with saccade amplitude. While amplitude / duration correlations were reduced in the feedback sessions, no effects were evident on the peak velocity / amplitude

correlations. Interestingly, further analyses showed that in the BF-slow sessions there was also a fall in the correlation of amplitude with peak acceleration as calculated from a mathematical differentiation of the velocity data arrays.

The modification of saccade durations and the relationship with saccade amplitudes showed that the saccadic system is sensitive to the degree of practice. This widespread feature of learned experience might seem to begin to provide empirical support for theories of biological modifications developed in terms of processes for acquiring or enhancing a motor skill where practice effects are well known. More research on this large issue is clearly required to determine the significance of other important variables, such as the frequency of information feedback and the distribution of practice on the modification process before we can put forward categorical conclusions on the status of the motor skill model in feedback research (see general discussion).

Experiment 3.1 showed that the saccadic system is able to modulate the duration of the signals generating a saccade depending on the demands imposed by a saccade movement task. This mechanism apparently has the capacity to modify a saccade duration, while permitting the saccade amplitude to be less restricted by the saccade duration when it does so.

The finding that it is possible to lengthen the duration of a saccade while inducing no general variations in the peak velocities implies that these saccade parameters may be determined by different components of the neurophysiological input. This is therefore consistent with neurophysiological research on this question. Schiller (1970) for example has shown that cells in the oculomotor nucleus increase their firing durations as the saccade amplitude increases although the frequency of response remains constant. Thus, saccade peak velocities can apparently be modified with the aid of feedback methods, although the possibility of adjustments in arousal states etc. cannot be ruled out.

Increased saccade durations have been observed previously in a patient with oculomotor paresis (Abel et al., 1978; but see Optican and Robinson, 1980), spinocerebellar patients (Zee et al., 1976) as well as with patients under the effects of alcohol and drugs (Carpenter, 1977). Although these effects have usually been observed with large saccade amplitudes. Abel et. al. (1978) concluded from their observations that the central mechanism responsible for saccades can 'selectively alter the operation of different aspects of the saccadic system'. These results provide further support for this view by demonstrating that the duration of saccades 5 degs and smaller can be lengthened, particularly with extended feedback practice.

Nevertheless, the results also make the point that trial-by-trial feedback is not sufficient to reduce the normal levels of saccade peak velocities or the tight relationship between saccade amplitudes and peak velocities. Therefore, in Experiment 2, continuous on-going feedback was used in an attempt to stimulate clear and reliable modifications of saccadic peak velocities. The use of this second form of feedback was encouraged by previous reports on its use in biofeedback studies (Yates, 1980). It was felt that it was crucial to distinguish between the limiting boundaries of plasticity characteristic of a specific feedback mode and the possible functional or generic physiological constraints in the control of saccades.

3.3

Experiment 3.23.3.1 Introduction

Previous demonstrations of the slowing of saccade peak velocities by using drugs have been confined to large saccades in the order of 20 to 60 degs. A number of experimenters have suggested that different control principles may apply to the regulation of small and large saccades (e.g Posner, 1978; Frost and Poppel, 1976). The fact that large saccades can attain peak velocities of 500-700 degs/sec and are the fastest movements of which the body is capable, suggests firstly that further increases in these peak velocities might be unlikely if they already travel at maximum velocities; and secondly, that large saccades might be amenable to attempts to induce a lowering of saccade velocities. Such an effect of baseline saccadic velocity levels would be reminiscent of the law of initial values frequently used in psychophysiological research.

Extensive research in the field of psychophysiology has shown that direct feedback is particularly effective in the modification of many biological systems (Schwartz and Beatty, 1977). Also continuous on-going feedback had already been successfully used in research on the control of congenital nystagmus eye movements (Abadi et al., 1979). In the following study direct on-going

feedback was therefore used to try to determine the plasticity of saccadic peak velocities as a function of saccade amplitude.

3.3.2 Method and Procedure

Eight Ss were tested for their ability to increase or decrease the speed of their saccadic eye movements. Ss were divided equally amongst the BF-fast and BF-slow tasks. They were asked to saccade between two point targets spaced at either 5 or 20 degs. of visual angle. The larger target amplitudes were used because it may be that the shorter duration of small saccades leaves insufficient time for any reductions in saccade velocity to occur. In addition 20 deg. saccades would avoid the possible floor effects on the lowering of saccade velocities, since they have much higher velocities than 5 deg. saccades. The converse would be true for increasing the speed of saccades.

In each condition two Ss were tested at each target eccentricity. Saccadic peak velocities were measured immediately before, during and after auditory feedback information trials. This feedback procedure used a variable analogue tone whose frequency was modulated with the position of the eye. Although the range of tone variation depended to some extent on the gain setting of the eye movement recording system, which could differ slightly for each S. A 20 deg. saccade corresponded

approximately to a change in tone frequency from 1 KHz to 3.5 KHz. Velocity information was given by the contingent relationship of the eye velocity and the gradient of the tone frequency modulation. Each S was also tested at different eccentricities in an equivalent control condition, without feedback, when the instructions were to saccade normally. Eye movements were recorded in a darkened room to minimize the effect of any distracting visual stimuli.

The Analyses

Fig. 3.8 and fig. 3.9 show the relationships between saccade amplitudes and peak velocities for the range of amplitudes used in this study. The data were analysed as in experiment 3.1 by evaluating peak velocities and durations of saccades of equivalent amplitudes in the control and feedback conditions. These velocities were then analysed in a t-test (Edwards, 1970; see experiment 3.1) by comparing the experimental and control sessions for each S's data. A further analysis was used to determine the significance of the changes in the two coefficients of the regression relationships, namely the slope and the intercept. The saccadic amplitudes and velocities obtained in each session were fitted to linear regression of the form $Y = mX + c$. The data for each session was analysed by calculating two F values. F_s , represented the F-statistic for the statistical significance of the difference between the slopes for the baseline saccades

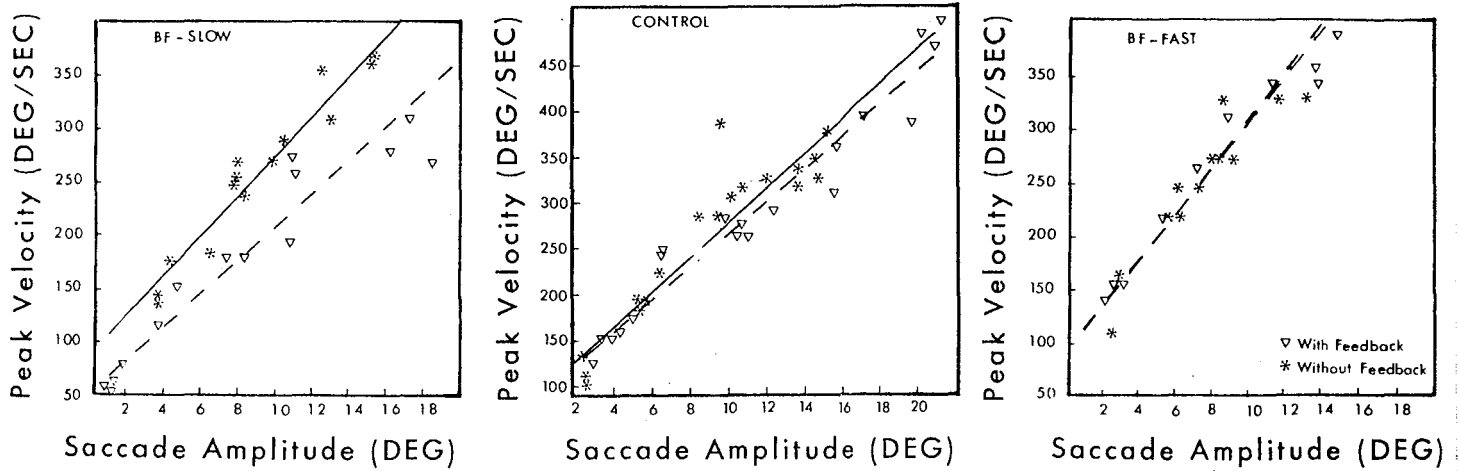

Fig. 3.8. The amplitude / peak velocity relationships were within the limits of a least squares linear regression analysis. The regressions lines accounted for between 75% and 98% of the variance. This comprised one of the analyses used to compare saccadic behaviour in the BF-slow, BF-fast and the control conditions. BF - biofeedback.

before feedback and for the final feedback saccades of each session with feedback. This analysis tested the null hypothesis $H_0: m(1) - m(2) = 0$, (Seber, 1977). This showed whether there was any significant change in the slope or gradient of the amplitude / velocity regression relationships. A second F-statistic, F_c , was calculated to test the $H_0: m(1) - m(2) = 0$ AND $c(1) - c(2) = 0$, where c represented the intercept of the curve on the Y-axis. If the relationships were in fact parallel but with a significant offset this would be shown by the second analysis. The mathematical details of these calculations are described in appendix B.

3.3.3 Results

Peak Velocity and Duration

The t-tests showed that under the instructions to speed up the eye movement, peak velocities were only raised in the 5 deg BF-fast condition (see table 3.3) where mean saccade velocities increased by +16.2 deg/sec and +66.1 deg/sec (S5: $t = 4.89$, $p < 0.005$; S6: $t = 5.25$, $p < 0.005$) while in the 20 degs. BF-fast condition velocities changed by 1 deg/sec and -84 deg/sec (S7: $t = 0.11$, $p < 0.45$; S8: $t = 14.6$, $p < 0.005$). The fall in saccade velocity for the second S in the BF-fast condition would seem to be consistent with the view that large saccades are more easily slowed than speeded up (see below). In the BF-fast

Peak Velocities and Durations

Ss	TE		BF-slow	Control	BF-fast	DF	p
1	20	PV	233.1(78.6)	263.6(83.2)		1/14	<0.01
		D	74.1(26.5)	64.8(17.3)			
2	20	PV	191.5(109)	285.6(147)		1/14	<0.005
		D	62.4(27.5)	56.8(13.5)			
3	5	PV	170.9(46.8)	172.2(54.3)		1/14	>0.35
		D	34.0(1.85)	28.6(6.1)			
4	5	PV	116.1(29.9)	153.6(31.5)		1/14	<0.005
		D	36.7(9.1)	38.4(9.6)			
5	5	PV		140.4(51.7)	206.5(73.1)	1/14	<0.005
		D		29.8(9.2)	32.9(13.1)		
6	5	PV		179.5(13.9)	195.7(20.4)	1/13	<0.005
		D		29.8(7.7)	39.2(3.9)		
7	20	PV		335.8(139)	336.9(158)	1/12	>0.45
		D		49.4(12.5)	51.2(17)		
8	20	PV		451.7(57.1)	367.6(67.2)	1/14	<0.005
		D		59.6(11.5)	70.2(14.4)		

Table 3.3. Details of the analyses of feedback and control saccades. Note the reduction in peak velocities (PV) of the 20 saccades in the BF-slow condition and the increase in peak velocities in the BF-fast 5 deg saccades. Standard deviations are shown in parenthesis. TE - target eccentricity, DF - degrees of freedom, p - probability level, BF - biofeedback, D - duration.

5 deg. condition one S enhanced peak velocities by the end of the session while the slope of the amplitude / velocity curve was unchanged ($S6:F_s = 0.01$, $p > 0.05$, $F_c = 6.93$, $p < 0.05$). The other S showed no significant change before and with feedback ($S6:F_s = 0.12$, $p > 0.05$; $F_c = 0.17$, $p > 0.05$). Three out of four Ss were able to slow saccades by the end of the BF-slow condition. These modified saccades had peak velocities which fell below the normal saccade amplitude / velocity relationship (see fig. 3.9). The reductions in peak velocities represented mean changes of 30.5, 94.1, 37.5 and 1.3 degs/sec respectively. Two of these Ss were trained in the 20 deg. target amplitude condition. ($S1: t = 2.8$, $p < 0.01$; $S2: t = 6.44$, $p < 0.005$; $S4: t = 12.3$, $p < 0.005$; $S3: t = 0.37$, $p > 0.35$).

The linear regression slope / coincidence analysis also confirmed that saccades were reduced by the end of each feedback session for these three Ss ($S1:F_c = 14.97$, $p < 0.01$; $S2:F_c = 33.68$, $p < 0.01$; $S4:F_c = 26.1$, $p < 0.01$; $S3:F_c = 2.36$, $p > 0.05$) although slopes of the amplitude / velocity functions were not significantly changed from the control sessions. Saccade durations were also lengthened in these BF-slow trials, which suggested that the saccades may have been controlled in a feedback loop in accordance with the model proposed by Jurgens et al. (1981).

Inspection of the velocity profiles of slowed saccades

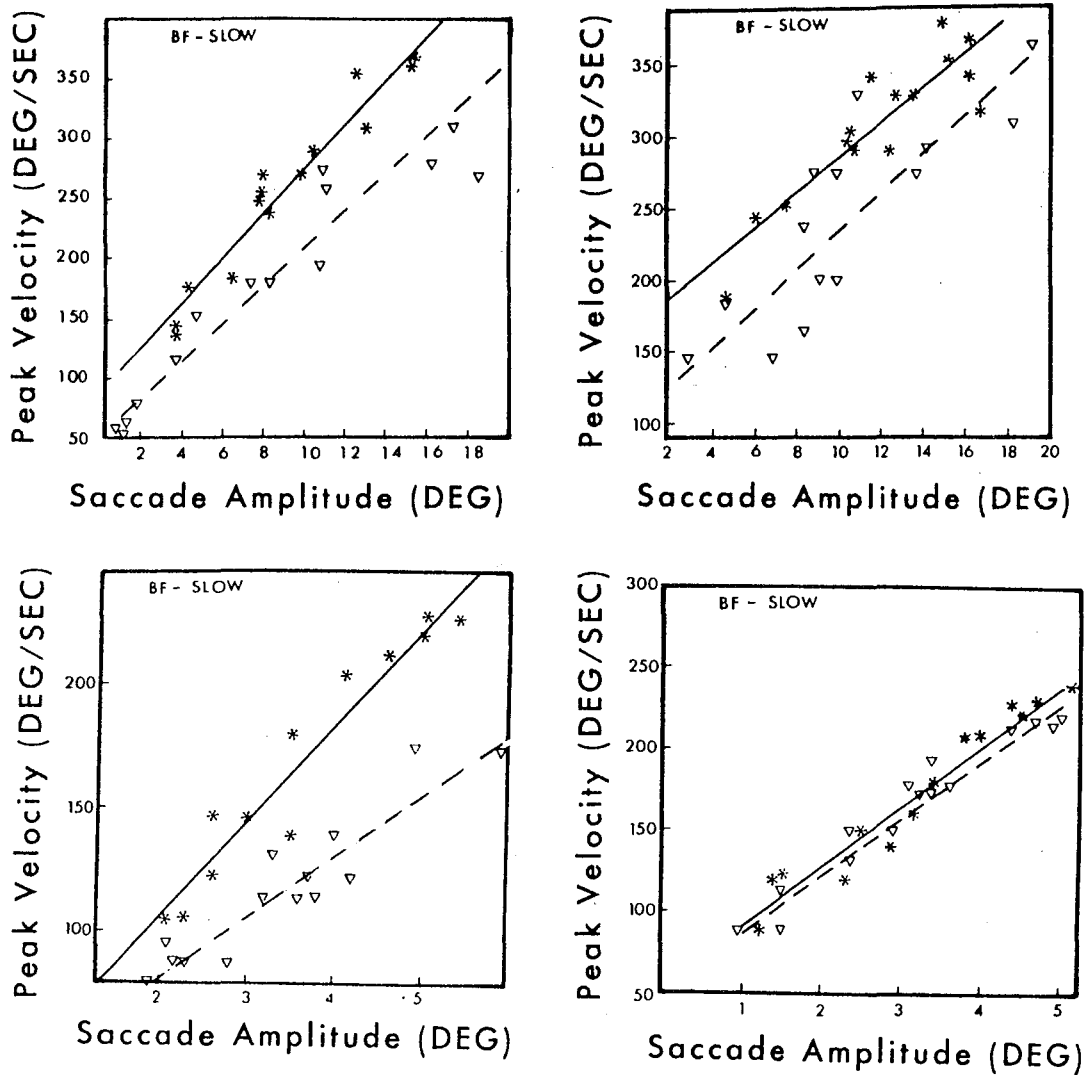
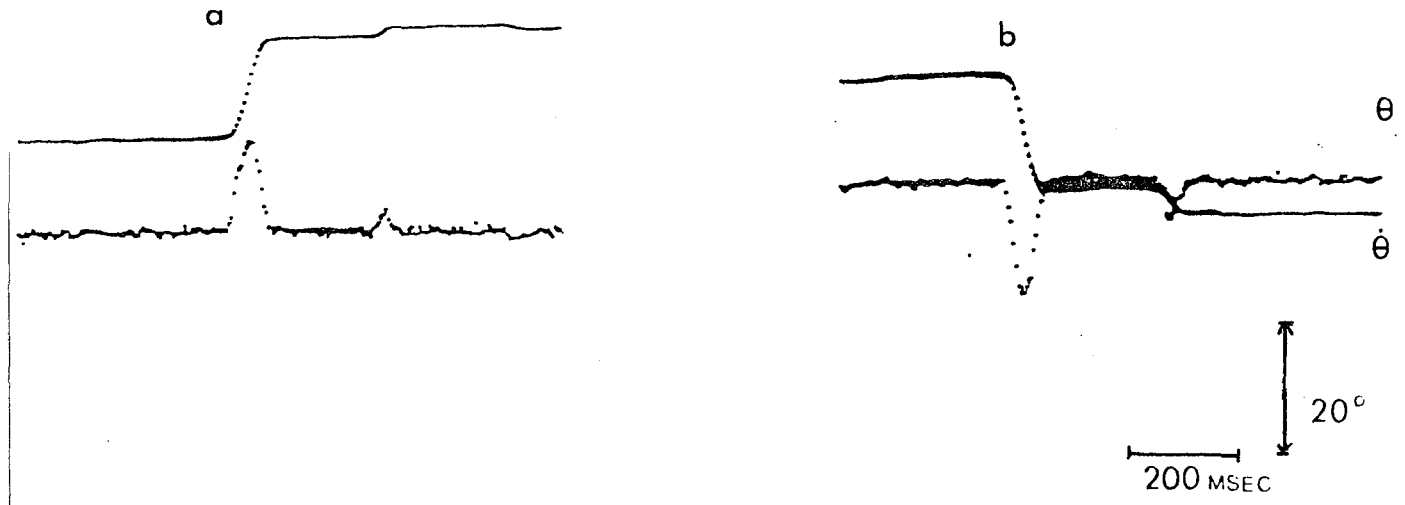

Fig. 3.9. Saccade amplitude / peak velocity regression lines. In 3 of the 4 subjects saccade peak velocities are reduced after training with continuous auditory feedback. BF - biofeedback.



Modified Saccades

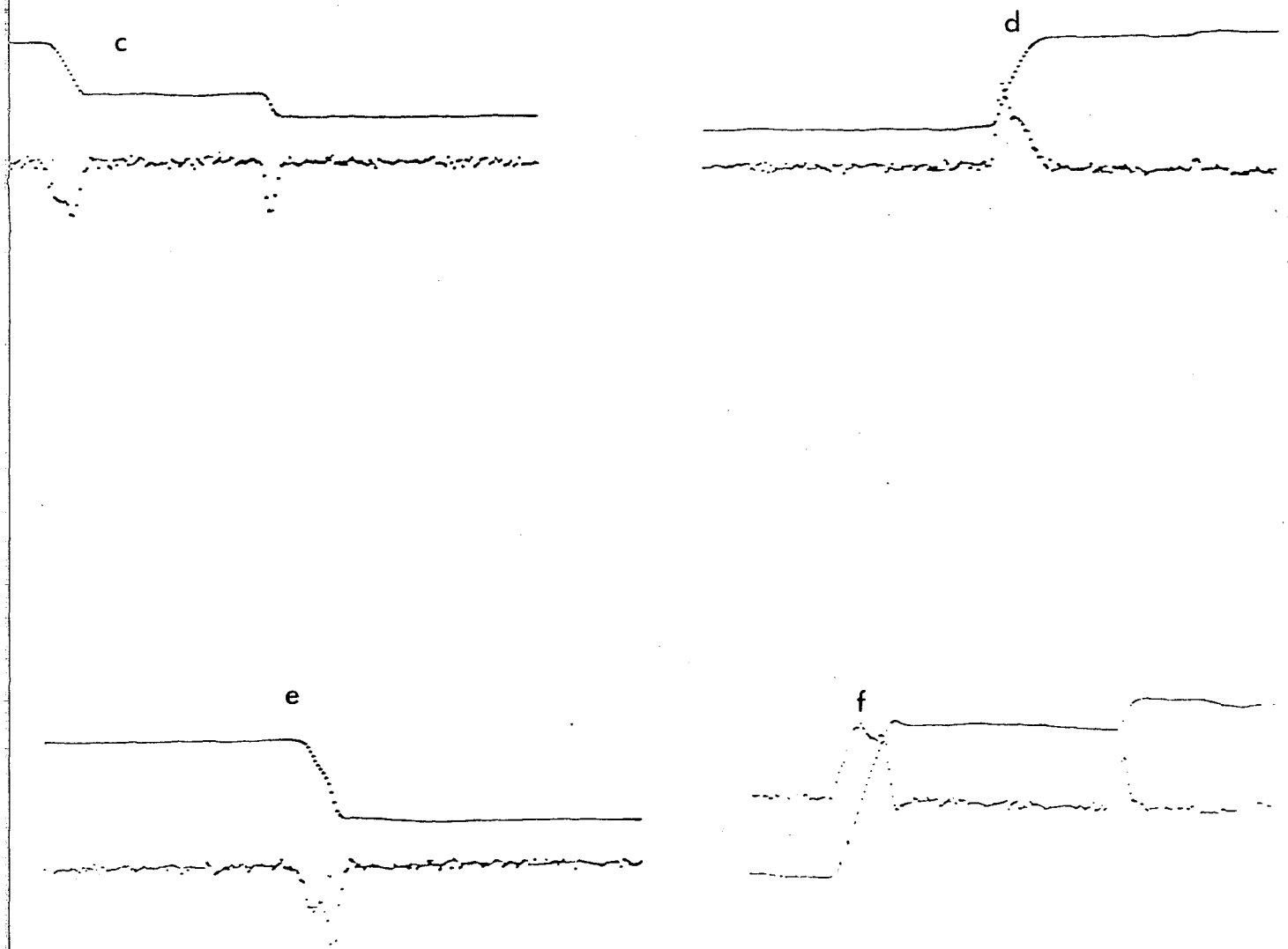

Fig. 3.10. Normal saccades have a single sinusoidal-like peaked waveform. Modified saccades have a discontinuous velocity waveform as shown in records c, d, e and f.

showed that the usual single peak was occasionally replaced by a double peak trajectory (see examples in fig. 3.10). Subsequent tests immediately after feedback training showed that normal velocity saccades were evident within 10-15 responses.

Correlations

The correlations for amplitude / velocity and amplitude / duration relationships are shown in table 3.4. As previously observed in experiment 3.1 correlations of 0.9 were produced for the amplitude / peak velocity relationships. The amplitude / duration correlations were weakened in the feedback trials relative to the relationships before feedback. However, this effect was small, the difference being usually less than 0.2.

Saccade Latencies

In the feedback conditions latencies were compared for baseline values before feedback and for saccades with feedback. Table 3.5 shows the results for 5 degs. and 20 degs. target eccentricities respectively. The longest responses were produced in the BF-slow condition and the fastest saccade responses were found in the BF-fast condition. However, whereas with trial-by-trial feedback saccade latencies in the BF-slow task were in the order of 800 msecs, mean saccade latencies were usually less than

Correlations (N=15)

Ss	TE		BF-slow	Control	BF-fast
1	20	A/PV	0.866	0.955	
		A/D	0.829	0.843	
2	20	A/PV	0.945	0.93	
		A/D	0.913	0.927	
3	5	A/PV	0.823	0.947	
		A/D	0.148	0.836	
4	5	A/PV	0.928	0.974	
		A/D	0.84	0.691	
5	5	A/PV		0.978	0.775
		A/D		0.965	0.67
6	5	A/PV		0.97	0.969
		A/D		0.97	0.878
7	20	A/PV		0.966	0.983
		A/D		0.905	0.884
8	20	A/PV		0.94	0.949
		A/D		0.926	0.884

Table 3.4. Correlation coefficients of amplitude / peak velocity (A/PV) and amplitude / duration (A/D) relationships. TE - target eccentricity, BF- biofeedback.

Latencies (msec)

Ss	TE	BF--slow	Control	BF--fast
1	20	379 (111)	270 (48)	
2	20	374 (80)	156 (39)	
3	5	271 (116)	197 (18)	
4	5	564 (199)	188 (51)	
5	5		241 (43)	164 (49)
6	5		246 (49)	199 (13)
7	20		249 (87)	252 (66)
8	20		306 (185)	170 (42)

Table 3.5. Mean saccade latencies and standard deviations. TE - target eccentricity, BF - biofeedback.

400 msec.

3.3.4 Summary

1. These results demonstrated that in addition to the lengthening of saccade durations the saccadic system can also slow the peak velocity.

2. The data also indicated that saccades in the 20 deg target condition were more consistently slowed than saccades in the 5 degs. condition. This is consistent with Frost and Poppel (1976) and others who have suggested that the processing of small saccades may be characterised by processing limitations that do not necessarily apply to larger saccades.

3.4

Experiment 3.33.4.1 Introduction

Experiment 3.1 demonstrated that with feedback Ss can increase the peak velocity of saccades of 5 degs. or less. Experiments 3.1 and 3.2 suggested that although the trajectory of a saccadic eye movement might be slowed relative to a control condition, increases in the speed of a saccade are less readily obtained with large saccades. Experiment 3.1 had also shown that the effect of trial-by-trial feedback could be enhanced if the training was distributed over several days. In this Experiment two further questions were posed: Firstly, does extended practice also enhance performance in the BF-fast task, (as it might not necessarily be that increasing and decreasing the velocity of an eye movement involves complementary mechanisms) ? Secondly, as the 20 deg. target eccentricity was outside the range of normal occurring saccades, which are usually less than 15 degs., could the velocity of a saccade directed to a 10 deg. target be enhanced ?

3.4.2 Method and Procedure

Four undergraduate students participated in this study. The details of the training conditions were identical to the BF-fast condition described in experiment 3.1, with

the exception that in this study Ss received 40 feedback trials in each session as in the extended BF-slow condition. The task of the Ss was to try to increase the speed of their saccades with the benefit of the post-trial saccade velocity feedback information (see Experiment 3.1). Two Ss were trained with a 5 deg. target step and two Ss with a 10 deg. step target movement. Each S was trained in this task for 5 days.

3.4.3 Results

Peak Velocity

As in previous experiments peak velocities and durations were analysed with respect to saccades of equivalent amplitudes in the baseline condition. Fig. 3.11 shows that peak velocities across the training sessions increased for three of the four Ss. Two Ss displayed faster velocity saccades on day 2 and one S showed increased velocities by day 3 of feedback training. The one S who showed only small enhancements in saccade velocities came from the 10 deg. target condition.

Saccade Duration

Fig. 3.12 shows that as in previous attempts to induce shortened saccade durations, no reliable decreases were found (for three out of four Ss). For S1 saccade duration

PEAK VELOCITY INCREASE (DEG/SEC)

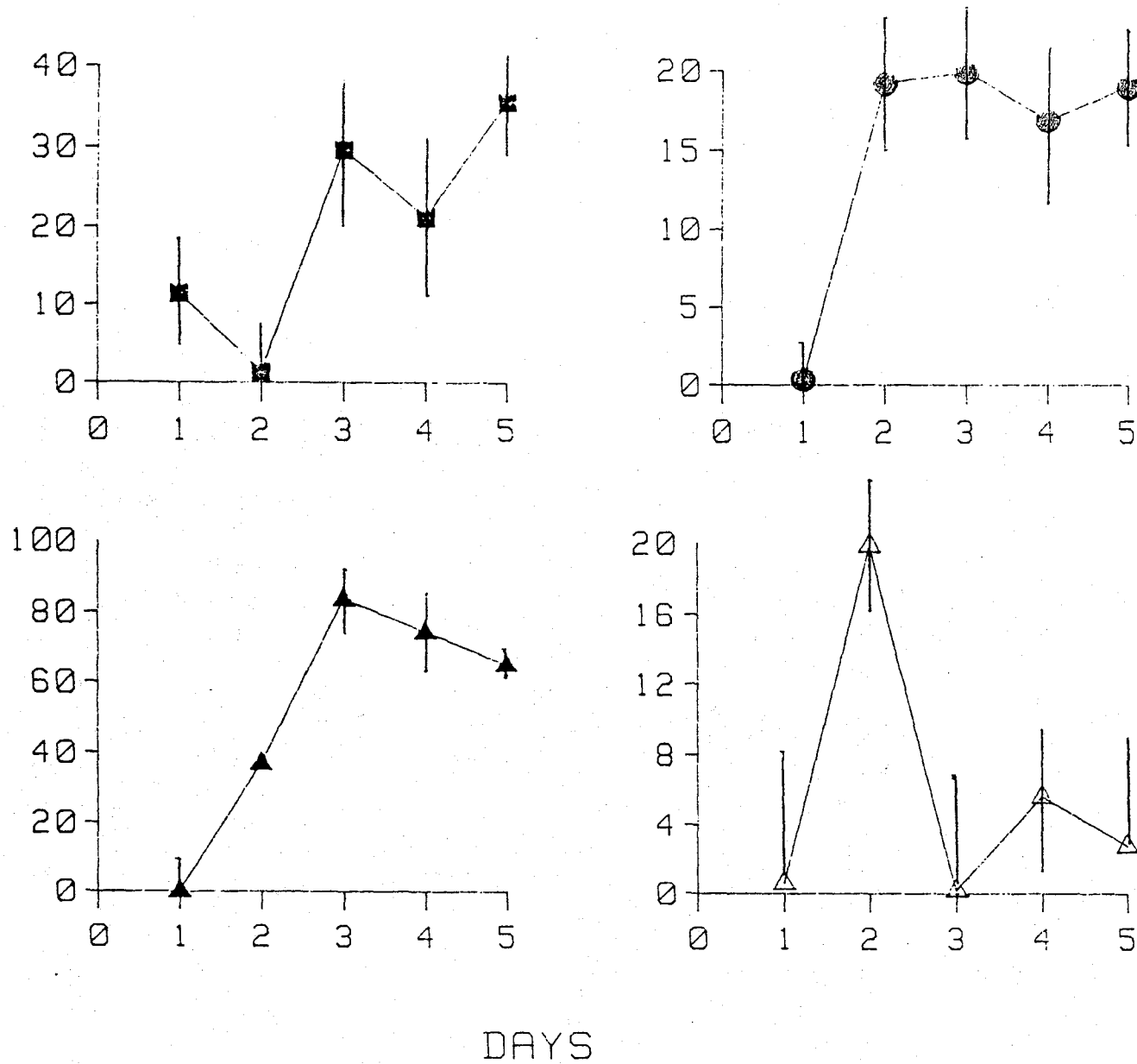

Fig. 3.11. Change in peak velocities of four subjects in each training session from the pretraining levels. The error bars show standard errors of peak velocities in each session.

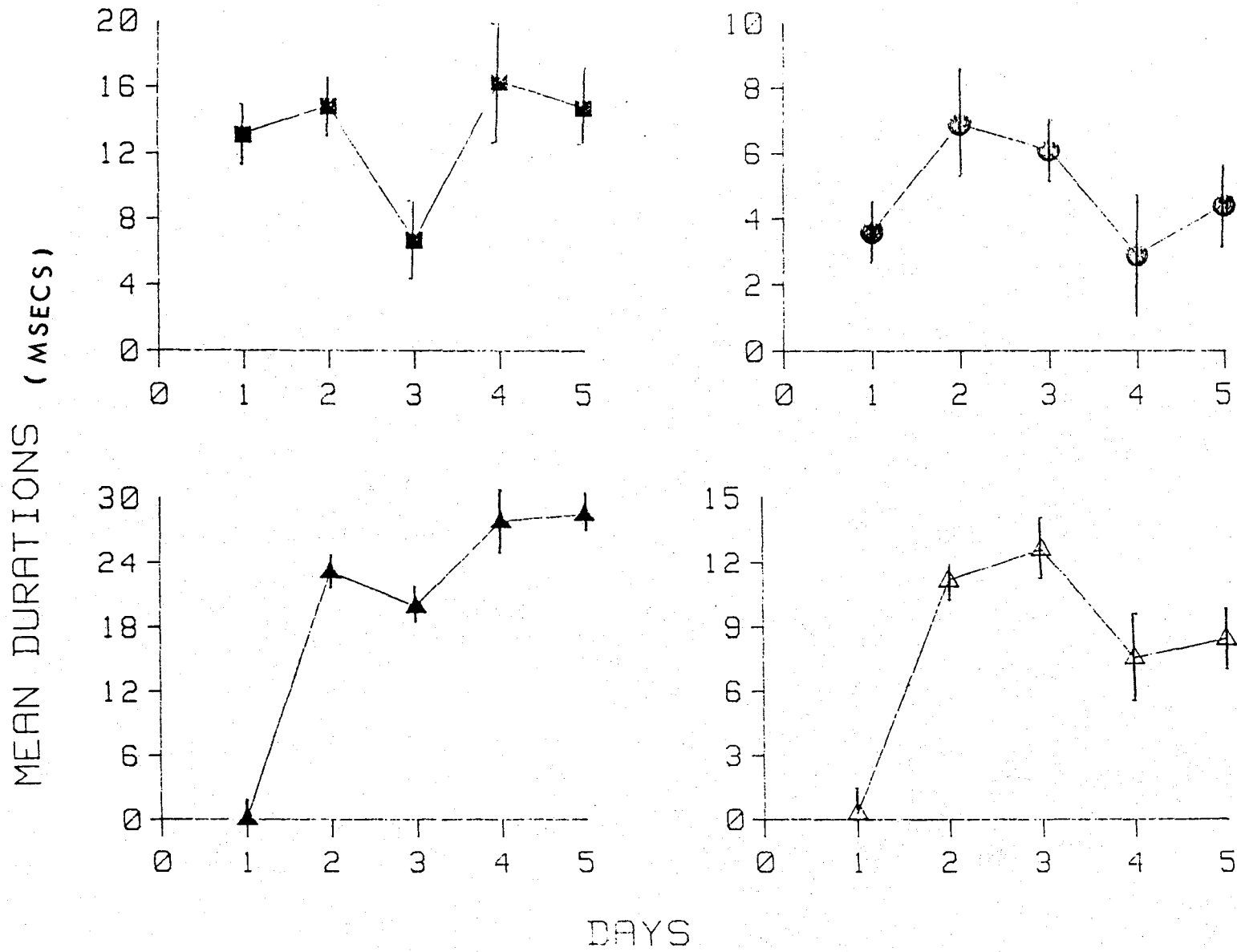

Fig. 3.12. Change in saccadic durations of four subjects in each session. The error bars show the standard errors of durations in each session.

differences relative to control saccades were 13.1 msec. longer on day 1 and 14.8 msec. longer on day 5. For S2 the differences were 3.6 msec on day 1 and 4.4 msec on day 5.

An analysis was performed on the direction of modifications of saccade peak velocities relative to the direction (i.e. increase or decrease) of saccade duration adjustments on consecutive days. This was achieved by comparing the direction of adjustment from the mean levels on the previous day. In 11 of the 16 comparisons an increase or decrease in peak velocities was associated with a change in the opposite direction for saccade durations. The phi co-efficient (a correlation statistic for comparing data which vary between two states only, as in binary data, Edwards, 1976) for this relationship was -0.4228 ($\chi^2=2.86$), although this just failed to be statistically significant due to the small number of comparisons.

Latency

The saccade latency data is shown in fig. 3.13. All Ss showed faster saccade reaction times with the feedback practice. This speeding of saccades reaction times is in contrast to the saccade control in the BF-slow task, where saccade latencies are always lengthened. However, in this case the 20-50 msec reductions is much smaller than the usual size of the latency increases produced in the

MEAN LATENCIES (MSECS)

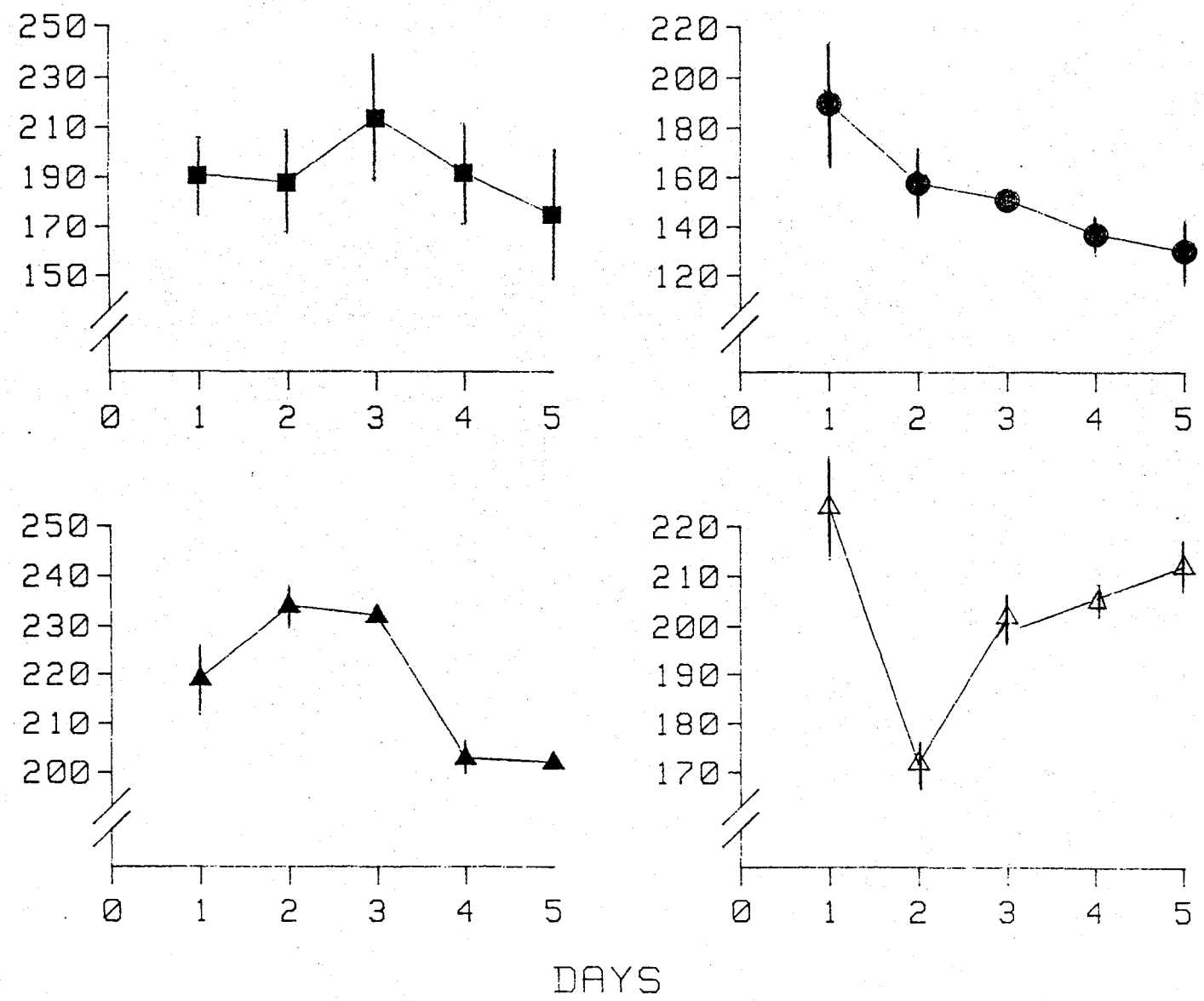

Fig. 3.13. The mean latencies in each session for the four subjects with standard errors.

BF-slow tasks.

3.4.4 Summary

1.) This study shows that saccade peak velocities can be raised with extended feedback practice.

2.) The absolute level of saccade durations in general is not reduced from baseline values.

3.) However, there is a negative correlation between the sign of peak velocity and duration modifications.

4.) Saccade latencies decreased gradually across the sessions.

3.5

Experiment 3.43.5.1 Introduction

Experiments 3.1, 3.2 and 3.3 have demonstrated that the peak velocity and duration parameters of a saccade can be controlled in ways which support the view that a saccade movement is regulated in a continuous on-line manner as proposed in Robinson's (1975) model. However, it is of theoretical importance to determine whether the entire duration of the saccade is under such control. Bahill and Stark (1975) argued that only the period of the saccade from its initiation to peak velocity (where the time to peak velocity varies inversely with saccade amplitude) is actively controlled by the neural input. This approach argued that only the acceleration region of the saccade is actively controlled by the pulse generator. The 'switching on' of the pulse input caused the eye to accelerate until the pulse is 'switched' off, whereupon the eye gradually decelerated to rest under its own inertia and the viscous damping of the orbit. Neurophysiological measures of the duration of the burst signals relative to the duration of the saccade (Schiller, 1970) seemed to indicate that the durations of these signals were somewhat less than the duration of a saccade. However, Robinson's (1975) recordings of the duration of firing of the oculomotor neuron cells indicated that the entire saccade is actively controlled by the

neurophysiological input to the eye muscles.

This experiment attempted to distinguish between these two approaches using behavioural, rather than neurophysiological measures. A task similar to that used by Viviani and Berthoz (1977) was used to encourage modifications in the velocity / time profiles of saccadic eye movements. The task required Ss to identify a visual stimulus which was present only during a saccade movement. It was predicted that if only the period of a saccade up to peak velocity (the speeding up phase or rise time) was actively controlled by the pulse generator, then any modifications in the velocity profile of a saccade should be confined to this temporal region of the saccade. If however, the entire flight of a saccade is under continuous control then modifications could occur in both the rise and fall time regions.

3.5.2 Method and Procedure

Four Ss participated in this experiment. All Ss had emmetropic vision with the exception of one subject who wore contact lenses.

The Ss were divided equally into the 2 conditions of this experiment. These conditions differed only the size of the eye movement target displacements. In one condition the amplitude of the target movement was 5 degs. and in the second condition this amplitude was 20 degs. Each

session began with a block of control trials. These trials were identical to the control trials described in experiment 3.2.

In the main session a trial sequence proceeded in the following way: a trial commenced with a signal from the subject controlled trial initiation button. The eye movement target then moved to the appropriate visual angle for that condition (either + or - 10 degs. or + or - 2.5 degs.), for a variable interval of 300, 400, 500 or 600 msec. The target then stepped to the corresponding visual angle in the other hemifield. The Ss were required to make accurate eye movements to this movement sequence. When the eye began a saccade to the second of these target movements a visual stimulus was presented in the central screen position providing the eye velocity exceeded 30 degs / sec. This stimulus was either a double vertical or double horizontal arrow (a length of 10 mm). The Ss were required to discriminate the orientation of the arrows. This orientation was randomised. After the presentation of the arrows the Ss pressed one of two buttons to indicate which type of arrow had been displayed.

The extra computational and visual display demands on the computer meant that the maximum sampling frequency possible was 250 Hz. However this provided sufficient information with which to perform a full analysis of the saccadic parameters.

3.5.3 Results

Shown in fig 3.14 are records of normal and modified saccades after approximately 40 trials in the arrow discrimination task. The upper traces are saccadic eye position waveforms over time. The lower traces in each pair show the eye velocity over time relationships. An analysis of these individual records showed that modifications occurred most frequently in the later trials of the 20 deg. eye movement target displacement condition, although similar modifications in saccade flights were occasionally observed in smaller amplitude movements. These modifications were frequently manifested as a 'kink' and a double perturbation in the velocity / time and acceleration / time curves respectively. In these saccades the normal steady changes in eye velocity were replaced by a region in which the eye velocity either stabilized or momentarily reversed direction.

Where do the modifications occur ?

Table 3.6 gives the temporal region in which the velocity kinks were observed. The table shows that the velocity modifications occurred in both the acceleration and deceleration regions as well as the middle region of saccades. In normal saccades the duration of the decelerating region tends to exceed that of the accelerating region (Baloh et al., 1975; Hyde, 1959).

Control Saccades

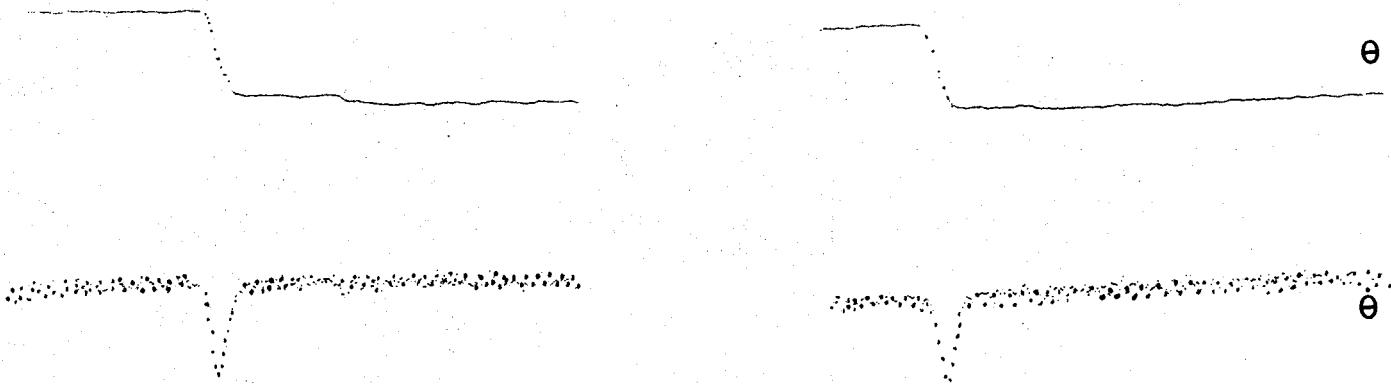

Saccadic Perturbations

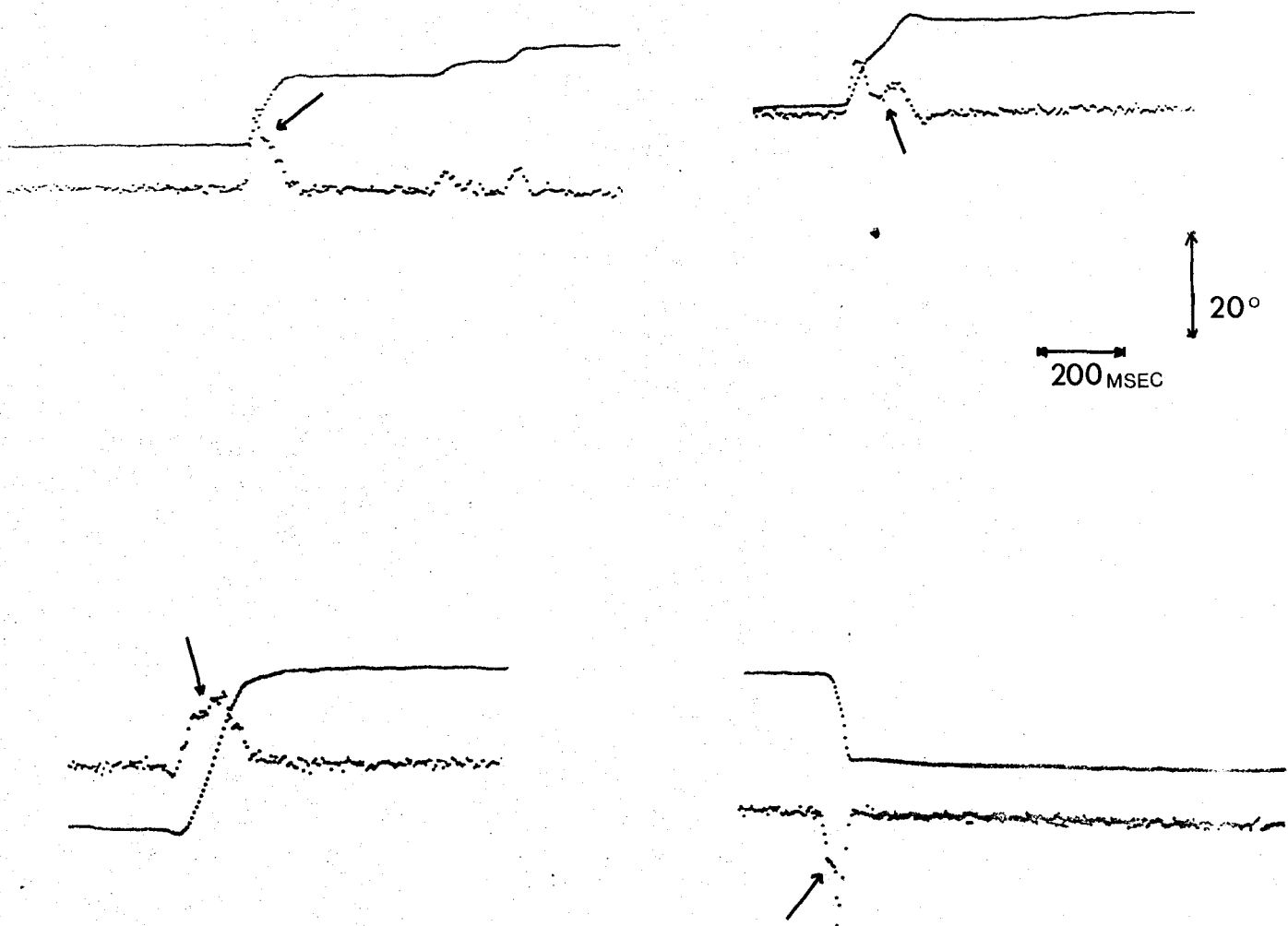

Fig. 3.14. Control saccades and saccades with velocity perturbations. Arrows indicate regions in which the saccade velocity changes from the normal waveform.

Temporal Region of Modifications in Velocity Profiles

Ss	TE	ACC-R	DEC-R	MID-R
1	20	25.0	25.0	50.0
2	20	44.7	25.0	39.4
3	5	27.2	9.09	63.6
4	5	61.5	30.7	7.6

Table 3.6. Temporal phase of saccadic velocity perturbations. ACC-R acceleration region; DEC-R, deceleration region; MID-R, middle region; TE - target eccentricity.

However this rule does not necessarily hold when modifications in the saccade velocity curves are produced. In modified saccades the duration of the speeding-up time and slowing-down time region is influenced by the region in which the perturbation occurs. The duration of a region will be lengthened if the velocity modification is located in that region of the velocity / time curve. This suggests that both the pulse height and duration can be controlled continuously in the saccade flight.

Table 3.7 shows that Ss were remarkably good at the discrimination task. One S made virtually no errors. In the Viviani and Berthoz (1977) task it was found that Ss were also surprisingly adept at registering visual information during the course of a saccade.

3.5.4 Discussion

These results show that modifications in the velocity of saccades can occur in both the acceleration and deceleration regions of the movement. However, any adjustments are more likely to occur in large movements rather than small movements.

The view that saccades are continuously controlled has also received support from a study by Mays and Sparks (1981). In this experiment it was found that when a goal directed saccade is interrupted in mid-flight and driven to a new position in the orbit, the eye will still saccade

Discrimination Performance (%)

Ss	TE(degs)	Correct
1	20	78.7
2	20	26.2
3	5	63.0
4	5	97.5

Table 3.7. Discrimination scores in the arrow orientation task. Chance level was 50%. TE - target eccentricity.

accurately to the true spatial location of the target. However these authors did not compare the effects of perturbations during the acceleration and deceleration regions of the saccade.

3.6 General Discussion

Modifications of a saccade trajectory were associated with increases in the amplitude / duration variability when trial-by-trial feedback training was supplied. A smaller increase in variability was also obtained with continuous feedback. This increase in variability indicated that the saccade durations were being less constrained by the amplitude of the saccade movements. A consistent feature of the results was that there was more variability in the amplitude / duration relationship than the amplitude / peak velocity correlations. This result was particularly interesting for the following reason: the neurophysiological study of the brain stem control of saccadic eye movements has shown that the duration of firing of cells in the pontine paramedian reticular formation (PPRF), correlates systematically with the duration of the saccade. However, the firing frequency of these cells, according to Schiller (1970), does not change with the amplitude of the saccade. However, recordings from single cells in other regions (e.g the oculomotor nucleus) of the brain stem, have shown that there is a relationship between the peak velocity of the saccade (and therefore its amplitude) and the discharge burst frequency

during the saccade. This neurophysiological distinction between processes responsible for the duration and velocity of the saccade is compatible with the demonstration of a behavioural separation of these parameters.

However, the firing rate of these cells does not change during the saccade itself. This perhaps indicates that other important factors in the control of the saccade have not been clearly defined. For example, the number of muscle motor units and the rate of recruitment of muscle fibers will also influence the velocity of a saccade. It is possible, for example, that the high correlation of saccade peak velocity and amplitude derives from factors which also determine the recruitment and rate of recruitment of extraocular motor fibres in saccadic eye movements.

3.6.1

The role of feedback

A comparison of the continuous feedback and trial-by-trial feedback experiments reveals that both methods lead to increases in the peak velocity of small saccades and saccade duration, but only the former generates a lowering of peak velocities. An account may be offered in terms of advantages of the continuous feedback method (see e.g. Johnston and Lethem, 1981). Firstly, this method almost

entirely eliminated the feedback delay associated with the periodic trial-by-trial feedback system. Secondly, continuous feedback increased the amount of information available to a subject about a saccade by also providing feedback when the eye was stable. Thirdly, and perhaps most importantly continuous feedback also provided information on the trajectory of the saccade during the saccade itself. These merits would suggest that this method is generally more effective for producing modifications of a saccade movement.

The results observed with feedback are not always evident under ordinary conditions. There are at least two reasons for this. Firstly, the control of the saccade will depend on the task. In a situation in which the movement of the visual stimulus is controlled in such a way that modifications of the saccade trajectory serve the purpose of re-positioning the eye to the new position of a rapidly moving target, on-line adjustments are observed (Jurgens and Becker, 1979; Van Gisbergen et al., 1982). Secondly, the absence or weakness of a conscious sense of eye movement may explain why saccades are not normally subject to the same types of control as used in voluntary limb movements, although Skavenski (1972) has asserted that this sense does exist for eye movements and that Ss can be made aware of this. Nonetheless, the primary source of information on the position of the eyes comes from the retinal image. However, this information is brief and is degraded during a saccade and is therefore inadequate to

provide a conscious sense of eye position during the saccade. In contrast with the movement of a limb such as an arm, both continuous visual and proprioceptive feedback are available. The major role of the external feedback information used in these experiments may have been to supplement any latent afferent information on the saccadic eye movement.

How does the biofeedback work?

The early research on the plasticity of physiological mechanisms was performed within the conceptual framework of instrumental conditioning (Kimmel, 1967; Miller, 1972). But in recent years investigators have come to the view that the development of control can best be understood entirely in terms of a motor skills model. Arguably the most complete formulation and presently the only biofeedback model generally applicable to non-cardiovascular control is that of Brener (1974).

Brener's model assumes that feedback pathways are fundamental to the development of the voluntary control of a motor behaviour. By 'voluntary' control Brener is referring to an act which can be systematically influenced by instructions which may be either explicitly or symbolically specified. An act is not intrinsically voluntary or involuntary, rather it is argued that in order to identify the control process the antecedent conditions surrounding the initiation of the act have to

be defined. The interoceptive afferent (IA) pathways provide a basis for the ability to discriminate the occurrence of a controlled act from which modulation of the target behaviour can occur. The next stage of the theory holds that with a repeated motor act the afferent information arising from the response is stored centrally as a response image (RI). If the RI is stimulated by specific instructions then the particular action associated with the RI will be initiated. One of the functions of feedback is that of establishing a lawful relationship linking the RI to the instructional labels outlined in an experiment. This is achieved by what Brener refers to as the 'calibration' process. The primary function of this process is to correlate the variations in the biofeedback information with the pattern of excitation associated with the available interoceptive signals. Thus when the exteroceptive feedback is correctly interpreted by the individual a functional feedback loop is eventually established between the central control processes and the motor consequences of the target behaviour thus enabling an individual to discriminate between the occurrence and non-occurrence of the target behaviour, in the case of a binary relationship, or finer control acuity, in the case of a proportional control system. The exteroceptive feedback, as mentioned above, may facilitate control by either substituting for a lack of available intrinsic feedback or it may serve to calibrate the available intrinsic feedback by defining, in the present context, the sensations

associated with fast and slow eye movement velocities.

Brener's theory represents one of the few attempts to provide a theoretical basis for the wealth of data already generated in this field, and has therefore been widely welcomed. However, the model is weakened by at least 2 critical points. Firstly, the motor skills approach in which the Brener model is embedded is now somewhat out of date. Current motor skills research is focusing more sharply on the programmed or planned nature of many aspects of motor behaviour. Many motor theorists no longer hold that feedback is necessary for the control of a motor response (Stelmach, 1978; Keele, 1968; cf motor programming discussion in chapter 1). Secondly, a number of reports have shown that contrary to the explicit predictions of the model, response discrimination is not necessary for effective voluntary control (Cott et al., 1981; Lacroix and Gowen, 1981). In the experiments subjective reports failed to reveal strong evidence for response discrimination when saccadic trajectories were controlled. Thus while the Brener model may represent a useful working model in which to interpret the general dynamics of the feedback process, there are still a number of problems that the model fails to deal with.

3.7 Conclusions

The experiments presented in this chapter which have

focussed on the use of feedback to explore the plasticity of the saccade dynamics, were largely stimulated by the unsubstantiated claims of Yarbus and other oculomotor researchers on the characteristics of saccadic control. The present data show that the peak velocity and duration of a saccade can be modified with extra afferent feedback information. However continuous on-going feedback has a greater range of effects than discontinuous feedback, while extended training over several days produces a greater modification of the saccade trajectory than practice in a single session. One interesting question concerns the behaviour of the saccadic characteristics when the feedback is withdrawn. Experiment 3.2 showed that normal saccades returned within 15 saccades after feedback. However, it does not follow that modified saccades cannot be generated once feedback is withdrawn. Firstly, Ss may need to be directed specifically to continue to control the eye movements in a particular mode following the feedback trials. Secondly, longer training periods than was employed in these studies may be required to so establish Brener's calibration mechanism to enable the modification of saccade velocities in the absence of information feedback.

The pattern of results is consistent with previous feedback findings in quite separate biological systems (Williamson and Blanchard, 1979). These results provide further support for the Robinson model in which a saccadic eye movement is controlled by a non-ballistic continuously

regulated feedback system (see chapter 7).

Chapter 4

Multiple Saccades and Saccade Latencies:

Consequences of the BF-slow task

The Experiments presented in chapter 3 suggested that there are associated consequences with the modification of human saccadic parameters. A clear example of this came from the BF-slow conditions. The modifications of peak velocities and durations were found in conjunction with the manifestation of multi-component saccades having characteristically prolonged latencies in the range of 600-800 msec (fig. 4.1). A given multi-component response (or multiple saccade(MS)) contained between 2 and 6 saccadic components. This chapter will attempt to explore a number of questions raised by these saccades and specifically to determine whether MSs are preprogrammed eye movements.

4.1 Introduction

Although saccadic sequences possessing 2 components are commonly reported (e.g Becker and Fuchs, 1969) an important problem, which has received little attention in eye movement research, concerns the question of how a continuous sequence of eye movements is controlled. Becker and Fuchs (1969) observed that corrective saccades

Multiple Saccades

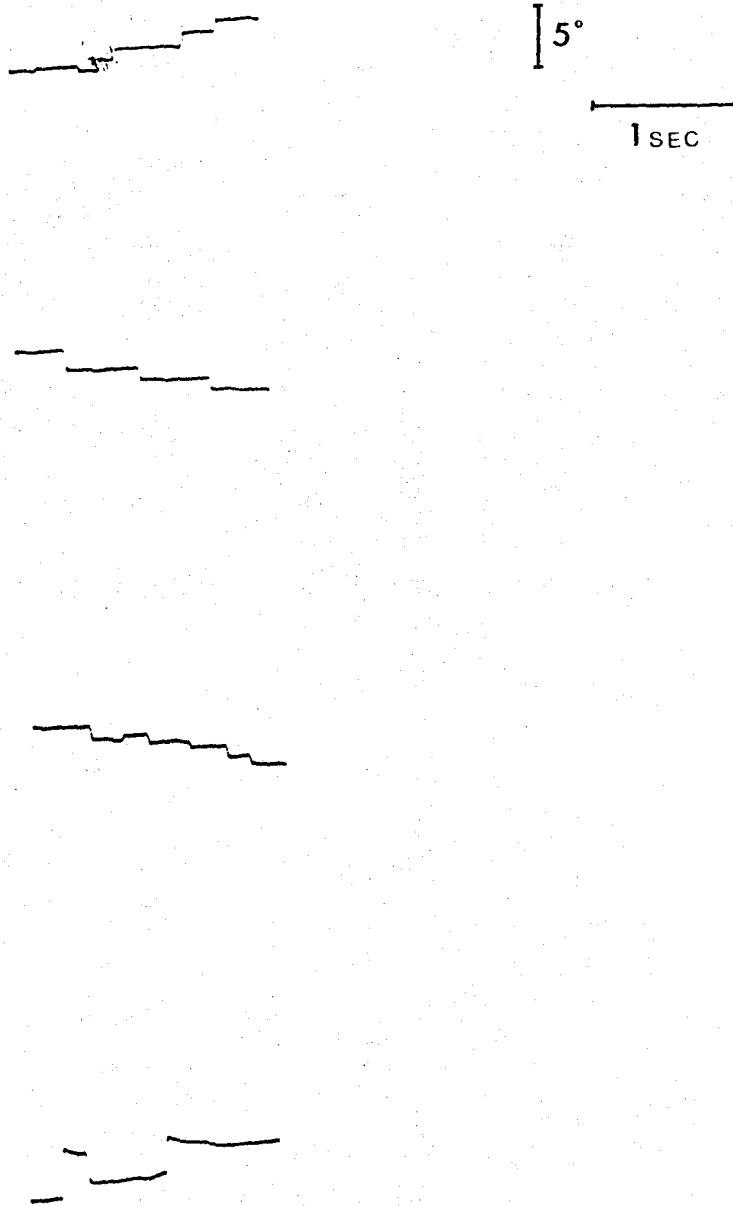

Fig. 4.1. Multiple saccades. Note that saccadic components after the initial saccade do not have reduced saccadic latencies.

following the primary saccade to a visual target had latencies that were about 50% of the normal saccade latencies. It was proposed that these corrective saccades were programmed simultaneously with the primary saccade. Becker and Jurgens (1975, 1979) measured saccade responses to pulse-step targets (cf introduction to chapter 3). Two features of their data were consistent with this possibility of saccadic preprogramming. Firstly, in cases where two saccades were generated, there was an inverse relationship between the initial saccade latency and the intersaccadic interval. Secondly, several cases were reported where the second of the two saccades seemed to have zero latency while still accurately moving the eye to the target position. These data showed that in some circumstances the saccadic system apparently does not demand the normal latency for a second saccadic movement which corrects for small spatial errors following a previous saccade. This raised the possibility that MSs, with their characteristically long latencies for the initial saccade might also display evidence for the preprogramming of saccades. It followed from Becker and Jurgens' (1975) argument that if MS components were prepared en masse then saccadic components after the initial saccade should have reduced latencies when compared to a normal single saccadic movement. However, if the saccades are produced independently then saccade component latencies would not necessarily be reduced from normal saccades.

4.1.2 Multiple Saccade(MS) Analysis

The data described in this section came from an analysis of the multiple saccades (MSs) generated in the BF-slow condition of experiment 3.1 (this was the first condition in which MSs were consistently produced). For the details of the design and procedures of this experiment see the methods section in chapter 3.

Results

Fig. 4.1 shows some examples of the multiple saccade (MS) patterns produced in the BF-slow condition of this experiment. In fig. 3.3d there is an example of a special case where a normal single saccade, followed by a return movement, precedes the MS sequence. It is evident from table 4.1 that all Ss produced a high proportion of MSs in the BF-slow task. One subject, who showed these responses, commented that it was difficult to prevent the eyes responding automatically to the immediate presence of the eye movement target. It appeared that in order to control the multiple eye movement Ss have to first inhibit 'reflexive' responses stimulated by the peripheral target onset. Eye movement traces of the kind shown in fig. 3.3d showed that this process was 'leaky' in some instances, although these 'mistakes' contributed less than 2% of all Ss records in BF-slow task.

Table 4.2 shows that there was a significant negative

Subjects		Control		BF-fast		BF-slow	
1	%	MS 6	SS 94	MS 3.5	SS 96.5	MS 68.3	SS 31.7
	LAT	185	181	201	195	593	194
2	%	14.7	85.3	24	76	45	55
	LAT	210	203	279	185	791	886
3	%	0	100	2	98	60	40
	LAT	*	189	242	195	589	250

Table 4.1. Proportions of multiple saccades (MS) and single component saccades (SS) in each condition of experiment 3.1. LAT - latency, BF - biofeedback.

Correlations

Subjects	Control	BF-fast	BF-slow	
		Amplitude / Latency	Amplitude/NSC	
1	0.06	-0.08	-0.08	-0.79 **
2	0.04	-0.17	-0.33	-0.5**
3	0.25*	-0.04	-0.57**	-0.89**

** p < 0.01

Table 4.2. Saccadic amplitude and latency Pearson's product-moment correlations. Also shown are the correlation coefficients of the relationship of amplitude and the number of saccadic components (NSCs) in a multiple saccade. BF - biofeedback.

correlation (Pearson product-moment coefficient) between the number of saccade components (NSC's) and the amplitude of the initial saccade in the trajectory. The interpretation that the system takes into account the dimensions of the available visual space between the eye and the target in the generation of the saccade components seemed a logical one. Table 4.2 also shows that for two Ss there was a significant negative correlation between initial saccade amplitudes and latencies in the BF-slow condition. As this only happened in the BF-slow task there was a strong likelihood that the MSs had contributed to this particular result. One prediction which followed from this was that since the amplitude of the initial component decreased with increasing NSCs, the saccade latency should be positively correlated with the NSCs. When single amplitude saccades are included in the analysis table 4.3a shows that this is in fact what occurred.

The MS / Latency Effect

The observed effect of MSS on saccade latencies seemed compatible with the direction of the amplitude / latency correlation. A simple interpretation of this effect was that the latency period before a MS included a preparatory time overhead for each saccade component as predicted by the preprogramming hypothesis. If this was the case the latency of saccades within the sequence should have been

reduced from the normal levels for saccade latencies (approximately 250 msec) as found with the secondary saccades in the Becker and Fuchs (1969) study. The examples in fig. 4.1 indicate that this was not the case, subsequent saccade components do not have reduced latencies but are generally in fact much longer than normal saccadic reaction times. The results of a correlational analysis between NSCs and saccade latencies for MS sequences only (therefore excluding cases where only single amplitude saccades were produced) showed that this subgroup did not significantly correlate with the NSC's (see table 4.3b). It was therefore unlikely that MSs were 'programmed' jointly. The initial NSCs / latency correlation seems more probably to have been derived from a categorical distinction between the total temporal programming demands of a multi-component sequence and that of a normal single response.

However, it was still possible that the enhanced latencies evidenced in the BF-slow task were due to deliberate decisions by Ss to delay the saccade as part of the general effort to reduce the saccade velocity, rather than as a direct consequence of MSs. It was necessary to try to separate MSs from the process of controlling saccadic velocities. In the following experiment MSs were examined under conditions when there were no instructions to attend to the speed of the saccade movement. If the latency effect was the outcome of special conditions unique to the BF-slow task and not due to MSs per se then MSs generated

BF-slow

a

Subjects	N	NSC / Latency
1	60	0.48**
2	60	0.23
3	60	0.57**

b

Subjects		NSC / Latency when NSCs > 1
1	41	0.14
2	27	0.16
3	36	0.01

Table 4.3. Multiple saccade component analysis and saccade correlation coefficients when single component saccades are (4.3a) and are not (4.3b) included in the analysis. NSC - number of saccadic components.

in quite different tasks should fail to show the effect. Alternatively if there is a genuine relationship causing MSs to prolong the release of a saccade this should show up even when Ss are not specifically required to produce slow saccades.

4.2

Experiment 4.14.2.1 Introduction

Under normal visual conditions the human eye finds it difficult to evoke a smooth pursuit eye movement in the absence of a smoothly moving target (although recent research has shown that for example, it is possible to track the movement of one's own hand in a completely darkened room; Glenny and Heywood, 1979). Instead what normally occurs is that a flight of MSs along the path of the target movement is released when Ss are required to attempt this task, although subjectively an individual may be quite confident that he has made a perfectly smooth eye movement. This task therefore provided a possible condition in which the analysis of the MS / latency relationship could be further explored. In a second condition MSs were probed by a more direct method. In this condition Ss were asked on each trial to make a specific number of intervening saccades (1-5) from the initial starting position to a target at a distance of 5 degs. away from the visual axis. In a third condition Ss were required to delay their saccades but no MSs were required. Following a foreperiod indicated by an auditory signal Ss were required to saccade accurately to the target. The purpose of this condition was to answer the question of the direction if any of the causal

relationship in the MS / latency effect. If MSs were an outcome rather than a stimulating factor in lengthening saccade latencies, MSs should also be evident in this condition (see diagram of conditions in fig. 4.2).

4.2.2 Method and Procedure

Subjects

Seven Ss (4 post-graduate students, 2 visitors to the psychology department and 1 undergraduate psychology student) were used in this experiment. S1, S2, S3 and S6 had participated in previous eye movement experiments, but none of the other Ss had taken part in previous psychophysical research. All Ss apart from S6, whose contact lenses corrected for a slight myopia, had normal uncorrected vision.

Procedure

The experiment was divided into a simulated pursuit (SP), inter-saccadic step (ISS) and saccade delay (SD) conditions. Three Ss participated in the SP condition, the ISS and SD conditions each used two Ss.

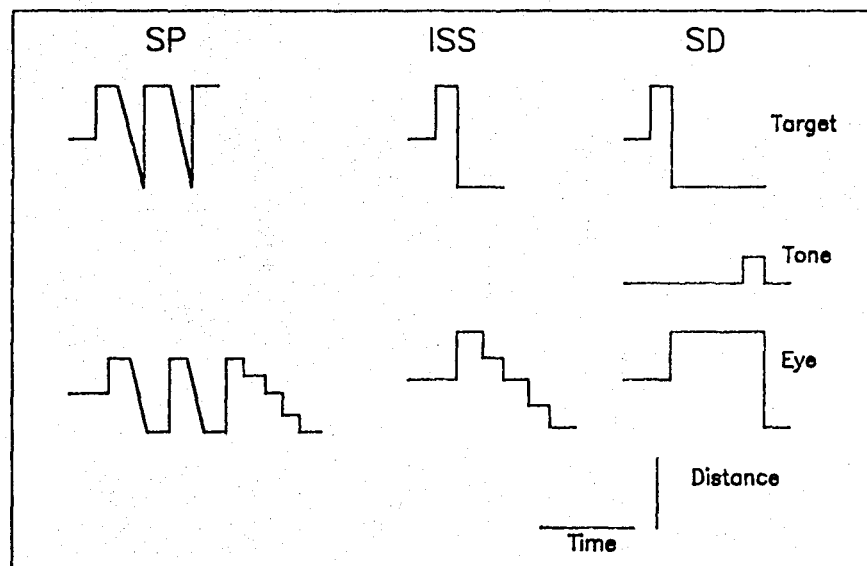

Fig. 4.2. Target trajectory conditions and required saccadic patterns. SP - simulated pursuit, ISS - Inter saccadic step, SD - Saccade delay.

The Simulated Pursuit(SP) Condition

In all conditions a trial began with a high contrast spot target at the central fixation position. On the initiation of a trial the target stepped + or - 2.5 degs. horizontally from the centre. After a randomized period of either 500, 700, 900, 1400 or 3000 msec the target moved smoothly at an average velocity of 3.5, 5.2 or 10.4 degs/sec for a distance of 5 degs. to a symmetrical locus across the screen. The target then immediately returned back to the starting position. After 1000 msec the smooth ramp movement was repeated. Ss were asked to track the target movement accurately at each stage. At the termination of the second ramp target movement the target was presented again at the ramp starting position (for 2500 msec) before disappearing off the screen. The Ss were instructed on this cue to attempt to reproduce their recent smooth eye movements (see diagram in fig. 4.2)

The Inter Saccadic Step(ISS) Condition

The initial target displacement was again a + or - 2.5 degs. step displacement from the central position. After the randomised interval the target moved in a single step to the 5 deg. position across the screen. Before moving the eyes to this target position Ss were required to make a number of intervening saccades. The number of required

saccades en route was indicated at the start of a trial by a digit, from 1 to 5 which flashed in the upper right quadrant of the screen for 2000 msec. The number of saccades per trial was processed on-line and used to provide Ss with feedback on their performance.

The Saccadic Delay(SD) Condition

In this condition a single amplitude saccade was required to the 5 deg. step displacement. However, Ss were required to delay the saccade to the target movement until a 430 Hz tone was presented. The interval from the movement of the target to the presentation of the tone was randomly varied on each trial between 300, 600, 900 and 1500 msec.

Each condition consisted of approximately 50 trials. Calibrations were taken at regular intervals during a session. Eye movement samples were taken at a frequency of 500 Hz and 1,024 samples were obtained for each trial.

4.2.3 Results

The results for the SP condition are summarized in table 4.4. S's attempts to produce pursuit movements in the absence of the ramp target resulted in the predicted flight of MSs (see fig. 4.3), although single saccades did

SP Condition

Subjects		N	Mean Amp	Mean NSC	Mean Lat
1	MS	32	2.25	2.6	405 (216)
	SS	10	4.3	1	173 (27.3)
2	MS	31	2.05	2.87	404 (228)
	SS	10	4.0	1	308 (190)
3	MS	45	1.88	2.44	430 (234)
	SS	10	6.0	1	195 (26.6)

Table 4.4. Mean amplitudes (Amp), number of saccadic components (NSCs) in a multiple saccade (MS) and mean latencies (Lat) in the simulated pursuit (SP) task. SS - single saccades.

sometimes occur. Table 4.4 shows that initial saccade amplitudes were reduced for MS sequences. The initial MS latency was also appreciably longer than latencies for single saccades in the control condition. Included amongst the small proportion of single saccades were responses which possessed latencies within the range of MS times. However, the small amplitude of these saccades suggested that they may have been part of a MS which was then completed after the sampling period. Also demonstrated was a dramatic effect on the variability of MS saccade latencies.

A number of individual records revealed some particularly interesting pursuit-like tracking eye movements. On several trials towards the end of the session S3 showed eye movements of the kind depicted in fig. 4.3. These records show that for some Ss pursuit movements can be generated in the absence of retinal motion.

The results from the ISS condition are summarized in table 4.5. MSs can also be reliably produced when Ss are directed to make intervening saccades between two points, although Ss fell increasingly behind the target frequency as the required number of intermediate responses increased. Saccade amplitudes are reduced for MS sequences relative to single amplitude movements. Saccade latencies for MSs exceeded those for single saccades as demonstrated for MSs in previous conditions. However, the size of differential latency effect was quite different

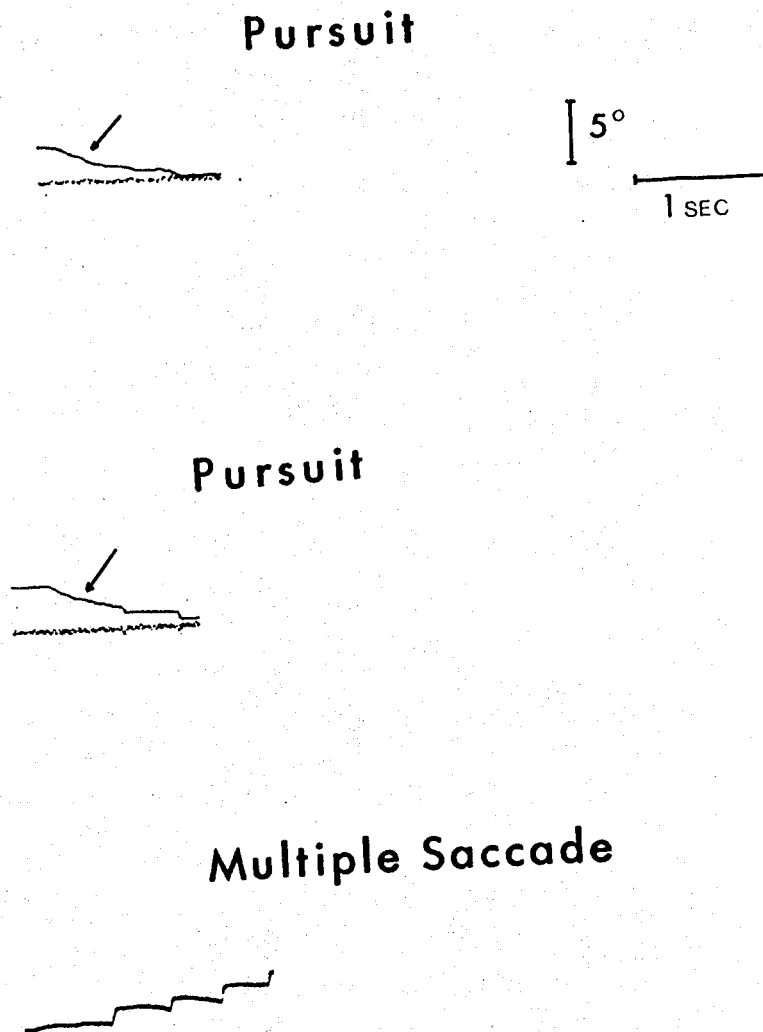

Fig. 4.3. Eye movement records illustrating pursuit eye movements in the simulated pursuit condition. Note that these responses occurred in the absence of any smooth target displacements. The lower record shows an apparent incompleting multiple saccade.

ISS Condition

	Subjects	N	Mean Amp	Mean NSC	Mean Lat	NSC / Lat
1	MS	36	2.03	2.48	896 (479)	0.18
	SS	13	4.29	1	459 (542)	
2	MS	36	2.2	2.6	460 (152)	-0.25
	SS	22	4.6	1	357 (153)	
Target	Subjects	1	2	3	4	5
Mean NSC	1	1.8	2.0	2.7	2.5	2.3
	2	1.7	1.6	2.3	2.7	2.1

Table 4.5. Mean amplitude (Amp), number of saccadic components (NSCs) in a multiple saccade (MS) and mean latency (Lat) of saccades in the inter-saccadic step (ISS) task. SS - single saccade. In the final column the correlation coefficients between NSC and saccadic latency are shown.

in the two Ss. Also as in the SP condition the latencies for single saccades were substantially longer (by about 200 msec) than for normal visually elicited saccades, suggesting that they may have been subject to an effect of the context of the task, similar to the reported change in the latencies of normal saccades in pulse-step experiments (Becker and Fuchs, 1969).

Table 4.6 summarizes the results of the SD condition. Ss were clearly producing delayed single amplitude responses. The accuracy of these long latency saccades was equivalent to the accuracy of normal latency saccades in the control block of this condition.

4.2.4 Discussion

These results are consistent with the original hypothesis concerning the effect of MSs on the reaction time of a saccade. Previous results had not ruled out the possibility that MSs were a product rather than a cause of the enhancement of saccade latencies. The direction of the relationship had not been unambiguously determined. It was possible, for example, that the long response times characteristic of MSs could have disturbed the normal processes controlling the saccade accuracy (as MSs latencies were well above the point at which saccade accuracy is improved by longer latencies; Kapoula, 1984). This might have caused the saccade to fall short of the

SD Condition

Subjects		N	Mean Amp	Mean Lat
1	Control	10	5.05 (0.4)	163 (32.1)
	Delayed saccades	57	5.5 (0.9)	1003 (435)
2	Control	9	5.13 (0.5)	332 (111)
	Delayed saccades	58	5.0 (0.7)	909 (449)

Table 4.6. Details of saccades generated in the saccade delay (SD) condition. Amp - amplitude, Lat - latency.

target thus stimulating corrective saccades. Condition SD was an attempt to determine whether this was a valid explanation of the effect. In fact, lengthened latency saccades were as accurate as normal latency saccades, thus supporting the contention that MSs have a substantial effect on latencies and not vice versa.

4.3

Experiment 4.24.3.1 Introduction

Experiment 4.1 showed that the slowing of saccadic reaction times could be explained in terms of the specific generation of MSs. The following study attempted to determine whether it might still be possible to eliminate or reduce the latency effect in the BF-slow task while still producing MSs. The original BF-slow task had not specifically required Ss to produce short saccade latencies while simultaneously slowing the saccade trajectory. In the following experiment the BF-slow was re-introduced with a time criterion on the saccade latency. If Ss are asked to do the BF-slow task with fast saccade latencies will this eliminate the MS / latency effect altogether? (In retrospect it would also have been nice to determine the effect on the saccade velocities. Unfortunately there was no control condition for the velocity comparison.)

4.3.2 Method and ProcedureSubjects

Three Ss (two post-graduate and one undergraduate psychology students) participated in the experiment. The

apparatus was identical to that used for the experiments of chapter 3, with the addition of a 6-channel digital tone generator.

Procedure

A trial began when the S pushed a start key. This triggered a movement of the target from the central fixation position to 2.5 degs. to the left or right. The target then jumped, after a random period, through a visual angle of 5 degs. to the corresponding position across the screen. As in the original BF-slow tasks the Ss were required to try to produce slow saccade trajectories to the 5 deg. target movement. The distinction between saccade velocities and latencies was made clear to the Ss. They were also informed that a warning tone (produced by a tone generator positioned approximately 0.5 m behind the S) would be heard "if the S waited too long before moving his/her eyes". This tone therefore indicated that the saccade was running behind schedule and that it should be produced without further delay. The details of the feedback for saccade velocity were identical to the methods used in experiment 3.1.

4.3.3 Results

Single saccades and multiple saccades produced saccade latencies with non-homogeneous variance. Therefore a

t-test analysis for groups with different variance and unequal observations (Edwards, 1970, p99-104) was used to test the significance of the difference between mean latencies of SS and MS. Table 4.7 shows that the general pattern of the data replicate the results of experiment 4.1. MSs have smaller initial saccade amplitudes and longer saccade latencies than single saccades. (S1: $t = 3.31$, $p < 0.005$; S2: $t = 5.24$; $p < 0.005$; S3: $t = 4.61$, $p < 0.005$). The magnitude of the MS effect on saccade latencies was 107, 405 and 152 msec. This result shows that even when Ss are required to reduce saccade latencies, when MS are generated they take significantly longer to release than accurate single saccades. Interestingly all the Ss reported great difficulty in completing the main task of reducing the saccade speeds while simultaneously attempting to prevent a large increase in the delay of the saccade.

Ss	Single Saccades	Multiple Saccades	DF	p
1	218.5 (39.8)	325.4 (153)	28/24	<0.005
2	398.8 (238)	803.4 (277)	34/18	<0.005
3	248.2 (139)	400.1 (126)	31/35	<0.005

Table 4.7. The table shows that multiple saccades produce significantly longer latencies than single saccades. DF - degrees of freedom, p - probability level.

4.4 Discussion

The results show that in situations where MSs are stimulated the reaction time of the saccadic system is substantially increased. The magnitude of this effect does not depend on the number of saccadic components in the trajectory. Furthermore the latency of the saccadic components in the sequence are not reduced from normal levels. This supports the view that each saccade was produced independently.

4.5 Summary

1. MSs produced in different settings are found in conjunction with latencies 400-600 msec longer than those of single saccades. Moreover, lengthened saccade latencies appear to be a necessary but not sufficient condition for MSs.
2. The number of saccade components in a given MS appears to have no additional effect on the saccade latencies.
3. In addition to the large increase in saccade latencies there is also a large effect on the variability of saccade latencies.
4. As would be expected from an adaptable control system the amplitude of the initial saccade in the MS sequence was inversely related to the NSC's. Thus the frequency of

saccades in a sequence was a function of the retinal space between the eye and the target.

5. Single amplitude saccades produced in sessions which involved a large proportion of MSs also had longer than normal latencies.

Conclusion

These experiments establish a direct link between the generation of multi-component saccades and the enhancement of saccade latencies. The data do not support the view that the components in a MS sequence are preprogrammed in advance of their release.

Chapter 5

The Effect of Temporal Parameters of the Stimulus Movement on the Saccade Trajectory

5.1 Introduction

The theory that a saccade is controlled by a preprogramming and stereotyping saccadic generator has received implicit support from research on the effects of spatial and temporal manipulations of the visual input on the parameters of a saccade. It was claimed that the saccadic trajectory is insensitive to such factors as the target direction, manipulations in the fixation target onset / offset, and preceding eye movements (Gurevich, 1957; Westheimer, 1954b; Young and Stark, 1963b; Harris and Cynader, 1981). These experiments have been inadequate in their scope and have frequently ignored the saccade duration in the measurement of saccadic eye movements. A further problem has been the predominant use of near infinite velocity steps as the stimulus input for a saccade. (But see Heywood and Churcher, 1981; Feinstein and Williams, 1972 for two exceptions.)

Recent experiments have shown that the trajectory of a saccade is not ballistic but appears to be controlled in a continuous fashion. This view has been supported by evidence of 'on-line' adjustments in the saccade movement

as reviewed in Chapter 3. Perturbations in the saccadic movement were usually produced in visual tracking tasks in which the target movement was controlled so as to make it visually advantageous for the saccadic system to execute readjustments in the saccade velocity while the eye was still in motion (Van Gisbergen et al., 1982; Becker and Jurgens, 1979). These results suggested that there might be a significant relationship between temporal parameters of the visual stimulus movement and the parameters of the saccadic response. Current models of the saccadic system assume that the stimulus movement does not feed directly into the operator controlling the dynamic characteristics of the saccade. Any effect of the stimulus is assumed to be manifested via the saccade amplitude.

Few studies have addressed the question of whether the visual input to the saccadic system can influence the dynamic components of a saccadic movement. An early attempt was made in 1957 by the Russian visual scientist, B.Kh. Gurevich. In his paper he reported the outcome of his studies on saccade peak velocities under a number of manipulations of the visual input. He concluded that:

"the numerical data on the speed of motion of the eyes are governed by a single pattern irrespective of (a) the original peripheral projection of the new point of fixation at the moment of projection of the turn (i.e the target movement), (b) the peripheral projection of the old

and new points of fixation at the moment of the jerk (the saccadic eye movement), (c) the orientation of the eyes at this moment, (d) the number and dimensions of the jerks preceding and coming after the given jerk in the turn, and (e) the direction of the jerk towards the side of the turn or away from it."

This encouraged Gurevich to propose a 'universal law' of saccades which stated that the velocity of a saccade was determined independently by the amplitude of the eye movement and not by the visual input.

The theoretical approach of Gurevich and others to the study of the saccadic system is subject to a major weakness. These experimenters seem not to have seriously considered the possibility that the saccadic control mechanisms may pay attention to the functional demands imposed by the visual context (or task). For example, it is not immediately apparent what functional advantages would be served by a control operator which modified the speed of a saccade depending on the position of the eyes in the orbit; or the number of saccades preceding or following a saccade (cf Gurevich op. cit.). A system which operated on such principles could not effectively carry out normal eye movements while still maintaining clear vision.

The stimulus movement used in Gurevich's study followed the tradition in saccadic eye movement research of using

step target displacements at velocities approaching infinity. In the world outside of visual science laboratories objects move at finite velocities. Although saccadic eye movements are not normally used to track a continuous smoothly moving object, saccades are required to null the initial displacement errors that are caused by smooth target movements (Heywood and Churcher, 1981). Saccades may also be required to compensate for errors when the eye movement falls out of alignment with the target movement (fig. 5.1).

The eye movement normally employed in the continuous smooth tracking of a visual stimulus is the pursuit movement (see examples in fig. 5.1). Making an accurate pursuit eye movement is achieved by setting the eye velocity approximately equivalent to that of the moving target. However, it is claimed that whereas the sensory input to the saccadic system is a position error signal, the pursuit system responds to velocity or movement information. A classic demonstration of this was first described by Rashbass (1961). If a stimulus is made to step in one direction while a ramp of the opposite direction is simultaneously imposed, first an initial pursuit movement is detected closely followed by a saccade in the opposite direction bringing the eye accurately onto the target (fig. 5.1b). The interesting point about the initial pursuit component is that the eye is actually taken further away from the target than if it had not moved at all. This highlighted the distinction between

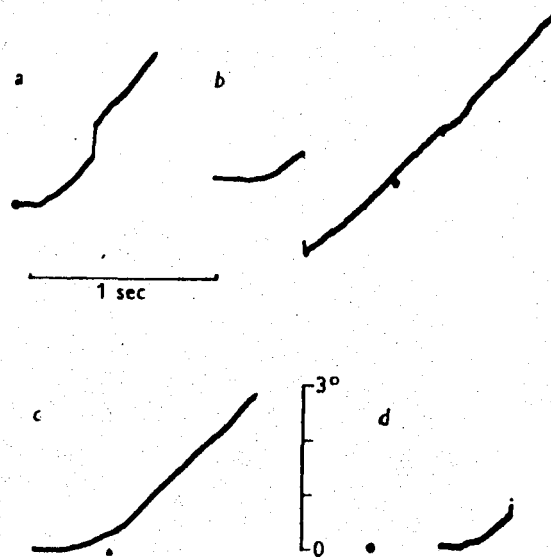

Fig. 5.1. Tracking responses to a target moving with uniform velocity preceded by a variety of displacements. (a) no displacement; (b) 3 deg. displacement in a direction opposite to the velocity; (c) 1 deg. displacement in a direction opposite to the velocity; (d) 1 deg. displacement in the same direction as the velocity. (after Rashbass, 1961).

the position error input for a saccade and the velocity information for pursuit.

It follows that although a saccade can be introduced to null any position offset when the eye is tracking a moving target, if Rashbass was right, the dynamics of the target movement should only be reflected in the pursuit component. Robinson (1965) recorded human eye movements to a target which made a horizontal jump or step followed by a constant velocity smooth motion in the same direction (i.e a step-ramp). The amplitude of the saccade increased with the velocity of the ramp but was predominantly related to the position of the stimulus 100 msec prior to the saccade. No measures were reported on the peak velocities and durations of these saccades.

The view that a saccade is not sensitive to velocity information seemed to be seriously challenged by Barmack (1970). He investigated monkey saccadic and pursuit movements to targets which decelerated and accelerated between 42 and 128 degs/sec. Changes in the velocity of the target modified the amplitude, velocity and acceleration of a saccade occurring between 50-80 msec later. The average latency from the start of the ramp to the onset of the saccade was 160 msec.

However, Barmack's data do not allow a clear interpretation of the modifications reported for his

saccadic parameters. It was claimed that both saccade amplitudes and peak velocities were reduced to decelerating ramps, but the absence of control saccades to step movements with which to compare these results makes it impossible to determine whether the findings represented a significant departure from the amplitude / velocity main sequence relationships.

Heywood and Churcher (1981) have recently re-emphasized that the amplitude of a saccade to a ramp target is based on a position error sample received prior to the onset of the saccade and not to the velocity of the ramp. But these authors only used ramp velocities below 24 degs/sec. It may be that the saccadic system responds differentially to fast and slow ramps. Evidence that the ramp velocity was registered by the saccadic system comes from their finding that, in the case of at least one subject, there was a negative correlation between the saccade latency and ramp velocity. Unfortunately, no measures were reported on the saccade peak velocities and durations. At the present time the effects of a smoothly moving ramp target on the control of the dynamics of a saccade has not been unambiguously determined.

There are at least two important reasons why saccadic eye movements to ramp stimuli should be examined in detail:

Firstly, ramp targets provide a good stimulus to re-examine the claim that the pursuit system but not the saccadic system is sensitive to the velocity or movement information contained in the trajectory of an eye target. In contrast to previous studies the following experiments measured the velocity and accuracy of the eye movements in addition to the saccade amplitude and latency. Ramp stimuli would seem to be a more appropriate movement with which to test the Gurevich claim than has previously been adopted. The original motive for the Gurevich studies was the desire to determine whether there was a relationship between visual information and the peak velocity of a saccade. However, the obvious analogue of the eye velocity, the target velocity was overlooked in his experiments. Secondly, an important related issue which has been under discussion in motor control theory, in recent years, concerns the processes which determine the accuracy of a motor act. However very little of this debate has included the control of human eye movements. Schmidt et al., (1979) and his colleagues have recently argued that the accuracy of a motor behaviour is determined directly by the forces controlling the dynamic characteristics of the movement. The theory holds that the precision of a movement will be a function of the variability of the impulses modulating the acceleration of the movement. Schmidt's idea can be put to the test by measuring the relationship between the variations in the peak velocity (which reflect the acceleration forces) and the accuracy of eye movements to ramp and step inputs.

According to Schmidt the movement accuracy and variability of velocity should be positively related.

In this chapter four experiments are presented. Experiment 1 considered the hypothesis that saccadic durations and peak velocities are controlled differently to step and ramp target movements. Saccades were elicited to ramp targets by using ramp speeds above the velocity threshold for smooth pursuit tracking. The possibility of pursuit movements was further ruled out by ensuring that the duration of the movement would be less than the normal 150-200 msec pursuit movement latency (Fuchs, 1967a). Experiment 2 attempted to determine whether the effects of the target movement could be accounted for in terms of the duration component independently of the movement velocity information by measuring saccadic responses to step targets in which a pure movement delay was introduced between the onset and offset of the step movement. These stimuli are referred to as 'open steps' target movements. Experiments 3 and 4 examined the relationship of the temporal parameters of the visual input to the saccade speed by evoking saccades to targets in a visual discrimination task using stimuli of different temporal durations. In Experiment 3 faster movements were predicted to the shorter duration targets. Slower saccadic movements were expected for the longer duration targets.

5.2

Experiment 5.15.2.1 Method and ProcedureSubjects

Three Ss were used in experiment 1. Subject 1 had had previous experience in psychophysical eye movement experiments, the other Ss had no previous experience. The Ss all had normal vision, but S1 wore contact lenses.

Procedure

A session began with a block of control trials as described in previous experiments. These trials consisted of step target displacements centred around the central fixation position. The target eccentricities were in the range of 1 to 5 degs. The Ss were required to move their eyes accurately to the target jumps. The ramp stimulus was a single high contrast point as had been used in previous experiments.

Following the control trials the remainder of a session proceeded in the following way: To begin a trial the Ss pressed a trial initiation key. The target would then step from the central position to a position 2.5 degs. to the right or left. The target remained at this location

for a random period of 500, 700, 900, 1000 or 1400 msec. During this period the S moved his/her eyes to the target location. At the end of this interval the target would then move smoothly a distance of 5 degs. to the opposite corresponding position, across the display scope. The velocity of this movement was either 35, 96 or 114 degs/sec. The total movement duration in each case was 144, 52 or 44 msec, respectively. The speed of the ramp was controlled by modulating the frequency of the refreshing cycle. From previous work it was anticipated that eye movement responses to these target movements would be composed entirely of saccades. This would be the case because the speed of the movement would be above the range for pursuit eye movements (Rashbass, 1961); and secondly, the short duration of each ramp movement also ensured that the movement would be completed before the subsequent eye movement response was released. This constant 5 deg. retinal error signal for the saccade amplitude, would reduce any effect of the saccadic amplitude on the saccade dynamics. The termination of a trial was indicated by the return of the target to the centre of the display. The details of calibration and eye movement sampling were identical to those used in Experiment 1, 2 and 3 of chapter 3. Eye movements were sampled at a frequency of 500 Hz and the analyses were based on 512 words of eye movement samples for each record. Eye position calibrations were recorded at regular intervals throughout a session.

5.2.2 Results

Saccadic Responses to Ramps

Fig 5.2 illustrates 3 general categories of saccadic movements generated to ramp movements. The upper record (OS) shows saccadic movements which take the eye between 0.2 and 0.6 degs. beyond the position of the target. The eye is then brought back by a corrective saccade with a reaction time frequently less than the mean 150-200 msec required for the primary saccade. Each saccadic component of the movement has the peaked velocity / time waveform shown with each saccade. These overshoot saccades (OSs) had a probability of 0.27 of all saccades to ramps. The middle traces (US) illustrate cases in which the eye falls initially short of the target. In some exceptional cases this can be by as much as 1 or 2 degs. (i.e 20% - 40% of the target distance). The probability of undershoots (USs) was 0.48. These 'errors' were similarly rectified by a single corrective movement. The lower traces are examples of saccades which hit the target accurately at the first attempt and had an overall probability score of 0.23 (ACC).

Fig. 5.3 shows the individual frequencies of OS, US and ACC saccades as a function of the ramp velocity. For step targets the probability of ACC saccades exceeds OS and US by at least a factor of 2. S1 showed effectively no OSs responses to steps. OSs occur with greater frequency to

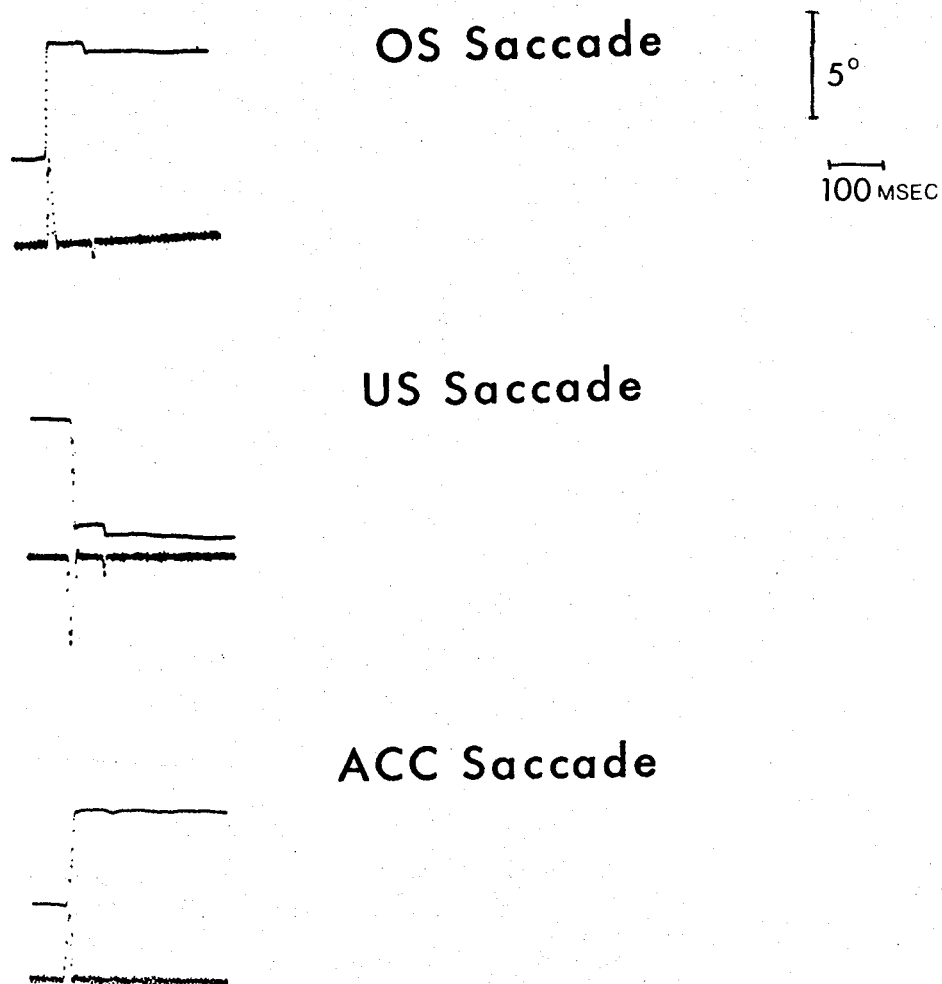

Fig. 5.2. Categories of saccadic responses to ramp targets. OS - overshoot; US - undershoot; ACC - accurate.

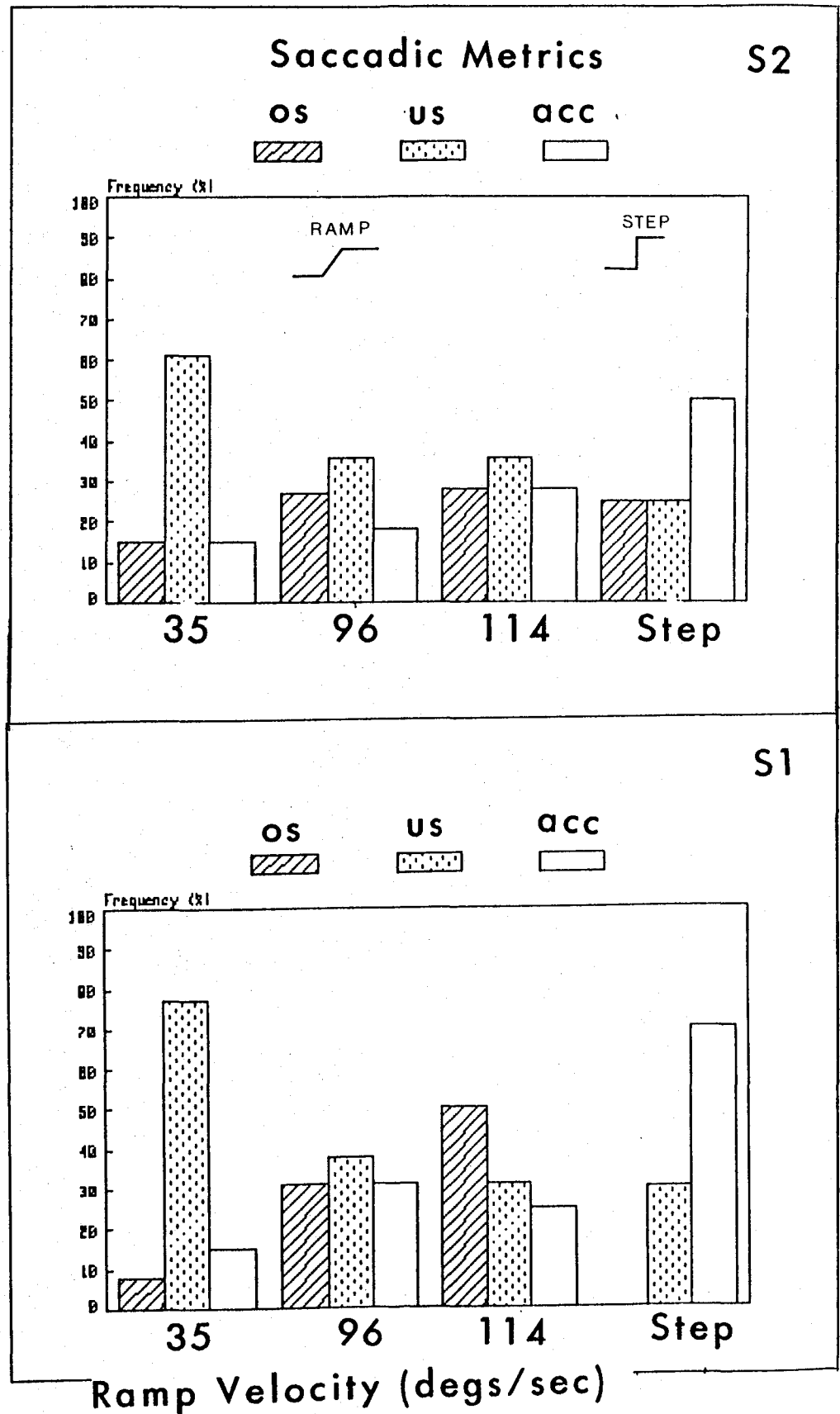

Fig. 5.3. Histograms showing frequencies of overshoots (OS), undershoots (US) and accurate (ACC) saccades to ramp and step velocity targets.

ramp movements, this was particularly noticeable to the faster ramps (96 and 114 degs/sec) where the proportions range from 27% to 45% compared to 7% and 15% to the slow ramp. USs at frequencies of 77% (S1) and 61% (S2) were the more likely response to the slow ramps. The frequency of ACC saccades were reduced from the control steps to the ramps by 21.5%, 31.9%, 34.7%(S1) and 50.0%, 39.3% and 54.7%(S2) for the 35, 96 and 114 deg/sec ramps respectively. A number of saccades to ramps were also observed in which the eye was somewhat unstable in the period immediately following the primary saccade. These are referred to as 'unstable' saccades in the records shown in the examples in fig 5.4. These results indicate that in directing the eye to a target the saccadic movement differentiates between a ramp and a step target displacement. The pattern of OSs and USs to ramp velocities suggests that the system is also to some degree sensitive to the rate of stimulus movement.

Peak Velocity and Duration

The amplitude / peak velocities and amplitude / durations relationships were assessed by applying the analysis for linear regressions (Seber, 1974) as described in Chapter 3, with each ramp velocity data set and comparing these to the control measures to step movements. In general no significant effect on slopes or intercepts were found for peak velocities at any ramp velocity (see fig. 5.5. S1:

Unstable Saccades

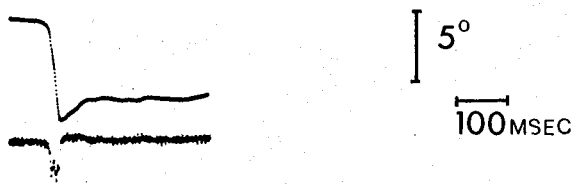

Fig. 5.4. Examples of saccades which have unmatched step and pulse innervation (cf Robinson, 1975) as evidenced by the post-saccadic drift and oscillation.

Peak Velocity (degs/sec)

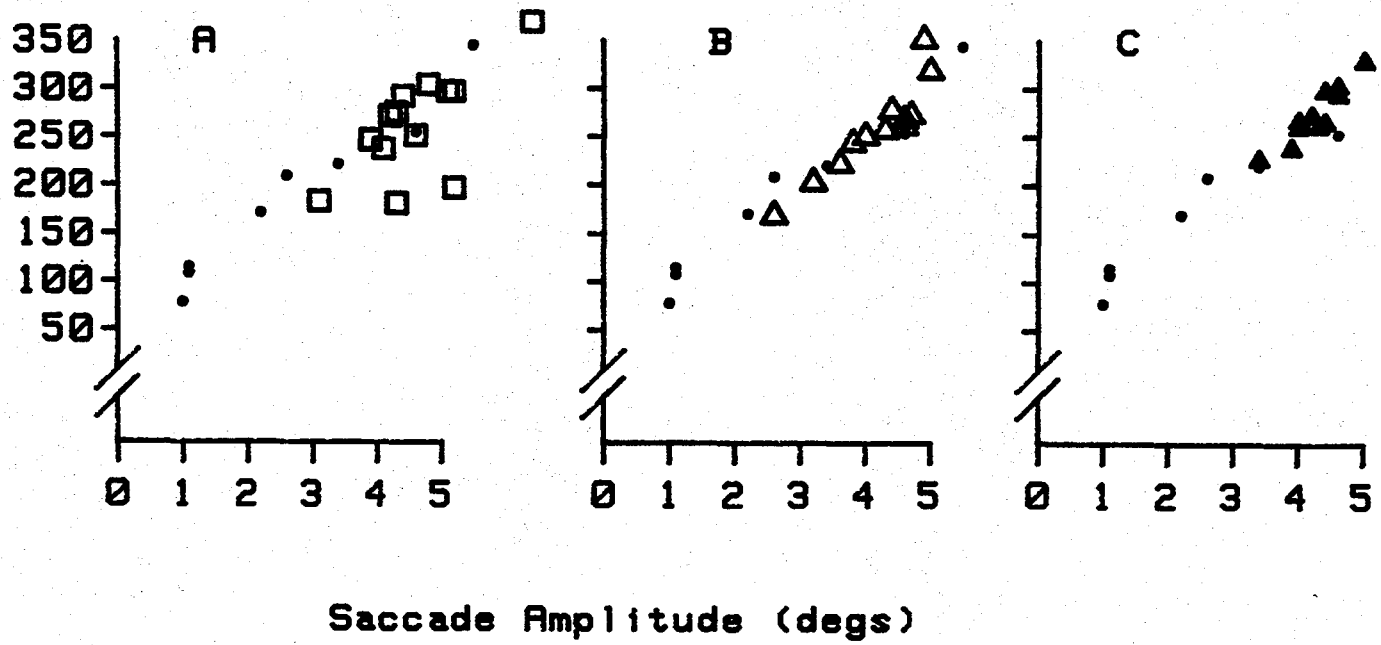

Fig. 5.5. Amplitude / peak velocity relationships to ramp and step targets. A - Control vs. 35 degs/sec ramp [□] B - Control vs. 96 degs/sec ramp [△] C - Control vs. 114 degs/sec ramp [▲]

at 35 degs/sec $F_p = 3.34$, $F_c = 3.19$, $df(2/21)$ $p > 0.01$, $S2:F_p = 0.89$, $F_c = 0.56$, $df(2/20)$, $p > 0.05$; at 96 degs/sec $S1: F_p = 0.24$, $p > 0.01$, $F_c = 6.27$, $p < 0.01$, $df(2/19)$, $S2: F_p = 0.83$, $F_c = 0.67$, $df(2/18)$ $p > 0.01$; at 115 degs/sec $S1: F_p = 5.05$, $p > 0.01$, $F_c = 5.21$, $p > 0.01$, $df(2/17)$, $S2:F_p = 0.11$, $F_c = 0.73$ $df(2/20)$, $p > 0.01$). As the analyses show the one exception was at the 96 deg/sec ramp where $Ss 1$ showed slightly slower velocity saccades than for the step target. Similarly ramps had no significant effect on saccade durations, ($S1: at 35 degs/sec F_p = 1.33$, $F_c = 0.90$, $df(2/21)$, $p > 0.01$, $S2: F_p = 3.33$, $F_c = 1.75$ $df(2/20)$, $p > 0.01$); at 96 degs/sec $S1: F_p = 0.32$, $F_c = 1.56$, $df(2/19)$, $p > 0.01$, $S2: F_p = 2.46$, $F_c = 1.24$, $df(2/18)$, $p > 0.01$; at 114 degs/sec $S1: F_p = 0.08$, $F_c = 1.02$, $df(2/27)$, $p > 0.01$, $S2: F_p = 0.19$, $F_c = 0.21$, $df(2/20)$, $p > 0.01$).

Saccade Latencies

The saccadic latency analyses suggested that ramps have a small inhibitory effect on the latency of the ensuing saccade. Mean ramp saccades latencies are 12-46 msec greater than to control steps. Since it was necessary to control the ramp velocity by modulating the ramp duration the saccade latency should be measured from the end of the ramp. The format of the experiment did not encourage anticipatory saccades therefore there is no reason to reject normal assumption that the saccade is generated to the final position of the target. Mean latencies are as

shown in the curves in fig. 5.6. The latency of the saccade increased with the velocity of the ramp.

5.2.3 Discussion

These results show that the saccadic system is sensitive to the dynamic information in a target displacement. The target velocity influences both the metrics of the saccadic aim and its latency. No effect was detected on the peak velocities and durations. The saccadic system though quite able to respond to ramp information responds more accurately to step inputs.

By using ramps of short durations it was possible to avoid the introduction of pursuit movements and the problem of and their possible non-linear interaction with saccades (Jurgens and Becker, 1975). It was felt that this was a significant factor in helping to clarify the behaviour of the saccadic system to ramps.

However, the present experiment did not distinguish between the significance of the velocity and the duration information within the stimulus movements, as they were varied simultaneously in the ramps. This arose from the requirement to hold the ramp amplitudes constant so that the elicited saccades would be comparable. It may have been that the velocity information was in fact irrelevant and that the manipulation of the duration of the stimulus

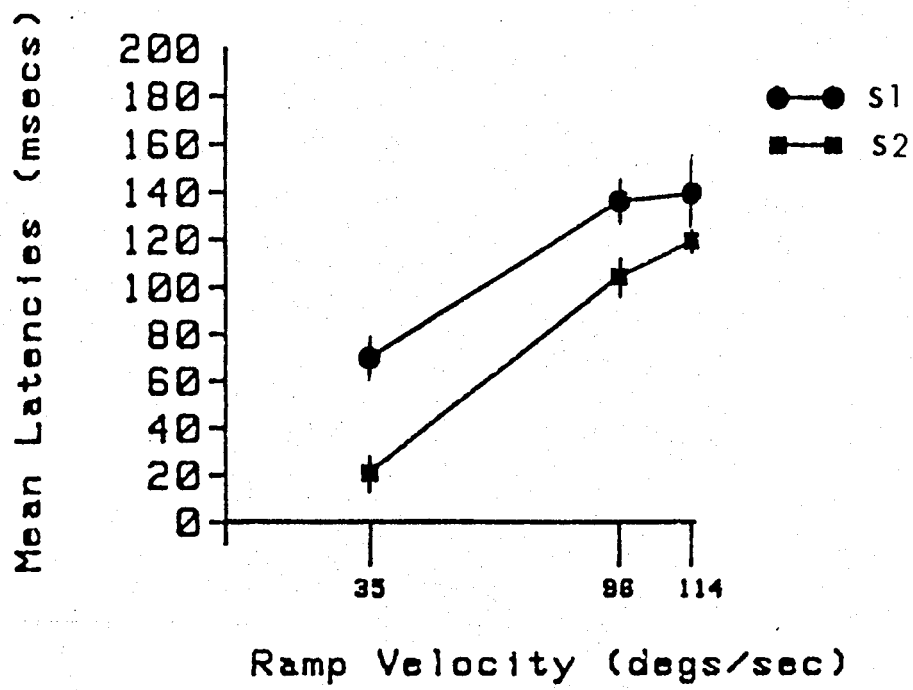

Fig. 5.6. Mean latency / ramp velocity relationships measured from the end of the ramps. The bars are standard errors for each ramp.

displacement was the crucial factor in the determining the effects of the temporal information on the saccade displacements. It was therefore decided to measure saccadic responses to step displacements where the duration of the step would be systematically modulated with no change in velocity information. Thus the effects of duration information alone could be estimated.

5.3

Experiment 5.25.3.1 Method and ProcedureSubjects

Two Ss participated in this experiment. S1 was an experienced psychophysical observer with slight corrected myopia. S2 had no previous experience of eye movement experiments.

Apparatus

The recording apparatus was identical to that used in previous studies (Chapter 2).

Procedure

The target movement manipulations used in this study are illustrated in fig. 5.7. A trial commenced with a point target at the central fixation position. The target movement was initiated from a push button controlled by the subject. When the start signal was received the target moved 2.5 degs. to the left or right of the central fixation position. The duration of the target at this location was randomised between 300 and 3000 msec. to reduce the likelihood of anticipatory responses. The screen was then blanked for a period of 50, 60, 70 or 80 msec., before the target reappeared at a distance of 5 degs. Ss were asked to follow the movement of the target as accurately as possible and were unaware of the

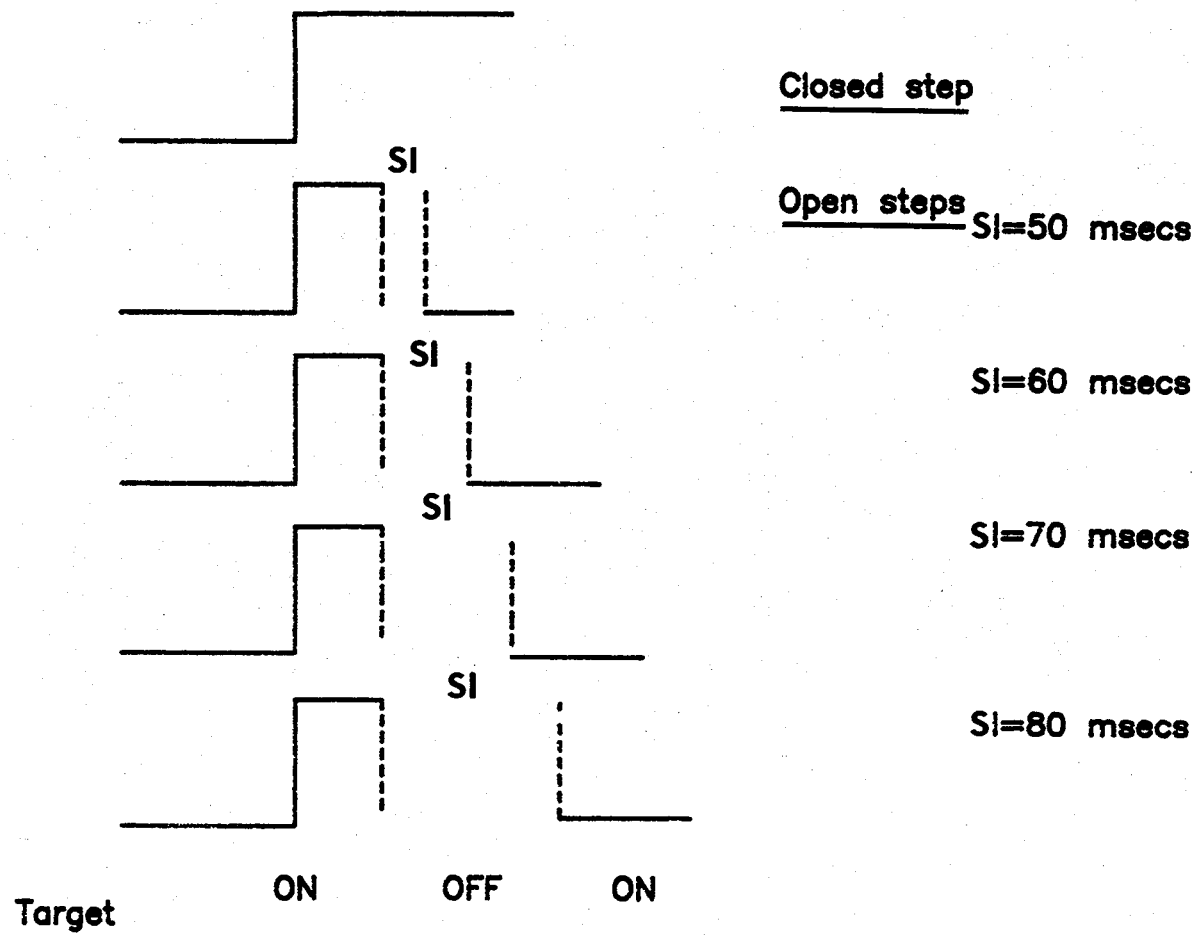

Fig. 5.7. Open and closed step target displacements.
SI - Step Interval.

rationale of the experiment or the target manipulations. Eye movements were sampled at 500 Hz and the analyses were based on 512 words of eye movement samples for each record. Calibrations were obtained every 20 trials.

5.3.2 Results

Saccadic Responses to Open Steps

Fig 5.8 gives the frequencies of OS, US and ACC saccades to open and closed steps. Considering first the results to the closed steps (i.e with zero step interval) ACC saccades are most frequently generated, while OS saccades are very rarely produced. This is the typical pattern of responses to closed step displacements. There was no typical pattern in the proportions of US generated by the Ss to the closed step illustrating that individual eye movement styles are an important feature in the general control of saccade aiming. The variability of options open to Ss in the correction of saccades undermines the preprogrammed model of saccadic eye movements (Weber and Daroff, 1972).

As in the case of the ramps of Exp 5.1 the proportion of ACC saccades to the open steps are reduced from the normal closed step level. With open step displacements the probability of ACC saccades is reduced by 24.6% to 35.4%(S1) and by 35.4% to 44.6%(S2). The data showed that the increase in saccadic aiming errors to open steps consisted predominantly of US saccades. The proportions

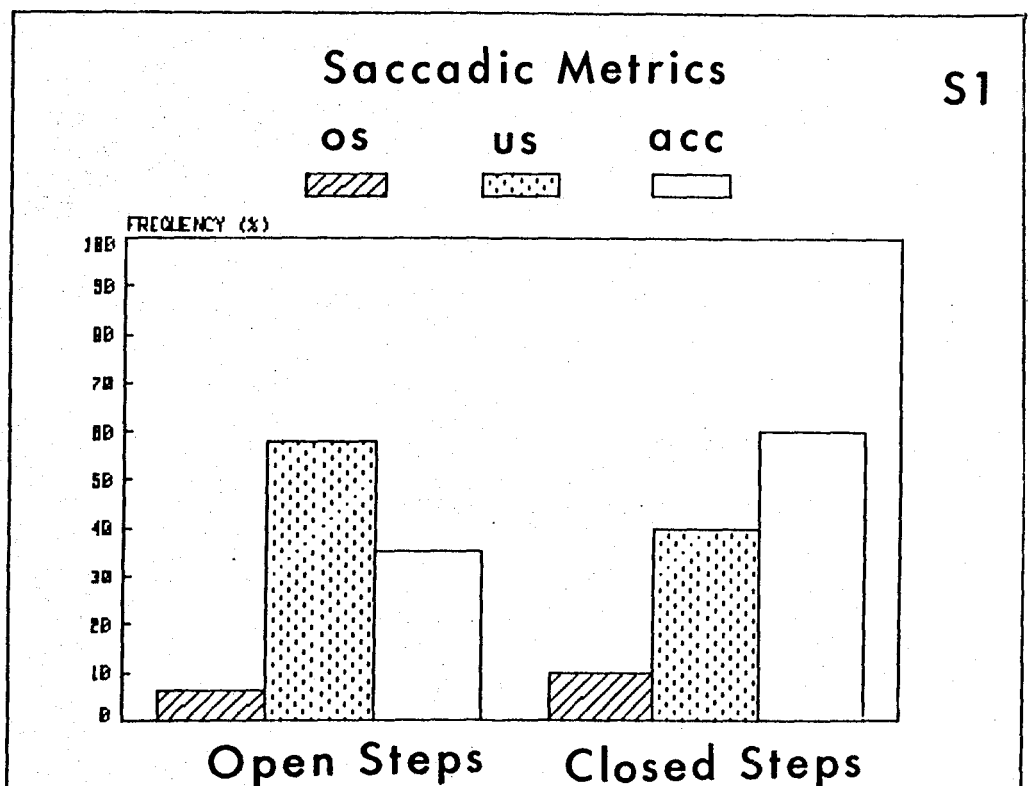
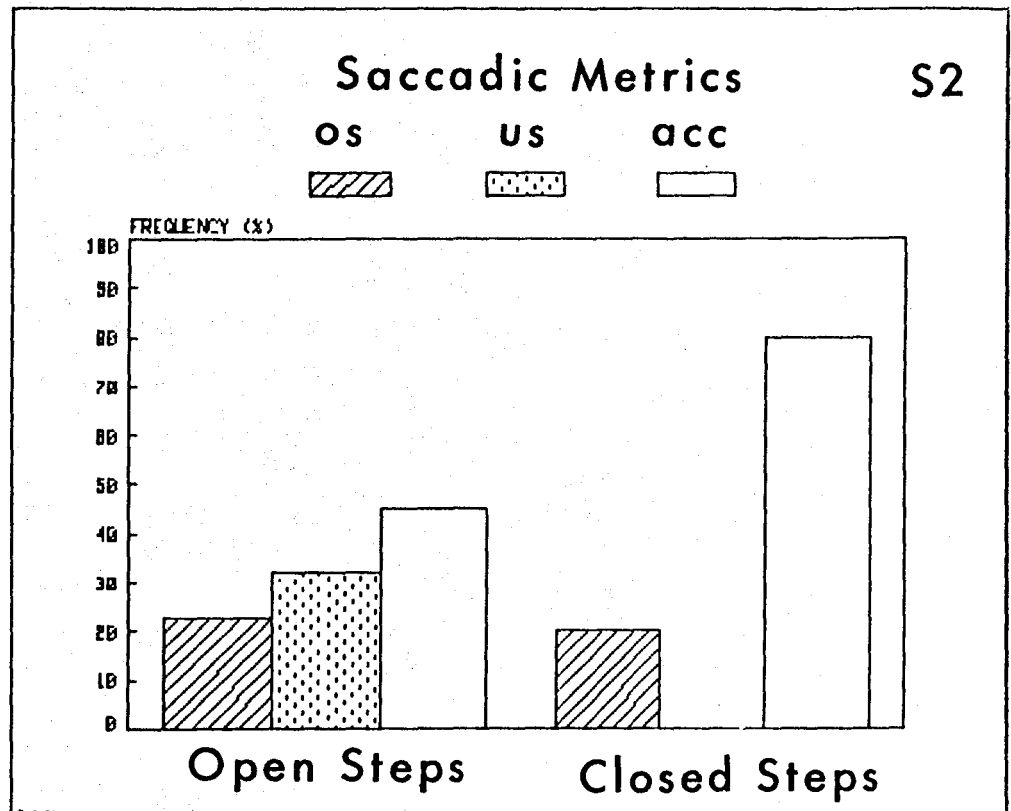

Fig. 5.8. Histograms of proportions of overshoots (OS), undershoots (US) and accurate (ACC) saccades to open and closed target movements.

of OSs were similar in each category of step movement. There was no apparent relationship between the step interval duration and these frequencies.

Peak Velocity and Duration

A between lines regression analysis (Seber, 1977) was performed on the amplitude / peak velocity data at each interval duration against the control saccades to closed step displacements. As shown table 5.1 there was no effect on amplitude / peak Velocity or amplitude / duration relationships at any open step duration. Details of the statistical analyses are presented in table 5.1 and table 5.2.

Variability in terms of standard deviations

Fig 5.9 shows the overall variability of three saccadic parameters to the open step displacements. Compared to the values for the closed steps the variability of saccade amplitudes, peak velocities and durations increased to the open steps.

Latencies

Table 5.3 shows the mean latency of saccades of each S. It is evident that as in the case of ramps, open steps had a similar but even larger facilitatory effect on saccade latencies. The effect has a mean value of 120 msec (S1)

Table comparing closed and open step amp/vel regressions							
SS	SI	Mean		Fp	Fc	N	DF
		Amps (degs)	P.Vels (degs/sec)				
1	50	4.5(0.6)	133(13.3)	0.53*	3.17*	23	2/19
	60	4.9(0.5)	142(17.4)	2.27*	2.23*	19	2/15
	70	4.8(0.5)	131(23.3)	0.23*	2.05*	25	2/21
	80	4.7(0.6)	138(22)	0.73*	0.82*	17	2/13
2	50	4.6(0.5)	154(16)	0.35*	0.54*	19	2/15
	60	4.0(1.2)	148(32.5)	0.04*	1.54*	20	2/16
	70	4.3(0.6)	149(19.5)	0.01*	0.02*	25	2/21
	80	4.0(1.0)	145(17.2)	0.43*	0.87*	16	2/12

* NS

Table 5.1. Summary of regression analyses on the effect of open steps on saccadic peak velocities. Fs = F-statistic for the statistical significance of the difference between the slopes of amplitude / peak velocity regressions to open and closed steps; Fc = F-statistic for the coincidence of open and closed step regressions (see chapter 3 Appendix B); SI - step interval; Amp - mean amplitude; P.Vel - peak velocity; DF - degrees of freedom.

Table comparing closed and open step amp/dur regressions							
SS	SI	Mean		Fp	Fc	N	DF
		Amps (degs)	Dur (msecs)				
1	50	4.5(0.5)	53(2.5)	0.01*	0.09*	23	2/19
	60	4.9(0.5)	54(1.7)	1.76*	0.99*	19	2/15
	70	4.8(0.5)	57(6.7)	0.13*	0.61*	25	2/21
	80	4.7(0.7)	53(4.0)	0.01*	0.44*	17	2/13
2	50	4.6(0.5)	48(2.6)	1.15*	1.04*	19	2/15
	60	4.0(1.2)	43(9.2)	0.16*	0.65*	20	2/16
	70	4.3(0.6)	46(4.3)	0.11*	0.28*	25	2/21
	80	4.0(1.0)	43(10.6)	2.71*	1.71*	16	2/12

* NS

Table 5.2. Summary of regression analyses on the effect of open steps on saccadic durations. Fs = F-statistic for the statistical significance of the difference between the slopes of amplitude / duration regressions to open and closed steps; Fc = F-statistic for the coincidence of open and closed step regressions (see chapter 3 Appendix B); SI - step interval; Amp - mean amplitude; Dur - Duration; DF - degrees of freedom.

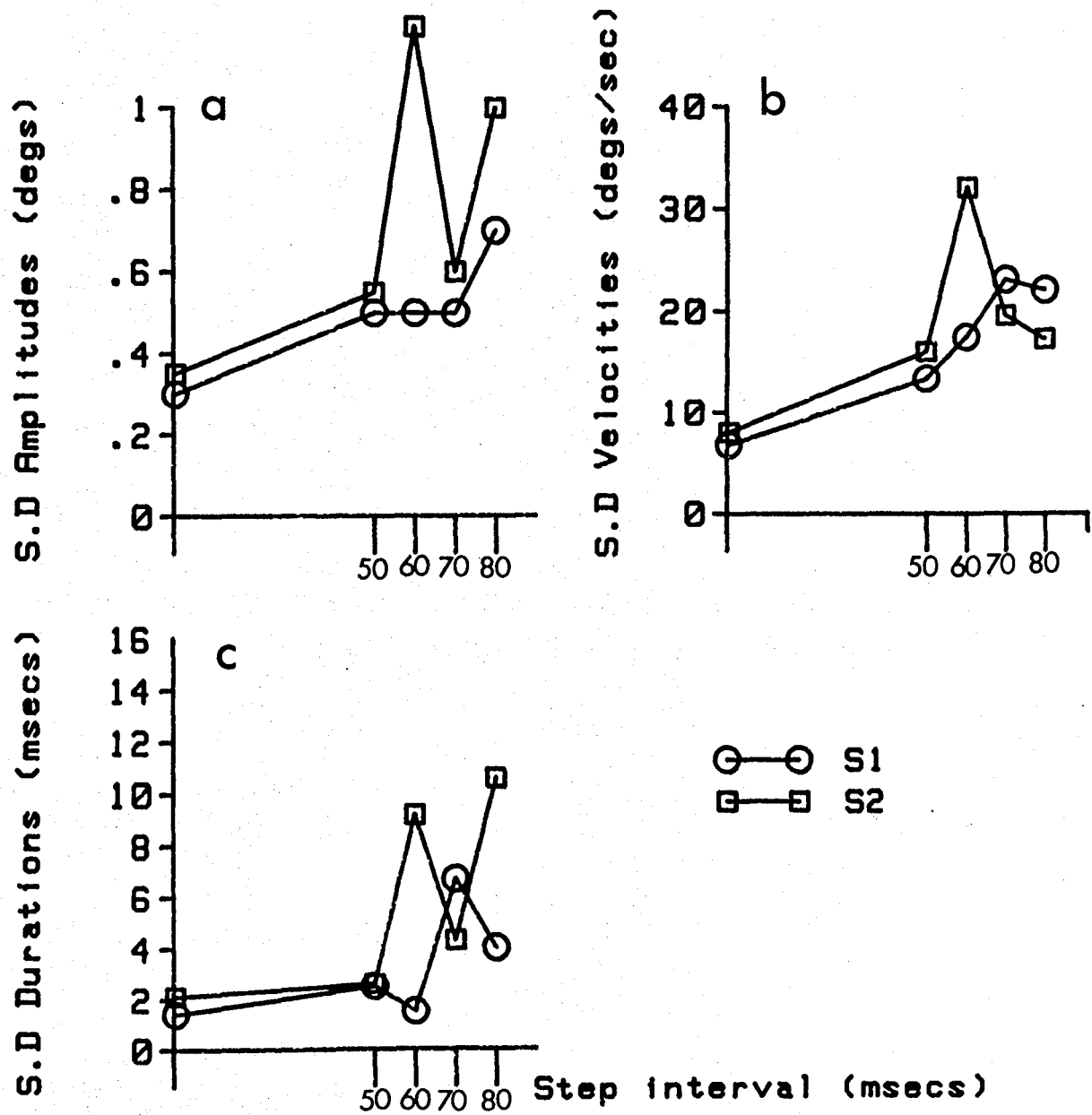

Fig. 5.9. The variability of amplitudes (A), peak velocities (B) and durations (C) are increased to open steps. The values on the y-axis are control values to the closed steps. S.D. - standard deviations.

Mean Latencies (msecs)					
Step interval					
Ss	50	60	70	80	Control
1	149 (26.6)	160 (35.8)	127 (24.7)	126 (33.5)	240 (33.1)
2	118 (42.3)	120 (63.5)	117 (52.1)	113 (55.5)	182.8 (30.0)

Table 5.3. Saccadic latencies and standard deviations (in parenthesis) to open and closed steps. The latencies of the saccades are reduced for saccades to open step targets relative to the control step target displacements. SI - refers to the of blanking within the target displacement; this was timed in units of milliseconds.

and 60 msec (S2).

5.3.3 Discussion

These results further suggest that the saccadic system does discriminate in behavioural terms between categories of visual movement. The saccadic accuracies, mean latencies and peak velocity variability were the most sensitive parameters of the target manipulations. However, the regression analyses show that the absolute level of peak velocities and durations did not depart from the main sequence relationships.

5.4

Experiment 5.35.4.1 Introduction

In this experiment the question of whether the velocity of saccades is influenced by the total duration of the stimulus presentation is addressed. In a task where accurate eye movements are required to identify a stimulus of low discriminability in the peripheral field a reasonable strategy would be for the eye to move more rapidly to short duration stimuli and less rapidly to stimuli of longer duration. The time it takes for the eye to arrive at the target position could, however be influenced by modifying either the saccade reaction time or the saccade velocity. In experiment 5.3 it was decided to leave these possibilities open thus allowing the system to manipulate either or both of these parameters.

A pilot study indicated that using symbols such as letters in a multiple discrimination task would encourage the 'programming' of accurate saccadic eye movements. The pilot study showed that the upper case letters "B-D-O-Q" when laterally masked by crosses (X X), would require fairly precise eye fixations to be able to discriminate these successfully. This was determined by estimating the discriminability of these letters as a function of

eccentricity (Bouma, 1978). Fig. 5.10 shows that optimal performance was only possible within a 1 deg. radius of the line of the visual axis. Eye fixations outside of this region increased the difficulty of the task.

5.4.2 Method and Procedure

Subjects

Eight psychology students participated in the experiment. With the exception of S1 who wore corrective contact lenses all Ss had normal emmetropic vision.

Procedure

The experiment used two conditions which were defined by the eccentricity of the target displacements, either 5 or 20 degs. of visual angle. Ss were divided equally into these conditions.

The stimuli used consisted of the upper case letter set "BDOQ". The dimensions of the letters were 0.2 degs x 0.33 degs. The pilot study had shown that this letter set would require accurate fixations within 1 deg. to ensure optimal performance.

On a typical trial a dot fixation was initially present at the centre position. When the S indicated that he or she was ready to begin the trial the dot target at the centre stepped to a position 2.5 (or 10) degs. to the left or

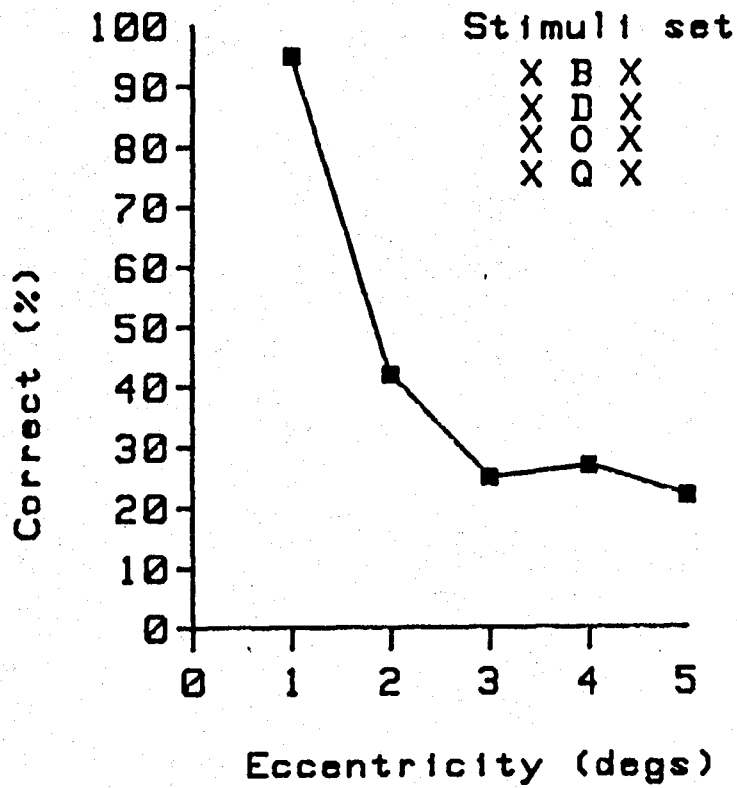

Fig. 5.10. Discriminability of laterally masked letters as a function of eccentricity. Chance level was 25%.

right for a random period between 400, 600, 800 or 1000 msec. A target letter was then presented at the appropriate eccentricity for that condition. Ss were required to saccade from the spot stimulus to the target letter and to indicate the letter presented by pressing one of 4 prescribed keys.

A session consisted of 2 blocks, each of 30 trials. One block had letters of 200 msec duration while the other contained letters of 600 msec duration. The order of blocks was counterbalanced at each target eccentricity.

Ss were instructed to move their eyes accurately to the stimuli and to attempt to identify the letters presented. They were not warned about the letter duration manipulations used in the experiment. Verbal feedback on the letter identification performance was provided throughout the session.

5.4.3 Results

Letter Identification Performance

Fig. 5.11 shows that as expected Ss were more successful at identifying letters in the 600 msec condition. The one S whose results did not conform to this pattern had poor parafoveal vision in previous tests; that is at eccentricities of 2 to 5 degs. her visual discrimination

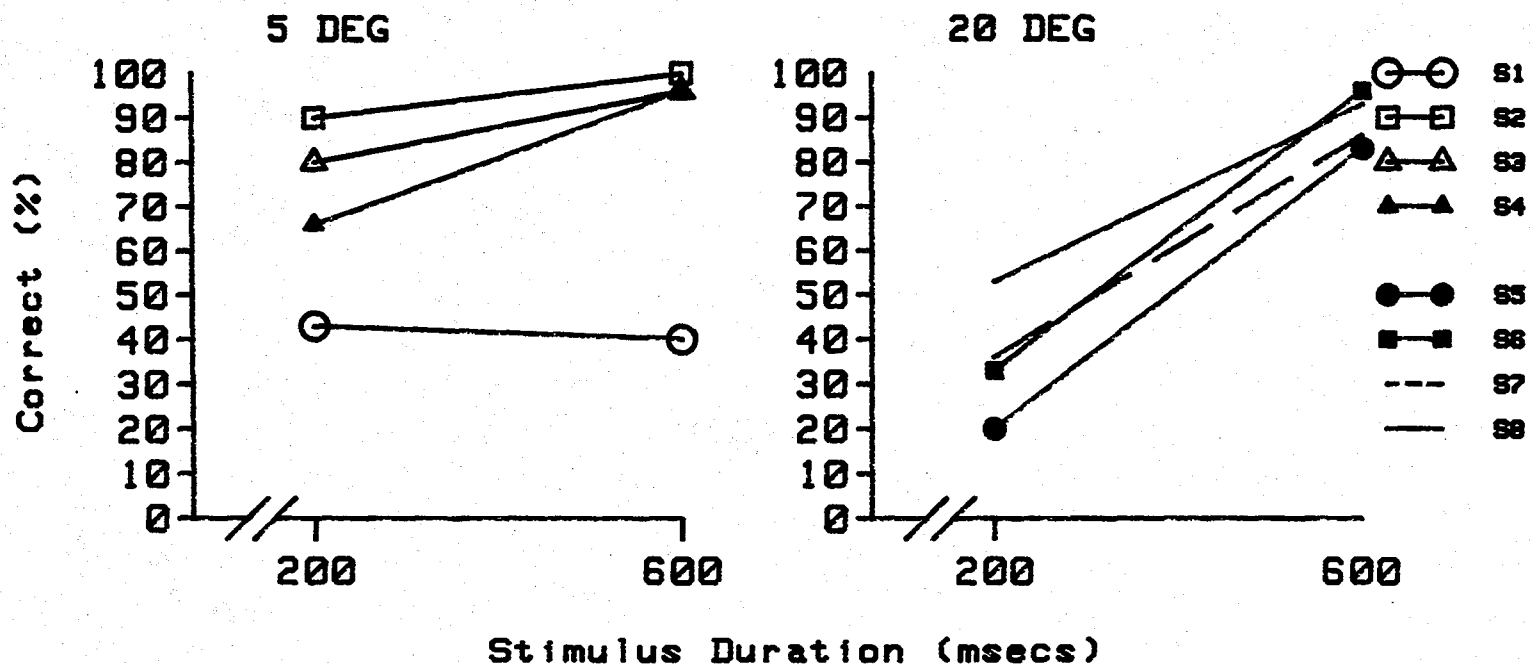

Fig. 5.11. The effect of eccentricity and stimulus duration on discriminability of masked letters in the eye movement task.

performance was inferior to that of other Ss. This S was retained in the main experiment however because her foveal vision was normal and the experiment was designed to encourage Ss to saccade accurately to the stimuli.

Peak Velocity and Durations

Tables 5.4 and 5.5 shows the mean values for the saccade peak velocities, mean durations and mean amplitudes. Also presented are the results of the regression analyses comparing the 200 and 600 msec saccades. Only one S(S7) showed a significant main effect for peak velocities and durations. In general the stimulus duration produced no effect on the absolute level of amplitude / velocity or amplitude / duration relationships, but 2 Ss (S1 and S7) showed a significant effect of the stimulus duration.

Latencies

The results plotted in fig. 5.12 showed that in both the 5 deg. and 20 deg. target conditions three of the four Ss demonstrated faster saccade latencies in the 200 msec duration blocks but the effect was small. Interestingly the variability of latencies was also reduced in the 200 msec blocks.

Accuracy

Although the 600 msec letter duration condition left

Table comparing the effect of stimulus duration on amp/vel regressions

5 DEG		MEAN		Fs	Fc	N	DF
Ss	SD	Amp (degs)	Vel (degs/sec)				
1	200	4.5(0.4)	219(19.4)	0.02*	6.82**	60	2/56
	600	4.8(0.6)	219(23.2)				
2	200	5.7(0.7)	301(52)	1.9*	1.77*	51	2/47
	600	4.2(1.1)	301(52.8)				
3	600	5.0(0.4)	246(22.3)	0.02*	4.56*	52	2/48
	200	5.0(1.2)	255(56.9)				
4	600	4.9(1.1)	248(55)	0.78*	0.42*	56	2/52
	200	3.7(1.4)	193(68.5)				
20 DEG							
5	200	22.6(2.7)	469(180)	0.93*	1.23*	54	2/50
	600	18.0(2.1)	378(36.9)				
6	200	20.8(1.9)	549(66)	0.86*	0.68*	60	2/56
	600	18.4(1.3)	487(48)				
7	600	17.0(1.9)	477(42)	23.1**	11.7**	49	2/45
	200	15.6(3.4)	439(135)				
8	600	19.1(2.4)	496(73)	0.1*	0.42*	51	2/47
	200	18.0(3.5)	482(105)				

* NS
** p < 0.01

Table 5.4. Saccadic amplitude / peak velocity relationships to 200 msec and 600 msec stimulus durations (SD). Fs = F-statistic for the significance of the difference between the slopes of the amplitude / peak velocity regressions; Fc = F-statistic for the coincidence of regressions (see chapter 3 Appendix B). Amp - amplitude, Vel - peak velocity, DF - degrees of freedom.

Table comparing the effect of stimulus duration on amp/dur regressions

5 DEG							
Ss	SD	MEAN		Fp	Fc	N	DF
		Amps (degs)	Dur (msecs)				
1	200	4.5(0.4)	33.1(2.2)	0.00*	4.26*	60	2/56
	600	4.8(0.6)	35.7(3.0)				
2	200	5.7(0.7)	34.3(5.1)	1.6*	0.85*	51	2/47
	600	4.2(1.0)	30.4(3.4)				
3	600	5.0(0.4)	33.0(2.1)	0.0*	0.05*	52	2/48
	200	5.0(1.2)	33.2(6.5)				
4	600	4.9(1.1)	33.3(3.9)	0.18*	0.36*	56	2/52
	200	3.7	29.9				
20 DEG							
5	200	22.9(2.7)	83.1(9.9)	8.69**	4.37**	54	2/50
	600	18.0(2.1)	79.8(7.7)				
6	200	20.8(1.9)	72.0(9.9)	0.07*	0.66*	60	2/56
	600	18.4(1.3)	71.1(6.9)				
7	600	17.0(1.9)	65.3(5.9)	17.2**	8.8**	49	2/45
	200	15.6(3.4)	65.8(18)				
8	600	19.1(2.4)	68.7(8.5)	3.8*	3.32*	51	2/47
	200	18.0(3.5)	69.5(13.2)				

* NS
** p < 0.01

Table 5.5. Saccadic amplitude / duration relationships to 200 msec and 600 msec stimulus durations (SD). Fs = F-statistic for the significance of the difference between the slopes of the amplitude / duration regressions; Fc = F-statistic for the coincidence of regressions (see chapter 3 Appendix B). Amp - amplitude, Dur - durations, velocity, DF - degrees of freedom.

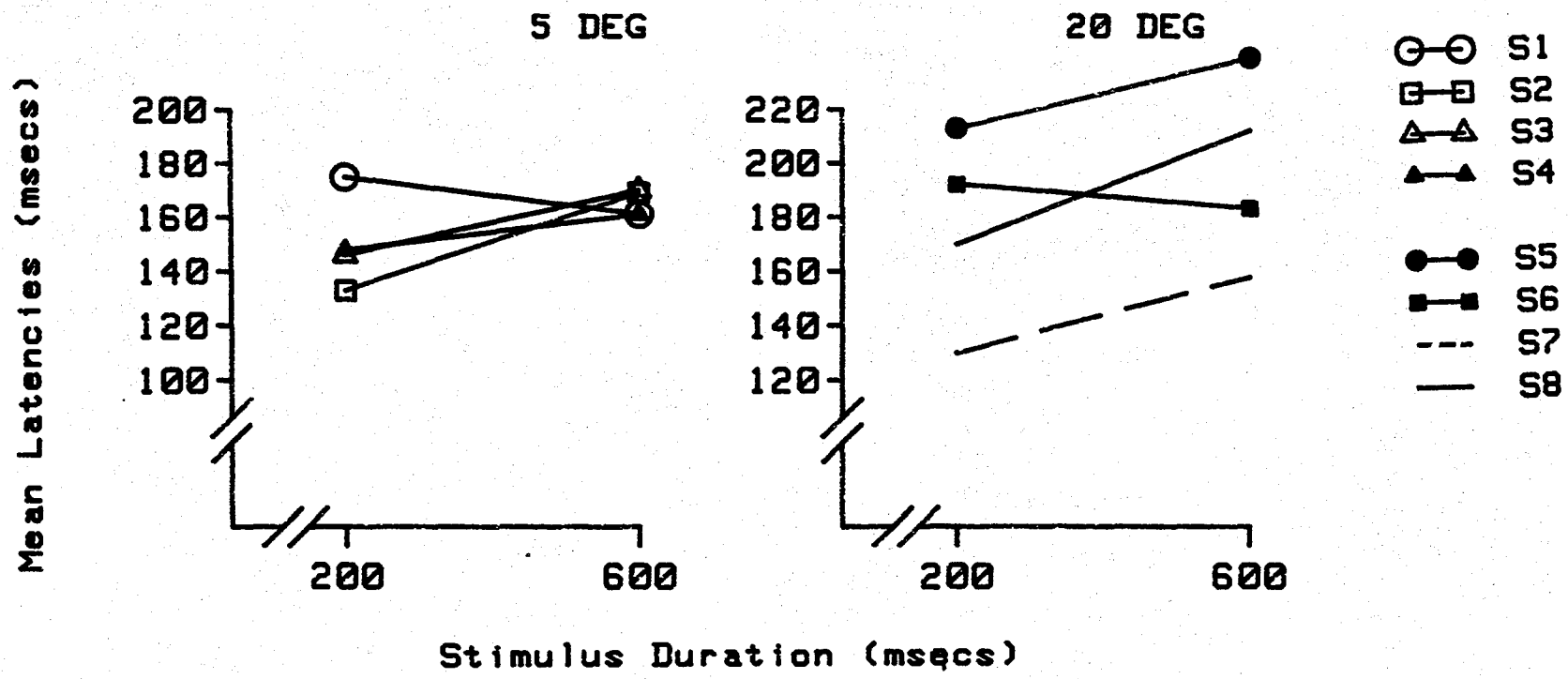

Fig. 5.12. The effect of stimulus duration on mean saccadic latencies.

sufficient time for corrective saccades, 6 of the 8 Ss produced more accurate initial saccades, both in terms of their standard deviations and their absolute position errors, in the 600 msec conditions (see Fig. 5.13, where the standard deviation data are plotted). The results also illustrate a parallel trend for each S with the variabilities of peak velocities.

5.4.4 Discussion

The saccadic system adjusts its response to manipulations in the duration of a stimulus presentation in some interesting ways. When the duration of the stimulus is relatively long the accuracy of saccades, particularly large saccades is improved over short duration presentations. The saccadic system allows more time for the preparation of the eye movement. This could be explained in two ways. It may be that a speed / accuracy trade off in the saccadic system means that the greater accuracy of saccades in the 600 msec condition requires the longer latencies observed. Kapoula (1984) has recently shown that a speed / accuracy trade-off does exist for saccadic eye movements. Alternatively, the saccade accuracy and latencies may have been independently determined by the stimulus duration. Further experiments are necessary to distinguish between these possibilities.

Saccades showed only minor modifications (< 5%) in peak

S.D Amplitudes (degs) S.D Velocities (degs/sec)

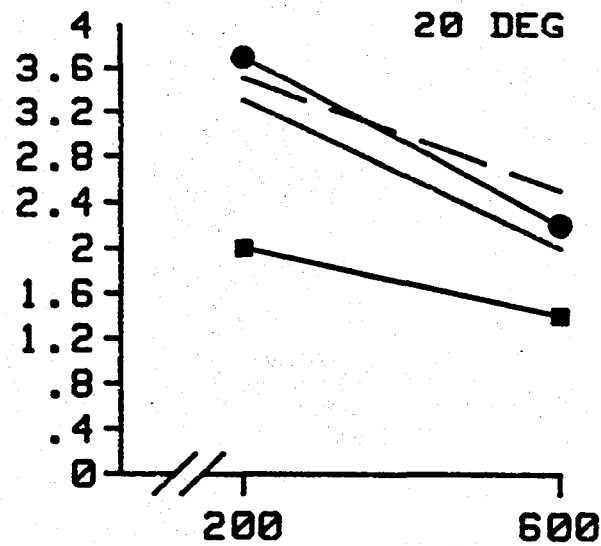
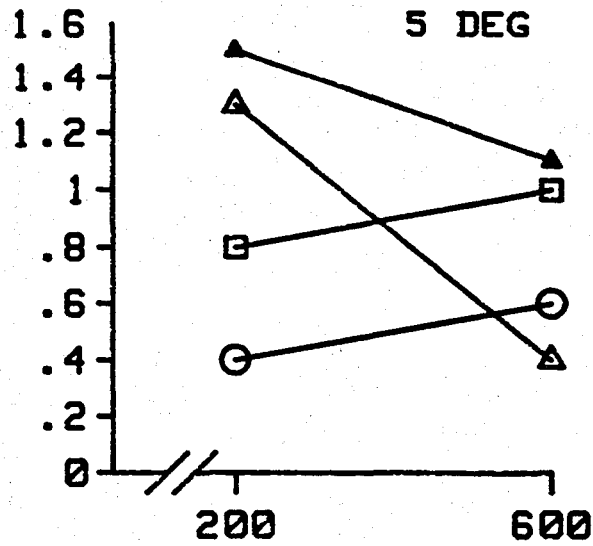

- S1
- S2
- △—△ S3
- ▲—▲ S4
- S5
- S6
- S7
- S8

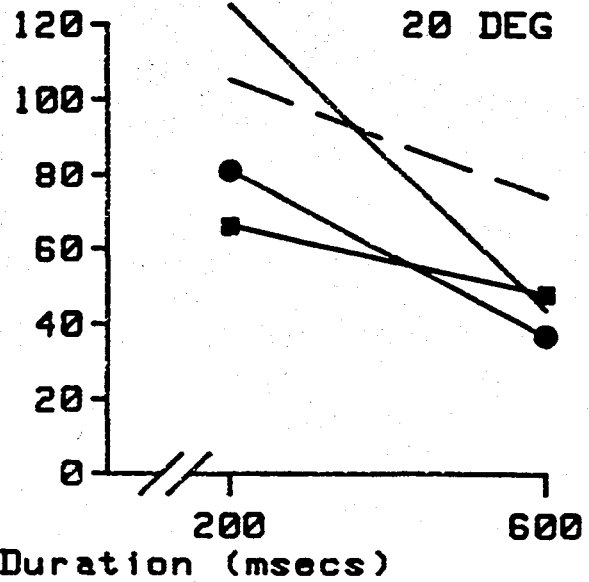
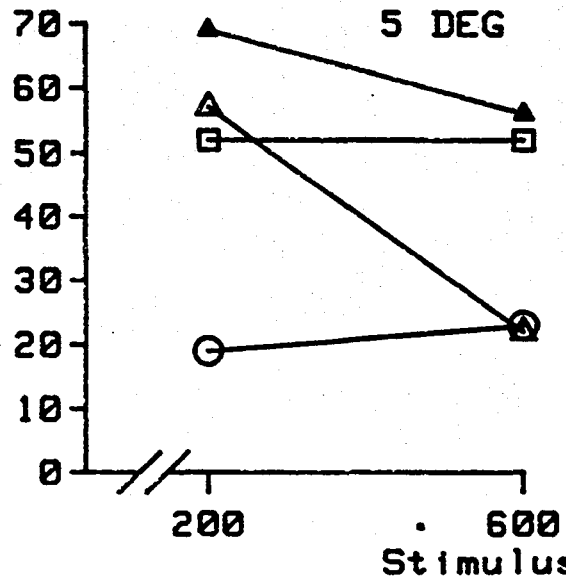

Fig. 5.13. Effect of stimulus duration on the variability of amplitudes and peak velocities. S.D. - standard deviations.

velocities and durations. However, the saccade latency results showed why modifications were not necessary for the task. By reducing the delay of the saccade the system was still able to locate the stimuli more rapidly in the short duration blocks. When possible it seems that the saccadic system quite sensibly uses the simplest or easiest route to maximize foveal vision when having to track a target.

In experiment 4 an attempt was made to guide the system into adjusting the saccade dynamics rather than the saccade latency. This was attempted by using a contingent procedure in which the duration of the stimulus was present for a fixed period relative to the onset of a saccadic movement. This method eliminated the effect of the saccade latency on the time that the stimulus would be present in the foveal region following a saccadic movement.

5.5

Experiment 5.45.5.1 Introduction

This experiment was designed to test the possibility that Ss could adjust the speed of the saccades in a letter identification paradigm in which the duration of the stimuli were short.

5.5.2 Method and Procedure

Two Ss participated in this experiment, one of whom S2, had taken part in experiment 5.3.

Procedure

Each condition started with a block of 20 target displacements, where the total duration of the target display was constant. The amplitude of these displacements was varied from 1 to 5 degs.

An experimental trial started with a fixation dot in the central position. When Ss were ready this was shifted + or - 2.5 degs. After a randomly determined foreperiod the spot was replaced by one of four laterally masked letters 5 degs. to the left or right (in the opposite direction to the spot displacement) "B-D-O-Q". Each letter was presented for a total duration of 150 + RT msec, where RT

was the reaction time of the saccade. The fixed period of 150 msec was chosen so as to encourage a fast saccade trajectory but not necessarily shortened reaction times. With respect to the visual system, a faster trajectory would increase the duration of the stimulus at the fovea but faster saccade latencies would have no effect. The on-line analysis of eye movements was based on eye position samples taken at 2 msec intervals. A saccade was signalled once the eye velocity exceeded 30 degs/sec and was accelerating. This required a minimum delay of 4-5 msec plus analytical time overheads which came to less than 1 msec. (see General Methods chapter for details of the algorithm common to all the experiments).

At the end of each trial Ss signalled the letter presented by pressing one of four response keys.

5.5.3 Results

Letter Identification

Table 5.6 also shows that although both Ss scored above chance level, many more errors were made in this task than in the conditions of experiment 5.3.

Peak Velocities and Durations

For S1 velocities increased to the letter targets from the control level by 11.9 deg/sec while for S2 showed an

Ss	MEAN LATENCIES (msecs)		Accuracy (degs)	% Correct
	Control	EXP		
1	164 (53.2)	163 (52.2)	1.3	35.7
2	158 (36.7)	211 (162.4)	1.5	40.3

Table 5.6. Saccadic latencies, accuracy and visual discrimination of contingently controlled letter stimuli. EXP - main experimental condition.

increase of only 3.41 deg/sec. For S2 the effect was less than the standard error of the amplitude / velocity regression. Saccade durations showed even smaller effects with both Ss showing modifications relative to the control conditions of approximately 1 msec. Table 5.7 show these saccadic durations and peak velocities were not significantly different from control saccades.

Latencies

Table 5.6 shows that there was no real difference in mean saccade latencies in the mean values over the control trials. One subject who seemed to show longer latencies in the contingency trials showed a difference that was substantially less than the standard deviation in this session. One explanation of the lack of an effect on latencies is that as it was not possible to use peripheral vision to identify the letters at 5 degs. there was no perceptual advantage in delaying the saccadic movement. There was also no advantage in speeding the reaction time of the eye because in contrast to experiment 5.3 this would not increase the duration of the stimulus at the fovea. However, the increased standard deviations for S2 suggested that although this S did not stick to either of these strategies consistently both were tried at points throughout the session.

Table comparing the effect of stimulus duration on amp/vel regressions							
Ss		Amp (degs)	Vel (degs/sec)	Fs	Fc	N	DF
1	Control	2.7(1.7) 3.4(1.3)	148(58) 180(46)	1.92	2.75	85	2/81
2	Control	2.5(1.6) 3.6(1.5)	138(51) 159(54)	0.03	0.71	82	2/78

Table 5.7. Saccadic amplitude / peak velocity relationships. Fs = F-statistic for the significance of the difference between the slopes of the amplitude / peak velocity regressions; Fc = F-statistic for the coincidence of regressions (see chapter 3 Appendix B). Amp - amplitude, Vel - peak velocity, DF - degrees of freedom.

Accuracy

The accuracy of saccades was similar to the levels achieved in the 200 msec duration letters in the 5 deg. condition of experiment 1 (Table 5.6).

5.5.4 Discussion

Several aspects of the results question the view that the control of a saccade is insensitive to the quality of information in the target motion. Two examples of the effect of the movement input on the saccade was the finding that the accuracy of saccades was severely impaired to the ramp and open step targets. It might be argued that these saccades were generated in response to position error information sampled prior to the saccade. This proposition is incompatible with the finding that OSS occurred to fast and in some cases slow ramps. Only USS would be expected if saccades were singularly based on presampled position information.

This interesting effect of ramps on saccadic position aiming may provide one answer to the question of why saccades are not the naturally favoured option of the oculomotor network for the tracking of smoothly moving targets. In order to generate the correct pulse for a saccade the system needs to have stable information about the target position. According to Becker and Jurgens

(1979) the spatial information for a saccade is picked up from the visual input over a finite time width (approximately 80 msec), this data is 'pooled' or averaged and a saccade is then programmed as a consequence of the spatio-temporal processing. It may be that if the visual information is in motion for a significant duration of the visual sampling it will be more difficult to estimate the appropriate pulse necessary to generate a saccade to a specific spatial location. The records which demonstrate what have been called 'unstable' saccades (cf fig. 5.4) show that ramps may also cause a problem for the system to determine the appropriate correspondence between the pulse for the saccadic movement and the step component for maintaining the eye position once it has arrived at the target location.

A possible relationship between the saccade accuracy, variability in peak velocities and length of saccade latency was raised in these experiments. Interestingly, there are previous observations which would support such a covariation of saccadic parameters. Ross and Ross (1981) and others have demonstrated that the offset of a foveal fixation point followed subsequently by the onset of a peripheral target reduces the latency of the ensuing saccade. Thus a luminance offset seems to act as a positive warning cue to increase the preparation for the release of a saccade. Reulen (1984) has recently developed a detailed model to explain this effect. There appears to be something unique about an offset cue as a

similarly timed luminance onset has an inhibitory effect on the saccade latency. The situation in experiment 2 where reduced latencies and an increase in the standard deviation of the saccade amplitude were found, was very similar to the Ross and Ross conditions in which saccade latencies are reduced from their baseline levels. In these terms the open step would be interpreted as a warning cue to the target movement. The relative change in mean saccade latencies in Experiment 3 can be explained by the need in that situation to move the eye more quickly in the short duration (200 msec) than in the longer stimulus presentation condition (600 msec). Kapoula (1984) has shown that there is a negative relationship between the variability of a saccade amplitudes and the mean saccade latency. In other words there is a speed / accuracy trade off. The results presented above support this view. However, also associated with this relationship is an increased variation in peak velocities, supporting the view that impulses controlling the accuracy and acceleration of a movement are functionally linked (Schmidt et al., 1979). In common with previous data Ss here showed individual variability in the control of their eye movement characteristics, further indicating that saccades are not stereotyped motor behaviours (cf Baloh et al., 1975).

5.6 Summary

1. Saccades are less accurate to a ramp than to a step movement. But the velocity of a ramp movement is not reflected in the velocity of a saccadic movement to that stimulus (Gurevich law). The proportion of OSs and USs depend on the velocity of the ramp. OSs are more likely to fast ramps and USs are more frequently produced to a slow ramp.

2. The saccade latency to the termination of a ramp was found to be positively correlated with the latency of the initial saccade, for the range of ramp velocities used in this study.

3. Increasing the temporal duration of a movement with no variation in the stimulus velocity reduces the saccade accuracy and peak velocity relative to near infinite velocity steps. Mean saccade latencies were also shortened for these saccades.

4. The variability of saccades are to some extent a function of the duration of the stimulus, when the saccade eye movement task maximizes the need for foveal vision.

5. The saccade latency is also lengthened to longer duration stimuli.

6. The dynamics of the saccade are only marginally

affected in this type of task even when the influence of saccade latencies is counteracted.

CHAPTER 6The Modification of Saccade Amplitudes6.1.1 Introduction to the Control of Saccade Amplitudes

The control of the size of a saccade has been of central significance to the question of whether saccades can be properly conceived as stereotyped, preprogrammed movements or continuously controlled behaviours. This chapter briefly reviews eye movement research which has focussed on the control of saccade amplitudes. Then 3 experiments are presented which attempted to investigate the use of spatial signals in the voluntary and involuntary control of saccadic amplitudes.

Dodge (1907) discovered that when a visual disparity between the line of the visual axis and the position of a target was detected a saccade of almost appropriate amplitude was triggered towards the target position. Any residual error following the initial saccade was corrected by a smaller reduced latency saccade. According to Weber and Daroff (1972), if the residual error following the primary saccade is unequal in the two eyes this disparity is corrected with what have been called 'glissade' eye movements. For small amplitudes (<10 degs.) the residual error following the primary saccade is in the order of 10% of the total visual angle (Becker and Fuchs, 1969). The

consistency of this undershoot coupled with the reduced latency of these corrections has led some workers to suggest that these responses were preprogrammed (Becker and Fuchs, 1969). This view was supported by the finding that corrective saccades were consistently produced in spite of the fact that the visual target was switched off prior to the onset of the primary saccade. Thus there was no visual disparity at the time of the movement to trigger the correction (but see Shebilske, 1975; Prablanc, 1980). The latencies of these corrective movements were reduced by approximately 50% of the primary fixation saccade latency.

However the data on corrective saccade amplitudes reported by Weber and Daroff (1972) showed that the Becker and Fuchs (1969) explanation had failed to take into account the intrinsic variability in the strategies available to the oculomotor system in the cancelling of foveal disparities. Weber and Daroff showed that corrective movements were comprised of several different categories. These included glissades, positive and negative corrections as well as a total absence of any observable corrective responses. These authors concluded that the wide range of methods available for re-aligning the eye to the target would make an account of the control process in terms of preprogramming mechanisms highly unlikely. Further evidence against the preprogramming concept came from Shebilske (1976) who found that the amplitudes of corrective saccades when the target was extinguished in

the dark were matched precisely to the size of the original residual disparity. This suggested that extraretinal feedback information on the position of the eye was actively used in the control of saccadic corrections (but see Prablanc, Masse and Echallier (1978), Experiment 1). Prablanc et al. (1978) reported results which differed from Shebilske's findings in a curious way. They observed that corrective saccades were produced when a target was extinguished at the onset of the primary saccade, although the corrective saccade only correctly compensated for the residual error when the target was switched off during the deceleration phase of the primary saccade (cf Experiment 2). This demonstrated that afferent feedback information can be reliably utilized in the control of corrective movements.

The limited research on corrective saccades seems to provide support for the conclusion that saccade amplitudes are precisely controlled to reduce retinal errors. This task may be facilitated by the regularity or predictability of any necessary corrections that follow a primary saccade (i.e the normal undershoots).

6.1.2 Pulse-Step Movements

Fig. 6.1 illustrates the categories of stimulus movements used in experiments on pulse-step movements. Research using these patterns of movements are based on the

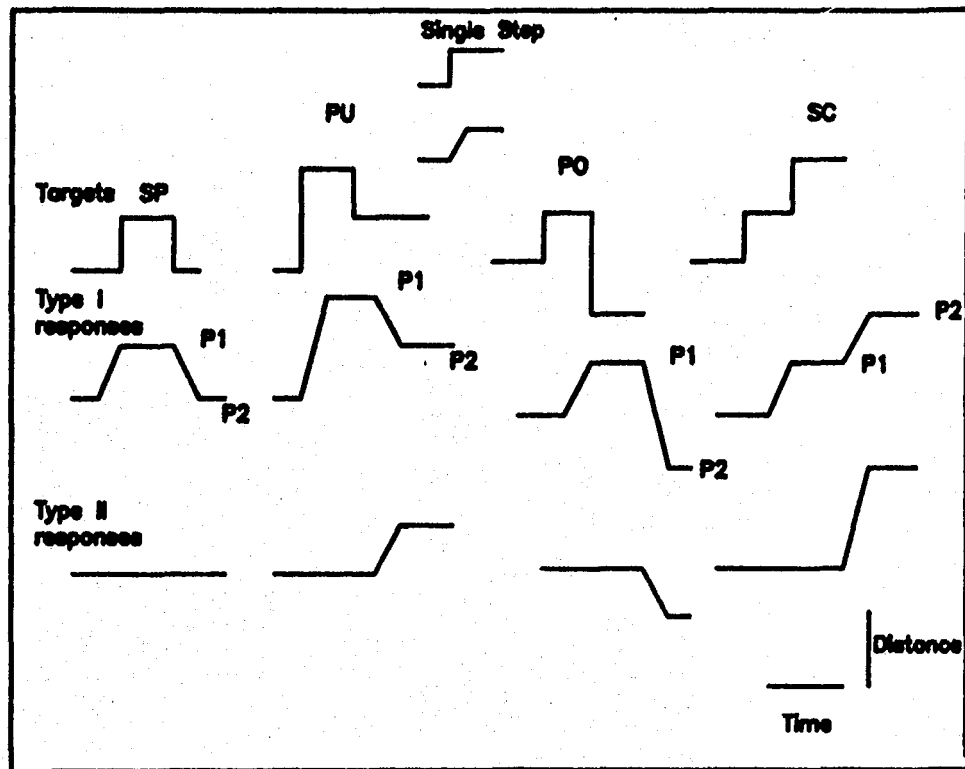

Fig. 6.1. Pulse-step stimuli and saccadic eye movement responses. SP - symmetrical pulse, PU - pulse under, PO - pulse over, SC - staircase, P1 - position 1, P2 - position 2.

rationale that when a target is flashed in the periphery the visual processing of this event triggers a chain of visual and motor operations which subsequently evokes a saccade towards the spatial location corresponding to the position of the image on the retina. The effect of the visual information on the control of the saccade and the question of whether these processes can be modified, can be ascertained by examining the response of the system to a second stimulus movement, which is presented at various times following the first movement.

The procedure was first employed by Westheimer (1954b). His experiment used a symmetrical pulse (SP, see fig. 6.1) movement with a variable pulse duration (W) from 40 to 200 msec. Westheimer reported that a single mode of response occurred to this event. This consisted of an initial saccade to the first target location followed 200 msec later by a return movement back to the central fixation position. In other words the saccade was not cancelled in spite of the return of the target to the central position before the take-off of the first saccade.

Westheimer's data, however, has been consistently undermined by more carefully controlled studies using a wider range of step-pulse movements. Wheelless et al. (1966) recorded saccadic eye movements to single step and PO target movements. He observed that double component (type I) and single component (type II) responses were elicited to pulse-over (PO) movements. The

probability of their occurrence was a function of the duration of the pulse. Type I responses increased and Type II decreased as W increased, (this had in fact been previously demonstrated by Bartlett, Eason and White, 1961). The latency of type II responses was analysed with respect to the latency of single steps by simply subtracting the value of W, the duration of the pulse, from the type II response latency. This showed that the delay of the modified saccade amplitudes exceeded the latencies of normal saccades to single steps as well as the latencies of type I responses. This effect of W on the probability of type I and II saccades has been replicated in a number of laboratories (Kommoda et al., 1973; Levy-Schoen and Blanc-Garin, 1974; Carlow et al., 1975; Lisberger et al., 1975; Nam, Park and Choi, 1975; Taumer, 1975; Becker and Jurgens, 1979). However, there are several questions on the control of saccade amplitudes which have received little attention in these studies. For example, are modified saccades (in this case type II saccades) controlled to the same level of performance in terms of their precision as saccades to single step targets? Are the end points from a population of modified saccades equivalent to the distribution of normal saccades? Are responses to PU movements simply the symmetrical opposite of SC movements?

Some of these issues have been addressed in the work of Becker and Jurgens (1975, 1979). Previous research had focused on latencies and amplitudes as a function of the

temporal separation of the two target positions. In their work, Becker and Jurgens showed by implication, firstly, that the categorization of saccades into type I and type II responses was an oversimplification. Saccade amplitudes to SP, SC and PU stimuli in fact form a 'transition' function in which the distribution comprises saccades whose extremes lie at P1 and P2 (see fig. 6.1) but many responses are positioned at intermediate locations between P1 and P2. Moreover, it was shown that the position of a saccade on the transition function was a function of the temporal delay from the second step of the sequence to the onset of the saccade. So the greater the temporal interval between the second target step and the onset of the initial saccade the more accurate were the saccades to the final target position. This further demonstrated that the initial processing for a saccade can be cancelled during programming stages and replaced with a redirected movement. But the system seems to require extra time in which to complete the adjustments.

A more detailed inspection of Jurgens and Becker data suggested that the modification of saccade amplitudes are not equally probable for all stimulus movements. Exact figures were not reported but an approximate estimation revealed that there were only 6 (<5%) complete on-target type II saccades to the SC stimuli compared to over 100 (>50%) type II responses to the PU stimulus. A similar assymetry in the modification of saccade amplitudes had been previously reported by Levy-Schoen and Blanc-Garin

(1974). This important result will be discussed again in subsequent sections.

6.1.3 Modification of Saccade 'Gains'

The issue of the capacity of the system to use the spatial stimulation from a single target to control its saccade amplitude to adjacent spatial locations has interested some workers. This task can be understood to require the 'recalibration' of a saccade by some mathematical operation on the neural output arising from the visual stimulation of the current target event.

The first experiment along these lines was conducted by Mclaughlin (1967). In this experiment a target was presented at a 10 deg. horizontal position to one side of the visual fixation point. The subject was asked to saccade to this point. While the elicited saccade was in progress the position of the target was shifted 1 deg. back towards the eye. This caused the first saccade to overshoot the target. However, within 3 to 4 trials the amplitudes of saccades were adjusted so that the eye was accurately directed to the final target (9.1 degs). Subsequent research using this paradigm has replicated this effect but also produced some contradictory results. Cavicchio (1975) argued that the effect was 'parametric' because the adjustments induced at the training eccentricity were generalized proportionally to other

target distances. Miller, Anstis and Templeton (1981) reported that there was a generalized adjustment of 42% of the trained amplitude adjustment to similarly directed target eccentricities. But there was only a 25% change in saccade amplitudes when the task required an increase in saccade 'gain', compared to a 60% decrease in the lower gain condition. (Gain is defined here as the ratio of the eye movement amplitude to the target eccentricity.) This apparent reluctance of the system to generate saccades which overshoot a previous target location is reminiscent of the low probability of type II responses to SC stimuli.

Miller et al., (1981) also showed that although the gain effect generalized to saccades of different amplitudes in the same direction as the training target, the effect did not transfer to saccades in the opposite direction. This had been previously shown by Weisfield (1972). He demonstrated with the contingent target shift saccades to a stationary target in the opposite direction to the modified saccade were as accurate as normal saccades. This showed that the motor channels controlling leftward and rightward saccades are independent and can be selectively manipulated.

An elegant experiment by Henson (1978) looked at the question of whether undershoots are a direct consequence of a controlled strategy by the saccadic operator. An optical distortion was produced by placing a hydrophyllic contact lens on the eye which caused a reduction in the

visual focal length (myopia). This myopia was counterbalanced by a spectacle lens of sufficient strength to restore normal visual acuity. The optical physical relationships were arranged such that to fixate accurately on a target a saccade with an amplitude of approximately 90% of the visual angle at the retina was required. Therefore the usual corrective saccades following a primary saccade would not in these circumstances be necessary. It was found that over the course of a session saccades which took the visual axis past the target were gradually replaced by saccades which re-established the negative target disparities. Interestingly, the results from at least 2 of the 3 Ss clearly showed that the frequency of normometric saccades was largely unaffected, showing that the system aims to minimize overshoots but not necessarily to make all saccades undershoots!

6.1.4 The Hallett Amplitude Recalibration Experiments

It may be that the curious assymetry found in the training of overshoots and undershoots (and similarly the frequency of type I and type II responses to PU and SC stimuli) are restricted to contexts in which very fast responses are encouraged when Ss have little awareness of their saccadic performance. Hallett and workers (Hallett, 1978; Hallett and Adams, 1980) carried out experiments on the modification of saccade amplitudes in voluntary eye movement tasks. These studies demonstrated that Ss can

consciously modify the amplitude of a saccade to a target with a consequential increase in saccade latencies of 40 to 60 msec. However, no data were reported on the relative accuracy of overshoots and undershoots.

6.2 Introduction to the Experiments

Extensive modifications of saccade amplitudes have already been demonstrated in the BF-slow tasks (cf Experiment 3.1) and also in the experiments described in chapter 4. These found that the 'programming' of a saccade was not automatically regulated by the visual processing at the current target eccentricity. For any saccade there were a range of spatial locations to which the eye could be directed around the target position. The most ardent supporter of the 'ballistic' approach would perhaps concede that saccade amplitudes are modifiable and to some degree open to voluntary control. Yet it is important to draw a distinction between this accepted view, which does not require any sophisticated or precise control of the saccadic generator and the possibility of finely controlled modifications in the saccade accuracy.

Precise, systematic adjustments of saccade amplitudes could in fact be achieved by the same mechanisms responsible for the continuous control of a saccade trajectory, previously described in chapter 3. The important factor here would be that the new target reference would be defined having a vector appropriately displaced from the spatial co-ordinates of the current target. With the required positional reference one can assume that the same principles postulated in the Robinson paradigm for the regulation of a saccade also operate for recalibrated saccades. (The model requires that the

saccadic goal be specified in absolute spatial co-ordinates and not purely in terms of the retinal position, although this information is necessary in order to calculate the former.)

The previous observations on saccade amplitudes in chapter 3 showed that hypometric and hypermetric saccades are not equally probable when saccades are modified. In our BF-slow task the large undershoots in the initial saccades were not matched by equivalent overshoots in the BF-fast task. This phenomenon, which as mentioned above has been alluded to in previous research led me to expect that there might also be a bias in the way the saccadic system uses spatial information to control fine adjustments in the saccade accuracy.

6.3 The Pilot Study

The purpose of the initial pilot study was to determine, using 2 psychophysically naive Ss whether controlled adjustments in the saccade amplitude could be achieved, and whether this could be done in both directions around the target. The continuous control model of saccades suggested that the system should have little difficulty controlling recalibrated saccades. However, the absence of isomorphic amplitude adjustments in the BF-slow and BF-fast tasks indicated that the control of hypermetric saccades might be more problematic than hypometric saccades. This aspect of saccadic control was

investigated by first running a simplified pilot study, with two Ss, where the hypometric and hypermetric tests were conducted in separate sessions.

6.3.1 Method and Procedure

Apparatus

The eye movement recording apparatus was identical to that previously described. The device used the fibre optic probe as described in the chapter 2.

Procedure

Two male Ss were tested in this study. Neither had previous experience of eye movement research. The experiment was divided into three main sessions which were run on consecutive days. On day 1 Ss were tested in a control session which required only target directed saccades. On days 2 and 3 the US and OS tasks were given to each S on different days. Therefore any given session consisted exclusively of either OS, US or N trials.

The Neutral(N) task

At the start of a trial a spot fixation target was switched from the centre to a position + or - 1.5 degs. A vertical arrow cue was then presented at a position 3 degs. in the opposite direction. This cue indicated the

position the eye was to be directed towards following the introduction of the target movement. A randomly determined interval of between 480 and 900 msec was allowed to elapse. The spot target was then made to step from its current position and to reappear at the cued position. The location of the spot displacement and the position of the cue for the eye movement were therefore identical in the N-task (see fig. 6.2).

The Undershoot(US) task

The movement of the target on these trials was exactly the same as for the N-trials. However, the cue for the positioning of the eye movement was presented 1 deg. inside the displacement position of the spot movement. Thus on these trials the Ss were required to make a hypometric saccade of 2 degs having an undershoot to the target of 1 deg.

The Overshoot(OS) task

An OS trial differed from a US trial in that the eye position cue was placed 1 deg. beyond the spot displacement. Therefore this task required Ss to make saccades of 4 deg. producing an overshoot of 1 deg.

In conjunction with the presentation of the arrow cue the amplitude of the required saccade (in digits) was also simultaneously displayed. Ss were able to gauge the

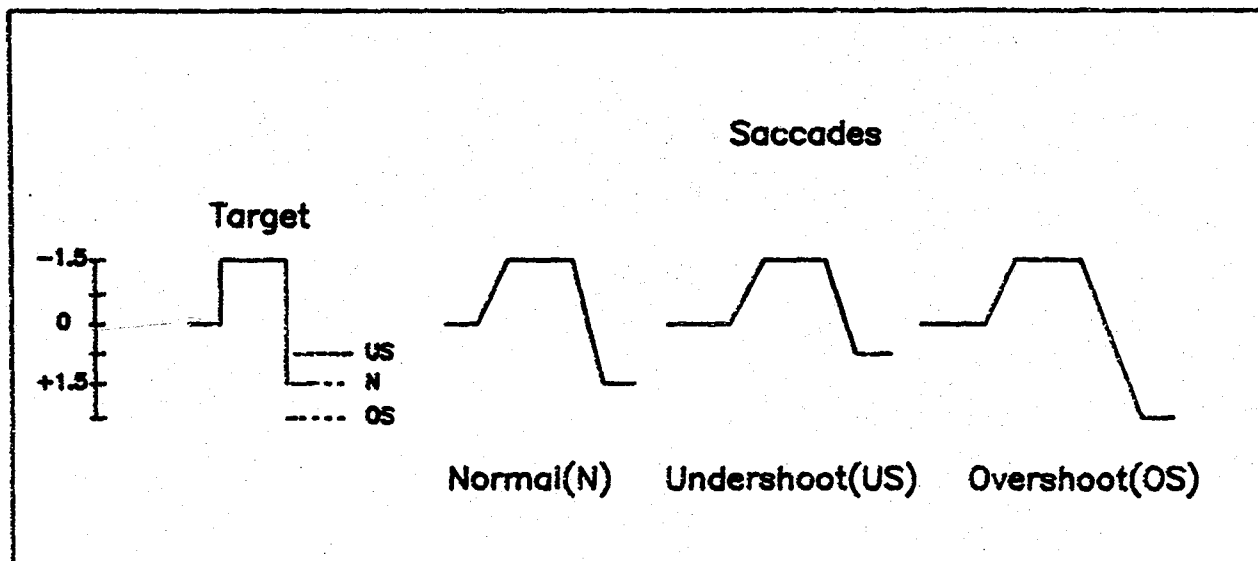

Fig. 6.2. Target displacements for experiment 6.1.

success of a trial by comparing this figure with feedback information on the ensuing saccade amplitude which the computer displayed on the oscilloscope immediately after the completion of the eye movement sampling period (1024 msec). Ss were given 10 practice trials for the appropriate task at the start of each session.

6.3.2 Results

Saccade amplitudes in the N-task session fell short of the target by mean values of 0.17 degs. (S1) and 0.24 degs. (S2); mean undershoots in the US session were 0.57 degs. (S1) and 1.54 degs (S2). Mean amplitude adjustments in the OS task were 0.79 degs. (S1) and 0.18 degs. (S2).

Standard Deviations

The accuracy of saccades in terms of the standard deviations of amplitude of adjustments are shown in table 6.1. Saccades were less variable in the N-trials and US-trials relative to the OS performance. The standard deviations in the US-trials approaches that achieved in the N task.

Latencies

Mean saccade latencies are shown in table 6.2. One important feature of these data is the observed increase

Ss		Conditions		
		US	N	OS
1	Standard deviations	0.82	0.46	1.49
	n	27	60	33
2	Standard deviations	0.63	0.49	1.56
	n	25	60	46

Table 6.1. Standard deviations of saccade amplitudes (degs). US - undershoot, N - neutral, OS - overshoot task.

<u>Mean Latencies (msecs)</u>				
Ss		US	N	OS
1	LAT	281.5	165.7	271.3
		(30.2)	(6.05)	(10.79)
2	LAT	196.1	191.2	176.2
		(21.5)	(21.5)	(12.5)

Table 6.2. Mean latencies and standard deviations. US - undershoot, N - neutral and OS - overshoot.

in the saccade latency variability from the levels for the N-task. This is particularly evident in the US-trials but also apparent in the OS cases. It is worth noting that this increase in variability is not a consequence of generally increased saccade latencies, for example, in the case of S2 saccade latencies are 20 msec shorter in the OS trials than for the N-trials.

6.3.3 Discussion

These results provide some support for the view that the visual processing for saccades provides scope for recalibrations in the mapping of spatial information to the saccadic generator. Saccades may be directed to produce controlled overshoots and undershoots to a fixed target movement. Moreover, in the case of one S overshoots required less time to evoke than normally directed saccades. However, this S showed standard deviations in the saccades amplitudes that were 15% larger than his variability in the US task.

This pilot experiment used a pure block non-randomised design which maximized the opportunity for a subject to develop a predictive strategy for approaching the tasks. The Hallett experiments in fact used a design in which Ss were never entirely certain which task would be presented on a given trial. The results of the pilot study may have arisen from the particular homogeneity of the task

environment. Experiment 6.1 was designed to answer the question of whether precise, systematic adjustments in a saccade amplitude to a fixed target can be controlled reliably by the saccadic system, when trial-by-trial control of the saccade metrics is necessary. In Experiment 6.2 the objective was to determine whether controlled improvements in the saccade accuracy could be achieved even when Ss were not directly aware of the metrics of their saccade amplitudes.

6.4

Experiment 6.16.4.1 Method and Procedure

Experiment 6.1 was conducted using a randomised mixed presentation of N, US and OS trials. Four Ss were tested in single sessions. In all other respects the experiment was identical to the pilot experiment.

6.4.2 ResultsSaccade Amplitude Adjustments

Fig 6.3 gives histograms of saccade amplitudes measured from the position of the target. These show that the US, N, and OS trials peak at -0.5 , 0.0 and $+0.5$ degs. respectively. An analysis of the frequency of undershoots and overshoots showed that this result was not due to a few extreme or exceptional saccades. The percentage of saccades which fell short of the target by 0.5 degs. or more in the US, N and OS tasks were 79%, 46% and 36% respectively. The percentage of overshoots in the US, N and OS tasks were 11%, 25% and 42%. These results support the view that the saccadic system can to some extent control whether or not a saccade will be directed precisely to a visual target. More importantly the system can also accurately set up the vector determining the size and direction of any adjustments. However, at least one

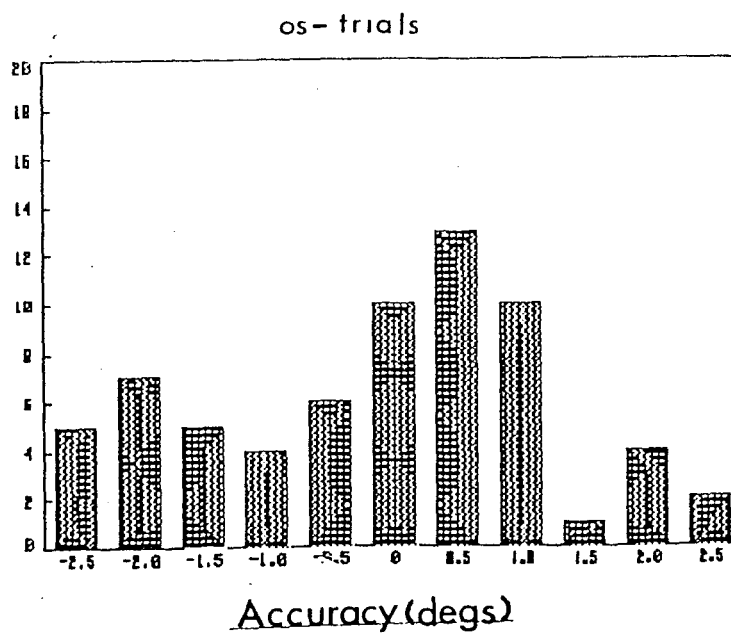
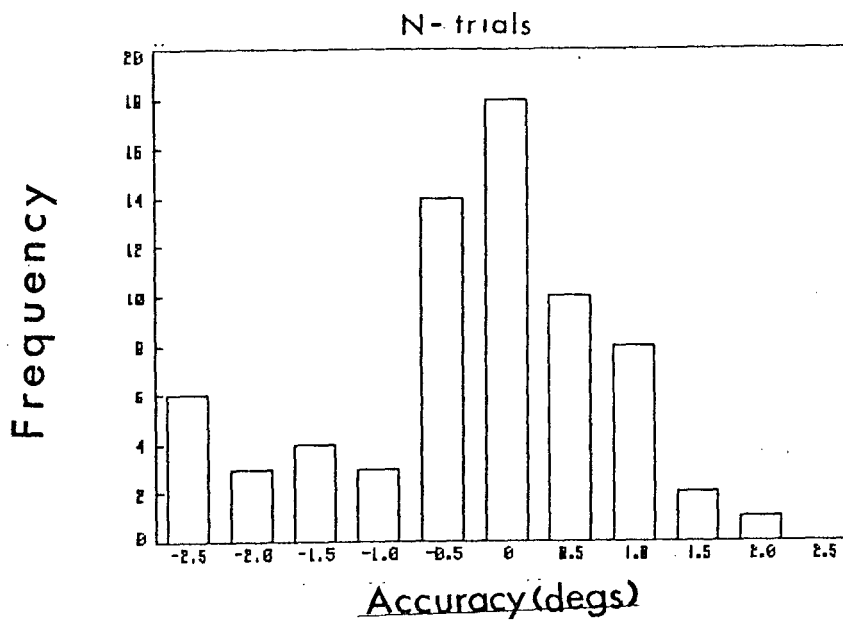
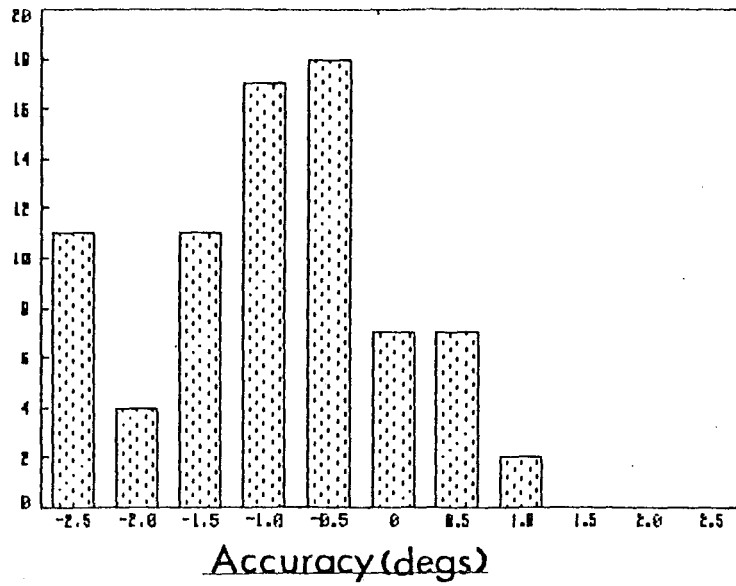

Fig. 6.3. Histograms of the saccade amplitudes from the cued position (accuracy) in the undershoot (US), neutral (N) and overshoot (OS) task.

feature of these statistics suggested that undershoots and overshoots are not isomorphic. This was indicated by the fact that the proportion of undershoots in the US and N-trials greatly exceeded the proportion of overshoots in the N-trials and OS-trials. Fig. 6.4 gives further details on the accuracy of these saccades. The standard deviation of saccade amplitudes were appreciably smaller in the US trials than for the N and OS tasks. This assymetry indicates that the control of saccade undershoots and overshoots are not equivalent and is consistent with previous observations in chapter 3 in the BF-slow and BF-fast tasks.

Latency / Saccade Adjustments

Fig 6.5 gives the plots of the saccade recalibrations in degs of visual angle as a function of saccade latency. There is a positive correlation between the size of the saccade adjustments and saccade latencies in either or both of the US and OS trials. Interestingly, in at least 2 cases the effect seemed to transfer clearly to the N-trials.

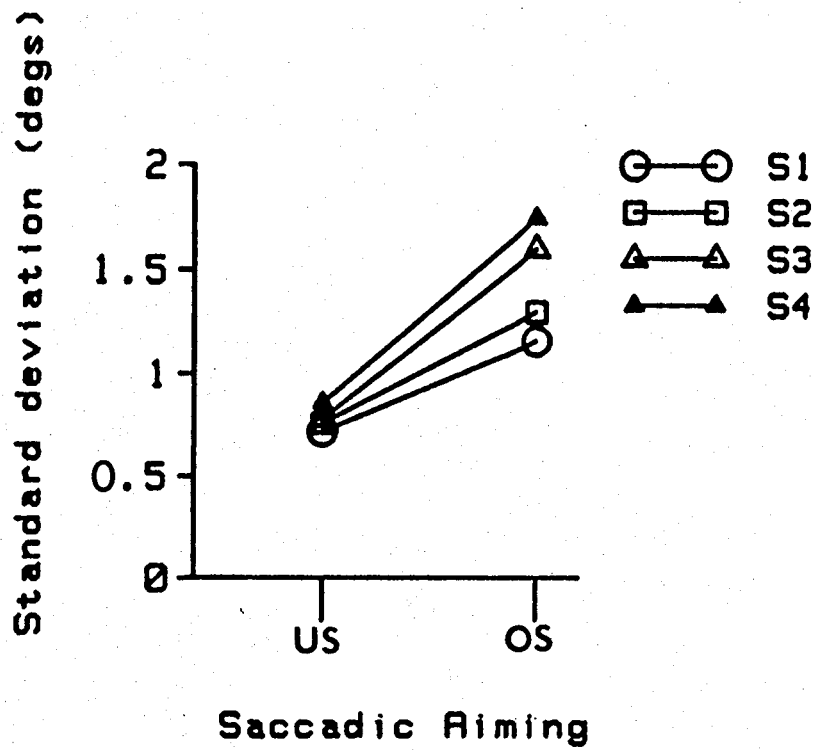

Fig. 6.4. Standard deviations in the undershoot (US) and overshoot (OS) tasks.

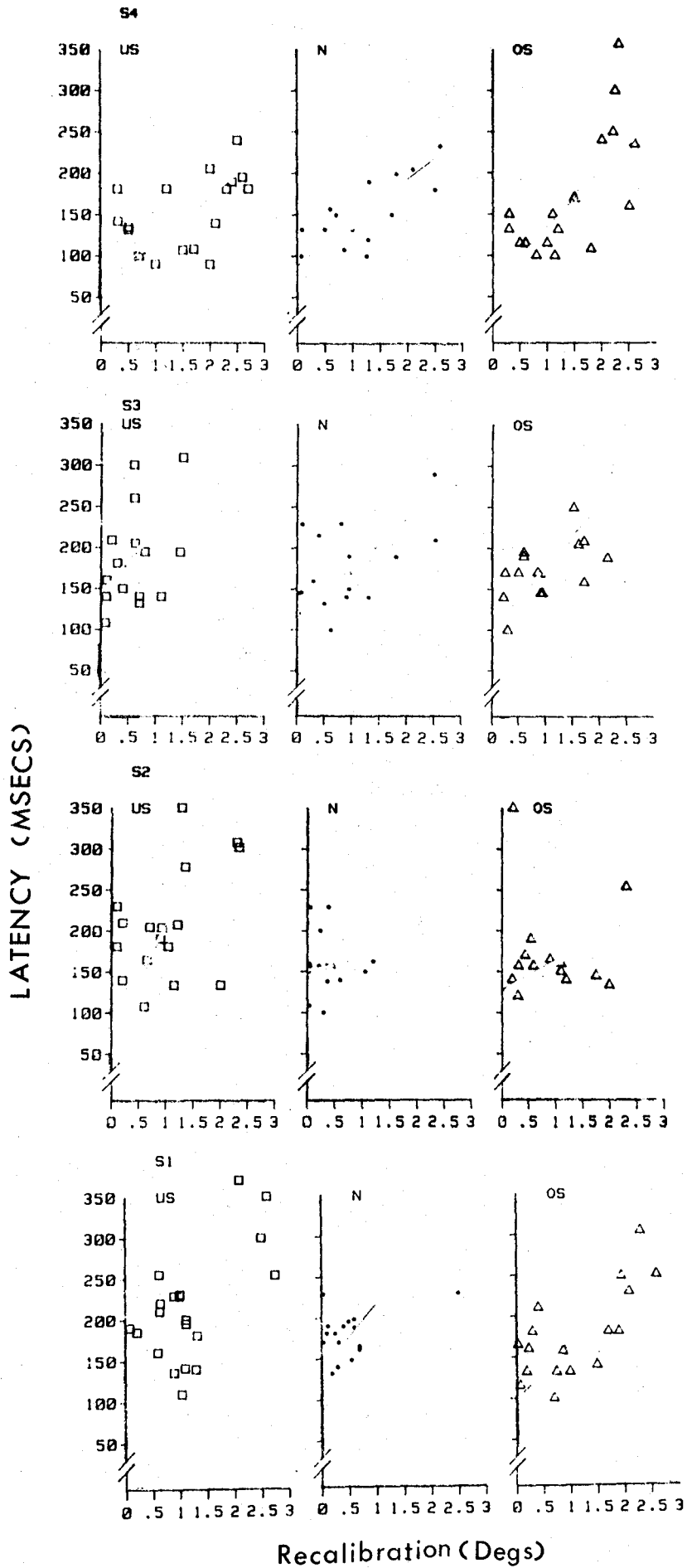

Fig. 6.5. Saccade latencies as a function of the saccade amplitudes from the 'target'. Note that the saccades in the undershoot (US) and overshoot (OS) tasks were directed towards the cued eccentricity.

6.4.3 Discussion

Research on saccade amplitudes shows fairly consistently that saccade overshoots are less frequently elicited than saccade undershoots in both the Hallett type experiments and with pulse-step movements. and Becker and Fuchs (1969) suggested that this bias in the system might be required to facilitate the release of subsequent corrective saccades. This is because the vector of the subsequent corrective saccades could then be anticipated in advance. Robinson (1973) argued that by consistently undershooting the visual system can retain the target in the same half of the brain. This would be particularly important if the saccadic system is lateralized. (One piece of evidence for this comes from work on the stimulation of frontal eye fields which evoke saccades contralateral to the stimulated hemisphere.) Time delays will be minimized if the visual processing can be limited to the same hemisphere. These arguments suggested that the visual system is designed to cope more easily with saccadic undershoots than overshoots. The results of the present experiments confirm that USs are more readily elicited than OS saccades (with probabilities of 0.88 and 0.12 respectively in experiment 6.1). Furthermore the variability of OSs are less tightly controlled. The level of variability of the OSs saccades which were aimed at a 4 deg. eccentricity, was in the order of approximately 1.3 degs. This was larger than the normal range of 0.3 to 0.5 degs. normally observed for 5 deg. saccades (e.g chapter

5). The increased amplitude of saccades in the OS conditions cannot therefore account for the level of their variability.

It has been known for some time that the accuracy of a manual motor movement is correlated with its latency, that is there is a speed accuracy trade-off (Fitts, 1954). However, this trade-off has not been clearly demonstrated with voluntary saccadic eye movements. If this trade-off also applies to the control saccadic eye movements (cf. Leushina, 1965; Viviani and Swennson, 1982; Kapoula, 1984) this should be manifest when adjustments in the saccade amplitude to a target are required. The results presented support this hypothesis.

6.4.4 Summary

The results show that the saccadic system can modify the amplitude of a saccade to a target movement by choosing to systematically undershoot or overshoot the current visual stimulus. The precise control of saccade amplitudes in conjunction with the regulation of the dynamic components of the saccadic trajectory would seem to be highly consistent with the Robinson model. However, at present the assymetry in hypometric and hypermetric saccadic control has not been formally incorporated into any model.

6.5

Experiment 6.26.5.1 Introduction

The demonstration that the saccadic system can readily modify the amplitude of a saccade around the target vicinity is consistent with previous findings on the plasticity of saccades. However, these experiments have only shown that the saccade amplitude to a current target can be manipulated by introducing a position offset relative to the 'target'. Thus with the exception of the clinical studies, so far we only have evidence that saccades can be reliably 'misdirected'. Clearly the plasticity of the saccadic system will be of limited value in the real world if this only permits an increase in the frequency of fixation errors. A more useful mechanism would also enable the system to improve the accuracy of fixation in the scanning of a visual scene.

In the following experiment a visual scanning task was used which previous experiments (Findlay, 1982) had shown produced inaccurate fixation responses. When the eye is presented with two squares in the same hemi-field an initial saccade is generated which takes the eye to an intermediate point between the two targets (fig. 6.6). The exact end points of these saccades will depend on the relative sizes and distance of the targets. The term 'global effect' has been used to describe this phenomenon.

SINGLE SQUARE 2°

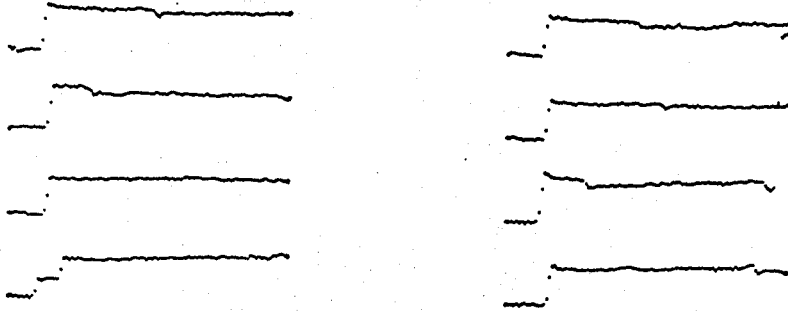

DOUBLE SQUARE

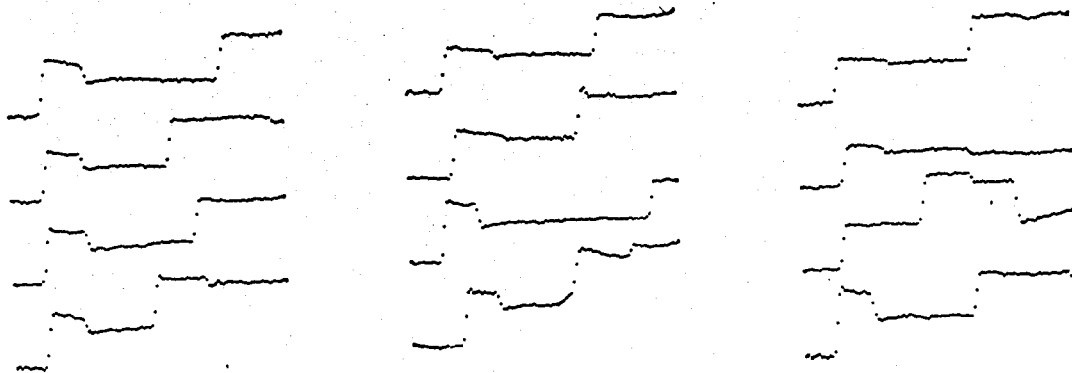

SINGLE SQUARE 4°

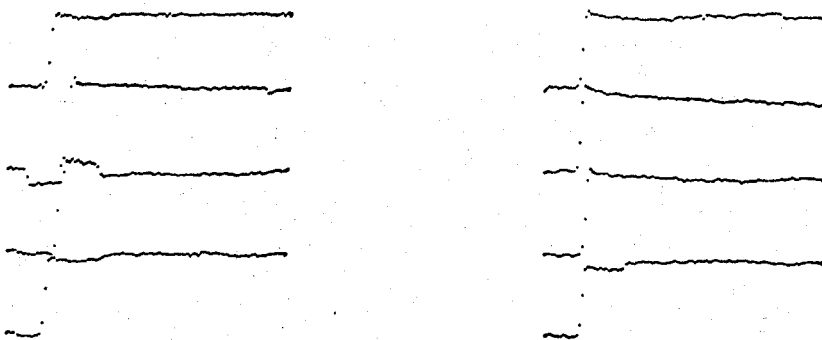

Fig. 6.6. Overshooting saccades are generated to double target patterns. Note the consistent pattern of overshoot and return saccades to the double square targets.

It is suggested that the initial saccadic vector is largely controlled by the global or course features of the spatial display. The effect has considerable potential value as a research tool in opening up further avenues of investigation on the channels of spatial information used in the processing of a saccade. One interesting special feature of this paradigm is that it seems to be one of the few experimental tasks in which negative corrective saccades in small amplitude movements can be studied.

Despite the robust nature of the global effect and the subsequent corrective saccade that is frequently elicited to carry the eye accurately to the target, Ss are quite unaware of what their eyes are doing. It was therefore decided to use this paradigm to examine whether the accuracy of saccadic eye movements could be improved when the eyes were directed to two targets presented simultaneously.

6.5.2 Method and Procedure

Subjects

Two female postgraduates served as Ss in this study. Both Ss had previous experience in psychophysical experiments, although only S2 had participated in previous eye movement research.

Stimuli

The visual targets consisted of a micro-pattern of four or five dots, surrounded by a square frame (see fig 6.7). The dots in each case occupied positions chosen at random from a 3*3 array of possible positions. The separation of the dots in the array was 2.8 min arc and the length of the side of the square was 9.1 min arc. These targets were chosen as they satisfied the requirement that they could only be discriminated with precise eye fixations. This was established in a pre-experimental discrimination test (fig. 6.7).

Procedure

On each trial the S was presented with either a single or a double target. The S was instructed to respond with one of two keys if a five dot pattern appeared in either square in the case of double targets. The other button was used when a single target had four dots or if both squares in the double targets had four dots. The eccentricities used were 2 deg. and 4 degs. Trials were run in blocks of 64; the first eight trials were not analysed and the remaining 56 contained 16 single 2 deg. targets, 16 single 4 deg. targets (in each case 8 targets had 4 dots and 8 had 5 dots) and 24 double targets (8 with 5 dots at 2 degs. and 4 dots at 4 degs., 8 with the reverse and 8 with an equal number of dots in both positions).

Discrimination  vs 

Functional visual field

(Percent correct detection vs stimulus eccentricity

100 msec exposure

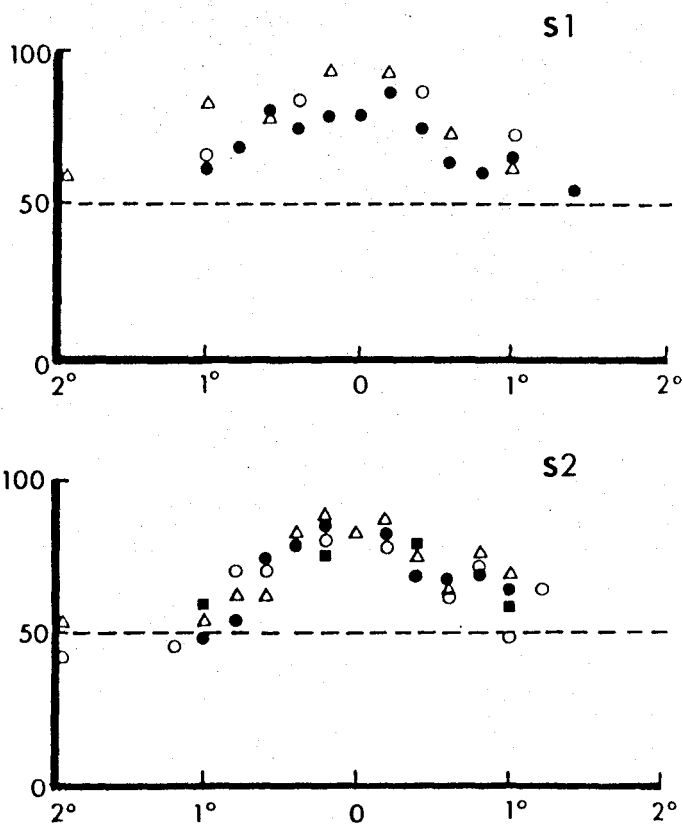

Fig. 6.7. Functional visual field for the numerosity discrimination for two subjects. Different symbols correspond to tests in different sessions.

Each trial commenced with the appearance of a fixation cross which remained visible until the S released a key when it was switched off and was replaced by the target stimulus. The S's task was then to make a saccade to the first box and to identify its contents. By pressing one of the prescribed keys the S was to indicate whether the box contained four or five points. The boxes were presented for 500 msec after which the central fixation cross reappeared in preparation for the trial. Two blocks of 64 trials were run on each day for five days. The training sequence was completed fully for S1 on consecutive days. In the case of S2 sessions 5A and 5B were run in the following week. In addition two further blocks were also tested.

6.5.3 Results

Fig 6.8 shows the percentage of saccade overshoots as the sessions progress. With the exception of rightward saccades of S1 there was a general saccade overshoot reduction of approximately 20%. However, training did not totally suppress the global effect.

Fig 6.9 shows the changes in mean latencies. Both Ss show a systematic decrease across the sessions similar to the trend previously observed in Experiment 4 of chapter 3. The improved accuracy of the saccades were produced with increasingly shorter saccade latencies.

Discrimination  vs 

Practice effect on first saccade amplitude to double squares

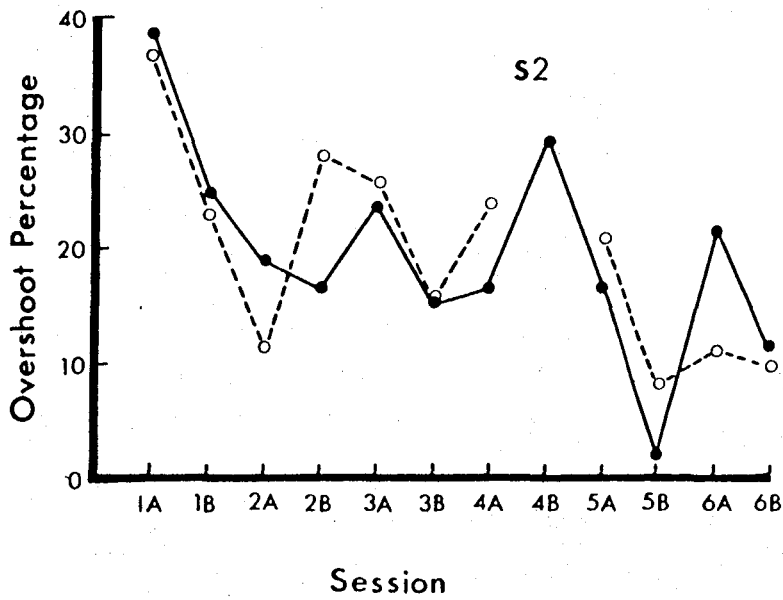
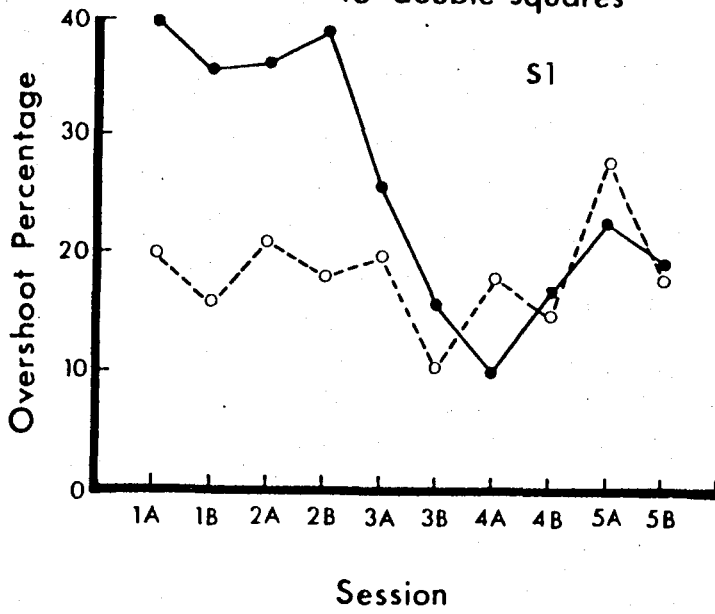

Fig. 6.8. Session by session variation in the amplitude of saccades to double square trials (one target at 2 degs and the second target at 4 degs). The overshoots are expressed relative to the amplitude of saccades to the 2 deg squares.

Practice effect on first saccade latency

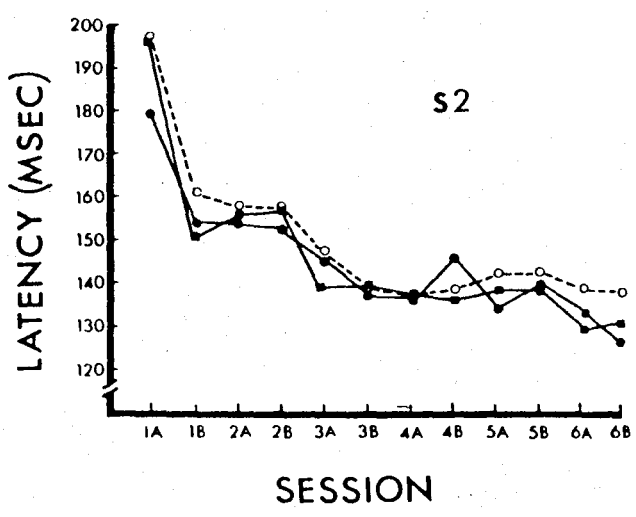
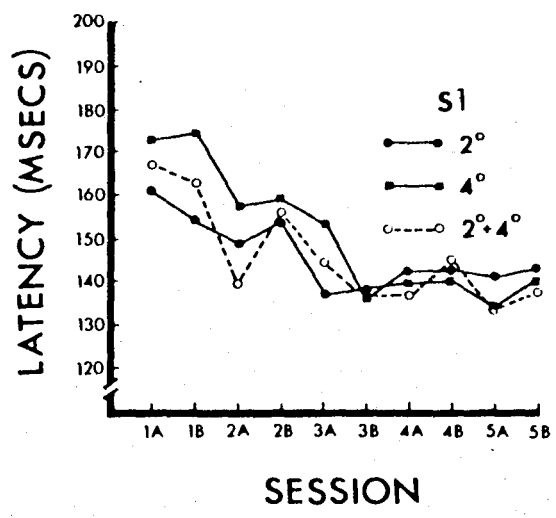

Fig. 6.9. Session by session variation in the latency of first saccades to the target configurations.

Fig 6.10 shows the percentage of errors made on each type of stimulus. The discrimination performance improved by 10-20% between the first and last sessions. S1 performed close to 100% towards the final sessions.

6.5.4 Discussion

Two related questions were posed by the experiments described in this section. The first question was addressed to the modulation of saccadic control around a target location. Could a saccade be directed accurately to generate a fine hypermetria or hypometria or do saccades lose their normal precision when they are not controlled automatically by the current target eccentricity ? Experiment 6.1 revealed that the saccadic system can generate systematic hypometric and hypermetric saccades to a previously cued location at least for the saccade amplitude range used in that study.

Previous eye movement research in a number of separate situations had seemed to form a consensus that, hypermetria was less commonly observed than hypometria. The results showed that this was also true of recalibrated voluntary saccades. It would seem that as Robinson (1973) noted the visual system prefers to have the saccadic stimulus remain in the same hemisphere following the initial saccade. When a corrective saccade becomes necessary this characteristic of the system will minimize the computational demands on the system.

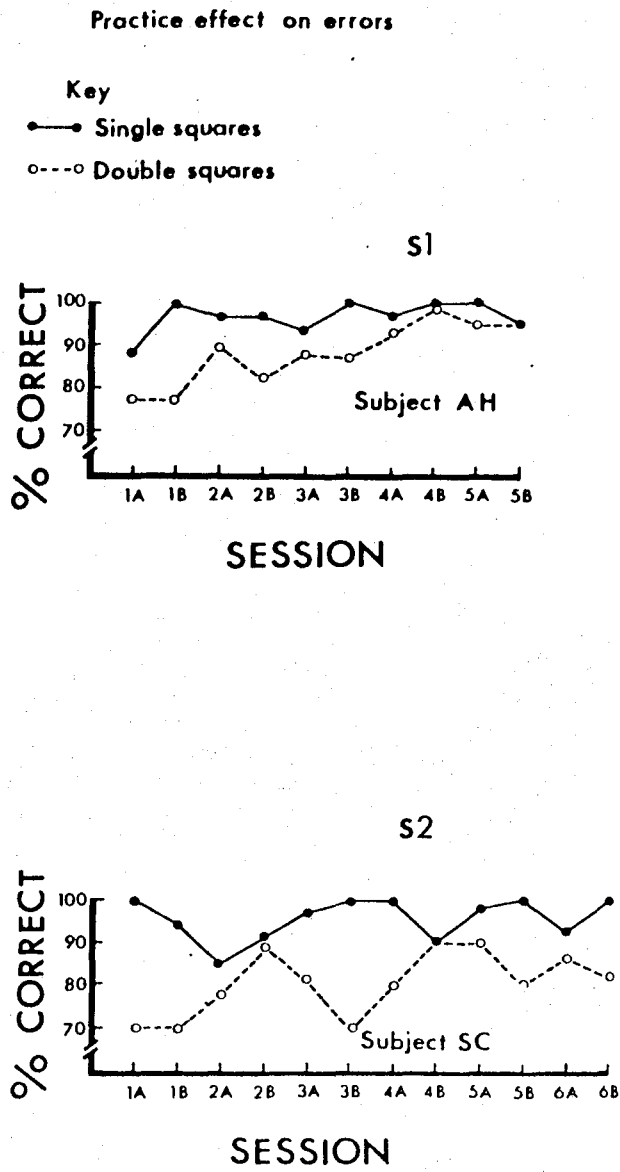

Fig. 6.10. Session by session performance in the numerosity discrimination task.

The second question asked whether the system could improve on its saccade accuracy in a situation where there was clear scope for such improvement. In Experiment 6.2 Ss were unaware of the overshoots made to the double targets and the subsequent corrective saccade back to the first target and they were generally surprised when they were shown their records at the end of the experiment. Nevertheless the size of these overshoots decreased progressively with training, thus the saccades become more accurately directed to the target. As previously demonstrated in the context of multiple saccades produced when individuals were asked to reduce the velocity of a saccade, the absence of direct awareness on the modification of saccades does not necessarily inhibit the control of saccadic eye movement parameters (cf Brener, 1974). The capacity for plasticity is incorporated within the normal functioning of the saccadic system. This undermines formulations which assume that purely reflex or stereotyped type processes define the motor mechanisms in the control of the saccade.

6.6 Conclusion

An important application of the capacity to modify the forces generating a saccade to a target has been demonstrated in patients suffering from an oculomotor paresis (Abel et al., 1978; Optican and Robinson, 1980). It has been shown with monocular viewing that the weakened

eye gradually comes to increase the neural innervation required to move the eye to a given target eccentricity. This reduces the amplitude of the saccade undershoot to the target in the paretic eye. However, this increased neural activity also causes the normal eye to now overshoot the target when examined. This limits the usefulness of this plasticity in monocular disorders. However in clinical cases where the two eyes are equally impaired this intrinsic plasticity of the saccadic system should enable some recovery of the precise control of goal-directed saccades.

CHAPTER 7General Conclusions

7.1

Review

This chapter provides a review of the preceding studies and discusses the theoretical implications for modelling the human saccadic system.

The experiments discussed in the preceding chapters have investigated the plasticity of the descriptive parameters of a saccadic eye movement. Three areas of short term plasticity were identified, namely in the saccadic dynamics, in the timing of a saccade and in the use of the visuo-spatial information in directing the saccadic amplitude. These experiments showed that the trajectory of a human saccade can be systematically manipulated. Early experiments described how modifications are generated in the peak velocity and duration of a saccade. These studies also illustrated the effect this has on other saccadic characteristics. The slowing of saccades resulted in the generation of a multi-component staircase pattern of eye jumps (what has been termed multiple saccades). This pattern dramatically raised the time required to release the saccadic movement. These saccades were not eliminated with extended training, but their frequencies were reduced when continuous feedback was provided. Later studies showed that the system can pick

up different visually cued sources of spatial information in the processing of the saccade amplitude and the use of this spatial information for directing the saccade can be improved with extended training.

The flow diagram in fig. 7.1 focusses on three processes in the making of an eye movement.

(1) The visual information processing (VIP) unit represents the analysis of the visual input to the system. The output need not be the usual simple retinal error, but takes into account the temporal and spatial content in the target trajectory. This level of visual analysis also incorporates the mechanisms involved in the 'global' topography of the target visual field (Findlay and Crawford, 1983). In a multiple target display each target is not processed independently for the programming of a saccade. The eye is directed to a 'centre of gravity' position of the targets. One interpretation of this eye behaviour is that the visual information is processed in parallel since input from both targets is used to direct the eye. Thus, the eye is initially guided by the 'course' or low spatial frequency information in the display.

The VIP also incorporates the temporal input supplied by the target trajectory. If a ramp target is sufficiently fast and of a short enough duration only saccades will be generated. This was demonstrated in chapter 5. The

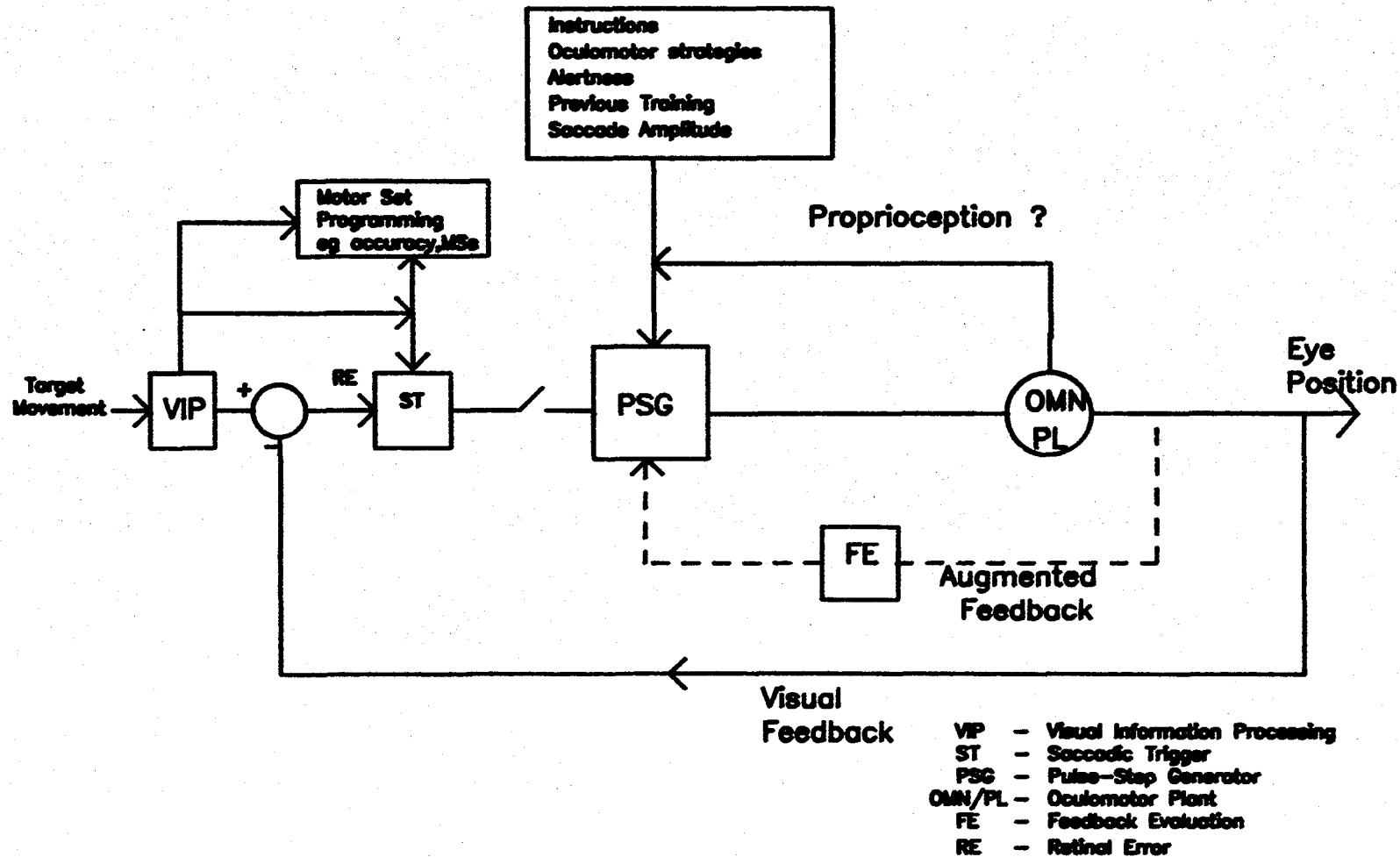

Fig. 7.1. A general model of the control of saccadic eye movements.

retinal stimulation produced by steps and ramps is quite different. Unlike ramps, during the period prior to a saccade the step target only stimulates the immediate area corresponding to the position of the target on the screen. In contrast a ramp stimulates a wider area of the retina. This factor causes the VIP to specify spatial information less precisely for ramp targets (chapter 5).

(2) The visual output is transmitted to processes instrumental in the systemizing and structure of the motor programs. This involves for example the recruiting of motor units and delineating the agonist and antagonist muscle activity. Thus it is at this stage that the direction of the movement is specified (Becker and Jurgens, 1979). These processes plus any passive delays in the neural machinery determine when the saccade will begin. But it is suggested that the planning or programming / latency relationship is not one-way, if the saccadic preparation time is inadequate this will adversely affect the saccadic movement. According to Ross and Ross (1980) the visual input can also directly affect the timing of a saccade with no reported effect on the accuracy of the movement itself.

(3) The saccadic flight is directed by the modulating impulses of the pulse-step generator (PSG) as argued by Robinson (see below), but the operating level of the pulse firing can be affected by a number of factors as outlined in chapter 3 and indicated in fig. 7.1. These can modify

a saccade from its stereotyped trajectory.

The experiments on the control of saccadic peak velocities and durations presented in chapter 3 supported the Robinson bang-bang guided control model rather than the ideas of Yarbus and others who have claimed that saccadic peak velocities are a fixed preprogrammed characteristic of a saccade. An initial lack of confidence in the preprogrammed concept was reinforced by the finding that modifications of the saccadic trajectory from the basic single peaked waveform could be produced during the saccadic motion. Moreover, perturbations occurred in both early and late periods of the saccadic trajectory, undermining the claim that only the early period of a saccade is under the active control of the pulse.

The model in fig. 7.1 also suggests that proprioceptive information can be used in the control of eye movements. Skavenski and others have shown that proprioceptive input from the eyes can be used to detect displacements of the eye and also to actively control the eye position. However, since visual feedback is such a powerful signal, it may be necessary to train Ss in order to enhance their awareness of extraretinal feedback. One of the goals of future research could be to determine the sensitivity of normal Ss to this information. Auditory feedback on eye position could be used in the initial training stages to facilitate the 'calibration' between eye position and proprioceptive feedback.

It is important to emphasize the conditions under which modifications in the saccadic motion are produced. As indicated in the schematic flow diagram in fig. 7.1 the amplitude of a saccade is one of the factors that have a significant influence on the variation of peak velocities. The peak velocity of small amplitude saccades was more readily increased than for large saccades, while the velocity levels of large saccades were more evidently reduced than for small saccades. These operational limitations are logically reasonable when one takes into account the nature of the velocities involved. A 20 deg. eye movement can easily attain peak speeds of over 700 degs/sec and are the fastest motor movements of which the body is capable. It is unlikely that this will be easily surpassed. As suggested elsewhere, Crawford (1984), faster saccades would possibly imply proportionally less time for the operation of the local feedback loop (Jurgens et al., 1979) controlling the saccade. Small saccades of 1 or 2 degs. have velocities within the approximate range of 50 - 120 degs/sec. If these saccades were made substantially slower they would enter the normal range of pursuit movements. [In the psychophysiology literature similar limits on physiological measures have been described as the law of initial values].

An important characteristic of the modification effects was that these were not all-or-nothing but the size of the effect was related to the degree of training. The slowing

of a saccade increased by up to 40% over a ten day training schedule. It was also found that continuous auditory feedback was a more effective way of reducing peak velocities than the presentation of information on a trial-by-trial basis. This supported the view that the saccadic system is a sophisticated mechanism with a sensitivity to the nature of the feedback signals in contrast to an all-or-nothing ballistic process. The effect of external feedback on the saccadic velocity is represented by the augmented feedback loop in fig. 7.1.

There are some questions which should be addressed in future research. Using a similar paradigm to the extended training experiment one needs to examine how long the feedback effects persist following both continuous and trial-by-trial feedback training. It would also be important to compare these conditions with a condition in which Ss are given no feedback but who are given direct instructions to modify their saccadic velocities in a longitudinal study. In order to ensure that Ss were suitably motivated in the no-feedback condition, some remunerative reward could be provided at the end of the experiment. Such a study would determine the duration of the feedback effects and would also show how significant auditory feedback per se is for the modification of saccade trajectories.

Since the velocity of a saccade was closely related its amplitude, even in modified saccades, the decision was

made to investigate the relationship of the saccadic dynamics to the accuracy of the eye movement. These experiments manipulated the temporal and spatial information in the target movements (chapter 5). The modulation of the velocity or duration of a target movement from the normal step displacement impaired the accuracy of saccades but the systematic amplitude / saccadic velocity relationships were maintained. The system response was most accurate to the normal step displacement. The accuracy of these saccades was related to the timing of the saccade, supporting the speed / accuracy relationship recently reported by Kapoula (1984). This is shown in the model by a link between the VIP stage and the saccadic trigger. A similar relationship also emerged from the studies in which Ss were directly cued to make undershoot, overshoot and on-target saccades (chapter 6). One experiment (chapter 6) showed that it was possible to control systematically the use of the spatial signals in the aiming of a saccade. A second experiment showed that Ss do not have to be directly aware of the saccadic errors (in this case overshoots) for this to be possible and for the accuracy of saccades to improve with training.

An exception to the latency / accuracy trade-off was observed under conditions where multiple saccades were generated (chapter 4). In these circumstances it seems that a separate effect on the timing of a saccade was involved. The generation of multiple saccades increased

saccadic latencies by up to 400-600 msec. When Ss were questioned about the MS data, particularly in the BF-slow task, Ss stated that they tried to control the movements of the eyes to make a smooth continuous movement from one visual location to the other. Only when Ss were presented with a computer display of their eye trajectories did they fully accept that a 'staircase' pattern with discrete saccadic components was the most frequent product of their attempts to elicit slow eye movements.

An account of MSs may be suggested in terms of recent developments in our understanding of the control of spatial attention and eye movements. Attention can be directed to localized regions of visual space. This can occur independently of eye movements and may also be separated from the programming of a saccade (Remington, 1980). However, it is generally recognized that the separation of saccadic and spatial attention mechanisms is observed under specialized conditions, normally the two systems must work together.

It has been found that there are limits on the rate at which the locus of attention can be moved through space. Shulman et al., (1979) investigated the movement of attention while the eyes remained stationary at the central fixation position. Attention was measured by comparing the reaction time to a visual target at a cued and an uncued position. The difference in reaction times to cued and uncued targets indicated the magnitude of the

facilitation or inhibition of the attention cue. Shulman et al., (1979) found that at short intervals following a central arrow cue, intermediate points between the fixation position and a peripheral target produced faster reaction times than stimuli occurring at the target position. They therefore concluded that the allocation of visual processing must move continuously through the visual field in an analogue fashion. From their data it can be estimated that attention moved at approximately 50 degs/sec, which is slower than the movement of the eye during a saccade. On the assumption that attention and eye movements normally work together, the generation of MS could be derived from such a spatial attention mechanism. The Ss internal perceptions may therefore have been a consequence of the operation of this mechanism.

There was no evidence that the saccadic components were preprogrammed as had been suggested for the secondary saccades of Becker and Jurgens (1969). It is interesting that multiple corrections, similar to the MSs observed here, have also been found for manual (finger) movements (Woodworth, 1938). The multiple saccade phenomenon was observed when Ss were required to slow 5 deg. saccades, but was also found when multiples saccades were generated by other methods. It is concluded that an eye movement sequence having several components and where there is a single peripheral stimulus, takes substantially longer to initiate than a single movement.

The implications of the findings for the saccadic system can be further clarified by contrasting a preprogrammed ballistic and a system 'guided' control model of the system. Two models of these forms are depicted in fig. 7.2 and fig. 7.3. The Ballistic model is of the type originally supported by Westheimer (1954b) Young and Stark (1963b), Yarbus (1967) and others. The input to the saccadic generation process is the retinal 'error' (RE). This is a differential signal proportional to the angle between the line of the visual axis and the target specifying the spatial input for the programming of the saccadic amplitude and direction. Decision judgements are set in operation to determine when a saccade should be triggered. Rashbass (1961) had suggested that a threshold trigger set at approximately 0.5 degs. had to be reached before the neural impulses for a saccade were generated. However, work by Steinman, Cunitz, Timberlake and Herman (1967) has seriously questioned the evidence for any such threshold specification or the idea of an operational saccadic 'dead zone'. They reported that it was possible to elicit voluntary micro-saccades. The extreme stereotyped, ballistic approach holds that once the saccadic generation mechanism is initiated the output cannot be cancelled or actively modified while it is in progress. Moreover, the speed of the saccade is preprogrammed and is a fixed descriptive characteristic of the system.

A Simple Ballistic Model
After Jurgens et. al., (1981)

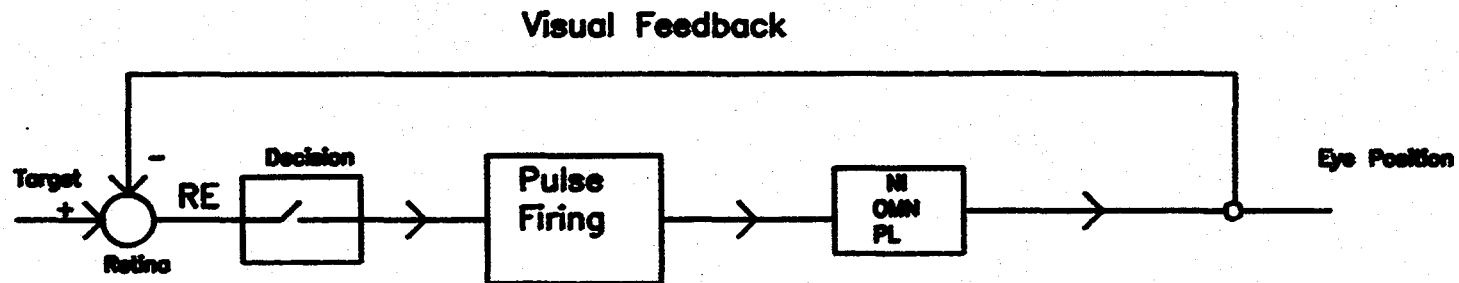

Fig. 7.2. A simple ballistic eye movement control model.
RE - retinal error, NI - neural integrator, OMN
PL - ocular motor neural plant.

A Simplified Guided Control Model

After Zee et. al.,(1976)

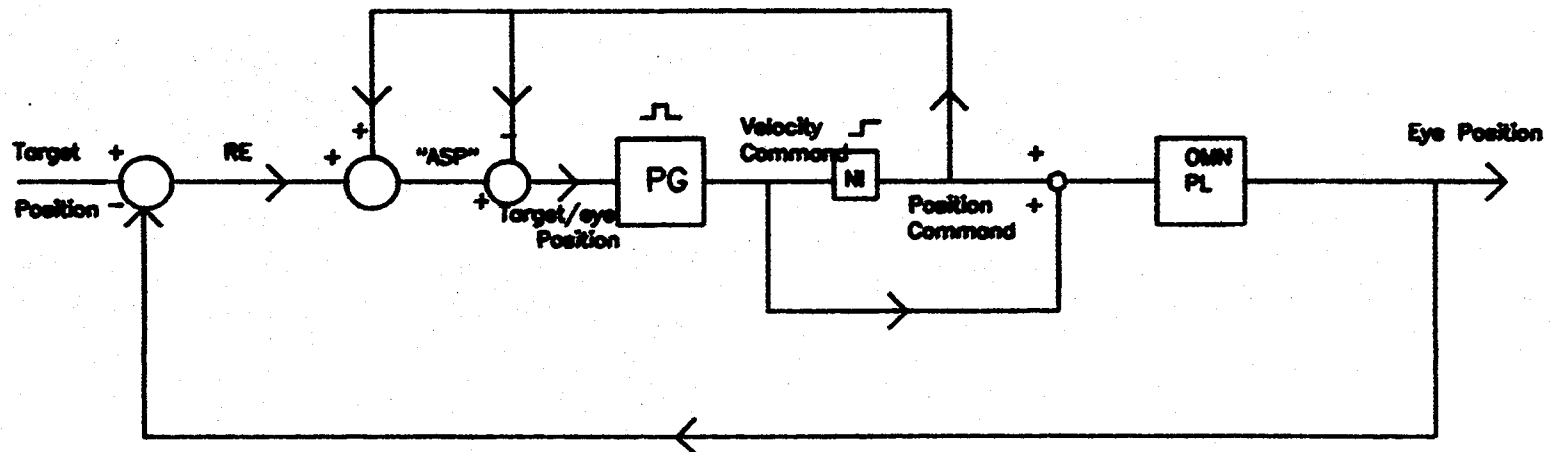

Fig. 7.3. A simple guided control model. RE - retinal error, ASP - absolute spatial position, NI - neural integrator, OMN PL - ocular motor neural plant.

In an early version of the ballistic approach (Young and Stark, 1962) it was claimed that the retinal error was sampled by an impulse modulator at intervals of 200 msec. This was claimed to be the refractory period for saccadic eye movements. The trigger for the sampler coincided with the onset of the target displacement. Providing the retinal error was of a sufficient magnitude the neural signal would then be used to generate a step command to move the eye towards the target. However, the model does not explain how the action of the impulse modulator is synchronized to the target motion. A further point concerns anticipatory or predictive saccades which are frequently produced to repetitive square wave target movements (Findlay, 1981). These saccades, which can have latencies less than 100 msec, undermine the idea of a critical refractory period of 200 msec.

The claim that a saccade cannot be cancelled while it is being programmed has been convincingly undermined by research which has shown that a saccade can be modified up to 80 msec and less before the saccade begins (cf introduction to chapter 6, Carpenter, 1977). The length of this period was less than the overall response time of the system. Therefore there must be an escape contingency for interrupting a saccade while it is being programmed. The present experiments also undermine this model by showing that the peak velocity and duration of a saccade are not fixed characteristics of the system but can be modified even during the saccadic flight. Extended

training also affected the operating characteristics of the system.

The central components of the so called bang-bang or guided control model have been described in detail in Chapter 1. The eye position is actively controlled by a combination of the pulse and step components of the neural input. (Lesion studies of areas of the cerebellum have shown that this structure is critically important in minimizing dysmetric saccades by ensuring the pulse and step are appropriately matched; Optican and Robinson, 1980). The pulse determines the acceleration force for the eye movement; the step, which is obtained from a neural summation of input pulse frequency (i.e. an integration), is used to hold the eye in the orbit when the saccadic flight is terminated. This position information from the neural integrator is fed back into the system. Robinson's model claims that the eye movement is coded in spatial co-ordinates rather than just in terms of the position of the image on the retina. An absolute spatial position is derived by summing retinal error (RE) and the system eye position signal, giving the position of the target in space by taking into account the angle of the eye in the orbit. This is represented by "ASP". Evidence in support of a spatial rather than purely retinal input came from Mays and Sparks (1981). A monkey can be trained to make an accurate eye movement to a briefly flashed visual target. When the training was complete during a goal-directed saccade the eye was driven

(by stimulating motor cells in the brain stem) to a new position in the orbit. The saccade was inhibited during the period of stimulation, however when the stimulus was switched off the saccade recommenced and the eye was projected to the true spatial position of the target and not the stimulated retinal location.

The model proposes that the size of the pulse is not preprogrammed, but that the input is terminated automatically when the eye position signal is equal to that of the saccadic goal. When this occurs no output is generated and the eye comes to rest. The control of the saccadic trajectory is regulated on-line. Our results are more in line with a model of this nature than the ballistic control model.

However, both the ballistic and guided control models fall short of what is required of a more comprehensive formulation of the saccadic system. In particular Robinson's model does not address questions concerning the factors involved in the timing of a saccade or the spatial processing for a saccade. Both models use the rather simplified notion of a simple retinal error input to the pulse generator (cf Findlay and Crawford, 1983). The studies of saccades to double targets and in reading demonstrate that the amplitude of a saccade is a response to the global features of the stimuli rather than a single retinal input. A further weakness of these models is that they make no reference to eye movements in other planes

than the horizontal. It is often implicitly assumed that saccades are controlled in the same form regardless of their direction. This is questionable since eye muscles contribute differentially to horizontal, vertical and oblique eye movements (chapter 1).

The present research can be extended by repeating some of the experiments with vertical and oblique saccades. Such experiments would require an eye movement recording system with a sensitivity to eye movements in all directions. Fortunately such a system, based on Robinson's scleral coil method, is now available in our laboratory.

7.2

Clinical Implications

'To what extent can man modify the sensorimotor control of his eye movements ? The answer promises to be of scientific interest as well as of practical importance...'
(Ron, 1981).

Ritchie (1976) found that lesions of the cerebellar vermis produced marked effects on the aiming of a saccade. Saccades towards the body midline became overshoots while those made away from the midline were undershoots. Interestingly, these saccades did not have the normal high correlation between saccade amplitudes and durations. This finding suggested that the cerebellum might be an

important cite in controlling the 'gain' of a saccade (where 'gain' is expressed as the ratio of the saccade amplitude to the distance of the eye target displacement). This idea was confirmed by Optican and Robinson (1980). They showed that cerebellar lesions in monkeys resulted in modified gains of up to 2.1 for 20 deg. target jumps.

Optican and Robinson (1980) also found that in totally cerebellectomized animals there was post-saccadic drift in the position of the eye following a saccade. It was argued that this drift was caused by a neural imbalance between the pulse input to move eye and the step force to hold the eye in position (see section 7.1). Thus a second important function of the cerebellum seems to be that of ensuring an appropriate match between the pulse and step components. It seems likely therefore that this is the cite of the local feedback loop postulated by Jurgens et al., (1981).

Saccadic aiming errors in cerebellar damage are normally followed by corrective eye movements which ultimately bring the eye in alignment with the target. In contrast animals with lesions of the superior colliculus, the mesodiencephalon and the dorsal thalamus do not correct for saccadic errors (Albano and Wurtz, 1981). Moreover, these animals do not recover normal accurate saccades.

Ron (1981) conducted a study on patients having traumatic brain injuries. These patients had lengthened saccade

latencies and initial symptoms of multiple saccades. It is encouraging to note that training lead to a reported improvement in the saccadic gain. In four of Ron's patients the mean saccade latency (329 msec) was much larger than for normal subjects. However, in several weeks latencies were reduced to the normal levels.

Neurological disorders which affect the brain stem often result in impairments in the timing of a saccade (Baloh, Yee and Boder, 1978). It has also been reported that cerebral dysfunctions in Alzheimer's disease (Feldon and Langston, 1977) and acute encephalopathy (Dell'Osso, Abel and Daroff, 1977) are also associated with abnormal saccade latencies. However, these patients are usually only tested with single displacement targets in conditions where information on the timing and placement of the targets is minimized. Further experiments are necessary to determine whether these patients suffer primarily from other handicaps in perception and general spatial localization. It would be of interest to determine whether eye tracking to repetitive predictable targets was also impaired in these patients. A study along these lines would indicate the extent to which the saccade latency abnormalities were intrinsically attributable to a motor deficiency.

Kommerell et al., (1976) examined a patient with a unilateral eye muscle palsy. The eye muscles in one eye produced weaker saccades than the other. However, the

weak eye was used for fixation because its acuity was greater than the normal eye. Thus while the weak eye would move accurately to a target the strong eye would overshoot the target. When the weak eye was occluded with an eye patch for three days the strong eye was able to make accurate saccades. The pulse and step components were not matched however, so that the weak eye drifted back to the primary position after a saccade. Adaptation of the pulse and step was nonetheless shown by the normality of saccades in the strong eye when that eye alone was used for viewing.

In contrast to the saccadic dysmetria caused by cerebellar damage, some recovery in saccade accuracy occurs following oculomotor paresis. Kommerell et al., (1976) argued that the modifications in the pulse-step forces to the eye muscles resulted from 'adaptive changes of the central ocular motor output'. In view of Optican and Robinson's (1980) work it can be concluded that this adaptation was generated by the intact cerebellum. Similar findings to those of Kommerell and his colleagues were obtained by Abel et al., (1978). In this study the strong eye, rather than the weak eye, was initially occluded for a period of six days. Adaptation of the saccade gain in the weak eye was evident by day 5, when accurate saccades were generated to a 10 deg. target. Simultaneously the saccades in the occluded strong eye began to overshoot the target, showing that the increased innervation affected both eyes in accordance with Hering's (1868) law.

The capacity of the oculomotor system to compensate for changes in muscular states is of crucial importance in normal development. Changes in muscular state occur continuously through processes of growth, ageing and disease. Thus the ability to adapt the neural input to the operating characteristics of the eye muscles, as shown in these studies, is of substantial significance in the regulation of eye movements.

The time scale of recovery of normal eye movements following brain injuries and other neural damage is often in the order of many months and longer (Ron, 1981). Further research into systems designed to improve oculomotor functions, and to reduce the period of recovery, is required. The experiments on the intact saccadic system, in conjunction with these reports (e.g. Abel et al., 1978), suggests that it might now be profitable to begin to develop fuller training procedures to facilitate recovery from central nervous system damage causing impairments in the control of saccadic eye movements. It is hoped that research on the plasticity of the human saccadic system will encourage further clinical research on methods of facilitating recovery from eye movement abnormalities.

Appendix AA Brief Introduction to Biofeedback

A Biofeedback definition:

"Biofeedback is a process in which a person learns to reliably influence physiological responses of two kinds: either responses which are not ordinarily under voluntary control or responses ... for which regulation has broken down due to trauma or disease" (Blanchard and Epstein, 1978).

The Biofeedback method consists of three characteristic operations. The first operation is the detection and amplification of the biological response which is not normally perceived to the individual. This process requires appropriate transducers and electronic amplifiers to reflect the physiological activity as accurately as possible. The second operation is the translation of the signal to an easily perceived form. In many cases this means that the raw signal is recoded in terms of a visual and/or auditory mode which can be easily interpreted by the individual. The precise functions relating the coded information on the physiological activity e.g whether a binary vs analogue or continuous vs discontinuous format is adopted will depend to some extent on the particular characteristics of the biological system. The third operation is the feeding back to the individual of his

behaviour state in this processed form.

Illustrations of the basic biofeedback phenomena

In a number of carefully controlled studies in which rats were immobilized with curare Dicara and Miller (1968) demonstrated that specific autonomic processes such as the heart rate (HR) and the vasoconstriction of blood vessels in the ear could be controlled by operant procedures. Evidence on the operant conditioning of human physiological processes came from Kimmel and Hill (1960) and Greene (1976) who demonstrated the effect on the galvanic skin response. Following on from these early successful attempts to modify the functions of the autonomic nervous system a vast body of research accumulated demonstrating acquired voluntary control of many other component functions of the nervous system (see e.g Yates, 1980 for a detailed review). However, research on single motor unit control represented some of the most dramatic effects of biofeedback procedures on bodily functions. In the first study using feedback to influence single motor unit activity, Harrison and Mortenson (1962) demonstrated that Ss could be trained to produce contractions of individual motor units (in the tibialis anterior muscle - the leg muscle next to the shin bone) with the aid of visual and auditory guidance (cues). Basmajian (1963a,b) found that each of 16 subjects could be successfully trained to contract single motor units in the abductor pollicis brevis (thumb). They could also

vary the rate of firing of the single motor units (SMU). Basmajian and Simard (1967) trained Ss to isolate and contract the right tibialis anterior muscle and then evaluated the effects of other muscle activity on this control. Remarkably precise SMU control was maintained even when gross body movements were in progress. However, it is worth noting that there is evidence that individual differences can influence the acquisition of SMU control (Scully and Basmajian, 1969) as has also been found in other biofeedback research fields (Williamson and Blanchard, 1979a,b).

Brener's early research (e.g Brener and Hothersall, 1966) showed that subjects can discriminate heart rate increases and decreases even when subjects were not informed about the details of the feedback contingent procedure. In a set up in which the fluctuations of a pen on a dial corresponded to HR fluctuations Lang, Strouf and Hastings (1967) showed that the variability in HR could also be significantly reduced. However, a number of studies (Bergman and Johnson, 1971, 1972; Levenson, 1976) have found that subjects who receive instructions alone can sometimes manifest levels of control equivalent to the effects found with feedback. This suggests that some subjects come to the biofeedback experiments already equipped with the ability to modify the physiological target parameter.

Types of Feedback

A number of papers have been published on the comparative effectiveness of a binary feedback system which informs the subject as to whether a given criterion level of performance has been achieved, and analogue forms of information in which proportional feedback on the magnitude of the target activity is provided. This research has generally found that the greater information contained in analogue feedback situation has a more pronounced effect on the target activity than the more rudimentary binary information (Blanchard and Young, 1972; Lang and Twentyman, 1974).

Blanchard and Young (1972) found that there was no differential effect between visual or auditory analogue feedback on the control of HR. In fact at present there is apparently no evidence for any difference in the effectiveness of visual and auditory feedback, at least in the control of cardiovascular mechanisms.

Studies on electromyographic feedback have relied largely on continuous auditory feedback directly related to the muscle activity, although visual feedback methods have also been widely used. However, there has been an increasing trend towards the use of combined auditory and visual feedback modalities. The one clear cut result from comparative feedback studies is that any form of feedback tends to be more effective than no feedback (see review in

Schandler and Grings, 1978).

Effects of Extended Feedback

Of the fifteen studies from 1973 to 1979 using extended training of HR control beyond one or two sessions only 2 studies failed to find sizable HR increases (Williamson and Blanchard, 1979). On the other hand other investigators using only one training session (Bell and Schwartz, 1975; Obrist et al., 1975) have found effects of equal or even greater magnitude! For HR decrease the results have been even more contradictory. Some workers (e.g Colgan, 1977) have reported that HR slowing does appear to improve as training progresses, while McCanne and Sandman (1975) have failed to confirm this result. Williamson and Blanchard (1979) concluded therefore that the use of additional training sessions can be of some benefit in modifying the target behaviour but that it is clearly not the only factor.

An unresolved problem in this area which can be traced back to the origins of this research (Kimble, 1961) is the question of whether the biofeedback process should be described in terms of operant conditioning (Engel, 1972) or as Brener and his colleagues describe it, in terms of information feedback. The basis for the distinction appears not so much in the details of procedure as in the underlying analytical framework associated with these formulations. According to Brener (1974) "whereas the

strict operant approach posits a response contingent event (the reinforcing stimulus) as the final cause of behaviour change, the feedback approach attempts to account for the processes by which response contingent events lead to behaviour change. Thus, the feedback approach permits a finer grain analysis of the voluntary control process". Interestingly, May and Johnson (1972) in a study involving different schedules of feedback, found that heart rate does not respond to schedules effects in the manner of most operants. However, this issue is is still open (Blanchard and Epstein, 1978).

APPENDIX B

F-values for testing the significance of the difference between the slopes and offsets (or coincidence) of two or more linear regression lines.

General Paradigm

It is assumed that the scores are derived from a data population which can be described in terms of the general linear regression equation:

$$Y = m(k)X + c(k)$$

The first stage of the analyses determine whether the regression coefficients $[m(n)]$ of each sample of X-Y data pairs have the same population estimate $M(n)$.

i.e. $H_0: m(1) - m(2) - m(3) \dots m(k) = 0.$

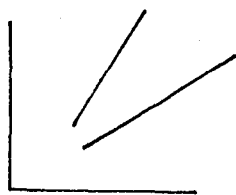

Fig. 1

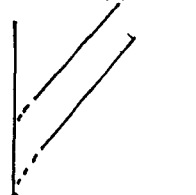

Fig. 2

In fig. 1 the linear regression lines clearly have different gradients (m). However, in fig. 2 the curves have similar gradients but will cross the ordinate at different points. A further stage of the analyses therefore describes an F-value $[F(c)]$ for testing:

$$H_0: m(1) - m(2) \dots m(k) = 0 \quad \underline{\text{AND}} \quad c(1) - c(2) \dots c(k) = 0$$

Estimation of M(k)

$$M = \sum (x - \bar{x})(y - \bar{y}) / \sum (x - \bar{x})^2$$

Residual Sum of Squares (RSS)

$$RSS = \sum y^2 - \sum (xy)^2 / \sum x^2$$

where

$$\sum y^2 = \sum Y^2 - \sum Y^2 / n$$

$$\sum (xy)^2 = \left(\sum XY - (\sum X)(\sum Y) / n \right)^2$$

$$\sum x^2 = \sum X^2 - \sum X^2 / n$$

The complete or total RSS using each regression coefficient for each sample is given by:

$$RSS(1) = \sum_{k=1}^k \left(\sum_i (Y - \bar{y})^2 - (\sum_i (Y - \bar{y}) \sum_i (X - \bar{x}))^2 / \sum_i (X - \bar{x})^2 \right)$$

where: k = number of samples (lines)
 i = is an element in the X - Y data array

The common regression coefficient of the total data sets is:

$$\left(\sum_k \sum_i (Y - \bar{y})(X - \bar{x}) \right) / \left(\sum_k \sum_i (X - \bar{x})^2 \right)$$

and the common residual sum of squares [RSS(2)] is then:

$$RSS(2) = \sum_k \sum_i (Y_{ki} - \bar{Y})^2 - \sum_k \left(\sum_i (X_{ki} - \bar{X}_k)^2 \sum_i (Y_{ki} - \bar{Y}_k)^2 / \sum_i (X_{ki} - \bar{X}_k)^2 \right)$$

If $m(1) = m(2) = M(k)$ then $RSS(2) - RSS(1)$ will be relatively small. Note that $RSS(1)$ must be less than $RSS(2)$ since $RSS(1)$ is the minimum RSS using the specific regression coefficient from each data set: $RSS(2)$ uses the common estimate.

The F-value is given as:

$$F(m) = \left((RSS(2) - RSS(1)) / (k-1) \right) / \left(RSS(1) / (N-2k) \right)$$

To test $m(1) = m(2) \dots m(k) = 0$ AND $c(1) = c(2) \dots c(k) = 0$

RSS(3) is determined with:

$$\bar{Y}_{..} = \sum_k \sum_i Y_{ki} / N \quad \text{and} \quad \bar{X}_{..} = \sum_k \sum_i X_{ki} / N$$

$$RSS(3) = \sum_k \sum_i (Y_{ki} - \bar{Y}_{..})^2 - \frac{\sum_k \left(\sum_i (Y_{ki} - \bar{Y}_{..}) \right)^2 \sum_i (X_{ki} - \bar{X}_{..})^2}{\sum_k \sum_i (X_{ki} - \bar{X}_{..})^2}$$

$$F(k) = (RSS(3) - RSS(1) / (2k - 2)) / (RSS(1) / (N - 2k))$$

Any number of samples can be used although in the experiments described in earlier sections 2 regressions were analysed at a time. Note that the analyses can be applied to data sets with unequal number of X-Y pairs. Mathematical derivations of these formulae are presented in detail in Seber (1977, pp197-205).

REFERENCES

- Abadi, R.V., Carden, D. & Simpson, J. (1979); Controlling abnormal eye movements. *Vision Res.* 19(8) 961-963.
- Abadi, R.V., Carden, D. & Simpson, J. (1980); A new treatment for congenital nystagmus. *Brit. Jour. Ophthal.* 64(1) 2-6.
- Abel, L.A., Schmidt & Dell'Osso, L (1978); Saccadic system plasticity in humans. *Ann. Neurol.* 4(4) 313-318.
- Albano, J.E. & Wurtz, R.H. (1981); The role of the primate superior colliculus pretectum and posterior-medial thalamus in visually guided eye movements. In Fuchs, A. & Becker, W. (Eds) *Progress in Oculomotor Research*, Elsevier Press, New York.
- Alpern, M (1962); Types of Movement. In 'The Eye' (Ed.) Davson, H. VOL. 3 *Muscular Mechanisms*. Academic Press. New York and London.
- Alvarado, J.A. & Horn, C Van. (1975); Muscle cell types of the cat inferior oblique. In *Basic Mechanisms of Ocular Motility*. (Eds.) Lennerstrand, G. & Bach-y-Rita, P. Pergamon Press. Oxford.
- Aschoff, J. (1968); Veranderungen rascher Blickwegungen (Saccaden) beim Menschen unter Diazepam (Valium). *Arch. Psychiatr. Nervenkr.* 211 325-332.
- Bahill, A.T., Clark, M.R. & Stark, L. (1975); The Main Sequence, a tool for studying human eye movement. *Math. Biosciences.* 24 191-204.
- Baloh, R.W., Andrew, W.S., Warren, E.K. & Honrubia, V. (1975); Quantitative measurement of saccade amplitude, duration and velocity. *Neurology* 25 1065-1070.
- Baloh, R.W., Yee, R.D. & Boder, E. (1978); Eye movements in ataxia telangiectasia. *Neurology* 28 1099-1104.
- Barnes, G.R. & Gresty, M.A. (1973); Characteristics of eye movements to targets of short duration. *Aerospace Med.* 44(11) 1236-1240.
- Bartlett, N.R., Eason, R.G. & White, C.T. (1961); Latency of ocular fixation upon the second of two successive stimuli. *Percept. Mot. Skills* 13 259-268.

- Barlow, H.B. (1952); Eye movements during fixation. *J. Physiol. (Lon.)* 116(3) : 209.
- Barmack, N.H. (1970); Modification of eye movements by instantaneous changes in the velocity of visual targets. *Vision Res.* 10 1431-1441.
- Basmajian, J.V. (1963a); Conscious control of single nerve cells. *New Scientist.* 369 662-664.
- Basmajian, J.V. (1963b); Control and training of individual motor units. *Science.* 141 440-441.
- Basmajian, J.V. & Simard, T.G. (1967); Effects of distracting movements on the control of trained motor units. *Amer. J. Pys. Med.* 46 1427-1449.
- Becker, W. (1972); The control of eye movements in the saccadic system. *Bibl. Ophthal.* 82 233-243.
- Becker, W. & Fuchs, A.F. (1969); Further properties of the human saccadic system: eye movements and correction saccades with and without visual fixation points. *Vision Res.* 9 1247-1258.
- Becker, W. & Jurgens, R. (1975); Saccadic reactions to double-step stimuli: Evidence of feedback and continuous information uptake. 519-524. In Basic Mechanisms of Ocular Motility. Lennerstand, G. & Bach-y-Rita, P. Pergamon Press. Oxford.
- Becker, W. & Jurgens, R. (1979); An analysis of the saccadic system by means of double step stimuli. *Vision Res.* 19 967-983.
- Bell, I.R. & Schwartz, G.E. (1975); Voluntary control and reactivity of human heart rate. *Psychophysiology.* 12 339-348.
- Bergman, J.S. & Johnson, H.J. (1971); The effects of instructional set and autonomic perception on cardiac control. *Psychophysiology.* 8 180-190.
- Bergman, J.S. & Johnson, H.J. (1972); Sources of information which affect training and raising of heart rate. *Psychophysiology.* 9 30-39.
- Bird, A.C. & Leech, J. (1976); Internuclear ophthalmoplegia: An electr-oculographic study of peak angular saccadic velocities. *Brit. J. Ophthal.* 60: 645-650.
- Bizzi, E., Kalil, R.E. & Tagliasco, V. (1971); Eye-head coordination in monkeys: Evidence for centrally patterned organization. *Science* 173 452-454.

- Bjork, A (1952); Electrical activity of human extrinsic eye muscles. *Experientia* 8 226-227.
- Bjork, A (1955); The electromyogram of the extraocular muscles in opticokinetic nystagmus and in reading. *Acta. ophthal., Kbh.* 33 437-454.
- Bjork, A. & Kugelberg, E. (1953); Electrical activity of the muscles of the eye and eye lids. *E.E.G. Journal.* 5 595-602.
- Blanchard, E.B. & Epstein, L.H. (1978); A Biofeedback Primer. Addison-Wesley publishing company.
- Blanchard, E.B. & Young, L.D. (1972); Relative efficacy of visual and auditory feedback for self-control of heart rate. *J. Gen. Psychol.* 87 195-202.
- Blanchard, E.B. & Young, L.R. (1973); Self-control of cardiac functioning: a promise as yet unfulfilled. *Psychological Bulletin.* 79(3)
- Bouma, H. (1978); Visual search and reading: eye movements and functional visual field: A tutorial review. *In* Requin, J. (Ed.) *Attention and Performance VII.* L.E.A. Hillsdale, New Jersey.
- Breitmeyer, B., Valberg, A., Kurtenbach, W. & Neumeyer, C. (1980); The lateral effect of oscillation of peripheral luminance gratings on the foveal increment threshold. *Vision Res.* 20 799-805.
- Brener, J. (1974); A general model of voluntary control applied to the phenomena of learned cardiovascular change. *In* *Cardiovascular Psychophysiology.* Obrist, P.A., Black, A.H., Brener, J. & Dicara, L.V. (Eds.) Chicago, Aldine.
- Brener, J. & Hothersall, D. (1966); Heart rate control under conditions of augmented sensory feedback. *Psychophysiology* 3 23-27.
- Brindley, G.S., Goodwin, G.M., Kulikowski, J.J. & Leighton, D (1976); Stability of vision with a paralyzed eye. *J. Physiol.* 258 65P.
- Brindley, G.S. & Merton, P.A. (1960); The absence of position sense in the human eye. *J. Physiol.* 153 127-130.
- Brooks, B.A. & Impelman, D.M. (1981); Suppressive effects of a peripheral grating displacement during saccadic eye movement and during fixation. *Expl. Brain Res.* 42 489-492.
- Burr, D.C., Holt, J., Johnstone, J.R. & Ross, J. (1982);

Selective depression of motion sensitivity during saccades. *J. Physiol.* 333 1-16.

- Buzzard, E.S. (1908); A note on the occurrence of muscle spindles in ocular muscles. *Proc. R. Soc. Med.* 1 83-87.
- Byford, G.H. (1963); Non-linear relations between the corneo-retinal potential and horizontal eye movements. *J. Physiol. (Lon.)* 168 14P-15P.
- Carlow, T., Dell'Osso, L.F., Troost, B.T., Daroff, R.B. & Birkett, J.E. (1975); Saccadic eye movement latencies to multimodal stimuli: Intersubject variability and temporal efficiency. *Vision Res.* 15 1257-1262.
- Carpenter, R.H.S., (1977); Movement of the eyes. Pion. London.
- Cavicchio, R.A. (1975); Adjustment of saccadic eye movements. Ph.D. Thesis. Tufts University, U.S.A.
- Chernikoff, R. & Taylor, F.V. (1952); Reaction time to kinaesthetic stimulation resulting from sudden arm displacement. *Jour. Exp. Psych.* 43 1-8.
- Ciuffreda, K.S., Goldrich, S. & Neary, C. (1980); Auditory biofeedback as a potentially important tool in the treatment of nystagmus. *Amer. J. Optometry.* 51: 615-617.
- Cohen, M.E. & Ross, L.E. (1977); Saccade latency in children and adults: effects of warning interval and target eccentricity. *Jour. Exp. Child Psych.* 23 539-549.
- Colgan, M. (1977); Effects of binary and proportional feedback on bidirectional control of heart rate. *Psychophysiology.* 14 187-191.
- Collewyn, H., Mark, F. & Jansen, T.C. (1975); Precise recording of human eye movements. *Vision Res.* 15 447-450.
- Collins, C.C. (1975); The human oculomotor control system. 145-180. *In* Basic Mechanism of Ocular Motility. Lennerstrand, G., Bach-y-Rita, P. Pergamon Press. Oxford.
- Collins, C.C. (1971); Orbital Mechanics. 283-325. *In* The Control of eye movements. Bach-y-Rita, P., Collins, C.C., Hyde, J. (Eds.) Academic Press.
- Cook, G. & Stark, L. (1965); Dynamics of human horizontal eye movement mechanisms. M.I.T., R.L.E., Quarterly Report, No. 76, 343-352.

- Cooper, S. & Eccles, J.C. (1930); The isometric response of mammalian muscles. *J. Physiol. (Lon.)* 69 377-385.
- Cords, R. (1927); *Uber Hebelnystagmographie.* *Graefes. Arch. Opthal.* 118: 771-784.
- Cott, A., Pavloski, R.P. & Black, A.H. (1981); Operant conditioning and discrimination of alpha: some methodological limitations inherent in response discrimination experiments. *Jour. Exp. Psych. (Gen.)* 110(3) 398-414.
- Crane, T.B., Yee, R.D., Baloh, R.W. & Helper, R.S. (1983); Analysis of characteristic eye movement abnormalities in internuclear ophthalmoplegia. *Arch. Ophthalmol.* 101: 206-210.
- Crawford, T.J. (1984); The modification of saccadic trajectories. 95-102. *In Theoretical and Applied Aspects of Eye Movement Research.* Gale, A.G. & Johnson, F.W. (Eds.) Amsterdam, North-Holland.
- Cummings, G. (1981); Extraretinal Feedback. Psychology Department Research Seminar, University of Durham.
- Cunitz, R.J. & Steinman, R.M. (1969); Comparison of saccadic eye movement during fixation and reading. *Vision Res.* 9 983-993.
- Dell'Osso, L.F., Abel, L.A. & Daroff, R.B. (1977); "Inverse latent" macro square wave jerks and macro saccadic oscillations. *Ann. Neurol.* 2 57-60.
- Derrington, A.M. (1984); Spatial frequency selectivity of remote pattern masking. *Vision Res.* 24 1965-1968.
- DiCara, L.V. & Miller, N.E. (1968a); Changes in heart rate instrumentally learned by curarized rats as avoidance responses. *J. Comp. Physiol, Psychol.* 65 8-12.
- DiCara, L.V. & Miller, N.E. (1968b); Instrumental learning of vasomotor responses by rats: learning to respond differentially in the two ears. *Science.* 159 1485.
- Ditchburn, R.W. (1973); *Eye Movements and Visual Perception.* Clarendon Press. Oxford.
- Dodge, R. (1900); Visual perception during eye movements. *Psychol. Rev.* 7 454-465.
- Dodge, R. (1907); An experimental study of visual

- fixation. Psychol. Monog. 8(1).
- Dodge, R. & Cline, T.S. (1901); The angle velocity of eye movements. Psychol. Rev. 8 145-157.
- Duke-Elder, W.S. (1932); Textbook of Ophthalmology. Vol. 1 London.
- Edwards, A.L. (1970); Experimental Design in Psychological Research. Holt, Rinehart & Winston.
- Edwards, A.L. (1976); An Introduction to Linear Regression and Correlation. Freeman, W.H. and Company. San Francisco.
- Engel, B.T. (1972); Operant conditioning of cardiac function: A status report. Psychophysiology. 9 161-177.
- Evinger, C., Kaneko, C.R.S. & Fuchs, A.F. (1981); Oblique saccadic eye movements of the cat. Experimental Brain Research. 41 370-379.
- Fantz, R.L. (1961); The origin of form perception. In Held, R. & Richards, W (Eds.) Perception: Mechanism and Models. Freeman, W.H. and Company, San Francisco.
- Feinstein, R. & Williams, W.J. (1972); Interactions of the horizontal and vertical human oculomotor systems: the vertical smooth pursuit and horizontal saccadic systems. Vision Res. 12 45-52.
- Feldon, S.E. & Langston, J.W. (1977); Square wave jerks: A disorder of micro saccades? Neurol. 27 278-281.
- Findlay, J.M. (1974); A simple apparatus for recording microsaccades during visual fixation. Quart. J. Exp. Psych. 26 167-170.
- Findlay, J.M. (1981); Spatial and temporal factors in the predictive generation of saccadic eye movements. Vision Res. 21 347-354.
- Findlay, J.M. (1982); Global processing for saccadic eye movements. Vision Res. 22 1033-1045.
- Findlay, J.M. (1983); Visual information processing for saccadic eye movements. In Hein, A., Jeannerod, M. (Eds.) Spatially Co-ordinated Behavior. New York and Berlin, Springer-Verlag.
- Findlay, J.M. & Crawford, T.J. (1983); The visual control of saccadic eye movements: evidence for limited plasticity. In Groner, R., Menz, C.,

- Fisher, D.F. & Monty, R.A. (Eds.) Eye Movements and Psychological Functions: International Views. Hillsdale. New Jersey. Lawrence Erlbaum.
- Findlay, J.M. & Harris, L.R. (1984); Small saccades to double step targets moving in two dimensions. In Gale, A.G. & Johnson, F. (Eds.) Theoretical and Applied Aspects of Eye Movement Research. North-Holland.
- Fitts, P.M. (1954); The information capacity of the human motor system in controlling the amplitude of movement. Jour. Exp. Psych. 47 381-391.
- Frost, D. & Poppel, E. (1976); Different programming modes of human saccadic eye movements as a function of stimulus eccentricity: Indications of a functional subdivision of the visual field. Biol. Cybernetics 23 39-48.
- Fuchs, A.F. (1967a); Saccadic and smooth pursuit eye movements in monkey. J. Physiol. 191 609-631.
- Fuchs, A.F. (1967b); Periodic eye-tracking in the monkey. J. Physiol. 193 161-171.
- Fuchs, A.F. (1971); The saccadic system. In Bach-y-Rita, P., Collins, C.C. & Hyde, J. (Eds.) The Control of Eye Movements. Academic Press, New York.
- Fuchs, A.F. (1976); The Neurophysiology of Saccades. In Monty, R. & Senders, R. (Eds.) Eye Movements and Psychological Processes. Lawrence Erlbaum Associates, Hillsdale, New Jersey.
- Fuchs, A.F. (1977); Role of the vestibular and reticular nuclei in the control of gaze. B: reticular prepositus and other internuclear activity. In Control of Gaze by Brain Stem Neurons. Developments in Neuroscience. Vol. 1 Baker, R. & Berthoz, A. (Eds.) 341-348. New York: Elsevier/North-Holland.
- Fuchs, A.F. & Binder, M.D. (1983); Fatigue resistance of extraocular muscles. J. Neurophysiol. 49(1)
- Fuchs, A.F. & Kornhuber, H.H. (1969); Extraocular muscle afferents to the cerebellum of the cat. J. Physiol. 200 713-722.
- Fuchs, A.F. & Luschei, E.S. (1970); Firing patterns of abducens neurons of alert monkeys in relationship to horizontal eye movement. J. Neurophysiology. 33 382-392.

- Fuchs, A.F. & Ron, S. (1968); An analysis of rapid eye movements of sleep in the monkey. *Electroenceph. Clin. Neurophysiol.*, 25 244-251.
- Gassovskii, L.N. & Nikolskaya, N.A. (1941); Mobility of the eye during fixation. *Problemy Fiziol. Optik.* 1(173)
- Ginsborg, B.L. (1953); Small voluntary movements of the eye. *Brit. J. Opthal.* 37 746-754.
- Glenny, G. & Heywood, S. (1979); Hans Gertz revisited: the different effects of invisibility and darkness on pursuit eye movements. *Perception* 8(1) 31-36.
- Gould, J.D. (1973); Eye movements during visual search and memory search. *Jour. Exp. Psychol.* 98 184-195.
- Greene, W.A. (1976); Operant conditioning of the GSR using partial reinforcement. *Psychol. Rep.* 19 571-578.
- Gurevich, B.Kh. (1957); Proprioception in Eye Movements. *Dokl. akad. Nauk. SSSR.* 115 754-757.
- Gurevich, B.Kh. (1959); The importance of proprioception in the oculomotor fixation reflex and in the functioning of the visual analyser in man. *Schenov. Physiol. J. of the USSR.* 45(11) 17-27.
- Gurevich, B.Kh. (1961); Universal characteristics of fixation eye jerkes: change in fixation as a cybernetic model of directed behaviour. *Biophysics* 6(3) 419-427
- Guensberger, E. & Zucha, I (1973); Conditioned blockade of optokinetic nystagmus as a model for analysing some regularities of learning. *In The Oculomotor System and Brain Function.* Zikmund, V. (Ed.)
- Hackman, R.B. (1940); An experimental study of variability in ocular latency. *J. Exp. Psychol.* 27 546-558.
- Haddad, G.M. & Steinman, R.M. (1973); The smallest voluntary saccade: implications for fixation. *Vision Res.* 13 1075-1086.
- Hallet, P.E. (1978); Primary and Secondary saccades to goals defined by instruction. *Vision Res.* 18 1279-1296.
- Hallet, P.E. & Adams, B.D. (1980); The predictability

of saccadic latency in a novel voluntary task. *Vision Res.* 20 329-339.

- Hallet, P.E. & Lightstone, A.D. (1976); Saccadic eye movements towards stimuli triggered during prior saccades. *Vision Res.* 16 99-106.
- Harris, L.R. & Cynader, M. (1981); The eye movements of the dark-reared cat. *Exp. Brain Res.* 44 41-56.
- Harrison, V.F. & Mortenson, O.A. (1962); Identification and voluntary control of single motor unit activity in the tibialis anterior muscle. *Anat. Res.* 144 109-116.
- Helmholtz, H. (1925); Helmholtz's Treatise on Physiological Optics. The Optical Society of America, Rochester, New York. Vol III, 37-123.
- Henn, V. & Cohen, B. (1976); Coding of information about rapid eye movements in the pontine reticular formation of alert monkeys. *Brain Res.* 108 307-325.
- Henry, F.M. & Rogers, D.E. (1960); Increased response latency for complicated movements and a 'memory drum' theory of neuromotor reaction. *Research Quarterly*, 31 448-458.
- Henson, D.B. (1978); Corrective saccades: effects of altering visual feedback. *Vision Res.* 18 57-61.
- Hering, E. (1868); Die Lehre vom Binocularen Sehen. Engelmann, Leipzig.
- Hess, A. & Pilar, G. (1963); Slow muscle fibres in the extraocular muscles of the cat. *J. Physiol. (Lon.)* 169 780-798.
- Heywood, S. & Churcher, J. (1981); Saccades to step-ramp stimuli. *Vision res.* 21 479-490.
- Hill, A.V. (1938); The rate of shortening and the dynamic constants of muscle. *Proc. Roy. Soc. B*, 126 135-195.
- Holst, E. Von. (1954); Relations between the central nervous system and peripheral organs. *Br. J. Anim. Behav.* 2 89-94.
- Hyde, J.E. (1959); Some characteristics of voluntary human ocular movements in the horizontal plane. *Amer. J. Ophthal.* 48 85-94.
- Irvine, S.R. & Ludvigh, E. (1936); Is ocular proprioceptive sense concerned in vision ?

- A.M.A. Arch. Ophthal. 15 1037-1049.
- Javal, L.E. (1879); Essai sur la physiologie de la lecture. Ann. Oculist. 82 242-253.
- Johnson, L.E. Jr. & Fleming, D.G. (1963); A model of feedback control for saccadic eye movements. Proceedings of the 16th Annual Conference on Engineering in Medicine and Biology, 76-77.
- Johnston, D.W. & Lethem, J. (1981); The production of specific decreases in interbeat interval and motor skills analogy. The Society for Psychophysiological Research, Inc.
- Judd, C.H., Mcallister, C.N. & Steele, W.M. (1905); General Introduction to a series of studies of eye movements by means of Kinetoscopic photographs. Psychol. Monogr. 7 1-16.
- Jurgens, R., Becker, W. & Kornhuber, H.H. (1981); Natural and drug-induced variations of velocity and duration of human saccadic eye movements: Evidence for a control of the neural pulse generated by local feedback. Biol. Cybern. 39 87-96.
- Kapoula, Z. (1984); Aiming Precision and characteristics of saccades. In Gale, A.G. & Johnson, F. (Eds.) Theoretical and applied aspects of eye movement research. North/Holland Amsterdam.
- Karlsruhe, J.S. (1940); The Purdue eye camera: A practical apparatus for studying the attention value of advertisements. J. Appl. Psychol. 24 417-440.
- Katkin, E.S & Murray, E.N. (1968); Instrumental conditioning of autonomically mediated behaviour: theoretical and methodological issues. Psychological Bulletin. 70: 52-68.
- Kay, H. (1965); One trial learning; Incremental or all-or-none? Acta Psychologica 24: 234-243.
- Keele, S.W. (1968); Movement control in skilled performance. Psych. Bull. 70 387-403.
- Keele, S.W. & Posner, M.I. (1968); Processing of visual feedback in rapid movements. Jour. Exp. Psych. 77(49) 155-158.
- Keller, E.L. (1974); Participation of medial pontine reticular formation in eye movement generation in monkey. J. Neurophysiol. 37 316-332.
- Keller, E.L. (1977); Control of saccadic eye movements by midline brain stem neurons. In Control of

Gaze by Brain Stem Neurons. Developments in Neuroscience. Vol. 1 Baker, R., Berthoz, A. (Eds.) 327-336. New York: Elsevier/North-Holland.

- Keller, E.L. (1981); Brain stem mechanisms in saccadic control. In Fuchs, A.F. & Becker, W. (Eds.) Progress in Oculomotor Research. Elsevier North/Holland.
- Kimble, G.A. (1961); Hilgard and Marquis' conditioning and learning. New York. Appleton-Century-Crofts.
- Kimble, G.A. & Perlmutter, L.C (1970); The problem of volition. Psychological Review. 77: 361-384.
- Kimmel, H.D. (1967); Instrumental conditionig of autonomically mediated behaviour. Psychological Bulletin. 29: 337-345.
- Kimmel, H.D. & Hill, F.A. (1960); Operant conditioning of the GSR. Psychol. Rep. 552-562.
- Kinsbourne, M. (1972); Eye and head turning indicates cerebral lateralization. Science 176 539-541.
- Klapp, S.T. (1975); Feedback versus programming in the control of aimed movement. Jour. Exp. Psych. H.P.P 104 147-153.
- Klein, R. (1980); Does oculomotor readiness mediate cognitive control of visual attention ? In Nickerson, R.S. (Ed.) Attention and Performance (VIII). Hillsdale, New Jersey.
- Kommerell, G., Olivier, D. & Theopold, H. (1976); Adaptive programming of phasic and tonic components in saccadic eye movements. Invest. Ophthal. 15 657-660.
- Kommoda, M.K., Festinger, L., Phillips, L.J., Duckman, R.H., Young, R.A. (1973); Some observations concerning saccadic eye movements. Vision Res. 13(6) 1009-1034.
- Kommerrell, G., Olivier, D., Theopold, H. (1976); Adaptive programming of phasic and tonic components in saccadic eye movements investigations in patients with abducens palsy. Invest. Ophthal. 15 657-660.
- Kris, E.C. (1960); Vision: Electro-oculography. In Glasser, O. (Ed.) Medical Physics, Year Book. Chicago.
- Lacroix, J.M. & Gowen, A. (1981); The acquisition of autonomic control through biofeedback: some

- test of discrimination theory.
Psychophysiology, 18: 559-572.
- Lang, P.J. & Twentyman, C.T. (1974); Learning to control heart rate: binary versus analogue feedback. Psychophysiology. 11 616-629.
- Lang, P.J., Strouf, L.A. & Hastings, J.E. (1967); Effects of feedback and instructional set on the control of cardiac variability. J. Exp. Psychol. 75 425-431.
- Lashley, K.S. (1917); The accuracy of movement in the absence of excitation from moving organ. Amer. J. Physiol. 43 169-194.
- Latour, P.L. (1962); Visual thresholds during eye movements. Vision Res. 2 261-262.
- Latour, P.L. (1966); Cortical control of eye movements. Ph.d thesis. Institute of Perception. R.V.O.-T.N.O., Soesterberg, Netherlands.
- Laycock, J. (1978); Human eye tracking movements and their control. Royal Aircraft Establishment. Technical Memorandum FS 156.
- Leushina, L.I. (1965); On the estimation of position of photostimulus and eye movements. Biofizika 10 130-136.
- Levenson, R.W. (1976); Feedback effects and respiratory involvement in voluntary control of heart rate. Psychophysiology. 3 108-114.
- Levy-Schoen, A. (1981); Flexible and/or rigid control of oculomotor scanning behaviour. In Fisher, D.F., Monty, R.A. & Senders, J.W. (Eds.) Eye Movements Cognition and Visual Perception. Hillsdale, Lawrence Erlbaum, New Jersey.
- Levy-Schoen, A. & Blanc-Garin, J. (1974); On oculomotor programming and Perception. Brain Research 71 443-450.
- Lippold, O.C.J. & Shaw, J.C. (1971); Alpha rhythm in the blind. Nature (Lon) 232(134)
- Lisberger, S.G., Fuchs, A.F., King, W.M. & Evinger, L.C. (1975); Effect of mean reaction time on saccadic responses to two-step stimuli with horizontal and vertical components. Vision Res. 15 1021-1025.
- Lord, M.P. & Wright, W.D. (1948); Eye movements during monocular fixation. Nature (Lon) 162(4105):25
- Ludvigh, E. (1952); Possible role of proprioception in

- the extra-ocular muscles. Arch. Ophthal. New York. 48 436-441.
- Luschei, E.S. & Fuchs, A.F. (1972); Activity of brain stem neurons during eye movements of alert monkeys. J. Neurophysiology. 35 445-460.
- Mackay, D.M. (1970); Elevation of visual threshold by displacement of retinal image. Nature (Lon) 225 90-92.
- Mackworth, N.F. & Mackworth, H.H. (1958); Eye fixations recorded on changing visual scenes by the T.V. eye-marker. J. Opt. Soc. Amer. 48(7):439
- Matin, E. (1976a); Saccadic suppression and the stable world. In Monty, R.A. & Senders, J.W. (Eds.) Lawrence Erlbaum, Hillsdale New Jersey.
- Matin, L. (1976b); A possible hybrid mechanism for modification of visual direction associated with eye movements - the paralyzed eye experiment reconsidered. Perception 5 233-239.
- Matin, L., Matin, E., Pola, J.R. & Pearce, D. (1968); Visual perception of direction during and after voluntary saccades. Psychonomic Society meeting, St Louis, Missouri.
- May, J.R. & Johnson, H.J. (1972); Operant of conditioning with human heart rate decreases and schedules of reinforcement. Paper presented to annual meeting of western Psychological Association, Portland.
- Mays, L. & Sparks, D. (1981); The localization of saccade targets using a combination of retinal eye position information. In Progress in Oculomotor Research. Fuchs, A.F. & Becker, W. (Eds.) Elsevier/North-Holland.
- McCanne, T.R. & Sandman, C.A. (1975a); Determinants of human operant heart rate conditioning: A systematic investigation of several methodological issues. J. Comparative & Physiological Psychology. 88 609-618.
- McCanne, T.R. & Sandman, C.A. (1975b); Human operant heart rate conditioning: the importance of individual differences. Psychological Bulletin, 587-601.
- McLaughlin, S.C. (1967); Parametric adjustment in saccadic eye movements. Perception and Psychophysics 2(8).
- Melvill-Jones, G. (1976); The vestibular system for eye movement control. In Eye Movements and

- Psychological Processes. Monty, R., Senders, J.W. (Eds.) Lawrence Erlbaum. Hillsdale, New Jersey.
- Metz, H.S. (1976); Saccadic velocity measurements in internuclear ophthalmoplegia. *Am. J. Ophthalmol.* 81 296-299.
- Michard, A., Tetard, G. & Levy-Schoen, A. (1974); Attente du signal et temps de reaction oculomoteur. *L'Annee Psychologique* 74 387-402.
- Miles, W.R. (1939); Experimental modification of the polarity of the human eye. *Science.* 90:404
- Miller, J.M. (1958); Electromyographic patterns of saccadic eye movements. *Amer. J. Ophthalm.* 46 183-186.
- Miller, J.M., Anstis, T. & Templeton, W.B. (1981); Saccadic Plasticity: Parametric adaptive control by retinal feedback. *Jour. Exp. Psychology.* *H.P.P* 7(2) 356-366.
- Miller, N.E. (1972); Postscript. *In* Singh, D. & Morgan, C.T. (Eds.) *Current Status of Physiological Psychology: Readings.* Monterey, California: Brooks-Cole.
- Mitrani, L., Mateef, St. & Yakimoff, N. (1971); Is saccadic suppression really saccadic? *Vision Res.* 11 1157-1163.
- Moses, R.A. (1975); *Adlers Physiology of the Eye.* 6th Ed. C.V. Mosby Company.
- Mowrer, O.H., Ruch, T.C. & Miller, N.E. (1936); The corneo-retinal potential as the basis of the galvanometric method of recording eye movements. *Amer. J. Physiol.* 114:423
- Nam, M.H., Park, S.H. & Choi, O. (1975); Saccadic eye movements characteristics to double-step stimuli. *Yonsei Medical Journal* 16(2)
- Newhall, S.N. (1928); Instrument for observing ocular movements. *Amer. J. Psychol.* 40:628
- Newell, K.M. (1981); *In* Human Skills. Holding, D. (Ed.) John Wiley and Sons Ltd.
- Obrist, P.A., Golosy, R.A., Lawler, J.E., Gaebelien, C.J., Howard, J.L. Shanks, E.M. (1975); Operant conditioning of heart rate: somatic correlates. *Psychophysiology* 12 445-455.
- Ogle, K.N., Mussey, F. & Prangen, A. (1949); Fixation disparity and the fusional processes in

- binocular single vision. Amer. J. Ophthal.
32:1069
- Ohm, J. (1928); Die Hebelnystagmographie. Graefes.
Arch. Ophthalm. 120:235
- Optican, L.M. & Robinson, D.A. (1980);
Cerebellar-dependent adaptive changes in control
of primate saccadic system. J. Neurophysiol.
44 1058-1076.
- Orschansky, J. (1899); Eine Methods, die Augenbewegungen
direct zu unter sachen (ophthalmographie).
Zentbl. Physiol. 12(787-790).
- Osterberg, G.A. (1935); Topography of the layer of rods
and cones in the human retina. Acta Ophthalmol.
Supplement VI
- Park, G.E. (1936a); The Precision Anglometer. Arch.
Ophthalmol. 15:703
- Park, G.E. (1936b); An investigation of the angular
relationship of the visual and optic axes of the
eye. J. Am. Ophthalmol. 19:967
- Peckham, R.H. (1934); Foveal projection during duction.
Arch. Ophthalmol. 12:562
- Posner, M.I. (1978); Chronometric Explorations of Mind:
The Experimental Psychology Series. Lawrence
Erlbaum.
- Powers, W.T. (1973); Feedback: Beyond behaviorism.
Science 199 351-356.
- Prablanc, C., Masse, D. & Echallier, J.F. (1978);
Error-Correcting mechanisms in large saccades.
Vision Res. 18 557-560.
- Rashbass, C. (1961); The relationship between saccadic
and smooth tracking eye movements. J. Physiol.
159 326-338.
- Reid, G. (1949); The rate of discharge of extraocular
motorneurons. J. Physiol. (Lon.) 110 217-225.
- Remington, R.W. (1980); Attention and saccadic eye
movements. Jour. Exp. Psych. HPP 6(4)
724-744.
- Reulen, Jos P.H. (1984); Latency of visuallay evoked
saccadic eye movements. Biol. Cybern. 50
251-262.
- Richards, W. (1969); Saccadic suppression. J. Opt.
Soc. Amer. 59 617-623.

- Riggs, L.A., Merton, P.A. & Morton, H.B. (1974); Suppression of visual phosphenes during saccadic eye movements. *Vision Res.* 14 997-1010.
- Ritchie, L. (1976); Effects of cerebellar lesions on saccadic eye movements. *J. Neurophysiol.* 39 1246-1256.
- Robinson, D.A. (1963); A method of measuring eye movements using a search coil in a magnetic field. *IEEE Trans. Bio. Med. Electron* 10 137-145.
- Robinson, D.A. (1964); The mechanics of human saccadic eye movements. *J. Physiol.* 174 245-264.
- Robinson, D.A. (1965); The mechanics of human smooth pursuit eye movements. *J. Physiol. (Lon.)* 180 569-591.
- Robinson, D.A. (1970); Oculomotor unit behaviour in the monkey. *J. Neurophysiol.* 33 393-404.
- Robinson, D.A. (1973); Models of the saccadic eye movement control system. *Kybernetik* 14 71-83.
- Robinson, D.A. (1975); Oculomotor control signals. *In Basic Mechanisms of Ocular Motility and their Clinical Implications.* Lennerstrand, G. Bach-y-Rita, P. (eds) Oxford, Pergamon.
- Ron, S., Robinson, D.A. & Skavenski, A. (1972); Saccades and the quick phase of nystagmus. *Vision Res.* 12(12) 2015-2023.
- Ron, S. (1981); Plastic changes in eye movements of patients with traumatic brain injury. *In Progress in Oculomotor Research.* Fuchs, A.F. & Becker, W. (eds) Elsevier/North-Holland.
- Ross, L.E. & Ross, S.M. (1980); Saccade latency and warning signals: Stimulus onset, offset and change as warning events. *Perception and Psychophysics* 27(3) 251-257.
- Saslow, M.G. (1967); Latency for saccadic eye movements. *J. Opt. Soc. Am.* 57 1030-1033.
- Schandler, S.L. & Grings, W.W. (1978); Feedback modalities as a consideration in biofeedback applications. *Behavior Research Methods Instrumentation.* 10(5) 597-606.
- Schiller, P.H. (1970); The discharge characteristics of single units in the oculomotor and abducens nuclei of the unanesthetized monkey. *Exp. Brain Res.* 10 347-362.

- Schmidt, R.A., & Russell, D.G. (1972); Movement velocity and movement time as determiners of the degree of preprogramming in simple movements. *J. Exp. Psychol.* 96 315-320.
- Schmidt, R.A., Zelaznik, H., Hawkins, B., Frank, S.S. & Quinn, J.T. (1979); Motor-output variability: A theory for the accuracy of rapid motor acts. *Psychological Review* 89 415-451.
- Schwartz, G. & Beatty, W. (1977); *Biofeedback: Research and Theory.*
- Scully, H.E. & Basmajian, J.V. (1969); Motor unit training and influence of manual skill. *Psychophysiology.* 5 625-632.
- Seber, G.A.F. (1977); *Linear Regression Analysis.* John Wiley & Sons. New York, London.
- Shaknovich, A.R. (1977); *The Brain and the Regulation of Eye Movements.* Plenum Publications.
- Shebilske, W.L. (1976); Extraretinal information in corrective saccades and inflow versus outflow theories of visual direction constancy. *Vision Res.* 16(6) 621-628.
- Sherrington, C.S. (1918); Observations on the sensual role of proprioceptive nerve supply of the extrinsic ocular muscles. *Brain* 41 332-343.
- Shulman, G.L., Remington, R.W. & Mclean, J.P. (1979); Moving attention through visual space. *Jour. Exp. Psych. H.P.P.* 5(3) 522-526.
- Skavenski, A.A. (1972); Inflow as a source of extraretinal eye position information. *Vision Res.* 12 221-229.
- Skavenski, A.A. & Steinman, R.M. (1970); Control of eye position in the dark. *Vision Res.* 10 193-203.
- Stelmach, G.E. (1976); *Motor Control: Issues and Trends.* Academic Press, New York, San Francisco, London.
- Stelmach, G.E. (1978); *Information Processing in Motor Control and Learning.* Academic Press. New York, San-Francisco, London.
- Stelmach, G.E. & Requin, J. (1980); *Tutorials in Motor Behavior.* North/Holland Publishing Company.
- Stevens, J.K., Emerson, R.C., Gerstein, G.L., Kallos, T., Neufeld, G.R., Nichols, C.W. & Rosenquist, A.C. (1976); Paralysis of the awake human: visual perceptions. *Vision Res.* 16(1) 93-98.

- Stratton, G.M. (1902); Eye movements and the Aesthetics of visual form. *Phil. Stud.* 20:336
- Tamler, E., Marg, E., Jampolsksy, A., & Nawratzki, I. (1959); Electromyography of human saccadic eye movements. *A.M.A. Arch. Ophthal.* 62 657-661.
- Taumer, R. (1975); Three reactions mechanisms of the saccadic system in response to a double jump (515-518). In Lennerstrand, G. & Bach-y-Rita, P. *Basic Mechanisms of Ocular Motility*. Pergamon Press, Oxford.
- Thomas, J.G. (1961); Subjective analysis of saccadic eye movements. *Nature (Lon.)* 189 842-843.
- Travis, R.C. (1936); The latency and velocity of the eye in saccadic eye movements. *Psychol. Monogr.* 47(2) 242-249.
- Tsal, Y. (1983); Movements of attention across the visual field. *Jour. Exp. Psych. H.P.P.* 9(4) 523-530.
- Van Gisbergen, J.A.M., Ottes, F.P. & Eggermont, J.J. (1982); Responses of the saccadic system to sudden changes in target direction. In *Physiological and Pathological Aspects of Eye Movements*. Roucoux, A. & Crommelinck, M. (Eds.) Dr. W. Junk Publishers, The Hague Boston, London.
- Viviani, P. & Berthoz, A. (1977); Voluntary deceleration and perceptual activity during oblique saccades. In *Control of Gaze by Brain Stem Neurons*. Baker, R. & Berthoz, A. (Eds.) Elsevier/North-Holland.
- Viviani, P. & Swennson, R.G. (1982); Saccadic eye movements to peripherally discriminated visual targets. *Jour. Exp. Psychol. H.P.P.* 8 113-126.
- Volkman, F.C. (1962); Vision during voluntary saccadic eye movements. *J. Opt. Soc. Amer.* 52 571-578.
- Volkman, F.C., Schock, A.M.L. & Riggs, L.A. (1968); Time course of visual inhibition during voluntary saccades. *J. Opt. Soc. Amer.* 58 562-569.
- Volkman, F.C. & Volkman, J. (1971); Eye fixations and latency in a simplified search situation. *Percept. Mot. Skills.* 33 971-979.
- Wallace, S.A. (1981); An impulse-timing theory for reciprocal control of muscular activity in rapid

- discrete movements. *Journal of Motor Behavior* 13 144-160.
- Weber, R.B. & Daroff, R.B. (1972); Corrective Movements following refixation saccades: types and control system analysis. *Vision Res.* 12 467-475.
- Weisfeld, G.E. (1972); Parametric adjustment to a shifting target alternating with saccades to a stationary reference point. *Psychon. Science* 28(2)
- Westheimer, G. (1954a); Mechanism of saccadic eye movements. *Arch. Ophthalmol.* (New York) 52 710-724.
- Westheimer, G. (1954b); Eye movement responses to a horizontally moving visual stimulus. *Arch. Ophthalmol.* 52 932-941.
- Wheless, L.L., Boynton, R.M. & Cohen, G.H. (1966); Eye movement responses to step and pulse-step stimuli. *J. Opt. Soc. Am.* 56 956-960.
- Wheless, L.L., Cohen, G.H. & Boynton, R.M. (1967); Luminance as a parameter of the eye movement control system. *J. Opt. Soc. Am.* 57 394-400.
- White, C.T., Eason, R.G. & Bartlett, N.R. (1962); Latency and duration of eye movements in the horizontal plane. *J. Opt. Soc. Amer.* 52(2) 210-213.
- Whitteridge, D. (1960); Central control of eye movements. In *Handbook of Physiology: Neurophysiology, Vol II*, American Physiology Society, Washington, D.C.
- Williamson, D.A. & Blanchard, E.B. (1979a); Heart rate and blood pressure biofeedback. I. A review of the recent experimental literature. *Biofeedback and Self-Regulation* 4 1-34.
- Williamson, D.A. & Blanchard, E.B. (1979b); Heart rate and blood pressure biofeedback. II. A review and intergration of recent theoretical models. *Biofeedback and Self-Regulation.* 35-50.
- Williamson, D.A. & Blanchard, E.B. (1979c); Effect of feedback delay upon learned heart rate control. *Psychophysiology* 16
- Wilkinson, I.M.S., Kime, R. & Purnell, M. (1974); Alcohol and human movement. *Brain.* 97 785-792.
- Woodworth, R.S. (1938); *Experimental Psychology.* Henry

Holt and Company, New York.

- Yarbus, A.L. (1967); Eye Movements and Vision. Translation by Riggs, L.A. New York, Plenum Press.
- Yates, A.J. (1980); Biofeedback and the modification of behaviour.
- Young, L.R. & Stark, L. (1962); A sampled-data model for eye tracking movements. MIT., RLE., Quarterly Report. No. 66. 370-383.
- Young, L.R. & Stark, L. (1963a); Variable feedback experiments testing a sampled data model for eye tracking movements. I.E.E.E. Trans. Hum. Factors.
- Young, L.R. & Stark, L. (1963b); A discrete model for eye tracking movements. I.E.E.E. Trans. Mil. Elect. MIL-7 113-115.
- Zahn, J.R., Abel, L.A. & Dell'Osso, L.F. (1978); Audio-Ocular response characteristics. Sensory Processes 2 32-37.
- Zee, D.S., Optican, L.M., Cook, J.D., Robinson, D.A. & Engel, W.K. (1976); Slow saccades in spinocerebellar degeneration. Arch. Neurol. 33 243-251.
- Zee, D.S. & Robinson, D.A. (1979); A hypothetical explanation of saccadic oscillations. Ann. Neurol. 5 405-414.
- Zikmund, V. (1973); The Oculomotor System and Brain Function. North-Holland.
- Zuber, B.L., Cook, G. & Stark, L. (1965); Microsaccades and the velocity-amplitude relationship for saccadic eye movements. M.I.T., R.L.E. Quarterly Report 717 399-402.

