



# Durham E-Theses

---

## *New methods for selective fluorination*

Mullins, Stephen T.

### How to cite:

---

Mullins, Stephen T. (1986) *New methods for selective fluorination*, Durham theses, Durham University.  
Available at Durham E-Theses Online: <http://etheses.dur.ac.uk/7056/>

### Use policy

---

The full-text may be used and/or reproduced, and given to third parties in any format or medium, without prior permission or charge, for personal research or study, educational, or not-for-profit purposes provided that:

- a full bibliographic reference is made to the original source
- a [link](#) is made to the metadata record in Durham E-Theses
- the full-text is not changed in any way

The full-text must not be sold in any format or medium without the formal permission of the copyright holders.

Please consult the [full Durham E-Theses policy](#) for further details.

UNIVERSITY OF DURHAM

A THESIS

ENTITLED

NEW METHODS FOR  
SELECTIVE FLUORINATION

Submitted by

STEPHEN T. MULLINS, B.Sc. (Dunelm)

(Grey College)

A Candidate for the Degree of Doctor of Philosophy

1986

The copyright of this thesis rests with the author.  
No quotation from it should be published without  
his prior written consent and information derived  
from it should be acknowledged.



13.FEB.1987

To Carole

MEMORANDUM

The work described in this thesis was carried out at the University of Durham between October 1983 and September 1986 and at Beecham Pharmaceuticals Biosciences Research Division between October 1985 and December 1985. This thesis is the work of the author, except where acknowledged by reference, and has not been submitted for any other degree.

Part of this work has formed the basis of the following publications:

M.R. Bryce, R.D. Chambers, S.T. Mullins and A. Parkin,  
J. Fluorine Chem., 1984, 26, 533.

M.R. Bryce, R.D. Chambers, S.T. Mullins and A. Parkin,  
J.Chem.Soc.,Chem.Comm., 1986, 1623.

M.R. Bryce, R.D. Chambers, S.T. Mullins and A. Parkin,  
Bull.Soc.Chim.France, In press.

Part of this work was also presented as a poster at the International Symposium celebrating the Centenary of the Discovery of Fluorine, Paris, 25-29 August 1986, abstract O<sub>58</sub>.

ACKNOWLEDGEMENTS

I would like to express my gratitude to Professor R.D. Chambers for his supervision, encouragement and guidance throughout the course of this work.

I would also like to thank Dr. Ann Parkin (Beecham Pharmaceuticals) and Dr. M.R. Bryce for their help and advice.

Thanks are also due to Mr. T.F.Holmes for his help in practical matters, Dr. R.S. Mathews for his advice on n.m.r. spectra and Dr. M. Jones and Mr. V.J. McNeilly for the running and discussion of mass spectra.

I would like to thank the many technical and laboratory staff for their assistance; Messrs. R. Hart and G. Haswell for their expert glass blowing, Mr. J.A. Parkinson for help and advice on chromatography and Mrs. M. Cox for elemental analysis.

I would also like to express my thanks to friends in the Chemistry Department and College, especially Andy, Chris, Mike and Richard and members of Lab.117.

I am also grateful to the staff at Beecham Pharmaceuticals Research Division at Great Burgh for their hospitality during my visit and to Mrs. Marion Wilson for typing this thesis.

Thanks must also go to S.E.R.C. and Beecham Pharmaceuticals for the provision of a C.A.S.E. award.

Last, but not least, my thanks go to my parents and to Carole for their considerable support and encouragement.

by

STEPHEN T. MULLINSABSTRACT

New methods have been developed for the selective introduction of fluorine into benzenoid aromatic compounds involving the cleavage of aryl-metal bonds by various 'electrophilic' fluorinating agents. Cleavage of aryl-metal bonds has been achieved using trifluoromethyl hypofluorite ( $\text{CF}_3\text{OF}$ ), caesium fluoroxysulphate ( $\text{CsSO}_4\text{F}$ ) and elemental fluorine and, by the nature of the process, is regiospecific. Attempts have been made to extend this method to the introduction of fluorine into imidazole bases with some success. This approach has involved the synthesis of trialkylstannyl derivatives of several benzene derivatives and trimethylstannyl derivatives of 1,2-dimethylimidazole and N-methylimidazole.

Prior to our attempts at selective introduction of fluorine into the sugar ring of 5-amino-1-( $\beta$ -D-ribofuranosyl)imidazole-4-carboxamide (AICAR) a series of protection and selective deprotection reactions on the nucleoside were carried out and trifluoromethane sulphonate ester derivatives of the protected nucleoside were synthesized. Fluoride ion displacement of the trifluoromethane sulphonate group to give a fluorosugar has been attempted.

NOMENCLATURE

The following numbering system for imidazole derivatives and nucleoside derivatives is used in this thesis:

1.

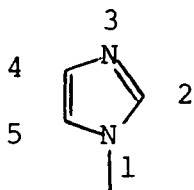

2.

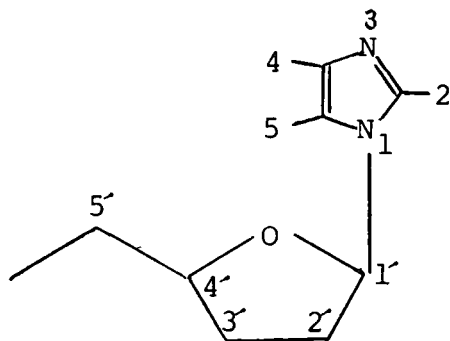

CONTENTS

	<u>Page No.</u>
Memorandum	i
Acknowledgements	ii
Abstract	iii
Nomenclature	iv
INTRODUCTION	1
CHAPTER ONE - MODERN METHODS FOR SELECTIVE FLUORINATION OF AROMATIC COMPOUNDS	2
Introduction	2
1A. The Balz-Schiemann Reaction	3
1B. Organic Hypofluorites	8
1. Preparation of Reagents	9
2. Reaction with Aromatic Compounds	11
3. Reaction with Heterocyclic Compounds	16
1C. Inorganic Hypofluorites	18
1. Preparation and Properties	18
2. Reaction with Aromatic Compounds	20
3. Reaction with Heterocyclic Compounds	24
4. Reaction Mechanism	25
1D. Elemental Fluorine	27
1. Reaction with Aromatic Compounds	28
1E. Xenon Difluoride	32
1. Reaction with Aromatic Compounds	32
2. Reaction with Heterocyclic Compounds	35
1F. Miscellaneous	36
1. N-Fluoro-N-alkylsulphonamides	36
2. Other Reagents containing the N-F group	37
3. Perchloryl fluoride	41
CHAPTER TWO - FLUORINE CONTAINING NUCLEOSIDES - INTRODUCTION	43
2A. Synthesis of Fluorinated Nucleosides	45
1. Fluorination of the Heterocyclic Base	45
(a) Imidazole Derivatives	45
(b) Stability of 2-Fluoroimidazole Derivatives	48
(c) Pyrimidine Derivatives	50
2. Introduction of Fluorine into the Sugar Ring	53
2B. Biological Properties of Fluorinated Nucleosides	58



	<u>Page No.</u>
DISCUSSION	63
CHAPTER THREE - SYNTHESIS OF ORGANOMETALLIC REAGENTS	64
3A. Introduction	64
3B. Synthesis of Arylorganostannane Derivatives	66
1. Model Compounds	66
2. Imidazole Derivatives	68
3C. Synthesis of Organomercurials	71
CHAPTER FOUR - SELECTIVE FLUORINATION OF AROMATIC COMPOUNDS	73
4A. Introduction	73
4B. Reactions of Trifluoromethylhypofluorite	73
1. Model Compounds	73
2. Imidazole Derivatives	76
4C. Reactions of Caesium Fluoroxysulphate	77
1. Model Compounds	78
2. Imidazole Derivatives	82
4D. Reactions of Elemental Fluorine	83
1. Model Compounds	83
2. Imidazole Derivatives	88
CHAPTER FIVE - PREPARATION OF FLUORINATED NUCLEOSIDES	90
Introduction	90
5A. Protection Reactions	90
5B. Deprotection Reactions	97
5C. Fluorination Reactions	108
1. By Displacement of Triflate Group	108
2. Other Fluorination Methods	111
5D. Miscellaneous	113
EXPERIMENTAL	117
INSTRUMENTATION	118

	<u>Page No.</u>
CHAPTER SIX - EXPERIMENTAL TO CHAPTER THREE	121
6.1 Preparation of Tetraphenyltin	121
6.2 Preparation of aryltrimethylstannanes	121
6.3 Preparation of 3-trimethylstannylpyridine	123
6.4 Preparation of tri-n-butylarylstannanes	123
6.5 Preparation of tricyclohexylarylstannanes	125
6.6 Preparation of 1,2-dimethyl-5-trimethylstannyl- imidazole	125
6.7 Preparation of 1,2-dimethyl-5-tri-n-butylstannyl- imidazole	127
6.8 Preparation of N-methyl-2-trimethylstannyl- imidazole	127
6.9 Preparation of Diphenyl Mercury	128
6.10 Preparation of Anisylmercury acetate	128
6.11 Preparation of 4-Acetomercury-1,2-dimethylimidazole	128
CHAPTER SEVEN - EXPERIMENTAL FOR CHAPTER FOUR	129
7.1 Reactions of $CF_3OF$	129
7.2 Reactions of Caesium Fluoroxysulphate	130
7.3 Reactions of Elemental Fluorine	133
CHAPTER EIGHT - EXPERIMENTAL TO CHAPTER FIVE	137
8.1 Preparation of 5-amino-1-( $\beta$ -D-2',3',5'-tri-O- benzoylribofuranosyl)imidazole-4-carboxamide (96)	137
8.2 Preparation of 5-benzoylamino-1-( $\beta$ -D-2',3',5'-tri-O- benzoylribofuranosyl)-4-cyanoimidazole (97)	137
8.3 Preparation of 5-(benzoylamino)-1-( $\beta$ -D-2',3',5'-tri- O-benzoylribofuranosyl)imidazole-4-carboxamide (95)	138
8.4 Preparation of 5-(triphenylmethyl)amino-1-( $\beta$ -D-2',- 3',5'-tri-O-benzoylribofuranosyl)imidazole-4- carboxamide (98)	139
8.5 Deprotection of Tribenzoate (96)	139
8.6 Deprotection of nitrile derivative (97)	140

	<u>Page No.</u>
8.7 N-Tritylation of a mixture of dibenzoates (99) and (100)	141
8.8 Deprotection of tetrabenzoate (95)	142
8.9 Attempted Preparation of Fluorinated Derivatives of Dibenzoates (99) and (100)	142
8.10 Attempted Triflation of (99) and (100)	143
8.11 Triflation of dibenzoates (99) and (100) to give (110) and (111)	144
8.12 Attempted Synthesis of a Fluoroderivative of (99) and (100) by displacement of a triflate group using TAS-F	144
8.13 Reaction of a mixture of (99) and (100) with DAST	145
8.14 Reaction of a mixture of (99) and (100) with Sulphurtetrafluoride	145
8.15 Reaction of Tribenzoate (96) with Perfluorocyclopentene	146
8.16 Reaction of Tribenzoate (96) with Hexafluoropropene	146
APPENDICES	148
APPENDIX ONE - INFRARED SPECTRA	149
APPENDIX TWO - MASS SPECTRA	158
APPENDIX THREE - PROTON N.M.R. SPECTRA	179
APPENDIX FOUR - CARBON-13 N.M.R. SPECTRA	194
APPENDIX FIVE - RESEARCH COLLOQUIA, SEMINARS, LECTURES AND CONFERENCES	203
REFERENCES	212

INTRODUCTION



## CHAPTER ONE

MODERN METHODS FOR SELECTIVE FLUORINATION  
OF AROMATIC COMPOUNDSINTRODUCTION

Methods for the preparation of polyfluorinated aromatic compounds are well documented,<sup>1,2</sup> in contrast methods for selective fluorination are poorly developed and investigation of such methods is a considerable challenge to organic chemistry. Selective fluorination, refers to the introduction of a single fluorine at a known site in an organic molecule. Replacement of hydrogen by fluorine can impart biological activity to a molecule<sup>3</sup> and it is therefore of interest to the pharmaceutical industry. The four main reasons behind introduction of fluorine into pharmaceutical compounds are:<sup>3</sup>

(i) the steric requirements of fluorine are very similar to those of hydrogen at enzyme receptor sites.

(ii) Fluorine is far more electronegative than hydrogen and so alters the electronic character and reactions of the compound.

(iii) The carbon-fluorine bond is stronger than the carbon-hydrogen bond and results in the fluorinated molecule having higher thermal and oxidative stability.

(iv) Lipid solubility of a compound is increased by replacement of hydrogen by fluorine.

In this chapter the preparation and reactions of reagents used for the selective fluorination of aromatic and hetero-aromatic compounds will be discussed. Most of these reagents belong to a class of compounds which can be described as

'electrophilic' fluorinating agents and have only been developed over the last few years. Previously, the most frequently used route to mono-fluorinated aromatics was the Balz-Schiemann reaction. This is still the most widely used method for selective fluorination of aromatics and has been extensively reviewed,<sup>4,5</sup> therefore only a brief description of the basic reaction methods is given here. The rest of the chapter deals with electrophilic fluorinating agents. The advantages of these reagents are becoming more apparent, especially in the fluorination of complex, naturally occurring molecules and in cases where  $^{18}\text{F}$ -labelled fluorine is to be introduced into a molecule for use in position emission spectroscopic studies.

#### 1A. The Balz-Schiemann Reaction

Since it was first reported in 1927 the Balz-Schiemann reaction<sup>6</sup> (B-S) has become the most widely used method for selective fluorination of aromatic compounds. Several reviews have been written<sup>4,5,7</sup> and many modifications made to the original reaction.

The classical B-S reaction is carried out in two steps. The first step is the preparation of a diazonium tetrafluoroborate and the second step is the controlled, thermal decomposition of this salt to give an aryl fluoride, boron trifluoride and nitrogen (Figure 1).

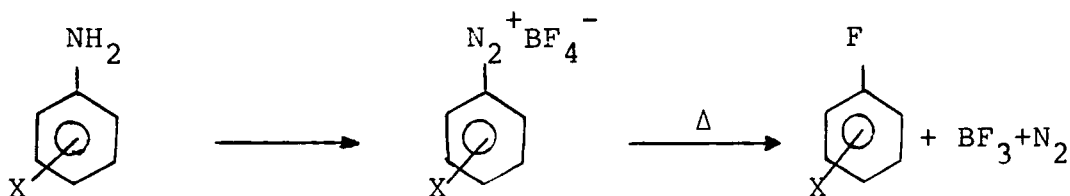

FIGURE 1.

This reaction benefits from the high stability of aromatic diazonium tetrafluoroborates; they can often be isolated and stored, when dry, for almost indefinite periods.

There are two general procedures used in the preparation of diazonium tetrafluoroborates:

- (a) The diazotisation of the amine in hydrochloric acid, followed by addition of tetrafluoroborate ion to precipitate the diazonium tetrafluoroborate salt.
- (b) The diazotisation of the amine in the presence of fluoroborate ion causing a gradual precipitation of the diazonium tetrafluoroborate as the reaction progresses.

Tables (I) and (II) give examples of reagents used for methods (a) and (b) respectively.

TABLE I

<u>Diazotising Agent</u>	<u>BF<sub>4</sub><sup>-</sup> Source</u>
HNO <sub>2</sub>	HF <sub>4</sub>
HNO <sub>2</sub>	NaBF <sub>4</sub>
HNO <sub>2</sub>	NH <sub>4</sub> BF <sub>4</sub>
Amylnitrate	HF <sub>4</sub>
Nitrosylsulphuric Acid	HF <sub>4</sub>
HNO <sub>2</sub> + HF	BF <sub>3</sub>

TABLE II

Source of Fluoroborate Ion

HF<sub>4</sub>  
 NaBF<sub>4</sub>  
 NH<sub>4</sub>BF<sub>4</sub>  
 Nitrosylfluoroborate

Various modifications have been made<sup>8,9,10,11</sup> to both methods of preparation, mainly in an attempt to increase the yield by lowering the aqueous solubility of the aryl diazonium tetrafluoroborate salt.

Thermal decomposition of diazonium tetrafluoroborates can also be achieved by two methods; either dry decomposition or solvent decomposition. The former process simply involves heating the diazonium tetrafluoroborate, often mixed with an inert solid such as sand,<sup>12</sup> or barium sulphate,<sup>13</sup> until its decomposition temperature is reached. Most diazonium tetrafluoroborates decompose smoothly between 100°C and 200°C. Nitro aryl-derivatives, however, are a notable exception,<sup>14</sup> with violent reactions often occurring to give very poor yields of fluoronitroaromatic derivatives. Passing a stream of nitrogen through the reaction vessel, during decomposition, helps to remove BF<sub>3</sub> as it is formed; this considerably reduces undesirable condensation reactions between the aryl fluorides and BF<sub>3</sub>.







Solvent decomposition, as the name suggests, involves heating the diazonium tetrafluoroborate to its decomposition temperature in an inert solvent. A wide variety of solvents have been used, *e.g.* petroleum ether<sup>15</sup> for the more unstable salts and quinoline<sup>16</sup> or nitrobenzene<sup>16</sup> if higher temperatures are needed. Although higher yields can sometimes be obtained by this method, it is not as widespread as the dry decomposition method. For example, p-fluoronitrobenzene is obtained in 81% yield by solvent decomposition compared with only 40-50% using the dry decomposition method and, solvent decomposition of 2-nitrobenzyl diazonium tetrafluoroborate in HMPA gives the fluoro-derivative in 70% yield compared with 10-20% by the dry method.

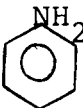

Sodium fluoride is normally added, with the solvent, to remove  $\text{BF}_3$  as it is formed, again to prevent coupling reactions. Addition of copper powder or copper(I) chloride is reported<sup>17</sup> to aid decomposition of diazonium salts in acetone or water.

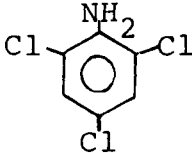
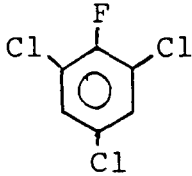
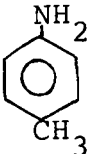
The diazonium tetrafluoroborate derivatives of some compounds are too unstable to be isolated, therefore the solvent decomposition method has to be used with the reaction medium acting as solvent. For example,<sup>18</sup> 2-pyridine diazonium tetrafluoroborate decomposes to 2-fluoropyridine as it is formed, 3-pyridine diazonium tetrafluoroborate is stable up to  $10^\circ\text{C}$  above which it decomposes to 3-fluoropyridine. The instability of the pyridine diazonium tetrafluoroborates is probably due to the electron withdrawing nature of the pyridine ring nitrogen which will be protonated in the acidic medium used to effect diazotisation. In general electron withdrawing groups destabilise diazonium salts. Table (III) gives examples of benzenoid and heterocyclic aromatic compounds fluorinated using the Balz-Schiemann reaction.

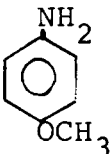
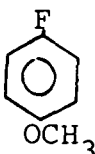
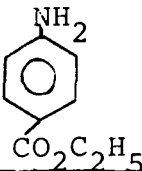
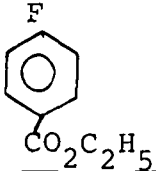
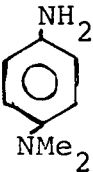
TABLE III

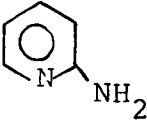
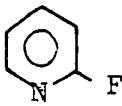
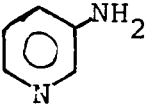
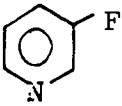
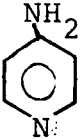
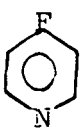
Aromatic Amine	Yield of Diazonium Tetrafluoroborate (%)	Fluoroaromatic	Yield <sup>a</sup> (%)
	58-97		51-100
	75		80
	67-90		97
	85		67
	75		90
	56-61		17
	Not isolated		34
	Not isolated		50
	Not isolated		0

a. Yield from diazonium tetrafluoroborate.

## 1B. Organic Hypofluorites

This class of compounds comprises two main groups; these are perfluoroalkyl hypofluorites, for example trifluoromethyl hypofluorite ( $\text{CF}_3\text{OF}$ ), and acyl hypofluorites, for example acetyl hypofluorite ( $\text{CH}_3\text{COOF}$ ). The active part of the molecule for fluorinations, in both cases, is the O-F group. These compounds, therefore, behave as 'electrophilic' fluorinating agents. The prerequisites for an 'electrophilic' fluorinating agent<sup>19</sup> are:

(i) Fluorine must be bonded to a good leaving group which is highly electronegative.

(ii) The leaving group must not have any unoccupied, low lying d orbitals as these can cause nucleophilic attack to occur on the leaving group rather than on fluorine.

Trifluoromethyl hypofluorite and acetyl hypofluorite both fill these conditions, indeed the trifluoromethoxy group is almost as electronegative as fluorine and the acetate group, the leaving group from electrophilic fluorination by  $\text{CH}_3\text{CO}_2\text{F}$ , makes an excellent leaving group.

The concept of 'electrophilic' fluorination is still under contention.<sup>20,21</sup> Although an electrophilic substitution mechanism explains the reactions of these reagents with aromatic compounds, the fluorination process can be regarded as taking place *via* nucleophilic attack, by an electron rich compound, on fluorine and the ejection of a good leaving group in a concerted manner (Figure 2). Under such conditions a deficiency of electrons need never develop about the fluorine atom.

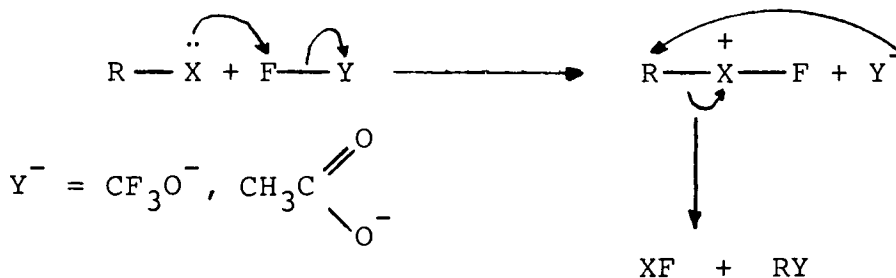

FIGURE 2

---

### 1B.1 Preparation of Reagents

Trifluoromethylhypofluorite (b.p.  $-97^{\circ}\text{C}$ ) was prepared by Cady and co-workers in 1948.<sup>22</sup> Their original method involved reaction of methanol vapour with fluorine using copper coated with silver fluoride as a catalyst. The equipment used in this reaction was complex and a far simpler method is to fluorinate carbon monoxide<sup>23</sup> using silver difluoride<sup>24</sup> as catalyst. Attempts have also been made to fluorinate carbonyl fluoride, using caesium fluoride as catalyst. This reaction, however, results in a poor yield of  $\text{CF}_3\text{OF}$  even when heated strongly. Longer chain fluoroxy compounds, *e.g.*  $\text{CF}_3\text{CF}_2\text{OF}$  and  $\text{CF}_3\text{CF}_2\text{CF}_2\text{OF}$ , can also be prepared. Methods used for preparing  $\text{CF}_3\text{OF}$ , however, give poor yields. Prager and Thomson<sup>25</sup> have reported that a series of long chain fluoroxy compounds can be synthesized by direct fluorination of a variety of oxygen containing compounds. Reaction of highly fluorinated alcohols and ketones with elemental fluorine results in excellent yields of fluoroxy compounds. For example 2-fluoroxyperfluoro-2-methylpropane is formed in high yield from perfluoro-*t*-butyl alcohol however, 1-fluoroxy-2-nitroperfluoroethane is formed in only 5% yield from 1,1,1-trifluoro-3-nitro-2-propanol. In general the greater the amount of fluorine in the starting material the higher the yield of 'hypofluorite'. Another successful method

for the preparation of long chain fluoroxy compounds is to bubble fluorine through a solution or suspension of sodium trifluoroacetate.<sup>26</sup> A mixture of fluoroxy compounds is formed, the major component of which is fluoroxy-pentafluoroethane (Figure 3). Reacting a solution of trifluoroacetic acid, rather than its sodium salt, results in trifluoroacetyl hypofluorite as the major product by direct replacement of hydrogen by fluorine (Figure 4).

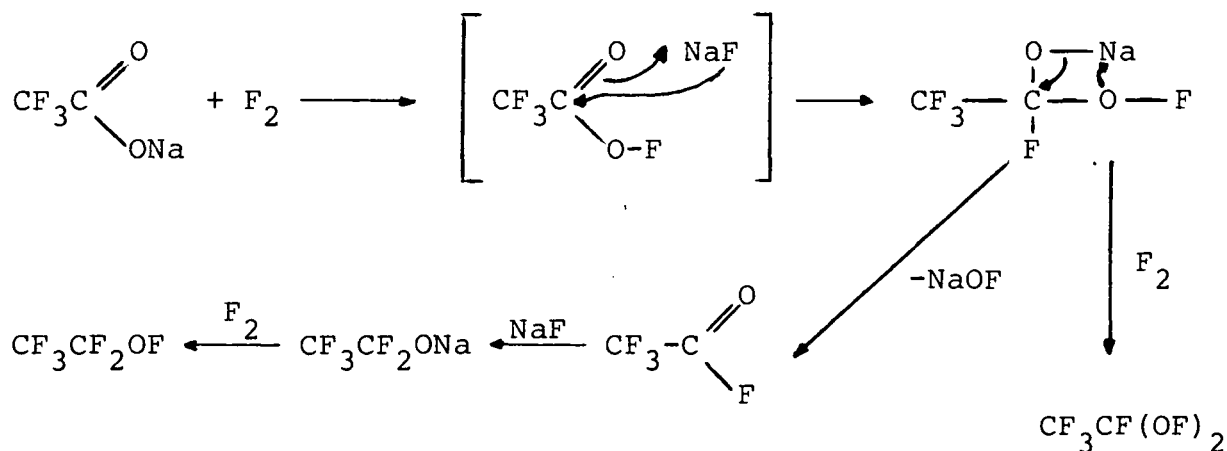

FIGURE 3

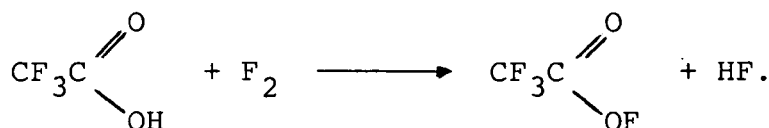
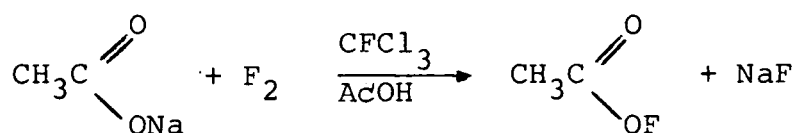

FIGURE 4

Acyl hypofluorites are generally prepared by the reaction of fluorine with suspensions of sodium carboxylates in  $\text{CFCl}_3$ . Thus treatment of sodium acetate with fluorine at  $-78^\circ\text{C}$  produces a strongly oxidising solution.<sup>27</sup> Fluorine is insoluble in the solvent used and does not react with it at  $-78^\circ\text{C}$ , therefore the oxidising agent must be formed by reaction with sodium acetate:



Acetyl hypofluorite, formed by the above reaction, can be used in solution;<sup>28</sup> the concentration of fluorinating agent is determined by iodometric titration.

Recent modifications, to this method, have made the isolation of  $\text{CH}_3\text{CO}_2\text{F}$  possible.<sup>29,30</sup> A 1% mixture of fluorine in nitrogen was passed through a column of  $\text{KOAc}(\text{HOAc})_2$  at  $-70^\circ\text{C}$ , acetyl hypofluorite thus formed was then reacted with a solution of tri-O-acetyl-D-glucal to determine its yield and quality. By this gas-solid method  $\text{CH}_3\text{CO}_2\text{F}$  can be synthesized in 70% yield and because it is not formed in solution it can be used to fluorinate solutions of polar substrates in water.<sup>30</sup>

## 1B.2 Reaction with Aromatic Compounds

### (a) Activated Compounds

In general, aromatic compounds substituted with electron donating groups react smoothly with hypofluorites to give the expected monofluorinated derivatives. Further fluorination can occur to give addition and difluorinated products; for example, 2-naphthol reacts with  $\text{CF}_3\text{OF}$  to give 1-fluoro-2-naphthol and a small amount of 1,1-difluoro-2-naphthalone.<sup>19</sup> If an excess of  $\text{CF}_3\text{OF}$  is used, in this reaction, then difluoro-2-naphthalone becomes the major product and further fluorin-

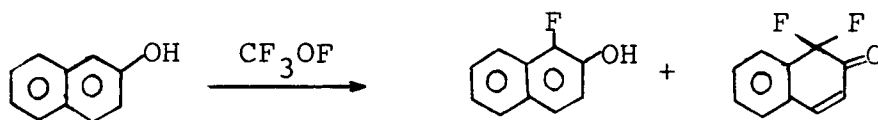

ation results in a complex mixture of products.<sup>31</sup> Salicylic acid gives 5-fluorosalicylic acid<sup>32</sup> in 70% yield when treated with  $\text{CF}_3\text{OF}$  in chloroform at  $0^\circ\text{C}$ ; the 3-fluoroisomer is also formed. Salicylamide undergoes a similar reaction to give its

5-fluoro derivative. The ease with which these fluorinated

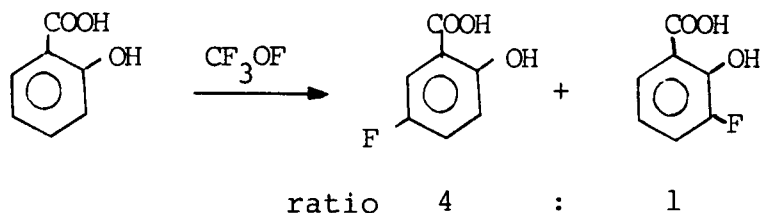

derivates are synthesized, using  $\text{CF}_3\text{OF}$  is striking by comparison with more complex, indirect routes.<sup>33</sup> Difficulties arise, however, when attempting to fluorinate amino substituted aromatic compounds. 2-Naphthylamine reacts with  $\text{CF}_3\text{OF}$  to give 1-fluoro-2-naphthylamine in only 9% yield and 1,1-difluoro-2-naphthalone in 19% yield. Reaction of N-acetyl-2-naphthylamine, however, results in an increase in yield of both the mono- and di-fluorinated products. The low yields of fluorinated products from treatment of amines with  $\text{CF}_3\text{OF}$  is probably due to oxidation of the amine competing with ring fluorination. The oxidation reactions are suppressed by N-acetylation.

Fluorination of aromatics by  $\text{CF}_3\text{OF}$  will tolerate a wide variety of functional groups within a molecule. This is clearly shown by the reaction of griseofulvin(1),<sup>34</sup> an antifungal antibiotic, with  $\text{CF}_3\text{OF}$ :

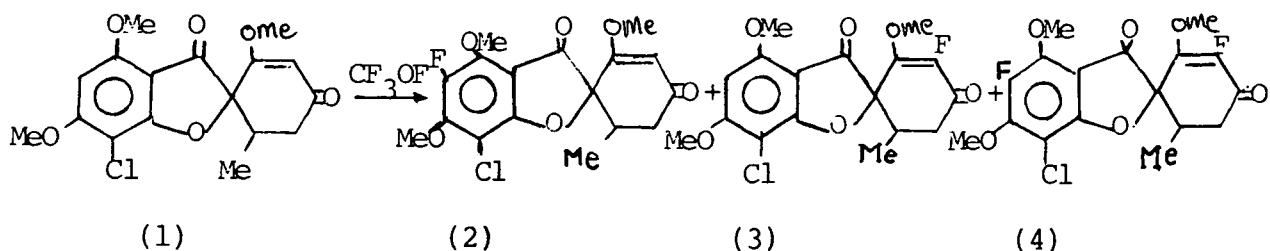

The major product is 5-fluorogriseofulvin(2) with smaller quantities of 3'-fluoro-(3) and 3',5-difluorogriseofulvin (4) being formed. Fluorination does not occur at any other sites in the molecule.

Electrophilic fluorination of activated aromatic compounds can also be effected by long chain fluoroxy reagents.<sup>35</sup> A 3:1 mixture of *ortho*- and *para*-fluoroanisole is produced on treating a solution of anisole, in  $\text{CFCl}_3$  at  $-78^\circ\text{C}$ , with a mixture of fluoroxyperfluoroalkanes. The chemistry of these longer chain fluoroxy reagents has yet to be developed. Bis-(fluoroxy)difluoromethane,  $\text{CF}_2(\text{OF})_2$ , is finding increasing usage as a fluorinating agent.<sup>36</sup> It reacts in a similar way to  $\text{CF}_3\text{OF}$  but has the advantage of having two fluoroxy groups, thus making it a more efficient "carrier" of fluorine.

Activated aromatic rings are also readily fluorinated by acetyl hypofluorite. Two methods have been employed; the first involves addition of a solution of the aromatic compound to a cold solution of acetyl hypofluorite, the second involves transferring acetyl hypofluorite in a stream of cold nitrogen into a cold solution of the aromatic substrate in  $\text{CFCl}_3$ . The latter method is more useful when very reactive aromatic substrates are present.<sup>37</sup>  $\text{CH}_3\text{CO}_2\text{F}$  is a milder fluorinating agent than  $\text{CF}_3\text{OF}$ , therefore its reactions with aromatic compounds tend to be slower and more selective. Anisole reacts at  $-75^\circ\text{C}$  to give a mixture of *ortho*- and *para*-fluoroanisole, 9:1 respectively, in an overall yield of 85%. In some cases the *ortho*-product is formed exclusively and the ratio of *ortho*- to *para*-substituted products is often high and is always higher than for corresponding reactions of  $\text{CF}_3\text{OF}$ .<sup>28</sup> This suggests that the mechanism is not a straightforward electrophilic substitution. It has been suggested that ipso attack occurs, followed by rearrangement of the fluorine substituent to the *ortho*- or *para*-position (Figure 5).<sup>38</sup> Fluorine, however, does not migrate easily therefore this mechanism is unlikely.



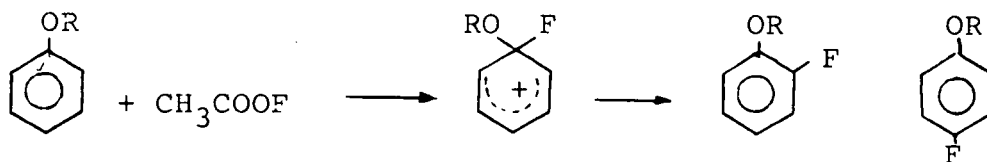

FIGURE 5

A more plausible explanation is that the mechanism involves an addition-elimination process (Figure 6).<sup>28</sup> Such reactions, though uncommon for aromatic rings, do have precedents<sup>39,40,41</sup>

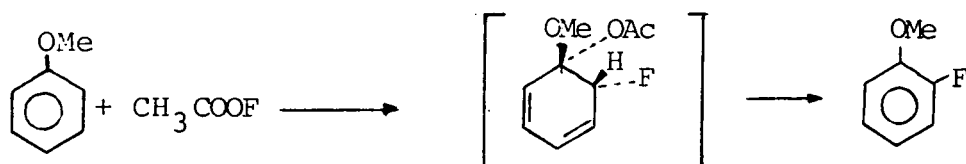
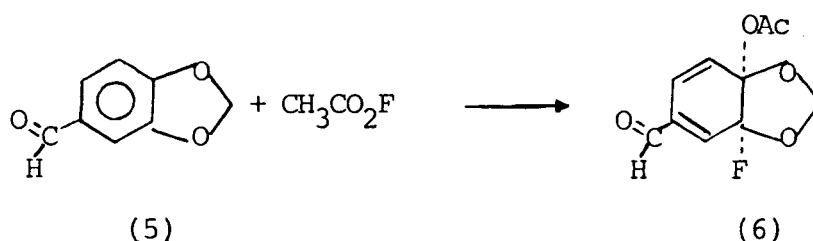

FIGURE 6

and 1,2-additions to aryloxygen compounds can occur.<sup>42</sup> Reaction of  $\text{CH}_3\text{COOF}$  with piperonal (5),<sup>28</sup> where elimination of  $\text{AcOH}$  is not possible, resulted in the formation of adduct (6) in 55% yield. This clearly indicates that an addition-elimination reaction is occurring, the overall effect of which



can be seen as electrophilic substitution. This mechanism contrasts with that for  $\text{CF}_3\text{OF}$  which is believed to proceed *via* a normal electrophilic substitution pathway.<sup>19</sup> It has been suggested, however, that in certain circumstances  $\text{CF}_3\text{OF}$  does react *via* an addition-elimination process; for example re-

action of  $\text{CF}_3\text{OF}$  with 4-acetoxypyrene. The exact mechanism for  $\text{CF}_3\text{OF}$  fluorination is not known, but it appears to be more complex than simple electrophilic substitution and may involve free radical reactions.

(b) Unactivated Aromatic Compounds

Reactions of fluoroxy compounds with benzenoid aromatics substituted with electron withdrawing groups are more complex than those with activated aromatics. Deactivated aromatics tend to react very slowly with  $\text{CF}_3\text{OF}$  and often require reaction conditions which cause free radical reactions to occur, resulting in addition products rather than substitution. Benzene<sup>43</sup> and naphthalene react to give complex mixtures of products. The major products from reaction of naphthalene with  $\text{CF}_3\text{OF}$  are tetralin derivatives. N-Acetyl-1-naphthylamine, when treated with  $\text{CF}_3\text{OF}$  in the presence of ethanol, gives the tetralin derivative (7) as major product:

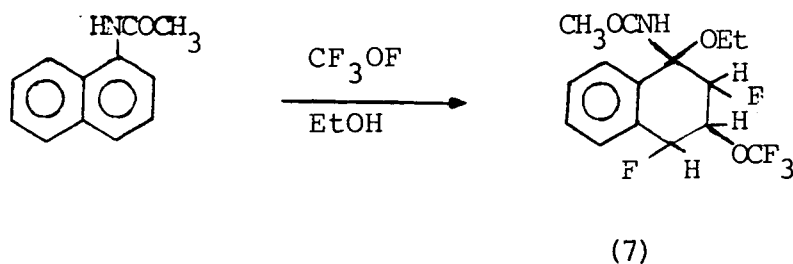

Even though reaction of most unactivated aromatics with  $\text{CF}_3\text{OF}$  leads to the formation of complex mixtures, some of these reactions can be synthetically useful. Reaction of the estrone derivative (8) with  $\text{CF}_3\text{OF}$  affords the dieonone (9) in high



yield<sup>44</sup> along with small amounts of fluorophenol derivatives. Formation of non-aromatic products is quite common when fluorine is introduced geminal to a weakly electron withdrawing group (ipso attack); for example, 2,6-dimethylphenol reacts with  $\text{CF}_3\text{OF}$  smoothly to give the dimer (10) of 6-fluoro-2,6-dimethylcyclohexadienone as the major product.<sup>19</sup> Acetylhypofluorite is a

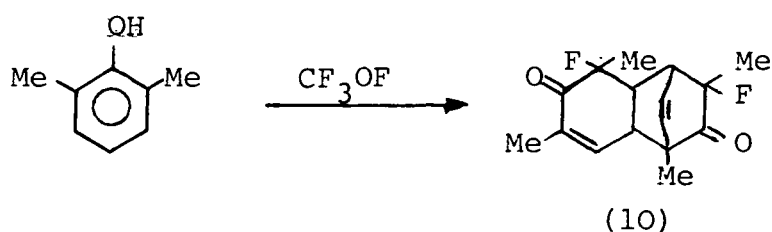

milder fluorinating agent than  $\text{CF}_3\text{OF}$  and reacts with unactivated aromatic compounds to give complex mixtures with very low yields of mono-fluorinated aromatics.<sup>28</sup>

### 1B.3 Reaction with Heterocyclic Compounds

Trifluoromethylhypofluorite reacts smoothly with suitably activated heterocyclic compounds to afford fluorinated products, however the tendency for addition reactions, rather than substitution reactions, to occur is greater than for benzenoid aromatics. This effect is consistent with the reactions of heterocyclic compounds with conventional electrophiles. Benzo-furan (11) reacts with  $\text{CF}_3\text{OF}$  giving two products by addition of the reagent across the furan double bond in a *cis*- and *trans*-manner, *viz* compounds (12) and (13) respectively, and a difluorinated product (14):

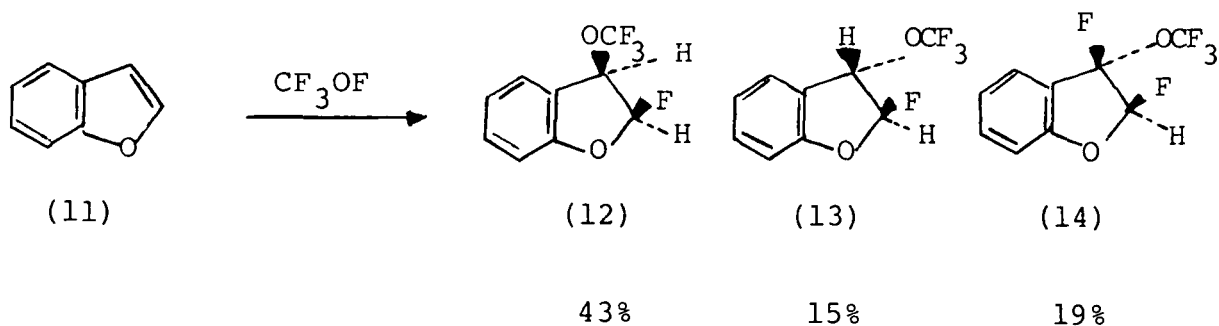

Indole reacts, as do most arylamines, to give a complex mixture of products, however N-acetyl-indole reacts to give products (15)-(17)<sup>19</sup> analogous to (12)-(14):

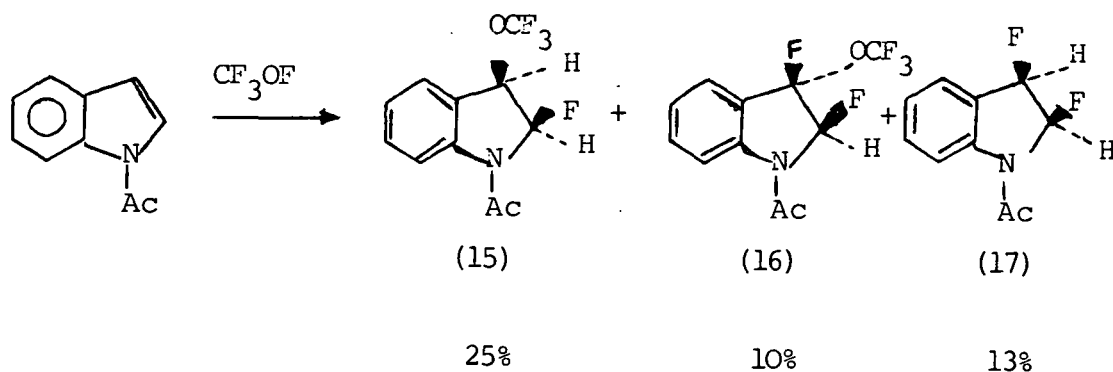

*Cis*-addition of  $\text{CF}_3\text{OF}$  predominates, as shown by the above examples. This is consistent with addition reactions of the reagent to alkenes<sup>45</sup> and the reaction of benzofuran and N-acetylated indole derivatives with conventional electrophiles.<sup>46,47</sup>

$\text{CF}_3\text{OF}$  reacts with small ring heterocycles to effect ring opening. N-Substituted aziridines<sup>48</sup> react *via* 1,3-addition of  $\text{CF}_3\text{OF}$ , with fluorine bonded to nitrogen and the trifluoromethoxy group bonded to carbon, and ring opening:

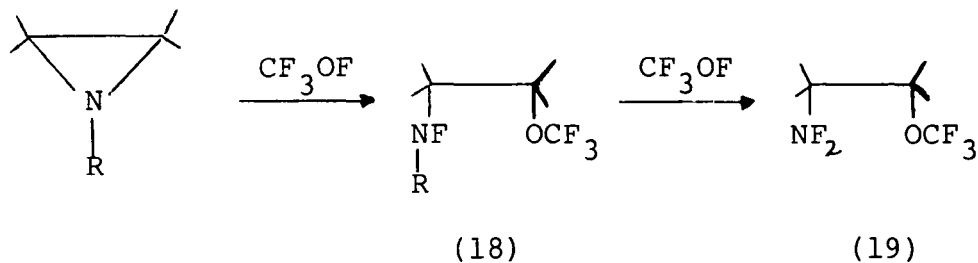

The nature of the group R determines how far the reaction proceeds. When R is benzenesulphonyl or chlorine the reaction stops at compound (18), if R is 4-nitrobenzyl- an extra molecule of  $\text{CF}_3\text{OF}$  reacts with (18) to give the difluoroamine product (19).

Trifluoromethylhypofluorite and acetylhypofluorite can also be used to introduce fluorine into uracil derivatives, carbohydrates, nucleosides and other compounds of biological interest. These reactions will be discussed in Chapter Two.

### 1C Inorganic Hypofluorites

The first inorganic hypofluorites to be synthesized were caesium and rubidium fluoroxysulphates. As with the organic hypofluorites, discussed in Section 1B, the fluoroxysulphate anion (20) contains an O-F group, which is the active fluorinating moiety, and thus (20) fulfils all the conditions required for an electrophilic fluorinating agent. These re-

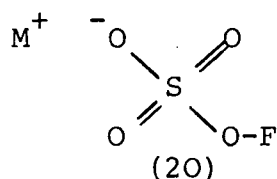

M = Cs or Rb.

agents are milder fluorinating agents than the organic hypofluorites and are easier to manipulate as they are solids. The most commonly used of the two inorganic reagents is caesium fluoroxysulphate ( $\text{CsSO}_4\text{F}$ ).

#### 1C.1 Preparation and Properties

Caesium fluoroxysulphate was first characterised in 1979 by Appelman and co-workers,<sup>49</sup> although similar compounds had been prepared as early as 1926<sup>50</sup> by passing fluorine through metal sulphate or metal hydrogen sulphate solution. The

identity of the oxidising species thus formed was not determined until Appelmann isolated its caesium and rubidium salts by passing fluorine through an aqueous solution of caesium or rubidium sulphate (Figure 7).  $\text{CsSO}_4\text{F}$  was isolated in 50%

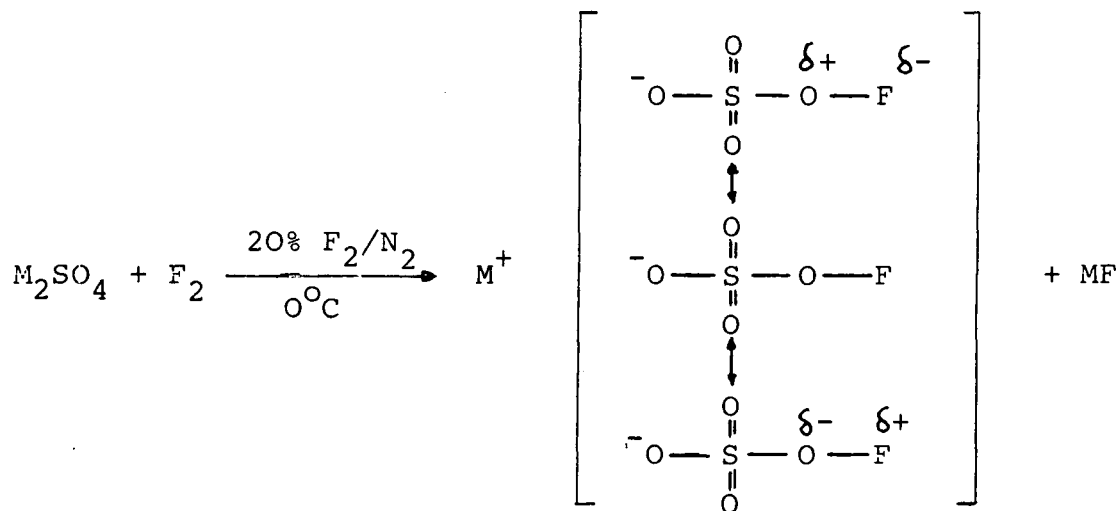

FIGURE 7

yield, although this has since been increased to 74%.<sup>51</sup> The yield appears to be limited by the instability of the fluoroxysulphate anion in aqueous media.

The infrared spectra of both caesium and rubidium fluoroxysulphate (Figure 8)<sup>49</sup> are consistent with the isoelectronic

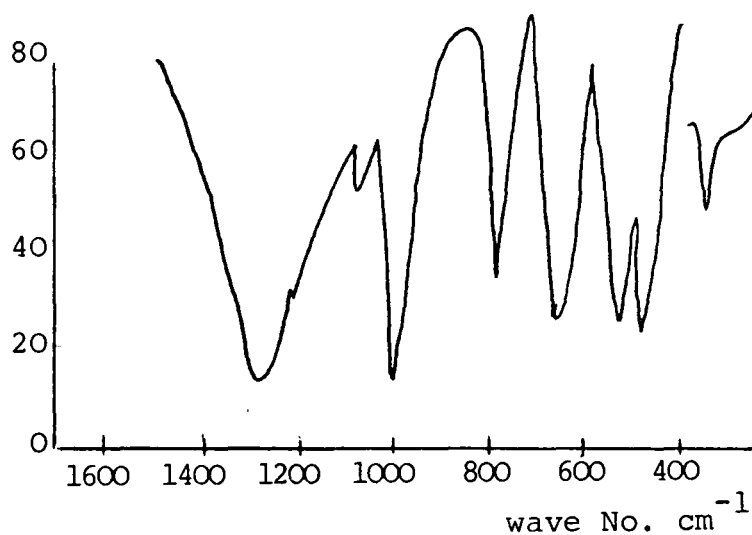

FIGURE 8

species  $\text{ClO}_4\text{F}$ ,<sup>52</sup> suggesting the formulation  $\text{O}_3\text{SOF}^-$  for the anion with the band at  $830\text{ cm}^{-1}$  assigned as the O-F stretching frequency. The  $^{19}\text{F}$  n.m.r. spectrum of  $\text{CsSO}_4\text{F}$  has a single resonance at  $-132.3$  p.p.m., which compares with the resonance at  $-147$  p.p.m.<sup>25</sup> for the O-F fluorine in  $\text{CF}_3\text{OF}$  and contrasts with a resonance at  $-37.5$  p.p.m. for the fluorine in  $\text{KO}_3\text{S-F}$ . This is decisive evidence that fluorine is bonded to oxygen rather than sulphur in the  $\text{SO}_4\text{F}^-$  anion.

$\text{CsSO}_4\text{F}$  is fairly stable when dry with a loss of only 3 to 5% in the oxidising strength occurring over a month. It is also a strong oxidising agent;<sup>49</sup> chlorides, bromides and iodides are all oxidised to the free halogen and transition metals to their highest oxidation state.<sup>49</sup> In most organic solvents  $\text{CsSO}_4\text{F}$  is insoluble, acetonitrile and nitromethane being the only solvents in which it is reasonably soluble.

### 1C.2 Reaction with Aromatic Compounds

The reaction of  $\text{CsSO}_4\text{F}$  with aromatic compounds is the most widely studied area of its chemistry. Fluorinations are normally carried out at room temperature in acetonitrile, occasionally with  $\text{BF}_3$  as a catalyst. Reaction with benzene gives mono-fluorobenzene in low yield,<sup>53</sup> together with some ring opened products:

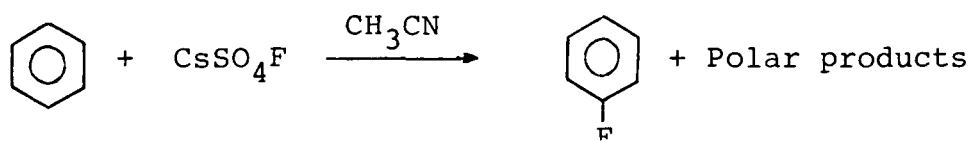

Benzenoid aromatics substituted with strong electron donating groups react to give higher yields of monofluorinated aromatics with fewer side products. The rate of reaction, as well as the yield, increases with increasing electron-donating strength

of the substituent on the aromatic ring. Tables (IV) and (V) clearly demonstrate this. There is a wide variation of reaction rates as expected for an electrophilic substitution reaction.

Fluorination occurs predominantly in the *ortho*- position, for activated molecules with some *para*- isomers also being formed. Unactivated or deactivated systems give approximately equal yields of *ortho*-, *meta*-, and *para*-fluorinated products. The very low reactivity of aromatic rings substituted with an electron withdrawing group is consistent with an electrophilic substitution reaction pathway.

Reactions of alkoxyaromatic compounds with  $\text{CsSO}_4\text{F}$ ,<sup>54</sup> using borontrifluoride as catalyst, give monofluorinated derivatives in 70 to 80% yield. Table (VI) shows the results obtained for various alkoxybenzenes. From the Table it is clear that the size of the group 'R' determines the product distribution; the bulkier the group the less *ortho*-fluorination takes place. This is probably a steric rather than an

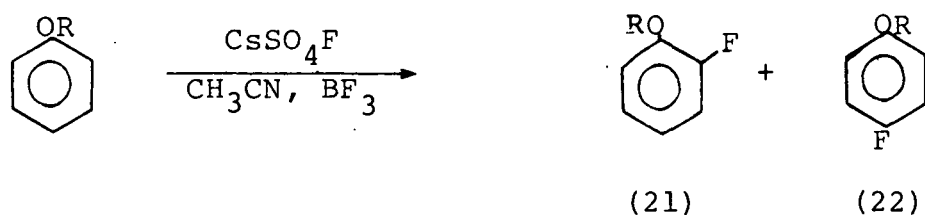

TABLE VI

Group 'R'	Ratio <sup>a</sup> (21):(22)
H	6.2:1
Me	2.8:1
<sup>n</sup> Bu	1.8:1
EtCHMe	1.2:1

a. Determined by  $^{19}\text{F}$  n.m.r.



TABLE IV. Yield of Fluorinated aromatics from  $\text{CsSO}_4\text{F}$  reaction

Aromatic Substrate	Stoichiometry (Substrate/ $\text{SO}_4\text{F}^-$ )	Yield of F-aromatics (% of $\text{SO}_4\text{F}^-$ )		
		<i>ortho</i> -	<i>meta</i> -	<i>para</i> -
Phenol	0.71	55	<0.15	4
Phenol	$\geq 0.92$	83	-	6
Anisole	0.67	39	<0.15	12
Anisole	$\geq 0.65$	50	<0.3	
Toluene	$\geq 0.73$	10	<0.3	
Biphenyl	0.35	10	0.3	5
Benzene	0.27	monofluorobenzene 12		
Fluorobenzene	0.14	4	<0.3	7
Benzonitrile	-	0.4	0.4	0.4
Nitrobenzene	-	0.6	0.9	0.2
Naphthalene	0.65	19	0.3	

TABLE V. Relative Rates of Aromatics to  $\text{CsSO}_4\text{F}$ 

Aromatic Substrate	Reactivity <sup>a</sup>
Phenol	740
Anisole	190
Toluene	41-90
Biphenyl	41-90
Benzene	1.00
Fluorobenzene	0.55
Methylbenzoate	0.17
Benzonitrile	0.07
Nitrobenzene	0.02

a. Relative to benzene.

electronic effect. A similar set of reactions was carried out on alkoxy substituted naphthalene derivatives (Table VII).<sup>55</sup> The size of the alkoxy group again determines the product distribution, increasing the size of the alkoxy group resulted

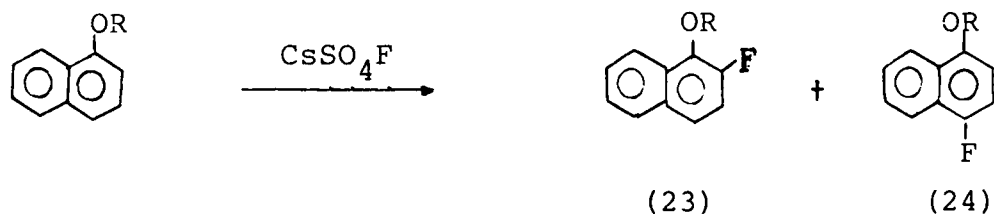
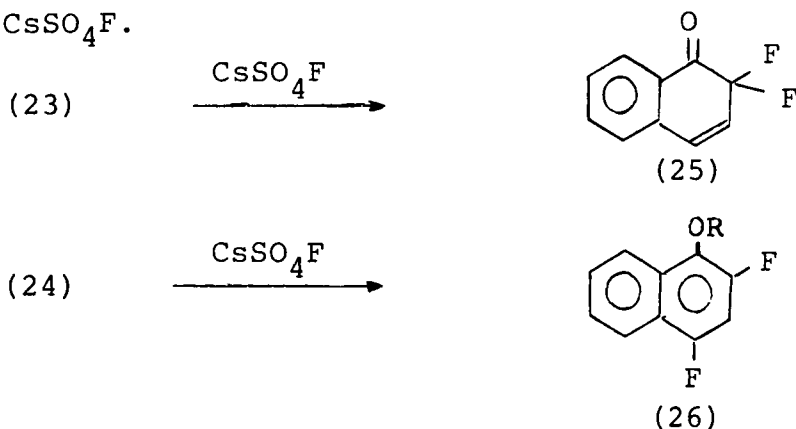

TABLE VII

Group 'R'	Ratio (23):(24)
H	8.1:1
Me	3.5:1
Et	3:1
Me <sub>3</sub> CH	1.85:1

in a decrease in the amount of *ortho*-fluorination. If the quantity of CsSO<sub>4</sub>F is increased then two difluorinated products are formed, (25) and (26), by reaction of CsSO<sub>4</sub>F with (23) and (24) respectively. Compounds (25) and (26) can also be synthesized by treating authentic samples of (23) and (24) with CsSO<sub>4</sub>F.



### 1C.3 Reaction with Heterocyclic Compounds

Few reactions have been documented between heterocyclic compounds and  $\text{CsSO}_4\text{F}$ . Stauber and Zupan<sup>56</sup> report that pyrimidine derivatives react in methanol to give high yields of fluorinated derivatives. Barbituric acid does not react at room temperature with  $\text{CsSO}_4\text{F}$ , heating in a sealed tube to  $100^\circ\text{C}$ , however, results in 5,5-difluorobarbituric acid being formed in 81% yield. 1,3-Dimethyl uracil reacts with  $\text{CsSO}_4\text{F}$  in acetonitrile to give a very low yield of 5-fluoro-6-hydroxy-1,3-dimethyl-5,6-dihydroxy uracil and 5-fluoro-1,3-dimethyluracil. In methanol, however, the reaction gives a mixture of *cis*- and *trans*-5-fluoro-6-methoxy-derivatives, (27) and (28). These can be converted into 1,3-dimethyl uracil (29) in high yield:

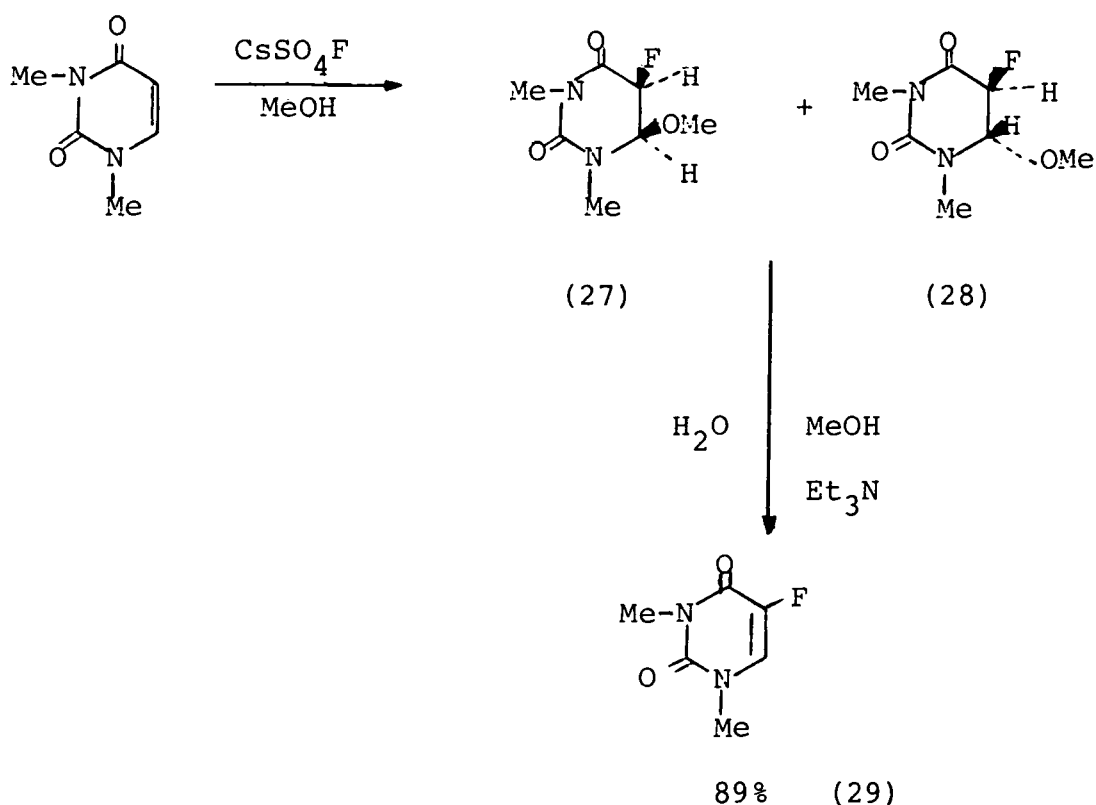

The reaction clearly goes *via* an addition-elimination pathway, with the methoxide group from the solvent adding to the inter-

mediate carbocation. As acetonitrile is not nucleophilic this

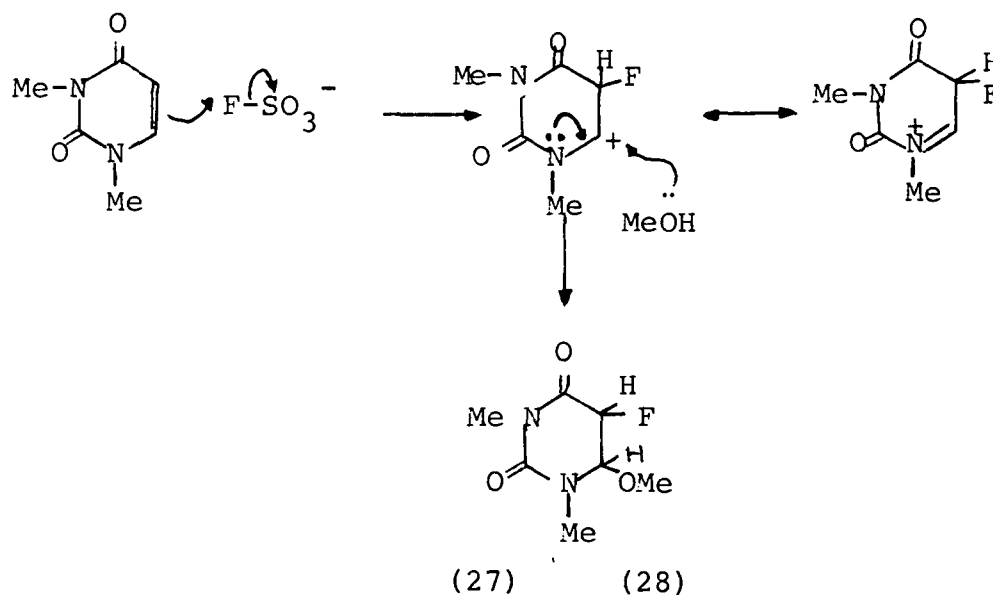

reaction cannot occur, and so an electrophilic substitution pathway will be followed. This results in the low yields observed for reactions of barbituric acid and uracil derivatives, in acetonitrile, as these compounds are not activated towards electrophilic attack.

#### 1C.4 Reaction Mechanism

With activated aromatic compounds CsSO<sub>4</sub>F reacts primarily *via* an electrophilic substitution mechanism. This is supported by the preponderance of *ortho*- and *para*- fluorinated products and the very small quantities of *meta*-fluorinated products when substituents on the aromatic ring are *ortho*- and *para*-directing, to electrophilic attack, and also by the increase in the yield of *meta*-fluorinated products for aromatic rings substituted with deactivating groups.

The formation of benzyl fluoride from toluene, the complex kinetics involved in the fluorination and the degradation of benzene during fluorination, however, suggest that free

radical reactions are also taking place (Figure 9).<sup>53</sup> The Hammett plot (Figure 10)<sup>53</sup> for the reaction of  $\text{CsSO}_4\text{F}^-$  with a variety of substituted benzene derivatives suggests that  $\text{SO}_4\text{F}^-$  reacts as an electrophile of relatively low selectivity; its

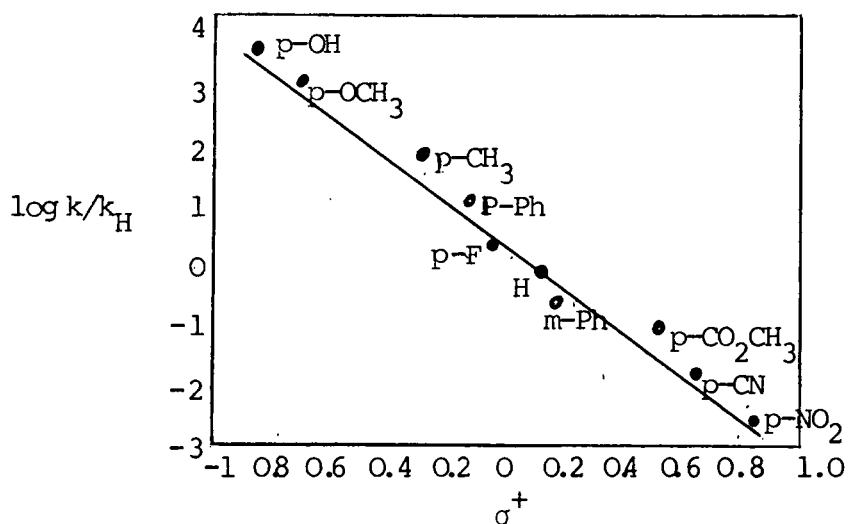

FIGURE 10

Correlation of  $\sigma^+$  with relative partial rate factors  $k/k_H$  for fluorination by  $\text{CsSO}_4\text{F}^-$ . Values of  $k/k_H$  are derived from data in Tables IV and V. Values of  $\sigma^+$  are from refs. 57 and 58.

selectivity, however, is higher than that for fluorine.

It is possible that the initial steps of the fluorination follow an electrophilic substitution pathway during which radical anions can form and in subsequent steps cause free radical reactions to occur. Free radical reactions occur especially with deactivated aromatic substrates for which the intermediate arenium cation (30) is unstable and loses a proton to give a radical. Toluene reacts *via* this mechanism, this is similar to its reaction with peroxydisulphate.<sup>59</sup>

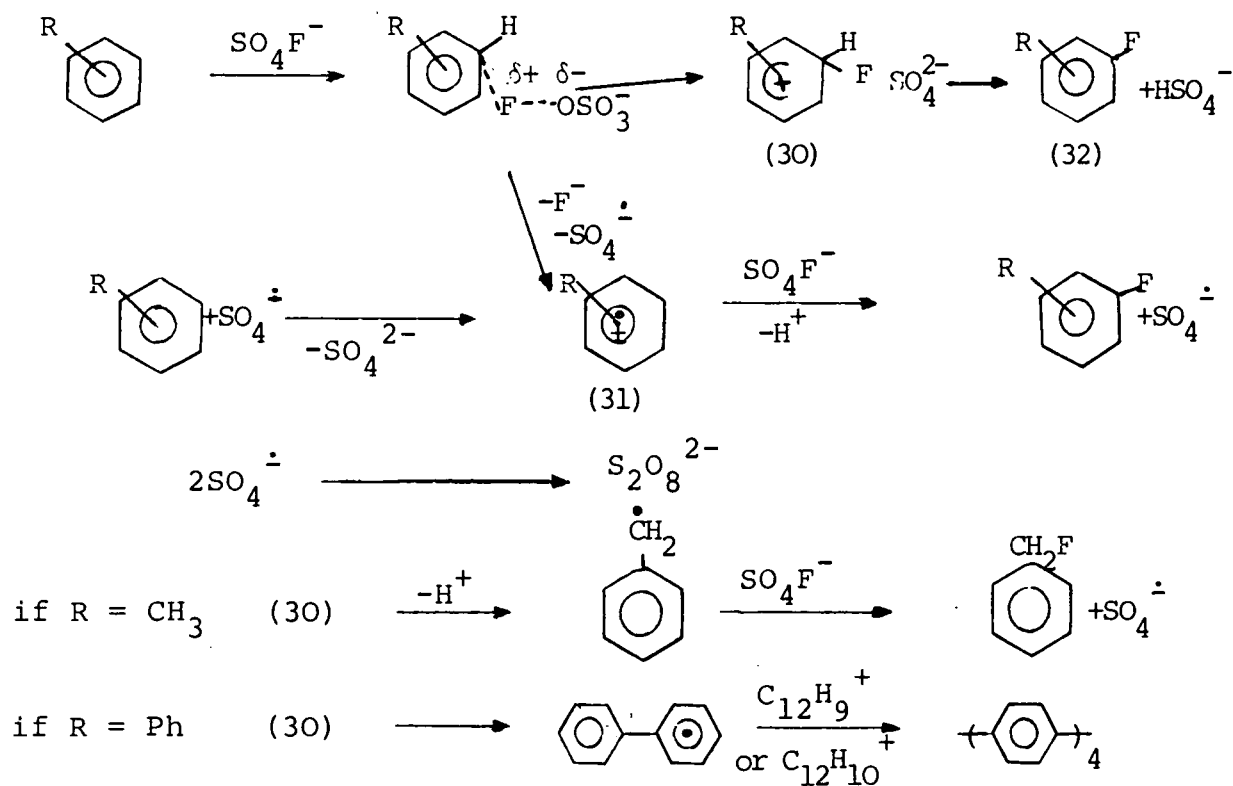

FIGURE 9

The reaction mechanism for fluorination using  $\text{CsSO}_4\text{F}$ , therefore, is complex and several reaction pathways can be followed in any one reaction. It is important to note, however, that  $\text{SO}_4\text{F}^-$  is unique in that it is an anionic electrophile and its ease of use make it an excellent reagent for fluorination of activated aromatic compounds.

#### 1D. Elemental Fluorine

Direct fluorination of organic compounds, using elemental fluorine, to afford monosubstituted products is not normally observed due to the high reactivity of the element. The earliest attempts were made by Moissan<sup>60</sup> who, like many workers after him, found that the reaction of fluorine with aromatic

compounds was uncontrollable; explosions occurred frequently and reaction products were often tars or complex mixtures. There have been few reports, because of these problems, on the preparation of mono-fluoroaromatics using elemental fluorine<sup>61,62</sup> despite theoretical interest<sup>63</sup> and considerable advances in experimental techniques.<sup>64</sup>

It is possible, however, even though there are problems associated with handling elemental fluorine, to selectively fluorinate aromatic molecules directly with fluorine under certain conditions. It is also possible to extend the approach to the fluorination of heterocyclic compounds and biologically active molecules.<sup>65</sup>

#### 1D.1 Reaction with Aromatic Compounds

The reaction of aromatic substrates with elemental fluorine is usually carried out using an inert solvent, such as  $\text{CFCl}_3$  or  $\text{CH}_3\text{CN}$ , at low temperatures, and using a high dilution of fluorine in nitrogen or helium. These conditions help to reduce the reactivity of fluorine and suppress free radical reactions which are the cause of many side reactions. Treatment of benzene in acetonitrile with fluorine at  $-35^\circ\text{C}$  produces a mixture of derivatives (Figure 11).<sup>61</sup> The major product is

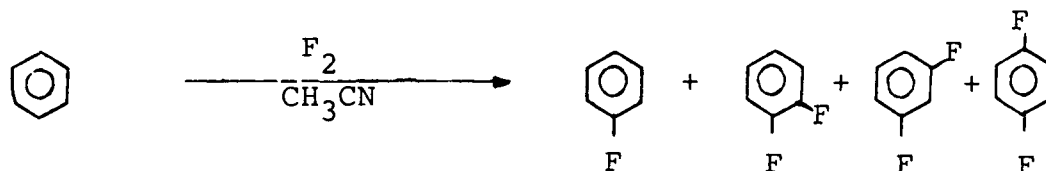
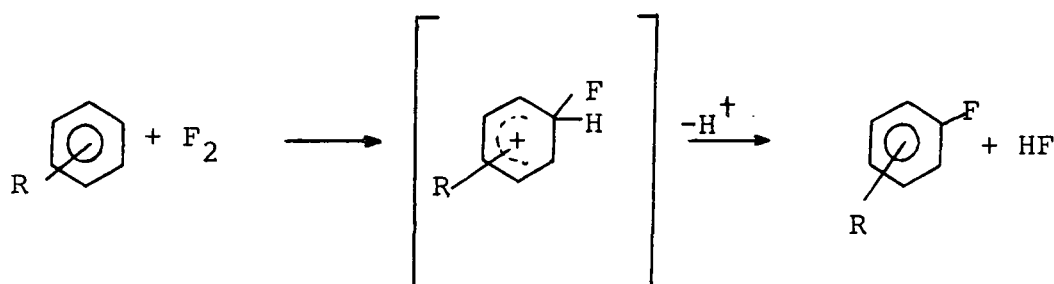

FIGURE 11

60 : 4 : 1 : 5

fluorobenzene, the three isomeric difluorobenzenes are also formed along with small amounts of tar. In this reaction a 0.7:1 molar ratio of fluorine:benzene is used, if the ratio is increased the amounts of polymeric materials formed increases and the yield of fluoro-aromatics decreases dramatically,

eventually the major products become perfluorinated polycyclohexenes. Thus polymerisation and addition reactions occur alongside the substitution reaction. The relative amounts of the three isomeric difluorobenzenes (o:m:p; 4:1:5) formed in this reaction suggest that the substitution proceeds *via* an electrophilic mechanism analogous to other halogenation reactions of aromatics.<sup>66,67</sup> This hypothesis is further supported by results obtained from the fluorination of toluene and nitrobenzene. *Ortho*-, *meta*- and *para*-fluorotoluene are formed in a ratio of 5:1:4 respectively from treatment of toluene at  $-70^{\circ}\text{C}$  with 0.7 molar equivalents of fluorine. Fluorination of nitrobenzene yields *ortho*-, *meta*- and *para*-fluoronitrobenzene in 1.5:9:1 ratio. These substitution patterns are those expected for an electrophilic fluorination:



The deactivating effect of electron withdrawing groups is shown by the sluggish reaction of 2,4-dinitrotoluene with fluorine; this can be compared with bromination of 2,4-dinitrotoluene which needs concentrated sulphuric acid and silver sulphate as catalyst to effect reaction.<sup>68</sup>









Further studies by Cacace and co-workers,<sup>69</sup> on the fluorination of substituted aromatic compounds, also gave results that corresponded to an ionic, electrophilic substitution reaction. Compounds substituted with electron donating groups gave almost exclusively *ortho*-, *para*-substitution and reacted faster than

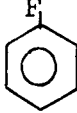
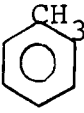
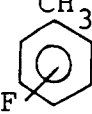
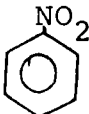
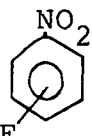

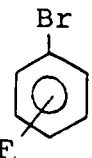
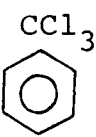
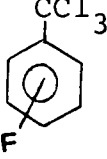
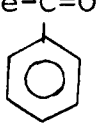
aromatic compounds substituted with electron withdrawing groups, which gave predominantly *meta*-substituted products. Side reactions were kept to a minimum by using a high dilution of fluorine in nitrogen and low percentage conversion of aromatic to fluoroaromatic. Examples of aromatic compounds which have been fluorinated by elemental fluorine are shown in Table (VIII). As with benzene, the aromatic substrate must be kept in excess and a high dilution of fluorine is maintained to avoid formation of polymeric perfluorocyclohexenes.

Monofluoroaromatics can also be prepared by the cleavage of aryl-metal bonds by elemental fluorine. These reactions will be discussed in a later chapter. The fluorination of uracil, uridine and other biologically active molecules will be discussed in Chapter Two. Clearly there is ample scope for development of fluorination of aromatics using elemental fluorine.

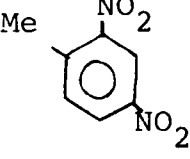
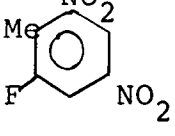
TABLE VIII

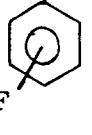
Aromatic Substrate	Ratio F <sub>2</sub> :Substrate	Product	Ratio o:m:p
	0.7 : 1		
	0.73 : 1		5 : 1 : 4
	1.5 : 1		1.5 : 9 : 1
	0.01 : 10		23 : 17 : 60
	1 : 1		1 : 2 : 1
	1 : 1		2 : 5 : 1
	0.6 : 1		3 : 1 : 9
	1 : 1		5% yield
	1 : 1		1 : 3 : 5

## 1E. Xenon Difluoride

Xenon difluoride was first prepared by Weeks and co-workers<sup>70</sup> in 1962 by a complicated, low pressure, u.v. irradiated reaction between xenon and fluorine. It can be prepared, however, simply by a u.v. initiated reaction between xenon and fluorine, in glass apparatus at atmospheric pressure.<sup>71</sup>

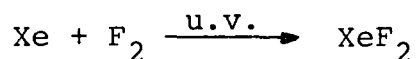

The reaction may also be thermally initiated, but this can lead to the formation of xenon tetrafluoride which, unlike  $\text{XeF}_2$ , is unstable towards moisture forming highly explosive xenon oxides.<sup>72</sup> Since  $\text{XeF}_2$  was first reported, much work has been carried out on fluorination reactions of this reagent because it can be used to fluorinate organic molecules containing a wide variety of functional groups.<sup>73,51</sup>

### 1E.1 Reaction with Aromatic Compounds

Xenon difluoride reacts with a variety of aromatic compounds, the course of the reaction depending upon four variables:<sup>73</sup>

- (a) structure of the aromatic molecule,
- (b) concentration of the substrate,
- (c) catalyst used,
- (d) reaction temperature.

Reaction of benzene with xenon difluoride, in  $\text{CCl}_4$ , gives fluorobenzene in 68% yield, using anhydrous HF as catalyst. In the absence of HF no reaction takes place. Small quantities of polymeric materials and biphenyls are also formed. E.s.r. studies of this reaction indicate that radical cations are

involved (Figure 12),<sup>75</sup> therefore the mechanism differs from other electrophilic fluorinating agents where ionic, electrophilic substitution takes place. The radical cationic mechanism explains the formation of biphenyls and the ratio of *ortho*-, *meta*- and *para*- difluorobenzenes obtained. The overall reaction is that of electrophilic substitution and so

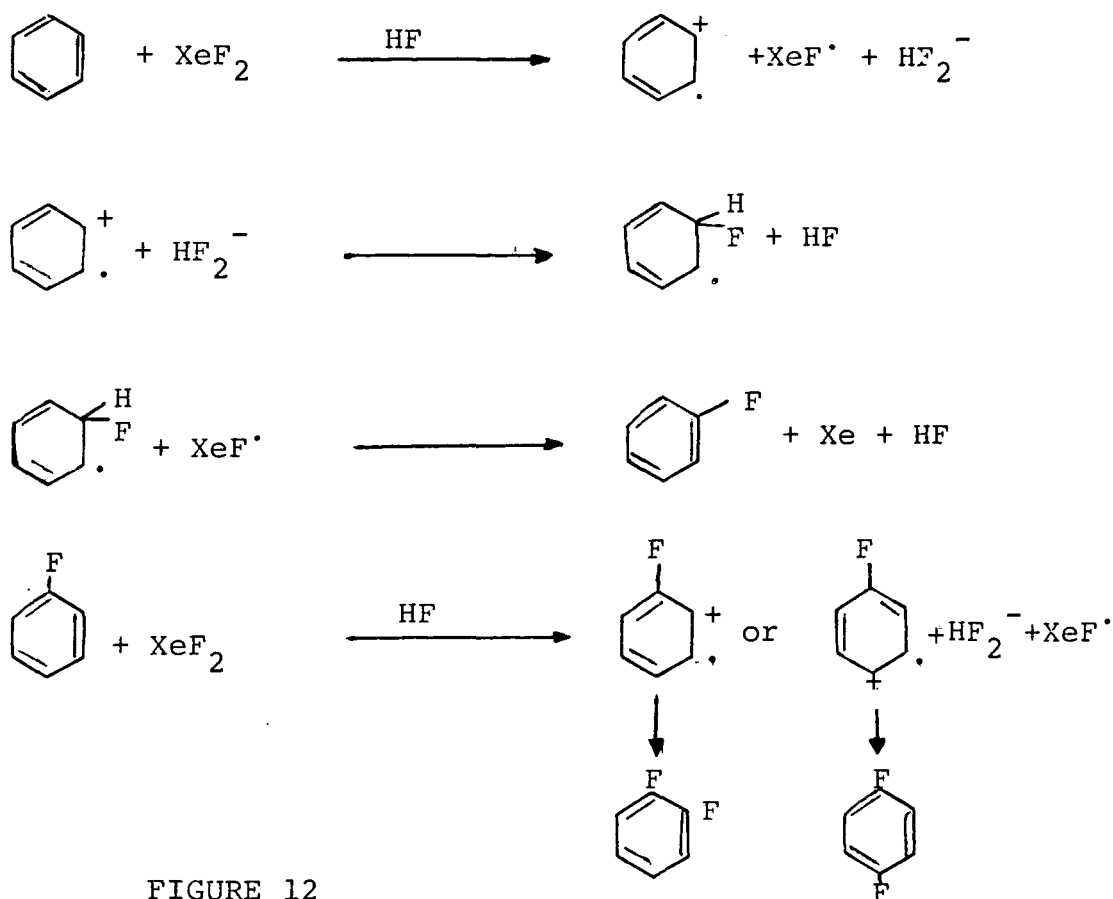

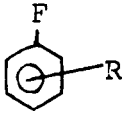

FIGURE 12

predominantly *ortho*- and *para*-disubstitution is expected.

This mechanism also occurs for reactions of substituted benzene derivatives with XeF2. Aromatic compounds containing electron donating groups yield mainly *ortho*- and *para*- substituted products, whereas nitro- and trifluoromethyl-substituted benzenes yield mainly *meta*-fluorinated products.<sup>76</sup> Table (IX) gives examples of aromatics fluorinated using XeF2.

TABLE IX

 R =			
	Yield (%)	o : m : p ratio	
OCH <sub>3</sub>	65.4	30.5 : 2.5 : 32.4	
CH <sub>3</sub>	32.4	16.1 : 2.6 : 13.7	
Cl	65.5	16 : 3.2 : 46.3	
F	46.9	11.8 : 2.8 : 32.3	
H	68.0		
CF <sub>3</sub>	75.0	0 : 71.7 : 3.8	
NO <sub>2</sub>	81.2	18.9 : 50.9 : 11.4	

-----

Aromatic compounds substituted with strongly electron donating groups react with XeF<sub>2</sub> without the use of a catalyst. For instance aryl oxygen<sup>57</sup> and aryl nitrogen<sup>77</sup> derivatives react in polar solvents to give monofluorinated products (Figure 13).

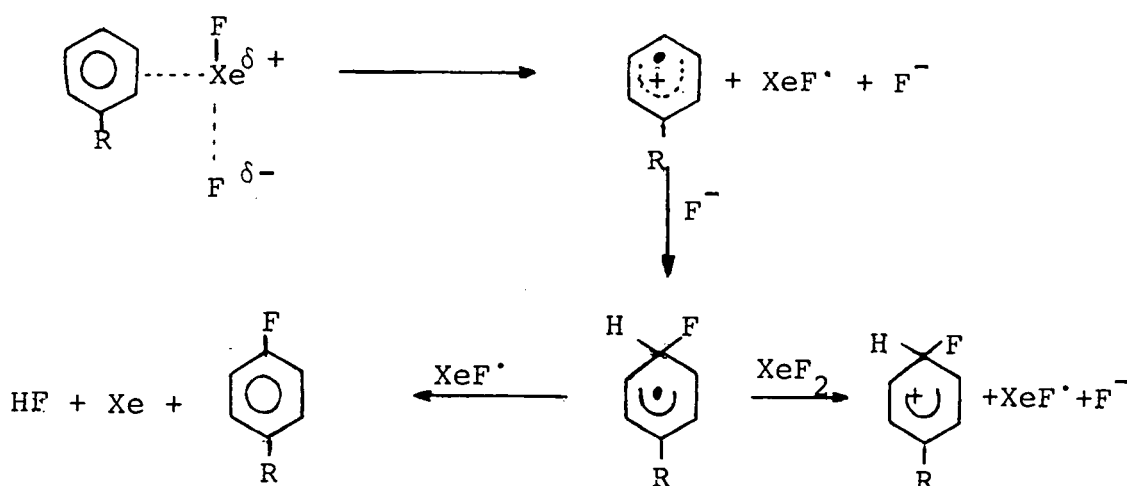
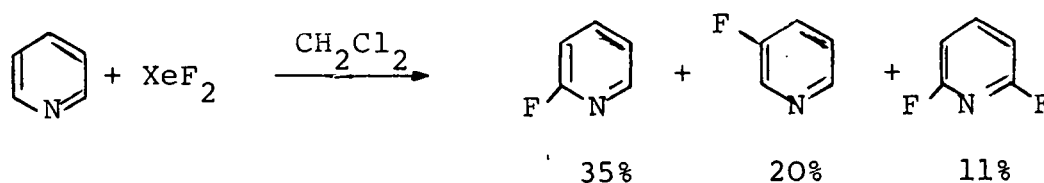

FIGURE 13

Activated aromatics are polar enough to interact with  $\text{XeF}_2$  to give a pseudo  $\text{XeF}^+$  species, without the addition of HF which normally polarises  $\text{XeF}_2$ <sup>78</sup> in HF catalysed reactions.

### 1E.2 Reaction with Heterocyclic Compounds

Pyridine reacts with  $\text{XeF}_2$ , with or without addition of HF, to afford a mixture of 2-fluoropyridine, 3-fluoropyridine and 2,6-difluoropyridine:



It is surprising that this fluorination occurs with such ease as forcing conditions are normally required to effect electrophilic substitution on the pyridine nucleus. The fluorination, therefore, probably goes *via* a more complex mechanism than the normal electrophilic substitution. 8-Hydroxyquinoline<sup>78</sup> also reacts with  $\text{XeF}_2$  giving 5-fluoro-8-hydroxyquinoline (33) as the only identifiable product.

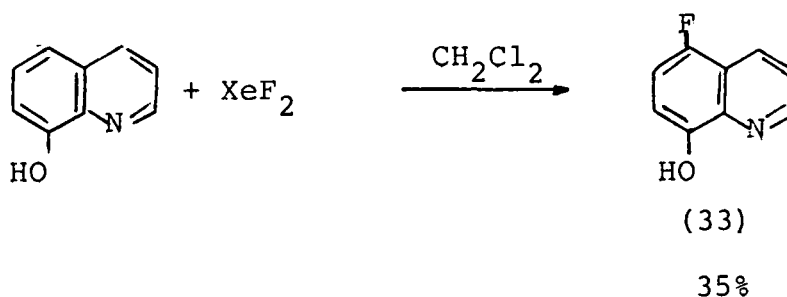

1F Miscellaneous1F.1 N-Fluoro-N-alkylsulphonamides

N-Fluoro-N-alkylsulphonamides<sup>79,80</sup> are generally stable compounds, often crystalline and easily prepared by the treatment of N-alkylsulphonamides with elemental fluorine (Figure 14). Several different R and R' groups have been incorporated including p-tolyl, methyl, tert-butyl, cyclohexyl and neopentyl.

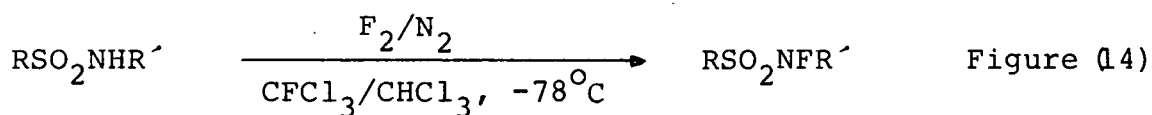

Table (X) details compounds which have been synthesized.

TABLE X

R	R'	Yield (%)	<sup>19</sup> F n.m.r.
p-tolyl	methyl	59	-37.62
p-tolyl	tert-butyl	14	-62.78
p-tolyl	exo-2-norbornyl	47	-46.91
p-tolyl	endo-2-norbornyl	71	-36.98
p-tolyl	cyclohexyl	11	-76.63
p-tolyl	neopentyl	57	-36.88

Treatment of a carbanion with an N-fluoro-N-alkylsulphonamide results in transfer of fluorine from nitrogen to carbon (Figure 15). A broad variety of anions can be fluorinated; malonates, ketones, acids and amides, enolates, alkyl and aryl-organometallics. Yields vary from fair to good (24 to 87%). These reagents (Table X) specifically fluorinate carbanions, the presence of nitrogen or oxygen anions does not effect the reaction. Reactions of N-fluoro-N-alkylsulphonamides are

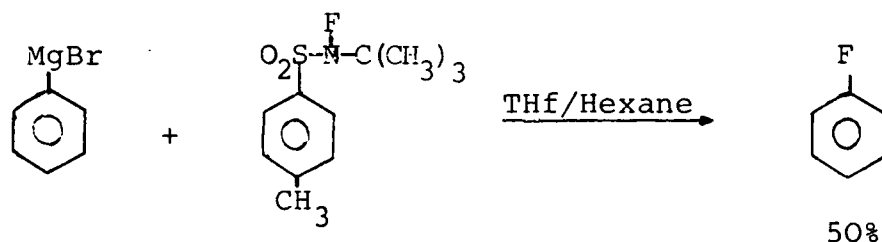

FIGURE 15

normally carried out in non-polar solvents rather than DMf or THf. For a typical reaction, the anion is generated in THf or ether then the solution is diluted with anhydrous toluene followed by dropwise addition to a solution of the sulphonamide in toluene. The temperature of the reaction is dependent upon the reactivity of the anion.

Problems can occur for strongly basic anions such as aryl organo metallics,  $\beta$ -elimination of HF from the fluorinating agent can become a major side reaction. In such cases an R' group is chosen for which the elimination is greatly reduced (norbornyl or neopentyl) or totally eliminated (R' = t-butyl). N-fluoro-N-alkylsulphonamids are likely to find increasing use as selective fluorinating agents, for aromatic compounds, for three main reasons: firstly, the ability to selectively generate anions of a wide variety of aromatic compounds has been well established, secondly the reagents selectively fluorinate carbanions, and thirdly use of the reagents does not require any specialised equipment.

## 1F.2 Other Reagents containing the N-F group

### (a) 1-Fluoro-2-Pyridone

N-Fluoro-2-pyridone (34) can be synthesized from 2-pyridone *via* two steps.<sup>81</sup> The first step is protection of the ketone by the trimethylsiloxy group, followed by treatment of this protected ketone with a dilute mixture of fluorine in nitrogen:



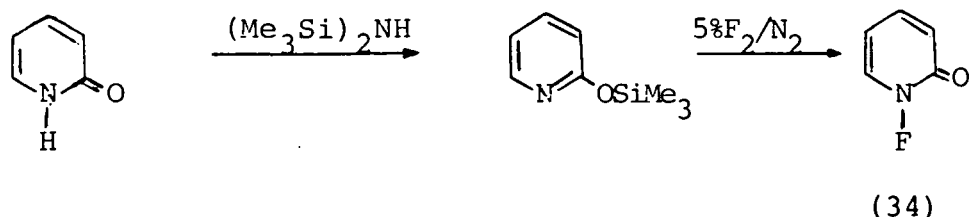

(34) Is a stable solid for which no specialised handling techniques are required. As with N-fluoro-N-alkyl sulphonamides, (34) is specific to the fluorination of carbanions. Addition of equimolar quantities of aryl Grignard reagents to a solution of N-fluoro-2-pyridone, in dichloromethane, results in the formation of monofluorinated aromatic derivatives.<sup>82</sup> The major drawback to this reagent is the low yield of monofluoroaromatics obtained:

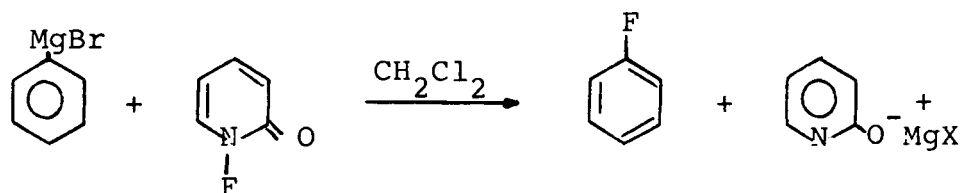

(b) N-Fluoroperfluoropiperidine

Undecafluoropiperidine (35) reacts with carbanions generated from 2-nitropropane and malonate ester to give monofluorinated products:<sup>83</sup>

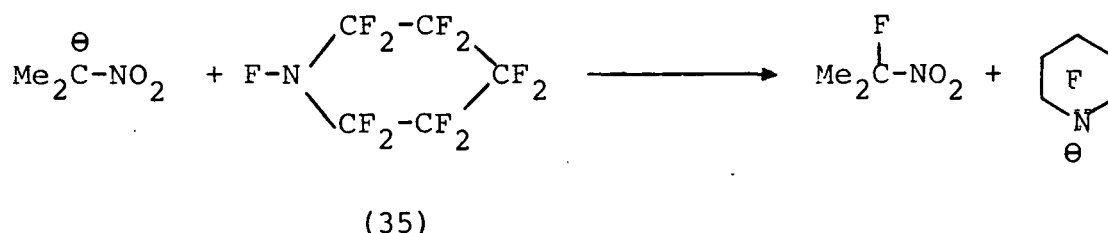

(35) Can also be used for the selective fluorination of suitably activated aromatic compounds. Tertiary aromatic amines react with (35), in pentane, to give *ortho*-fluorinated

products (Figure 16).<sup>84</sup>

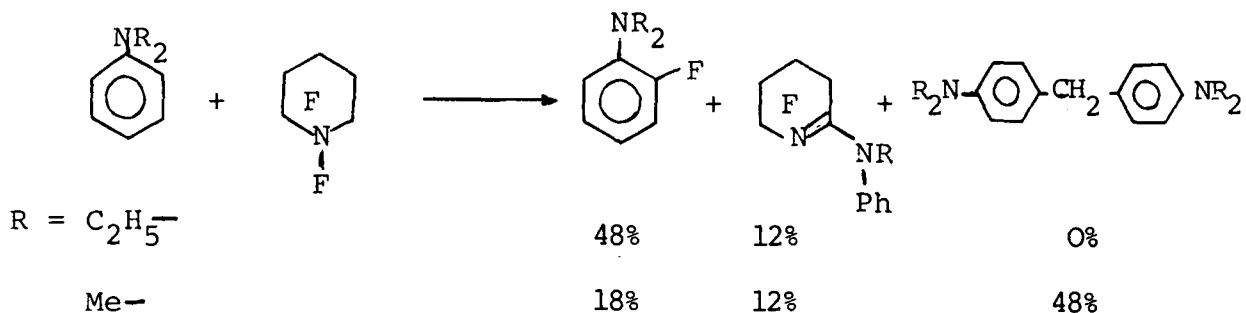
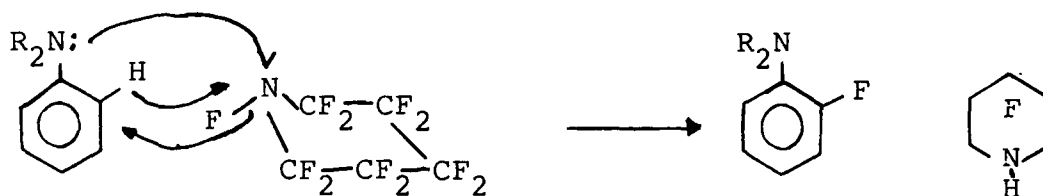
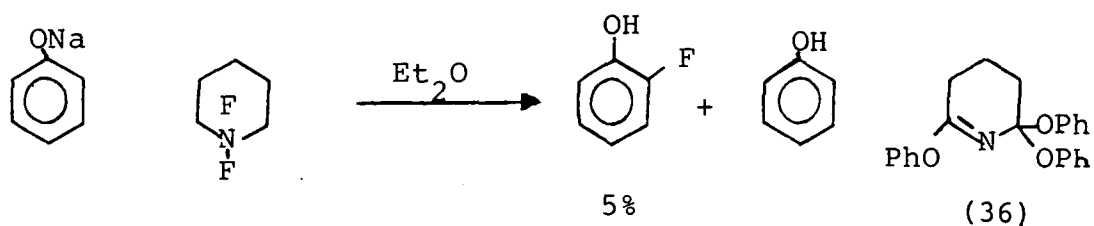

FIGURE 16

E.s.r. studies suggest that the reaction mechanism involves a one electron transfer, followed by fluorine attack at the *ortho*-position of the aniline derivative in a concerted manner:



Phenols react by a similar mechanism to give *ortho*-fluorophenols:<sup>85</sup>



The yield of *ortho*-fluorophenol is low as a considerable amount of the phenolate starting material is used in the formation of 2,6,6-triphenoxyl-1-azaperfluorocyclohexene (36).

It has recently been reported<sup>86</sup> that a better alternative to N-fluoro-perfluoropiperidine is N-fluoro-quinuclidinium fluoride (37). The leaving group, after transfer of 'F<sup>+</sup>',

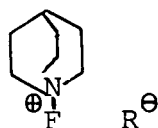

(37)

will be a neutral molecule. The main problem with (37), however, is its lack of solubility except in polar solvents.

Alternatives to both (35) and (37) are polymer supported N-fluoro compounds.<sup>86</sup> The most effective of this class of compound is (38). An N-fluoro-perfluoropiperidine group is attached to a perfluoro-carbon backbone by a perfluorocyclohexane ring. This reagent can be used to effect fluorinations in the same manner as perfluoro-N-fluoropiperidine.

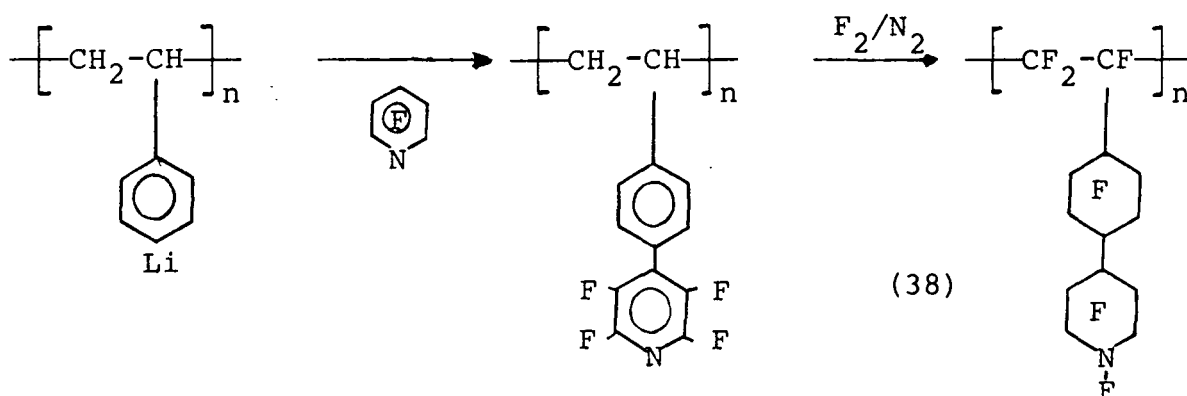

(c) N-Fluoropyridinium Triflates

This class of reagents has only recently been reported as being useful, selective, electrophilic fluorinating agents. They are prepared<sup>87</sup> by passing fluorine, diluted with nitrogen, through a solution of a pyridine derivative in  $\text{CFCl}_3$  at  $-78^\circ\text{C}$  followed by addition of sodium triflate in acetonitrile:

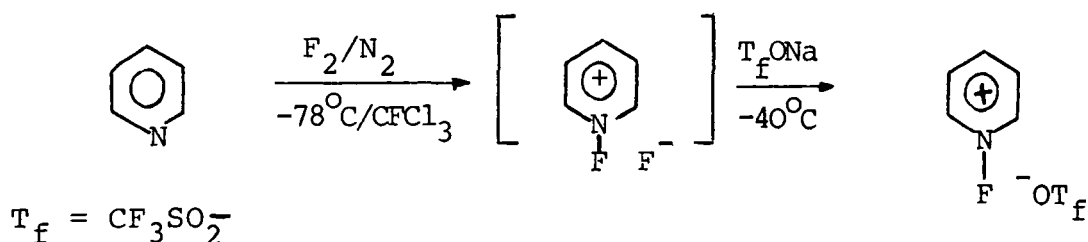

N-Fluoropyridinium triflates can be used to introduce fluorine into a variety of organic compounds,<sup>88</sup> including aromatic derivatives. Phenol reacts in refluxing dichloromethane to give a mixture of *ortho*- and *para*-fluorophenol:<sup>89,90</sup>

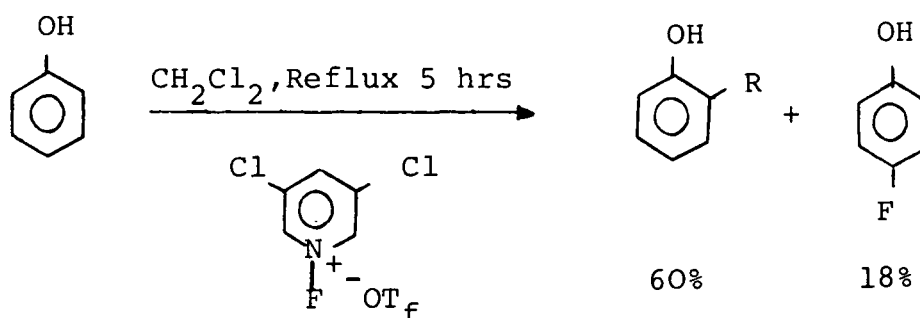

Anisole and ethylcarbanilate react in an analogous manner to give mono-fluoroderivatives in high yield.<sup>89,90</sup> Reaction of aryl Grignard reagents with N-fluoropyridinium triflates will also give monofluorinated aromatics:<sup>89,91</sup>

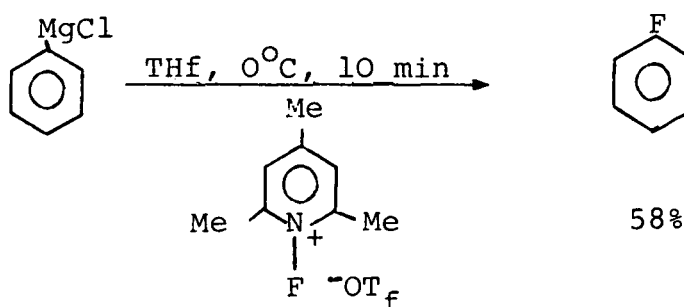

### 1F.3 Perchloryl fluoride

Although perchloryl fluoride has found use in the selective fluorination of aliphatic compounds,<sup>92</sup> it is not as useful for the fluorination of aromatic molecules. In theory any aromatic compound from which a carbanion can be generated can be converted to the monofluorinated derivative using perchloryl fluoride. In practice, however, many side reactions occur and in some cases no fluoroaromatics are formed at all.

Fluorobenzene can be prepared by treating a solution of phenylmagnesium bromide or phenyllithium in THf with perchloryl-

fluoride.<sup>93</sup> Benzene is formed as a side product in the reaction of phenyllithium and as the major product from phenylmagnesiumbromide:

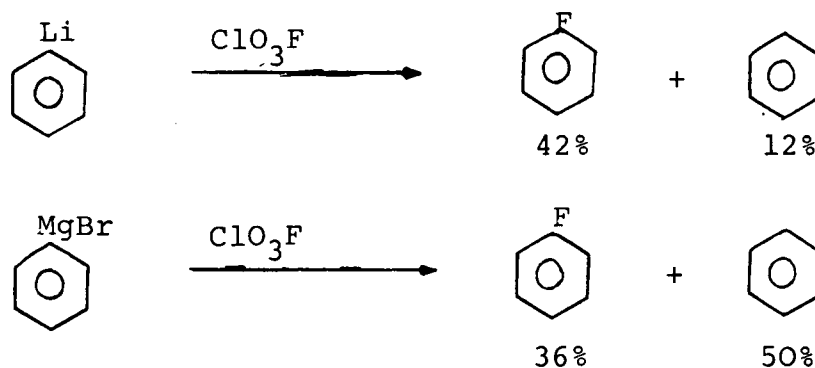

Problems also occur due to the formation of perchlorylbenzene.<sup>94</sup> This can be rationalised if the mechanism involves nucleophilic attack of the aryl-anion on chlorine, which is the most electrophilic site in perchlorylfluoride, without subsequent displacement of the  $\text{ClO}_3^-$  group by fluorine:

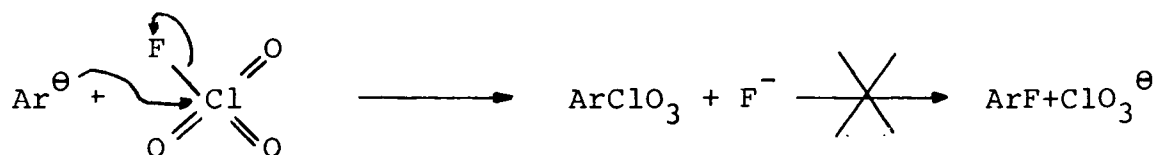

In general perchlorylfluoride has not proved useful as a reagent for the selective fluorination of aromatic compounds due to the side reactions detailed above and difficulties in handling this explosive gas.

## CHAPTER TWO

FLUORINE CONTAINING NUCLEOSIDESINTRODUCTION

The ultimate aim of our work is the development of new methods for the selective introduction of fluorine into nucleosides containing an imidazole base, for example 5-amino-1-( $\beta$ -D-ribofuranosyl)imidazole-4-carboxamide (AICAR) (39).

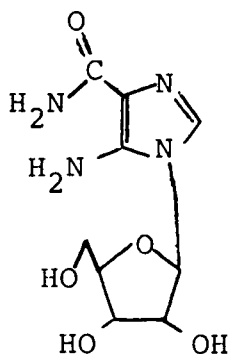

AICAR (39)

Such nucleosides are formed as intermediates in the biosynthetic pathway leading to the synthesis of inosinic acid (40) and other purine nucleosides.

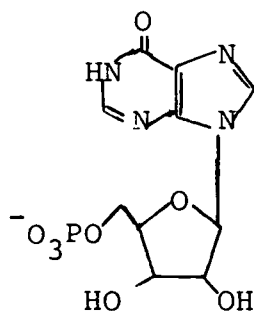

(40)

Part of this metabolic pathway is shown in Figure 17.<sup>95</sup> Replacement of hydrogen by fluorine, in the base of an imidazole nucleoside (as indicated by the arrows), could produce derivatives

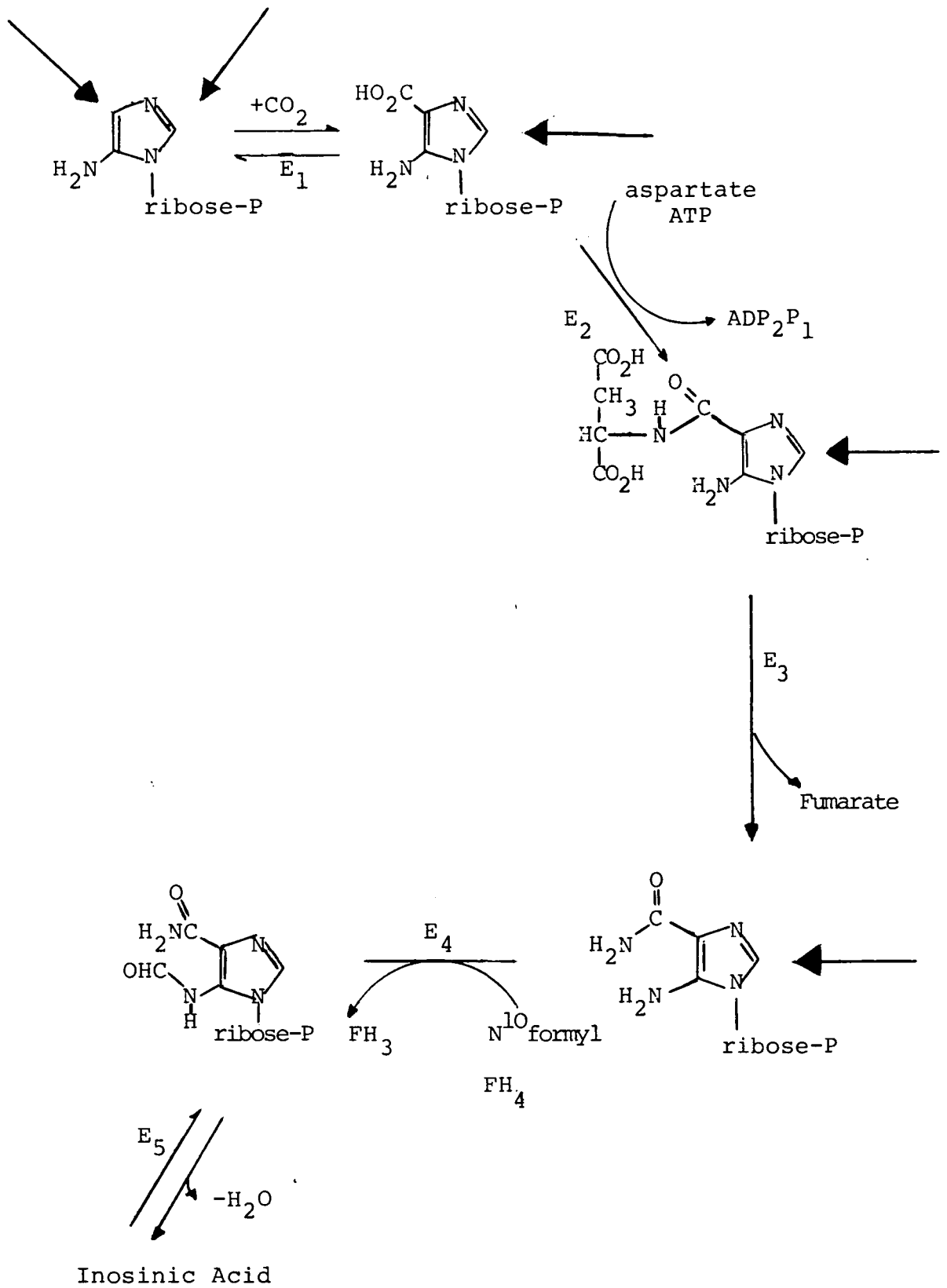

FIGURE 17.

which might block one of the pathway enzymes. Introduction of fluorine into a nucleoside does not significantly alter the size of the molecule thus it will still bind to the active site in an enzyme, however the electronic nature of the nucleoside will be altered thus preventing further reaction or release from the enzyme. Replacement of an hydroxyl group by fluorine, in a nucleoside may also produce derivatives which block this pathway by a similar process.

It is convenient to review the synthesis of fluorinated nucleosides in two sections. Firstly the fluorination of the base and secondly, the introduction of fluorine into the sugar ring. A third section will review the antiviral activity of fluorinated nucleosides.

## 2A. Synthesis of Fluorinated Nucleosides

### 1. Fluorination of the Heterocyclic Base

#### (a) Imidazole Derivatives

Since the basic fragment of AICAR (39) is an imidazole base, it is important to review (a) methods which are currently available for the selective fluorination of imidazoles, and (b) the stability of the monofluoroimidazoles thus synthesized. The most common method for synthesis of fluoroimidazoles is based on the Balz-Schiemann (B-S) reaction. This classical method, however, results in very poor yields and so modified procedures have been developed.

In 1971 Kirk and Cohen<sup>96</sup> reported the synthesis of the first C-fluorinated imidazole derivatives. A modified B-S reaction was used to prepare 2-fluoroimidazole, 5-fluoroimidazole and ethyl-4-fluoroimidazole-5-carboxylate. The major modification was to effect decomposition of the diazonium tetrafluoro-



borate salt by irradiation with u.v. light, irradiations normally being carried out at  $-10^{\circ}\text{C}$  using a medium pressure mercury lamp. Attempts to decompose imidazolediazonium tetrafluoroborates thermally gave no fluorinated imidazole derivatives. Even using the irradiation method, however, the yields of fluorinated imidazole derivatives are not high, as shown in Table XI.<sup>97,98</sup>

Isolated yields of 4- and 5-fluoroimidazoles are generally lower than those of 2-fluoroimidazoles, when using the irradiation method; for instance 2-fluoro-N-methylimidazole can be obtained in 48% yield whereas synthesis of 4- or 5-fluoro-N-methylimidazole occurs in only 8% and 2% yield respectively.<sup>99</sup> The low yields of fluoroimidazoles generally, is due mainly to the inherent instability of 4- and 5-aminoimidazoles and the ease by which fluorine, substituted at the 2-position, can be displaced by nucleophiles. Because of the instability of 4- and 5-aminoimidazoles, nitro derivatives are often used as starting materials, with reduction *'in situ'* to the amine prior to diazotisation. Various methods are used to effect this reduction including sodium amalgam in methanol<sup>99</sup> and zinc dust. Curtius rearrangement of imidazole-3-carbonyl azide<sup>100,101</sup> can be used to prepare both 4- and 5-aminoimidazoles (Figure 18).

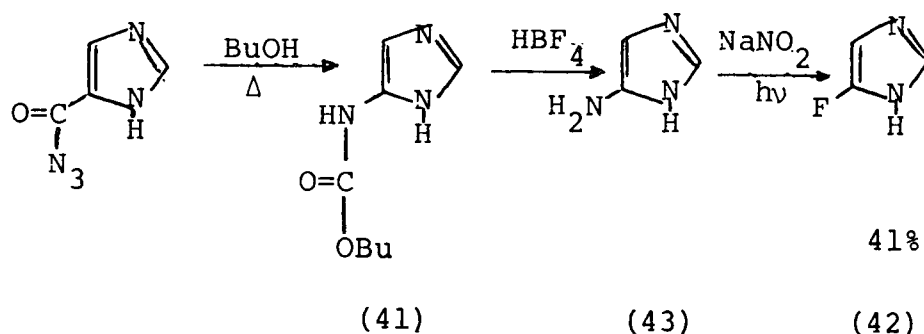
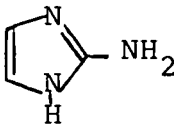
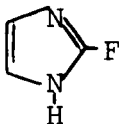
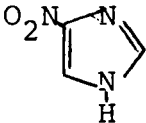
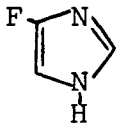
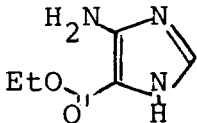
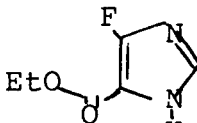
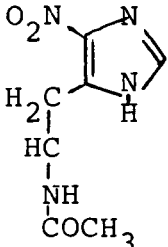
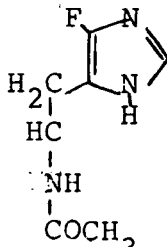
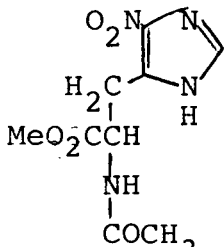
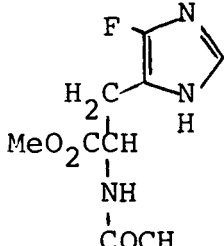
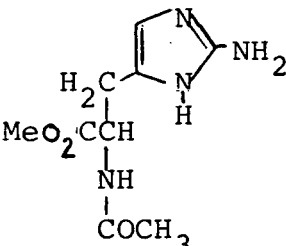
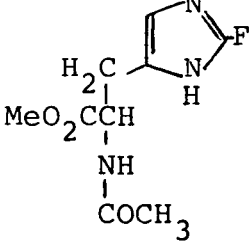
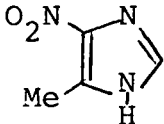
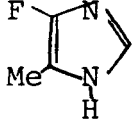

FIGURE 18

TABLE XI

Starting Material <sup>a</sup>	Product	Yield (%)
		30
		17
		38
		18
		10
		32
		37

(a) 4,5 aminoimidazoles are unstable, therefore nitroimidazoles are reduced 'in situ' to the amine derivatives prior to diazotisation.

Deprotection of the amine (41) is effected in tetrafluoroboric acid, therefore the diazotisation simply involves addition of sodium nitrite, irradiation of the reaction mixture then leads to the formation of 5-fluoroimidazole (42). Generating the amine (43) by reduction of 4-nitroimidazole using zinc dust, results in a lower yield of 4-fluoroimidazole. Recently the use of perchloryl fluoride for the introduction of fluorine into imidazoles, has been described.<sup>102</sup> Treatment of N-methylimidazole with butyllithium followed by reaction of the lithioimidazole derivative with perchloryl fluoride gave 2-fluoro-N-methylimidazole in 55% yield:

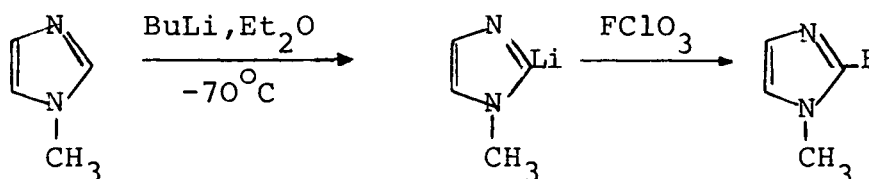

(b) Stability of 2-Fluoroimidazole Derivatives

2-Fluoroimidazole derivatives are susceptible to nucleophilic displacement of fluorine by a large variety of nucleophiles. This reaction probably takes place *via* an addition-elimination mechanism as does the nucleophilic displacement of bromine, from bromoimidazolium ions<sup>103</sup> and displacement of chlorine from 2-chlorobenzimidazoles by nucleophiles.<sup>104</sup> The displacement of fluorine occurs more readily than displacement of other halogens because fluorine is more electronegative and so activates the C-2 carbon towards nucleophilic attack to a greater extent. Indeed a wide variety of nucleophiles can cause displacement including water, methoxide, sulphur and nitrogen nucleophiles. The displacement reaction occurs most

easily in acidic media, under such conditions the imidazole ring will be protonated, therefore displacement occurs from an imidazolium ion (Figure 19).

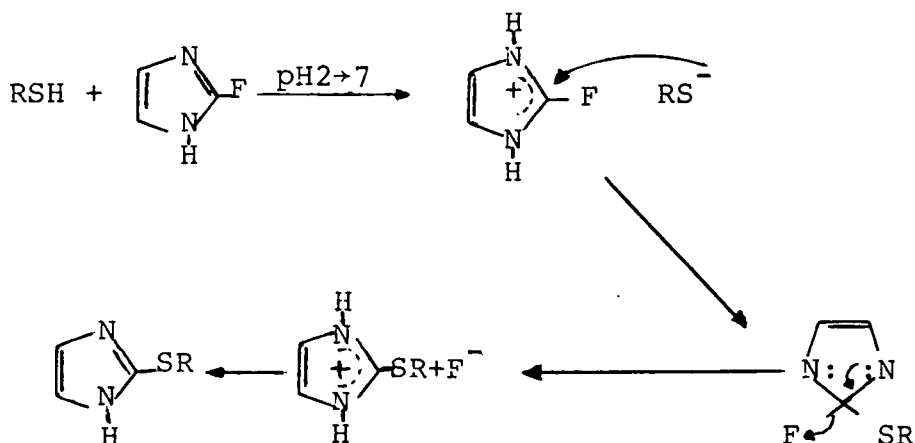

FIGURE 19

In some cases it is possible for the nitrogen of an imidazole ring to act as a nucleophile and displace a C-2 fluorine, further displacements lead to the formation of cyclic trimers (Figure 20).<sup>105</sup> 2-Fluoroimidazole undergoes cyclic trimerisation even when stored as a solid or hydrochloride derivative, at  $-10^\circ\text{C}$ :<sup>105</sup>

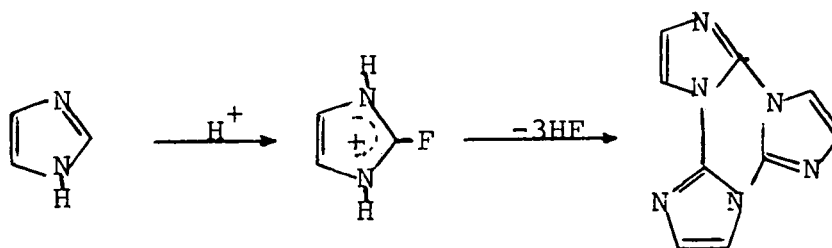

FIGURE 20

It has been suggested<sup>105</sup> that slow release of hydrogen fluoride initiates the trimerisation, which then becomes autocatalytic. 2-Fluoroimidazoles are stabilized to this cyclisation reaction by protecting the ring N-H, thus preventing loss of HF. Any form of substitution at the 4(5)-position on an

imidazole ring also retards the cyclisation. Electron donating groups activate the ring to nucleophilic attack but, retard ring protonation while electron donating groups deactivate the C-2 carbon to nucleophilic attack and bulky groups cause steric hindrance to the cyclisation. Higher temperatures are therefore required to cyclise 4(5)-substituted imidazoles.

### (c) Pyrimidine Derivatives

The selective fluorination of pyrimidine bases and their nucleoside derivatives has been developed to a far greater extent than imidazole based compounds. A brief review is given here of the methods used to introduce fluorine into uracil (44) and uridine (45), the biological activity of which has been extensively reviewed.<sup>106-108</sup> 5-Fluorouracil was first reported in 1957<sup>109,110</sup> and was synthesized by the condensation of uronium or thiouronium salts with  $\alpha$ -fluoro- $\beta$ -ketoester enolates.<sup>109</sup>

The most important method, now used, is the direct fluorination of uracil by bubbling fluorine through aqueous solution of the base.<sup>111</sup> 5-Fluoruridine is synthesized on an industrial scale using this aqueous fluorination method.<sup>112,114</sup> The active fluorinating agent, in such reactions, is probably hypofluorous acid (HOF), which is formed by the reaction of fluorine with water.<sup>115</sup> Reaction of uracil or acylated uridine derivatives with elemental fluorine can also be carried out in acetic acid<sup>116</sup> or trifluoroacetic acid.<sup>117</sup> Intermediates can be isolated in which addition of fluorine and a solvent molecule to the double bond has occurred (Figure 21).

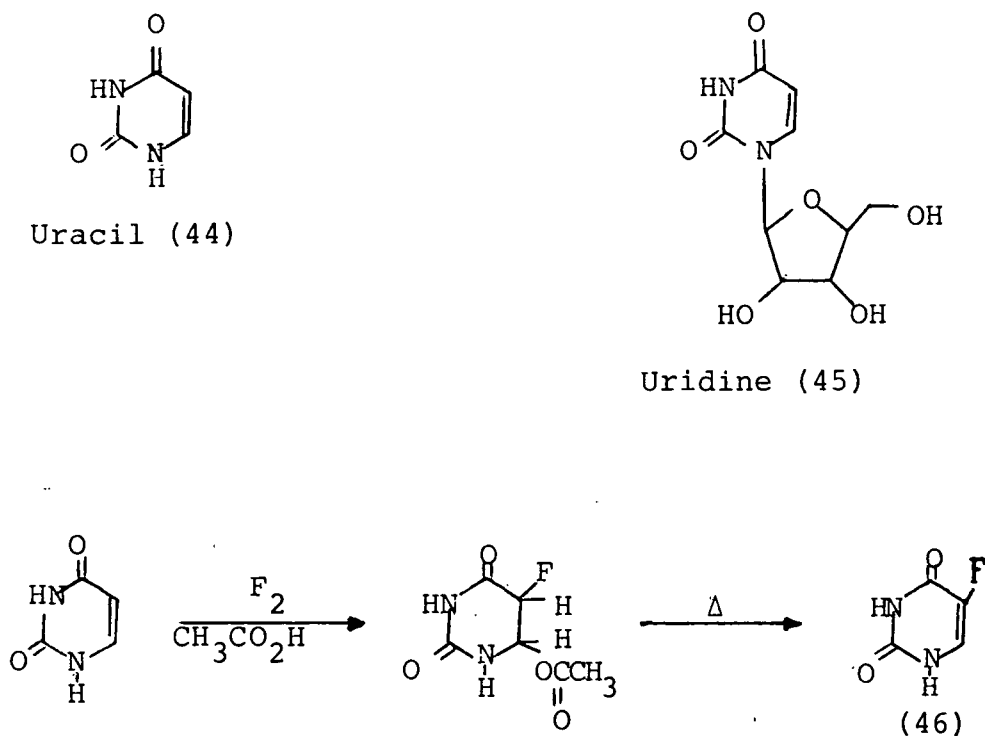

FIGURE 21

5-Fluorouracil (46) and 5-fluorouridine derivatives are then generated from the adducts by thermolysis,<sup>115</sup> treating with base<sup>116</sup> or passing down an ion exchange resin.<sup>117</sup> Reaction of uridine, without protection of the hydroxyl groups, with elemental fluorine results in the formation of difluorinated, cyclic products (Figure 22).<sup>65</sup> <sup>18</sup>F-labelled 5-fluorouracil can readily be synthesized by the aqueous fluorination method as the reaction time is much shorter than the half life of the <sup>18</sup>F-isotope.

Trifluoromethyl hypofluorite,<sup>118</sup> caesium fluoroxysulphate,<sup>157</sup> acetyl hypofluorite<sup>119</sup> and xenon difluoride<sup>120</sup> have all been used to fluorinate uracil and its nucleoside derivatives. Hypofluorites all react with uracil in the same manner. In polar solvents an addition-elimination reaction takes place with

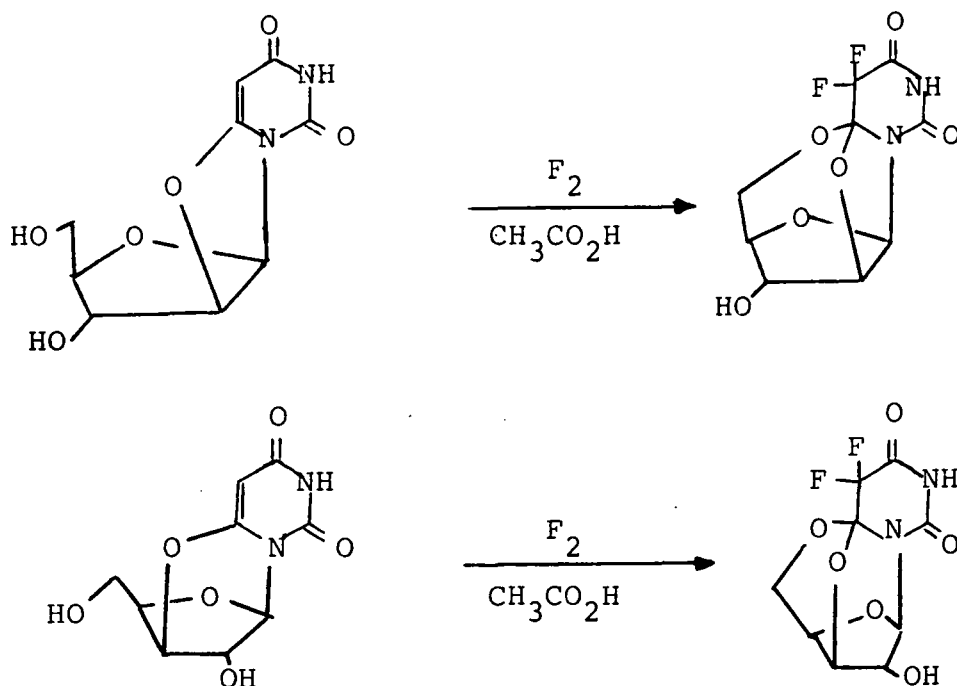

FIGURE 22

fluorine and solvent adding across the double bond to form saturated intermediates (47a, 47b). Thermolysis or treatment of this intermediate (47) with base results in the formation of 5-fluorouracil. The same reaction occurs with uridine (Figure 23).

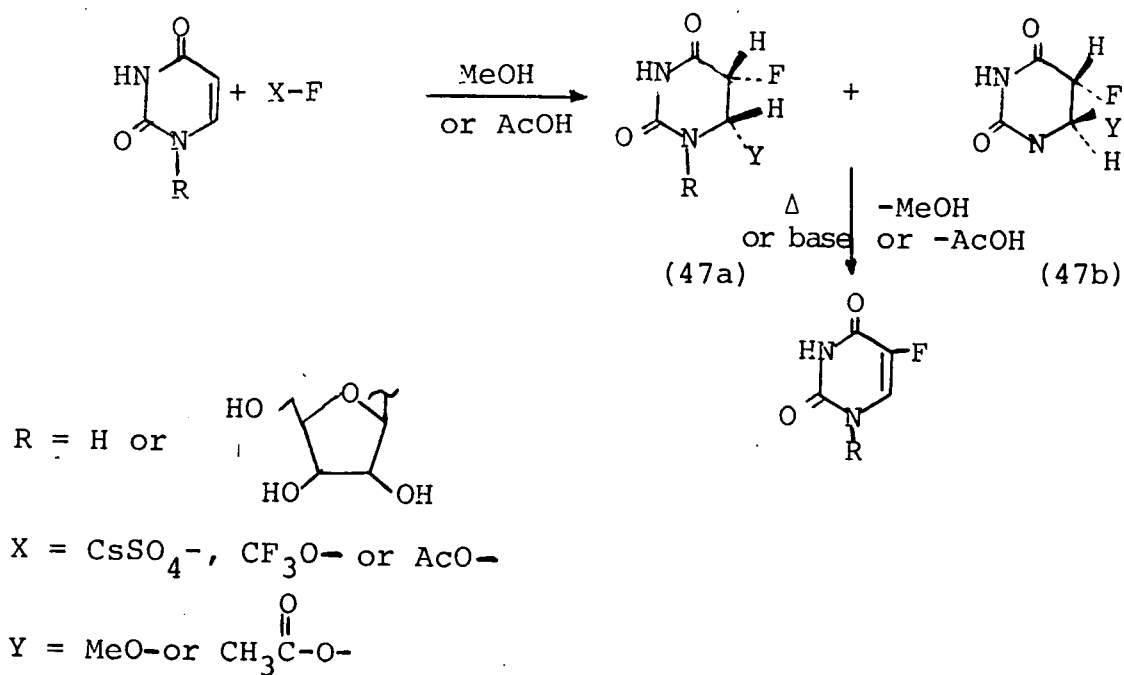
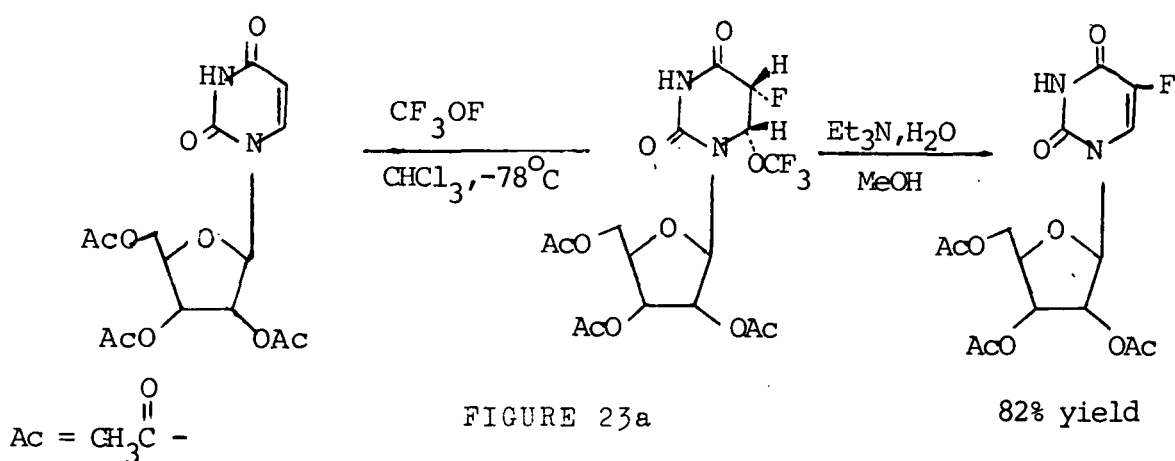

FIGURE 23

Trifluoromethyl hypofluorite reacts in a stereospecific manner giving only *cis*-addition to form intermediate (47a) only,<sup>121</sup> while caesium fluoroxy sulphate and acetyl hypofluorite react to give mixtures of (47a) and (47b) however elimination of methanol or acetic acid from either intermediate leads to 5-fluorouracil derivatives. Trifluoromethyl hypofluorite also reacts with uracil and its derivative in  $\text{CFCl}_3$  to give 5-fluorinated products (Figure 23a).<sup>122</sup> Reactions of acetyl



hypofluorite with pyrimidines have always been carried out in acetic acid.<sup>119</sup>

## 2A. 2. Introduction of Fluorine into the Sugar Ring

Fluorine can be introduced into saccharides by two basic methods; (a) electrophilic fluorination of an unsaturated sugar<sup>123,124,29,125,126</sup> or (b) nucleophilic displacement of a suitable leaving group by fluoride ion. In our work we have concentrated on the use of method (b), therefore the electrophilic fluorination method will not be reviewed.

There are two routes available for introducing fluorine into sugars by fluoride ion displacement;



- (a) displacement of a leaving group by fluoride ion from an isolated intermediate,
- (b) direct replacement of a hydroxyl group by fluorine using diethylaminosulphur trifluoride (DAST).

By using suitable protecting groups<sup>127</sup> on the hydroxyl functions of the sugar, fluorine can be introduced at any position in the carbohydrate. The protecting group reactions are designed so that the position where fluorine is to be introduced has a free hydroxyl group which can be substituted by, or converted into a suitable leaving group. Trifluoromethylsulphonate-(triflate), mesylate, tosylate and various sulphonate esters have been used as leaving groups. In our work we have concentrated on the use of the triflate group, therefore a brief review of methods of introducing this group into carbohydrates and its displacement by fluoride ion is given. This is followed by a short description of the use of DAST in synthesizing fluorocarbohydrates.

The synthesis of triflate derivatives of simple alcohols is well documented<sup>128,129</sup> and a variety of methods have been employed. Trifluoromethylsulphonyl chloride (triflylchloride) and trifluoromethylsulphonic anhydride (triflicanhydride) are the two reagents which are most frequently used.

Treatment of a protected carbohydrate, containing one free hydroxyl group, with sodium hydride followed by addition of trifluoromethanesulphonyl chloride will yield a triflate derivative; for example nucleoside (48) can be converted to its 2'-triflate ester (49) in 67% yield<sup>130</sup> (Figure 24), displacement of the triflate group by fluoride ion then yields the 2'-fluorinated nucleoside (50). Since the displacement step, (49)

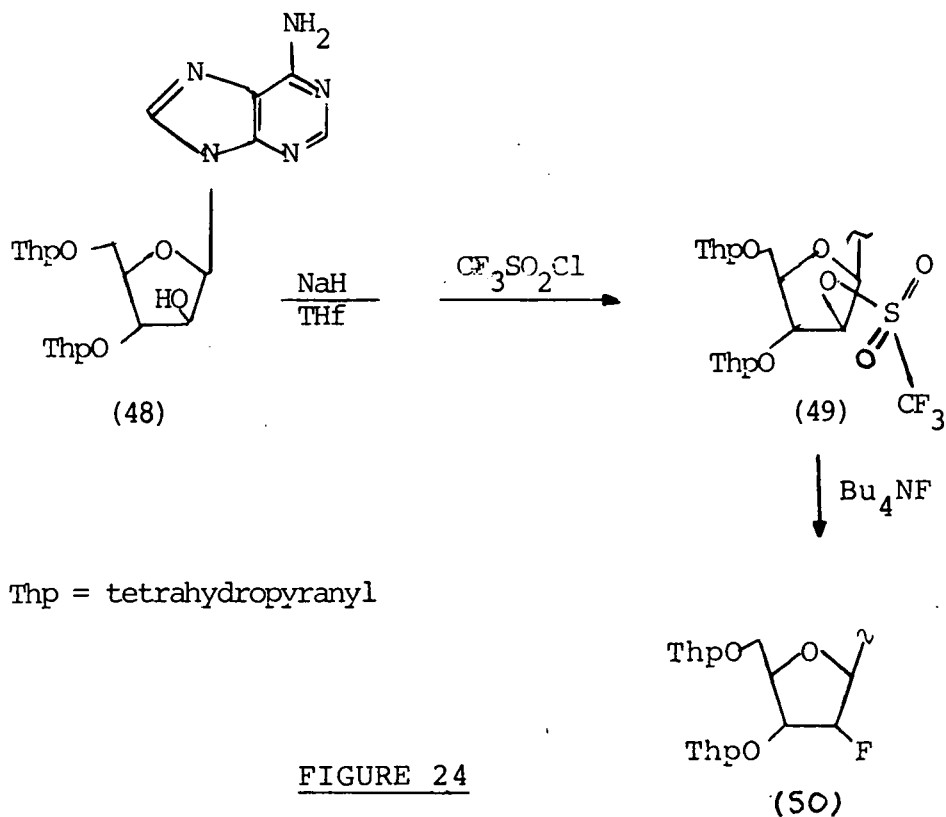
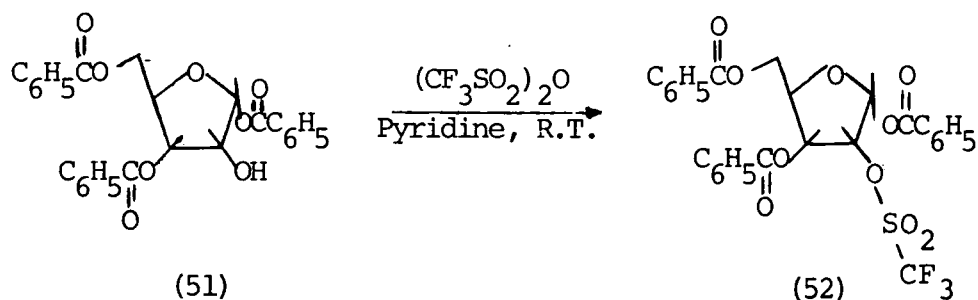

FIGURE 24

to (50) is an  $\text{S}_{\text{N}}2$  process, an inversion of configuration occurs at the reaction site. 2'-Deoxy-2'-fluoroguanosine can also be prepared by this route.<sup>131</sup>

The above method can only be used if the protecting groups are stable to strongly basic conditions, triflic anhydride in pyridine is used to effect triflation if sodium hydride cleaves the protecting groups. The protected sugar (51) reacts with triflic anhydride at room temperature to afford the 2'-triflate derivative (52) in 84% yield:<sup>134</sup>



Treatment of (52) with a variety of fluoride ion sources, however, did not yield the 2'-fluoroderivative although the fluorocarbohydrate (53) can be prepared<sup>135</sup> by fluoride ion displacement of a triflate group from (54):

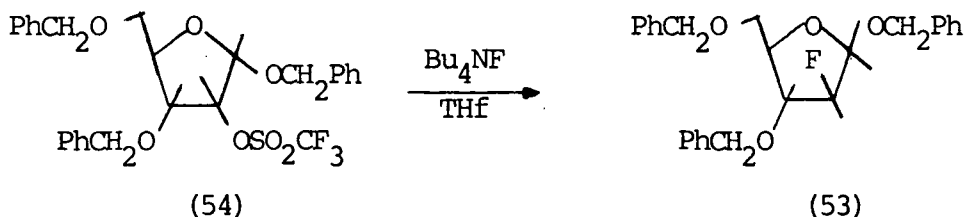

Triflate group displacement reactions are now used to introduce a variety of functional groups into carbohydrates.<sup>132,133</sup>

A free hydroxyl group can be substituted for fluorine directly using diethylaminosulphur trifluoride (55).

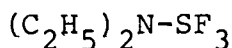

DAST (55)

The preparation of DAST and its reaction with simple alcohols was first reported in 1975 by Middleton.<sup>136</sup> Alcohols react under very mild conditions with DAST giving the corresponding fluoroderivatives by fluoride ion displacements of the sulphur containing leaving group from the intermediate (56):

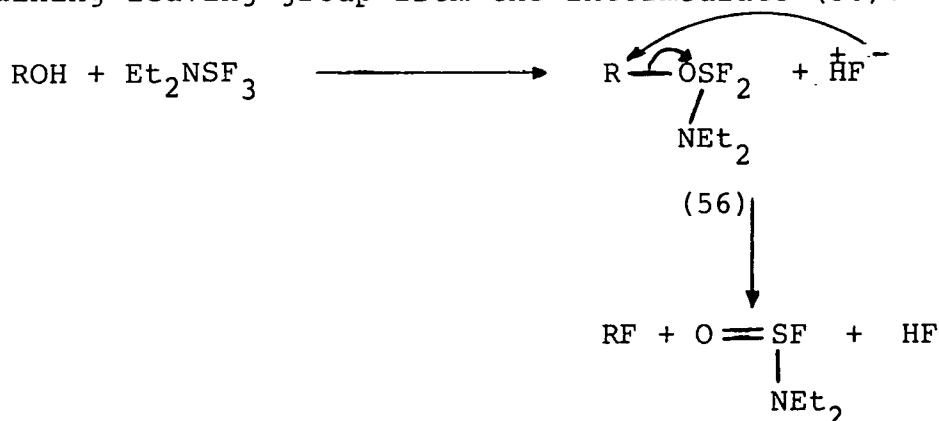

DAST reacts in an analogous manner with a free hydroxyl group of a carbohydrate. 3-Deoxy-3-fluoroglucose can be prepared<sup>137</sup>

by treatment of 1,2:5,6-di-O-isopropylidene- $\alpha$ -D-allofuranose (57) with DAST, followed by hydrolysis of the two protecting groups. The reaction is carried out in a mixture of pyridine and methylene chloride at 0°C. The first step is to form the intermediate (58) which undergoes attack by fluoride ion to give the protected monofluorosugar (59), hydrolysis then yields 3-fluoroglucose (60):

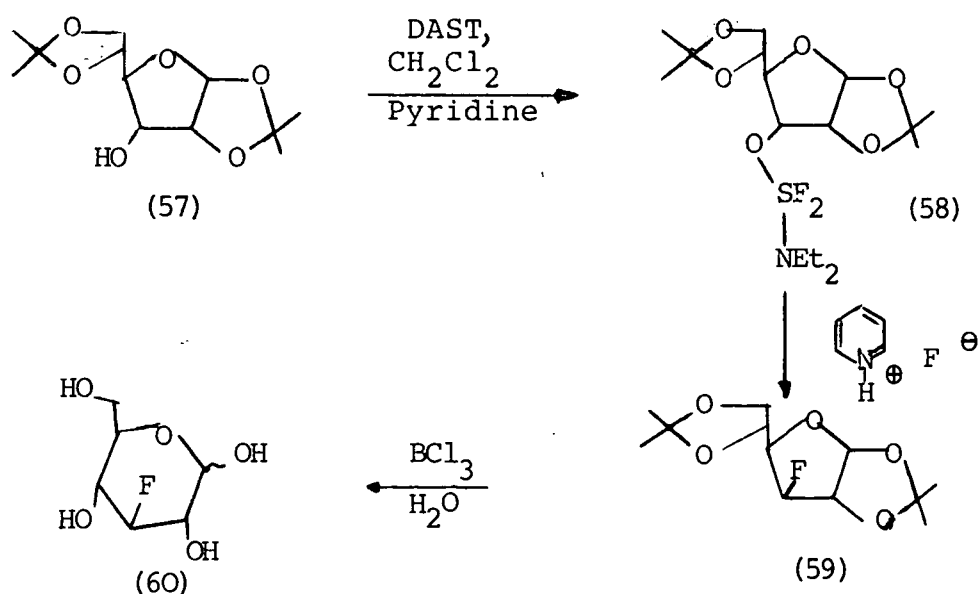

Fluorination using DAST, therefore, is similar to the nucleophilic displacement of a triflate group in that a good leaving group is introduced into the carbohydrate, by DAST, followed by fluoride ion displacement *via* an  $\text{S}_{\text{N}}2$  process to give the fluoro derivative, therefore inversion of configuration at the reaction site takes place. The anomeric hydroxyl group of a variety of protected carbohydrates has been substituted for fluorine using DAST.<sup>138,139</sup> Commonly used protecting groups such as benzyl, benzoyl and acetonide functionalities have been found not to interfere with the fluorination. Mono-fluorinated carbohydrates have also been synthesized by reaction

of only partially protected sugars with DAST,<sup>140,141</sup> for instance methyl- $\alpha$ -D-glucopyranoside (61) gives its 6-fluoro-derivative (62) in 70-88% yield:

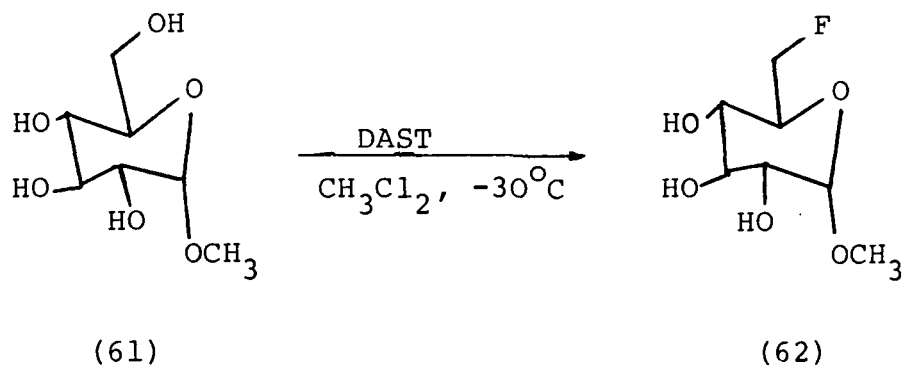

## 2B. Biological Properties of Fluorinated Nucleosides

The effects of introducing a single fluorine atom into a molecule, on its physical and chemical properties have already been discussed (see Chapter One). These effects tend to impart biological activity to nucleoside molecules often making them useful as drugs providing they are not too toxic. The most important fluorinated nucleoside derivatives, in the area of medicinal chemistry, are probably 5-fluorouridine and its related compounds. 5-Fluorouracil and its nucleoside derivatives have been the subject of many publications concerning their chemistry, biochemistry and clinical use in cancer chemotherapy. Since their effects as anti-cancer agents were first published,<sup>109,110</sup> further studies have shown that 5-fluoro-2'-deoxy-uridine (63) is even more effective and less toxic. It is often the degree of toxicity of a compound which determines its use in chemotherapy.

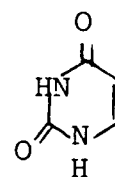
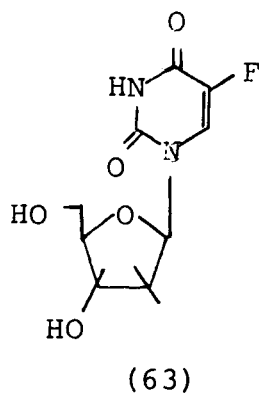

5-Fluorouracil

5-Fluorouracil and (63) are both metabolised to 5-fluoro-2'-deoxyuridylate (64), an inhibitor of thymidylate synthetase; the enzyme which converts 2'-deoxyuridylic acid to thymidylic

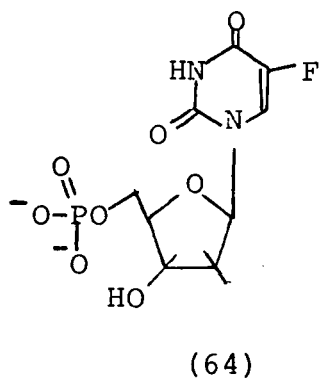

acid (an essential component of DNA) (Figure 25). The inhibition is caused by the presence of fluorine at C-5 which prevents formylation at this position. Cancer cells, which are rapidly reproducing, are rich in the enzyme thymidate synthetase.

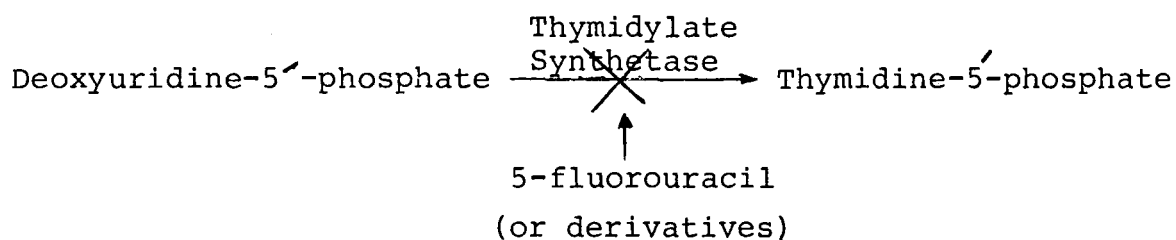
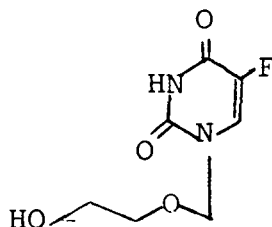

FIGURE 25

Thus the fluorinated nucleoside blocks the enzyme in tumour cells to a greater extent than in normal cells. This is an example of lethal synthesis, *i.e.* the enzyme accepts the fluorinated nucleoside at an active site but the differing chemical properties of the fluorinated derivative prevents further reaction involving the enzyme and ultimately blocks its release from the enzyme. 5-Fluorouracil has been used with varying degrees of success in the treatment of human breast cancer and other malignant cancers, however a combination of 5-fluorouracil with methotrexate cyclophosphamide, and prednisone is more effective in the treatment of leukemia, breast cancer and Hodgkins disease than the individual drugs.<sup>142</sup>

A series of uracil nucleosides have now been reported to have tumour inhibitory effects, including 5'-deoxy-5-fluorouridine,<sup>143</sup> 2',5'-dideoxy- and 2',3',5'-trideoxy nucleoside derivatives of 5-fluorouracil.<sup>144</sup> Acyclouracil nucleosides have also been reported to have anti-tumour properties, for example 5-fluoro-1-(2-hydroxyethoxymethyl)uracil (65),<sup>145</sup> has shown activity against leukemia in mice, with fewer side effects than 5-fluorouracil.



(65)

Pyrimidine nucleosides containing fluorine in the sugar fragment also find chemotherapeutic use. 2'-Fluoro-2'-deoxyarabinosyl-5-iodocytosine, 2'-fluoro-2'-deoxyarabinosyl-5-

methyluracil and 2'-fluoro-2'-deoxyarabinosyl-5-ethyluracil are all potential anti-tumour agents,<sup>146</sup> especially 2'-fluoro-2'-deoxyarabinosyl-5-iodocytosine (66) which has shown a high degree of activity against the herpes simplex 1 virus (HSV-1).

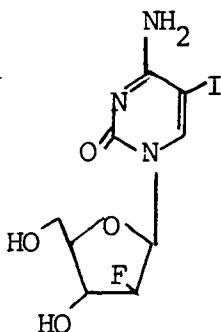

(66)

Unlike pyrimidine based nucleosides, the antiviral effects of fluorinated imidazole nucleosides have not been developed. This is probably due to difficulties in synthesizing the mono-fluorinated compounds. Some fluorinated imidazole derivatives, however, have been shown to have antiviral activity. 5-Fluoro-1-( $\beta$ -D-ribofuranosyl)imidazole-4-carboxamide (67) has been prepared<sup>147</sup> and its use as an antiviral agent studied. It acts by blocking DNA and RNA biosynthesis in cell culture systems.<sup>147a</sup> The biosynthetic pathway to purine nucleosides has been detailed earlier (see Chapter Two, Introduction) and it is this pathway which is blocked by fluorinated imidazole nucleosides.

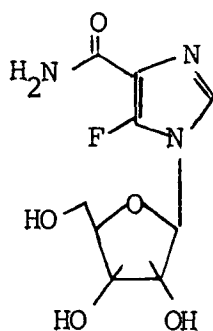

(67)



Since (67) acts as an antiviral agent and pyrimidine nucleosides containing fluorine in the sugar residue also have anti-tumour properties we have attempted to introduce fluorine into both the imidazole ring and the sugar fragment of AICAR, which is formed as part of the biosynthetic pathway to inosinic acid. Fluorinated derivatives of AICAR (68) and (69), therefore, may have antiviral properties by blocking this pathway. At present methods available for the synthesis of fluorinated

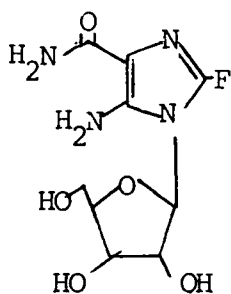

(68)

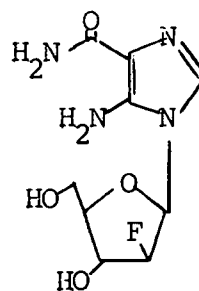

(69)

imidazole nucleosides are not well developed.

DISCUSSION

## CHAPTER THREE

SYNTHESIS OF ORGANOMETALLIC REAGENTS3A. Introduction

The ultimate aim of our work, as stated earlier, is to develop methods for selectively introducing fluorine into AICAR (39). In this chapter and the following two chapters, our development of new methods for selective fluorination of aromatic compounds will be discussed and their possible application to fluorination of imidazole derivatives. At the outset of our work there were very few methods available for the selective fluorination of aromatic compounds and the introduction of fluorine into imidazoles was only possible *via* the Balz-Schiemann reaction.<sup>148</sup> It was necessary, therefore, to develop a new approach towards the fluorination of aromatic compounds in general.

Imidazoles are  $\pi$  electron rich compounds and are prone to electrophilic attack on carbon,<sup>148a</sup> nucleophilic attack occurs only when there is a strongly electron withdrawing group in the ring. Due to this susceptibility of imidazoles to electrophilic attack we have concentrated on the use of electrophilic fluorinating agents, the properties of which were reviewed in Chapter One. It is clear from the results presented that these reagents are not always particularly selective and problems due to addition reactions and poly fluorinations occur, especially in reactions with heterocyclic molecules. A major part of our work, therefore, has been to develop a new methodology for the selective fluorination of aromatic compounds with the aim of extending the approach to fluorination of imidazole derivatives. To this end the approach we

have been developing is the cleavage of aryl-metal bonds with electrophilic fluorinating agents.

The cleavage of aryl-metal bonds by  $\text{Cl}_2$ ,  $\text{Br}_2$  and  $\text{I}_2$  in an electrophilic process, with the organometallic residue as leaving group, is well established<sup>149</sup>:

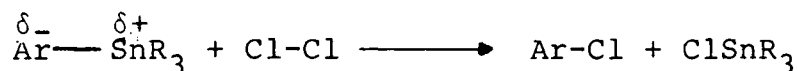

This methodology, however, was not used until recently for fluorinations even though the aryl-metal bond is polarized in the correct manner for reaction with an electrophilic fluorinating agent to give an aryl fluoride.

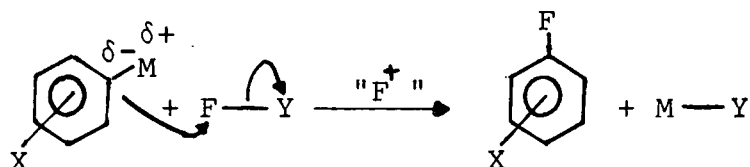

Canadian workers described the preparation of  $^{18}\text{F}$ -labelled arylfluorides by electrophilic cleavage of Ar-M bonds (M=Sn, Pb, Ge, Si, Hg and Tl) with  $\text{CH}_3\text{CO}_2\text{F}$  and fluorine, both labelled with  $^{18}\text{F}$ .<sup>150,151</sup> Electrophilic radiofluorination of aryltrimethylsilanes<sup>152</sup> with these reagents and fluorination of aryl-mercurials with  $\text{CH}_3\text{CO}_2\text{F}$ <sup>153</sup> and fluorine<sup>154</sup> have also been described recently by other groups.

The cleavage of aryl-metal bonds, within the group (IV) elements, becomes easier as the group is descended<sup>97</sup> so our work has been based on the reactions of organostannanes with electrophilic fluorinating agents; we have also carried out some work on the cleavage of aryl-organomercurials. Substitution of an organometallic residue on an aromatic ring strongly activates the carbon atom, to which the metal is bonded, towards electrophilic attack:

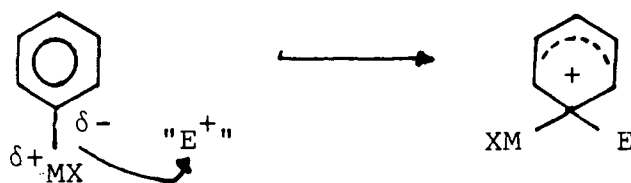

The major advantage, therefore, in cleavage of aryl-metal bonds, compared with direct reaction of the aromatic compound with fluorinating agents, is that the reaction is regioselective. Fluorine is introduced at a known site in a molecule and, unless a large excess of fluorinating agent is present, the formation of difluorinated products and addition products is avoided. A series of model compounds has been synthesised and their reactions with electrophilic fluorinating agents studied prior to studies on imidazole systems.

### 3B. Synthesis of Arylorganostannane Derivatives

#### 1. Model Compounds

The preparation of trialkylarylorganostannanes is well documented<sup>155,156,157,158</sup> and a variety of methods are available, including preparations *via* Grignard reagents, lithio derivatives, stannylsodium derivatives and the use of organoaluminium reagents. The compounds we have prepared have, in general, been synthesised *via* Grignard reagents or organolithium reagents. Table (XII) summarises the model compounds synthesised.

The compounds in Table (XII) were all identified by comparison of observed spectral data with literature values. Purification, in some cases, proved a major problem. Distillation or recrystallization did not always remove all impurities. Trialkyltin chloride used in the preparation and its hydrolysis product trialkyltin hydroxide were the main impurities.

TABLE XII

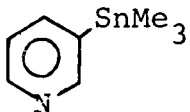
Compound No.	Organostannane	b. p. (m. p)	Yield (%)	Method <sup>a</sup>	Ref.
70	Ph <sub>4</sub> Sn	(234°C)	74	A	158
71	PhSnMe <sub>3</sub>	97°C/18 mmHg	65	B	155
72	p-MeC <sub>6</sub> H <sub>4</sub> SnMe <sub>3</sub>	97°C/4 mmHg	48	B	155
73	p-MeOC <sub>6</sub> H <sub>4</sub> SnMe <sub>3</sub>	130°C/14 mmHg	50	B	159
74	p-ClC <sub>6</sub> H <sub>4</sub> SnMe <sub>3</sub>	110°C/5.5 mmHg	41	A	155
75		60°C/10 mmHg	35	C	157
76	PhSn(n-Bu) <sub>3</sub>	168°C/5 mmHg	59	B	160
77	p-MeC <sub>6</sub> H <sub>4</sub> Sn(n-Bu) <sub>3</sub>	139°C/0.1 mmHg	35	B	161
78	p-MeOC <sub>6</sub> H <sub>4</sub> Sn(n-Bu) <sub>3</sub>	150°C/0.1 mmHg	44	A	162
79	PhSn(cyclo-C <sub>6</sub> H <sub>11</sub> ) <sub>3</sub>	(195-196°C)	30	B	155
80	p-MeOC <sub>6</sub> H <sub>4</sub> Sn(cyclo-C <sub>6</sub> H <sub>11</sub> ) <sub>3</sub>	(100°C)	38	B	155
81	p-Me <sub>2</sub> NC <sub>6</sub> H <sub>4</sub> Sn(cyclo-C <sub>6</sub> H <sub>11</sub> ) <sub>3</sub>	(145-146°C)	55	A	155

(a) Method of Preparation: A - *via* Organolithium derivative  
 B - *via* Grignard Reagent  
 C - *via* Me<sub>3</sub>SnLi

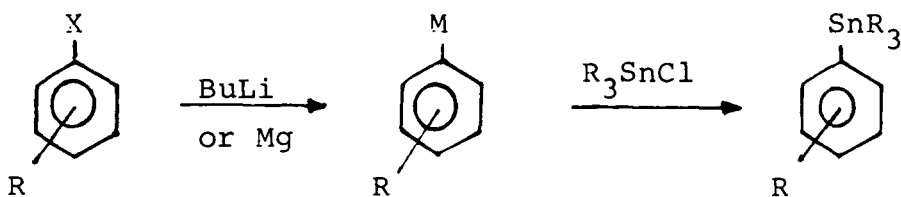

M = Li or MgX

X = Cl or Br.

Addition of sodium or potassium fluoride to the reaction mixture, during work up, can remove some of the residual trialkyltin chloride by converting it to insoluble trialkyltin fluoride. Repeated distillation or recrystallization can then, eventually, lead to pure product. P-Methoxyphenyltributyltin, however, was not obtained analytically pure. After several distillations impurity remained in the sample as can be seen in the proton nmr spectrum.

Trialkylarylstannanes containing methyl-, butyl- or cyclohexyl- groups attached to tin were synthesized in order to determine what effect, if any, the nature of the alkyl group has on the cleavage reaction. It has been suggested by Eaborn and co-workers<sup>162</sup> that longer chain alkyl groups increase the rate of cleavage of the tin-aryl bond by stabilizing the carbocationic intermediate. This effect will be discussed in more detail later. The effect on the cleavage reaction by varying the substituents on the aromatic ring was also studied as aromatic derivatives with a variety of substituents were stannylated.

## 2. Imidazole Derivatives

Organostannane derivatives of two, simple imidazoles have been synthesized; N-methylimidazole (82) and 1,2-dimethylimidazole (83).

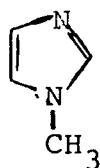

(82)

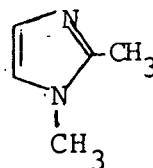

(83)

These compounds were chosen as their trimethylstannyl- and tributylstannyl- derivatives have already been reported.<sup>163,164</sup> The organostannane derivatives, shown in Table XIII, were synthesized *via* organolithium derivatives. Both 5-trimethylstannyl- (84) and 5-tri-*n*-butylstannyl-1,2-dimethylimidazole (85)

TABLE XIII

Compound No.	Organostannane	Yield (%)
84		43
85		Crude Product
86		25

were synthesized. Metallation occurs primarily at the 5-position rather than on the 2-methyl group in 1,2-dimethylimidazole. The position of substitution depends on the hardness or softness of the quenching electrophile.<sup>148</sup> Removal of a proton from the 5-position of 1,2-dimethylimidazole



generates a harder base (anionic charge present in  $sp^2$  hybridised orbital) than one generated by removal of a proton from the 2-methyl group (charge probably present in a p-orbital assuming  $sp^2$ -hybridisation of the side chain carbon atom):

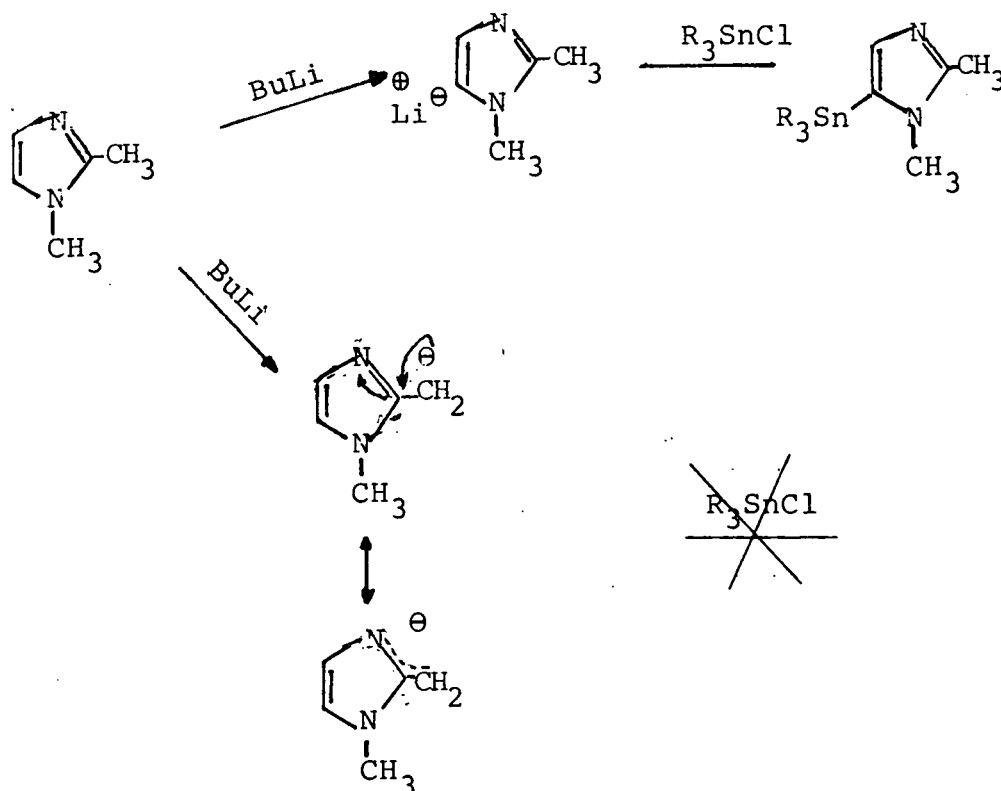

Electrophilic reagents, therefore, which are hard acids (*e.g.*  $Me_3SnCl$  or  $Bu_3SnCl$ ) result in exclusive substitution at the 5 position. Softer acids quench at the 2 position, *e.g.*  $Me_2S_2$ . There are problems in purifying the tributyltin-derivative (85) due to the formation of tributyltin hydroxide, which is insoluble in water and is not removed by aqueous washing of the product. Attempts were made to remove this impurity by column chromatography. Proton n.m.r. spectra, however, show that some impurity remains even after repeatedly chromatographing the product.

2-Trimethylstannyl-N-methylimidazole (86) was synthesized in an analogous manner and obtained analytically pure

after reduced pressure distillation. The most acidic proton in N-methylimidazole is at the C-2 position; butyllithium, therefore, removes this proton preferentially forming 2-imidazolyl lithium which, when quenched with trimethyltin chloride produces 2-trimethylstannyl-N-methylimidazole:

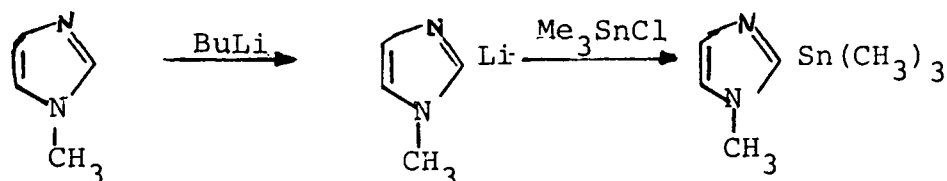

### 3C. Synthesis of Organomercurials

Three organomercurials have been synthesized: diphenylmercury (87), p-anisylmercuryacetate (88) and 1,2-dimethyl-5-aceto-mercuryimidazole (89). Diphenylmercury was prepared by a standard literature method.<sup>165</sup> Care had to be taken to ensure

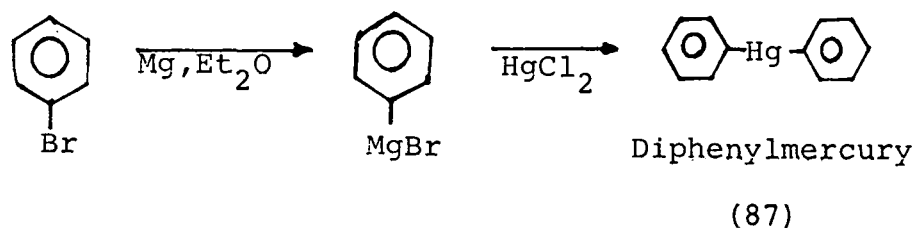

the Grignard reagent was always in excess over mercuric chloride and that no magnesium came into contact with the product in the absence of Grignard reagent. These precautions prevent the formation of phenylmercury chloride.

Anisylmercury acetate was synthesized by direct mercuration of anisole using mercuric acetate in acetic acid solution. Anisylmercury acetate precipitates out from the reaction medium and is isolated by filtration. A pure sample was obtained after recrystallization which removed acetic acid trapped as solvent of recrystallisation. The ability of organomercury

acetates to trap acetic acid has been reported in other preparations.<sup>166</sup> 1,2-Dimethylimidazole was also directly mer-

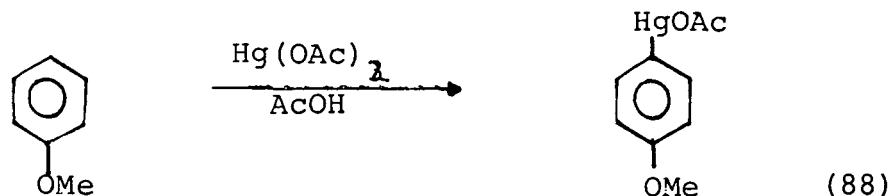

Yield 27% m.p. 184°C

curated using the same conditions as above. The yield, however, was very low. Replacing acetic acid with methanol as solvent resulted in a much higher yield and easier purification of the product. Problems were not encountered, of methanol acting as solvent of crystallization.

Direct mercuriation takes place *via* an electrophilic substitution mechanism and so occurs primarily at the C-4 position of an N-protected imidazole.<sup>148</sup>

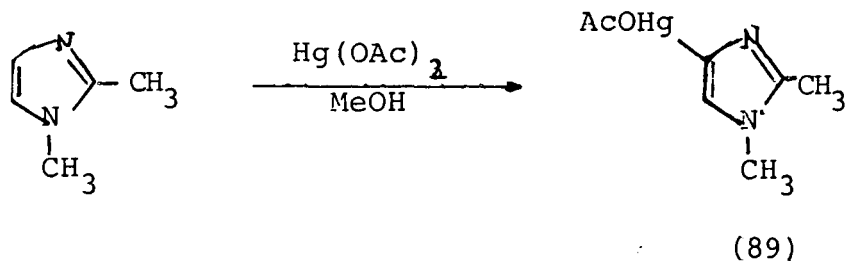

## CHAPTER FOUR

SELECTIVE FLUORINATION OF AROMATIC COMPOUNDS4A. Introduction

The method we have developed for selective fluorination is the cleavage of aryl-metal bonds using trifluoromethylhypofluorite, caesium fluoroxy sulphate or elemental fluorine. It will be shown that, by this method fluorination of aromatic molecules can be achieved at a specific site with few by-products being formed and in some cases no detectable side products at all. This is a significant improvement over direct reaction of aromatics with electrophilic fluorinating agents, where mixtures of isomers are often formed along with byproducts due to addition reactions, and the Balz-Schiemann reaction.<sup>167</sup> Fluorination reactions were first carried out on model compounds to test the viability of method as a general route to fluoroaromatics. Attempts were then made to extend the method to the introduction of fluorine into imidazole derivatives.

Trifluoromethylhypofluorite ( $\text{CF}_3\text{OF}$ ) has been, by far, the most widely used electrophilic fluorinating agent, therefore it seemed the ideal reagent with which to begin our investigations. This is the first study of the reactions of  $\text{CF}_3\text{OF}$  with organometallics.

4B. Reactions of Trifluoromethylhypofluorite1. Model Compounds

Fluorinations using trifluoromethylhypofluorite ( $\text{CF}_3\text{OF}$ ) were performed by bubbling the gas through a dilute solution

of the organometallic derivative (70,71,87,88) in chloroform or dichloromethane. Results are shown in Table (XIV). Products were identified by glc-mass spectrometry and  $^{19}\text{F}$  n.m.r. by

TABLE XIV

Starting Material	Product	Yield (%) <sup>a</sup>	$\delta_{\text{F}}$ (ppm)
$\text{Ph}_4\text{Sn}$ (70)	PhF	22	114
$\text{Me}_3\text{SnPh}$ (71)	PhF	50	114
$\text{Ph}_2\text{Hg}$ (87)	PhF	83	114
p-MeOC <sub>6</sub> H <sub>4</sub> HgOAc (88)	p-MeOC <sub>6</sub> H <sub>4</sub> F	86	126

(a) glc yields.

comparison with authentic samples. The higher yield of fluorobenzene obtained from reaction of trimethylphenyltin compared with tetraphenyltin indicates that the trimethyltin residue is a better leaving group, in electrophilic cleavage reactions, than the triphenyl tin group. This result is in

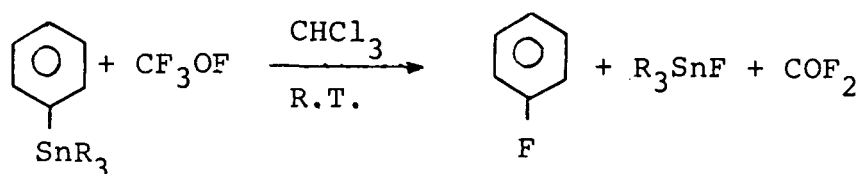

agreement with published data<sup>150,168,169</sup> and the effect can be attributed to negative induction effects of the non-cleaved phenyl groups in tetraphenyltin which withdraw electron density along the  $\sigma$  framework, thus deactivating the aryl-tin bond to electrophilic attack. Back donation through  $d_{\pi}-p_{\pi}$  interaction, between tin and phenyl groups, is not sufficient to outweigh the electron withdrawal. Methyl substituents, however, have a positive induction effect and so activate the aryl-tin bond to electrophilic attack, the trimethylstannyl group is also able

to stabilise the intermediate carbocation (90) to a greater extent than the triphenyltin group:

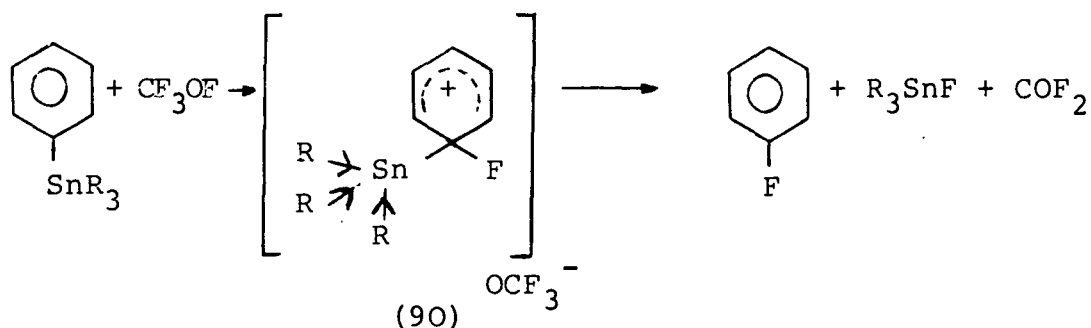

The solid residues obtained in the reaction analyse as triorganotin fluorides. From reaction of tetraphenyltin both diphenyltin difluoride and triphenyltin fluoride are formed indicating that cleavage of more than one phenyl group takes place; no alkyl-tin bond cleavage occurs with trimethylphenyltin, however, the only solid product is trimethyltin fluoride. The cleavage reaction occurs *via* an electrophilic substitution reaction (Figure 26); mechanisms involving radical cations have been proposed for reaction of acetylhypofluorite<sup>34</sup> with organometallics, but such mechanisms are unlikely to occur in our reactions due to the polarity of the carbon-tin bond. Also we would expect to observe trifluoromethoxy derivatives if a radical reaction had occurred. We have not observed such derivatives in any product mixtures.

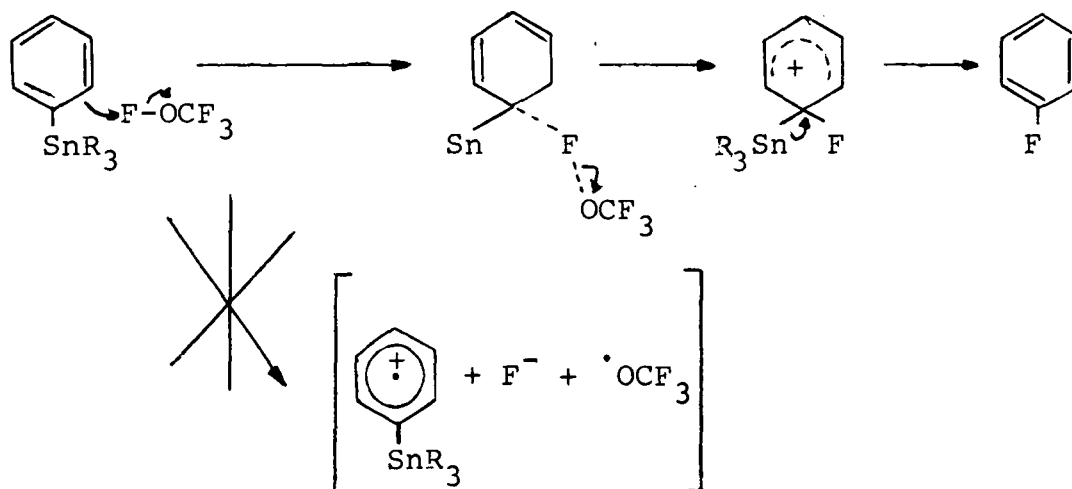
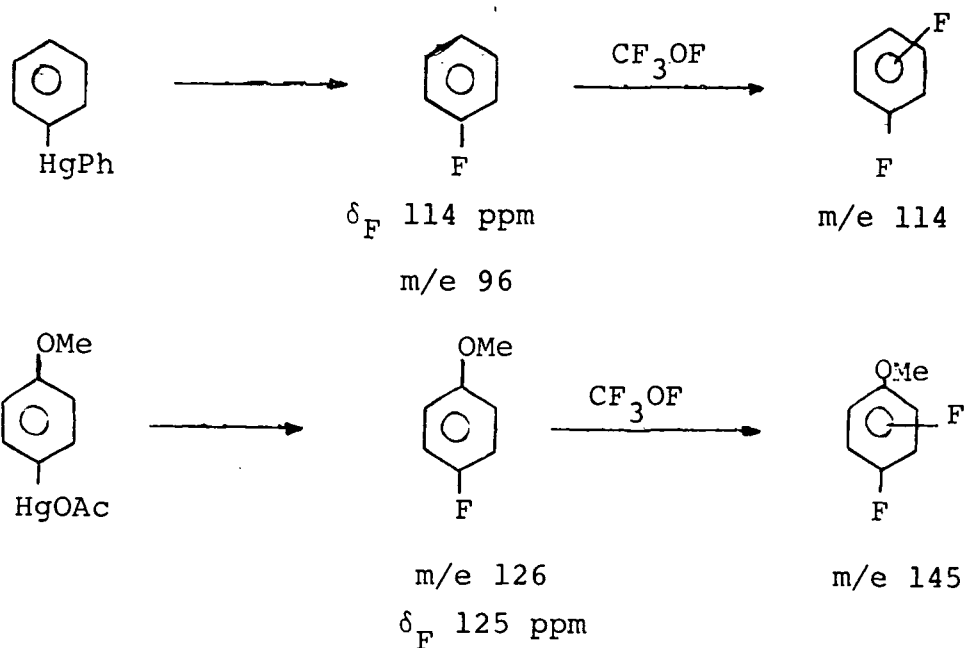

FIGURE 26

Yields of fluorobenzenes obtained from cleavage of aryl-mercury bonds were higher than those from organostannanes. Some difluorinated products are observed, however, probably due to radical reactions occurring as in the fluorination of aryl-mercurials using acetylhypofluorite<sup>170</sup> or the reaction of  $\text{CF}_3\text{OF}$  with fluorinated products. The major product from cleavage of diphenylmercury is fluorobenzene; from anisylmercuryacetate p-fluoroanisole is obtained but, in this case the amounts of difluorinated products are greater. The difluorinated materials are formed by reaction of fluorobenzene or p-fluoroanisole with excess  $\text{CF}_3\text{OF}$ :



It is important to note, however, that in reactions of both organostannanes and organomercurials selective fluorination, by cleavage of the metal-aryl bond, has taken place and the impurities, though present in some cases, are very small.

## 2. Imidazole Derivatives

The approach described above was extended to the synthesis of 5-fluoro-1,2-dimethylimidazole by bubbling  $\text{CF}_3\text{OF}$  through a solution of 1,2-dimethyl-5-trimethylstannylimidazole in chloroform.

Trimethyltinfluoride was isolated suggesting that a cleavage reaction had occurred and  $^{19}\text{F}$  n.m.r. spectroscopy of the product mixture shows a peak at 154 ppm which, when compared with literature data on fluoroimidazoles, indicates that 5-fluoro-1,2-dimethylimidazole has been formed. The product, however, was not prepared in sufficient quantity to isolate.

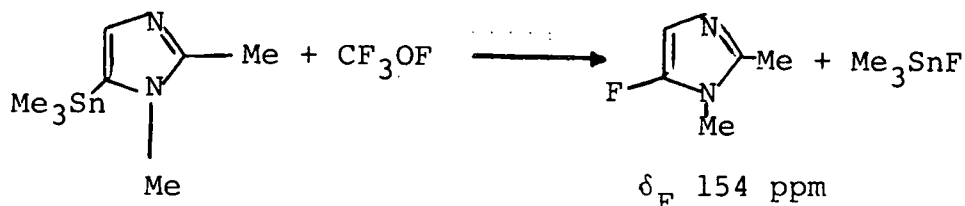

At this point our available stocks of  $\text{CF}_3\text{OF}$  were exhausted and we found it impossible to obtain the reagent commercially. Considering the difficulties associated with attempting to synthesize  $\text{CF}_3\text{OF}$  on a large scale in the laboratory we decided to turn our attention to caesium fluoroxysulphate. There were two major reasons for using caesium fluoroxysulphate; (a) it is relatively easy to prepare on a large scale and (b) it is easier to handle than any of the gaseous fluorinating agents available. A review of its chemistry is given in Chapter One.

#### 4C. Reactions of Caesium Fluoroxysulphate

Our method of preparation of  $\text{CsSO}_4\text{F}$  is basically the same as that used by Appelman,<sup>49</sup> however, we have increased the scale of reaction and routinely fluorinate 80g of caesium sulphate. The method involves bubbling a 20% mixture of fluorine in nitrogen through an aqueous solution of caesium sulphate cooled in an ice/salt bath. An off-white solid precipitates out of solution and is collected by filtration. The yield of  $\text{CsSO}_4\text{F}$  is generally about 44%, this rather low yield is due mainly to



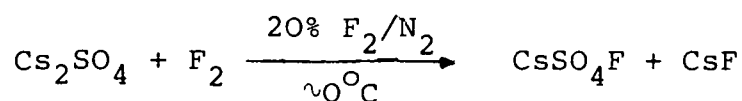



loss of product through decomposition in water. Therefore in order to maximise the yield a saturated solution of caesium sulphate is used as the reaction temperature kept as low as possible. The product is filtered off at regular intervals, during the reaction, to avoid prolonged contact with water, this also avoids losses due to decomposition. Once the reagent is dry it can be stored at  $-10^\circ\text{C}$  for several months without appreciable loss of oxidising strength, which is determined by iodometric titration prior to use. Typically the oxidising strength is 6.6 mequiv/g out of a theoretical maximum of 8.1 mequiv/g. The main impurities,  $\text{Cs}_2\text{SO}_4$  and  $\text{CsF}$ , could, in principle, be removed by washing the product with water, however we have found that this results in rapid decomposition of caesium fluoroxysulphate. The only special precautions taken in handling this reagent have been to use a teflon spatula, thus avoiding contact with metallic surfaces, and to avoid heating the material. We have found that the only suitable solvent for the reagent is acetonitrile, generally the reagent is used as a solution-suspension in acetonitrile as it is not particularly soluble. It is completely insoluble in most other organic solvents and can form explosive mixtures with chlorinated solvents.

#### 1. Model Compounds

A series of substituted aryl-trialkylstannanes have been reacted with caesium fluoroxysulphate by stirring an excess of the organostannane in acetonitrile solution with the fluorinating agent at room temperature. The reagent is partially soluble in acetonitrile. The product solutions were analysed by

glc-mass spectrometry and  $^{19}\text{F}$  n.m.r., the products being identified by comparison of spectral data with authentic samples. The reactions are described in Table (XV) and

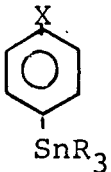
TABLE XV

Starting Material		Product %
		
X	R	Yield (%)
(71) H	Me	69
(72) Me	Me	86
(73) OMe	Me	79
(74) Cl	Me	87
(78) OMe	n-Bu	42 <sup>b</sup>
(77) Me	n-Bu	11 <sup>b</sup>
(79) H	cyclohexyl	0 <sup>b</sup>
(80) OMe	cyclohexyl	0 <sup>b</sup>

(b) Organostannane insoluble in acetonitrile.

are, by the nature of the process, regiospecific. In all examples where cleavage of the aryl-metal bond took place only one signal appears in the  $^{19}\text{F}$  n.m.r. spectrum of the product mixture and this corresponds to p-fluoroderivatives. It is important to note that, unlike  $\text{CF}_3\text{OF}$  fluorinations, no difluorinated products are observed. This is almost certainly due to the fact that the stoichiometry of the reaction can be accurately controlled with the fluorinating agent never being in excess. The ratio of organostannane to  $\text{CsSO}_4\text{F}$  was generally 1.5:1 though increasing this to 1:1 does not markedly effect the

reaction. Caesium fluoroxysulphate is also a milder fluorinating agent than  $\text{CF}_3\text{OF}$  especially as it is normally used as a suspension or, when acetonitrile is used as solvent, as a very dilute solution.

The mechanism of reaction is probably an ionic electrophilic substitution rather than a radical process (Figure 27). The observation that increasing the electron donating strength of substituents on the aromatic ring increases the yield of fluoroaromatic products supports this mechanism, along with the lack of reaction with the methyl substituent in p-tolyl-

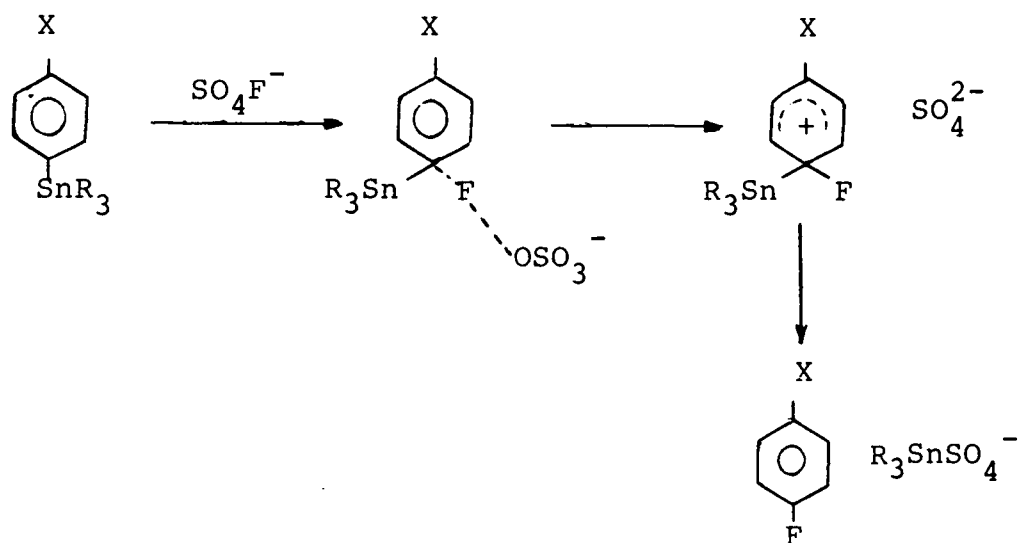
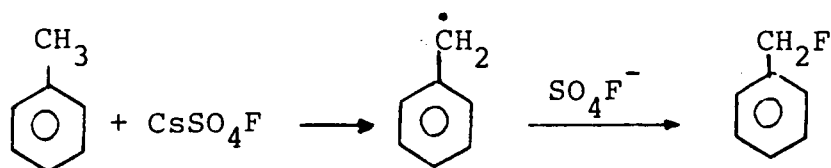

FIGURE 27

trimethylstannane to give benzylfluoride derivatives. Toluene, itself, reacts by a radical process to give benzyl fluoride as the major product:<sup>53</sup>



No ring degradation products nor biphenyls, which are reported to be formed by radical reaction of  $\text{CsSO}_4\text{F}$  with aromatics, have been detected.<sup>53</sup> It therefore appears that the trialkyltin groups activate the aryl-tin bond to electrophilic attack sufficiently to avoid any radical reactions. Keeping the fluorinating agent in a deficiency also prevents formation of by-products by radical reaction of excess  $\text{CsSO}_4\text{F}$  with aryl-fluoride products.

The trimethyltin group is replaced with F in high yield, in all reactions studied, but cleavage of  $n\text{-Bu}_3\text{Sn}$  groups (77) and (78) is far less efficient and cleavage of the tricyclohexylstannyl was not effected at all by  $\text{CsSO}_4\text{F}$ . The low reactivity of  $\text{CsSO}_4\text{F}$  with (77), (78), (79) and (80) is probably due to their low solubility in acetonitrile. Mixed solvent systems with  $\text{CH}_3\text{CN}$  and  $\text{CHCl}_3$  were used, in which the organostannane was soluble, but again very little reaction occurred. In this case  $\text{CsSO}_4\text{F}$  was found to be insoluble. As well as problems due to solubility, the larger alkyl groups may cause steric hindrance towards approach of  $\text{CsSO}_4\text{F}$  to the aryltin bond. This result was not predicted as increasing the size of the alkyl groups in the trialkyltin residue has been reported to increase reactivity of organostannanes towards electrophilic cleavage reactions.<sup>162</sup>

The reaction of phenyllithium with  $\text{CsSO}_4\text{F}$  has also been studied by generating organolithium in ether then adding solid  $\text{CsSO}_4\text{F}$  at room temperature. Organolithium derivatives which are readily produced are generally very reactive towards electrophiles, including electrophilic fluorinating agents such as  $N$ -fluoro- $N$ -alkylsulphonamides.<sup>79</sup> It was hoped that  $\text{CsSO}_4\text{F}$

would react with phenyllithium to give fluorobenzene and a mixture of lithium and caesium sulphate. After aqueous work-up of the reaction, however, the only organic product detected was benzene and the solid isolated by filtration of the reaction mixture was strongly oxidising. This would appear to indicate that no reaction has taken place and that phenyllithium was quenched by water to give benzene. The problem could again be lack of solubility of  $\text{CsSO}_4\text{F}$  in diethyl ether; acetonitrile cannot be used as solvent as this reacts with phenyllithium. It is also possible that fluoroxysulphate, being an anionic electrophile, is prevented from approaching the phenyl carbanion due to electrostatic repulsions. The reaction of  $\text{CsSO}_4\text{F}$  with organostannanes should be generally applicable to any organometallic derivatives. Any pseudo carbanion, which is soluble in acetonitrile and does not react with it, should react with  $\text{CsSO}_4\text{F}$  to give a monofluorinated derivative. There is a wide scope for the study of reactions of organosilanes and many other organometallics:

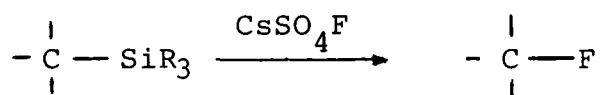

## 2. Imidazole Derivatives

Attempts have been made to synthesize fluorinated-imidazole derivatives by reaction of trialkylstannylimidazoles with  $\text{CsSO}_4\text{F}$ . Solutions of 1,2-dimethyl-5-trimethylstannylimidazole have been treated with  $\text{CsSO}_4\text{F}$  without success. In all cases tar formation occurred even when the reaction was cooled to  $-45^\circ\text{C}$ . The solvent system was also varied by using chloroform-methanol mixes but tar formation still occurred. Since reaction of  $\text{CsSO}_4\text{F}$  with pyrimidines gives monofluorinated pyrimidines<sup>56</sup> we

have attempted to prepare monofluorinated imidazoles by direct reaction of 1,2-dimethyl- and 1-methylimidazole with  $\text{CsSO}_4\text{F}$  in methanol. Tar formation again occurred with no fluorinated products being isolated.

Despite the fact that reaction of  $\text{CsSO}_4\text{F}$  with organostannane derivatives of substituted benzenes leads to efficient and stereospecific formation of monofluorobenzenes the use of  $\text{CsSO}_4\text{F}$  has not provided a viable route to monofluorinated imidazoles.



#### 4D. Reactions of Elemental Fluorine

##### 1. Model Compounds

Since the onset of our work other groups have reported the cleavage of aryl-tin bonds, using fluorine, to give fluoroaromatics.<sup>150,173</sup> Previously, however, this method has been used for the introduction of  $^{18}\text{F}$ -labelled fluorine into aromatic molecules for use in position emission tomography<sup>151,172</sup> and the scale of reaction has been small, typically on the micromol scale using very dilute fluorine in nitrogen. We have attempted to effect fluorination on a larger scale with the use of more concentrated fluorine in nitrogen, to compare the effectiveness of fluorine as an electrophilic fluorinating agent with caesium fluoroxysulphate. In a typical reaction a 10-20% mixture of fluorine in nitrogen was bubbled through a solution of an arylorganostannane in  $\text{CFCl}_3$  cooled to  $-70^\circ\text{C}$ . The gas inlet has to be of wide bore to prevent trialkyltin fluoride blocking it as it precipitates. An excess of  $\text{F}_2$  was used followed by allowing the mixture to warm to room temperature over several hours. Product solutions were analysed by glc-mass

spectrometry and  $^{19}\text{F}$  n.m.r., products being identified by comparison of spectra with standard solutions. Results obtained are shown in Table (XVI).

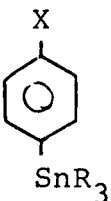
TABLE XVI

Starting Material		Product	
			
R	X	Yield(%)	
(71) Me	H	30	
(72) Me	Me	57	
(73) Me	OMe	60	
(74) Me	Cl	67	
(76) nBu	H	41	
(79) $\text{C}_6\text{H}_{11}$	H	47	

The major product in all the reactions was a p-fluorinated benzene derivative showing that fluorination is again regio-specific. Unlike  $\text{CsSO}_4\text{F}$  fluorinations, however, fluorine tended to give difluorinated products, especially with the more reactive organostannanes. From the reaction of trimethylphenyltin the main product is fluorobenzene, glc-mass spectrometry, however, shows a second product, only as a very small impurity, with a mass spectrum corresponding to difluorobenzene. This indicates that fluorine is reacting with monofluorobenzene subsequent to the cleavage reaction:

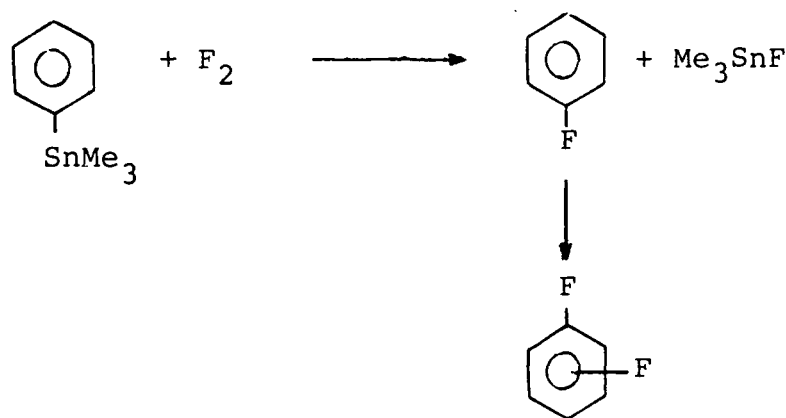

No other impurities were observed, nor any products from further substitution or addition reactions. No difluorinated products were detected from the reaction of p-tolyltrimethylstannane although reaction of p-anisyltrimethylstannane does result in the formation of difluorinated anisole derivatives, in less than 5% yield, alongside p-fluoroanisole which is the major product:

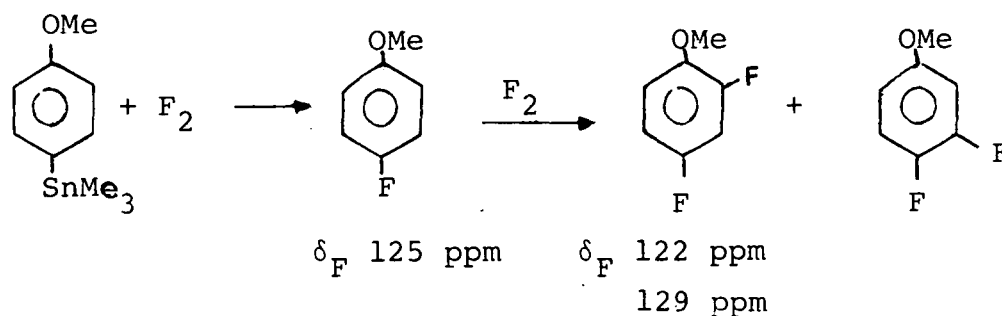

The reaction of anisole with fluorine has been carried out by bubbling 10%  $F_2/N_2$  through a solution of anisole in  $CFCl_3$  at  $-78^\circ C$  using a capillary gas inlet. The  $^{19}F$  n.m.r. spectrum of the product mixture was compared with that obtained from reaction of p-anisyltrimethylstannane with  $F_2$ . Grakauskas<sup>61</sup> has performed similar direct fluorinations of substituted aromatics in acetonitrile and obtained mixtures of o-, m- and p-fluoroaromatics in all cases. The major product from reaction of anisole is *ortho*-fluoroanisole<sup>61</sup> along with p-fluoroanisole and 2,4-difluoroanisole:



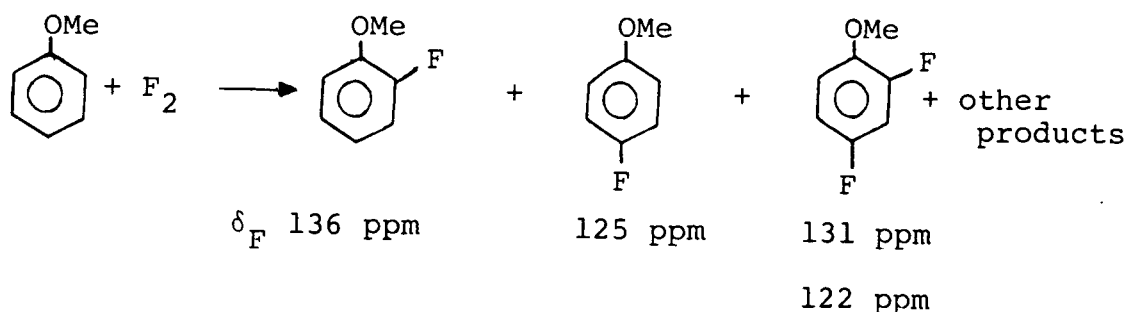

Ratio

5.2 : 3.4 : 1

Comparison of results from the two reactions show that it is possible for the difluorinated anisole derivatives to be formed by reaction of p-fluoroanisole with fluorine. This reaction will generate HF, which, itself, cleaves the aryl-tin bond of p-anisyltrimethylstannane to give the very small quantities of anisole observed in the glc-mass spectrum. Reaction of p-chlorophenyltrimethylstannane with  $\text{F}_2$  gave only p-chlorofluorobenzene with no detectable difluorinated products.

Similar results to those described for trimethylarylstannanes have been obtained for tri-nbutyl and tricyclohexylstannyl benzene derivatives. Major products are always mono-fluorobenzenes with small amounts of difluorinated products being formed:

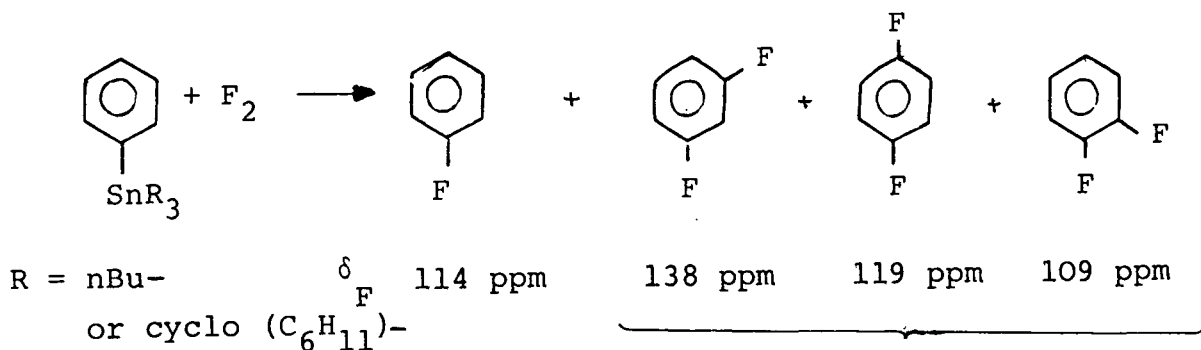

less than 5%

The cleavage of aryl-tin bonds by the other halogens<sup>149</sup> is an electrophilic process so it is likely that cleavage of aryl-tin bonds by fluorine occurs *via* an ionic electrophilic mechanism (Figure 28) rather than a free radical mechanism. This is supported by the observation that electron donating groups on the aromatic ring increase the yield of monofluoroaromatic product. Furthermore, if a free radical mechanism occurred, abstraction of a hydrogen atom from the methyl-side chain in *p*-tolyltrimethylstannane would be expected rather than cleavage of the carbon-tin bond. No products due to this type of reaction were observed:

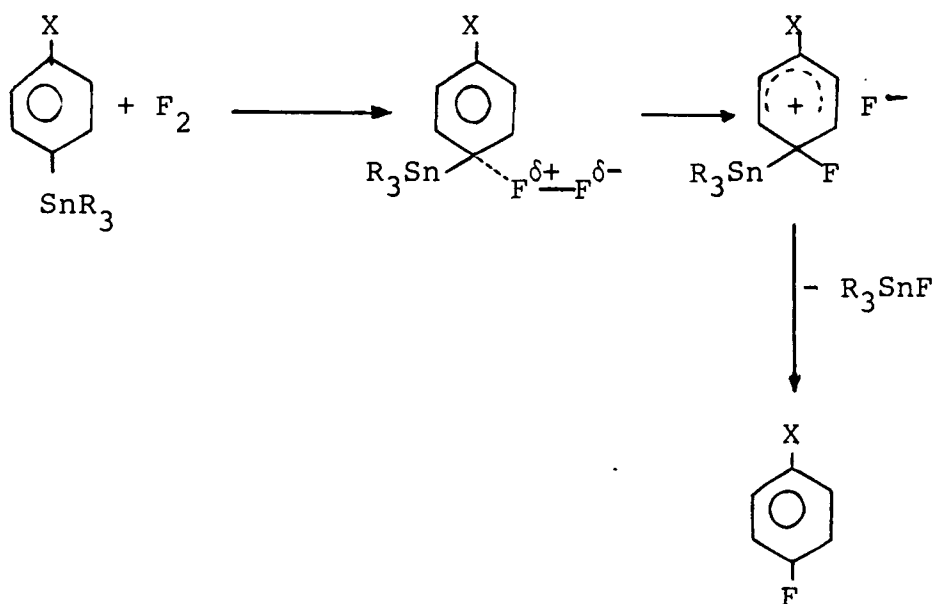
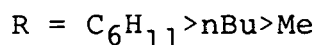
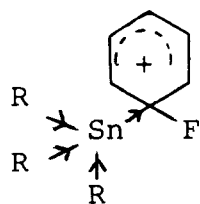

FIGURE 28

A major difference between fluorinations using  $\text{CsSO}_4\text{F}$  and elemental fluorine is that for the latter there is an increase in yield with increasing size of the alkyl substituents on tin. This is due to an increase in the ability of the alkyl groups, with size, to stabilize the carbocationic intermediate by electron donation. This is observed in the reaction with fluorine as all the organostannane are soluble in  $\text{CFCl}_3$ . A similar

effect has been seen in cleavage reactions of iodine:<sup>162</sup>



←  
increasing electron donation

In general, however, it must be noted that reactions involving fluorine are less easy to control than those of  $CsSO_4F$  and the yields of *mono*-fluoroaromatics lower with more difluorination occurring. We have firmly established that  $CsSO_4F$  cleavage reactions provide a better route to fluoroaromatics *via* trimethylstannyl derivatives.

## 2. Imidazole Derivatives

Unlike the reaction of organostannane derivatives of imidazoles with  $CsSO_4F$ , some success has been achieved in synthesizing *mono*-fluoroimidazoles using fluorine. We have reacted 1,2-dimethyl-5-trimethylstannylimidazole (84) and a mixture of 2-trimethylstannyl-(86) and 5-trimethylstannyl-N-methylimidazole (91) with fluorine at  $-78^\circ C$ . Analysis of the crude product mixtures by  $^{19}F$  n.m.r. spectroscopy and comparison with literature data for fluorinated imidazole derivatives<sup>99</sup> indicates that the expected fluoro-imidazole derivatives (92), (93) and (94), respectively, have been formed. These products were not, however, isolated as the reactions were not carried out on a large enough scale. These preliminary results do indicate, though, that cleavage of aryl-tin bonds is a viable route to fluoroimidazoles and may be a more successful method than the modified Balz-Schiemann processes.<sup>174</sup>

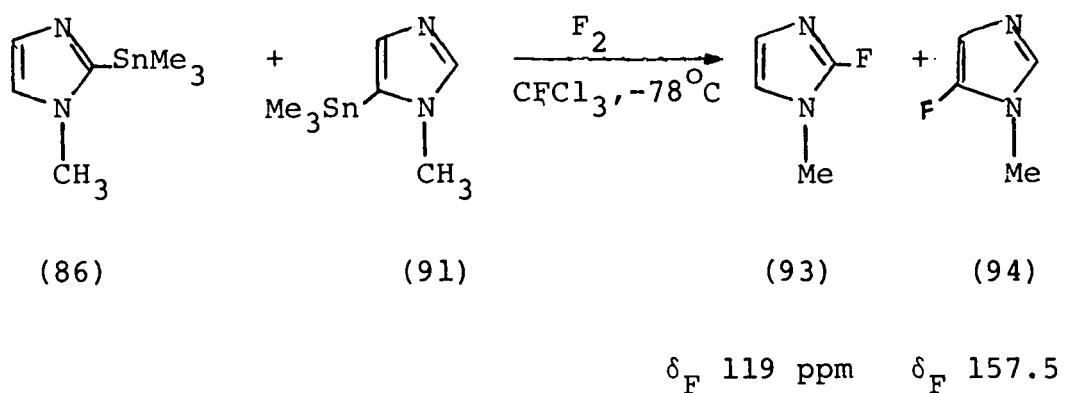
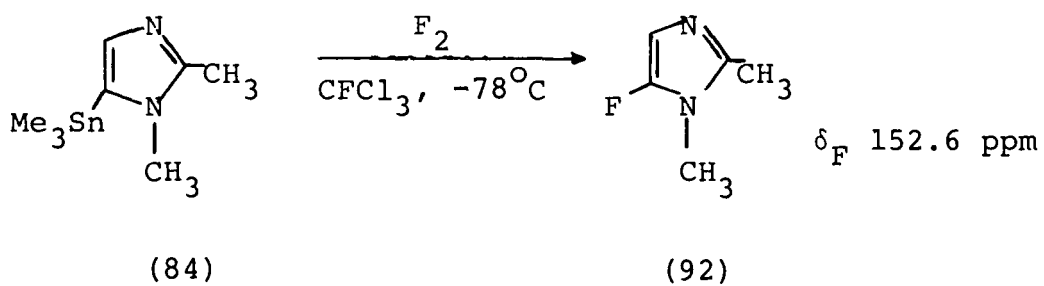

## CHAPTER FIVE

PREPARATION OF FLUORINATED NUCLEOSIDESINTRODUCTION

The approach we are developing towards the selective introduction of fluorine into the sugar fragment of AICAR involves protection and selective deprotection of hydroxyl functions in the nucleoside molecule using methods which have previously been applied to purine and pyrimidine nucleosides.<sup>127,175</sup> The overall strategy involved trying to obtain a derivative containing only one free hydroxyl function, converting this hydroxyl function into a triflate derivative and then attempting to form the fluoro-sugar derivative by fluoride ion displacement:

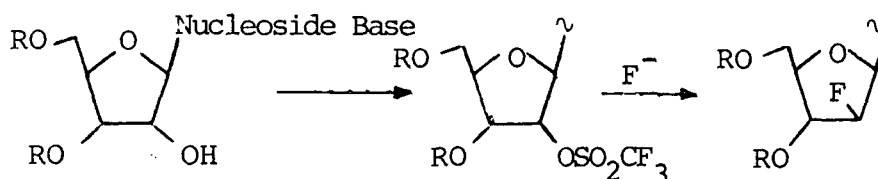

Protection and deprotection reactions, involving the benzoate group have been well established by us and we are continuing to work on the synthesis of triflate derivatives and their displacement by fluoride ion.

5A. Protection Reactions

The protection of AICAR has been based on benzylation reactions, the general scheme is shown in Figure (29). Initially we attempted to prepare the tetrabenzoate derivative of AICAR (95) by a single step synthesis, however treatment of

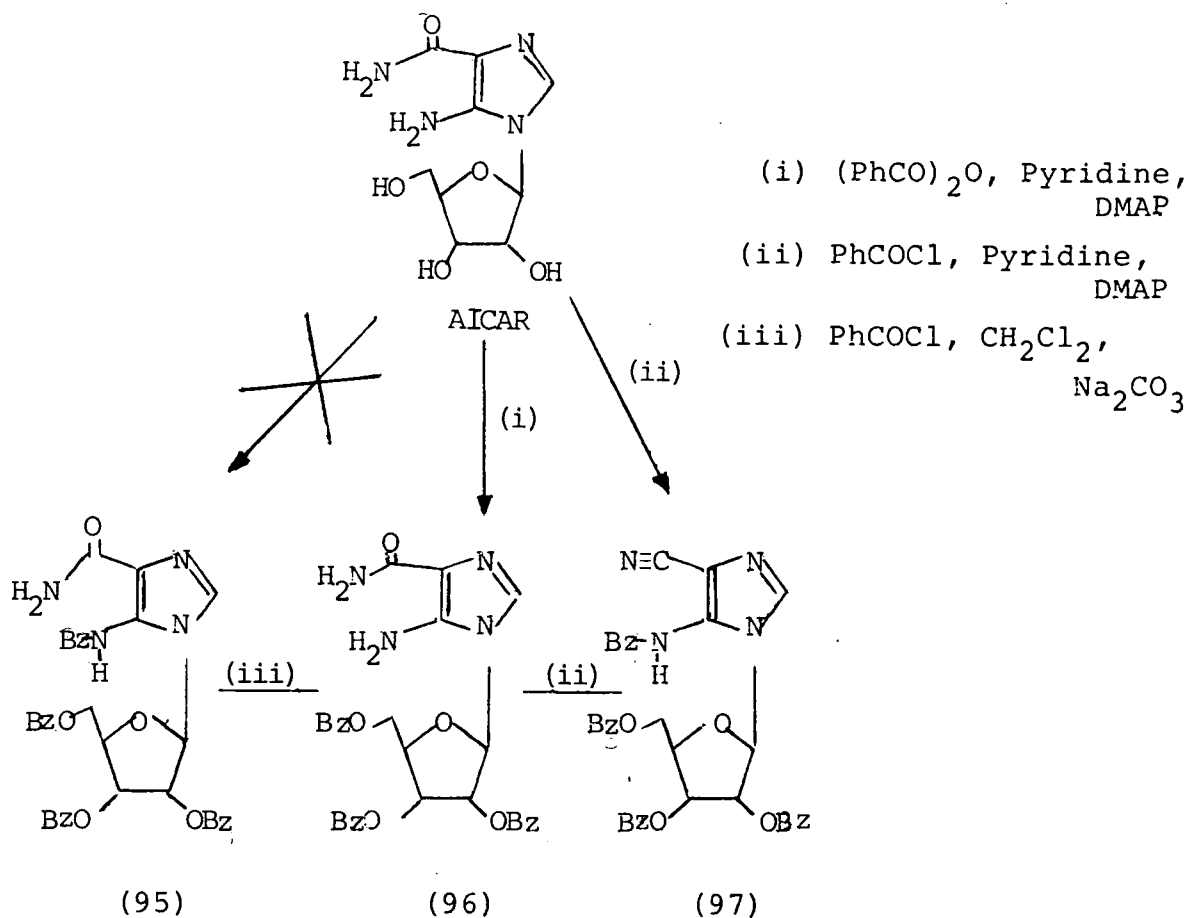
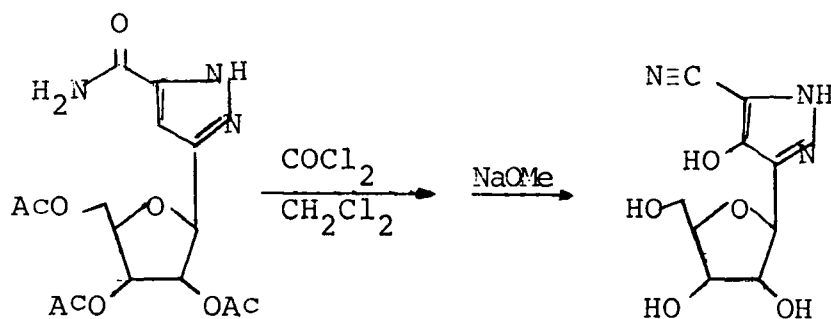

FIGURE 29

AICAR with benzoyl chloride in pyridine resulted in dehydration of the amide function of AICAR, along with protection of the hydroxyl and amino groups to give the benzoylated nitrile derivative (97) in 42% yield. Dehydration of amides, by acid anhydrides or acid chlorides in pyridine has been reported<sup>176,177</sup> and so has the dehydration of amide functions in nucleosides,<sup>178</sup> where phosgene is used:



We have prepared the tetrabenzoate (95) by a two-stage synthesis; (a) benzylation of the hydroxyl groups in AICAR to give (96) and (b) N-benzylation of (96) to give the tetrabenzoate (95).

Benzylation of the hydroxyl functions in AICAR was effected by benzoic anhydride in pyridine to give (96) (in 80% yield after chromatography), however benzoic anhydride is not a strong enough acylating agent to react with the C-5 amine group nor does it cause dehydration of the C-4 amide function. The proton n.m.r. spectrum of (96) is shown in Figure (30). It is interesting to note that the amide protons are inequivalent appearing as broad peaks at 6.7 and 6.8 ppm. In comparison to the  $^1\text{H}$  n.m.r. spectrum of AICAR (Figure 31) signals due to 1', 2', 3', 4', 5', protons all move downfield by over one ppm due to deshielding effects of the benzoate groups. The C-2 proton signal moves far enough downfield to be covered by the signals due to the benzoate group protons.

Subsequent reaction of the tribenzoate (96) with benzoyl chloride in dichloromethane in the presence of  $\text{Na}_2\text{CO}_3$  resulted in formation of (95) (27% yield). Even under such mild conditions, however, the nitrile derivative (97) was also formed (29% yield), and further treatment of (96) with benzoylchloride in pyridine gave the nitrile derivative (97) exclusively. Dehydration of the amide occurs by benzylation of the carbonyl oxygen followed by removal of the imine proton and loss of the benzoate group:

FIGURE 30

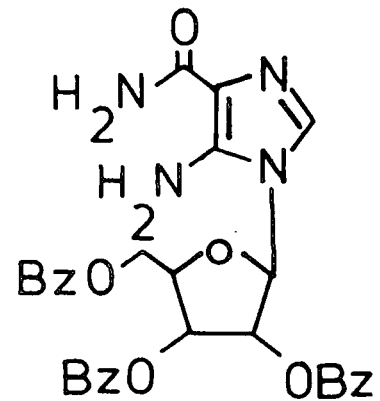

a = 1' proton  
b = 2' "  
c = 3' "  
d = 4' "  
e = 5' "

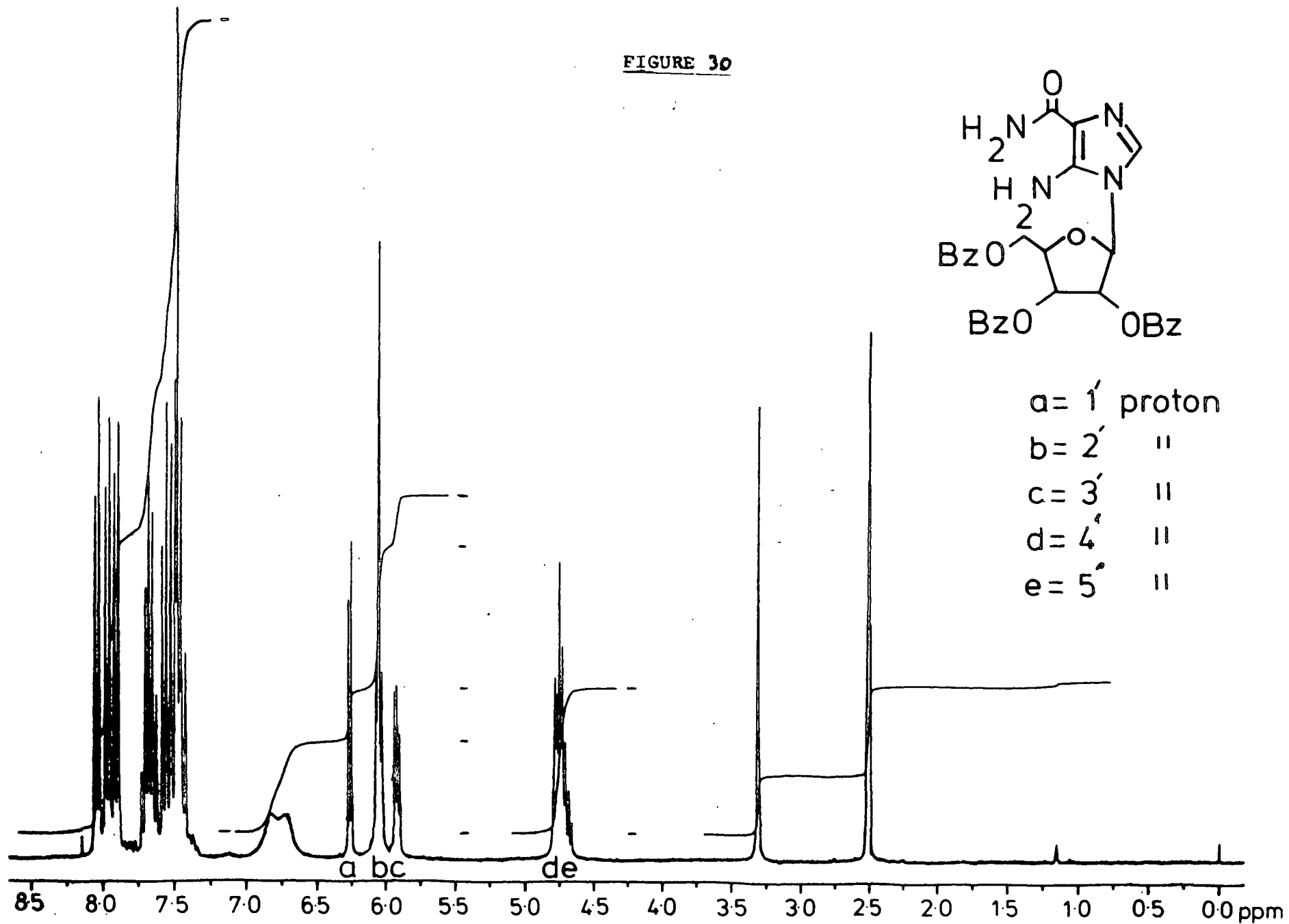



D<sub>2</sub>O Exchange

FIGURE 31



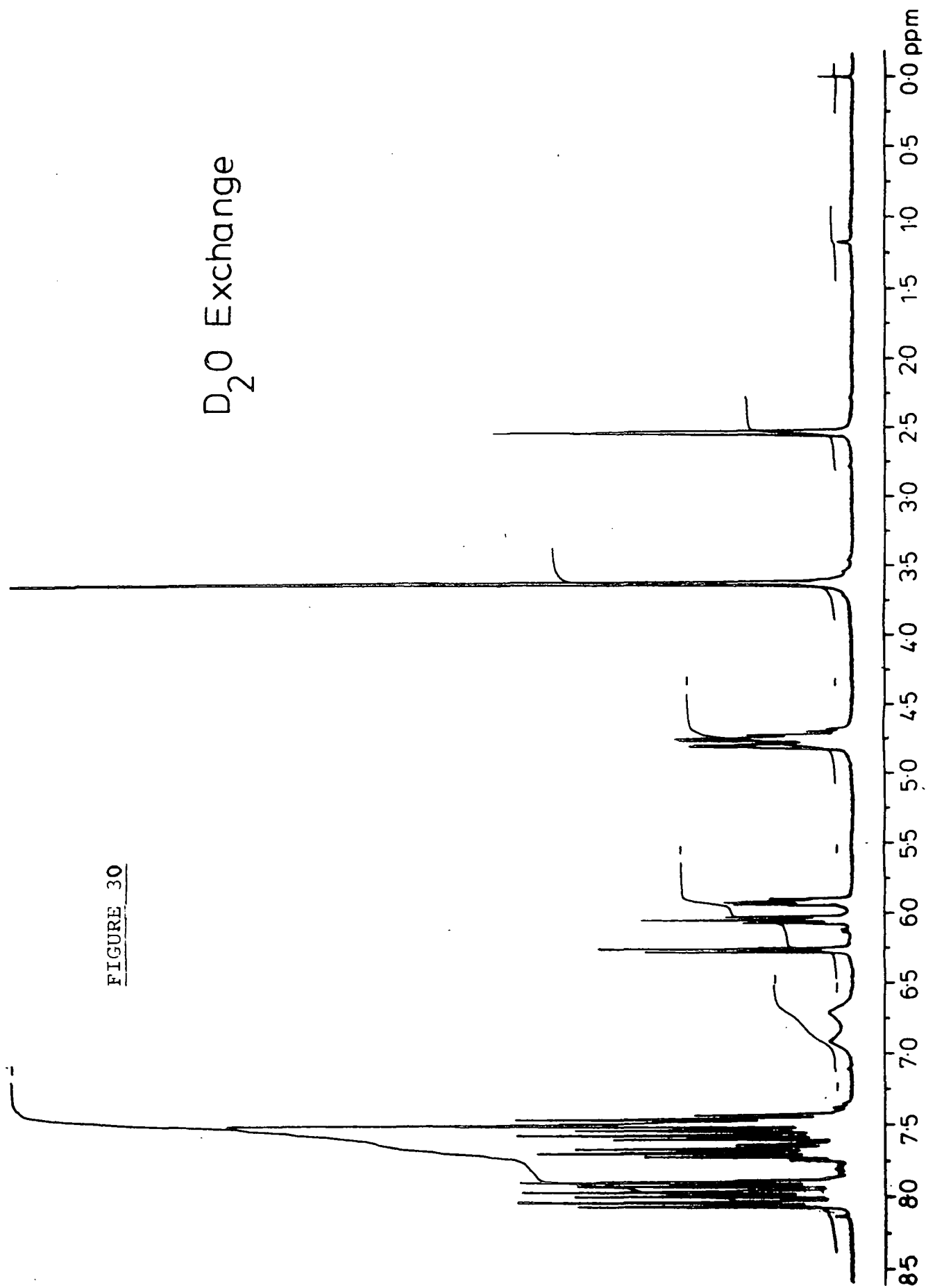
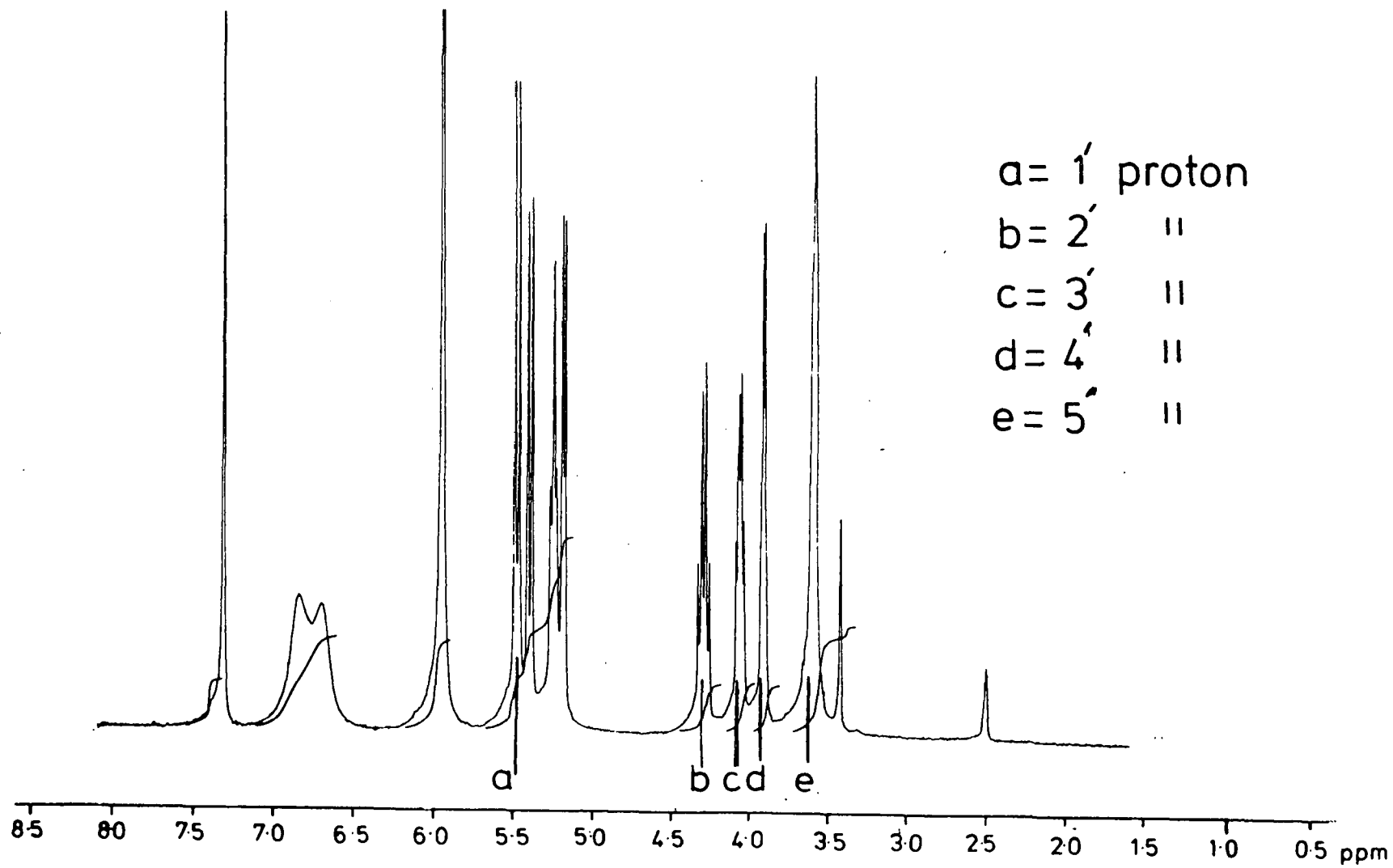
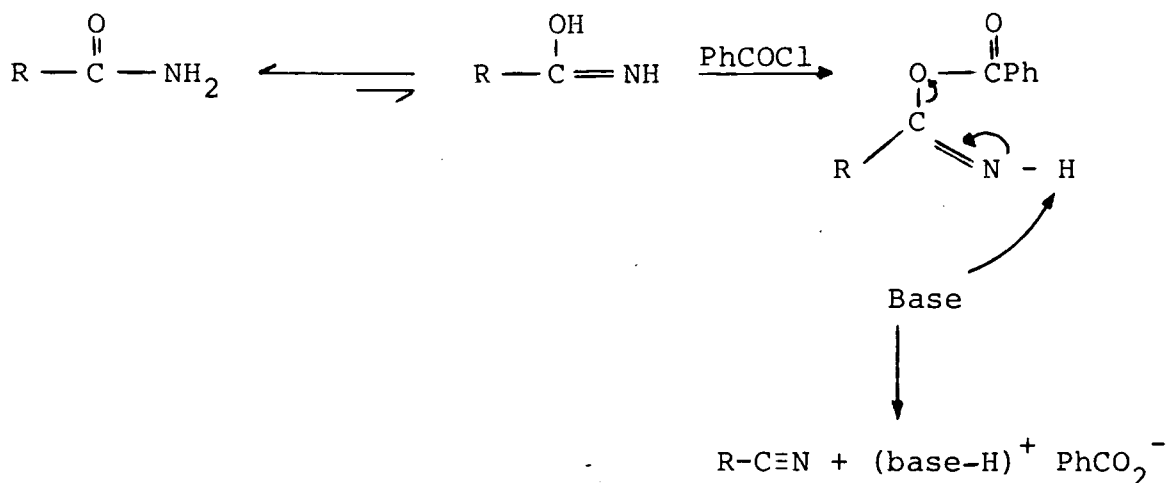

From our studies, therefore, it appears that benzoylation of the amide of AICAR occurs as readily as benzoylation of the amine.

Due to problems in attempting to benzoylate the amine group we turned to the triphenylmethyl group as an alternative N-protecting group. The tribenzoate (95) was treated with triphenylmethyl chloride (trityl chloride) to give the N-tritylated nucleoside (98):

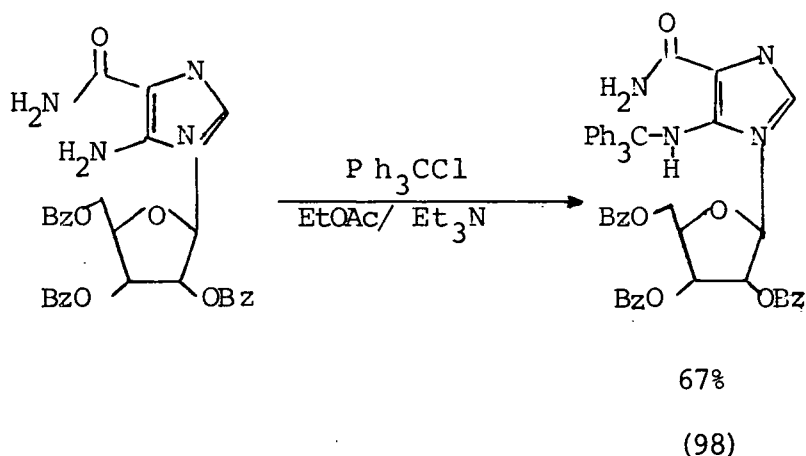

Contact of (98) with acid must be avoided as this results in deprotection giving the amine and trityl alcohol. It is important to note that dehydration of the amide does not occur

under these conditions. N-Tritylation reactions are normally carried out in DMF using a slight excess of triethylamine as base, over tritylchloride. We found, however, that these conditions resulted in a very poor isolated yield of (98) and it appeared from tlc analysis of the reaction mixture that only partial reaction was taking place regardless of how large an excess of tritylchloride over tribenzoate (96) was used. Replacing DMF with ethylacetate and using triethylamine as a co-solvent has resulted in far greater yields of (98).

### 5B. Deprotection Reactions

We have studied the selective deprotection of the tribenzoate (96), protected nitrile derivative (97) and the N-tritylated nucleoside (98) in order to generate a nucleoside derivative in which only one hydroxyl function is unprotected. In all the deprotection reactions carried out we have observed similar results.

It has been reported that treatment of per-benzoylated nucleosides with hydroxylaminium acetate in pyridine leads, in some cases, to good yields of 3', 5'-dibenzoylated nucleosides.<sup>175</sup> When these conditions were applied to (96) a 73% yield of dibenzoylated nucleosides was obtained:

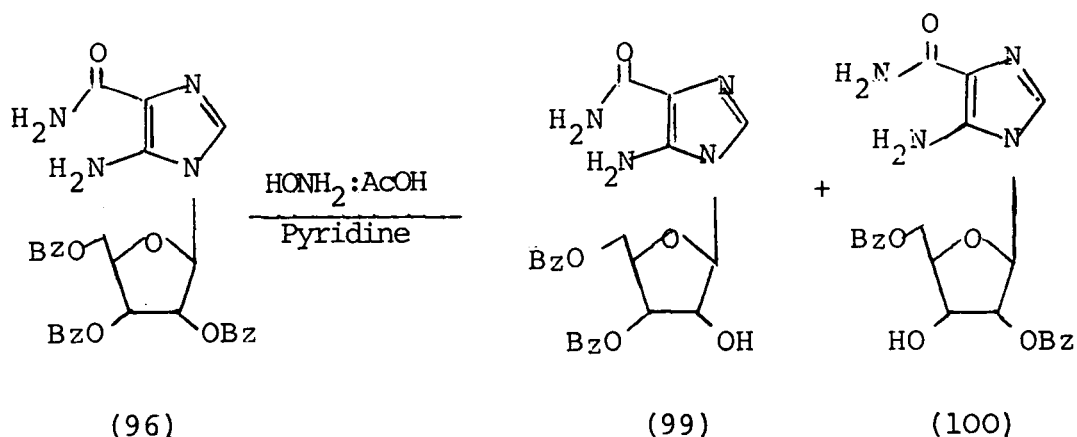

The product mixture was identified from its 270MHz  $^1\text{H}$  n.m.r. spectrum as a mixture of the 3',5'- and 2',5'-dibenzoates (99 and 100), present in the ratio 2:1 respectively. The ratio was determined by comparing the integration of the C-2 protons for the two isomers. These appear at 7.3 for (99) and 7.4 for (100). The benzoate group at the 2' position in (100) deshields the C-2 proton more than the 3' benzoate group in (99), therefore the C-2 proton in (100) is at slightly lower field. Comparison of the integration of the 1' protons in (99) and (100) also gives the ratio 2:1. The 1' protons appear as sharp doublets at 5.7 (J=7Hz) for (99) and 6.02 (J=4Hz) for (100). Again the benzoate group at the 2' position in (100) deshields the 1' proton more than the benzoate group at the 3' position in (99). Therefore the doublet due to the 1' proton in (100) appears at lower field. The n.m.r. spectrum of the dibenzoate mixture is shown in Figure (32).

Chromatographic separation of the mixture of isomers was not possible but, selective crystallization from ethyl acetate afforded a 95% pure sample of the 3' deprotected nucleoside (100). Evaporation of the mother liquor then afforded a 95% pure sample of the 2' deprotected isomer (99). The isomeric purity was determined by integration of the C-2 and 1' protons from the  $^1\text{H}$  n.m.r. spectra. The  $^1\text{H}$  n.m.r. spectra of (99) and (100) are shown in Figures (33) and (34) respectively. The structural assignments of the two isomers were confirmed by decoupling experiments and by comparison of their spectra with  $^1\text{H}$  and  $^{13}\text{C}$  spectra of AICAR and the tribenzoate derivative (96). Further recrystallization of each isomer results in samples of high purity, >95%. We have found, however, that

FIGURE 32

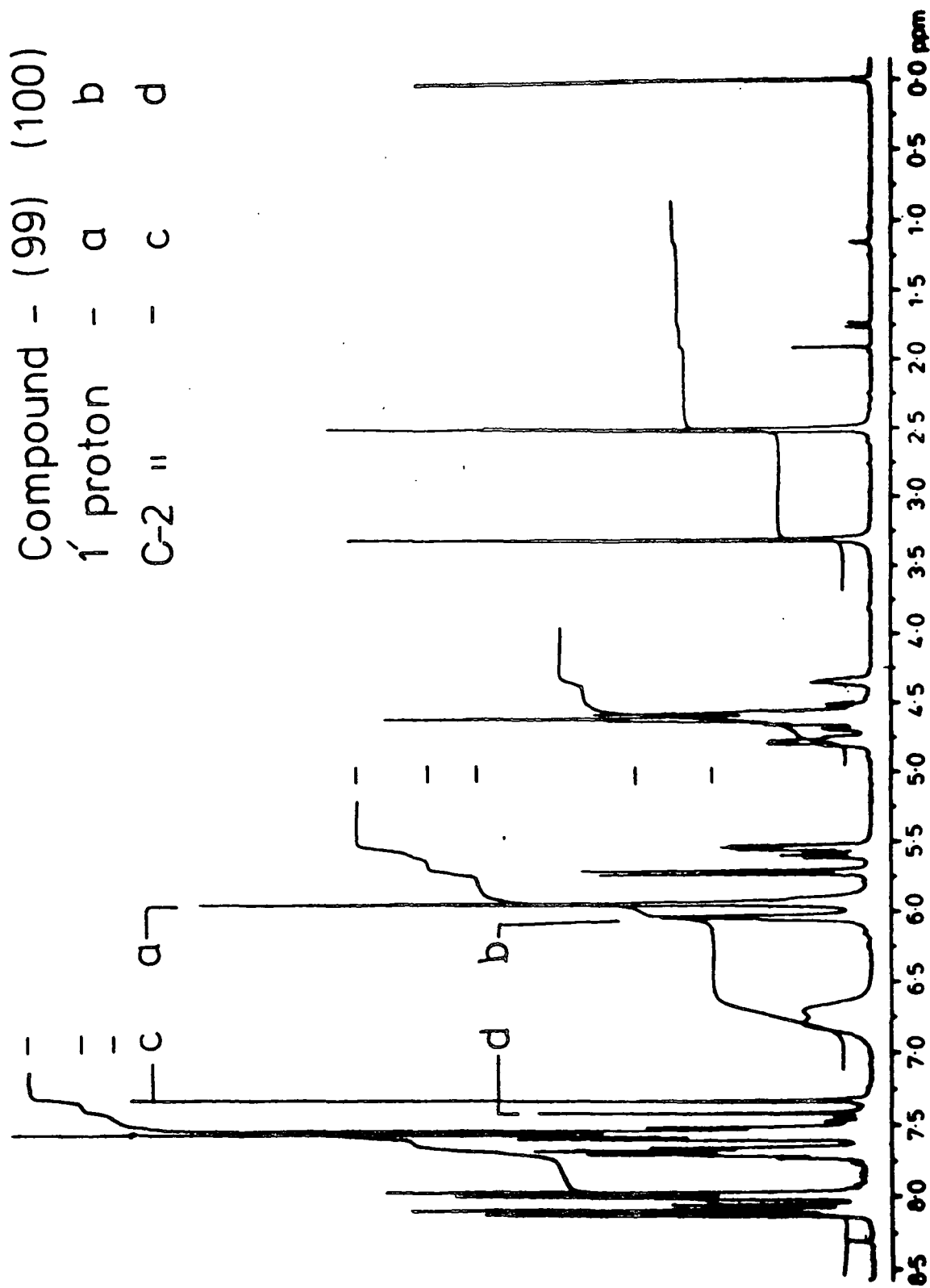

FIGURE 32

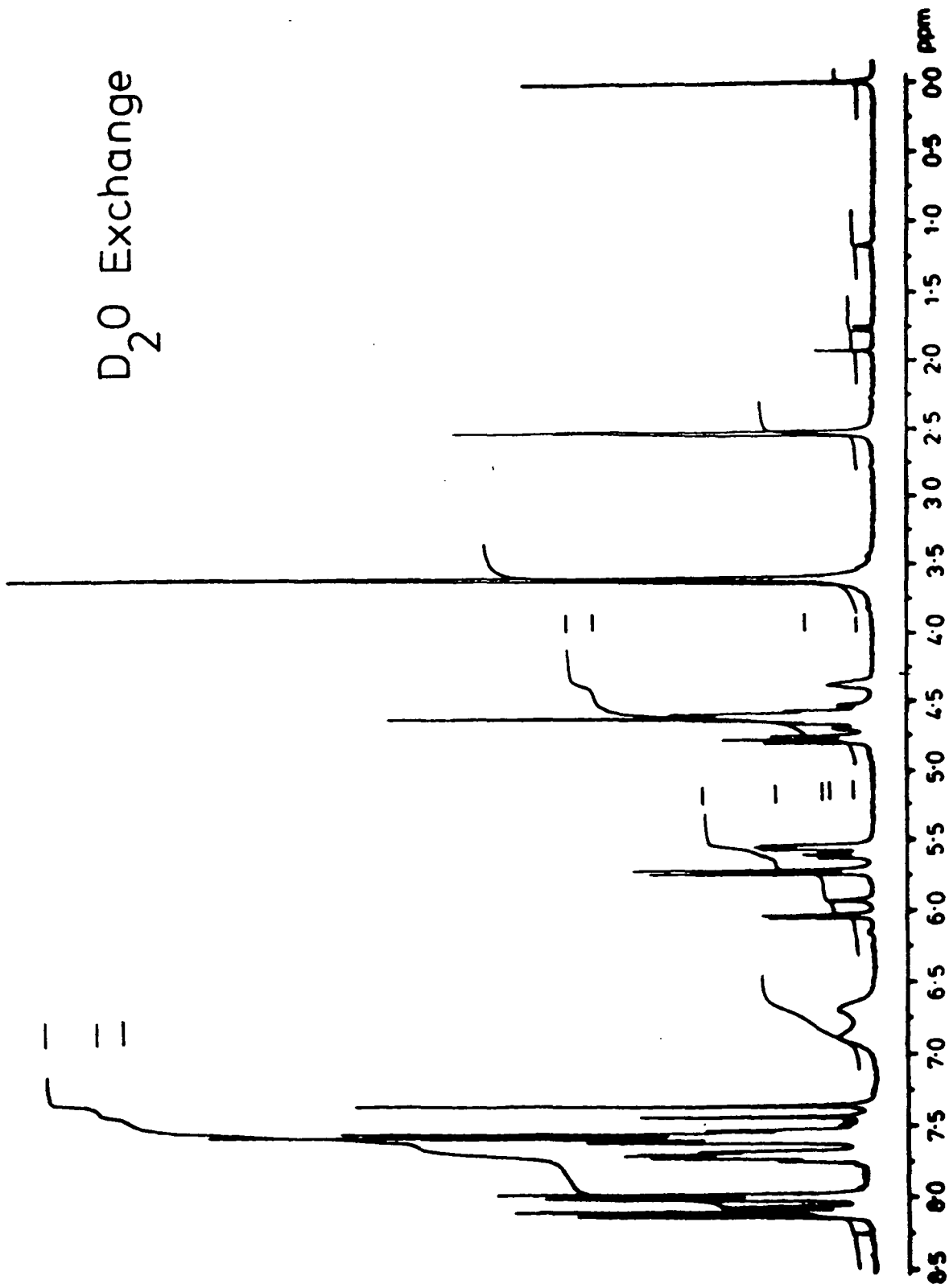

FIGURE 33

Compound (99)

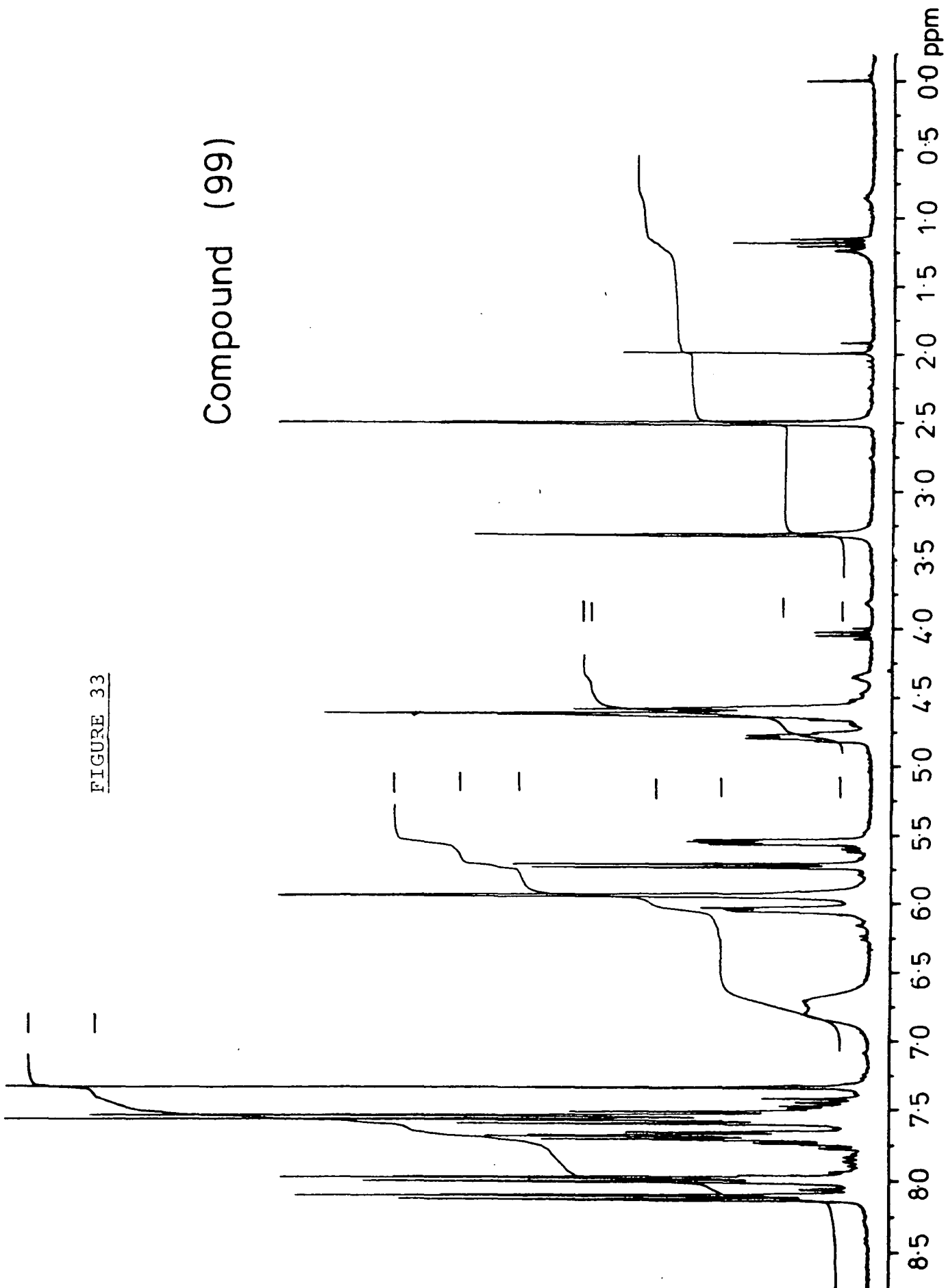



FIGURE 33

D<sub>2</sub>O Exchange.

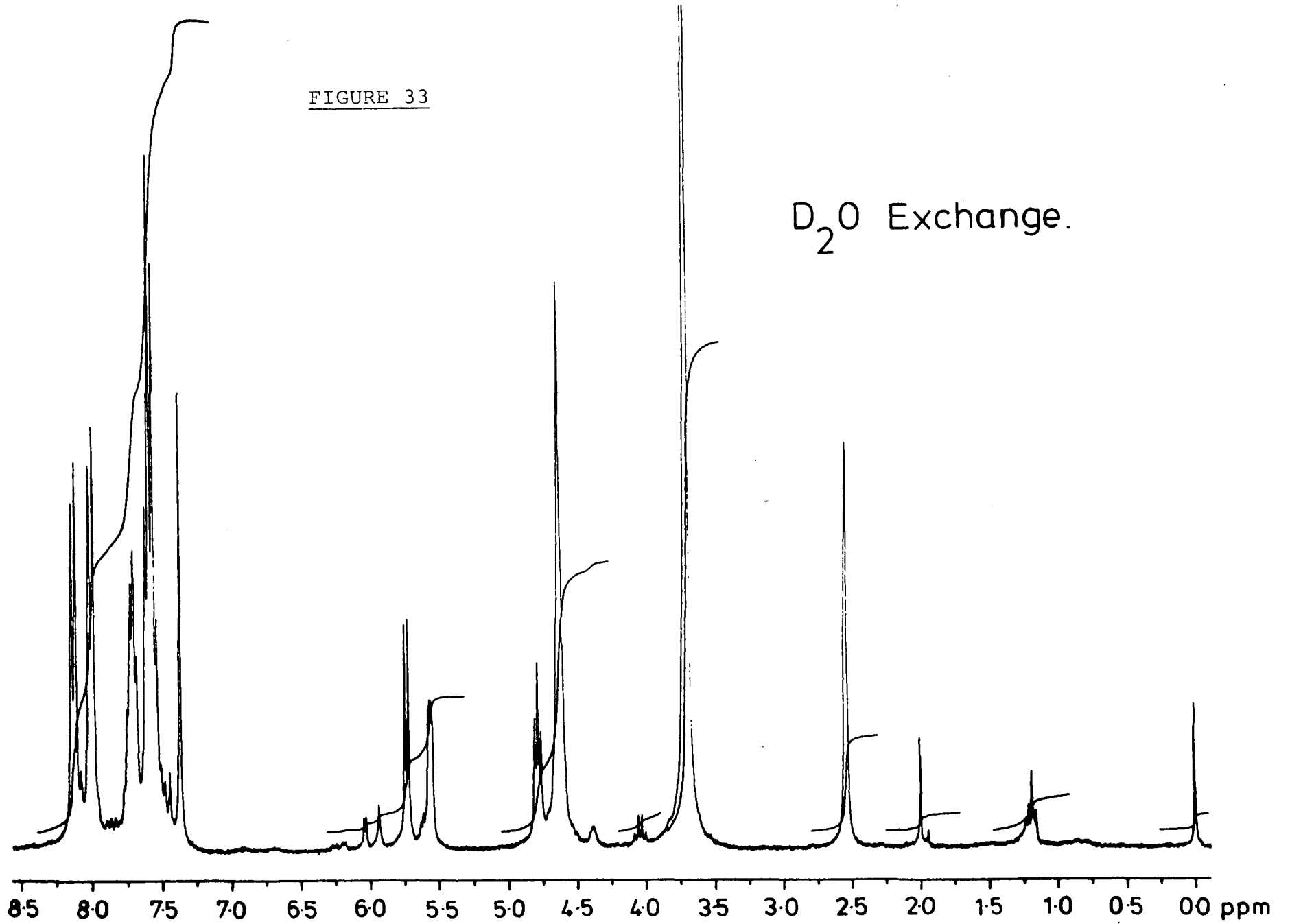
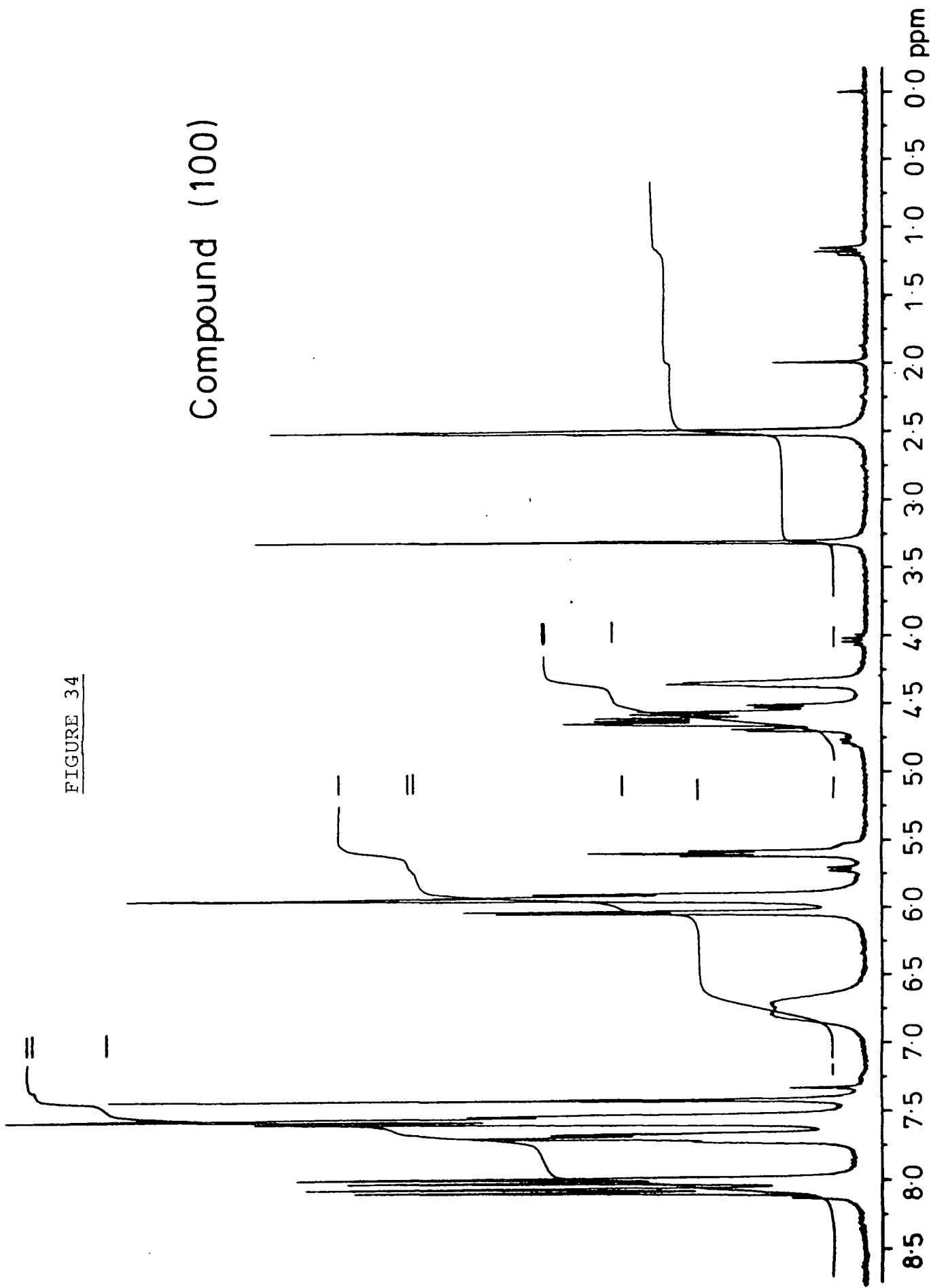

FIGURE 34

Compound (100)



very slow equilibration occurs if either purified dibenzoate (99) or (100) is left standing in solution for long periods, the integration of 1' or C-2 protons changes if (99) or (100) are left in DMSO for a few days. This equilibration does not occur if materials are stored as dry solids.

It has been reported that isomeric enrichment, in similar systems, can be achieved by equilibration of mixtures of isomers on silica gel.<sup>179</sup> When this technique was applied to the mixture of (99) and (100) no significant change in the isomeric ratio was observed. This could be due to the fact that the equilibration process is very slow and from our observations occurs for both (99) and (100). Recrystallization, from ethyl acetate, has proved the most effective method of separation and purification.

Other protected nucleosides were also selectively deprotected. The perbenzoylated nitrile derivative (97) was treated with four equivalents of hydroxylaminium acetate. After 24h at room temperature two products were obtained, which were separated by chromatography and identified as amidoximes (101) and (102). The formation of both (101) and (102) suggests

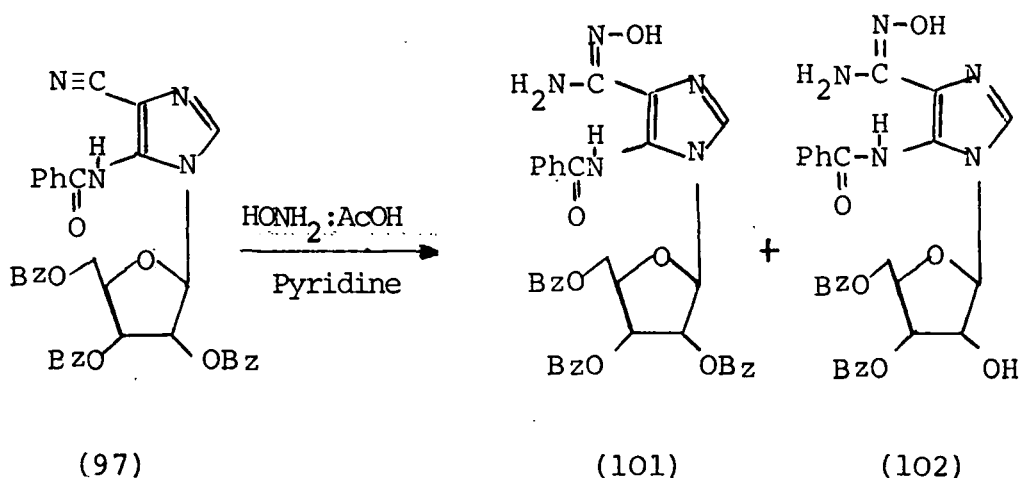

that hydroxylaminium acetate first adds to the nitrile group, then deprotects the 2' hydroxyl function. Recrystallization from methanol gives (102) in 100% isomeric purity as identified by  $^1\text{H}$  n.m.r. The amidoxime hydroxyl proton appears as a sharp singlet at 9.3 ppm for both (101) and (102), the amide proton appearing at lower field, 10.1 ppm, and as a broader peak due to quadrupolar broadening caused by nitrogen. The 2' hydroxyl proton in (102) appears as a doublet ( $J=6\text{Hz}$ ) at 6 ppm. The formation of amidoxime derivatives such as (101) has previously been reported.<sup>178</sup> In an attempt to fully convert the nitrile derivative (97) to (102) the reaction was repeated using a greater excess of hydroxylaminium acetate. The  $^1\text{H}$  n.m.r. spectrum of the product, after chromatography however, suggest structure (103) in which deprotection has occurred at the 2' and 3' positions, it also appears that the amide function at C-4 has been regenerated. The  $^1\text{H}$  n.m.r. has signals at 7.02 and 7.27 ppm, and there is no absorption in the infra red spectrum in the nitrile region. This compound is of little use in our work as more than one hydroxyl function has been deprotected.

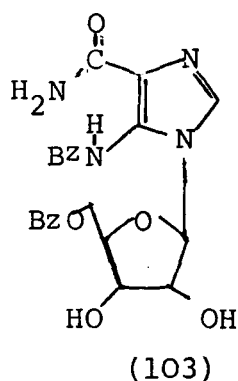

An attempt has also been made to deprotect the 2' or 3' hydroxyl functions in the N-tritylated derivative (98). This, however, proved unsuccessful as it was clear from the tlc analysis of the reaction mixture that the trityl group was being

cleaved. This is unusual as trityl protecting groups are normally stable under basic conditions. Derivatives (104) and (105), however, were synthesized by N-tritylating a mixture of (99) and (100). The trityl group selectively protects the amine group in these systems:

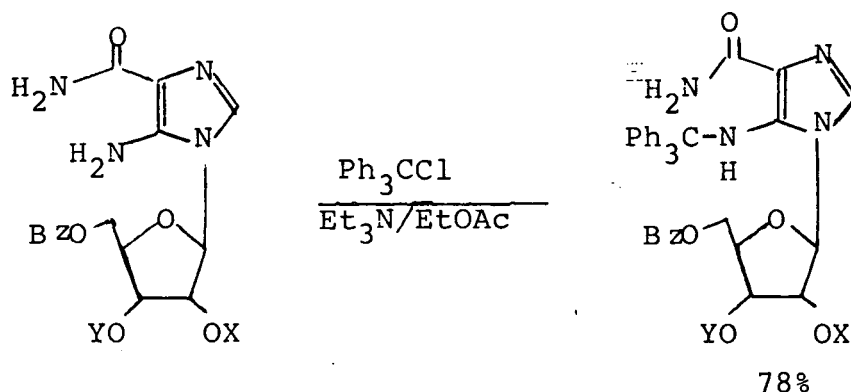

X = H, Bz

X = H, Bz

Y = Bz, H

Y = Bz, H

(99), (100)

(104), (105)

After chromatography an inseparable mixture of (104) and (105) was identified by  $^1\text{H}$  n.m.r. spectroscopy. Integration of the 1' protons, after  $\text{D}_2\text{O}$  exchange, indicates (104) and (105) are present in 2:1 ratio respectively; this is identical to the ratio of (99):(100) in the starting material, suggesting that benzoate migration is not occurring during reaction.

The tetrabenzoate (95) has been deprotected to ascertain if protection of the C-5 amine group in AICAR effects the ratio of 2':3' debenzoylation. Compound (95) was treated with hydroxylaminium acetate and after chromatography the product mixture was examined by  $^1\text{H}$  n.m.r. spectroscopy. This revealed a mixture of (106) and (107) had been formed in 1.3:1 ratio respectively, by integration of the 1' protons. Signals for

the 1' protons appear at 5.9 (doublet  $J=4\text{Hz}$ ) for (106) and 6.07 (doublet,  $J=6.5\text{Hz}$ ) for (107). It appears that the deprotection of (95) is not quite as selective as deprotection of (96).

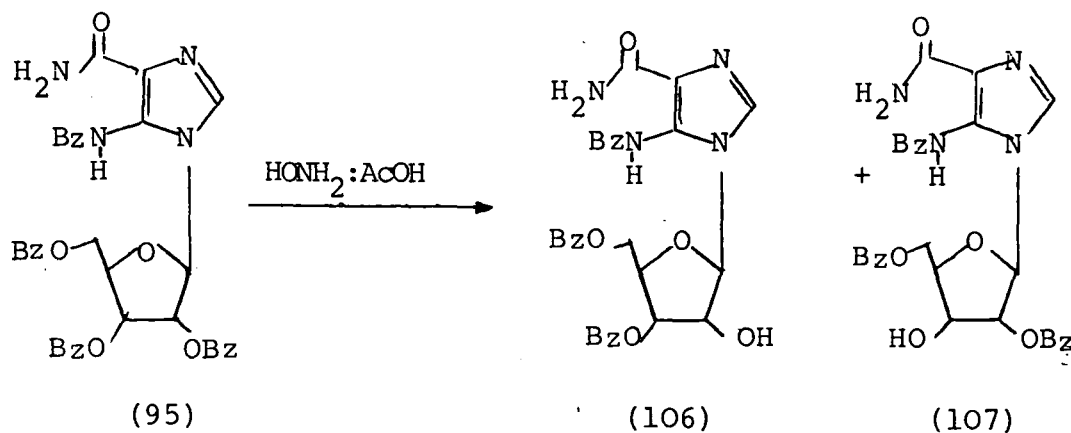

In almost all cases the debenzoylation of our protected systems has led to mixtures of 2' and 3' deprotected isomers in ratio 2:1. This is in agreement with literature results<sup>175,179</sup> and so it appears that the ratio is dependent on the base used to effect the deprotection rather than the structure of the perbenzoylated nucleoside. Recently Nishimo and co-workers<sup>180</sup> reported that potassium tert-butoxide can be used to effect selective de-benzoylation. Their results suggest that lowering the reaction temperature increases the proportion of 2'-deprotected isomer:

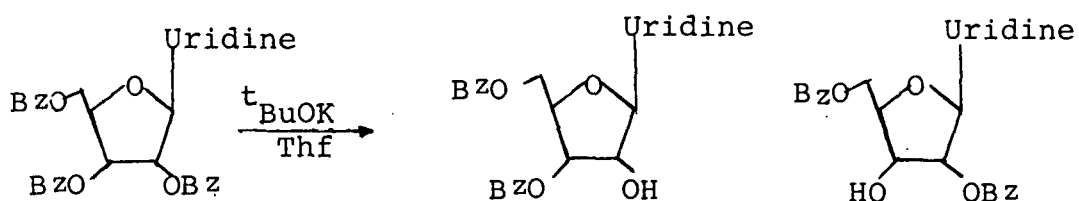

Reaction Temperature

25°C

-20°C

-56°C

2

4

5

Ratio

: 1

: 1

: 1

It is possible, therefore, that by lowering the temperature of our reactions we could increase the quantity of 2'-deprotected isomer. Our method, however, is particularly useful as we are able to obtain both 2' and 3' deprotected nucleosides in reasonably high purity from a single reaction. We have prepared several new derivatives of AICAR, the next step, therefore, was to attempt to convert the free hydroxyl functions to fluorine. We have used three basic methods: (a) displacement of a triflate group with fluoride ion, (b) treatment of deprotected nucleosides with DAST, and (c) reaction of deprotected nucleosides with SF<sub>4</sub>.

### 5C. Fluorination Reactions

#### 1. By Displacement of Triflate Group

The two methods which are generally used to prepare triflate derivatives of nucleosides are discussed in Chapter Two.<sup>181</sup> We have used the triflic anhydride method to effect triflation as treating our benzoylated nucleoside derivatives with sodium hydride and triflyl chloride causes migration of the benzoate groups to occur, and chloride ion, formed during the reaction, can effect displacement of a triflate group thus forming a chlorinated nucleoside derivative:

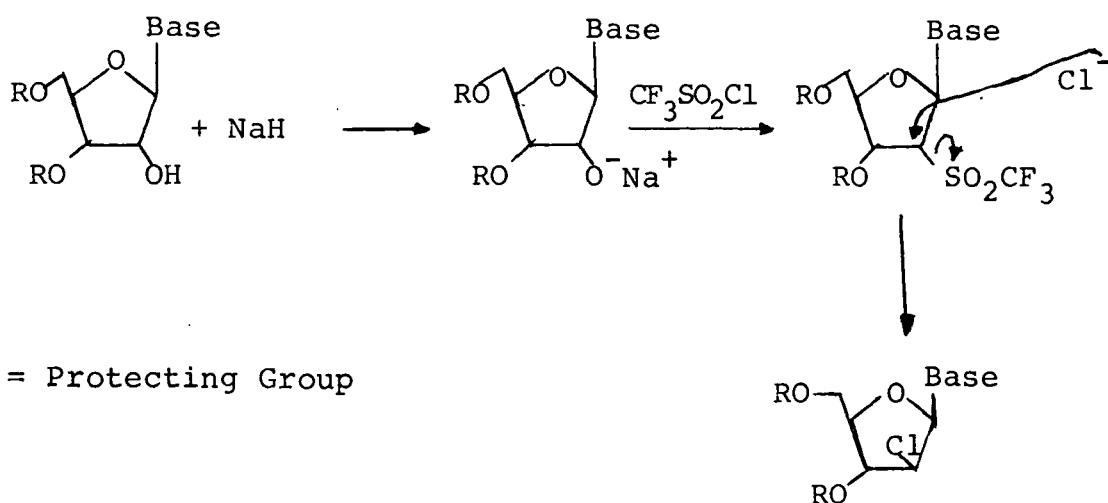

The majority of our triflation reactions have been carried out on dibenzoates (99) and (100) or a mixture of the two isomers. A variety of conditions have been used in attempting to form the triflate derivative but, so far we have been unable to isolate a triflate derivative.

The formation of triflate derivatives of (99) and (100) is complicated by the facile dehydration of the C-4 amide group. We have used a variety of solvents and temperatures to try and effect triflation of the dibenzoates but, treatment of mixtures of (99) and (100), or the pure isomers, with stoichiometric amounts of triflic anhydride has invariably led to complex mixtures of products being formed (dehydration of the C-4 amide group occurs along with triflation) and unreproducible results. We have achieved results, which are more reproducible by using a three-fold excess of triflic anhydride and using a 2:1 mixture of dichloromethane and pyridine as solvent. Reaction of a mixture of (99) and (100) with triflic anhydride, under these conditions gives a relatively non-polar nucleoside product, by tlc. We found the product to be unstable to aqueous work-up conditions. It was converted to a more polar material which, although having a very similar retention time to (99) and (100) is quite clearly a different product. This was deduced from mixed t.l.c. experiments.

A proton n.m.r. spectrum of the solid product, obtained after chromatography, indicated that there were possibly four isomeric nucleosides present. Four hydroxyl groups can be identified from the n.m.r. spectrum but the number of  $D_2O$  exchangeable hydroxyl groups, as determined from the overall integration pattern, is consistent with one free hydroxyl group



per nucleoside molecule. Since these products are not identified as (99) or (100) it is possible that inversion of the 2' and 3' hydroxyl functions has occurred by displacement of triflate groups from (108) and (109). The infrared spectrum shows that some dehydration has taken place:

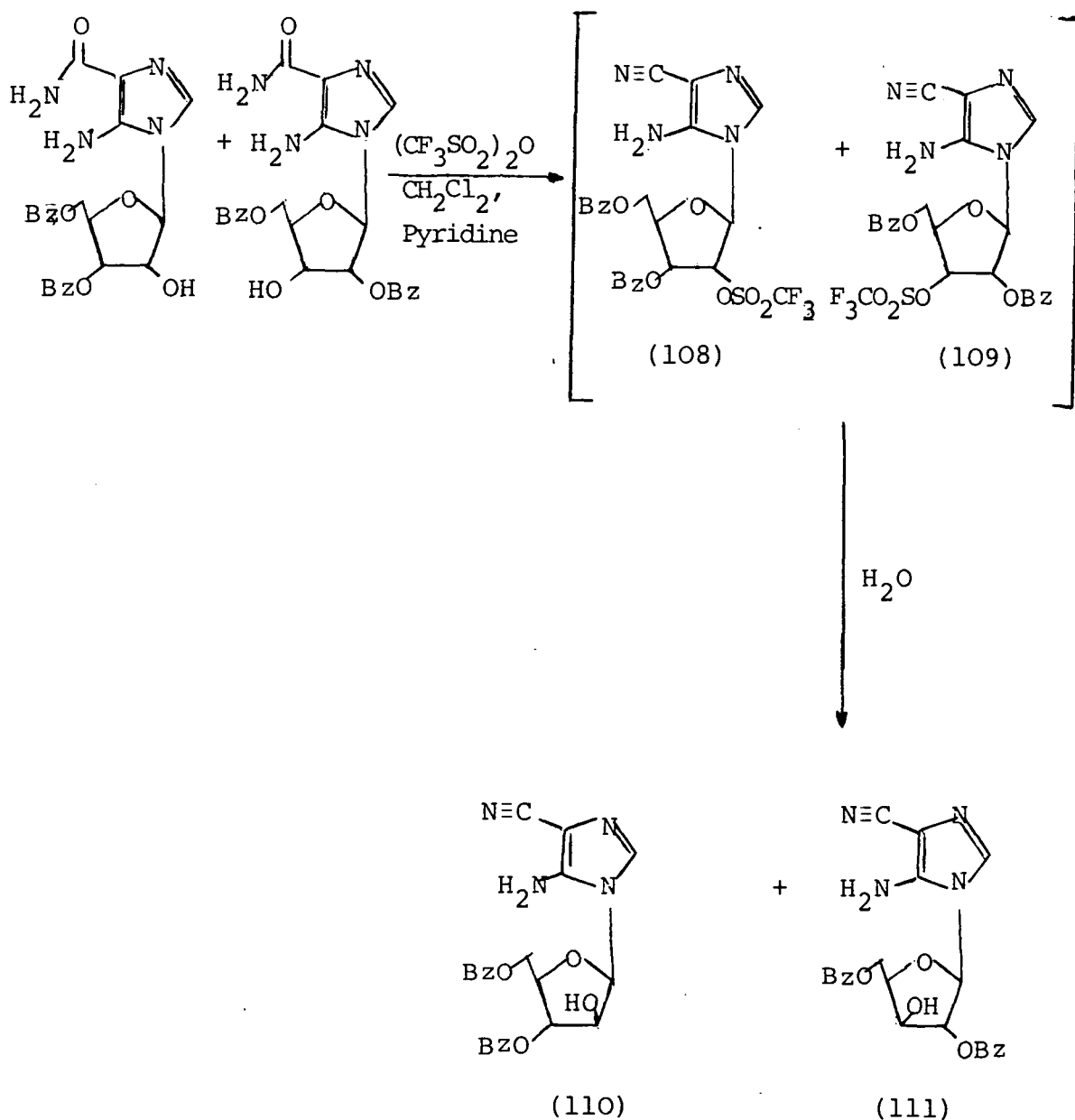

The reaction was followed by  $^{19}\text{F}$  n.m.r. spectroscopy which showed the disappearance of the  $\text{CF}_3$  fluorine signal after aqueous work-up suggesting the triflate groups had been displaced. It does not seem possible, however, to distinguish between  $\text{CF}_3$  in triflic anhydride and  $\text{CF}_3$  in the triflate

derivative by  $^{19}\text{F}$  n.m.r. The susceptibility of triflate derivatives of (99) and (100) to hydrolysis would explain many of our earlier results where aqueous work-up conditions were generally used. Isolated materials, therefore, would have been 'inverted' sugar derivatives similar to (110) and (111) rather than triflate derivatives.

In view of this result the displacement of triflate groups has recently been attempted '*in situ*'. A mixture of (99) and (100) was treated with triflic anhydride in pyridine and dichloromethane. The solvent was then removed and the oil obtained redissolved in dry acetonitrile. To this a dry solution of tris(dimethylamino)sulphonium trimethylsilyldifluoride (TAS-F) was added. TAS-F is an excellent source of fluoride ion and has been used to effect fluoride displacements.<sup>182</sup> In our case, however, TAS-F has proved too susceptible to hydrolysis and reacts with residual triflic anhydride, triflic acid formed during triflation and pyridine. The  $^{19}\text{F}$  n.m.r. spectrum of the product mixture only shows the presence of decomposition products of TAS-F and residual triflic anhydride.

Other fluoride ion sources will probably be more successful for '*in situ*' reactions. For instance CsF can be used in dry acetonitrile or tetrabutylammonium fluoride trihydrate, a fluoride ion source which is soluble in organic solvents and has been used previously in triflyl group displacements.<sup>130</sup>

## 2. Other Fluorination Methods

We have attempted fluorination of the dibenzoate mixture of (99) and (100) by two other methods: (i) reaction with DAST and (ii) reaction with  $\text{SF}_4$ . Reaction of (99) and (100) with

DAST, using standard conditions,<sup>138,137</sup> did not yield any fluorinated nucleoside products. In fact, a complex mixture of materials was obtained as shown by t.l.c. analysis. This was not altogether surprising as it has been reported that (112), which is the sugar fragment of (99) and (100) does not react with DAST to give a fluoro derivative.<sup>134</sup>

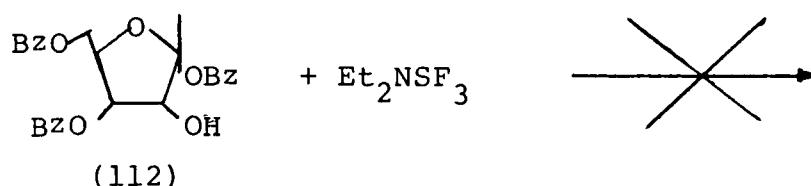

Sulphur tetrafluoride is known to react with alcohols to effect replacement of the hydroxyl group by fluorine.<sup>183</sup> Treatment of a mixture of (99) and (100) however at room temperature and at elevated temperatures resulted in the decomposition of  $\text{SF}_4$  and the formation of a complex mixture of products.  $^{19}\text{F}$  n.m.r. spectra of the product mixture reveal the presence of  $\text{SOF}_2$  and residual  $\text{SF}_4$ . No other fluorinated products can be seen.

It is clear from the above observations that introduction of fluorine into derivatives of AICAR by either triflate displacement or direct reaction of an hydroxyl function with a fluorinating agent is not a trivial matter. We have been able to show that the most promising method is fluoride ion displacement of a triflate group and it now appears that triflate derivatives of (99) and (100) can be made, even though they are unstable to hydrolysis. The major problem now is to find a suitable fluoride ion source to effect displacement of the triflate group.



manner to the reaction of *o*-aminobenzamide with HFP. The compounds thus formed would be fluorinated derivatives of inosinic acid:

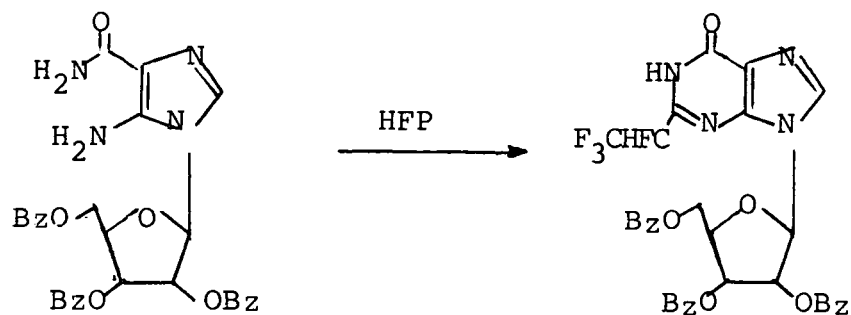

2-(1,2,2,2,-tetrafluoroethyl)-  
inosinic acid

We have found that both HFP and F-cyclopentene react with the tribenzoate (96) to form fluorine containing products. The reaction of (96) with F-cyclopentene was followed by  $^{19}\text{F}$  n.m.r. spectroscopy. At room temperature the signals due to F-cyclopentene (Figure 35) were gradually decreased while signals at 127 ppm and 173 ppm gradually appeared. After

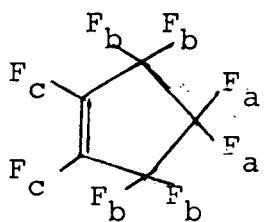

$\delta_{\text{F}}$

119 ppm	F <sub>b</sub>
131 ppm	F <sub>a</sub>
150 ppm	F <sub>c</sub>

FIGURE 35

heating the reaction for 15h at 60°C the signals due to F-cyclopentene had completely disappeared and the  $^{19}\text{F}$  n.m.r. spectrum now contained only two signals at 173 ppm and 127 ppm. The reaction was repeated on a larger scale and identical results were obtained. After aqueous work-up, however, we were unable to isolate any fluorine containing materials, thus it appears that the addition products are susceptible to hydrolysis. Sufficient data is not yet available to identify any of the products, however,  $^1\text{H}$  n.m.r. of the product mixture before aqueous work-up seems to indicate that the nucleoside has not been broken down.

In an attempt to clarify the situation tribenzoate (96) was reacted with HFP under similar conditions to those reported for the reaction of o-aminobenzamide with HFP.<sup>187</sup> A solution of the tribenzoate in acetonitrile was sealed in a carius tube with an excess of HFP and potassium carbonate. The mixture was then shaken and heated at 60°C for 15h. The  $^{19}\text{F}$  n.m.r. spectrum of the product after removal of solvent shows two major signals at 74 ppm and 203 ppm. This corresponds to signals observed in  $^{19}\text{F}$  n.m.r. spectrum of (113), Figure (36):

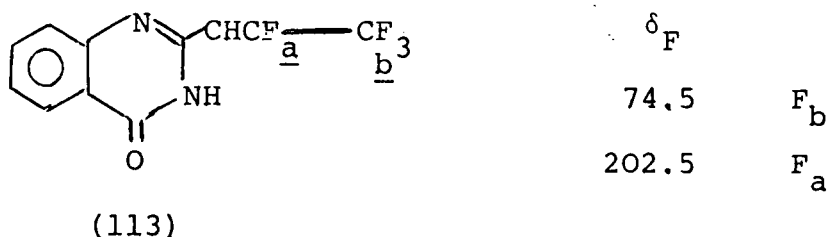
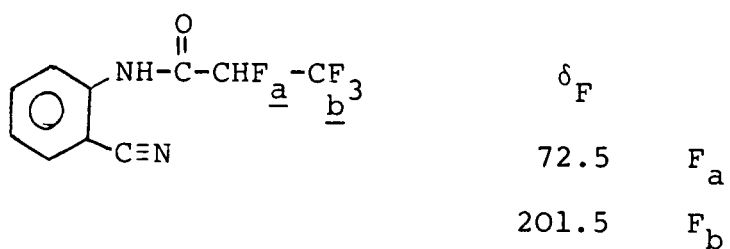

FIGURE 36

This result suggests that a compound analogous to (113) has been formed. Other signals can also be observed in the  $^{19}\text{F}$  n.m.r. of the crude produce mixture at 74 ppm and 212 ppm, thus it is possible that a product analogous to (114) has also been

formed, though this is a very minor component:



Again, however, sufficient data is not yet available to assign structures to any of our products. The results, so far obtained, do appear to suggest that perfluoroalkyl substituted derivatives of inosinic acid and AICAR have been formed.

EXPERIMENTAL



## INSTRUMENTATION

### Infrared Spectra

I.R. spectra were recorded on a Perkin-Elmer 577 Infrared Spectrophotometer or on a Perkin-Elmer 580A Infrared Spectrophotometer.

Solid samples were recorded as KBr discs or nujol mulls between KBr plates. Liquid samples were recorded as contact films between KBr plates.

### N.m.r. Spectra

Proton ( $^1\text{H}$ ) n.m.r. spectra were recorded on a Varian EM360L spectrometer or an Hitachi Perkin-Elmer R-24B spectrometer both operating at 60 MHz. Proton n.m.r. spectra were also recorded on a Brüker AC250 spectrometer operating at 250 MHz or a Jeol GX spectrometer operating at 270 MHz.

Fluorine ( $^{19}\text{F}$ ) n.m.r. spectra were recorded on either a Varian EM360L spectrometer operating at 56.45 MHz or a Brüker AC250 spectrometer operating at 235.3 MHz.

Carbon ( $^{13}\text{C}$ ) n.m.r. spectra were recorded on either a Brüker AC250 spectrometer operating at 62.9 MHz or a Jeol GZ spectrometer operating at 67.8 MHz.

### Mass Spectra

Mass spectra of solid samples or pure liquids were recorded on an A.E.I.M.S.9 spectrometer or a VG 7070E spectrometer with electron impact, chemical ionisation, negative ion and fast atom bombardment modes. Thioglycerol or p-nitrobenzylalcohol/ $\text{Na}^+$  were used as the matrix for FAB spectra. Mass spectra of solutions were run on either a VG Micromass 12B Spectrometer fitted with a Pye 104 Gas Chromatograph or a

VG 7070E spectrometer fitted with a Capillary Column Gas Chromatograph (25m fused silica column with  $O_{V1}$  coating).

### Elemental Analysis

Carbon, hydrogen and nitrogen analyses were obtained using a Perkin-Elmer 240 Elemental Analyzer or a Carlo Erba Model 1106 analyser. Analysis for halogens was obtained as described in the literature.<sup>188</sup> Mercury and tin analyses were obtained using a Perkin-Elmer Atomic Absorption Spectrometer.

### Chromatography

Gas liquid chromatograph (g.l.c.) analysis was carried out using either a Varian Aerograph Model 920 or Pye Unicam GCD chromatographs using columns packed with silicon elastomer (5%, 10% or 20%) on chromasorb P. G.l.c. analysis was also carried out on a Hewlett Packard 5890A Gas Chromatograph fitted with a 25m fused silica column with  $O_{V1}$  coating.

Column chromatography was performed using Merck Kieselgel 60H and dry solvents. Thin layer chromatography was performed using DC-Alufolien Kieselgel 60 F<sub>254</sub> purchased from Merck.

Melting points and boiling points were determined at atmospheric pressure, unless otherwise stated, and are uncorrected.

### Calculation of Yields

Yields of monofluorinated benzene derivatives synthesized by cleavage of aryl-metal bonds (see Chapters Four and Seven) were determined by g.l.c. analysis using standard procedures.<sup>189</sup>

Reagents and Solvents

Reagents were used as supplied, without further purification, and solvents were dried by standard procedures.<sup>190</sup>

## CHAPTER SIX



EXPERIMENTAL TO CHAPTER THREE6.1 Preparation of Tetraphenyltin<sup>158</sup>

A solution of phenyllithium, prepared from bromobenzene (78.5g, 0.5 mol) and lithium (8g, 1.1 mol), in dry diethylether was added, with stirring, to a solution of triphenyltinbromide (3.3g, 0.08 mol) in diethylether. The reaction mixture was heated under reflux for 12h, then poured onto ice. The ethereal layer was separated and combined with ether extracts of the aqueous layer. The combined extracts were dried over magnesium sulphate, the solvent evaporated and the resulting solid recrystallized from ethanol/cyclohexane to give tetraphenyltin (2.4g, 74%), m.p. 234°C; (Found: C, 67.4; H, 4.7. Calc. for C<sub>24</sub>H<sub>20</sub>Sn, C. 67.5; H, 4.7%); n.m.r. No. 1, infrared No. 1, mass spectrum No.1.

6.2 Preparation of aryltrimethylstannanes

A solution of trimethyltinchloride in dry diethyl ether was added to an ethereal solution of a Grignard reagent or organo lithium reagent prepared from the appropriate arylbromide or aryl iodide and magnesium or lithium. The reaction mixture was stirred, at room temperature, for 15h then poured onto ice. The ethereal layer was separated and combined with ether extracts of the aqueous layer. After drying the ether solution over magnesium sulphate the solvent was evaporated and the resulting oil fractionated under reduced pressure to give the aryltrimethylstannane. Results and analysis of the products are given in Table (XVII).

TABLE XVII

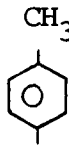
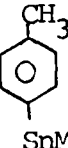
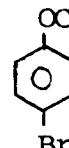
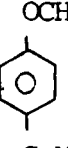
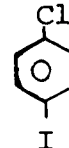
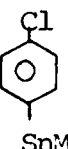
Starting Material (g, mol)	Magnesium or Butyl Lithium	Trimethyl- tin Chloride	Product	Yield (%)	b.p. (°C/mmHg)	Analysis	Spectrum No.			Ref
							I.R.	Mass	N.M.R.	
 Br 15.7, 0.1	Mg	16.4, 0.08	 SnMe <sub>3</sub>	65	97/18	Found: C, 44.6; H, 5.3. Calc. for C <sub>9</sub> H <sub>14</sub> Sn: C, 44.9; H, 5.85%.	2	2	2	155
 CH <sub>3</sub> Br 5.2, 0.03	Mg  1g	6, 0.03	 CH <sub>3</sub> SnMe <sub>3</sub>	48	97/4	Found: C, 47.4; H, 6.6. Calc. for C <sub>10</sub> H <sub>16</sub> Sn: C, 47.1; H, 6.3%.	3	3	3	155
 OCH <sub>3</sub> Br 5.6, 0.03	Mg  5g	6, 0.03	 OCH <sub>3</sub> SnMe <sub>3</sub>	50	130/14	Found: C, 44.3; H, 6.2. Calc. for C <sub>10</sub> H <sub>16</sub> OSn: C, 44.33; H, 5.95%.	4	4	4	159
 Cl I 6, 0.025	1.6M BuLi  15.6 ml, 0.025 mol	4.9, 0.025	 Cl SnMe <sub>3</sub>	41	110/55	Found: C, 39.0; H, 4.5. Cl, 13.2. Calc. for C <sub>9</sub> H <sub>13</sub> ClSn: C, 39.25; H, 4.75; Cl, 12.9%.	5	5	5	155





### 6.3 Preparation of 3-trimethylstannylpyridine<sup>157</sup>

A solution of trimethyltin chloride (6g, 0.03 mol) in dry tetrahydrofuran (50 ml) was added, with stirring, to a mixture of lithium (2g, 0.28 mol) and tetrahydrofuran (75 ml) cooled to  $-78^{\circ}\text{C}$ . The reaction mixture developed a green colouration and was stirred, at  $-78^{\circ}\text{C}$ , for 3h. A solution of 3-bromopyridine (4.75g, 0.03 mol) in tetrahydrofuran (25 ml) was added and the resulting mixture allowed to warm to ambient temperature while being stirred for 15h. The reaction mixture was poured onto ice, the ether layer separated and combined with ethereal extracts of the aqueous layer. After drying over magnesium sulphate the solvent was evaporated and the resulting oil fractionated to give 3-trimethylstannylpyridine (2.5g, 35%), b.p.  $60^{\circ}\text{C}/10\text{ mmHg}$ ; n.m.r. spectrum No. 6; mass spectrum No.6.

### 6.4 Preparation of tri-n-butylarylstannanes

A solution of tri-n-butyltin chloride in dry diethylether was added to an ethereal solution of a Grignard reagent or organolithium reagent prepared from the appropriate aryl-bromide and magnesium or butyllithium. The reaction mixture was stirred, at room temperature, for 15h then poured onto water. The ether layer was separated and combined with ether extracts of the aqueous layer. After drying over magnesium sulphate the solvent was evaporated and the resulting oil fractionated to give the aryltri-n-butylstannane. Results and analysis of the products are given in Table (XVIII).

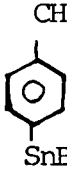
TABLE XVIII

Starting Material (g, mol)	Magnesium or Butyl Lithium	Tributyl- tin Chloride, g,mol	Product	Yield (%)	b.p. (°C/mm Hg)	Analysis	Spectrum No.			Ref.
							I.R.	Mass	N.M.R.	
 Br 8, 0.051	Mg  1.5g	16.3, 0.05	 SnBu <sub>3</sub>	59	168/5	Found: C, 58.0; H, 8.70. Calc. for C <sub>18</sub> H <sub>32</sub> Sn: C, 58.88; H, 8.8%.	6	7	7	160
 CH <sub>3</sub> Br 10, 0.058	Mg  1.5g	17.4, 0.053	 CH <sub>3</sub> SnBu <sub>3</sub>	35	139/0.1	Found: C, 58.8; H, 8.54. Calc. for C <sub>19</sub> H <sub>34</sub> Sn: C, 59.87; H, 8.99%.	7	8	8	161
 OCH <sub>3</sub> Br 10, 0.054	1.6M BuLi  34 ml, 0.054 mol.	17.4, 0.054	 OCH <sub>3</sub> SnBu <sub>3</sub>	44	150/0.1	-	8	9	9	162

### 6.5 Preparation of tricyclohexylarylstannanes







Tricyclohexyltinchloride was added to a stirred solution of an ethereal solution of a Grignard or organolithium reagent prepared from the appropriate aryl bromide and magnesium or butyllithium. The reaction mixture was stirred, at room temperature, for 15h then poured onto a 5% ammonium chloride solution. The ether layer was separated and combined with ether extracts of the aqueous layer. After drying over magnesium sulphate the solvent was evaporated and the resulting solid recrystallized from ethanol or ethanol/benzene to give the aryltricyclohexylstannane. Results and analysis are given in Table (IX).

### 6.6 Preparation of 1,2-dimethyl-5-trimethylstannylimidazole.<sup>163</sup>

1.6M BuLi (66.5 ml, 0.106 mol) in hexane was added to a stirred solution of 1,2-dimethylimidazole (10.2g, 0.106 mol) in dry diethyl ether at room temperature. The reaction mixture was stirred for 4h after which time trimethyltinchloride (20.3g, 0.101 mol) was added in one lot. After stirring, at room temperature, for 15h the mixture was poured onto 5% ammonium chloride solution. The ether layer was separated, combined with ether extracts of the aqueous layer, dried over magnesium sulphate and solvent evaporated. The resulting yellow solid was then sublimed under high vacuum (0.001 mmHg) to give 1,2-dimethyl-5-trimethylstannylimidazole (7.4g, 30%), (Found: C, 37.3; H, 6.3; N, 10.5. Calc. for  $C_8H_{16}N_2Sn$ : C, 37.11; H, 6.23; N, 10.82%); infrared spectrum No.12;  $^1H$  n.m.r. spectrum No. 13.



TABLE XIX

Starting Material (g, mol)	Magnesium or Butyl Lithium	Tricyclo- hexyltin Chloride	Product	Yield (%)	m.p. (°C)	Analysis	Spectrum Number			Ref.
							I.R.	Mass	N.M.R.	
 Br 2.4, 0.015	Mg  0.5g	6g, 0.015mol	 $\text{Sn}(\text{C}_6\text{H}_{11})_3$	30	195-196	Found: C, 64.60; H, 8.25. Calc. for $\text{C}_{24}\text{H}_{38}\text{Sn}$ : C, 64.74; H, 8.6%.	9	10	10	155
 OCH <sub>3</sub> Br 2.8, 0.015	Mg  0.5g	6g, 0.015 mol	 OCH <sub>3</sub> $\text{Sn}(\text{C}_6\text{H}_{11})_3$	38	100	Found: C, 63.5; H, 8.7. Calc. for $\text{C}_{25}\text{H}_{40}\text{OSn}$ : C, 63.17; H, 8.48%.	10	11	11	155
 N(CH <sub>3</sub> ) <sub>2</sub> Br 3, 0.015	1.6M BuLi  10 ml, 0.016 mol	6g, 0.015 mol	 N(CH <sub>3</sub> ) <sub>2</sub> $\text{Sn}(\text{C}_6\text{H}_{11})_3$	55	145-146	Found: C, 63.65; H, 8.60; N, 2.95. Calc. for $\text{C}_{26}\text{H}_{43}\text{NSn}$ : C, 63.95; H, 8.87; N, 2.87%.	11	12	12	155

### 6.7 Preparation of 1,2-dimethyl-5-tri-n-butylstannylimidazole.<sup>163</sup>

9.5M Butyllithium (2.5 ml, 0.024 mol) was added to a stirred solution of 1,2-dimethylimidazole (2.4g, 0.024 mol) in dry diethyl ether (100 ml). This mixture was stirred for 1h. A solution of tri-n-butyl tin chloride (7.8g, 0.024 mol) in ether (40 ml) was then added and after stirring for a further 3.5h the reaction mixture was poured onto saturated ammonium chloride solution. The ether layer was separated and combined with ether extracts of the aqueous layer. After drying over magnesium sulphate the solvent was evaporated to give an oil which was chromatographed on basic alumina (ethylacetate: cyclohexane, 1:1, v/v) to give 1,2-dimethyl-5-tri-n-butylstannylimidazole. The product still contained some impurities. N.m.r. spectrum No. 14, I.R. spectrum No.13, mass spectrum No.13 .

### 6.8 Preparation of N-methyl-2-trimethylstannylimidazole.<sup>164</sup>

1.6M Butyllithium (31ml, 0.05 mol) was added to a solution of N-methylimidazole (4g, 0.05 mol), in dry diethyl ether, at  $-60^{\circ}\text{C}$ . The reaction mixture was allowed to warm to room temperature with stirring then trimethyltin chloride (10g, 0.05 mol) was added and the mixture stirred for 15h, it was then poured onto saturated ammonium chloride solution. The ether layer was separated and combined with ethereal extracts of the aqueous layer and dried over magnesium sulphate. After evaporation of the solvent the resulting oil was fractionated to give N-methyl-2-trimethylstannylimidazole (3g, 25%), b.p.  $115^{\circ}\text{C}/8\text{ mmHg}$ ; (Found: C, 35.2; H, 5.8; N, 11.4. Calc. for  $\text{C}_7\text{H}_{14}\text{N}_2\text{Sn}$ : C, 34.33; H, 5.76; N, 11.44%); n.m.r. spectrum No. 15, i.r. spectrum No.14.

### 6.9 Preparation of Diphenyl Mercury<sup>165</sup>

Mercury (II) chloride (10.2g, 0.038 mol) was added to a solution of phenylmagnesiumbromide, prepared from bromobenzene (15g, 0.095 mol) and magnesium (2.25g, 0.01 mol) in dry diethyl ether. The mixture was heated, under reflux, for 72h and while still hot poured onto ice. The ether layer was separated and combined with ether extracts of the aqueous layer. After drying over magnesium sulphate the solvent was evaporated and the resulting solid recrystallized to give diphenylmercury (8.5g, 60%), m.p. 128°C (from chloroform/ethanol); (Found: C, 40.6; H, 3.0. Calc. for C<sub>12</sub>H<sub>10</sub>Hg, C, 40.62; H, 2.84%); n.m.r. spectrum No.16; i.r. spectrum No.15; mass spectrum No.14.

### 6.10 Preparation of Anisylmercury acetate

To a suspension of mercury (II) acetate (16g, 0.05 mol) in acetic acid (35 ml) a solution of anisole (5.4g, 0.05 mol) in acetic acid (15 ml) was added. The mixture was heated under reflux for 1h and then allowed to cool to room temperature. The crystals which separated out were collected, dried, then recrystallized to give p-anisylmercuryacetate (5.9g, 27%), m.p. 184-186°C; i.r. spectrum No. 16.

### 6.11 Preparation of 4-Acetomercury-1,2-dimethylimidazole<sup>166</sup>

1,2-Dimethylimidazole (2g, 0.02 mol) was added to a suspension of mercury (II) acetate (6.6g, 0.02 mol) in warm methanol (50 ml). The reaction mixture was warmed at 50°C for 2h then filtered. The solvent was evaporated to leave a yellow solid which was washed with boiling acetone then dried.

## CHAPTER SEVEN

EXPERIMENTAL FOR CHAPTER FOUR7.1 Reactions of CF<sub>3</sub>OF(a) With Model Compounds

Organometallic compound (70), (71), (87) or (88) was dissolved in chloroform or dichloromethane (75 ml) and excess CF<sub>3</sub>OF passed through the solution for 0.5h at room temperature. The insoluble organometallic products were removed by filtration to leave a solution of the fluoroaromatic product, which was analysed by <sup>19</sup>F n.m.r. spectroscopy and glc-mass spectrometry. Results are shown in Table (XX). Products were identified by comparison of analytical data with that of standard solutions of authentic materials.

TABLE XX

Organometallic g (mol)	Product	Yield (%)	<sup>19</sup> F n.m.r.	Mass (No)	glc retention time	
					product	standard
(70) Ph <sub>4</sub> Sn 4.2g(9.8x10 <sup>-3</sup> )	PhF	22	114	96	6.7 min	6.7 min
(71) Me <sub>3</sub> SnPh 2.4g(10x10 <sup>-3</sup> )	PhF	50	114	96	6.1 min	6.0 min
(87) Ph <sub>2</sub> Hg 3.5g(10x10 <sup>-3</sup> )	PhF	83	114	96	4.0 min	3.9 min
(88) MeOC <sub>6</sub> H <sub>4</sub> HgOAc 3.7g(10x10 <sup>-3</sup> )	MeOC <sub>6</sub> H <sub>4</sub> F	86	125	126	3.9 min	4.0 min

(b) Imidazole Derivatives

An excess of CF<sub>3</sub>OF was bubbled slowly through a solution of 1,2-dimethyl-5-trimethylstannylimidazole (0.55g, 2x10<sup>-3</sup> mol)

in dichloromethane. After filtration of the product mixture the solvent was evaporated to give a gum,  $\delta_F$  ( $\text{CH}_2\text{Cl}_2$ , 56.45 MHz) 152 (aromatic fluorine);  $\delta_H$  (60 MHz,  $\text{CDCl}_3$ ) 0.5 (impurity), 2.6 (3H, C-Me), 3.7 (3H, N-Me), 7.2 (1H, aromatic H). Trimethyltinfluoride was also isolated.

## 7.2 Reactions of Caesium Fluoroxysulphate

### (a) Preparation of $\text{CsSO}_4\text{F}$

Fluorine (9g, 0.24 mol), as a 20% mixture in nitrogen, was bubbled slowly through a solution of caesium sulphate (80g, 0.22 mol) in water (120 ml), at  $0^\circ\text{C}$ . Filtration of the product mixture gave an off white solid which was dried under vacuum without heating to yield caesium fluoroxysulphate (24g, 44%),  $\nu_{\text{max}}$  (nujol) 1250-1100 (S-O stretch), 830 (O-F stretch)  $\text{cm}^{-1}$ ; (Found: Cs, 52.2; S, 12.5. Calc. for  $\text{CsSO}_4\text{F}$ : Cs, 53.6; S, 12.9%).

### (b) Reaction with organostannanes

To a stirred suspension of caesium fluoroxysulphate (1.0m equiv) in acetonitrile (5 ml), a solution of organostannane (71) to (74) (1.5m equiv) in acetonitrile was added at  $0^\circ\text{C}$ . The mixture was allowed to warm to room temperature with stirring over 15h. Solid products were removed by filtration and the solution analysed by  $^{19}\text{F}$  n.m.r. and glc-mass spectrometry. For reaction of derivatives (77) to (80) the organostannane was suspended in chloroform (5 ml) and allowed to react with caesium fluoroxysulphate in a mixed solvent system for 72h. In all cases products were identified and yields calculated by comparison of spectra with those of authentic samples. Results are shown in Table (XXI).

TABLE XXI

Organometallic	Product	Yield (%)	$^{19}\text{F}$ n.m.r.	Mass Spectrum (m/z)
71	PhF	69	114 ppm	96
72	p-MeC <sub>6</sub> H <sub>4</sub> F	86	120 ppm	110
73	p-MeOC <sub>6</sub> H <sub>4</sub> F	79	126 ppm	126
74	pClC <sub>6</sub> H <sub>4</sub> F	87	116 ppm	130,132
77	pMeC <sub>6</sub> H <sub>4</sub> F	11	120 ppm	110
78	pMeOC <sub>6</sub> H <sub>4</sub> F	42	126 ppm	126
79	PhF	0	-	-
80	p-MeOC <sub>6</sub> H <sub>4</sub> F	0	-	-

(c) Reaction with Imidazole Derivatives(i) 1,2-dimethyl-5-trimethylstannylimidazole:

A solution of 1,2-dimethyl-5-trimethylstannylimidazole (1.0g, 4 mmol) in acetonitrile (3 ml) was added to a suspension/solution of caesium fluoroxysulphate (1.1g, 4.5 mmol) in acetonitrile (5 ml) under a nitrogen blanket. The reaction mixture was stirred overnight and then the solids filtered off. The solution was analysed by  $^{19}\text{F}$  n.m.r. No fluorine containing material was detected. The solvent was evaporated to give a tar which was not analysed further. The solids obtained by filtration were dissolved in water and  $^{19}\text{F}$  n.m.r. spectrum of this solution shows only the presence of fluoride ion. at 128 ppm.

The above reaction was repeated, however, the reaction mixture was stirred at  $-45^{\circ}\text{C}$  for 2h then allowed to warm to room temperature over 15h. Analogous results were obtained to those above.

(ii) 1,2-dimethylimidazole:

A solution of 1,2-dimethylimidazole (0.96g, 10 mmol) in dichloromethane (5 ml) was added to a suspension of caesium fluoroxysulphate (2.5g, 10 mmol) in dichloromethane (5 ml) at room temperature. After stirring the reaction mixture for 4h a solution of  $K_2CO_3$  was added and the mixture vigorously stirred for 0.5h. The organic layer was separated and the aqueous layer continually extracted with dichloromethane for 24h. The combined extracts were dried over  $MgSO_4$  and solvent evaporated to yield a yellow oil. The  $^{19}F$  n.m.r. spectrum of the oil reveals that no fluorinated products have been formed.

The reaction was repeated using acetonitrile as solvent. Again, however, no fluorinated products could be isolated.

(iii) N-Methylimidazole:

A solution of N-methylimidazole (0.25g, 3 mmol) in acetonitrile (5 ml) was added to a stirred suspension/solution of  $CsSO_4F$  (0.7g, 3 mmol) in acetonitrile (5 ml) at  $0^\circ C$ . The reaction mixture was allowed to warm to room temperature with stirring over 15h. The solids were filtered off and the solution analysed by  $^{19}F$  n.m.r. No fluorinated products were observed. Evaporation of the solvent gave a tarry residue which was not further purified.

The reaction was repeated using a 1:1 mixture of acetonitrile and methanol as solvent. Again, however, no fluorinated products were observed, only tarry residues.

### 7.3 Reactions of Elemental Fluorine

#### (a) General

Fluorine was used as a 10% mixture in oxygen free nitrogen. This mixture was prepared using a gas flow system, shown in the diagram below:

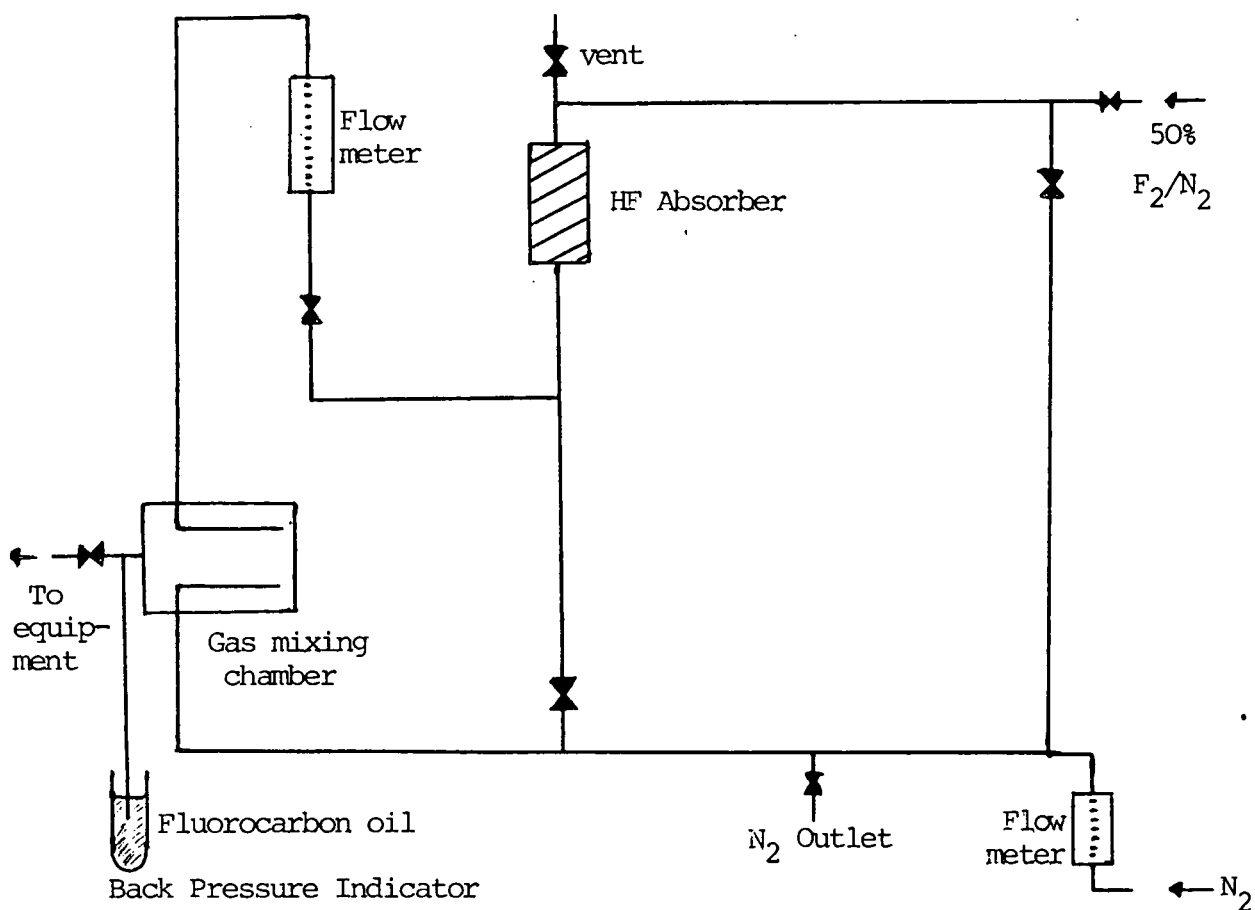

By regulating the gas flow rates of fluorine and nitrogen any percentage mixture of the two gases can be generated and fed into the reaction mixture.



A second method for preparing a known mixture of fluorine in nitrogen, which is used for reactions of imidazole derivatives with fluorine, is to fill an evacuated, purged steel cylinder with elemental fluorine at 1 atmosphere, then to pressurise the cylinder with nitrogen until the required dilution of fluorine is obtained. The weight of available fluorine can be calculated knowing the volume of the cylinder and the percentage mixture of  $F_2$  in  $N_2$ . The fluorine/nitrogen mixture was bubbled into the reaction mixture through a 5mm internal diameter glass inlet tube, the reaction mixture was stirred vigorously to prevent blockage of the inlet tube by trialkyltinfluorides, which precipitate during the reactions.

(b) Reaction with Model Compounds

A solution of the organostannane (1mol.equiv.) in  $CFCl_3$  (40ml) was cooled to  $-78^\circ C$  under a flow of dry nitrogen. Fluorine (10% in nitrogen, 1.5 mol.equiv.) was bubbled through the solution at *ca.*  $120ml\ min^{-1}$ . The solution was then warmed to room temperature with nitrogen bubbling through the mixture. After filtration of organometallic solids the mixture was analysed by  $^{19}F$  n.m.r. and glc-mass spectrometry. For all reactions described in Table (XXII) the fluoroaromatic compound was identified and estimated by glc-mass spectrometry and  $^{19}F$  n.m.r. spectra using authentic compounds as standards.

TABLE XXII

Organometallic g (mol)	Product	Yield	$^{19}\text{F}$ n.m.r.	Mass Spectrum $M^+$ (m/z)
71 1.23 (5 mmol)	$\text{C}_6\text{H}_5\text{F}$	30%	113 ppm	96
72 0.8g (3 mmol)	<i>p</i> -MeC $_6\text{H}_4\text{F}$	57%	119 ppm	110
73 2.2g (8 mmol)	<i>p</i> -MeOC $_6\text{H}_4\text{F}$	60%	124 ppm	126
74 1 g (3.6 mmol)	<i>p</i> -ClC $_6\text{H}_4\text{F}$	67%	116 ppm	130, 132
76 1.2g (3.1 mmol)	PhF	41%	114 ppm	96
79 1 g (2.25 mmol)	PhF	47%	114 ppm	96

(c) Reaction with Imidazole Derivatives(i) 1,2-Dimethyl-5-trimethylstannylimidazole

A solution of 1,2-dimethyl-5-trimethylstannylimidazole (2g, 7.7 mmol) in dichloromethane (50 ml) was cooled to  $-78^\circ\text{C}$  under a flow of nitrogen. Fluorine (7% in nitrogen) was bubbled through the reaction mixture which was then allowed to warm to room temperature under nitrogen. After filtration the solvent was evaporated to leave an oily residue. Analysis by  $^{19}\text{F}$  n.m.r. of the oil suggests 1,2-dimethyl-5-fluoroimidazole is present as the only fluorinated product;  $\delta_{\text{F}}$  (56.45 MHz,  $\text{CDCl}_3$ ) 152.6 (d,  $J = 9\text{Hz}$ ).

- (ii) N-methyl-2-trimethylstannylimidazole (86) and N-methyl-5-trimethylstannylimidazole (90).

An inseparable mixture of (86) and (90) (2.3g, 9mmol) was dissolved in dichloromethane (50<sup>o</sup>ml) and cooled to -78<sup>o</sup>C under a flow of nitrogen. Fluorine (10% in nitrogen) was bubbled through the solution which was then allowed to warm to room temperature under nitrogen. After filtration the solvent was evaporated and the resulting pale yellow liquid analysed by <sup>19</sup>F n.m.r. Analysis suggests 5-fluoro- and 2-fluoro-N-methylimidazole are the only fluorinated products.  $\delta_F$  (56.45 MHz, neat) 118 (s, 2-fluoro-N-methylimidazole, Lit.<sup>99</sup>, 117.3), 157.5 (d, J = 7.5 Hz, 5-fluoro-N-methylimidazole, Lit.<sup>99</sup>, 154.8, J = 8.0 Hz).

(d) Reaction with Anisole

A solution of anisole (2g, 19 mmol) in CFCl<sub>3</sub> (5 ml) was cooled to -78<sup>o</sup>C under a flow of nitrogen. Fluorine (10% in nitrogen, 0.36g, 19 mmol) was bubbled through the solution using a metal capillary inlet over 15h. The product solution was purged with nitrogen as it was allowed to warm to room temperature. The product mixture was analysed by <sup>19</sup>F n.m.r. without further purification.  $\delta_F$  (56.45 MHz) 122 and 131 (p and o fluorines in o, p-difluoroanisole), 125 (p-fluoroanisole), 136 (o-fluoroanisole), 141, 150 ppm.

## CHAPTER EIGHT

EXPERIMENTAL TO CHAPTER FIVE8.1 Preparation of 5-amino-1-( $\beta$ -D-2',3',5'-tri-O-benzoyl-ribofuranosyl)imidazole-4-carboxamide (96)

To a suspension of AICAR (7g, 0.027 mol) and dimethylamino-pyridine (DMAP) (3.4g, 0.028 mol) in pyridine (70 ml), benzoic anhydride (25g, 0.11 mol) was added and the reaction mixture was stirred for 36h at room temperature. The mixture was then poured onto ice and water and the mixture extracted with ethylacetate. The organic layer was separated, washed with 5M hydrochloric acid, neutralized with saturated  $\text{NaHCO}_3$  solution, dried over  $\text{MgSO}_4$  then the solvent evaporated to give an oil which was chromatographed on silica gel (ethyl acetate) to yield (96) (12.4g, 80%); m.p. 83-85°C (from ethylacetate/carbon tetrachloride) (Found: C, 63.4; H, 4.5; N, 9.6.  $\text{C}_{30}\text{H}_{26}\text{N}_4\text{O}_8$  requires C, 63.2; H, 4.6; N, 9.8%); Infrared spectrum No. 20;  $^1\text{H}$  n.m.r. spectrum No.18;  $^{13}\text{C}$  n.m.r. spectrum No.1; mass spectrum No.15.

8.2 Preparation of 5-benzoylamino-1-( $\beta$ -D-2',3',5'-tri-O-benzoylribofuranosyl)-4-cyanoimidazole (97)(a) From AICAR

Benzoylchloride (8.4ml, 10.2g, 73 mmol) was added dropwise to a suspension of AICAR (3g, 12 mmol) and DMAP (1.5g, 12 mmol) in pyridine (30 ml) with cooling in an ice bath. The reaction mixture was stirred for 15h then poured into a mixture of ice and dilute hydrochloric acid (400 ml). The resulting mixture was extracted with ethyl acetate and the organic layer separated then washed with saturated  $\text{NaHCO}_3$  solution until neutral. After drying the solution over  $\text{MgSO}_4$  the solvent was evaporated to

give oil which was chromatographed on silica gel (acetone: hexane, 1:2, v/v). The major component was collected and re-chromatographed on silica gel (ethylacetate:hexane, 2:3, v/v) to give (97) (1.2g, 42%), m.p. 178-180°C (from ethanol/water) (Found: C, 66.5; H, 4.5; N, 8.4.  $C_{37}H_{28}N_4O_8$  requires: C, 67.7; H, 4.3; N, 8.5%); infrared spectrum No.21;  $^1H$  n.m.r. spectrum No.19;  $^{13}C$  n.m.r. spectrum No.2; mass spectrum No.16.

(b) From tribenzoate (96)

Benzoylchloride (2.1g, 15 mmol) was added dropwise to a solution of (96) (2.1g, 3.7 mmol) and DMAP (1.8g, 15 mmol) in pyridine (50 ml) at 0°C. The mixture was allowed to warm to room temperature and was stirred for 65h, it was then poured onto a mixture of ice and dilute hydrochloric acid (400 ml). The resulting suspension was extracted with ethyl acetate, the organic layer separated, washed with dilute hydrochloric acid, then water, and finally neutralized with saturated  $NaHCO_3$  solution. After drying the organic solution over  $MgSO_4$  the solvent was evaporated to give an oil which was chromatographed on silica (ethylacetate/hexane, 1:1, v/v) and the product recrystallized to give (97) (1.6g, 65%). Infrared and n.m.r. spectra were identical to those of (2) prepared by method (a).

8.3 Preparation of 5-(benzoylamino)-1-( $\beta$ -D-2',3',5'-tri-O-benzoylribofuranosyl)imidazole-4-carboxamide (95).

Benzoylchloride (6.4g, 45.4 mmol) was added dropwise to a solution of tribenzoate (96) (10.4g, 18 mmol) and  $Na_2CO_3$  (4.8g, 45.4 mmol) in dichloromethane (200 ml). The reaction mixture was heated under reflux for 15h then allowed to cool to room temperature before pouring onto ice. The organic layer was separated and combined with extracts ( $CH_2Cl_2$ ) of the aqueous

layer. After washing with dilute hydrochloric acid then neutralising with saturated  $\text{NaHCO}_3$  solution the organic layer was dried over  $\text{MgSO}_4$  then the solvent evaporated to give an oil. This oil was chromatographed on silica (ethylacetate/hexane, 1:1 v/v), after the first fraction had been collected the elutant was changed to ethylacetate. The first fraction was identified as (97) by comparison of spectral data with authentic material. The second fraction was recrystallized from ethanol/water to give (95) (3.3g, 27%) m.p. 97-98°C (Found: C, 65.8; H, 4.8; N, 8.3.  $\text{C}_{37}\text{H}_{30}\text{N}_4\text{O}_9$  requires: C, 65.9; H, 4.5; N, 8.3%); infra red spectrum No.22;  $^1\text{H}$  n.m.r. spectrum No. 20;  $^{13}\text{C}$  n.m.r. spectrum No.3; mass spectrum No. 17.

#### 8.4 Preparation of 5-(triphenylmethyl)amino-1-( $\beta$ -D-2',3',5'-tri-O-benzoylribofuranosyl)imidazole-4-carboxamide (98).

Triphenylmethylchloride (1.5g, 5.25 mmol) was added to a solution of the tribenzoate (96) (2g, 3.5 mmol) in ethylacetate (15 ml) and triethylamine (10 ml). The mixture was stirred at room temperature for 15h then poured onto water (200 ml). Ethylacetate was added and the organic layer separated, extracted with water then dried over magnesium sulphate. The solvent was evaporated and the resulting oil chromatographed on silica (ethyl acetate/hexane, 5:1, v/v) to give (98) (1.9g, 67%); (Found: C, 72.6; H, 5.0, N, 6.8;  $\text{C}_{48}\text{H}_{39}\text{N}_4\text{O}_8$  requires: C, 72.1; H, 4.9; N, 7.00%); infrared spectrum No. 23,  $^1\text{H}$  n.m.r. spectrum No. 21.

#### 8.5 Deprotection of Tribenzoate (96).

Hydroxylaminium acetate (1.3g, 14 mmol) was added to a stirred solution of (96) (2g, 3.5 mmol) at room temperature in

pyridine (15 ml). The reaction mixture was stirred for 30h at room temperature, acetone (20 ml) was then added and the solvent evaporated to give an oil which was chromatographed on silica gel (chloroform/methanol, 19:1, v/v) to give a mixture of 5-amino-1-( $\beta$ -D-3',5'-di-O-benzoylribofuranosyl)-imidazole-4-carboxamide (99) and 5-amino-1-( $\beta$ -D-2',5'-di-O-benzoylribofuranosyl)imidazole-4-carboxamide (100) (1.2g, 73%); m.p. 103-106°C (Found: C, 58.4; H, 4.8; N, 11.7;  $C_{23}H_{22}N_4O_7$  requires: C, 59.2, H, 4.8, N, 12.0%); infrared spectrum No.24;  $^1H$  n.m.r. spectrum No.22;  $^{13}C$  n.m.r. spectrum No. 4; mass spectrum No.18.

The above reaction was repeated using 6g of tribenzoate (96). After work-up and chromatography the product was recrystallized to give a pure sample of (100) (1.1g, 23%), m.p. 188-192°C (Found: C, 59.2; H, 4.8; N, 12.0.  $C_{23}H_{22}N_4O_7$  requires: C, 59.2 ; H, 4.8 ; N, 12.0 %); infrared spectrum No. 25;  $^1H$  n.m.r. spectrum No.23,  $^{13}C$  spectrum No.5.

Evaporation of the mother liquor revealed a purified sample of (99)  $^1H$  n.m.r. spectrum No.24;  $^{13}C$  n.m.r. spectrum No. 6.

#### 8.6 Deprotection of nitrile derivative (97)

(a) Hydroxylaminium acetate (280mg, 3 mmol) was added to a stirred solution of (97) (500 mg, 0.75 mmol) in pyridine (10 ml). The reaction mixture was stirred for 27h at room temperature, then acetone (50 ml) was added and the solvent evaporated to give an oil which was chromatographed on silica (chloroform/methanol, 19:1 v/v). Two fractions were collected as oils and recrystallized from methanol/water to give as first fraction

5-(benzoylamino)-1-( $\beta$ -D-2',3',5'-tri-O-benzoylribofuranosyl)-imidazole-4-carboamidoxime (101) (135 mg, 33%); (Found: C, 63.5; H, 4.6; N, 9.6.  $C_{37}H_{31}N_5O_9$  requires: C, 64.4; H, 4.5; N, 10.1%) infrared spectrum No.26;  $^1H$  n.m.r. spectrum No.25;  $^{13}C$  n.m.r. spectrum No.7; mass spectrum No.19; and as second fraction 5-(benzoylamino)-1-( $\beta$ -D-3',5'-di-O-benzoylribofuranosyl)imidazole-4-carboamidoxime (102) (138g, 31%); (Found: C, 62.5; H, 5.3; N, 11.7.  $C_{30}H_{27}N_5O_8$  requires: C, 61.53; H, 4.6; N, 12.0%); infrared spectrum No.27;  $^1H$  n.m.r. spectrum No. 26; mass spectrum No. 20.

(b) Hydroxylaminium acetate (12.1g, 0.13 mol) was added to a solution of (97) (14.7g, used without chromatographic purification), in pyridine (100 ml). The reaction mixture was stirred at room temperature for 3 days then acetone (150 ml) was added and the solution evaporated to give an oil which was chromatographed on silica (chloroform/methanol, 19:1, v/v). The major fraction was collected and recrystallized from methanol. Spectral analysis of the product suggest it is 5-(benzoylamino)-1-( $\beta$ -D-5'-benzoylribofuranosyl)imidazole-4-carboxamide (103) (4.3g) infrared spectrum No.28;  $^1H$  n.m.r. spectrum No.27;  $^{13}C$  n.m.r. spectrum No.8.

#### 8.7 N-Trytylation of a mixture of dibenzoates (99) and (100)

Triphenylmethylchloride (0.18g, 0.65 mmol) was added to a solution of a mixture of (99) and (100) (200mg, 0.43 mmol) in ethyl acetate (5 ml) and triethylamine (5ml). The reaction mixture was stirred at room temperature for 15h then poured onto water. The organic layer was separated and washed with water several times until most of the triethyl amine had been removed. The solution was dried over  $MgSO_4$  then the solvent evaporated



to give a solid. The crude product was chromatographed on silica (chloroform/methanol, 10:1, v/v) to a solid which was tentatively assigned as a mixture of 5-(triphenylmethyl)amino-1-( $\beta$ -D-3',5'-di-O-benzoylribofuranosyl)imidazole-4-carboxamide (104) and 5-(triphenylmethylamino-1-( $\beta$ -D-2',5'-di-O-benzoylribofuranosyl)imidazole-4-carboxamide (105) (240 mg, 78%),  $^1\text{H}$  n.m.r. spectrum No.28.

#### 8.8 Deprotection of tetrabenzoate (95)

Hydroxylaminium acetate (440 mg, 4.7 mmol) was added to a solution of (95) (790 mg, 1.2 mmol) in pyridine (20 ml). The reaction mixture was stirred, at room temperature, for 15h and then acetone (20 ml) was added. The solvent was evaporated to give an oil which was chromatographed on silica (chloroform/methanol, 19:1, v/v) to give what appeared to be a mixture of 5-(benzoylamino)-1-( $\beta$ -D-3',5'-di-O-benzoylribofuranosyl)-imidazole-4-carboxamide (106) and 5-(benzoylamino)-1-( $\beta$ -D-2',5'-di-O-benzoylribofuranosyl)imidazole-4-carboxamide (107). The product mixture was identified by  $^1\text{H}$  n.m.r. spectrum No.29, and comparison of this with  $^1\text{H}$  n.m.r. spectra of other deprotected nucleosides.

#### 8.9 Attempted Preparation of Fluorinated Derivatives of Dibenzoates (99) and (100)

Trifluoromethanesulphonic anhydride (200 mg, 0.7 mmol) was added to a solution of (99) and (100) (300 mg, 0.64 mmol) in pyridine (3ml). After 3h the mixture was poured onto a mixture of ice and 5M HCl, extracted with chloroform and neutralized with  $\text{NaHCO}_3$  solution. The organic solution was dried over  $\text{MgSO}_4$  and the solvent evaporated to give a solid, which was dried under

vacuum. This product was dissolved in THF (30 ml) and to the solution tetrabutylammonium fluoride (1g, 3.2 mmol) in THF was added. The mixture was stirred for 15h then poured onto a mixture of ice and water, extracted with chloroform, the organic layer dried over  $\text{MgSO}_4$  and solvent evaporated to give an oil. The oil was chromatographed on silica (ethylacetate) and fractions with an  $R_f = 0.39$  combined and evaporated to give a solid (22.5 mg) which was tentatively assigned as 5-(benzoylamino)-1-( $\beta$ -D-5'-benzoylribofuranosyl)-4-cyanoimidazole from its  $^1\text{H}$  n.m.r. spectrum. m.p.  $187^\circ\text{C}$  (from ethanol/hexane); infra-red spectrum No.29;  $^1\text{H}$  n.m.r. spectrum No.30.

#### 8.10 Attempted Triflation of (99) and (100)

(a) A solution of a mixture of dibenzoates (99) and (100) (100 mg, 0.21 mmol) and DMAP (28 mg, 0.22 mmol) in dichloromethane (5 ml) was cooled to  $-65^\circ\text{C}$  under a flow of nitrogen. Trifluoromethane sulphonic anhydride (65 mg, 0.23 mmol) was added dropwise then the reaction mixture was allowed to warm to room temperature with stirring. The mixture was stirred at room temperature and under nitrogen for 22h then filtered and the solvent evaporated to give a glass which was chromatographed on silica (ethyl acetate) and the fraction with  $R_f=0.37$  collected (18mg). This was tentatively assigned as a mixture of 5-amino-1-( $\beta$ -D-3',5'-di-O-benzoyl-2'-triflylribofuranosyl)-imidazole-4-carboxamide and 5-amino-1-( $\beta$ -D-2',5'-di-O-benzoyl-3'-triflylribofuranosyl)imidazole-4-carboxamide from  $^1\text{H}$  n.m.r. and comparison with  $^1\text{H}$  n.m.r. of the mixture of (99) and (100)  $^1\text{H}$  n.m.r. No. 31.

(b) The above reaction was repeated using a pure sample of (100). After aqueous work-up a solid was obtained which was

analysed without further purification.  $^1\text{H}$  n.m.r. spectrum No.32.

#### 8.11 Triflation of dibenzoates (99) and (100) to give (110) and (111)

A solution of a mixture of (99) and (100) (240 mg, 0.5 mmol) in dichloromethane (5ml) and pyridine (2.5 ml) was cooled to  $0^\circ\text{C}$ . Trifluoromethanesulphonic anhydride (300 mg, 1.1 mmol) was added in two equal portions at  $\frac{1}{2}$ h intervals. The reaction mixture was stirred for 24h while warming to room temperature and then poured onto a mixture of ice and water. Dichloromethane (50 ml) was added and the organic layer separated. The aqueous layer was extracted with dichloromethane, the combined organic extracts were then washed with 5M HCl, then water, then saturated  $\text{NaHCO}_3$ . After drying over  $\text{MgSO}_4$  the solvent was evaporated to give an oil which was chromatographed on silica (chloroform/methanol, 10:1, v/v) to give a solid, the  $^1\text{H}$  n.m.r. of which suggest 5-amino-1-( $\beta$ -D-3',5'-di-O-benzoyl-arabinosyl)-4-cyanoimidazole (110) and 5-amino-1-( $\beta$ -D-2',5'-di-O-benzoyl-xylofuranosyl)-4-cyanoimidazole (111) are present.  $^1\text{H}$  n.m.r. spectrum No.33; infrared spectrum No.30.

#### 8.12 Attempted Synthesis of a Fluoroderivative of (99) and (100) by displacement of a triflate group using TAS-F

Trifluoromethane sulphonic anhydride (40 mg,  $1.4 \times 10^{-4}$  mol) was added to a solution of a mixture of (99) and (100) (66 mg,  $1.4 \times 10^{-4}$  mmol), in dichloromethane (1ml) and pyridine (1ml). The mixture was stirred for 15h then the solvent evaporated and the resulting solid dried under vacuum. This solid was dissolved in dry acetonitrile (2ml) and a solution of tris(dimethylamino)sulphonium trimethylsilyldifluoride (77mg,  $2.8 \times 10^{-4}$  mol)

in acetonitrile (1ml) was added at room temperature. No products were isolated from this reaction. The  $^{19}\text{F}$  n.m.r. spectrum of the reaction mixture shows only decomposition products of TAS-F and possible triflate derivative  $\delta_{\text{F}}$  (235 MHz) 79 (trifluoromethane sulphonic anhydride and possible triflate derivative), 132 ( $\text{F}^-$ ), 157 ( $\text{me}_3\text{SiF}$ ). No fluorinated nucleosides are observed.

#### 8.13 Reaction of a mixture of (99) and (100) with DAST

A solution of a mixture of (99) and (100) (150 mg,  $3.2 \times 10^{-4}$  mol) in THF (3 ml) and dry triethylamine (3ml) was cooled to  $-50^\circ\text{C}$ . Diethylaminosulphur trifluoride (60 $\mu$ l,  $4.8 \times 10^{-4}$  mol) was added in one lot and the reaction mixture stirred while warming to room temperature. Dimethylformamide (6ml) was added and the reaction mixture stirred for a further 1h. The reaction mixture was then poured onto a mixture of ice and 5M HCl and extracted with ethyl acetate. After neutralising the organic layer, with saturated  $\text{NaHCO}_3$ , the solution was dried over  $\text{MgSO}_4$  and solvent evaporated to give an oil which was chromatographed on silica (chloroform/methanol, 10:1, v/v) to give a glassy product. Proton n.m.r. and t.l.c. analysis shows this glass to be a mixture of products, no fluorinated products were observed.

#### 8.14 Reaction of a mixture of (99) and (100) with Sulphurtetrafluoride

A sealed tube containing a solution of a mixture of (99) and (100) (0.54g, 1.15 mmol) in dichloromethane (10 ml) and sulphurtetrafluoride (0.8g, 7.4 mmol) was agitated at room temperature for 15h over which time the mixture darkened considerably. Analysis of the reaction by t.l.c. revealed a

complex mixture of products which were inseparable.

The reaction was repeated using a 1:1 stoichiometry of (99) and (100): SF<sub>4</sub>. Analogous results were obtained. A complex mixture was also obtained when the reaction was heated at 70°C for 3h. In all cases <sup>19</sup>F n.m.r. reveals the presence of SOF<sub>2</sub> and SF<sub>4</sub>.

#### 8.15 Reaction of Tribenzoate (96) with Perfluorocyclopentene

A solution of tribenzoate (96) (2.9g, 5x10<sup>-3</sup> mol) in acetonitrile (20 ml), potassium carbonate (0.7g, 5.2x10<sup>-7</sup> mol) and perfluorocyclopentene (1.1g, 5.2x10<sup>-7</sup> mol) were sealed in a glass tube and heated, with shaking, at 75°C for 24h. The product mixture was then filtered and the solvent was evaporated to give a dark brown solid. δ<sub>F</sub> (235 MHz, d<sup>6</sup>-DMSO) 106.4, 107.8 and 108.2. The solid was then dissolved in ethylacetate and washed with water, after drying the organic layer over MgSO<sub>4</sub> the solvent was evaporated to give a solid product. Analysis by <sup>19</sup>F n.m.r. shows that this product contains no fluorine.

#### 8.16 Reaction of Tribenzoate (96) with Hexafluoropropene

A solution of the tribenzoate (96) (0.86g, 1.5x10<sup>-3</sup> mol) in acetonitrile (10ml), potassium carbonate (0.3g, 2.25x10<sup>-3</sup> mol) and hexafluoropropene were sealed in a tube and heated at 60°C for 24h. After the reaction mixture had cooled the solids were removed by filtration and the solvent evaporated to give a light brown solid. The solid was analysed by <sup>19</sup>F n.m.r. spectroscopy, before and after washing with water. Identical spectra were obtained. δ<sub>F</sub> (235 MHz, d<sup>6</sup>-DMSO) 74.7 (3H, m, CF<sub>3</sub>

group) and 203.5 (1H, m,  $\underline{\text{CFH}}$ );  $\delta_{\text{H}}$  (250 MHz,  $\text{d}^6$ -DMSO)  
5.2 (broad signal, probably 4', 5' protons), 6.28-6.99 (com-  
plex multiplets, probably 1', 2', 3' protons), 7.76-8.66  
(aromatic protons).

APPENDICES

APPENDIX ONEINFRARED SPECTRA

<u>Spectrum No.</u>	<u>Compound</u>
1	Tetraphenyltin (70)
2	Trimethylphenyltin (71)
3	Trimethyl-p-tolytin (72)
4	Trimethyl-p-anisyltin (73)
5	Trimethyl-p-chlorophenyltin (74)
6	Tributyl phenyltin (76)
7	Tributyl-p-tolytin (77)
8	Tributyl-p-anisyltin (78)
9	Tricyclohexylphenyltin (79)
10	Tricyclohexyl-p-anisyltin (80)
11	Tricyclohexyl-N,N-dimethylaminophenyltin (81)
12	1,2-Dimethyl-5-trimethylstannylimidazole (84)
13	1,2-Dimethyl-5-tributylstannylimidazole (85)
14	N-methyl-2-trimethylstannylimidazole (86)
15	Diphenylmercury (87)
16	Anisylmercuryacetate (88)
17	4-Acetomercury-1,2-dimethylimidazole (89)
18	Trimethyltin Fluoride
19	Caesium Fluoroxysulphate
20	5-Amino-1-( $\beta$ -D-2',3',5'-tri-O-benzoylribofuranosyl)-imidazole-4-carboxamide (96)
21	5-Benzoylamino-1-( $\beta$ -D-2',3',5'-tri-O-benzoylribofuranosyl)-4-cyanoimidazole (97)
22	5-Benzoylamino-1-( $\beta$ -D-2',3',5'-tri-O-benzoylribofuranosyl)imidazole-4-carboxamide (95)
23	5-Tritylamino-1-( $\beta$ -D-2',3',5'-tri-O-benzoylribofuranosyl)imidazole-4-carboxamide (98)



<u>Spectrum No.</u>	<u>Compound</u>
24	A mixture of 5-amino-1-( $\beta$ -D-3',5'-di-O-benzoylribofuranosyl)imidazole-4-carboxamide (99) and 5-amino-1-( $\beta$ -D-2',5'-di-O-benzoylribofuranosyl)imidazole-4-carboxamide (100)
25	5-Amino-1-( $\beta$ -D-2',5'-di-O-benzoylribofuranosyl)imidazole-4-carboxamide (100)
26	5-Benzoylamino-1-( $\beta$ -D-2',3',5'-tri-O-benzoylribofuranosyl)imidazole-4-carboxamidoxime (101)
27	5-Benzoylamino-1-( $\beta$ -D-3',5'-di-O-benzoylribofuranosyl)imidazole-4-carboxamidoxime (102)
28	5-Benzoylamino-1-( $\beta$ -D-5'-O-benzoylribofuranosyl)imidazole-4-carboxamide (103)
29	5-Benzoylamino-1-( $\beta$ -D-5'-O-benzoylribofuranosyl)
30	A mixture of 5-Amino-1-( $\beta$ -D-2',5'-di-O-benzoylxylofuranosyl)-4-cyanoimidazole and 5-amino-1-( $\beta$ -D,3',5'-di-O-benzoylarabinofuranosyl)-4-cyanoimidazole (110)

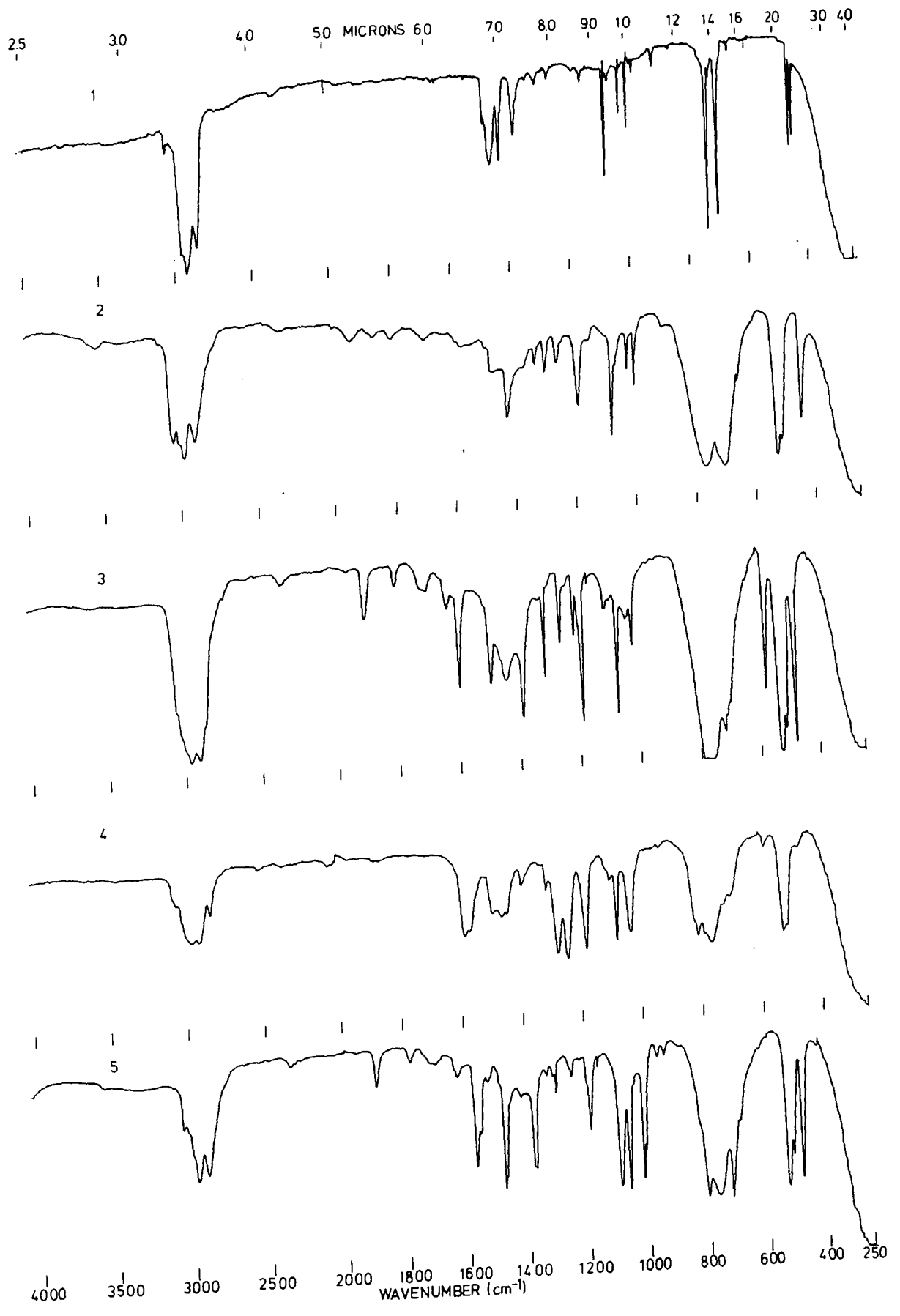

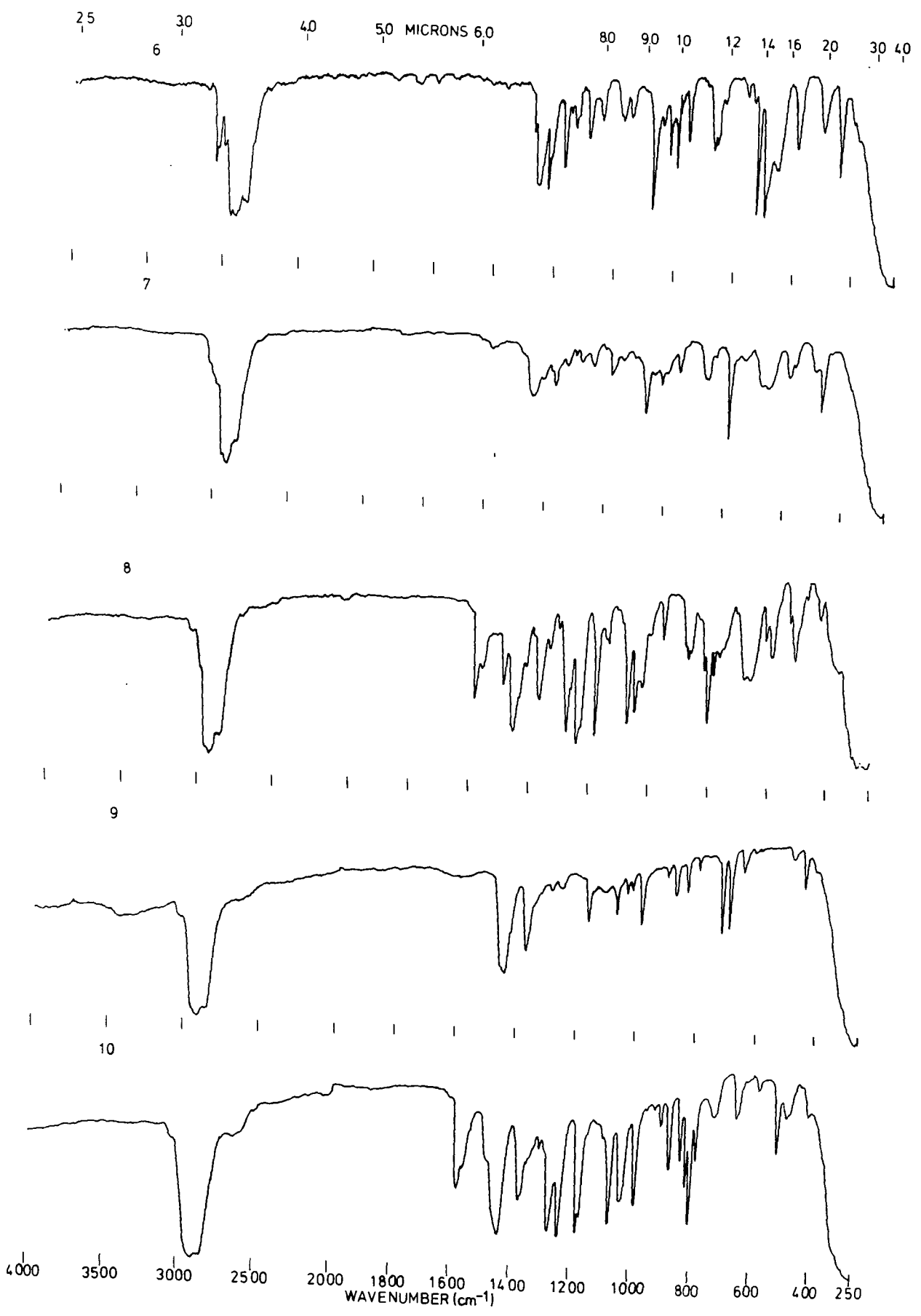

2.5 3.0 4.0 5.0 MICRONS 6.0 7.0 8.0 9.0 10 12 14 16 20 30 40

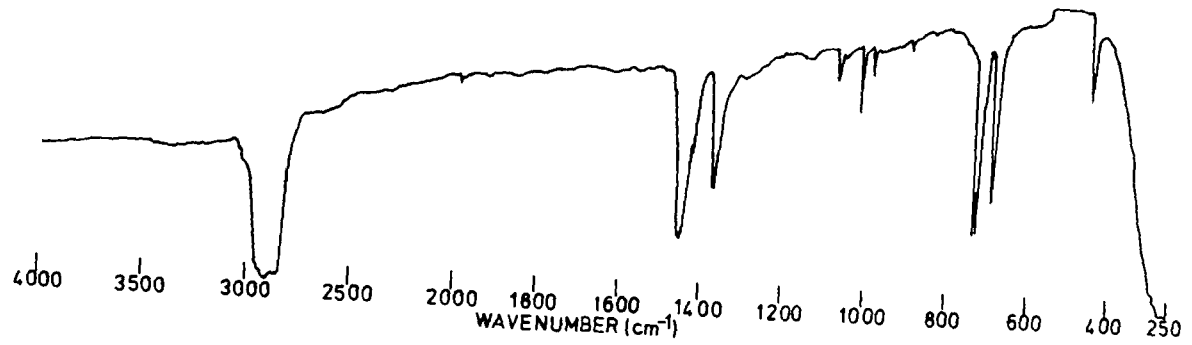
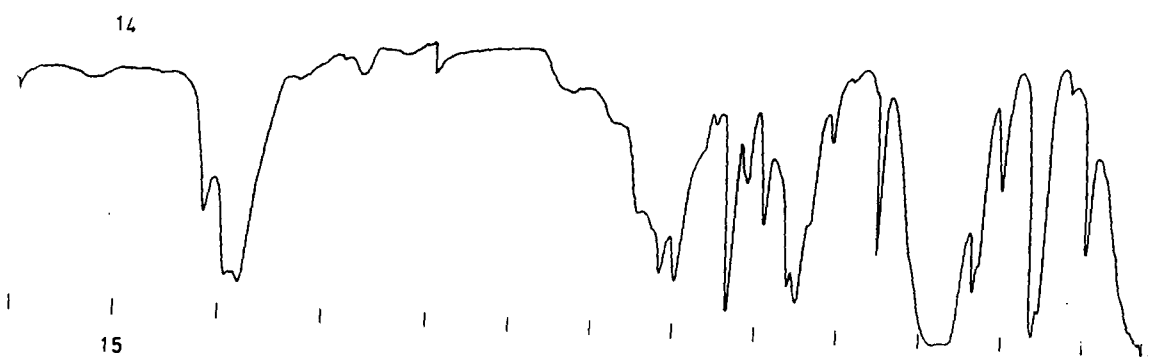
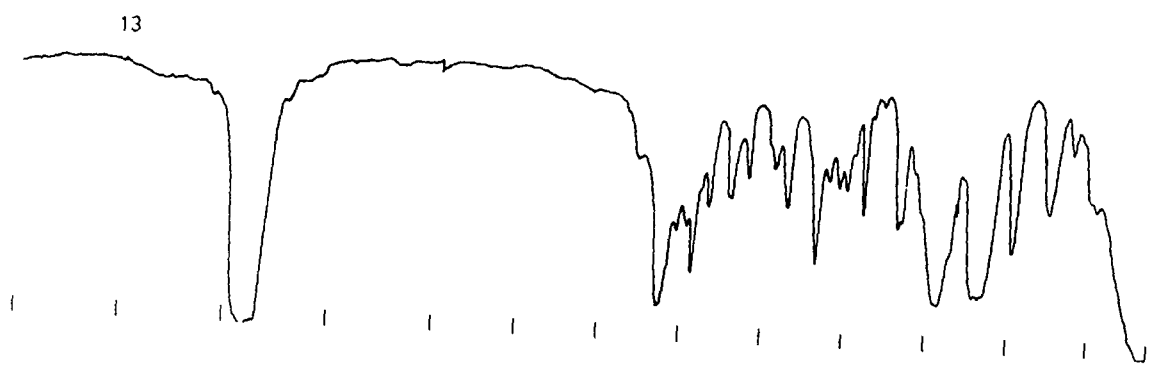
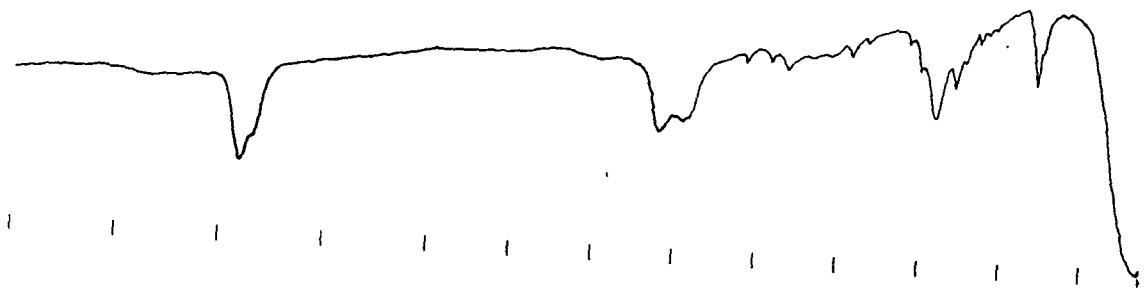
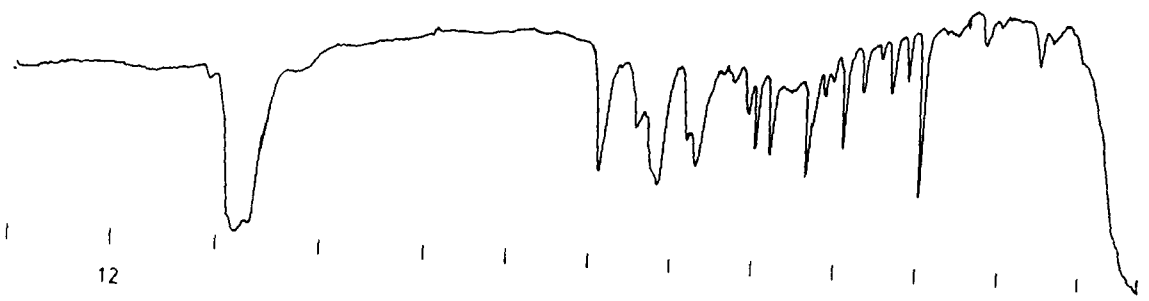

2.5 3.0 4.0 5.0 MICRONS 6.0 7.0 8.0 9.0 10 12 14 16 20 30 40

16

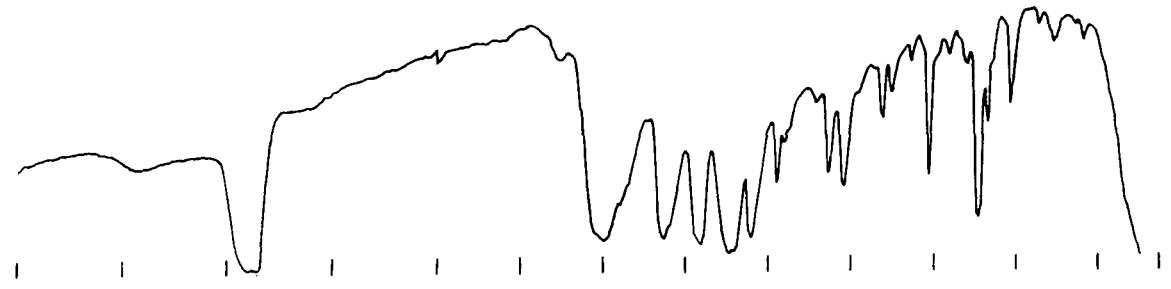

17

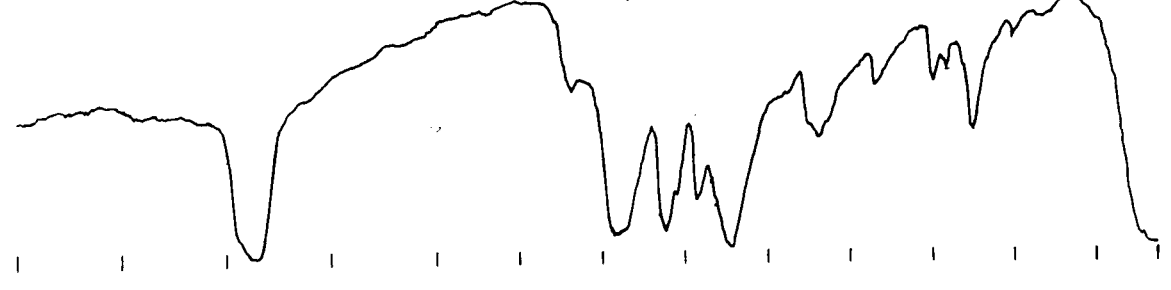

18

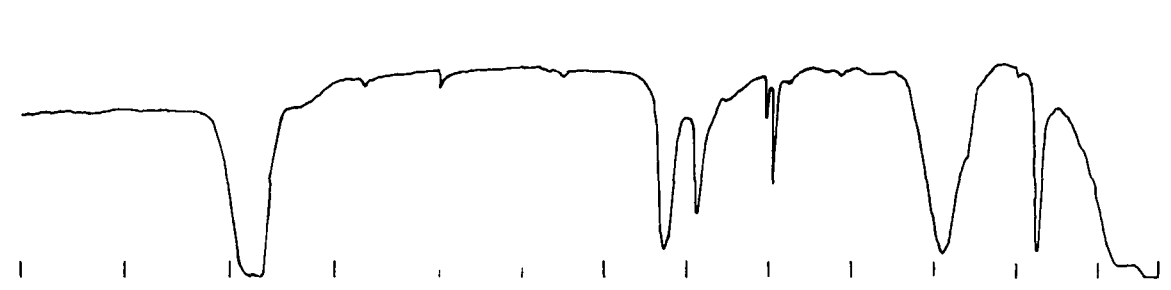

19

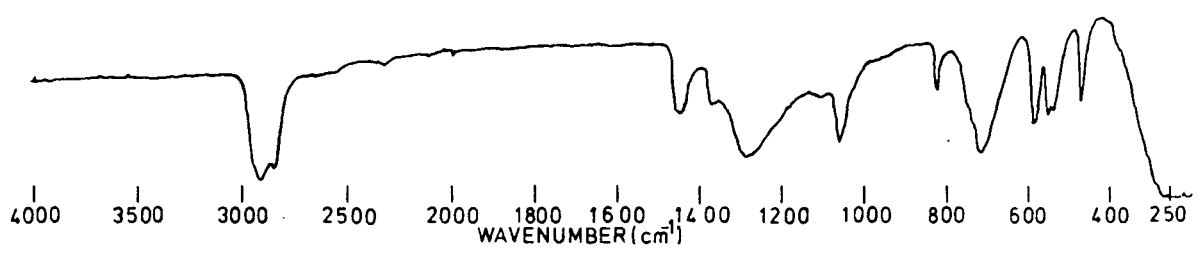

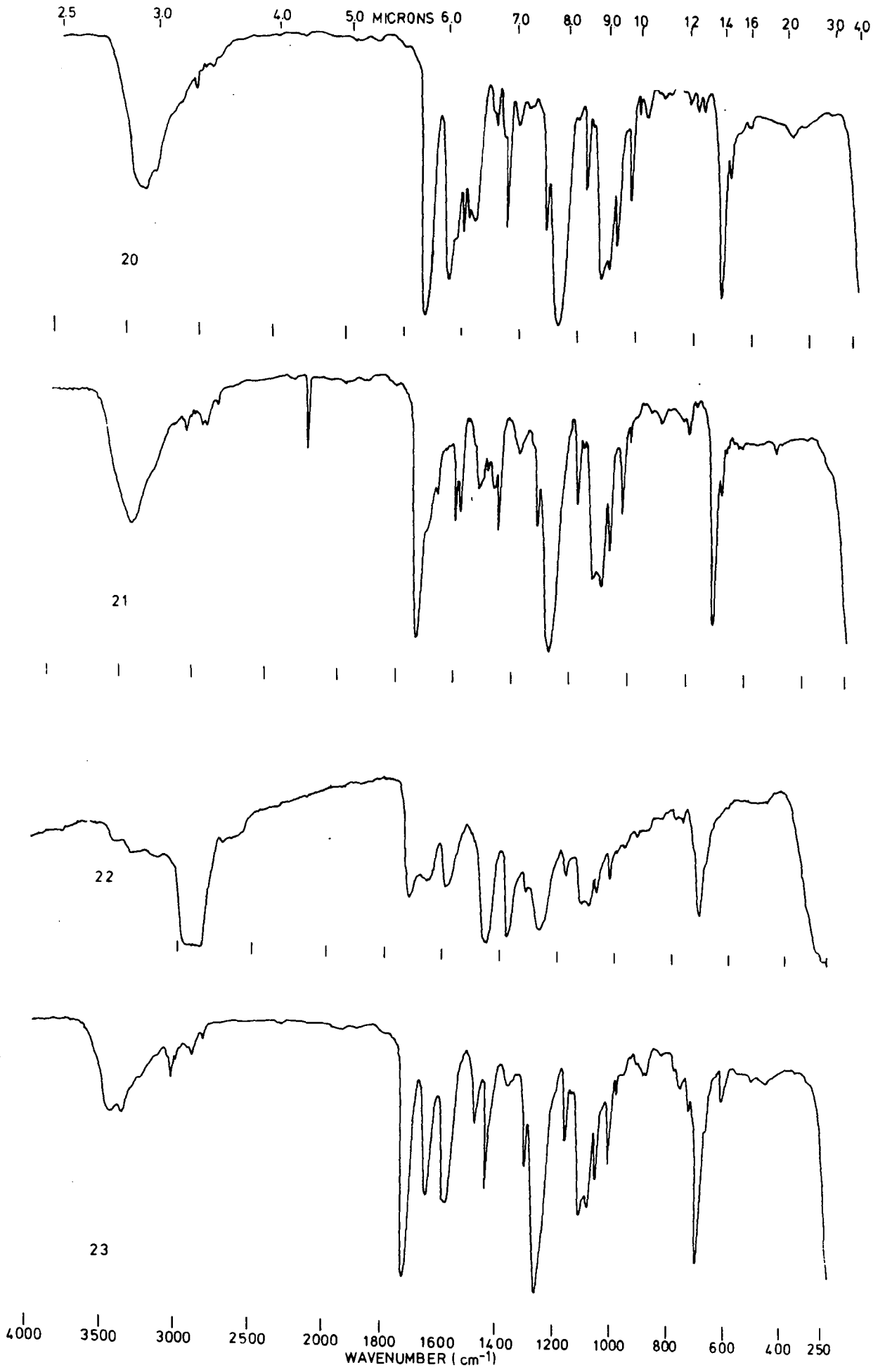

25 30 40 50 MICRONS 60 70 80 90 10 12 14 16 20 30 40

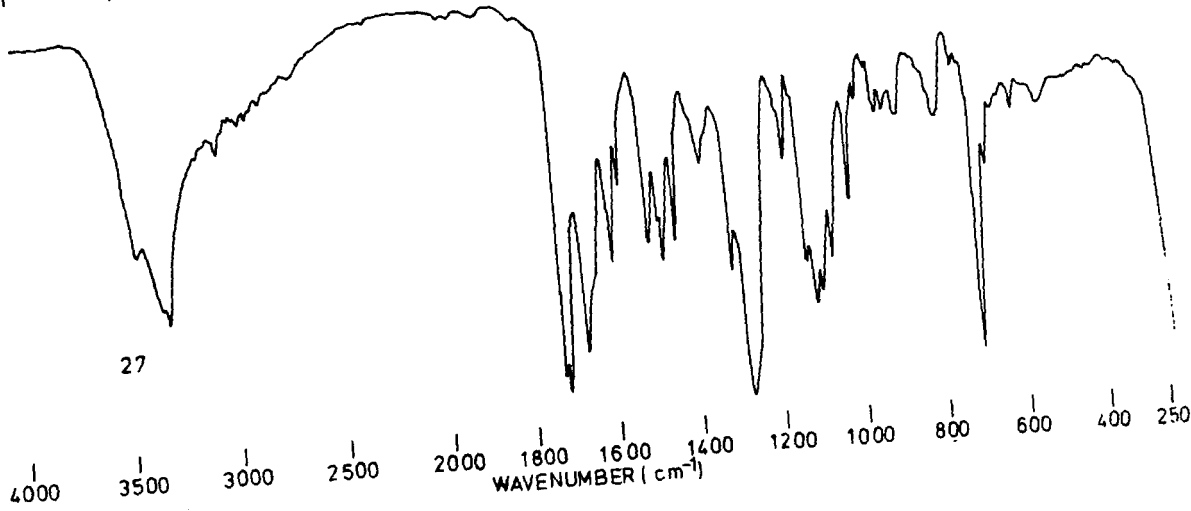
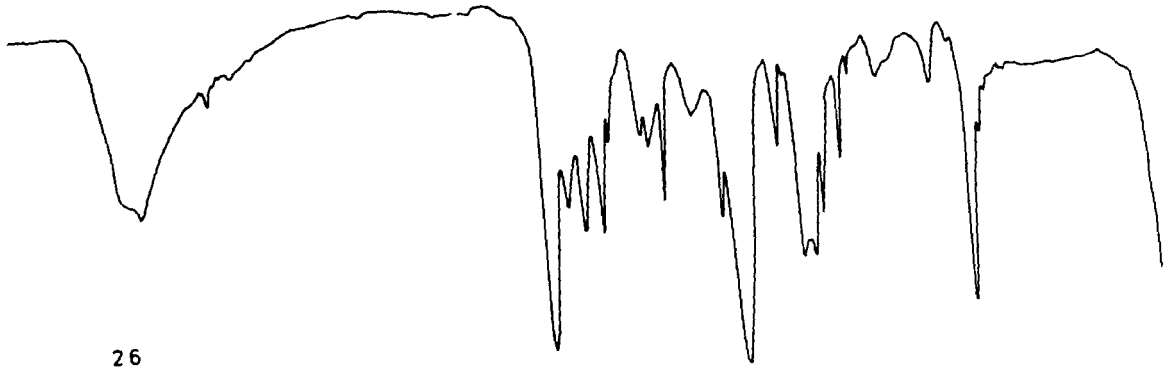
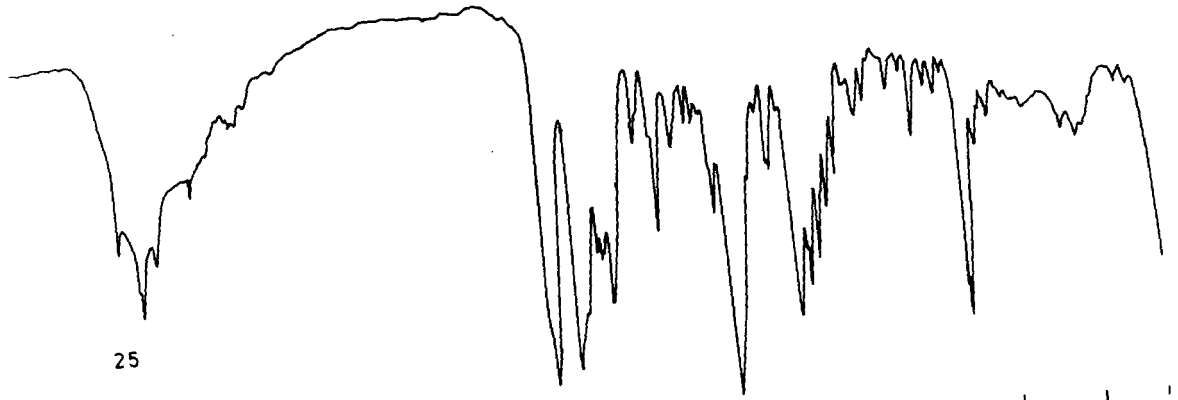
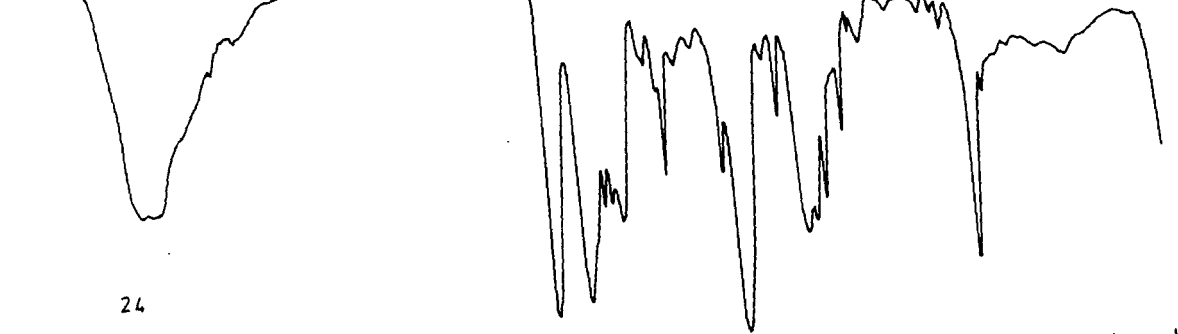

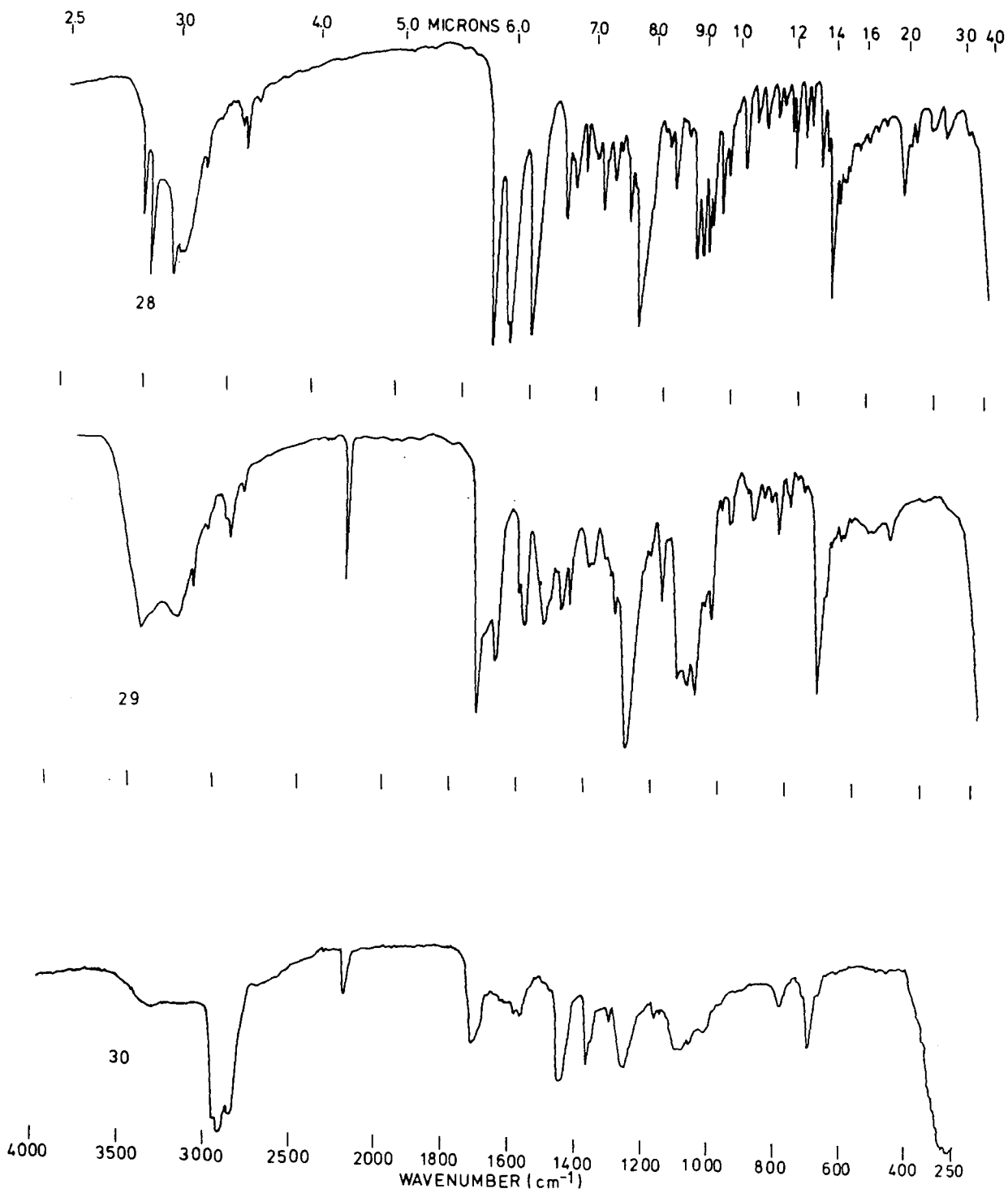



APPENDIX TWOMASS SPECTRA

<u>Spectrum No.</u>	<u>Compound</u>
1	Tetraphenyltin (70)
2	Trimethylphenyltin (71)
3	Trimethyl-p-tolytin (72)
4	Trimethyl-p-anisyltin (73)
5	Trimethyl-p-chlorophenyltin (74)
6	Trimethyl-3-pyridyltin (75)
7	Tri-n-butylphenyltin (76)
8	Tri-n-butyl-p-tolytin (77)
9	Tri-n-butyl-p-anisyltin (78)
10	Tricyclohexylphenyltin (79)
11	Tricyclohexyl-p-anisyltin (80)
12	Tricyclohexyl-p-N,N-dimethylaminophenyltin (81)
13	1,2-Dimethyl-5-tri-n-butylstannylimidazole (85)
14	Diphenyl mercury (87)
15	5-Amino-1-( $\beta$ -D-2',3',5'-tri-O-benzoylribofuranosyl)imidazole-4-carboxamide (96)
16	5-Benzoylamino-1-( $\beta$ -D-2',3',5'-tri-O-benzoylribofuranosyl)-4-cyanoimidazole (97)
17	5-Benzoylamino-1-( $\beta$ -D-2',3',5'-tri-O-benzoylribofuranosyl)imidazole-4-carboxamide (95)
18	A mixture of 5-amino-1-( $\beta$ -D-2',5'-di-O-benzoylribofuranosyl)imidazole-4-carboxamide (100 and 5-amino-1-( $\beta$ -D-3',5'-di-O-benzoylribofuranosyl)imidazole-4-carboxamide (99)
19	5-Benzoylamino-1-( $\beta$ -D-2',3',5'-tri-O-benzoylribofuranosyl)imidazole-4-carboxamidoxime (101)
20	5-Benzoylamino-1-( $\beta$ -D-3',5'-di-O-benzoylribofuranosyl)imidazole-4-carboxamidoxime (102)

SMSX 10  
CAL: CALT9S. MULLINS E. I.  
STR:26-SEP-80  
1:34

NO. 1

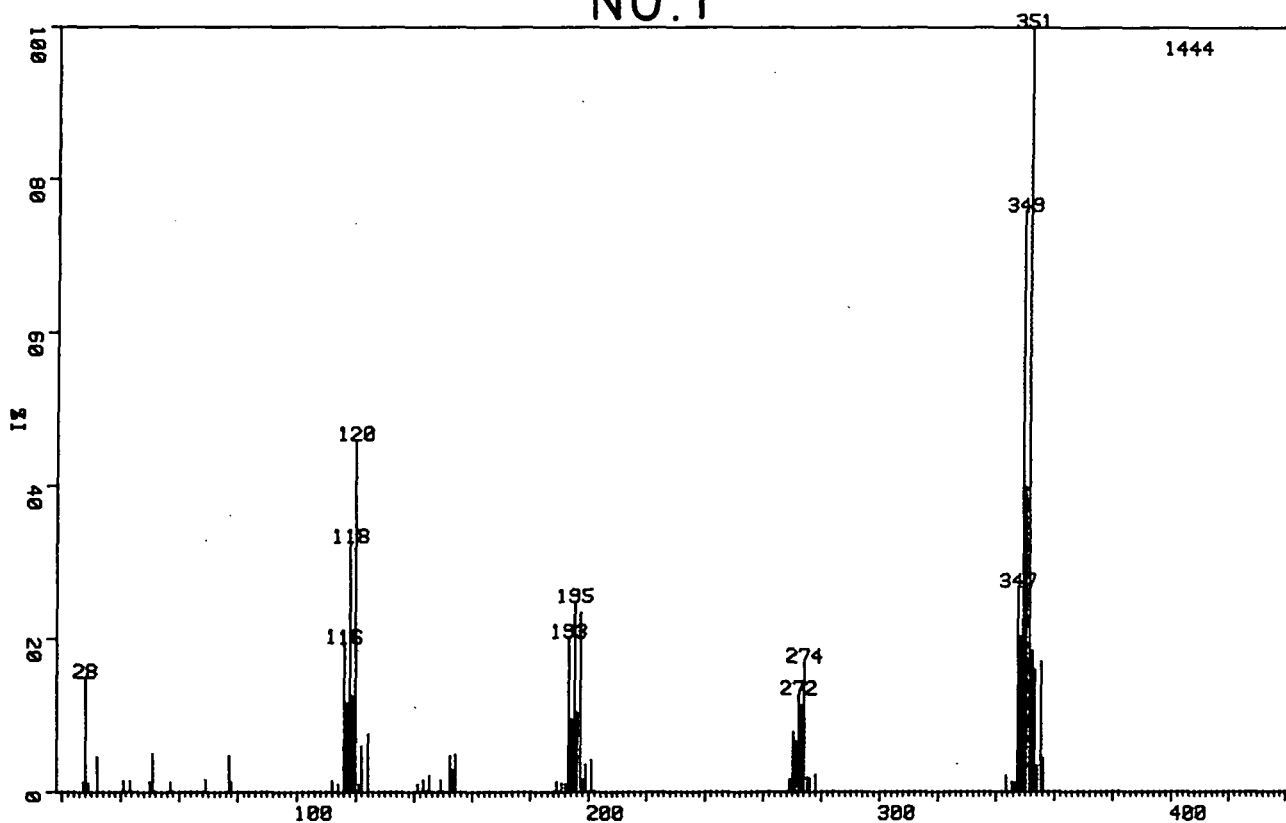

MASS	ZHT. BASE	MASS	ZHT. BASE
27.23	1.25	192.05	1.04
28.10	14.96	193.06	20.15
28.99	1.18	194.06	9.49
31.97	4.64	195.07	24.79
40.95	1.45	196.07	10.32
43.12	1.45	197.06	23.41
49.90	1.39	198.04	1.66
50.98	5.06	199.02	3.53
57.16	1.25	201.03	4.09
69.10	1.66	269.10	1.59
77.16	4.78	270.11	7.83
78.10	1.32	271.08	6.58
112.01	1.45	272.11	12.74
114.05	1.04	273.08	11.22
116.05	19.46	274.09	16.97
117.04	11.63	275.09	1.87
118.02	32.69	276.10	1.80
118.99	12.53	278.10	2.29
119.95	46.05	343.35	2.08
120.99	1.04	345.33	1.39
122.02	6.02	346.36	1.18
124.06	7.48	347.35	26.80
141.05	1.04	348.34	20.29
143.09	1.52	349.33	75.83
145.11	2.08	350.33	39.82
149.14	1.52	351.35	100.00
152.15	4.71	352.37	18.42
153.13	2.84	353.35	15.93
154.15	4.92	354.37	3.39
189.03	1.39	355.38	16.97
191.01	1.11	356.37	4.36

SM44AX 4 S.MULLINS EI  
CAL:CALT31 STR:23-JAN-85  
8:43

NO. 2

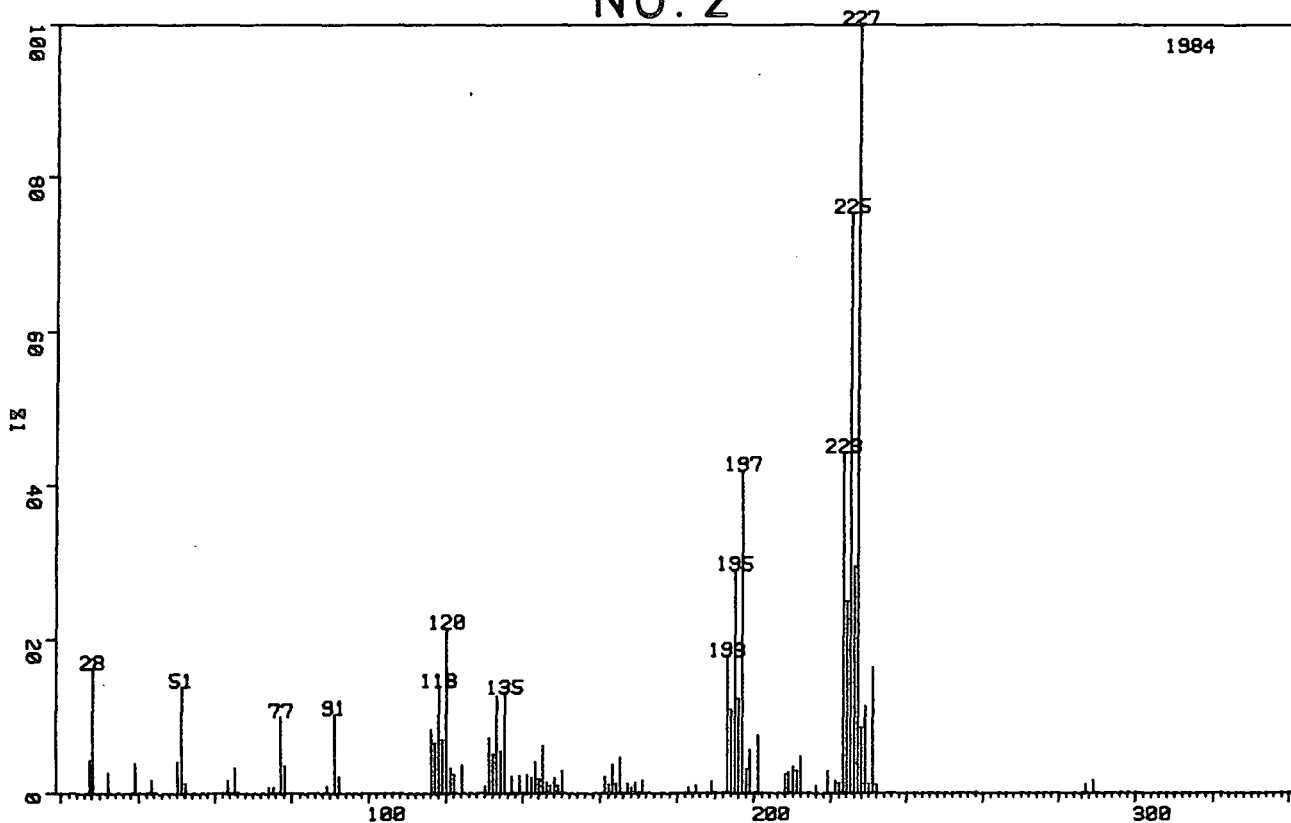

MASS	ZHT. BASE	MASS	ZHT. BASE	MASS	ZHT. BASE
27.23	4.39	148.02	2.07	230.05	1.21
28.11	16.28	148.99	1.06	231.04	16.33
31.97	2.67	149.97	2.97	232.08	1.11
38.96	3.88	161.01	2.17	287.08	1.16
43.11	1.76	162.05	1.16	289.04	1.76
49.88	4.13	163.05	3.78		
50.96	13.86	164.07	1.26		
52.04	1.41	165.06	4.69		
63.09	1.76	167.03	1.26		
65.14	3.33	167.99	0.66		
74.06	0.86	168.99	1.41		
75.07	0.81	170.97	1.66		
77.06	9.93	183.00	0.86		
78.04	3.58	185.02	1.06		
88.98	0.96	188.99	1.61		
90.99	10.33	193.03	17.84		
92.04	2.17	194.02	10.79		
115.94	8.32	195.03	29.03		
116.93	6.50	196.03	12.30		
117.91	13.86	197.02	41.94		
118.88	7.01	198.02	3.18		
119.87	21.47	198.98	5.75		
120.95	3.23	200.99	7.51		
121.97	2.57	208.04	2.57		
124.00	3.73	209.00	2.72		
129.93	0.96	209.99	3.48		
130.97	7.26	211.02	2.97		
131.99	5.09	212.03	4.74		
133.01	12.65	216.07	1.06		
134.03	5.49	219.05	2.97		
135.03	13.00	221.06	1.71		
137.02	2.27	222.08	1.36		
138.97	2.32	223.07	44.30		
140.95	2.37	224.09	24.95		
141.98	2.02	225.08	75.35		
143.00	4.03	226.09	29.44		
144.01	1.86	227.07	100.00		
145.01	6.15	228.06	8.52		
146.04	1.46	228.92	1.31		
147.02	1.06	229.05	11.29		

SM47AX 6 S.MULLINS EI  
CAL:CALT31 STA:

24-JAN-85  
1:0

# NO. 3

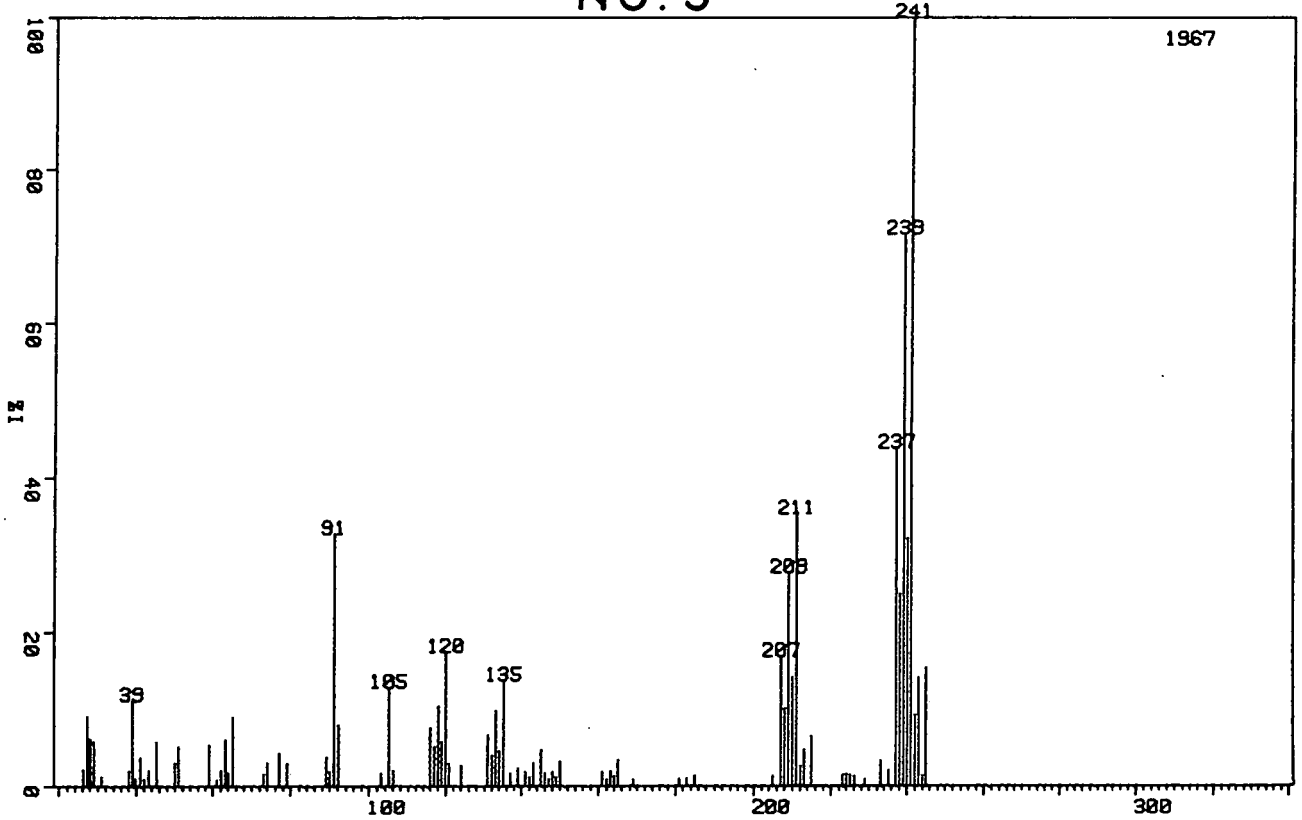

MASS	ZHT. BASE	MASS	ZHT. BASE	MASS	ZHT. BASE
26.30	2.19	124.00	2.69	233.04	3.30
27.23	9.05	130.95	6.61	235.04	2.03
28.11	6.10	131.98	3.86	237.02	43.87
28.13	0.81	133.00	9.76	238.01	24.96
28.97	2.59	134.01	4.52	239.00	71.58
29.00	5.85	135.01	13.78	239.97	32.08
30.88	1.27	137.00	1.78	240.98	100.00
38.04	1.93	138.96	2.29	242.01	9.15
38.96	11.13	140.93	1.88	243.02	14.03
39.80	0.92	141.95	1.17	244.03	1.42
39.86	1.02	142.98	3.05	245.01	15.46
40.94	3.71	144.99	4.68		
42.03	0.86	146.03	1.73		
43.07	1.27	147.00	0.97		
43.10	2.03	148.00	1.88		
45.13	5.85	148.96	1.17		
49.88	3.05	149.95	3.20		
50.95	5.08	160.98	1.88		
59.01	5.29	162.00	0.92		
60.95	0.76	163.02	1.98		
62.01	2.03	164.04	1.32		
63.07	6.10	165.02	3.41		
64.10	1.73	168.95	0.92		
65.12	8.95	180.92	0.97		
73.06	1.63	182.94	1.02		
74.09	3.05	184.97	1.37		
77.04	4.22	204.94	1.27		
78.97	2.90	206.95	16.88		
88.95	3.76	207.94	10.12		
89.91	1.88	208.92	27.76		
90.96	32.74	209.89	14.18		
92.01	7.93	210.94	35.38		
103.02	1.78	211.96	2.59		
105.05	12.81	212.97	4.73		
106.06	2.03	214.98	6.46		
115.88	7.52	222.99	1.47		
116.91	5.13	224.00	1.58		
117.89	10.37	225.00	1.47		
118.89	5.80	225.99	1.32		
119.88	17.44	228.84	0.86		
120.93	2.95				

SMSAX 5 S. MULLINS  
CAL: CALT1 STA: 203-JUN-89  
01:58

NO. 4

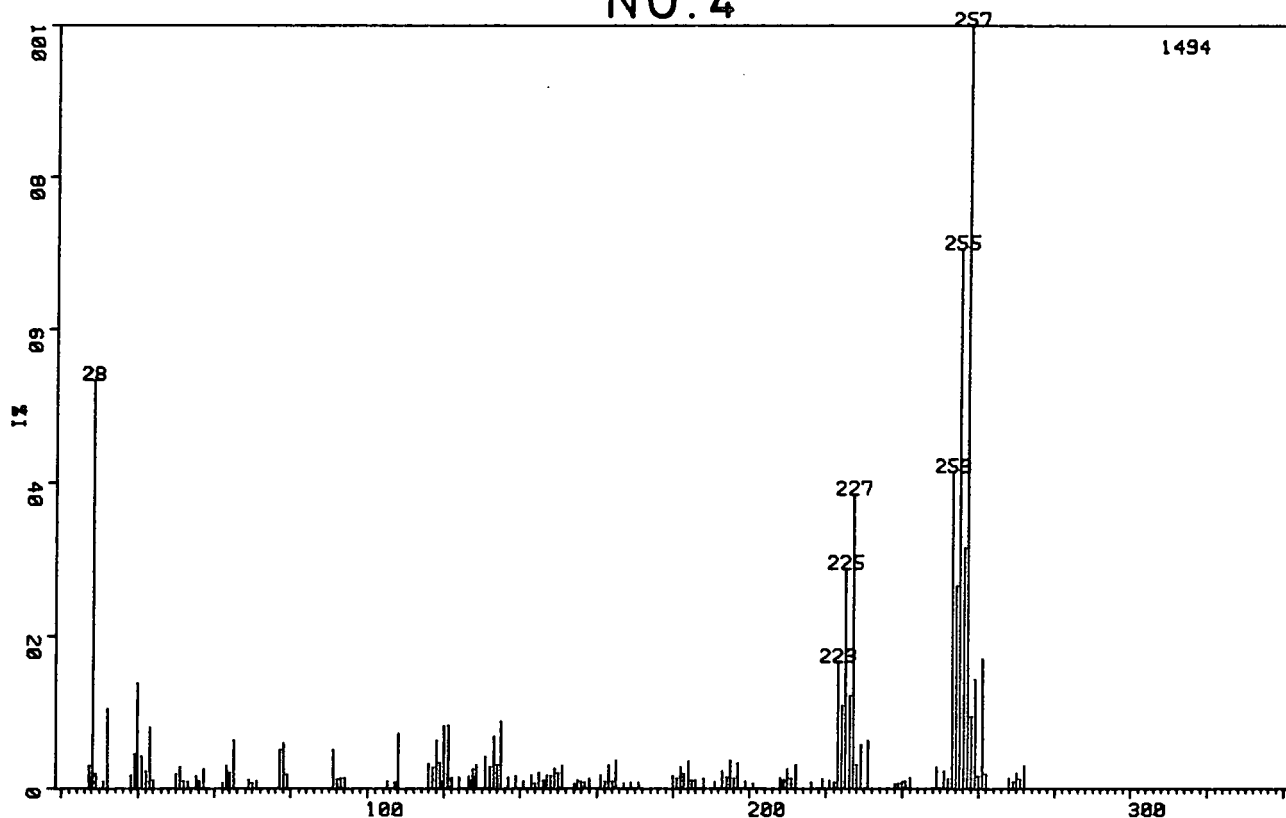

MASS	%HT. BASE	MASS	%HT. BASE	MASS	%HT. BASE	MASS	%HT. BASE
27.30	3.01	116.91	2.81	160.98	1.81	227.98	3.15
28.17	53.48	117.88	6.36	162.01	1.00	228.95	5.82
29.06	1.94	118.89	3.48	163.02	3.21	230.96	6.36
30.95	0.94	119.07	1.00	164.03	1.07	237.98	0.67
32.03	10.51	119.88	8.30	165.03	3.75	238.98	0.74
38.08	1.74	120.94	1.94	167.01	0.74	239.97	0.94
38.99	4.62	121.10	8.37	168.96	0.87	240.98	1.00
39.83	13.92	121.96	1.20	170.94	0.87	241.99	1.47
40.98	4.22	122.13	1.47	179.91	1.74	249.00	2.88
42.07	2.34	123.97	1.54	180.93	1.41	250.99	2.34
43.10	0.94	126.56	1.67	181.96	2.88	252.02	1.34
43.14	8.10	127.05	1.00	182.96	1.94	253.03	41.43
44.10	1.14	127.54	2.61	183.98	3.68	254.03	26.71
49.89	1.94	128.03	1.47	184.98	1.14	255.04	70.68
50.97	2.88	128.52	3.15	186.01	1.20	256.04	31.59
52.05	1.00	130.92	4.28	188.00	1.41	257.02	100.00
53.10	0.94	131.96	2.88	190.93	0.94	258.03	9.44
55.16	1.67	132.97	6.89	192.98	2.41	259.01	14.39
56.15	1.00	133.99	3.15	193.99	1.54	260.01	1.61
57.14	2.61	134.14	1.67	194.99	3.75	261.03	17.00
62.03	0.80	134.96	8.90	195.98	1.41	262.04	1.94
63.07	3.01	136.94	1.54	196.98	3.41	268.04	1.41
64.11	2.07	138.90	1.74	198.94	1.00	269.02	0.94
65.09	6.36	140.89	1.07	200.94	0.74	270.01	2.07
69.01	1.20	142.96	1.81	207.96	1.47	271.02	1.34
69.96	0.74	143.96	0.74	208.95	1.20	272.05	3.01
71.03	1.07	144.97	2.21	209.92	2.61		
77.07	5.15	146.01	1.14	210.94	1.41		
78.05	6.02	146.97	1.81	211.96	3.15		
79.02	1.87	147.98	1.74	215.97	0.87		
91.03	5.15	148.93	2.68	218.96	1.34		
92.05	1.27	149.93	2.14	220.95	1.14		
93.07	1.41	150.93	3.08	221.96	0.87		
94.10	1.47	153.99	0.67	222.98	16.67		
105.12	1.00	154.99	1.20	224.00	10.98		
107.05	0.87	155.98	1.07	224.99	28.92		
108.03	7.30	156.97	0.87	225.99	12.25		
115.89	3.35	157.96	1.41	226.98	38.55		

SMS2AX 2 S.MULLINS EI  
CAL: CALT31 STA:

31-JAN-85  
8:28'

NO. 5

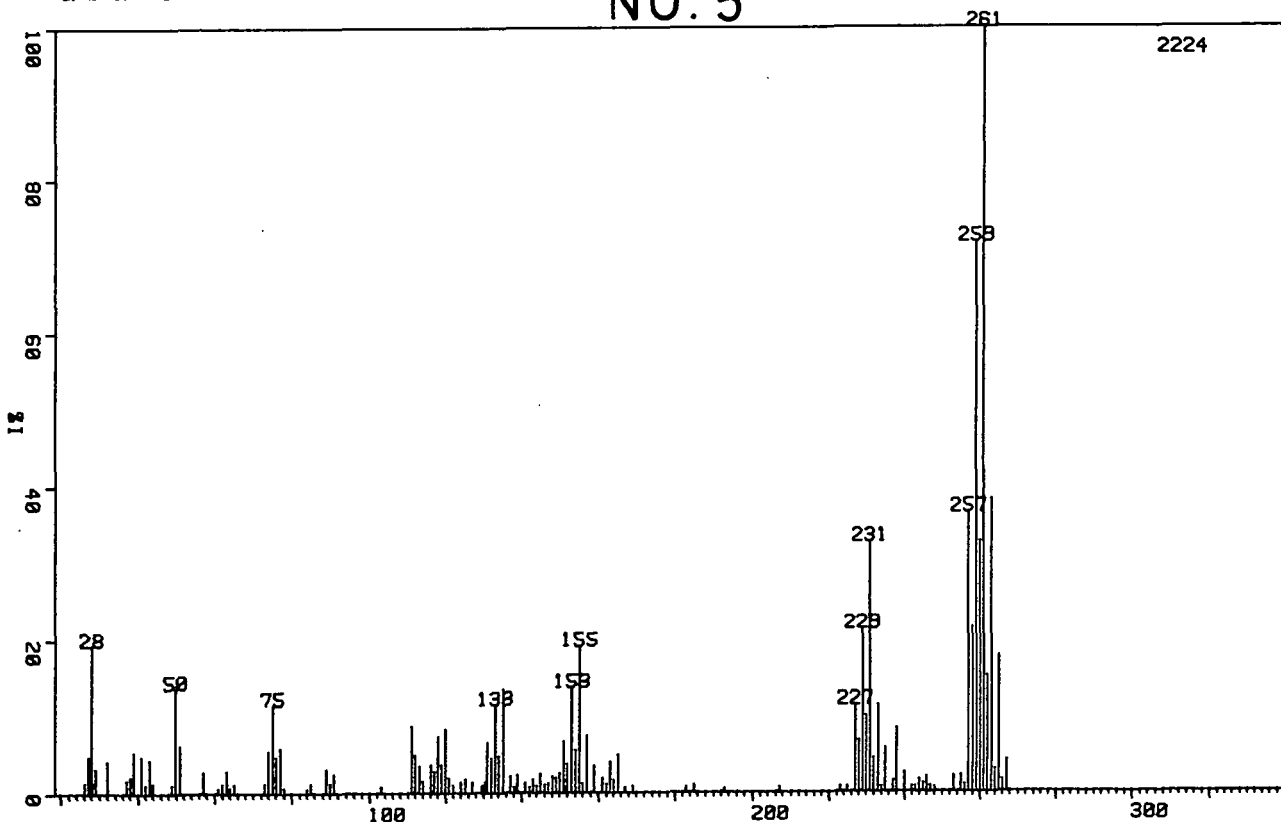

MASS	ZHT. BASE	MASS	ZHT. BASE	MASS	ZHT. BASE	MASS	ZHT. BASE
26.30	1.48	116.92	2.83	160.90	1.03	259.97	32.78
27.23	4.86	117.90	7.37	161.02	1.98	260.99	100.00
28.11	19.33	118.91	3.78	162.03	1.21	262.00	15.20
28.13	1.44	119.87	8.36	163.04	4.00	263.02	38.26
29.00	3.28	120.93	2.07	164.06	1.66	264.03	3.06
31.97	4.23	121.96	1.08	165.06	4.99	265.02	17.76
37.10	1.80	123.99	1.48	166.99	0.72	266.04	1.57
38.04	2.20	125.12	1.89	167.05	0.72	267.03	4.18
38.96	5.40	126.96	1.44	168.98	0.99		
40.95	4.81	129.46	1.03	182.97	0.85		
42.04	1.21	129.90	1.03	185.00	1.08		
43.08	1.35	130.49	1.53	193.00	0.63		
43.11	4.50	130.95	6.61	207.08	0.85		
44.08	1.30	131.98	4.63	223.00	0.85		
48.96	1.17	132.99	11.51	224.99	0.85		
49.89	13.67	134.01	4.86	226.97	11.47		
50.96	6.25	135.02	13.62	227.97	6.79		
57.14	2.83	137.00	2.16	228.96	21.31		
60.96	0.67	138.09	0.81	229.93	9.94		
62.04	1.26	138.97	2.38	230.94	32.73		
63.09	2.92	140.95	1.21	231.96	4.45		
64.12	0.76	141.05	1.39	232.97	11.42		
65.11	1.21	141.98	0.85	233.98	0.76		
73.01	1.26	142.98	1.84	234.97	5.85		
74.04	5.53	144.01	0.94	236.98	1.53		
75.05	11.56	145.00	2.56	237.97	8.36		
76.06	4.72	146.04	1.12	239.93	2.61		
77.05	5.89	147.01	1.26	241.97	0.85		
78.02	0.76	148.01	2.16	242.98	0.76		
83.99	0.58	148.97	1.98	243.99	1.71		
85.01	1.26	149.97	2.61	245.00	1.21		
88.97	3.15	150.91	6.74	245.98	2.07		
89.92	1.30	151.00	1.75	246.97	0.81		
90.98	2.52	151.93	3.82	247.98	0.67		
103.05	0.90	152.94	13.80	253.01	2.11		
110.96	8.81	153.96	5.62	255.02	2.25		
112.00	4.99	154.97	19.15	256.03	1.03		
113.01	3.64	155.95	1.26	257.01	36.51		
114.03	1.57	156.94	7.46	258.01	21.54		
115.93	3.78	158.92	3.60	258.99	71.90		

SM3SAX 4 S.MULLINS EI  
CAL: CALT3 STA:

16-OCT-85  
8:44

NO. 6

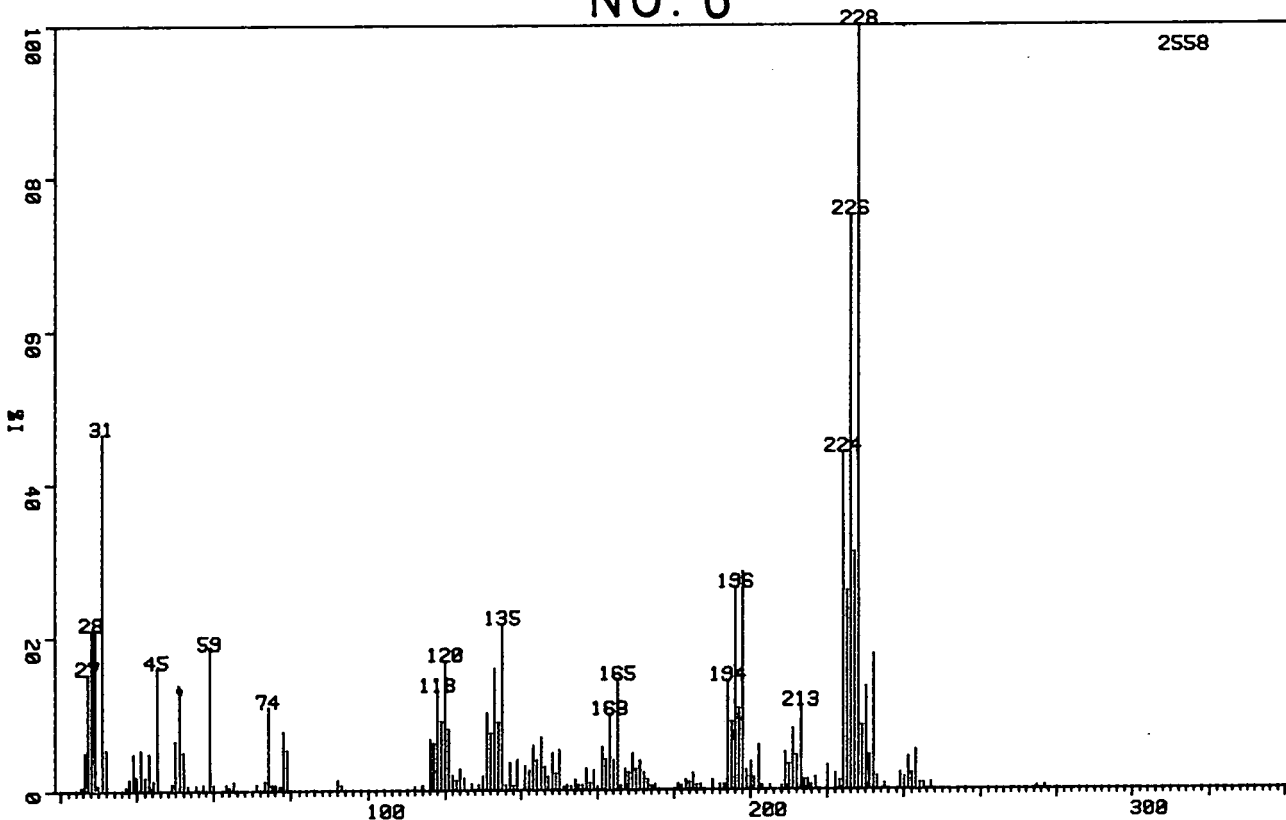

MASS	ZHT. BASE	MASS	ZHT. BASE	MASS	ZHT. BASE	MASS	ZHT. BASE	MASS	ZHT. BASE
25.40	0.43	75.03	0.51	147.04	1.76	194.05	14.23	239.06	2.15
26.36	5.00	75.10	0.74	148.04	4.89	195.04	8.87	240.05	1.64
27.29	15.29	76.03	0.78	149.01	2.19	196.04	26.39	241.06	4.26
28.17	20.95	77.03	0.55	149.99	5.24	197.01	10.71	242.08	2.11
29.02	4.96	78.00	7.66	151.02	0.47	198.01	28.46	243.09	5.20
29.05	20.60	78.97	5.24	152.04	0.70	198.95	2.54	244.10	0.82
29.85	0.74	92.03	1.37	152.98	0.51	199.87	0.59	245.11	0.90
29.88	0.78	93.06	0.70	154.06	1.37	200.01	3.67	247.08	0.98
30.95	46.60	111.87	0.51	155.02	0.66	200.92	1.60	274.91	0.43
32.03	5.39	113.94	0.51	156.04	0.66	202.06	5.79	276.93	0.51
32.06	0.70	114.04	0.66	157.06	2.85	202.95	0.59		
37.14	0.51	115.93	6.68	158.03	0.98	203.09	0.43		
38.07	1.52	116.94	6.14	159.02	2.62	205.10	0.59		
39.00	4.81	117.91	12.94	160.00	0.43	208.06	0.51		
39.83	1.80	118.89	9.03	161.06	5.59	209.04	4.89		
39.89	0.66	119.87	16.89	162.07	4.03	209.91	0.55		
40.98	5.32	120.94	7.97	163.09	9.89	210.03	3.32		
42.03	0.74	121.97	1.99	164.10	3.87	211.04	8.05		
42.07	1.76	122.99	1.33	165.10	14.39	212.03	4.50		
43.10	4.57	123.99	2.81	166.05	0.59	213.07	10.99		
43.14	4.89	125.01	1.64	167.03	2.78	214.02	1.29		
44.11	0.39	127.01	0.86	168.01	2.31	214.97	0.39		
44.14	1.33	128.96	0.74	169.01	4.77	215.09	1.29		
45.16	16.03	129.93	1.92	169.96	2.78	215.96	0.66		
48.98	0.98	130.96	10.09	170.99	3.83	217.07	1.64		
49.90	6.53	131.99	7.47	172.00	2.27	220.05	3.17		
50.97	13.29	133.02	15.87	173.02	1.37	222.11	2.07		
52.04	5.04	134.02	8.87	174.03	0.55	223.10	1.21		
53.09	0.70	135.03	21.70	175.04	0.74	224.10	44.10		
55.16	0.78	136.03	0.70	181.00	0.82	225.09	26.00		
57.14	0.82	137.02	3.64	182.01	0.59	226.09	75.02		
59.02	18.49	138.00	0.59	183.01	1.33	227.08	31.04		
59.95	0.74	138.98	3.95	184.03	1.06	228.08	100.00		
63.09	0.82	140.97	3.17	185.02	2.15	229.01	8.37		
64.11	0.39	142.00	2.58	186.04	0.66	230.05	13.45		
65.14	1.21	143.02	5.90	187.02	0.74	230.98	4.53		
71.01	0.82	144.03	3.95	190.00	1.29	232.10	17.67		
73.10	1.25	145.03	6.96	192.02	0.74	233.02	1.76		
74.11	10.87	146.05	3.01	193.04	0.78	234.96	0.82		

SM56AX 4 S.MULLINS EI  
CAL: CALT31 STA:

26-FEB-85  
0:43

NO. 7

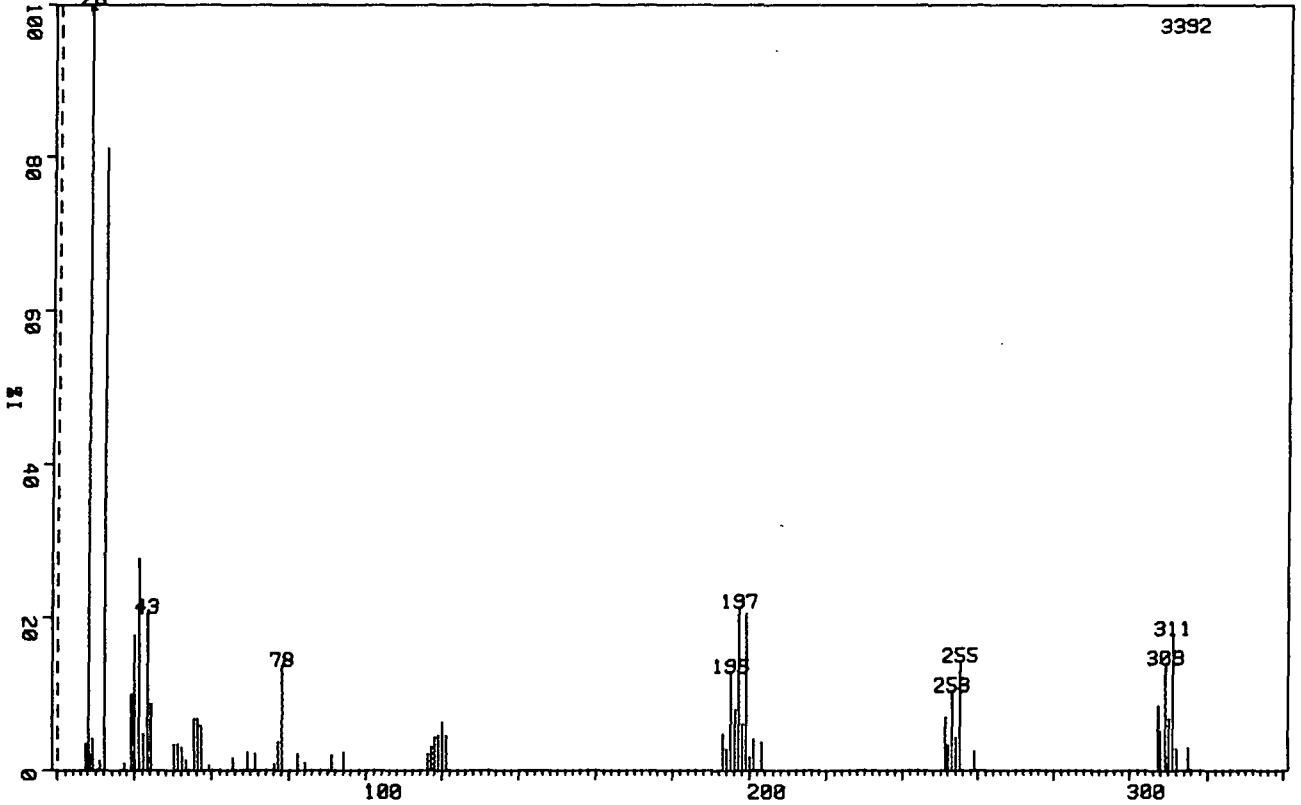

MASS	ZHT.	MASS	ZHT.
	BASE		BASE
27.23	1.74	195.09	6.46
28.11	100.00	196.08	3.98
28.13	1.00	197.08	10.70
29.00	2.09	198.07	3.10
30.89	0.62	199.05	10.26
31.97	40.54	200.05	0.88
37.11	0.47	201.07	2.06
38.98	4.98	203.11	1.83
39.82	8.84	251.17	3.54
39.87	0.74	252.13	1.65
40.96	13.89	253.11	5.22
42.06	2.39	254.11	2.18
43.10	0.65	255.11	7.16
43.13	10.35	259.10	1.27
44.10	4.33	307.28	4.27
49.91	1.71	308.21	2.59
50.99	1.74	309.15	7.02
52.07	1.53	310.09	3.39
53.13	0.68	311.12	8.93
55.19	3.36	312.11	1.42
56.19	3.39	315.09	1.53
57.18	2.92		
59.06	0.32		
65.19	0.77		
69.06	1.18		
71.08	1.09		
76.12	0.44		
77.11	1.86		
78.06	6.87		
82.05	1.09		
84.15	0.50		
91.01	1.00		
94.08	1.21		
115.99	1.06		
116.98	1.56		
117.96	2.15		
118.94	2.30		
119.90	3.15		
120.97	2.27		
193.14	2.36		
194.10	1.39		



ST67AX 7 S.MULLINS E.I.  
CAL:CALT9 STA:

25-SEP-86  
1.9

NO. 8

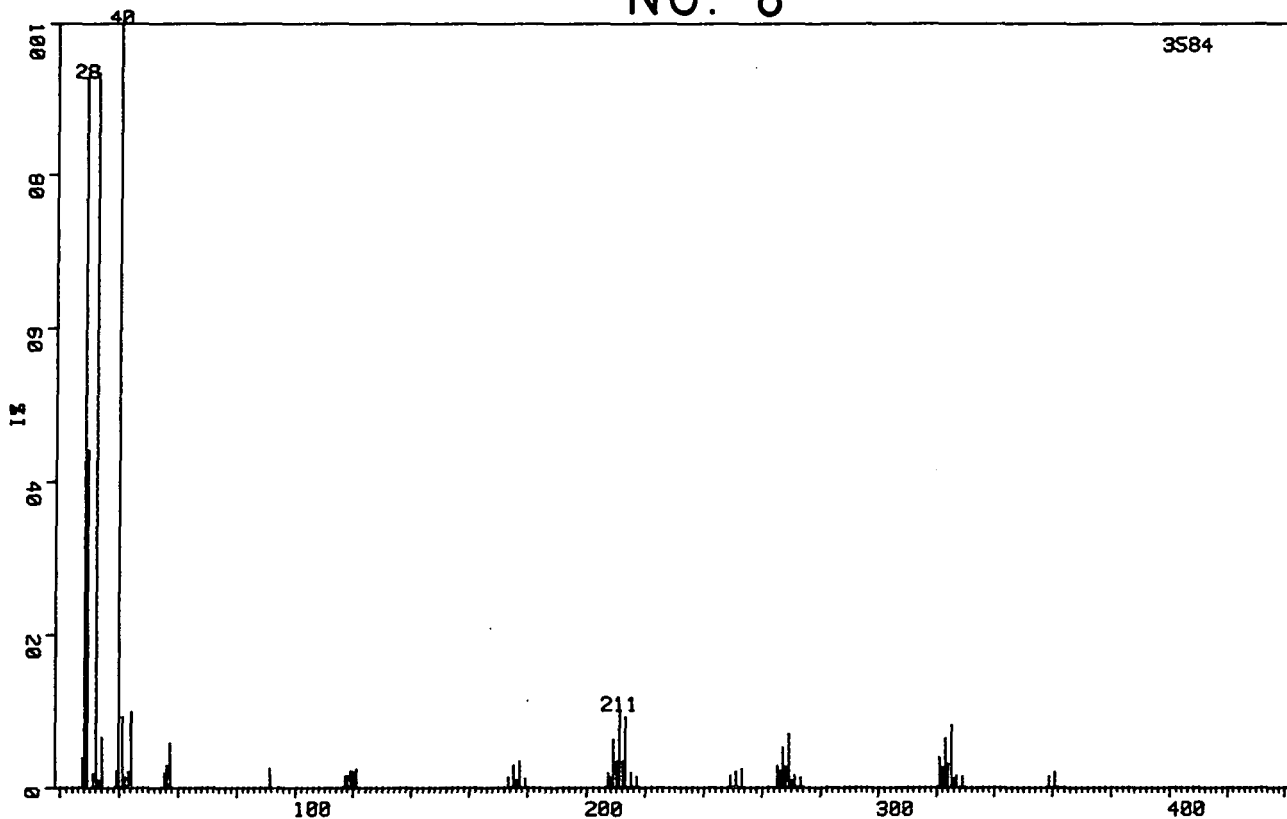

MASS	ZHT.	MASS	ZHT.
	BASE		BASE
27.23	3.82	251.09	2.06
28.10	92.86	253.09	2.54
28.97	44.20	265.09	2.87
29.00	8.43	266.08	2.15
30.89	1.87	267.08	5.22
31.97	93.36	268.07	2.76
33.06	1.00	269.06	7.14
34.11	6.50	270.07	1.03
38.97	2.20	271.07	1.70
39.81	100.00	273.10	1.31
40.96	9.18	321.21	3.93
42.05	1.42	322.18	2.68
43.09	1.20	323.13	6.45
43.13	2.06	324.12	3.12
44.09	9.91	325.09	8.26
55.18	1.87	326.08	1.23
56.18	2.99	327.04	1.65
57.17	5.83	329.06	1.51
91.16	2.54	358.97	1.53
116.96	1.56	361.02	2.01
117.93	1.53		
118.90	2.15		
119.86	2.01		
120.94	2.46		
173.16	1.42		
175.11	2.82		
176.08	1.00		
177.08	3.49		
179.04	1.14		
207.11	1.87		
208.05	1.42		
209.04	6.33		
210.04	3.46		
211.05	10.18		
212.06	3.38		
213.08	9.26		
215.09	1.95		
217.10	1.48		
249.15	1.53		

ST74AX 6 S.MULLINS  
CAL: CALT31 STR:09-APR-85  
0.56

NO. 9

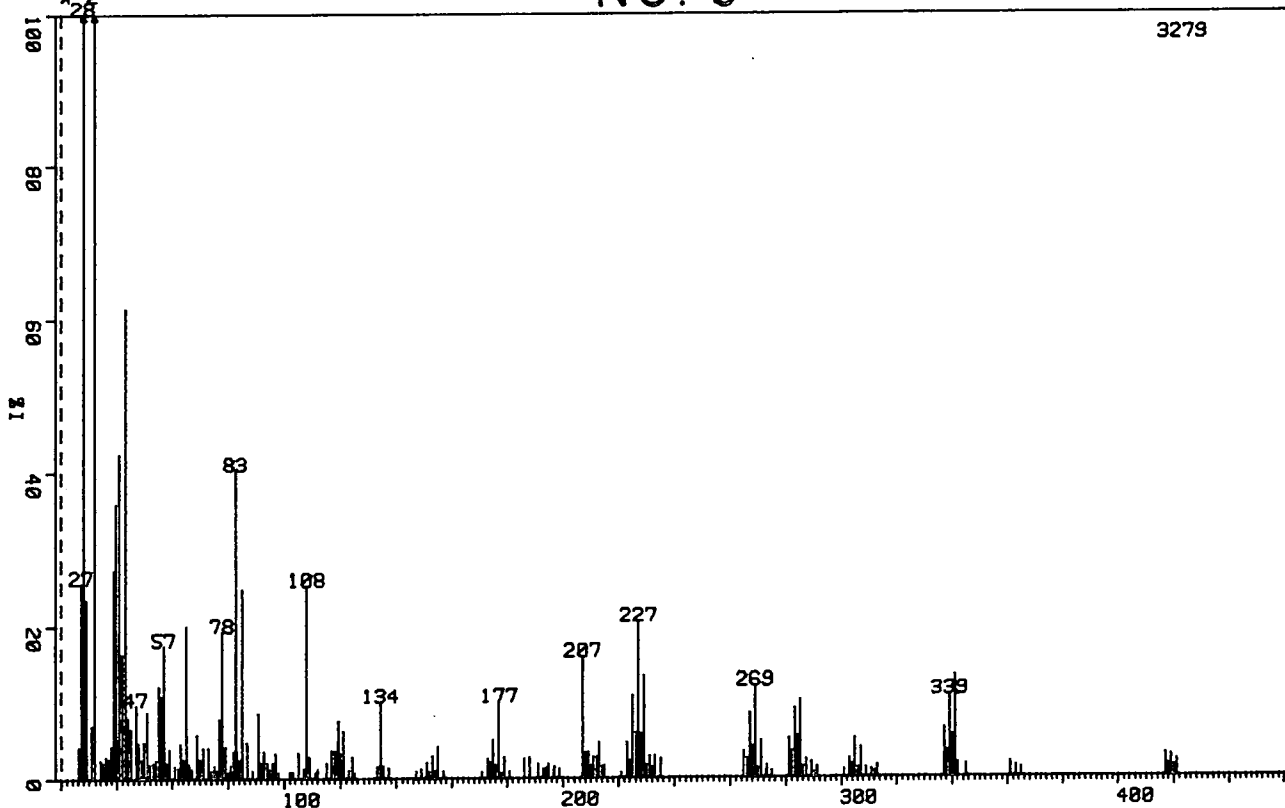

MASS	ZHT. BASE	MASS	ZHT. BASE	MASS	ZHT. BASE	MASS	ZHT. BASE	MASS	ZHT. BASE
26.30	2.10	64.10	1.28	108.94	1.40	196.79	0.55	289.01	1.01
27.23	12.78	65.10	9.97	111.02	0.43	196.97	0.79	290.08	0.34
28.11	99.42	66.09	0.98	112.05	0.61	198.82	0.64	291.06	0.73
28.97	11.68	67.08	0.67	115.02	1.04	207.08	7.96	300.80	0.55
29.00	9.76	68.95	0.61	116.85	1.83	208.08	1.68	302.87	1.25
30.89	3.48	69.02	2.90	117.87	1.80	209.01	1.71	303.92	0.88
31.97	100.00	69.96	1.25	118.88	2.26	209.94	0.85	304.92	2.59
34.10	1.19	70.99	0.67	119.05	3.75	210.98	1.37	305.94	0.61
35.10	1.10	71.03	2.01	119.88	1.62	211.97	1.37	306.91	1.98
36.10	1.43	73.07	2.04	120.06	0.85	212.99	2.35	308.90	0.70
37.05	0.98	74.05	0.55	120.92	3.14	213.98	0.43	310.99	0.55
37.09	1.31	75.06	0.88	121.10	0.82	214.15	0.79	312.04	0.46
38.04	2.17	76.06	0.55	123.00	0.55	214.98	0.82	313.04	0.82
38.96	13.63	77.05	3.90	124.14	1.40	220.94	0.37	337.13	3.20
39.80	17.93	78.02	9.64	124.96	0.37	222.97	2.35	338.09	1.77
39.86	2.65	78.97	2.10	133.05	0.79	223.96	1.16	339.08	5.40
40.94	21.23	79.93	0.46	133.11	0.46	224.97	5.40	340.07	2.74
42.04	8.14	80.98	0.88	134.12	5.03	225.97	2.99	341.05	6.71
43.07	1.92	81.90	1.07	135.07	0.82	226.96	10.25	342.07	0.95
43.11	30.68	82.04	1.80	137.06	0.73	227.96	2.93	345.08	0.88
44.08	4.00	82.96	20.16	147.07	0.52	228.95	6.71	360.89	1.01
44.12	0.76	83.11	1.89	148.88	0.61	229.92	0.88	362.94	0.76
44.15	1.31	83.94	1.19	150.87	1.07	230.95	1.43	364.97	0.64
45.14	3.26	84.09	1.22	151.89	0.46	232.01	0.73	416.95	1.56
47.04	4.85	84.96	12.41	152.90	1.52	232.97	1.49	417.94	0.82
48.00	2.35	85.11	1.34	153.92	0.52	235.02	1.25	418.93	1.40
48.92	1.25	86.90	2.38	154.93	2.10	264.96	1.74	419.92	0.73
49.85	0.67	87.04	0.91	156.90	0.52	265.95	1.25	420.93	1.13
49.88	2.41	88.93	0.55	170.94	0.46	266.94	4.24		
50.95	4.36	90.93	4.27	172.98	1.31	267.93	2.04		
52.03	0.95	91.96	1.07	173.99	1.04	268.92	6.01		
53.09	1.07	92.98	1.80	174.98	2.50	269.91	0.64		
54.13	1.22	94.01	1.07	176.00	0.88	270.90	2.44		
55.11	0.70	95.06	0.64	176.99	5.03	272.79	0.52		
55.15	6.07	95.97	1.07	177.98	0.34	273.00	0.82		
56.15	5.40	96.06	0.30	178.96	1.37	274.85	0.49		
57.13	8.69	97.05	1.65	180.93	0.49	280.98	2.59		
58.06	0.61	98.03	0.40	185.96	1.31	281.99	1.74		
58.10	1.07	101.97	0.46	187.96	1.37	283.00	4.54		
59.01	1.95	103.00	0.49	190.94	0.95	284.01	2.74		
60.96	0.82	105.04	1.71	192.93	0.61	285.00	5.09		
62.02	0.73	107.00	0.70	193.94	0.70	286.01	0.73		
63.07	2.29	107.98	12.60	194.92	0.95	287.02	1.22		

ST63AX 3 S.MULLINS E.I.  
CAL:CALTS STR:26-SEP-86  
8:35

NO. 10

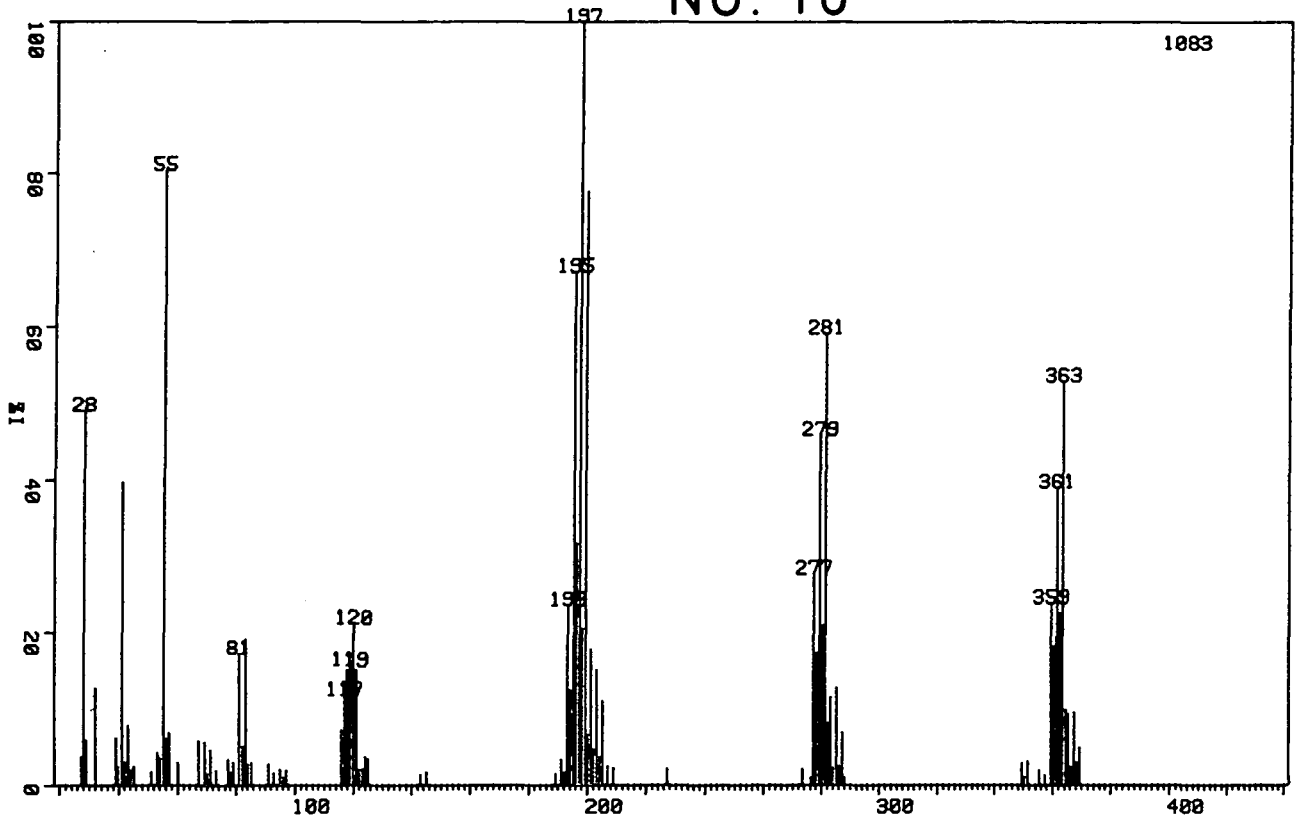

MASS	ZHT. BASE	MASS	ZHT. BASE	MASS	ZHT. BASE
27.23	3.69	116.89	11.73	284.14	2.22
28.10	49.12	117.90	15.05	285.13	12.74
28.96	3.05	118.87	15.70	286.17	2.49
28.99	5.91	119.86	21.14	287.17	6.83
31.97	12.65	120.94	15.05	288.11	1.02
38.96	6.19	121.96	1.94	349.27	2.86
39.80	2.49	122.99	2.12	350.21	1.11
40.95	39.70	124.00	3.69	351.21	3.14
42.05	3.05	125.02	3.42	355.34	1.94
43.08	3.05	143.04	1.39	357.34	1.39
43.12	7.85	145.06	1.75	359.30	23.92
44.09	1.94	189.11	1.57	360.31	18.28
45.11	2.49	191.10	3.42	361.33	39.06
45.15	2.22	192.07	1.75	362.34	22.44
50.98	1.75	193.09	23.64	363.35	52.82
53.12	4.25	194.11	12.47	364.37	9.88
54.15	3.51	195.08	67.13	365.38	9.33
55.17	80.42	196.09	31.67	366.40	2.40
56.17	6.09	197.08	100.00	367.37	9.51
57.16	6.83	198.08	20.50	368.39	2.95
59.94	2.86	199.06	77.56	369.40	4.89
67.16	5.82	200.05	6.56	446.62	2.03
69.05	5.63	201.07	17.73		
70.00	1.57	202.12	4.71		
71.08	4.62	203.08	15.05		
73.11	1.94	204.13	3.69		
77.09	3.32	205.10	10.99		
78.07	1.75	207.06	2.49		
79.04	3.05	209.03	2.22		
81.07	17.27	227.06	2.12		
82.11	4.99	273.22	2.12		
83.13	19.11	276.18	1.02		
84.11	2.68	277.14	27.70		
85.11	2.95	277.87	1.75		
90.97	2.77	278.11	17.27		
93.04	1.66	279.14	45.80		
95.08	2.03	280.14	20.96		
96.08	1.02	281.15	59.00		
97.07	1.94	282.12	8.13		
115.90	7.20	283.13	11.45		

ST64AX 3 S.MULLINS E.I.  
CAL: CALT9 STR:

NO. 11

26-SEP-86  
0:35

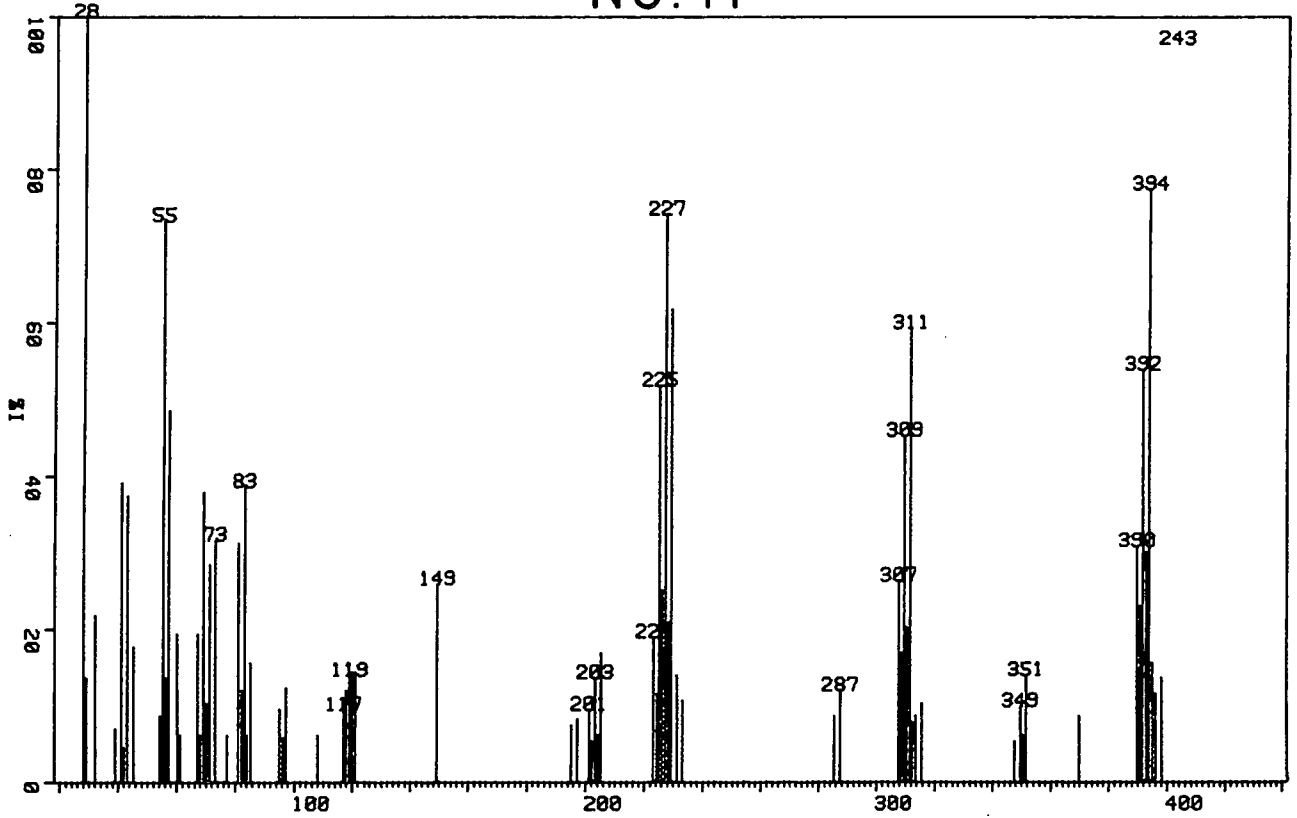

MASS	ZHT. BASE	MASS	ZHT. BASE
28.10	100.00	202.11	5.35
28.99	13.58	203.12	13.58
31.97	21.81	204.13	6.17
38.97	7.00	205.14	16.87
40.95	39.09	223.12	18.93
42.05	4.53	224.11	11.52
43.08	9.47	225.13	51.85
43.12	37.45	226.13	25.10
45.15	17.70	227.12	74.07
54.16	8.64	228.11	20.99
55.18	73.25	229.11	61.73
56.18	13.58	231.12	13.99
57.16	48.56	233.15	10.70
59.95	19.34	285.37	8.64
61.02	6.17	287.37	11.93
67.17	19.34	307.37	26.34
68.10	6.17	308.37	16.87
69.06	37.86	309.36	45.27
70.01	10.29	310.37	20.16
71.08	28.40	311.40	59.26
73.11	31.69	312.40	7.82
77.10	6.17	313.42	8.64
81.04	31.28	315.42	10.29
82.09	11.93	347.46	5.35
83.13	38.68	349.47	9.88
84.13	6.17	350.44	6.17
85.11	15.64	351.46	13.99
95.07	9.47	369.66	8.64
96.08	5.76	389.65	30.86
97.07	12.35	390.67	23.05
108.01	6.17	391.68	53.91
116.90	9.47	392.70	30.04
117.90	11.93	393.79	77.37
118.89	13.99	394.89	15.64
119.88	14.40	395.96	11.52
120.95	14.40	397.92	13.58
149.13	25.93		
195.13	7.41		
197.11	8.23		
201.11	9.47		

SM62AX 3 S.MULLINS E.I.  
CAL:CALT31 STR:

03-MAR-85  
0:34

NO.12

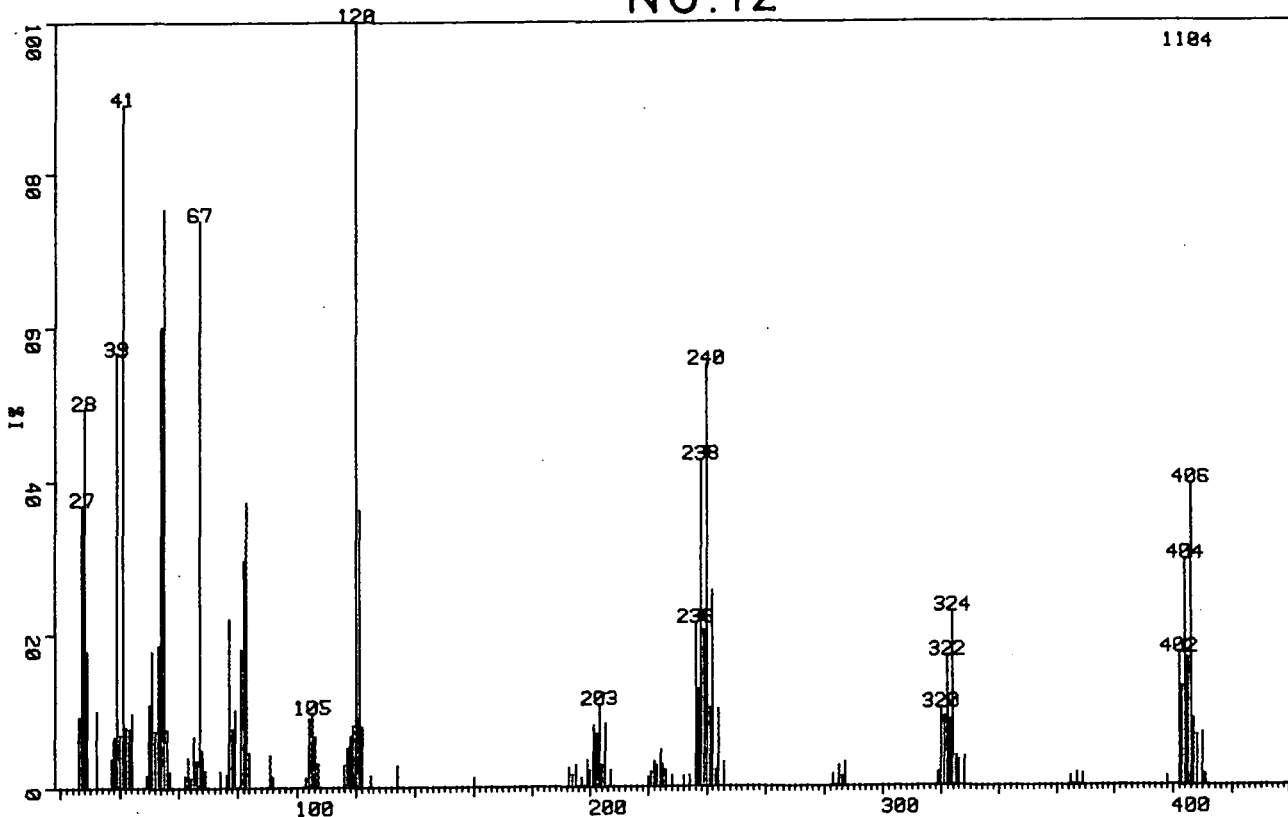

MASS	ZHT. BASE	MASS	ZHT. BASE	MASS	ZHT. BASE
26.30	9.15	83.06	37.23	223.95	4.80
27.23	36.87	84.08	4.53	224.97	2.81
28.11	49.55	90.95	4.26	225.96	2.17
28.13	10.60	92.00	1.36	227.95	1.45
28.97	4.17	103.01	1.27	231.96	1.36
29.00	17.84	104.02	8.97	233.96	1.45
31.97	9.96	105.04	9.69	235.94	21.38
37.09	3.80	106.04	6.61	236.93	12.68
38.04	6.61	107.04	3.08	237.92	42.75
38.96	56.52	115.88	2.90	238.92	20.38
39.86	6.88	116.91	5.07	239.90	55.07
40.94	89.04	117.88	6.61	240.91	10.24
42.03	7.79	118.07	3.17	241.92	25.63
43.06	1.54	118.88	8.06	242.95	2.08
43.10	7.70	119.08	1.63	243.94	10.05
44.07	9.69	119.87	8.79	245.93	3.17
44.13	2.36	120.08	100.00	282.98	1.54
48.95	1.54	120.94	8.79	284.97	2.72
49.87	10.78	121.13	36.23	285.98	1.27
50.95	17.75	122.12	7.88	286.97	3.17
52.02	7.43	124.95	1.54	318.90	1.81
53.08	18.57	134.11	2.81	319.93	10.14
54.12	60.05	159.99	1.27	320.92	9.06
55.14	75.36	192.84	2.54	321.95	16.94
56.14	7.52	193.87	1.54	322.94	8.61
57.12	2.08	194.90	2.90	323.94	22.83
62.01	1.54	196.93	1.18	324.97	3.89
63.06	3.99	198.94	3.53	325.96	3.35
64.09	1.27	199.92	2.08	327.96	3.80
65.11	6.61	200.95	7.97	364.86	1.27
66.09	3.53	201.96	4.62	367.07	1.72
67.07	73.91	202.13	6.88	369.06	1.63
68.04	4.89	202.95	10.78	398.03	1.18
69.00	2.26	203.11	2.63	402.00	17.30
74.04	2.17	203.93	2.81	403.00	12.86
76.05	1.72	204.93	8.24	404.00	29.62
77.03	22.01	206.93	2.17	405.01	16.58
78.01	7.61	219.84	1.27	405.97	39.49
78.97	10.05	220.90	1.90	406.98	8.70
80.97	17.93	221.90	3.26	407.98	6.43
82.03	29.62	222.94	2.72	409.95	6.88
				410.98	1.45

SMS4X 5 S.MULLINS E.I.  
CAL:CALT9 STR:

NO.13

25-SEP-86  
0:52

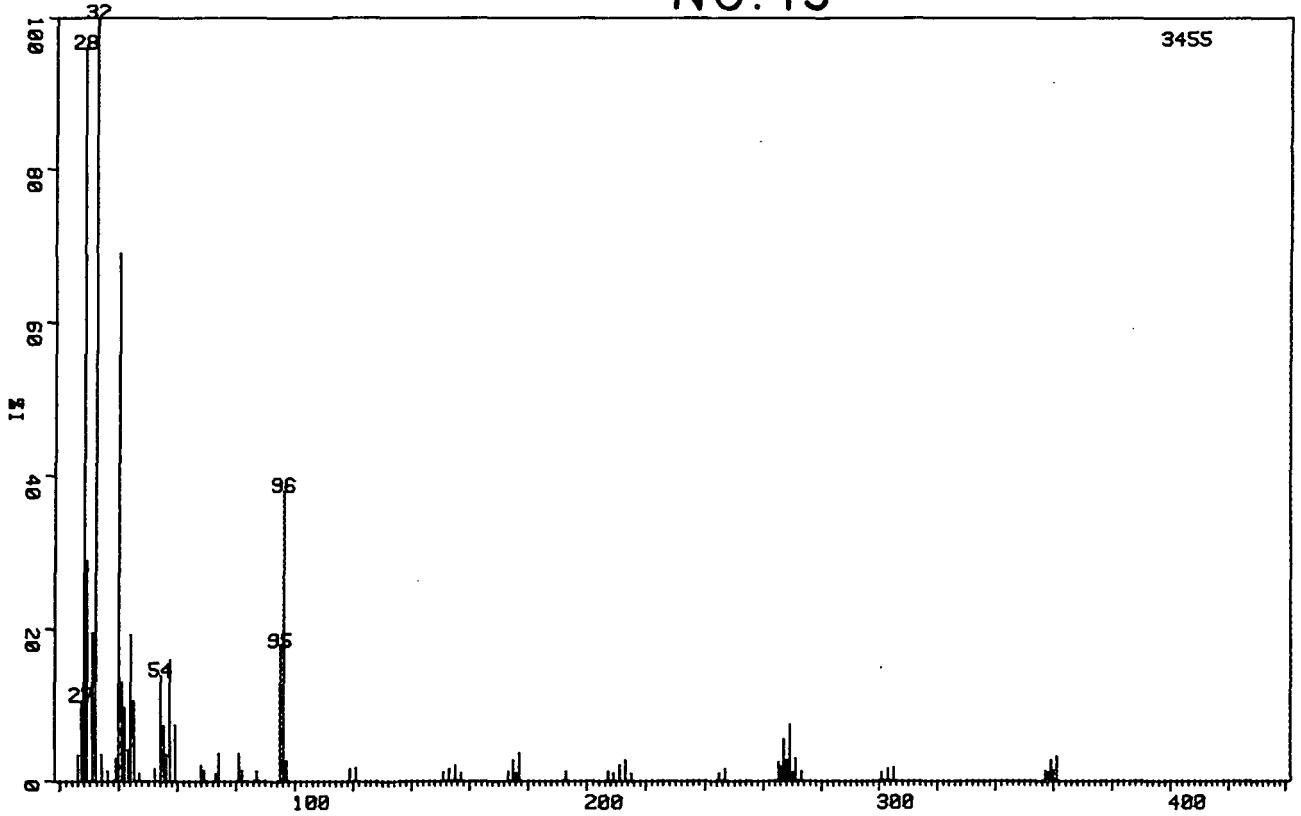

MASS	ZHT. BASE	MASS	ZHT. BASE
26.30	3.44	155.06	2.05
27.23	10.62	157.05	1.10
28.10	95.98	173.17	1.27
28.12	8.94	175.10	2.72
28.97	28.91	176.09	1.13
29.00	17.60	177.07	3.73
30.89	19.57	193.12	1.27
31.97	100.00	207.16	1.24
34.11	3.53	209.00	1.13
36.11	1.42	211.03	2.14
38.97	3.04	213.06	2.78
39.81	69.00	215.07	1.01
39.86	3.50	244.98	1.10
40.96	13.00	246.97	1.71
42.04	9.70	265.20	2.55
43.11	4.08	266.14	1.88
44.09	19.19	267.10	5.53
44.14	1.16	268.09	2.75
45.16	10.62	269.08	7.38
47.12	1.01	270.09	1.19
52.06	1.65	271.09	3.04
54.15	13.89	273.12	1.30
55.17	7.26	300.93	1.19
56.18	3.53	302.98	1.71
57.17	15.98	304.97	1.85
59.06	7.38	357.16	1.36
68.09	2.14	358.14	1.19
69.06	1.45	359.09	2.78
73.15	1.01	360.09	1.48
74.15	3.70	361.10	3.24
81.01	3.68		
82.05	1.36		
87.06	1.39		
95.07	17.74		
96.08	38.06		
97.07	2.69		
118.90	1.59		
120.96	1.82		
151.00	1.16		
153.03	1.68		

SM21X 7 S.MULLINS E.I.  
CAL:CALTS STR:

26-SEP-86  
1.9

NO. 14

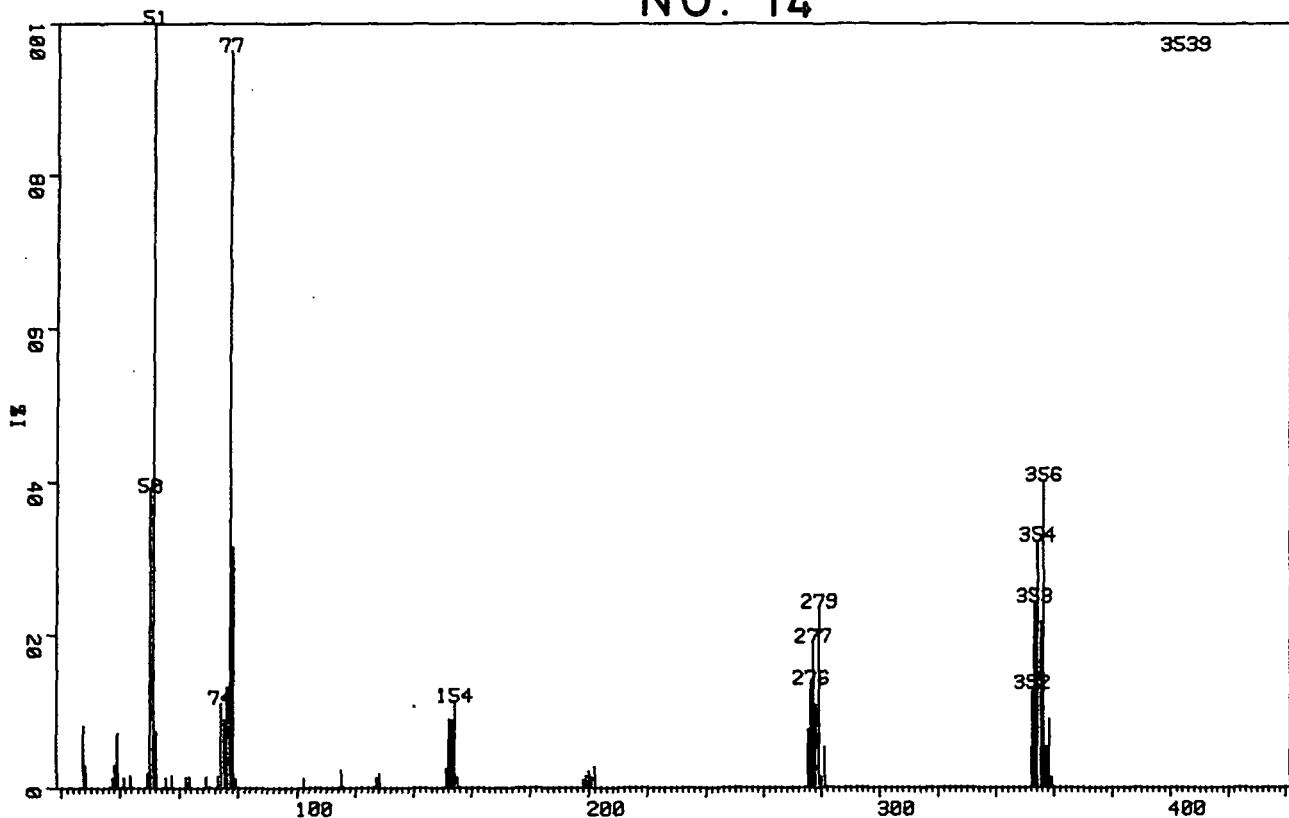

MASS	%HT. BASE	MASS	%HT. BASE
27.23	8.14	277.11	18.96
28.10	3.00	278.08	10.82
37.10	1.22	279.06	23.54
38.04	2.94	280.08	1.47
38.97	7.12	281.09	5.28
40.95	1.36	352.36	13.00
43.12	1.55	353.34	24.27
48.98	1.89	354.36	32.30
49.90	38.85	355.38	21.70
50.98	100.00	356.36	40.21
52.06	7.23	357.34	5.34
55.18	1.33	358.32	8.93
57.17	1.61	359.31	1.22
62.07	1.41		
63.12	1.50		
69.01	1.47		
73.04	1.55		
74.06	11.05		
75.09	8.87		
76.08	13.20		
77.08	96.41		
78.05	31.51		
79.01	1.16		
102.06	1.27		
115.12	2.29		
127.08	1.33		
128.07	1.86		
151.10	2.40		
152.11	8.96		
153.10	8.79		
154.10	11.22		
155.10	1.41		
198.01	1.05		
198.99	1.55		
199.98	2.12		
201.00	1.27		
202.03	2.74		
275.23	7.52		
276.17	13.56		

F07908 0 23-OCT-85 CAL:GDR1 STA: BG SCAN = 0  
S.T. MULLINS STB 6 +VE ION FAB

0:19

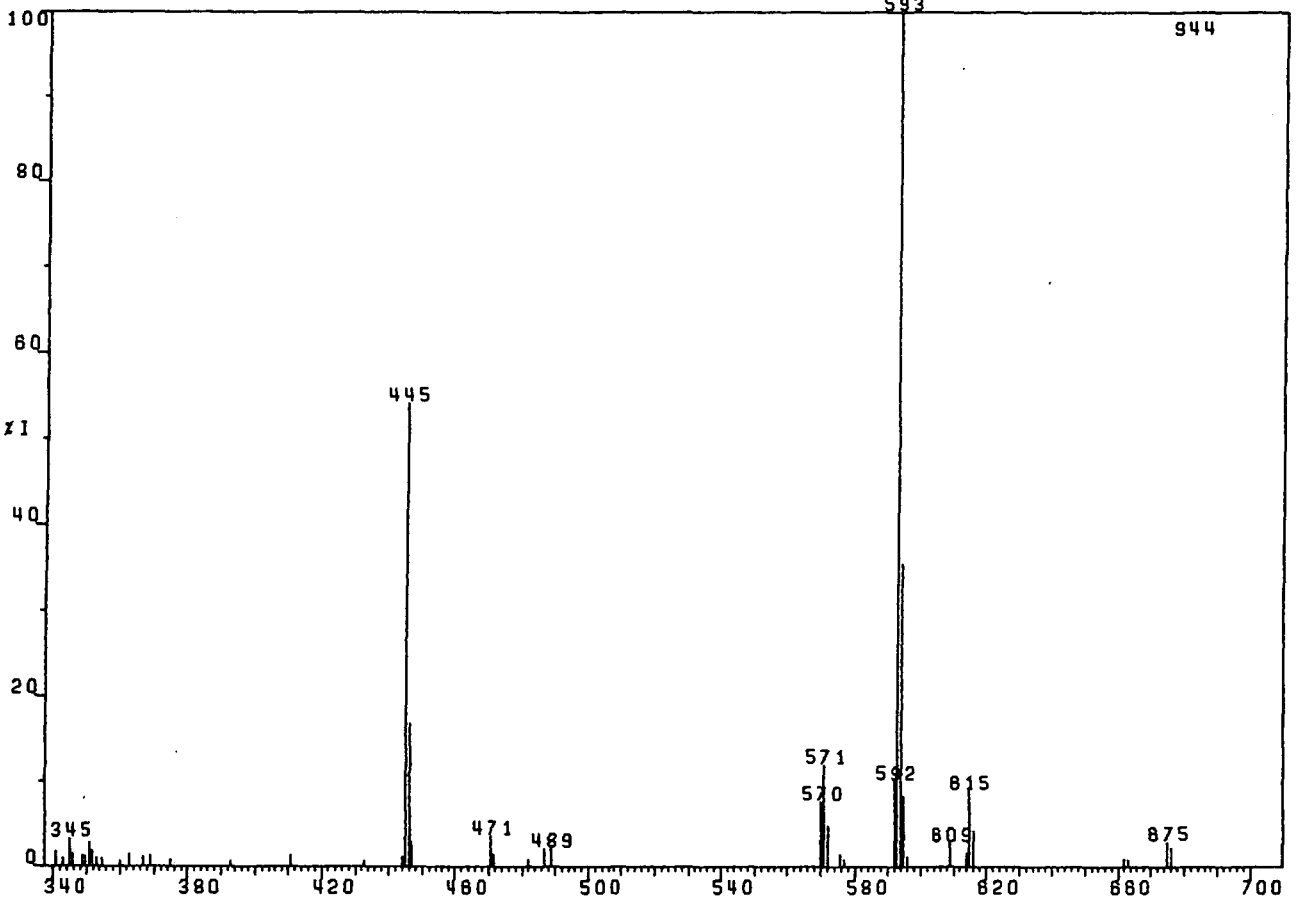

L07908 55 24-OCT-85 CAL:C24 STA: BG SCAN = 15  
S.T. MULLINS STB 6 685/4237 E.I.

9:32

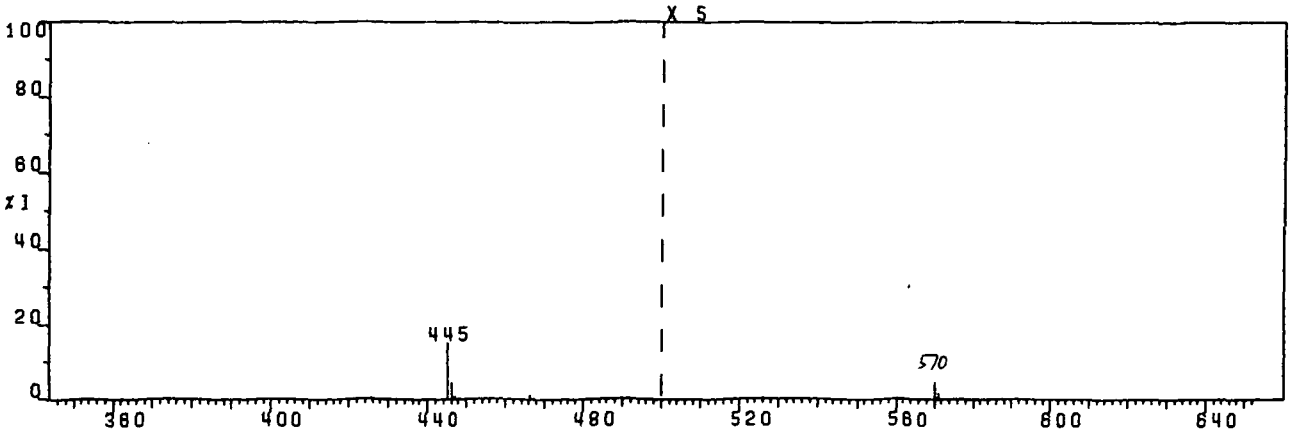
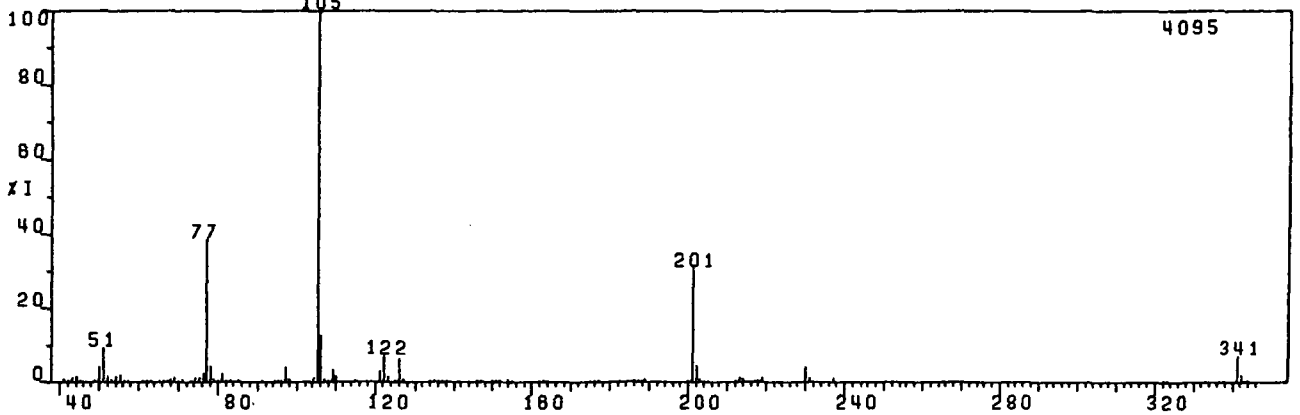



# NO.16

174

F87849F. 1 22-OCT-85 CAL:GDR1 STA: BG SCAN = 0  
A. PARKIN ST4 +VE ION FAB

0:44

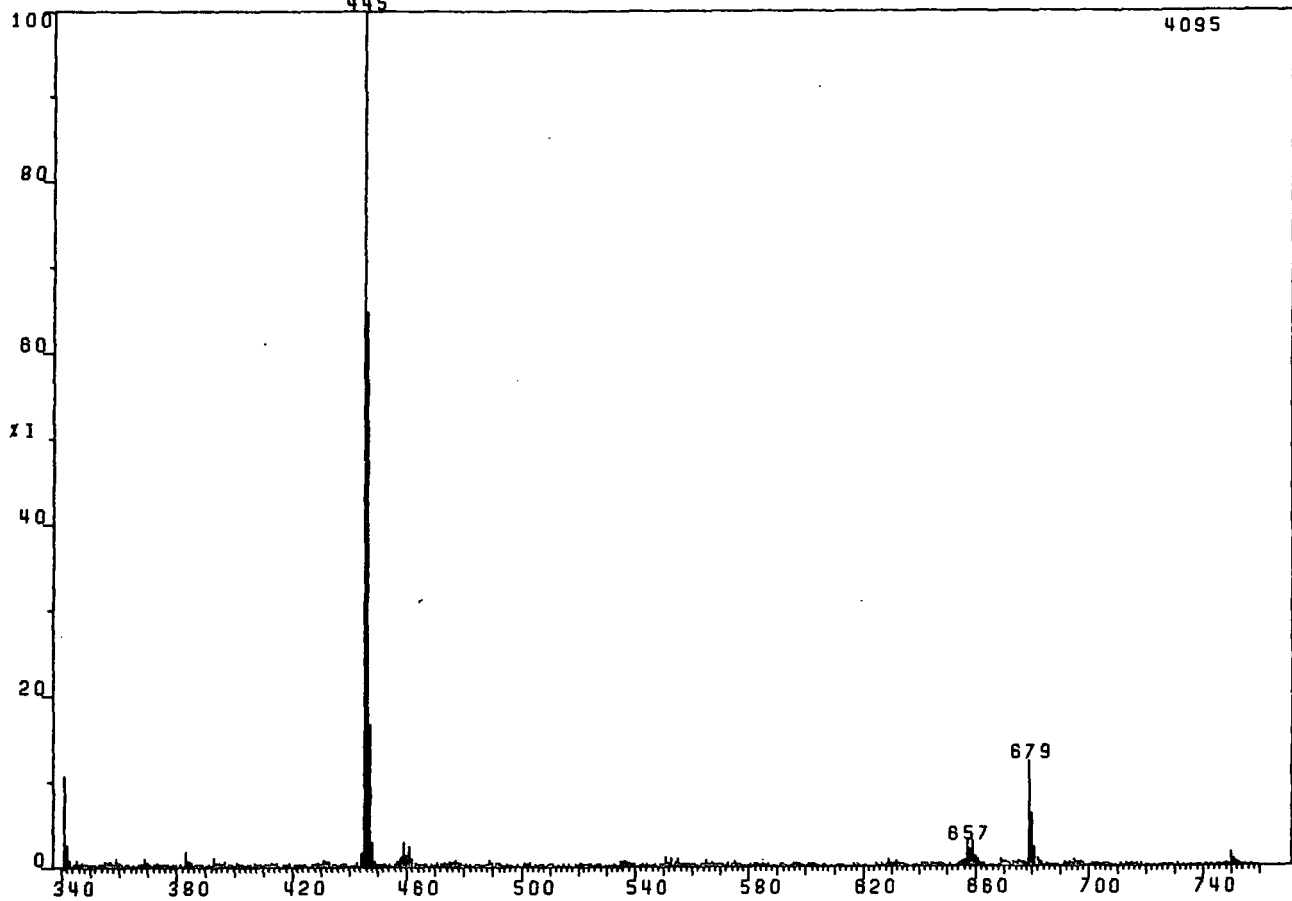

F87849. 0 22-OCT-85 CAL:GDR1 STA: BG SCAN = 0  
A. PARKIN ST4 +VE ION FAB 3NoBA/Na+

0:19

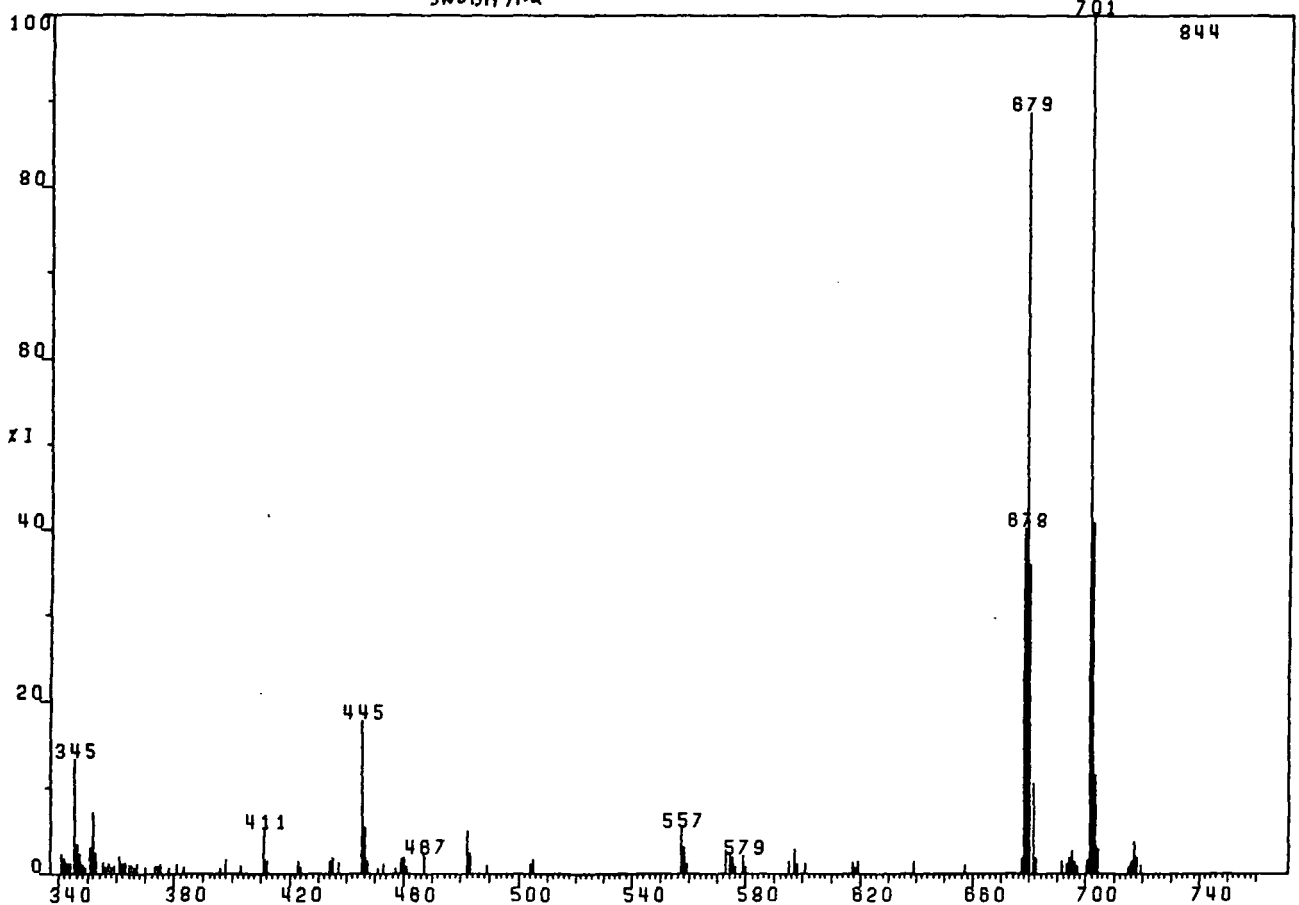

ST84CX 6 S.MULLINS FAB 3NBA+G  
CAL: CALT1 STA:18-SEP-86  
1:33

NO.17

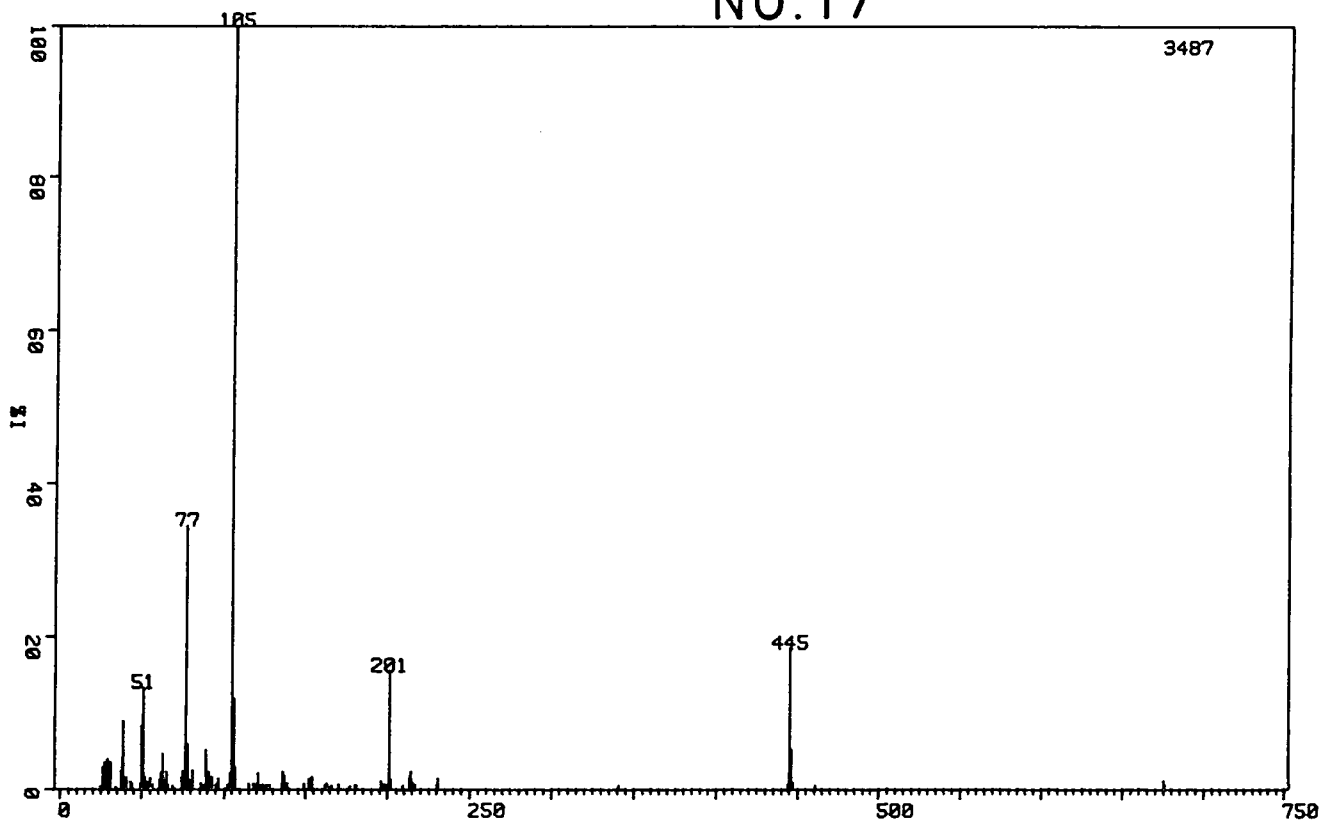

MASS	ZHT. BASE	MASS	ZHT. BASE	MASS	ZHT. BASE
24.92	0.37	86.02	0.86	169.95	0.60
25.37	0.37	87.01	0.54	177.00	0.37
26.33	2.95	88.95	5.19	179.97	0.54
27.26	3.53	89.91	2.35	180.99	0.52
28.99	3.99	90.82	0.83	195.99	1.12
29.02	0.72	90.95	2.32	196.97	0.37
29.81	3.13	91.98	0.89	198.02	0.66
30.90	3.58	93.02	1.61	198.97	0.52
33.86	0.32	95.07	0.54	199.93	0.54
37.08	2.38	96.02	0.75	200.91	15.46
38.02	4.10	97.00	1.43	201.96	1.26
38.95	8.95	102.00	0.60	209.00	0.46
39.84	0.49	103.02	0.75	213.00	1.46
40.92	1.61	104.02	2.15	213.99	2.29
43.04	1.06	105.01	100.00	215.00	0.95
44.08	0.75	106.01	11.82	216.95	0.57
48.92	0.72	107.00	2.90	229.98	0.63
49.84	8.35	115.00	0.77	230.95	1.43
50.90	13.25	117.97	0.72	340.98	0.43
51.98	1.58	119.90	0.66	444.09	0.72
53.01	1.06	120.92	2.12	445.03	18.50
54.08	0.49	121.98	0.43	446.08	5.19
55.05	1.55	123.00	0.37	447.10	0.89
55.73	0.43	124.03	0.63	461.06	0.49
56.57	0.37	126.03	0.52	675.19	1.15
57.06	0.60	127.02	0.43	676.10	0.54
60.90	1.41	128.01	0.63		
61.95	2.15	135.00	0.83		
63.01	4.70	136.01	2.32		
64.03	1.26	137.00	1.86		
65.06	2.29	138.01	0.75		
66.04	0.60	138.96	0.80		
68.93	0.46	148.96	0.69		
74.01	1.69	152.00	1.29		
75.03	2.38	153.04	0.54		
76.03	1.81	154.03	1.63		
77.01	34.44	161.98	0.60		
78.00	5.94	163.02	0.83		
78.96	1.23	164.04	0.32		
80.94	2.52	166.04	0.43		

# NO.18

L87907. 0 23-OCT-85 CAL:GDR1  
S.T.MULLINS STB8 +VE ION FAB

STA: BG SCAN = 0

0:19

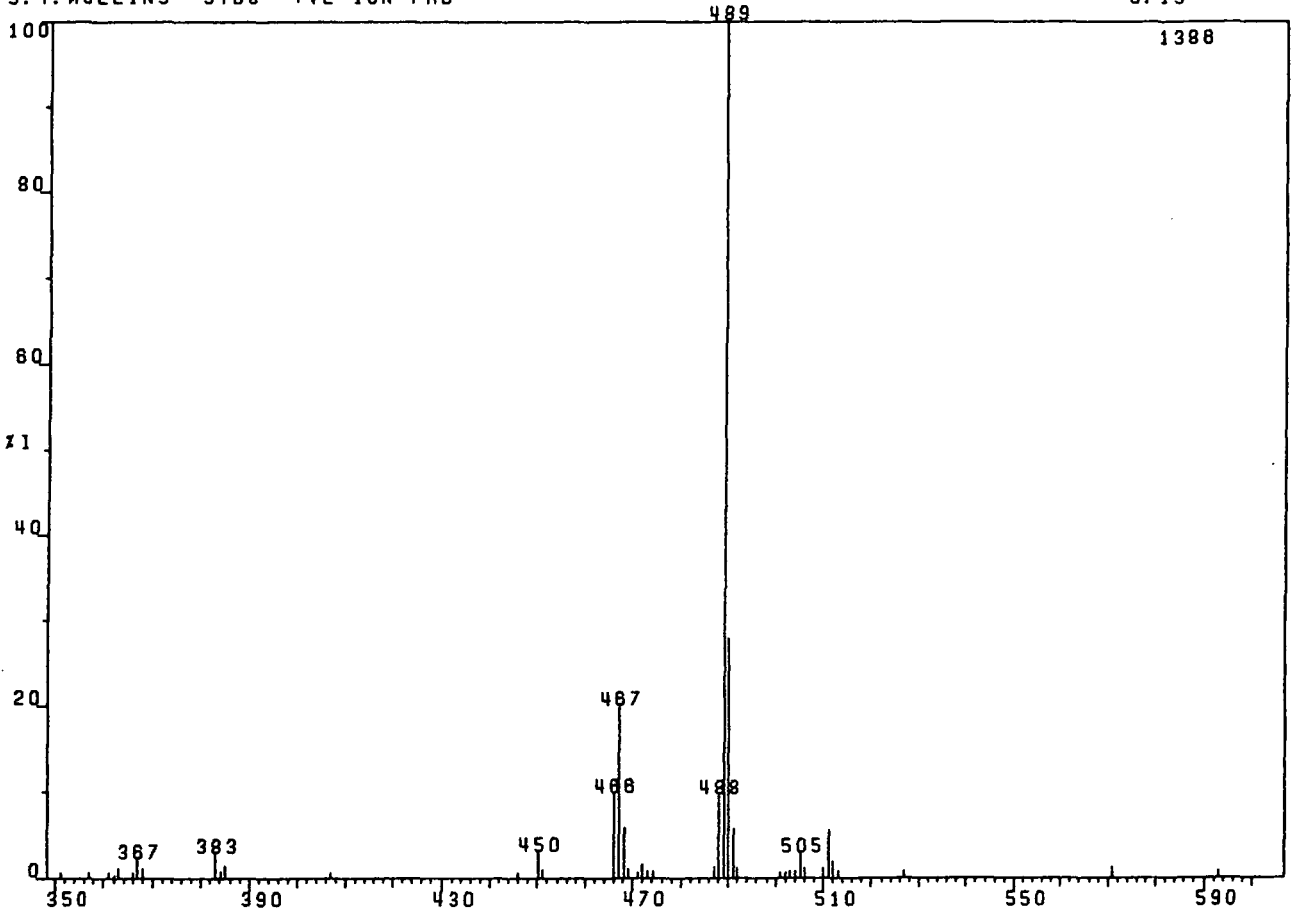

L87907. 13 24-OCT-85 CAL:C24  
S.T.MULLINS STB 8 685/4237

STA: BG SCAN = 0  
E. I.

2:30

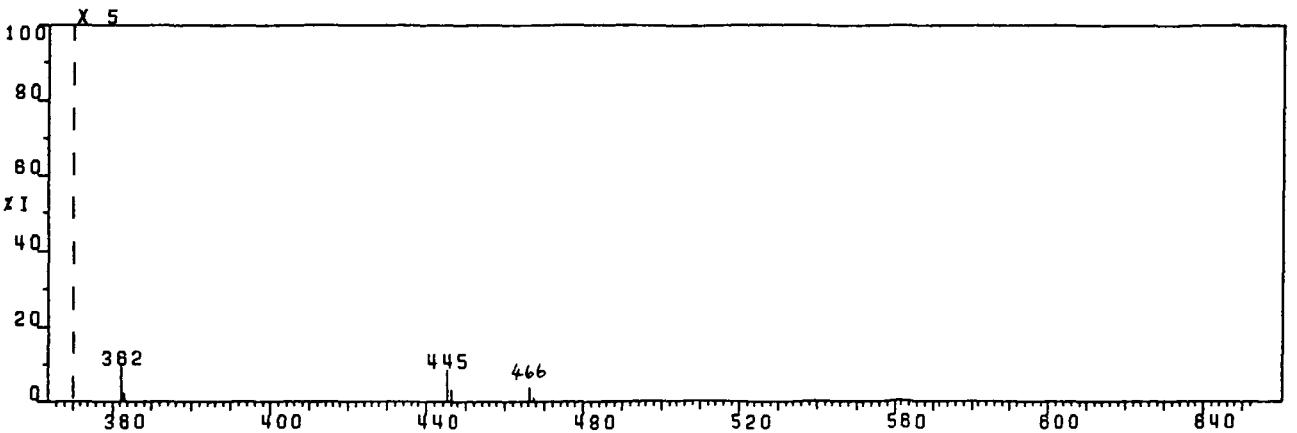
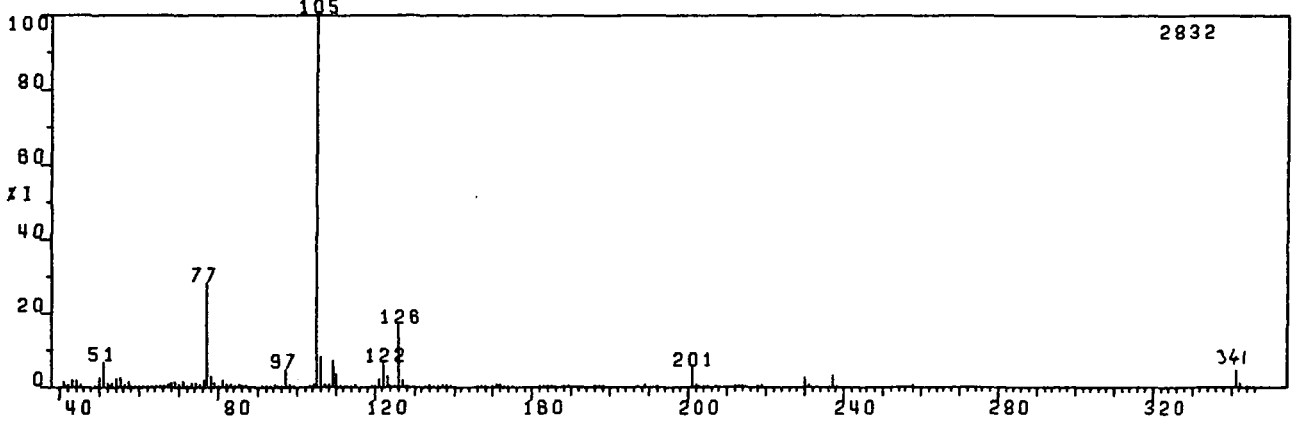

# NO. 19

F88584. 1 22-NOV-85 CAL: C25  
S. J. MULLINS 685/4824 +VE ION FAB

STA: BG SCAN = 0

0: 28

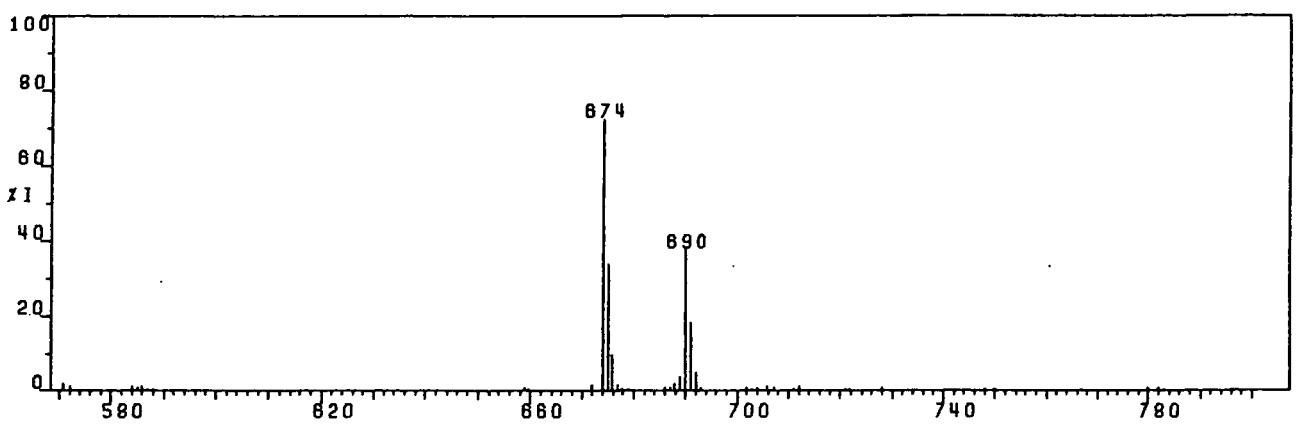
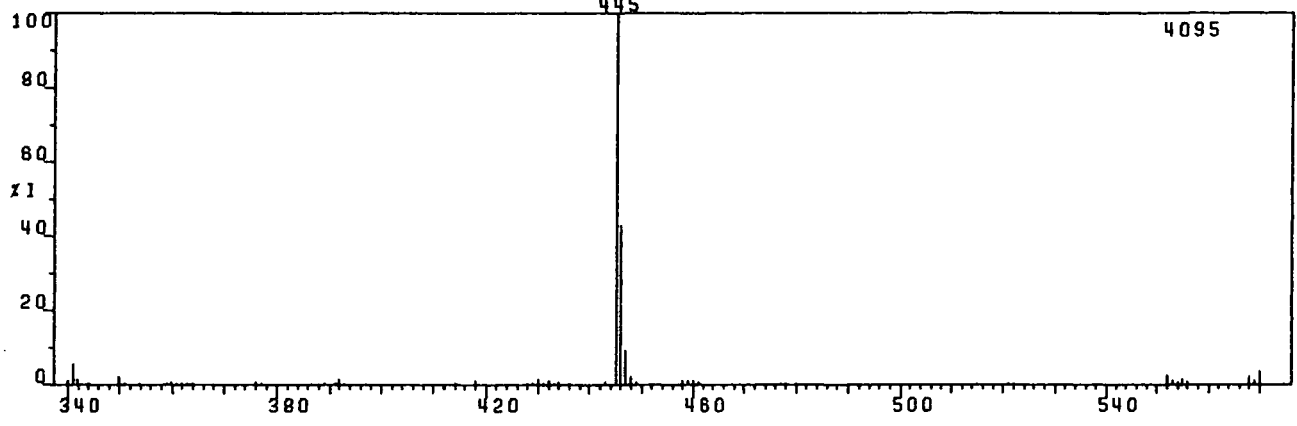

L88584. 82 27-NOV-85 CAL: C27  
S. J. MULLINS 685/4824 E. I.

STA: BG SCAN = 10

10: 2

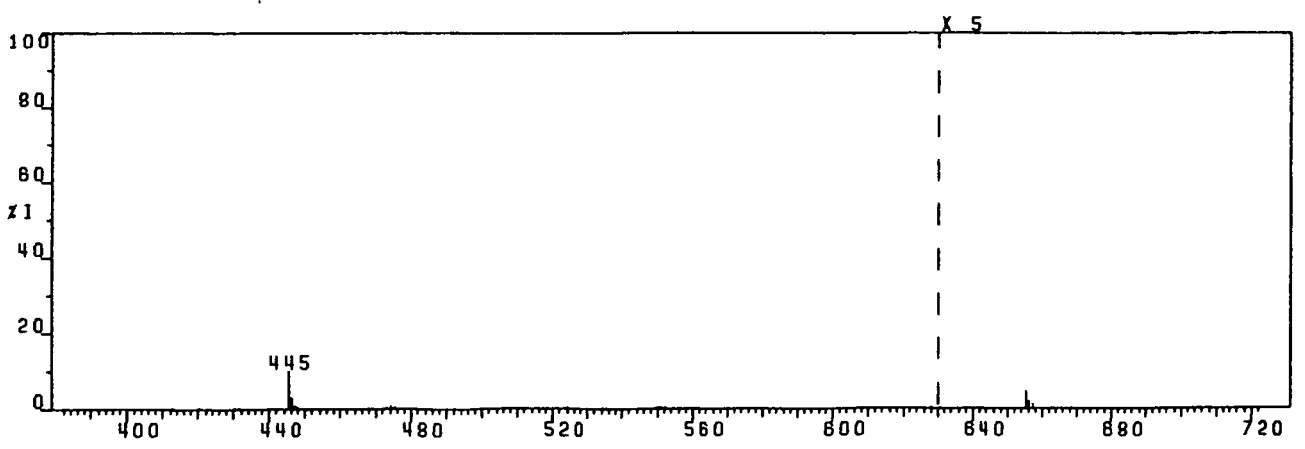
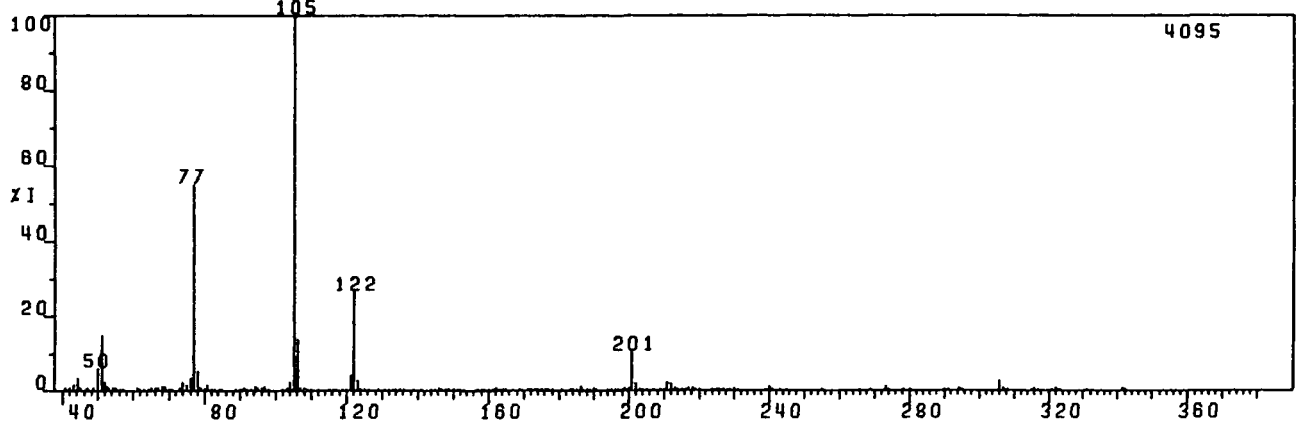

88583F. 1 22-NOV-85 CAL: C25 STA: BG SCAN = 0  
S. J. MULLINS 685/4823 +VE ION FAB 570 0:28

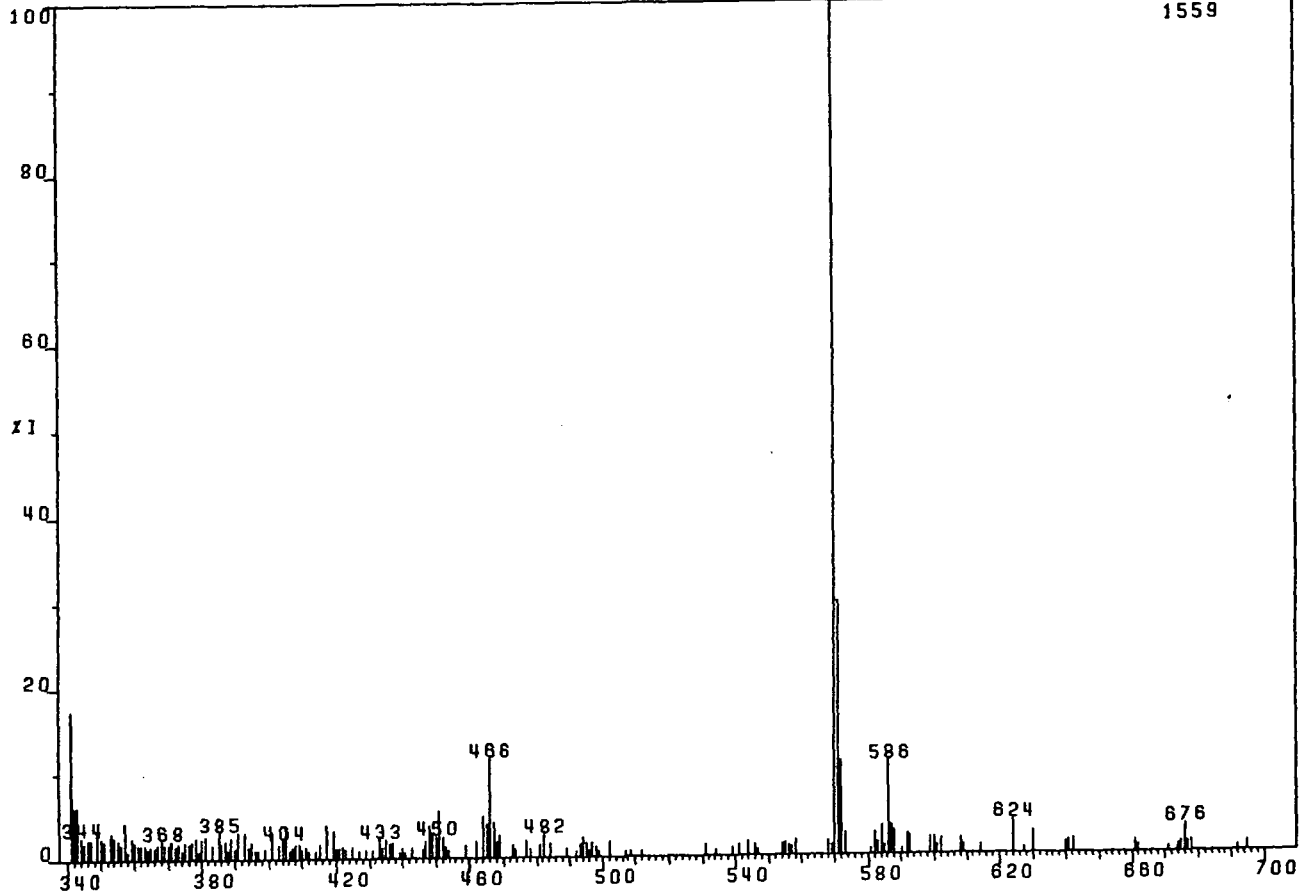

188583. 50 27-NOV-85 CAL: C27 STA: BG SCAN = 0  
S. T. MULLINS 685/4823 E. I. 105 5:38

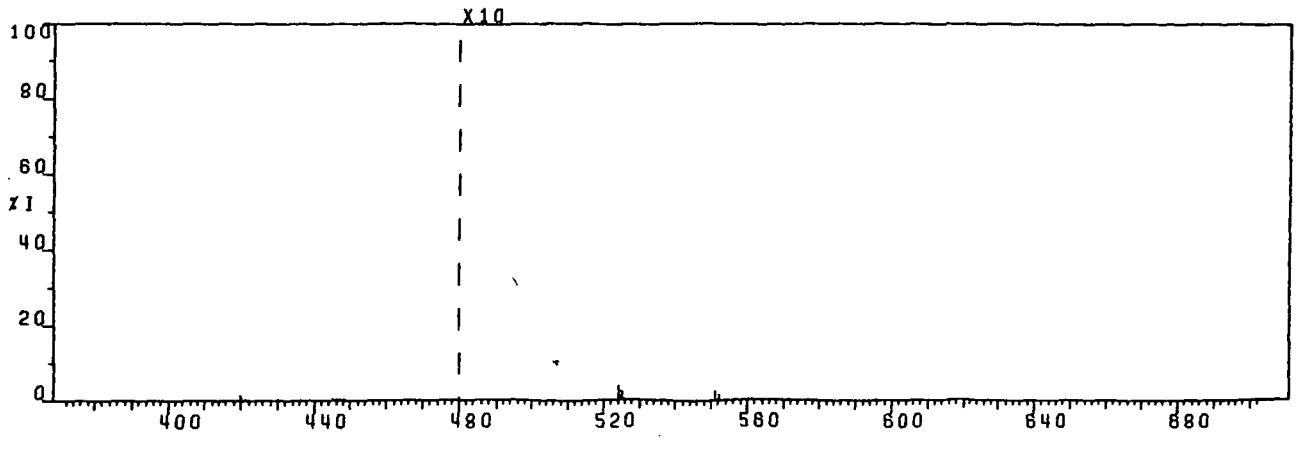
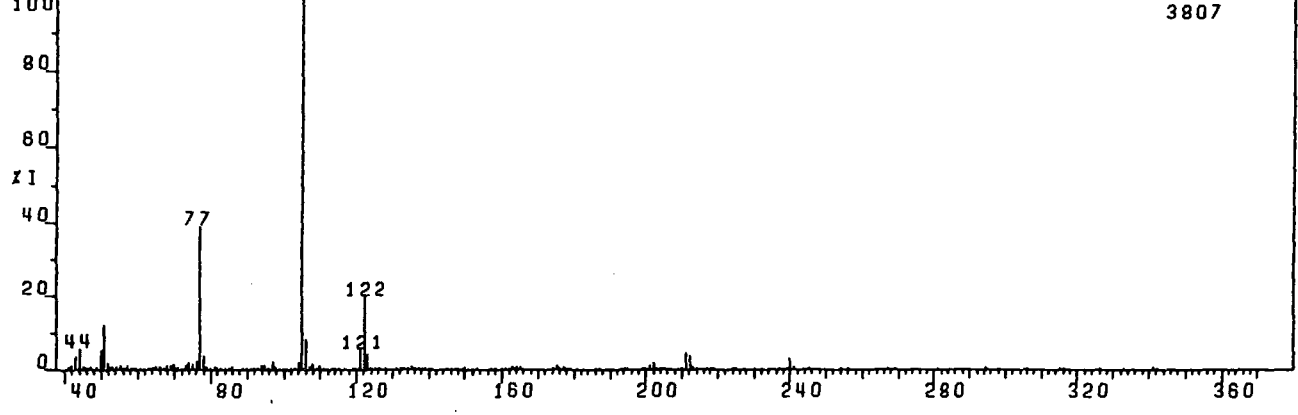

APPENDIX THREEPROTON N.M.R. SPECTRA

<u>Spectrum No.</u>	<u>Compound</u>
1	Tetraphenyltin (70)
2	Trimethylphenyltin (71)
3	Trimethyl-p-tolytin (72)
4	Trimethyl-p-methoxyphenyltin (73)
5	Trimethyl-p-chlorophenyltin (74)
6	3-Trimethylstannylpyridine (75)
7	Phenyltri-n-butyltin (76)
8	p-Tolyl-tri-n-butyltin (77)
9	p-Methoxyphenyl-tributyltin (78)
10	Phenyl-tricyclohexyltin (79)
11	Tricyclohexyl-p-anisyltin (80)
12	Tricyclohexyl-p-N,N-dimethylaminophenyltin (81)
13	1,2-Dimethyl-5-trimethylstannylimidazole (84)
14	1,2-Dimethyl-5-tri-n-butylstannylimidazole (85)
15	N-methyl-2-trimethylstannylimidazole (86)
16	Diphenylmercury (87)
17	Anisylmercuryacetate (88)
18	5-Amino-1-( $\beta$ -D-2',3',5'-tri-O-benzoylribofuranosyl)-imidazole-4-carboxamide (96)
19	5-Benzoylamino-1-( $\beta$ -D-2',3',5'-tri-O-benzoylribofuranosyl)-4-cyanoimidazole (97)
20	5-Benzoylamino-1-( $\beta$ -D-2',3',5'-tri-O-benzoylribofuranosyl)imidazole-4-carboxamide (95)
21	5-(Triphenylmethyl) amino-1-( $\beta$ -D-2',3',5'-tri-O-benzoylribofuranosyl)imidazole-4-carboxamide (98)
22	A mixture of 5-amino-1-( $\beta$ -D-3',5'-di-O-benzoylribofuranosyl)imidazole-4-carboxamide (99) and 5-amino-1-( $\beta$ -D-2',5'-di-O-benzoylribofuranosyl)imidazole-4-carboxamide (100)

<u>Spectrum No.</u>	<u>Compound</u>
23	5-Amino-1-( $\beta$ -D-2',5'-di-O-benzoylribofuranosyl)-imidazole-4-carboxamide (100)
24	5-Amino-1-( $\beta$ -D-3',5'-di-O-benzoylribofuranosyl)-imidazole-4-carboxamide (99)
25	5-Benzoylamino-1-( $\beta$ -D-2',3',5'-tri-O-benzoylribofuranosyl)imidazole-4-carboxamidoxime (101)
26	5-Benzoylamino-1-( $\beta$ -D-3',5'-di-O-benzoylribofuranosyl)imidazole-4-carboxamidoxime (102)
27	5-Benzoylamino-1-( $\beta$ -D-5'-O-benzoylribofuranosyl)-imidazole-4-carboxamide (103)
28	A mixture of 5-(triphenylmethyl)amino-1-( $\beta$ -D-3',5'-di-O-benzoylribofuranosyl)imidazole-4-carboxamide (104) and 5-(triphenylmethyl)amino-1-( $\beta$ -D-2',5'-di-O-benzoylribofuranosyl)imidazole-4-carboxamide (105)
29	A mixture of 5-benzoylamino-1-( $\beta$ -D-2',5'-di-O-benzoylribofuranosyl)imidazole-4-carboxamide (107) and 5-benzoylamino-1-( $\beta$ -D-3',5'-di-O-benzoylribofuranosyl)imidazole-4-carboxamide (106)
30	Products from reaction 8.9
31	Products from reaction 8.10(a)
32	Products from reaction 8.10(b)
33	Products from reaction 8.11.

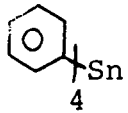
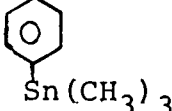
<u>Spectrum No.</u>	<u>Compound, Spectrum</u>	<u>Solvent</u>
1	 7.2-7.9 (aromatic protons)	CDCl <sub>3</sub>
2	 0.3 (9H, s, methyl protons) 7.2-7.9 (5H, m, aromatic protons)	CDCl <sub>3</sub>

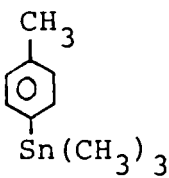
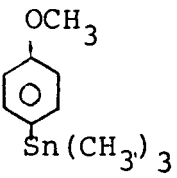
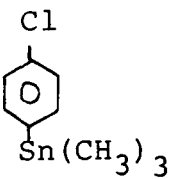
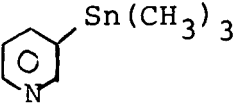
<u>Spectrum No.</u>	<u>Compound, Spectrum</u>	<u>Solvent</u>
3	 <p>0.2 (9H, s, Sn-CH<sub>3</sub> protons) 2.2 (3H, s, methyl protons). 7.3 and 7.5 (AA'BB', H=8Hz, 4H, aromatic protons)</p>	CDCl <sub>3</sub>
4	 <p>0.3 (9H, s, Sn-CH<sub>3</sub> protons) 3.7 (3H, s, methyl protons) 6.5 and 7.4 (AA'BB', J=8Hz, 4H, aromatic protons)</p>	CDCl <sub>3</sub>
5	 <p>0.55 (9H, s, Sn-CH<sub>3</sub> protons) 7.3 (4H, m, aromatic protons)</p>	CDCl <sub>3</sub>
6	 <p>0.2 (9H, s, Sn-CH<sub>3</sub> protons) 7.1 (1H, m, aromatic proton) 7.7 (1H, m, aromatic proton) 8.5 (2H, m, aromatic protons)</p>	CDCl <sub>3</sub>

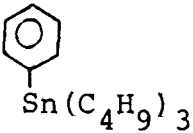
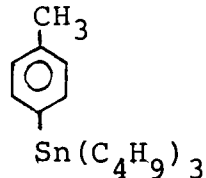
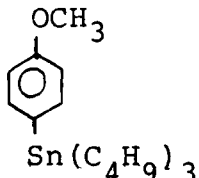
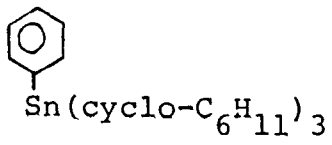
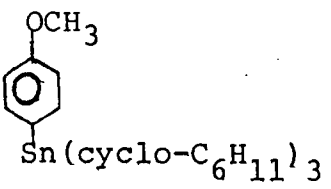

<u>Spectrum No.</u>	<u>Compound, Spectrum</u>	<u>Solvent</u>
7	 $\text{Sn}(\text{C}_4\text{H}_9)_3$	$\text{CDCl}_3$
	0.6 - 1.9 (27H, m, n-butyl protons)	
	7.0 - 7.5 (5H, m, aromatic protons)	
8	 $\text{Sn}(\text{C}_4\text{H}_9)_3$	$\text{CDCl}_3$
	0.5 - 1.8 (27H, m, n-butyl protons)	
	2.3 (3H, s, $\text{CH}_3$ protons)	
	7 and 7.36 ( $\text{AA}'\text{BB}'$ , $J = 6\text{Hz}$ , 4H, aromatic protons)	
9	 $\text{Sn}(\text{C}_4\text{H}_9)_3$	$\text{CDCl}_3$
	0.5 - 1.8 (27H, m, n-butyl protons)	
	3.7 (3H, s, O- $\text{CH}_3$ protons)	
	7.1 (4H, m, aromatic protons)	
10	 $\text{Sn}(\text{cyclo-C}_6\text{H}_{11})_3$	$\text{CDCl}_3$
	1.0 - 2.2 (33H, m, cyclohexyl protons)	
	7.2 (5H, m, aromatic protons)	
11	 $\text{Sn}(\text{cyclo-C}_6\text{H}_{11})_3$	$\text{CDCl}_3$
	1.0 - 2.2 (33H, m, cyclohexyl protons)	
	3.7 (3H, s, O- $\text{CH}_3$ protons)	
	6.8 and 7.3 ( $\text{AA}'\text{BB}'$ , $J = 8.4\text{Hz}$ , 4H, aromatic protons)	

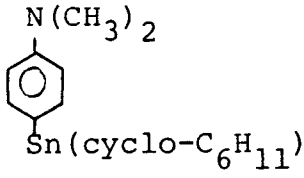
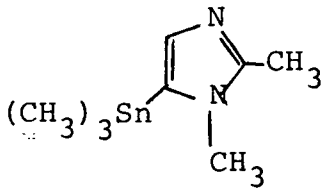
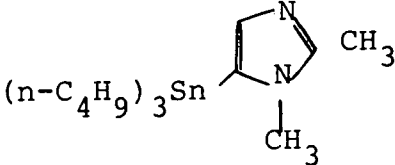
<u>Spectrum No.</u>	<u>Compound, Spectrum</u>	<u>Solvent</u>
12	 <p>1.0 - 2.1 (33H, m, cyclohexyl protons)  2.9 (6H, s, N-CH<sub>3</sub> protons)  6.6 and 7.23 (AA' BB', J = 9Hz,  4H, aromatic protons)</p>	CDCl <sub>3</sub>
13	 <p>0.3 (9H, s, Sn-CH<sub>3</sub> protons)  2.3 (3H, s, C-CH<sub>3</sub> protons)  3.5 (3H, s, N-CH<sub>3</sub> protons)  6.8 (1H, s, C-4 proton).</p>	CDCl <sub>3</sub>
14	 <p>0.3 - 1.7 (multiplet, n-butyl protons)  2.4 (singlet, C-2 CH<sub>3</sub> protons)  3.6 (singlet, N-CH<sub>3</sub> protons)  6.8 (singlet, C-4 proton)</p>	CDCl <sub>3</sub>

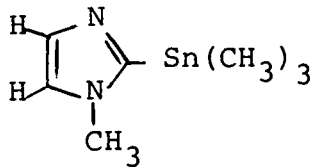
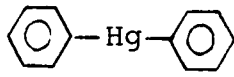
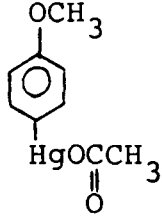
<u>Spectrum No.</u>	<u>Compound, Spectrum</u>	<u>Solvent</u>
15	 <p>0.46 (9H, s, Sn-CH<sub>3</sub> protons)  3.7 (3H, s, N-CH<sub>3</sub> protons)  7.0 (1H, s, C-4 proton)  7.2 (1H, s, C-5 proton)</p>	CDCl <sub>3</sub>
16	 <p>7.5 (aromatic protons, multiplet)</p>	CDCl <sub>3</sub>
17	 <p>0.86 (3H, s, acetate protons)  2.7 (3H, s, O-CH<sub>3</sub> protons)  5.7 - 6.4 (4H, m, aromatic protons)</p>	d <sup>6</sup> -DMSO

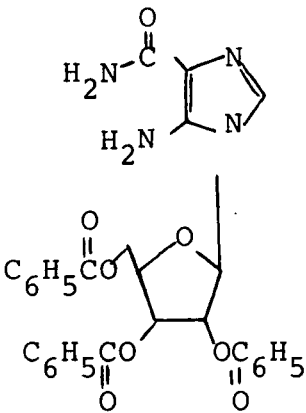
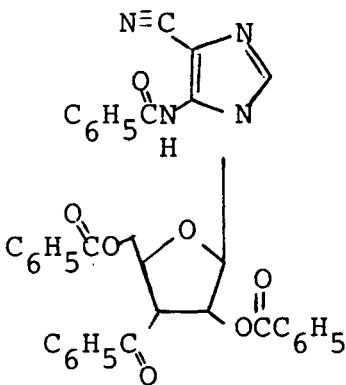
<u>Spectrum No.</u>	<u>Compound, Spectrum</u>	<u>Solvent</u>
18		$d^6$ -DMSO
	<p>4.67 - 4.78 (3H, m, 4' and 5' protons)</p> <p>5.91 (1H, m, 3' proton)</p> <p>6.0 - 6.06 (3H, m, 2' proton and C-5 amine protons)</p> <p>6.26 (1H, doublet, J=6Hz, 1' proton)</p> <p>6.78 (2H, broad, C-4 amide protons)</p> <p>7.41 - 8.05 (16H, m, aromatic and C-2 protons)</p>	
19		$CDCl_3$
	<p>4.64 - 4.92 (3H, m, 4' and 5' protons)</p> <p>5.72 - 5.87 (2H, m, 2' and 3' protons)</p> <p>6.06 (1H, d, J=3Hz, 1' proton)</p> <p>7.32 - 8.04 (21H, m, aromatic and C-2 protons)</p> <p>8.72 (1H, s, C-5 amide proton)</p>	

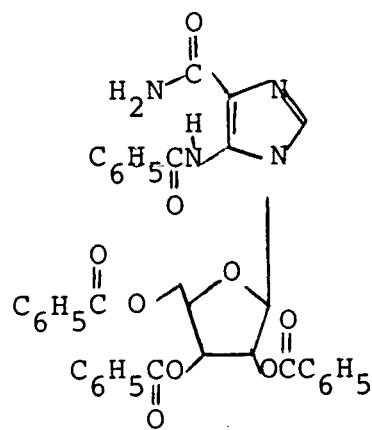
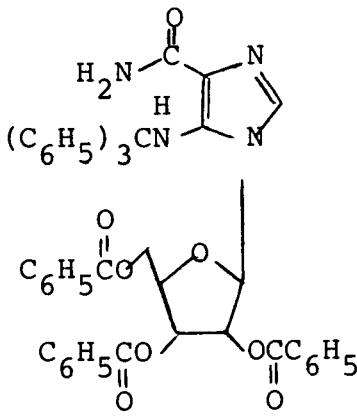
Spectrum No.	Compound, Spectrum	Solvent
20		$d^6$ -DMSO
	<p>4.65 - 4.8 (3H, m, 4' and 5' protons)</p> <p>5.9 - 6.08 (3H, m, 1', 2' and 3' protons)</p> <p>7.13 (1H, s, C-2 proton)</p> <p>7.32 - 8.14 (22H, m, aromatic and C-4 amide protons)</p> <p>10.36 (1H, s, C-5 amide proton)</p>	
21		$d^6$ -DMSO
	<p>4.18 - 4.62 (3H, m, 4' and 5' protons)</p> <p>5.63 - 5.9 (3H, m, 1', 2' and 3' protons)</p> <p>6.85 (1H, s, C-5 NH proton)</p> <p>7.06 - 8.03 (3H, m, aromatic, C-2 protons and C-4 NH<sub>2</sub> protons)</p>	

Spectrum No.                      Compound, Spectrum                      Solvent

22

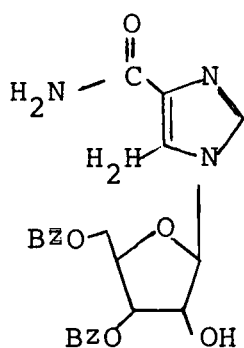
 $d^6$ -DMSO

(a)

and

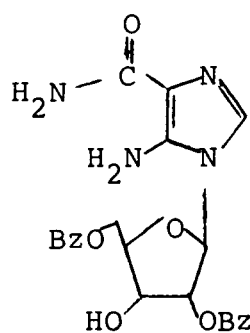

(b)

4.51 - 4.70	(3H, m, 4', 5' protons)
4.78	(2/3H, m, 2' proton isomer (a))
4.35	(1/3H, m, 3' proton isomer (b))
5.53	(2/3H, m, 3' proton isomer (a))
5.60	(1/3H, m, 2' proton isomer (b))
5.72	(2/3H, d, J=6.9Hz, 1' proton isomer (a))
5.94	( $2\frac{1}{3}$ H, s, D <sub>2</sub> O exchangeable, C-5 amine and OH isomer (b))
6.0	(1H, m. OH isomer (a) and 1' proton isomer (b))
6.71	(broad, 2H, C-4 amide)
7.33	(2/3H, s, C-2 proton isomer (a))
7.41	(1/3H, s, C-2 proton isomer (b))
7.51-8.13	(10H, m. aromatic protons).

Spectrum No.Compound, SpectrumSolvent

23

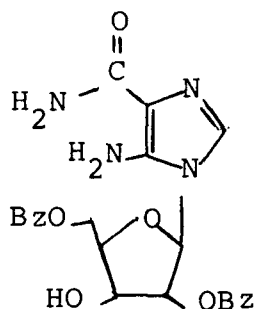
d<sup>6</sup>-DMSO

- 4.34 (1H, m, 3' proton)  
 4.51 - 4.70 (3H, m, 4', 5' proton)  
 5.59 (1H, m, 2' proton)  
 5.9 (1H, d, J=5.5Hz, 3' hydroxyl proton)  
 5.93 (2H, s, C-5 amine group)  
 6.70 (2H, broad, C-4 amide)  
 7.41 (1H, s, C-2 proton)  
 7.53-8.12 (10H, m, aromatic protons)

There is evidence of signals due to the 2' deprotected isomer, but these are very small.

24

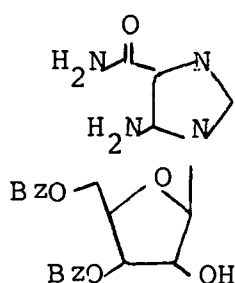
d<sup>6</sup>-DMSO

- 4.57 - 4.65 (3H, m, 4', 5' protons)  
 4.78 (1H, m, 2' proton)  
 5.54 (1H, m, 3' proton)  
 5.72 (1H, d, J=6.8Hz, 1' proton)  
 5.94 (2H, s, C-5 amine)  
 6.04 (1H, d, J=4.4Hz, D<sub>2</sub>O exchangeable, 2' hydroxyl group)  
 6.70 (2H, broad signal, C-4 amide)  
 7.33 (1H, s, C-2 proton)  
 7.44-8.12 (10H, m, aromatic protons)

Signals due to the 3' deprotected isomer can be seen but these are very small.

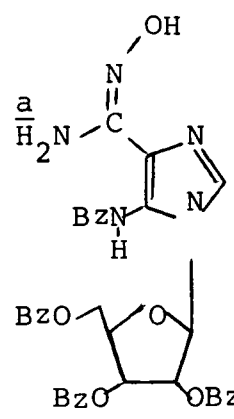
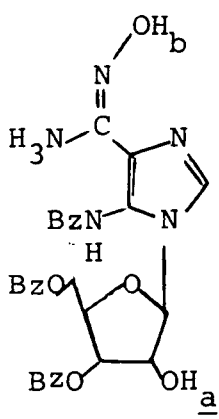
<u>Spectrum No.</u>	<u>Compound, Spectrum</u>	<u>Solvent</u>
25		$d^6$ -DMSO
	4.64 - 4.79 (3H, m, 4', 5' protons)	
	5.50 (2H, s, amine <u>a</u> )	
	5.89 - 5.98 (1H, m, 3' proton)	
	6.0 - 6.04 (2H, m, 1', 2' protons)	
	7.32 - 8.14 (21H, m. aromatic protons and C-2 proton)	
	9.32 (1H, s, $D_2O$ exchangeable N-O-H proton)	
	10.17 (1H, s, $D_2O$ exchangeable C-5 benzamide N-H proton)	
26		$d^6$ -DMSO
	4.62 (3H, broad signal, 4', 5' protons)	
	4.74 (1H, m, 2' proton)	
	5.47 (3H, broad signal, 2' protons $D_2O$ exchangeable, $NH_2$ and 3' proton)	
	5.60 (1H, d, $J=4.1Hz$ , 1' proton)	
	6.07 (1H, d, $J=5.8Hz$ , $D_2O$ exchangeable, 2'-OH <sub>a</sub> )	
	7.46-8.04 (15H, m, aromatic protons and C-2 proton)	
	9.29 (1H, s, $D_2O$ exchangeable, C-5 amide proton)	
	10.07 (1H, s, $D_2O$ exchangeable, N-OH <sub>b</sub> )	



Spectrum No.Compound, SpectrumSolvent

27

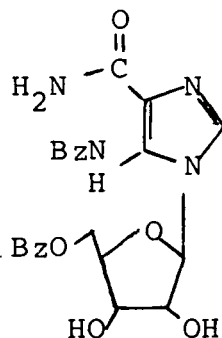
 $d^6$ -DMSO

4.18	(2H, m, 5' protons)
4.30	(1H, m, 4' protons)
4.42-4.58	(2H, m, 2' and 3' protons)
5.37	(1H, d, $J=5.2\text{Hz}$ , $D_2O$ exchangeable, 3'-OH)
5.50-5.53	(2H, m, one proton $D_2O$ exchangeable, 1' proton and 2'-OH)
7.02 and 7.27	(2H, singlets, $D_2O$ exchangeable C-4 amide protons)
7.50-8.01	(11H, m, aromatic protons and C-2 proton)
10.15	(1H, s, $D_2O$ exchangeable, C-5 benzamide proton)

28

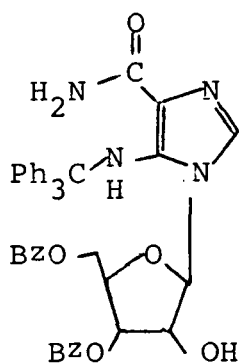

(a)

and

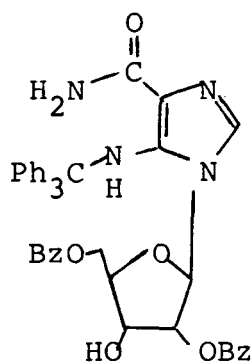

(b)

 $d^6$ -DMSO

4.4 - 4.8	(4H, m, 4' and 5' protons, 2' proton isomer (a), 3' proton isomer (b))
5.53- 5.60	(1H, 3' proton isomer (a) and 2' proton isomer (b)).
5.72	(2/3H, d, $J=7\text{Hz}$ , 1' proton isomer (a))
5.93-6.08	( $2\frac{1}{3}$ H, m, two protons $D_2O$ exchangeable, 1' proton isomer (b), 2'-OH isomer (a), 3' OH isomer (b) plus impurity)
6.44	(1H, s, $D_2O$ exchangeable, C-5 NH)
6.86	(2H, broad signal, $D_2O$ exchangeable, C-4 amide protons).
7.11-8.13	(29H, m, aromatic protons and C-2 proton plus small amount of impurity)

Spectrum No.Compound, SpectrumSolvent

29

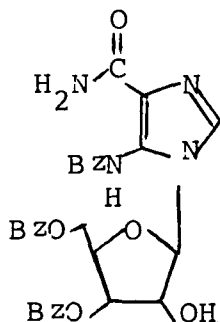

(a)

and

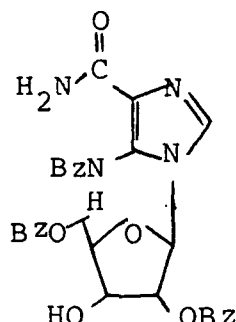

(b)

 $d^6$ -DMSO

- 4.31-4.75 (4H, m, 4' and 5' protons, 2' proton isomer (a), 3' proton isomer (b)).
- 5.46 (2/3H, m, 3' proton isomer (a))
- 5.62 (1H, m, 1' proton isomer (a), 2' proton isomer (b))
- 5.88 (1H, m, 2'-OH isomer (a) and 3'-OH isomer (b)).
- 6.07 (1/3H, d,  $J=6\text{Hz}$ , 1' proton isomer (b))
- 7.09 and 7.35 (2H, singlets,  $D_2O$  exchangeable, C-4 amide protons).
- 7.44-8.31 (16H, m, aromatic protons and C-2 proton)

30

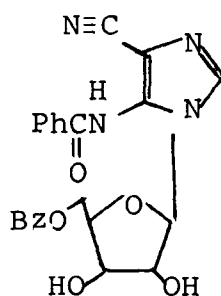
 $d^6$ -DMSO

- 4.15-4.59 (5H, m, 2', 3', 4' and 5' protons).
- 5.45 (1H, d,  $J=5.2\text{Hz}$ ,  $D_2O$  exchangeable, hydroxyl proton).
- 5.60 (1H, d,  $J=4.1\text{Hz}$ , 1' proton).
- 5.67 (1H, broad signal,  $D_2O$  exchangeable hydroxyl proton).
- 7.51-8.08 (11H, m, aromatic protons and C-2 proton)
- 10.69 (1H, broad singlet,  $D_2O$  exchangeable, C-5 benzamide proton).

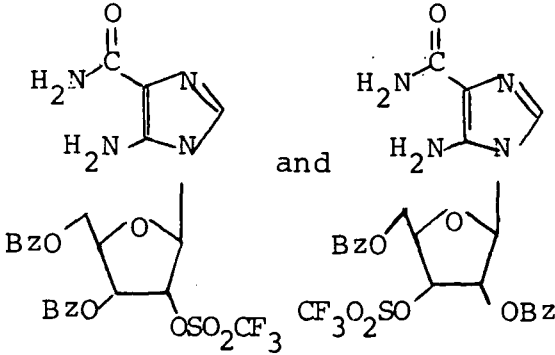
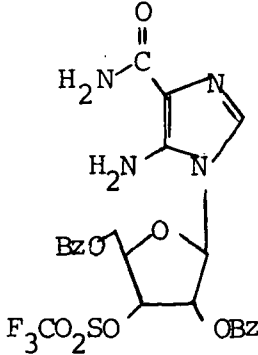
<u>Spectrum No.</u>	<u>Compound, Spectrum</u>	<u>Solvent</u>
31		CDCl <sub>3</sub>
	4.75 (3H, m, 4' and 5' protons)	
	5.16 (1H, s, D <sub>2</sub> O exchangeable)	
	5.29 (1H, s, D <sub>2</sub> O exchangeable)	
	5.62-6.03 (3H, m, 1', 2' and 3' protons)	
	6.6 (1H, broad signal, C-4 amide protons)	
	7.13 (1H, s, C-2 proton)	
	7.32-8.09 (10H, m, aromatic protons).	
32		CDCl <sub>3</sub>
	4.6 (3H, broad signal, 4' and 5' protons)	
	5.2 (2H, broad signal, 2' and 3' protons)	
	5.5-6.0 (5H, m, 1' proton, C-5 amine and C-4 amide protons)	
	7.1 (1H, s, C-2 proton)	
	7.2-8.2 (10H, m, aromatic protons).	



APPENDIX FOURCARBON-13 N.M.R.

<u>Spectrum No.</u>	<u>Compound</u>
1	5-Amino-1-( $\beta$ -D-2',3',5'-tri-O-benzoylribofuranosyl)imidazole-4-carboxamide (96)
2	5-Benzoylamino-1-( $\beta$ -D-2',3',5'-tri-O-benzoylribofuranosyl)-4-cyanoimidazole (97)
3	5-Benzoylamino-1-( $\beta$ -D-2',3',5'-tri-O-benzoylribofuranosyl)imidazole-4-carboxamide (95)
4	A mixture of 5-amino-1-( $\beta$ -D-2',5'-di-O-benzoylribofuranosyl)imidazole-4-carboxamide (100) and 5-amino-1-( $\beta$ -D-3',5'-di-O-benzoylribofuranosyl)imidazole-4-carboxamide (99)
5	5-Amino-1-( $\beta$ -D-2',5'-di-O-benzoylribofuranosyl)imidazole-4-carboxamide (100)
6	5-Amino-1-( $\beta$ -D-3'-5'-di-O-benzoylribofuranosyl)imidazole-4-carboxamide (99)
7	5-Benzoylamino-1-( $\beta$ -D-2',3',5'-tri-O-benzoylribofuranosyl)imidazole-4-carboxamidoxime (101)
8	5-Benzoylamino-1-( $\beta$ -D-5'-O-benzoylribofuranosyl)imidazole-4-carboxamide (103)

Spectrum No.CompoundSolvent

1

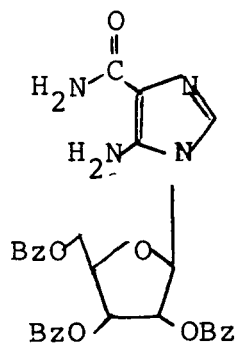
d<sup>6</sup>-DMSOShift (p.p.m.)Assignment

63.8	5' carbon
70.8	3' carbon
73.0	2' carbon
79.3	4' carbon
84.0	1' carbon
112.5	unassigned
127.0	unassigned
128-134	aromatic carbons
143.0	unassigned
164.3-166.4	carbonyl group carbons

Spectrum No.CompoundSolvent

2

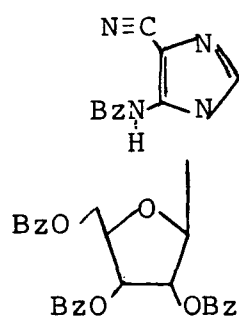
CDCl<sub>3</sub>Shift (p.p.m.)Assignment

62.6	5' carbon
70.15	3' carbon
75.42	2' carbon
80.27	4' carbon
88.19	1' carbon
110.1	C≡N carbon
113.65	unassigned
127.9-134	aromatic carbons
165.19, 165.69, 166.02, 166.17	carbonyl group carbons.

Spectrum No.CompoundSolvent

3

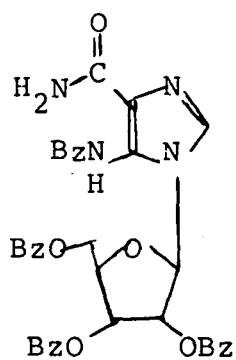
 $d^6$ -DMSOShift (p.p.m.)Assignment

63.8 , 5' carbon

70.5 3' carbon

74.5 2' carbon

79.1 4' carbon

85.7 1' carbon

127.8-133.7 aromatic carbons

163.4, 164.3,  
164.4, 165.4,  
166.8 carbonyl  
group  
carbons



Spectrum No.CompoundSolvent

4

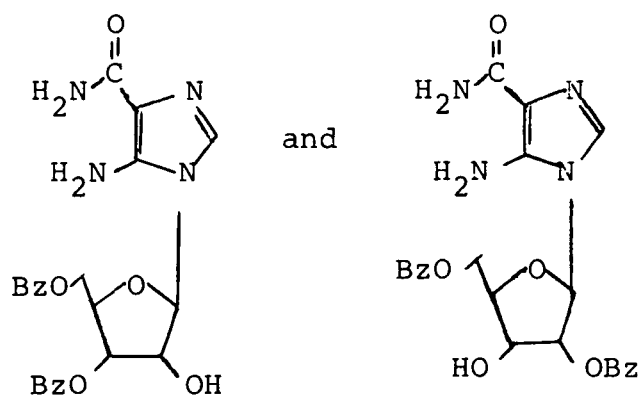
CDCl<sub>3</sub>Shift (p.p.m.)Assignment

63.2, 63.8, 68.6, 72.5, 73.0,

sugar ring

80.8, 81.6, 87.0, 88.9

carbons.

113.33, 113.22

unassigned

127.5 - 134

aromatic carbons

143.0, 143.4

unassigned

166.0, 166.2, 166.4, 166.5,

carbonyl  
group

167.4, 175.4

carbons

Spectrum No.CompoundSolvent

5

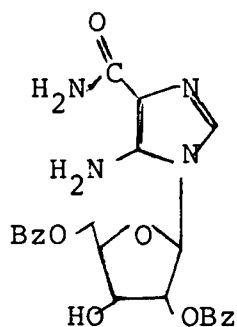
d<sup>6</sup>-DMSOShift (p.p.m.)Assignment

64.00	5' carbon
68.4	3' carbon
75.6	2' carbon
81.3	4' carbon
84.6	1' carbon
112.6	unassigned
127.1	unassigned
127.3 - 133.8	aromatic carbons
142.8	unassigned
164.9, 165.6, 166.5	carbonyl group carbons

Spectrum No.CompoundSolvent

6

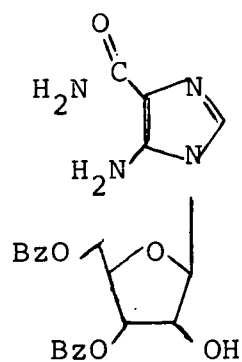
d<sup>6</sup>-DMSOShift (p.p.m.)Assignment

64.2

5' carbon

71.6

3' carbon

72.95

2' carbon

79.2

4' carbon

86.0

1' carbon

112.7

unassigned

127.1

unassigned

127.3 - 133.5

aromatic carbons

143.3

unassigned

165.0, 165.5, 166.6

carbonyl group  
carbons

Signals due to the 3' deprotected isomer can also be seen.

Spectrum No.CompoundSolvent

7

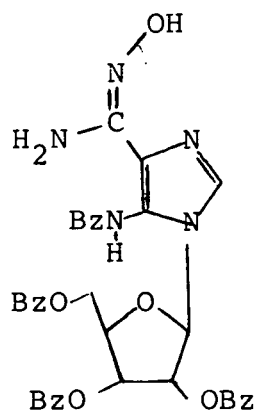
d<sup>6</sup>-DMSOShift (p.p.m.)Assignment

63.8	5' carbon
70.5	3' carbon
74.6	2' carbon
79.00	4' carbon
85.7	1' carbon
123.9	amidoxime carbon?
127.7 - 133.7	aromatic carbons
146.9	unassigned
164.3, 164.4, 165.4, 166.7	carbonyl group carbons

Spectrum No.CompoundSolvent

8

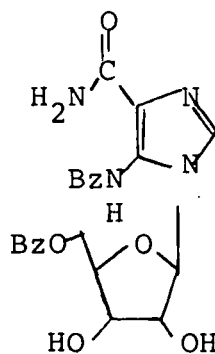
d<sup>6</sup>-DMSOShift (p.p.m.)Assignment

64.6 5' carbon

70.0 3' carbon

74.6 2' carbon

80.8 4' carbon

88.5 1' carbon

128.0 unassigned

128.4 - 133.5 aromatic carbons

163.6, 165.6, 166.8 carbonyl group carbons

## APPENDIX FIVE

RESEARCH COLLOQUIA, SEMINARS, LECTURES  
AND CONFERENCES

The Board of Studies in Chemistry requires that each postgraduate research thesis contains an appendix, listing:

- (A) all research colloquia, research seminars and lectures arranged by the Department of Chemistry during the period of the author's residence as a postgraduate student;
- (B) Lectures organised by Durham University Chemical Society;
- (C) all research conferences attended and papers presented by the author during the period when research for the thesis was carried out;
- (D) details of the postgraduate induction course.

(A) LECTURES ORGANISED BY DURHAM UNIVERSITY - 1983-1986.

- \* 5.10.83 Prof. J.P. Maier (Basel, Switzerland) "Recent approaches to spectroscopic characterization of cations".
- 12.10.83 Dr. C.W. McLeland (Port Elizabeth, Australia), "Cyclization of aryl alcohols through the intermediacy of alkoxy radicals and aryl radical cations".
- \* 19.10.83 Dr. N.W. Alcock (Warwick), "Aryl tellurium (IV) compounds, patterns of primary and secondary bonding".
- 26.10.83 Dr. R.H. Friend (Cavendish, Cambridge), "Electronic properties of conjugated polymers".
- 30.11.83 Prof. I.M.G. Cowie (Stirling), "Molecular interpretation of non-relaxation processes in polymer glasses".
- \* 2.12.83 Dr. G.M. Brooke (Durham), "The fate of the ortho-fluorine in 3,3-sigmatropic reactions involving polyfluoro-aryl and -hetero-aryl systems".
- 14.12.83 Prof. R.J. Donovan (Edinburgh), "Chemical and physical processes involving the ion-pair states of the halogen molecules".

10. 1.84 Prof. R. Hester (York)  
"Nanosecond Laser Spectroscopy of Reaction Intermediates"
18. 1.84 Prof. R.K. Harris (UEA)  
"Multi-nuclear solid state magnetic resonance"
- \* 8. 2.84 Dr. B.T. Heaton (Kent)  
"Multi-nuclear NMR studies"
- \* 15. 2.84 Dr. R.M. Paton (Edinburgh)  
"Heterocyclic Syntheses using Nitrile Sulphides"
- \* 7. 3.84 Dr. R.T. Walker (Birmingham),  
"Synthesis and Biological Properties of some 5-substituted Uracil Derivatives; yet another example of serendipity in Anti-viral Chemotherapy"
21. 3.84 Dr. P. Sherwood (Newcastle)  
"X-ray photoelectron spectroscopic studies of electrode and other surfaces"
21. 3.84 Dr. G. Beamson (Durham/Kratos)  
"EXAFS: General Principles and Applications"
23. 3.84 Dr. A. Ceulemans (Leuven)  
"The Development of Field-Type models of the Bonding in Molecular Clusters"
- \* 2. 4.84 Prof. K. O'Driscoll (Waterloo)  
"Chain Ending reactions in Free Radical Polymerisation"
3. 4.84 Prof. C.H. Rochester (Dundee)  
"Infrared Studies of adsorption at the Solid-Liquid Interface"
- \* 25. 4.84 Dr. R.M. Acheson (Biochemistry, Oxford)  
"Some Heterocyclic Detective Stories"
- \* 27. 4.84 Dr. T. Albright (Houston, U.S.A.)  
"Sigmatropic Rearrangements in Organometallic Chemistry"
- \* 14. 5.84 Prof. W.R. Dolbier (Florida, USA)  
"Cycloaddition Reactions of Fluorinated Allenes"
- \* 16. 5.84 Dr. P.J. Garratt (UCL)  
"Synthesis with Dilithiated Vicinal Diesters and Carboximides"
22. 5.84 Prof. F.C. de Schryver (Leuven)  
"The use of Luminescence in the study of micellar aggregates" and  
"Configurational and Conformational control in excited state complex formation"
- \* 23. 5.84 Prof. M. Tada (Waseda, Japan)  
"Photochemistry of Dicyanopyrazine Derivatives"
31. 5.84 Dr. A. Haaland (Oslo)  
"Electron Diffraction Studies of some organometallic compounds"

- \* 11. 6.84 Dr. J.B. Street (IBM, California)  
"Conducting Polymers derived from Pyrroles"
- \* 19. 9.84 Dr. C. Brown (IBM, California)  
"New Superbase reactions with organic compounds"
- 21. 9.84 Dr. H.W. Gibson (Signal UOP, Illinois)  
"Isomerization of Polyacetylene"
- \* 19.10.84 Dr. A. Germain (Languedoc, Montpellier)  
"Anodic Oxidation of Perfluoro Organic Compounds in  
Perfluoroalkane Sulphonic Acids"
- 24.10.84 Prof. R.K. Harris (Durham)  
"N.M.R. of Solid Polymers"
- 28.10.84 Dr. R. Snaith (Strathclyde)  
"Exploring Lithium Chemistry: Novel Structures,  
Bonding and Reagents"
- 7.11.84 Prof. W.W. Porterfield (Hampden-Sydney College, USA)  
"There is no Borane Chemistry (only Geometry)"
- \* 7.11.84 Dr. H.S. Munro (Durham)  
"New Information from ESCA Data"
- 21.11.84 Mr. N. Everall (Durham)  
"Picosecond Pulsed Laser Raman Spectroscopy"
- \* 27.11.84 Dr. W.J. Feast (Durham)  
"A Plain Man's Guide to Polymeric Organic Metals"
- 28.11.84 Dr. T.A. Stephenson (Edinburgh)  
"Some recent studies in Platinum Metal Chemistry"
- 12.12.84 Dr. K.B. Dillon (Durham)  
"<sup>31</sup>P N.M.R. Studies of some Anionic Phosphorus  
Complexes"
- \* 11. 1.85 Emeritus Prof. H. Suschitzky (Salford)  
"Fruitful Fissions of Benzofuroxanes and Isobenzimidic  
azoles (umpolung of o-phenylenediamine)"
- \* 13. 2.85 Dr. G.W.J. Fleet (Oxford)  
"Synthesis of some Alkaloids from Carbohydrates"
- \* 19. 2.85 Dr. D.J. Mincher (Durham)  
"Stereoselective Synthesis of some novel Anthracyclin-  
ones related to the anti-cancer drug Adriamycin and to the  
Steffimycin Antibiotics"
- 27. 2.85 Dr. R. Mulvey (Durham)  
"Some unusual Lithium Complexes"
- \* 6. 3.85 Dr. P.J. Kocienski (Leeds)  
"Some Synthetic Applications of Silicon-Mediated  
Annulation Reactions"



7. 3.85 Dr. P.J. Rodgers (I.C.I. plc. Agricultural Division, Billingham)  
"Industrial Polymers from Bacteria"
12. 3.85 Prof. K.J. Packer (B.P. Ltd./East Anglia)  
"N.M.R. Investigations of the Structure of Solid Polymers"
- \* 14. 3.85 Prof. A.R. Katritzky F.R.S. (Florida)  
"Some Adventures in Heterocyclic Chemistry"
20. 3.85 Dr. M. Poliakoff (Nottingham)  
"New Methods for detecting Organometallic Intermediates in Solution"
28. 3.85 Prof. H. Ringsdorf (Mainz)  
"Polymeric Liposomes as Models for Biomembranes and Cells?"
- \* 24. 4.85 Dr. M.C. Grossel (Bedford College, London)  
"Hydroxypyridone dyes - Bleachable one-dimensional Metals?"
25. 4.85 Major S.A. Shackelford (U.S. Air Force)  
"In Situ Mechanistic Studies on Condensed Phase Thermochemical Reaction Processes: Deuterium Isotope Effects in HMX Decomposition, Explosives and Combustion"
- \* 1. 5.85 Dr. D. Parker (I.C.I. plc. Petrochemical and Plastics Division, Wilton)  
"Applications of Radioisotopes in Industrial Research"
- \* 7. 5.85 Prof. G.E. Coates (formerly of University of Wyoming, U.S.A.)  
"Chemical Education in England and America: Successes and Deficiencies"
8. 5.85 Prof. D. Tuck (Windsor, Ontario)  
"Lower Oxidation State Chemistry of Indium"
- \* 8. 5.85 Prof. G. Williams (U.C.W. Aberystwyth)  
"Liquid Crystalline Polymers"
9. 5.85 Prof. R.K. Harris (Durham)  
"Chemistry in a Spin: Nuclear Magnetic Resonance"
- \* 14. 5.85 Prof. J. Passmore (New Brunswick, U.S.A.)  
"The Synthesis and Characterisation of some Novel Selenium-Iodine Cations, aided by  $^{77}\text{Se}$  N.M.R. Spectroscopy"
15. 5.85 Dr. J.E. Packer (Auckland, New Zealand)  
"Studies of Free Radical Reactions in aqueous solution using Ionising Radiation"
17. 5.85 Prof. I.D. Brown (McMaster University, Canada)  
"Bond Valence as a Model for Inorganic Chemistry"
- \* 21. 5.85 Dr. D.L.H. Williams (Durham)  
"Chemistry in Colour"

- \* 22. 5.85 Dr. M. Hudlicky (Blacksburg, U.S.A.)  
"Preferential Elimination of Hydrogen Fluoride  
from Vicinal Bromofluorocompounds"
- \* 22. 5.85 Dr. R. Grimmett (Otago, New Zealand)  
"Some Aspects of Nucleophilic Substitution in  
Imidazoles"
4. 6.85 Dr. P.S. Belton (Food Research Institute, Norwich)  
"Analytical Photoacoustic Spectroscopy"
- \* 13. 6.85 Dr. D. Woolins (Imperial College, London)  
"Metal - Sulphur - Nitrogen Complexes"
14. 6.85 Prof. Z. Rappoport (Hebrew University, Jerusalem)  
"The Rich Mechanistic World of Nucleophilic  
Cinylic Substitution"
19. 6.85 Dr. R.N. Mitchell (Dortmund)  
"Some Synthetic and NMR - Spectroscopic Studies  
of Organotin Compounds"
- \* 26. 6.85 Prof. G. Shaw (Bradford)  
"Synthetic Studies on Imidazole Nucleosides and  
the Antibiotic Coformycin"
12. 7.85 Dr. K. Laali (Hydrocarbon Research Institute,  
University of Southern California)  
"Recent Developments in Superacid Chemistry and  
Mechanistic Considerations in Electrophilic Aromatic  
Substitutions: A Progress Report"
13. 9.85 Dr. V.S. Parmar (University of Delhi),  
"Enzyme Assisted ERC Synthesis"
- 30.10.85 Dr. S.N. Whittleton (University of Durham),  
"An Investigation of a Reaction Window"
- 5.11.85 Prof. M.J. O'Donnell (Indiana-Purdue University),  
"New Methodology for the Synthesis of Amino acids"
- 20.11.85 Dr. J.A.H. MacBride (Sunderland Polytechnic).  
"A Heterocyclic Tour on a Distorted Tricycle-  
Biphenylene"
- 28.11.85 Prof. D.J. Waddington (University of York),  
"Resources for the Chemistry Teacher"
15. 1.86 Prof. N. Sheppard (University of East Anglia),  
"Vibrational and Spectroscopic Determinations of the  
Structures of Molecules Chemisorbed on Metal Surfaces"
- \* 29. 1.86 Dr. J.H. Clark (University of York),  
"Novel Fluoride Ion Reagents"
- \* 12. 2.86 Prof. O.S. Tee (Concordia University, Montreal),  
"Bromination of Phenols"
12. 2.86 Dr. J. Yarwood (University of Durham),  
"The Structure of Water in Liquid Crystals"

- \* 19. 2.86 Prof. G. Procter (University of Salford),  
"Approaches to the Synthesis of some Natural Products"
- 26. 2.86 Miss C. Till (University of Durham),  
"ESCA and Optical Emission Studies of the Plasma  
Polymerisation of Perfluoroaromatics"
- \* 5. 3.86 Dr. D. Hathway (University of Durham),  
"Herbicide Selectivity"
- 5. 3.86 Dr. M. Schroder (University of Edinburgh),  
"Studies on Macrocyclic Complexes"
- \* 12. 3.86 Dr. J.M. Brown (University of Oxford),  
"Chelate Control in Homogeneous Catalysis"
- 14. 5.86 Dr. P.R.R. Langridge-Smith (University of Edinburgh),  
"Naked Metal Clusters - Synthesis, Characterisation  
and Chemistry"
- \* 9. 6.86 Prof. R. Schmutzler (University of Braunschweig),  
"Mixed Valence Diphosphorous Compounds"
- 23. 6.86 Prof. R.E. Wilde (Texas Technical University),  
"Molecular Dynamic Processes from Vibrational  
Bandshapes"

B. Lectures Organised by Durham University Chemical Society  
during the period 1983-1986

- \* 20.10.83 Prof. R.B. Cundall (Salford)  
"Explosives"
- 3.11.83 Dr. G. Richards (Oxford)  
"Quantum Pharmacology"
- \* 10.11.83 Prof. J.H. Ridd (U.C.L.).  
"Ipso-Attack in Electrophilic Aromatic Substitution"
- \* 17.11.83 Dr. J. Harrison (Sterling Organic),  
"Applied Chemistry and the Pharmaceutical Industry"  
"Joint Lecture with the Society of Chemical Industry)"
- 24.11.83 Prof. D.A. King (Liverpool),  
"Chemistry in 2-Dimensions"
- \* 1.12.83 Dr. J.D. Coyle (The Open University),  
"The Problem with Sunshine"
- 26. 1.84 Prof. T.L. Blundell (Birkbeck College, London)  
"Biological Recognition: Interactions of  
Macromolecular Surfaces"
- 2. 2.84 Prof. N.B.H. Jonathan (Southampton),  
"Photoelectron Spectroscopy - A Radical Approach"

- \* 16. 2.84 Prof. D. Phillips (The Royal Institution),  
"Luminescence and Photochemistry - a Light  
Entertainment"
- \* 23. 2.84 Prof. F.G.A. Stone F.R.S. (Bristol),  
"The Use of Carbene and Carbyne Groups to  
Synthesise Metal Clusters"  
(The Waddington Memorial Lecture)
- 1. 3.84 Prof. A.J. Leadbetter (Rutherford Appleton Labs.),  
"Liquid Crystals"
- 8. 3.84 Prof. D. Chapman (Royal Free Hospital School of  
Medicine, London)  
"Phospholipids and Biomembranes: Basic Science  
and Future Techniques"
- \* 28. 3.84 Prof. H. Schmidbaur (Munich, F.R.G.),  
"Ylides in Coordination Sphere of Metal:  
Synthetic, Structural and Theoretical Aspects"  
(R.S.C. Centenary Lecture)
- \* 18.10.84 Dr. N. Logan (Nottingham),  
" $N_2O_4$  and Rocket Fuels"
- \* 23.10.84 Dr. W.J. Feast (Durham),  
"Syntheses of Conjugated Polymers. How and Why?"
- 8.11.84 Prof. B.J. Aylett (Queen Mary College, London),  
"Silicon - Dead Common or Refined?"
- \* 15.11.84 Prof. B.T. Golding (Newcastle-upon-Tyne),  
"The Vitamin  $B_{12}$  Mystery"
- 22.11.84 Prof. D.T. Clark (I.C.I. New Science Group),  
"Structure, Bonding, Reactivity and Synthesis as  
revealed by ESCA"  
(R.S.C. Tilden Lecture)
- 29.11.84 Prof. C.J.M. Stirling (University College of North Wales)  
"Molecules taking the Strain"
- \* 6.12.84 Prof. R.D. Chambers (Durham),  
"The Unusual World of Fluorine"
- 24. 1.85 Dr. A.K. Covington (Newcastle-upon-Tyne),  
"Chemistry with Chips"
- 31. 1.85 Dr. M.L.H. Green (Oxford),  
"Naked Atoms and Negligee Ligands"
- \* 7. 2.85 Prof. A. Ledwith (Pilkington Bros.),  
"Glass as a High Technology Material"  
(Joint Lecture with the Society of Chemical Industry)
- \* 14. 2.85 Dr. J.A. Salthouse (Manchester),  
"Son et Lumiere"

21. 2.85 Prof. P.M. Maitlis, F.R.S. (Sheffield),  
"What Use is Rhodium?"
- \* 7. 3.85 Dr. P.W. Atkins (Oxford),  
"Magnetic Reactions"
- 17.10.85 Dr. C.J. Ludman (University of Durham)  
"Some Thermochemical aspects of Explosions"  
(A Demonstration Lecture)
- 24.10.85 Dr. J. Dewing, (U.M.I.S.T.),  
"Zeolites - Small Holes, Big Opportunities"
- 31.10.85 Dr. P. Timms, (University of Bristol),  
"Some Chemistry of Fireworks"  
(A Demonstration Lecture)
- 7.11.85 Prof. G. Ertl, (University of Munich),  
"Heterogeneous Catalysis",  
(R.S.C. Centenary Lecture)
- 14.11.85 Dr. S.G. Davies (University of Oxford),  
"Chirality Control and Molecular Recognition"
- 21.11.85 Prof. K.H. Jack, F.R.S. (University of Newcastle/Tyne),  
"Chemistry of Si-Al-O-N Engineering Ceramics"  
(Joint Lecture with the Society of Chemical Industry)
- 28.11.85 Dr. B.A.J. Clark (Research Division, Kodak Ltd.)  
"Chemistry and Principles of Colour Photography"
- \* 23. 1.86 Prof. Sir Jack Lewis, F.R.S. (University of Cambridge),  
"Some More Recent Aspects in the Cluster Chemistry  
of Ruthenium and Osmium Carbonyls"  
(The Waddington Memorial Lecture)
30. 1.86 Dr. N.J. Phillips, (University of Technology, Loughborough)  
"Laser Holography"
- \* 13. 2.86 Prof. R. Grigg (Queen's University, Belfast),  
"Thermal Generation of 1,3-Dipoles"  
(R.S.C. Tilden Lecture)
- \* 20. 2.86 Dr. C.J.F. Barnard, (Johnson Matthey Group Research),  
"Platinum Anti-Cancer Drug Development - From  
Serendipity to Science"
27. 2.86 Prof. R.K. Harris, (University of Durham),  
"The Magic of Solid State NMR"
- \* 6. 3.86 Dr. B. Iddon (University of Salford),  
"The Magic of Chemistry"  
(A Demonstration Lecture)

(C) Research Conferences attended

- 21 December 1983     17th Sheffield Symposium on "Modern Aspects of Stereochemistry", Sheffield.
- April 1984             Graduate Symposium, Durham.
- 16-20 July 1984      International Symposium on "Chemistry of Carbanions", Durham.
- April 1985             Graduate Symposium, Durham.
- August 1985            Fourth European Symposium on "Organic Chemistry", Aix-en-Provence.
- April 1986             Graduate Symposium, Durham.
- August 1986            International Symposium on "Fluorine Chemistry", to celebrate the Centenary of the Discovery of Fluorine, Paris.

(D) First Year Induction Course, October 1982

This course consists of a series of one hour lectures on the services available in the department.

1. Departmental organisation
2. Safety matters
3. Electrical appliances and infrared spectroscopy
4. Chromatography and Microanalysis
5. Atomic absorptiometry and inorganic analysis
6. Library facilities
7. Mass spectrometry
8. Nuclear magnetic resonance spectroscopy
9. Glassblowing technique.

REFERENCES

1. R.D. Chambers, "Fluorine in Organic Chemistry", Wiley Interscience, New York, 1973.
2. M. Hudlicky, "Chemistry of Organic Fluorine Compounds", Ellis Horwood, New York, 2nd Edn.
3. R. Filler and Y. Kobayashi, "Biomedical Aspects of Fluorine Chemistry", Kodansha, Tokyo, 1982.
4. A. Roe, Org.React., 1949, 5, 193.
5. H. Suschitzky, Adv. Fluorine Chem., 1965, 4, 1.
6. G. Balz and G. Schiemann, Chem.Ber., 1927, 60, 1186.
7. A.E. Pavlath and A.J. Leffler, "Aromatic Fluorine Compounds", Am.Chem.Soc. Monograph No.155, Reinhold, New York, pp.12-16 and 42-45.
8. J. von Braun and W. Rudolph, Chem.Ber., 1931, 64, 2465.
9. A.P.J. Luttringhaus and H. Neresheimer, Liebigs.Ann., 1929, 473, 259.
10. E.B. Starkey, Organic Synthesis, 1943, Coll.vol.2, 225.
11. G.G. Yakobson, A.I. D'Yachenko and F.A. Bel'chikova, Zh.Obshch.Khim., 1962, 32, 842.
12. G. Schiemann and R. Pillarsky, Chem.Ber., 1929, 62, 3035.
13. A. Roe and W.F. Little, J.Org.Chem., 1955, 20, 1577.
14. G. Lock, Chem.Ber., 1936, 69, 2253.
15. B.L. Zenitz and W.H. Hartung, J.Org.Chem., 1946, 11, 444.
16. B. Backmann and T. Hokamo, J.Am.Chem.Soc., 1957, 79, 4370.
17. E.D. Bergman, S. Berkovic and R. Ikan, J.Am.Chem.Soc., 1965, 78, 6037.
18. A. Roe and G.F. Hawkins, J.Am.Chem.Soc., 1947, 69, 2443.
19. R.H. Hesse, Isr.J.Chem., 1978, 17, 60.
20. K.O. Christe, J.Fluorine Chem., 1983, 22, 519.
21. M.M. Cartwright and A.A.Woolf, J.Fluorine Chem., 1984, 25, 263.
22. J.B. Kellogg and G.H.Cady, J.Am.Chem.Soc., 1948, 70, 3986.
23. R.S. Porter and G.H. Cady, J.Am.Chem.Soc., 1957, 79, 5625.
24. J.A.C.Allison and G.H.Cady, J.Am.Chem.Soc., 1959, 81, 1089.
25. J.H. Prager and P.G. Thompson, J.Am.Chem.Soc., 1965, 87, 230.

26. S. Rozen and O. Lerman, J.Am.Chem.Soc., 1979, 101, 2782.
27. S. Rozen, O. Lerman and H. Kol, J.Chem.Soc.Chem.Commun., 1981, 443.
28. O. Lerman, Y. Tor, D. Hebel and S. Rozen, J.Org.Chem., 1984, 49, 806.
29. D.M. Jewett, J.F. Polocki and R.E. Ehrenkaufner, J.Fluorine Chem., 1984, 24, 477.
30. D.M. Jewett, J.F. Polocki and R.E. Ehrenkaufner, Synth.Commun., 1984, 14, 45.
31. T.B. Patrick and E.C. Hayward, J.Org.Chem., 1974, 39, 2120.
32. D.H.R. Barton, A.K. Ganguly, R.H. Hesse, S.M.Loo and M.M. Pechet, Chem.Commun., 1968, 806.
33. N.P. Buu-Hoi, D. Lavit and N.D. Xuong, J.Org.Chem., 1954, 19, 1617.
34. D.H.R. Barton, R.H. Hesse, L. Ogunkoya, W.D. Westcott and M.M. Pechet, J.Chem.Soc.Perkin Trans.1, 1972, 2889.
35. G.K. Mulholland and R.E. Ehrenkaufner, J.Org.Chem., 1986, 51, 1482.
36. M.J. Fifolt, R.T. Olczak and R.F. Mundhenke, J.Org.Chem., 1985, 50, 4576.
37. O. Lerman, Y. Tor and S. Rozen, J.Org.Chem., 1981, 46, 4629.
38. R.B. Moodie and K. Schofield, Acc.Chem.Res., 1976, 9, 287.
39. T.B. Patrick, G.L. Cantrell and C. Chang, J.Am.Chem.Soc., 1979, 101, 7434.
40. P.V.D. de la Mare, Acc.Chem.Res., 1974, 7, 361.
41. R.D. Brown, Tetrahedron Suppl., 1963, 19, 337.
42. M. Lustig and J.M. Schneeve, Adv.Fluorine Chem., 1973, 7, 175.
43. J. Kollonitsch, L. Barash and G.A. Douldouras, J.Am.Chem., 1970, 92, 7494.
44. J. Airey, D.H.R. Barton, A.K. Ganguly, R.H. Hesse and M.M. Pechet, An.Quim., 1974, 70, 871.
45. D.H.R. Barton, L.J. Danks, A.K. Ganguly, R.H. Hesse, G.Tarzia and M.M. Pechet, Chem.Commun., 1969, 227.
46. D.H.R. Barton, R.H. Hesse, H.T. Toh and M.M. Pechet, J.Org.Chem., 1972, 37, 329.
47. R.H. Hesse and M.M. Pechet, J.Chem.Soc.Perkin Trans.1, 1974, 2095.
48. M. Seguin, J.C. Adenis, C. Michaud and J.J. Basselier, J.Fluorine Chem., 1980, 15, 201.



49. E.H. Appelmann, L.J. Basile and R.C. Thomson, J.Am.Chem.Soc., 1979, 101, 3384.
50. F. Fichter and K. Humpert, Helv.Chim.Acta., 1926, 9, 602.
51. M. Zupan, Vestn.Slov.Kem.Drus., 1984, 31(Suppl), 151.
52. H. Aghion, A.P. Gray and G.D. Vicker, Can.J.Chem., 1962, 40, 157.
53. D.P. Ip, C.D. Arthur, R.E. Winnans and E.H. Appelmann, J.Am.Chem.Soc., 1981, 103, 1964.
54. S. Stavber and M. Zupan, J.Chem.Soc.Chem.Commun., 1981, 148.
55. S. Stavber and M. Zupan, J.Org.Chem., 1985, 50, 3609.
56. S. Stavber and M. Zupan, J.Chem.Soc.Chem.Commun., 1983, 563.
57. S.P. Anand, L.A. Quaterman, H.H. Hyman, G.H. Migliorese and R. Filler, J.Org.Chem., 1975, 40, 807.
58. S.P. Anand, L.A. Quaterman, P.A. Christian and H.H. Hyman, J.Org.Chem., 1975, 40, 3796.
59. A. Ledwith and P.J. Russell, J.Chem.Soc.Chem.Commun., 1974, 291 and 959.
60. H. Moissan, Ann.Chim.Phys., 1891, 19, 272.
61. V. Grakauskas, J.Org.Chem., 1970, 35, 723.
62. L.C. Sams, T.A. Reames and M.A. Durrance, J.Org.Chem., 1978, 42, 2273.
63. L. Ebecson, Z. Blum, B. Helgee and K. Nyberg, Tetrahedron, 1978, 34, 73.
64. W.J. Hehre, P.C. Hiberty, J.Am.Chem.Soc., 1974, 96, 7163.
65. I. Kumadaki, M. Nakazawa and Y. Kobayashi, Tetrahedron Lett., 1983, 24, 1055.
66. H. Gilman, Ed., "Organic Chemistry", 2nd ed., Vol.1, John Wiley and Sons Inc., New York, N.Y., 1945, p.179ff.
67. C.K. Ingold, "Structure and Mechanisms in Organic Chemistry", Cornell University Press, Ithica, N.Y., 1953, p.221ff.
68. D.H. Derbyshire and W.A. Waters, J.Chem.Soc., 1950, 573.
69. F. Cocace, P. Giacomello and A.P. Wolf, J.Am.Chem.Soc., 1980, 102, 3511.
70. J.L. Weeks, C.L. Chernick and M.S. Matheson, J.Am.Chem.Soc., 1962, 84, 4612.
71. S.M. Williamson, Inorganic Synthesis, 1968, 11, 147.
72. W.E. Falconer and W.A. Sunder, J.Inorg.Chem., 1967, 29, 1380.
73. R. Filler, Israel.J.Chem., 1978, 17, 71.

74. M.J. Shaw, R. Filler and H.H. Hyman, J.Am.Chem.Soc., 1969, 91, 1563.
75. M.J. Shaw, J.A. Weil, R. Filler and H.H. Hyman, J.Am.Chem.Soc., 1970, 92, 5096.
76. M.J. Shaw, H.H. Hyman and R. Filler, J.Am.Chem.Soc., 1970, 92, 6498.
77. M.J. Shaw, H.H. Hyman and R. Filler, J.Org.Chem., 1971, 36, 2917.
78. S.P. Anand and R. Filler, J.Fluorine Chem., 1976, 7, 1979.
79. W.E. Barnett, J.Am.Chem.Soc., 1984, 106, 452.
80. D.H.R. Barton, R.H. Hesse, M.M. Pechet and H.H. Toh, J.Chem.Soc.Perkin Trans.1, 1974, 732.
81. S.T. Purrington and W.A. Jones, J.Org.Chem., 1983, 48, 761.
82. S.T. Purrington and W.A. Jones, J.Fluorine Chem., 1984, 43.
83. R.E. Banks and G.E. Williamson, Chem.Ind., 1964, 1865.
84. V.R. Polishchuk, B.Ya.Medvedev, N.N. Bubnov, L.S. Germain, and I.L.Knunyants, Izv.Akad.Nauk.SSSR. Ser.Khim., 1972, 2805.
85. V.R. Polishchuck and L.S.Germain, Tetrahedron Lett., 1972, 5169.
86. R.E. Banks, D.A. Du Boisson and E. Tsiliopoulos, Centenary of the Discovery of Fluorine, International Symposium, Abstract No. 07, Paris (Sept. 1986).
87. T.Umemoto and K. Tomita, Centenary of the Discovery of Fluorine International Symposium, Abstract No.08, Paris, (Sept.1986).
88. K. Tomita, K. Kawada and T. Umemoto, Centenary of the Discovery of Fluorine, International Symposium, Abstract 043, Paris (Sept.1986).
89. T. Umemoto, K. Kawada and K. Tomita, Tetrahedron Lett., in press (1986).
90. T. Umemoto, K. Onodera and K. Tomita, 52nd National Meeting of the Japanese Chemical Society, Abstract No. 1L15, Kyoto (Apr.1, 1986).
91. K. Tomita and T. Umemoto, 52nd National Meeting of the Japanese Chemical Society, Abstract No. 1Z04, Kyoto (Apr.1,1986).
92. C.M. Sharts and W.A. Sheppard, Org.React., 1974, 21, 125.
93. M. Schlosser and G. Heinz, Chem.Ber., 1969, 102, 1944.
94. W.A. Sheppard, Tetrahedron Lett., 1969, 86.
95. E. Golovinsky and N. Spassova, Pharmac.Ther., 1981, 13, 385.
96. K.L. Kirk and L.A. Cohen, J.Am.Chem.Soc., 1971, 93, 3060.
97. K.L.Kirk, W. Nagai and L.A.Cohen, J.Am.Chem.Soc., 1973, 95, 8389.
98. K.L.Kirk and L.A.Cohen, J.Org.Chem., 1973, 38, 3647.

99. F. Fabra, C. Gálvez, A. González, P. Viladoms and J.Vilarrasa, J.Heterocycl.Chem., 1978, 15, 1227.
100. K.L.Kirk and L.A. Cohen, J.Am.Chem.Soc., 1973, 95, 4619.
101. I.E. Balaban, J.Chem.Soc., 1930, 268.
102. M. ElBorai, A.H. Moustafa, M. Anwar and F.I. Abdel Hay, Polish J.Chem., 1981, 55, 1659.
103. A.W.Lutz and S. deLorenzo, J.Heterocycl.Chem., 1967, 4, 399.
104. K. Hofman, "Imidazole and its Derivatives", Interscience, New York N.Y., 1953, p.302.
105. Y. Takeuchi, K.L.Kirk and L.A.Cohen, J.Org.Chem., 1979, 44, 4243.
106. C. Heidelberger, Progr.Nucleic Acid Res.Mol.Biol, 1965, 4, 1.
107. W.H. Pruscott, Pharmacol.Rev., 1967, 19, 209.
108. C. Heidelberger, Annual Rev.Pharmacol., 1967, 7, 101.
109. R. Duschinsky, E. Plevén and C. Heidelberger, J.Am.Chem.Soc., 1957, 79, 4559.
110. C. Heidelberger, N.K.Chandhuri, P. Danneberg, D. Mooren, L. Griesback, R. Duschinsky, R.J. Schnitzer, E. Plevén and J. Scheiner, Nature, 1957, 179, 663.
111. M. Diksic and P. DiRaddo, Tetrahedron Lett., 1984, 4885.
112. Y. Ike, S. Ozaki, K. Sasama and Y. Fukai, Jap.P., 28924 (Chem.Abs.93:P47116c).
113. T. Takahara, Jap.P. 78 56,676/1978, (Chem.Abs.90:P6417n).
114. P.D. Schuman, G. Westmoreland R. Anderson, Can.P.991,641/1976, (Chem.Abs.85:P192758i).
115. E.H. Appelman and R.C. Thompson, Chem.Eng.News, 1983, 18.
116. K. Ishiwata, T. Ido, T. Takahashi, M. Monma, R. Iwata, Y. Abe, T. Matsuzawa, Y. Tsurumi and M. Kameyam, Nucleic Acids Res. Symp.Ser., 1984, 15, 25.
117. J.S. Fowler, R.D.Fin, R.M. Lambrecht and A.P. Wolf, J.Nucl. Med., 1973, 14, 63.
118. M.J. Robins and S.R. Naik, J.Am.Chem.Soc., 1971, 93, 5277.
119. M. Diksic and S. Farrokhzad, Can.J.Chem., 1986, 64, 424.
120. T.I. Yurasova, Zh.Obschch.Khim., 1974, 44, 956.
121. M.J.Robins, M. MacCross, S.R.Naik and G. Ramani, J.Am.Chem. Soc., 1976, 98, 7381.
122. M.J.Robins, M.MacCross and S.R.Naik, Nucleic Acid.Chem., 1978, 2, 895.

123. C-Y.Schiue, P.A. Salvadori, A.P.Wolf, J.S.Fowler and R. MacGregor, J.Nucl.Med., 1982, 23, 899.
124. M. Diksic and D. Jolly, Int.J.Appl.Radiat.Isot., 1983,34,893.
125. R.E.Ehrenkauf, J.F.Potocki and D.M.Jewett, J.Nucl.Med., 1984, 25, 333.
126. M.J.Adam, B.D.Pate, J.R.Nesser and L.D.Hall, Carbohydrate Res., 1983, 124, 215.
127. T.W.Green, "Protective Groups in Organic Synthesis", Wiley Interscience, 1981, New York.
128. S.S.Yemul and H.B. Kagan, Tetrahedron Lett., 1980,21,277.
129. R.D.Hawells and J.D.McCown, Chem.Rev., 1977, 77, 69.
130. S. Uesagi, T. Kanegasu, J. Matsugi and M. Ikehara, Nucleosides and Nucleotides, 1983, 2, 373.
131. M. Ikehara and J. Imura, Chem.Pharm.Bull., 1981, 29, 1034.
132. R. Ranganathan and D. Larwood, Tetrahedron Lett.,1978, 45, 4341.
133. M. Ikehara, Heterocycles, 1984, 21, 75.
134. C.H. Tann, P.R. Brodfuehrer, S.P. Brundidge, C.Sepino Jr., and M.G. Howel, J.Org.Chem., 1985, 50, 3644.
135. T-L.Su., R.S.Klein and J.J.Fox, J.Org.Chem., 1982, 47, 1506.
136. W. Middleton, J.Org.Chem., 1975, 40, 574.
137. T.J. Tewson and M.J. Welch, J.Org.Chem., 1978, 43, 1090.
138. G.M. Posner and S.R.Hains, Tetrahedron Lett., 1985, 26, 5.
139. Wm.Rosenbrook,Jr., D.A.Riley and P.A. Larky, Tetrahedron Lett., 1985, 26, 3.
140. P.J.Card, J.Org.Chem., 1983, 48, 393.
141. P.J. Card and G.S.Reddy, J.Org.Chem., 1983, 48, 4734.
142. A. Goldin, Chemtech., 1973, 2, 424.
143. W. Bollag and H.R.Hartman, Eur.J.Cancer, 1980, 16, 427.
144. A.F.Cook, M.J. Holman and M.J. Kramer, J.Med.Chem., 1980, 23, 852.
145. A.Rosowsky and S.H.Kim, Abstracts, 181st A.C.S.Meeting, Atlanta, Georgia, March 29-April 3, 1981, MEDI 34.
146. J.J.Fox, K.A. Watanabe, R.S. Kein, C.K.Chu, S.Y-K.Tam. V. Reichman, K. Hirota, I. Wempen, C. Lopez, and J.H.Buchenal in "Nucleosides, Nucleotides and their Biological Applications", INSERM Symposia Series, 81, eds. J.L.Barascut and J.L.Imback, INSERM, Paris, 1979, pp.241-270.

147. R.C.Reepmeyer, K.L.Kirk and L.A.Cohen, Tetrahedron Lett., 1975, 4107.
- 147a. K.L.Kirk and L.A.Cohen, Abstracts, 7th Symposium on Fluorine Chemistry, Santa Cruz, Calif., 1973, and 2nd Winter Symposium St. Petersburg, Fla, Feb. 1974.
148. See Chapter Two, Section 2.A.1a.
- 148a. A.R. Katritzky and C.W.Rees, "Comprehensive Heterocyclic Chemistry", Vol.5, Pergamon Press, 1984.
149. R.K. Ingham, S.D. Rosenberg and H. Gilman, Chem.Rev., 1960, 60, 49.
150. M.J.Adam, J.M. Berry, L.D. Hall, B.D.Pate and T.J. Ruth, Canad.J.Chem., 1983, 61, 658.
151. M.J.Adam, T.J. Ruth, S. Jivan and B.D. Pate, J.Fluorine Chem., 1984, 25, 329.
152. N. Speranza, C-Y. Shiue, A.P.Wolf, D.S.Wilbur and C.Angelini, J.Fluorine Chem., 1985, 36, 97.
153. G.W.M. Visser, B.W. v. Halkeren, J.D.M. Herschied, G.A. Brinkman and R. Hoekster, J.Chem.Soc.,Chem.Commun, 1984, 655.
154. D. Naumann and H. Lange, J.Fluorine Chem., 1983, 23, 37.
155. C. Eaborn and J.A.Walters, J.Chem.Soc., 1962, 1131.
156. W.P.Neuman, "The Organic Chemistry of Tin", Wiley,London,1970.
157. Y. Yamamoto and A. Yanagi, Heterocycles, 1981, 16, 1161.
158. M. Dub and R.W. Weiss, "Organometallic Compounds", Springer-Verlag, New York, Vol.2, 1967, p.166.
159. C. Eaborn, H.L.Harfield and D.R.M.Walters, J,Chem.Soc.B., 1967, 1036.
160. H. Gilman and S.D.Rosenberg, J.Am.Chem.Soc., 1953, 75, 2507.
161. H. Azizian, C. Eaborn and A. Didcock, J.Organomet.Chem., 1981, 215.
162. R.W. Bott, C. Eaborn and J.A.Waters, J.Chem.Soc., 1963, 681.
163. B. Iddon and B.L. Lim, J.Chem.Soc.Perkin Trans.1, 1983, 271.
164. P. Jutzi and U. Gilge, J.Organomet.Chem., 1983, 246, 163.
165. P. Borgstrom and M.M.Dewar, J.Am.Chem.Soc., 1929, 31, 3387.
166. A.P.Korn, F.P.Ottensmeyer and T.R.Jack, J.Inorg.Biochem., 1979, 10, 235.
167. See Chapter One.
168. J.G.A.Luijten and G.J.M.van der Kerk, "Investigations in the Field of Organo Tin Chemistry", Tin Research Institute, Greenford, 1955, 19, 4.

169. G. Grüttner and E. Krause, Chem.Ber., 1917, 50, 1802.
170. G.W.M. Visser, C.N.M. Bakker, B.W. van Halteren, J.D.M. Herscheid, G.A. Brinkman and A. Hoekstra, J.Org.Chem., 1986, 51, 1883.
171. G.W.M. Visser, J.D.M. Herscheid and A. Hoekstra, Centenary of the Discovery of Fluorine, International Symposium, Abstract No.06, Paris (Sept. 1986).
172. A.P. Wolf, Semin.Nucl.Med., 1981, 11, 2.
173. M.J. Adam, B.D. Pate, T.J. Ruth, J.M. Berry and L.D. Hall, J.Chem.Soc., Chem. Commun., 1981, 733.
174. See Chapter Two.
175. Y. Ishido, N. Sakairi, K. Okazaki and N. Nakazaki, J.Chem. Soc. Perkin Trans.1, 1980, 563.
176. A. Saednya, Synthesis, 1985, 184.
177. K. Mai and G. Patil, Tetrahedron Lett., 1986, 2203.
178. C.R. Petrie III, G.R. Revankar, N.K. Dalley, R.D. George, P.A. McKernan, R.L. Hamill and R.K. Robins, J.Med.Chem., 1986, 29, 268.
179. N. Sakairi, M.D. Rahman, K. Tamaki and Y. Ishido, Nucleosides and Nucleotides, 1982, 1, 99.
180. S. Nishino, H. Takamura and Y. Ishido, Tetrahedron, 1986, 42, 1995.
181. See Chapter Two, Section 2A.2.
182. W.J. Middleton, U.S. Patent, 3 940 420, 1984.
183. G.A. Boswell, Jr., W.C. Ripka, R.M. Scribner and C.W. Tullock, Organic Reactions, 1974, 21, 1.
184. D.C. England, L.R. Melby, M.A. Dietrich and R.V. Lindsey, Jr., J.Org.Chem., 1960, 32, 5116.
185. A.E. Bayliff, M.R. Bryce and R.D. Chambers, J.Chem.Soc., Perkin Trans.1, in press.
186. H. Harada, S. Mizutaki, S. Hayashi and N. Ishikawa, J. Fluorine Chem., 1978, 21, 211.
187. T. Nakai, N.M. Hassan and N. Ishikawa, Bull.Soc.Chem.Japan, 1977, 50, 3014.
188. R.E. Banks, F. Cuthbertson and W.K.R. Musgrave, Anal.Chim.Acta, 1955, 13, 442.
189. H.M. McNair and E.J. Bonelli, "Basic Gas Chromatography", Varian Aerograph, California, 1969, p.140.
190. A.I. Vogel, "A Text Book of Practical Organic Chemistry", Longman, London, 1970.

