

"Circular (University of Alaska, Fairbanks, Agricultural and Forestry  
Experiment Station)"



SCHOOL OF AGRICULTURE &  
LAND RESOURCES MANAGEMENT  
AGRICULTURAL & FORESTRY EXPERIMENT STATION

# PRODUCING & PROCESSING REINDEER VELVET ANTLER

by

Ray Grover Jr., B.A.  
Biology/Wildlife Management

and

Lyle A. Renecker, Ph.D.  
Associate Professor

ALASKA  
S  
33  
E22  
no. 99

UNIVERSITY OF ALASKA FAIRBANKS

## INTRODUCTION

Velvet antler from various deer species has been used for thousands of years by Oriental cultures. The first record of velvet antler used as a medicine appeared on a silk scroll unearthed from a Han tomb in China dated 100 BC. Since then velvet antler has been a prized folk and tonic medicine in Korea, China, Hong Kong, Taiwan, Indonesia, and Mongolia. While the demand for velvet antler is in the Orient, major supplies of velvet antler are produced commercially on deer farms and reindeer herding operations throughout the world (Table 1). Species of deer commonly raised for velvet antler production include Siberian elk, maral deer, sika deer, red deer, North American elk (wapiti), and reindeer.

Although there are many medical and pharmaceutical uses of velvet antler the greatest use is as an elixir. Chinese medicine is based on the concept of Yin and Yang. This is not only the main theory in medicine, but it pervades every aspect of Oriental life. The balance between these two forces is viewed as the fundamental factor in natural phenomena and life processes. Yin represents a negative, passive force that is female. Yang is male, bright, high flying, and ascending. These forces are mutually dependent; one cannot exist without the other. The ideal state in nature is a balance between the two

Table 1. World production of dried velvet antler.

Location/ Species	Quantity Produced (kg)
<b>Russia</b>	
Siberia elk	30-35,000
<b>New Zealand</b>	
Total production	350-450,000
<b>North America</b>	
Elk	8,000
Reindeer	8,800
<b>Korea</b>	
Total production	40,000
<b>China</b>	
Total production	75-100,000

forces. Within limits, the body can adjust the balance of Yin-Yang, however, when an imbalance reaches a critical level, medication is needed.

Yin and Yang have domains within the body. Half the vital organs are Yin and the other half are Yang. Yin governs blood and Yang controls "qi" energy. In Chinese medicine, velvet antler is used to increase blood in the body. When this is accomplished the body will have more energy and maintain a better

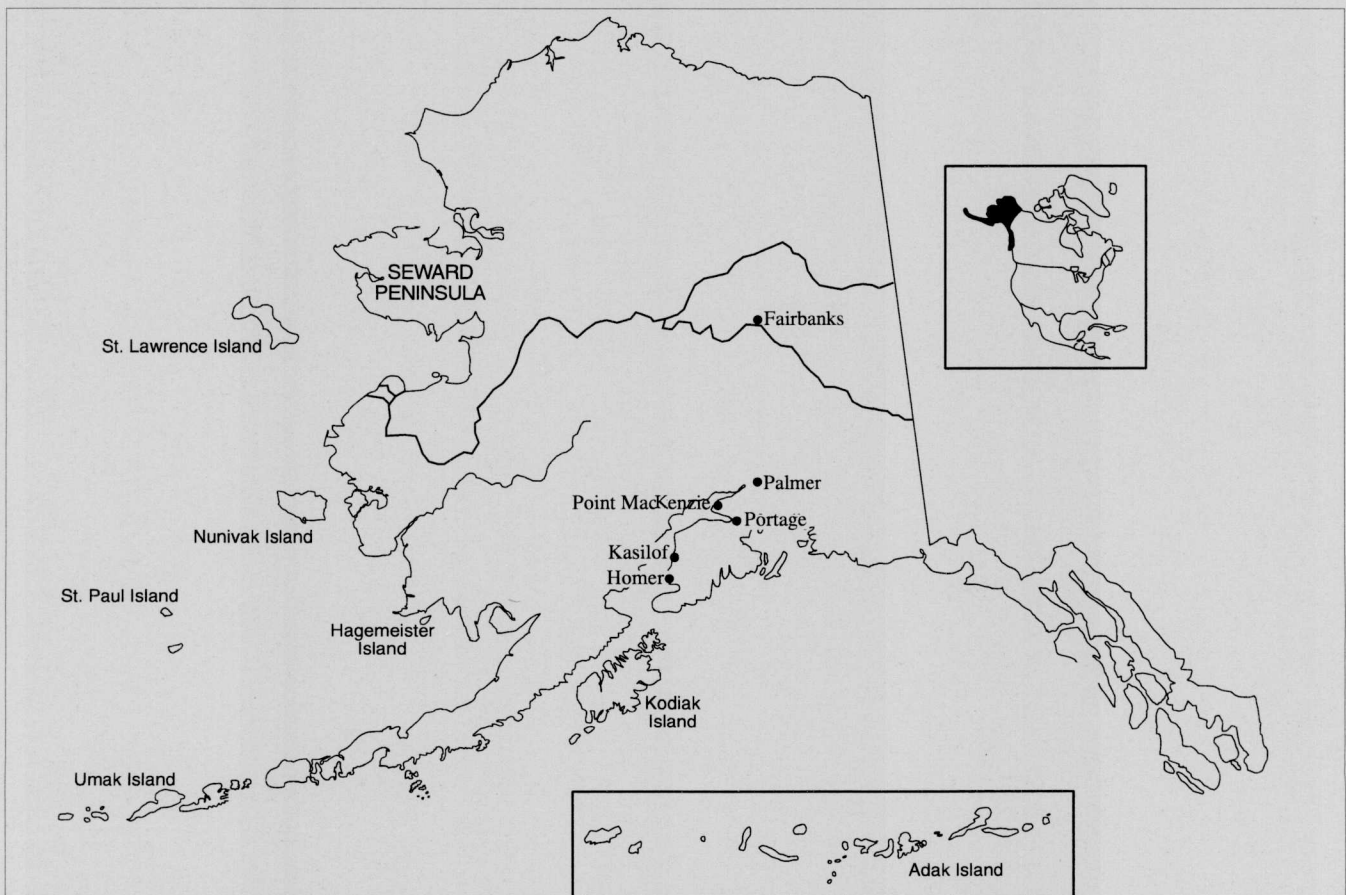

Fig. 1 Distribution of reindeer in Alaska.



state of health. Velvet antler is also consumed for various purposes including: kidney deficiency; gastrointestinal disorders; cardiovascular disorders; sexual disorders in men; and menstrual disorders and menopause in women. It has also been used to promote rapid healing and to treat weight loss, slow growth in children, weak bones, and cold hands and feet. Contrary to popular belief, velvet antler is not widely used as an aphrodisiac.

Oriental medicine continues to be important in Korea. For example, at the Kyong Dong market in Seoul there are approximately 1,000 shops, 300 doctors, and 3,000 medicines. All the medicines incorporate some aspect of processed velvet antler.

It was reported in the 1880s that velvet antlers from maral deer were prized by the Chinese and this stimulated further domestication and farming of deer in China and western Siberia. In 1963, an import-export merchant from San Francisco ventured to Alaska in search of velvet antler from reindeer, molding an industry around this product. Reindeer herding started in Alaska during the early 1890s with the importation of one to two thousand reindeer from Norway and later Siberia. Today, there are 20 herds and farms that comprise about 43,000 reindeer in Alaska. Their distribution includes: Adak and Umnak Islands in the Aleutian Archipelago; Kodiak, St. Paul, Nunivak, and St. Lawrence Islands; and the Seward Peninsula. Farms are located near Fairbanks, Palmer, Kasilof, Homer, Portage, and Point MacKenzie (Fig. 1).

Reindeer are both herded and farmed in Alaska. Extensive herding occurs under an open grazing system. In June, animals are herded into corrals by helicopter, all-terrain vehicle, snow machine, or on foot. The reindeer are moved through a handling system and the velvet antler is harvested from both males and females with manual or pneumatic de-horning shears. The antler is then stacked with cut end up in cardboard cartons to avoid blood loss and damage. As soon as possible after packing (usually the end of the handling), the velvet antlers are transported to a freezer facility and frozen at  $-20^{\circ}\text{C}$ . Presently, frozen green velvet antler is sold and shipped to the buyer and processed later.

Drying velvet antler is a prized and confidential art in the Orient. The process is shared and handed down only to very close family members. Drying the velvet antler is one method of preserving the product. By drying it, the herder or farmer has potentially more options for sale of the product and therefore more control over the market. Traditionally, velvet antlers have been processed using a combination of dipping in hot water and oven drying. Other techniques include air and freeze drying.

We initiated this study to develop a single small scale boiling tank and test a drying technique on

samples of velvet antler.

## BOILER CONSTRUCTION

The following procedures outline the construction of the boiling apparatus (Table 2) used in this study. We recommend you gather all parts before beginning construction.

**STEP 1:** The first and most important step is to insure that the drum is clean and fitted with a drain if possible. We recommend that the inside of the drum be lined or painted with high heat resistant paint.

**STEP 2:** Punch two holes, with a knockout punch, in the side of the drum near the bottom. The size of the first hole should be 2 inches (5.08 cm) and the second hole  $\frac{3}{4}$  inches (1.91 cm) in diameter. Next weld a 2 inch and  $\frac{3}{4}$  inch bushing into the appropriate holes (Fig. 2). The weld must be tight to prevent leakage. The 2 inch hole is for placement of the heating element while the  $\frac{3}{4}$  inch hole holds

Table 2. Boiler apparatus parts.

- 1 - 55 gal. drum (208 L)
- 1 - hot water heater blanket
- 2 - 2"x24" channel iron (5.08x60.9 cm)
- 1 - foam lid (23.5" diameter) (59.6 cm)
- 1 - 11' 3/4" conduit (335x1.91 cm)
- 1 - plywood lid (23.5" diameter) (59.6 cm)
- 1 - 3/4" coupling (black iron) (1.91 cm)
- 1 - lid handle
- 1 - 3/4" 90° coupling (1.91 cm)
- 1 - 5/16"x 5' cord (0.79x152 cm)
- 1 - 3/4" cap (black iron) (1.91 cm)
- 1 - thermometer
- 1 - 6"x 3/4" pipe (15.2x1.91 cm)
- 1 - thermostat probe
- 1 - water heater element (30 amp, 250 volts)
- 2 - 3/4" water tight bushings (1.91 cm)
- 1 - 10"x3/4" seal tight (25.4x1.91 cm)
- 1 - 2" bushing (5.08 cm)
- 1 - 10/3 power cord
- 1 - 1/2" bushing (1.27 cm)
- 1 - 30 amp plug 250 volts
- 2 - watertight automatic controllers
- 1 - 5/16" eyelet (0.79 cm)
- 1 - 1/4" pulley (0.63 cm)
- 1 - 3/8"x24" cold roll steel (0.952x60.9 cm)
- 1 - 3/4" sleeve (1.91 cm)
- 1 - heat resistant paint

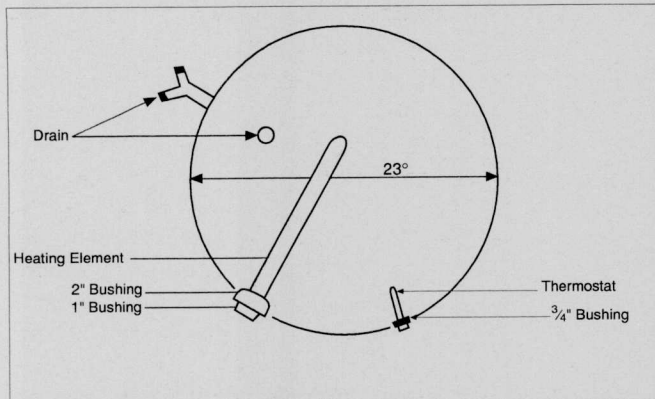

Fig. 2. Top view of boiling apparatus.

the thermostat sensor unit. In this study, we used a standard hot water heating element. The element must have a 30 amps minimum capacity and 250 volts for the water to reach a temperature of 96°C. Wrap the heating element threads with high heat resistant silicone and then thread into the 2 inch bushing. This procedure lets you remove the element for cleaning or replacement. Install a thermostat into the 3/4 inch hole using the same technique.

**STEP 3:** The correct wiring of the thermostat, heating element, and power cord are extremely important to insure proper operation and safe use of the boiler apparatus. In all electrical areas, water tight electrical products must be used. The thermostat and heating element should be grounded to the tank by welding a bolt to the outside near the thermostat (Fig. 3). Use extreme caution around all electrical parts and water when operating to avoid electric shock.

**STEP 4:** Other important features of the boiler apparatus included the lid and heater blanket. The lid and heater blanket around the outside of the drum provides protection from the hot drum and are installed for the water to reach and maintain proper temperature. We constructed the lid of plywood and styrofoam cut slightly larger in diameter than the drum opening (Fig. 4).

**STEP 5:** The lowering unit (Fig. 4) is a safety device that allows the operator to maintain a safe distance from the hot steam as well as a device that suspends and lowers the velvet antlers into the hot water. Using 3/4 inch electrical conduit and 3/8 inch (0.952 cm) cold roll steel, we welded a 50 inch (127 cm) length of 3/4 inch electrical conduit to the side of the drum. We then bent a second piece of 3/4 inch conduit 80 inches (203 cm) long 90° at 50 inches from one end and welded a 3/4 inch sleeve and 3/4 inch cap to the drum on the side opposite the 50 inch length of conduit (Fig. 4). We slipped the bent conduit through the sleeve to rest in the cap and allow the lowering unit to swing away from the tank when loading and unloading velvet antlers. We built the suspension rack from 3/8 inch

cold roll steel and three hooks from 4 inch (10.16 cm) lengths of steel. We then welded the hooks to a 12 inch (30.5 cm) length of cold roll steel. The suspension rack design can be modified to accommodate different sizes of velvet antler.

Remember these designs are for a small personal tank and modifications would be required for an industrial setup.

## Dryer unit

For this study, we used a VWR model #1660 air drying oven from SHEL-LAB, Sheldon Manufacturing Inc., in Cornelius, Oregon. We made an important modification to the oven by suspending the velvet antlers so the bulbous soft tip did not rest against any hard surface and damage or deform the antler.

## STUDY DESIGN

### Green velvet antler

We collected velvet antler for this study from two sources. The location of harvest, date of harvest, sex and age of animal, and green weight of velvet antler are listed in Table 3.

After harvest, we protected the velvet antler from moisture loss by wrapping the base with plastic Saran® wrap. We then placed the entire antler in a plastic bag to prevent further dehydration and freezer burn. The velvet antler was stored base up at -20°C until processing.

### Drying protocol

The objective of the dipping and drying technique was to obtain a high grade velvet antler that was processed and ready for market. The processing method should reduce fats and oils from the sur-

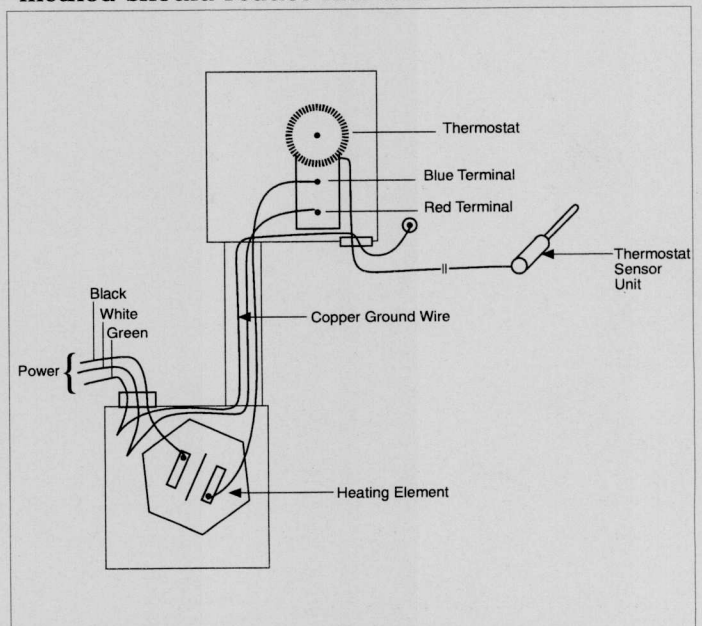

Fig. 3. Wiring schematic for thermostat and heating element.



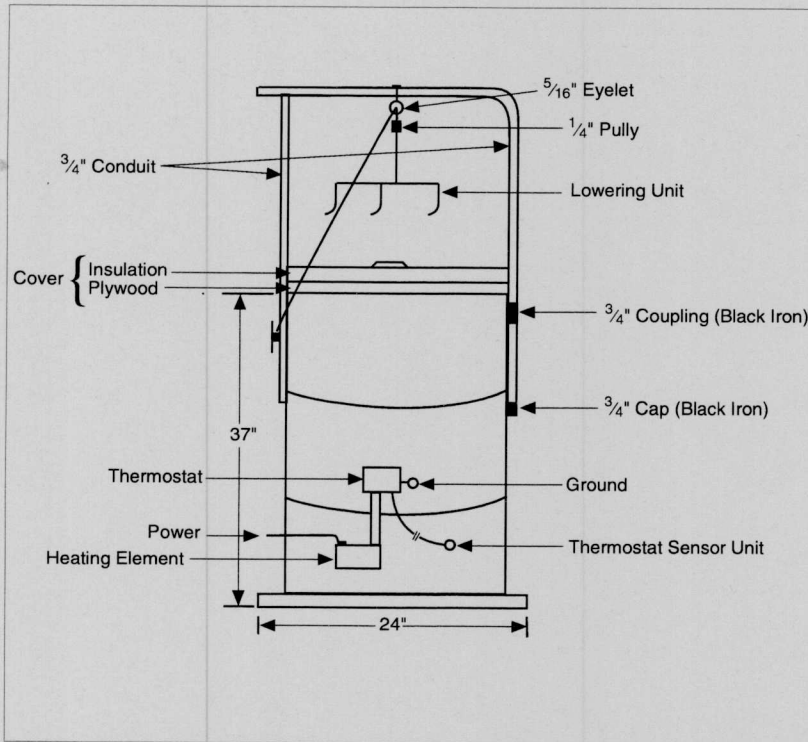

Fig. 4. View of completed boiling apparatus.

face and under the skin; minimize shrinkage; prevent cracking and bubbling of the skin; maintain fresh, dark red color; and destroy certain bacteria.

We filled the boiler apparatus with water to within 12 inches (30.5 cm) of the top and heated it to 96°C. One end of a wire was attached around the main beam of the velvet antler near the base (tip down) and the other end to the suspension rack (Fig. 5). We dipped the antlers in the hot water using the times and frequency in Table 4. The shorter dipping times were for the smaller velvet antlers while the longer dipping times were for the larger ones.

Table 3. Collection data on velvet antler samples.

Harvest Location	Harvest Date (m/d/y)	Animal		Green wt. (g)
		Sex	Age (Yr)	
LARS <sup>1</sup>	6-1-89	M	1	266
LARS	6-1-89	F	5	524
LARS	7-19-89	F	4	566
LARS	6-1-89	F	8	573
LARS	6-1-89	F	8	692
LARS	7-19-89	M	1	1045
Nome, Alaska	6-10-91	M	3	939
Nome, Alaska	6-10-91	M	4	1903

<sup>1</sup>LARS = Large Animal Research Station

The water was permitted to return to 96°C and the antlers are cooled to ambient air temperature between each dipping cycle.

After completing the series of dippings, we let the antlers cool and then suspended them from the oven drying rack (Fig. 6). Antlers are normally suspended curve up, **except** on day one during the first drying procedure when the antlers are suspended curve down. The duration of the drying period depended on whether or not blisters or cracks formed. We removed velvet antlers from the oven at the first sign of blistering or cracking. If no blistering or cracking occurred the velvet antlers were dried for the maximum time. It was important to weigh the antlers after they thawed and also at the beginning of each day to determine the total weight loss during the drying process. Other studies indicate that the dry weight of quality antlers should be about 30 to 40 percent of the wet weight.

Before and during the drying process, be sure to:

- Check for blisters after each boiling or oven cycle. If the antler is bent or damaged, prick the tine with a needle before dipping to prevent blisters from forming. If blisters occur, prick the area with a needle to expel liquid and press the surface down so it is flat.
- Remove the calcified portion of mature velvet antler. Prime velvet antler that is soft and fleshy will not require trimming.
- After the antler is removed from the oven and cools down, clean any grease from the surface with a soft brush.
- If the antler cracks during any portion of the process clean the area with a cloth and wrap it tightly with an ace bandage type material. It is important that the two pieces of skin are in contact with each other. When the process is finished the skin will be joined together again.

You should see a decrease in weight during this drying process. After the fourth day, the antlers will be 80 to 90 percent dry. Store the velvet antlers in a shaded cool area with good ventilation for 10 to 15 days. The drying process will continue until the velvet antler reaches a constant weight. The total drying process takes about one month.

## MEASUREMENTS

We weighed velvet antlers using a Mettler PE11 electronic balance prior to and during the drying process. We calculated and correlated percent moisture loss on initial green weight.

## Weight loss during drying

There was a significant relationship between the initial green weight of the velvet antler and moisture loss (Fig. 7). Larger velvet antlers lost a lower percentage of their initial weight than smaller antlers. The overall range in moisture loss ranged between 49 and 65 percent of the green velvet antler. Other factors which may have affected weight loss in drying included degree of calcification, cutting date of the antler, and age of the animal.

What does this mean to the producer and processor? In simple terms, it means financial returns. Antlers cut too early before the prime stage will be lighter in weight and of a higher moisture content. Therefore there will be a loss of weight and dollar returns. If the antler is overdeveloped and, or blood drains to the tip there will be more calcification and, or a lighter color at the base, respectively. The antler buyer will then cut the antler at various places from the base to the tip until dark red color is observed. The colored portion of the antler is then sold for a higher price while the lower portion only obtains the value of hard antler. Overall, the value of the antler is greatly reduced.

Antler quality is first influenced at the time of cutting. The producer must first judge antler growth at its optimum for best quality. This could vary from 50 to 65 days and depend on whether reindeer are farmed or herded. Removal and storage of the product is equally important.

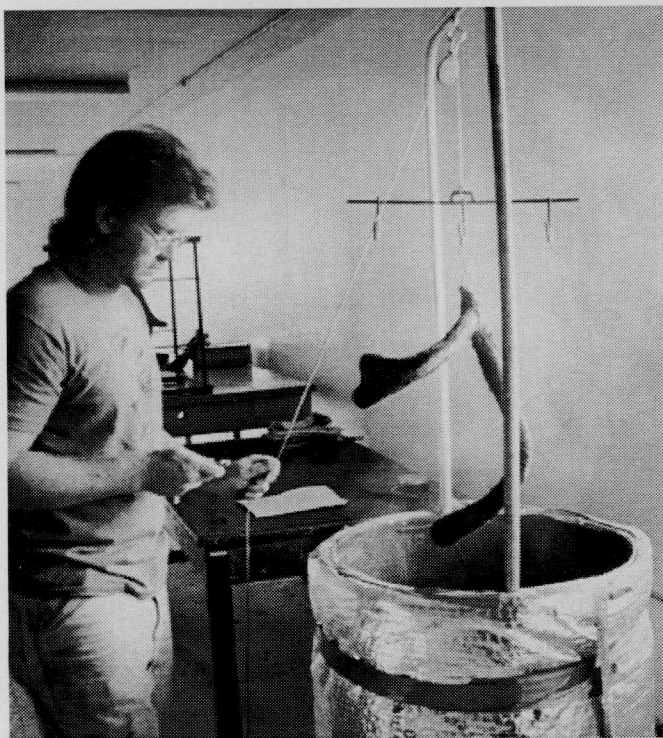

Fig. 5. Submersion of velvet antler.

Table 4. Dipping and drying schedule of velvet antler.

Day	Oven Cycle	Dipping Frequency	Dipping Time (sec)	Oven Temp. (°C)	Drying Time (hr)
1	1	3-4	30-45	70-75	2-3
"	2	6-7	30-45	65-70	1.5-2.5
2	1	6-7	30-45	65-70	1.5-2.5
"	2-3			65-70	1.5-2.5
"	4-7			65-70	1-1.5
3	1	5-6	25-30	65-70	1-1.5
"	2-4			65-70	1-1.5
"	5-11			65-70	.75-1
4	1	4-5	20-25	65-70	0.75-1
"	2-7			65-70	0.75-1
"	8-15			65-70	.50-.75

## ANTLER REMOVAL RECOMMENDATIONS

Restrain the animal to avoid struggling and possible injury. Some processors (F. McAllister, personal communication, 1993) suggest using an alcohol swab on the area to be cut. This eliminates bacteria which can accelerate spoilage. The dehorning saw or shears should also be kept in a bucket of sterile solution after each antler removal to reduce bacterial contamination of the cut area. This also reduces the chance of infection to the animal. By cutting the antler about one inch (2.54 cm) above the coronet (burr) of the antler, you will lessen bleeding and the chance of animal injury. If you cut too

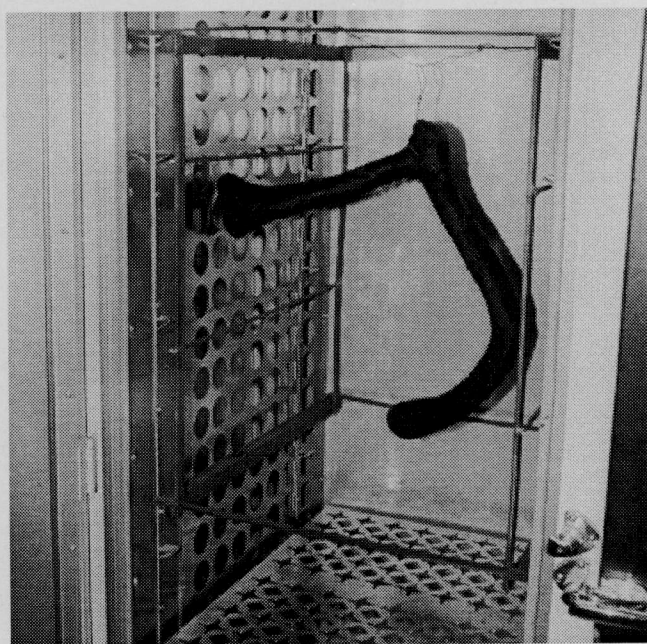

Fig. 6. Velvet antler in drying oven.



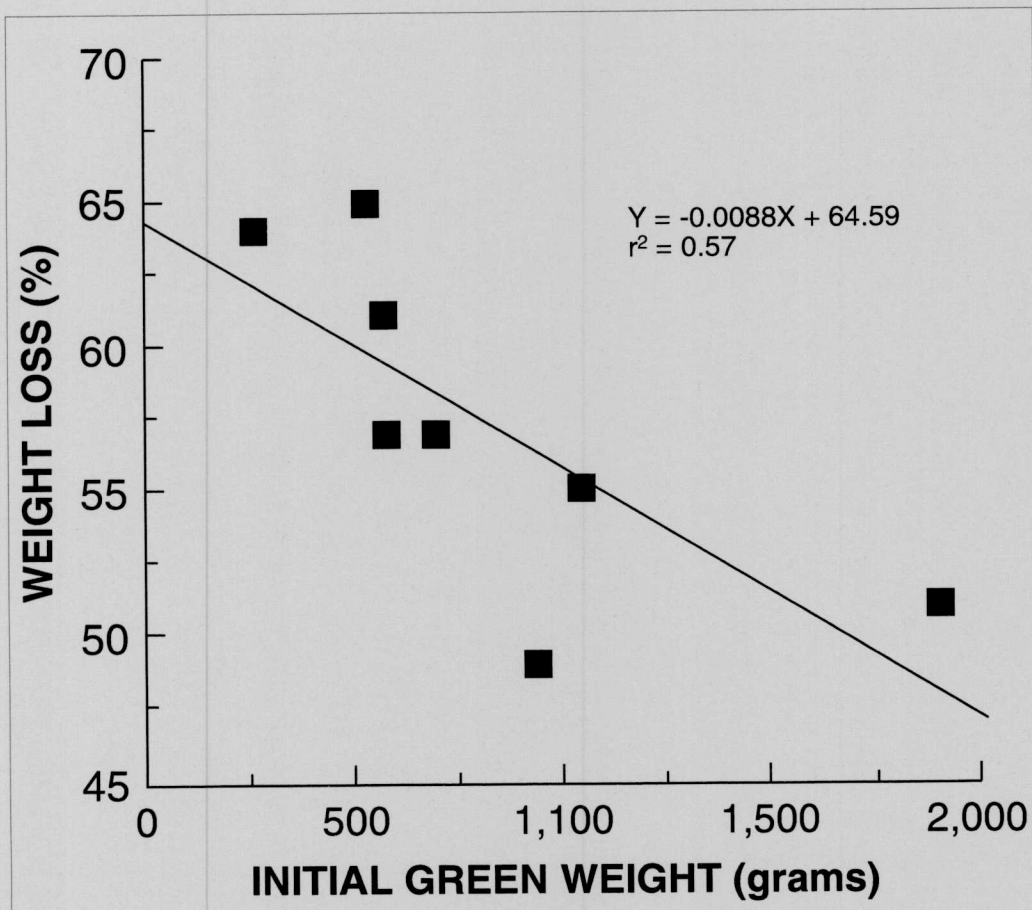

Fig. 7. Regression moisture loss against green weight.

close to the burr, you risk damaging the pedicels (outgrowth from the frontal bone of the skull) and permanent deformation of the antler. The cutting tools should be sharp to avoid stripping of the velvet (skin) from the antler as this will reduce the grade and product value. A tourniquet is often used for one to two minutes to reduce bleeding. Using blood stop powder and/or sulfanilamide powder on the cut surface will also help stop bleeding and reduce the chance of infection, respectively.

### Velvet antler care

#### BEFORE PROCESSING

Once cut, invert the velvet antler with the base up to avoid blood loss. Do not place it vertically with the cut surface up or all the blood will flow to the tip. Seal the cut surface with a piece of Saran® wrap or cauterize it with flour. Seal the pair of antlers in a plastic bag and freeze at -20°C within 10 minutes of cutting. Caution: ensure the soft antler tip does not rest against a hard surface which will deform it and result in a lower grade when sold. The antler should be processed within one year of cutting.

### Velvet antler care

#### AFTER PROCESSING

Once velvet antlers are processed, the velvet is

removed from each stick. The stick is then cut into very thin wafers. High quality velvet antlers that are processed correctly should appear porous (sponge-like) and be dark red (burgundy) in color. In our trial, the velvet antler varied from red and porous to light brown (almost white) and calcified. Velvet antler piece number 177 was cut June 1, and was red and porous, while number 22 was cut July 19 and was sandy colored and calcified (Fig. 8). As stated before, harvest date is crucial. The producer must judge antler growth at its optimum. Antler number 177 would bring substantially more financial return. Antler 22

was harvested too late and it had calcified. This antler could be sold as hard antler at a price considerably less than prime velvet antler.

## DISCUSSION

It may take a considerable amount of trial and error for the methodology to obtain the type of product required for retail sale. In our trial, velvet antler moisture loss varied from 49 to 64 percent. Other studies, with wapiti and red deer velvet antler, indicated 62 percent moisture loss can be expected from prime antlers. The same research at the University of Alberta, Edmonton revealed that the blood piece of wapiti antlers comprise a composition of 66.7 percent protein, 3.2 percent lipid, 22.7 percent ash, and 0.61 percent cholesterol.

As velvet antler world trade begins to meet demand, both commodity price and quality will be influenced. This will force producers to become more critical of product quality and antler processing techniques. Through processing, antlers become more marketable and less expensive to export. However, the drying process must focus on maintaining color, preventing cracks, and preserving the shape.

Currently, the world trade and supply of velvet antler is almost equal at 300 tonnes. This implies

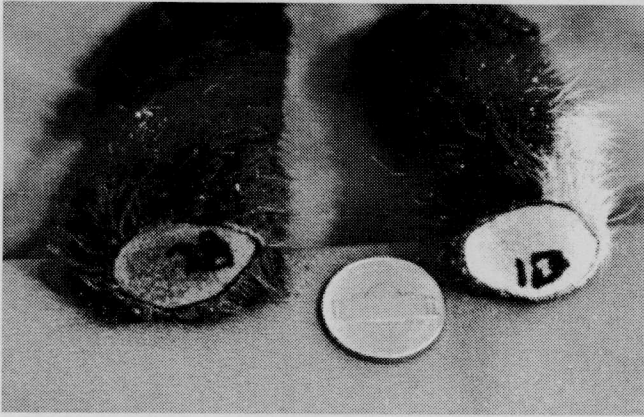

Fig. 8. Processed velvet antler, number 177 cut June 1 (left) and number 22 (right) cut July 19.

greater stress on quality assurance and market innovation. There will be a greater need for producers to take time and care to produce, harvest, and store the best product possible. In turn, processors will need to combine the Oriental knowledge with technology to process the product. This cooperative relationship in combination with an education program for western societies about the use of antler products will insure markets and sales. Recently, North American processors have begun to capitalize on the health food markets. This combination of old and new marketplaces will undoubtedly initiate greater demands for production of high quality velvet antlers.

## ACKNOWLEDGMENTS

We wish to thank Larry Burke, Agriculture and Forestry Experimental Farm Supervisor, for use of farm space to conduct this trial; Alan Tonne, agriculture assistant; and Steve Spores, farm maintenance mechanic, for boiler fabrication.

## REFERENCES

- BENNETT, B. 1993. Traditional trade in velvet. *In: Proceedings of the 1<sup>st</sup> world deer congress.* (ed. Ian Woodhouse). Christchurch, New Zealand. p. 207-208.
- FAN, Y., B. HU, AND Y. CHENG. 1991. Assessment of velvet antler quality. *In: Wildlife production: conservation and sustainable development.* (eds. L.A. Renecker and R.J. Hudson). AFES Misc. Pub. 91-6. University of Alaska Fairbanks. p. 598-599.
- JOHNSON, R.S. 1991. Cost comparison of velvet and hard antlers in North American wapiti, red deer, or wapiti x red deer crosses, 1980-1990. *In: Wildlife production: conservation and sustainable development.* (eds. L.A. Renecker

and R. J. Hudson). AFES Misc. Pub. 91-6. University of Alaska Fairbanks. p. 576.

- LUICK, J.R. 1982. The velvet antler industry. *In: Antler Development in Cervidae.* (ed. R.D. Brown) Caesar Keberg Wildlife Research Institute, Kingsville, TX p. 329-338.
- MCALLISTER, F. 1993. Personal communication.
- PEARSE, A.J., AND P.F. FENNESSY. 1991. Optimal velvet antler production in Wapiti and Red Deer. *In: Wildlife production: conservation and sustainable development.* (eds. L.A. Renecker and R.J. Hudson). AFES Misc. Pub. 91-6. University of Alaska Fairbanks. p. 548-56.
- RENECKER, L.A. 1993. Game ranching and elk. *In: Proceedings of Rocky Mountain Elk Foundation wildlife professionals symposium.* Reno, NV p. 18-35.
- SIM, J.S., AND R.J. HUDSON. 1991. Chemical characteristics and processing technology of Alberta wapiti velvet antlers. *In: Wildlife production: conservation and sustainable development.* (eds. L.A. Renecker and R.J. Hudson). AFES Misc. Pub. 91-6. University of Alaska Fairbanks. p. 533-535.
- WONG, S. 1991. Velvet antlers for medicine. *In: Wildlife production: conservation and sustainable development.* (eds. L.A. Renecker and R.J. Hudson). AFES Misc. Pub. 91-6. University of Alaska Fairbanks. p. 530-532.
- YUDIN, M.A. 1974. A guide for the preparation and storage of uncalcified male antlers as a medicinal raw material. (ed. J.R. Luick). Institute of Arctic Biology, UAF. p. 1-19.

## DISCLAIMER

*The University of Alaska Fairbanks provides equal education and employment opportunities for all, regardless of race, color, religion, national origin, sex, age, disability, status as a Vietnam era or disabled veteran, marital status, changes in marital status, pregnancy or parenthood pursuant to applicable state and federal laws. Material appearing herein may be reprinted provided no endorsement of a commercial product is stated or implied. Please credit the researchers involved and the Agricultural and Forestry Experiment Station, School of Agriculture and Land Resources Management, University of Alaska Fairbanks.*

Editor ..... Donna Gindle  
 Graphic Artist ..... Keith Swarner  
 Photographer ..... J. Stephen Lay