

THE SYNTAX OF HEAD MOVEMENT
A STUDY OF BERBER

by

Jamal Ouhalla

Thesis submitted in fulfillment of the requirements
for the degree of Ph.D. in Linguistics

University College London

1988



The Syntax of Head Movement
A Study of Berber

ABSTRACT

The thesis investigates the syntactic properties of head-movement processes as well as the structures of phrasal categories. The discussions are based mainly, though not exclusively, on data from Berber, in particular the Tarifit dialect spoken in the northern part of Morocco. The theoretical framework adopted is that of Government Binding (GB) as outlined by Chomsky (1981), (1982), (1986a), (1986b) and others.

The first chapter introduces the GB theory and its modules. The second chapter discusses sentential structure and the properties of head-movement processes involved in the derivation of the surface forms of sentences. The basic properties of the sentential clause in Berber are investigated in detail. On the basis of the distribution of clitics and the order of the verbal affixes with respect to the verb the conclusion is reached that the Infl(ection) node needs to be fleshed out in such a way that each of the elements occupying it (AGR(ement), TENSE(TNS) and NEG(ation)) is attributed a full categorial status in the sense of X-bar theory. It is demonstrated that the clausal structure that results from this revision differs with respect to the order of AGR and TNS according to whether the language in question is SVO or VSO. The structures of infinitival clauses, both inflected and uninflected, as well as small clauses are also investigated in the light of the conclusion mentioned above. Finally, the structural properties of nominal and copular sentences in Berber and other languages are also subjected to an analysis in terms of the same conclusion.

The third chapter investigates the structures of nominal and prepositional phrases, and the head-movement processes involved in their derivation in Berber and other languages. The structure of nominal phrases turns out to be strikingly similar to that of sentential clauses with the slight but significant difference that instead of TNS nominal phrases contain a NOM(inalisation) category. Surface word order variations among languages are discussed in the light of this conclusion. The structure of pre/postpositional phrases is found in some languages to contain an AGR element. The chapter also incorporates an attempt to reclassify the existing categories in terms of a binary division which recognises only two categorial classes, verbal and nominal.

The fourth chapter investigates the processes of clitic-movement in Berber and Romance languages, and of preposition-movement in Berber. On the basis of the properties of these movement processes and the conclusion reached in the second chapter with respect to the Infl node a unified analysis of morphological and non-morphological causatives is suggested. An analysis of the so-called Restructuring constructions in Italian is also suggested where the process of restructuring is argued to be a movement process of the embedded verbal complex to C. With respect to clitics they are argued to be head categories with an affixal nature, and their movement is argued to be governed by the ECP. The process of preposition movement in Berber, on the other hand, is shown to share significant properties with the process of clitic-movement, a fact that is shown to provide significant support for the treatment of clitics as head categories.

ACKNOWLEDGEMENTS

I am forever grateful to my supervisor Neil Smith, a truly ideal supervisor. I am not going to list all the nice qualities that he has, and the numerous ways in which he has helped me in my thesis, my academic career, and my personal life for that would take too long. I just want to thank him for his much-needed warmth, kindness, and encouragement.

A number of other people have also contributed to this work in different ways. I wish to thank, in particular, Hagit Borer, Misi Brody, Robyn Carston, Ken Hale, Dick Hudson, Ruth Kempson, Rita Manzini, Ian Press, Deirdre Wilson, and Hilary Wise.

My friends and peers in London have also been very helpful in many ways. I would like to mention Ahmed Bada, Elabbas Benmamoun, Billy Clark, Aman and Latifa Fakim, Mireia Llinas-Grau, Keba Marinah, Mohamed Monkaila, Dorota Rychlik, Peter Simpson, Christine Theodoulou, and Chris Wilder.

Abderrafi Benhallam and Abderrahim Jamari were among the first to teach me Linguistics. I am grateful to them for that. I am also grateful to them for their much-appreciated efforts in helping me do my postgraduate studies.

My deepest gratitude I reserve for my family back at home, in particular my parents and my brother Rachid. I also would like to express my deepest gratitude to Mrs Adama Mohamed and her family for their help that was crucial to the completion of this work.

TO SIMA

TABLE OF CONTENTS

Chapter One Introduction : Theoretical Framework

1.0. Introduction	1
1.1. Levels of representation	1
1.2. Modules of Grammar	3
1.2.1. X bar theory	3
1.2.2. Theta theory	5
1.2.3. Case theory	7
1.2.4. Government theory	8
1.2.5. Movement theory	13
1.2.6. Morphology theory	14
1.2.7. Binding theory	17

Chapter Two Verb Movement : Sentential Structure

2.1. Introduction	19
2.2. Basic Properties	20
2.2.1. Construct system and Case	20
2.2.1.1. Construct-marking	21
2.2.1.2. Construct-marking v Case-marking	26
2.2.2. Verb morphology	28
2.2.2.1. Aspect	28
2.2.2.2. Auxiliary <u>ila</u>	32
2.2.3. Infl structure	34
2.2.3.1. Infl elements	34
2.2.3.2. Standard analysis and problems	39
2.2.3.3. An articulated Infl structure	41
2.2.3.4. Auxiliary <u>ila</u> revisited	46
2.3. Sentential structure	48
2.3.1. Against a directionality parameter	48
2.3.2. Thematic domains and predication	53
2.3.3. Word Order and the Mirror Principle	59
2.3.2.1. Mirror Principle	59
2.3.2.2. VSO languages	60
2.3.2.3. SVO languages	68
2.3.3.4. Celtic languages and Aspect	71
2.3.4. Infinitival clauses	76
2.3.4.1. Inflected infinitivals	76
2.3.4.2. Non-inflected infinitivals	79
2.3.5. Small clauses	86
2.3.6. The status and position of NEG	92
2.4. Nominal sentences and copular constructions	97
2.4.1. Introduction	97
2.4.2. The status of the prefix <u>d-</u>	101
2.4.3. The structure of nominal sentences	106
2.4.4. The structure of copular constructions	110
2.5. Conclusion	116

Footnotes	120
-----------	-----

Chapter Three *Noun Movement : The Structure of Nominal and Prepositional Phrases*

3.1. Introduction	143
3.2. Nominal phrases	144
3.2.1. Basic properties	144
3.2.1.1. Noun morphology in Berber	144
3.2.1.2. Nominal INFlectional elements	149
3.2.1.3. The structure of nominal phrases	152
3.2.1.4. On the nature and function of the complementizer	157
3.2.1.5. Possessor argument	166
3.2.1.6. Derived nominals	171
3.2.2. Nominalisation and auxiliary verbs	176
3.2.2.1. Irish ProgPs	176
3.2.2.2. Participles	180
3.2.3. Word order variation	185
3.2.3.1. Subject-initial languages	185
3.2.3.2. Noun-initial languages	189
3.2.3.3. Romance nominal phrases	198
3.3. Adjectival, adverbial and quantified nominal phrases	201
3.3.1. Adjectival and adverbial nominal phrases	202
3.3.2. Quantified nominal phrases	210
3.4. Prepositional phrases	213
3.4.1. The paradigm	213
3.4.1.1. Genuine prepositions	213
3.4.1.2. Disguised adverbial PPs	216
3.4.1.3. The dative and genitive markers	220
3.4.1.4. The coordination morpheme	224
3.4.2. The status and nature of prepositions	227
3.4.2.1. Prepositions and the syntactic features	227
3.4.2.2. Guerssel's analysis	230
3.4.2.3. AGR in PP?	232
3.5. Conclusion	234
Footnotes	236

Chapter Four *Clitic and Preposition Movement : The Structure of Causative Constructions*

4.1. Introduction	250
4.2. Basic properties	252
4.2.1. Clitics	252
4.2.1.1. Object-of-V clitics	252
4.2.1.2. Object-of-N clitics	258
4.2.1.3. Object-of-P clitics	262
4.2.2. P+clitic complex	265
4.3. Clitic- and P+cl movement and the ECP	272
4.3.1. Kayne's analysis	272

4.3.2. Clitic-movement in Berber	276
4.3.2.1. Clitics as heads	276
4.3.2.2. Movement to TNS	279
4.3.2.3. Movement to NEG	283
4.3.2.4. Movement to C	284
4.3.2.5. Dative, benefactive and possessor clitics	287
4.3.3. P+cl-movement	290
4.3.4. Clitic-movement in Romance	293
4.3.4.1. Movement to TNS	293
4.3.4.2. Movement to AGR	295
4.3.4.3. Movement to C	297
4.3.4.4. Subject clitics	300
4.4. Clitic- and P- climbing and the ECP	303
4.4.1. Discussion	303
4.4.2. Clitic-climbing in causatives	308
4.4.3. The structure of causative constructions	311
4.4.3.1. Romance causatives	311
4.4.3.2. Berber causatives	316
4.4.3.3. A unified account	319
4.4.3.4. Clitic- and P- climbing in causatives	326
4.4.4. Italian perestroika	329
4.4.4.1. Restructuring constructions	329
4.4.4.2. Restructuring as movement	331
4.4.4.3. Clitic-climbing	333
4.4.4.4. Object-preposing	338
4.5. Against the HMC	341
4.6. Conclusion	347
Footnotes	350
Bibliography	365

GLOSSES

The following is a list of the glosses used in this thesis :

1,2,3...etc	person
ACC	accusative
AGR/Agr	agreement
AOR	aoist
ASP	aspect
AUX	auxiliary
Cause	causative morpheme/verb
Comp	complementizer
CS	construct state (see 2.2.1. of chapter 2)
DAT	dative Case marker
f	feminine
FS	free state
FUT	future tense marker
GEN	genitive Case marker
Infl/INFL/I	inflection
IMPR	imperfective
IRREA	irrealis
m	masculine
y n—n	neutral AGR (see fn.2 of chapter 2)
NEG	negation marker
NOM	nominative Case
NOM	nominalisation morpheme
p	plural
PERF	perfective
Pred	predication marker
PROG	progressive
s	singular
TNS	tense

With respect to data from languages other than Berber the glosses used are those that appear in the cited sources.

The method of transcribing the Berber data used in this thesis takes into consideration the underlying/idealised forms of morphemes rather than their surface forms. For example, the wh-complementizer is represented as ay- despite the fact that in some subdialects of Tarifit it surfaces as (i)g-. Another example is the fact that the l and ll sounds are replaced in some subdialects of Tarifit (e.g. the Ait Waryagher subdialect) by the r and dz sounds, respectively. The reasons for choosing to provide the underlying/idealised forms of morphemes rather than their surface forms is, first, to make the data easily accessible to the speakers of other dialects of Berber, and, secondly, and more importantly, to try to get across the message that this study is probably as relevant to other dialects of Berber as it is to Tarifit, the underlying assumption, open to empirical investigation, of course, being that all dialects of Berber have in common a core syntax that forms (part of) the grammar of the Berber language.

Chapter One

Introduction

Theoretical Framework

1.0. Introduction

The theoretical framework within which the research in this work is conducted is the Government-Binding theory as it has been developed by Chomsky (1981), (1982), (1986a), (1986b) and others. In this chapter I will try to outline the general principles and main concepts of this theory with the hope that the explanations will make the rest of the work reasonably accessible to those who are not familiar with the theory. As to those who are familiar with the theory I hope that the questions raised and the revisions suggested will prove challenging enough to hold their attention for the rest of the work.

1.1. Levels of representation

The mainstream GB literature recognizes the levels of analysis represented in the following diagram :

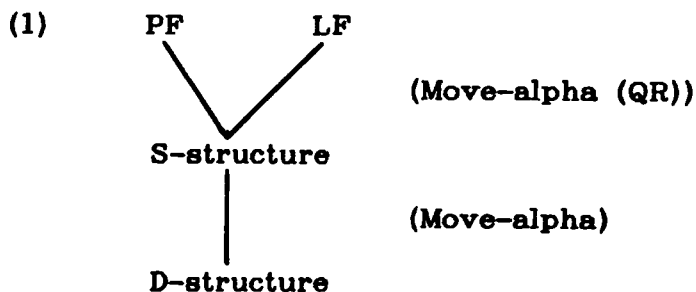

D(eep)-structure is the level at which relations between elements in a sentence are structurally encoded in the form of phrase-markers

represented by tree diagrams or labelled bracketing. The structural relations between elements are constrained by the principles of X-bar theory. The D-structure phrase-markers are mapped onto the S(urface)-structure level by the rule/principle of Move-alpha where alpha is a variable that ranges over all existing categories subject to parametric variation. The S-structure phrase-markers are in their turn mapped onto the LF (Logical Form) level by a process of Move-alpha called Quantifier Raising (QR). LF is the interface at which the principles governing language interact with other modules of the mind/brain. PF (Phonological Form) is the level at which the constituents of the phrase-markers receive a phonological representation.

The link between all these levels of representations is the Projection Principle which guarantees that the lexical properties of lexical items be preserved throughout the derivation, that is at all levels of representation. Among the consequences of the Projection Principle is the fact that all elements that move must leave behind a trace that preserves the position evacuated.

The diagram above obviously presupposes the existence of a lexicon which can be thought of as a set of lexical entries which specify, inter alia, the syntactic, semantic and phonological properties of the lexical items. The syntactic properties include the categorial specification and the selectional or subcategorisation properties. The latter specify which category a certain lexical item takes as complement (e.g. the verb eat takes a noun phrase as complement). The semantic specification include a representation of the conceptual content of the lexical item, among other possible properties. Finally, the phonological specifications include a phonological representation of the lexical item.

The specifications in question have been defined here fairly loosely and people may differ as to what information should be included in the lexical entry of lexical elements. People may also differ as to whether to conceive of the lexicon as a sort of store room where the idiosyncrasies of languages are relegated or as a well defined level of representation with governing principles and functions similar in status to those which are assumed to govern other levels of representation.

1.2. Modules of Grammar

1.2.1. X-bar theory

The principles of this theory constrain structural representations in terms of the following schemata (cf. Chomsky (1986b)) :

- (2) a. $X' = X X''^*$
b. $X'' = X''^* X'$

where * implies zero or more occurrences. X'' is a maximal projection, while X is the head. X' is the projection intermediate between the maximal projection and the head. X'' in (a) is the complement of the head X both of which constitute the X' projection. X'' in (b) is the specifier which together with the head and its complement form the phrasal category. The order of the head in relation to its complement is fixed by the Head Parameter. In Head-initial languages (e.g. English, Berber) the head precedes its complement, while in Head-final languages (e.g. Turkish, Japanese) the head follows its complement. The X-bar schemata hold essentially of D-structure representations.

X-bar theory makes a distinction between lexical and non-lexical categories. The lexical categories include the Verb, the Noun, the Adjective and the Preposition, all of which are distinguished in terms of a feature system based on the feature matrix [+,- N; +,- V]. The Verb is [- N, +V],

the Noun [+ N, - V], the Adjective [+ N, +V] and the Preposition (or rather adposition) [- N, - V]. The non-lexical categories include the elements that are usually considered to belong under the I(nflection) node (e.g. AGR(ement), Tense (TNS), NEG(ation) element ...etc) as well as the C(omplementizer). Chomsky (ibid) extends the range of the X-bar schemata above to cover non-lexical categories in addition to the lexical categories. Accordingly, the canonical structure of a clause takes on the following form where CP stands for Complementizer Phrase and IP stands for Inflectional Phrase :

(3) [CP Spec [C' C [IP Spec [I' I [vp V NP (PP)]]]]]

The Spec of IP is the canonical subject position, while the Spec of CP is the position occupied by moved wh-phrases.

It is not difficult to see that this version of X-bar theory has a number of what might be considered serious defects. For example, some categories such as Adverbs and Conjunctions seem to be completely left out by the system. Are they lexical or non-lexical categories? If they are lexical categories how do they fit into the feature system mentioned above? A number of other questions arise that are left unanswered. For example, What is the status of the non-lexical categories with respect to the feature system? Are they specified for the categorial features as well or are they featureless? With respect to the elements that are believed to belong under the I node one might wonder what a strange assortment they make. AGR is considered to be a nominal element while in fact, together with TNS, it is one of the most robust of all the verbal satellites. One might also want to question the distribution of the features among the so-called four major categories mentioned above. One might wonder what Prepositions have in common with Verbs so that they both are specified as [- N]. One might also wonder in what sense Prepositions are different in nature from Nouns so

that they should be assumed as having no feature in common.

In the course of this work I will suggest two major revisions of the X-bar system. First, I will assume that all the elements that are believed to belong under the I node are head categories in their own right with projections that are constrained by the general X-bar schemata in (2) (cf. Pollock (1987)). Secondly, I will assume a feature system which recognises only two categorial classes, verbal and nominal, which can be formally specified in terms of the feature matrix [-, + N] or [-, + V] (cf. Abney (1987)). Adjectives will be argued to be nominal categories and so will Complementizers and some Adverbs. TNS and the AGR element which assigns nominative will be argued, together with the verb, to be verbal categories. The AGR element which assigns genitive Case and which occurs in noun phrases in a number of languages will, however, be argued to be nominal in nature. Elements will be classified on the basis of the nature of the Case they assign and whether their phrasal projections can function as arguments. All categories, including AGR and TNS, are assumed to have lexical selectional properties which specify the categorial nature of the elements they can take as complements.

1.2.2. Theta theory

The concern of this theory is to organise the semantic dependencies between lexical elements in a structure. Lexical elements are assumed to have associated with them a number of theta-roles which correspond to the number of arguments they select. Lexical heads are assumed to directly theta-mark their complements and indirectly theta-mark their subject. The theta-roles that are assigned to complements are sometimes referred to as "internal theta-roles" while the theta-roles that are assigned to non-derived subjects are called "external theta-roles". The class of

theta-roles assumed may vary but it generally includes "agent", "patient", "goal", "experiencer" ...etc. (see Gruber (1965), Fillmore (1968), Jackendoff (1972)).

Central to theta-theory is the principle that is known as the "Theta Criterion" which can be formulated as follows (cf. Chomsky (1982)) :

- (4) Each term of LF that requires a theta role (each argument) is assigned a theta role uniquely, and each theta role determined by the lexical properties of a head is uniquely assigned to an argument.

The Theta Criterion is a "criterion of adequacy for LF", a condition on assignment of theta-roles by the heads to their complements. Theta-role assignment is assumed to be constrained by structural conditions. Theta-roles are assigned from heads situated in specific positions to their arguments also situated in specific positions. The positions to which theta roles are assigned are generally known as Θ -positions. Positions which are not assigned a theta-role are known as Θ' -positions. At D-structure all arguments are in Θ -positions. At other levels the Theta Criterion is satisfied through chain relations. Arguments that move are in a chain-relation with their trace in their (thematic) D-structure position. Assuming that arguments which do not move also form (non-movement) chains the Theta Criterion can be thought of as essentially holding of chains (cf. Brody (1984), Chomsky (1986a)).

In addition to the theta-roles assumed to be assigned by Verbs, Nouns and Prepositions to their complements I will assume the existence of a "functional" theta-role (cf. Abney (1986) & (1987)) assigned by (functional) heads such as AGR, TNS, C to their complements. We will see that the existence of this theta-role is crucial for some fundamental relations to hold. I will also assume, along with Baker (1985), that all elements which assign a theta role occupy independent structural positions at D-structure.

Baker formulates this assumption as in (4) below and refers to it as the Uniformity of Theta Assignment Hypothesis (UTAH) :

- (5) Identical thematic relationships between items are represented by identical structural relationships between those items at the level of D-structure.

As Baker argues, this hypothesis, in a sense, strengthens further the idea that D-structure is a direct representation of thematic structures. Notice that if AGR and TNS are assumed to be categories which assign theta roles then by virtue of (5) each of them must occupy an independent structural position at D-structure.

1.2.3. Case theory

This module of grammar is concerned with the assignment of Case to noun phrases. Case in some languages (e.g. English) is abstract while in others (e.g. Turkish) it is overt/morphological. The underlying assumption of Case theory is that noun phrases are required to be Case-marked. There are two different ways the Case requirement has been formulated in the literature. One is in the form of a Case Filter which applies at PF to exclude noun phrases which are not Case-marked (cf. Rouveret and Vergnaud (1980)), Chomsky (1981)). The other is in the form of what is known as the Visibility Hypothesis suggested originally by Aoun (1982). The latter makes Case-marking follow from theta-marking as a condition for theta role assignment. For a noun phrase argument to be visible for theta-marking, which is obligatory by the Theta Criterion, the noun phrase has to have Case (cf. Chomsky (1981), (19886a)). I will assume both formulations of the Case requirement on noun phrases.

Case is assumed to be assigned to noun phrases under government (see below). In Chomsky (1981) only the Verb, the Preposition and tensed INFL are assumed to be Case-assigning categories. In Chomsky (1986a) the Noun and the Adjective are also assumed to be Case-assigning categories. In the same reference, Chomsky introduces a distinction between "structural Cases" and "inherent Cases". Structural Cases are the nominative assigned by the AGR element of INFL and the objective assigned by the verb. Inherent Cases are the oblique assigned by Prepositions and genitive assigned by Nouns and Adjectives. Structural Cases are assigned at S-structure while inherent Cases are assigned at D-structure and are associated with theta-marking.

We will see later, however, that the distinction made between structural and inherent Cases breaks down in some cases. In some languages genitive Case-assignment by Nouns must be assumed to be structural, assigned at S-structure under government. We will see also that in some languages (some) Prepositions assign genitive Case which, according to the classification mentioned above, Chomsky seems to treat as distinct from oblique Case assumed to be assigned by Prepositions. Case will play a significant role in the third chapter of this work where a binary classification of categories is proposed which makes crucial use of the nature of the Case assigned by the elements under investigation. Accusative and nominative Cases will be considered to be indicative of a verbal nature of their assigners, while the genitive will be considered to be indicative of a nominal nature of its assigner.

1.2.4. Government theory

The notion of government is central to the GB theory. Government relations define strict locality domains within which certain grammatical

relations and processes take place. The definition of government adopted in this work is the one presented in Chomsky (1986b) in terms of the notion of barrier :

- (6) A governs B iff A m-commands B and there is no C, C a barrier for B, such that C excludes A.

This definition incorporates three crucial notions which are "m-command", "exclusion" and "barrier". These notions are defined as follows, respectively :

- (7) A m-commands B iff A does not dominate B and every C^{\max} that dominates A dominates B.
- (8) A excludes B if no segment of A dominates B.
- (9) C is a barrier for B iff (a) or (b) :
- a. C immediately dominates D, D a Blocking Category for B;
 - b. C is a Blocking Category for B.

The definition of barrier obviously makes use of the notion of "Blocking Category" which is defined as in (10) below :

- (10) C is a Blocking Category (BC) for B iff C is not L-marked and C dominates B.

The definition of "Blocking Category" in its turn makes use of the notion of L-marking which is defined as follows :

- (11) A L-marks B iff A is a lexical category that governs B.

Let us now see how each of these definitions works. The notion of m-command is borrowed from Aoun and Sportiche (1983) who revised the already existing notion of c-command so that the domain of a head is its maximal projection and not the first, possibly non-maximal, projection that dominates it. In (12) below, for example, the m-command domain of X is XP since XP is the maximal projection of X :

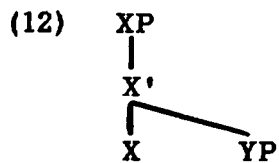

The X' domain does not count as the m-command domain of X because X' is not a maximal projection.

The notion of exclusion on the other hand is based on May's (1985) assumption that for an element to be dominated by a certain maximal projection it has to be dominated by all the member nodes of that projection. The assumption is most relevant to adjunction structures. In (13) below, for example, YP is not dominated by XP because YP is dominated by only the upper node of XP which results from the adjunction process :

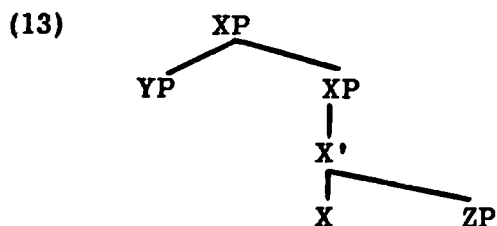

X and ZP, however, are dominated by XP because they are dominated by both member nodes of XP.

The notion of exclusion is based on May's assumption in the sense that YP in (13), though not dominated by XP, is not excluded by XP because YP is dominated by one member node (segment) of XP. A category is excluded by a maximal projection if that category is not dominated by any member node of that maximal projection. In (14) below, for example, Y is excluded by XP, unlike YP in (13) above which is not :

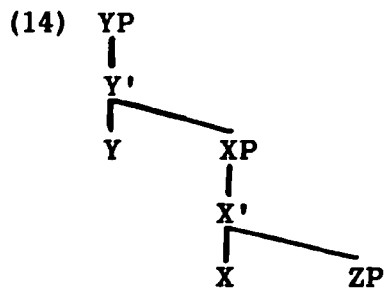

Having illustrated how the notions of m-command and exclusion work let us now turn to what maximal projections in a simple sentence are barriers. Consider the following embedded sentential (CP) structure :

(15) ...V [CP C [IP Spec [I' I [VP V NP]]]]

Now, both VP and IP in this structure are barriers because neither of them is L-marked. The governor of VP is I which is not a lexical category and therefore does not qualify as an L-marker. The governor of IP, on the other hand, is C which is also not a lexical category. Both VP and IP are therefore barriers by virtue of condition (b) of the definition of barrier in (7) above. CP, however, is not a BC because it is L-marked by the (matrix) verb governing it. However, because CP immediately dominates IP, which is a BC, CP becomes a barrier by inheritance. In different terms, CP is a barrier by virtue of condition (a) of the definition of barrier in (9) above.

Let us now concentrate instead on the following structure where both VP and IP have been adjoined to, assuming that adjunction to IP of a wh-word is possible :

(16) ...V [CP C [IP wh- [IP Spec I [vp wh- [vp V NP]]]]]

In this structure neither VP nor IP are barriers for the wh-element adjoined to them because neither VP nor IP excludes the wh-element. VP and IP, however, remain barriers for the other elements which they exclude.

Chomsky (1986b) argues that there are two concepts of barrier. The first is the one discussed above and the second is known as the "Minimality Condition" which he formulates as in (17) below. (18) is an extension of the definition of barrier which Chomsky remarks is relevant to the theory of government but not to the theory of movement :

(17) ...A...[C ...D...B...]

(18) A does not govern B in (17) if C is a projection of D excluding A.

(19) C is a barrier for B if C is a projection of D, a zero-level category distinct from B.

In (17) C is a barrier because its head D is a closer governor of B than A. In different terms, D, strictly speaking C, protects B against government by A.

Among the conditions that are formulated on the basis of government is the Empty Category Principle (ECP) which regulates the distribution of non-pronominal empty categories in that it requires them to be "properly governed" where proper government is as defined in (21) below. (20) is the definition of the ECP (cf. Lasnik and Saito (1984)) :

(20) Non-pronominal empty categories must be properly governed.

(21) A properly governs B iff A is coindexed with B and A governs B.

What this definition of the ECP implies is that only antecedent-government (i.e. government by a coindexed element) can satisfy the ECP to the exclusion of theta-/lexical- government (i.e. government by a theta-marking lexical category) (cf. Lasnik and Saito (ibid) and Chomsky (1986b)), contrary to what is assumed in Chomsky (1981) (1982) and other works where either lexical- or antecedent- government is assumed to be sufficient to satisfy the ECP.

1.2.5. Movement theory

Central to movement theory is the principle of Move-alpha. In principle Move-alpha can apply freely to move any element to any position over any distance. However, there are constraints on the application of Move-alpha as there are constraints on the free application of a number of other principles in the theory. Among these constraints is, obviously, the ECP discussed above. As a condition on the successful application of Move-alpha the ECP requires that the trace left behind be antecedent-governed. In other words, the ECP requires that no barriers separate the moved element from its trace. Another constraint on Move-alpha is known as the Subjacency Condition, sometimes referred to in the context of a theory of Bounding, which is basically a locality condition on movement. It requires that an element cannot be moved, in one step, across more than one bounding node where bounding nodes are assumed to vary from language to language (cf. Rizzi (1982) Chomsky (1986b)).

Further constraints are imposed by what is known as the Structure Preserving Hypothesis (cf. Emonds (1976) Chomsky (ibid)). According to this hypothesis only maximal projections can move to maximal projection (Specifier) positions, while only head categories can move to head positions. The Theta Criterion, on the other hand, requires that maximal projections can only move to non-theta-marked positions (e.g. Spec of IP in passive and raising constructions and Spec of CP). It follows from the Theta Criterion that movement to complement positions is illegitimate since it gives rise to a chain that has two theta-roles. A further crucial constraint on the application of Move-alpha is the condition that only maximal projections and heads can be affected, that is can be moved, to the exclusion of single-bar projections.

Two types of movement are assumed to exist : substitution and

adjunction (cf. Chomsky (ibid)). Substitution is the movement of either a maximal projection or a head category to an empty Spec or head position, while adjunction consists in the movement of a maximal projection or a head category and the adjoining of it to a maximal projection or to a head position. I will argue in the course of this work, however, that substitution is not available to head-movement processes even to empty positions. All moved head categories are adjoined to their hosts whether the latter are empty or filled, thus always resulting in complex X-0 structures, that is complex head categories.

Movement of head-categories is assumed to be governed by a condition that is known as the Head Movement Constraint and is formulated in Chomsky (ibid) (cf. Travis (1984) and Baker (1985)) as follows, with a minor adjustment bearing on the status of the complementizer :

- (22) Movement of a zero-level category B is restricted to the position of a head A that governs the maximal projection C of B where A theta-governs or L-marks C.

This condition clearly puts a severe locality restriction on head-movement processes, expressing the belief that head categories can only move to the next head position in their structure. Chomsky, however, argues that the HMC is not likely to be a principle of UG because its effects can be made to follow from the ECP. In chapter 4 of this work I will argue against the HMC on grounds that are more crucial than the fact that its effects are derivable from the ECP, namely that it makes wrong predictions with respect to some head movement processes.

1.2.6. Morphology theory

Following Marantz (1984) and Baker (1985) I will assume that morphology theory is one of the modules of Grammar in the same way that

the other theories mentioned above are considered to be modules of Grammar. As such the principles of morphology are not confined to certain specific levels of representation (e.g. Lexicon or PF) but can apply at any level. Baker (ibid) defines the role of morphology theory as involving two tasks : one is to determine whether the X-0 structures that result from morphological processes are well-formed with respect to specific languages, and the other is to assign well-formed X-0 structures phonological representations. Both tasks can be assumed to be carried out in the lexicon, in the syntax or at PF. It should be clear, however, that the domain of the principles of morphology theory is the X-0 level. Projections beyond the X-0 level are the domain of other modules.

As defined above the role of morphology theory seems to be largely determined by language-specific factors given that the possibilities of morphological combination and phonological representation vary between languages. However, I will assume that in addition to these necessary language-specific principles morphology theory contains two principles which have universal validity, both of which are not unfamiliar. One of these principles I will refer to as the Affix Principle (AP) (cf. Baker (1985)) and the other I will refer to as the Head Opacity Condition (HOC). They are defined as follows, respectively :

- (23) The morphological subcategorisation frame of affixes must be satisfied prior to the S-structure level (cf. Baker (ibid)).
- (24) The internal structure of X-0 categories is opaque to Move-alpha.

(23) appears in a number of studies though perhaps in different forms, while in others its existence is assumed tacitly, that is without it being formulated as a formal principle of UG. It basically requires that affixal elements, that is elements that are marked as morphologically dependent by virtue of morphological subcategorisation frames, and which are

base-generated under independent structural positions by virtue of UTAH, be attached to suitable categories prior to the S-structure level. By suitable category is meant the category that is specified in the morphological subcategorisation frame. We will see during the course of this work that there exist in different languages affixal elements which are required to attach to verbal categories while there exist others which are required to attach to nominal categories. (23) can be understood as a well formedness condition on the morphological make-up of elements, a sort of filter which filters out affixes that remain stranded or which are attached to the wrong category. As we will see later the effect that the AP has is that it forces syntactic head-movement processes which in some cases become instrumental in paving the way for other syntactic relations to hold.

(24), on the other hand, is familiar from the literature on the Lexical Integrity Hypothesis. The fact that it makes reference to Move-alpha specifically, instead of syntactic rules in general, follows from the status attributed to morphology theory within the overall framework where morphological processes can apply in the syntax. What the HOC should be understood to mean is that Move-alpha cannot extract part of a base-generated X-0 structure, which can either be affixal or non-affixal, and move it to another X-0 position, nor can it extract an element that has been adjoined to an X-0 structure and move it to a different X-0 position. Once a moved element has been adjoined to an X-0 category the resulting structure becomes "frozen/opaque". However, the resulting X-0 as a whole can still be subject to movement since in this case Move-alpha makes reference to the (complex) X-0 as a whole and not just to parts of it. Notice that as a consequence of the restriction on Move-alpha expressed by (24) the situation will never arise where a head category dominates more than one trace e.g. *[_v t_j [V t_i]]. Therefore, Baker's (1985) (see also

Kayne (1987)) prohibition against traces dominated by an X-0 category follows.

I have disregarded the possibility that Move-alpha could apply to move affixes inside an X-0 category as suggested by Pesetsky (1985) to solve the so-called "bracketing paradoxes" raised by examples such as unhappier which is required by the phonological condition on the comparative -er element to have the structure [A un- [A happy -er]], while its semantic interpretation implies the structure [A[A un- happy]-er] since the word means 'more not happy' rather than 'not more happy'. Pesetsky solves the paradox that arises by assuming that the word in question undergoes a process of QR (Move-alpha) at LF which moves the comparative affix inside the X-0 structure to a higher (adjoined) position where it has scope over (where scope is understood in terms of the c-command relation) the prefix un- and the root happy to yield the appropriate interpretation. If Pesetsky's analysis is correct then condition (24) should be understood to mean that Move-alpha cannot extract elements out of an X-0 structure. The possibility that elements can be moved inside an X-0 structure is, accordingly, left open.

1.2.7. Binding theory

This subtheory regulates the relation between anaphors (e.g. himself, each other), pronominals (e.g. he, pro) and r(eferential)-expressions (e.g. John, wh-traces) and their antecedents in terms of the notion of "binding". A is said to bind B if A m-commands and is coindexed with B. Central to Binding theory are the Binding Conditions which are formulated as follows (cf. Chomsky (1986a)) :

- (25) (A) An anaphor is bound in a local domain
- (B) A pronominal is free in a local domain
- (C) An r-expression is free

where "local domain" is referred to as Governing Category and is defined as the maximal projection which contains a subject and a governor for A (i.e. anaphor, pronominal or r-expression). Chomsky (ibid) defines Governing Category further as a "complete functional complex" (CFC) by which is meant a maximal projection which contains, obviously, the head (necessary by the principles of X-bar theory), the complements of the head (necessary by the Projection Principle), and a subject whose presence Chomsky assumes to be optional unless required by the principles of predication to license a predicate.

Because Binding theory will not play a crucial role in this work I will content myself here with what has been mentioned, while pointing out that a number of problems arise with respect to Binding Conditions in Berber (cf. Ouhalla (1988c)) and in other languages which seem to suggest that the notion Government Category should probably be parametrised in relation to individual lexical elements (cf. Manzini & Wexler (1987)).

Chapter Two

Verb Movement Sentential Structure

2.1. Introduction

The purpose of this chapter is to analyse the structure of sentential clauses. The main argument is that the inflectional elements AGR, TNS and NEG which are standardly assumed to belong under I should be treated as categories in their own right heading projections according to the principles of X-bar theory. These categories should also be organised in the sentential structure hierarchically with respect to each other and to the verb. The attempt to organise them accordingly is based on the generalisation made by the Mirror Principle (MP) (cf. Baker (1985)) and the constraint on head-movement imposed by the HMC/ECP.

The ultimate structure that results from the combination of these observations and principles is fairly articulated compared with the standard structure, where I is assumed to be the head of the sentence and which harbours a range of inflectional elements that vary from language to language. Having postulated the structure in question the rest of the chapter is spent on pointing out its advantages over its predecessor as in (3) in the previous chapter. It is shown, for example, that it accounts fairly naturally for the SVO/VSO variation among languages in terms of the organisation of the inflectional heads without having to resort to a "directionality parameter". Other properties which characterise VSO languages and differentiate them from SVO languages are shown to fall out without stipulation.

The postulated structure is also shown to account structurally for the

properties of infinitival clauses, both inflected (as in Portuguese) and non-inflected (as in English). Infinitival clauses in general are found to have a TNS node contrary to the common belief. The difference between inflected and non-inflected infinitives is explained in terms of the absence v presence of the AGR node (cf. George & Kornfilt (1981)). The structures of small clauses is argued to be similar to that of infinitival clauses with the difference that in the case of small clauses the predicate is a non-VP category. The latter property is also argued to characterise so called nominal sentences, i.e. sentences which do not contain a verb, as well as some copular constructions.

2.2. Basic properties

2.2.1. Construct system and Case

The morphological shape of nouns in Berber dialects is to a certain extent determined by their position in a syntactic structure. A noun is said to be in the Construct State (CS) when it functions as object of a preposition or a noun, or as a postverbal subject. Otherwise, it is in the Normal/Free State (FS). The CS/FS alternation is manifest by a corresponding morphological alternation determined to some extent by the quality of the sounds which constitute the initial syllable of the noun.

The fact that whether a certain noun is in the CS or the FS depends on whether its governor belongs to the class of categories which induce the CS morphology makes the Construct system look similar to a morphological Case system of the familiar type. However, because the Construct morphology does not correspond synchronically to a Case system traditional grammarians working on Berber have tended to treat the CS/FS alternation as being separate and distinct from Case-marking. We will discuss later a number of other reasons which indicate that the Construct system is in actual fact different from the Case system which also exists in

the language, thus consolidating the conclusion reached by the traditional grammarians but for totally different reasons. Before we do that, however, let us see how the morphological make up of nouns is affected by the CS/FS alternation .

2.2.1.1. Construct-marking

The morphological variation exhibited by nouns in the CS is largely conditioned by the quality of the segments in their initial syllable. The pattern that emerges, however, is highly complex, the complexity being the immediate consequence of an intricate interplay between the number-gender morphology and the CS morphology. The task of disentangling them and isolating each and every morpheme and process requires a detailed morphophonological study which is well beyond the scope of this work (I refer the reader to Guerssel (1976) & (1983) for a phonological study of this phenomenon in relation to the Tamazight dialect). I will therefore simplify considerably the facts that are of immediate relevance to the syntactic issues discussed in this work. We will come back to the morphology of nouns in more detail in chapter 3.

Nouns in Berber are specified morphologically for number and gender. Masculine nouns are generally vowel-initial while feminine nouns are consonant-initial. The initial vowel can be any one of the three basic vowels in the language a, i or u, whereas the initial consonant in feminine nouns is generally t, the consonantal sound of the prefix part of the feminine-diminutive marker ta-t :

(1) a. Masc.

argaz	"man"
ahamosh	"boy"
ilf	"pig"
ushshn	"wolf"

b. Feminine.

targazt	"manhood"
tahamosht	"girl"
taslit	"bride"
tandint	"town"

The CS forms are derived from the number-gender inflected forms of the nouns by two different processes :

- (2) a. prefixing the vowel u- to nouns with initial a or u,
and i- to nouns with initial i;
b. dropping the vowel a of the number-gender prefix
ta- in feminine nouns.

Applying these two processes to the examples in (1) yields the following results :

(3) a. Masc.

u-argaz
u-ahamosh
i-ilf
u-ushshn

b. Fem.

trgazt
thamosht
tslit
tdint

These forms are then subjected to phonotactic constraints which alter their morphological make-up to the extent that in some cases the Construct morphology is obscured completely¹.

It was mentioned above that nouns appear in the CS when they are governed by a P or a N or when they function as postverbal subject. Assuming that the subject in the postverbal position is governed by AGR, we will call, for ease of reference, these governors (i.e. P, N and AGR) Construct-governors. Since the direct object of the verb is never in the CS we will call V a non-Construct-governor (or a Free-governor). Nouns in non-governed positions, such as topicalised and left-dislocated nouns, also appear in the FS. A Construct-governor Construct-marks the noun it Construct-governs, where Construct-marking involves the processes of prefixation and vowel-deletion discussed above. Construct-marking can be thought of as a process of feature-transmittal. The feature [+,- Construct] is subsequently spelled out on the nouns by morphophonological rules. The direct object of the verb will receive the feature [- Construct], which is

manifest morphologically by not undergoing any of the processes in (2).

Notice that in order to guarantee that all Construct-governed nouns are in the CS and that all non-Construct-governed nouns are in the FS we have to have a special filter, a well formedness condition on nouns which would apply at PF, presumably, to filter out the offending nouns. We will call this filter the Construct Condition (CC) and formulate it as follows :

(4) Construct Condition (PF)

- a. *NP if NP is [+Construct] (i.e. is in the CS) and is not Construct-governed; or
- b. *NP if NP is [-Construct] (i.e. is in the FS) and is Construct-governed.

Let us see how the two clauses of this disjunctive condition apply to derive all and only the well-formed constructions :

- (5) a. **y-nya x- u-aghyur/*aghyur**
3ms-rode on- CS-donkey/FS-donkey
"He rode (on) the donkey."
- b. **taddart n-talit/*taslit**
house GEN-CSbride/FSbride
"The house of the bride"
- c. **y-usid u-ahamosh/*ahamosh idnnat**
3ms-came CS-boy/FSboy yesterday
"The boy came yesterday."
- (6) a. ***u-ahamosh/ahamosh y-usid idnnat**
CS-boy/FSboy 3ms-came yesterday
"The boy came yesterday."
- b. **zri-gh *u-ahamosh/ahamosh ithyadn**
saw-1s CS-boy/FS-boy last year
"I saw the boy last year."
- c. ***u-hamosh/ahamosh, zri-gh-t ithyadn**
CS-boy/FS-boy saw-1s-him last year
"The boy, I saw him last year."
- d. ***u-ahamosh/ahamosh ay- zri-gh ithyadn**
CS-boy/FS-boy comp- saw-1s last year
"It was the boy that I saw last year."

The starred noun phrases in (5) are excluded by clause (b) of (4) because

they are in the FS form while they are governed by Construct-governors, P, N and AGR, respectively. The starred examples in (6), on the other hand, are excluded by clause (a) because they are in the CS while they are not governed by a Construct-governor. In (6b) the noun phrase ahamosh is governed by the verb which is not a Construct-governor. In (6a,c&d) ahamosh is without a governor. Notice that the preverbal subject patterns with topicalised and dislocated noun phrases, a fact that should not be surprising once we know that Berber is basically a VSO language (see 2.3.3.2. below for details).

The formal mechanism of the Construct system as explained above looks similar to that of a Case system. What is more, in some cases the Construct morphology serves as an indicator of the grammatical function of noun phrases, a function that is traditionally associated with Case-marking in languages with morphological Case. Consider the following examples :

(7) a. y-zra u-ahamosh argaz
 3ms-saw CS-boy FS-man
 "The boy saw the man."

b. y-zra argaz u-ahamosh
 3ms-saw FS-man CS-boy
 "The boy saw the man."

(8) a. axxam u-amqqrان
 room CS-Amqqrان
 "Amqqrان's room"

b. axxam amqqrان
 room FS-big
 "Big room"

(7a&b) are synonymous. Despite the fact that both arguments of the verb are postverbal the sentences are not ambiguous. In both of them 'boy' is the subject and 'man' is the object of the verb. The reason for the lack of ambiguity is the fact that 'boy' is in the CS and 'man' is in the FS. Because 'boy' is in the CS it must be the subject, and because 'man' is in the FS it cannot be the subject. Similarly, the two noun phrases in (8)

have different meanings. In (8a) amqgran is the object of the noun axxam; he is the possessor of the room. In (8b), however, amqgran, though a noun phrase, functions like an adjective which modifies the room.

The two noun phrases obviously have different underlying structures which can be represented, respectively, as follows, assuming that adjectival modifiers are adjoined to NP :

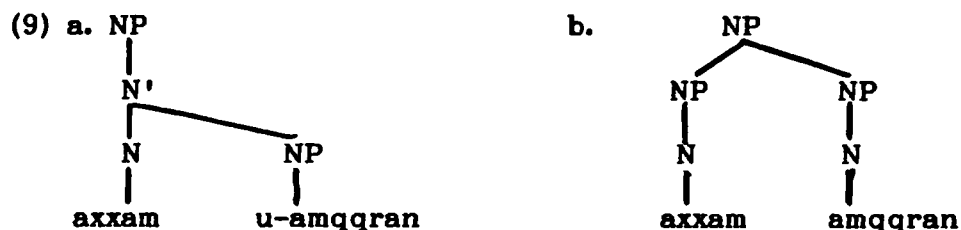

At the surface level it is the Construct morphology which indicates the grammatical function of the noun phrase amqgran. When the latter is in the CS, as in (8a), it can only be interpreted as the object of the noun preceding it. When it is in the FS, as in (8b), it cannot be interpreted as the object of the noun preceding it.

Faced with facts like these it is very tempting to conclude that the Construct system is nothing more than a Case system, a conclusion that has in fact been reached in a number of studies, among them Prasse (1974), Bader and Kenstowicz (1984), Guerssel et al (1985), and Choe (1987). One could strengthen this conclusion further by arguing that if an (abstract) Case system is assumed to exist in the language along with the Construct system there would be considerable unnecessary redundancy since the two systems would overlap in function. However, there are a number of good reasons, both theoretical and empirical, which suggest rather strongly that the Construct system is separate and independent from the Case system, and that it should be treated as being so. We turn to these reasons immediately.

2.2.1.2. Construct-marking v Case-marking

Before we move on to outline and discuss the arguments for not reducing Construct-marking to Case-marking let us have a look at the Case system in the language. Generally, Case in Berber is abstract. However, there exist in the language two elements which have traditionally been treated as either prepositions or morphological Case-markers. These are the genitival element n-, in constructions such as (5b) above, and the dative i- in constructions such as the following :

- (10) t-usha aslm i-u-argaz
3fs-gave FS-fish DAT-CS-man
"She gave the fish to the man."

We will see in the next chapter that these two elements behave differently from the true prepositions in the language in important respects, thus suggesting that they are not genuine prepositions but are probably simply Case-markers. All other Cases in the language, however, are abstract. This is not a surprising conclusion if we assume, along with many linguists, that in English, which also has a generally abstract Case system, the genitival of is also not a genuine preposition but simply a genitive Case-marker.

One argument relates to the fact that the noun phrases to which the genitive and the dative markers mentioned above are attached are always in the CS as can be observed in (5b) and (10). Now if the Construct morphology was sufficient for the noun phrase to satisfy the Case requirement on noun phrases (be it the Case Filter or the Visibility Hypothesis) there seems to be no reason why the Case-markers should appear, and obligatorily so.

Another argument is the fact that the distinction made between the Construct-marking categories and the non-Construct-marking categories does not correspond to the distinction usually made between Case-marking

categories and non-Case-marking categories. V is one of the most robust of all Case-assigning categories, and yet it is a non-Construct-marking category. Looking at this distinction from a different angle we can formulate a further argument, namely, that noun phrases which are governed by non-Construct-governors or are ungoverned (and these include, remember, direct objects of the verb, preverbal subjects, and topicalised and dislocated noun phrases) would all fail to satisfy the Case-requirement. If the latter is understood in terms of the Case Filter then all noun phrases which are either governed by a non-Construct-governor or not governed at all would be excluded, obviously wrongly. If, on the other hand, the Case-requirement is understood in terms of the Visibility Hypothesis then it would mean that all noun phrases in the FS, including the direct object of the verb, would be unable to receive a theta role, again wrongly.

A further argument is the fact mentioned earlier that the Construct system does not correspond, historically, to a Case system (Penchoen (1973)), that is it has not evolved as a substitute for a Case system. To these can be added the fact that in some dialects of Berber the class of noun phrases that are required to be in the CS differs. For example, it has been reported that in Taqbaylit, a dialect spoken in Algeria, even direct objects of the verb are required to be in the CS.

Based on these arguments I will conclude, along with the traditional Berberist grammarians, that the Construct system is independent of the Case system and that it should be treated as such (for a similar conclusion based on relatively different arguments see Guerssel (1987)). As a final remark it is perhaps important ~~to~~ to point out the fact that CS/FS alternation is disappearing from the speech of the younger generation, and this is true not only for the Tarifit dialect but also for the Tachelhit

dialect as has been reported by Boukous (1979). The Construct morphology will not play a crucial role in the rest of this work except as a useful diagnostic to determine the categorial nature of lexical items as well as the underlying structures of certain constructions.

2.2.2. Verb morphology

2.2.2.1. Aspect

The basic verbal oppositions in Berber are aspectual. They mainly involve the perfective and imperfective. However, verbs generally display two more distinct Mood forms which are the aorist and the irrealis. The four forms are articulated by intricate morphophonological variations which affect the internal structure of verbs and are largely of a non-concatenative nature. The following paradigm illustrates these variations with respect to the verbs included which are by no means representative of the whole paradigm in the language (cf. Guerssel (1986a)) :

(11)	<u>Aorist</u>	<u>Perfective</u>	<u>Imperfective</u>	<u>Irrealis</u>	
	af	ufi/a	tt-af	ufi	"Find"
	ar	ari/a	tt-ar	ari	"Return"
	ngħ	ngħi/a	nqq	ngħi/a	"kill"
	sgh	sghī/a	ss-gh	sghī/a	"Buy"

The vowel alternation i/a is determined by the person feature, a being the third person vowel.

The perfective and the imperfective are the most heavily marked for tense. Besides the aspectual information they carry they also convey temporal information. The perfective form usually conveys the past while the imperfective form conveys the present :

- (12) a. y-sgha iharkusn
 3ms-buyPERF shoes
 "He bought shoes."
 b. y-ssagh iharkusn
 3ms-buyIMP shoes
 "He is buying/buys shoes."

The aorist is the least marked with respect to tense. Some linguists (e.g. Penchoen (1973), Bentolila (1981)) have in fact treated it as the unmarked form of the verb.

The aorist occurs typically in clauses which contain the future tense marker ad- (ad-clauses) :

- (13) a. y-tush [ad- y-sgh iharkusn]
 3ms-want to- 3ms-buyAOR shoes
 "He wants to buy shoes."
 b. y-ggur [ad- y-sgh iharkusn]
 3ms-went to- 3ms-buyAOR shoes
 "He went to buy shoes."

Note that the ad-clauses in these sentences correspond to infinitival clauses in English and other languages. In fact control and purposive clauses in Berber are invariably ad-clauses. These facts, along with others, serve as the basis for the arguments in Ouhalla (1986b) that the aorist form can be treated as a sort of inflected infinitival of the type that is reported to exist in European Portuguese (Raposo (1987)). The function of ad- in these clauses would then be similar to the function of to in English to-infinitives. The fact that ad-clauses convey the future tense when used in non-control clauses (14a) and as root clauses (14b) can be made to follow from Stowell's (1983) assumption that to-infinitives do have a tense frame which conveys a possible future (see 2.3.4.1. for details about this point) :

- (14) a. y-nna qa [ad- y-sgh iharkusn]
 3ms-said that to- 3ms-buyAOR shoes
 "He said that he will/would buy shoes."

- b. ad- y-sgh iharkusn dudshsh
 to- 3ms-buyAOR shoes tomorrow
 "He will buy shoes tomorrow."

The irrealis form, on the other hand, occurs typically in clauses with the negation element ur- (ur-clauses) :

- (15) a. ur- y-sgha iharkusn
 NEG- 3ms-buyIRREA shoes
 "He did not buy shoes."
 b. ur- t-ufi umas
 NEG- 3fs-findIRREA her brother
 "She didn't find her brother."

As is shown by these examples the irrealis form by itself, like the perfective form, conveys the past. In order to have a negative present or future tense reading it is the imperfective and aorist, respectively, forms that are used as shown by the examples below :

- (16) a. ur- y-ssagh iharksun
 neg- 3ms-IMP shoes
 "He does not buy shoes."
 b. ur- ad- y-sgh iharkusn
 neg- to- 3ms-buyAOR shoes
 "He will not buy shoes."

It seems that while the irrealis form can only be used in combination with the negation element the negation element can be used in combination with the imperfective and aorist forms, in addition to the irrealis form.

It is clear that the aspectual/mood forms of the verbs in Berber carry tense information. The only form which does not seem to do so is the aorist which we said above is a sort of infinitival form. However, the aorist can only occur in combination with ad- which in a sense is a tense marker because it potentially conveys the future. While ad- is a morphologically distinct element this is not the case with the perfective, imperfective and

irrealis where the tense information is built into the internal structure of verbs. In autosegmental terms one can assume that the four forms in (11) are the result of a mapping process from a common root onto the four prosodic templates which correspond to the four aspectual/mood forms (cf. Guerssel (1986a)). If the mapping process is assumed to take place in the lexicon, given its non-concatenative nature, then it would not be possible to assume the existence of a syntactic tense feature/node in clauses, an assumption that is necessary given the role that Tense plays in the syntax (Chomsky (1981)). On the other hand, one can assume that the aspectual/mood templates are base-generated under a separate tense node as a sort of bound morpheme, and that the mapping process takes place subsequent to raising of the root, also understood as a sort of bound morpheme, to I.

The general framework adopted in this work certainly does not disallow this possibility. The problem is that given that the process is not a straightforward affixational process it is not clear how it can be handled. As a matter of fact it is not generally clear how the theory of morphology adopted here can in general handle non-concatenative processes which are typical of the Semitic languages. My personal opinion is that non-concatenative processes should not offer any major problems to the theory if the consonantal roots and the vocalic tiers on which they are mapped are assumed to be a special type of affixes which require to be mapped onto certain specific templates to be interpretable in practically the same way that affixes require to be attached to certain specific categories to be interpretable. In other words, consonantal roots and vocalic tiers are as morphologically dependent as orthodox affixes and therefore are subject to the AP. The mapping process is performed by phonological rules which apply subsequent to raising of the root to the TNS node in I. I will come back to this point in more detail in the next chapter.

2.2.2.2. Auxiliary ila

The auxiliary verb ila "be" is used in combination with the main verb mainly in sentences which involve temporal contrastiveness or antecedence :

- (17) a. ila/ili-n sghi-n iharkusn atchmi xdl-gh
AuxPERF/AUXPERF-3p buyPERF-3p shoes when arrived-1s
"They had already bought shoes when I arrived."
- b. ila/ili-n uggur-n rux-nni
Aux-PERF/AuxPERF-3p goPERF-3p time-that
"They had left by that time."
- c. ad- ili-n uggur-n rux-nni
to- AuxAOR-3p goPERF time-that
"They will have left by that time."

ila is also used as a main verb in constructions which correspond to copular constructions in English (see 2.4.4. for a detailed discussion of copular constructions) :

- (18) a. y-lla gi- tendint
3ms-AuxIMP in- town
"He is/ has been in the town."
- b. ad- ili-n gi- tndint dudshsha
to- AuxAOR-3p in- town tomorrow
"They will be in town tomorrow."

The fact that ila inflects for agreement, is marked for aspect/mood, and can function as a main verb implies that it is actually a verb and not just an aspect/mood marker. I will therefore assume, for the present moment, that ila, when used as an auxiliary or as a main verb is base-generated under a separate V node which heads a VP that is separate from the VP headed by the main verb (but see 2.4.4. for a radically different view).

The most striking of the properties of ila is that it inflects along with the main verb in the same clause. In many languages, when both an auxiliary and a main verb are present in a clause it is usually the auxiliary that carries the agreement inflection. This makes it possible to assume the

presence of a single AGR element in the clause which is base-generated under a node (I) that is separate from the V node. This assumption clearly runs into problems with respect to clauses like those in (16) where there are two AGR elements. In order to get around this problem it is assumed in Ouhalla (1986b) that the AGR element in Berber is not base-generated separately under I but attached to the verb/auxiliary, a conclusion that has been reached independently by Choe (1987) in relation to the Tamazight dialect.

Because the process of affixation of the AGR element to the verb/auxiliary takes place prior to D-structure there is in principle no limit as to the number of AGR elements that can appear in a clause. The complex V+AGR then raises to I in the syntax obligatorily in order to make it possible for AGR to assign nominative to the subject, a process that cannot take place from the D-structure position of V+AGR for lack of m-command. While this analysis is not implausible I will not adopt it here because it would conflict with some fundamental assumptions that will be made later to account for I structure and the order of the verbal affixes in relation to the verb. I will come back to this point in 2.2.3.4. For reference the AGR paradigm in Berber is given here :

(19) <u>Singular</u>	<u>Plural</u>
1. ---gh	1. n---
2. t---	2. t---m (masculine)
	t---mt (feminine)
3. y--- (masculine)	3. ---n (masculine)
t--- (feminine)	---nt (feminine)

It is clear from the paradigm that some AGR elements are prefixes, others are suffixes, while some others consist of both a prefix and a suffix.

2.2.3. Infl structure

2.2.3.1. Infl elements

The elements that are standardly assumed to occupy the I node are, generally, AGR, tense (TNS), the negation element (NEG) and, in English, Modals. Putting aside AGR for the moment let us consider TNS and NEG. We saw above that past and present tense are conveyed as part of the aspectual information of verbs. The future tense, however, is conveyed by a morphologically distinct element which is ad-. One can assume that TNS oppositions in Berber operate on the basis of the feature [+,- FUTURE] in the same way that TNS oppositions in English are assumed to operate on the basis of the feature [+,- PAST]. When the value of the TNS feature is set positively it is realised as ad-. But when it is set negatively it implies two possibilities [+,- (IM)PERFECTIVE]. Each of the two possibilities incorporated into this feature matrix is realised under the I node by the corresponding vocalic trier, which we are assuming to be a special type of affix. Taking the position of the future marker ad- as being indicative of the position of TNS in the clause we now have to provide evidence that the position held by ad- is really the I position.

One argument can be based on the general assumption that TNS is base-generated under I, and, in a sense, plays a role in assigning Case to the subject (Chomsky (1981)). TNS, therefore, has to be in a position from which it can m-command and govern the subject. The argument receives further support from the fact mentioned earlier that ad-clauses in Berber perform some of the functions that to-infinitives perform in English, with ad- having a status similar to that of to. Since to is usually assumed to occupy the I position the assumption that ad- also occupies the I position becomes only natural. However, the best evidence that ad- occupies the I position, however, comes from the facts of the distribution of clitics in the

language. Since a detailed study of the status of clitics and their distribution is given in chapter 4 we will content ourselves for the moment with a brief survey of their main distributional properties.

Generally, clitics in Berber can only attach to head elements. Their placement, however, is governed by a fairly rigid condition which can be formulated as follows :

(20) Clitic Placement Condition (CPC)

Clitics must attach to the highest head element in a clause.

What this condition says is that if the C position is filled with a complementizer then the clitic must attach to it, and not to any other lower head element in the clause such as the I elements. If, on the other hand, the C position is not filled then the clitic must attach to the I elements, and not to the verb. Finally, if the I position is not filled by any element then the clitic attaches to the verb. The effects of the CPC can be illustrated by the following examples² :

- (21) a. u ay-as ghar- y-sgh-n iharkusn ?
who comp-for-him will- n-buy-n shoes
"Who will buy shoes for him ?"
- b. *u ay- ghar-as y-sgh-n iharkusn
who comp- will-for-him n-buy-n shoes
- c. *u ay- y-sgh-n-as iharkusn ?
who comp- n-bought-n-for-him shoes
"Who bought shoes for him ?"

In (21a) the C position is filled by the complementizer ay- and the clitic is attached to it. (21b&c) are ungrammatical because the clitic is attached to the TNS element ghar- in (21b) and to the verb in (21c) while the C position is filled .

With this much in mind let us consider the following examples :

- (22) a. *y-tush ad-as y-sgh iharkusn*
3ms-wants to-for-him 3ms-buy shoes
"He wants to buy him shoes."
- b. *y-nna qa ad-as y-sgh ihrkusn*
3ms-said that to-for-him 3ms-buy shoes
"He said that he would/will buy him shoes."
- c. **y-tush ad- y-sgh-as iharkusn*
3ms-wants to- 3ms-buy-for-him shoes
- d. **y-nna qa ad- y-sgh-as iharkusn*
3ms-said that to- 3ms-buy-for-him shoes

Now, (22c&d)) is, presumably, excluded for the same reasons that (21b&c) above are, namely by the CPC. Assuming that this conclusion is correct, ad- must be in a position that is higher in the clausal structure than the position held by the verb and lower than the C position. This position is not likely to be anything other than I.

Notice, however, that in example (22b) the clitic is attached to the future marker despite the fact that the C position is filled by a complementizer. This is obviously in violation of the CPC as formulated in (20) and the sentence should consequently be ill-formed, but it is not. The fault lies with the formulation of the CPC. As a matter of fact clitics in Berber generally attach to affixal elements only, so that the CPC should be formulated in such a way that it specifies that the host of the clitic should be an affixal element. This way the complementizer qa, but not the wh-complementizer ay-, is excluded as a possible host, hence the fact that example (22b) is well-formed³.

There exists in the language another future tense marker which is in complementary distribution with ad-. This marker (ghar-) occurs only in clauses which contain the wh-complementizer ay-, clauses which we will refer to in the rest of this work as operator-movement clauses (see Ouhalla

(in preparation) for details) as in (21a) above. There is a selectional relationship between the wh-comp ay- and the I node in that ay- requires I to be filled with ghar- instead of ad- when the TNS frame of the clause is [+ FUTURE]. This selectional relationship is in a sense similar to the corresponding selectional relationship between C and I that is known to exist in English. While for requires I to be [- TNS] that requires it to be [+TNS]. The fact that ghar- is in complementary distribution with ad- implies that ghar- occupies the same position that ad- occupies, namely I. Notice that the test of cliticisation cannot be used in this respect to confirm the conclusion that ghar- does occupy the I position, the reason being that because ghar- occurs only in clauses which contain the wh-comp the clitic would never be allowed to attach to ghar- because of the CPC. For this reason ghar- can never host a clitic, unlike ad-.

The other potential candidate for the I position that we mentioned above is the NEG element ur-. Examples illustrating its position with respect to the verb and the other elements in the clause are in (15) above. One may argue, as in the previous case, that because the negation element is standardly assumed to be an I element the same can be assumed for Berber. This conclusion can be supported by the argument that in order for NEG to have scope over the whole clause in which it occurs and which it negates it is natural for it to be in I because from this position it can m-command the whole IP projection, including the subject position. Further support for the conclusion can be based on the linear order of ur- in sentences like (16b) above which in addition to the verb also contain the future marker ad-. Because ur- precedes ad-, which we concluded is an I element, in linear order, then ur- must hold the same position as ad-. This position is obviously the I position.

The most important piece of evidence for this conclusion in the present context, however, comes from the fact that, like ad-, ur- can also host a clitic :

- (23) a. ur-as y-sgh iharkusn
NEG-for-him 3ms-bought shoes
"He didn't buy shoes for him."
b. ur-tn y-sgh i-Hemmu
NEG-them 3ms-bought DAT-Hemmu
"He didn't buy them for Hemmu."

When ur- is present in a clause the clitic cannot attach to the verb, implying that ur- is in a position that is higher in the structure than the position occupied by the verb :

- (24) a. *ur- y-sgh-as iharkusn
NEG- 3ms-bought-for-him shoes
b. *ur- y-sgh-tn i-Hemmu
NEG 3ms-bought-them DAT-Hemmu

Although the evidence seems to be pretty clear with respect to the elements discussed here it is not so for AGR. Unlike ad- and ur- AGR can never host a clitic. This can be attributed for the moment to some idiosyncratic property of AGR that prevents it from hosting a clitic. It seems to be generally true, as is remarked in Ouhalla (1986b) and Choe (1987), that AGR in Berber is more associated with the verb than with the I elements, a property that differentiates it from the AGR in English, for example, which does attach to the I elements, such as modals, when they are present in the clause. This difference will be explained later in this chapter where a more articulated I structure is suggested and a structural distinction is made between SVO languages such as English and VSO languages such as Berber that will have direct bearing on the status of AGR and its position inside the sentential structure.

2.2.3.2. Standard analysis and problems

Assuming that AGR, like the NEG and TNS elements, is also base-generated under I a standard analysis of the structure of I in Berber would assign it the following form :

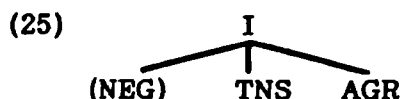

The order in which these elements appear under I is supposed to reflect their order in relation to each other and to the verb. Any different order necessarily results in ill-formedness as shown by the following examples :

- (26) a. * ad- ur- y- sgh iharkusn
TNS- NEG- AGR- buy shoes
"He will not buy shoes."
- b. * ur- y- ad- sgh iharkusn
NEG- AGR- TNS- buy shoes
- c. * y- ur- ad- sgh iharkusn
AGR- NEG- TNS- buy shoes

...etc. While the optionality of NEG is obvious the obligatoriness of TNS isn't and therefore needs explanation.

In the discussion above TNS has been used to refer to the future marker ad-. In present and past tense sentences, however, the latter element does not appear. It could therefore be assumed that in these sentences the TNS node is not base-generated, and therefore its presence is optional just like that of NEG. Past and present, recall, are conveyed, respectively, by the perfective and imperfective aspectual forms of the verbs. Alternatively, one could assume, as we did above, that the aspectual template is base-generated under I (TNS) and that the unmarked form of the verb (i.e. the consonantal root), base-generated under V, is mapped onto it subsequent to V-raising to I. In this case, however, it becomes

difficult to talk about the order of TNS in relation to the other I elements since the aspectual morphology is of a non-concatenative nature. Pending further clarification let us assume the latter view, while pointing out that this choice does not affect the ensuing discussion in any serious sense.

The standard analysis embodied by (25) raises a number of serious problems which cast considerable doubt on its viability. One such problem is the fact that the order of elements in (25) is an extrinsically imposed order. There seems to be no principled reason to prevent the generation of a different order of the elements in question. In different terms, once the verb has moved to I there is no reason why NEG instead of AGR, or TNS instead of AGR should not attach to it first. In order to filter out the undesirable orders an ad hoc principle is required. An analysis that would make the only attested order follow from general principles while at the same time excluding all the other unattested orders on principled grounds is, of course, to be favoured.

The rest of the problems with the standard analysis are better formulated in terms of questions that remain unanswered. First, Why do clitics attach to NEG obligatorily when NEG is present and to TNS when NEG is not present as exemplified by the following sentences?

- (27) a. ur-tn ad- y- sgh
NEG-them TNS AGR- buy
"He will not buy them."
b. * ur- ad-tn y- sgh
NEG- TNS-them AGR buy
c. * ur- ad- y-tn sgh
NEG- TNS- AGR- buy

Secondly, Why do clitics never attach to AGR even when neither NEG nor TNS (ad-) are present?

(28) a.* y-tn sgha
 AGR-them bought
 "He bought them."

b. y-sghi-tn
 AGR-bought-them

The facts of cliticisation are very revealing in this respect because they imply clearly that there is a hierarchical relationship between the I elements. The reason why clitics attach obligatorily to NEG when it is present is because NEG is in a higher position than TNS and AGR. The same can be said about the obligatory cliticisation to TNS when NEG is not present. As to why clitics never attach to AGR the answer could be that AGR is never the highest node in the clause given that TNS is obligatory. If we assume that the I elements are ordered hierarchically in relation to each other and to the verb then the facts of cliticisation would follow naturally from the structure postulated in combination with the CPC. We turn to this point immediately.

2.2.3.3. An articulated Infl structure

On standard GB assumptions about sentential structure and the principles of X-bar theory a possible way of ordering the I elements hierarchically is to assume the following structure for I :

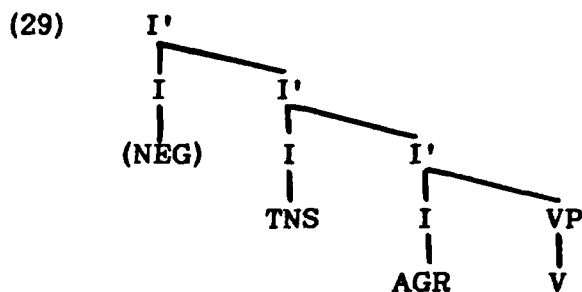

The facts of cliticisation now follow without stipulation. NEG is the highest node, hence the fact that clitics must attach to it obligatorily. When NEG is not present its I' level does not project, thus leaving TNS in the highest

position, hence the fact that clitics must attach to it when NEG is not present. The fact that TNS is obligatory explains why clitics never attach to AGR since AGR is never the highest node.

Although the structure in (29) accounts for the facts of cliticisation it falls short of accounting in a principled way for a number of other facts pertaining to the order of the I elements in relation to V. Presumably, the correct order can be derived from the structure in (29) if the verb is assumed to move stepwise, that is to AGR, then to TNS and finally to NEG. Direct movement to TNS or to NEG would yield the wrong order. The principle that is likely to prevent such movement is obviously the HMC/ECP. Notice, however, that the HMC/ECP would be applicable to (29) only if the elements in question are separated from each other by maximal projections since only maximal projections can be barriers to movement. The nodes that separate the I elements in (29) are single-bar projections and therefore cannot function as barriers to movement. In addition, it is not clear whether one can assume the existence of a theta-marking relationship between the I elements and the single-bar projections they dominate, a relationship that is crucial for the operation of the HMC/ECP, the underlying assumption being that only maximal projection can be theta-marked.

Given this there seems to be no principle that could prevent the verb from moving across AGR and TNS to NEG or across AGR to TNS, thus yielding the wrong order. Although in some cases the structures that would be derived from this type of movement would be excluded independently, by the AP, for example, since AGR, or AGR and TNS, which are affixes, would be left without a carrier in violation of the AP, there are other cases where this would not be the case. These are the cases where AGR is a suffix such as -gh (1sg). One could wonder why TNS (ad-) and AGR cannot

attach to each other to satisfy the AP.

The structure required is obviously one where what we have been calling I elements are separated each from the other by a maximal projection. To this effect I will assume that NEG, TNS and AGR are heads in the sense of X-bar theory, and that each one of them heads a separate maximal projection in the following fashion :

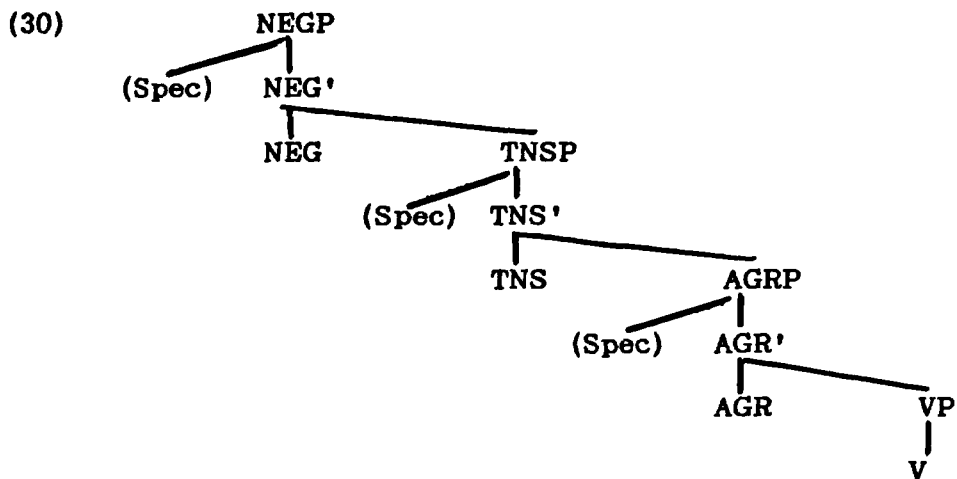

I will assume further that there is a (functional) thematic relationship between these heads and the maximal projections they govern, that is NEG theta-marks TNSP and TNS theta-marks AGRP and AGR theta-marks VP. NEG, TNS and AGR, however, do not L-mark the maximal projections they govern because they are non-lexical categories. As is assumed in Chomsky (1986b) functional heads can only L-mark their complements if a lexical category moves up to them.

The combination of these assumptions yields the correct results with respect to the order of NEG, TNS and AGR in relation to the verb as well as the facts of cliticisation. Given the structure in (30) any attempt to move the verb to NEG across AGR and TNS or to TNS across AGR would necessarily result in a violation of the HMC/ECP since the movement would involve the crossing of a non-L-marked maximal projection. Notice that this

movement is excluded regardless of whether the head elements crossed over are affixal or not. A stepwise movement, however, does not result in a violation of the HMC/ECP since each step voids the barrierhood of the maximal projection crossed. By moving V to AGR the latter becomes an L-marker, thus voiding the VP barrier, and by moving the complex [AGR+V] to TNS the latter also becomes an L-marker, thus voiding the AGRP barrier, and so on :

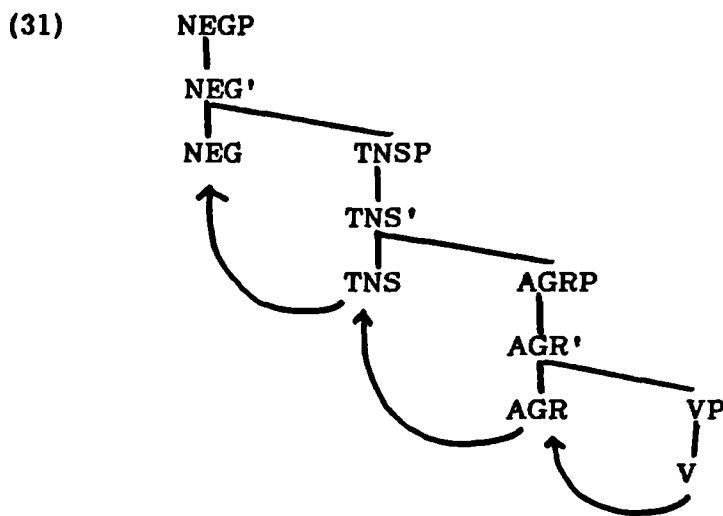

The facts of cliticisation also follow in a straightforward manner. In a structure like (30) the clitic has to attach to NEG because NEG is the highest head element in the clause. When NEG is absent, that is in affirmative clauses, I will simply assume that its node does not project, thus leaving TNS the highest head position in the clause :

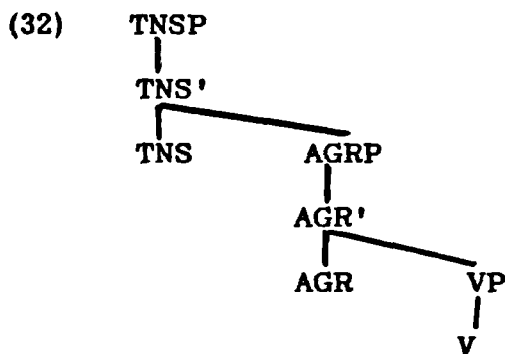

The fact that clitics never attach to AGR follows from the fact that AGR is

never the highest head element because AGR is selected by TNS which we will assume projects obligatorily. We will see later that TNS is an essential element in sentential clauses, that is clauses which make complete sentences.

What the idea underlying (30) amounts to is a rejection of the standard assumption that I exists as a category and consequently that it is the head of the sentential clause. Within the proposed system I has no categorial status except as a convenient cover term for the functional heads. Also, the maximal projection of what used to be the S/IP is not a fixed category anymore. In negative sentences it is NEGP as in (30) while in affirmative sentences it is TNSP as in (32). In fact we will see later that this maximal projection also differs from language to language, a fact that will be shown to account for surface word order variations involving the subject.

Talking about the subject one might wonder where its position in the structures in (30) and (32) is. Assuming, as is standardly the case, that the subject is assigned Case by AGR through coindexation (Spec-head agreement) the obvious position for the subject is the Spec of AGRP. As to the Spec of TNSP and NEGP one could assume that they simply don't project when not needed, specifiers being generally optional elements. This assumption obviously needs clarification with respect to the Extended Projection Principle. We will come back to this issue later in 2.3.2.

The postulation of the structure in (30) is necessary in order to account for the facts of the order of NEG, TNS and AGR in relation to each other and to the verb, as well as the facts of cliticisation, both of which imply that inflectional elements should be ordered hierarchically. In a sense the structure in (30) is also forced by the theoretical apparatus adopted, in particular the HMC/ECP, since we saw above that in order to derive the correct orders we must assume that the inflectional elements are separated

from each other by a maximal projection. The theoretical and empirical viability of the structure in (30) will be vindicated later when word order variations across languages, in particular SVO v VSO, are discussed in detail. It will receive further vindication as the work progresses and other phenomena are brought under scrutiny⁴.

2.2.3.4. Auxiliary ila revisited

In order to have some idea about how the postulated structure accounts for certain facts that the standard I-analysis fails to account for adequately let us turn to the property mentioned earlier and illustrated by the examples in (16), namely, that the auxiliary verb in Berber appears inflected for TNS and AGR along with the main verb. Under the I-analysis this fact is problematic in an obvious sense, since the I-analysis postulates the presence of a single I node which includes a single TNS element and a single AGR element as illustrated by the structure in (18) above. Under the proposed analysis the auxiliary verb and the main verb can be assumed to acquire their TNS and AGR inflections from separate nodes through head-movement as follows :

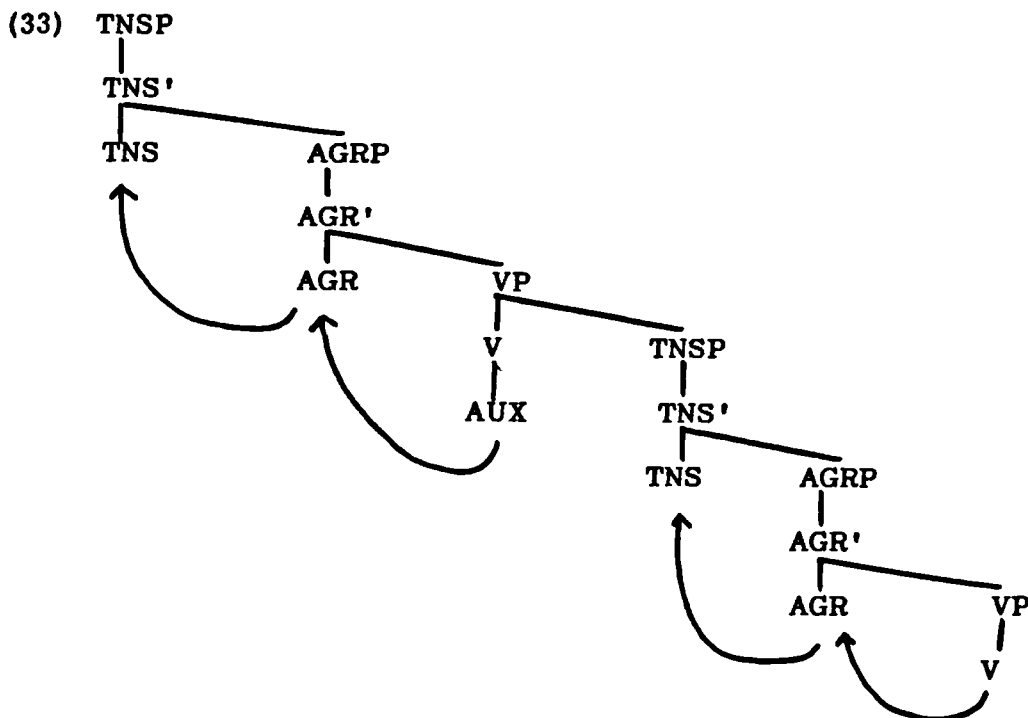

The Berber auxiliary verb selects a TNSP, unlike the auxiliary verb in English, for example, which one can assume selects a VP. AUX acquires its inflection by moving to the AGR and TNS nodes most closely dominating it and the main verb acquires its inflection by moving to the AGR and TNS nodes most closely dominating it. The process is obviously a head-to-head movement motivated by the AP since both AGR and TNS are affixal.

Given that there are two AGR nodes one might wonder what could prevent the base-generation of two distinct subjects for a single clause. The Case requirement certainly wouldn't exclude the possibility in this case because two Cases are available. The possibility would be excluded by the theta-criterion, however, since given that there is usually only one external theta-role available one of the two subjects would fail to be assigned a theta-role. This, however, would not be the case if that subject is a pleonastic element, an expletive *pro* since Berber does not have overt expletives. I will come back to this issue later.

Before I leave this discussion I would like to point out a fact that probably requires a revision of the structure in (33) as well as the assumption that TNS and ASP in Berber occupy the same node. Consider the following examples :

- (34) a. ad-ili-n uggur-n rux-nni
to-AUX AOR-AGR(3p) go-PERF-AGR(3p) time-that
"They will have left by that time."
b. *ad-ili-n ad-uggur-n rux-nni
to-AUX AOR-AGR(3p) to-goAOR-AGR(3p) time-that

Given the structure in (33) which includes two TNS nodes there seems to be no reason why (34b) should be excluded. What the two examples in (34) demonstrate clearly is that while both verbs are marked for aspect/mood there is only one TNS element in the clause. This fact implies that TNS and ASP are probably two distinct elements which head two different maximal

projections. It seems that while there may be two ASP nodes in a clause there may be only one single TNS node.

2.3. Sentential structure

2.3.1. Against a directionality parameter

In recent years there has been a growing conviction among many linguists that the surface order of sentences in VSO languages should be derived from an underlying SVO order instead of these sentences being assigned a flat structure. This conviction came largely as a result of works such as Anderson and Chung (1977), Stephens (1982), McCloskey (1983), and Sproat (1985), among others, which show clearly that VSO languages must be assumed to have a VP node just like SVO languages. The obvious question that this conclusion prompts is, given that both SVO and VSO languages have a similar base-structure what determines their basic surface orders? Whatever the nature of the determining factor in this case is, it would represent the parameter which if set in a certain way would yield an SVO language and if set in a different way would yield a VSO language. This parameter was provided in Koopman (1983), Travis (1984) and Sproat (1985) and came to be known as the "directionality-of-Case-assignment parameter" or simply as "the directionality parameter" as we will call it in this work⁵.

The idea behind the directionality parameter is that VSO languages differ from SVO languages in that the directionality of Case-assignment in VSO languages is strictly and uniformly to the right while in SVO languages it is not. In SVO languages the subject can receive its Case from AGR in I which is to the right, while in VSO languages it cannot because Case-assignment in these languages can only operate rightward. In order for the subject to receive Case, I has to move to a position which precedes

the subject position. This process, however, yields the ISVO order which is not the order sought, so an extra assumption is needed in order to motivate V-fronting and derive the I+VSO order. This assumption has been that I by itself cannot assign Case, it needs to be morphologically supported by a lexical category to be able to do so, hence the necessity of V-movement to I. Among the analyses based on the directionality parameter for deriving the SVO surface order are Sproat (1985) for the Celtic languages, Choe (1987) for Berber, and Fassi Fehri (1987) for Arabic⁶.

One interesting prediction that Sproat's analysis makes is that when I is infinitival the only order possible should be SVO since in this case there would be no reason for I to move to the front and, consequently, for the verb to follow it. The subject in the infinitival clauses must receive Case from a different source. That the prediction is correct is shown by the following examples from Welsh where the subject of the infinitival clause is assigned Case by a prepositional complementizer (but see 2.3.4.2. below for a different analysis for (35b)) :

- (35) a. Disgwyliais i [yr ennilla Siôn] (Harlow (1981))
 expected-1s I that would-win-3s John
 "I expected that John would win."
- b. Disgwyliais i [i Siôn ennill]
 expected-1s I for John to win
 "I expected for John to win."

Notice that the directionality parameter in question reduces to the presence v absence of a restriction on the directionality of Case-assignment by I which is a non-lexical category. In SVO languages I can presumably assign Case both rightward and leftward (or perhaps only leftward) whereas in VSO languages I can assign Case rightward only. The strictly rightward Case-assignment by lexical categories, however, is the same in both types of languages since they both are head-initial languages. Because

complements always follow their heads, Case-assignment is always to the right. Therefore, there is no need to stipulate a directionality parameter for the lexical categories, the restriction follows from the head parameter of X-bar theory. Having said that, the idea that transpires is that the directionality parameter in question seems to be associated with I, more precisely with the AGR element of I.

The idea that parametrisation is associated with lexical items has been suggested in the literature, in particular in Manzini & Wexler (1987) in the form of the Lexical Parametrisation Hypothesis, but the fact that I is a non-lexical category, and more seriously the fact that AGR is generally assumed to be no more than a bundle of features, makes it difficult to imagine the possibility of a parameter associated with AGR/I. Moreover, unlike lexical categories AGR/I assigns Case via coindexation which is generally assumed to be governed not by directionality but by the structural notion of *m*-command.

In addition to what has been mentioned the analyses based on the directionality parameter suffer from other serious theoretical and empirical defects. Sproat's analysis, for example, suggests that I-fronting is a process of daughter-adjunction under S (IP). Within the restricted theoretical apparatus adopted here this process is obviously not allowed. We therefore have to reinterpret the process as a movement to C, apparently the only possibility allowed by the theory and the structure adopted for the sentence. We also have to assume that the verb does not join I in C after I has moved to C, because in this case movement of the verb would violate the HMC/ECP since it would cross over I which is filled by the trace of I. In order to observe the restriction imposed by the HMC/ECP on head-movement processes the verb must be assumed to move to I first and that it is the complex [I+[V]] which results from this movement that moves to C. This process would yield the following

S-structure where the inflected verb precedes the subject :

(36) [CP [C' [I+V]_j] [IP Spec [I' _t] [VP _t NP]]]]

Having said that it is plausible to make the natural assumption that movement to C implies that the C position should be empty or, as we will see later in this work, filled by an affixal complementizer. However, it is quite common for VSO clauses to be embedded under a non-affixal complementizer :

(37) a. y-nna [qa t-sgha Munat iharkusn] (Berber)
3ms-said that 3fs-bought Munat shoes
"He said that Munat bought shoes."

b. Disgwyliais i [yr ennillai Siôn] (Welsh: Harlow (1981))
expected-1s I that would-win-3s John
"I expected that John would win."

That the Berber complementizer qa is not affixal is shown by the fact that it defines a stress domain by itself, as well as the fact, briefly mentioned earlier, that it can never host a clitic despite its position as the highest head element in the clause.

Another empirical respect in which Sproat's analysis breaks down is the failure to account for Grennberg's (1963) Universal 6 which states that VSO languages generally have an alternative SVO order illustrated here by the following examples from Berber and Arabic, respectively :

(38) a. t-sgha Munat iharkusn
3fs-bought Munat shoes
"Munat bought shoes."

b. Munat t-sgha iharkusn
Munat 3fs-bought shoes
"Munat bought shoes."

(39) b. y-nna [qa Munat t-sgha iharkusn] (cf. (37a))
3ms-said that Munat 3fs-bought shoes
"He said that Munat bought shoes."

- (40) a. ?ishtara-t Mariam-u sayyaarat-an
bought-3fs Mariam-NOM car-ACC
"Mariam bought a car."
b. Mariam-u ?ishtara-t sayyaarat-an
Mariam-NOM bought-3fs car-ACC
"Mariam bought a car."
- (41) a. qaal-a [?ishtara-t Mariam-u sayyaarat-an
said-he bought-3fs Mariam-NOM car-ACC
"He said that Mariam bought a car."
b. qaal-a [?inna Mariam-a ?ishtara-t sayyaarat-an]
said-he that Maria-ACC bought-3fs car-ACC
"He said that Mariam bought a car."

The minimal assumption that one can make in this respect is that SVO clauses in VSO languages are instances of subject-topicalisation, a fairly standard assumption among linguists who have worked on VSO languages. In Berber, for example, it is demonstrated in Shlonsky (1987a) and in Ouhalla (in preparation), among others, that "topicalisation" does not involve movement. "Topicalised" subjects are base-generated in their CP-peripheral position and are coindexed with a resumptive pro occupying the subject position and identified by the AGR inflection. Topicalised objects, on the other hand, are also coindexed with a resumptive clitic whose presence is obligatory. The same seems to be true for Arabic (Fassi Fehri (1984) & (1987)).

Having said that, it is clear in what sense the sentences in (39b)) and (41b) are problematic for Sproats' analysis. Because of the assumed restriction on the directionality of Case-assignment by I, [I+[V]] must be in C in these sentences where AGR of I can assign Case to the subject. However, besides the fact that the C position is already filled by a complementizer there is a noun phrase (the preverbal subject) separating the inflected verb from the complementizer, thus implying that the inflected verb cannot be in the C position. Moreover, it is hard to see what sort of position the preverbal subject is occupying given that the assumed

structure (36) simply does not provide for it⁷.

There are a number of other problems, both theoretical and empirical, which face the analyses based on the directionality parameter, but we will content ourselves here with what has been mentioned above. Obviously, an analysis which makes the SVO and VSO orders follow from general and independently motivated properties of the SVO and VSO languages without having to postulate the existence of a directionality parameter, and at the same time accounts in a principled fashion for the empirical problems pointed out above is to be favoured. The directionality of Case-assignment by lexical categories is determined by the head parameter of X-bar theory and therefore need not be assumed to be regulated by a special extrinsically imposed constraint. It is only natural to assume that the directionality of Case-assignment of the subject also follows from some general property, namely the Spec-head agreement relation which, being a relation of coindexation, is not regulated by directionality but the structural condition of m-command. Below I will propose an analysis which seeks to do exactly that. The viability of the analysis will be strengthened by the fact that it makes use of the conclusion reached above with respect to the articulated structure of I. A number of other as yet mysterious properties will also be shown to fall out naturally. As a first step I would like to discuss the thematic structures of verbs and how they can possibly be structurally encoded at D-structure and at other levels of analysis.

2.3.2. Thematic domains and predication

Following a number of recent studies (Kitagawa (1984), Koopman and Sportiche (1986), Kuroda (1985), Fukui (1986), among others) I will assume that the subject of sentences is base-generated in the Spec position of the predicate VP and is then raised to the Spec of IP/AGRP in the following

fashion :

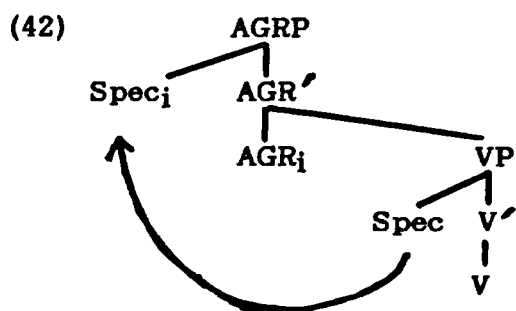

The principle that motivates the movement is the Case requirement on noun phrases. In its D-structure position the subject cannot receive Case either from the verb or from AGR. Although the verb does m-command the Spec of VP it does not govern it because the Spec is on the lefthand side of the verb. Given that Case-assignment operates under government the verb cannot assign Case to the Spec of VP. Notice that even if it was possible for the verb to govern the Spec of VP we should prevent the verb from assigning Case to it because the Case that would presumably be assigned by the verb is the accusative Case, i.e. the wrong Case.

AGR on the other hand cannot assign Case to the Spec of VP because AGR assigns Case via coindexation, and AGR and the Spec position of VP are not coindexed. Notice that the assumption here is that Spec-head agreement is a formal relationship which operates between the head AGR and its Spec position which may be empty at the D-structure level. That is coindexation operates between AGR and the Spec of AGRP position regardless of whether the Spec position is filled or not. Obviously, the element that would fill the coindexed Spec position would have to have grammatical features that are identical to the features contained in AGR. Case-assignment operates only if there is a perfect match of features between AGR and the subject. Alternatively, one can assume, along with

Borer (1986), that Case-assignment by AGR is in itself a manifestation of the agreement relationship between AGR and the subject⁸.

As is pointed out in Kuroda (1986), by assuming that the subject originates in the Spec of VP we overcome one of the long standing theoretical defects in the handling of the principles of X-bar theory, namely that the Spec of VP position never seems to play any role whatsoever in sentential structure. In addition, we simplify the notion of the structural encoding of the thematic structure of lexical categories. Within the framework proposed the thematic domain of a lexical head corresponds structurally to the m-command domain of that lexical head. That is, all the arguments bearing the theta roles associated with a lexical head are contained at D-structure (and at S-structure and LF through traces), within the maximal projection of that lexical head. The single-bar domain is the domain of the head and its complements, that is the domain of the head and its internal arguments, while the Spec position is the domain of the external argument. From this point of view the expression "external argument" refers to the argument that is external to the complement domain of the lexical head. In this sense "external argument" would correspond to any argument that is theta-marked but not strictly subcategorised for by the lexical head. A lexical head directly theta-marks its complements but only indirectly theta-marks its specifier. Consequently, the lexical head theta-governs its complement but not its specifier, assuming that theta-government requires direct theta-marking (cf. Chomsky (1986b))^{9,10}.

Notice that the process of external theta role assignment suggested here differs fundamentally from the quite standard assumption that the subject is assigned a theta role via predication, that is as a consequence of predicate-subject linking¹¹. I believe that external theta role assignment and predicate-subject linking are two different processes which should be

kept distinct from each other. The predicate-subject linking process does not make reference to theta roles as is well known from the fact that the subject does not have to be an argument as in the following examples from Chomsky (1986a) :

- (43) a. It is raining
- b. I expect there to be rain
- c. Its having rained surprised me
- d. It seems that there will be rain tomorrow

Moreover, predicate-subject linking is a process which operates between a predicate and a structural subject regardless of whether an external theta-role is available. Thus, in Italian constructions with postverbal subjects (see Rizzi (1982) and Chomsky (1986a)), for example, predicate-subject linking operates between VP and the expletive *pro* subject even though there is an external theta role available. It also applies between a VP and a pleonastic subject in sentences where there is no external theta role available as in the examples in (43). Predicate-subject linking applies between two syntactic constituents and is blind as to whether the subject is an argument with a theta role or not.

The notion of predication has two aspects, one is purely syntactic and the other is semantic. The semantic aspect of predication follows from Chomsky (1986a)'s principle of Full Interpretation (FI). Every predicate in a sentence must be linked to a subject in order for the predicate to be licensed, that is in order for it to receive an interpretation at LF. The subject in this case must be an argument with a theta role, since expletives do not receive any semantic interpretation. The syntactic aspect of predication, however, does not follow from the principle of FI. It requires predicates to be linked to a formal subject in the syntax (cf. Rothstein (1983)) as a condition of syntactic licensing. A formal subject can

be an argument with a theta role or an expletive as in the examples in (43). In constructions where an external theta role is available the licensing subject usually (though not always) carries that theta role, or if it is an expletive, is linked to an argument which carries that external theta role. On the other hand, in constructions where no external theta role is available the licensing subject is necessarily an expletive element. Expletives make no contribution to semantic interpretation and therefore are eliminated at LF (cf. Chomsky (ibid)). Both these aspects of predication have traditionally been expressed in the form of the Extended Projection Principle.

It is not difficult to see how these notions can be incorporated into the system outlined above. In constructions where an external theta role is available the argument bearing that theta role is structurally realised under the Spec of VP at D-structure. In this position the external argument cannot receive Case, so it has to move to the Spec of AGRP where it can receive Case. In this position the external argument serves as a licensing subject for the predicate in the syntax and at LF. In constructions where no external theta role is available an (overt) expletive is inserted under the Spec position of AGRP to serve as a formal licensing subject in the syntax. In constructions where there is an external theta role borne by an argument that is not occupying the Spec of AGRP, such as there is a unicorn in the garden, the expletive element is inserted under the Spec of AGRP position again to serve as a formal licensing subject in the syntax. At LF the expletive is eliminated as a result of a movement of the postverbal subject to the Spec of AGRP position. In that position the subject serves as a licenser for the predicate as required by the principle of FI.

One of the consequences of the analysis suggested above discussed in

Fukui (1986) is that the distinction between A/A'-positions and θ/θ' -positions is eliminated completely. A-positions have traditionally been defined as the positions in which an argument can appear at D-structure. The subject position (Spec of IP) is therefore an A-position. It is also a θ -position in constructions with active non-raising predicates. In passive and raising constructions, however, it is a θ' -position since it is the target of movement given that movement is possible only to θ' -positions, a consequence of the definition of movement-chain. In the system proposed, however, there is a total overlap between θ -positions and A-positions. The positions in which an argument can appear at D-structure are all and only the positions which are assigned a theta role. It follows that all movements, including that of the subject from the Spec of VP to the Spec of AGRP, are to θ' -positions. Consequently, all movement chains are A'-chains, and in a sense the definition of chain follows in its entirety.

The fact that movement of the subject from the Spec of VP to the Spec of AGRP is movement to an A'-position apparently looks problematic if one hangs on to the assumption that only wh-traces are A'-bound. For a start it is not clear that binding condition A is at all relevant to NP-traces. As is argued in Ouhalla (in preparation) the only principle that seems to govern the distribution of NP-traces is the ECP. As a matter of fact, one can already sense this approach in Barriers where Chomsky avoids an analysis of NP-traces in terms of binding in favour of an analysis in terms of the ECP. In addition, in the system proposed here the A/A'-binding distinction simply does not exist in relation to traces. Since all movements are to A'-positions it follows, trivially, that all traces, whether they are NP-traces or Wh-traces, are A'-bound.

2.3.3. Word order and the Mirror Principle

2.3.3.1. Mirror Principle

Baker (1985) makes the interesting observation that the order in which affixes appear in relation to a host, in particular the verb, reflects the order of the application of the corresponding morphosyntactic processes which attach those affixes to the host. He encodes this observation in a principle which he refers to as the Mirror Principle and formulates as follows :

(44) The Mirror Principle (MP)

Morphological derivations must directly reflect syntactic derivations (and vice versa).

To illustrate the effect of the generalisation made by the MP consider the following abstract example : ...Affix₂+Affix₁+V... The MP implies that the morphosyntactic process which attaches Affix₁ to the verb precedes, that is applies prior to, the process which attaches Affix₂.

To illustrate with concrete examples let us consider the following sentences from Chamorro cited in Baker (ibid) :

(45) a. para#u#fan-s-in-aolak i famagu'un gi as tata-n-niha
irr-3pS-pl-pass-spank the children obl father-their
"The children are going to be spanked by their father."

b. hu#na'-fan-otchu siha
asS -caus-pl-eat them
"I made them eat."

The affix fan- occurs only with plural subjects. In (45a), where the order of affixes is fan-passive-stem, the affixation of fan- follows the affixation of the passive morpheme because fan- agrees with the derived subject. In (45b), where the order is causative-fan-stem, the affixation of fan- precedes the affixation of the causative morpheme because here fan- agrees with the subject prior to the process of causativisation. Baker argues that

fan- affixation and agreement-checking are parallel processes which apply prior to causativisation and subsequent to passivisation. The order in which the agreement, causative, and passive affixes appear in relation to the verb stem reflects the order in which the corresponding morphosyntactic processes of agreement, causativisation and passivisation apply.

It is clear that the generalisation captured by the MP makes sense only within a theory of morphology such as the one adopted in this work, that is a theory that allows for maximum interaction between the rules of morphology and the rules of syntax. Morphological and syntactic derivations are assumed to be isomorphic, in the sense that the morphological processes and their corresponding syntactic processes must match, if they don't the derivation would be ruled out under the generalisation made by the MP.

After having introduced the MP I would like to demonstrate how it gives us an interesting insight into sentential structure and the crosslinguistic typological differences involving surface word order. More concretely, I will argue that the order of the TNS and AGR affixes with respect to the verb reflects directly the position of those elements in the sentential structure, and, consequently, determine the order of the subject with respect to the verb. It will turn out that the difference between SVO languages and VSO languages reduces to the fact that in SVO languages the AGR element follows the TNS element in relation to the verb whereas in VSO languages it precedes the TNS element in relation to the verb.

2.3.3.2. VSO languages

Structure (30) which we constructed earlier for Berber negative sentences reflects the order of the NEG, TNS and AGR affixes in relation to

each other and to the verb. We assumed that the process of affixation of these elements to the verb is the result of a stepwise movement process of the verb dictated by the HMC/ECP. Ignoring for the moment the NEG element let us consider the order derived as a result of V-movement to AGR and TNS and subject movement to Spec of AGRP :

- (46) ad-y-sgh Hemmu iharkusn
 will(TNS)-3ms(AGR)-buy Hemmu shoes
 "Hemmu will buy shoes."

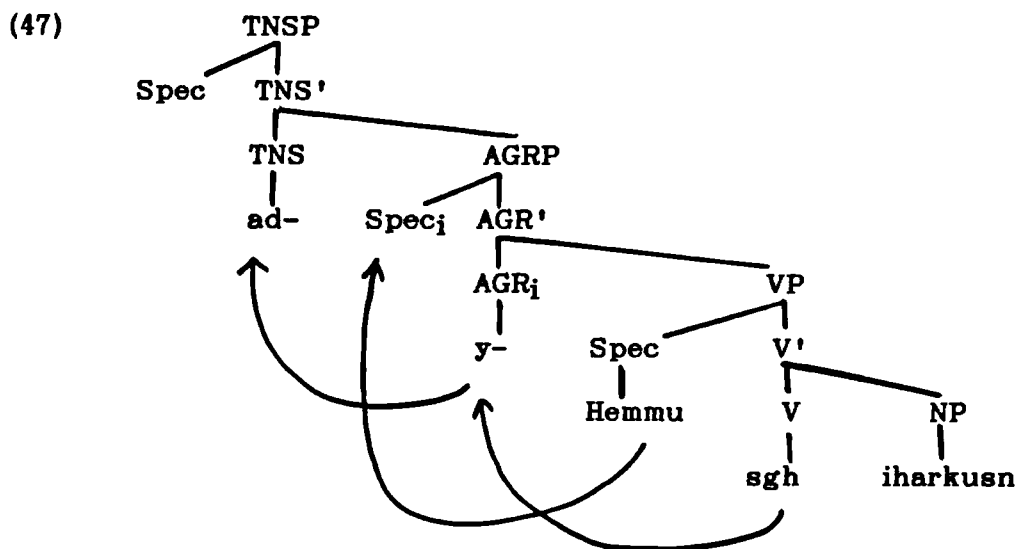

(47) is the structure underlying the sentence in (46). For AGR and TNS to satisfy the AP the verb has to move up to attach to them, assuming that downward movement of TNS and AGR is excluded for the same reason that downward movement processes are excluded in general. In its movement up the verb cannot cross over AGR to move directly to TNS because that would constitute a violation of the HMC/ECP. At S-structure the verb ends up under TNS. The subject Hemmu, on the other hand, moves up to the Spec of AGRP to receive Case since it cannot receive it in its D-structure position for reasons discussed above.

Evidence for the assumption that the VSO order in VSO languages is the consequence of the fact that the AGR element in these languages

precedes the TNS element in relation to the verb in sentential structure can be derived from other VSO languages such as Standard Arabic and Chamorro below (more examples from the Celtic languages will be discussed later) :

- (48) *sa-y-ashtarii Zayd-un sayyaarat-an* (Standard Arabic)
will(TNS)-3ms(AGR)-buy Zayd-NOM car-ACC
"Zayd will buy a car."
- (49) *Para ufan-maigu'* (Chamorro : Chung (1983))
fut(TNS) 3p(AGR)-sleep
"They are going to sleep."

Both Standard Arabic and Chamorro, along with Berber and the Celtic languages, are standard examples of VSO languages in the literature. In all these languages the TNS element follows the AGR element in relation to the verb, thus reflecting the fact that the TNS element is hierarchically higher in the sentential structure, a fact that we established earlier on the quite independent grounds of cliticisation in Berber. At S-structure the canonical position of the subject is the Spec of AGRP where it receives Case from AGR via coindexation. This position is structurally lower than the TNS position, hence the linear VSO order. Viewed as such the surface VSO order falls out as a consequence of the structure based on the generalisation made by the MP, and, with respect to Berber, the facts of cliticisation as well. Recall that clitics in Berber never attach to the AGR element, a fact that follows from the conclusion that AGR is never the highest head element in the clause since TNS, whose presence we assume to be obligatory in every sentential clause, is always higher than AGR, Berber being a VSO language.

In addition to what has been mentioned the proposed analysis provides a straightforward explanation for a well known property of VSO languages which we referred to earlier as Greenberg's Universal 6, namely, that in addition to the basic VSO order VSO languages generally have an

alternative SVO order both in matrix and embedded clauses. Assuming that all maximal projections may take subjects the Spec of TNSP in (47) is the obvious location for the preverbal subject. In this position the subject precedes the verb and follows the complementizer, hence the possibility, illustrated by examples (39) & (41b), that an SVO clause can be embedded under a complementizer, a possibility that is excluded by any analysis which assumes V-movement to C.

Using the SVO alternative of the sentence in (46) for illustration (50a), the structure of SVO clauses is expected to look like the one below :

- (50) a. Hemmy ad-y-sgh iharkusn
 Hemmu will(TNS)-3ms(AGR)-buy shoes
 "Hemmu will buy shoes."

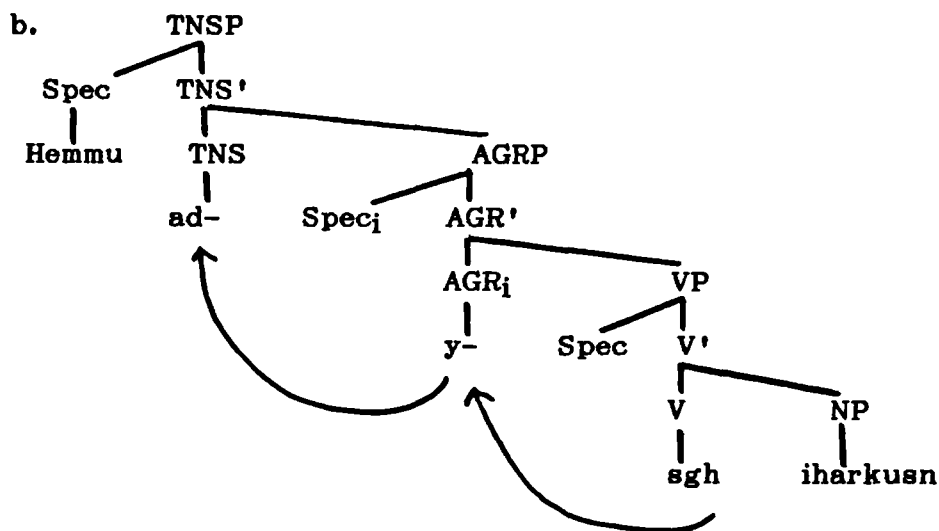

Evidence that the subject in this case is not governed by AGR comes from the fact mentioned earlier that preverbal subjects are never in the CS form. AGR, recall, is a Construct-governor. If AGR did govern the preverbal subject the latter would be required to be in the CS form.

There are a number of questions that need to be answered with respect to the structure in (50). First, Is the preverbal subject moved from the Spec of VP position or base-generated in the Spec of TNSP? Second, if

the subject is moved from the Spec of VP does the movement pass through the Spec of AGRP? Third, if the subject is base-generated in its surface position what elements, if any, occupy the Spec of VP at D-structure and the Spec of AGRP at S-structure ?

Let us consider first the option that the subject is base-generated in the Spec of VP and then raised to the Spec of TNSP. There are two ways the movement can operate via Spec of AGRP or directly. What is at stake here, obviously, is the ECP. VP and AGRP are both potential barriers to movement because they are not L-marked. However, their barrierhood is voided subsequent to V-movement which we are assuming operates obligatorily under the AP. The subject can therefore move to the Spec of TNSP position either directly or through the Spec of AGRP without causing an ECP violation.

The question then is whether the intermediate step, that is movement to the Spec of AGRP, is necessary. One possibility could be that the subject has to move to the Spec of AGRP to pick up Case. However, this possibility is excluded by the fact that the preverbal subject can appear bearing a non-nominative Case assigned by an outside governor as in example (41b) from SA where the preverbal subject bears an accusative Case assigned by the complementizer ?inna. Similar examples can be found in Berber as well. In the following examples the preverbal subject is assigned accusative by the matrix verb illustrated clearly in (51b) by the fact that it can be replaced by an accusative clitic :

(51) a. ufi-n [Hemmu y-sgha iharkusn]
found-3p Hemmu 3ms-bought shoes
"They found that Hemmu has bought shoes."

b. ufi-n-t [y-sgha iharkusn]
found-3p-himACC 3ms-bought shoes
"They found that he has bought shoes."

On the basis of these facts we can conclude that the subject does not move, if it moves at all, through the Spec of AGRP position.

As a matter of fact it is a common belief among linguists (cf. Fassi Fehri (1984)&(1987), Guerssel (1986b), among others) who have worked on VSO languages that preverbal subjects do behave like topicalised elements in a number of respects, among them the fact just mentioned. Assuming this belief to be essentially correct we can conclude that the preverbal subject does not move from the Spec of VP since topicalisation, at least in Berber, is not a movement process, a fact that was pointed out earlier in this chapter and is discussed at length in Ouhalla (in preparation). "Topicalised" elements are base-generated in their surface structure positions and are linked to thematic positions inside the clause. This linking guarantees an interpretation for the topicalised elements under the principle of FI.

Having concluded that the preverbal subject is base-generated in the Spec of TNSP the question that we need to answer now is, What is the nature of the element which is base-generated in the Spec of VP and which, presumably, serves as the receiver of the external theta role of the verb? This element can be assumed to be the pronominal empty category *pro*. There are two options with respect to *pro*, argumental and expletive. Given that *pro* must be linked to the preverbal subject under the principle of FI, and given that there is only one external theta role available it is tempting to conclude that *pro* should be expletive and not argumental. *pro* could then be assumed to receive the external theta role and transmit it to the preverbal subject, thus forming with it a sort of expletive–argument chain or perhaps CHAIN as in Chomsky (1986a)). In order to satisfy the Case requirement *pro* can then be assumed to move up to the Spec of AGRP to receive Case from AGR. However, this would imply that the

argument-expletive chain which includes the preverbal subject and pro has two Cases, a clear violation of the condition that chains have only one Case (cf. Brody (1985) and Chomsky (1986a)). It seems then that the assumption that pro is a pleonastic element cannot be correct.

In order to shed more light on the problem let us have a close look at the nature of the relationship between topicalised elements and the thematic positions with which they are linked. In SA, for example, topicalised noun phrases usually appear in the nominative form, a sort of default form (cf. Fassi Fehri (1984) & (1987)), regardless of whether they are linked to a subject position or to an object of verb position :

- (52) a. Zayd-un_i (,) ?ishatar-a pro_i sayyaarat-an
 Zayd-NOM bought-3s car-ACC
 "Zayd, he bought a car."
- b. Zayd-un_i (,) ra?ay-tu-hu_i lbaariha
 Zayd-NOM saw-1s-him yesterday
 "Zayd, I saw him yesterday."

In (52a) Zyad is the logical subject of the sentence, while in (52b) it is the logical object of the verb. In both sentences the thematic position is occupied by a resumptive pronoun, pro in (52a) and the clitic -hu in (52b). Zayd and the resumptive pro in (52a) bear a similar Case, namely nominative. But in (52b) Zayd bears a nominative Case while the resumptive pronoun bears an accusative Case. It is clear that although the topicalised noun phrase and the resumptive pronoun are linked they can bear different cases. Whether the relationship between the two elements constitutes a chain that is distinct from the usual movement chain in that it can have two Cases or does not form a chain at all, or whether the constraint that chains should have only one Case should be relaxed with respect to some specific relationships are questions that I will not try to answer here.

The parallel between this case and the case of the preverbal subject, however, is clear. The pro base-generated in the Spec of VP is a resumptive pronoun of some sort which receives the external theta role of the verb at D-structure and the nominative Case from AGR at S-structure, subsequent to movement to the Spec of AGRP. This argumental pro is linked to the preverbal subject which, however, is assigned a separate Case from a different source that enables it to satisfy the Case requirement on noun phrases. This different source can either be a complementizer as in the Arabic example in (41b) or a matrix verb as in the Berber examples in (51). In Case there is no governor available that would serve as the source for Case the preverbal subject is assigned Case by a default mechanism just like topicalised noun phrases. It must be emphasized, however, that the structural Case assigned by a governor takes precedence over the default Case, a fact that is well supported by evidence discussed at length in Fassi Fehri (1984) & (1987).

Whatever the nature of the relationship between the preverbal subject and pro turns out to be the fact that is most relevant to the present discussion is that a structure like (50) does provide a natural position for preverbal subjects, thus accounting, in a principled fashion, for Greenberg's Universal 6 mentioned above which characterises VSO languages generally. It should be noticed, however, that rather than being a motivation for the postulation of a structure like (50) for VSO languages, Greenberg's Universal 6 is only a natural consequence of the postulation of structure (50) which was undertaken on quite independent grounds.

Before we move on to discuss SVO languages and how they differ from VSO languages I would like to point out that movement of the pro subject from the Spec of VP to the Spec of AGRP in SVO sentences, in fact movement of subjects to the same position in general, does not give rise to

an ECP violation. The VP barrier is voided by V-movement to AGR. VP does not form a Minimality barrier either because, as will be argued in chapter 4, (see also Ouhalla (in preparation)), NP-trace relations, unlike Wh-trace relations, are not sensitive to Minimality barriers.

2.3.3.3. SVO languages

It was argued above that the VSO order in VSO languages is the immediate consequence of the fact that the AGR element precedes the TNS element in relation to the verb and therefore that the AGR element is lower in the sentential structure than the TNS element. The minimal assumption with respect to SVO languages in this respect is that the SVO order should also be an immediate consequence of the arrangement of TNS and AGR in the sentential structure. Armed with the MP let us look closely at the order of the TNS and AGR elements in the following standard SVO languages, French and Chichewa, respectively :

- (53) a. Marie achè^ht-er-a des souliers demain
Marie buy-will(TNS)-3s(AGR) some shoes tomorrow
"Marie will buy shoes tomorrow."
- b. mdyerekezi a-ku-funa ine, osati iwe (Bresnan & Mchombo (1986))
devil SM(AGR)-past(TNS)-want me not you
"The devil wants me, not you."

The order of TNS and AGR in relation to the verb in these languages, and presumably in SVO languages generally, is the reverse of the order of the same elements in VSO languages as we saw above. Continuing to assume that TNS and AGR are categories in the sense of X-bar theory the MP implies that in SVO languages the verb attaches to the TNS element before it attaches to the AGR element, and, consequently, that the position of TNS in the sentential structure is lower than the position of AGR.

Put together these observations give us the following structure for

SVO languages :

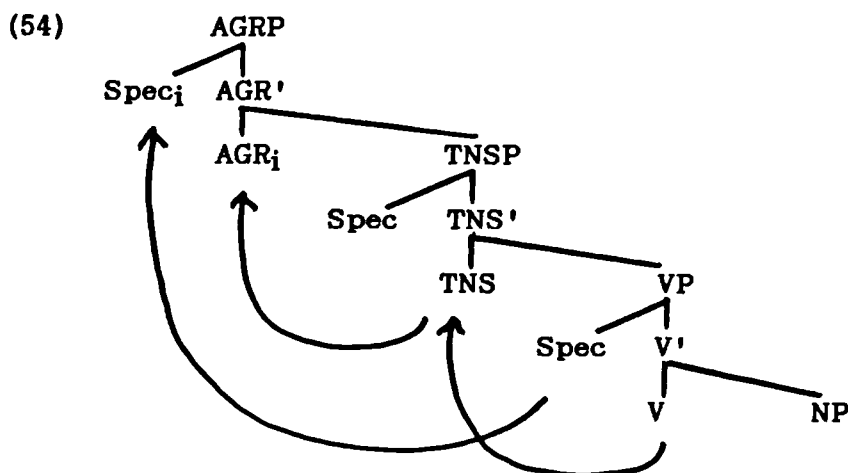

The verb moves up to TNS and then to AGR, a movement that is obligatory by the AP since both TNS and AGR are affixal heads. The subject, on the other hand, moves up from the Spec of VP to the Spec of AGRP to receive Case from AGR through coindexation. The linear order that these two movements produce is SVO, necessarily. In this way the surface SVO order falls out from the properties of the sentential structure which is constructed on the basis of the generalisation made by the MP. As in the previous case there is no need to assume a certain directionality constraint on Case-assignment by AGR. In SVO and VSO languages Case-assignment by AGR is uniform, that is via coindexation^{12,13}.

An obvious question that may be raised with respect to the proposed analysis is, What prevents the subject from moving only as far as Spec of TNSP, thus deriving a VSO order instead of the desired SVO order? Assuming the discussion above, in particular the conclusion that a subject that is not in the Spec of AGRP position must get Case from a different source, one way of excluding this possibility is to assume that, regardless of the nature of the element that would occupy the Spec of AGRP, the subject cannot receive Case in the Spec of TNSP position. The possibility that the subject can be assigned Case by a default mechanism can be

excluded by assuming that this mechanism, being a default mechanism, operates only in the absence of a (structural) Case-assigner. In the discussion of the VSO languages above, the Case assigned by AGR is taken by the argumental pro whose presence at D-structure is necessary in order to saturate the external theta role of the subject. Therefore, the default mechanism can operate to assign Case to the topicalised subject in the Spec of TNSP position. In structure (54) the subject is the only argument present in the sentence. The Spec of AGRP position is empty and therefore is a possible target for the movement of the subject. Therefore, the default mechanism cannot operate since there is a structural Case available.

This way we derive the fact that SVO languages generally do not have an alternative VSO order in the way that VSO languages have an alternative SVO order. The possibility is excluded, in a principled way, by the Case requirement on noun phrases. VSO order is predicted to be possible in SVO languages only if the verb moves to a position that is higher than the AGR position, namely the C position. This prediction is borne out by languages like Spanish where there is evidence (cf. Torrego (1984), Suñer (1987) and Ouhalla (in preparation)) that the VSO order is the result of a process of V-movement to C.

Surface word order variations thus follow without having to appeal to an extrinsically imposed directionality constraint on Case assignment. One can argue, however, that we may still need, within the proposed analysis, a similar sort of constraint that would guarantee the generation of the correct order of AGR and TNS in the two types of languages. This constraint, like the directionality constraint, can also be understood as the parameter which differentiates the two types of languages. My personal belief is that such a constraint is not required at all. The differences can be accounted for in terms of the selectional properties of AGR and TNS in

the two types of languages. In SVO languages AGR selects TNSP and the latter selects VP, while in VSO languages TNS selects AGRP and the latter selects VP. These lexical selectional specifications, I believe, are sufficient to guarantee the generation of the correct order of these elements in sentential structure and consequently the correct surface order of the subject, verb and object.

Among the advantages that this explanation has is that it makes learnability with respect to this particular phenomenon look a relatively straightforward process. One could argue that in the same way that a child learns on the basis of the data presented to her/him that certain verbs are transitive and take certain specific categories as complement she/he learns that TNS and AGR take certain specific categories as complement. In SVO languages the complement of AGR is TNSP and the resulting surface order is SVO given the processes discussed above, while in VSO languages the complement of TNS is AGRP and the resulting surface order is VSO.

2.3.3.4. Celtic languages and Aspect

Using Welsh for illustration, finite clauses are known to have two basic forms. The first is called the simple clause form and is used when TNS, but not ASP is expressed. The second is called the periphrastic form and is generally used as an alternative to the simple clause and when both TNS and ASP are expressed. Both forms, however, have in common the fact that the inflected verb occupies the initial position of the clause. The first form is illustrated by example (55a) and the second by examples (55b&c), respectively :

- (55) a. Darllenodd Siôn y llyfr (Sadler (1988))
 read-3s John the book
 John read the book."

b. Gwnaeth Siôn ennill
 did-3S John win
 "John won."

c. Roedd Siôn yn darllen y llyfr
 pt-was-3S John prog read the book
 "John was reading the book."

The fact that these sentences illustrate clearly is that TNS and ASP are two distinct elements and therefore should be treated as such. This is a conclusion that we came to earlier with respect to Berber on independent grounds despite the fact that in Berber the aspectual forms of the verb do convey temporal information.

On the basis of the data from Welsh it seems possible to assume that, like TNS and AGR, ASP is also a head category in the sense of X-bar theory, that is a head that has an ASPP maximal projection. Given the position of aspectual elements in the clause in (55c) we can assume the following structure for sentences with aspectual elements :

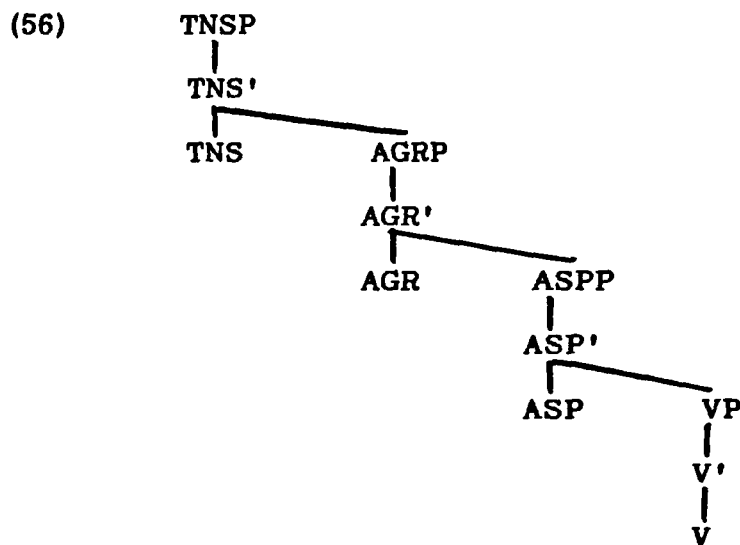

In constructions such as (55a) where there is no visible aspectual element it can be assumed that ASP does not project or that it does project but is left empty. Which option should be chosen may turn out to be an empirical

question. Having said that the question we need to answer is, How does structure (56) allow us to account for the simple-clause/periphrastic-clause distinction and the possible surface orders?

In sentences which do not contain an ASP element the verb can either move to AGR and TNS (as in (55a)) or remain in its D-structure position (as in (55b)). In the latter case a carrier verb is inserted to support the AGR and TNS elements to help them satisfy the AP since they are both affixal. Because the nature of the carrier verb is similar to the English do we will call the process that inserts this dummy element Do-support, a familiar term from earlier work in Generative Grammar. Do can be assumed to be inserted under AGR, thus forming a complex with it which later raises to TNS. Alternatively, we can assume that do is a sort of aspectual element and that it is base-generated under ASP. Its merger with AGR and TNS can then be understood to be the result of a simple process of stepwise ASP-movement.

The reason why in this type of sentences the verb does not carry inflection can be explained in terms of the HMC/ECP. To carry inflection the verb has to move to AGR and TNS. However, to do so it has to move across ASP. If we assume that, like AGR and TNS, ASP is also a non-lexical category, then VP would be a barrier to movement. In sentences such as (55a) we can assume that because ASP is empty the verb can move to it, thus voiding the VP barrier, or that ASP does not project, in which case no problem arises.

A similar analysis can be adopted for sentences such as (55c). The reason why the main verb cannot carry inflection as illustrated by the following examples :

(57) a. *darllenodd Pawl fod wedi y llythrau
read-3S Paul be perf the letters
"Paul had read the letters."

b. Roedd Pawl wedi darllen y llythrau
pt-was-3S Paul perf read the letters

can be attributed to a possible violation of the HMC/ECP. In order for the main verb to carry inflection it has to move up to AGR and then to TNS. However, to move to these positions the verb has to cross over ASP which we assumed above is a non-L-marker, hence a blocker of head-movement out of the maximal projection it governs, namely VP.

The next question that needs to be answered with respect to sentences such as (55c) and (57b) is, What is the status of the auxiliary verb be? There are two possibilities, one is to assume that be is base-generated under a V position heading a VP inside the clause that is separate from the VP headed by the main verb. The other possibility is to assume that be is inserted directly under AGR forming with it a complex which subsequently is raised to TNS. The latter is not an implausible possibility given that be is simply a copula, a dummy verbal form which does not make any contribution to sentence interpretation (see section 2.4. below). The first possibility, on the other hand, receives support from sentences such as the following where be occupies a position between two aspectual elements :

(58) Mae Siôn wedi bod yn gweithio ers amser cinio
is-3S John perf be prog work since time dinner
"John has been working since dinner time."

Notice, however, that this example in fact provides equal support for the possibility that be is inserted in the fashion described above since the sentence contains two be verbs, one is inflected and the other not. The conclusion that seems to transpire is that both possibilities seem to receive equal support from the data.

Assuming that inflected be is inserted in the way described above what we have to account for is the presence of the uninflected be in examples such as (58). Let us assume that ASP has the property that it obligatorily selects a VP so that the presence of two aspectual elements necessarily implies the presence of two VP projections. Example (58) must therefore have two VP projections, one headed by the main verb and the other by be. The latter can be understood as a sort of verbal expletive that is inserted to fill the V position of the VP selected by bod that would otherwise be left empty. Evidence for this analysis of the copula will be discussed later in 2.4. within a more general analysis of copular constructions and nominal sentences.

Based on this analysis the structure of (58) is expected to be roughly as follows :

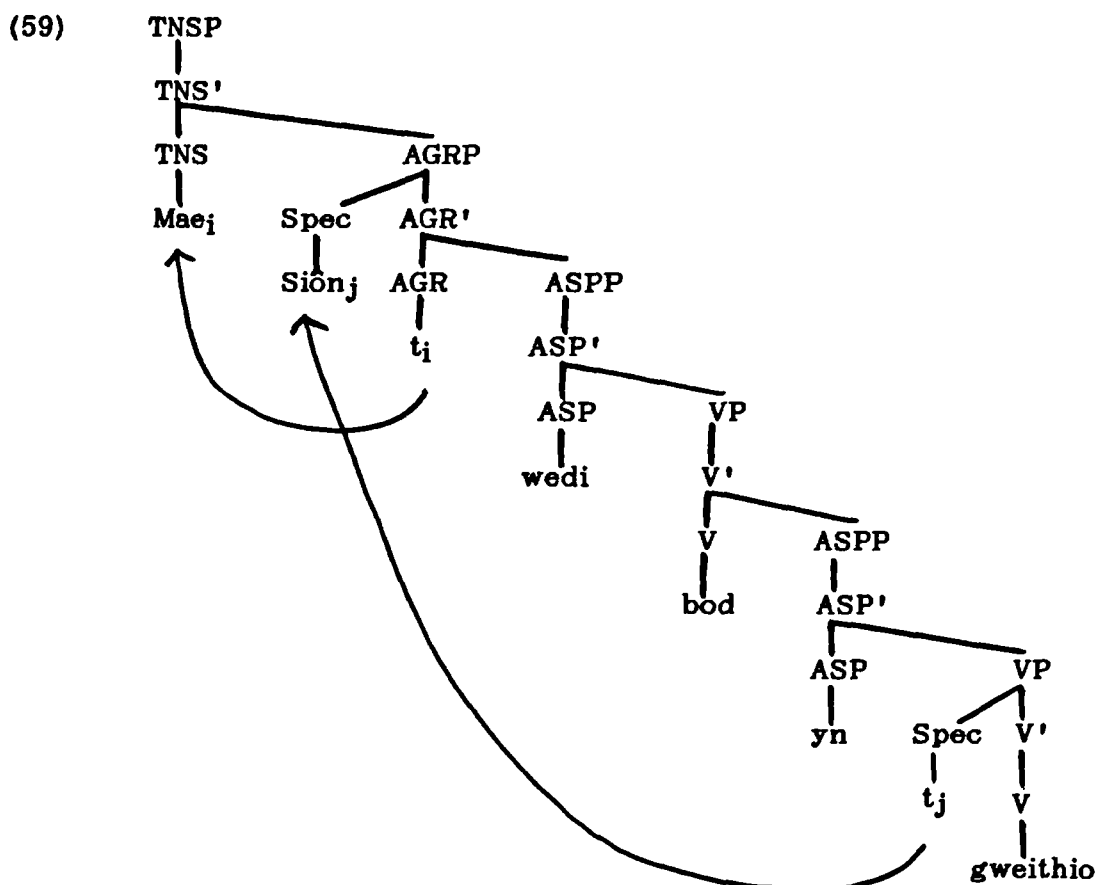

The problem that this structure encounters, however, has to do with movement of the subject from the Spec of VP to the Spec of AGRP. If it is assumed that the main verb and the inserted copula do not move up to the ASP positions that govern them, then movement of the subject would be blocked since both VPs and ASPPs would be barriers. However, if we assume that the two verbs do move to the ASP positions that govern them, then the intervening maximal projections cease to be barriers and the subject can consequently move to its S-structure position in one swoop.

2.3.4. Infinitival clauses

2.3.4.1. Inflected infinitivals

It was pointed out earlier that ad-clauses in Berber serve functions that are typically served by infinitival clauses in many languages. For example, control and purposive clauses, illustrated by the examples in (13), are invariably ad-clauses. For these reasons it was assumed that ad-clauses can be considered to be in a sense similar to the inflected infinitival clauses that exist in European Portuguese (EP), for example, with ad- having a status that is similar to the status of to in English to-infinitives. Given the fact that ad-clauses can also be used as root sentences expressing a future tense, as illustrated by examples such as (46), their structure is identical to the structure of finite clauses in that it contains both an AGR element and a TNS element. This is obvious from the fact that we constructed structure (47) on the basis of example (46) which is an ad-clause. If this is the case then the standard assumption that infinitival clauses are tenseless must be incorrect if tenselessness is understood in terms of the absence of the TNS projection. The alternative view that we have to adopt is the one expressed by Stowell (1983), namely that infinitives do have a tense frame which conveys a "possible future", an assumption that is not only plausible but necessary in Berber where

ad-clauses are used to express future tense.

Because the structure of infinitival (ad-)clauses in Berber is identical to the structure of finite clauses there is no need to reproduce it here. However, it would be interesting to see what the structure of an inflected infinitival clause of an SVO language would look like in comparison. To this effect let us consider closely the following paradigm from EP cited in Raposo (1987) :

(60)	<u>Singular</u>	<u>Plural</u>
1.	eu come-r- \emptyset I eat-r-1s(AGR)	nos come-r-mos we eat-r-1p(AGR)
2.	tu comer-r-es you eat-r-2s(AGR)	vos come-r-des you eat-r-2p(AGR)
3.	ele come-r- \emptyset he eat-r-3s(AGR)	eles come-r-em they eat-r-3p(AGR)

Raposo calls the -r element, which is common to probably all Romance languages (with variation), the "infinitive morpheme", in the same way that a number of linguists call the English to the infinitive marker. If the infinitive marker in EP has a similar status to the English to, and if both these have a similar status to the Berber ad-, then it is quite plausible to make the assumption that the infinitive markers, including that of EP, are TNS elements. Notice that if this assumption is correct it follows that all infinitival clauses have a TNS node and, consequently, are marked for tense if tense-marking is understood in terms of the presence or absence of a TNS element.

As a matter of fact Berber is not unique in making use of the infinitive marker to express future tense. When considered carefully the Romance languages are found to do exactly that. Consider, for example, the French sentence in (53a) above repeated here for convenience along with its equivalent in Spanish :

- (61) a. Marie achet-er-a des souliers demain
 Marie buy-will-3s some shoes tomorrow
 "Marie will buy shoes tomorrow."
 b. Maria compra-r-a zapatos manana
 Maria buy-will-3s shoes tomorrow

Like Berber the Romance languages also make use of the infinitive marker to convey the future. This fact lends significant support to the treatment of the infinitive marker as a TNS element as well as to the assumption that infinitives are indeed marked for tense, contrary to the standard belief¹⁴.

Assuming that this conclusion is essentially correct then the order of TNS and AGR with respect to the verb is as predicted for SVO languages, namely V+TNS+AGR or AGR+TNS+V. As was explained above this order implies that TNS attaches to the verb prior to AGR and, consequently, that TNS is lower in the sentential structure than AGR. The D-structure of an inflected infinitival clause in EP, therefore, looks like the following :

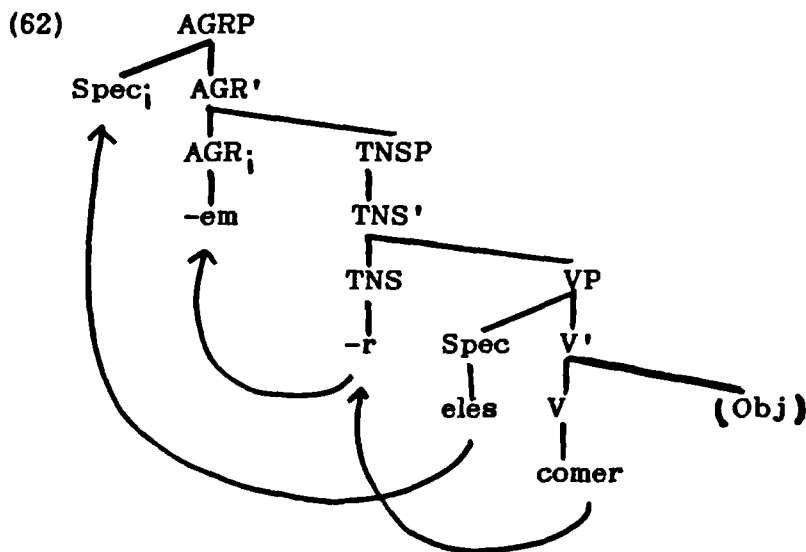

Movement of the verb to TNS and then to AGR is obligatory by the AP since both TNS and AGR are filled by affixal elements. Movement of the subject from the Spec of VP to the Spec of AGRP is necessary by the Case requirement on noun phrases since in its D-structure position the subject cannot receive Case.

2.3.4.2. Non-inflected infinitivals

Corresponding to the inflected infinitival forms illustrated in (60) EP has non-inflected infinitival forms, that is forms where the AGR element is missing. These forms resemble the standard infinitival forms in the rest of the Romance languages and in English. Given that the AGR element is missing and given that, unlike inflected infinitives, non-inflected infinitives cannot take lexical subjects, illustrated by the examples in (63) from Raposo (ibid), the minimal assumption in this respect would be that the AGR node does not project so that the structure of non-inflected infinitival clauses is as in (64) below :

- (63) a. Será difícil [eles aprovar-em a proposta]
 "It will be difficult they to-approve-AGR the proposal."
 b. *Será difícil [eles aprovar a proposta]

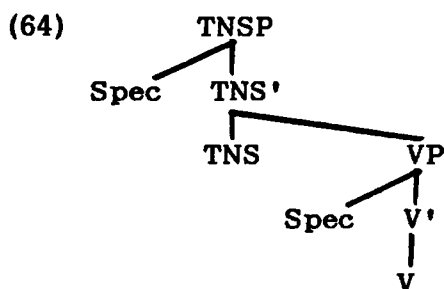

In Romance languages TNS is occupied by the infinitive marker which is affixal, while in English it is occupied by to which apparently is not affixal. In Romance languages the verb moves up to TNS obligatorily under the AP, the infinitive marker being an affix, while in English the verb does not move up to TNS since to is not an affix¹⁵.

If the subject, base-generated under the Spec of VP, is lexical then it has to move to the Spec of TNSP to receive Case from an external governor if such a governor is available. An external governor can either be a prepositional complementizer (as in (65a)) or a matrix verb of the

appropriate type (as in (65b)) :

(65) a. I want [CP for [TNSP him to leave immediately]

b. I believe [TNSP him to have left immediately]

Notice that at its D-structure position the subject would not be able to receive Case, being separated from the external governor by two maximal projections (VP and TNSP) which are barriers to government.

If, on the other hand, the subject is an empty category, presumably a PRO, it can, in principle, either be assumed to remain in its D-structure position or to move up to the Spec of TNSP position, though not for Case reasons, obviously. The latter assumption could be motivated by, for example, predication in the sense that for a syntactic and semantic predication relationship to hold between the VP predicate and PRO the latter has to move to an m-commanding position. Other possible motivations for the movement can be thought of, but I will not discuss them here. Notice that in the Spec of TNSP PRO would still be ungoverned from without because it is protected by TNSP and CP together, the latter, though L-marked, inherits barrierhood from TNSP in the sense explained in Chomsky (1986b)¹⁶.

The above analysis provides wh^t may be the key to a fact that has largely been ignored in the literature, namely, that VSO languages generally lack non-inflected infinitivals. Ignoring for the moment the Celtic languages which involve some slight complication that will be cleared up later, the fact that Berber and Arabic lack non-inflected infinitivals is illustrated by the examples in (66) and (67) below, respectively. As for Chamorro, Chung (1983) states that "both infinitives and finite clauses have an INFlection that includes AGREement features,..." (p. 235).

- (66) a. * y-tush [ad- sgh iharkusn] (cf. (13a&b))
 3ms-want to- buy shoes
 "He wants to buy shoes."
- b. * y-uggur [ad- sgh iharkusn]
 3ms-went to- buy shoes
 "He went to buy shoes."
- (67) a. y-uriidu [?an [y-ashtarii sayyaarat-an]]
 3ms-wants that 3ms-buy car-ACC
 "He wants to buy a car."
- b. * y-urridu [?an [ashtarii sayyaarat-an]]
 3ms-wants that buy car-ACC

The explanation that can be offered within the framework developed here goes as follows. Assuming the existence of a selectional relationship between TNS and AGR as suggested earlier, and assuming that the absence of either of these elements implies the absence of their corresponding projections, the fact that AGR can be lacking in SVO languages but not in VSO languages is a consequence of the fact that AGR in SVO languages is, strictly speaking, not selected, on the contrary it is a selector itself, while AGR in VSO languages is selected by TNS which governs it. In different terms, because TNS in SVO is the top node in the structure it can be missing since no selector requires its presence. In VSO languages, however, the presence of AGR is required by TNS which is its selector.

A relevant question that may be raised in this respect, however, is, Why can't TNS in VSO languages be missing in the same way that AGR in SVO languages can be missing since TNS in VSO languages is the top node and its presence is not required by a selector? The answer to this question lies in the assumption that TNS, unlike AGR, is an essential component of a sentential proposition, an assumption that goes as far back in history as Aristotle. In addition to the predicate and the subject TNS is also an essential ingredient of a sentential clause, that is its presence is required, supposedly, by an independent general principle. The presence of AGR, on the contrary, is required solely to assign Case to the subject so

that if an alternative Case-assigner for the subject is available, as in (65a&b) above, AGR can simply be dropped. That this assumption is probably correct is suggested by the fact pointed out earlier that even infinitival clauses which have traditionally been assumed to be tenseless do seem to have a TNS element.

Let us now turn to the Celtic languages which seem to be problematic for the predicted generalisation that VSO languages generally lack non-inflected infinitives. Continuing to assume that the absence of agreement implies the absence of the corresponding AGR node, the minimal assumption to be made with respect to examples such as (37b) above, reproduced below, is that AGR does not project :

- (68) Disgwyliais i [i Siôn ennill]
expected-1S I for John to win
"I expected for John to win."

The absence of AGR means that the subject must seek Case from a different source. The standard assumption in this particular situation is that the subject receives Case from the *i* element which is assumed to be a sort of prepositional complementizer similar in function to the prepositional complementizer for in English. However, if it is possible for AGR to be missing in Welsh, which is a VSO language, then our analysis above is in a sense challenged because it predicts that in VSO languages the presence of AGR is obligatory because it is required by TNS which is its selector. I would like to argue that once we look closely at the facts of Welsh we discover that the problem is only apparent. In this respect I wish to challenge the standard analysis of sentences like (68) on two crucial accounts. I will argue, first, that *i* is not a Case-assigner, and, secondly, that *i* does not occupy the C position.

That *i* is probably not a Case-assigner is suggested by at least two

different facts. The first, discussed in Borsley (1986), is that *i* occurs in control constructions governing the controlled subject position :

- (69) Mae Gwyn yn awyddus i PRO weld Megan
is Gwyn in eager to see Megan
"Gwyn is eager to see Megan."

Assuming the analysis where the controlled empty subject is PRO, a standard assumption in mainstream GB literature, then in this sentence *i* cannot be a governor of the subject position, still less a Case-assigner. The second fact is that *i* can appear inflected for the subject agreement features, that is can serve as host for the AGR element :

- (70) Disgwyliodd Gwyn iddo (ef) weld Megan
expected Gwyn to-3sgm he see Megan
"Gwyn expected him to see Megan."

The optionality of the pronominal subject *ef* is made possible by the presence of the rich agreement inflection realised on *i*. When the overt pronoun is missing the standard assumption is that its position is filled by a pro identified by the rich agreement inflection (see McCloskey and Hale (1984) in relation to Irish). Now, both the overt pronoun and pro require Case, the former because it is lexical and the latter because Case-marking is a condition for its licensing (see Rizzi (1986b)). This Case is obviously assigned by AGR. But if we assume that *i* is also a Case-assigner then we should have a situation of Case conflict in sentences like (70). The two facts mentioned above therefore argue against the assumption that *i* is a Case-assigner, unless it is assumed that *i* is a Case-assigner in certain contexts but not in others, in which case the assumption amounts to nothing more than an ad hoc stipulation.

The assumption that *i* is a C element is more difficult to challenge on empirical grounds, at least in the present context. However, Sadler (1988) argues that the second fact mentioned above, that is the fact that *i* can

appear inflected for the agreement features can be understood as an indication that *i* is in INFL and not in C. Within the present context I would like to suggest that *i* is simply an infinitive marker just like *to* in English, *ad-* in Berber and *-r* in EP discussed above. Like all these elements *i* is also base-generated under TNS which in Welsh is the top node in the sentential structure given that Welsh is a VSO language. The presence of TNS implies the presence of AGR given the selectional relationship between them. In sentences such as (68) the subject is in the Spec of AGRP where it is assigned Case by an abstract AGR and not by *i*.

Accordingly, the structure underlying example (68) is expected to be as follows :

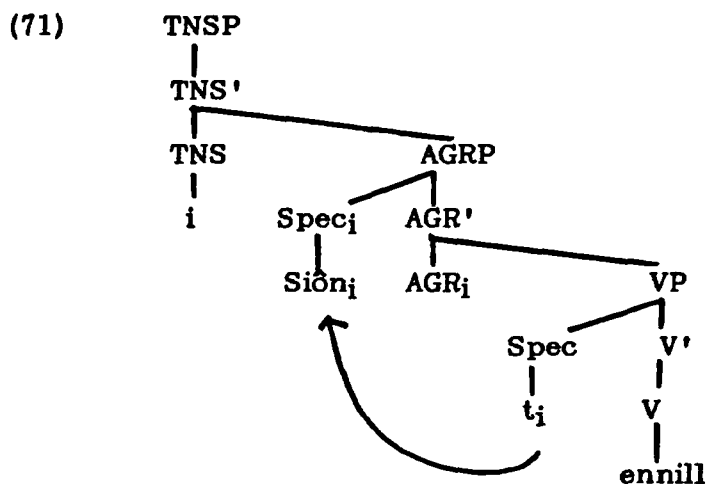

The subject moves from the Spec of VP to the Spec position of AGRP to receive Case from the abstract AGR. If the abstract AGR is assumed to be affixal, in the sense that it needs a carrier, then there are two options. One is V-raising to AGR and the other is AGR-raising to TNS. Both options, however, depend on whether the verb and the element filling the TNS position are suitable closing elements, that is whether they satisfy the specifications of the morphological subcategorisation frame of AGR. From independent evidence we know that both the verb (as in (37a) and others)

and *i* (as in (70)) are possible carriers for agreement. In sentences where AGR is abstract either process can be assumed to have taken place since the movement does not have a visible/audible effect.

However, judging from sentences such as (70) it seems that the process which takes place is AGR raising to TNS. If this is the case we have to explain why the verb cannot move up to AGR and form with it a complex which later moves up, or doesn't move up, depending on whether *i* is affixal or not, to TNS. In this respect Welsh differs from Berber where the surface order as discussed above is ad+AGR+V which suggests the process just described. It seems that for some reason Vmovement to AGR and subsequently to TNS is blocked in constructions such as (70) and, presumably, (68), which fact accounts for their surface SVO order. I will not try to discuss the reason why V-movement is blocked, if it is at all. However, I would like to point out that if the verb does not move out of VP movement of the subject to the Spec position of AGRP would be illegitimate within the present framework since we have made it dependent on verb movement which voids the VP barrier.

If the explanation given here for examples such as (68) is correct then the Celtic languages are no exception to the general tendency among VSO languages not to have non-inflected infinitives. In examples such as (68) the AGR element is present in the same way that it is present in sentences such as (70). The only difference is that in the former the AGR element is abstract, a fact that has led people to believe that it is missing. If the conclusion that the Celtic languages lack non-inflected infinitives is correct then the proposed analysis is vindicated.

Before we leave this topic let me discuss how the proposed analysis accounts for control sentences such as (69). Notice that the assumption that these sentences contain an abstract AGR element which governs the subject

position implies that the controlled empty category cannot be a PRO. So, in a sense the criticism that we levelled against the analysis which treats *i* as a prepositional complementizer with respect to (69) can in this respect be levelled against the proposed alternative analysis. That is, the problem that PRO is governed remains, with a change in the nature of the governor, the new governor being the abstract AGR. However, this would be true only if the proposed analysis assumed, along with the initial analysis challenged above, that the controlled empty category was PRO. That the controlled empty category cannot be assumed to always be PRO is clear from the Berber examples such as the following :

- (72) a. *y-tush* [*ad-y-sgh pro iharkusn*]
 3ms-wants to-3ms(AGR)buy shoes
 "He wants to buy shoes."
- b. *y-rezzu* [*ad-y-sgh pro iharkusn*]
 3ms-try to-3ms(AGR)-buy shoes
 "He tries to buy shoes."

where the controlled empty category subject is a pro that is Case-marked, hence governed, and identified by an overt AGR element. Based on this fact we can assume that in the Welsh example in (69) the controlled empty category is a pro that is Case-marked by the abstract AGR¹⁷.

The problem that arises in this respect is that of identification. Surely, it cannot be claimed that the pro is identified by the abstract AGR because the latter is not overt, still less sufficiently rich. However, it is possible to assume, along with Huang (1984) and Borer (1987), that a controlled pro that is not identified locally by an overt AGR is identified by the controller, that is the subject of the matrix clause which is coindexed with it.

2.3.5. Small clauses

In this section I will try to see what could be the structure of so-called small clauses, illustrated by the English examples below, within the framework developed here :

(73) They consider [him a fool/ out of his mind/ crazy]

Given that small clauses typically lack inflectional elements (I-elements) the minimal assumption would be that neither AGR nor TNS project so that the structure of small clauses is as in (74) below :

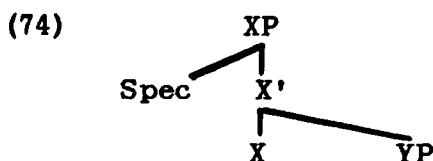

where X = N, P or A

This structure is consistent with the widespread belief that small clauses form syntactic constituents (Stowell (1981), Chomsky (1981)&(1986b), Chung and McCloskey (1987), among others). This belief stems from the requirements of the Projection Principle in the sense that if the verb consider is subcategorized for a proposition at Logical Form then it must take the syntactic equivalent of the proposition at all levels of analysis. In terms developed by Grimshaw (1981), Pesetsky (1982) and Chomsky (1986a) if the verb consider s-selects a proposition then it must c-select the Canonical Structural Realisation (CSR) of the proposition at all levels of analysis. Chomsky assumes that the CSR of the proposition is CP or NP of the appropriate type.

Small clauses, however, cannot be considered to be CPs for familiar reasons, chief among them the fact that the matrix verb governs and assigns Case to the embedded (pronominal) subject illustrated in (73) by the fact that the pronominal subject is in the objective form, a possibility

that is excluded if small clauses are assumed to be CPs since CP in this case would inherit barrierhood from any maximal projection that it dominates thus blocking government and, consequently, Case-assignment. If, on the other hand, the categorial nature of small clauses is assumed, as in Stowell (1983) and Chomsky (1986b), to be determined by the categorial nature of the predicate, that is, if the predicate is an adjective then the small clause would be an AP and if it is a noun then the small clause would be an NP ...etc, then we would lose the generalisation that there is a correlation between semantic categories (s-selection) and syntactic categories (c-selection).

In order to have a broader picture of the problem at hand the examples in (73) should be compared to their paraphrases in (75) below as well as to the Berber sentences in (76) and (77)¹⁸ :

(75) They consider [him to be a fool/ out of his mind/ crazy]

(76) a. thsab-n [Hemmu d-abuhali]
 consider-3p Hemmu ?-lunatic
 "They consider Hemmu a lunatic."

b. thsab-n [Hemmu y-bbuhlel]
 consider-3p hemmu 3ms-become crazy
 "They consider Hemmu to have gone mad."

(77) a. ufi-n [Hemmu gi teddart]
 found-3p Hemmu in house
 "They found Hemmu in the house."

b. ufi-n [Hemmu y-hlek]
 found-3p Hemmu 3ms-be ill
 "They found Hemmu ill."

(76b) and (77b) have in common with (75) the fact that the predicate of the embedded clause is a VP. (76a) and (77a) have in common with the examples in (73) the fact that the predicates of the embedded clauses are non-VP categories. In (76a) it is an NP while in (77a) it is a PP. That the subject of the embedded clause in the Berber examples is assigned Case by the matrix verb is shown by the fact that the subject Hemmu can be replaced

by an accusative clitic attached to the matrix verb :

- (78) a. thsab-n-t d-abuhali
consider-3p-himACC ?-crazy
"They consider him crazy."
b. thsab-n-t y-bbuhlel
consider-2p-himACC 3ms-become crazy
"They consider him to have gone crazy."
- (79) a. ufi-n-t gi teddart
found-3p-himACC in house
"They found him the house."
b. ufi-n-t y-hlek
found-3p-himACC 3ms-be ill
"They found him ill."

Let us focus our attention on (76b), (77b), (78b) and (79b) first where the predicate is a VP and where AGR is overtly realised. These facts imply that we are dealing with a full clause rather than a small clause. The structure of these clauses must be similar to the structure of examples such as (51) discussed above, that is they are instances of clauses with an SVO order. The preverbal subject in these clauses, we concluded above, is base-generated under the Spec of TNSP and receives Case from either an external governor, e.g. a matrix verb, or by default. The Spec position of AGRP is filled by an argumental pro which receives Case from AGR. The preverbal subject and the pro are in a topic-argument relationship expressed by some sort of coindexation. The structure involved has the following form :

- (80) ...V [TNSP Hemmu TNS [AGRP pro [AGR' AGR [VP V...]]]]

This analysis can be extended to the English example in (75) in a straightforward way. We concluded earlier that non-inflected infinitivals in SVO languages have the property that AGR does not project, suggested by the lack of the agreement inflection. Lack of AGR implies that the subject must seek Case from an outside governor which in (75) is the matrix verb.

However, to be accessible to government by the matrix verb, the subject has to move from the Spec of VP to the Spec of TNSP so that the derived structure would look like the following :

(81) ...Consider [TNSP him [TNS' to [VP be ...]]]

Alternatively, the subject can be assumed to be base-generated in the Spec of TNSP as in the Berber SVO sentences discussed above. This assumption is supported by the fact, to be discussed extensively in the next section, that the verb be is not a theta-role assigner simply because it does not have a thematic structure associated with it. If this is true then the subject in (81) has to be assumed to be base-generated in the Spec of TNSP. The structure is an instance of an ECM construction in the traditional sense which requires CP deletion to allow the matrix verb to govern into the Spec position of the maximal projection it governs.

With these ideas in mind let us see what could be the structure of the clauses, which lack a verb, and, apparently, inflection could be. Given the fact that these so-called small clauses express complete propositions let us assume that at D-structure they are CPs, which is the CSR of propositions as we saw above, and that they undergo CP-deletion in the syntax. This way we can preserve the attractive correlation between semantic and syntactic categories as well as the content of the Projection Principle. Let us assume further, as suggested earlier for independent reasons, that TNS is an essential component of a proposition so that each of the small clauses must be assumed to have a TNS node. Given that the tense specification of small clauses is identical to that of matrix clauses we can assume that TNS in small clauses is anaphoric in nature, hence perhaps the fact that it is abstract. In different terms, the TNS frame of small clauses is bound by the TNS frame of the matrix clause. Assuming that binding is a form of identification, in the sense that the content of the bindee is determined or

derived from the content of the binder, the fact that TNS is abstract does not result in a loss of its specification.

The combination of these assumptions leaves us with a structure like (82) for small clauses in English and a structure like (83) for small clauses in Berber, after CP-deletion has applied :

(82) [TNSP Subject [TNS' TNS [NP/PP/AP ...]]]

(83) [TNSP Subject [TNS' TNS [AGRP Spec AGR [NP/PP ...]]]]

The presence of AGR in (83) is necessary because it is selected by TNS. The Spec of AGRP can be assumed to be occupied by an expletive pro Case-marked by AGR which is abstract. Alternatively we can assume that AGR in this particular case is not a Case-assigner and that the Spec of AGRP remains empty, or simply does not project, given that the projection of Spec positions is generally optional.

The subject in (82) and (83) is in the Spec position of TNSP. It can either be assumed to have been moved from the Spec position of the predicate or base-generated there. Given that the predicate can be a PP or an AP it is not clear in what sense the subject can be considered the external argument of a P or an A. We will therefore tentatively conclude that the subject is base-generated in the Spec position of TNSP. This conclusion renders small clauses similar to their non-small counterparts in that they have similar structures with similar properties. (83) is similar to (80) and (82) is similar to (81). The only difference is that the predicate in (80) and (81) is a VP whereas in (82) and (83) it is an NP, a PP or an AP. Each of the two pairs can be collapsed into a single structure by representing the predicate with a variable category.

This conclusion implies that the predicate of a clause can be a non-VP category, thus putting all phrasal categories on the same footing as VP in

that they can also function as predicate of a sentential clause, a function that has been traditionally considered to be a prerogative of VP (cf. $S \rightarrow NP\ Infl\ VP$). It is around this issue that the discussion in the next section centers, where the structures of nominal and copular constructions are investigated and found, in some cases, to have non-VP predicates.

2.3.6. The status and position of NEG

In structure (30) above NEG, strictly speaking NEGP, is the top node, thus reflecting the fact that the negation element in Berber follows the AGR and TNS elements. This fact is illustrated by examples such as (16b), repeated here :

- (84) ur- ad- y- sgh iharkusn
NEG will(TNS) 3ms(AGR)- buy shoes
"He will not buy shoes."

In English, however, the NEG element seems generally to precede the TNS and AGR elements in relation to the verb :

- (85) a. Mary does not like apples
b. *Mary not likes apples
c. Mary will not eat apples
d. *Mary not will eat apples

This fact suggests structure (86) below for negative sentences in English where NEG immediately dominates VP. The structure of negative sentences in Berber is reproduced for comparison :

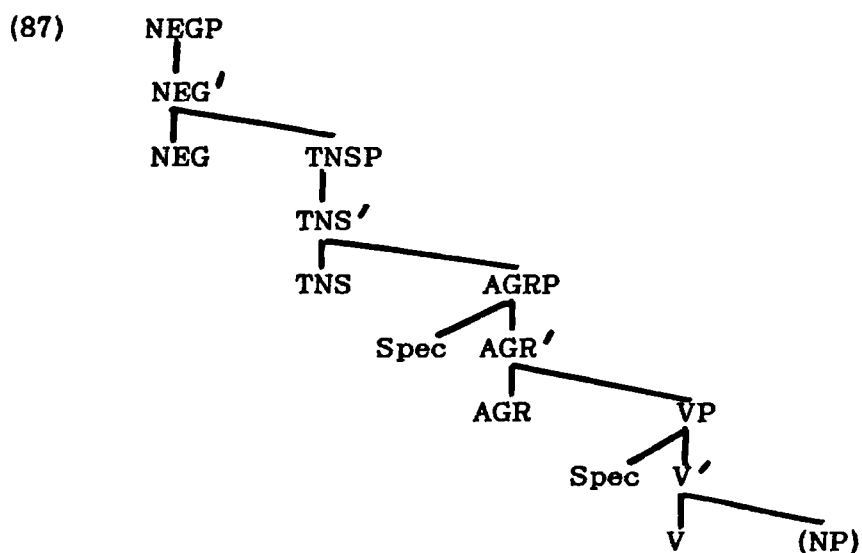
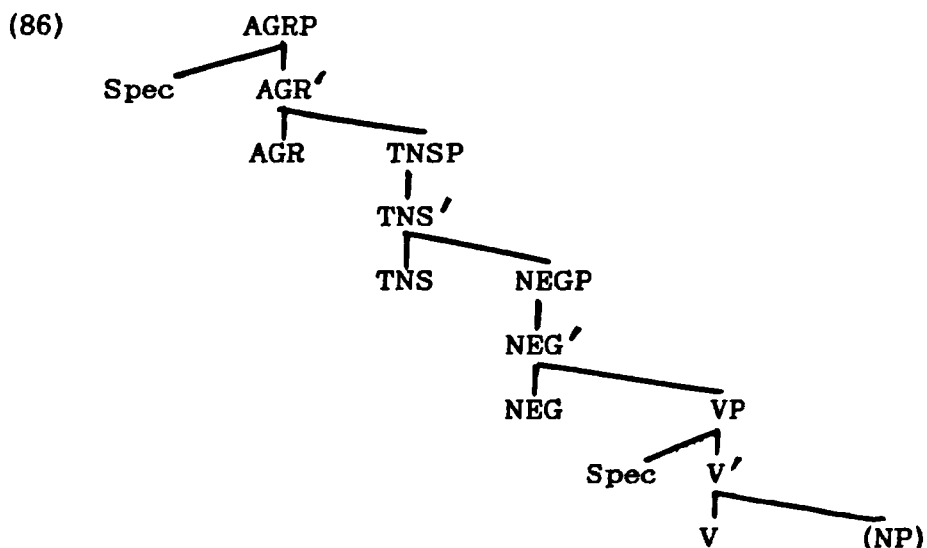

Notice, incidentally, that the order of the elements NEG, TNS and AGR in Berber is the mirror image of the order of the same elements in English. In Berber it is NEG+TNS+AGR while in English it is AGR+TNS+NEG¹⁹.

Having said that let us see how the two structures account for the grammaticality patterns in the two languages. Let us see first how structure (86) accounts for the ungrammaticality of the examples in (85b&d) as well as the ungrammaticality of the following examples :

- (88) a. *Mary likes not apples
b. *Mary will eat not apples

(85b&d) can be derived either by movement of NEG to a position preceding the AGR position or by movement of AGR and TNS down to the verb, a sort of Affix Hopping process in the traditional sense. I want to argue that both processes are illegitimate for principled reasons, hence the ungrammaticality.

With respect to the first process the movement is disallowed by the HMC/ECP since NEG would have to cross over both TNS and AGR. In addition, there is no head position available that could serve as the landing site for the moved NEG, certainly not C because negative sentences can generally be embedded under a complementizer, a fact that hardly needs illustration. The second process, on the other hand, involves a lowering movement which is also disallowed by the HMC/ECP for familiar reasons having to do with the fact that the moved element would fail to m-command its trace. Besides, in (85d) will can hardly be called an affix.

(88a&b) are excluded for similar reasons. They can be derived either by a process of NEG lowering or by a process of V raising. The first is excluded for the same reason that the process of Affix Hopping is excluded, namely that the trace would fail to be antecedent-governed. Moreover, not is not an affix and it is not clear which position it moves to. The second process, on the other hand, is excluded by the HMC/ECP since it involves movement across the NEG position.

Having explained why (85b&d) are ungrammatical let us now see how (85a&c) are derived. One possibility is to assume that, because the TNS and AGR elements, at least in (85a), are affixal, they require a carrier to satisfy the AP, and that because of this reason do is inserted to serve as a support for them. This analysis, however, does not extend easily to (85c)

unless will is assumed to also be a carrier instead of an orthodox tense marker. Alternatively, we can assume, as we did earlier with respect to the Welsh do, that do and will (probably all Modals) are in fact ASP elements which are base-generated under an ASP node which precedes the NEG node as in the following structure²⁰ :

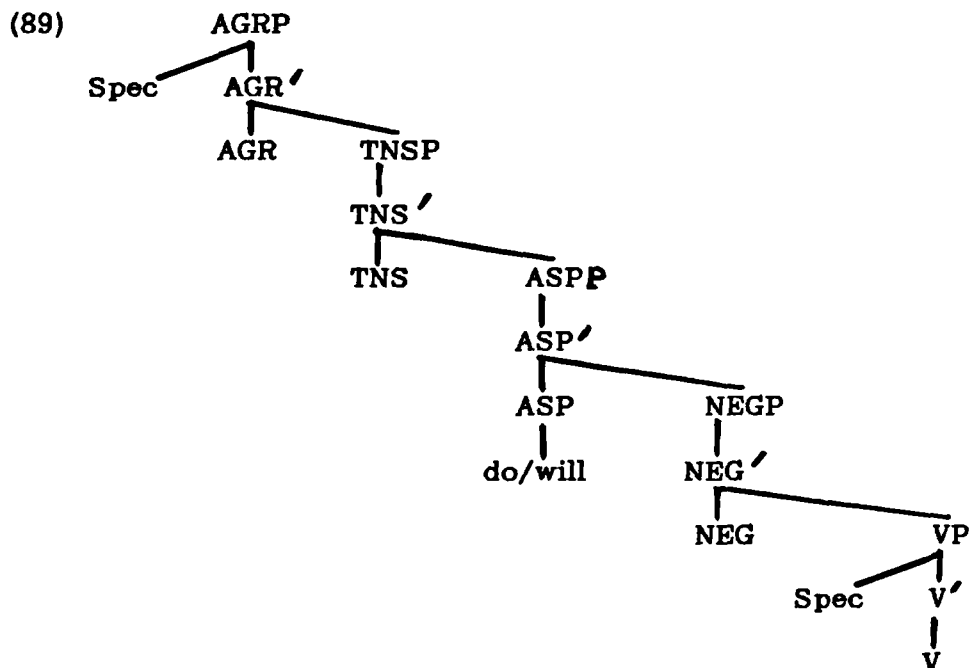

From the ASP position do and will raise to TNS and then to AGR, thus helping them satisfy the AP²¹.

There is a third logical possibility which is not excluded in principle but which does not seem to be supported by the data, namely that the verb can move to NEG and from there to AGR and TNS. But this process implies that the order of NEG, AGR and TNS with respect to the verb should be TNS+AGR+NEG+V, which obviously is not the order attested. The question that one might raise in this respect is, Why is this process not attested? One possibility could be that V-movement to NEG is blocked by some barrier, namely VP. The possibility that the VP barrier can be voided once the verb has moved up to it can be excluded by assuming that unlike the other functional head categories NEG does not theta-mark its

complement (VP) so that even if the verb moves up to it L-marking would always fail to obtain for lack of theta-marking.

That this cannot be the case in Berber, however, is shown by the Berber example in (84) where the complex TNS+AGR+V is attached to NEG, thus implying that the verbal complex moves to NEG without causing an ECP violation. In different terms, the fact that the complex can move up to NEG without giving rise to ungrammaticality under the ECP implies that NEG must theta-mark its complement so that L-marking holds subsequent to movement. A more plausible explanation for the fact that the verb cannot move up and attach to it in English but it can in Berber is that NEG in English is not affixal whereas in Berber it is. In other words, movement of the verb to NEG in English is not motivated (by the AP) in the same way as movement of the verb to NEG in Berber is since the negation element in Berber is clearly affixal (but see chapter 4 for a different explanation)²².

There are, however, two exceptions to the general pattern illustrated by the examples in (88) that the verb cannot precede the negation element in linear order. These exceptions are the aspectual verb have and the copula be :

- (90) a. Mary has not accepted the offer
 b. *Mary does not have accepted the offer
 c. Mary is not happy about the offer
 d. *Mary does not be happy about the offer

Under the analysis proposed above the grammaticality pattern expected is the reverse of the one displayed in (90), that is (90a&c) are expected to be ill-formed while (90b&d) are expected to be well-formed. (90a&c) should involve a HMC/ECP violation if have and be are assumed to be moved from VP across NEG. Since (90b&d) do not involve such a movement the possibility of HMC/ECP violation does not arise and therefore the sentences

should be well-formed.

However, as has just been said, this would be true only if have and be were assumed to be base-generated inside VP and then moved from there. Given that have is an aspectual element it is not implausible to assume that it is base-generated not inside VP but under ASP which, as illustrated by structure (89), precedes the NEG node. Its movement from that position to TNS and AGR does not give rise to a HMC/ECP violation, thus accounting for the well-formedness of (90a). A similar analysis can be adopted for be. If be is also assumed to be base-generated under ASP, then its movement to TNS and AGR proceeds in a similar fashion. Alternatively, we can assume, as we did earlier for the Welsh example in (58), that be is inserted directly under TNS to serve as a carrier for TNS and AGR by virtue of TNS+be movement to AGR. On both accounts the predicate of (90c) would not be a VP but an AP with happy as head. As to the ungrammaticality of (90b&d) it can be accounted for in terms of an illegitimate (lowering) movement of have/be or an illegitimate (long) raising movement of NEG.

2.4. Nominal sentences and copular constructions

2.4.1. Introduction

Berber, along with Arabic (Fassi Fehri (1984)&(1987)), Hebrew (Doron (1983)&(1986), Rapoport (1985)), Russian (Kayne (1984)), has a class of sentences referred to traditionally as nominal sentences because they do not contain a verb. Their predicate can be an NP (91a), a PP (91b) or an AP as in the Standard Arabic example in (91c). The equivalents of nominal sentences in English and similar languages contain a copular verb²³ :

- (91) a. Hemmu d-amhdar
Hemmu ?-student
"Hemu is a student."

- b. Hemmu gi teddart
 Hemmu in house
 "Hemmu is in the house."
- c. Zayd-un mariid-un
 Hemmu-NOM sick-NOM
 "Hemmu is ill."

The analyses suggested in the literature for these sentences have varied between three major opinions. Fassi Fehri (1984), for example, argues, on the basis of SA, for the orthodox sentential structure specified by the PS rule $S \longrightarrow NP\ INFL\ VP$, implying that every sentence must have a VP predicate. The copular verb, which is assumed to be present at D-structure, fails to surface for some reason. Doron (1983) & (1986), on the other hand, argues, on the basis of Hebrew, for a sentential structure with a non-VP predicate so that the predicate in sentences such as (91a) is an NP, a PP in (91b) and an AP in (91c). Kayne (1984) argues, on the basis of Russian, for a third position where nominal sentences are treated as small clauses in the orthodox sense of small clause. This view is adopted for Hebrew by Rapoport (1985).

There exists in Berber another class of nominal sentences which, typically, contain atmospheric predicates. The following, for example, are complete sentences which express complete propositions :

- | | |
|--|--|
| <p>(92) a. (d-)asmmid
 ?-cold
 "It is cold."</p> | <p>c. (d-)anzar
 ?-rain
 "It rains."</p> |
| <p>b. (d-)arih
 ?-wind
 "It is windy."</p> | <p>d. (d-)adfl
 ?- snow
 "It snows."</p> |

Like the examples in (91) these sentences also lack a verb. Unlike the examples in (91), however, these sentences lack an overt subject as well. If atmospheric predicates are assumed to assign a special atmospheric theta role then we have to assume the presence of an empty atmospheric

quasi-argument in these sentences. If, on the other hand, atmospheric predicates are assumed not to assign a theta role then we have to assume the presence of an empty pleonastic subject required by the theory of syntactic predication as explained above. On both accounts the subject can be assumed to be a pro.

In order to have a comprehensive picture of nominal sentences a number of facts have to be pointed out. First, note that the presence of a copula in the sentences in (91) is optional. The following are perfect paraphrases of the sentences in (91) with the auxiliary verb ila in the imperfective form :

- (93) a. y-lla Hemmu d-amhdar
 3ms(AGR)-beIMPR Hemmu ?-student
 "Hemmu is a student."
 b. y-lla Hemmu gi teddart
 3ms(AGR)-beIMPR Hemmu in house
 "Hemmu is in the house."

When the auxiliary verb is present the sentences display the basic VSO order with the SVO order as a possible alternative.

Secondly, the past tense and future tense equivalents of the nominal sentences in (91) require the presence of an auxiliary verb obligatorily. (the *() notation here means that the sentences, understood to have a past tense reading, would be ill-formed with the auxiliary verb missing) :

- (94) a. *(y-ila) Hemmu d-amhdar
 3ms(AGR)-bePERF Hemmu ?-student
 "Hemmu was a student."
 b. *(y-ila) Hemmu gi teddart
 3ms(AGR)-bePERF Hemmu in house
 "Hemmu was in the house."
 c. *(ad-y-ili) Hemmu d-amhdar
 will-3ms-be Hemmu ?-student
 "Hemmu will be a student."

- d. *(ad-y-ili) Hemmu gi teddart
 will-3ms-be Hemmu in house
 "Hemmu will be in the house."

That the sentences in (91) have a present tense reading is shown by the following examples (cf. Fassi Fehri (1987) for similar examples from Standard Arabic) :

- (95) a. Hemmu d-amhdar rux/*ithyadn/*dudshsha
 Hemmu ?-student now/last year/tomorrow
 b. Hemmu gi teddart rux/*idnnat/*dudshsha
 Hemmu in house now/yesterday/tomorrow

The fact that nominal sentences are sensitive to present tense adverbials but not to past tense and future tense adverbials shows clearly that they necessarily have a present tense reading.

Thirdly, the negative counterparts of the Berber nominal sentences in (91) also require the presence of the auxiliary :

- (96) a. ur-*(y-lli) Hemmu d-amhdar
 NEG- 3ms(AGR)-beIRRE Hemmu ?-student
 "Hemmu is not a student."
 b. ur-*(y-lli) Hemmu gi teddart
 NEG- 3ms(AGR)-beIRRE Hemmu in house
 "Hemmu is not in the house."

Finally, the interrogative counterparts of the nominal sentences in (91) also require the presence of the auxiliary :

- (97) a. u ay- *(y-lla-n) d-amhdar?
 who comp n-(AGR)-beIMPR-n ?-student
 "Who is a student ?"
 b. u ay- *(y-lla-n) gi teddart?
 who comp- n-beIMPR-n in house
 "Who is in the house ?"

The obvious question that this array of facts gives rise to is, What do the constructions which require the presence of the auxiliary have in

common that makes the appearance of the auxiliary obligatory? In different terms, What turns a nominal sentence, obligatorily, into a verbal (copular) sentence? I will try to demonstrate below that an adequate answer to this question should not only account for the facts pointed out above but also provide a principled explanation as to why languages like Berber, Arabic, Hebrew and Russian allow nominal sentences while English does not. As a matter of terminology I will call a nominal sentence every sentence that does not have a verb in it, and I will call a copular sentence every sentence that contains a copular verb.

2.4.2. The status of the prefix d-

Before we discuss the structure of nominal sentences let us have a close look at the nature and behaviour of the particle d- which in a number of sentences above is represented by a question mark. Compare the following two examples :

- (98) a. Hemmu d-amhdar
Hemmu ?-student
"Hemmu is a student."
b. Hemmu amhdar
Hemmu student
"Hemmu the student"

(98a) is a complete sentence which expresses a complete proposition, whereas (98b) is simply a noun phrase. Yet, the only difference between the two constructions is that (98a) contains the d- particle whereas (98b) does not. For this reason some linguists (e.g. Shlonsky (1987), Choe (1987), among others) have concluded that d- must be a copular form of some sort.

This conclusion is apparently supported by the fact that d- also appears attached to clefted NPs :

- (99) a. d-amhdar ay- y-lla Hemmu
 ?-student comp 3ms-beIMPR Hemmu
 "A student is what Hemmu is."
- b. d-Hemmu ay- y-lla-n d-amhdar
 ?-Hemmu comp- n-beIMPR-n ?-student
 "It is Hemmu who is a student."

The analogy with English in this respect is clear. Clefted elements in English are preceded by a copula and a pleonastic subject (*it*). Likewise, the cleft constructions in (99) have a copula which is d- and a pleonastic subject which, presumably, is *pro* given that Berber is a *pro* drop language. Although there is no rich agreement element in the matrix clause, no problem is expected to arise since pleonastic *pro* does not require to be identified, though it is not clear from which source it receives Case which, remember, is crucial for its licensing.

However, there are a number of reasons to believe that d- cannot be a copular form. First, d- appears only in sentences where the predicate is a noun phrase. When the predicate is PP d- does not appear, not even optionally, as is clearly shown by example (91b) and others above compared with (100a) below. It does not appear in cleft constructions either when the clefted element is a non-NP :

- (100) a. *Hemmu d- gi- teddart
 Hemmu ?- in- house
 "Hemmu is in the house."
- b. gi teddart ay- y-lla Hemmu
 in house wh-comp 3ms-beIMPR Hemmu
 "In the house is where Hemmu is."
- c. *d- gi- teddart ay- y-lla Hemmu
 ? in- house wh-comp 3ms-beIMPR Hemmu

If d- was really a copular form it remains an odd fact that it appears only in sentences where the predicate is a noun phrase, assuming that clefted elements function as predicates of the matrix clause. We will see later that the fact that d- appears only in sentences with an NP predicate is

significant but for a different reason altogether.

Secondly, unlike all the other verbs in the language the particle d-, on the assumption that it is a (copular) verb, is apparently the only verb that is never marked for the subject agreement features, that is it never carries the AGR element. Third, if d- was a copular form it would mean that in a simple sentence such as (93a) and others above there are two copular verbs, one is ila and the other is d-. Besides the fact there is no apparent reason why in a simple sentence like (93a) there should be two copular verbs, it will be shown later that while the presence of the auxiliary ila is explainable on principled grounds the presence of d-, on the assumption that it is a copular verb, remains a total mystery²⁴.

These are, to my eyes, reasonable grounds on which to doubt the assumption that d- is a copular form. If it is not a copular form, What is it then? In order to have a clear idea about the nature and function of d- let us compare example (101c) below with the two examples in (98) repeated here as (101a) and (101b), respectively :

- (101) a. Hemmu d-amhdar
Hemmu ?-student
"Hemmu is a student."
- b. Hemmu amhdar
Hemmu student
"Hemmu the student"
- c. Hemmu u-amhdar
Hemmu CS-student
"Hemmu of the student"

The noun phrase amhdar has a different grammatical function in each of these constructions. In (c) it is the complement of the head Hemmu, shown by the fact that amhdar is in the CS form, N being a Construct-governor. In (b) amhdar is an attributive noun phrase with an adjectival function modifying Hemmu. The fact that amhdar in (b) is not in the CS form implies

that it is not governed by, and therefore is not a complement of, Hemmu. In (a) amhdar clearly has a predicational function indicated by the presence of the particle d-. Without d- (a) would be identical to (b), and an ambiguity of grammatical function with respect to amhdar would arise. The function of d-, therefore, appears to indicate that the noun phrase it appears attached to is to be understood not as a complement or an attributive noun phrase but as a predicational noun phrase. A similar conclusion was reached a few years ago by Chaker (1975).

Having concluded this it is not difficult to see how the facts pointed out above as problematic for the analysis which assumes d- to be a copular form fall out immediately. The reason why d- appears only with nominal sentences with a noun phrase predicate is that only in these constructions does the possibility of ambiguity of grammatical function arise. When the predicate is a PP the possibility of ambiguity does not arise at all, for PPs in Berber cannot fulfill a modificational function as the noun phrase in (101b) does. The equivalent of an English construction like the woman with the blond hair is necessarily a relative clause construction :

- (102) tamghart din- ghar-s azakhukh ashahbar
 woman who has-she hair blond
 "The woman who has blond hair."

Nor can PPs in Berber serve as complements of a N as the noun phrase in (101c) above does (see chapter 3).

The fact that d- does not inflect for the subject agreement features and that it co-occurs with another copular verb in the sentence follow trivially from the conclusion that d- is not a verb. Also, the fact that d- appears with clefted noun phrases follows if we assume that the clefted noun phrase functions as the predicate of the matrix clause of the cleft construction with a null pleonastic subject required by predication.

The conclusion that d- is a sort of predication marker is strongly supported by examples such as (103a), pointed out by Calabrese (1987) who, incidentally, takes a similar view on the status of d-, as well as examples such as (103b&c)) below it :

- (103) a. y-ffgh d-ahamosh, y-dewwrd d-argaz
 3ms-left pred-boy 3ms-came back pred-man
 "He left a boy and came back a man."
 b. y-ffegh x-idarn in-s, y-dwer gi-lkamiyya
 3ms-left on-feet of-his 3ms-came back on-stretcher
 "He left on his feet and came back on a stretcher."
 c. y-dwer d-axuwwan
 3ms-became pred-thief
 "He became a thief."

The verbs ffgh and dwwrd in (103a) are typical intransitive verbs. ahamosh and argaz are secondary predicates whose function is indicated by the particle d-. With d- missing both noun phrases would be understood as postverbal subjects (ignoring the fact that the two noun phrases are not in the CS form) so that the sentence would mean "The boy left, the man came back." In (103b) where the secondary predicates are PPs the presence of d- is not required and no ambiguity of grammatical function arises. In (103c) axuwwan is also a secondary predicate whose function is indicated by the particle d-.

On the basis of these facts and the others discussed above I will conclude that d- is a predication marker which appears attached to NP predicates in the following way²⁵ :

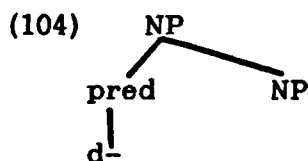

I will leave open the question of how this structure arises.

2.4.3. The structure of nominal sentences

A number of facts pointed out above show fairly clearly that nominal sentences have a full fledged sentential structure just like verbal sentences. The fact that nominal sentences are sensitive to present tense adverbials shows that they are marked for tense and therefore have a TNS node. The tense specification is also required independently by the fact that nominal sentences express full propositions, assuming that tense is an essential component of a sentential proposition. Recall also that TNS in Berber implies AGR since TNS selects AGR. The structure of nominal sentences, accordingly, should look like the following :

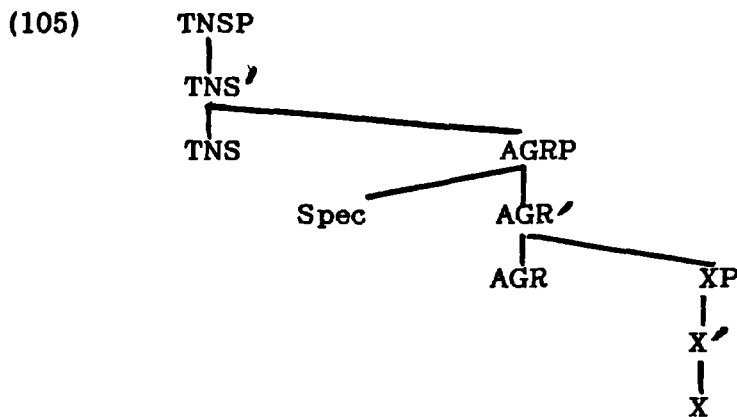

(where X can be a N or a P or an A)

What this structure amounts to is the claim that nominal sentences differ minimally from verbal sentences in that they have nonVP predicates. This is a desirable consequence given the propositional status that both types of sentences have. What we have to determine now is how the subject receives Case given that AGR is not overtly realised.

In order to be able to do that let us draw a parallel between nominal sentences and so-called small clauses discussed above. Like nominal sentences the NP predicate of a clause embedded under thsb "consider" also requires the presence of the predicational particle, while the clauses

that have a PP predicate do not as illustrated by examples (76a) and (77a). I will take this fact to be indicative of an underlying similarity in structure between small clauses and nominal sentences, a fact that is already expressed by structure (105) above as compared with (82). The only difference between the two structures is in the position of the subject which is in the Spec of AGRP in (105) and in the Spec of TNSP in (82). The reason why we assumed that the subject in small clauses is base-generated under the Spec of TNSP is to make it accessible to government by the matrix verb which assigns it accusative Case. The Spec of AGRP, we assumed, is filled by a pro which receives Case from an abstract AGR. The relationship between the subject and this pro is similar to the relationship between the preverbal subject and the pro in the Spec of AGRP in SVO sentences. The possibility that the subject in small clauses could be moved from the Spec of the maximal projection of the predicate was eliminated by the fact that the predicate can be headed by a lexical category, such as P, which we assumed does not assign an external theta role.

Now, given that the subject in nominal sentences is not assigned Case by an external governor since nominal sentences function as root clauses we have to determine how the subject receives (nominative) Case. The answer, I believe, is already contained within the account given above. Unlike small clauses the subject in nominal sentences is base-generated in the Spec of AGRP and receives Case from the abstract AGR. The Spec of TNSP can be assumed to be left empty or not to project altogether. Notice that we have to assume that TNS is also abstract. The reason for its abstract realisation, along with that of AGR, can be attributed to the lack of a suitable carrier, assuming a morphological subcategorisation frame for overt TNS and AGR which specifies that only a verbal category can serve as a carrier for them. Given that nominal sentences have non-VP predicates the lack of a suitable carrier is only apparent.

Notice that in constructions where the predicate is a noun phrase one might argue that the latter is also subject to the Case requirement. If the noun phrase predicate is indeed subject to the Case requirement then the question arises as to how it is assigned Case. This is not an easy question to answer since there apparently is no possible source for Case in the construction. However, the question arises only if we understand the Case requirement in terms of the Case Filter which requires all noun phrases to have Case. If we understand the Case requirement in terms of the Visibility Hypothesis instead then the noun phrase would not be required to have Case because it is not an argument. The Visibility Hypothesis, remember, makes theta-marking of argument noun phrases conditional upon them having Case so that if a noun phrase is not required to be theta-marked, because it is a non-argument, then it does not need to have Case.

The proposed analysis makes two interesting predictions. One is that the basic word order in nominal sentences should be Subject-predicate since no movement to AGR and TNS takes place to yield a different order. That the prediction is correct is shown by all the nominal sentences mentioned above which all have the predicted order Subject-Predicate. This, however, does not necessarily mean that the order Predicate-Subject is not attested. The following examples where the predicate precedes the subject are possible paraphrases of their counterparts above :

- (106) a. d-amhdar Hemmu
 pred-student
 "Hemmu is a student."
 b. gi teddart Hemmu
 in house Hemmu
 "Hemmu is in the house."
 c. marrid-un Zayd-un
 sick-NOM Zayd-NOM
 "Zayd is sick."

These can be analysed as either instances of predicate-preposing or as

instances of subject-postposing. Evidence that can decide between the two is hard to come by. The fact that sentences like (106a&b) are usually pronounced with an intonation break between the predicate and the subject cannot decide between the two since both postposed and preposed elements are usually separated from the rest of the sentence by an intonational break.

The second prediction that the proposed analysis makes is that pro drop should not be possible in nominal sentences because AGR is abstract, that is it is not rich in the required sense to be able to identify the missing subject. That the prediction is correct is borne out by the following examples :

- (107) a. * pro d-amhdar
 pred-student
 "He is a student."
 b. * pro gi teddart
 in house
 "He is in the house."

The analysis proposed here for nominal sentences with argumental subjects extends naturally to nominal sentences with non-argumental subjects, namely atmospheric sentences illustrated by the examples in (92) and the matrix clause of cleft constructions illustrated by examples such as (99a&b). In both constructions the subject is a pleonastic pro that is assigned Case by the abstract AGR. The fact that AGR is abstract should not be problematic in this case since unlike argumental pro pleonastic pro does not require identification by rich AGR, Case-marking being sufficient to license its presence

Viewed as such, nominal sentences turn out to have a structure that is similar to that of small clauses, as explained above, and verbal sentences.

The only difference lies in the fact that small clauses and nominal sentences have non-VP predicates. Being non-VP predicates has the consequence that AGR and TNS are not overtly realised because if they were they would be in violation of the AP since the structure lacks a suitable carrier for them, i.e. a verbal category. The next question we need to answer is how nominal sentences differ minimally from their copular counterparts. The answer to this question will hopefully provide us with an explanation for why English does not have nominal sentences. The answer will turn out to be crucially linked to the overt v abstract realisation of TNS²⁶.

2.4.4. The structure of copular constructions

Let us assume that the minimal difference between the nominal sentences in (91) and their copular counterparts in (93) is that in the latter AGR and TNS are realised overtly while in the former they are abstract. Let us see how this minimal distinction can be made to account for the presence of the copula in the examples in (93) as well as those in (94), (96) and (97). The overt realisation of AGR and TNS implies that they have to satisfy the AP. But to do so they have to attach to a verbal category. Because nominal sentences have non-VP predicates they do not contain a verbal category that can move up to AGR and TNS to help them satisfy the AP. The solution is to insert a dummy verbal category that would serve as a carrier. This dummy verbal category is the copula which does not seem to make any contribution to sentence interpretation in the same way that nominal pleonastic elements do not make any contribution to sentence interpretation. This is shown by the fact that with or without the copula the sentences in (91) and (93) have the same interpretation. Therefore, we can refer to the copula as a verbal pleonastic that corresponds to the nominal pleonastics it and there in English. What the

analysis amounts to is the claim that the copular counterparts of the nominal sentences, which remember all have a present tense reading, contain a copula because AGR and TNS are realised overtly, thus automatically falling under the scope of the AP.

Another question that we need to answer is, Why do future and past tense sentences require the presence of the copula as illustrated by the examples in (94)? With respect to future tense sentences the answer is straightforward. Future tense is realised as ad- which is affixal, hence the obligatory presence/insertion of the copula to serve as a carrier. With respect to past tense sentences the answer is not so straightforward. Recall that we assumed that temporal oppositions in Berber operate on the basis of the feature matrix [+,- FUTURE]. [+FUTURE] is realised as ad- while [-FUTURE] implies [+,- (IM)PERFECTIVE]. But now that we have dissociated tense from aspect we have to change this feature system. We can assume instead that [-FUTURE] implies past tense automatically. The present tense can be assumed to be derived by a default mechanism, a tense frame that is neither [+FUTURE] nor [-FUTURE] is present. It follows from this specification that both future and past tense are realised but the present tense isn't. From this also follows the fact that the presence/insertion of the copula in future tense and past tense constructions is obligatory to serve as a vehicle for the specified future and past tense, but in present tense constructions it is only optional, hence the possibility of having nominal sentences.

The examples in (96), which are the negative counterparts of the nominal sentences, and the examples in (97), which are the corresponding wh-questions of the nominal sentences, have in common with each other and with the future and past tense constructions the fact that they contain affixal elements which require a verbal category to satisfy the AP. In (96)

the affixal element is the negation marker ur- and in (97) the affixal element is the wh-comp ay-. The affixal nature of NEG has been discussed at length above. The affixal nature of the wh-comp, however, will be discussed in chapter 4 (see also Ouhalla (in preparation)) where we will see that it is responsible for the obligatory movement of the verbal complex to C in operator-movement constructions. The copula in the examples in (97) can be assumed to be inserted under AGR and from that position it raises to C through TNS.

Before we move on to discuss copular sentences in English I would like to adduce evidence from other languages for the analysis suggested above. Moroccan Arabic (MA) and Hebrew are languages which, like Berber, allow nominal sentences :

- (108) a. Hemmu (huwwa) taalib (MA)
 Hemmu is student
 "Hemmu is a student."
 b. Hemmu (huwwa) f-ldar
 Hemmu is in-house
 "Hemmu is in the house."
 c. Hemmu (huwwa) mriid
 Hemmu is ill
 "Hemmu is ill."
- (109) a. David (hu) student (Hebrew, Rapoport (1985))
 David is student
 "David is a student."
 b. David (hu) ba-xeder
 David is in-room
 "David is in the room."
 c. David (hu) xole
 David is sick
 "David is sick."

The element hu(wwa) referred to in the relevant literature as PRON has been argued to be a verbal element despite the fact that its form is identical to that of the third person singular pronoun in the languages in question (see Rapoport (1985) and Doron (1983) & (1986)). PRON in a sense

compensates for the gap in the paradigm of the copula (h.y.y. in Hebrew and k.n. in MA) which lacks a present tense conjugation. So, PRON plays the role that the copula in similar Berber examples plays. The fact that the presence of PRON is optional implies that in MA and Hebrew, like in Berber, present tense need not be overtly realised, a fact that is made obvious by the lack of a present tense conjugation of the copula in the two languages. The past and future tense counterparts of the examples in (108) and (109), as in Berber, also require the presence of the copula :

- (110) a. Hemmu *(kaan) taalib
 Hemmu was student
 "Hemmu was a student."
 b. David *(haya) student
 David was student
 "David was a student."

Let us now see what happens when nominal sentences in these languages are negated or their subject is wh-moved. Consider the following examples from MA :

- (111) a. Hemmu mashi (huwwa) taalib
 Hemmu not is student
 "Hemmu is not a student."
 b. shkun lli (huwwa) taalib ?
 who comp is student
 "Who is a student?"

Unlike their counterparts in Berber neither the negation element nor the wh-comp in MA is affixal, hence the optional presence of the copula.

Concerning Hebrew Rapoport reports that when the subject of a nominal sentence is relativised or long-wh-moved the PRON element appears obligatorily :

- (112) a. David, she-*(hu) student, gar be-Yerusalayim
 David, that-is student lives in-Jerusalem
 "David, who is a student, lives in Jerusalem."

- b. mi amart-a she-*(hu) student?
 who said-you that-is student
 "Who did you say is a student?"

Like the wh-comp ay- in Berber the Hebrew complementizer she- (cf. Shlonsky (1988)) is also affixal, hence the obligatory presence of the PRON element which we are assuming to be a copular form.

To make the argument clearer let us compare the sentences in (112) with their equivalents in Berber and MA, respectively :

- (113) a. Hemmu, din-*(y-lla-n) d-amhdar, y-zeddegh gi- Al Quds
 Hemmu comp- n-beIMP-n pred-student 3ms-lives in-Jerusalem
 "Hemmu, who is a student, lives in Jerusalem."

- b. u ay- t-nni-t qa (y-lla) d-amhdar?
 who comp- 2s-said-2s that 3ms-is pred-student
 "Who did you say is a student?"

- (114) a. Hemmu, lli (huwwa) taalib, kayskun f-Al Quds
 Hemmu comp is student lives in-Jerusalem

- b. shkun ghti belli (huwwa) taalib?
 who said-you that is student

The Berber relative clause complementizer din-, as we will see in chapter 4, is affixal (cf. Ouhalla (in preparation)), hence the obligatory presence of the copula. Its counterpart in MA lli, however, is not, hence the optionality of the copula. On the other hand, the Berber non-wh-comp qa in (113b) is not affixal, hence the optionality of the copula. Its counterpart in MA is also not affixal, hence the optionality of the copula.

The facts discussed above show clearly that the obligatory presence of the copula in the constructions that we have examined so far is conditioned by purely morphological factors. The copula is obligatory only in those constructions which contain an affixal element that requires a verbal category to satisfy the requirement that its morphological subcategorisation frame be satisfied (further evidence for copula insertion will be presented in the next chapter in relation to copular constructions in Irish which have

a ProgP (cf. McCloskey (1983)) as predicate.

It is interesting to see to what extent the analysis adopted here for Berber copular constructions can be extended to English copular constructions. The suggestion that English copular sentences such as those in (115) below have non-VP predicates and that the copula is inserted merely as a support for the AGR and TNS elements has already been made in the literature, in particular Rothstein (1983) :

- (115) a. John is/was a student.
b. John is/was in the house.
c. John is/was sick.

Rothstein argues that the predicates in these sentences are NP, PP and AP, respectively and that the copula is inserted to bear the agreement and tense elements. Within the framework developed here copula insertion is obligatory under the AP since both AGR and TNS are affixal.

That this analysis is probably correct is suggested by the fact that the copula is apparently the only verb in English that can move to C in yes/no questions, for example :

- (116) a. Is/was John a student?
b. Is/was John in the house?
c. Is/was John sick?
- (117) a. *Loves John Mary?
b. *Saw you John?
c. *Eat she bananas?

If the copula in these examples is assumed not to be base-generated under a V node heading a VP predicate of the sentence but is inserted directly under the inflectional nodes then it is possible to maintain the generalisation that verbs in English do not move to C, for some specific reasons (cf. Ouhalla (in preparation))²⁷.

Having said this it is worth asking the question : Why is copula-insertion in English present tense sentences obligatory? In other words, Why is it not possible to have nominal sentences in English? Continuing to assume that it is the overt realisation of TNS that is responsible for the appearance of the copula the fact that English lacks nominal sentences can be explained in terms of the assumption that present tense in English is realised overtly, contrary to its counterpart in Berber where it is inferred by a default mechanism as we concluded above. Tense oppositions in English are standardly assumed to operate on the basis of the feature [+,- PAST]. [+PAST] is realised as -ed, while [-PAST] implies [+,-FUTURE/PRESENT]. The future tense is realised by will while the present tense, with respect to the copula, is realised by distinct verbal forms (am, are, is ...etc.). These facts seem to imply that the present tense is not inferred by a default mechanism, as is the case in Berber and presumably in the other languages which allow nominal sentences, but is realised overtly. Recall that nominal sentences in all the languages that allow them that we have examined here invariably have a present tense reading. The fact that Arabic and Hebrew, though historically related, do not have a present tense conjugation of the copula, when considered in the light of the fact just mentioned, cannot be simply accidental. The analysis proposed here is to a large extent based on this observation plus the facts pointed out above with respect to negative and wh-copular constructions. The general conclusion that these facts seem to point to is that copula-insertion is conditioned by purely morphological factors. The copula is inserted to satisfy the morphological subcategorisation properties of a certain affixal element in the sentence²⁸.

2.5. Conclusion

In this chapter I have proposed and discussed a fairly articulated

structure of the sentential clause which in a way amounts to a rejection of the standard assumption that I is a category which hosts a number of inflectional elements (AGR, TNS, NEG...etc) and which functions as the head of the sentence. The order of inflectional elements in relation to each other and to the verb in Berber sentences as well as the facts of cliticisation have forced us to treat each of them (NEG, TNS, AGR and ASP) as a category in its own right heading a maximal projection of its own according to the principles of X-bar theory. These categories are also organised hierarchically with respect to each other and to the verb. The task of organising them in sentential structure has been based on the generalisation made by the MP and the constraints on head-movement laid down by the HMC/ECP.

When the conclusions reached with respect to Berber were extended to English and other SVO languages it turned out that the surface word order variations between VSO languages and SVO languages are the consequence of the fact that in VSO languages TNS selects AGR, strictly speaking AGRP, while in SVO languages it is the other way round. The surface word order is generated as a result of V-movement to AGR and TNS, and subject-movement to the Spec of AGRP. The former is motivated by the AP since both AGR and TNS are affixal and the latter is motivated by Case, in the sense that the subject moves to the Spec of AGRP to receive Case from AGR via coindexation. Given that AGRP is the top node in the sentential structure in SVO languages the two movements yield an SVO order. On the other hand, given that the top node in the sentential structure of VSO languages is not AGRP but TNSP the two movements yield a VSO order. Such a desirable consequence has obviated the need for a directionality parameter of Case-assignment to account for surface word order variations, among languages, involving the subject. Another desirable consequence of this analysis is that it provides a natural account of the

fact that VSO languages generally make use of the SVO order as an alternative, the fact that we have been referring to as Greenberg's Universal 6. The Spec of TNSP in VSO languages provides a natural position for the preverbal subject.

The same conclusions were also extended to account for the structures of infinitival and so-called small clauses. Infinitival clauses turned out to have a TNS frame, contrary to the standard belief. The difference between inflected infinitivals and non-inflected infinitivals is that AGR projects in the former but not in the latter. The analysis provided then was shown to account naturally for the fact that VSO languages generally lack non-inflected infinitivals. Because AGR in VSO languages is selected by TNS it cannot fail to project, unlike AGR in SVO languages which is not selected by any element. In SVO languages the relationship between AGR and TNS is the reverse of that in VSO languages; it is AGR that selects TNS in SVO languages. Small clauses, on the other hand, were found to have a structure that in many respects resembles that of the normal infinitival clauses with the difference that the predicate in small clauses is a non-VP category.

The latter property was also found to distinguish nominal sentences and some copular constructions from the normal verbal sentences. It was argued that the copula is simply a verbal pleonastic element that is inserted as a suitable category to satisfy either the morphological or the syntactic (or both) subcategorisation frame of certain categories.

The ultimate and, from my point of view, the most interesting result of the investigation undertaken in this chapter is that there is no such thing as a fixed sentential category. In VSO affirmative sentences the top node is TNSP while in negative sentences it is a NEGP. In SVO finite clauses it is an AGRP while in non-inflected infinitival clauses it is a TNSP. In Berber

negative sentences it is a NEGP while in English negative sentences it is not ...etc. It is perhaps for this reason that IP, generally, does not function as an argument. Assuming that subcategorisation operates in categorial terms, it becomes understandable why an unstable category like the one we have been discussing seems to never be subcategorised.

The conclusions reached, on the other hand, provide us with a glimpse into what could be one of the functions of the complementizer, namely, to give a fixed categorial identity to the clause so that subcategorisation becomes straightforward whether understood in traditional terms or in terms of a correlation between semantic and syntactic categories. In the next chapter we will discuss a not unrelated function of the complementizer, namely, that it nominalizes the sentential clause, thus making it possible for it to function as an argument, a function that I will argue can only be fulfilled by nominal categories. This will allow us to account for the fact that although noun phrases have a structure that is remarkably similar to that of sentential clauses they generally do not seem to take complementizers.

Footnotes

1. The effect that some of these phonotactic constraints have on the examples in (3a) can be seen in their surface forms which are as follows :

- (i) a. wargaz
- b. uhamosh
- c. ilf/i-y-ilf
- d. ushshn/u-w-ushshn

In (ia) the Construct prefix turns into a semi-vowel, while in (ib) the number-gender vowel deletes. (ic&d) involve two strategies : the Construct vowel deletes or a semi-vowel is inserted to break the hiatus that results from the prefixation of the Construct vowel (cf. Ouhalla (1984) & Chtatou (1982)).

2. The affixal elements y---n attached to the verb in these examples are known as "neutral AGR". They appear in clauses which involve wh-movement of the subject. The reason why they are called neutral AGR is because they do not agree with the subject in grammatical features in the sense that they maintain a fixed form regardless of the features of the subject as illustrated by the following examples :

- (i) a. ma n-ahamosh ay- y-sghi-n iharkusn?
 what GEN-boy comp n-bought-n shoes
 "Whih boy bought the shoes?"
- b. ma n-temghart ay- y-sghi-n iharkusn?
 what GEN-woman comp- n-bought-n shoes
 "Whic woman bought shoes?"
- c. ma n-immidn ay- y-sghi-n iharkusn?
 what GEN-people comp- n-bought-n shoes
 "Which people bought shoes?"

For a detailed account of the function of neutral AGR and why it appears only in clauses which involve wh-movement of the subject see Ouhalla (in preparation).

3. The only exception to the condition that the host be affixal is the verb. However, we will see later that cliticisation to the verb is only a last resort strategy that clitics turn to when there is no other suitable host in the clause. Being morphologically dependent elements themselves clitics have to attach to a category to satisfy the AP.

4. I would like to point out at this stage that I am not alone in reaching the conclusion that the structure of I needs to be more articulated than is standardly believed. In his GLOW (1987) paper Pollock came to a similar conclusion with respect to French and English on quite independent grounds that have to do with the scope of verb-movement in the two languages illustrated by examples such as the following :

- (i) a. *John likes not Mary (Pollock (1987))
b. Jean (n')aime pas Marie
- (ii)a. *Like he Mary?
b. Aime-t-il Marie?
- (iii)a. *John kisses often Mary
b. Jean embrasse souvent Marie
c. John often kisses Mary
d. *Jean souvent embrasse Marie
- (iv) a. *My friends love all Mary
b. Mes amis aiment tous Marie
c. My friends all love Mary
d. *Mes amis tous aiment Marie

By the time I received Pollock's paper it was too late to incorporate a detailed discussion of its content into the main body of this work. For this reason my comments on it will be confined to footnotes only. Although the underlying idea is practically the same in both analyses there are significant differences which will be pointed out and discussed at the relevant stages.

5. Evidence that the Tarifit dialect of Berber used for illustration here does have rules which make reference to VP is discussed in Ouhalla (1986b) assuming the standard IP framework. The evidence is summarised here for reference. Examples (ia&b) below are instances of VP-deletion under identity, while examples (iia&b) and (iiaa&b) are instances of VP-preposing. Examples (iva&b) show that Tarifit has VO idioms. All these properties are indicative of the existence of a VP node :

- (i) a. t-sgha Munat iharkusn; la nesh
 3fs-bought Munat shoes also I
 "Munat bought shoes and so did I."
- b. t-fgh Munat zikh; la Hemmu
 3fs-left Munat early also Hemmu
 "Munat left early and so did Hemmu."
- (ii) a. y-hlkh Hemmu
 3ms-be ill hemmu
 "Hemmu is ill."
- b. y-hlkh ay- y-lla Hemmu
 3ms-be ill comp- 3ms-is Hemmu
 "It is ill that Hemmu is."
- (iii) a. ad-ili-n tf-n axuwwan rux-nni
 will-be-3p caught-3p thief time-that
 "They will have caught the thief by that time."
- b. tf-n axuwwan ad-ili-n rux-nni
 caught-3p thief will-be-3p time-that
 "They will have caught the thief by that time."
- (iv) a. y-shsha ixfin
 3ms-ate himself
 "He ate himself." (literally)
 "He was very angry."
- b. y-ush-as arih
 3ms-gave-him wind
 "He gave him the wind." (literally)
 "He gave him nothing."

It should be pointed out, however, that what is considered to be a VP in Ouhalla (ibid), where the orthodox IP structure is assumed, may not be a VP within the framework developed here.

6. The analyses suggested by Choe (1986) and Fassi Fehri (1987), though based on the notion of directionality, differ in important respects from the analysis suggested by Sproat in the references cited above. Choe assumes that AGR is base-generated attached to the verb and that the subject moves down from the Spec of IP and adjoins to the left of V+AGR, thus yielding a structure like the following where the subject follows the inflected verb :

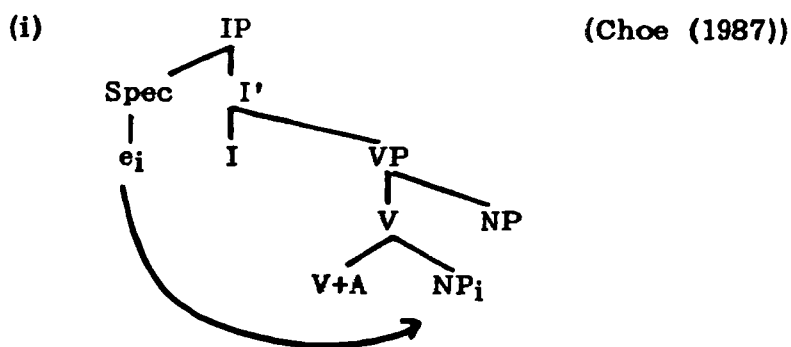

There are obvious conceptual problems with this analysis as Choe herself admits. Among these problems is, first, the fact that the adjunction process violates the Structure Preserving Hypothesis because it adjoins a maximal projection to an X-0 category, and secondly, that the movement is a downgrading movement.

Fassi Fehri, on the other hand, argues that the subject is base-generated in the Spec position of VP and that the VSO order is the result of a movement of the verb to I motivated by the necessity to support I for the latter to be able to assign Case to the subject which remains in its D-structure position :

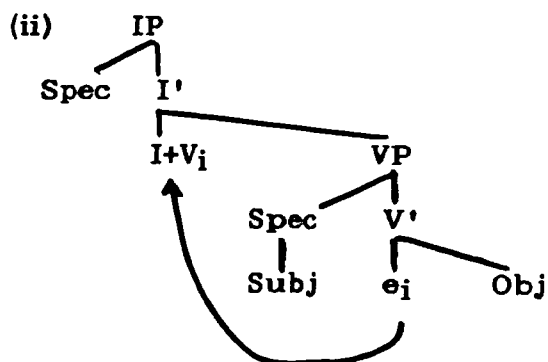

I is on the left side of the subject and therefore can assign it Case. Among the advantages of this analysis is the fact that it provides for a preverbal subject position (Spec of IP) and therefore accounts for the possibility of the alternative SVO order in Standard Arabic.

7. McCloskey (1983) and Sadler (1988) report that the Celtic languages differ from the mainstream VSO languages in that they do not allow for the SVO order in root clauses as an alternative to the VSO order. Examples such as the following from Welsh are assumed to be instances of subject clefting rather than instances of SVO order since there is a complementizer separating the subject from the rest of the sentence :

- (i) a. Siôn a balodd yr ardd (Sadler (1988))
John pt(comp) dug-3s the garden
"It was John who dug the garden."
b. Siôn sy'n palu'r ardd
John is-3s-prog dig-the garden
"It is John who is digging the garden."

The reason why the Celtic languages should lack this property is not clear to me. I suspect that this property may really turn out not to be lacking in the Celtic languages at all and that its appearance is obscured by some still unknown reasons.

However, it is interesting to point out in this respect a fact reported by Sadler (ibid), citing Richards (1938), that Old Welsh used to have an alternative SVO order. In this order the verb agreed with a lexical subject in number. But in the VSO order the verb agrees in number only with pronominal subjects; with non-pronominal subjects the verb is always singular.

This is remarkable in view of the fact that exactly the same situation holds in Standard Arabic as explained in Fassi Fehri (1984)&(1987). To illustrate from Standard Arabic consider the following examples :

- (ii) a. l-?awla:d-u ja:?-u: Fassi Fehri (1987))
 the-boys-nom came-3pl.
 "The boys came."
 b. *l-?awla:d-u ja:?-a
 the-boys-nom came-sg.
- (iii) a. ja:?-a l-?awla:d-u
 came-sg. the-boys-nom
 b. *ja:?-u: l-?awla:d-u
 came-3pl. the-boys-nom
- (iv) a. hum ja:?-u:
 they came-3pl
 "They came."
 b. ja:?-u: hum
 came-3pl they

in (iia) the verb agrees with the preverbal subject in number. Failure of this agreement results in ill-formedness as is illustrated by (iib). Examples (iia&b) illustrate the fact that the verb does not agree with the postverbal subject in number. In VSO sentences the verb is always in the singular when the subject is non-pronominal. When the subject is pronominal as in (iva&b) the verb agrees with it in number regardless of whether it is in the preverbal or the postverbal position.

Examples from Welsh illustrating the same facts are the following :

- (v) a. Maent hwy yn canu (Sadler (ibid))
 are-3P they prog sing
 "They are singing."
 b. Mae y plant yn canu
 is-3S the children are singing
 "The children are singing."
 c. Agorodd *hwy/ef/hi y drws
 opened-3S they/he/she the door
 "He/she opened the door."
 d. Agorodd y dynon/y dyn y drws
 opened-3S the men/the man the door
 "The man/men opened the door."
 e. *Agoron y dynion y drws
 opened-3P the men the door
 "The men opened the door."

Fassi Fehri takes these facts of Arabic to be arguments for the assumption that the preverbal subject is not occupying the canonical subject position governed by AGR but is a sort of topic/focus element related to the argumental subject position held by the (pronominal) AGR element which later incorporates into the verbal complex.

Before we leave this issue I would like to emphasize that the remarkable correlation between the facts of Welsh and Standard Arabic pointed out above should not be dismissed as accidental but rather as revealing of the underlying properties of SVO sentences not only in the two languages but perhaps in VSO languages in general. At the moment I have nothing to add to what has already been said by Fassi Fehri (ibid).

8. It is doubtful that nominative Case is assigned by AGR as is the belief in the mainstream GB literature. It seems to me that nominative is rather a sort of an elsewhere/default Case that appears on noun phrases that lack a Case-assigning governor. This can be easily discerned in Arabic where nominative appears on topicalised and dislocated noun phrases as well as on subjects of sentences (cf. Fassi Fehri (1984)). In some other languages which also have rich morphological Case systems (e.g. Turkish and Hungarian) subjects of sentences (nominative noun phrases) are simply unmarked for Case, again suggesting the elsewhere/default nature of nominative. Despite these doubts I will continue to assume, for practical reasons, that nominative is assigned by AGR via coindexation.

9. If the assumption that the subject theta role is assigned compositionally by the lexical head and its complement is correct, as suggested originally by Marantz (1984), then one can assume that the subject theta role is assigned by the X' projection which contains the head and its complement.

10. For arguments in support of the assumption that subjects are base-generated in the Spec position of VP and raised to the Spec of IP for Case reasons see Kitagawa (1986). Kitagawa argues that this analysis predicts that subjects which do not fall under the scope of the Case Filter, such as clausal subjects, should be expected to remain in the Spec position of VP since there is no motivation for them to raise. Kitagawa argues that this is precisely the situation in extraposition sentences such as the following :

- (i) a. It [VP turned out [that he was a spy]]
- b. It [VP bothers me [he hasn't called us yet]]
- c. It is [AP likely [that he will arrive late]]

where the clausal subject is on the right of the material contained within VP and the subject position is filled by a pleonastic element to satisfy the Extended Projection Principle.

For further arguments, based on different facts, in support of the assumption that the subject is base-generated inside the VP predicate and then raised to the canonical subject position see Koopman and Sportiche (1986).

11. The process linking of an external theta role to an external argument, and the process of linking of a predicate to a licensing subject (via coindexation (cf. Williams (1980)) have been considered in some sources as one and the same process. Hale & Keyser (1986), for example, state that the "agent role...[is] assigned to a subject in syntax, via predication." (p.26).

12. The argument that AGR in subject-initial languages is higher in the sentential structure than TNS receives significant support from SOV languages such as Turkish as well. In the following representative sentence from George and Kornfilt (1981) AGR clearly follows TNS in order with respect to the verb :

- (i) (biz) viski-yi iç-eceğ-iz
 we whisky-ACC drink-FUTURE(TNS)-1pl(AGR)
 "We will drink whisky."

If the assumptions made above are correct then the structure of this Turkish sentence is expected to be as follows, bearing in mind that Turkish is a head-final language :

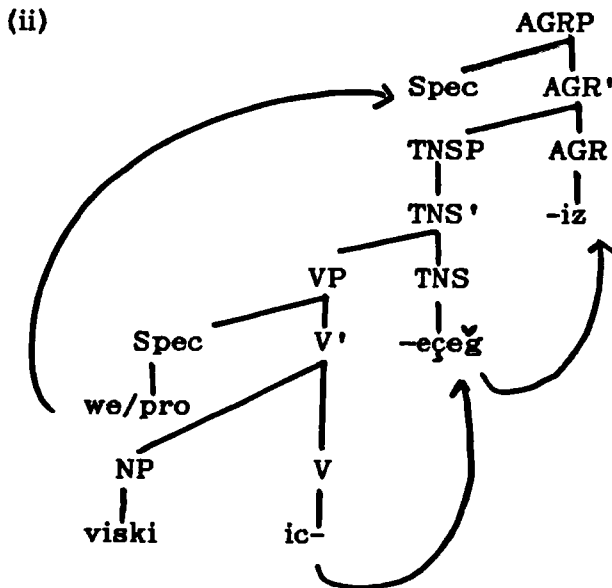

The verb in this structure moves up to TNS and then to AGR to attach to the elements occupying them. The subject, on the other hand, moves to the Spec of AGRP to receive Case from AGR through coindexation. It is clear, therefore, that it is the placement of AGR that is responsible for the position of the subject in the surface structure regardless of whether the language is head-first or head-last.

13. Assuming that the conclusion reached above with respect to

subject-initial languages is essentially correct the structure that Pollock (1987) suggests for French and English, reproduced here with minor modifications, is obviously not accurate :

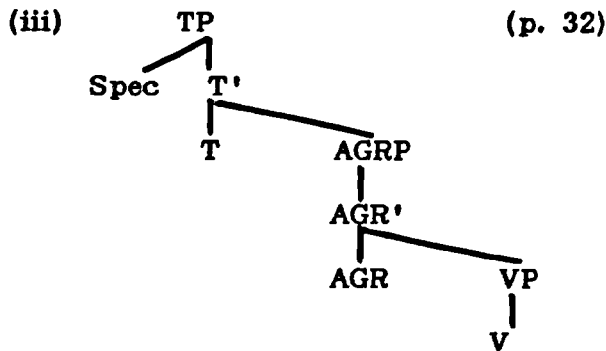

(This structure differs from the original one in Pollock in that it does not include the negation element. The position of the negation element in the sentential structure will be discussed later.) Given that both French and English are subject-initial languages AGR has to be higher in the sentential structure than T(NS). This is shown clearly by the French example in (53a) where the TNS element precedes the AGR element in relation to the verb.

As a matter of fact Belletti in her GLOW (1988) paper has argued for a structure where AGR is the top node on the basis of simple examples from Italian such as the following :

- (iv) Legge-va-no (Belletti (1988))
 read-imp(TNS/ASP)-3pl(AGR)
 "They read " (imperfective)

The structure that Belletti suggests for Italian and, presumably, for French as well is the following, which, if anything, looks identical to the one suggested in this work :

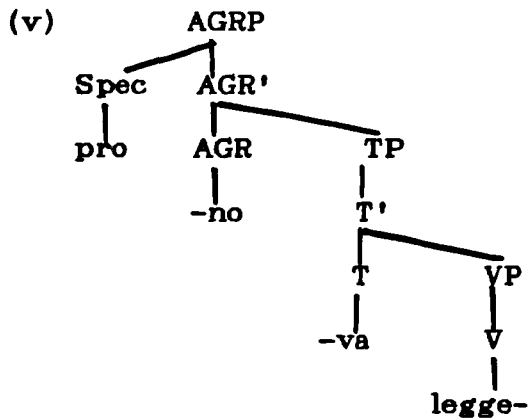

TNS and AGR being both affixal the verb raises obligatorily to attach to them, thus satisfying the AP. The order that results from this movement is one where the subject precedes the verbal complex and the complement of the verb, i.e. SVO.

14. Likewise, Pollock (1987) considers the infinitive endings in French (-er, -ir and -oir) as being TNS elements. However, Pollock assumes that it is not the verb that moves up and attaches to the infinitive endings in TNS but it is the infinitive endings which affix-hop down onto the verb. In the present framework this type of movement is not allowed for the simple reason that it is a downgrading movement, the underlying general assumption being that all syntactic movements leave behind a trace which is subject to the ECP.

Notice that the possibility that the affix-hopping of the infinitive endings could be assumed to operate at PF where the ECP does not apply is excluded in the present context by the fact that the AP is an S-structure condition. Because the infinitive endings are affixal they are subject to the AP and therefore have to attach to the verb prior to the S-structure level, that is in the syntax.

The alternative possibility that the infinitive endings could be assumed to be base-generated attached to the verb is equally excluded by

the assumption that all categories which assign a theta role, TNS affixes included, must hold an independent structural position at D-structure which governs their complements, i.e. the assumption expressed by the UTAH. Recall that we have been assuming throughout that functional heads assign a (functional) theta role to the maximal projections they select.

15. The distinction made here between the infinitive marker in English and its counterpart in the Romance languages can be argued to be the reason behind the possibility of VP-deletion in English illustrated by (i) below and its lack in the Romance languages (cf. Zagana (1982) & (1988)) :

(i) John wants to leave and Bill would like to [vp e] , too

Deletion of the VP constituent in this sentence does not result in a violation of the AP by to since the latter is not affixal. Its Romance counterpart, however, is affixal as we saw above so that VP-deletion inevitably results in a violation of the AP by the infinitive marker.

The contrast between the following examples can also be explained along similar lines :

(ii) a. John has left and Pablo has [vp e] too
b. *Juan has[⊗] sal do y Pablo ha [vp e] tambien

(iia) does not involve a violation of the AP since the aspectual have is non-affixal and the TNS and AGR elements are attached to it. The Spanish example in (iib), however, does involve a violation of the AP by ha if the latter is assumed to be affixal in nature. That the latter assumption is correct is suggested by the well known fact that haber + past participle form an inseparable unit in contemporary Spanish. They cannot, for example, be separated by a subject :

- (iii) *Qué ha Juan leído ? (Zagona (1982))
what has Juan read

Assuming ha to be an affixal element which requires to attach to a verbal category to satisfy the AP examples (iib) and (iii) can be accounted for in terms of a violation of the AP. The fact that ha and the past participle form two separate phonological words can be explained if ha is assumed to be affixal only morphosyntactically (cf. Zubizarreta (1985)). For more on this point with respect to the causative verb see chapter 4.

16. Alternatively, one could assume, along with Borer (1987), that AGR in non-inflected infinitivals does project so that the structure of non-inflected infinitivals would be similar to that of inflected infinitivals and finite clauses. The only difference would be that AGR in non-inflected infinitivals is abstract and that it can only identify a subject *pro* in control structures, that is in structures where the abstract AGR is coindexed with an overt matrix subject from which it receives its features (cf. Borer (1987)) & Huang (1984)). This I believe is a rather attractive alternative because it postulates identical structures for all types of clauses and reduces the difference between non-inflected infinitivals, on one hand, and inflected infinitivals and finite clauses, on the other, to a mere abstract vs overt realisation of AGR. I leave open the question of which of the two analyses is more adequate, a question that is clearly of an empirical order.

17. See Borer (1987) for a range of control examples from different languages which involve *pro* and even overt pronominals in controlled positions.

18. The status of the particle d- in example (76a) and others below, glossed as "?", will be determined later in 2.4.2.

19. Obviously, the structure in (86) cannot possibly be generalised to all SVO languages in the sense that in all SVO languages NEG holds the position that it holds in English sentences illustrated by (85a). The reason is simply the fact that in some SVO languages, such as French, the equivalents of (85b&d) are grammatical :

- (i) a. Marie ne mange pas les pommes
 Marie NEG eat-TNS-AGR NEG the apples
 "Marie does not eat apples."
- b. Marie ne mang-er-a pas les pommes
 Marie NEG eat-FUT(TNS)-3s(AGR) NEG the apples
 "Marie will not eat the apples."

Assuming that NEG in French consists of ne- , which we will assume to be a prefix, and -pas, which we will assume to be a suffix, it is clear from these examples that NEG must be higher in sentential structure than TNS and AGR. Therefore, the structure of negative sentences in French should look like the following :

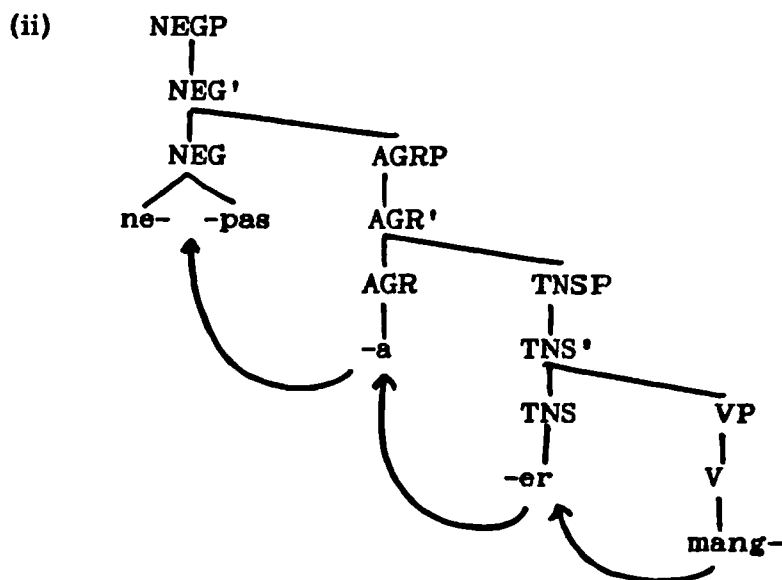

The verb moves obligatorily to TNS, AGR and then to NEG, the latter all being affixal elements. Notice, however, that if we assume that the subject is in the Spec position of AGRP at S-structure, the proposed analysis would

yield the wrong order for French, that is VSO instead[†] SVO. However, if we assume that in negative sentences the subject is in the Spec of NEGP then the correct order would be derived. The reason as to why the subject in negative sentences should occupy the Spec position of NEGP, instead of the Spec of AGRP position, is not clear to me.

The suggestion that the NEG elements in French ne and pas are affixal in the sense explained receives some support when viewed in relation to related facts in other languages. In some languages, including Old English, Berber and Moroccan Arabic, NEG does consist of a prefix and a suffix. In Berber, for example, the presence of a NEG suffix along with the prefix ur- is optional so that alongside examples like (iiia) there are examples like (iiib) :

- (iii) a. ur-t-sgha iharkusn
 NEG-3fs-bought shoes
 "She did not buy shoes."
 b. ur-t-sgha-shi iharkusn
 NEG-3fs-bought-NEG shoes
 "She did not buy shoes."

In Moroccan Arabic, however, the presence of the NEG suffix -shi, along with the prefix ma-, is generally obligatory :

- (iv) ma-shra-t-(shi) ssebbat
 NEG-bought-3fs-NEG shoes
 "She did not buy shoes."

In nominal sentences, that is in sentences which lack a verb (see 2.4. below), the prefix and the suffix appear attached to each other :

- (v) Hemmu ma-shi mriid
 Hemmu NEG-NEG ill
 "Hemmu is not ill."

These facts show that the morphological subcategorisation properties of the NEG elements seem to specify V as the only category that can serve as a

carrier. When such a category is missing the two elements attach to each other to satisfy the AP.

I believe that this is likely to be what happens in French infinitival clauses where, for some reason, the verb fails to raise to NEG :

- (vi) Ne pas manger les pommes ...
NEG-NEG eat the apples
"Not to eat apples...etc"

The ill-formedness of examples such as :

- (vii) *Marie ne pas mangera les pommes
Marie NEG-NEG eat-will the apples

implies that attaching to each other is a last resort strategy that the two NEG elements turn to in the absence of a verb that can move up to NEG and attach to them.

20. Notice that the structure in (89) gives the wrong result with respect to the order of NEG and TNS (to) in English to-infinitives :

- (') a. Not to like apples...
b. Not to speak a language...

However, the facts in this respect are not very clear since, as Pollock (1987) points out, sentences such as the following are acceptable :

- (ii) a. John wants to not go
b. Peter expects his friends to not object to his proposals

Sentences like these display the expected order, that is to not instead not to displayed by examples such as (1). I will take the expected order to be the basic order and assume that any different order is the result of some low-level, perhaps non-syntactic reordering rule.

21. Notice that in the structures in (86) and (89) the position that is presumably occupied by the subject, i.e. Spec of AGRP, is not within the scope of NEG, assuming that the scope of NEG is its m-command domain. This is apparently counterintuitive since negation affects the subject as much as it affects the rest of the elements in the clause. There are at least two possible explanations for this fact. One is to say that although NEG does not m-command the subject itself it does m-command its trace in the Spec position of VP, that is, it m-commands part of the (subject, t) chain. If this explanation is correct NEG will always have scope over the subject regardless of the position of NEG with respect to AGR since NEG is always higher in the structure than VP which contains, at D-structure, and at S-structure through traces, the verb and its arguments, including the subject. The other possible explanation is to assume that NEG, being an operator, moves to C at LF where it has scope over the whole of the clause.

22. This explanation also accounts for French examples such as (ia&b) of fn.19 if the analysis proposed there for ne pas is correct. The fact that the verbal complex can move up to NEG implies that NEG must theta mark the maximal projection it governs (AGRP) for otherwise L-marking would not hold and the trace of the verbal complex would fail to be antecedent-governed, thus resulting in a violation of the ECP.

23. Example (91c) is taken from Standard Arabic because Berber does not have the category Adjective. The standard adjectival functions are performed by attributive NPs and stative verbs. The two categories are distinguished clearly by the nature of the inflection they bear. I will demonstrate in the next chapter that Berber is not unique in this respect, a fact that will lead me to argue that the category Adjective does not exist,

contrary to the standard belief. The elements that have traditionally been referred to as Adjectives will be shown to be, in actual fact, NPs or, in some languages, stative verbs. For the moment, however, I will continue to assume that the predicate in (91c) is an Adjective.

24. This should not be understood to mean that it is not possible in general to have two copular verbs in a clause. The Welsh example in (58) testifies to the possibility of the coexistence of two copular verbs in a clause and so does the English example He is being sarcastic, assuming that all be's are copulas. However, unlike these examples the Berber example in (93a) is not aspectually complex since generally copular verbs cooccur in aspectually complex clauses.

25. A particle with a similar function has been reported by Chung & McCloskey (1987) to exist in Irish illustrated by the following example :

- (i) Tá sé ina dhlíodóir (p. 179. fn.4)
be(Pres) he in-his lawyer
"He is a lawyer."

Chung & McCloskey conclude that the particle ina in this sentence, which they refer to as the Agr-particle since it carries the subject agreement features, serves the "function of morphologically marking the NP as predicative rather than referential." (p. 180. fn.4)

Chung and McCloskey demonstrate further that the particle in question, just like its counterpart in Berber as we saw above, also appears in small clauses attached to the predicative NP as illustrated by examples such as the following :

- (ii) a. agus é 'na dhlíodóir (p.180 fn.4)
and him S3 lawyer
"and him a lawyer"

- b. Tharlaigh 'na dhlíodóir é
happen(Past) S3 lawyer him
"He happened to be a lawyer."
- c. B' fhada é 'na dhlíodóir
Cop(Past) long him S3 lawyer
"He had been a lawyer for a long time."

26. The analysis in terms of an orthodox small clause structure suggested by Kayne (1984) for Russian nominal sentences and adopted by Rapoport (1985) for Hebrew runs into a number of problems pointed out and discussed in Ouhalla (1987c). One of the problems has to do with the assignment of nominative Case to the subject. If nominal clauses lack an I node as the small clause analysis suggests then it is difficult to see from which source the subject can receive Case, especially in root sentences as well as sentences embedded under a complementizer. Rapoport suggests that in these constructions the subject receives Case from the predicate under the condition that the predicate "uniquely governs the subject." The uniqueness condition is required in order to prevent the predicate from assigning Case to the subject of nominal clauses embedded under epistemic verbs. In this situation the predicate would not assign nominative Case to the subject in addition to the accusative Case it receives from the matrix verb and the Case conflict that would ensue is thereby avoided. Besides the fact that the uniqueness condition is at best ad hoc the assumption that a maximal projection can assign Case goes against the standard belief based on the principles of X-bar and Case theories that only heads of constructions can assign Case.

A further problem has to do with the well known assumption that small clauses cannot be introduced by a complementizer. In this respect Rapoport says that "Small clauses, which have no Infl, cannot be introduced by Comp; or...a clause introduced by Comp must contain Infl, since it is the head of the complement selected." (p.361). This statement is based on the

well known fact that there is a selectional relationship between C and I illustrated in English by the fact that for requires a [-TNS] I whereas that requires a [+TNS] I. However, it is quite common for nominal sentences in Berber and other languages to be embedded under a complementizer :

- (i) a. t-nna qa Hemmu gi teddart (Berber)
3fs-said that Hemmu in house
"She said that Hemmu is in the house."
b. qaal-at ?inna Zayd-an fii l-bayt-i (Standard Arabic)
said-3fs that Zayd-ACC in the-house
"She said that Zayd is in the house."

So, by Rapoport's own reasoning at least those nominal sentences which are embedded under a complementizer have an I node heading the IP selected by C.

27. It has been pointed out to me by Neil Smith that in some dialects of English the possession verb have can also precede the subject as in

- (i) Have you any change?

A possible way of explaining this fact is to assume that the verb have is treated by the speakers of these dialects on a par with the aspectual have in sentences such as

- (ii) Have you seen Mary?

In other words, it seems that the speakers of the dialects in question extend the process of Aux-movement to C in Yes/No-questions to the possession verb have. However, In order to make this assumption technically viable in view of the general fact that verbs in English do not move to C, it has to be assumed with respect to (i) above that the possession verb is not base-generated heading a VP predicate but, like the copula in examples (116a,b&c), is inserted under the TNS element and later

raised to C through AGR. The implication here is that (1) has a non-VP predicate just like the copular constructions in (116a,b&c).

Evidence for this analysis can be drawn from the fact that in languages which allow nominal sentences expressions which involve a possession relationship are usually nominal sentences. Consider the following examples from Berber, Arabic and Russian, respectively :

- (iii) a. ghar-as tun'ashin
chez-him money
"He has money."
b. 'inda-hu kitaab-un
chez-him book
"He has a book."
c. u Ivana krasivye glaza (Chvany (1975) cited in Kayne (1984))
by Ivan pretty eyes
"Ivan has pretty eyes."

Ignoring the question of whether PP is the subject or the predicate, it is clear that these sentences do not contain a verb. The possession relationship is conveyed by a predication relationship between the PP and the NP which make up the sentences. Given this fact there is a sense in which the sentence in (i) can be analysed as having a non-VP predicate, with the verb have serving the function of supporting the TNS and AGR elements. If this analysis is correct then it remains generally true that in English verbs, that is Vs which head VP-predicates, cannot move to C.

28. There are some copular constructions in English, however, which the proposed analysis does not account for. In the examples below the presence of the copula is obligatory and yet there is no affixal element that would require its presence :

- (i) a. John will/would *(be) a student/in the house/ sick
b. John can/could/should *(be) a student/in the house/sick

One way of accounting for these examples is the following. Given that they involve Modals which we assumed earlier in this chapter to be ASP elements, and given the assumption that ASP has the property of selecting VP obligatorily, the presence of the copula can be explained in terms of the necessity to fill the V position heading the selected VP that would otherwise remain empty in violation of some version of the Projection Principle. In other words, the copula in these sentences is inserted to satisfy the syntactic subcategorisation frame of the Modals.

Evidence for this explanation can be drawn from examples such as :

(ii) He is being silly

where two be verbs are present. One is inserted to satisfy the morphological selectional properties of the TNS and AGR elements and the other is inserted to satisfy both the morphological and syntactic selectional properties of the aspectual element -ing. Assuming the structure of (ii) to be as in (iii) below :

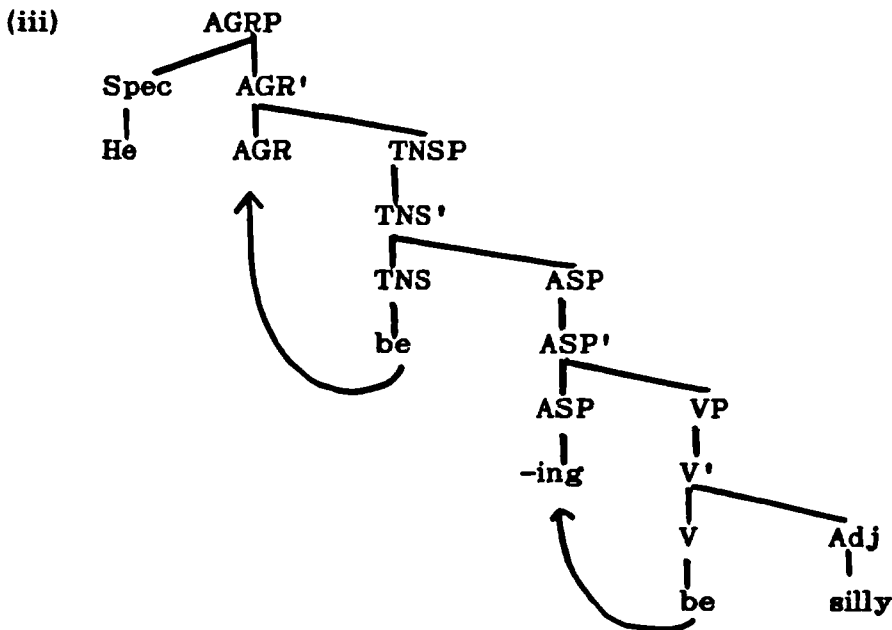

the surface form can be assumed to be derived as a result of movement of the copula inserted under V to ASP to attach to -ing. Viewed as such the

function of the copula is that of a (verbal) place-holder. It is required to satisfy either the morphological or the syntactic (or both) selectional properties of certain head elements.

Chapter Three

Noun Movement

The Structure of Nominal and Prepositional Phrases

3.1. Introduction

The purpose of this chapter is to analyse the structure of nominal and prepositional phrases on the basis of the principles assumed and the conclusions reached in the previous chapter with respect to sentential clauses. Nominal phrases are shown to have a clausal structure that is strikingly similar to that of sentential clauses. The only significant difference lies in the fact that while sentential clauses usually contain a TNS element nominal phrases contain a NOM(inalization) element instead. Word order variation among languages is also shown to fall out from independent facts and therefore need not be stipulated or accounted for in terms of a directionality parameter. Like sentential clauses and nominal phrases prepositional phrases in some languages are shown to have an AGR element, a fact that makes the structure of prepositional phrases in a sense similar to those of sentential and nominal phrases, though it must be pointed out that the differences are more significant.

In addition, an attempt is made to re-classify the range of existing categories in terms of a binary system which recognizes only two major categories, nominal and verbal (formally specified in terms of either of the two matrices [+,- N] or [+,- V]), an attempt that has already been made in the literature, specifically Abney (1987). TNS and the AGR which appears attached to verbs and which assigns nominative are argued to be verbal categories, while NOM and the AGR which appears attached to nouns and which assigns genitive are assumed to be nominal categories. The

complementizer is also argued to be nominal in nature, and its function is defined accordingly. Being a nominal category which is always the top node in the clause the function of the complementizer is to nominalize otherwise verbal clauses so that they can function as arguments, the underlying assumption being that only nominal categories can function as arguments. The conclusions drawn are shown to explain a number of facts that have been reported in the literature but which have remained without a satisfactory explanation.

Adjectives and quantifiers are also argued to be nominal categories. With respect to adjectives the arguments go as far as denying that such a thing as adjective category exists. The elements that have traditionally been called adjectives will be shown to be nominal phrases with functions that have traditionally been associated with adjectives. A similar claim is made with respect to adverbs. Adverbial phrases are shown to be either nominal phrases or prepositional phrases with functions that have traditionally been associated with adverbial expressions. Finally, prepositions are also argued to have a nominal nature conveyed, mainly, by the fact that in some languages they assign genitive Case which is considered a typical property of nominal categories, and also by the fact that prepositional phrases function as arguments, a function that is exclusively reserved for nominal phrasal categories.

3.2. Nominal phrases

3.2.1. Basic properties

3.2.1.1. Noun morphology in Berber

It was mentioned in the previous chapter that nouns in Berber are marked morphologically for the number and gender features. A lexical item such as hamosh can either mean "boy" or "girl" or "children", depending

on the number-gender morphology affixed to it :

- (1) a. a-hamosh
"boy"
- b. ta-hamosh-t
"girl"
- c. i-hamosh-(i)n
"children"

The masculine singular marker consists of the prefix a- illustrated by example (1a), while the feminine singular marker consists of both a prefix (ta-) and a suffix (-t)¹. The plural marker consists also of both a prefix (i-) and a suffix (-(i)n) illustrated by (1c). I must, however, hasten to add in this respect that the plural marker illustrated in (1c) is by no means the only one that exists in the language. While the other two markers, i.e. masculine singular and feminine singular, are fairly regular in that they appear with most items, plural morphology is rather complex. Not all words form their plural form by prefixing i- and suffixing -(i)n. The plural form of the word azru "stone", for example, is izra "stones". The irregularity, however, affects mostly the suffixal part of the marker, especially the vowel. I will not attempt to give a detailed study of the different alternations that exist in the language in this respect since the details are not crucial to the main concern of this work. All we need retain from what has been said is that nouns in Berber are marked for the number and gender features.

Action nouns also carry the number and gender morphology though not as productively as the other nouns. As the following examples illustrate clearly some action nouns take the masculine singular form while others take the feminine singular form, though in the latter form the suffix is missing, a fact for which I have no explanation :

- (2) a. a-mshunshaf
 "fighting"
 b. ta-ra
 "writing"
 c. ta-zzra
 "running"

It is not clear, however, that the vowel of the prefix in (c) and (d) belongs to the inflectional marker or to the stem, the reason being that that vowel appears when the word is used as a verb y-ara tabrat "He wrote a letter."

It may be the case that the inflection used with action nouns is different from the inflection used with the other nouns in that with action nouns the inflection consists of only a- for masculine and t- for feminine. Again I will refrain from venturing into the details because of the complexity of the facts involved. To give one example of such complexity there are nouns which apparently do not seem to be marked for the features discussed, e.g. ufugh "leaving" and uduf "entering". In addition, the internal vowel of these nouns does not appear in their verbal counterparts, e.g. y-ffgh "He left." and udf-gh "I entered.", thus implying that these nouns are perhaps derived by a mapping process onto a nominal template similar to the process that derives the various Aspect/Mood forms of the verb discussed briefly in the the previous chapter.

One of the questions that we may raise at this stage is whether the number-gender inflection discussed is an AGREEMENT inflection. The idea implicit in such an assumption is that if the number-gender inflection is an AGR inflection then it must be expected to agree and, as we will see later, assign Case to the noun phrase it governs. Before we provide an answer to this question let us consider the following examples from Hungarian and Turkish where the inflection in question clearly agrees and assigns Case to the noun phrase it governs :

- (3) a. az én kalap-om (Szabolcsi (1987))
 the I-NOM hat-POSS.1sg
 "my hat"
- b. a te kakap-od
 the you-NOM hat-POSS.2sg
 "your hat"
- c. a Péter kalap-ja
 the Peter-NOM hat-POSS.3sg
 "Peter's hat"
- (4) a. ben-im istakoz-um (Kornfilt (1985))
 I-Gen lobster-1.sg
 "my lobster"
- b. biz-im istakoz-umuz
 we-GEN lobster-1.pl
 "our lobster"

That the agreement inflection in these examples agrees with the possessor is clear from the data. The fact that this AGR inflection assigns Case to the possessor becomes equally clear when we know that in the Hungarian example the AGR element is identical to the AGR element that appears in verbs and, moreover, that it assigns nominative Case to the possessor in the examples above in practically the same way that it assigns nominative to the subject in sentential clauses. In the Turkish examples, however, the AGR element assigns the genitive Case. We will see later the nature and implications of this difference in Case-assignment by the AGR element.

Let us now consider the equivalents of the examples above in Berber :

- (5) a. a-slm in-u
 ms-fish GEN-me(clitic)
 "my fish"
- b. ta-slm-t in-kh
 fs-fish-fs GEN-you(clitic.ms)
 "your small fish"
- c. i-slma-n n-Hemmu
 pl-fish-pl GEN-Hemmu
 "Hemmu's fish"

Ignoring the order of the possessor with respect to the possessee at the

moment, although the possessor is marked with the genitive Case there is no agreement between the the possessor and the inflection on the possessee. In addition, the possessor in (5a&b) is morphologically identical to the object clitic, thus implying that the possessor in Berber acts like a complement, instead of a subject governed by an AGR which is the case in the Hungarian and Turkish examples above, a fact that we will come back to in more detail later. Another difference between the inflection in Berber nouns and the AGR inflection in Hungarian and Turkish that is worth bearing in mind is that the AGR inflection in Hungarian and Turkish carries a person feature whereas the inflection in Berber does not. The conclusion that seems to transpire from these facts is that the number-gender inflection in Berber is not an AGR inflection.

Rather, the number-gender inflection in Berber seems, to a certain extent, to resemble the number-gender inflection that appears on the determiners of French nouns, i.e. la, le, les, un, une, des, the first three being definite and the rest indefinite. Notice that like the Berber inflection these elements do not carry a person feature. It seems that the only apparent difference between French and Berber in this respect is that while in Berber the number-gender inflection is realised on the noun in French it is realised on the determiner. However, one can eliminate this difference by assuming that the affixes which realise the number-gender features in Berber are in fact determiners which, being affixal, attach at some stage in the derivation to the noun. The determiner in French is not affixal and therefore does not have to attach to the noun. The latter explanation is supported by the fact that an adjectival element can intervene between a determiner and the noun, e.g. Le meilleur écrivain "The best writer", a possibility that is excluded in Berber altogether, e.g. *ta-ahamosh tamqqrant -t "The big girl".

Before we move on to the next stage it is worth pointing out that the definite/indefinite distinction in Berber is not marked morphologically as it is in French and many other languages. The definite/indefinite distinction, to my eyes, seems to be a matter of context, both linguistic and pragmatic. This is despite the fact that there is a tendency among the speakers of the language to treat nouns as being definite unless they are modified by the numeral quantifier *ij* "one". In many contexts nouns are treated as being indefinite although they are not modified by the numeral quantifier in question.

3.2.1.2. Nominal INFLECTIONAL elements

In order to identify all the possible inflectional elements that can occur in a nominal phrase we are going to concentrate in this section on languages other than Berber which have a richer (affixal) inflectional system. These languages are Hungarian and Turkish. Notice to this effect that we have already identified an inflectional element in these languages, namely AGR. Since the AGR element in Hungarian nominal phrases is identical to the AGR element that appears with verbs in sentences we can extend the conclusion reached in the previous chapter with respect to verbal AGR to nominal AGR, namely, that the AGR element in the Hungarian nominal phrases, and, presumably, in Turkish also, is a category in the sense of X-bar theory. Support for this conclusion, and consequently the conclusion that AGR in these languages assigns Case to the subject, comes from the fact that in both languages AGR can license a *pro*. This fact is illustrated by the following example from Turkish corresponding to the examples in (4a&b) above² :

- (6) a. *pro istakoz-um*
 lobster-1.sg
 "my lobster"

- b. pro *istakoz-umuz*
 lobster-1.pl
 "our lobster"

As to Hungarian Szabolsci (1987) states that "AGR also licenses pro-drop in the noun phrase, just as it does in clauses." (p. 171) If licensing of pro is understood in the terms explained in Rizzi (1986b), that is in terms of Case-marking by a designated head (X^0), then AGR must be a head since it licenses pro.

In order to see what other inflectional elements can occur in nominal phrases let us consider the following Turkish example from George and Kornfilt (1981) :

- (7) Ahmet [(biz-im) viski-yi iç-me-miz]-i iste-di
 Ahmet we-GEN whisky-ACC drink-GER-1pl-ACC wanted
 "Ahmet wanted us to drink the whisky."

The embedded clause in this sentence is a nominal phrase because, as George and Kornfilt (ibid) argue, it behaves like a lexical NP, a point that is supported further by the fact that the phrase as a whole is assigned (accusative) Case. In addition to the AGR element there is an affixal element that attaches to the verb *me* (represented by the archiphoneme *mA*) which, together with another element *dIk* (we will come back to the difference between these two elements later), is known as the "nominalization morpheme." What is implied by the latter expression is that the nominalisation morpheme turns the verb into a noun, thus accounting for the fact that the overall phrase is nominal in nature and that the subject receives the genitive Case which is a property of nominal phrases.

On the basis of a comparison between the inflectional morphology in nominal phrases (Gerunds) such as the embedded clause in (7) above and the inflectional morphology in sentences, illustrated by (8) below, George and Kornfilt (ibid) come to the conclusion that in nominal phrases "certain

'nominalisation' suffixes [i.e. mA and dIk] fill the slot otherwise occupied by the tense markers in the sequence of verbal morphemes, to a certain extent neutralising tense." (p. 107) :

- (8) (biz) viski-yi iç-eceğ/iyor/ti-i/uz
 we whisky-ACC drink-FUT/PRES/PAST-1pl
 "We will drink/are drinking/drank the whisky."

Ignoring for the moment the fact that the nominalisation morpheme dIk, unlike mA, does convey tense information (see 3.2.1.4. below) let us assume along with George and Kornfilt that the minimal difference between sentential clauses and nominal clauses is that sentential clauses have a TNS affix while nominal clauses don't. In the latter the tense affix is replaced with the nominalisation affix. Carrying the analogy further let us assume that like TNS the nominalisation morpheme (NOM) is also a head in the sense of X-bar theory. Viewed as such the structure of affirmative nominal phrases becomes identical to that of sentential clauses as we will see in more detail in the next section.

Another inflectional element that we concluded in the previous chapter should also be treated as a head in the sense of X-bar theory is the NEG element. Now, in Turkish the NEG element occurs in phrases with dIk (dIk-phrases) but not in phrases with mA (mA-phrases). In the latter the NEG element appears in the matrix clause :

- (9) a. [kimse-nin geç gel-me-diğ-in]-i hatırla-dı-lar
 nobody-GEN late come-NEG-dIg-3sg-ACC remember-PAST-3pl
 "They remembered that nobody came late."

- b. [kimse-nin geç gel-me-sin-]-i iste-me-di-ler
 nobody-Gen late came-mA-3sg-ACC want-NEG-PAST-3pl
 "They didn't want that anybody should come late."

I will try to demonstrate later that the difference between the dIk-phrases and mA-phrases is expected once the real nature of dIk is revealed and the structural properties of the construction in which it occurs are

outlined. We will continue to consider the negation element to be a head category in the sense of X-bar theory. What we will have to explain is why it generally does not occur in nominal phrases.

3.2.1.3. The structure of nominal phrases

Assuming as we did in the previous chapter with respect to sentences that the subject of the nominal phrase is base-generated in the Spec position of the predicate the general structure of nominal phrases in Turkish and similar languages can be outlined as follows (using example (7) above for illustration), bearing in mind that Turkish is a head-final language :

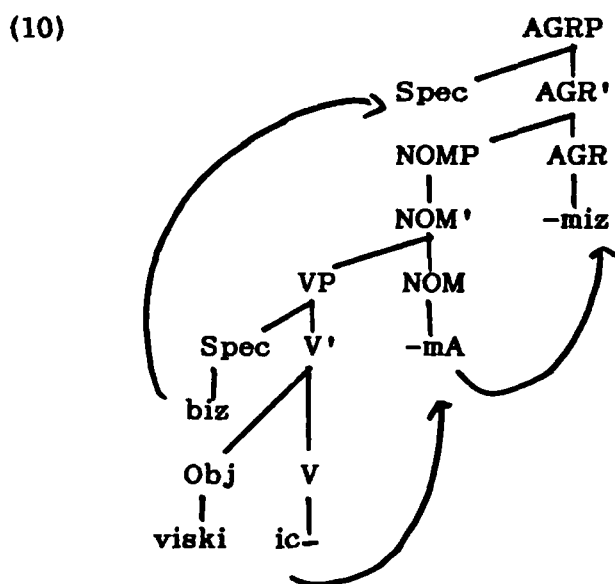

Given that the NOM element precedes the AGR element with respect to the verbal head of the predicate, the generalisation made by the Mirror Principle implies that the verb must attach to NOM before it attaches to AGR. Assuming that the process of attachment is syntactic, given the independent categorial nature of AGR and, we assume here, NOM, this in turn implies that AGR must be higher in the structure than NOM. Assuming that like AGR and TNS NOM also assigns a (functional) theta role its

base-generation under an independent node follows from the UTAH.

The verb moves up to NOM and then to AGR obligatorily under the AP since both NOM and AGR are affixal. The subject, on the other hand, moves up to the Spec position of AGRP to receive the genitive Case under government by AGR via coindexation (I will come back later to the fact that AGR in Hungarian assigns nominative). The predicate is assumed to be a VP headed by a verb in order to account for the fact that the object receives the accusative Case, a property that is characteristic of verbs only. The accusative can be assumed to be assigned by V at D-structure or by the trace of V at the S-structure level, assuming that although the verb moves to a nominal category its trace retains the verbal status (we will see later constructions from other languages where the predicate is an NP headed by a N and where the object receives the genitive Case).

The process of "nominalisation" is understood in terms of the adjunction of the verb to NOM in the by now familiar fashion. When the verb moves up to NOM it adjoins to it so that the new dominating X⁰ node is still NOM, a nominal category. At the same time the moved verb preserves its initial verbal features, a necessary assumption to account for the fact that its object is marked with accusative. Therefore, it should be clear that the nominalisation process assumed does not affect the features of the nominalised element, so that the general assumption that categories cannot change their categorial features in the syntax, perhaps at all levels of analysis, can be maintained. This way the dual nature of gerunds is accounted for on principled grounds, a fact that has already been pointed out with respect to English by Abney (1986) & (1987) and others within the DP-Hypothesis.

The NOM element in English gerunds is obviously -ing and the AGR element can be assumed to be the '-s. Alternatively, the AGR element can

be assumed to be abstract as the verbal AGR is standardly assumed to be in English verbal clauses. The structure of a gerund construction such as John's hitting the ball is as in (11a) below. Its counterpart where the object is in the genitive (i.e. John's hitting of the ball) can be assumed to be as in (11b) below it where the predicate is an NP instead of a VP :

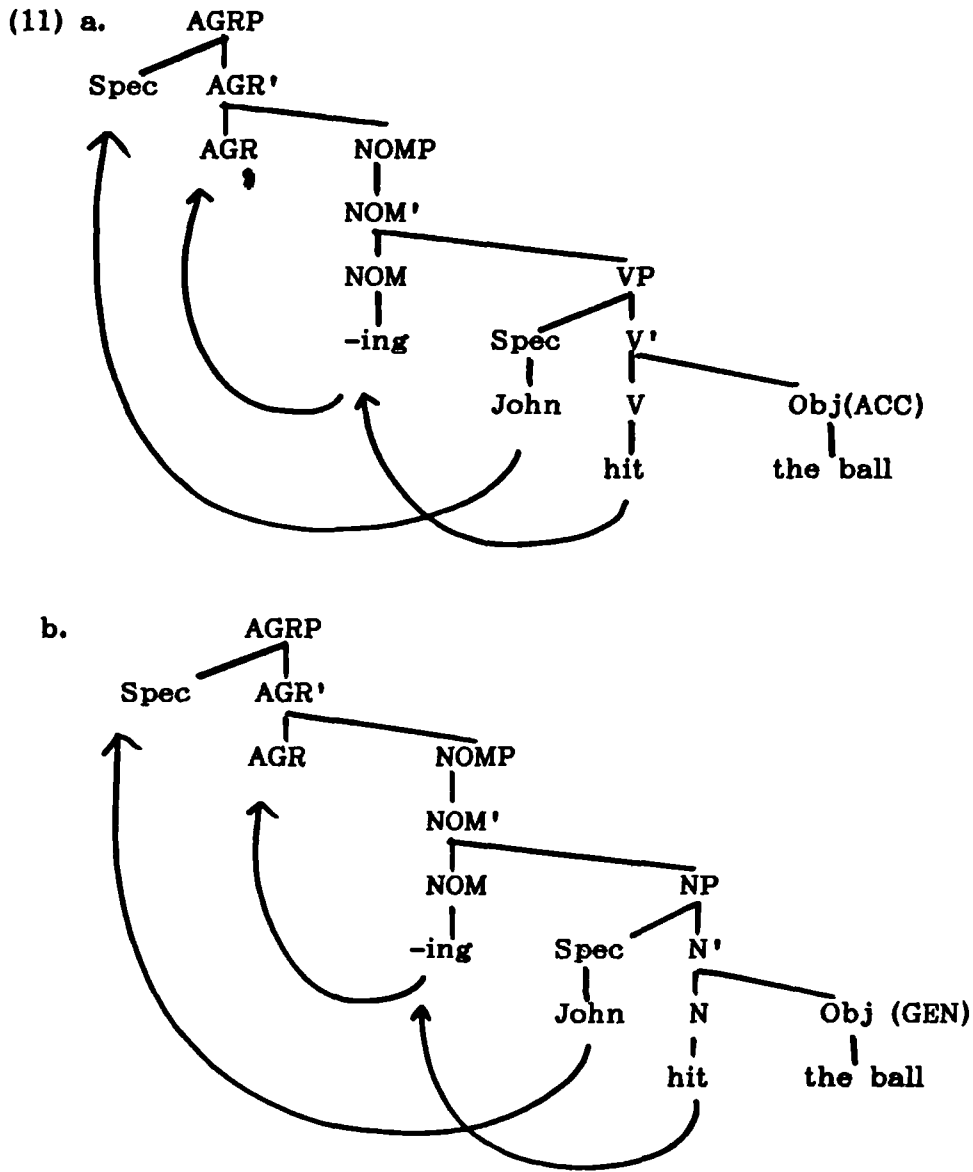

The verb hit in (11a) moves obligatorily to NOM and then to AGR to attach to the elements occupying them which are both affixal in nature. The object of the verb is assigned accusative by the trace of the moved verb. The subject, on the other hand, moves directly to the Spec of AGRP to receive Case from AGR through coindexation. The movement does not cross any

barrier since both VP and NOMP have been voided as a result of V-movement to AGR through NOM. In (11b) similar processes take place. The predicate in this case, however, is assumed to be an NP in order to account for the fact that its object receives the genitive Case. The genitival of can either be assumed to be the realisation of the genitive Case assigned by N (or its trace), assuming that N in English is a Case-assigning category, or inserted to assign Case to the object if it is assumed that N in English is not a Case-assigning category. Notice, however, that in both accounts it is always the noun that is responsible for the appearance of the genitival of.

The structure postulated above for nominal phrases bears a strong similarity to the structure of sentential clauses in subject-initial languages discussed in the previous chapter in that they are both clausal. This way we account for the well known fact that nominal phrases/clauses and sentential clauses resemble each other in many respects, chief among them the fact that they both can form Complete Functional Complexes (CFC) in the sense of Chomsky (1986a). In the present context the difference between the two categories is reduced to a mere difference in the categorial nature of one of the functional elements in their respective structures, namely TNS and NOM.

This conclusion in a sense conflicts with the assumption made in the previous chapter that the tense specification is an essential component of the semantic category "proposition" since nominal clauses clearly constitute propositions. Notice, however, that there is a crucial difference between sentential clauses and nominal clauses, namely, that the latter cannot function as well formed complete sentences while the former can. Nominal clauses can only function as arguments inside a sentential clause that has independent tense specification. So, our assumption that the tense

specification is an essential component of a propositional clause should be understood, more precisely, to mean that tense is an essential component of a sentential proposition.

Let us assume then that it is these two elements (TNS & NOM) which are the heads of their respective clauses in the sense that they determine their categorial nature. More concretely, let us assume that TNS is a verbal category and NOM, obviously, a nominal category. Consequently, their respective clauses would have a verbal and a nominal nature. Notice, however, that it may not be accurate to call TNS and NOM heads of their clausal constructions while none of them, at least in subject-initial languages, is the top node. If we assume that AGR, which is the top node, is nominal as is the standard belief, then by virtue of the adjunction process adopted for head movement processes the overall category would always be a nominal category in both sentential and nominal clauses, thus losing the distinction just made between them in categorial terms. If, however, we assume instead that verbal AGR, that is AGR that appears generally attached to verbs and which assigns nominative, is, like TNS, a verbal category, and that nominal AGR, that is AGR that appears in nominal phrases and which assigns genitive, is, like NOM, a nominal category then the distinction between the two clauses can be maintained in categorial terms³.

Evidence for this categorial distinction between the two AGR elements will be discussed later in relation to Hungarian nominal clauses. Notice that the implication for Hungarian, which, remember, has one AGR element which appears in both sentential and nominal clauses and which assigns nominative in both contexts, is that Hungarian nominal phrases are verbal in nature since their AGR element is verbal. This fact sounds like a severe blow to the distinction just made between nominal and verbal AGR. However,

I will try to show below that it is not, once other structural properties of nominal clauses in Hungarian have been unravelled.

3.2.1.4. On the nature and function of the complementizer

Given the striking similarity between the structures of sentential clauses and nominal clauses it is tempting to ask whether nominal clauses, like sentential clauses, also have a C(omp) position and consequently a complementizer element. To my knowledge there have been two serious attempts in the literature to argue for a C position in nominal phrases, namely, Szabolsci (1987) for Hungarian and Horrocks & Stavrou (1985) for Greek.

Szabolsci observes that the position of the determiner a(z) in the constructions below is "reminiscent" of the position of C in sentential clauses :

- (12) a. én-nek-em a kalap-om
I-DAT1sg the hat-POS.1sg
"my hat"
- b. te-nek-ed a kalap-od
you-DAT-2sg the hat-POSS.2sg
"your hat"
- c. Péter-nek a kalap-ja
Peter-DAT the hat-POSS.3sg
"Peters hat"

She also points out that these constructions differ from those in (3) above in that the subject in (12a,b&c) is in the dative instead of the nominative and that it precedes the determiner instead of following it. She concludes that the dative subject holds a position that is different from the position held by the nominative subject which is the canonical position of the subject since it is governed by AGR. The position held by the dative subject, Szabolsci argues, is the Spec position of CP whose head position is

filled by the determiner a(z) (now considered to be a Comp), thus accounting for the fact that the subject in (12) precedes the determiner. The arguments amount to the claim that nominal clauses do have a C node in practically the same way that sentential clauses have a C node.

Horrocks & Stavrou, on the other hand, argue for a C node in nominal clauses from a completely different perspective. Their argument is based on the fact that wh-movement out of nominal clauses in Greek violates the Subjacency condition (CNPC) on movement illustrated by the following example :

- (13) [S'pyon [S akuses [NP ti fimi [S'oti [S apelisan]]]]]
-
- whom heard-2s the story that dismissed-3p
 "Who did you hear the story that they dismissed ?"

The second step of the movement in this construction obviously violates Subjacency. Horrocks & Stavrou argue, however, that if NP is assumed to have a further projection that is parallel to the CP projection in sentential clauses then its Spec position can serve as an escape hatch for the wh-movement, thus avoiding a Subjacency violation and accounting for the grammaticality of the sentence. They argue further that this additional projection is the projection of the determiner DETP, the determiner (DET) being the head of the noun phrase.

Notice that the conclusion reached in this respect is similar to the conclusion reached by Szabolsci above since both agree that this C-like position is held by the determiner. I will take this conclusion and the idea underlying it in both analyses to be basically correct and incorporate them into the present analysis but in a slightly different guise. But before I spell out in which way this could be done I would like to discuss the function of the complementizer in the sentential clause and see how it can

be extended to the nominal clause.

The term "complementizer" is in itself very suggestive of the function of the complementizer category; it only needs to be spelled out in more detail. The most insightful observation in this respect, I believe, comes from Szabolsci (ibid). She says that the function of the complementizer is to "turn the proposition into something that can act as an argument." (p.180) Szabolsci substantiates her observation by providing a semantic account of how a complementizer converts a proposition into an argument. While I endorse Szabolsci's observation completely along with the semantic argument supporting it I would like to complement her proposal by spelling out how a complementizer turns a clause (= proposition) into an argument syntactically.

Recall that we assumed earlier that AGR and TNS are both verbal categories in the sentential clause and that consequently the overall structure is verbal. Let us assume here that the complementizer is a nominal category and that its function, syntactically, is to nominalise the otherwise verbal sentential clause. No wonder complementizers always occupy the top node in the clause, assuming that it is the top node which determines the categorial nature of the clause, a fairly standard assumption of X-bar theory. If this is correct we can then maintain the general assumption that only nominal categories can function as arguments, an assumption which would account fairly naturally for the well known fact that only clauses (i.e. CPs) and nominal phrases (alias NPs) can function as arguments. By assuming the complementizer to be a nominal category we have in fact accommodated under the categorial feature system assumed, an element that has always escaped classification in terms of the standard feature matrices^{4,5}.

One of the immediate consequences of this proposal is that nominal

clauses do not need a complementizer. However, this would be true only if all nominal clauses have a nominal nature. Our last observation in the previous section with respect to Hungarian nominal clauses shows that not all apparently nominal clauses are nominal in nature. Recall that we assumed that because the AGR element in Hungarian nominal clauses is the same as the AGR element that appears attached to verbs in sentential clauses, and also because it assigns nominative Case, it is verbal in nature. Consequently, for Hungarian nominal clauses to be able to function as arguments, syntactically, they have to be nominalised, hence the presence of the complementizer that Szabolsci argues for quite convincingly. Therefore, we arrive at the same conclusion that Szabolsci arrives at but from a different route. However, I will differ from Szabolsci by assuming that the element in question, though very similar in function and position to the complementizer, is actually a D(eterminer). Viewed as such D in nominal clauses is the equivalent of C in sentential clauses; sentential arguments are CPs while nominal phrase arguments are DPs. This way we come, again from a different route, to the same conclusion that Brame (1981)&(1982), Hudson (1984)&(1987) and Abney (1986)&(1987), among others, came to, namely that the determiner is the head of the noun phrase and that noun phrases are consequently DPs⁶.

The parallelism between sentential clauses and nominal clauses is thereby complete :

- (14) a. [CP C [AGRP AGR [TNSP TNS [XP X ...]]]]
 b. [DP D [AGRP AGR [NOMP NOM [XP X ...]]]]

The difference between the C and D lies in the fact that the latter contains features other than the categorial features, namely a definiteness feature, gender-number features ...etc which play a crucial role in referentiality. So, in addition to the function of nominalising a possibly verbal clause the

D has the function of carrying the afore-mentioned features. This explains the fact that in many languages the presence of the D is obligatory even with phrases which are inherently nominal e.g. phrases which consist of a noun alone. D also differs from C in that D may be missing altogether, while the presence of C is obligatory, at least at D-structure, with sentential clauses. I will spend the rest of this section adducing evidence in favour of the conclusion that the function of the complementizer is to nominalise sentential clauses.

Significant evidence for this conclusion comes from Turkish. There are two well known facts about Turkish which may seem superficially unrelated but turn out to be two sides of the same coin when viewed within the context of the analysis proposed here. One is that embedded clauses in Turkish are generally nominal (gerunds) and the other is that Turkish lacks a complementizer equivalent to that in English. If we ask within the present context why Turkish embedded clauses are nominal the answer would be, because Turkish does not have a complementizer that would nominalise the clause if it was verbal. On the other hand, if we ask why Turkish does not have a complementizer like that the answer would be, because it does not need it since all embedded clauses are nominal. The two otherwise mysterious facts of Turkish thereby receive a principled explanation.

However, the generalisation that all embedded clauses in Turkish are nominal is not accurate because of the existence of the so called Direct Complement clauses (George and Kornfilt (1981)) which are not nominal simply because they do not contain the nominalisation morpheme; they have a TNS morpheme instead. The following example illustrates these clauses :

- (15) herkes [(biz) viski-yi iç-ecēğ-iz] san-iyor
 everybody we whisky-ACC drink-FUT(TNS)-1pl believe-Pres(TNS)
 "Everybody believes we will drink the whisky."

I will try to demonstrate below that even dIk-clauses are not nominal, contrary to the standard belief, thus providing further evidence that the generalisation that all embedded clauses in Turkish are nominal cannot be true. Notice that the important implication in this respect is that embedded clauses which are not nominal must have a C position, albeit lexically null, necessary to nominalise the clause, thus turning it into an argument. A further implication is that genuine nominal clauses, i.e. mA-clauses, do not have a C position because they are nominal irrespective. If we can provide evidence that Direct Complement clauses and dIk-clauses do have a C position, and consequently a CP projection, and that mA-clauses do not have a C position then the proposed theory would be vindicated since the prediction is that all verbal clauses must have a C/D position.

With respect to dIk-clauses I will demonstrate, first, that dIk itself as well as the AGR element that cooccurs with it are verbal in nature and not nominal and, secondly, in fact consequently, that dIk-clauses are dominated by a CP projection. That dIk has a verbal nature is indicated by the fact that, unlike mA, it is marked for TNS. It alternates with the future TNS marker (y)AcAk and conveys non-future :

- (16) iyi keyif cat-acag/tig-iniz-i bil-iyor-um
 good pleasure collide-TNS-2pl-ACC know-PROG-1s
 "I know that you will enjoy / enjoyed yourself/yourselfes."

The verbal nature of the AGR element that cooccurs with it, on the other hand, is suggested by the fact that, unlike the AGR that cooccurs with mA, it can assign nominative to the subject of the clause (this fact is discussed in (Kennelly (1987))). Both the property of being marked for TNS and the property of assigning nominative Case, with respect to AGR, we concluded above, are indicative of a verbal nature. It seems therefore that dIk-clauses, unlike mA-clauses, are verbal in nature.

That dIk-clauses, as a consequence of being verbal in nature, are dominated by a CP projection and that mA-clauses aren't¹ is suggested by at least two facts discussed in Kornfilt (1985). The first has to do with the scope of wh-questions. Turkish, unlike English, and like Chinese (cf. Huang (1982)), doesn't seem to have syntactic wh-movement, for wh-words generally surface in-situ. However, wh-questions in Turkish allow the same range of interpretations that wh-questions in English allow, based on scope relations. This fact implies that wh-movement takes place at LF just like in Chinese, an implication that is independently warranted by the general assumption that all wh-words must be in comp at LF for scope reasons (cf. Chomsky (1986b)). Kornfilt observes that while wh-words may have a narrow scope reading in dIk-clauses they can never have such a reading in mA-clauses :

- (17) a. [parti-ye kim-in gel-di^v-in]-i bil-iyor-um
 party-DAT who-GEN come-dIk-3sg-ACC know-PRO-1sg.
 "I know [who came to the party]."
- b. *[parti-ye kim-in gel-me-in]-i isti-yor-um
 "I want [that who came to the party]."

Kornfilt explains this discrepancy by assuming that dIk-clauses have a wh-operator while mA-clauses don't. Within the context of the present work this discrepancy falls out automatically. Assuming that wh-words can only move to the Spec position of CP, both in the syntax and at LF, the fact that wh-words cannot have a narrow scope reading in mA-clauses follows from the fact that mA-clauses lack a Spec of CP position that can serve as a landing site for them. dIk-clauses, however, do have a Spec of CP position, hence the possibility of narrow scope reading for the wh-words, expressed by movement to the Spec position of the embedded CP.

The second fact that shows that dIk-clauses do have a CP projection and that mA-clauses don't has to do with the scope of negative

quantifiers. In this respect Kornfilt observes that a negative quantifier has to cooccur with a NEG element in a certain domain which she identifies as S' (CP). She then demonstrates that while a negative quantifier in an embedded mA-clause can cooccur with a NEG element in the matrix clause a negative quantifier in an embedded dIk-clause cannot :

- (18) a. [kimse-nin geç gel-me-sin]-i iste-me-di-ler
 nobody-GEN late come-mA-3.sg.-ACC want-NEG-PAST-3pl
 "They didnt want that anybody should come late."
- b. *[ara-larin-dan kimse-nin Mekke-ye git-tiğ-in]-i
 interval-3.pl.-ABL nobody-GEN Mecca-DAT go-dIk-3.sg.-ACC

 hatırla-ma-di-lar
 remember-NEG-PAST-3.pl

 "They didnt remember anybody among them had gone to Mecca."
- c. [kimse-nin geç gel-me-diğ-in]-i hatırla-di-lar
 nobody-GEN late come-NEG-dIk-3.sg.-ACC remember-PAST-3.pl
 "They remembered that nobody came late."

In terms of Kornfilt's explanation this fact shows that mA-clauses must be S_s (AGRPs) while dIk-clauses must be S' (CPs) i.e. the position defended here.

Using a different type of terminology while maintaining the same ideas it seems that the NEG element behaves like an operator that defines the scope of the negative quantifier in the manner described for French by Kayne (1984). When the NEG element is in the embedded clause the cooccurring negative quantifier can only have narrow scope, but when the NEG element is in the matrix clause the cooccurring quantifier can have wide scope, that is over both the embedded and the matrix clauses. Assuming that scope is determined by Quantifier Raising (QR) at LF in the standard manner, it seems that the movement of the quantifier to the matrix clause is blocked in constructions such as (18b) above by the presence of a CP, thus suggesting a possible violation of the ECP. The violation arises as a result of crossing AGRP and CP together, AGRP being

non-L-marked CP inherits barrierhood from it. QR is possible from an embedded mA-clause because the latter does not have a CP projection that would give rise to an ECP violation. Because CP is missing AGRP is theta-governed, hence L-marked, by the matrix verb and therefore is not a barrier.

Before we move on to the next piece of evidence it should be pointed out that mA-clauses would be as opaque if they are assumed to have a D position and therefore a DP projection. Like CP in dIk-clauses DP would be a barrier to movement. It should be the case, therefore, that mA-clauses do not have a DP projection, a fairly plausible assumption to make in view of the fact that D carries (in)definiteness features that normally are not associated with clausal arguments.

Further evidence that nominal clauses do not have a C position, because they are inherently nominal and therefore do not need to be nominalised, comes from the facts of gerunds in English. Gerunds in English, unlike sentential clauses, can never be introduced by a complementizer, thus implying that gerunds lack a C position :

- (19) a. I prefer that John hits the ball
b. I prefer Johns hitting (of) the ball
c. *I prefer that Johns hitting (of) the ball

Moreover, gerunds do not allow short wh-movement (cf. Reuland (1983)), thus implying that they lack a Spec of CP position :

- (20) a. I do not remember what John hit
b. *I do not remember what Johns hitting

Put together these two facts show fairly clearly that gerunds lack a CP projection, the reason being, within the present framework, that gerunds are nominal in nature and therefore do not need to be nominalised by a complementizer in the same way that sentential (verbal) clauses do.

3.2.1.5. Possessor arguments

We saw earlier that the possessor argument in Hungarian (3a,b&c) and Turkish (4a&b) possessive nominal clauses is governed by the AGR element thus implying that it is the S-structure subject of the nominal clause. It is worth asking, however, whether the possessor argument is also a D-structure subject. That is, whether it is base-generated in the Spec of the nominal predicate and then raised to the Spec of the AGRP or is base-generated in the object position of the predicate and then raised to the Spec of the AGRP in a process that resembles the process of movement of the object to the Spec of AGRP in passive constructions. I would like to argue for the latter view, namely, that the possessor is a D-structure object.

The first argument derives from the fact that in some languages (e.g. Berber and Arabic) the possessor can be realised as an object clitic. The Berber examples illustrating this fact are in (5a&b)) above where the object clitic is attached to the genitive preposition. Arabic examples illustrating this fact are the following :

- (21) a. kitaabu-hu
book-his (clitic)
"his book"
- b. kitaabu-ha
book-her (clitic)
"her book"

The fact that the possessor argument can surface as an object clitic is clear evidence that it is a D-structure object since D-structure Specifiers can never be realised as object clitics. Moreover, it will be argued in chapter 4 that clitics are head categories whose movement to their host positions is regulated by the HMC/ECP. It follows that the clitic in (5a&b) and (21a&b) must be D-structure objects since if they were specifiers their

cliticisation to the possessee would be warranted neither by the Structure Preserving Hypothesis because it is a Spec-to-head movement, nor by the HMC/ECP because it is a downgrading movement.

The second argument draws on some facts of agreement in Yupik and Mayan discussed in Abney (1988). Abney observes that "possessed" nouns in Yupik pattern with transitive verbs in that the AGR element they bear is the object agreement that transitive verbs usually bear (23), and that "unpossessed" nouns pattern with intransitive verbs in that they bear the subject agreement marker which in a sense specifies their referential features (23) :

- (22) a. angute-m kiputa-a- \emptyset
 man-ERG buy-OM-SM
 "The man bought it."
 b. angute-m kuiga- \emptyset
 man-ERG river-SM
 "The mans river"
- (23) a. yurartug- \emptyset "(S)he dances"
 yurartu-t "They (pl) dance"
 yurart-k "They (du) dance"
- b. arnag- \emptyset "a woman"
 arna-t "women (pl)"
 arna-k "women (du)"

The fact that the agreement relation that holds between the possessee and the possessor is of the objective type (since it is the object marker that appears and not the subject marker) shows fairly clearly that the possessor is an object of the possessee. A similar situation has been reported to exist in possessive nominal clauses in Mayan (Abney (ibid)).

Both facts mentioned so far represent evidence that possessor arguments are D-structure objects. Based on this evidence I will conclude that possessor arguments are base-generated in the object position of the possessee and are assigned a "possessor" theta-role . The possessor

argument then either moves to the Spec position of AGRP or remains in its place, thus allowing for two possible surface structures of possessive nominal clauses illustrated by the following examples from English :

(24) a. God's house

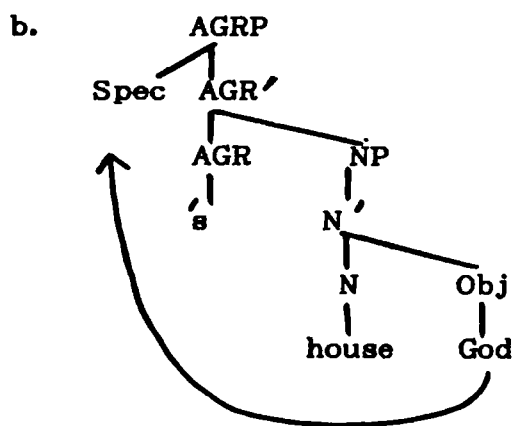

c. The house of God

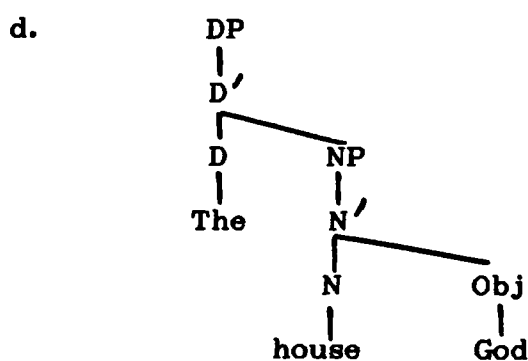

In (24a&b) the object moves to the Spec of AGRP to receive Case from AGR through coindexation. In (24c&d), however, the AGR element does not project (we will see below further examples of nominal clauses where AGR fails to project) and consequently the option of moving to the Spec of AGRP position in search of Case is not available to the object argument. In this case the genitive preposition is inserted to help the possessor argument satisfy the Case requirement. It seems from this analysis that movement to AGRP is obligatory when the AGR element is present, that is when AGR projects, so that Case-assignment by AGR has priority over preposition-insertion, a plausible conclusion, I believe, if the process of

preposition-insertion is assumed to be a default mechanism which only applies in the absence of a Case-assigner.

As has just been said the analysis suggested here for possessive nominal phrases in a sense puts them on a par with the so called nominal passives:

- (25) a. The city's destruction
- b. The destruction of the city

(25a&b) correspond to (24a&c) above. The city in (25a) is clearly a D-structure object because it bears an objective theta role. (25a) represents the option where the AGR element projects while (25b) represents the option where AGR does not project. The structures of the two constructions are identical to the structures in (24a&c), respectively. In both constructions the movement is legitimate since it is a movement from a theta-marked non-Case-marked position to a non-theta-marked Case-marked position which results in the formation of a well formed movement chain. As to the ECP a potential violation can be avoided if N is assumed also to move to AGR, thus voiding the NP barrier which is the only intervening maximal projection.

The possessive nominal phrase in Berber also receives a fairly straightforward explanation, assuming that a nominal AGR element similar to the one that exists in Hungarian, Turkish, English...etc does not exist in Berber, a conclusion we came to earlier in this chapter⁷ :

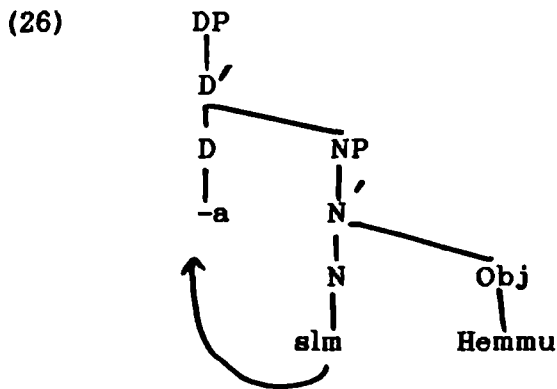

The N moves obligatorily to D since the element occupying it (-a) is affixal. The genitive Case on the object Hemmu can be explained in at least two ways. One is to assume that it is assigned by the trace of the moved N and the other is to assume that it is inserted by a default mechanism for lack of adjacency brought about by N-movement to D. That the trace of N in Berber is not capable of assigning Case will be discussed later in 3.2.3.2. where it is argued that the N assigns Case under linear adjacency. Notice for the moment that although the N is not structurally adjacent to the object after movement it is still linearly adjacent to it.

Notice, finally, that the assumption that Berber does not have a nominal AGR element makes the correct prediction with respect to the order of the possessor and the possessee. Because AGR is lacking the possessor can never precede the possessee in Berber :

- (27) a. *(n-)Hemmu aslm
of- Hemmu fish
- b. *(n-)Hemmu taddart
of- Hemmu house

This is true in a number of other VSO languages as we will see later in section 3.2.3. where surface word order in nominal phrases is discussed⁸.

3.2.1.6. Derived nominals

The discussions above are largely restricted to the so called gerundive noun phrases as well as possessive noun phrases. However, the underlying assumption throughout has been that all nominal phrases have, in principle, identical underlying structures with variations in the categorial nature of the predicate and the possibility of the projection or non-projection of AGR. If this is the case then so-called derived nominals must also have a similar structure. Notice in this respect, however, that derived nominals, unlike gerunds in English, do not have an ING element which we have been considering to be the NOM affix. Let us, however, assume that the NOM element is obligatory in a nominal clause, its presence being required by a nominal AGR which selects it so that whenever nominal AGR is present NOM must also be present, but when nominal AGR is not present NOM may either project or not. The relationship between AGR and NOM in this respect parallels the relationship between AGR and TNS in sentential verbal clauses.

Using the item destruction in the construction the army's destruction of the city for illustration let us assume that the NOM element is the -ion suffix and that destruct attaches to it in the syntax as a result of head movement in roughly the following manner :

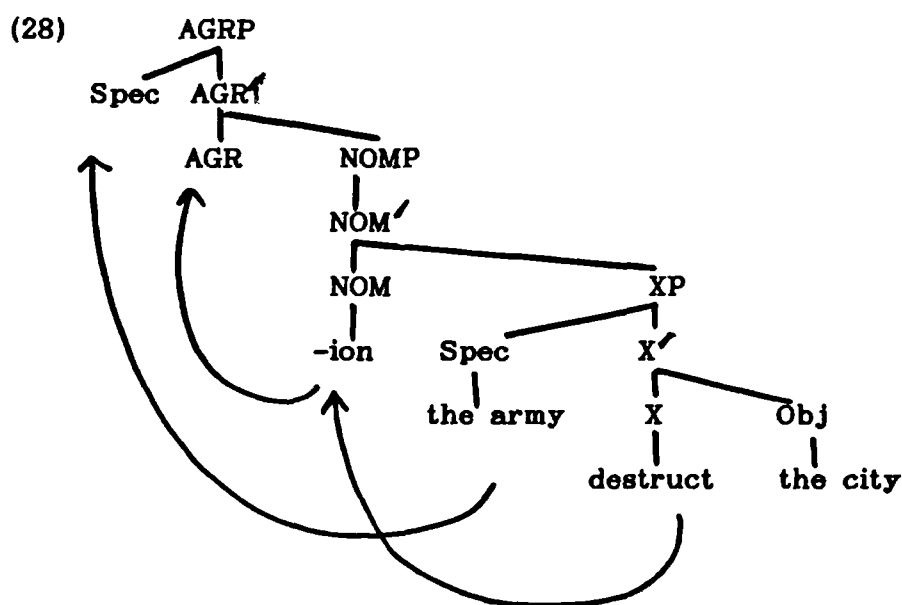

The subject the army moves to the Spec of AGRP to receive Case from AGR via coindexation, and destruct moves to NOM to attach to the nominalisation affix -ion and probably also to AGR. What this analysis of derived nominals amounts to is the claim that derivational processes can take place in the syntax, a claim that has consistently been made in the literature of the recent years by a number of linguists, among them Fabb (1984) and Baker (1985). The structure and derivation of derived nominals viewed this way parallels that of gerunds in every major respect. The only difference is that while the object in gerunds can appear in the accusative as in (11a) above in derived nominals it cant : *the army's destruction the city. Before we see why this should be the case we have to have a slight diversion⁹.

Notice that the predicate in the structure in (28) is left unspecified as to its categorial nature. In fact by leaving it unspecified I intend to make a claim which at first glance may sound counterintuitive but which I believe receives some backing from the facts in some languages that I will discuss below. The claim is that, at least some, lexical items are not specified as to their categorial nature in the lexicon as is the standard belief but that they acquire their categorial features in the syntax. More generally, I would like to claim that it is not so-called lexical categories that are specified for the categorial features but the functional categories and that the lexical categories acquire their features as a consequence of attaching to the functional categories. More concretely I assume that the item destruct becomes a nominal when it attaches to a NOM element such as -ion and that it becomes verbal when it attaches to a verbal element such as TNS or verbal AGR as in the following sentential clause :

(29) a. The army destroyed the city

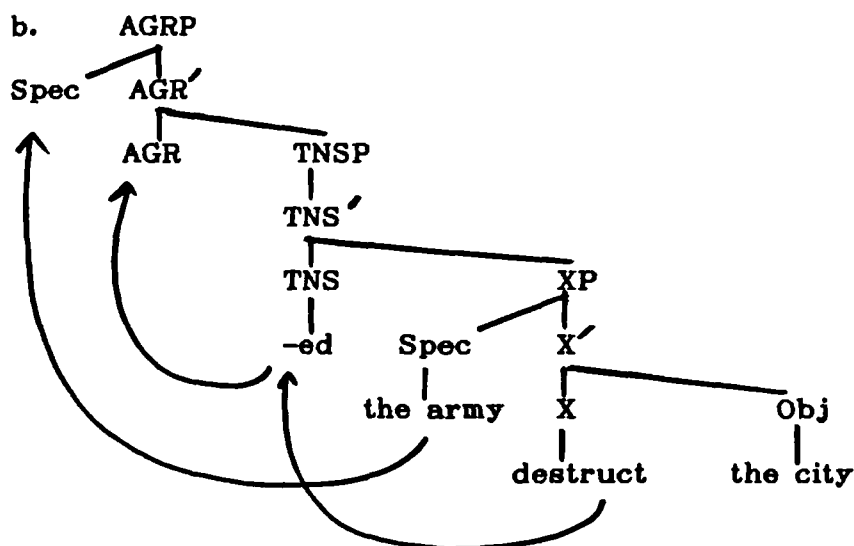

The features that the item X acquires percolate down to its trace which therefore acts accordingly. That is, if the item acquires verbal features the trace would act like a verb in that it assigns an accusative Case, and that if destruct acquires nominal features the trace would act like a noun in that it does not assign Case at all so that the process of of-insertion applies, or in that it assigns genitive realised as of in English.

Needless to say that this proposal requires a detailed re-analysis of a number of facts that have long been believed to be established. Also dozens of questions arise that have to be answered if the proposal is to stand. Needless to say also that it is impossible to do justice to all those questions within the present context. I will content myself with pointing out some theoretical and empirical advantages that a theory which adopts this proposal would have. But before that, I have to make it clear that I am restricting my claim to only semantically related nouns and verbs. I am not contesting, for example, the fact that proper names such as John are inherently nominal and that they are specified as such in the lexicon.

Let us see first how this proposal accounts for the fact that the object can be accusative in gerunds but not in derived nominals. Let us assume that the NOM element -ing can either be verbal or nominal, an assumption

that is made only natural by the fact that -ing is also an aspectual element (PROG), so that in the constructions where the object is in the accusative -ing can be assumed to be verbal. When the lexical item destruct (or its equivalent) attaches to it, it acquires verbal features which then percolate down to the trace which then assigns structural accusative to the object it governs. On the other hand, in constructions where -ing is nominal the moved item acquires nominal features which it then transmits to its trace. The object then is assigned genitive under government by the now-nominal trace. Turning to derived nominals the fact that the object can be in the accusative can be attributed to the assumption that -ion (or its equivalent) can never be verbal, a fairly reasonable assumption in view of the fact that, unlike -ing, -ion does not have any function inside verbal clauses.

An analysis which assumes that the categorial nature of the predicate is fixed prior to syntax can only explain the discrepancy noted between gerunds and derived nominal by assuming that while the predicate in gerunds can either be an NP or a VP the predicate in derived nominal can only be an NP. Besides the fact that these assumptions amount to little more than arbitrary stipulations, the root item in gerunds, that is the head of the predicate (destruct) is the same in both types of gerund constructions. To label it a verb on one occasion and a noun in another seems to me to ignore the otherwise obvious possibility that that item is simply unspecified/neutral with respect to the categorial features.

The proposal made above receives significant backing from the facts of derivational morphology in the Semitic languages as analysed by McCarthy (1979) and (1981). It is a well known fact that morphological derivation in the Semitic languages is based on roots which consist of three or four consonants and which express specific notions e.g. ktb "write". From these roots are derived various forms which can be either nominal (e.g. kitaabun

"book", kitaabatun "act of writing") or verbal (e.g. kataba "he wrote", takaatabuu "they kept up correspondence") via certain clearly identifiable and fairly predictable consonant and vowel permutations. McCarthy discusses evidence showing that the consonantal root is a morpheme in its own right and that the various nominal and verbal forms that derive from it are the result of mapping processes of the consonantal tier on affix and vocalic tiers which incorporate categorial, aspectual, temporal...etc information.

Given this fact it is only natural to assume that the consonantal root, which we said above represents the concept which forms the semantic field around which the derived forms center, is unspecified for the categorial features in its entry in the lexicon. Since the derivational process described above involves ASP, TNS, AGR, NOM ...etc, elements which we have been considering to be autonomous syntactic categories, it should be the case that the consonantal root acquires its categorial features in the syntax as a consequence of movement from inside the maximal projection of the predicate to these nodes. The mapping rules apply subsequently to derive the surface forms.

With respect to Berber the position suggested here has been maintained by Chaker since at least (1978) though within a radically different framework. Chaker argues that the categorial nature of the lexical items is determined by the type of inflectional morphology that attaches to them. For verbs the inflectional morphology includes ASP and AGR elements, while for nouns it includes NOM elements (that is the vocalic tier that derives nouns from a consonantal root), D elements (that is number-gender marking) and the CS/FS morphology which we concluded in the previous chapter is determined by syntactic factors, namely, the nature of the governor. Notice that practically all the morphology that Chaker argues

determines the categorial nature of lexical items is of a syntactic nature (in the sense that the elements belong to independent syntactic (functional) categories), thus implying that the lexical items acquire their categorial features in the syntax¹⁰.

From the theoretical point of view it seems to me that the proposal made gives more substance to the fact originally pointed out by Chomsky (1970) that semantically related nouns and verbs have identical thematic structures. This fact would probably be captured better if instead of talking in terms of semantically related nouns and verbs we talk in terms of category neutral items (e.g. destruct) which represent specific concepts and which have associated with them a thematic structure which forms part of their conceptual structure. These items are projected onto possibly category-neutral X-bar structures which encode their thematic structures in configurational terms so that the internal argument occupies the object position and the external argument occupies the Spec position of the maximal projection of the predicate.

Having said that I would like to point out that in the absence of a coherent theory that would incorporate this proposal and provide adequate answers to the undoubtedly numerous questions that it gives rise to I will continue to adopt in the rest of this work the standard assumption that lexical items are projected already marked for the categorial features.

3.2.2. Nominalisation and auxiliary verbs

3.2.2.1. Irish ProgP_s

The non-finite forms of the verb in Irish usually consist of a deverbal form known as the Verbal Noun (VN) and a particle which "historically and orthographically" corresponds to a preposition of some sort (cf. McCloskey (1983) and McCloskey & Hale (1984)). One such form is the progressive form

illustrated by the following example :

- (30) tá siad ag tógáil tithe
are they PTC build(VN/PROG) houses
"They are building houses."

The progressive form exhibits some properties which are typical of nominal categories, namely, that its object is marked with the genitive Case and its subject, when pronominal, is realized as a possessive pronoun. Both properties are illustrated by the following examples, respectively :

- (31) a. bhí muid ag quartú tí
were we PTC seek(VN/PROG) house (GEN)
"We were looking for a house."
b. bhí siad mo chuartú
were they my seek(VN/PROG)
"They were looking for me."

We clearly have here a case where the main verb of a clause is nominalized when in the progressive form. Notice, incidentally, that it may not be simply accidental that the nominalization affix in English gerunds as we saw above is also a progressive aspectual marker.

It is not clear from the data what is precisely the function of the particle ag- that precedes the verbal noun. The assumption that it might be the nominalization particle, that is a NOM element, is undermined by the underlying assumption in the relevant literature that the verbal noun is nominal independently of the particle. That is, the verbal noun is not nominalized as a result of attaching to the particle in question but is nominal prior to the attachment process. For lack of clear evidence as to the function of the particle in question I will assume here that it is a NOM element and I will leave open the question of whether the nominalization process results from attachment to it or not. The possibility that the particle in question is a preposition is no hindrance to assuming that it is a NOM element since we will see later that prepositions are also nominal in

nature.

Accordingly, the sentence in (30) is predicted to have the following structure :

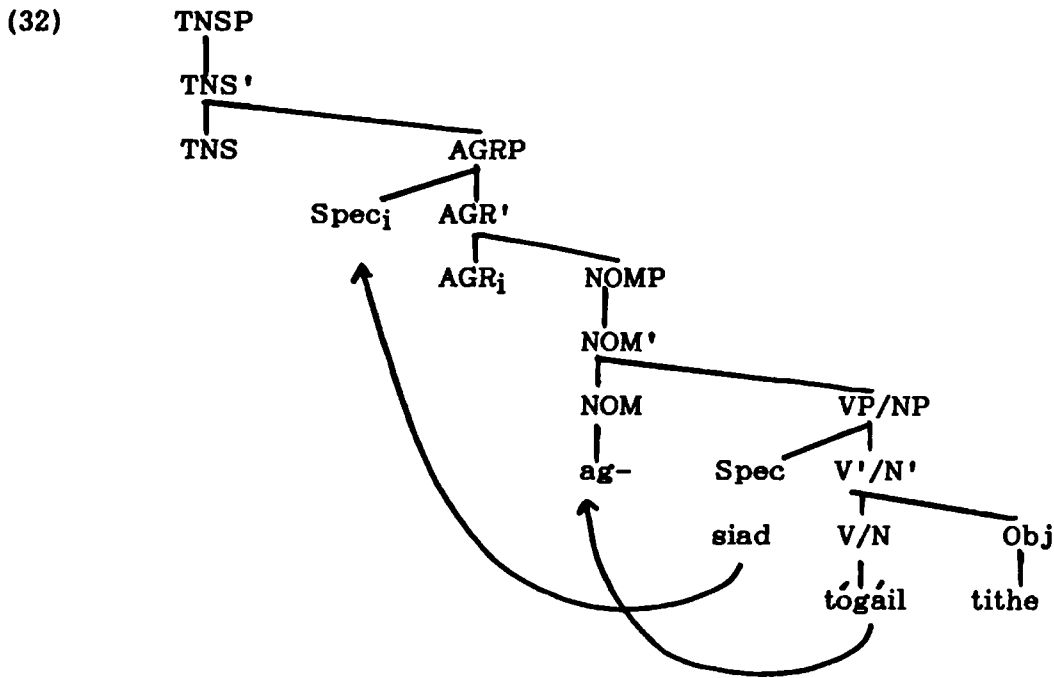

The verbal noun moves up to NOM and attaches to the element occupying it. Assuming that verbal AGR and TNS, being verbal categories themselves, can only attach to verbal categories (further evidence for this assumption will be presented later in relation to participles), the AGR and TNS elements remain stranded, that is they are left without a suitable carrier inside the clause. Being affixal they are, however, subject to the AP, hence the insertion of the copula to serve as a carrier for them in the sense described in the previous chapter. The subject, on the other hand, moves directly to the Spec position of AGRP to receive Case. Although the verbal noun does not move up further than NOM, the NOMP barrier can be assumed to be voided as a result of the insertion of the copula under AGR which subsequently becomes lexical and consequently an L-marker.

If this analysis of ProgPs in Irish is correct then a prediction is made as to whether they have a C position or not. The analysis predicts that

they don't because they are nominal inherently, assuming that the function of a C is to nominalize otherwise verbal clauses. That the prediction is correct is amply evidenced in McCloskey (ibid) where he discusses a number of arguments that demonstrate that ProgPs are not "clausal", by which is meant that they are not S's (CPs).

One such argument is based on the distribution of the NEG element. McCloskey explains in the same reference and elsewhere that the negation marker in Irish always appears in the initial position of the clause and therefore can be assumed to occupy the C position :

- (33) dúirt mé nach bhfaca mé ach mo dheartháir
 said I COMP+NEG saw I but my brother
 " I said that I saw only my brother."

He goes on to argue that if ProgPs had a C position, examples like (34a&b) below should be expected to be grammatical but they are not. The negation element, he argues, must appear in the matrix clause when the embedded clause is a ProgP as in (34c)¹¹ :

- (34) a. *bhí siad gan ag ithe ach prá taí
 were they NEG eat(VN/PROG) but potatoes
 "They were eating only potatoes."
 b. *bhí siad ag gan ithe ach prátaí
 were they eat(VN/PROG) NEG but potatoes
 c. ní raibh siad a ithe ach prátaí
 NEG were they eat(PROG) but potatoes
 "They were eating only potatoes."

Notice, however, that McCloskey's explanation operates on the assumption that the copular verb in (34c) is the matrix verb and that the ProgP is embedded under it. In the analysis suggested above there is no sense in which the copula could be a matrix verb and the ProgP be embedded under it. Examples such as (30) and (34a&b)) are simplex copular constructions which happen to have a nominal phrase as predicate and which therefore

need a verbal expletive to serve as carrier for the TNS and AGR elements, just like the copular constructions described in the previous chapter. Understood as such the fact that ProgPs do not have a C position follows trivially.

3.2.2.2. Participles

I would like to argue here that the participles in the following constructions in English and similar languages resemble verbal nouns in Irish in that they are nominal in nature, the nominalization element being the suffix -en (and its equivalents e.g. -ed) :

- (35) a. Mary has eaten the apples.
 b. The apples were eaten by Mary.

Assuming as we did in the previous chapter that have is an aspectual element the structures of these two examples are roughly as follows, respectively :

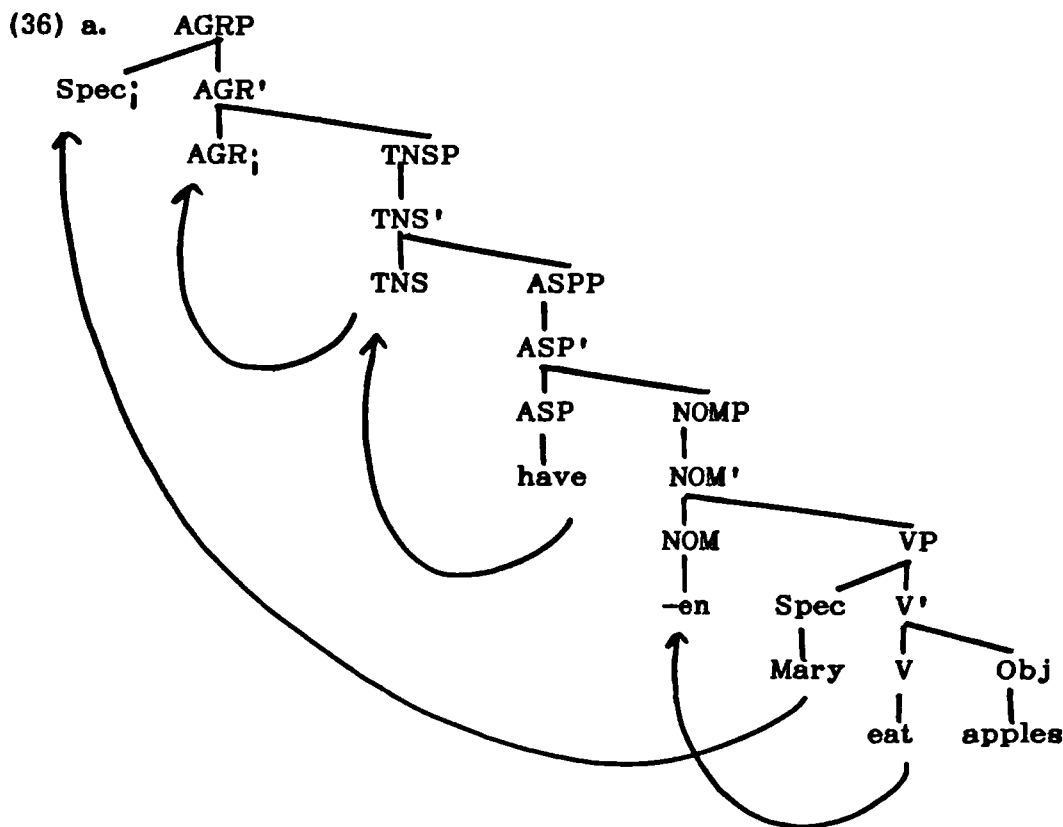

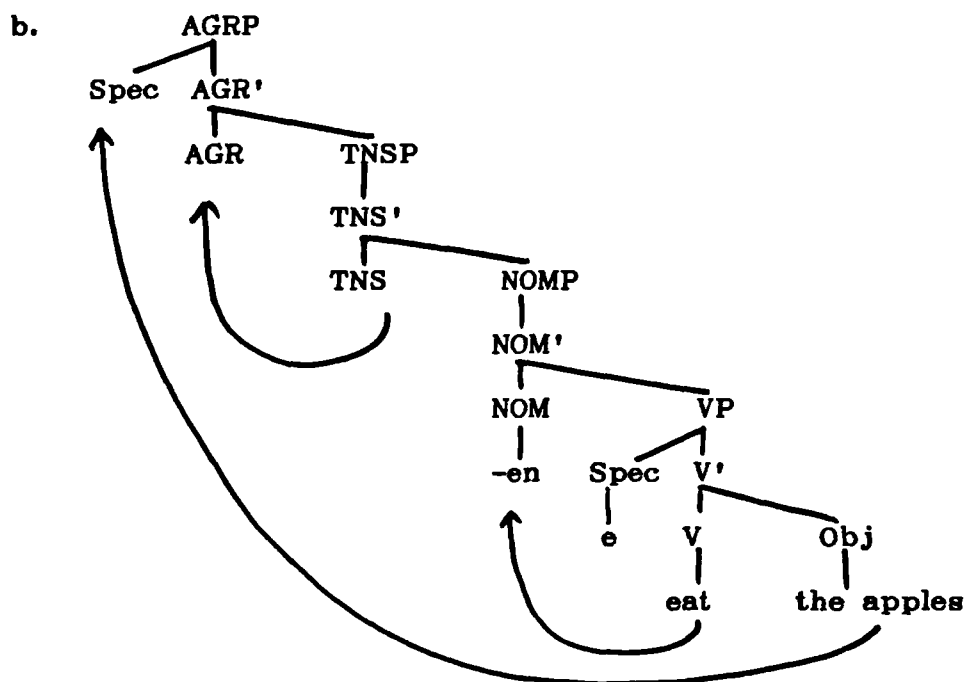

In (36a) the aspectual verb raises to TNS and AGR while the verb eat raises to NOM occupied by en. The subject, on the other hand, moves up directly to the Spec of AGRP, crossing no barriers, VP having been voided by V-movement to NOM and NOMP is L-marked by ASP while TNSP is voided by movement of the aspectual verb to AGR¹². In (36b) the verb also raises to NOM occupied by -en while the TNS and AGR are supported by the inserted copular verb. The object of the verb, on the other hand, moves up to the Spec of AGRP to receive Case from AGR via coindexation. As a consequence of this movement the subject is left without a potential Case-assigner, hence the fact that it can only be realized as an empty category which does not require Case or as an adjunct by-phrase.

Notice that if this analysis is correct then the assumption that the object in passive constructions moves to the canonical subject position because it cannot receive Case from the verb in its D-structure position, the assigned Case having been absorbed by the passive morphology, cannot be correct. The reason is that if this were the case then (35a) should be ungrammatical for the same reason. Given that the same item, namely -en, is

involved in both constructions it would be totally ad hoc to assume that it absorbs Case in constructions like (35b) but not in constructions like (35a). The assumption that objects move in passive constructions for Case reasons has already been challenged in the literature on different grounds. Rothstein (1983), for example, challenges it on the basis of the fact that in Icelandic the surface subject of passive and unaccusative verbs is assigned objective Case, presumably by the verb¹³.

On the basis of this I would like to suggest the following alternative explanation for movement in passive constructions which does not rest crucially on Case, and which is based on the explanation suggested by Rothstein (ibid) in terms of predication. We assumed in the previous chapter that AGR and the Spec of AGRP are coindexed regardless of whether the Spec position is filled or not, the coindexation being a formal expression of the Spec-head agreement relationship. We assumed further that for (nominative) Case-assignment to take place the element that fills the Spec position of AGRP has to agree in grammatical features with the features contained in AGR. Assuming as we did in the previous chapter that every clause requires a subject necessary to license the predicate, the object of the verb in passive constructions, and only the object of the verb, has to move to the Spec of AGRP given that AGR agrees with the object and not with the subject. If the subject moves to the Spec of AGRP there would be a mismatch of features which would then result in a failure of nominative Case-assignment to take place.

One of the obvious questions that immediately arise is, Why shouldn't it be possible to insert a pleonastic element in the Spec of AGRP which would be coindexed with the object and which would serve as a formal licensing subject for the predicate. One way of ruling out the possibility of an expletive subject in passives with non-clausal (heavy) D-structure

objects can be formulated in terms of a failure of agreement between the pleonastic element and AGR. Pleonastics are usually marked with third person singular features (cf. Rizzi (1986b)), a fact that is best illustrated by the the following familiar example from French :

- (37) Il est arrivé trois personnes
there have arrived three people

The postverbal logical subject is plural while the the agreement inflection on the verb is singular. The verb in this example agrees with the pleonastic element which is the formal subject of the clause. In passive constructions, however, the AGR element agrees with the D-structure object which may have any possible combination of features, so that if a pleonastic element is inserted in the Spec of AGRP a mismatch of features would immediately result. To illustrate with a concrete example, in the sentence under (35b) above the features contained in AGR are the same as those contained by the nominal phrase apples, namely, third person plural, while the features contained by the pleonastic are third person singular, hence the mismatch.

Notice, however, that in the English equivalent of the French example in (37) above AGR apparently agrees with the postverbal subject and not with the pleonastic element. If there is assumed to be marked for the third person feature then a mismatch of features between there and AGR would arise. If, instead, there is assumed to be unmarked for the features in question then the problem can be avoided. In this respect there can be assumed to differ from it which usually agrees with the AGR features in the sentences in which it appears.

Conceived of in this manner movement of the object to the Spec of AGRP in passive constructions is accounted for irrespective of whether the Case borne by the moved element is objective or non-objective, the crucial

condition being that the argument agrees with the grammatical features of AGR. Notice that if AGR is assumed to assign Case obligatorily to the argument it governs, that is if it is assumed that AGR must discharge the Case it is marked for, as is assumed in Fukui (1986), for example, then in languages where the subject carries objective Case there would obviously be a Case conflict as well as a violation of the condition that a chain can only have one Case (cf. Brody (1985) and Chomsky (1986a)). If, however, nominative Case is assumed to be assigned by a default mechanism under the agreement condition, then the subject would not be assigned nominative because it already has an objective Case.

Notice, however, that a similar situation of Case conflict, and consequently a violation of the condition that chains can only have one Case, would arise if we assume, within the proposed analysis, that the verb assigns Case to the trace of the moved argument since in this case the resulting chain would have two Cases, one assigned to the moved argument by AGR and the other to the trace of the moved argument by the verb. It must therefore be the case that the trace of the subject is not assigned objective Case. This conclusion in a sense takes us back to square one, i.e. the initial standard position of GB that the objective Case gets absorbed by the passive morphology, an explanation that we rejected above.

I will assume instead that the subject is assigned nominative Case in its D-structure position by the same mechanism that has been argued to assign nominative Case to the direct object in the following examples from Italian discussed in Taraldsen (1985) :

(38) a. arrivato io/*me, gli altri se ne andarono
arrived I/me the others left

b. bruciato tu/*te, i crociate avanzeranno sulla capitale
burnt you/you(Objective) the crusaders will-advance on the
capital

In the Italian examples in (38) the objects of the unaccusative verbs arrivato and bruciato receive the nominative shown by the fact that only the nominative form of the pronoun is allowed. This is true despite the fact that the verbs are transitive, being unaccusative. Unlike passive verbs unaccusative verbs apparently do not have extra morphology that could be blamed for the absorption of the objective Case assigned by the verb. I wish to propose that these arguments are assigned nominative in their D-structure position by the assumed mechanism triggered by the agreement relationship between the object and the AGR element. In different terms because the features of the object of the verb and those of AGR match the mechanism responsible for nominative Case-assignment applies despite the fact that the argument is in the object position of the verb. The proposal becomes clearer if we assume along with Borer (1986) that nominative Case-assignment is nothing more than a manifestation of the agreement relationship between the subject and the AGR element. By virtue of its agreement with the features of AGR the D-structure object is marked with the nominative Case. Its obligatory movement to the Spec of AGRP, on the other hand, is required for a different reason, namely the principle of formal predication¹⁴.

A similar analysis can be applied to movement of the possessor argument in possessive nominal phrases discussed above. Because the possessor nominal phrase, which, remember, is the D-structure object of the possessee just like the subject of passive constructions, agrees with the AGR element it is marked with the genitive Case. Its movement to the Spec of AGRP can also be understood to be motivated by the principle of formal predication.

3.2.3. Word order variation

3.2.3.1. Subject-initial languages

The task of this section is to see to what extent surface word order in nominal clauses can be made to fall out from the distributional properties of the AGR and NOM elements in the same way that we made surface word order in verbal clauses fall out from the distributional properties of TNS and AGR in the previous chapter. There is no a priori reason to assume that languages which are subject-initial in verbal clauses must also be subject-initial in nominal clauses. It may conceivably be the case that the order of elements in nominal clauses differs from the order of the same or equivalent elements in verbal clauses. In fact we will see later that, apart from some marginal cases, the subject in Romance nominal clauses can only be realised as a by-phrase following the object despite the fact that Romance languages are standard SVO languages. Having said that, the analysis developed in the previous chapter does, however, make the prediction that in those languages where the subject systematically precedes the nominal head the AGR element must precede the NOM element, or to be more general, the AGR node must be the top node, ignoring for the moment the D node.

That the prediction is correct is clearly shown by a number of examples from Turkish mentioned above. For illustration, example (7) is repeated here :

- (39) Ahmet [(ibiz-im) viski-yi iç-me-miz]-i iste-di
 Ahmet we-GEN whisky-ACC drink-NOM-1pl(AGR)-ACC wanted
 "Ahmet wanted us to drink whisky."

Turkish is a subject-initial language in both verbal and nominal clauses. That AGR follows TNS in verbal clauses is demonstrated in fn.12 of the previous chapter. With respect to nominal clauses the fact that AGR follows NOM in relation to the head is clearly shown by the example in (39). Given this fact, together with the assumption that AGR and NOM form separate syntactic categories and the Head-parameter of X-bar theory, the Mirror

Principle predicts the following structure for Turkish nominal clauses such as the one embedded under the matrix verb in (39) :

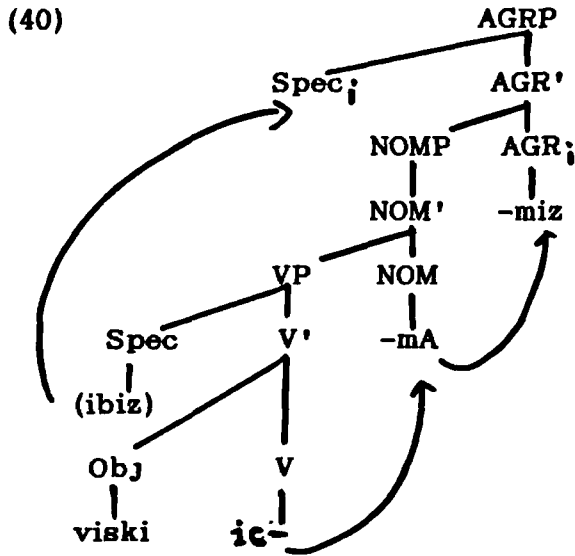

The verb raises to NOM and then to AGR to attach to the affixal elements occupying them, while the subject moves from the Spec position of VP to the Spec position of AGRP to receive Case from AGR via coindexation. Both these movements yield the Subject Object Noun (SON) order, that is the basic surface order of nominal clauses in Turkish. The verbal head undergoes nominalisation as a result of affixation to the NOM element during the derivation.

With respect to Hungarian which is also a subject-initial language the examples given above are all instances of possessive clauses. They all involve categories that are nominal inherently (e.g. common and proper nouns) and therefore do not contain nominalisation affixes. The fact that AGR is the top node in these constructions only trivially bears out the prediction. However, in constructions with gerunds or derived nominals the NOM element is expected to precede the AGR element with respect to the head. The overall structure and the surface word order derived from it are expected to be similar to that of nominal clauses in Turkish.

The AGR element in English nominal clauses is also expected to precede the NOM element. However, given that AGR in English is abstract and given that the 's element attaches to the subject the expected order is not easily discernible. I will assume that the structures in (11) and (29), which encode the expected order, are essentially correct and that the derivation proceeds as indicated there, yielding a surface SNO order, English being a head-initial language.

If the parallelism between the structures of nominal and verbal clauses is carried further the analysis proposed and developed predicts that the AGR element of nominal clauses in subject-initial languages may fail to project in the same way that the AGR element of verbal clauses in the same type of languages also may fail to project, thus giving the infinitive clauses, which, remember, were concluded to be different from finite clauses in that AGR fails to project. The analysis also predicts that in this case a lexical subject would have to get Case from an external governor. That both predictions are borne out is shown by the following examples, respectively, from Turkish and English :

- (41) a. (ben) [viski-yi iç-meğ]-e razı ol-du-m
 I whisky-ACC drink-NOM-DAT consent-PAST-1.sg.
 "I consented to drink whisky."
 b. Mary hated [them playing football]
 c. The manager counted on [him scoring a goal]

The AGR element in (41a) is missing and the subject position is filled by an empty category that is controlled by the matrix subject. The lack of AGR in (41b&c) is indicated by the absence of 's. In both constructions the embedded subject, occupying the Spec position of NOMP, has objective Case assigned by the matrix verb in (41b) and by the governing preposition in (41c). This fact implies that gerunds do not have a CP projection because if they did government of the embedded subject in the Spec position of

NOM would not be possible since CP would inherit barrierhood from NOMP, thus blocking government from without. This is a desirable conclusion which lends further support to the analysis developed in this work since we came to the same conclusion earlier on quite independent grounds, namely, that gerunds are nominal inherently and therefore do not need a C to nominalise them so that they can function as arguments.

3.2.3.2. Noun-initial languages

It was pointed out above that there is no a priori reason to assume that the surface order of elements in a language would be the same in both nominal and verbal clauses so that if a language is VSO in verbal clauses it should be expected to be NSO in nominal clauses. However, in practically all the VSO languages that I have examined the surface order of elements in nominal clauses turns out to reflect that of verbal clauses. That is the basic surface order in nominal clauses of VSO languages is NSO. The following examples from Berber, Arabic, Welsh and Chamorro, respectively, illustrate this fact :

- (42) a. axarab n-ljish i-tendint
 destruction of-army to-town
 "The army's destruction of the town"
- b. tadmiir-u l-?aduw-w-i li-l-maddinat-i (Fassi Fehri (1987))
 destruction-NOM the-enemy-GEN to-the-town
 "The enemy's destruction of the town"
- c. distrywiad Siôn o'r dref (Sproat (1985))
 destruction Sion of-the town
 "John's destruction of the town"
- d. i bisita-na si Francisco as Teresa (Chung (1982))
 the visit-AGR(3.sg) Unm Francisco of Teresa
 "Francisco's visit to Teresa"

Also, in all these languages the possessor follows the possessee in order, unlike in subject-initial languages (not all of them, obviously; see

3.2.3.3. below) where the possessor precedes the possessee. Examples illustrating this fact in Berber are given above in (5). Examples from Arabic, Welsh and Chamorro are given below :

- (43) a. bayt-u l-mudarris-i
house-NOM the-teacher-GEN
"The teacher's house"
- b. brawd yr athro (Sadler (1988))
brother the teacher
"The teacher's brother"
- c. i kareta-nniha i famalo'an (Chung (1982))
the car-AGR(3pl) the women
"The women's car"

It is clear then that in both types of constructions the subject follows the head. As we did with verbal clauses we should expect this order to fall out from independent facts that have to do with the underlying structure and the order of affixal elements in relation to the head category of the predicate.

Notice that apart from Chamorro none of the other languages has an overt AGR element. With respect to Berber we concluded above that it does not have a nominal AGR element, and the same can be said about Arabic. Welsh differs from Berber and Arabic in that the object in the examples in (42) is marked with a genitive preposition while in Berber and Arabic it is marked with a dative preposition. In this respect Welsh resembles Chamorro where the object is also marked with a genitive preposition. In both Berber and Arabic the subject which immediately follows the head is marked with the genitive while in Welsh and Chamorro it is unmarked. Given these facts let us assume that Welsh and Chamorro differ from Berber and Arabic in that they have an AGR element while Berber and Arabic don't. Having said that we have to specify the underlying structures of nominal clauses in these languages and determine how the subject and the object receive Case.

Despite the observed similarity between Berber and Arabic there is a slight difference between them with respect to the examples in (42) and (43). While the head noun in Berber has a D element the head noun in Arabic doesn't. As a matter of fact the head noun in the Arabic example cannot carry the (in)definite article, a fact that was explained earlier with respect to the genitive construction in fn.8. The same explanation carries over to non-possessive nominal clauses such as the one in (42b). Accordingly, the structures underlying the constructions in (42a) and (42b) are the following, assuming that the prefix ta- is the nominalisation affix in the Arabic example¹⁵ :

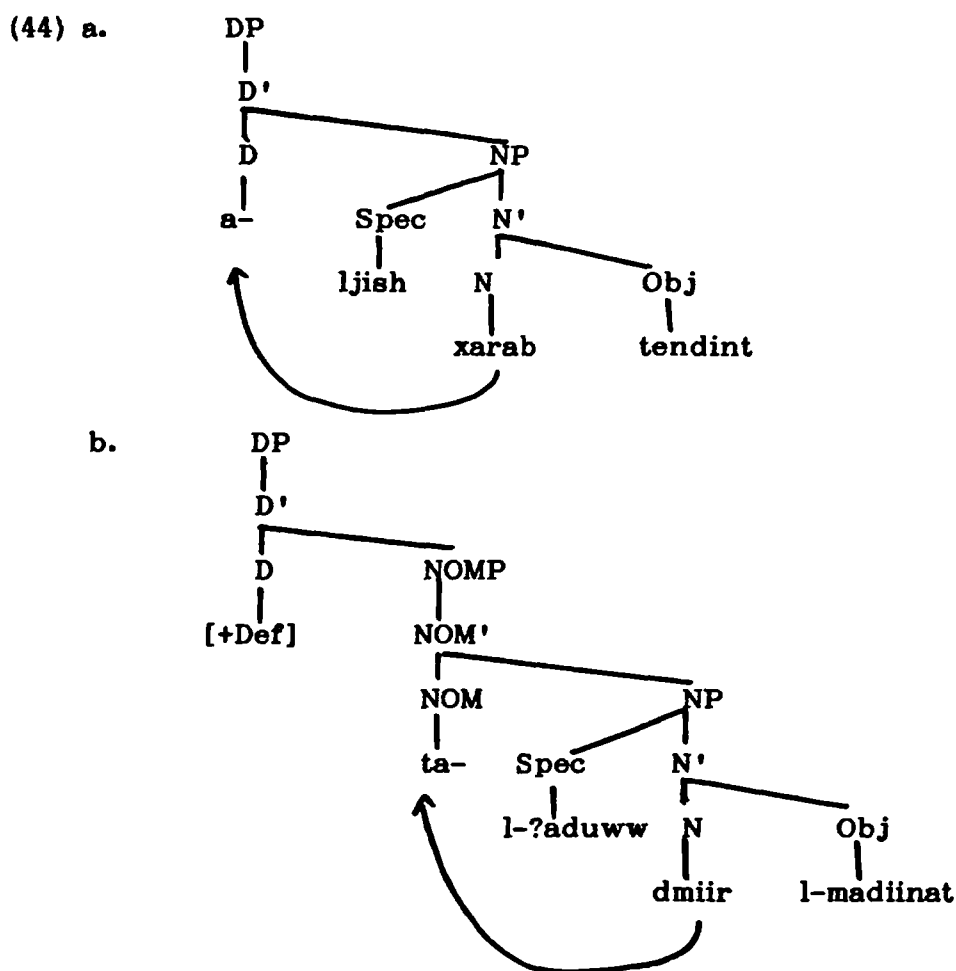

In (44a) the lexical head raises obligatorily to D. As a result of this movement adjacency with the object is lost, hence the insertion of the dative preposition to assign Case to the object. The subject remains in its

D-structure position and receives (structural) genitive Case from the moved head under D. In the Arabic example in (44b) the lexical head raises only as far as NOM. As in the Berber example movement of the head results in a loss of adjacency with the object and the insertion of the dative preposition to assign it Case. The subject also remains in its D-structure position and receives (structural) genitive under government by the moved head under NOM. Alternatively, the subject could be assumed, in both structures, to be assigned genitive by D and NOM, respectively¹⁶.

That the genitive Case assigned to the subject of the nominal clause is structural in Berber and Arabic is shown by the fact that when the subject is missing it is the object that is assigned the genitive :

(45) a. axarab n-tendint
 destruction of-town
 "The destruction of the town"

b. tadmiir-u l-madiinat-i
 destruction-NOM the-town-GEN

Generally, genitive Case is assigned to the argument that immediately follows the head noun, regardless of whether the argument is a subject or an object, a clear indication that the genitive Case is structural. However, the adjacency that seems to be required for Case-assignment is not immediately clear. Based on the analysis suggested for the examples in (42a&b) the underlying structures of (45a&b) are as follows :

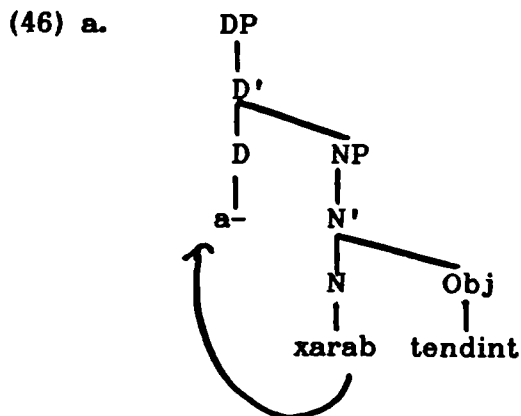

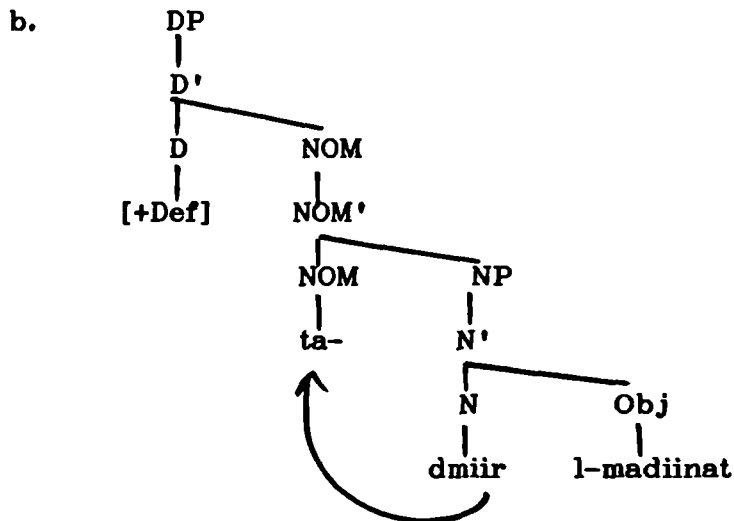

In both structures the lexical head moves up to a higher position, D in (46a) and NOM in (46b). As a result of this movement structural adjacency with the object is lost in exactly the same way that adjacency is lost in the structures in (44) and the preposition is inserted. In (45a&b), however, no preposition-insertion takes place. It seems that the type of adjacency that is at work here is linear adjacency and not structural adjacency. In (44a&b) the lexical head is adjacent to the subject both structurally and linearly, while in (46a&b) the lexical head is adjacent to the object only linearly. If we assume that the genitive Case in (46a&b) is assigned via the trace of the moved N which is structurally adjacent to the object the question would arise as to why this should not be the case in (44a&b). So, it must be assumed that the trace of N is not capable of assigning Case at least in Berber and Arabic (but see below for a different explanation).

Possessive nominal phrases receive an analysis along similar lines. The structure of the possessive nominal phrase in Berber is outlined in (26) above where the possessee is base-generated as head of NP and is later raised to the D position to attach to the affixal element occupying it. Although structural adjacency is lost with the possessor noun phrase as a result of this movement linear adjacency still holds, hence the genitive Case. The structure of the possessive nominal in Arabic is practically the

same except that in Arabic the possessee does not raise to D since there is no affixal element occupying the D position that needs to satisfy the AP :

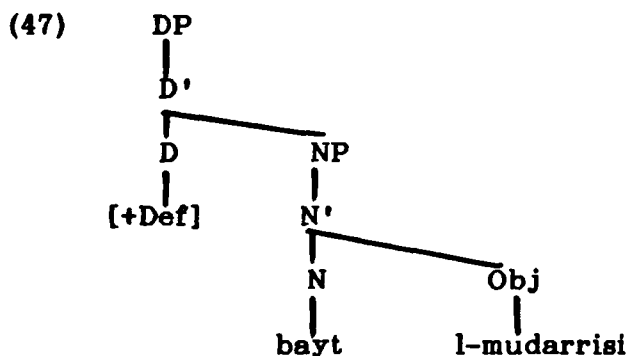

The lexical head is adjacent to the object both structurally and linearly. Consequently, genitive Case-assignment can take place.

Let us now turn to the examples from Welsh and Chamorro. Assuming that the Welsh nominal phrases have an abstract AGR element that is similar to the overt AGR element in the Chamorro nominal phrases and assuming that it is this AGR that assigns Case to the subject the underlying structure of the examples in (42c&b) is roughly as follows, using the Chamorro examples for illustration :

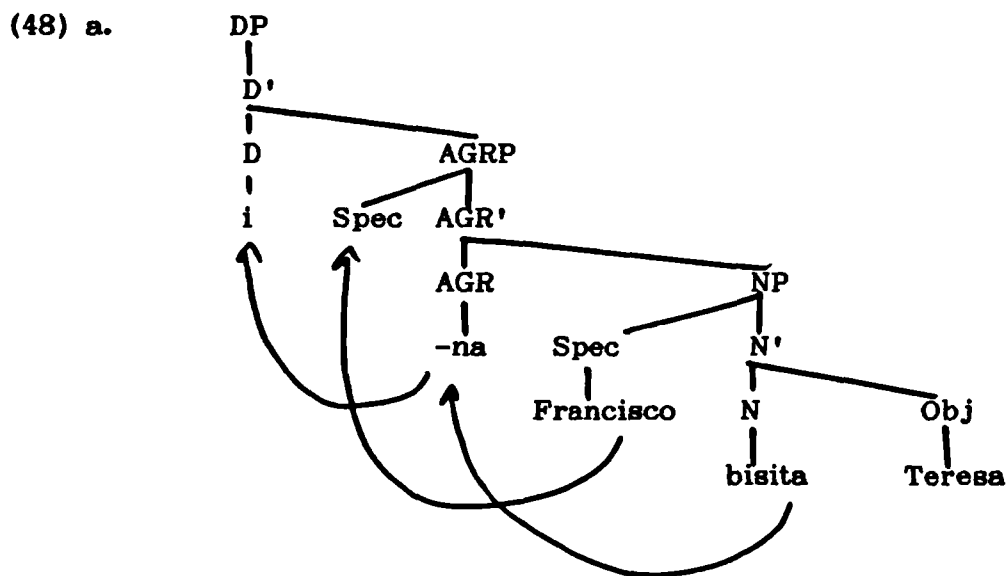

Assuming that the determiner i is affixal as in Berber and Arabic the

lexical head noun moves up to AGR and then to D, while the subject moves directly to the Spec of AGRP to receive Case from AGR via coindexation. The object receives genitive Case, presumably from the trace of the moved head. If this is correct then the obvious question that arises in this respect is why the trace of N should be able to assign Case in Chamorro and Welsh but not in Berber and Arabic as we concluded above.

Notice that in the Welsh and Chamorro nominal phrases there are two potential Case-assigners, AGR and N, while in the Berber and Arabic nominal phrases there is only one potential Case-assigner, namely, N since AGR is lacking. At the same time there are two arguments that require Case, namely, the subject and the object. Having made that observation it is easy to see the need for an external (inserted) Case-assigner in the Berber and Arabic examples but not in the Welsh and Chamorro examples. It is also easy to see why no external Case-assigner is needed when the subject is missing from the nominal phrases in Berber and Arabic. To give a formal explanation to these observations let us assume that a chain (e.g. (N) or (N,t)...) can assign at most one Case. In the examples in (44) the Case of the chain (N,t) is assigned to the subject in the Spec position of NP, and in (46) to the object. As a consequence, the object in (44) is left without a Case-assigner, hence the insertion of the preposition. What needs to be explained here is why the subject should have priority over the object. I must admit I have no adequate explanation for this.

In the Welsh and Chamorro examples in (46) the Case of the movement chain (N,t) is assigned to the object while the subject is assigned Case by AGR. Even in this case there is a sense in which the subject has priority. One could say that the Case of the chain (N,t) is assigned to the object only because the subject has an independent Case-assigner. Notice that if this explanation is correct the question as to whether the trace of N is a

Case-assigner in some languages but not in others does not arise. Generally, the trace of N can assign Case to the object provided that the subject receives Case independently.

The derivation of the possessive nominals in Welsh and Chamorro can be argued to operate along similar lines. The possessor is base-generated in the object position and from there moves to the Spec of AGRP to receive Case. The lexical head noun, on the other hand, moves to AGR and then to D to attach to the affixal elements occupying these positions. Using the Chamorro example for illustration again the structure is roughly as follows:

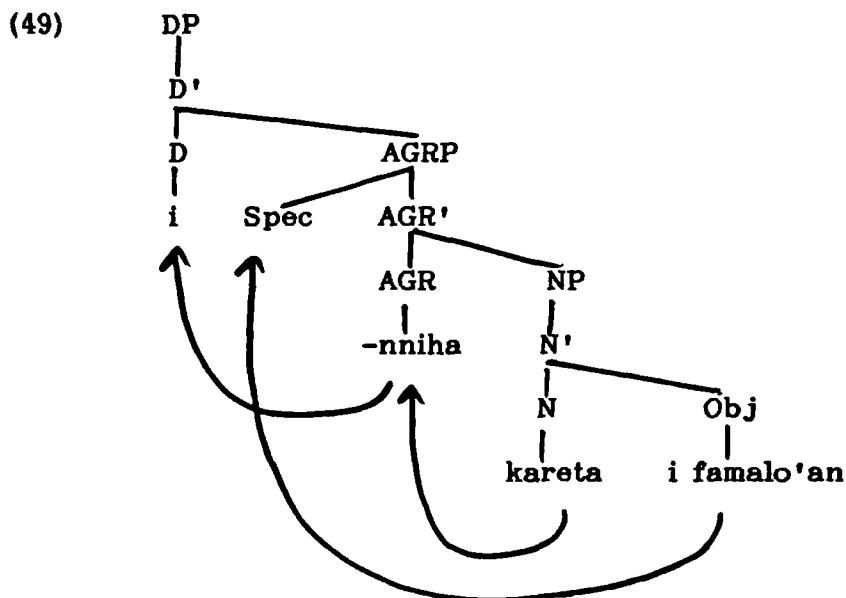

The only intervening potential barrier between the initial position of the object and the Spec of AGRP is NP which is voided as a consequence of N-movement to AGR.

Despite the similarities there is an apparent difference between nominal phrases in the Celtic languages and in Chamorro, namely, that while an overt pronominal possessor cannot appear in Chamorro it can in the Celtic languages :

(50) a. mo theach
my house

(McCloskey & Hale (1984))

- b. i lepblo-nna (*gui') (Chung (1982))
 the book-AGR (3.sg)a/he
 "His/her book"

Notice, however, that the pronominal possessor in the Irish example in (50a) precedes the possessee unlike non-pronominal possessors which invariably follow the possessee. This fact in a sense runs contrary to what is predicted by the analysis outlined above. Nevertheless, seen from a different angle this fact ceases to be a problem and in fact turns out to be evidence in support of the analysis suggested.

Precisely because the pronominal possessor behaves differently from the non-pronominal possessors with respect to their order in relation to the possessee McCloskey and Hale (ibid) argue that what we have been calling a pronominal element is in fact an overt realisation of the AGR element itself. McCloskey and Hale discuss further evidence in support of their claim, notably, the fact that this element behaves similarly to the AGR elements that appear attached to verbs and to some prepositions. For example, like the "synthetic" verbal AGR element the element in question cannot cooccur with an overt independent pronominal :

- (51) *mo theach mé
 my house me/I

Given this fact the statement made earlier that Chamorro and the Celtic languages differ in that Chamorro does not allow for cooccurrence of the overt pronoun with AGR while the Celtic languages do is obviously wrong. This statement was based on the wrong assumption that in addition to the element in question there is an abstract AGR element whose presence we assumed earlier in order to account for the similarity between Chamorro and the Celtic languages with respect to non-possessive nominal phrases. The question as to why an overt pronoun cannot cooccur with an overt AGR is still a mystery to me. However, the fact that Chamorro and the Celtic

languages pattern together in this respect represents evidence for the analysis suggested.

3.2.3.3. Romance nominal phrases

Nominal phrases in the Romance languages differ in that, apart from some marginal cases, a non-pronominal lexical subject can only be realised as a by-phrase¹⁷ :

- (52) a. La destruction de la ville par les soldats
the destruction of the town by the soldiers
- b. *Des/les soldats la destruction de la ville
the soldiers the destruction of the town
- c. *La destruction des soldats de la ville
the destruction of-the soldiers of the town

The possessor (subject) in possessive nominal phrases, however, receives the genitive :

- (53) a. Les armes des soldats
the arms of-the soldiers
- b. La maison de Marie
the house of Marie

The discrepancy between the subject of the possessive nominals and the subject of the derived nominals is clear. However, the discrepancy disappears under the analysis adopted in this work where the possessor is considered a D-structure object. Viewed as such the possessor behaves exactly like the object in the example in (52a) in that they both are assigned genitive, presumably under government by the head noun.

The obvious question that we have to answer with respect to the Romance nominal phrases is why a non-pronominal subject can only be realised as a by-phrase. The parallel with passive constructions is clear, thus implying that the reason has to do with Case theory. Let us assume

that like Berber and Arabic the Romance languages do not have a nominal AGR element so that their nominal phrases never contain an AGR node. The number-gender features, we concluded earlier, are part of the D morphology just like in Berber. Let us assume further that the head noun in the Romance languages never moves up to D which is the only head dominating its maximal projection, the reason being that D elements are not afixal and therefore do not need a carrier, unlike the D elements in Berber. Put together these assumptions predict the following structures for nominal phrases in the Romance languages :

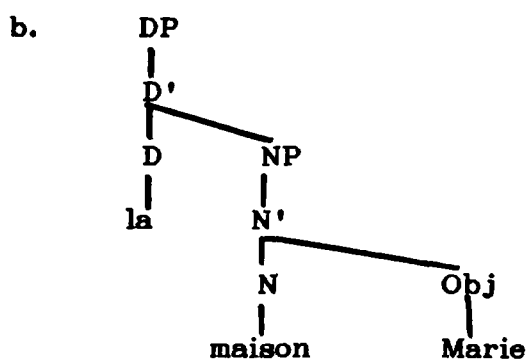
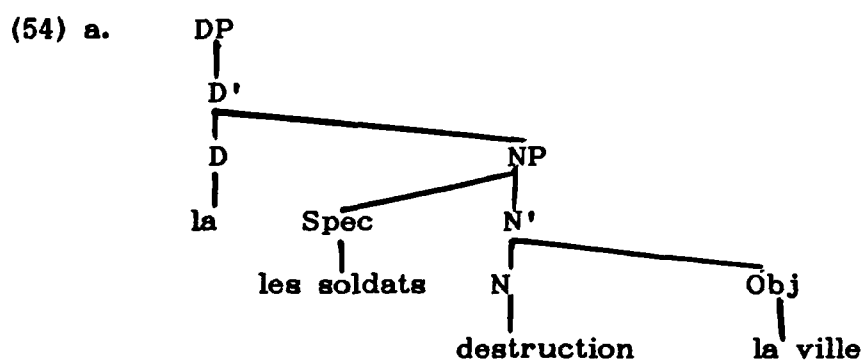

In both structures the object is assigned genitive Case by the head noun which remains in its D-structure position. The subject in (54a), however, has no source of Case whatsoever, hence the fact that it can only be realised as an adjunct by-phrase where it is assigned Case by par. The parallel with the D-structure subject of passive constructions in this instance is striking. As we saw earlier the only potential Case-position for

the subject in passive constructions is filled by the argument moved from the object position. As a consequence the subject is left without a source of Case, hence the fact that it can only appear as an adjunct by-phrase.

It is interesting to point out with respect to nominal phrases in the Romance languages that they resemble nominal phrases in the Celtic languages in that when the subject is an overt pronominal element it precedes the lexical head noun instead of following it as is the case with non-pronominal subjects :

(55) Sa maison
her/his house

The first idea that comes to mind within the present context is that these pronominal elements, like their counterparts in the Celtic languages, may also be AGR elements, in which case the analysis suggested above would extend to them with no revision.

However, there are reasons to believe that these elements are not likely to be AGR elements. Take for example the fact that an adjective can intervene between the pronominal element and the head noun :

(56) Sa belle maison
her/his beautiful house

This example shows clearly that the pronominal is not attached to the head noun as an AGR element is expected to be. Rather the pronominal element behaves like an independent element which holds an independent syntactic position.

The question then is what this position is likely to be. Judging from Italian examples such as (57) below :

(57) Il suo libro
the his book

the position is likely to be the Spec of the maximal projection of the head noun since it is the only syntactic position that intervenes between the determiner and the head noun. The pronominal possessor can be assumed to move to this position from the object position where it is base-generated in accordance with the assumption made above that possessor arguments are internal arguments. Like the surface subject of passive constructions the pronominal possessor is assigned Case in its D-structure position prior to movement.

3.3. Adjectival, adverbial and quantified nominal phrases

In this section I will have a brief look at the structure of nominal phrases with adjectival, adverbial and quantifying functions. I will then argue that Adjective does not exist as an independent category, and that the elements that have been traditionally called adjectives are either stative verbs or nominal phrases, and that adverbs are either nominal phrases or prepositional phrases. The discussion of these two points is based on the simple fact that Berber, among other languages, does not have Adjective and Adverb as independent categories. The elements that perform adjectival functions bear either verbal inflection and therefore are (stative) verbs, or bear nominal inflection and therefore are (attributive) nominal phrases. On the other hand, elements that have adverbial functions are either nominal phrases or prepositional phrases which consist of a preposition and a nominal phrase complement. Likewise, I will argue that quantifiers do not form a separate categorial class either but are nouns which assign genitive Case to the nominal phrases they quantify. In many ways the discussions included here will provide further support for the binary classification of categories in terms of the feature matrix [+,- N] or [+,- V] adopted in this work. If adjectives and adverbs are really basic categories as they have traditionally been considered one might wonder

why Berber, and indeed a number of other languages, simply don't have them¹⁸.

3.3.1. Adjectival and adverbial nominal phrases

The following are examples which illustrate the facts that the adjectival expressions in Berber are either nominal phrases (58a&b) or verbal sentences (59a&b), and that adverbial expressions are also either nominal phrases (60a&b) or prepositional phrases (60c) :

- (58) a. a-hamosh a-kkuh
ms-child ms-small
"the small boy"
- b. ta-hamosh-t ta-kkuh-t
fs-child fs-small fs
"the small girl"
- (59) a. y-hlkh Hemmu
3ms-be ill Hemmu
"Hemmu is ill."
- b. t-uhhl Munat
3fs-be tired Munat
"Munat is tired."
- (60) a. y-udf a-mzgaru/ t-udf ta-mzgaru-t
3ms-entered ms-first 3fs-entered fs-first fs
"He/she entered first."
- b. y-xdl nhar-a
3ms-arrived day-this
'He arrived today.'
- c. y-ffgh s-uzir
3ms-left with-dawn
"He left early."

In (58a&b) the adjectival element is a nominal phrase which agrees in number and gender with the nominal phrase it modifies. In (59a&b) the adjectival element is a stative verb which carries verbal agreement. In (60a) the adverbial element is again a nominal phrase which agrees in number and gender with the subject and AGR of the verb. In (60b) the adverbial element is a nominal phrase with a demonstrative pronoun

attached to it. In (60c) the adverbial element is a PP which consists of a prepositional head and a nominal phrase complement. Because we will talk in more detail about prepositional phrases in the next section this example will be ignored here. In the rest of this work I will use the terms "adjective" and "adverb" simply as "notional" categories (cf. Abney (1987)), or as labels which refer to the function rather than the categorial nature of lexical items.

Another language where adjectives and some adverbs are clearly nominal phrases is Standard Arabic. This is shown by, among other things, the fact that these categories bear a determiner and are marked for Case :

- (61) a. wasal-a l-mudarris-u l-mariid-u muta?axxir-a-n
 arrived-3ms the-teacher(male)-NOM the-ill-NOM late-ACC-a
 "The sick teacher arrived late."
 b. zur-tu mudarris-at-a-n marrid-at-a-n
 visited-1s teacher-f--ACC-a sick-ACC-a
 "I visited a sick teacher."
 c. nahad-tu sabaah-a-n / fi- l-sabaah-i
 woke-up-1s morning-ACC-a in- the-morning-GEN
 "I woke up in the morning."

The adjectival phrase in (61a) agrees with the subject in definiteness (both bear a definite article), number-gender (both are masculine singular), and Case (both bear the nominative). In (61b) the adjectival phrase agrees with the direct object in indefiniteness (both bear an indefinite article), number-gender (both are feminine singular), and in Case (both bear the accusative). The adverbial (nominal) phrases in (61a) and (61c), however, agree with the subject only in number and gender. They bear an indefinite article as well as an accusative Case while the subjects are definite and obviously bear the nominative Case. As an alternative to the nominal adverbial in (61c) it is possible to have a PP adverbial. As in Berber, possibly in all languages, adverbials in Standard Arabic are either nominal or prepositional phrases. The interesting thing about these data from

Standard Arabic is that they could give us important clues as to the possible sources of Case for the adjectival and adverbial nominal phrases, Case being morphological in Standard Arabic. Needless to say that being nominal phrases these elements are subject to the Case-requirement.

There exists in English a set of nominal phrases which have adverbial functions known in the literature as bare NP-adverbs. The following examples from Larson (1985) illustrate this particular use of nominal phrases :

- (62) a. I saw John [that day]/ [someplace you'd never guess]
b. John was headed [that way]
c. Max pronounced my name [every way imaginable]

Larson also provides examples to make the point that not all nominal phrases can perform this function :

- (63) a. John arrived *(on) [that occasion]/*(during) [this vacation]
b. John stayed in New York *(during) [that period of his life]

These adverbial phrases differ from those above in that they take a preposition obligatorily. Obviously the presence of the preposition is required by Case theory since the phrases between brackets are nominal phrases and therefore are subject to the Case requirement. The question that has to be answered in this respect is how the nominal phrases in (62) satisfy the Case requirement.

Larson suggests that these nominal phrases satisfy the Case requirement via a special feature [+F] which is a lexical property of the head N. This feature is then inherited by the whole nominal phrase containing the feature-bearing N thereby receiving an oblique Case. It is by virtue of this inherent feature that bare NP-adverbs satisfy the Case requirement in the absence of a Case-governor. It is also by virtue of this lexically determined feature that a distinction can be made between those

particular nominal phrases which can function as bare NP-adverbials and those which can't.

As to adjectives Larson (1987) argues that they typically receive their Case "indirectly", through some form of agreement with a Case-marked nominal phrase. He distinguishes three types of adjectives, prenominal modifier (64a), predicational (64b) and adjunct (64c) :

- (64) a. The red barn
 b. John painted the barn red
 c. John walks quick-ly

The adjectives in (64a&b) satisfy the Case requirement by agreeing with the nominal phrase "barn". In (64c), however, the adjective satisfies the Case requirement by attaching to the suffix -ly which Larson considers to be a sort of Case-marker affix whose function is to license an adjunct adjective. With these ideas in mind let us turn back to the Arabic data in (61).

That adjectival nominal phrases satisfy the Case requirement through some sort of concord with the nominal phrases they modify is clear from the data. However, the suggestion that adverbial nominal phrases receive oblique Case through the special [+F] feature does not seem to be supported by the data because the adverbial phrases bear the accusative which usually is not considered an oblique Case. Let us assume instead that adverbial nominal phrases satisfy the Case requirement through some sort of (Case) agreement relationship with the verb in the same way that adjectival nominal phrases satisfy the Case requirement through a concord relationship with the nominal phrases they modify. This suggestion is in keeping with the common belief that while adjectives usually modify nominal categories adverbials usually modify verbal categories. The nature of the Case that adjectives bear is determined by the nature of the Case that the

nominal element they modify bears. The Case that bare nominal adverbs bear, however, is the accusative or any other Case that is assigned by verbal categories, the accusative being the most typical. Notice that the nominal adverbial in (61a) is in the accusative despite the fact that the verb is intransitive.

If this proposal is correct then the need for the [+F] feature suggested by Larson is obviated. What needs to be made clear in this respect is why some nominal phrases can function as bare adverbials while others can't as pointed out by Larson. I must admit that I have no adequate answer to this question. I suspect, however, that the restrictions may turn out to be semantic rather than syntactic, that is, the type of restrictions that regulate modification relationships between elements.

An alternative analysis to the one suggested here is to assume, along with Bresnan and Grimshaw (1978), that bare nominal adverbials are underlyingly prepositional phrases with a null preposition as head. This way the adverbial nature of these apparently nominal phrases is accounted for since it is generally quite common for PPs to have adverbial functions. One of the advantages of this analysis is that it provides a uniform account for both overt PP and bare nominal adverbials by treating them both as PPs. However, the Arabic data in (61) makes it difficult to imagine how the proposal can be made to work. Prepositions in Arabic invariably assign genitive to their complements, while the nominal adverbials in the examples in (61) are in the accusative. If these phrases were really governed by a null preposition which presumably assigns them Case then that Case should be genitive and not accusative. With respect to Berber the PP analysis can be rejected further on the ground that the adjectival and adverbial nominals are not in the CS form, thus implying that they are not Construct-governed. The preposition, however, is a Construct governor as

we saw in the previous chapter. If the adjectival and adverbial nominal phrases were governed by a preposition they should be expected to be in the CS form. We will see later that dative arguments though governed and assigned Case by a null preposition they are always in the CS in conformity with the Construct Condition.

Another alternative analysis is to assume, along with the Visibility Hypothesis, that nominal adverbials as well as nominal adjectives do not need Case because they are not arguments that are required to be licensed by theta-marking. We did in fact adopt this approach in the previous chapter with respect to nominal phrases which function as predicates of nominal sentences. We assumed that because these nominal phrases are not arguments they are not required to be Case-marked. Here again Arabic can be useful in providing us with the correct explanation. One might wonder why bare nominal adverbs and nominal adjectives should be marked for Case if they do not need it. The fact that they do is an indication that they are required to. To accommodate this fact under the Visibility Hypothesis we can assume that adverbs as well as adjectives require theta-marking in order to be licensed at LF. The theta-marking, however, can only take place if the adverbs and adjectives have Case, that is if they are visible, just like nominal arguments. PP adverbials receive their Case from the prepositional head while nominal adjectivals and adverbials receive their Case via agreement in the manner described above.

As to predicational nominal phrases a look at some further data from Standard Arabic shows that they also are Case-marked :

- (65) a. Zayd-un mariid-un (Fassi Fehri (1987))
 Zayd-NOM sick-NOM
 "Zayd is sick."
- b. ?a-dunnu [Zayd-an mariid-an]
 I-believe Zayd-ACC sick-ACC
 "I believe Zayd to be sick."

In these examples the nominal predicate agrees with the subject in Case. They both bear nominative in (65a) and accusative in (65b). As in the case of adjectival nominals we can assume that predicational nominals also satisfy the Case requirement by agreeing with the nominal phrase they are predicated of. We can assume further that this Case-marking is necessary for the nominal predicate to be assigned the functional theta role that we have been assuming through this work is assigned to predicates by the head that immediately dominates them.

Before we leave this topic I would like to discuss a few facts from English and other languages which bear on the nominal nature of the phrases traditionally known as adjectives. We concluded above that assignment of genitive Case is indicative of a nominal nature, genitive Case being a property of nominal categories in the same way that accusative Case is a property of verbal categories. That adjectives assign genitive is a well known fact illustrated by the following examples from English, French and Spanish, respectively :

- (66) a. John is fond of Mary
- b. Jean est content de lui meme
 Jean is pleased with himself
- c. contento de sus notas (Plann (1985))
 content of his grades

The fact that like nouns and nominal AGR adjectives assign genitive Case implies that they have a nominal nature.

Other properties of adjectival categories that reveal their nominal nature have to do with -ing and -en adjectives as in :

- (67) a. The working class
- b. The singing detective
- c. The broken promises

We concluded above that -ing and -en/-ed are nominal categories which have the effect of nominalising the verbs they attach to them. Assuming the analysis suggested above the adjectival categories in these examples are in fact nominal categories which consist of a verb and a nominal head which is -ing or -en. If the analysis is correct then we have further evidence that adjectives are in fact nothing else than nominal phrases.

Two final points in this respect are in order. One is the fact that adjectives, like nouns, can take a determiner so that it is possible to have examples such as (68a) below. The other is the fact that some adjectives can function as arguments as in example (68b) below :

(68) a. They all gathered there; the happy and the sad, the young
and the old ...etc.

b. I have seen the best

Again, determiners are typical properties of nominal categories and so is the ability to function as an argument. The fact that adjectives can take a determiner and function as argument of a verb constitute further evidence that adjectives are indeed nominal categories.

The question that remains to be answered is, Why can't adjectives function easily as an argument as nouns do, a fact that hardly needs illustration, if they both have a similar categorial nature? One possible answer to this question is to assume that nominal categories are specified either positively or negatively with respect to a referentiality feature so that those which are specified positively can function as arguments while those that are not cannot or can do so only marginally¹⁹. Alternatively, one might assume, as we did earlier that the referentiality feature is a property of the determiner, possibly related to the (in)definiteness feature. Notice that this proposal would explain why adjectives, generally, can function as arguments only if they are preceded by a determiner :

(69) a. They all gathered there; *(the) happy, and *(the) sad,
*(the) young and *(the) old ...etc.

b. *(The) worst is still to come

There are other possible features that one might make use of to distinguish between items that can function as arguments and those that can't (cf. Abney (1987)).

3.3.2. Quantified nominal phrases

Quantifiers in Berber behave like nominal heads in that they assign genitive Case to the nouns they modify :

(70) a. tlata n-ihamoshn
three of-children
"three children"

b. attas n-immidn
lot of-people
"lot of people"

c. shi n-temghart
some of-woman
"some woman"

d. ijj n-wargaz
one of-man
"a man"

Assuming on the basis of the principles of Case and X-bar theories that only head categories can assign Case the quantifiers in the examples above must be heads and not specifiers/determiners as their counterparts in English are standardly believed to be. Abney (1987), however, argues for a structure of nominal phrases in English where DET elements are the head of the nominal phrase construction. This analysis brings English quantifiers closer to their counterparts in Berber since both are considered to be head categories. What needs to be explained is why Berber quantifiers assign Case to the nominal phrases they modify while English quantifiers apparently do not, assuming that the absence of the genitive preposition of

signals the absence of Case-assignment.

A possible explanation could be that quantifiers are Case-assigning categories in English but not in Berber. However, this explanation implies that quantifiers constitute a separate categorial class that is different from the class of nouns. I will demonstrate below that Berber quantifiers are nominal categories because their phrases behave exactly like nominal phrases. Another possible explanation could be that while quantifiers are determiners in English they are nouns in Arabic, assuming that determiners do not assign (genitive) Case. I will leave this question open for I have nothing more to say about it. I will turn now to examine the nature and distribution of quantified nominal phrases in Berber.

There exist languages other than Berber where quantifiers assign genitive Case to the nouns they quantify. Pesetsky (1982) demonstrates that Russian is one such language. Other languages are Arabic and Hebrew (Shlonsky (1987)). Pesetsky suggests on the basis of the fact that some prepositions in Russian assign genitive Case to their complements that Russian quantifiers may be prepositional in nature. Although it is quite plausible to group categories together on the basis of the fact that they assign the same type of Case I believe that Pesetsky's suggestion goes in the wrong direction. I suggest turning Pesetsky's argument around and saying instead that the fact that genitive prepositions in Russian assign genitive implies that they are nominal in nature, assuming that genitive Case-assignment is a typical property of nominal categories.

There are empirical reasons to believe that quantified phrases in Berber are nominal in nature, notably the fact that they behave similarly to nominal phrases in a number of respects. For example, they can function as the subject of non-copular verbs, agreeing fully with the verb, and as the object of V, P or N receiving the appropriate Case :

- (71) a. t-xdl shi n-teslit
 3fs-arrived some of-bride
 "Some bride arrived."
- b. y-usha lxaṭnd i-shi n-teslit
 3ms-gave ring to(DAT)-some of-bride
 "He gave the ring to some bride."
- c. n-uggur ag- shi n-teslit
 1p-went with some of-bride
 "We went with some bride."
- d. t-weddar txaṭnd n-teslit
 3fs-be lost ring of-bride
 "The bride's ring is lost."

In addition, quantified nominal phrases undergo syntactic processes that are typically associated with nominal phrases such as raising in passives. They also enter into binding and control relationships :

- (72) a. tw-atf-n attas n-ixwwanen ithyadn
 PASS-catch lot of-thieves last year
 "A lot of thieves were caught last year."
- b. ijj n-uxwwan y-jarh ixfinns
 some of-thief 3ms-hurt himself
 "Some thief hurt himself."
- c. tṭayn n-ixwwanen arzu-n [e ad-awwr-n]
 two of-thieves tried to-escape-3p
 "Two thieves tried to escape."

It should be clear from the data above that Berber quantifiers are nominal in nature. This is a desirable conclusion in view of the attempt undertaken in this work to reduce all categories to two basic classes, nominal and verbal.

That quantifiers in English are also nominal is conveyed by a long tradition to treat them as nouns precisely because their distribution is similar to that of noun phrase, a fact that can easily be discerned from the English glosses of the Berber examples in (72). The following examples demonstrate further the nominal nature of quantifiers by showing that in some constructions they assign genitive Case, indicated by the presence of

the genitival preposition of :

- (73) a. Some of his friends
b. Few of his friends
c. One of his friends

Having concluded that quantifiers are nominal categories our next task is to see what is the status of prepositions within the binary classification adopted. Are they nominal or verbal, or do they form a different class altogether?

3.4. Prepositional phrases

3.4.1. The paradigm

3.4.1.1. Genuine prepositions

The basic class of prepositions in Berber consists of affixal elements which appear prefixed to the nominal phrases they select :

- (74) a. y-arzm tawwart sg-tghenjajt
3ms-opened door with-spoon
"He opened the door with a spoon."
b. y-usid x-ughyur
3ms-came on-donky
"He came riding a donkey."
c. y-ufa aqzin g-uxxam
3ms-found dog in-room
"He found the dog in the room."
d. t-xdl zi-tendint
3fs-arrived from-town
"She arrived from the town."
e. y-ffegh ag-um-as
3ms-left with-brother-his
"He left with his brother."

The affixal nature of these prepositions is conveyed, primarily, by the fact that they do not receive a stress independently of their complements. Given the standard assumption that prepositions assign a theta role to their complements the affixal prepositions in Berber must hold a structurally

independent position at D-structure by virtue of the UTAH. This conclusion is supported further by the fact that the complements of prepositions are usually in the CS form, thus suggesting that they are governed by a Construct-governor, namely the preposition. On the other hand being affixal the prepositions are required to be attached to their potential host prior to S-structure. It follows that the process of affixation that attaches the preposition to its nominal complement operates in the syntax and therefore is an instance of Move-alpha.

Assuming the general structure of prepositional phrases to be as in (75) below, affixation can be considered to be the consequence of a head movement process which raises the head of the nominal phrase first to D to pick up the determiner and then to P :

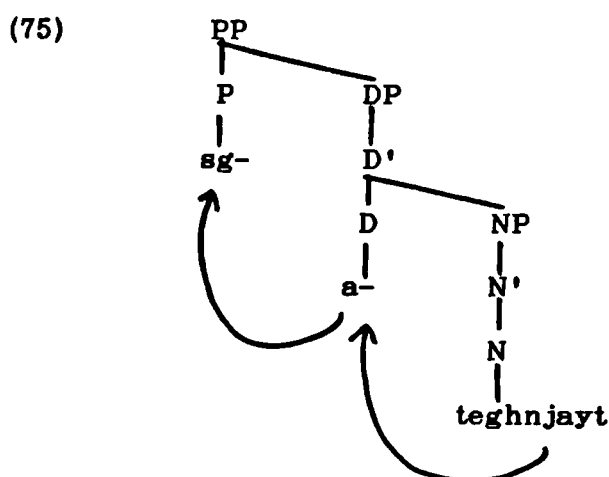

Assuming a theta-marking relationship between D and NP, and P and DP the movement does not give rise to an ECP violation. With respect to the first step, L-marking holds subsequent to movement thus nullifying the NP barrier. As to the second step we can assume that prepositions, being lexical categories, are capable of L-marking their complements. Otherwise, L-marking can be assumed to hold subsequent to movement as in the first step.

The affixal prepositions listed above can also appear attached to clitics

which, like lexical nominal phrases, function as complements which satisfy both the syntactic and the morphological subcategorisation frames of the prepositions :

- | | |
|--------------------------|------------------------|
| (76) a. sg-as
with-it | c. zg-as
from-it |
| b. x-as
on-it | d. akid-as
with-him |

The cliticisation process can be assumed to operate along the same lines described above with respect to lexical complements. In chapter 4 clitics will be argued to be nominal head categories which differ from the main class of nouns in the language in that clitics are affixal. Their movement will be shown to be governed by the HMC/ECP just like the movement of other head categories.

It is important to see what type of Case Berber prepositions assign to their complements. Because Case in Berber is generally abstract it is difficult to define the nature of the Case assigned by the preposition. Any arguments provided in this respect would have to rely on indirect evidence. Let us take, for example, the fact that the clitic that appears with prepositions is the so called dative clitic. Assuming, along with Aoun (1979), Borer (1984), among others, that clitics are the realisation of the Case assigned by their hosts, can the fact that Berber prepositions take dative clitics be taken to mean that Berber prepositions assign dative?

My immediate answer is no, the reason being the fact that so-called dative clitic also appears attached to Kinship Nouns :

- | | |
|------------------------------|---------------------------|
| (77) a. ymma-s
mother-his | c. utchma-s
sister-his |
| b. uma-s
brother-his | d. aba-s
father-his |

Nouns in Berber assign the genitive Case and not the dative. It follows that the fact that the dative clitic appears on a lexical category cannot be taken to mean that that category assigns dative Case. One can argue, however, that the fact that the clitic that appears with prepositions is the same as the one that appears with nouns may be taken as evidence that prepositions in Berber have a nature that is similar to that of nouns and that they assign genitive Case. The fact that the genitive marker -n never appears on the complement of prepositions can be understood to be a consequence of the incorporation of the nominal complement into the preposition in the manner described above. Baker (1985) discusses ample evidence from a wide range of languages which illustrates the fact that incorporated nouns are in some sense exempt from the Case requirement since even in languages which have rich morphological Case systems the incorporated nouns generally do not appear marked for Case. Notice in this respect that prepositions have in common with the Kinship Nouns the fact that they both have their complements incorporated into them.

3.4.1.2. Disguised adverbial PPs

In addition to the basic class of prepositions mentioned above Berber has another class of adverbial elements which have traditionally been considered to be prepositions despite the fact that they differ from the basic class of prepositions in a number of respects :

- (78) a. y-nuffar swadday n-ttifur
 3ms-hid under of-table
 "He hid under the table."
- b. y-illa sudara' n-teddar
 3ms-was over of-house
 "He was on the top of the house."
- c. y-bedd zzdat n-uxxam
 3ms-stood near of-room
 "He stood near the room."

One result in which these elements differ from the basic class of prepositions discussed above is that they are not affixal, they receive stress independently of the element that follows them. Another respect is that the complements of the elements in question are marked with the genitive marker while we saw above that the genitive marker never appears on the complement of the basic class of prepositions for reasons explained above.

Further differences emerge when the elements in (78) are analysed in detail. When considered closely they are found to consist of two distinct elements, a preposition, which is the (initial) s- sound that is common to all of them in (78) (in (78c) s assimilates to z), and which means roughly "towards", and a noun awadday "bottom" in (81a), adara' "top" in (81b) and adat "side" in (81c). That these elements are nouns is shown by the fact that they carry the nominal inflection -a. Their nominal nature is also conveyed by the fact that they are in the CS form shown by the change in the quality of the initial vowel a change that we saw in the previous chapter is induced by Construct-marking. Recall that only nouns exhibit the CS/FS distinction. The conclusion that these elements are nouns explains the presence of the genitive marker on their complements.

Notice that the fact that the nouns awadday and adara' are in the CS implies that they must be Construct-governed for otherwise they would be in violation of the Construct Condition. This fact clearly implies that the prefix s- must be a Construct governor, namely, a preposition. As a matter of fact the preposition appears with a number of other nominal adverbials in the language :

- (79) a. y-ffgh s-uzir
 3ms-left towards-dawn
 "He left early in the morning."

- b. y-dwer s-u'shshi/s-llilt *
 3ms-returned towards-evening/towards-night
 "He returned in the evening/night."

So what have traditionally been considered prepositions turn out to be prepositional phrases which consist of a preposition and a nominal phrase.

It is plausible to conclude in this respect that the function of the preposition s- is to assign Case to the adverbial nominal phrase to which it is prefixed. Nevertheless, from this particular point of view the presence of the preposition is not necessary since adverbial phrases can satisfy the Case requirement in the manner described above, that is by agreeing with the verb. There is a sense, however, in which the adverbial phrases above have become "fossilized", a fact that, I suspect, is largely behind the attempt by many Berberists to treat them as semantic and syntactic units. This explanation is supported by the fact that in other dialects of Berber (e.g. Tamazight (cf. Guerssel (1987))) the prepositional prefix does not appear with the adverbial phrases corresponding to the ones discussed here :

- (80) a. tama n waryaz (Guerssel (ibid) p. 163)
 'near the man'
 b. afella n wghyul
 'on the donkey'

Notice that like their counterparts in Tarifit the complements of these elements appear marked with the genitival n. Given this fact one can conclude that these adverbial elements in Tarifit have undergone a historical process which seems to have reanalysed their originally PP structure as a nominal phrase²⁰.

Note that whether these adverbial expressions turn out to be prepositional or nominal phrases the point being made here, namely that adverbs do not exist as a separate categorial class in Berber, is vindicated.

The claim can be extended to English adverbials if we assume, along with Larson (1987), that the morpheme -ly is a "Case-marking element that allows a Case-dependent category to appear in an adjunct site." (p.251). The structure of ly-adverbials that Larson provides is the following where -ly is an adverbial prefix governing an AP which is its complement :

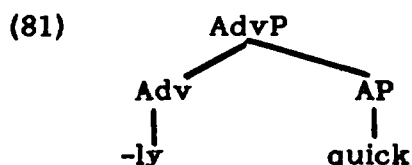

In the present context where we assume that adverbs and adjectives do not exist as separate categories we can assume that -ly is an affixal preposition and that quick is a noun. Accordingly, the structure of ly-adverbials becomes identical to the structure of prepositional adverbs as outlined in (75) above. The surface form is derived by a head-movement process that moves the head N and adjoins it to P :

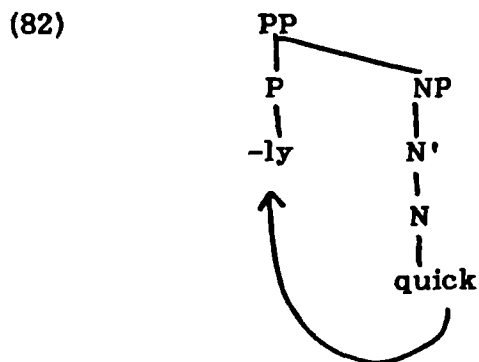

The nominal nature of the elements that attach to -ly, in fact of all the phrases that have traditionally been called adjectives, as we saw earlier, is revealed by the fact that they can take a determiner the quick/the sad/the happy ...etc. This is in addition to the fact also pointed out earlier that transitive adjectives assign genitive to their complements, a property which we have been assuming and demonstrating to be typical of nominal categories.

3.4.1.3. The dative and genitive markers

The dative and genitive markers in Berber (i- and n-, respectively) have peculiar properties which set them apart from the basic class of prepositions mentioned above. The dative marker behaves differently in at least two crucial respects. One is that unlike the other prepositions it can never host a clitic :

- (83) a. y-usha aslm i-wargaz
3ms-gave fish to-man
"He gave the fish to the man."
b. *y-ush aslm i-as
3ms-gave fish to-him

The other respect in which the dative marker differs has to do with a process that will be discussed in detail in chapter 4, namely, P+cl-movement.

Berber prepositions, it will be demonstrated, undergo a productive process of movement to functional positions such as TNS, NEG and C which resembles the process of clitic-movement briefly introduced in the previous chapter. This process is illustrated by the following examples:

- (84) a. y-arzm tawwart sg-as
3ms-opened door with-it
"He opened the door with it."
b. y-tush ad-sg-as y-arzm tawwart
3ms-want to-with-it 3ms-open door
"He wants to open the door with it."
c. ur-sg-as y-arzm tawwart
NEG-with-it 3ms-opened door
"He did not open the door with it."
d. u ay-sg-as yarzm tawwart?
who wh-comp-with-it opened door
"Who opened the door with it?"

In (84a) the preposition and its complement clitic are in their D-structure position. In (84b) they are attached to the TNS element, while in (84c&d)

they are attached to NEG and C elements, respectively. The movement process can involve other prepositions as well as we will see in chapter 4. The dative preposition, however, can never undergo this movement :

- (85) a. *y-tush ad-i-as y-ush aslm
 3ms-wants to-to-her 3ms-give fish
 "He wants to give her the fish."
- b. *ur-i-as y-usha aslm
 NEG-to-her 3ms-give fish
 "He did not give her the fish."
- c. u ay-i-as yushn aslm?
 who wh-comp-to-him gave fish
 "Who gave her the fish?"

These two facts may be taken to imply that the dative marker is not a genuine preposition but simply a morphological Case marker.

The genitive marker, on the other hand, differs from the dative marker in that it can host a clitic, though when it does so it gets augmented by a vowel or a consonant, a fact that may make one wonder whether one might be dealing with two different items, one a Case-marker and the other a preposition :

- (86) a. taddart n-temghart
 house of-woman
 "the woman's house"
- b. taddart in-/nn-s
 house of-her
 "her house"

So as far as clitic-hosting is concerned it seems that the genitive marker does not behave differently from the basic class of prepositions described above. The difference lies in the fact that the genitive marker can never undergo movement to TNS, NEG or C :

- (87) a. *y-tush ad-in-as y-zar taddart
 3ms-wants to-of-her 3ms-see house
 "He wants to see her house."

- b. *ur-in-as y-zra taddart
 NEG-of-er 3ms-saw house
 "He did not see his house."
- c. *u ay-in-as yzrin taddart?
 who wh-comp-of-her say house
 "Who has seen her house?"

Again this fact may be taken to imply that the genitive marker, like the dative marker, is also not a (genuine) preposition.

There is an important respect, however, in which both the dative and the genitive markers behave like prepositions, namely, that their complements are always in the CS as can be easily observed in the data above. This fact seems to imply clearly that the dative and genitive markers must be prepositions which hold independent structural positions from which they Construct-govern their complements. However, one could argue, quite correctly, with respect to the genitive marker, that it is not really the genitive marker that induces the Construct-marking on the complement of the noun to which it is attached but the head noun itself (recall that the noun is a Construct-governor). If this is correct then the fact that the nominal phrase that the genitive marker attaches to is in the CS does not represent any conclusive evidence as to the prepositional nature of the genitive marker. It seems that the genitive marker has a dual nature in that it behaves like a preposition in some respects but not in others. I will therefore conclude that it is a *preposition* which is inserted to serve as a genitive *Case-marker* assigned by the nominal head. This way the duality in the nature of the genitive marker is preserved and the facts are accounted for. Its status is in a sense similar to the status of the genitive preposition *of* in English as explained in Chomsky (1986a).

With respect to the dative marker an argument such as the one put forward above in relation to the genitive marker, namely that the nominal phrase it is attached to is Construct-governed independently, cannot go

through because the only other available governor in the dative construction is the verb, which, recall, is not a Construct-governor. On the contrary, in this case we have to make sure that the verb does not govern the dative argument because if it did a violation of the CC would ensue since we would have a situation where a Construct noun phrase is governed by a non-Construct governor. In order to avoid a violation of the CC we have to assume that the dative marker is a preposition which holds an independent structural position at D-structure and which governs the dative argument. This way the dative nominal phrase would be protected from government by the verb under the Minimality Condition, the dative preposition being a closer governor.

The problem with this solution, however, is that it treats the dative marker like a genuine preposition on a par with the clear cases of prepositions, contrary to what we concluded above. An alternative solution which avoids this problem is to assume that the dative preposition which Construct-governs the dative argument is a null preposition, and that the dative Case is an inherent (lexical) Case, in the sense that it is not assigned by a specific category. The latter assumption is necessary since we concluded earlier that prepositions in Berber need not assign Case to their complements because the latter are incorporated into them. This solution guarantees that the dative argument is not governed by the verb while maintaining the conclusion reached above that the dative marker is not a genuine preposition. Evidence that dative arguments are underlyingly prepositional phrases is discussed in Ouhalla (in preparation) where it is shown that they pattern with prepositional phrases with respect to movement. I will therefore conclude that the dative marker is a *Case-marker* which is the morphological realisation of the inherent dative Case and that the dative argument is governed by a null dative preposition.

3.4.1.4. The coordination morpheme

The coordination morpheme d- is another element that exhibits some ambiguities in its behaviour. It behaves like prepositions in that the nominal phrase it is attached to (the second coordinate) is always in the CS form :

- (88) a. t-uggur Munat d-wargaz in-s
3fs-left Munat and-man of-her
"Munat and her husband left."
b. y-zzenza Hemmu d-temghart in-s tafunast
3ms-sold Hemmu and-woman of-him cow
"Hemmu and his wife sold the cow."

Unlike prepositions, however, the coordination morpheme can never host a clitic :

- (89) a. *Munat d-s
Munat and-him
b. *Hemmu d-s
Hemmu and-her

Notice that it is necessary to assume that the second conjunct is governed by a Construct-governor for otherwise a violation of the CC would arise. This governor is not likely to be the first conjunct, though a Construct-governor, because there is no sense in which the second conjunct is the complement of the first conjunct, so that it would be governed by it. It must, therefore, be the case that the Construct-governor is the coordination morpheme.

However, for the latter to be a Construct-governor it has to be either a N or a P. Assuming that it is a preposition the structure of the coordinate nominal phrases would look like either of the following structures where the coordinating preposition is simply adjoined to the second conjunct (90a) or heads a prepositional phrase which has the

second conjunct as complement (90b) :

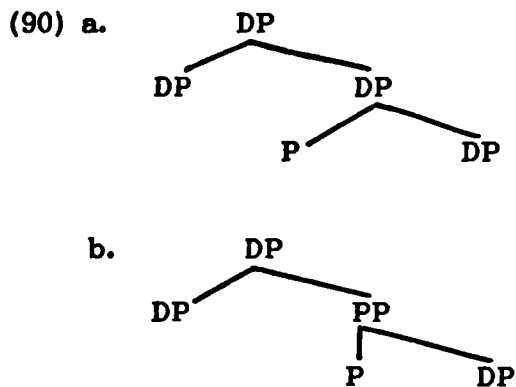

In both structures the coordination preposition governs the second conjunct but not the first; in (90a) for lack of the right directionality and in (90b) for lack of m-command.

Which of the two structures in (90) is the correct one is an empirical question. Empirical evidence seems to suggest that (90b) is probably the correct structure. The evidence derives from the fact illustrated by the examples in (88) above that it is only the first conjunct that agrees with the agreement morphology of the verb. Although the coordinate subject consists of two nominal phrases (two persons) the agreement morphology on the verb is singular. This fact shows that the first conjunct acts as the head of the coordinate nominal phrase since it agrees with the agreement morphology of the verb. This possibility is obviously allowed by (90b) but not by (90a) since in (90b) the second conjunct is simply a complement of the prepositional coordinating element (see Choe (1987) for a similar conclusion). McCloskey and Hale (1984) report that a similar phenomenon holds in Irish, thus suggesting that in Irish also the structure of coordinate nominal phrases is probably as outlined in (90b) above.

It is important, however, to point out that when a coordinate subject precedes the verb in Berber the verbal agreement exhibits plural features, that is it agrees with the whole of the coordinate nominal phrase and not

simply with the first conjunct :

- (91) a. Munat d-wargaz in-s uggur-n/*t-uggur
Munat and-man of-her left-3p 3fs-left
"Munat and her husband left."
b. Hemmu d-temghart in-s zzenz-n/*y-zzenz tafunast
Hemmu and-woman of-him sold-3p 3ms-sold cow
"Hemmu and his wife sold the cow."

Although this fact seems to suggest, superficially, that the structure of preverbal coordinate nominal phrases may be like (90a) this cannot be the case. Recall that we concluded in the previous chapter that preverbal subjects in Berber and other VSO languages do not occupy the canonical subject position which is the Spec of AGRP and therefore are not governed by AGR. Therefore, it is not the coordinate nominal phrase in (91) that agrees with the verbal agreement morphology but the pro that occupies the canonical subject position governed by AGR. The conclusion that coordinate nominal phrases have the structure outlined in (90b) above can therefore be maintained.

Obviously, this conclusion cannot be extended to English coordinate nominal phrases which unlike their Berber and Irish counterparts agree fully with the verbal agreement morphology. This fact suggests that the structure of coordinate nominal phrases in English is more likely to be (90a) which is a fairly standard structure in the literature apart from the designation of the coordinating element as "preposition" instead of "Conj". We have thus managed to classify a further category in terms of our binary division which has escaped classification in terms of the standard system of categorial feature-specification. This is a desirable step in the context of the present work where lexical items are being reduced to two categorial sets, nominal and verbal. Notice, however, that so far we have not taken a stand yet as to whether prepositions themselves are nominal or verbal or constitute a separate categorial class altogether. The task of the

next section is to try to determine the categorial nature of prepositional phrases in terms of their inherent and distributional properties.

3.4.2. The status and nature of prepositions

3.4.2.1. Prepositions and the syntactic features

As has just been mentioned we will try in this section to determine the nature of prepositions in relation to the binary classification of categories advocated in this work. There are two important properties of prepositions that indicate that they are nominal in nature. One is the fact that in some languages (e.g. Arabic, Russian) prepositions assign genitive Case which we have been assuming throughout is a property of nominal categories, in particular N and nominal AGR. The other property is the fact that prepositional phrases function as arguments of verbs, a function that we have been assuming can only be performed by nominal categories^{21,22}.

Another distributional fact that apparently looks like good evidence that can be brought to bear on the classification adopted is the well known fact that in English only noun phrases and prepositional phrases can be clefted :

- (92) a. It is John that Mary saw in the garage
b. It is in the garage that Mary saw John
c. *It is happy that Mary is
d. *It is quickly that Mary did her homework
e. *It is saw John that Mary did in the garage

Notice, however, that when considered seriously these examples do not constitute evidence at all in favour of the classification of prepositions specified above. On the contrary, they apparently provide an argument against the general binary classification adopted, in particular against the classification of adjectives and adverbs as either nominal phrases or prepositional phrases. If adjectives and adverbs are as claimed here then there is no reason why (92c&d) should be ungrammatical.

I believe that the fault lies not with the binary system adopted but probably with the assumption that categories which undergo similar rules must have syntactic features in common that make of them a "natural class", a notion borrowed from phonology where it is used to justify feature systems. In the current system of GB all transformational rules have been reduced to a single rule/principle (Move-alpha) which ranges over all existing categories and is assumed to be, in principle, capable of moving any category anywhere. The conditions that determine what category can move where, which before used to be built into the formulation of the transformational rules themselves, now belong to different modules of the system. Within such a system it does not make any sense at all to say that such and such categories form a syntactic natural class because they can serve as input to the same rule. The reason why adjectives and adverbs cannot be clefted in English therefore has nothing to do with whether these elements have different or identical syntactic features to those categories which can be clefted.

That the notion of syntactic natural classes cannot be correct is shown by the fact that in Berber DPs, PPs and VPs with stative verbs can be clefted, but not VPs with non-stative verbs (see Ennaji and Sadiqi (1986) for a detailed study of clefting in Berber) :

- (93) a. Hemmu ay- t-zra Munat gi- ssuq
 Hemmu comp- 3fs-saw Munat in- market
 "It is Hemmu that Munat saw in the market."
- b. gi- ssuq ay- t-zra Munat Hemmu
 in- market comp- 3fs-saw Munat hemmu
 "It is in the market that Munat saw Hemmu."
- c. y-hlkh ay- lla Hemmu
 3ms-be sick comp- is Hemmu
 *"It is sick that Hemmu is."
- d. *t-zra Hemmu gi- ssuq ay- t-lla Munat
 3fs-saw hemmu in- market comp- 3fs-is
 *"It is saw Hemmu in the market that Munat did."

Stative verbs have nothing in common with DPs and PPs as far as syntactic feature specification is concerned. On the other hand, stative verbs are identical to other verbs in terms of syntactic features specification and yet the former can be clefted but not the latter. It should be clear from these facts that the factors which determine which elements can be clefted and which can't seem to have little if anything to do with their categorial nature²³. I will not try to provide here an explanation as to what could be the nature of those factors.

The two criteria which we made use of to determine the nominal nature of prepositions above differ radically from the notion of natural classes based on rule application. The first criterion refers to an inherent property of prepositions in certain languages, namely, the fact that they assign genitive Case. The second criterion, though apparently distributional, is based on the functional properties of prepositional phrases, that is their ability to function as arguments, rather than their ability to undergo a certain specific transformational rule. To these can be added a further distributional fact which testifies to the nominal nature of prepositions, namely that prepositions can function as complementizer (see fn. 4). If our account of the function of complementizers presented above is correct then the fact that a preposition can function as a complementizer implies that the preposition must be a nominal category since the function of the complementizer is to nominalize verbal clauses.

The status of prepositions in relation to the other major categories recognized in the grammar has not been a clear cut matter. In Fillmore's (1968) Case Grammar, for example, prepositions are considered to be not categories but simply Case-markers. Underlying this analysis is the fact that the complement of prepositions is usually a nominal phrase. However, the real basis on which this analysis rests is semantic, namely, the fact

that what are Case-markers in some languages behave like prepositions in other languages and vice versa. For example, the dative marker in Berber discussed above has the properties of a Case-marker and yet its equivalent in English (to) and many other languages is a preposition. As a matter of fact an attempt (by Guerssel (1987)) has already been made in the literature, within the GB framework, to analyse the basic class of prepositions in Berber as Case-markers. We turn to the analysis immediately.

3.4.2.2. Guerssel's analysis

Guerssel's proposal amounts, ultimately, to a denial that the elements in question are prepositions. He argues that they are Case-markers which along with the nominal phrases they are attached to form what he calls "Kase Phrases". Before we move on to the details I would like to point out that if Guerssel's proposal is correct then it must be welcomed within the present framework as a step in the right direction since the outcome is the same, namely, to reduce the existing range of categorial classes to a basic minimum of two.

Guerssel makes use of the traditional terminology familiar from languages with morphological Case to refer to the items under discussion :

- (94) a. sg- "with" Instrumental
 b. i- "to" Dative
 c. n- "of" Genitive
 d. x- "on" Superessive
 e. gi- "in" Inessive
 f. zi- "from" Elative
 ...etc.

The collective term for this class of Case-markers is Kase which presumably is considered to be a category in the sense of X-bar theory. The overall node that dominates these elements and the nominal phrases they are

attached to are consequently referred to as Kase Phrases.

The following illustrates what the structure of a Kase Phrase looks like, with some adjustments :

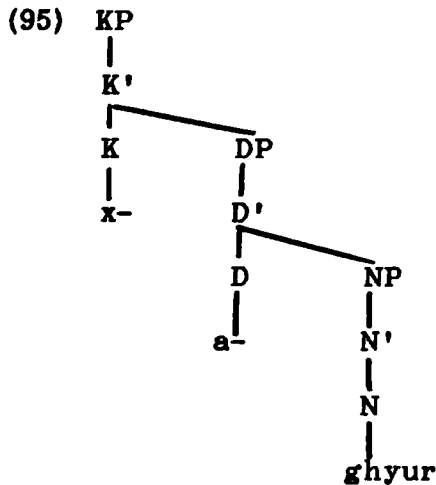

Notice that this structure is identical to a substructure of the structure postulated above under (75). The only difference is in the labelling of the elements under discussion. What are traditionally known as prepositions are treated by Guerssel as different categories, namely, Kase categories. Given this fact one could argue quite correctly that Guerssel's analysis does not reduce the range of existing categories as claimed above since what seems to have been done is that one category gets substituted for another. However, when viewed in relation to the present framewok Guerssel's proposal does make a significant reduction. It is a well known fact that Case is primarily a property of nominal phrases, thus implying that it is itself a nominal category, if it is a category at all. So, by treating the elements under discussion as Case-markers Guerssel makes the implicit assumption, when interpreted within the present context, that prepositions are in fact nominal categories.

3.4.2.3. AGR in PP?

Another proposal that has been made in the literature which also provides some evidence as to the nominal nature of prepositions has to do with the possibility of the appearance of a nominal AGR element in PP in some languages. The nature of the AGR element in question as well as the Case it presumably assigns might give us a clue as to the categorial nature of PPs themselves. Recall that the verbal nature of sentential clauses and the nominal nature of nominal clauses were determined, partly, on the basis of the nature of the AGR element they contain and the Case it assigns.

The crucial data in this respect come from Turkish which because it is a head-last language has postpositions instead of prepositions. The following examples from Kornfilt (1985) exhibit quite clearly an AGR element attached to the postposition. This AGR element assigns genitive Case to the object of the postposition which can be missing altogether, thus implying the possibility of pro drop in PPs :

- (96) a. (sen-in) hakk-in-da çok güzel şey-ler duy-du-m
you-GEN about-2.sg.-LOC very nice thing-pl hear-PAST-1.sg.
"I have heard very nice things about you."
b. masa-nın alt-ı
table-GEN under-3.sg.
"under the table"

The possibility of pro drop implies, among other things, that AGR must be a head category since pro can only be licensed by a designated X-0 category (cf. Rizzi (1986b)).

If AGR is a head then the structure of PPs in Turkish must be as follows :

(97)

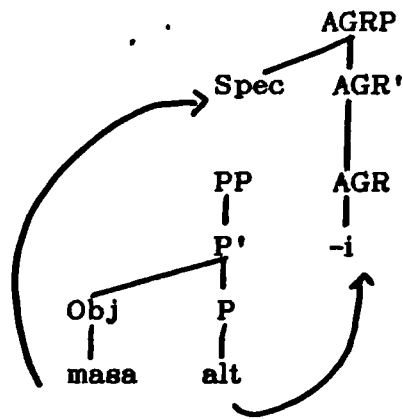

The object of the postposition moves to the Spec position of AGRP to receive genitive Case from AGR and the postposition moves to AGR to attach to the affixal element occupying it. A plausible question that may be asked in this respect is, Why should the object of the postposition move to the Spec position of AGRP to receive Case? Why can't it receive Case in its D-structure position from the postposition? A possible answer to these questions is to assume, on the basis of a suggestion made by Kornfilt (ibid fn. 3 of chapter 2), that (at least some) postpositions in Turkish are not Case-assigning categories. In cases where no AGR element appears the object of the postposition receives Case by a default mechanism.

Alternatively, Turkish postpositions can be assumed to assign Case optionally so that when a potential Case-assigner is present they do not have to assign Case. When a potential Case-assigner is lacking then they assign Case to their complements. Whatever the right explanation is, the important point for us is that the fact that the object of the postposition receives genitive Case is indicative of the nominal nature of the postpositional phrase.

Notice, however, that the structure postulated above for PPs with an AGR element is somewhat curious because when applied to PPs in head-first languages it makes prepositions look like postpositions because the nominal

phrase complement would precede instead of following the preposition :

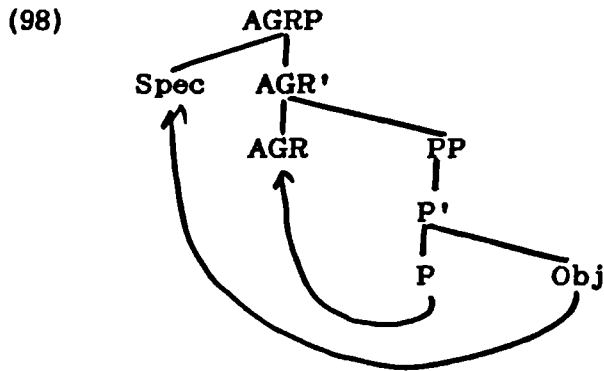

It should be the case, therefore, that AGR never projects in head-last languages or that its complement does not move up to the Spec of AGRP. The former is not likely to be the correct explanation since we would expect AGR to project regardless of whether a language is head-first or head-last since there is apparently no link between the two properties. In addition we would expect to find head-first languages where an AGR element projects and where the complement follows the preposition. A possible candidate in this respect is Irish, where, according to McCloskey and Hale (1984), prepositions can be inflected for the AGR features in a way similar to the way verbs and nouns appear inflected. It must be assumed, therefore, that the complement receives its Case, probably from AGR, possibly from P, in its D-structure position. The same assumption can be made with respect to PPs in Turkish. In this case whether the complement moves to the Spec of AGRP or remains in its D-structure position has no effect on the surface order. In both cases the complement precedes the postposition.

3.5. Conclusion

The major aim of this chapter has been twofold. First to outline the structure of nominal and prepositional phrases on the basis of the assumptions made in the previous chapter with respect to verbal clauses.

Secondly, to re-classify lexical items in terms of a binary distinction which recognises only two types of categories, nominal and verbal.

With respect to the first point nominal phrases have been found to have a structure that is significantly similar to that of sentential verbal clauses. Corresponding to the AGR element that assigns nominative in sentential clauses nominal phrases contain an AGR element that assigns genitive . On the other hand, corresponding to the TNS element which we concluded in the previous chapter is an essential component of sentential clauses, nominal phrases contain a NOM element whose function is to guarantee that the overall structure is nominal given that nominal phrases function as arguments, a function that is assumed to be exclusively reserved for nominal categories. As to prepositional phrases they have been found in some languages to contain an AGR element which assigns genitive to the complement of the preposition, a fact that makes the structure of PPs in those languages look a bit similar to that of nominal phrases and sentential clauses.

With respect to the second point TNS and nominative AGR have been argued to have a verbal nature, while their counterparts in nominal phrases, i.e. NOM and genitive AGR, have been argued to be nominal in nature. Complementizers, conjunctives and prepositions have also been argued to be nominal categories.

Footnotes

1. The feminine marker is also used as a diminutive marker. For example, the word a-zru means "stone" but when the feminine marker is affixed to it ta-zrut its meaning becomes "small stone".

2. The Turkish data in this chapter are drawn from George and Kornfilt (1981) and Kornfilt (1985). Any Turkish example that is not acknowledged in the main text is hereby acknowledged.

3. That nominative Case is indicative of the verbal nature of its assigner is shown by the fact that in some languages (e.g. Italian and Finnish; see 3.2.2.2. below) the direct object of certain verbs is marked with nominative. Another fact which illustrates the claim better is mentioned briefly in Taraldsen (1986) in relation to Finnish, namely, "...the general fact that any plural non-pronominal NP is marked morphologically as a nominative in contexts where a singular NP is in the accusative Case" (p. 139). The fact that nominative alternates with the accusative, which we concluded earlier is indicative of the verbal nature of its assigner, shows that nominative Case is also indicative of the verbal nature of its assigner.

4. The clauses that can function as arguments are of at least two major types. One type consists of clauses that are introduced by the complementizers that (ia), for (ib) and whether (ic), and the other type consists of infinitival (id) and gerundive (ie) clauses :

- (i) a. [That [John is a happy man] pleases me
- b. [For [John to eat in public] is immoral
- c. [Whether [he came] is a different question
- d. [C [PRO to eat in public] is immoral
- e. [C [PRO eating in public] is immoral

The claim made in the main text as to the nominal nature of

complementizers in general may be questioned with respect to the prepositional complementizer in (ib), at least. One might wonder whether one would be justified in calling a preposition a nominal category despite the fact that it functions as a complementizer. I will argue later in this chapter that prepositions are indeed nominal in nature. Assuming the conclusion to be correct, in anticipation, the fact that a preposition can function as a complementizer, i.e. as a nominaliser, represents evidence in favour of the claim made here that the function of the complementizer is to enable a verbal clause to function as argument, by nominalizing it.

With respect to (ic&d) it is possible to assume that although empty the C position is marked for nominal features so that the clause it heads is also nominal. Alternatively, one might assume that the absence of the complementizer implies that C does not project so that the head of the infinitival clause in (ic) is TNS occupied by to and the head of the gerundive clause is NOM occupied by ing, assuming, as we did earlier in the main text, that AGR does not project in infinitival and gerundive clauses. The PRO subject can then be assumed to remain in the Spec of VP where it is protected from government from without by VP and TNSP together, the latter having inherited barrierhood from the non-L-marked VP (recall that in English infinitival clauses the verb does not move up to TNS so that VP is always a barrier). Notice, however, that this assumption yields the wrong result with respect to the infinitival clause, though not with respect to the gerundive clause, in the sense that as a result of the non-projection of C/CP, TNS, which we have been assuming is a verbal category, becomes the head of the clause.

But there is a sense in which the element occupying the TNS position in infinitival clauses differs from the element occupying it in finite clauses. In the former it is clearly a preposition which we said above will be

argued later to be nominal. If this explanation is correct then the otherwise mysterious fact that infinitival clauses do not seem to take a complementizer unless a lexical subject is present, in which case a prepositional complementizer only, ^{can appear} receives a natural explanation. Infinitival clauses are nominal inherently and therefore do not need a complementizer to nominalize them. In cases where the subject is lexical the presence of the prepositional complementizer is obviously required by the necessity to assign Case to the lexical subject.

5. The assumption made here with respect to the categorial nature of the complementizer runs into problems with respect to the Arabic complementizer ?inna (cf. e.g. (41b) of chapter 2) which seems to assign accusative to the noun phrase it governs. Accusative Case, we have been assuming, is indicative of the verbal nature of its assigner. It should be clear that there is a conflict in this respect between the assumption that the complementizer is nominal in nature and the assumption that accusative Case-assignment is indicative of verbality. The conflict, however, would disappear if ?inna is shown not to be a complementizer or if the Case that appears on the noun phrase that immediately follows it is shown not to be assigned by ?inna. In the absence of evidence for one or the other I leave the problem open.

6. The fact that the subject that precedes the determiner in the Hungarian examples in (14) is in the dative instead of the nominative can be explained by assuming that the dative Case is assigned to it by a default mechanism. The position held by the dative subject can be assumed to be the Spec position of DP or, alternatively, a peripheral TOP position such as the one usually assumed to be occupied by focused elements. The canonical subject position (i.e. Spec of AGRP) can be assumed to be occupied by a resumptive

pro identified by the AGR inflection.

Szabolsci (1987) points out that dative subjects differ further from nominative subjects in that they can be extracted while nominative subjects can't :

- (i) a. Péter- nek_i láttam [t_i [DP a kalap-já-t]
Peter-DAT saw-I the hat-POSS.3sg.-ACC
"For x = Peter, I saw x's hat"
- b. ki- nek_i láttam [t_i [DP a kalap-já-t]
who-DAT saw-I the hat-POSS.3sg.-ACC
"For x = Peter, I saw x's hat"
- (ii) a. *Péter- \emptyset_i láttam [DP a [AGRP t_i kalap-já-t]
Peter-NOM saw-I the hat-POSS.3sg.-ACC
- b. *ki- \emptyset_i láttam [DP a [AGRP t_i kalap-já-t] ?
who-NOM saw-I the hat-POSS/3.sg.-ACC

The discrepancy between the two constructions in relation to the extraction of the subject can be explained in terms of the ECP in the following manner. The position of the dative subject in examples such as (ia&b) is, we concluded above, peripheral to DP. Therefore, its extraction does not give rise to an ECP violation since the only maximal projection that it crosses is L-marked by the matrix verb. In examples such as (iia&b), however, the nominal subject is inside DP, occupying the Spec of AGRP. Its extraction, unlike that of the dative subject, crosses AGRP which is a barrier because it is not L-marked, D being a non-lexical category. Consequently, DP inherits barrierhood from it and becomes itself a barrier. Alternatively, one could assume, along with Chomsky (1986b) that AGRP/IP is a defective projection which can never be a barrier inherently but which can transmit barrierhood to the maximal projection immediately dominating it although the latter may be L-marked. Both explanations yield similar results since they both predict that movement across AGRP and DP together, like movement across AGRP and CP together, gives rise to an ECP violation.

Notice, however, that this explanation would go through only if the Spec of DP is assumed to be unable to serve as an escape hatch for the movement. If it is possible for the extraction movement to pass through the Spec of DP then no ECP violation would arise and the ungrammaticality of the sentences would fail to receive an explanation in terms of the ECP. If, on the other hand, the Spec of DP cannot serve as an escape hatch for extraction then the Greek example in (15) discussed by Horrocks & Stavrou (1985) must receive a different explanation. I leave the issue open.

7. By treating a- and ta- as determiners, that is heads of the nominal phrase, we indirectly give an explanation to why Construct-marking affects them precisely as we saw in the previous chapter. This is similar to the familiar fact about German that Case-marking appears on the determiner, an indication that the determiner is the head of the noun phrase.

8. The analysis proposed here may hold the key to a mysterious fact about Construct noun phrases in the Semitic languages discussed in Borer (1984) (see also Ritter (1987), Fassi Fehri (1987) and Borer (1988)). As in Berber, the possessor in the Semitic languages follows the possessee and appears marked with the genitive Case as can easily be observed in the following examples from Standard Arabic :

- (i) a. daxal-tu daar-a r-rajul-i (Fassi Fehri (1987))
entered-I house-ACC the-man-GEN
"I entered the man's house."

The possessee nominal phrase in this construction is not marked (at least morphologically) for definiteness. Borer demonstrates that when the possessee nominal phrase is marked for definiteness, that is when the definite article appears attached to the possessee, the presence of a preposition in the position immediately preceding the possessor becomes

obligatory. The following examples from Hebrew and Moroccan Arabic illustrate this fact :

(ii) a. *beit ha-mora* (Borer (1984))
house the-teacher

b. *ha-bayit *(shel) ha-mora*
the-house of the-teacher

(iii) a. *daar l-mudrris*
house the-teacher

b. *l-daar *(dyal) l-mudrris*
the-house of the-teacher

Like their counterparts in Berber these examples have the following structure :

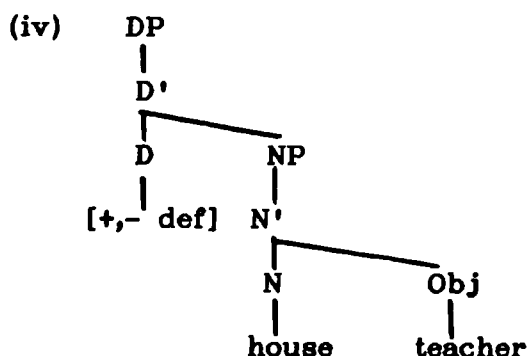

When the definiteness feature is not realized morphologically the noun "house" remains in its D-structure position. But when the the definiteness feature is realized morphologically the noun "house" moves up, to D obligatorily since in both Arabic and Hebrew the (in)definite article is affixal. As a result of this movement adjacency with the object nominal phrase is lost and the latter remains without a source of Case, hence the obligatory appearance/insertion of the preposition. Notice, however, that if this analysis is correct then genitive Case must be a structural Case. Moreover, the trace of N must be assumed to be unable to assign genitive to the object of the noun.

9. It is a well known fact that in English and a number of other languages the (in)definite article cannot cooccur with a lexical subject in nominal phrases :

- (i) a. *The/a the army's destruction of the city
- b. *The/a the city's destruction
- c. *The God's house

Notice that syntactically there is no apparent reason why the two elements should not be able to cooccur since they are assumed to occupy different positions. Assuming that the (in)definite article is a realisation of the (in)definiteness feature the fact noted above can be explained by assuming that the appearance of the subject is sufficient to define the identity of the destruction in question. In other words, the subject sufficiently restricts the range of reference for the destruction so that the presence of the article is not needed. However, when the subject is not realized it is the (in)definite article which performs that function, hence its appearance.

10. In this respect Chaker (1984) points out that

"noms et verbes sont des complexes obtenus par adjonctions de marques spécifiques à des racines lexicales communes, indifférenciées. En d'autres termes, la dichotomie nom-verbe, nette au plan de la syntaxe de la phrase, cache une unité plus profonde de l'ensemble des formes constituant le lexique de la langue. Si l'on part des unités minimales, l'existence d'un système verbo-nominal unique apparaît avec clarté." (p. 128)

He goes on to conclude that

"En tout état de cause, la structure du système verbo-nominal du berbère amène à relativiser fortement la notion de catégorie : les ensembles que l'on peut délimiter ne sont pas radicalement étrangers l'un à l'autre." (p. 129).

11. Notice that in this respect the Irish ProgPs resemble the mA-phrases in

Turksih which we saw earlier (see e.g. (9)) also do not allow a NEG element to appear inside them, unlike dik-phrases which do. In both cases the NEG element has to appear on the matrix clause. A possible explanation of this fact is to assume that NEG is a verbal category and as such cannot occur inside a nominal phrase. This assumption would not only account for the observed fact but would also allow us to accommodate the NEG category under the binary system of categorial classification adopted in this work.

12. The assumption that ASP in (36a) L-marks the maximal projection it theta-governs conflicts with the assumption made in the previous chapter with respect to the Welsh examples in (55) that ASP is not an L-marker because it is not lexical. As a matter of fact it is not entirely clear in the present context what categories are lexical and what are not. By attributing inflectional elements the status of categories in the sense of X-bar theory which are specified for the categorial features just like the so-called major categories we have in fact caused the distinction made between the two types of categories based on the notion of "lexicality" to be blurred. As a consequence it seems necessary to substitute the existing definition of "L-marking" with another definition which makes a distinction between the two types of categories not in terms of "lexicality" but in some other terms which take into account the revisions effected. In the absence of such a definition, however, I will account for the conflict pointed out above by assuming that ASP is lexical in English but not in Welsh.

13. Rothstein (1983) illustrates her argument with respect to Icelandic by citing the following examples :

- (i) a. Mig (A) kelur (acc. subject)
"I am getting frost-bitten/am freezing."
- b. Mér (D) líkar þeir bílar (dative subject)
"I like these cars."

(ii) a. Jón kastadi steini-DAT
"John threw a stone."

b. Steini-DAT var kastad
"The stone was thrown."

(ia&b) contain unaccusative verbs whose D-structure objects surface as subjects. The Case that these surface subjects bear, however, is an objective Case assigned by the unaccusative verb. (iib) is the passive counterpart of (iia). The derived subject in (iib) bears the objective (dative) Case assigned by the verb "throw" to its object as illustrated by (iia). Rothstein argues that if these noun phrases are assumed to move to the subject position to receive Case then they should be expected to appear in the nominative since the Case assigned to subjects, by AGR presumably, is standardly believed to be nominative.

14. There have been a number of suggestions in the literature that the D-structure objects of passive and unaccusative verbs receive Case in their D-structure position. Pollock (1981) and (1983), for example, argues that passive and ergative verbs must be assumed to assign Case to their objects. He demonstrates that this assumption would account for the discrepancy in grammaticality between examples such as the following :

(i) a. Il est arrivé un homme
it has arrived a man

b. Il a été tué un homme
it was killed a man

c. *Il était stupide un homme
it was stupid a man

If the verbs in (ia&b) are assumed to assign Case to the nominal phrase on their right the ungrammaticality of (ic) can be explained in terms of the assumption that adjectives differ from verbs in that adjectives do not assign Case.

Another suggestion that the object of passive and ergative verbs receives Case in its D-structure position has been made by Belletti (1988a). Belletti, however, argues that the Case assigned is an inherent partitive Case. Her suggestion is based on, among other things, the fact that in some languages, e.g. Finnish, partitive Case is morphologically realized on those objects. In languages where Case is not morphological she assumes that the partitive Case assigned to the object of passive and ergative verbs is abstract.

15. The prefix ta- attaches to a number of other root items in the language to form nouns. The following are some examples :

- (i) a. ta-?liif "writing books"
- b. ta-ksiir "breaking"
- c. ta-dwiin "documentation"
- d. ta-sdiir "export"
- ...etc.

16. The suggestion that genitive Case borne by the subject in Arabic examples such as the one in (44b) is assigned by D subsequent to N-raising is made in Fassi Fehri (1987). The structure that Fassi Fehri postulates differs from the one in (44b) in that it does not include a NOM projection so that D immediately dominates the NP predicate. Among the important facts that this suggestion accounts for is that the object in these examples can appear in the accusative instead of the genitive :

- (i) tadmiir-u l-'aduww-i l-maddinat-a
- destruction the-enemy-GEN the-town-ACC
- "The enemy's destruction of the town"

The fact that the object is in the accusative implies that the head of the predicate is a verb and that the predicate is consequently a VP. If the head is a verb then the assumption made in the main text here that the subject is assigned genitive by the moved head cannot be maintained since

the moved head is a verb and therefore cannot assign genitive. If, on the other hand, the genitive Case is assumed to be assigned by D then the fact that the moved head is a verb would cease to be a problem since adjunction to D results in a complex D which is a nominal category, presumably.

17. The marginal cases in question are phrases such as the following mentioned in Zubizarreta (1988) :

- (i) La traduction de l'oeuvre de Proust de Jean
the translation of the work of Proust of Jean
"Jean's translation of the work of Proust"

where the subject Jean appears marked with the genitive preposition in the position immediately following the object. Given the position one can make the point that the function of the genitive preposition is the same as that of by in the following phrase which is a well formed paraphrase of (i), namely to assign Case to the subject noun phrase :

- (ii) La traduction de l'oeuvre de Proust par Jean
the translation of the work of Proust by Jean

18. In a book with the very suggestive title Where Have All the Adjectives Gone? Dixon (1982) remarks that "...not all languages have the major word class Adjective" (p. 2). In answer to the question of how the concepts that are expressed through adjectives in languages like English are rendered in these languages he cites the facts that in some languages (e.g. Chinese) they are rendered through intransitive verbs while in others (e.g. Hausa and Chinook) they are expressed through nouns and verbs. He also remarks that as far as he knows all languages have nouns and verbs. For a discussion of the lack of the Adjective category in Navajo see Hale and Platero (1985). Like Chinese Navajo makes use of verbs to render adjectival expressions.

19. The referentiality feature in question is used in Ouhalla (1987a) to account for the fact that non-clitic pronouns in Berber and other languages cannot function as objects of the verb unlike their counterparts in other languages such as English :

- (i) a. *zri-gh ntta
saw-1s him
"I saw him."
- b. *ushi-gh aslm i- ntta
gave-1s fish to-him
"I gave him a fish."

The reason why the non-clitic pronouns in Berber cannot appear in these positions, it is argued, is that they are specified negatively for the referentiality feature, unlike their equivalents in English which are specified positively and therefore can appear in the object position of the verb, and also unlike clitic pronouns which can appear in the positions specified as demonstrated by the following examples :

- (ii) a. zri-gh-t
saw-1s-him
- b. ushi-gh-as aslm
gave-1s-to-him fish

If the distinction made in Ouhalla (ibid) between non-clitic pronouns and clitic pronouns in terms of the referentiality feature is correct then the need for the referentiality feature is independently motivated.

20. A similar reanalysis process is assumed to have been undergone by similar adverbial phrases in Spanish as discussed by Plann (1986). Expressions such as

- (i) a. encima de la mesa
on-top of the table

b. enfrente de la mesa
in-front of the shouse

were originally prepositional phrases which consisted of the preposition en "in" and the noun cima "top" and frente "front". These phrases resemble their Berber counterparts in that they also assign genitive (de) to the nominal phrase that follows them. Plann argues that these adverbial phrases have undergone some historical reanalysis process that has turned them into what she calls "neutralized syntactic categories". Within the present context, however, the fact that these phrases assign genitive is indicative of their nominal nature, a conclusion that is supported by the fact pointed out and demonstrated by Plann that in many respects these adverbial phrases behave similarly to nominal and adjectival phrases.

21. Hale and Platero (1985) discuss facts, which are different in nature from the one discussed here, which show quite clearly that postpositions in Navajo are also nominal in nature.

22. The standard assumption in the literature is that prepositions assign oblique Case. In some contexts the term oblique is used to refer to some specific Case that appears on the object of prepositions, while in others it is used^{as} a sort of cover term to mean any Case that is assigned by prepositions, where in some languages it may be partitive while in others it may be genitive. Chomsky (1986a), for example, distinguishes between "structural" and "inherent" Cases. He then points out that "The latter include the oblique Case assigned by prepositions and ... also genitive Case, which we assume to be assigned by nouns and adjectives...". (p.193) Clearly, Chomsky distinguishes between oblique Case which he assumes is assigned by prepositions and genitive Case which he assumes is assigned by nouns and adjectives. However, we saw above that prepositions in

Arabic, Russian and Berber assign genitive Case just like nouns. Would the genitive Case assigned by the prepositions in these languages still be called oblique? I would like to emphasize, though, that the fact that Chomsky has grouped prepositions and adjectives together with nouns with respect to Case-marking may be understood as indicative of the possibility that they have identical categorial nature, i.e. the position defended here.

23. For more arguments against the (natural) classification based on the standard feature system of X-bar theory see Riemsdijk (1978) and Muysken and Riemsdijk (1985).

Chapter Four

Clitic and Preposition Movement

The Structure of Causative Constructions

4.1. Introduction

This chapter deals with movement of clitics in general as well as movement of prepositional complexes in Berber. It is argued, along with Kayne (1987), that clitics are head categories with an affixal nature and that their placement is governed by the same principles which govern syntactic movement processes in general. The assumption that clitics are head categories is shown to receive significant support from the facts of Berber. In particular, clitic-placement is shown to bear strong similarities to the behaviour and distribution of prepositional complexes which are complex prepositional heads which consist of a preposition and a clitic incorporated into it.

The chapter is divided into three major sections. The first introduces the phenomena of clitic- and preposition- movement in Berber and discusses their basic properties. The second section examines the process of clitic-movement in Berber and the Romance languages and of preposition-movement in Berber in the light of the conclusions reached in the previous chapters with respect to the structures of sentential and nominal clauses. It is argued that clitics and the prepositional complex move to inflectional heads in the clause in a direct fashion that violates the restriction imposed on head-movement processes by the HMC. The conclusions reached in this respect stand in sharp contrast to the conclusions reached by Kayne (1987) in his study of clitic-movement, in particular the conclusion that clitics move to their S-structure positions in

a stepwise fashion. It is demonstrated that despite the long nature of the movement assumed it does not give rise to an ECP violation.

The third major section examines the process of clitic and preposition-climbing, that is movement of a clitic or a prepositional complex from an embedded clause to a matrix clause. The constructions which involve this process are referred to as clitic- and P- climbing constructions to differentiate them from the constructions which involve movement of a clitic or a prepositional complex inside the same clause and which are referred to as clitic/P-movement constructions. Clitic- and P- climbing constructions include causatives in Berber and the Romance languages as well as the Italian restructuring constructions. Movement of the clitic and the prepositional complex in these constructions is also argued to operate directly, in violation of the HMC. Again, the process is shown not to involve a violation of the ECP despite its unusually long nature.

The conclusions reached in this respect are shown to lead to a conflict between the predictions made by the HMC and the ECP. This conflict is then resolved in the final section by eliminating the HMC altogether on the grounds that its effects with respect to some head-movement processes are derivable from the ECP (cf. Chomsky (1986b)) and, more crucially, that it makes wrong predictions with respect to some other head-movement processes. It is demonstrated that while the HMC makes correct predictions with respect to movement of the verbal complex it makes wrong predictions with respect to movement of the clitic and the prepositional complex as well as movement of the preposition in some applicative constructions discussed in Baker (1985). The only principle that seems to govern clitic- and preposition- placement processes, it is argued, is the principle that governs movement processes in general, i.e. the ECP.

4.2. Basic properties

4.2.1. Clitics

4.2.1.1. Object-of-V clitics

It was pointed out at the beginning of chapter 2 that clitics in Berber attach to head categories only. These categories can be the wh-comp (1b), NEG (1c), TNS (1d), V (1e), N (1f) or P (1g) :

- (1) a. **y-arzm tawwart sg-tghenjajt**
3ms-opened door with-spoon
"He opened the door with the spoon."
- b. **u ay-t y-arzm-n sg-tghenjajt ?**
who wh-comp-it n-opened-n wiht-spoon
"Who opened it with the spoon?"
- c. **ur-t y-arzm sg-tghenjajt**
NEG-it 3ms-opened wiht-spoon
"He did not open it with the spoon."
- d. **y-tush ad-t y-arzm sg-tghenjajt**
3ms-wants to-it 3ms-open wiht-spoon
"He wants to open it with the spoon."
- e. **y-arzmi-t sg-tghenjajt**
3ms-opened-it with-spoon
"He opened it with the spoon."
- f. **y-arzm tawwart n-um-as sg-tghenjajt**
3ms-opened door of-brother-his with-spoon
"He opened his brother's door with the spoon."
- g. **y-arzm tawwart sg-as**
3ms-opened door with-it
"He opened the door with it."

For the moment we will concentrate on the accusative and dative argument clitics (object-of-V clitics). Later we will discuss the possessor (object-of-N) clitics and the oblique (object-of-P) clitics in separate subsections¹.

It was also pointed out in chapter 2 that the distribution of clitics in Berber is regulated by a strict hierarchical condition which we referred to as the Clitic Placement Condition (CPC). This condition requires that clitics

be attached to the highest head element in the clause at the S-structure level. The effect of this condition on the distribution of clitics can be illustrated by the following examples which are ungrammatical because they are in violation of the CPC :

- (2) a. *u ay- ghar-t y-arzm-n sg-tghenjajt ?
 who wh-comp- will-it n-open-n with-spoon
 "Who will open it with the spoon."
- b. *ur- y-arzmi-t sg-tghenjajt
 NEG- 3ms-opened-it wiht-spoon
 "He will not open it with the spoon."
- c. *y-tush ad- y-arzmi-t sg-tghenjajt
 3ms-want to- 3ms-open-it with-spoon
 "He wants to open it with spoon."

In (2a) the clitic is attached to the TNS element ghar- while the C position is filled by the wh-comp. In (2b) the clitic is attached to the verb (more precisely the [V+AGR] complex) while the clause contains a NEG element which, recall, is higher in the clausal structure than AGR and V in Berber. In (2c) the clitic is attached to the [V+AGR] complex while the clause contains a TNS element which is higher in the structure than both V and AGR.

It is clear from the facts above that attachment to the verb is a sort of last resort option that is forced on clitics in the absence of a suitable host. Clitics seem to attach to the verb only in cases where none of the other possible hosts is present in their clause. When more than one potential host is present there is a rigid order of preference which is based on hierarchical terms expressed by the CPC. As far as I can see at the present moment the CPC does not seem to follow from any general principles. It has to be stated as an independent principle of Berber grammar and be conceived of as a sort of filter which operates at the S-structure level and filters out the constructions which violate the condition it expresses.

There are, however, two significant exceptional cases to the otherwise rigid CPC which involve the non-wh-comp qa and the NEG element ur-. Each of these elements is an exception in a different way. With respect to the non-wh-comp qa clitics seem never to attach to it despite the fact that, being a comp, it is the highest head element in declarative clauses. In this respect qa differs from the wh-comp ay- which generally hosts the clitics in its clause whenever it is present, as illustrated by example (1b) above (but see below for an exception) :

(3) a. *t-nna qa-t y-arm sg-tghenjajt
 3fs-said that-it 3ms-opened with-spoon
 "She said that he opened it with the spoon."

b. t-nna qa y-arzmi-t sg-tghenjajt
 3fs-said that 3ms-opened-it with-spoon

(3a) is consistent with the CPC and yet it is ill-formed, while (3b) is in violation of the CPC and yet it is well-formed. It seems that the CPC needs to be revised so that the complementizer qa would be excluded as a possible host for clitics while the general hierarchical condition on the appearance of clitics is maintained.

To be able to effect this revision we have to see in what way qa differs from the wh-comp ay-. The difference between these two elements that immediately strikes the mind is the fact that while ay- is affixal qa is not. This is shown by, among other things, the fact that qa defines a stress domain by itself while ay- receives stress in relation to the verbal complex which it always appears attached to. The affixal nature of ay- is demonstrated further by the fact (discussed in detail in Ouhalla (in preparation)) that it does not allow a subject to intervene between it and the verbal complex while qa does so freely :

(4) a. *u ay- Hemmu y-zra?
 who wh-comp Hemmu 3ms-saw
 "Who did Hemmu see?"

- b. u ay- y-zra Hemmu?
 who wh-comp 3ms-saw Hemmu
- (5) a. t-nna qa Hemmu y-zra Munat
 3fs-said that Hemmu saw Munat
 "She said that Hemmu saw Munat."
- b. t-nna qa y-zra Hemmu Munat
 3fs-said that 3ms-saw Hemmu Munat

It is argued in Ouhalla (in preparation) that sentences such as (4a) are excluded by the AP, ay- being an affixal element which requires to be attached to the verbal complex which consists of the verb, AGR and TNS. The latter attaches to the affixal complementizer via a process of stepwise head-movement. Sentences like (5a), on the other hand, are grammatical because unlike ay- qa is not affixal and therefore does not attract the verbal complex to the C position.

It should be clear now in what sense the CPC should be revised so that it excludes the comp qa. It should be reformulated in such a way that it makes reference to affixal head categories only. A tentative way of reformulating it is the following :

(6) Clitic Placement Condition (CPC)

Clitics must attach to the highest affixal head
 in a clause.

Despite the fact that the non-wh-comp qa is always the highest head element in the clauses in which it appears it does not fall under the scope of the CPC as formulated in (6) because it is not affixal in nature. Consequently, the examples in (3) cease to be problematic. Note that by specifying that the host must be an affixal element we have in fact defined cliticisation as a process whereby affixal lexical categories satisfy the AP. In general, cliticisation seems to be a process that is motivated by the AP since both the clitics and their hosts are affixal elements. This will become clearer as we proceed.

The NEG element ur- behaves exceptionally with respect to the CPC in a totally different way. When present in the clause, clitics must attach to the NEG element even if the C position is filled by the wh-comp :

- (7) a. *Hemmu ay-t ur- y-arzm-n sg-tghenjajt
 Hemmu wh-comp-it NEG n-opened-n with-spoon
 "It was Hemmu who did not opene it with the spoon."
 b. Hemmu ay- ur-t y-arzm-n sg-tghenjajt
 Hemmu wh-comp NEG-it n-opened-n with-spoon

The situation with respect to these two sentences is similar to the one discussed above with respect to the examples in (3). (7a) is consistent with the CPC and yet it is ill-formed, while (7b) is in violation of the CPC and yet it is well-formed. Despite the fact that the C position in (7b) is filled by the wh-comp the clitic appears attached to the NEG element which, given the discussion in chapter 2, is lower in the clausal structure than the position of the complementizer.

Do we have to revise the CPC further in order to accommodate this fact as we did above with respect to the non-wh-comp qa? Not really because we will see later that the facts illustrated by the examples in (7a&b) follow from a more general claim, namely that the NEG element generally blocks clitic-movement across it. We will discuss well-known examples from the Romance languages where clitic-climbing is, interestingly enough, also blocked by the presence of a NEG element in the clause. For the moment it is important to note that the TNS element, unlike the NEG element, does not block clitic movement across it. The grammaticality pattern in the following pair of examples is the reverse of the one in (7) above :

- (8) a. u ay-t ghar^z y-arzm-n sg-tghenjajt ?
 who wh-comp-it will- n-open-n with-spoon
 "Who will open it with the spoon ?"
 b. *u ay- ghar-t y-zrzm-n sg-tghenjajt ?
 who wh-comp will-it n-open-n with-spoon

Both these examples are consistent with the CPC as formulated above. It is because of examples such as these that the CPC has to be maintained as it is. The facts that apparently seem to violate it, such as the one pointed out above with respect to the NEG element, should be made to follow from some general restrictions on clitic placement.

Note that not only the accusative argument clitic but also the dative argument clitic can appear attached to the C, NEG, and TNS elements :

- (9) a. *y-usha aslm i-Munat*
 3ms-gave fish to-mUnat
 "He gave the fish to Munat."
- b. *u ay-as y-ushi-n aslm ?*
 who wh-comp-her n-gave-n fish
 "Who gave her the fish ?"
- c. *ur-as y-ush aslm*
 NEG-her 3ms-give fish
 "He did not give her the fish."
- d. *y-tush ad-as y-ush aslm*
 3ms-wants to-her 3ms-give fish
 "He wants to give her the fish."
- e. *y-ush-as aslm*
 3ms-gave-her fish
 "He gave her the fish."

The distribution of the dative argument clitic is similar to that of the accusative argument clitic in every respect, including the fact that its movement to C is blocked by the presence of a NEG element :

- (10) a. **Hemmu ay-as ur- y-ushi-n aslm*
 Hemmu wh-comp-her n-gave-n fish
 "It was Hemmu who did not give her the fish."
- b. *Hemmu ay- ur-as y-ushi-n aslm*
 Hemmu wh-comp- NEG-her n-gave-n fish
 "It was Hemmu who did not give her the fish."

Notice in this respect that the dative argument clitic behaves like the accusative argument clitic despite the fact that the former is governed by a (null) preposition while the latter is governed by the verb. We will come

back to the reason behind this similarity in behaviour later².

4.2.1.2. Object-of-N (possessor) clitics³

Recall that we concluded in the previous chapter that possessor nominal phrases are internal arguments of the possessee which assigns them an (internal) "possessor" theta role. Among the facts on the basis of which this conclusion was reached is that the possessor argument can, in some languages, be realised as an object clitic attached to the possessee. Berber is one such language. However, in Berber only a limited class of nouns, which we identified in the previous chapter as Kinship Nouns (KN), can host clitics :

- (11) a. *tawwart n-um-as*
door of-brother-his
"His brother's door"
- b. *tawwart n-ab-as*
door of-father-his
"His father's door"
- c. **tawwart-as*
door-his
"His door"
- d. **aslm-as*
fish-his
"His fish"

With non-KNs the clitic appears attached to the genitival marker (i)n which we saw above has a dual nature as a preposition and as a Case-marker :

- (12) a. *tawwart in-as*
door of-his
"His door"
- b. *aslm in-as*
fish of-his
"His fish"

What we have to determine now is what is special about KNs that makes it possible for them to host clitics.

What is special about KNs is simply the fact that, unlike the rest of the nouns in the language, they are affixal in nature. They cannot stand by themselves and function, for example, as subject of a sentence or object of a verb or of a preposition :

- (13) a. *t-xdl utchm-/ymm-
 3ms-arrived sister/mother
 "The sister/mother arrived."
- b. *zrigh um-/yll-
 saw-1s brother/daughter
 "I saw the brother/daughter."
- c. *t-awr zi- um-/utchm-
 3fs-fled from- brother/sister
 "She ran away from the brother/sister."

Given the affixal nature of KNs these sentences are ill-formed by virtue of the AP since the morphological subcategorisation frame of the KNs fails to be satisfied. In examples such as (11a&b) the morphological subcategorisation frame of the KNs is satisfied by the clitics attached to them. Notice that this fact lends further support to our revision of the CPC to make it relevant to affixal categories only as hosts for clitics. The assumption that cliticisation is a process that is essentially motivated by the AP is thereby vindicated.

Like object-of-V clitics possessor clitics can also appear attached to the wh-comp, NEG, TNS or V, but only optionally :

- (14) a. u ay-as y-arzm-n tawwart sg-tghenjajt?
 who wh-comp-his n-opened-n door with-spoon
 "Who opened his door with the spoon?"
- b. ur-as arzm-n tawwart sg-tghenjajt
 NEG-his opened-3p door with-spoon
 "They opened his door with the spoon."
- c. tush-n ad-as arzm-n tawwart sg-tghenjajt
 want-3p to-his open-3p dorr with-spoon
 "They want to open his door with the spoon."

- d. arzm-n-as tawwart sg-tghenjajt
 opened-3p door with-spoon
 "They opened his door with the spoon."
- (15) a. u ay- y-arzm-n tawwart in-as sg-tghenjajt
 who wh-comp n-opened-n door of-his with-spoon
- b. ur- arzm-n tawwart in-as sg-tghenjajt
 NEG- opned-3p door of-his with-spoon
- c. tush-n ad- arzm-n tawwart in-as sg-tghenjajt
 want-3p to- open-3p door of-his with-spoon
- d. arzm-n tawwart in-as sg-tghenjajt
 opened-3p door of-his with-spoon

The examples in (15) are synonymous with their counterparts in (14). The fact that they are grammatical testifies to the statement made earlier that cliticisation of the possessor argument to C, NEG, TNS or V is optional. In this respect possessor clitics differ from object-of-V clitics whose cliticisation to higher positions is obligatory under the CPC.

It would be wrong, however, to conclude on the basis of this observation that the possessor clitic is not subject to the CPC. That the possessor clitic is indeed subject to the CPC like all the other clitics in the language is demonstrated by the fact that it cannot appear attached to a TNS element in a clause whose C position is filled by a wh-comp, or to a verb in a clause which contains a TNS element :

- (16) a. *u ay- ghar-as y-arzm-n tawwart sg-tghenjajt?
 who wh-comp will-his n-open-n door with-spoon
 "Who will open his door with the spoon?"
- b. u ay-as ghar- y-arzm-n tawwart sg-tghenjajt ?
 who wh-comp-his n-open-n door with-spoon
 "Who will open his door with the spoon?"
- (17) a. *ad- arzm-n-as tawwart sg-tghenjajt
 to- open-3p-his door with-spoon
 "They will open his door with the spoon."
- b. ad-as arzm-n tawwart sg-tghenjajt
 to-his opne-3p door with-spoon
 "They will open his door with the spoon."

The ill-formedness of the (a) examples in these sentence is obviously on a par with the ill-formedness of the examples above which we concluded constitute violations of the CPC.

If this is the case then why is it that possessor clitics cliticise to higher positions in the clause only optionally in apparent violation of the CPC since in the sentences in (15) the genitival marker is obviously not the highest head element in the clause. The answer to this question lies in the fact that contrary to what was said above cliticisation of the possessor clitic to higher positions is not optional. The fact that the examples in (15) are possible alternatives to the examples in (14) does not necessarily imply that the cliticisation process is optional once considered carefully. Notice that the examples in (15) differ from those in (14) in that the former contain the genitival preposition in-. Taking this fact to be a fundamental distinction between the two sets of examples let us consider each of them separately.

Given the ill-formedness of the examples in (16a) and (17a) there is a clear sense in which the possessor clitics in the set of examples in (14) are subject to the CPC. What needs to be explained is the fact that the following examples, corresponding to those in (15), are ill-formed despite the fact that they conform to the CPC :

- (18) a. *u ay-as y-arzm-n tawwart in- sg-tghenjajt?
 who wh-comp-his n-opened door of- with-spoon
- b. *ur-as zrzm-n tawwart in- sg-tghenjajt
 NEG-his opened door of- with-spoon
- c. *ad-as arzm-n tawwart in- sg-tghenjajt
 to-his opened door of- with-spoon
- d. *arzm-n-as tawwart in- sg-tghenjajt
 opened-3p-his door of- with-spoon

Notice that these are cases where a (genitival) preposition is left stranded,

its complement having been moved higher in the clause. Consequently, these sentences are ungrammatical by virtue of any principle which disallows preposition-stranding in Berber or other languages. Alternatively, the ungrammaticality of these examples can be explained in terms of the AP, the genitival preposition being an affixal element which requires to attach to its complement to satisfy the AP (see 4.2.1.3. below).

Viewed from this angle the optionality that is conveyed by the two sets of examples in (14) and (15) is not that of the cliticisation of the possessor but of the appearance or non-appearance of the genitival preposition. When absent the possessor clitic cliticises obligatorily as prescribed by the CPC and the resulting sentences are grammatical. On the other hand, when the genitival preposition is present the possessor clitic cannot cliticise to higher positions as prescribed by the CPC because the process would result in a violation of the AP by the stranded genitival preposition. In view of this we can maintain the conclusion that all clitics are subject to the CPC in that they must cliticise to the highest affixal head in the clause. What we have to add to this conclusion is the proviso that clitics can do so only in situations where they are not required to do otherwise by some independent general principle. In the examples in (15) above the clitic is required by the AP to attach to the genitival preposition, thus exempting it from the requirement of the CPC⁴.

4.2.1.3. Object-of-P clitics

Unlike direct object, indirect object, and possessor clitics object-of-P clitics cannot cliticise to higher positions without giving rise to ill-formed constructions :

- (19) a. y-arzm tawwart sg-as
 3ms-opened door with-it
 "He opened the door with it."
- b. *u ay-as y-arzm-n tawwart sg- ?
 who wh-comp-it n-opened-n door with
 "Who opened the door with it ?"
- c. *ur-as y-arzm tawwart sg-
 NEG-it 3ms-opened door with
 "He did not open the door with it."
- d. *y-tush ad-as y-arzm tawwart sg-
 3ms-wants to-it 3ms-open door with
 "He wants to open the door with it."

As illustrated by example (19a) the object-of-P clitic can only cliticise to the preposition governing it. The obvious question that we need to answer with respect to the ill-formed examples in (19) above is why cliticisation of the clitic out of PP results in ill-formedness. Notice that the situation here is similar to the one discussed above with respect to the genitival preposition. The explanation suggested there can therefore be extended to the ill-formed examples in (19), namely that they involve a violation of the AP by the affixal prepositions. Alternatively, they can be accounted for in terms of any principle which disallows preposition stranding in some languages but not in others.

One of the desirable consequences of the explanation in terms of the AP is that it provides a natural account for the fact that dative argument clitics, though governed by a preposition, as we concluded in the previous chapter, can cliticise to higher positions without giving rise to ill-formedness. This fact is illustrated by the examples in (9) where the dative clitic is attached to the wh-comp in (9b), to the NEG element in (9c), to the TNS element in (9d) and to the verb in (9e). The reason why the dative clitic can cliticise out of PP is that the head of PP is a null category and therefore is not subject to the AP, the latter being a well-formedness condition on the morphological make-up of lexical

categories. In different terms, because the preposition which governs the dative clitic and heads the PP dominating it is null the clitic can escape out of PP without causing an AP violation.

That this is probably the correct explanation is suggested by the behaviour of benefactive clitics. Benefactive arguments in Berber resemble dative arguments in that they also appear bearing the dative Case :

- (20) a. *y-arzm tawwart i-uhamosh sg-tghenjajt*
3ms-opened door DAT-boy with-spoon
"He opened the door for the boy with the spoon."
b. *snenni-n acsum i-inbjiwn*
cooked-3p meat DAT-guests
"They cooked meat for the guests."

We concluded in the previous chapter with respect to dative arguments that the dative Case is an inherent Case which is not assigned by a specific category but simply appears attached to the dative nominal phrase. We also concluded that dative arguments are underlyingly PPs where the dative nominal phrase is governed by a null preposition which protects it from government by the verb, since dative arguments are always in the CS form while the verb is a non-Construct governor. Given that benefactive arguments are also marked with the dative Case and given that they also are in the CS form, it is only natural to conclude that they also are underlyingly PPs headed by a null preposition which protects them from government by the verb, assuming, as we will see later, that benefactive arguments are arguments of the verb which assigns them a theta role just like dative arguments (see 4.3.2.5 below).

Assuming this conclusion to be correct our analysis predicts that benefactive clitics should be able to cliticise to higher positions just like dative clitics. The prediction is borne out by the fact that the following examples are well formed :

- (21) a. u ay-*asn* y-*snenni-n* *acsum*?
 who wh-comp-for-them n-cooked-n meat
 "Who cooked meat for them?"
- b. ur-*asn* *snenni-n* *acsum*
 NEG-for-them cooked-3p meat
 "They did not cook meat for them."
- c. tuhs-n ad-*asn* *snenni-n* *acsum*
 want-3p to-for-them cook-3p meat
 "They want to cook meat for them."
- d. *snenni-n-asn* *acsum*
 cooked-3p-for-them meat
 "They cooked meat for them."

In (21a) the benefactive clitic *-asn* is attached to the wh-comp *ay-*, while in (21b,c&d) it is attached to NEG, TNS and the verb, respectively. The fact that the benefactive clitic can cliticise out of the PP dominating it without giving rise to ill-formedness lends support to the explanation in terms of the AP suggested above to account for the impossibility of cliticisation out of PPs with overt prepositional heads.

Note, finally, that as we said above with respect to the genitival preposition, the fact that example (19a) is well-formed despite the fact that the clitic is not attached to the highest head element in the clause should not necessarily be understood to undermine the effectiveness of the CPC if the latter is interpreted in the way explained above. That is, if the CPC is interpreted as meaning that, unless required to do otherwise by some principle, clitics must attach to the highest head element in their clause.

4.2.2. P+clitic complex

In Berber, the complex that consists of a preposition and its clitic complement (P+cl(itic)) behaves in many respects like clitics, notably in that it can appear attached to a wh-comp, to a NEG element, or to a TNS element:

- (22) a. u ay-sg-as y-arzm-n tawwart?
 who wh-comp-with-it n-opened-n door
 "Who opened the door with it ?"
- b. ur-sg-as y-arzm tawwart
 NEG-with-it 3ms-opened door
 "He did not open the door with it."
- c. y-tush ad-as y-arzm tawwart
 3ms-wants to-with-it 3ms-open door
 "He wants to open the door with it."

In (22a) the complex P+cl is attached to the wh-comp ay-. In (22&cb) it is attached to the NEG and TNS elements, respectively. Movement to these positions of the complex in question is optional since the following sentences where the complex remains in its D-structure position are perfect grammatical paraphrases of their counterparts in (22) above :

- (23) a. u ay- y-arzm-n tawwart sg-as?
 who wh-comp- n-opened-n door with-it
- b. ur- y-arzm tawwart sg-as
 NEG- 3ms-opened door with-it
- c. y-tush ad- y-arzm tawwart sg-as
 3ms-wants to- 3ms-open door with-it

In this respect the P+cl complex differs from clitics whose movement to higher positions is obligatory under the CPC.

The P+cl differs further from clitics in that it never attaches to the verb. Even in sentences where the complex is adjacent to the verb the complex receives stress independently, unlike in examples such as (22) above where it is stressed in combination with the elements it is attached to. The reason why the P+cl never attaches to the verb is because unlike clitics it is not morphologically dependent; it can stand alone as a complete word. Recall that cliticisation to the verb is a last resort option that clitics turn to in the absence of a more suitable host. Because the P+cl is not morphologically dependent the option of attaching to the verb is never forced on it.

It is probably this difference in nature which accounts for the fact that when both a clitic and a P+cl complex are present in a clause only the clitic can attach to the head elements specified above :

(24) a. *u ay-sg-as y-arzm-n-t?
 who wh-comp-with-it n-opened-n-it
 "Who opened it with it ?"

b. u ay-t y-arzm-n sg-as?
 who wh-comp-it n-opened-n with-it

(25) a. *ur-sg-as y-arzmi-t
 NEG-with-it 3ms-opened-it
 "He did not open it with it."

b. ur-t y-arzm sg-as
 NEG-it 3ms-opened with-it

(26) a. *y-tush ad-sg-as y-arzmi-t
 3ms-want to-with-it 3ms-open-it
 "He wants to open it with it."

b. y-tush ad-t y-arzm sg-as
 3ms-want to-it 3ms-open with-i

It seems that the dependent nature of the clitic gives it priority over the P+cl complex. It is not clear that this priority is due to some privileged relationship that the clitic has with the verb over the P+cl, in the sense that the clitic is an argument of the verb but the instrumental P+cl is not, since we will see later that instrumental PPs are arguments of the verb which assigns them a theta role in practically the same way that it assigns a theta role to a dative argument. The same mechanism which allows the clitic to move up to higher positions will be shown also to allow the P+cl complex to move to the same positions.

The similarity in behaviour between the P+cl complex and clitics goes well beyond what has already been mentioned. Like clitics the distribution of the P+cl is also governed by the CPC :

(27) a. *u ay- ghar-sg-as y-arzm-n tawwart?
 who wh-comp will-with-it n-opened-n door
 "Who will open the door with it?"

- b. u ay-sg-as ghar- y-arzm-n tawwart?
 who wh-comp-with-it will- n-open-n door
 "Who will open the door with it?"

(27a) is ill-formed because the P+cl is attached to the TNS element while the C position is filled by the wh-comp. (27b) conforms to the CPC and therefore is well-formed.

Like clitics movement of the P+cl is also blocked by the presence of the NEG element :

- (28) a. *u ay-sg-as ur- y-arzm-n tawwart?
 who wh-comp-with-it NEG- n-opened-n door
 "Who did not open the door with it?"
- b. u ay- ur-sg-as y-arzm-n tawwart?
 who wh-comp- NEG-with-it n-opened-n door
 "Who did not open the door with it?"

The similarity in behaviour between the P+cl and the clitics exhibited by these facts implies that the two elements may have an identical categorial nature. We turn to this point immediately.

The fact that the complex P+cl patterns with clitics in its placement may be understood as suggesting that the complex is possibly a PP clitic similar to the PP clitics that are known to exist in some Romance languages. The following are illustrative examples from French where the clitic *y* in (29a) and the clitic *en* in (29b) stand for the PP "about it" :

- (29) a. Cela *y* fait penser tout le monde
 that about-it make think all the people
 "That makes everyone think about it."
- b. On essaiera d'*en* faire parler ton ami
 we will-try to-about-it make talk your friend
 "We will try to make your friend talk about it."

Now, if clitics are clitics by virtue of the fact that they are morphologically dependent elements, that is if the defining property of clitics is the fact that they cannot stand by themselves, then the complex P+cl in the Berber

examples above is obviously not a clitic. The reason is simply that unlike clitics, including the Romance PP clitics, the complex in question can quite happily stand by itself defining a stress domain and be separated from the verb by lexical material as in the examples in (23).

Moreover, the P+cl complex consists of two elements that are clearly distinct both morphologically and semantically so that the overall meaning of the complex is always compositional, derived from the meanings of the preposition and the clitic together. The Romance PP clitics, however, consist, morphologically and semantically, of a single unit whose meaning is read directly from its phonological shape just like the other non-PP clitics. In view of these facts it is legitimate to conclude that the P+cl, though it patterns with clitics in many crucial respects, is not a clitic itself.

Another possibility is to consider the P+cl a normal PP maximal phrase which consists of a preposition which is the head and a clitic which is a nominal phrase complement. There are at least three reasons to believe that the P+cl complex is not likely to be a PP maximal projection. First, the fact that the P+cl complex moves to head positions implies, under the Structure Preserving Hypothesis, that it cannot be a maximal projection since maximal projections can only move to maximal projection positions. Secondly, movement of a PP with a non-clitic complement to the positions to which the complex moves gives rise to ill-formed constructions :

- (30) a. *u ay-sg-tghenjajt y-arzm-n tawwart ?
 who wh-comp-with-spoon n-opened-n door
 "Who opened the door with the spoon ?"
- b. *ur-sg-tghenjajt y-arzm tawwart
 NEG-with-spoon 3ms-opened door
 "He did not open the door with the spoon."
- c. *y-tush ad-sg-tghenjajt y-arzm tawwart
 3ms-want to-with-spoon 3ms-open door
 "He wants to open the door with the spoon."

If the complex P+cl was really a PP it would remain an odd fact that when the complement is a non-clitic nominal phrase the movement produces an ill-formed construction.

The third reason is the fact that when PPs move in Berber they move to positions that apparently are peripheral to the clause, not to positions inside the clause as is the case with the complex in question :

- (31) a. **sg-as/sg-tghenjajt** (,) **y-arzm tawwart**
with-it with-spoon 3ms-opened door
"With it/ the spoon he opened the door."
- b. **sg-as/sg-tghenjajt ay- y-arzm tawwart**
with-it/ with-spoon wh-comp- 3ms-opened door
"It was with it/ the spoon that he opened the door."

In (31a) the instrumental PP, which can consist of either a preposition and a clitic complement or of a preposition and a non-clitic complement, is topicalised and therefore is somewhat peripheral to the CP (or C' projection if topicalised elements are assumed to occupy the Spec of CP) that contains the rest of the sentence. This is shown by the fact that the topicalised PP can be separated from the rest of the sentence by an intonational break. In (31b) the instrumental PP is clefted and appears in a position that clearly precedes the position of the wh-comp ay-. It should be clear that the positions to which PPs move in Berber are not the same positions to which the complex P+cl moves. It follows that the complex P+cl is not a PP.

Having concluded that the P+cl is neither a clitic nor a PP maximal projection let us now determine what it actually is. The fact that the P+cl complex moves to, and attaches to elements in, head positions implies, by virtue of the Structure Preserving Hypothesis, that it is a head category. The fact that it has a complex nature can be explained in terms of an incorporation process of the clitic into the preposition. The structure of

the P+cl can then be assumed to be as follows where the clitic is adjoined to the prepositional head :

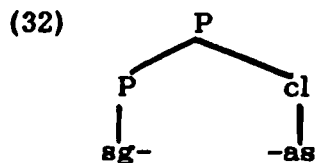

I will argue later that this structure is the result of a head-movement process which moves the clitic from its D-structure position as the head of the nominal phrase complement of P and adjoins it to the preposition. This analysis implies, however, that clitics are head categories, a position that I will also argue for later in this chapter. Note for the moment that if all clitics are head categories then our argument above that the prepositional complex is not a clitic loses its force since both the clitic and the prepositional complex are head categories. The only difference between them is the fact that while clitics are morphologically dependent elements the prepositional complex is not.

Assuming the conclusion that the prepositional complex is a complex preposition is correct one may object to it on the ground that movement of the preposition by itself, that is without the clitic complement, to the same positions results in ill-formedness :

- (33) a. *u ay-sg- y-arzm-n tawwart -as/tghenjajt?
 who wh-comp-with- n-opened-n door -it/spoon
- b. *ur-sg- y-arzm tawwart -as/tghenjajt
 NEG-with- 3ms-opened door -it/spoon
- c. *y-tush ad-sg- y-arzm tawwart -as/tghenjajt
 3ms-want to-with- 3ms-open door -it/spoon

The question that one may raise in this respect is, If the prepositional complex is really a head category why shouldn't a bare preposition be able to move without giving rise to ill-formed constructions? In order to answer

this question adequately we have to recall, first, that prepositions in Berber are affixal elements and, therefore, are subject to the AP, and, secondly, that the morphological subcategorisation frame of the prepositions specifies nominal categories as the only elements which can satisfy them. These nominal categories, we concluded in the previous chapter, are always the complements of the prepositions themselves, regardless of whether they are full lexical nouns or just clitics. Given these facts the preposition in all the three examples in (33) is in violation of the AP because it is not attached to a nominal category. Notice that in the environment where it is in these examples the element that is adjacent to the preposition from the righthand side is the verbal complex. In cases where the complement of the preposition is a clitic each of the examples in (33) represents, in fact, a double violation of the AP, by the preposition and by the clitic.

It is clear then that what looked, at first glance, like a counterargument to the conclusion that the prepositional complex is a head category has turned out, after a closer look, to be, in actual fact, an argument for the general analysis developed in this work which predicts that such a process should inevitably result in ill-formedness for the reasons spelled out above. Our next task is to examine the status of the cliticisation processes as well as the movement of the prepositional complex with respect to the HMC/ECP.

4.3. Clitic- and P+cl- movement and the ECP

4.3.1. Kayne's analysis

Kayne (1987) proposes an analysis for the possibility of clitic-climbing (movement of a clitic to a higher clause) in Italian and its lack in French, illustrated by the two examples in (34) below, by linking it to the well-known possibility of licensing a null subject in Italian and its lack

in French :

- (34) a. Gianni li vuole vedere
Gianni them-want-3ms to-see
"Gianni wants to see them."
b. *Jean les veut voir
Jean them-want-3ms to-see
"Jean wants to see them."

Kayne relates this contrast to the other contrast between the two languages concerning the licensing of a null subject in terms of the following assumption :

- (35) An I that can license a null subject can L-mark its VP complement even if the verb does not move up to I.

This assumption differs essentially from the assumption made in Chomsky (1986b) that I, whether it can license a null subject or not, can never L-mark its VP complement simply because I is not a lexical category. Kayne ignores the fact that I is not a lexical category and links its ability or inability to L-mark its VP complement with its ability or inability to license a null subject. Assuming for the moment that (35) is correct the crucial point is to see how it accounts for the contrast between Italian and French illustrated by the examples in (34).

The underlying structure of the two sentences in (34) is roughly as follows, irrelevant details omitted :

- (36) ...V [CP [IP Spec I [vp V cl]]]

Given this structure in order for the clitic in the object position of the embedded verb to be able to move up to the matrix clause it has to be able minimally to escape out of the embedded VP. In Italian the embedded infinitival I is capable of L-marking the VP it governs so that the latter is never a barrier to movement of the clitic. In French, however, the

embedded infinitival I is not capable of L-marking VP so that the latter is always a barrier to movement of the clitic. The possibility that the VP barrier in French can be voided by V-movement to I is excluded on the assumption that the infinitival verb in French does not move to I for some reason that need not concern us at the moment. Note that the assumption that the infinitival verb in French does not raise to I cannot be made to follow from the fact that the French I cannot license a null subject. For that would necessarily make it impossible for finite verbs, not only in French but in all non-null subject languages, to move up to I, which is a totally undesirable consequence for obvious reasons.

The possibility that the clitic could adjoin to VP to void its barrierhood is excluded in Kayne's analysis by the assumption that clitics are head categories in combination with the Structure Preserving Hypothesis. The assumption that clitics are heads is based minimally on the fact pointed out above with respect to Berber that clitics move to, and attach to elements in, head positions.

It is clear that according to Kayne clitic-climbing is possible in Italian because the clitic can minimally escape out of the embedded VP, and is impossible in French because the clitic cannot minimally escape out of the embedded VP. In order to account for the fact, pointed out earlier with respect to Berber, that clitic-movement is blocked by the presence of a NEG element, illustrated by the examples in (37) below, Kayne proposes, first, that the NEG element is a head category in the sense of X-bar theory, and secondly, that NEG, like the French I, is not capable of L-marking its VP :

- (37) a. *Gianni li vuole non vedere
Gianni them-want-3ms NEG to-see
"Gianni wants not to see them."

- b. Gianni vuole non vederli
 Gianni want-3ms NEG to-see-them
 "Gianni wants not to see them."

Because non does not L-mark VP movement of the clitic results in the crossing of the VP barrier, and, consequently, in the violation of the ECP.

Kayne argues further that the clitic does not move to its S-structure position directly, that is in one swoop, but stepwise, that is by moving through the intervening head positions in the way demonstrated by the following structure :

(38) ...cl_i...[CP t_i [IP Spec [I' t_i [VP V t_i]]]]

The first step, that is movement to the embedded I, is necessary so that the resulting complex can subsequently void the IP barrier by moving to C, assuming that IP is a barrier inherently, contrary to what is assumed in Chomsky (1986b). The scenario goes as follows : the clitic moves from its D-structure position as an object of the embedded verb to I and adjoins to it forming a complex I. Then, the latter complex moves up to C thereby voiding the IP barrier, and from there the clitic moves to the matrix clause, CP being a non-barrier because it is L-marked by the matrix verb.

The IP barrier is voided by a process that is similar to the process whereby the VP barrier is voided suggested in Chomsky (ibid), namely, the IP barrier is voided subsequent to I-movement to C in practically the same way that the VP barrier is voided as a result of V-movement to I. The comparison, however, would hold only if I is assumed to be an L-marking category. Note that movement of the clitic from its D-structure position directly to C would result in the crossing of the IP barrier since the latter would not be L-marked. Likewise, movement of the clitic directly to the matrix clause would also cross the IP barrier, as well as the CP barrier since the latter would inherit barrierhood from the non-L-marked IP.

The stepwise movement of the clitic accounts for, among other things, the fact that a filled C blocks clitic-climbing, a fact that is illustrated by the following examples :

- (39) a. *Non li so se fare
NEG them-know-1s if to-do
"I don't know whether to do them."
b. Non so se farli
NEG know-1s if to-do-them
"I do not know whether to do them."

Since clitic-climbing has to pass through C for the reasons specified above Kayne makes the plausible prediction that movement to/through C is possible only if the C position is empty. The C position in (39a&b) is filled by the complementizer se and therefore blocks movement of the [cl+[I]] complex to C, hence the fact that (39a) is ill-formed.

Note, finally, that crucial to this analysis is the assumption that clitic-trace relations are not sensitive to Minimality barriers, for otherwise the initial trace of the clitic in (38) would be separated from its antecedent-governor by the VP barrier under the broad interpretation of the Minimality Condition and by the VP and V' barriers under the narrow interpretation of the Minimality Condition.

The rest of this section will be spent on trying to see to what extent the conclusions reached by Kayne can be accommodated within the framework developed in this work which assumes a more articulated structure of the clause. The discussions are based on the facts of cliticisation in Berber as well as in the Romance languages.

4.3.2. Clitic-movement in Berber

4.3.2.1. Clitics as heads

After having demonstrated that clitics climb stepwise and not in one

swoop, Kayne claims that this conclusion confirms the assumption, made originally on the basis of the fact that clitics move to head positions, that clitics are indeed head categories. Head-movement processes are believed to be strictly local, a belief that is explicitly expressed by the HMC. The fact that clitics move in the fashion demonstrated by Kayne makes them conform to the standard processes of head-movement and, consequently, implies that clitics are head categories themselves.

Note that over and above the fact that clitics in Berber also move to head positions the assumption that clitics are head categories receives independent support. One of the arguments put forward above in trying to establish the nature of the prepositional complex is that the fact that the complex behaves like a clitic in its placement suggests that it is a clitic itself. However, now that we have established the nature of the complex as a complex prepositional head we can switch the argument around and say instead that the fact that clitics behave like the prepositional complex in their placement implies that clitics are, like the prepositional complex, head categories. The difference between the two head categories, that is the prepositional complex and the clitic, reduces to the trivial fact that the former is not morphologically dependent while the latter is, hence the fact pointed out above that movement of clitics in search for a host is obligatory while movement of the prepositional complex is not. From this minimal distinction also follows the further fact that the prepositional complex never attaches to the verb, the latter process being a last resort option that is forced on clitics because of their dependent nature⁵.

Having said that let us now outline the details of the process whereby the prepositional complex is derived. Assuming the structure of PPs in Berber to be as outlined in (75) in the previous chapter, and assuming that clitics are Ns which head the NP complement of the D head of the nominal

phrase complement of P, the structure of the prepositional complex is expected to be roughly as follows⁶ :

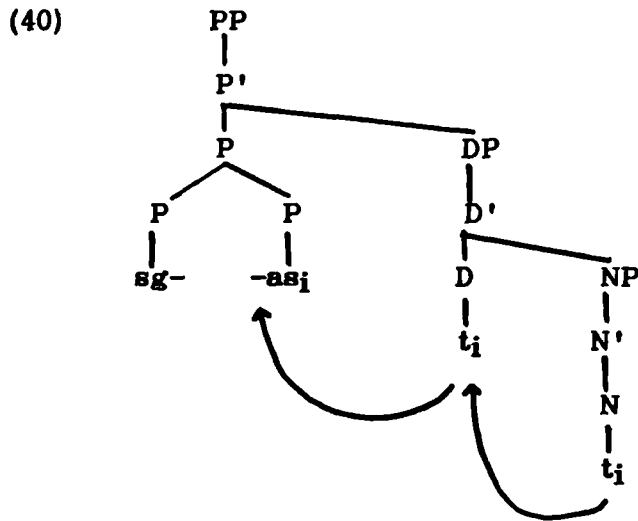

The clitic moves to D first and then to P. Movement to D as an intermediate step is necessary in order to get around the NP barrier. NP becomes L-marked subsequent to clitic-movement to D. Note that this explanation entails that clitics are lexical categories which are capable of L-marking the maximal projections they govern. From D the clitic moves further up to P, DP being a non-barrier because it is L-marked by the preposition. Note again in this respect that prepositions are also assumed to be capable of L-marking their complements. The movement of the clitic to P is, needless to say, motivated by the AP, the clitic and the preposition being both affixal elements.

Viewed as such clitics have in a sense a nature that is similar to that of KNs. Recall that the distinctive property of KNs is that they are affixal and that for this reason they can host clitics unlike the rest of the nouns in the language which can't, cliticisation being essentially a means of satisfying the AP. Like KNs clitics are specified in the lexicon as being affixal in terms of a morphological subcategorisation frame which requires them, under the AP, to attach to specific categories in the syntax. Given

this similarity the process whereby the KN complex is derived can be defined along the lines outlined above for the derivation of the prepositional complex :

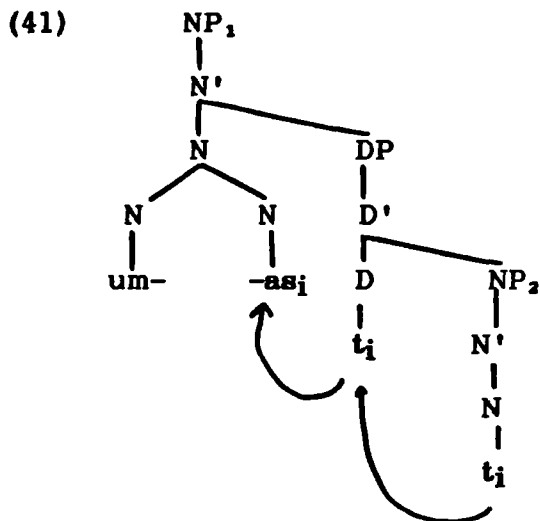

The voiding of the NP₂ barrier operates along the same lines discussed above with respect to the derivation of the prepositional complex. As to DP it is not a barrier because it is L-marked by the KN.

4.3.2.2. Movement to TNS

We have been assuming so far that one of the possible hosts of clitics in Berber is the verb. However, when considered carefully this statement is found to be at odds with the CPC given the structure of the verbal clause in Berber assumed in the first chapter of this work. The verb is never the highest head in the clause and therefore can never host a clitic by virtue of the CPC. In sentences such as (1e) where the clitic appears attached to the verbal complex the host is, in actual fact, TNS which is the highest head in the clause. This fact is illustrated clearly in constructions such as (1d) (ad-clauses in general) where the clitic appears clearly attached to the TNS element ad-. The difference between constructions such as (1e) and constructions such as (1d) is that the latter contain a TNS element that can

host a clitic because it is lexical, while the former contain a TNS element that cannot host a clitic by itself because it is in a sense abstract. A TNS node that is occupied by an abstract element can only host a clitic in combination with the [V+AGR] complex.

Assuming this distinction to be correct the structures underlying sentences (1e) and (1d) are as follows, respectively, irrelevant details omitted :

- (42) a. [TNSP TNS+[AGR+V]_j +cl_i [AGRP t_j [VP t_j t_i PP]]]
 b. ...V [TNSP TNS+cl_i [AGRP AGR+[V]_j [VP t_j t_i PP]]]

In (42a) the verb moves up to AGR and then to TNS. The clitic, on the other hand, moves up to TNS after the verbal complex has moved to that position. Notice that the clitic cannot move to TNS prior to movement of the [AGR+V] complex because the TNS node is filled by an abstract element which we concluded above cannot host a clitic. In (42b) the verb moves up only as far as AGR. It is the clitic which moves to TNS to help the element occupying it (ad-) satisfy the AP. Note that the [TNS+cl] complex forms a unit/word that is morphologically and phonologically independent of the unit/word formed by the [AGR+V] complex.

Among the obvious questions that arise with respect to the structures in (42) is whether the clitic moves to its S-structure position directly, as is implied by the structures, or stepwise as is required by the HMC. Notice that there are two head positions (V and AGR) intervening between the S-structure position of the clitic and its initial position. The HMC requires the clitic to move through these intervening positions on its way up to its S-structure position. If the clitic does move through V and AGR there are two logically possible ways it can do so. One is to attach first to V, the L-marker of its maximal projection, and form with it a complex verb that

subsequently moves to AGR and then to TNS. The other is to wait until the verb moves up to AGR and TNS in (42a) and to AGR in (42b), thus emptying the V and AGR positions or just V. The clitic can then move through the now empty intervening head positions. Neither of these two possibilities is tenable for the following reasons.

The first possibility where the clitic attaches to the verb first and forms with it a complex that later moves to AGR and TNS predicts, under the MP, an unattested order of the elements in question, namely, *TNS+[[V+cl]+AGR], where the clitic precedes the AGR and TNS elements in relation to the verb. A well known fact about clitics in general that is hardly in need of illustration is that they always appear outside the domain of the derivational and inflectional morphology. Given this fact the possibility entertained here simply cannot be correct. Notice, in addition, that in (42b) the clitic is attached to the TNS element and forms with it a complex that is independent of the [AGR+V] complex phonologically as well as morphologically.

As to the second possibility where the clitic moves through the V and AGR positions after they have been emptied it is excluded by the Head Opacity Condition (HOC) of chapter 1 which, recall, specifies that the ECP, or Move-alpha for that matter, cannot make reference to the internal structure of an X-0 category. When V and AGR move from their positions they leave behind traces. When the clitic adjoins to these positions on its journey up it also leaves traces. The structure that results from these movements is that of a complex X-0 category (V and AGR) that dominates two different traces. Assuming that all traces are subject to the ECP the latter would have to look into the internal structure of the X-0 category to distinguish between the two traces. In addition, in structure (42b) the AGR position is not empty in the way the V position is. To maintain a stepwise

analysis of clitic-movement in this case would require the clitic to adjoin to the complex in AGR and then gets extracted from it and moved to TNS. Again this possibility is excluded by the HOC for the same reason that adjunction to a head position filled by a trace is excluded.

The obvious conclusion that transpires from the discussion above is that the clitic moves to its S-structure position in one swoop and not stepwise. We will see later that the same reasoning leads to a similar conclusion with respect to clitic-movement in the Romance languages contrary to what is argued for by Kayne (*ibid*) who, incidentally, also assumes a principle that is similar to the HOC in that it does not allow for traces to be dominated by an X-0 category (*cf.* Baker (1985)). Having concluded that clitics move to their S-structure positions directly the next step is to define the status of this rather long movement, judging by the known standard of head-movement processes, with respect to the ECP. That the movement violates the HMC is a fact that barely needs pointing out. What I want to demonstrate is that although the movement violates the HMC it does not violate the ECP. If this is the case then the HMC must be a misguided principle and therefore should be discarded (*see* 4.5.).

Starting with (42) we notice that there are two maximal projections which separate the clitic from its initial position, VP and AGRP, which are both potential barriers because their theta-markers (AGR and TNS, respectively) are non-lexical categories. However, both VP and AGRP are voided as a result of V-movement to AGR and then to TNS, thus making it possible for the moved clitic to antecedent-govern its trace inside VP. As to the Minimality barriers we will assume, along with Kayne (*ibid*) and Ouhalla (*in preparation*), that clitic-trace relations, in fact all non-wh-word-trace relations, are not subject to Minimality barriers.

Turning to (42b) we see that as in the previous case both VP and

AGRP separate the moved clitic from its trace. However, unlike the previous case in (42b) the verb moves up only as far as AGR so that while the VP barrier is voided the AGRP barrier remains, TNS being a non-lexical category. But notice that the TNS element has attached to it the clitic which we concluded earlier with respect to (40) is capable of L-marking the maximal projection it governs. We can therefore assume that subsequent to clitic-movement to TNS the latter becomes lexical and, consequently, AGRP ceases to be a barrier, thus allowing the moved clitic to antecedent-govern its trace in satisfaction of the ECP.

5.3.2.3. Movement to NEG

Like the TNS element ad- the NEG element ur- can also host a clitic. As illustrated by example (1c) the complex that results from the cliticisation is morphophonologically independent of the complex which contains the verb, AGR and TNS. Like the rest of the cliticisation processes in the language this one is also motivated by the AP. The NEG element satisfies its morphological subcategorisation frame as a consequence of hosting the clitic, hence the fact that it is morphophonologically independent of the verbal complex. Recall that in the absence of a clitic the NEG element attaches to the verbal complex.

Assuming the structure of negative sentences in Berber postulated in the first chapter is correct, the structure underlying example (1c) is expected to be as follows where NEG is the top node, ignoring the C node for the moment :

(43) [NEGP NEG+cl_i [TNSP TNS+[AGR+[V]_j]_k [AGRP t_k [VP t_j t_i PP]]]]

The verb moves up to AGR and then to TNS while the clitic moves to NEG, in one swoop, presumably. As in the case of movement to TNS discussed

above the maximal projections (VP, AGRP and TNSP) which separate the moved clitic from its initial position all become L-marked subsequent to the head-movement processes. VP and AGRP become L-marked as a result of V-movement to AGR and [AGR+[V]]-movement to TNS, and TNSP becomes L-marked as a result of clitic-movement to NEG. Recall that we concluded earlier that the clitic is capable of L-marking the maximal projection it governs. Antecedent-government of the trace by the moved clitic therefore holds despite the long nature of the movement, thus satisfying the ECP.

The possibility that the clitic moves to its S-structure position in a stepwise fashion is excluded for the same reasons that a similar movement of the clitic to TNS was excluded earlier. Assuming the HOC and the generalisation made by the MP, the order of the clitic and the NEG, TNS, AGR elements with respect to the verb suggests rather strongly that the movement of the clitic is not likely to have operated in a stepwise fashion. Notice again in this respect that the fact that the movement operates in one swoop without giving rise to an ECP violation implies that the severe restriction put by the HMC on head-movement processes must be erroneous (see 4.5. below).

4.3.2.4. Movement to C

As in the previous two cases the clitic and its host, the wh-comp ay-, form a complex that is morphophonologically independent of the verbal complex. Like the TNS and NEG elements the wh-comp is also affixal and therefore is subject to the AP. In the absence of a clitic the wh-comp satisfies the AP by attaching to the verbal complex. The attachment is the result of a head-movement process which moves the [TNS+[AGR+[V]]] complex to the C position (see Ouhalla (in preparation)). The process is illustrated by (44b) below which is the structure of the sentence in (44a) :

(44) a. u ay- ghar- y-arzm-n tawwart sg-tghenjajt?
 who wh-comp- will- n-open-n door with-spoon
 "Who will open the door with the spoon?"

b. [CP C+[TNS+[AGR+[V]_i]_j]_k [TNSP t_k [AGRP t_j [VP t_i DP PP]]]]

The complex which consists of the wh-comp, the TNS element, the AGR element and the verb forms a single phonological unit, i.e. one word, despite its very complex nature.

In constructions which contain a clitic such as the one in (1b) the complex [TNS+[AGR+[V]]] does not need to move up to C because the morphological subcategorisation frame of the wh-comp is satisfied by the clitic. The structure underlying the wh-question in (1d) is therefore as follows :

(45) [CP C+cl_i [TNSP TNS+[AGR+[V]_j]_k [AGRP t_k [VP t_j t_i PP]]]]

For reasons that are similar to the ones put forward above with respect to movement to TNS and to NEG the clitic in (45) also moves directly. VP and AGRP, though potential barriers, become L-marked subsequent to the movement of the verb to AGR and the movement of [AGR+[V]] to TNS. As to TNSP it becomes L-marked subsequent to movement of the clitic to C. Alternatively, it is possible to assume, along with Chomsky (1986b), that the inflectional maximal projections (IP in his system, and TNSP or AGRP in the present system) are defective projections which are never barriers inherently. Given that no barriers separate the moved clitic from its trace inside VP antecedent-government holds in satisfaction of the ECP.

Having concluded that, let us now see why and in what sense the presence of a NEG element blocks clitic-movement to C. Recall that Kayne (1987) explains this phenomenon in the Romance languages by assuming that NEG is not an L-marker and that as a consequence the maximal projection it governs is always a barrier to movement, hence the blocking effect.

However, given the discussion above it should be clear that Kayne's explanation would be valid only if it is assumed that the verbal complex does not move up to NEG and attach to the element occupying it because if the verbal complex does move up to NEG then NEG can become an L-marker as a result of this movement as we saw in chapter 2 above with respect to the Berber examples. If the explanation proposed for the NEG elements in French in chapter 2 is correct then it must be the case that it is not the maximal projection governed by the NEG element that blocks cliticisation.

To see why Kayne's explanation cannot be correct when extended to Berber and to have a glimpse into what could be the blocking category consider the examples in (7a) above repeated below along with their respective underlying structures :

(46) a. *Hemmu ay-t ur- y-arzm-n sg-tghenjajt
 Hemmu wh-comp-it NEG- n-opened-n with-spoon
 "It was Hemmu who did not open it with the spoon."

b. *Hemmu [CP C+cl_i [NEGP NEG+[TNS+[AGR+[V]_j]_k]_l]
 [TNSP t_l [AGRP t_k [VP t_j t_i PP]]]]

(47) a. Hemmu ay- ur-t y-arzm-n sg-tghenjajt
 Hemmu wh-comp NEG-it n-opened-n with-spoon
 "It was Hemmu who did not open it with the spoon."

b. Hemmu [CP C+[NEG+cl_i]_j [NEGP t_j [TNSP TNS+[AGR+[V]_k]_l]
 [AGRP t_l [VP t_k t_i PP]]]]

In (47) the clitic is attached to the NEG element which together with the wh-comp forms a single complex. The complex is the result of the movement of [NEG+cl] to C. We have already discussed in what way clitic-movement to NEG satisfies the ECP and therefore no further explanation is needed at the moment. The fact that the sentence in (47) does not involve an ECP violation accounts for its well-formedness.

Notice, however, that (46) also satisfies the ECP and yet the sentence is ill-formed. VP, AGRP and TNSP are not barriers because they become

L-marked subsequent to V-movement to AGR, [AGR+[V]]-movement to TNS and [TNS+[AGR+[V]]]-movement to NEG, respectively. NEGP, on the other hand, becomes L-marked after the clitic has moved to C. Whatever the correct explanation for the ill-formedness of (46) it is not likely to be along the lines suggested by Kayne for the similar phenomenon in the Romance languages. According to Kayne's analysis (47), in fact all cases of clitic-movement to NEG, should be ungrammatical because they involve movement across the maximal projection governed by NEG. It seems to me that, if anything, it is NEGP itself that is likely to be the blocking category. It seems that even when L-marked NEGP still blocks the movement of elements across it. I, however, have no explanation at the present moment for why this should be the case.

4.3.2.5. Dative, benefactive and possessor clitics

Recall that what dative and benefactive arguments have in common is that they bear the dative Case and are underlyingly PPs headed by a null preposition. We concluded above that it is precisely because the head of the PP is null that the dative and benefactive clitics can move up to higher positions without causing an AP violation by the stranded null preposition. The following is a partial structure of the sentences in (9) and (21), assuming that clitic-arguments have the structure outlined above in (40) and (41) :

(48) a. ...cl_i...[VP V DP [pp P [DP t_i [NP t_i]]]

Movement of the clitic out of VP to higher positions operates along the lines discussed above, hence the fact that the structure in (48) is incomplete. The clitic moves from its D-structure position to D first in order to get around the NP barrier as explained above, and from D it moves to its S-structure position directly. DP is L-marked by the null P

while PP is L-marked by the verb.

Notice, however, that this explanation assumes crucially that the verb theta-marks the PP in the structure in (48). While it is pretty clear that dative arguments are theta-marked by the verb, this is not the case with benefactive arguments. That dative arguments are indeed arguments of the verb is usually illustrated by the fact that their omission results in ill-formedness, a violation of the Projection Principle, presumably :

(49) a. He gave/handed the book *(to Mary)

b. y-usha aslm *(i-Munat)
3ms-gave fish to-Munat
"He gave Munat the fish."

Omission of benefactive arguments, however, does not result in ill-formedness :

(50) a. They cooked meat (for the guests)

b. snenna-n acsum (i-inbjiwn)
cooked-3p meat to-guests
"They cooked meat for the guests."

This fact, among others, has led some linguists, notably Marantz (1984), to conclude that benefactive PPs are not arguments of the verb but are simply adjunct modifiers of VP. As such they are not theta-marked, hence not L-marked, by the verb, and, consequently, movement out of them is predicted to be impossible. However, precisely because movement out of benefactive PPs is attested in a number of languages Baker (1985) argues that benefactive PPs are indeed arguments of the verb from which they receive a theta-role. The fact that their omission does not result in ill-formedness is explained by assuming that benefactives are optional arguments of the verb. The theta-role that they receive from the verb is passed on to the nominal phrase complement via the prepositional head. The

theta marking mechanism assumed can be illustrated by the following structure where the lines indicate the theta-marking relationship (cf. Baker (ibid)) :

(51) ...V...[pp P [DP]]

The verb assigns a theta-role to the benefactive PP and the head of the latter passes the theta-role assigned on to its complement.

Note that the fact that benefactive clitics can move out of their PPs to higher positions in Berber shows fairly clearly that benefactive PPs are indeed theta-marked by the verb. For if they were not the PP would be a barrier to movement because it would not be L-marked. Baker's conclusion which, incidentally, is based on an extensive study of applicative constructions, that is constructions which involve incorporation of a preposition into the verbal complex, in a number of languages, therefore receives significant support from the facts of benefactive clitic-movement in Berber.

As to possessor clitic its movement does not raise any problems with respect to the ECP since its phrase is L-marked by the possessee noun, while the maximal projection of the latter is L-marked by the verb. Using the examples in (14) for illustration the structure underlying them is predicted to be roughly as follows, irrelevant details omitted :

(52) ...cl_i...[VP V [DP₁ D+[N]_j [NP₁ t_j [DP₂ t_i [NP₂ t_i]]]]]

The clitic moves to D₁ first to get around the NP₂ barrier and from there moves to its S-structure position. DP₂ is L-marked by the possessee noun N_j which raises to D₁ to attach to the determiner, thereby voiding the NP₁ barrier. As to DP₁ it is L-marked by the verb. Movement out of VP to higher positions also satisfies the ECP thus accounting for the possibility

of movement of the possessor clitics.

4.2.3. P+cl-movement

It was observed and demonstrated earlier that movement of the prepositional complex to TNS (22c), to NEG (22b) and to C (22a) resembles in every crucial respect movement of the clitics to the same positions discussed above. Assuming the conclusions reached with respect to movement of the clitics to be correct the structures of the sentences in (22) are expected to be as follows, where (53a) corresponds to (22c) and (53b) corresponds to (22b), while (53c) corresponds to (22a) :

(53) a. [TNSP TNS+[P+cl]_i [AGRP AGR+[V]_j [VP t_j DP [PP t_i]]]]

b. [NEGP NEG+[P+cl]_i [TNSP TNS+[AGR+[V]_j]_k [AGRP t_k [VP t_j DP [PP t_i]]]]]]

c. [CP C+[P+cl]_i [TNSP TNS+[AGR+[V]_j]_k [AGRP t_k [VP t_j DP [PP t_i]]]]]]

In (53a) VP becomes L-marked after the verb has moved to AGR, while AGRP becomes L-marked after the prepositional complex has moved to TNS. In (53b) VP and AGRP become L-marked subsequent to V-movement to AGR and [AGR+[V]]-movement to TNS. TNSP, on the other hand, is L-marked by NEG which becomes lexical after the prepositional complex has moved to it. In (53c) VP and AGRP also become L-marked after the verb has moved to AGR and [AGR+[V]] has moved to TNS. TNSP, however, is L-marked by C which becomes lexical after the prepositional complex has attached to it. In all these structures, therefore, no barrier intervenes between the moved prepositional complex and its trace, thus satisfying the ECP.

The possibility that the prepositional complex could have moved to its S-structure position in a stepwise fashion is excluded for exactly the same reasons that a similar process of clitic-movement is excluded. The order of

elements attested shows, in combination with the generalisation made by the MP and the restriction imposed by the HOC, that the prepositional complex moves to its S-structure position in one swoop. The same arguments put forward above against a stepwise movement of clitics apply to the movement of the prepositional complex, given the striking similarity in behaviour between the two elements which we attributed, mainly, to the fact that they are both head categories.

There is, nevertheless, a potential problem with respect to the movement of the prepositional complex out of PP. All the examples given above involve an instrumental prepositional complex. Other types of prepositional complexes (e.g. locative/source) can also move to the positions indicated:

- (54) a. *y-gga timllalin g- uqrab/g-as*
 3ms-put eggs in- basket/in-it
 "He put the eggs in the basket/it."
- b. *u ay- g-as y-ggi-n timllalin?*
 who wh-comp- in-it n-put-n eggs
 "Who put the eggs in it?"
- c. *ur- g-as y-gga timllalin*
 NEG- in-it 3ms-put eggs
 "He did not put the eggs in it."
- d. *y-tush ad-g-as y-gg timllalin*
 3ms-want to-in-it 3ms-put eggs
 "He wants to put the eggs in it."
- (55) a. *y-xdl zi-tendint/zi-as*
 3ms-arrived from-town/from-it
 "He arrived from the town/it."
- b. *u ay- zi-as y-xdl-n?*
 who wh-comp- from-it n-arrived-n
 "Who arrived from it ?"
- c. *ur- zi-as y-xdl*
 NEG- from-it 3ms-arrived
 "He did not arrive from it."
- d. *y-ugi ad-zi-as y-xdl*
 3ms-refused to-from-it 3ms-arrive
 "He refused to arrive from it."

The potential problem mentioned above has to do with the question of whether the instrumental/locative/source PPs are theta-marked by the verb or not. Here again, as in the case of benefactive PPs, opinions differ. Marantz (1984) argues, on the basis of the fact that omission of instrumental PPs does not result in ill-formedness, that they are not arguments of the verb but are simply adjuncts. The fact that the omission of instrumental, as well as source, PPs in the examples above does not result in ill-formedness is illustrated by the following examples :

- (56) a. *y-arzm tawwart (sg-tghenjajt)*
 3ms-opened door with-spoon
 "He opened the door (with the spoon)."
- b. *y-xdl (zi-tendint)*
 3ms-arrived from-town
 "He arrived from the town."

As to the locative PP in (54) its deletion does result in ill-formedness, implying that the PP is an argument of the verb, a fairly standard assumption with the verb 'put' in many languages :

- (57) *t-gga timllalin *(g-uqrab)*
 3fs-put eggs in-basket
 "She put the eggs in the basket."

Baker (1985), on the other hand, argues on the basis of the fact that in some languages instrumental, as well as some locative prepositions, do incorporate into the verbal complex that instrumental and, at least some, locative PPs are indeed arguments of the verb from which they receive a theta-role in the fashion illustrated by the structure in (51) above.

In the present context the facts are clear-cut and the conclusion is straightforward. That instrumental, locative and source prepositional complexes can move out of their PPs to higher positions in the clause implies that their respective PPs are arguments of the verb. For the prepositional complexes to be able minimally to escape out of PP without

causing an ECP violation the latter has to be L-marked by the verb.

4.3.4. Clitic-movement in Romance⁷

4.3.4.1. Movement to TNS

We concluded in the first chapter that non-inflected infinitival clauses in SVO languages, including the Romance languages, lack an AGR projection so that the top node in the infinitival clause, apart from C, is TNS. In the Romance languages the infinitival TNS node is filled by the infinitive marker *-r* (or its other equivalents) which attaches to the verb as a result of an obligatory V-movement process to TNS. Given this the clitics that apparently appear attached to infinitival verbs (cf. (37b) and (39b)) are in fact attached to a complex which consists of the verb and the infinitive marker. Using example (37b) for illustration the D-structure of the embedded clause is as follows, ignoring the negation element :

(58) Gianni vuole [CP [TNSP *-er* [VP *ved-* [DP *li*]]]

The infinitive marker occupies the TNS position while the clitic occupies its position as the object of the embedded verb. In order for the verb to attach to the the infinitive marker it has to move up to TNS, downgrading movement being an unlawful process in the present context. The fact that the clitic follows the infinitive marker implies, under the generalisation made by the MP, that the clitic attaches to the verbal complex after the verb has attached to the infinitive marker. It follows that the clitic attaches to the TNS node and not to the bare verb. Given that verbs in Romance are always either tensed or marked with the infinitive marker technically the bare verb is never the host of the clitic given the well-known peripheral nature of clitics in relation to derivational and inflectional morphology.

The conclusion that seems to transpire is that the clitic moves directly to TNS without passing through the V position as the HMC requires, given that the verb is the L-marker of the maximal projection dominating the clitic argument. Let us consider the possibility that the clitic moves through V first before moving on to TNS. As in the previous case there are two ways this can be done. Either the clitic attaches to the verb and forms with it a complex that later moves up to TNS and attaches to the element occupying it, or, instead, the clitic waits until the verb moves up to TNS and empties its position so that it can be used as an intermediary station by the clitic. The first possibility would yield an order of elements where the clitic precedes the infinitive marker, i.e. *ved-li-er, an unattested and ill-formed order, obviously. The second possibility is excluded by the HOC because the clitic would attach to the V position, which is filled by the trace of the moved verb, and then gets extracted from it, thus resulting in a V node which dominates two different traces [v t_i [v t_j]]. The ECP, according to the HOC, is not allowed to look into the structure of an X-0 as it would have to do in this case.

After movement of the verb and the clitic in (58) have taken place the S-structure is expected to look like the following :

(59) Gianni vuole [CP [TNSP [[ved-]j -er]+h₁ [vp t_j t_i]]]

Both movements satisfy the ECP trivially, the only intervening maximal projection being VP which becomes L-marked subsequent to V-movement to TNS. If this analysis is correct then Kayne's conclusion that clitics move according to the restrictions laid down by the HMC must be false. Notice in this respect that when looked at carefully Kayne's analysis involves a violation of the HMC in practically the same way that the present analysis involves a violation of the HMC. Looking back on structure (38) we find that in its movement to I the clitic does in fact cross over the verb which

is the L-marker of the clitic. The HMC, however, does clearly require the clitic to move to V as a first step. Now, if the clitic does move through V there will always be a violation of the HOC, which Kayne crucially assumes in his analysis, though in a different form, whichever way one looks at it. If the clitic moves to V while the verb is still there the clitic would have to be extracted later from the resulting V complex, which means that Move-alpha would have to make reference to the internal structure of an X-0 category, a violation of the HOC. If, on the other hand, the clitic waits until the verb empties the V position then a similar violation of the HOC arises since the ECP would have to make reference to the internal structure of V.

4.3.4.2. Movement to AGR

Finite clauses in SVO languages, including Romance languages, differ from non-inflected infinitival clauses in that finite clauses have an AGR node, which, given the discussion in chapter 2, is the top node in the clause apart from C. Given that the verb in these clauses moves obligatorily to TNS and AGR we would expect, on the basis of the conclusions reached above along with the peripheral nature of clitics, that an object clitic would be attached to the complex that results from this movement. Unlike in the previous case, however, it is not possible to verify this conclusion simply on the basis of an observation of the order of the clitic in relation to the inflectional elements and the verb. The reason is that in Romance languages clitics generally appear prefixed to tensed verbal complexes while the TNS and AGR elements are suffixed to the verb as the following example from French illustrates :

- (60) Elle les mang-er-a demain
 she them-eat-will(TNS)-3s(AGR) tomorrow
 "She will eat them tomorrow."

Given this order it is not possible, on the basis of the generalisation made by the AP, to determine whether the clitic attaches to the verb prior to movement to TNS and AGR so that the structure of the verbal complex is as in (61a) below, or that the clitic attaches to the verbal complex subsequent to movement of the verb to TNS and then to AGR so that the structure of the verbal complex is as in (61b) below :

- (61) a. [[[cl+[V]]+TNS]+AGR]
 b. [cl+[[[V]+TNS]+AGR]]

There are at least two important reasons to favour (61b) over (61a), that is to favour the analysis where the clitic moves directly to AGR over the analysis where the clitic attaches to the verb before moving up to TNS and AGR. The first reason is empirical and has to do with the well-known fact mentioned earlier that clitics usually appear in positions that are peripheral to the domain of the inflectional morphology. (61b) is consistent with this fact while (61a) is not because in (61a) the clitic is ~~inside~~ the domain, indicated by the brackets, of the TNS and AGR elements. The second reason is theoretical and has to do with the fact that given that direct movement of the clitic to AGR is warranted by the ECP there is no reason why we should assume that the clitic does not move in one swoop. In different terms, if the stepwise movement that yields the structure in (61a) is understood to be forced by the ECP then the fact that the clitic can move directly without giving rise to an ECP violation eliminates the original motivation, the *raison d'être*, so to speak, for the stepwise analysis. In addition to what has been mentioned consistency forces us to conclude that as in the previous cases the clitic in constructions such as (60) also moves in one swoop, thus favouring (61b) over (61a).

To see how a direct movement of the clitic in constructions such as (60) satisfies the ECP let us outline the underlying structure of the

example in (60) :

(62) [CP [AGRP Elle [AGR' les_i+[[[mang]_j+er]_k+a] [TNSP t_k
[VP t_j t_i]]]]]

VP and TNSP become L-marked as a result of V-movement to TNS and [[V]+TNS]-movement to AGR, thus clearing the way for the clitic to move in one swoop without giving rise to an ECP violation.

4.3.4.3. Movement to C

The discussion here will be restricted to Spanish data with the possibility that the conclusions can be extended to Catalan, at least. The reason is that Spanish has been argued, by Torrego (1984), to have a process of subject-verb inversion which applies obligatorily in wh-questions illustrated by the following examples where the subject follows the verbal complex in (63a) and precedes it in (63b) :

(63) a. A quién dio Juan el libro ?
to whom gave Juan the book
"To whom did Juan give the book?"

b. *A quién Juan dio el libro ?
to whom Juan gave the book

Torrego argues that the inversion process involved in these constructions differs crucially from the subject-postposing process attested in declarative clauses in that the inversion process preposes the verbal complex instead of postposing the subject. In different terms, in wh-questions such as (63) it is the verbal complex that is the object of movement while in declarative subject-postposing sentences it is the subject that is the object of movement (cf. Rizzi (1982) and Chomsky (1986a)).

The V-preposing process in wh-questions differs further from the subject-postposing process in that the verb-preposing process is

obligatory, hence the ill-formedness of (63b), while the subject-postposing process is basically optional. Torrego argues that the verb-preposing process moves the verb from its D-structure position inside VP and adjoins it to S (IP/AGRP).

While I take Torrego's analysis to be essentially correct I am forced by the restricted theory of movement adopted in this work to differ from her with respect to the landing site of the moved verbal complex. I will assume instead that the verbal complex lands in C, the only head position that precedes the subject position given the clausal structure of SVO languages postulated in chapter 2. Obviously, on its way up to C the verb moves through TNS and AGR to pick up the elements occupying them, thus avoiding a violation of the AP as well as of the ECP. Having said that, the similarity between Spanish *wh*-questions such as the one in (63) above and the Berber operator-movement constructions discussed briefly earlier (and in detail in Ouhalla (in preparation)) is obvious. Like Spanish *wh*-questions Berber operator-movement constructions involve an obligatory movement process which moves the verbal complex to the C position filled by the affixal *wh*-comp ay- so that the ill-formedness of the Berber example in (4a) above is on a par with the ill-formedness of the Spanish example in (63b). The only difference between the two languages is that while the Berber operator-movement constructions contain an affixal *wh*-comp the Spanish ones do not, a difference that can be explained in terms of an assumption that Berber has a *wh*-comp while Spanish does not.

Assuming the revision suggested above to be correct it follows that the clitics in the following examples are in C :

- (64) a. A quién lo dio Juan ?
to whom it-gave Juan
"Who did Juan give it to ?"

- b. Qué le dio Juan ?
 what to-him-gave Juan
 "What did Juan give to him ?"

Here again the question arises as to whether the clitic moves directly to C or in a stepwise fashion. As in the previous case it is difficult to draw a conclusion on the basis of the MP by just observing the order of the clitic with respect to the inflectional elements and the verb, the reason being that given that the verb is inflected the clitic and the inflectional elements attach to different sides of the verbal complex.

It is fairly plausible, however, to extend the conclusions reached earlier with respect to movement to AGR to the constructions in (64), namely that the clitic moves directly to C and that the structure of the verbal complex that results from the movements that operate is as in (61b) above where the clitic is outside the domain of the inflectional elements. Accordingly, the structure underlying the wh-questions in (64) is as follows, ignoring the wh-movement process as well as the fact that in one case it is the direct object that cliticise while in the other it is the indirect object :

- (65) [CP wh [C' cl_i+[[[V]_j+TNS]_k+AGR]_l [AGRP Juan [AGR' t_l
 [TNSP t_k [VP t_j t_i e]]]]]]

All the maximal projections that intervene between the moved clitic and its trace are L-marked, thus making it possible for the clitic to antecedent-govern its trace. VP becomes L-marked as a result of V-movement to TNS and TNSP becomes L-marked as a result of [[V]+TNS]-movement to AGR, while AGRP becomes L-marked subsequent to movement of the [[[V]+TNS]+AGR] complex to C. AGRP also becomes L-marked as a result of clitic-movement to C. I would like to point out, however, that an alternative analysis where the clitic moves to AGR first and then moves to C along with the verbal complex is not to be excluded; or, at least, I

have no reasons to exclude it at the moment.

4.3.4.4. Subject clitics

Subject clitics are problematic for the assumption that clitics are head categories in an obvious sense. If subject clitics were head categories which attach to the verbal complex via a syntactic process of head-movement, as we have been assuming for object clitics, then we would be dealing with an unusual process which involves movement of an element from a Spec position to a head position. Using the French example in (66a) below for illustration the structure that results from the process of subject cliticisation is as in (66b) :

- (66) a. Elle mangera les pommes
She eat-will-3s the apples
"She will eat the apples."
- b. [CP [AGRP t_i [AGR' cl_i+[[[mang-]j+er]_{k+a}] [TNSP t_k
[VP t_j les pommes]]]]]

The process is unusual when seen in the light of the extensive discussion in Baker (1985) of the fact that incorporation of subjects into the verb seems to be unattested in natural languages. The apparent counterexamples turn out to be, after investigation, subjects of unaccusative verbs, that is subjects that are D-structure objects. Baker argues that this fact follows from the ECP since the process would involve a lowering movement. The trace of the moved subject would not be m-commanded, therefore not antecedent-governed, by the moved head.

Notice, however, that subject clitics, given their peripheral nature, attach to the verbal complex and not just to the bare verb. In different terms, subject clitics incorporate into AGR (I in the orthodox structure) which does m-command the Spec of AGRP, the canonical subject position, thus implying that no ECP violation is involved since the moved clitic in

AGR does antecedent-govern its trace in the Spec of AGRP. Despite the fact that the movement satisfies the ECP the fact that it involves movement of an element from a Spec position to a head position looks as if it is in violation of some version of the Structure Preserving Hypothesis.

One could assume, instead, that subject clitics are AGR elements which function as licensers for null subjects, an assumption that has been made by Sportiche (1983) for Standard French (SF), Roberge (1986a)&(1986b) for Colloquial French (CF), Jaeggli (1984), Rizzi (1986), among others, for the northern Italian dialects. This assumption, in a sense, puts subject clitics on a par with overt/rich AGR in null subject languages. That the assumption is probably correct is suggested by the fact that in some languages the subject clitic can be doubled by a non-clitic nominal phrase :

- (67) a. Jean il part (CF : Roberge (1986b))
 Jean he leaves
 "Jean leaves."
 b. El Mario el magna (Trentino : Rizzi (1986a))
 the Mario he eats
 "Mario eats."
 c. Le ragazze le vengano (Fiorentino : Roberge (ibid))
 the girls they come
 "The girls come."

In SF, however, doubling is not allowed, unless a pause is made between the doubling nominal phrase subject and the clitic in which case the nominal phrase is clearly a topicalised/dislocated element occupying a peripheral position⁸ :

- (68) a. *Jean il mange
 Jean he eats
 b. Jean, il mange
 "Jean, he eats."

In addition to this fact Rizzi (ibid) remarks that subject clitics in SF and in the northern Italian dialects behave differently in a number of other crucial respects. For example, while the subject clitic and a nominal phrase subject are in complementary distribution in SF their cooccurrence in the northern Italian dialects is generally obligatory :

- (69) El Gianni *(el) magna (Trentino)
 the Gianni he eats

Another difference which shows that the cooccurring subject in the northern Italian dialects is not in a peripheral position is illustrated by the following examples where the nominal phrase subject is quantified :

- (70) a. Gnun l'a dit gnent (Torinese)
 nobody he has said anything
 b. Nessuno l'ha detto nulla (Fiorentino)
 nobody he has said anything
- (71) a. Personne n'a rien dit (SF)
 nobody hasn't said anything
 b. *Personne, il n'a rien dit (SF)
 nobody he hasn't said anything

(71b) shows that a quantified subject is generally excluded from the position of topicalised elements. The well-formedness of the examples in (70) suggests that the cooccurring nominal phrase subjects in the northern Italian dialects are not topicalised elements, unlike their counterparts in SF.

In order to account for the discrepancy in behaviour observed above Rizzi argues that subject clitics in SF and in the northern Italian dialects differ in categorial nature as well as in structural position. In SF the subject clitic is base-generated in the subject position as a full argument which later cliticises to the verbal complex at PF, while in the northern Italian dialects the subject clitic is base-generated under I (AGR in the

present context). From this perspective the northern Italian dialects, and presumably CF as well, are null subject languages in practically the same way that Standard Italian is, the only difference in this respect being that in the northern Italian dialects the spelling out of AGR in the form of a clitic is obligatory⁹.

The ultimate conclusion that Rizzi (ibid) draws from this study is that "the very notion 'subject clitic' ... turns out to define a spurious syntactic class; still the notion appears to be linguistically significant elsewhere, in that it seems to define a genuine class in the PF component." If this conclusion, together with the analysis outlined above, is correct then subject clitics do not offer any major problem to the analysis suggested here for object clitics which treats them as head categories that attach to their hosts via a syntactic process of head-movement.

4.4. Clitic- and P- climbing and the ECP

4.4.1. Discussion

Unlike Italian, and like French, Berber does not allow clitic-climbing of the type illustrated by the example in (34a) above repeated here along with its ill-formed Berber counterpart :

- (72) a. Gianni li vuole vedere
Gianni them-wants to-see
"Gianni wants to see them."
b. *y-tush-tn ad- y-zar
3ms-wants-them to 3ms-see
"He wants to see them."

Recall that Kayne accounts for (72a) on the basis of the assumption expressed in (35). Because Italian is a pro-drop language its infinitival I is capable of L-marking the VP it theta-governs, thus making it possible for the clitic to escape out of the embedded VP. French, on the other hand, is

not a pro-drop language and therefore the clitic in the equivalent construction is incapable of escaping out of the embedded VP, hence the ill-formedness of (34b). Notice, however, that given that Berber is a robust pro-drop language Kayne's analysis predicts that (72b) above should be well-formed, a false prediction, obviously.

While I agree with Kayne that (72b) and (34b) are instances of an ECP violation I wish to disagree with him on the assumption that it is the embedded VP that is responsible for this violation. I will argue that the ECP violation involved in (72b) and (34b) is the result of crossing a non-L-marked IP/AGRP/TNSP together with the CP immediately dominating it. The well-formedness of the Italian restructuring construction in (34a) is due to the fact that the IP/AGRP is L-marked as a result of V-movement to C (see 4.4.4. below), a process that is lacking in similar French constructions. The ultimate consequence of the analysis is that clitic-climbing can be accounted for without having resort to the assumption in (35), which, given the Berber example in (72b) above, is untenable anyway.

Having said that, let us see in detail how (72b) involves a violation of the ECP in the sense intended above. The S-structure underlying the sentence is as follows :

(73) ...cl_i... [CP C [TNSP ad+[y+[zra]j]_k [AGRP t_k [VP t_j t_i]]]]

Although VP and AGRP cease to be barriers subsequent to movement of the verb to AGR, and the resulting complex to TNS, TNSP remains a barrier because it is not L-marked, C being empty. CP, though L-marked, inherits barrierhood from TNSP and, consequently, movement of the clitic across both of them gives rise to an ECP violation, hence the ill-formedness of the sentence. Notice, however, that the ECP violation in question would be

avoided if the clitic move through the embedded C, especially in view of the conclusion reached earlier that clitics can function as L-markers. As a consequence of movement to C TNSP would cease to be a barrier, being L-marked by the now lexical C, and CP would not inherit barrierhood from it.

In order to maintain the otherwise attractive analysis just suggested we have to make movement of the clitic through C an unlawful step. We need not resort to an extra principle, however, to be able to exclude movement of the clitic through C. The illegitimacy of the movement follows from the HOC whose existence, needless to say, is independently needed. Recall that head-movement, unlike movement of phrasal categories, is crucially an adjunction movement whereby a head category is adjoined to another head category which can be empty as is the case with C in the example in (72b)/(73). Once the adjunction has taken place the resulting complex becomes opaque to extraction processes because of the HOC. The complex as a whole can move but not any of its constituent parts. Given that it is only the clitic, and not the complex [cl+[C]], which is assumed to climb to the matrix clause, movement of the clitic through C would necessarily involve a HOC violation because the clitic would have to be extracted out of the [C cl+[C]] complex and moved further up. Assuming this analysis is correct movement of the clitic either directly or through C would always result in the violation of either the ECP or the HOC, hence the ill-formedness of (72b).

Given the HOC, which, I would like to point out again, Kayne also assumes in his paper, though in a different form, along with the assumption that all head-movement processes are necessarily adjunction processes, Kayne's conclusion that the clitic moves through I and C on its way up to the matrix clause implies that what ends up in the matrix clause

verbs in Italian allow clitic-climbing (e.g. unlike volere "want" odiare "hate" does not allow clitic-climbing (76a&b)) Kayne proposes that there are two necessary conditions ((77a&b)) for clitic-climbing to be able to operate:

(76) a. *Mario lo odia leggere
Mario it-hate-3s to-read
"Mario hates to read it."

b. Mario odia leggerlo
Mario hate-3s to-read-it

(77) a. The infinitival I must be able to L-mark VP
b. The matrix V must be compatible with clitic-climbing

Condition (77a) is met by all constructions in Italian since Italian is a null subject language. Condition (77b), however, is met by only a specific class of verbs. The ill-formedness of (76a) is therefore to be attributed to a failure to meet condition (77b). Odiare, unlike volere, does not belong to the class of verbs which are compatible with clitic-climbing.

In French the impossibility of clitic-climbing is attributed to a failure to meet condition (77a) since French is not a null subject language. As to condition (77b) it is difficult to tell whether there are verbs in French which can satisfy it because the general impossibility of clitic-climbing can always be attributed to a failure to meet condition (77a). In different terms, there seems to be no way one can know whether there are verbs in French which are compatible, or incompatible, for that matter, with clitic-climbing if clitics are incapable of minimally escaping out of the embedded VP.

I have already demonstrated that the principle upon which condition (77a) is based is untenable as well as unnecessary. We must therefore substitute it with the condition that requires that all the intervening barriers be voided. The latter, however, would simply be a restatement of the content of the ECP and, therefore, is redundant. As to condition (77b) I will argue below that it should be revised to mean that the matrix verb

should be compatible with restructuring, that is the process which involves movement of the embedded verbal complex to the embedded C position and on which clitic-climbing depends crucially.

4.4.2. Clitic-climbing in causatives

Berber does, however, allow clitic-climbing as well as P-climbing in causative constructions as illustrated by the examples below. Berber has what are known in the literature as morphological causatives where the causative verb is a prefix ss- which appears attached to the causativised verb :

- (78) a. t-ss-shsha acsum i-Hemmu sg-tghenjajt
 3fs-cause-eat meat to-Hemmu with-spoon
 "She made Hemmu eat meat with the spoon."
- b. t-ss-shshi-t i-Hemmu sg-tghenjajt
 3fs-cause-eat-it to-Hemmu with-spoon
 "She made Hemmu eat it with the spoon."
- c. t-ss-shsh-as acsum sg-tghenjajt
 3fs-cause-eat-him meat with-spoon
 "She made him eat meat with the spoon."
- d. t-ss-shsha acsum i-Hemmu sg-as
 3fs-cause-eat meat to-Hemmu with-it
 "She made Hemmu eat the meat with it."
- (79) a. t-tush ad-t t-ss-shsh i-Hemmu sg-tghenjajt
 3fs-want to-it 3fs-cause-eat to-Hemmu with-spoon
 "She wants to make Hemmu eat it with the spoon."
- b. t-tush ad-as t-ss-shsh acsum sg-tghenjajt
 3ms-want to-him 3fs-cause-eat meat with-spoon
 "She wants to make him eat meat with the spoon."
- c. t-tush ad-sg-as t-ss-shsh acsum i-Hemmu
 3fs-want to-with-it 3fs-cause-eat meat to-Hemmu
 "She wants to make Hemmu eat meat with it."
- (80) a. ur-t t-ss-shsh i-Hemmu sg-tghenjajt
 NEG-it 3fs-cause-eat to-Hemmu with-spoon
 "She did not make Hemmu eat it with the spoon."
- b. ur-as t-ss-shsh acsum sg-tghenjajt
 NEG-him 3fs-cause-eat meat with-spoon
 "She did not make him eat meat with the spoon."

c. **ur-sg-as t-ss-shsh acsum i-Hemmu**
 NEG-with-it 3fs-cause-eat meat to-Hemmu
 "She did not make Hemmu eat meat with it."

(81) a. **u ay-t y-ss-shsh-n i-Hemmu sg-tghenjajt?**
 who wh-comp-it n-cause-eat-n to-Hemmu with-spoon
 "Who made Hemmu eat it with the spoon?"

b. **u ay-as y-ss-shsh-n acsum sg-tghenjajt?**
 who wh-comp-him n-cause-eat-n meat with-spoon
 "Who made him eat meat with the spoon."

c. **u ay-sg-as y-ss-shsh-n acsum i-Hemmu?**
 who wh-comp-with-it n-cause-eat-n meat to-Hemmu
 "Who made Hemmu eat meat with it ?"

(78a) is an example of a causative construction in Berber which involves causativisation of a transitive verb. In (78b) the accusative clitic, which is the D-structure object of the embedded verb, is attached to the verbal complex in the matrix clause. In (78c) the dative clitic, which is the subject of the embedded clause, is attached to the verbal complex. In the examples in (79) the accusative and dative clitics , as well as the prepositional complex, are attached to the TNS element of the matrix clause. The examples in (80) and (81) are instances where the same accusative and dative clitics as well as the prepositional complex are attached to, respectively, the NEG element and the wh-comp of the matrix clause.

Assuming that causative constructions in Berber have a biclausal structure, as we will see shortly, the sentences above are examples of clitic/P-climbing since they involve movement of a clitic or a prepositional complex from the embedded clause to the matrix clause. In this respect Berber resembles French where clitic-climbing is also allowed in causative constructions despite the fact that it is not allowed in constructions such as (34b). Unlike Berber, French has non-morphological causatives where the causative verb is a complete word that is phonologically independent of the causativised verb :

- (82) a. Jean a fait manger la viande à Marie
Jean has caused to-eat the meat to Marie
"Jean made Marie eat the meat."
- b. Jean l'a fait manger à Marie
Jean it has caused to-eat to Marie
"Jean made Marie eat it."

The accusative clitic in (82b) is the D-structure object of the embedded verb. Its appearance on the matrix verbal complex implies a climbing process which involves movement of the clitic from its D-structure position to the matrix clause.

Given the typological difference between Berber and French the fact that both languages allow clitic-climbing in causative constructions but not in other constructions implies that causative constructions must have similar underlying properties in both languages despite the apparent differences. Later I will propose a unified analysis for causative constructions in Berber and the Romance languages which is based on the conclusions reached in chapter 2 of this work and which reduces the differences between the two to a trivial morphophonological property of the causative verb.

Notice, finally, with respect to the causative constructions above that the fact that causative constructions allow clitic- and P- climbing implies that the movement does not give rise to an ECP violation. Given the conclusions reached earlier this movement presumably applies directly. Our next task is to see how the clitic and the prepositional complex, which, recall, we have been assuming are head categories, move from the embedded clause to the matrix clause in one swoop without causing an ECP violation. In order to be able to do that, however, let us first examine the properties of the structure of causative constructions in Romance and in Berber.

4.4.3. The structure of causative constructions

4.4.3.1. Romance causatives

As was pointed out above with respect to French the causative verb in the Romance languages (faire in French, fare in Italian, hacer in Spanish ...etc) is phonologically a complete word in the sense that it defines a stress domain by itself independently of the causativised verb. Moreover, it inflects separately for tense and agreement. The following are illustrative examples from French, Italian and Spanish, respectively :

- (83) a. Je ferai écrire une lettre à mon ami
I cause-will to-write a letter to my friend
"I will make my friend write a letter."
- b. Maria a fatto riparare la macchina a Gianni
Maria has caused to-repair the car to Gianni
"Mari made Gianni repair the car."
- c. María hizo arreglar el coche a Juan
Maria caused to-repair the car to Juan
"Maria made Jaun repair the car."

However, despite the fact that the causative (matrix) and the causativised (embedded) verbs are two independent words they have to be adjacent to each other in linear order. They cannot, for example, be separated by the embedded subject :

- (84) a. *Je ferai mon ami écrire une lettre
I cause-will my friend to-write a letter
- b. *Maria a fatto Gianni riparare la macchina
Maria has caused Gianni to-repair the car
- c. *María hizo (a) Juan arreglar el coche
Maria caused to Juan to-repair the car

In this respect causatives in Romance differ clearly from causatives in English where the embedded subject does intervene between the causative and the causativised verbs. This is despite the fact that Romance and English causatives are both considered to be, unlike the causatives in

Berber and similar languages, non-morphological and therefore clearly biclausal.

It is important to point out, however, that the possibility of an intervening subject between the causative and the causativised verbs is allowed in the Romance languages with other arguably causative verbs such as the French laisser "to let". (85b) below is a perfectly well-formed paraphrase of the sentence in (85a) :

(85) a. Je laisserai écrire une lettre à mon ami
I let-will to-write a letter to my friend
"I will let my friend write a letter."

b. Je laisserai mon ami écrire une lettre
I let-will my friend to-write a letter

In (85a) the two verbs are adjacent to each other, while in (85b) they are separated by the embedded subject. Given this fact, whether the embedded subject can intervene between the two verbs or not seems to be determined by the nature of the causative verb. While faire requires to be adjacent to the causativised verb laisser does not. It should be clear that the difference in this particular requirement is due to a difference in the properties of the causative verbs and not to some fundamental structural differences between the two constructions.

When an intransitive verb is causativised, the embedded subject is assigned the accusative Case. This is shown in the French example in (86b) below by the fact that the subject Jean in (86a) is replaced by the accusative clitic le :

(86) a. Je ferai téléphoner Jean à Marie
I cause-will to-telephone Jean to Marie
" I will make Jean telephone Marie."

b. Je le ferai téléphoner à Marie
I him-cause-will to-telephone to Marie
"I will make him telephone Marie."

On the other hand, when a transitive verb is causativised it is the embedded object that receives the accusative while the embedded subject receives the dative. Both facts are illustrated by the Italian examples below where la macchina in example (83b) above is replaced by the accusative clitic la in (87a) below and Gianni by the dative clitic gli in (87b) :

- (87) a. Maria la fa riparare a Gianni
Maria it caused to-repair to Gianni
"Maria Gianni repair it."
b. Maria gli fa riparare la macchina
Maria him caused repair the car
"Maria made him repair the car."

Corresponding to the constructions in (83) Romance languages have another type of causative where the embedded subject appears as a by-phrase (par-phrase in French, da-phrase in Italian and por-phrase in Spanish) :

- (88) a. Je ferai écrire une lettre par Jean
I cause-will to-write a letter by Jean
b. Maria ha fatto riparare la macchina da Gianni
Maria has caused to-repaire the car by Gianni
c. Hicieron destruir la ciudad por los soldados
caused destroy the city by the soldiers

In order to distinguish these constructions from their counterparts in (83) they are referred to in the relevant literature as Faire-par causatives while those in (83) are referred as Faire-a or the Faire-I(nfinitive) causatives. Kayne (1975) (cf. Burzio (1986)) argues that the by-phrase in the Faire-par constructions has properties which are similar to those of the by-phrase usually found in passive constructions.

It should be clear that in addition to the similarities pointed out above that exist between Romance causatives there are differences as well. Among the differences between Romance languages with respect to causatives is

the fact that while it is possible to have a PP complement of the embedded verb preceding the embedded subject in Italian it is not possible in French:

- (89) a. *Faro scrivere Gianni a Maria*
cause-will to-write Gianni to Maria
"I will make Gianni write to Maria."
b. *?Faro scrivere a Maria Gianni*
cause-will to-write to Maria Gianni
c. **Je ferai écrire à Marie Jean*
I cause-will to-write to Marie Jean

The Italian example in (89b) is not perfect but still it is not as bad as its French equivalent in (89c).

These differences, however, are not likely to be the consequences of some fundamental differences between the structural properties of causatives in the languages. As we will see later these are rather marginal differences which can be accounted for in terms of some low level reordering processes.

Romance causatives have received a great deal of attention from a number of linguists among them Kayne (1975), Rouveret and Vergnaud (1980) and Burzio (1986). The analyses suggested in these works have in common the assumption that causatives are basically biclausal with the causative verb heading the matrix VP and the causativised verb heading the embedded VP. The surface order is derived by movement processes which apply either to the whole embedded VP or simply to a sequence of its elements. These movement processes are obligatory, triggered by the causative verb which is assumed to be lexically marked as a "triggering verb".

Kayne assumes that when the embedded verb is intransitive the movement process applies to the verb alone extracting it from the

embedded VP and adjoining it to the matrix VP. This process accounts for the obligatory word order where the matrix and the embedded verbs are adjacent. On the other hand, when the embedded verb is intransitive the movement process applies to the sequence V+NP (the V' projection within an analysis which assumes that the indirect object is outside the domain of the single-bar projection which dominates the verb and its direct object : [vp [v' V NP] PP]) only, thus leaving the indirect object behind. This assumption makes it possible to account for, among other things, the word order facts displayed by the French examples such as (86a) above.

Burzio (1986), however, argues against Kayne's V+NP movement analysis on theoretical as well as empirical grounds. In a restricted theory of movement that allows movement only of either a maximal projection or a head category Kayne's analysis is obviously untenable. The empirical reason is the fact that in Italian it is possible for the embedded indirect object to precede the embedded subject, a fact that is illustrated by example (89b) above. With respect to this particular sentence it has to be assumed, it seems, that the whole embedded VP moves and not just the sequence that consists of the verb and its direct object.

Burzio discusses a number of other problems with Kayne's analysis some of which are pointed out by Kayne himself. One such problem is the fact that non-indirect object PPs cliticise easily :

- (90) a. Cella y fait penser tout le monde
this about-it cause to-think all the people
"This makes everybody think about it."
b. On essaiera d'en faire parler ton ami
we try-will to-about-it cause to-talk your friend
"We will try to make your friend talk about it."

These examples cast considerable doubt on the assumption that the indirect object does not move along with the verb. On the basis of these facts and

others that he discusses, Burzio concludes that what moves is always the VP and that the unpredicted orders attested are the result of some low level reordering processes. The moved VP is daughter-adjoined to the matrix VP.

The analysis suggested by Rouveret and Vergnaud (*ibid*) differs in that the moved VP is adjoined to the embedded clause (S). They also suggest a slightly different mechanism of Case-assignment. The alternative analysis that I will suggest below has an eclectic nature in that it borrows from the works discussed above as well as from Zubizarreta (1985) and Baker (1985). For the moment let us see how the properties of Berber causatives compare with those of the Romance languages.

4.4.3.2. Berber causatives

It was pointed out above that the Berber causative verb differs from its Romance counterparts in that the Berber causative verb is a prefix which appears attached to the causativised verb. Berber causatives also differ in that not all transitive verbs can be causativised :

(91) a. *ss-wkt-n tawwart i-Hemmu
cause-hit-3p door to-Hemmu
"They made Hemmu hit the door."

b. *ss-zri-n afighar i-Munat
cause-see-3p snake to-Munat
"They made Munat see the snake."

The transitive verbs that can be causativised, in fact, form a rather limited class. They are mostly verbs which have to do with 'eating' and 'drinking', that is 'ingestion' verbs. Given this fact the generalisation that one can make with respect to the possibility of causativisation in Berber is that, generally, only intransitive verbs can be causativised (see Guerssel (1985) for a detailed study of causativisation in Berber).

Guerssel (ibid), however, demonstrates that not all apparently intransitive verbs can be causativised, either. There is a class of apparently intransitive verbs which systematically resist causativisation. The following are some examples :

- (92) a. t-arzm tewwart
3ms-open door
"The door is open."
b. *ss-arzm-n tawwart
cause-opened-3p door
"They caused the door to open."
- (93) a. y-wda uhamosh
3ms-fell boy
"The boy fell."
b. *ss-wda-n ahamosh
cause-fell-3p boy
"They caused the boy to fall."

Guerssel demonstrates that these verbs are in actual fact unaccusative in nature, that is they are verbs whose S-structure subjects are D-structure objects. In view of this fact the generalisation that only intransitive verbs can be causativised in Berber can be maintained since unaccusative verbs are transitive in the sense that they subcategorise an object¹¹.

Putting aside these differences casuatives in Berber display a range of significant similarities with the Romance causatives. For example, as in Romance when an intransitive verb is causativised the embedded subject is assigned the accusative Case. This is demonstrated in the examples below by the fact that Hemmu in (94a) does not bear a dative marker, and also by the fact that it can be replaced by the accusative clitic (94b) but not by the dative clitic (94c) :

- (94) a. ss-idf-n Hemmu
cause-entered-3p Hemmu
"They made Hemmu enter."

- b. *ss-idfi-n-t*
 cause-entered-3p-him
 "They made him enter."
- c. **ss-idf-n-as*
 cause-entered-3p-him
 "They made him enter."

As in Romance also when a transitive verb is causativised it is the embedded object that is assigned the accusative while the embedded subject is assigned the dative. These facts are illustrated by the examples in (78), among others. In (78a) the embedded subject Hemmu bears the dative marker, while in (78c) it is replaced by the dative clitic attached to the verbal complex. That the embedded direct object acsum is assigned accusative is shown by the fact that it is replaced by an accusative clitic in (78b) attached to the verbal complex.

As in Italian a PP complement of the embedded verb can precede the embedded subject in surface linear order :

- (95) *?ss-shsh-n acsum sg-tghenjajt i-Hemmu*
 cause-ate-3p meat with-spoon to-Hemmu
 "They made Hemmu eat meat with the spoon."

The sentence is not perfect but it is not bad either. The parallelism with the Italian example in (89b) in this respect is rather striking.

As has already been pointed out the observed similarities are quite significant in the sense that they suggest that the underlying structural properties of causative constructions and the mechanisms involved in deriving the surface orders are probably the same in Berber and the Romance languages. The fact that Berber and the Romance languages are genetically and typologically different suggests further, in the light of the similarities pointed out above, that the syntax of causative constructions is probably fundamentally the same in all languages (cf. Baker (1985) for further arguments). The surface differences may turn out to be the result

of some idiosyncratic properties of the lexical items involved, in particular the causative verb.

4.4.3.3. A unified account

The crucial questions with respect to the structure of causatives are, first, whether causatives are all biclausal, and, second, whether the embedded clause is a full clause or simply a reduced, perhaps small (cf. Manzini (1983)), clause. The structure that we will assign to causative constructions below is based on the conclusions reached in the first chapter with respect to the sentential structure.

Starting with Romance causatives we notice that the embedded (causativised) verb is in the infinitive form. Given the conclusions reached in the first chapter with respect to infinitival clauses in SVO languages this fact implies that the embedded clause in Romance causatives has the D-structure in (96) below where the AGR node is lacking and where the embedded subject is base-generated in the Spec position of VP :

(96) ...V [CP C [TNSP -er [VP Spec [V' V (DP) (PP)]]]]

The verb moves up to TNS obligatorily to attach to the infinitive marker occupying it, and from there, I will assume, moves further up to C. Movement to C would account for the fact pointed out earlier and illustrated by the examples in (83) and (84) that the causative verb and the causativised verb are always adjacent despite the fact that each of them is phonologically independent of the other. By having the embedded verb in C we capture both facts¹².

When the embedded verb is transitive its trace assigns accusative to the direct object in its D-structure position, hence the fact that when the causativised (embedded) verb is transitive its object is assigned the

accusative. The subject, however, remains without a potential Case-assigner since AGR is lacking. Notice that the situation here is similar to the one in passive constructions discussed in chapter 2 where the subject remains without a Case-assigner and as a result is realised as an adjunct by-phrase, possibly via a movement process which removes it from the Spec position of VP and right-adjoins it to VP or to some other projection. It is only natural to conclude that this is exactly what takes place in the Faire-par causatives, especially in view of the fact pointed out above that the by-phrases in the Faire-par causatives behave similarly to the by-phrases in the passive constructions.

With respect to the Faire-a causatives the situation is not very different once we assume, along with Zubizarreta (1985) and others, that the dative preposition which appears immediately preceding the embedded subject does not hold a base-generated P position but is simply inserted to serve as a Case-assigner for the stranded subject. Notice, however, that P-insertion cannot be assumed to apply to the embedded subject in its D-structure position since the resulting surface order would be different from the attested order where the subject follows the complements instead of preceding them. It seems that in this case also the subject is moved to another postposed position where the process of P-insertion can apply. In order to account for why the P-insertion process does not apply to the subject in its D-structure position one may assume a certain restriction on the process of P-insertion whereby it can only apply to nominal phrases in certain specific contexts, e.g. peripheral positions.

When the embedded subject is realised as a clitic, however, the latter satisfies the Case requirement by cliticising to a head, given the assumption made in the previous chapter (cf. Baker (1985)) that incorporated elements are either exempt from the Case requirement or that

they satisfy it by incorporating into another head. Later we will examine the cliticisation process in relation to the ECP.

Let us now turn to the constructions where the embedded verb is intransitive. Recall that in this case the embedded subject is assigned the accusative. I will assume that this accusative Case is (structurally) assigned to the subject, after the latter has moved to the Spec of TNSP, under government by the moved verb in C despite the fact that the latter is an intransitive verb. Accordingly, the question that immediately leaps to mind is why should the same process not apply in constructions with transitive verbs where instead the subject is realised either as a *by-* or a *to-* phrase. The answer to this question lies precisely in the fact that in one case the verb is transitive and in the other it is intransitive. When the verb is transitive the Case of the verb is necessarily assigned to its object through the trace. Assuming that a chain can assign at most one Case the subject cannot receive another accusative Case from the head of the (V, t) chain in C. When the verb is intransitive, however, there is no direct object that would require Case in addition to the subject. The subject is therefore assigned structural accusative under government by the verb in C.

Turning now to Berber I will assume that the only difference between the Berber causatives and the Romance causatives is that the embedded verb in Berber causatives does not remain in C but moves further up to the matrix V occupied by the causative verb¹³. The motivation for this further step is obviously the fact that the causative verb in Berber is affixal which is not the case with the causative verb in Romance. Assuming that the Berber causative verb is specified so that it can only attach to a verbal category to satisfy its morphological subcategorisation frame, movement of the verb from C to the matrix V is the only possibility

available. The mechanism of Case-assignment, however, is practically the same except that in the Berber constructions with intransitive verbs the embedded subject is assigned accusative under government by the trace of V in C instead of V itself. Alternatively, the subject can be assumed to move to the Spec of CP where it becomes accessible to government by the matrix verb.

Before I move on to discuss an alternative analysis of causatives a word must be said about the structure of the embedded clause in Berber causatives. Given the conclusions reached in chapter 2 with respect to sentential structure in VSO languages the structure in (96) cannot be extended to Berber since in Berber TNS implies AGR whereas it is clear from the data above that the embedded verb is not inflected for AGR separately from the causative verb. Given that the AGR element follows the causative prefix in relation to the embedded verb it follows that the AGR element belongs to the matrix and not to the embedded clause. If the embedded clause does not have an AGR node the implication is that it does not have a TNS node either. Evidence for this conclusion derives from the fact that in constructions such as those in (79) above there is only one TNS element which given its position with respect to the verbal complex, must be concluded to belong to the matrix clause.

Notice, however, that despite the fact that the embedded verb carries neither a TNS nor an AGR element it does carry an ASP element, a fact that is easily discernable from the presence of the vowels given the conclusions reached in chapter 2. Recall that verbal roots in Berber consist of only consonant clusters and that the vowels, which are the means through which the aspectual information is channelled, belong to the ASP node. The surface forms, remember, are the result of a mapping process which maps the consonantal root onto the vocalic tiers which form the ASP morphemes.

Assuming this analysis to be correct the only change that needs to be effected in the structure in (96) to account for the Berber causatives is to change TNSP to ASPP :

(97) ...V [CP C [ASPP ASP [vp Spec [v' V (DP) (PP)]]]]

Movement of the verb to ASP is obligatory for the same reason that movement of the verb to TNS in (96) is obligatory. Note that unlike TNS the presence of ASP does not necessarily imply the presence of AGR since ASP does not select AGRP.

The alternative analysis that I would like to discuss briefly is basically the one proposed in Ouhalla (1988b) where the embedded clause is assumed to undergo CP-reduction and the subject to move to the matrix V in both Romance languages and Berber. The analysis is based, partly, on the distinction made in Zubizarreta (1985) between morphophonological affixes and morphosyntactic affixes. The causative verb in Berber is assumed to be affixal both morphophonologically and morphosyntactically, thus accounting for the fact that it cannot define a stress domain by itself. Romance causative verbs, however, are affixal only morphosyntactically, thus accounting for the fact that they do define a stress domain separately from the causativised verb. Both types of affixes, however, are assumed to be subject to the AP. Assuming that these affixes can only satisfy the AP if they attach to a verbal category, the obligatory nature of the movement of the embedded verb to the matrix V becomes only natural. Evidence that the Romance causative verb does behave like an affix is discussed in Zubizarreta (1985), though from a different perspective.

This analysis is obviously not radically different from the one discussed above. However, it has a number of advantages which when considered seriously appear to favour it over the preceding one. The most

general of these advantages is the fact that it reduces the difference between causatives in Romance and in Berber further than the previous analysis does. Viewed from the perspective of the alternative analysis Romance and Berber causatives differ merely in the fact that while the causative verb in Romance is affixal only morphosyntactically the causative verb in Berber is affixal both morphosyntactically and morphophonologically.

By assuming the Romance causative verb to be affixal in nature an explanation for the ill-formedness of the examples in (84) in terms of a violation of the AP becomes readily available. In the previous analysis no explanation is given for these examples since no reason was given for why the embedded verb should move obligatorily to C so that the two verbs are adjacent. In the alternative analysis the ill-formedness of the examples in (84) is treated as parallel to the ill-formedness of the following examples from Berber where the embedded subject intervenes between the two verbs of the causative construction :

- (98) a. *t-ss- [Hemmu (y-)adf]
 3fs-caused- Hemmu 3ms-enter
 "She made Hemmu enter."
 b. *t-ss- [Hemmu (y-)shsha acsum sg-tghenjajt]
 3fs-caused- Hemmu 3ms-eat meat with-spoon
 "She made Hemmu eat meat with the spoon."

These are constructions where the embedded verb fails to raise to attach to the matrix V, thus causing the matrix causative verb to fail to satisfy the AP¹⁴.

Another fact can be accounted for by assuming the causative verb faire to be affixal, namely, the difference discussed earlier between it and laisser with regard to the possibility of allowing the embedded subject to intervene between the two verbs in the causative construction. Recall that

laisser differs from faire in that laisser does not require to be adjacent to the embedded verb. This can be accounted for either by assuming that laisser, unlike faire, is not affixal and therefore is not subject to the AP, or that it is affixal only optionally and therefore may or may not be subject to the AP, hence examples (85a&b).

In terms of the technicalities of the movement involved in causatives and the mechanisms of Case-assignment the alternative analysis also seems to have some advantages. By eliminating the C position we avoid the assumption whereby, in Berber causatives, what moves to the matrix V is a complex which also includes an empty C [_C C+[ASP+[V]]]. We expressed our doubts earlier in this chapter about a similar assumption implicit in Kayne's analysis of clitic-climbing in terms of a stepwise process which goes through C.

As to Case-assignment, by eliminating the CP projection we make it possible for the embedded subject in constructions with intransitive verbs to receive the accusative from the matrix clause instead of from the embedded verb, an assumption that in a way is undermined by the fact that the verb in question is intransitive. Within the alternative analysis the Case-assigner of the subject in the Spec position of ASPP can be assumed to be the verbal complex that is derived as a result of the affixation of the embedded verb to the matrix verb. In order to avoid a similar process taking place in constructions with transitive verbs where the embedded subject, recall, is assigned Case by an inserted dative preposition, we can put a condition on the Case-assignment capability of the derived verb to the effect that for it to be able to assign Case none of the two constituents of the derived verb should be a Case-assigner. Notice that this proposal still maintains the intuitive idea that what makes the difference with respect to the nature of the Case assigned to the embedded

subject is whether the embedded verb is transitive or intransitive.

A further advantage that the alternative analysis has is that by assuming the causative verb in Romance to be affixal we can provide a formal explanation for the otherwise mysterious lexical property associated with it, namely, the "triggering" property. In the analyses discussed above the causative verb is assumed to be specified as a triggering verb in order to account for the obligatoriness of the movement processes which take place in causative constructions and which have the effect of rearranging the order of the elements so that the two verbs are always adjacent. Within the context of the alternative analysis the triggering nature of the causative verb is nothing other than its morphological subcategorisation frame, it being affixal. The causative verb triggers movement simply because its morphological subcategorisation frame requires it to be attached to a verbal category.

Despite the fact that the alternative analysis, that is the analysis where the causative verb in Romance is assumed to be affixal and the embedded clause to undergo CP-reduction, has some significant advantages I will leave the question of choosing between the two analyses open, the main concern of this chapter being what it is about causative constructions that makes it possible for a clitic to climb up from the embedded clause to the matrix clause without giving rise to an ECP violation, an issue to which we turn immediately.

4.4.3.4 Clitic- and P- climbing in causatives

It should be obvious from the discussion above what is the property of causatives that makes it possible for the clitic to move to the matrix clause in one swoop. It is the movement of the verbal complex to TNS/ASP and then to C or to the matrix V depending on which analysis one chooses to

adopt. By virtue of this movement all the intervening maximal projections that are potential barriers become L-marked, thus allowing the clitic to move to the matrix clause in one swoop without causing an ECP violation.

The moved clitic can either be the subject of the embedded clause as in the Berber examples in (78c) and (94b) and the Italian example in (87b), or the direct object of the embedded verb as in the Berber example in (78b) and the French example in (82b), or the object of a P as in the French examples (90a&b), or still a prepositional complex as in the Berber example in (79c). The D-structures underlying all three possibilities are given here, ignoring the fact that the head immediately dominating the embedded VP is an ASP in Berber and a TNS in Romance :

- (99) a. ...V ([CP C] [TNSP TNS [VP cl [v' V (DP) (PP)]]](I))
 b. ...V ([CP C] [TNSP TNS [VP Spec [v' V cl (PP)]]](I))
 c. ...V ([CP C] [TNSP TNS [VP Spec [v' V DP [pp cl]]](I))

In (99a) the clitic is the subject of the embedded clause sitting in its D-structure position in the Spec of VP. From that position it moves up to the matrix clause. The effect that the process of V-movement to TNS/ASP and [TNS/ASP[+V]]-movement to C or to the matrix V has is to clear the path between the moved clitic and its trace so that antecedent-government holds in satisfaction of the ECP. In (99b) it is the direct object of the embedded verb that cliticises up, while in (99c) it is the complement of a null P or the prepositional complex that moves up to the matrix clause. In these constructions the same scenario takes place as in (99a), hence the fact that they are well-formed.

The conclusion that clitic-climbing in causative constructions is possible because of the movement process of the verbal complex that they involve receives significant support from examples such as the following from

Spanish and French, respectively¹⁵ :

- (100) a. *La hice examinar al doctor*
her caused-1s to-examine the doctor
"I made the doctor examine her."
b. **La hice al doctor examinar*
her caused-1s the doctor to-examine
c. *Hice al doctor examinarla*
caused-1s the doctor to-examine-her
- (101) a. *Jean l'a laissé écrire à Marie*
Jean it-has let to-write to Marie
"Jean let Marie write it."
b. **Jean l'a laissé (à) Marie écrire*
Jean it-has let to Marie to-write
c. *Jean a laissé Marie l'écrire*
Jean has let Marie it-to-write

In (100a) movement of the verbal complex has applied as indicated by the fact that the embedded verbal complex precedes the embedded subject in linear order. Clitic-climbing is therefore possible and the sentence is well-formed. In (100b), however, movement of the verbal complex has not applied, as indicated by the fact that the embedded verbal complex follows the embedded subject in linear order. Clitic-climbing is therefore not possible, hence the ill-formedness of the construction. When movement of the verbal complex to C or to the matrix V fails to take place, the clitic can only attach to the embedded verbal complex as illustrated by (100c).

The French examples in (101) convey the same conclusion. The causative verb in these examples is laisser which we assumed above allows movement of the verbal complex optionally because of its nature as a non-affix or as an optional affix. In (101a) clitic-climbing is possible because movement of the verbal complex has taken place, while in (101b) clitic-climbing is not possible because movement of the verbal complex to C or to the matrix V has failed to take place. In this case the clitic has to attach to the verbal complex in the embedded clause as in (101c).

It is clear from the discussion above that clitic-climbing seems to be contingent upon the movement of the verbal complex as a means to clear its path of all potential barriers that would block antecedent-government of the trace by the moved clitic. If this conclusion is correct then the Italian restructuring constructions illustrated by (34a) above which also allow clitic-climbing must involve a similar process. We turn to this issue immediately^{16,17}.

4.4.4. Italian perestroika

4.4.4.1. Restructuring constructions

Rizzi (1982) (see also Burzio (1986)) demonstrates that the so-called restructuring constructions in Italian behave exceptionally in at least three major respects. One has to do with the fact demonstrated above that they allow clitic-climbing (102a) and the other two have to do with the fact that they allow preposing of the embedded object (103a) and that they select the auxiliary essere (104a) :

- (102) a. Mario lo vuole leggere (cf. (34a))
 Mario it-wants to-read
 "Mario wants to read it."
 b. *Mario lo odia leggere
 Mario it-hates to-read
 "Mario hates to read it."
- (103) a. Questi libri si volevano proprio leggere
 these books SI wanted really to-read
 "We really wanted to read these books."
 b. *Questi libri si odiavano proprio leggere
 these books SI hated really to-read
 "We really hated to read these books."
- (104) a. Mario sarebbe proprio voluto andare a casa
 Mario would be really wanted to-go home
 "Mario would have really wanted to go home."
 b. *Mario sarebbe proprio odiato andare a casa
 Mario would be really hated to-go home
 "Mario would have really hated to-go home."

The contrast between the restructuring constructions in (a) and the normal constructions in (b) illustrates clearly the exceptionality of behaviour that restructuring constructions exhibit.

In order to account for the clustering of these properties Rizzi (ibid) proposes that these constructions undergo a "restructuring rule...which optionally reanalyses a terminal string V (P) V as a single verbal complex, hence automatically transforming the underlying bisentential structure into a simple sentence." (p.5). The effect that this restructuring process has, Rizzi argues, is to create a matrix VP which looks like the following :

(105) VP
 V
 V (Comp) V

where the intervening Comp node is included to accommodate constructions such as (106) below where a wh-word intervenes between the matrix and the embedded verbs :

(106) Non ti saprei che dire
 NEG you-would know what to-say
 "You would not know what to say."

What this example illustrates clearly is the fact that the embedded clause in restructuring constructions must be a full CP clause.

Burzio (ibid), on the other hand, tries to assimilate restructuring constructions to causatives by assuming that, like causatives, restructuring constructions also undergo an (optional) process of VP-movement to the matrix clause. This movement has the effect of turning a normal biclausal structure into the following structure :

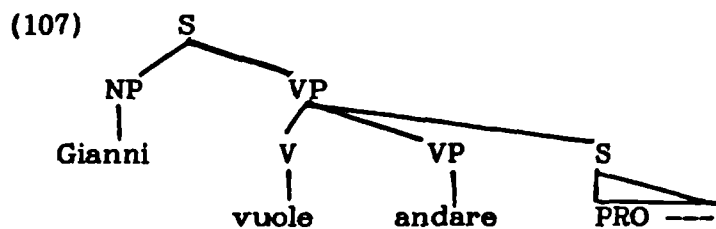

where the moved embedded VP is daughter-adjoined to the matrix VP. The PRO under the embedded S node is the subject of the embedded clause which is controlled by the matrix subject. Note, incidentally, that virtually all restructuring constructions are either control or raising constructions, a fact that we will come back to later. Note also that Burzio's attempt to assimilate restructuring constructions to causatives contrasts sharply with Rizzi's insistence that the two constructions exhibit different properties.

4.4.4.2. Restructuring as movement

It is clear that neither Rizzi's nor Burzio's analysis can be accommodated within the more restricted theoretical framework adopted in this work, which does not allow the structures that the processes assumed to take place give rise to. I would like to suggest here an analysis for the restructuring constructions in terms of a simple movement process similar to the one suggested for causatives above. This analysis will allow us to account not only for the process of clitic-climbing but also for the process of object-preposing illustrated above.

Notice that, as in causative constructions, the embedded verb in restructuring constructions is in the infinitive form, thus implying that the embedded clause is an infinitival clause with a structure that lacks an AGR node. This conclusion along with the fact pointed out above that a wh-word can intervene between the matrix and the embedded verbs, implying that the embedded clause is a full CP clause, predicts that the D-structure of restructuring constructions is as follows :

(108) ...V [CP (wh-) [C' C [TNSP TNS [VP Spec [v' V (DP)]]]]]

The verb moves up to TNS obligatorily to attach to the affixal infinitive marker occupying it. From the TNS position, I will assume, the verb moves further up to C, the movement being optional given the optionality of restructuring. Notice that the possibilities that the embedded verb moves further up to the matrix V or that CP undergoes deletion, as we assumed above for causative constructions, are immediately excluded by the fact that a wh-word can intervene between the two verbs, a possibility that is excluded in causatives.

The latter fact can be understood as further evidence that the alternative analysis for causatives discussed above, that is the analysis where the embedded clause undergoes CP-reduction, is probably the correct one since the first analysis predicts that a wh-word can intervene between the two verbs since the Spec position of CP remains free. Assuming the alternative analysis of causatives to be the correct one the analysis presented here for restructuring constructions accommodates the otherwise conflicting views of Rizzi and Burzio in that the proposed analysis implies that restructuring constructions are both similar to and different from causative constructions. The similarity lies in the assumption that both constructions undergo a movement process of the verbal complex, and the difference lies in the assumption that while the verbal complex in restructuring constructions moves only as far as C, in causatives it moves further up to the matrix V, in addition to the assumption that causatives undergo CP-reduction while restructuring constructions don't.

Note that the structure in (108) above accounts for the fact that some restructuring constructions are control constructions. Assuming the controlled category to be PRO the latter can be assumed either to remain in its D-structure position in the Spec of VP or to move to the Spec of TNSP.

In both positions it is protected from government from the matrix clause by VP, TNSP and CP together in the first case, and by TNSP and CP together in the second case. The fact that some restructuring constructions are also raising constructions is accounted for below. In this respect the presence of CP might look as if it is going to cause some problem.

4.4.4.3. Clitic-climbing

Given the analysis suggested above it should be obvious why clitic-climbing is possible in restructuring constructions. Using example (102a) for illustration the S-structure of a restructuring construction looks like the following, irrelevant details omitted :

(109) Mario *lo* vuole [CP [[legge-]_k+re]_j [TNSP *t_j* [VP *t_k* *t_i*]]]

The verb moves up to TNS and then to C as explained above. As a result all the maximal projections that intervene between the initial position of the clitic and its S-structure position become L-marked, thus allowing for antecedent-government to hold between the clitic and its trace. Accordingly, what we have to explain now is why constructions such as (102b) do not allow clitic-climbing. We also have to explain why French does not allow clitic-climbing even in constructions such as (102a).

With respect to Italian constructions such as (102b) an obvious explanation would be that unlike constructions such as (102a) they do not allow (optionally) for a process which moves the verbal complex to C (restructuring) so that TNSP remains a barrier along with CP which would then inherit barrierhood from it. The crossing of these two maximal projections together by the clitic would always give rise to an ECP violation, hence the impossibility of clitic-climbing. This explanation, however, begs another obvious question, namely why constructions such as

(102b) do not undergo movement of the verbal complex to C, restructuring, that is. In different terms, what prevents the embedded verbal complex in these constructions from moving up to C given the implicitly assumed structural similarity between them and the restructuring constructions? It seems to me that at this stage no adequate answer to this rather intriguing question can be properly formulated. I therefore leave the issue open¹⁸.

An alternative explanation would be to assume that constructions such as (102b), like the restructuring constructions, also undergo (optionally) movement of the verbal complex to C and that the impossibility of clitic-climbing follows from some other reason. This reason could be condition (77b) above which, remember, was suggested by Kayne (1987) to account for precisely the problem we are facing now. Notice that by suggesting condition (77b) Kayne in a sense rejects the analyses where a structural difference (restructuring) between the two constructions is deemed responsible for the possibility or impossibility of clitic-climbing. Clitic-climbing, according to Kayne, is not possible in (76a) and (102b) not because these constructions fail to undergo restructuring but simply because their matrix verb odiare "hate", unlike the matrix verb volere "want" in (34a) and (102a), is not compatible with clitic-climbing.

However, given that clitic-climbing is only one example of the cluster of properties, pointed out above, which distinguish restructuring constructions from their non-restructuring counterparts Kayne's proposal would amount to the claim that the verb odiare is also incompatible with the process of object-preposing. The fact that both clitic-climbing and object-preposing are movement processes implies, as far as I can see, that the difference between the two types of constructions must have to do with the ECP, in the sense that these processes are not possible in non-restructuring constructions because these constructions contain some

barriers which block the movement of these elements. If this is correct then the analysis suggested above in terms of the movement of the verbal complex to C (restructuring) is to be favoured over the analysis suggested by Kayne in terms of the notion of (in)compatibility. I will content myself with this conclusion while emphasizing that there is at least one crucial question that remains unanswered, namely what prevents movement of the verbal complex from applying in non-restructuring constructions.

That clitic-climbing is crucially dependent on restructuring in the sense explained above receives significant support from examples such as the following where the presence of the auxiliary essere is indicative of the fact that restructuring has applied (cf. Burzio (1986)):

- (110) a. Mario sarebbe proprio voluto andarci
 Mario would be really wanted to-go-there
 "Mario would have really wanted to go there."
 b. Mario ci sarebbe proprio voluto andare
 Mario there would be really wanted to-go
- (111) a. Mario avrebbe proprio voluto andarci
 Mario would have really wanted to-go-there
 b. *Mario ci avrebbe proprio voluto andare
 Mario there would have really wanted to-go

A comparison of (110a&b) with (111a&b) shows that clitic-climbing is optional when the auxiliary is essere but impossible when the auxiliary is avere. Assuming, as suggested above that the presence of the auxiliary implies that the construction in question is a restructuring construction, the ill-formedness of (111b) follows in a straightforward manner. Clitic-climbing in (111b) violates the ECP because the clitic crosses a non-L-marked TNSP and a CP together. The conclusion that clitic-climbing is contingent upon movement of the verbal complex to C is consequently vindicated.

Like Kayne's analysis the analysis suggested here also accounts for why a filled C should block clitic-climbing (cf. (39a)), but for a different

reason. In Kayne's analysis a filled C blocks clitic-climbing because the latter process is assumed to operate through C. In the present context a filled C blocks clitic-climbing only indirectly. In more precise terms, it is not really clitic-climbing that a filled C blocks but movement of the verbal complex to C. But because clitic-climbing depends crucially on the movement of the verbal complex to C for reasons explained above it fails to apply successfully in constructions where movement of the verbal complex to C fails to take place¹⁹.

Examples (74a&b) remain problematic for both analyses, nevertheless. Notice that in the present context both examples have to be assumed to undergo the same movement process of the verbal complex to C, for otherwise they would necessarily involve an ECP violation and, consequently, they would wrongly be predicted to be ill-formed. A possible explanation would be to assume that unlike the complementizer in (39a) the complementizers in (74a&b) are optionally morphosyntactically affixal, just like the Romance causative verb (faire and its equivalents) discussed above, while the complementizer in (39a) is not. If this assumption is valid then, although these complementizers fill the C position, movement of the verbal complex to it would not be blocked. On the contrary, the movement would be required to take place by the AP so that the affixal complementizers can have their morphological subcategorisation frame satisfied^{20,21}.

The question as to why clitic-climbing should not be allowed in the French counterparts of (34a) and (102a) also receives a similar answer. The French counterparts of the Italian restructuring constructions do not undergo movement of the verbal complex to C. This explanation is in a sense similar to the one provided by Kayne (ibid) who, recall, assumes that in French the clitic cannot escape out of the embedded infinitival VP

because the French I is not an L-marker. The possibility that VP would be voided as a result of V-movement to I is excluded by the assumption, which Kayne argues is arrived at independently by Emonds (1978) and Pollock (1987), that the infinitival V in French does not raise to I.

In his analysis, Kayne assumes the orthodox structure where the infinitive marker is base-generated attached to the verb inside VP. VP in this analysis corresponds to TNSP in the present analysis since the infinitive marker is assumed to be a TNS element. So, if Kayne's assumption is transferred to the present context it would mean that the infinitival verbal complex in French does not raise out of TNSP to, inevitably, C. In the present context what this assumption amounts to is simply the claim that these French constructions do not undergo restructuring in the sense understood in the present work. But here again the crucial question of what prevents restructuring from applying in these constructions remains unanswered.

Notice, finally, that among the consequences the analysis suggested above has is that it treats French examples such as (34b) as being parallel to the Italian non-restructuring constructions, a fairly plausible and desirable consequence, I believe, in view of the fact that they both disallow clitic-climbing. This consequence, however, fails to be captured by Kayne's analysis because the latter makes a crucial distinction between French and Italian in terms of condition (77a) combined with assumption (35). Clitic-climbing is disallowed in Italian non-restructuring constructions, in Kayne's system, for a reason that is different from the reason why the same process is disallowed in the French constructions such as (34b). In the present analysis, however, the reason behind the failure of clitic-climbing to apply successfully in both types of constructions is the same, namely the absence of restructuring.

Further support for the analysis suggested here for the process of restructuring comes from the fact that it allows for a natural analysis of the possibility of object-preposing in restructuring constructions and its impossibility in non-restructuring constructions.

4.4.4.4. Object-preposing

Given that object-preposing is a movement process which moves the embedded object to the matrix clause the reason why it can operate in restructuring constructions can immediately be attributed to the assumption that these constructions involve a movement process of the verbal complex which has the consequence of voiding all the potential barriers in the embedded clause. To see how let us consider the underlying structure of the example in (103a), irrelevant details omitted :

(112) Questi libri_i...[CP [[legge-]_j+re]_k [TNSP t_k [VP t_j t_i]]]

VP and TNSP become L-marked as a result of movement of V to TNS and of [[V]+TNS] to C. CP, on the other hand, is L-marked by the matrix verb. The moved object can therefore antecedent-govern its trace from its S-structure position.

However, this analysis runs immediately into problems with the Minimality Condition. Being a non-clitic/head the movement of the object in question is supposed to be sensitive to Minimality barriers. If this is the case then at least the embedded VP would be a barrier and antecedent-government would obviously fail to hold, thus wrongly predicting the construction to be ill-formed. So, we either have to assume that what moves in these constructions is also a head category, or assume, along with Ouhalla (in preparation)), that, like movement of head categories, movement of non-wh-phrases is also not sensitive to Minimality barriers.

The first option is not likely to be correct for obvious reasons. The second option, however, merits some consideration.

Consider the following simple passive and raising constructions :

(113) a. John was hit

b. [AGRP John_i [AGR' was_j [TNSP t_j [VP Spec [v' hit t_i]]]]]

(114) a. John seems to be happy

b. [AGRP John_i [AGR' seems_j [TNSP t_j [VP t_j [TNSP to [VP t_i [v' be happy]]]]]]]

Assuming that the option of adjoining to WP and TNSP is not available to non-wh-phrases (cf. Chomsky (1986b)) the moved nominal phrase in (113) is separated from its trace in the object position of V by at least one Minimality barrier. In (114) the moved nominal phrase is also separated from its trace by at least one Minimality barrier. If we assume, however, that like head categories non-wh-phrases are not sensitive to Minimality barriers then the passive and raising constructions above cease to be problematic. Notice that in both structures above no movement barriers exist between the moved phrase and its trace. In (113) VP and TNSP become L-marked subsequent to movement of the verb to TNS and of the complex that results from this movement to AGR. In (114) the embedded VP is L-marked by to, while the embedded TNSP is L-marked by the matrix verb. The matrix VP and TNSP, on the other hand, become L-marked as a result of the movement of the verbal complex in the familiar way.

If the assumption that non-wh-phrases are not sensitive to Minimality barriers is correct as seems to be necessary from the passive and raising constructions above (see Ouhalla (in preparation)) for more arguments) then the process of object-preposing in Italian restructuring constructions ceases to be problematic with respect to the ECP since it also involves movement of a non-wh-phrase²².

The assumption that non-wh-phrases are not sensitive to Minimality barriers would also allow us to account for the fact mentioned earlier that some of the restructuring constructions are also raising constructions. It was also briefly mentioned that the assumption that the embedded clause in restructuring construction is a CP might prove problematic for this particular case given the standard assumption that raising verbs generally induce CP-reduction on their clausal complements. However, when the structure that results from the various movement processes that take place is considered carefully no problem relating to the ECP is found to be involved despite the fact that the embedded clause maintains its CP projection.

Consider in this respect the raising construction in (115a) below and its S-structure in (115b) :

- (115) a. Giovanni dovrebbe prendere il libro
 Giovanni would have to-fetch the book
- b. $Giovanni_i$ dovrebbe [CP [[prende-]_j+rel]_k [TNSP t_k
 [vp t_i [v' t_j il libro]]]]

None of the maximal projections in the embedded clause is a barrier, for reasons that should be familiar. CP, on the other hand, is L-marked by the matrix verb. Notice, however, that both TNSP and CP would be barriers if the movement process of the verbal complex to C is not assumed to take place. TNSP would not be L-marked and CP would inherit barrierhood from it. Assuming the moved phrase not to be sensitive to Minimality barriers the ECP is satisfied by the structure in (115b). It should be clear therefore that the fact that restructuring constructions can also be raising constructions is entirely predictable within the present context.

4.5. Against the HMC

The conclusion that clitics and the prepositional complex, which we have argued are head categories, move to their S-structure positions, either in the same clause or in the upstairs clause, in one swoop is in flagrant conflict with the HMC which puts severe locality restrictions on head-movement processes in general. If our conclusion is correct, as I have tried to demonstrate in most parts of this chapter, then the HMC must be incorrect even if it is understood simply as a descriptive statement which bears on the nature of head-movement processes in general. I wish to argue here that while the HMC is correct with respect to some head-movement processes, the ones that gave rise to its formulation, it is not so with respect to some other head-movement processes.

Chomsky (1986b) (cf. Baker (1985)) argues that the HMC is not likely to be an independent principle of UG because its effects can be derived from the ECP. In the English sentences below, for example, movement of the verb directly to C crosses the VP barrier :

(116) a. *Where be John AGR?

b. [CP Where [C' be_i [IP John [I' AGR [VP t_i]]]]]

The only way the VP barrier in this case (in fact generally) can be voided is by V-movement to I prior to movement to C, I being the theta-governor of VP. A two-step movement process in a construction like (116) yields a well-formed construction as shown in (117) below :

(117) a. Where is John?

b. [CP Where [C' is_i [IP John [I' t_i [VP t_i]]]]]

It is clear that any process of V-movement to a higher position that does not go through I is bound to give rise to an ECP violation. In this sense

the role played by the HMC is redundant. The same conclusion would be reached in a framework which assumes a more articulated structure of the inflectional elements such as the one suggested in this work.

Chomsky's conclusion that the effects of the HMC can be derived from the ECP combined with the conclusion reached here that the HMC makes false predictions with respect to at least some head-movement processes apparently sound in conflict unless a revision of the ECP is undertaken. However, a close look at the facts reveals that the two conclusions are not in conflict and that no revision of the ECP is required. That no revision of the ECP is required to account for long clitic/P-movement is obvious from the discussions above. The source of the apparent conflict, I believe, lies with the false assumption, expressed by the HMC, that all head-movement processes should pattern like movement of the verbal complex.

The discussion in Chomsky (ibid) that led to the formulation of the HMC is mainly centered around the process of V-movement to I and to C. We saw above, however, that the strictly local nature of V-movement follows from the fact that the only way the VP barrier can be voided for the elements contained inside VP, including the verb itself, is by V-movement to the inflectional head that immediately dominates it. The possibility that the VP barrier could be voided by some other process so that the verb can move directly to C without having to pass through the inflectional head that immediately dominates it is never available for obvious theoretical reasons. However, with respect to the clitic and the prepositional complex the VP barrier, as well as all the other intervening barriers, as we saw above, are voided by the concomitant movement process of the verbal complex.

There is a clear sense then in which the HMC is correct only as far as the movement processes of the verb and the inflectional heads are concerned. The assumption that all head-movement processes should pattern

like the movement processes of the verbal complex is therefore wrong. The correct assumption, and in fact the only one needed, is the one made by the ECP, namely that any category, regardless of whether it is a maximal projection or a head category, can move any distance as long as the movement does not give rise to an ECP violation. Insofar as clitics and the prepositional complex can move long distance without causing an ECP violation the process is warranted.

In addition to Barriers the HMC also appears in Travis (1984) and in Baker (1985), though in these works the HMC is formulated slightly differently. Again, Travis formulates the condition on the basis of a discussion largely dominated by the movement processes of the verb and the inflectional heads in the Germanic languages. Movement of these categories is so restricted for the reasons discussed above. Baker, however, extends the condition to account for incorporation phenomena, e.g. incorporation of a noun into its governing verb in noun-incorporation constructions, incorporation of a preposition into its governing verb in applicative constructions and so on. In these cases, however, there is no a priori theoretical reason to assume that movement of these incorporated elements should be as restricted as the movement of the verb and the inflectional heads. If our reasoning is correct then we should expect that if a language that allows noun and preposition -incorporation has a mechanism whereby the immediate VP barrier can be voided (e.g. V-movement) then the incorporating elements should be able to incorporate into (i.e. move directly to) positions higher than the verb position.

That this is probably the case is suggested by the representative applicative construction in (118b) below from the Bantu language Kinyarwanda discussed in Baker (ibid) :

(118) a. umwaana y-a-taa-ye igitabo mu maazi
child SP-past-throw-asp book in water
"The child has thrown the book into the water."

b. umwaana y-a-taa-ye-mo amaazi igitabo
child SP-past-throw-asp-appl water book
"The child has thrown the book into the water."

(118b) is the applicative counterpart of (118a) where the preposition mu/o is attached to the verbal complex. The attachment/incorporation is the result of a head-movement process which moves the preposition from its D-structure position inside the PP complement of V and adjoins it to the verbal complex.

Notice, however, that the preposition appears at the periphery of the verbal complex which includes, in addition to the verb, such elements as TNS and ASP which in the orthodox analyses of the sentential structure are standardly associated with the I node, and in the present work are given full categorial status in the sense of X-bar theory. Given the generalisation made by the MP, which, incidently, plays a crucial role in Baker's system, the order of the elements which constitute the verbal complex in (118b) seems to suggest that the applicative preposition must have adjoined to the verb after the latter has moved up to the inflectional heads. In different terms, the applicative preposition does not incorporate into the verb but into the top inflectional head in the clause. This process is clearly in violation of the HMC since the latter requires the preposition to attach first to the verb since the verb is the L-marker of the PP which dominates the applicative preposition. The order of the elements predicted is one where the applicative preposition precedes the inflectional elements, a false prediction obviously, given that the order attested is a different one as illustrated by the example in (118b) above.

The noun-incorporation constructions, however, do seem generally to conform to the restriction imposed by the HMC. In the following examples

from Iroquoian also discussed in Baker (ibid) the incorporated noun appears inside the domain of the inflectional elements :

(119) a. watesyvts hra-nuhs-nuhwe?-s
doctor 3ms-house-like-perf
"The doctor liked the house."

b. i?i ye-k-kar- hrek-s
I 1l-1sS-bark-push-perf
"I push the bark."

Clearly, it cannot be assumed with respect to these examples that the noun incorporates into the verbal complex and not just into the bare verb because if this were the case we would expect the incorporated noun to appear at the periphery of the verbal complex as is the case with the applicative preposition in the applicative construction above. Given the MP it must be assumed that the noun incorporates into the verb prior to the latter's movement up to the inflectional heads, a process that is consistent with the restrictions imposed by the HMC.

We need not, however, appeal to the HMC to account for the fact that the noun incorporates into V but not into any of the inflectional heads, despite the fact that the analysis proposed in this work predicts that the noun can incorporate directly into any of the inflectional heads without giving rise to an ECP violation given the movement of the verb involved. A plausible account can be formulated in terms of the morphological subcategorisation frame of the incorporated nouns. The latter can be assumed to be specified so that they can only attach to V, excluding the inflectional, and possibly other, heads. From this it would follow that any order of the elements that constitute the verbal complex which differs from the attested order in that it allows for an inflectional element to intervene between the verb and the incorporated noun, would necessarily involve a violation of the morphological subcategorisation frame of the incorporated noun and, consequently, of the AP.

Notice that the morphological subcategorisation specifications suggested above are needed quite independently of what is being discussed at the moment. They are required for a number of reasons discussed during the course of this work. They are also required in order to exclude incorporation processes which are possible in principle but are not attested in some languages. For example, in a language which allows noun-incorporation but not preposition-incorporation the suggested morphological subcategorisation specifications are required to rule out instances of preposition-incorporation. Viewed from this angle the fact that the process of noun-incorporation exemplified by the Iroquoian examples conforms to the HMC does not follow from the ECP at all but rather from the morphological requirement of the incorporated noun. As far as the ECP is concerned the noun might as well incorporate into any of the inflectional heads since the intervening barriers are presumably all voided by movement of the verbal complex to the inflectional heads.

In summary, I have tried to demonstrate that it is desirable to eliminate the HMC not only because its effects with respect to some head-movement processes are derivable from the ECP but, more crucially, because it makes false predictions with respect to some other head-movement processes. The only condition on head-movement processes needed is the condition on movement processes in general, i.e. the ECP. By showing that clitics as well as the prepositional complex, which we have established as head categories, can move long distance without giving rise to an ECP violation, and by showing that they can do so only if no ECP violation is involved, we have in fact provided significant evidence not only against the HMC but also in favour of the ECP and the definition of "barrier" as formulated in Chomsky (1986b) and adopted in this work.

Finally, by showing that movement of clitics is governed by the ECP we

have provided equally significant evidence that clitic-placement is essentially a syntactic process governed by the same principles which govern movement processes in general. Any theory of clitic-placement that adopts a non-movement analysis or a PF cliticisation analysis faces the prospect of failing to account for what seems to be a basic property of clitic-placement phenomena.

4.6. Conclusion

In this chapter I have tried to outline an analysis of clitic-placement in Berber and the Romance languages and of preposition-movement in Berber which assumes clitics to be head categories with an affixal nature. This assumption is based on the general fact that clitics invariably attach to head categories as well as the fact, peculiar to Berber, that clitics pattern in their distribution with the prepositional complex which consists of a preposition and a clitic complement attached to it and which we established as a complex head category.

Movement of the clitic in Berber and the Romance languages, as well as movement of the prepositional complex in Berber, to inflectional heads inside the clause have been shown to operate directly in violation of the HMC. The conclusion is reached on the basis of the generalisation made by the MP and the order of elements which constitute the verbal complex. The peripheral nature of clitics is argued clearly to imply that the clitic moves to its S-structure position directly and not stepwise as suggested by Kayne (1987).

Clitic-climbing is also shown to operate directly despite its long nature. This process is attested in causative constructions in Berber and the Romance languages and in the Italian restructuring constructions. To demonstrate how and why the process of clitic-climbing can apply in these

particular constructions analyses of causatives and restructuring constructions have been proposed and discussed.

Two alternative analyses have been proposed for causatives in Berber and the Romance languages both of which try to minimize the structural differences between the causative constructions in the two languages given the similarities that their surface forms exhibit. Both analyses, for example, assume that all causative constructions, whether they are morphological or not, are essentially biclausal in nature. The differences between the two analyses are the following. The first assumes that the embedded clause retains its CP projection and that the embedded causativised verb in Romance moves up to C while in Berber it moves further up to the matrix clause because the causative verb in Berber is a prefix which appears attached to the causativised verb, while in the Romance languages the causative verb is apparently not affixal since it defines a stress domain separately from the causativised verb.

The second analysis assumes that the embedded clause undergoes CP-reduction and that in Both Berber and the Romance languages the embedded causativised verb moves up to the matrix V and attaches to the causative verb occupying it. The Romance causative verb is assumed to be, like the Berber causative verb, affixal in nature. In order to account for the fact that while the Romance causative verb defines a stress domain by itself while its Berber counterpart does not, a distinction, suggested originally in Zubizarreta (1985), is introduced between morphophonological and morphosyntactic affixes. The Berber causative verb is affixal both morphophonologically and morphosyntactically while its Romance counterpart is affixal only morphosyntactically. Both types of affixes, however, are subject to the AP, hence the obligatory nature of the movement which accounts for the fact that in Romance the causative and the causativised

verbs must be adjacent.

It has been demonstrated that it is because causative constructions involve the movement process of the verbal complex to either C or the matrix V that clitics or the prepositional complex can move directly to the matrix clause without giving rise to an ECP violation.

An analysis along similar lines has been suggested for the Italian restructuring constructions. The fact that a wh-phrase can intervene between the matrix and the embedded verbs in these constructions has been taken to imply that the embedded clause is a CP. The embedded verbal complex moves to the C position thereby clearing the path for the moved clitic in the matrix clause to antecedent-govern its trace in the embedded clause. The effect that the movement of the verbal complex to C has is that the intervening maximal projections become L-marked, thus making it possible for the clitic to move in one swoop without causing an ECP violation. This movement process has been argued to be lacking in the Italian non-restructuring constructions as well as in French. A tentative analysis of subject-raising and object-preposing has been suggested which assumes, crucially, that non-wh-phrases are not sensitive to Minimality barriers, an assumption that has been instrumental in the analysis of clitic-climbing as well.

Footnotes

1. I am referring here to the dative argument clitic as object-of-verb simply to draw a parallel between it and the accusative argument clitic with respect to movement. Recall that we concluded in the previous chapter that dative arguments are underlying PPs headed by a null P. We will see later that the dative argument clitic differs from clitics which are objects of overt prepositions with respect to the possibility of cliticisation to higher positions.

2. When both an accusative and a dative clitic are present in a clause the dative clitic precedes the accusative clitic :

- (i) a. y-ush-as-t
3ms-gave-her-it
"He gave it to her."
- b. *y-ush-t-as
3ms-gave-it-her
- (ii) a. y-tush ad-as-t y-ush
3ms-want to-her-it 3ms-give
"He wants to give it to her."
- b. *y-tush ad-t-as y-ush
3ms-want to-her-it 3ms-give

The rigidity in the order of clitic arguments contrasts sharply with the relatively free order of the corresponding non-clitic arguments :

- (iii) a. y-ush aslm i-Munat
3ms-gave fish to-Munat
"He gave the fish to Munat."
- b. y-sha i-Munat aslm
3ms-gave to-Munat fish
"He gave Munat the fish."

Notice that when the dative argument precedes the accusative argument it does not lose its dative marker. In other words, the examples in (iii) are not likely to be instances of dative shift constructions parallel to the

English construction in the glosses.

3. The discussion of object-of-N clitics here is restricted to possessor clitics to the exclusion of patient and theme object-of-N clitics. The latter, recall, are to be found in constructions with action nouns discussed in the previous chapter.

4. One might ask what happens when the possessive clitic moves in constructions with KNs. The prediction that the general analysis developed in this work makes is that the movement must result in ill-formedness since the KN would be left without a suitable category to satisfy its morphological subcategorisation frame. That the prediction is correct is shown by the following examples :

- (i) a. *wkth-n-as um-
hit-3p-his brother
"They hit his brother."
- b. *tush-n ad-as wkth-n um-
want-3p to-his hit-3p brother
"They want to hit his brother."
- c. *u ay-as y-wkth-n um-?
who wh-comp-his n-hit-n brother
"Who hit his brother?"

The well-formed versions of these sentences are the following where the moved clitic is doubled by an identical clitic attached to the KN :

- (ii) a. wkth-n-as um-as
hit-3p-his brother-his
- b. tush-n ad-as wkth-n um-as
want-3p to-his hit-3p brother-his
- c. u ay-as y-wkth-n um-as ?
who wh-comp-his n-hit-n brother-his

This type of clitic-doubling is distinct from the well-known type of clitic-doubling (Jaeggli (1981), Aoun (1979)& 1981), Borer (1984), Ouhalla

(1987a), among others) illustrated by the following examples from Spanish and Berber, respectively :

- (iii) a. **Lo vimos a Juan** (Jaeggli (1981))
him saw-we to Juan
"We saw Juan."
b. **y-sh-as alsm i-Munat**
3ms-gace-her fish to-Munat
"He gave the fish to Munat."

The doubling in the examples in (ii) involves the doubling of a clitic by another clitic whereas the doubling illustrated by the examples in (iii) involves the doubling of a non-clitic argument by a clitic, or, rather, the other way round as we will see later.

There are at least two possible ways the doubling phenomenon in (ii) can be explained. One is to assume that the D-structure clitic cliticises up to higher positions and that a copy of it is inserted to help the KN satisfy the AP. The other possible explanation is to assume, along with Ouhalla (in preparation), that when the clitic moves, it leaves behind another (identical) clitic as trace. Within the analysis developed in Ouhalla (ibid) this suggestion would put clitic-movement on a par with other movement processes which are assumed to leave behind any category, null or overt, as trace and that it is general principles of UG which determine what categories can function as traces in which contexts.

This suggestion is consistent with the fact that even with non-KNs doubling is possible. The following are perfectly well-formed paraphrases of the sentences in (14) and (15) in the main text :

- (iv) a. **u ay-as y-arzm-n tawwart in-as sg-tghenjajt?**
who wh-comp-his n-open-n door of-his with-spoon
"Who opened his door with the spoon?"
b. **ur-as arzm-n tawwart in-as sg-tghenjajt**
NEG-his opened-3p door of-his with-spoon
"They did not open his door with the spoon."

- c. tush-n ad-as arzm-n tawwart in-as sg-tghenjajt
 want-3p to-his open-3p door of-his with-spoon
 "They want to open his door with the spoon."
- d. arzm-n-as tawwart in-as sg-tghenjajt
 opened-3p-his door of-his with-spoon
 "They opened his door with the spoon."

However, given that the genitival preposition in- is, like KNs, affixal in nature the appearance of the doubling clitic in these constructions can be argued to be motivated by the same reason which motivates the appearance of the doubling clitic in constructions with KNs, the latter being also affixal.

With respect to the phenomenon of standard clitic-doubling illustrated by the examples in (iii) above the non-clitic arguments must be assumed to hold non-argument positions given the analysis developed in this work which assigns clitics full argumental status. Viewed as such it is the non-clitic argument that doubles the clitic instead of the other way round. In this respect I depart radically from the view expressed in Ouhalla (1986c), (1987a) and (1988c) which assumes that clitics do not have an argument status and that they are simply object agreement elements which serve the function of identifying a pro occupying the subcategorised argument position.

5. Further evidence for the assumption that clitics are head categories comes from the fact pointed out earlier in the previous footnote that possessor clitics leave behind a copy of themselves when they move to higher positions. Baker (1983) and (1985) discusses a number of cases of noun-incorporation where the noun leaves a copy of itself in its D-structure position after it has moved. Assuming, along with Baker, that noun-incorporation is a process which moves a head noun category and attaches it to the verb the similarity noticed here implies that clitics, like

incorporated nouns, are also head categories which incorporate into their hosts via a process of head-movement.

As a matter of fact the treatment of clitics suggested here and in Kayne (1987) is in many ways similar to the treatment of the Italian clitic ne in Belletti and Rizzi (1981). Belletti and Rizzi argue that the clitic ne is a non-phrasal nominal element which heads the nominal phrase that contains the quantifier. They argue further that the process of ne-cliticisation to the verb is a syntactic movement process which leaves behind a trace just like the rest of the movement processes that fall under the range of Move-alpha. The fact that ne-cliticisation exhibits the subject-object asymmetry (complements of the verb, but not subjects, can undergo ne-cliticisation) reflects the fact pointed out and discussed extensively by Baker (1985) that generally noun-incorporation is possible only from the complement position. Baker argues that the fact that subjects generally do not incorporate is a consequence of the ECP (see 4.3.4.4. below).

6. Being pronominal the clitic can be assumed to be a D element rather than a N head of the NP complement of D as in the structure in (40). Both Hudson (1987) and Abney (1988) have argued that pronouns are D elements.

7. The French, Italian and Spanish data that are cited here are drawn mainly from the references cited and discussed. Therefore, any examples that are not acknowledged in the relevant places are herein acknowledged.

8. Roberge (1986) cites Carroll (1982) as arguing that subject doubling is possible in SF as well in complex inversion constructions of the following type :

- (i) Marie_i veut-elle_j voir Pierre?
 Marie wants-she to-see Pierre
 "Does Marie want to see Pierre?"

In order to show that the subject Marie is occupying the canonical subject position and not a peripheral position Roberge cites examples such as (iia&b) below :

- (ii) a. Qui Marie_i veut-elle_j voir?
 who Marie wants-she to-see
 "Who does Marie want to see ?"
- b. Marie_i, qui veut-elle_j voir?
 Marie who wants-she to-see
 "Marie, who does she want to see ?"

where (iia) shows that the doubled subject is not in a peripheral position since it follows the wh-word in linear order. In order to have a dislocation reading the subject has to move to a position that precedes the wh-word and is separated from it by a pause/comma) as in (iib) .

9. Notice, however, that if complex inversion constructions of the type discussed in fn.8 above are really cases of subject doubling then they are problematic for Rizzi's analysis in an obvious way. The subject clitic in this case cannot be assumed to be base-generated in the canonical subject position because the subject position is filled by the non-clitic subject.

Related to this is another potentially problematic fact pointed out in Safir (1982) and discussed briefly in Rizzi (1986). Subject clitics in SF and in the northern Italian dialects seem to behave similarly with respect to inversion :

- (i) a. Quand a-t-il mangé? (SF)
 when has-he eaten
 "When has he eaten ?"
- b. Quando a-lo magna? (Trentino)
 when has-he eaten

Assuming, along with Kayne (1983), that inversion is the result of a leftward V(AUX)-movement process which we can understand as movement to C, and assuming that the subject clitic attaches to the nearest lexical (verbal) complex at PF the French example in (ia) receives a straightforward explanation. The Trentino example, however, does ^{not} receive an equally straightforward explanation. Assuming that (ib) is also derived by movement of the verbal complex to C there seems to be no apparent reason why inversion should take place since the clitic, being an AGR element, moves along with the verbal complex to C.

10. The empirical viability of Kayne's suggestion that the Spanish complementizer que occupies the Spec of CP instead of C is called into question by examples such as the following which involve, in addition to clitic-climbing, movement of a wh-phrase from the embedded clause :

- (i) a. Para quién lo tienes que hacer?
 for whom it-have-you that to-do
 "For whom do you have to do it?"
- b. Porque lo tienes que hacer?
 why it-have-you that to-do
 "Why do you have to do it?"

Given these examples it is difficult to imagine how movement of the wh-phrase from the embedded clause could be assumed to have operated through the Spec position of the embedded CP if the latter is assumed to be occupied by the complementizer que as Kayne suggests.

11. Guerssel (1986a) mentions another class of transitive verbs which, like ingestion verbs, also causativise. He refers to them as "motion verbs" and illustrates them with examples such as the following :

- (i) a. y-ndw waryaz ighzar
 3ms-cross man river
 "The man crossed the river."

- b. y-ndw waryaz i y-ghzar
 3ms-cross man to river
 "The man crossed the river."
- c. y-ss-ndw wma aryaz i yghzar
 3ms-cause-cross my-brother man to river
 "My brother made the man cross the river."

Guerssel demonstrates that the verbs which form this class differ from the ingestion verbs in two major respects. In simple sentences the object can either be in the accusative or in the dative as illustrated by examples (ia) and (ib), respectively. Secondly, when causativised the (embedded) subject of the motion verbs receives the accusative as illustrated by (ic) above, instead of the dative as is the case with the ingestion verbs.

As a matter of fact the classifications discussed on which is based the generalisation that only intransitive verbs can be causativised are not clear-cut. In Tarifit, at least, there exist transitive verbs which causativise and which belong to neither of the two classes, mentioned by Guerssel. The following example is drawn from Cadi (1985) :

- (ii) a. t-arbu um-as
 3ms-carry-on-back brother-her
 "She carries her brother on her back."
- b. t-ss-arbu ahnjir i-yedg-as
 3ms-cause-carry-on-back boy to-daughter-her
 "She made her daughter carry the boy on her back."

On the other hand, there are unaccusative verbs which do seem to causativise easily :

- (iii) a. t-khmed teddart
 3ms-burned house
 "The house has burnt."
- b. ss-khmd-n ixwwanen taddart
 cause-burn-3p thieves house
 "The thieves caused the house to burn/ burnt the house."

Finally, there are also non-unaccusative intransitive verbs which do not

seem to be able to causativise :

- (iv) a. y-azr Hemmu
3ms-ran Hemmu
"Hemmu ran."
b. *ss-azr-n Hemmu
cause-run-3p Hemmu
"They made Hemmu run."

It is clear that while some verbs apparently group together with respect to the (im)possibility of causativisation there are others which apparently do not seem to form any coherent class. It seems that whether a verb can causativise or not may turn out to be a matter of lexical specification.

12. Notice in this respect that although the matrix verb in (96) moves up to TNS and AGR obligatorily it still is linearly adjacent to the embedded verb, thus preserving the property that the matrix and the embedded verbs must be adjacent.

13. I am assuming here that morphological causatives are biclausal in structure just like non-morphological causatives. For arguments in support of this assumption see, among others, Marantz (1984) and Baker (1985). Some arguments with respect to Berber causatives are discussed in Lumsden & Tenny 1987).

14. Burzio (1986) attributes the ungrammaticality of the Italian example in (84b), and, presumably, its equivalents in the other Romance languages, to a failure on the part of the embedded subject to satisfy the Case requirement. While Burzio assumes that the causative verb is an ECM verb he argues that Case-assignment across the sentence boundary is contingent upon the application of the process of VP-movement, that is the matrix causative verb assigns Case to the embedded subject just in case

VP-movement has applied. This assumption would account for the general lack of ECM constructions in Italian :

- (i) a. *Giovanni ritiene [Mario esser partito]
Giovanni beleives Mario to-have left
- b. Giovanni ritiene [di aver finito]
Giovanni beleives comp to-have finished
"Giovanni beleives to have finished."

The matrix verb in (ia) cannot assign Case to the embedded subject because the VP-movement process has not applied. (ib), on the other hand, is a control construction wherein the subject is a PRO which does not require Case.

It is not clear to me why Case-assignment by the causative verb should be made contingent upon the application of VP-movement. This assumption is counterintuitive in the sense that, if anything, movement of the embedded VP to the matrix VP should be expected to prevent Case-assignment of the embedded subject by the matrix verb from taking place instead of the other way round. In its S-structure position, i.e. daughter-adjoined to the matrix VP, the moved embedded VP intervenes between the matrix verb and the embedded subject, thus destroying the adjacency that is generally necessary for Case-assignment to take place.

15. Notice that the Spanish example in (100c) is problematic for the alternative analysis of causatives discussed above which assumes the causative verb hacer requires to attach to a verbal category to satisfy its morphological subcategorisation frame, since the category that is adjacent to it in (100c) is the embedded subject. The example, however, is not problematic for the analysis which does not assume the causative verb to be affixal.

16. One of the advantages of the present analysis of clitic-climbing over the one suggested by Kayne (1987) is that it accounts for clitic-climbing in French causatives without having to resort to the assumption that the embedded clause in causatives is a VP, instead of a full clause. This assumption is crucial to Kayne's analysis in order to eliminate the presence of an I in the embedded clause that would otherwise be expected to block clitic-climbing given the assumption that I in French is an L-marker.

17. Note that the implication here is that in constructions such as (81a,b&c) the clitic moves from the embedded clause to the C position of the matrix clause. One might wonder whether this rather long movement does not involve a violation of Subjacency. However, in a theory where bounding nodes are understood in terms of barriers (cf. Chomsky (1986b)) the fact that the movement in question does not cross any barriers as I tried to demonstrate above implies that the movement does not involve any Subjacency violation.

18. One can in fact ask the reverse question, namely, Why should the verbal complex move up to C in restructuring constructions? A possible answer to this question, at least with respect to the restructuring constructions which are also control constructions, can be formulated along the lines suggested by Borer (1987) to account for control phenomena (see fn. 10 of chapter 2) .

Essentially, Borer agrees with Manzini (1983) and others (e.g. Bouchard (1984)) that control should be reduced to binding. She, however, differs in assuming that in obligatory control constructions it is not the empty category in the embedded subject position that has an anaphoric nature but the (infinitival) AGR element, the assumption being that infinitival clauses do contain an (abstract) AGR element. Being anaphoric

the AGR element has to move to the embedded C position where it becomes accessible to government from the matrix clause and, consequently, to binding by the matrix subject which is coindexed with it. The embedded subject position is filled by a pro which is identified, through binding, by the matrix subject via the AGR element in C. Borer argues further that the embedded pro subject is assigned nominative Case by a special rule which applies to subjects in the context where the verbal complex has moved to C, the rule that Rizzi (1982) originally suggested to account for AUX-to-Comp phenomena. The rule is reproduced here for reference :

(i) Assign nominative Case to NP in the context AUX/V —

Assuming Borer's analysis to be essentially correct the reason why the verbal complex has to move to C in control restructuring constructions can be attributed to the necessity to create the right context for the rule above to apply to assign Case to the subject pro, otherwise the latter would not be licensed given Rizzi (1986)'s licensing principle which makes licensing of pro dependent on Case-assignment by a designated head. Notice that this analysis would directly link restructuring constructions to Rizzi's AUX-to-Comp constructions, a desirable consequence, I believe, in the sense that it shows that the process is more general than is otherwise believed.

With respect to raising restructuring constructions we will see later that movement of the verbal complex to C in these constructions can also be made to follow from a specific reason, namely the necessity to void the AGRP/TNSP barrier. Notice that if these suggestions are correct then clitic-climbing in restructuring constructions turns out to be an only parasitical phenomenon. The verbal complex moves up to C for reasons that have nothing to do with clitic-climbing.

19. The blocking effect that a filled C has on movement of the verbal complex to C is used in Ouhalla (in preparation) to account for the that-trace effect in English and similar languages. It is argued that the presence of the complementizer that in the embedded C position blocks movement of the verbal complex to C, the process whereby the IP/AGRP barrier is voided, so that IP/AGRP remains a barrier to movement, hence the ungrammaticality. In sentences where that is missing the verbal complex is assumed to have moved to the embedded C, thus voiding the IP/AGRP barrier and consequently allowing the moved wh-phrase to antecedent-govern its initial trace in the subject position. With respect to movement out of the object position of the verb the initial trace is antecedent-governed by the intermediate trace adjoined to VP. As to the intermediate trace itself it is assumed that it deletes subsequent to the S-structure level (cf. Lasnik and Saito (1984), and Chomsky (1986b)).

The well-known fact that null subject languages do not observe the that-trace effect is accounted for by assuming, within the context of a general theory of movement which allows for any category to be left behind as trace, general principles of UG permitting, that the trace left behind by wh-movement of the subject is a pro and therefore is not subject to the ECP which is relevant to only non-pronominal empty categories. pro is subject to identification by rich AGR morphology for its licensing, hence the fact that violation of the that-trace filter is attested in null subject languages only. In languages such as English pro as a trace in the subject position is excluded by the fact that it would fail to be identified. In other words, this explanation maintains the association between rich AGR morphology and the possibility of the violation of the that-trace filter which are accounted for together in Chomsky (1981) and (1982) in terms of the pro-drop parameter.

20. Evidence for the assumption that a C filled by que in Spanish can still serve as host for a verbal complex can be drawn from the fact that VSO clauses can be embedded under que together with the assumption that VSO order in Spanish is derived by movement of the verbal complex to C :

- (i) a. Dice que dio Juan el libro a María
said-he that gave-he Juan the book to Maria
"He said that Juan gave the book to Maria."
b. Creí que ha visto Juan a María
thought-I that has seen Juan to María
"I thought that Juan has seen Maria."

The embedded clause in these sentences exhibits the order where the subject intervenes between the verbal complex and the object. This order implies that the verbal complex moves to a position that is higher than the position of the highest inflectional head in the clause which in SVO languages is, recall, AGR. The position to which the verbal complex moves can only be the C position which in the examples above is filled by the complementizer que. If, however, que is assumed to be (optionally) affixal then movement of the verbal complex to C ceases to be a problem. The movement results into a complex C which consists of the complementizer and the verbal complex.

21. Rizzi (1982) points out that some adverbs can also intervene between the matrix and the embedded verbs in the restructuring constructions as in the following examples :

- (i) a. Lo verro subito a scrivere
"I it will come at once to write —."
b. Gli stessi errori si continuano stupidamente a commetter
"The same errors si continues stupidly to do —."

It seems to me that in both examples the intervening adverb seems to modify the matrix verb rather than the embedded verb. If this is the case

then the adverb can be assumed to be base-generated adjoined to the matrix VP, and the order obtained is the consequence of the movement of the matrix verb to the matrix TNS and AGR. Notice, however, that this explanation is possible only within an analysis which assumes that the embedded verb moves only as far as the embedded C.

22. Notice that this analysis not only allows us to account for simple passive and raising constructions with minimal conceptual tools but also for the ill-formedness of the so-called super-raising constructions which are known to involve "improper movement" :

(i) a. *John_i seems [CP that [AGRP it appears [TNSP t_i to be ill]]]

b. *John_i seems[CP that [AGRP it is considered[TNSP t_i to be ill]]]

Assuming that John, being a non-wh-phrase, cannot adjoin to any of the intervening maximal projections it must be assumed to have moved directly, that is in one swoop. The most embedded TNSP is not a barrier because it is L-marked by the matrix verb. The AGRP embedded under the complementizer that, however, is a barrier because it is not L-marked, thus causing the CP that immediately dominates it to inherit barrierhood. The crossing of these two maximal projections together, therefore, results in an ECP violation, thus accounting for the impossibility of super-raising.

Bibliography

- Abney, S. (1986) "Functional Elements and Licensing", paper presented to GLOW 1986, Girona.
- Abney, S. (1987) The English Noun Phrase in its Sentential Aspect, Doctoral Dissertation, MIT, Cambridge, Mass.
- Anderson, S. (1982) "Where is Morphology", Linguistic Inquiry 13.4. 571-612.
- Anderson, S. & S. Chung (1977) "On Grammatical Relations and Clause Structure in Verb-initial Languages", in P. Cole & J. Sadock (eds.), Syntax and Semantics 8 : Grammatical Relations, Academic Press, New York.
- Aoun, J. (1979) "On Government, Case Marking and Clitic Placement", Ms., MIT, Cambridge, Mass.
- Aoun, J. (1982) The Formal Nature of Anaphoric Relations, Doctoral Dissertation, MIT, Cambridge, Mass.
- Aoun, J. (1985) A Grammar of Anaphora, MIT Press, Cambridge.
- Aoun, J. & D. Sportiche (1983) "On the Formal Theory of Government", The Linguistic Review 2, 211-236.
- Bada, A. (1987) On Complement Structure in Berber: A GB Approach, MA Dissertation, School of Oriental and African Studies, London.
- Bader, Y. & M. Kenstowicz (1984) "Syllables and Case in Kabylie Berber", Ms., Yarmouk University, Jordan, and University of Illinois, Urbana.
- Baker, M. (1983) "Noun Incorporation in Iroquian" Ms., MIT, Cambridge, Mass.
- Baker, M. (1985a) "The Mirror Principle and Morphosyntactic Explanation", Linguistic Inquiry 16, 373-417.
- Baker, M. (1985b) Incorporation : A Theory of Grammatical Function Changing, Doctoral Dissertation, MIT, Cambridge.
- Belletti, A. (1988a) "The Case of Unaccusatives", Linguistic Inquiry 19, 1-34.
- Belletti, A. (1988b) "Generalised Verb-movement. On Some Differences and Similarities Between Italian and French", Paper presented to GLOW 1988, Budapest.
- Belletti, A. & L. Rizzi (1981) "The Syntax of Ne : Some Theoretical Implications". The Linguistic Review 1, 117-154.
- Benmamoun, E. (1987) Causatives in Moroccan Arabic, MA Dissertation, University College London.
- Bentolila, F. (1981) Grammaire fonctionnelle d'un parler berbère, Ait seghrouchen d'Oum Jeniba (Maroc), SELAF, Paris.

- Bordelois, I. (1987) "Causatives : From Lexicon to Syntax", Natural Language and Linguistic Theory 6, 57-69.
- Borer, H. (1983) Parametric Syntax, Foris Publications, Dordrecht.
- Borer, H. (1986) "I-Subjects", Linguistic Inquiry 17.3.
- Borer, H. (1987) "Anaphoric AGR", Paper presented to GLOW 1987, Venice.
- Borer, H. (1988) "On the Morphological Parallelism Between Compounds and Constructs", Ms., UC Irvine.
- Borsely, R.D. (1986) "Prepositional Complementisers in Welsh", Journal of Linguistics 22, 67-84.
- Bouchard, D. (1984) On the Content of Empty Categories, Foris Publications, Dordrecht.
- Boukous, A. (1979) "Le profil sociolinguistique du Maroc, considerations methodologiques", B.E.S.M. 140.
- Brame, M. (1981) "The General Theory of Binding and Fusion", Linguistic Analysis 7.
- Brame, M. (1982) "The Head Selector Theory of Lexical Specifications and the Nonexistence of Coarse Categories", Linguistic Analysis 10.
- Bresnan, J. & J. Grimshaw (1978) "The Syntax of Free Relatives in English", Linguistic Inquiry 9, 331-391.
- Bresnan, J. & S. Mchombo (1986) "Grammatical and Anaphoric Agreement", Proceedings of the Chicago Linguistic Society 1986 meeting.
- Brody, M. (1984a) "On Contextual Definitions and the Role of Chains", Linguistic Inquiry 15, 355-380.
- Brody, M. (1984b) Conditions and NP-types, Doctoral Dissertation, University College London.
- Brody, M. (1985) "On the Complementary Distribution of Empty categories" Linguistic Inquiry 16, 505-546.
- Brody, M. (1988) "Old English Impersonals and the Theory of Grammar", Ms., University College London.
- Burzio, L. (1986) Italian Syntax : A Government-Binding Approach, Reidel, Dordrecht.
- Cadi, K. (1985) "Valence et derivation verbal en Tarifit", Awal : cahiers d'etudes berberes 1, 111-123, Maison des sciences de l'homme, Paris.
- Cadi, K. (1987) System Verbal Rifain, SELAF, Paris.
- Calabrese, A. (1987) "Focus Structure in Berber : A Comparative Analysis with Italian", in Guerssel, M. & K. Hale (eds.).

- Carroll, S. (1982) "Redoublement et dislocation en Français populaire", in C. Lefebvre (ed.) La syntaxe comparée du Français standard et populaire, Tome I: 291-357. OLF : Editeur Officiel du Québec.
- Chaker, S. (1975) "Types de syntagmes predicatifs en berbère", C.L.O.S, 5-6 (Hommage a G. Mounin), pp. 75-88.
- Chaker, S. (1978) Un parler berbère d'Algérie (Kabylie) : Syntax, Doctoral Dissertation, Université René Descartes, Paris V, Paris.
- Chaker, S. (1984) Textes en Linguistique Berbère: Introduction au domaine berbère Publications of the CNRS, Paris.
- Choe, H-S. (1987) "An SVO Analysis of VSO Languages and Parametrization : A Study of Berber" in M. Guerssel and K. Hale (eds.).
- Chomsky, N. (1970) "Remarks on Nominalisation", in R.A. Jacobs and P.S. Rosenbaum (eds.), Readings in English Transformational Grammar, Waltham, Massachusetts, Ginn.
- Chomsky, N. (1977) "On wh-movement", in P. Culicover, T. Wasow and A. Akmajian, (eds.) Formal Syntax, Academic Press, New York.
- Chomsky, N. (1980) "On Binding", Linguistic Inquiry 11, 1-46.
- Chomsky, N. (1981) Lectures on Government and Binding, Foris Publications, Dordrecht.
- Chomsky, N. (1982) Some Concepts and Consequences of the Theory of Government and Binding, MIT Press, Cambridge, Mass.
- Chomsky, N. (1986a) Knowledge of Language : Its Nature, Origin, and Use, Praeger, New York.
- Chomsky, N. (1986b) Barriers, MIT Press, Cambridge, Mass.
- Chtatou, M. (1982) Aspects of the Phonology of a Berber Dialect of the Rif, Doctoral Dissertation, School of Oriental and African Studies, London.
- Chung, S. (1982) "On Extending the Null Subject Parameter to NPs", Proceedings of the First West Coast Conference on Formal Linguistics.
- Chung, S. (1983) "The ECP and Government in Chamorro", Natural Language and Linguistic Theory, 1, 207-244.
- Chung, S. & J. McCloskey (1987) "Government, Barriers, and Small Clauses in Modern Irish", Linguistic Inquiry 18, 173-239.
- Di Sciullo, A.M. & E. Williams (1987) On the Definition of Word, MIT Press, Cambridge, Mass.
- Dixon, R.M.W. (1982) Where Have All the Adjectives Gone?, Mouton Publishers, Berlin.
- Doron. E. (1983) Verbless Predicates in Hebrew, Doctoral Dissertation, University of Texas, Austin.

- Doron, E. (1986) "The Pronominal 'Copula' as Agreement Clitic", in Borer, H. (ed.) Syntax and Semantics : The Syntax of Pronominal Clitics, Academic Press, Orlando, London.
- Emonds, J. (1976) A Transformational Approach to English SYntax, Academic Press, New York.
- Emonds, J. (1978) "The Verbal Complex V'-V in French", Linguistic Inquiry 9, 151-175.
- Ennaji, M. (1985) Contrastive Syntax : English, Moroccan Arabic and Berber Complex Sentences, Konigshausen & Neumann, Wurzburg.
- Ennaji, M. & F. Sadiqi (1986) "The Syntax of Cleft Sentences in Berber", Studies in Language 10.1., 53-77.
- Fabb, N. (1984) Syntactic Affixation, Doctoral Dissertation, MIT, Cambridge, Mass.
- Fassi Fehri, A. (1980) "Some Complement Phenomena in Arabic, the Complementizer Phrase Hypothesis and the Non-Accessibility Condition", Analyse/Theorie, University of Paris VIII Vincennes.
- Fassi Fehri, A. (1981) Linguistique arabe : forme et interpretation, Publications of the Faculty of Letters, Rabat.
- Fassi Fehri, A. (1986) "Anti-Causative in Arabic, Causativity and Affectedness" Lexicon Project Working Papers 15, Center for Cognitive Science, MIT, Cambridge.
- Fassi Fehri, A. (1987) "Generalised IP Structure, Case, Inflections, and VS Order", to appear in the proceedings of the first International Conference of the Linguistic Society of Morocco, Rabat.
- Fillmore, C. (1968) "The Case for Case", in E. Bach & R. Harms, (eds.) Universals in Linguistic Theory, Holt, Reinhart and Winston, New York.
- Fukui, N. (1986) A Theory of Category Projection and Its Applications, Doctoral Dissertation, MIT, Cambridge, Mass.
- George, L. & J. Kornfilt (1981) "Finiteness and Boundness in Turkish", in Heny (ed.).
- Greenberg, J. (ed.) (1963) Universals of Language, MIT Press, Cambridge, Mass.
- Grimshaw, J. (1981) "Form, Function and the Language Acquisition Device", in C.L. Baker and J. McCarthy (eds.), The Logical Problem of Language Acquisition, MIT Press, Cambridge, Mass.
- Gruber, J. (1965) Studies in Lexical Relations, Doctoral Dissertation, MIT, Cambridge, Mass.
- Guerssel, M. (1976) Issues in Berber Phonology, MA Dissertation, University of Washington, Seattle.
- Guerssel, M. (1983) "A Phonological Analysis of the Construct State in Berber", Linguistic Analysis 11.

- Guerssel, M. (1986a) "On Berber Verbs of Change : A Study in Transitivity Alternations", Center for Cognitive Science Working Papers 9, MIT, Cambridge, Mass.
- Guerssel, M. (1986b) "Subject Clitic Doubling in Berber", Ms., MIT, Cambridge, Mass.
- Guerssel, M. (1986c) "Glides in Berber and Syllabicity", Linguistic Inquiry 17, 1-12.
- Guerssel, M. (1987) "Status of the Lexical Category Preposition in Berber : Implications for the Nature of the Construct State", in M. Guerssel & K. Hale (eds.).
- Guerssel, M. & K. Hale (1987) "Studies in Berber Syntax", Lexicon Project Working Papers 14, MIT, Cambridge, Mass.
- Guerssel, M., K. Hale, M. Laughren, B. Levin and J. White Eagle (1985) "A Cross-Linguistic Study of Transitivity Alternations", paper presented at the Parassession on Causatives and Agentivity at the Twenty-first Regional Meeting of the Chicago Linguistic Society.
- Hale, K. & P. Platero (1985) "Parts of Speech", in Muysken, P. & H. van Riemsdijk (eds.).
- Hale, K. & S. Keyser (1986) "Some Transitivity Alternations in English", Lexicon Project Working Papers 7, Center for Cognitive Science, MIT, Cambridge, Mass.
- Harlow, S. (1981) "Relativisation in Celtic" in F. Heny (ed.).
- Heny, F. (ed.) (1981) Binding and Filtering, Croom Helm, London.
- Horrocks, G. & M. Stavrou (1987) "Bounding Theory and Greek Syntax : Evidence for Wh-moveemnt in NP" Journal of Linguistics 23, 79-108.
- Horvath, J. (1986) Focus in the Theory of Grammar and the Syntax of Hungarain, Foris Publications, Dordrecht.
- Huang, C-T. J. (1982) Logical Relations in Chinese and the Theory of Grammar, Doctoral Dissertation, MIT, Cambridge, Mass.
- Huang, C-T. J. (1984) "On the Distribution and Reference of Empty Pronouns", Linguistic Inquiry 15.4.
- Hudson, R. (1984) Word Grammar, Basil Blackwell, Oxford.
- Hudson, R. (1987) "Zwicky on Heads", Journal of Linguistics 23, 109-132, Cambridge University Press, Cambridge.
- Jackendoff, R. (1972) "Semantic Interpretation in Generative Grammar", MIT Press, Cambridge, Mass.
- Jackendoff, R. (1977) X-bar Syntax : A Study of Phrase Structure, MIT Press, Cambridge, Mass.
- Jaeggli, O. (1981) Topics in Romance Syntax, Foris Publications, Dordrecht.

- Jaeggli, O. (1984) "Subject Extraction and the Null Subject Parameter", Proceedings of NELS 14.
- Kayne, R. (1975) French Syntax, MIT Press, Cambridge, Mass.
- Kayne, R. (1983) "Chains, Categories External to S, and French Complex Inversion", Natural Language and Linguistic Theory, 1, 107-141.
- Kayne, R. (1984) Connectedness and Binary Branching, Foris Publications, Dordrecht.
- Kayne, R. (1987) "Null Subjects and Clitic Climbing", paper presented to GLOW 1987, Venice.
- Kennelly, S. (1987) "Turkish Gerunds", in Boeschoten, H.E. & L. Th. Verhoeven (des.) Studies on Modern Turkish : Proceedings of the Ththird Conference on Turkish Linguistics, Tilburg University Press, Tilburg.
- Kitagawa, Y. (1986) Subjects in Japanese and English, Doctoral Dissertation, MIT, Cambridge, Mass.
- Koopman, H. (1983) The Syntax of Verbs, Foris Publications, Dordrecht.
- Koopman, H. & D. Sportiche (1985) "Theta Theory and Extraction", paper presented to GLOW 1985, Brussels.
- Kornfilt, J. (1985) Case Marking, Agreement, and Empty Categories in Turkish, Doctoral Dissertation, Harvard University, Cambridge, Mass.
- Kuroda, S-Y. (1985) "Whether You Agree or Not : Rough Ideas about the comparative Grammar of English and Japanese" Ms., University of California, San Diego.
- Larson, R. (1985) "Bare NP Adverbs", Linguistic Inquiry 16, 595-622.
- Larson, R. (1987) "'Missing Prepositions' and the Analysis of English Free Relative Clauses", Linguistic Inquiry 18, 239-266.
- Lasnik, H. & M. Saito (1984) "On the Nature of Proper Government", Linguistic Inquiry 15.2.
- Lieber, R. (1980) On the Organization of the Lexicon, Doctoral Dissertation, MIT, Cambridge, Mass.
- Llinas-Grau, M. (1988) The Syntax of Some Verbal Sequences in Catalan, MA Dissertation, University College London.
- Lumsden, J. & C. Tenny (1987) "The Causative, Passive, and Reciprocal in Berber", in Guerssel, M. & K. Hale (eds.).
- Manzini, M.R. (1983a) "On Control and Control Theory", Linguistic Inquiry 14, 421-446.
- Manzini, M.R. (1983b) Restructuring and Reanalysis, Doctoral Dissertation, MIT, Cambridge, Mass.

- Manzini, M.R. & K. Wexler (1987) "Parameters, Binding Theory and Learnability", Linguistic Inquiry 18, 413-445.
- Marantz, A. (1984) On the Nature of Grammatical Relations, MIT Press, Cambridge, Mass.
- May, R. (1985) Logical Form, MIT Press, Cambridge, Mass.
- McCarthy, J.J. (1979) Formal Problems in Semitic Phonology and Morphology, Doctoral Dissertation, MIT, Cambridge, Mass.
- McCarthy, J.J. (1981) "A Prosodic Theory of Nonconcatinative Morphology", Linguistic Inquiry 12, 373-418.
- McCloskey, J. (1983) "A VP in a VSO Language?", in G. Gazdar, E. Klein and G. Pullum (eds.) Order, Concord and Constituency, Foris Publications, Dordrecht.
- McCloskey, J. & K. Hale (1984) "On the Syntax of Person-Number Inflection in Modern Irish", Natural Language and Linguistic Theory 1, 487-533.
- Muysken, P. & H. van Riemsdijk (1985) "Projecting Features and Featuring Projections", in Muysken, P. & H. van Riemsdijk (eds.).
- Muysken, P. & H. van Riemsdijk (1985) Features and Projectitions, Foris Publications, Dordrecht.
- Ouhalla, J. (1984) "Some Phonological Issues of Tarifit Berber", Ms., Mohamed V University, Rabat.
- Ouhalla, J. (1986a) "On Postverbal Subjects in Null Subject Languages", Ms., University College London.
- Ouhalla, J. (1986b) "Remarks on the Distribution of pro : A Study of Berber", Ms., University College London.
- Ouhalla, J. (1986c) "Clitics as Agreement Affixes", paper presented at the Autumn Meeting of the LAGB, Edinburgh.
- Ouhalla, J. (1987a) "Clitics and Pronouns in Berber", Ms., University College London.
- Ouhalla, J. (1987b) "Causatives in Berber", paper presented at SOAS Morphology Seminar, London.
- Ouhalla, J. (1987c) "The Syntax of Verbless Sentences", paper presented at the Autumn Meeting of the LAGB, Bradford.
- Ouhalla, J. (1988a) "Movement in Noun Phrases", paper presented at the Spring Meeting of the LAGB, Durham.
- Ouhalla, J. (1988b) "P-movement, Clitic-climbing and the HMC", paper presented to GLOW 1988, Budapest.
- Ouhalla, J. (1988c) "A Note on Bound Pronouns", Linguistic Inquiry 19.3.
- Ouhalla, J. (in preparation) "On the Interaction Between Head Movement and Operator Movement, and the ECP".

- Öztekin, H. (1987) Clausal Complementation in Turkish, Doctoral Dissertation, University College London.
- Penchoen, T.G. (1973) Tamazight of the Ait Ndhir, Undena Publications, Los Angeles.
- Pesetsky, D. (1983) Paths and Categories, Doctoral Dissertation, MIT, Cambridge, Mass.
- Pesetsky, D. (1985) "Morphology and Logical Form", Linguistic Inquiry 16, 193-246.
- Plann, S. (1985) "Substantive : A neutralized Syntactic Category in Spanish", in I. Bordelois, H. Contreras & K. Zagona (eds.) Generative Studies in Spanish Syntax, Foris Publications, Dordrecht.
- Pollock, J-Y. (1981) "On Case and Impersonal Constructions", in May, R. & J. Koster (eds.) Levels of Syntactic Representation, Foris Publications, Dordrecht.
- Pollock, J-Y. (1983) "Accord, Chaines Impersonelles et Variables" Linguisticae Investigationes 7.1., 131-181.
- Pollock, J-Y. (1987) "Verb Movement, UG, and the Structure of IP", paper presented to GLOW 1987, Venice.
- Rapoport, T.R. (1985) "Copular Constructions in Hebrew", Proceedings of the Chicago Linguistic Society.
- Raposo, E. (1987) "Case Theory and Infl-to-Comp : The Inflected Infinitive in European Portuguese", Linguistic Inquiry 18.1.
- Reuland, E. (1983) "Governing -ing", Linguistic Inquiry 14, 101-136.
- Riemsdijk, H.C van (1978) A Case Study in Syntactic Markedness, Foris Publications, Dordrecht.
- Ritter, B. (1987) "A Head Movement Approach to Construct State Noun Phrases", Ms., MIT, Cambridge, Mass.
- Rizzi, L. (1982) Italian Syntax, Foris Publications, Dordrecht.
- Rizzi, L. (1986a) "On the Status of Subject Clitics in Romance", in O. Jaeggli & C. Silva-Corralan (eds.) Studies in Romance Linguistics, Foris Publications, Dordrecht.
- Rizzi, L. (1986b) "Null Objects in Italian and the Theory of pro" Linguistic Inquiry 17, 501-555.
- Roberge, Y. (1986a) "On Doubling and Null Argument Languages", Proceedings of NELS 16.
- Roberge, Y. (1986b) On the Syntactic Recoverability of Null Arguments, Doctoral Dissertation, University of British Columbia.
- Rothstein, S. (1983) The Syntactic Forms of Predication, Doctoral Dissertation, MIT, Cambridge, Mass.

- Rouveret, A. & J-R. Vergnaud (1980) "Specifying Reference to the Subject : French Causatives and Conditions on Representations", Linguistic Inquiry 11, 97-202.
- Sadiqi, F. (1986) Studies in Berber Syntax : The Complex Sentence, Konigshausen & Neumann, Wurzburg.
- Sadler, L. (1988) Welsh Syntax : A GB Approach, Croom Helm, New York.
- Safir, K. (1982) Syntactic Chains and the Definiteness Effect, Doctoral Dissertation, MIT, Cambridge, Mass.
- Shlonsky, U. (1987a) "Focus Constructions in Berber", in M. Guerssel & K. Hale (eds.).
- Shlonsky, U. (1987b) Null and Displaced Subjects, Doctoral Dissertation, MIT, Cambridge, Mass.
- Shlonsky, U. (1988) "Complementizer-Cliticization in Hebrew and the Empty Category Principle", Natural Language and Linguistic Theory 6, 191-206.
- Sportiche, D. (1983) Structural Invariance and Symmetry, Doctoral Dissertation, MIT, Cambridge, Mass.
- Sproat, R. (1985) "Welsh Syntax and VSO Structure", Natural Language and Linguistic Theory 3, 173-216.
- Stephens, J. (1982) Word Order in Breton, Doctoral Dissertation, University of London.
- Stowell, T. (1981) Origins of Phrase Structure, Doctoral Dissertation, MIT, Cambridge, Mass.
- Stowell, T. (1982) "The Tense of Infinitives" , Linguistic Inquiry 13, 561-570.
- Suñer, M. (1987) "Haber+Past Participle", Linguistic Inquiry 18, 683-690.
- Szabolcsi, A. (1987) "Functional Categories in the Noun Phrase", in Kenesei (ed.), Approaches to Hungarian, Vol.2, 167-189.
- Taraldsen, T. (1985) "On the Distribution of Nominative Objects in Finnish", in P. Muysken & H. van Riemsdijk (eds.).
- Torrego, E. (1984) "On Inversion in Spanish and Some of Its Effects", Linguistic Inquiry 15, 103-129
- Travis, L. (1984) Parameters and Effects of Word Order Variation, Doctoral Dissertation, MIT, Cambridge, Mass.
- Williams, E. (1980) "Predication", Linguistic Inquiry 11, 203-238.
- Zagona, K. (1982) Government and Proper Government of Verbal Projections, Doctoral Dissertation, University of Washington, Seattle.
- Zagona, K. (1988) "Proper Government of Antecedentless VP in English and Spanish", Natural Language and Linguistic Theory 6.1., 95-128.

Zubizarreta, M-L. (1985) "The Relation Between Morphophonology and Morphosyntax : The Case of Romance Causatives", Linguistic Inquiry 16, 247-290.

Zubizarreta, M-L. (1988) Levels of Representations in the Lexicon and in the Syntax, Foris Publications, Dordrecht.