

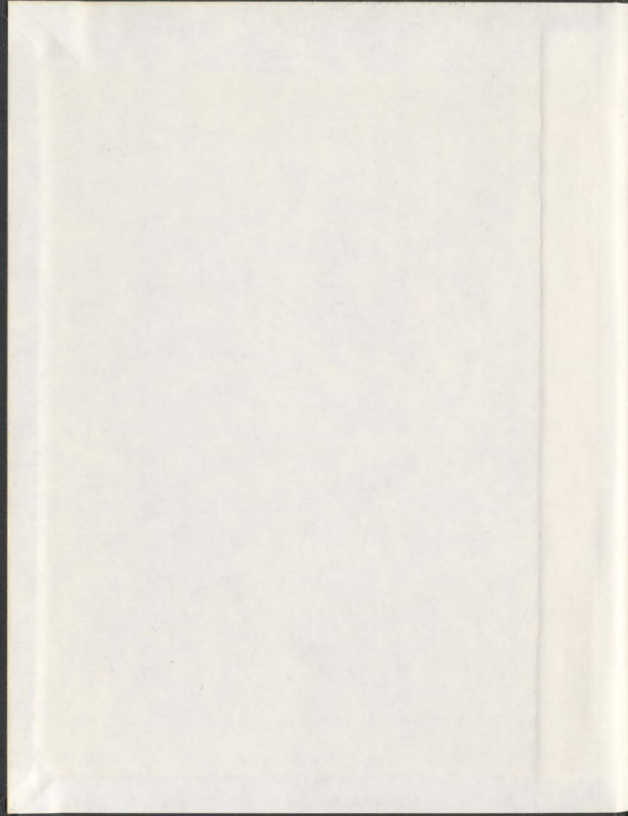
DIFFERENTIAL METABOLISM OF EICOSAPENTAENOIC  
ACID AND DOCOSAHEXAENOIC ACID

CENTRE FOR NEWFOUNDLAND STUDIES

**TOTAL OF 10 PAGES ONLY  
MAY BE XEROXED**

(Without Author's Permission)

RYNA LEVY MILNE



001311







National Library  
of Canada

Acquisitions and  
Bibliographic Services

395 Wellington Street  
Ottawa ON K1A 0N4  
Canada

Bibliothèque nationale  
du Canada

Acquisitions et  
services bibliographiques

395, rue Wellington  
Ottawa ON K1A 0N4  
Canada

*Your file* Votre référence

*Our file* Notre référence

The author has granted a non-exclusive licence allowing the National Library of Canada to reproduce, loan, distribute or sell copies of this thesis in microform, paper or electronic formats.

The author retains ownership of the copyright in this thesis. Neither the thesis nor substantial extracts from it may be printed or otherwise reproduced without the author's permission.

L'auteur a accordé une licence non exclusive permettant à la Bibliothèque nationale du Canada de reproduire, prêter, distribuer ou vendre des copies de cette thèse sous la forme de microfiche/film, de reproduction sur papier ou sur format électronique.

L'auteur conserve la propriété du droit d'auteur qui protège cette thèse. Ni la thèse ni des extraits substantiels de celle-ci ne doivent être imprimés ou autrement reproduits sans son autorisation.

0-612-56664-1

Canada

**Differential Metabolism of  
Eicosapentaenoic Acid and Docosahexaenoic Acid**

A Thesis presented to  
the Department of Biochemistry  
of  
Memorial University of Newfoundland

by

Ryna Levy Milne

**In partial fulfillment of the  
requirements for the degree of  
Doctor of Philosophy**

December 1996

© R. Levy Milne 1996

To Derek,

for the vision of living, loving, learning, and laughing,

....and for Terran.

## ABBREVIATIONS

ACAT	Acyl-CoA cholesterol acyltransferase
ACC	Acetyl CoA carboxylase
CHD	Congestive heart disease
CPT	Carnitine palmitoyltransferase
CPT <sub>i</sub>	Carnitine palmitoyltransferase-inner mitochondrial membrane
CPT <sub>o</sub>	Carnitine palmitoyltransferase-outer mitochondrial membrane
CPT <sub>p</sub>	Peroxisomal carnitine palmitoyltransferase
CVD	Cardiovascular Disease
DHA	Docosahexaenoic acid (22:6, n-3)
EDL	Extensor digitorum longus
EPA	Eicosapentaenoic acid (20:5, n-3)
ETF	Electron-transferring flavoprotein
FABP	Fatty acid binding protein
HDL	High density lipoprotein
HSL	Hormone-sensitive lipase
IDL	Intermediate density lipoprotein
LDL	Low density lipoprotein
Lp(a)	Lipoprotein a
LPL	Lipoprotein lipase
PC	Phosphatidylcholine
PDGF	Platelet derived growth factor
PE	Phosphatidylethanolamine
PGI	Prostaglandin
PI	Phosphatidylinositol



PPAR	Peroxisome proliferator activated receptor
PS	Phosphatidylserine
SM	Sphingomyelin
TAG	Triacylglycerol
Tx	Thromboxane
VLDL	Very low density lipoprotein

## ABSTRACT

We hypothesized that EPA is preferentially metabolized in peripheral tissues thus making less of this acid available for storage. The three proposed mechanisms investigated to explain how EPA is preferentially utilized included; 1) EPA is oxidized at a greater rate relative to DHA in skeletal and cardiac muscle, 2) EPA is preferentially hydrolyzed from circulating triacylglycerols, and/or 3) EPA is selectively secreted in bile by the liver.

To investigate the first proposal, fatty acid oxidation studies were conducted using soleus muscle homogenates, intact soleus muscle and cardiac myocytes. Our findings indicated that even though the rate of oxidation of EPA over DHA was doubled in the experiments which employed soleus muscle homogenates, there was no differential oxidation between EPA and DHA in muscle when these fatty acids were incubated with either the intact soleus muscle or cardiac myocytes. Since the latter two experiments are more representative of the physiological state, it appears that these results do not support our first postulated mechanism that EPA is preferentially oxidized compared to DHA by muscle.

We also suggested that EPA is preferentially hydrolyzed compared to DHA from circulating triacylglycerols by muscle LPL with the hypothesis that if more EPA is released to the peripheral tissues for metabolism then less would be available for storage in adipose tissue. Therefore, chylomicrons were incubated

with cardiac lipoprotein lipase (LPL) to determine if there was selective release of EPA. This study demonstrated no difference in the hydrolysis pattern of the two n-3 fatty acids. Thus, preferential release of EPA from chylomicrons by LPL does not appear to explain the lower storage of EPA in adipose tissue.

The third mechanism examined the proposal that supplementation of fish oil in the diet results in more EPA compared to DHA being available for hepatic phospholipid synthesis. Consequently, more EPA is secreted in bile by the liver. In this part of the investigation, we determined the fatty acid profile as well as the proportion of fatty acids of phospholipids secreted in the bile of rats being fed a diet containing MaxEPA oil as its primary fat source. Even though biliary phospholipids were enriched in the long chain n-3 fatty acids found in dietary fish oils, no significant difference in the relative proportion of EPA and DHA was observed. The differential storage of DHA compared to EPA is thus, not due to the selective secretion of EPA into bile by the liver.

From our data, we were able to conclude that the suggested mechanisms are not responsible for the preferential metabolism of EPA relative to DHA. We found that EPA was oxidized at a greater rate than DHA in soleus muscle homogenates. However, when more physiological models were used, i.e., cardiac myocytes or the intact skeletal muscle, there were no differences in the oxidation of either of these fatty acids. Furthermore, we determined that EPA

and DHA were released from triacylglycerols in lymph-derived chylomicrons at similar rates and that both fatty acids were secreted in bile to the same extent.

## ACKNOWLEDGMENTS

My sincere gratitude is extended to Dr. Gene R. Herzberg for his continued guidance and supervision throughout my program. I also gratefully acknowledge the other members of my supervisory committee for their help and assistance, Dr. Sean Brosnan and Dr. Phil Davis. A special thank you for Craig Skinner for his technical assistance, his computer wizardry and for being a friend.

To my family and friends, I give my warm appreciation for their constant support. I would like to especially thank my husband, Derek, for his encouragement and his patience. I also would like to convey my gratitude to the following individuals since their friendship, kindness and generosity were invaluable for the completion of this thesis-Marjorie Scott, Darlene Witherall, Marie Codner and Betty Power.

This research was funded by the Newfoundland and Labrador Branch of the Heart and Stroke Foundation of Canada.

## TABLE OF CONTENTS

	Page
<b>ABBREVIATIONS</b> .....	iii
<b>ABSTRACT</b> .....	v
<b>ACKNOWLEDGMENTS</b> .....	viii
<b>TABLE OF CONTENTS</b> .....	ix
<b>LIST OF TABLES</b> .....	xii
<b>LISTS OF FIGURES</b> .....	xiii
<b>CHAPTER 1.0: DIFFERENTIAL METABOLISM OF FATTY ACIDS</b> .....	1
1.1 INTRODUCTION .....	1
1.2 DIFFERENTIAL METABOLISM OF FATTY ACIDS.....	8
1.3 n-3 FATTY ACIDS.....	14
1.3.1 WHY THE INTEREST IN n-3 FATTY ACIDS?.....	14
1.3.2 EICOSAPENTAENOIC ACID [EPA, 20:5(n-3)] AND DOCOSAHEXAENOIC ACID [DHA, 22:6(n-3)] .....	26
1.4 THE PROBLEM STATEMENT-EPA IS PREFERENTIALLY METABOLIZED RELATIVE TO DHA.....	30
1.4.1 RATIONALE.....	30
1.4.2 OVERALL HYPOTHESIS .....	33
1.4.3 PRIMARY OBJECTIVES OF THE STUDY.....	33
1.4.4 SECONDARY OBJECTIVES OF THE STUDY.....	35
<b>CHAPTER 2.0: FATTY ACID OXIDATION IN SKELETAL AND CARDIAC       MUSCLE</b> .....	37
2.1 INTRODUCTION .....	37
2.2 $\beta$ -OXIDATION OF FATTY ACIDS IN MUSCLE .....	43
2.2.1 THE PATHWAY OF MITOCHONDRIAL $\beta$ -OXIDATION OF FATTY ACIDS.....	44
2.2.2 PEROXISOMAL $\beta$ -OXIDATION OF FATTY ACIDS .....	47
2.2.3 REGULATION .....	49
2.2.3.1 ENZYMATIC REGULATION .....	53
2.3 PURPOSE OF EXPERIMENTS.....	62
2.4 MATERIALS AND METHODS .....	63

2.4.1	CHEMICALS .....	63
2.4.2	ANIMALS .....	64
2.4.3	SKELETAL MUSCLE HOMOGENATE PREPARATION AND INCUBATION .....	65
2.4.4	INTACT SKELETAL MUSCLE PREPARATION AND INCUBATION .....	67
2.4.5	PREPARATION OF CARDIAC MYOCYTES AND INCUBATION .....	69
2.4.6	STATISTICAL ANALYSIS .....	73
2.5	RESULTS .....	73
2.5.1	OXIDATION OF FATTY ACIDS IN SKELETAL MUSCLE HOMOGENATES .....	73
2.5.2	OXIDATION OF FATTY ACIDS IN INTACT SKELETAL MUSCLE .....	77
2.5.2.1	VIABILITY OF INTACT MUSCLE .....	77
2.5.2.2	FATTY ACID OXIDATION RESULTS IN INTACT SKELETAL MUSCLE .....	81
2.5.3	OXIDATION OF FATTY ACIDS IN CARDIAC MYOCYTES .....	89
2.6	DISCUSSION .....	95
<b>CHAPTER 3.0: HYDROLYSIS OF CHYLOMICRON TRIALYGLYCEROL BY MUSCLE LIPOPROTEIN LIPASE .....</b>		<b>107</b>
3.1	INTRODUCTION .....	107
3.2	LIPOPROTEIN LIPASE IN MYOCYTES .....	108
3.3	PURPOSE OF EXPERIMENT .....	121
3.4	MATERIALS AND METHODS .....	121
3.4.1	CHEMICALS .....	121
3.4.2	CANNULATION OF THE MAIN INTESTINAL LYMPH DUCT AND CHYLOMICRON COLLECTION .....	121
3.4.3	ISOLATION OF CHYLOMICRONS .....	123
3.4.4	PREPARATION OF CARDIAC LIPOPROTEIN LIPASE .....	124
3.4.5	INCUBATION OF CHYLOMICRONS WITH LIPOPROTEIN LIPASE .....	125
3.4.6	STATISTICAL ANALYSIS .....	126
3.5	RESULTS .....	126
3.6	DISCUSSION .....	135
<b>CHAPTER 4.0: SECRETION OF FATTY ACIDS IN BILE .....</b>		<b>142</b>
4.1	INTRODUCTION .....	142
4.2	EFFECT OF DIETARY FAT ON BILE PHOSPHOLIPID COMPOSITION .....	145
4.3	PURPOSE OF EXPERIMENTS .....	148
4.4	MATERIALS AND METHODS .....	149
4.4.1	CHEMICALS .....	149
4.4.2	ANIMALS .....	149
4.4.3	CANNULATION OF THE BILE DUCT .....	150

4.4.4	BILE COLLECTION TO EXAMINE THE EFFECT OF DIET ON BILE OUTPUT AND COMPOSITION .....	151
4.4.5	BILE COLLECTION TO EXAMINE THE EFFECT OF DIET AND FAT INFUSED ON BILE OUTPUT AND COMPOSITION .....	152
4.4.6	ANALYSIS OF BILIARY LIPIDS .....	152
4.4.7	STATISTICAL ANALYSIS .....	154
4.5	RESULTS .....	154
4.5.1	EFFECT OF FISH OIL DIET ON EPA AND DHA SECRETION IN BILE .....	154
4.5.2	EFFECT OF DIETARY FISH OIL AND CORN OIL ON BILE OUTPUT AND COMPOSITION .....	155
4.5.3	EFFECTS OF A SINGLE INTRADUODENAL INFUSION OF FISH OIL OR CORN OIL ON BILE OUTPUT AND COMPOSITION AFTER ADAPTATION TO DIETS CONTAINING FISH OIL OR CORN OIL ...	163
4.6	DISCUSSION .....	175
4.6.1	BILIARY SECRETION OF EPA AND DHA .....	175
4.6.2	BILE OUTPUT AND COMPOSITION .....	175
4.6.3	CONCLUSION .....	192
<b>CHAPTER 5.0: GENERAL DISCUSSION AND CONCLUSION .....</b>		<b>195</b>
5.1	GENERAL DISCUSSION .....	195
5.2	OXIDATION OF EPA BY LIVER .....	197
5.3	INTERCONVERSION OF n-3 FATTY ACIDS .....	198
5.4	SELECTIVE MOBILIZATION OF EPA .....	203
5.5	PREFERENTIAL INCORPORATION OF EPA INTO PHOSPHOLIPIDS .....	207
5.6	CONCLUSION .....	211
<b>CHAPTER 6.0: REFERENCES .....</b>		<b>215</b>



## LIST OF TABLES

	Page
Table 1.1 Dietary Fats in Inuit and Danish Food Intake Computed on a Daily Energy Consumption of 3000 kcal. ....	16
Table 1.2 n-3 Fatty Acid Content in Common Marine Oils. ....	29
Table 2.1 Fatty Acid Composition of the Diets and Oils ....	66
Table 2.2 Summary of Primary and Secondary Objectives and Results for Mechanism #1.....	98
Table 3.1 Fatty Acid Composition of Chylomicron Triacylglycerols ....	128
Table 3.2 Summary of Primary Objective and Result for Mechanism #2. ....	136
Table 4.1 Total Amount of Bile Flow and Biliary Lipids in 6 Hours. ....	155
Table 4.2 Fatty Acid Composition of Bile Phospholipids.....	158
Table 4.3 Total Bile Flow and Biliary Lipids Secreted in 6 Hours.....	164
Table 4.4 Fatty Acid Composition of Bile Phospholipids.....	173
Table 4.5 Summary of Primary and Secondary Objectives and Results for Mechanism #3.....	194

## LISTS OF FIGURES

	Page
Figure 1.1 Structure of a Saturated Fatty Acid.....	1
Figure 1.2 Biosynthetic Pathway of Fatty Acids.....	4
Figure 1.3 Biosynthetic Pathway of Long Chain Polyunsaturated Fatty Acids.....	6
Figure 1.4 Synthesis of Eicosanoids From Arachidonic Acid (20:4, n-6) .....	9
Figure 1.5 Synthesis of Thromboxanes From Fatty Acid Substrates .....	10
Figure 1.6 Interconversion of Fatty Acyl Coenzyme As and Fatty Acyl Carnitines .....	12
Figure 1.7 Structures of the Main n-3 and n-6 Fatty Acids .....	28
Figure 1.8 Lymph Fatty Acids as Percentage of MaxEPA and Epididymal Fatty Acids-MaxEPA-Percentage of Diet.....	32
Figure 2.1 Muscle Lipoprotein Lipase Activity.....	40
Figure 2.2 Hindquarter Fatty Acid Clearance.....	41
Figure 2.3 $\beta$ -oxidation of Long Chain Fatty Acids in Heart .....	42
Figure 2.4 Fatty Acid $\beta$ -oxidation in the Mitochondrial Matrix.....	46
Figure 2.5 Transport of Fatty Acids in Heart Tissue.....	52
Figure 2.6 Possible Schemes for Malonyl CoA Inhibition of CPT <sub>o</sub> .....	59
Figure 2.7 Deeper Muscles of the Rat Hindlimb .....	75
Figure 2.8 Fatty Acid Oxidation By Soleus Muscle Homogenates.....	76
Figure 2.9 Time Course for Oleic Acid Oxidation in Isolated Soleus Muscle Pre- Incubated Without and Incubated With Labelled Oleic Acid.....	83
Figure 2.10 Time Course for Oleic Acid Oxidation in Isolated Soleus Muscle Preincubated and Incubated With Labelled Oleic Acid.....	84
Figure 2.11 Oxidation of Oleic Acid and EPA in Intact Soleus Muscle.....	85
Figure 2.12 Oxidation of EPA and DHA in Chow Fed Rats.....	87
Figure 2.13 Oxidation of EPA and DHA in Intact Soleus Muscle of Fish Oil Fed Rats .....	88
Figure 2.14 <sup>14</sup> C Production in Cardiac Myocytes of Fish Oil Fed Rats Using 0.2 mM Fatty Acid.....	91
Figure 2.15 <sup>14</sup> C Production in Cardiac Myocytes of Corn Oil Fed Rats Using 0.2mM Fatty Acid.....	92

Figure 2.16 <sup>14</sup> C Production in Cardiac Myocytes of Fish Oil Fed Rats Using 0.4 mM Fatty Acid.....	93
Figure 2.17 <sup>14</sup> C Production in Cardiac Myocytes of Corn Oil Fed Rats Using 0.4 mM Fatty Acid.....	94
Figure 3.1 Synthesis, Transport and Site of Action of Lipoprotein Lipase.....	112
Figure 3.2 The Proportion of EPA and DHA in the Original Chylomicron Triacylglycerols Found in Monoacylglycerols.....	129
Figure 3.3 The Proportion of EPA and DHA in the Original Chylomicron Triacylglycerols Found in Diacylglycerols.....	130
Figure 3.4 The Proportion of EPA and DHA in the Original Chylomicron Triacylglycerols Released as Free Fatty Acids.....	131
Figure 3.5 The Proportion of EPA and DHA in the Original Chylomicron Triacylglycerols Remaining in the Triacylglycerols.....	132
Figure 3.6 The Proportion of Fatty Acid From the Original Chylomicron Remaining in Triacylglycerols or Accumulating in Monoacylglycerols, Diacylglycerols, or Free Fatty Acids for 18:1(n-9).....	133
Figure 3.7 The Proportion of Fatty Acid From the Original Chylomicron Remaining in Triacylglycerols or Accumulating in Monoacylglycerols, Diacylglycerols, or Free Fatty Acids for 18:2(n-6).....	134
Figure 4.1 Bile output in rats fed diets containing MaxEPA or Corn Oil.....	157
Figure 4.2 Bile acid concentrations in bile of rats fed diets containing MaxEPA or Corn Oil.....	159
Figure 4.3 Cholesterol concentrations in bile of rats fed diets containing MaxEPA or Corn Oil.....	160
Figure 4.4 Phospholipid concentrations in bile of rats fed diets containing MaxEPA or Corn Oil.....	161
Figure 4.5 Bile output in rats fed diets containing MaxEPA or Corn Oil and given an infusion of either oil.....	165
Figure 4.6 Cholesterol concentrations in bile of rats fed diets containing MaxEPA or Corn Oil and given an infusion of either oil.....	166
Figure 4.7 Phospholipid concentrations in bile of rats fed diets containing MaxEPA or Corn Oil and given an infusion of either oil.....	167
Figure 4.8 Bile acid concentrations in bile of rats fed diets containing MaxEPA or Corn Oil and given an infusion of either oil.....	168

## CHAPTER 1.0

### DIFFERENTIAL METABOLISM OF FATTY ACIDS

#### 1.1 INTRODUCTION

The focus of this thesis is to examine the differential metabolism of the two long chain n-3 fatty acids found in marine oils, eicosapentaenoic acid (20:5, n-3) and docosahexaenoic acid (22:6, n-3). For simplification these two fatty acids will be referred to as EPA and DHA, respectively, throughout the text. In order to better understand the metabolism of these two fatty acids, a general overview of fatty acids and their role in metabolism are discussed in this chapter.

Fatty acids are a class of compounds that contain a long hydrocarbon chain with a carboxyl group on one end and a methyl group on the terminal end (Figure 1.1). In biological systems, fatty acids usually contain an even number of carbon atoms, typically between 14 and 24. They are either saturated or unsaturated, containing one or more double bonds that generally exist in the *cis* configuration.

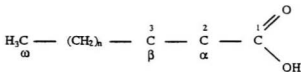


Figure 1.1 Structure of a Saturated Fatty Acid

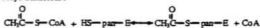
Fatty acids play two major physiological roles in mammalian tissues; a structural role and a role in energy storage and production. First, they are building blocks of phospholipids and glycolipids, and thus, important components of biological membranes. In fact, the fatty acyl chains account for more than half the mass of most major phospholipids and are primarily responsible for the apolar nature of the membrane bilayer (Goodridge, 1991). Consequently, fatty acids influence many membrane properties and functions such as membrane fluidity, ion transport and the activities of membrane-associated proteins. In addition, polyunsaturated fatty acids found in phospholipids may serve as substrates for production of biologically potent and versatile compounds, the eicosanoids (Cook, 1991). The eicosanoids are involved in the modulation of a host of physiological or pathophysiological processes including tissue perfusion, immune response, thrombosis, inflammation and atherosclerotic disease.

Second, as part of triacylglycerols, fatty acids are involved in energy storage and fuel production in animals. During meals, fatty acids may be incorporated into triacylglycerols and stored mostly in adipose tissue which represents the largest reservoir of these storage lipids. Triacylglycerols are highly concentrated stores of metabolic energy because they are reduced and anhydrous. The yield from the complete oxidation of fatty acids is about 37 kJ/g, in contrast to about 17 kJ/g for carbohydrate and protein. In situations

such as fasting or between meals, fatty acids are mobilized from stores and transported to the tissues where they are required for energy (Lin and Connor, 1990; Halperin and Rolleston, 1990).

Individual fatty acids are acquired through the diet, *de novo* synthesis and via elongation and/or desaturation. All mammals can synthesize saturated fatty acids *de novo* from simple precursors such as glucose or amino acids. The cells of most tissues can synthesize fatty acids. However, the liver and adipose tissue are the most important organs for fatty acid biosynthesis. Acetyl CoA carboxylase (ACC), the key regulatory enzyme in the conversion of citrate to long chain fatty acids, catalyzes the carboxylation of acetyl CoA to malonyl CoA. The synthesis of long chain fatty acids from acetyl CoA and malonyl CoA involves a sequence of six reactions for each two carbon addition and this sequence is repeated several times until the long chain fatty acid is produced. These reactions are catalyzed by the fatty acid synthase complex which consists of two multifunctional polypeptides (Figure 1.2). The end product of these reactions in mammals is usually 16:0 and, to a lesser extent, 18:0. Many eucaryotic cells have the capacity for two carbon chain elongation, both of endogenously synthesized acids and of exogenous dietary acids (Cook, 1991; Thompson, 1992). In tissues such as brain and liver there are two systems for elongation, one in endoplasmic reticulum and the other in the mitochondria. The enzymes involved in fatty acid

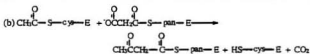
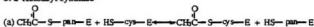
1. Acyl transferase



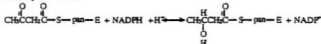
2. Acyl transferase



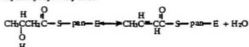
3.  $\beta$ -Ketoacyl synthase



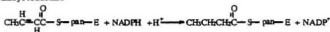
4.  $\beta$ -Ketoacyl reductase



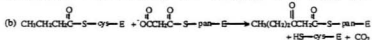
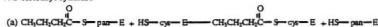
5.  $\beta$ -Hydroxyacyl dehydrase



6. Enoyl reductase



7.  $\beta$ -Ketoacyl synthase



8 - 10. Repeat reactions 4,5, and 6, forming Hexanoyl-pan-E

11 - 30. Repeat reaction 3,4,5 and 6 five times, with the molecule growing by 2 carbons with each cycle to produce Palmitoyl-pan-E

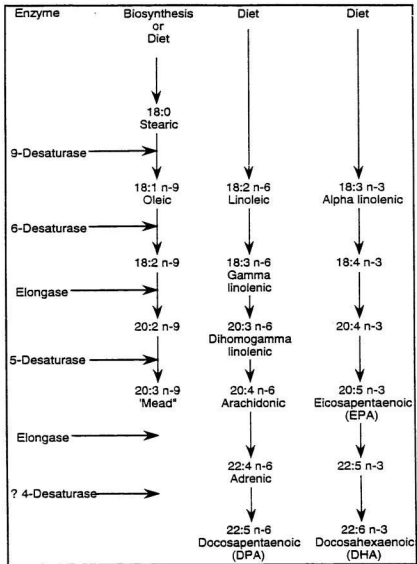


**Figure 1.2 Biosynthetic Pathway of Fatty Acids (Adapted from Vance and Vance, 1991)** Abbreviations are: HS-cys=cysteiny residues; HS-pan=4'phosphopantetheine.

biosynthesis are active when high carbohydrate, low fat diets are eaten but suppressed when the consumption of fat is high.

Unsaturated fatty acids must be supplied by dietary acids of plant and animal origin or by oxidative desaturation (Figure 1.3). Monounsaturated fatty acids (i.e., 18:1(n-9)) are either obtained from the diet or formed by direct oxidative desaturation of preformed long chain saturated fatty acids via the enzyme,  $\Delta^9$ -desaturase. For the polyunsaturated fatty acids, animals are dependent on plants for the two major precursors of the n-6 and n-3 fatty acids, 18:2(n-6) and 18:3(n-3), respectively (Thompson, 1992).





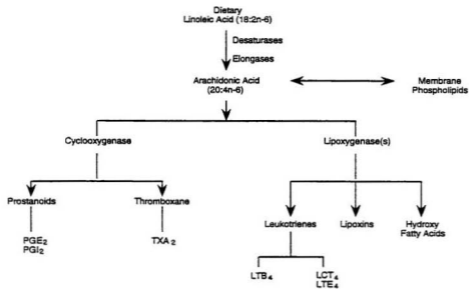
**Figure 1.3 Biosynthetic Pathway of Long Chain Polyunsaturated Fatty Acids**  
(Adapted from British Nutrition Foundation, 1992).

The predominant unsaturated fatty acid families are the n-6 fatty acids derived from 18:2(n-6), the n-3 fatty acids derived from 18:3(n-3), and the n-9 fatty acids derived from 18:1(n-9). All three parent compounds compete for the enzymes responsible for elongation and desaturation. For instance, these 18-carbon unsaturated fatty acids require  $\Delta 6$ -desaturase for the introduction of a double bond at position 6. Each of these fatty acids can compete for the same enzyme and therefore influence the metabolism of fatty acids of other families. The reaction rates for the enzyme are different, with 18:3(n-3) being preferred to 18:2(n-6) which is preferred to 18:1(n-9). Since the North American diet has more 18:2(n-6), the predominant pathway is that of the n-6 series in which 18:2(n-6) is converted to 20:4(n-6) (Lands, 1992 ; Cook, 1991). If 18:2(n-6) is low in the diet, then the other two 18-carbon unsaturated fatty acids compete for the  $\Delta 6$ -desaturase. Usually, 18:1(n-9) is more abundant than 18:3(n-3), and thus, its desaturation and elongation is enhanced, resulting in an accumulation of the 'Mead acid', 20:3(n-9). This fatty acid contributes to the structural integrity of membranes; however, it is not a precursor for the eicosanoids as are 20:4(n-6) or 20:5(n-3) and it does not alleviate the signs of essential fatty acid deficiency (Cook, 1991; British Nutrition Foundation, 1992). As a consequence of the competition for the enzymes involved in elongation and desaturation, 18:3(n-3) appears to be poorly converted to the long chain fatty acids produced in its pathway; i.e., DHA and EPA (Lands, 1992) .

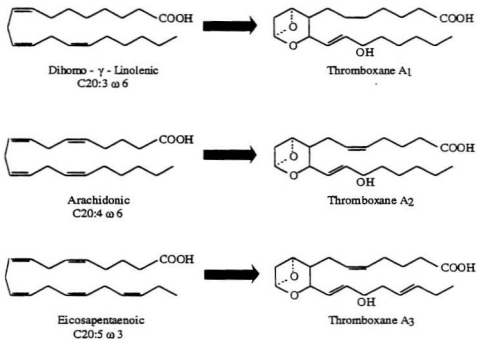
## 1.2 DIFFERENTIAL METABOLISM OF FATTY ACIDS

As a constituent of triacylglycerols and phospholipids, fatty acids are to some extent positionally restricted with a saturated fatty acid usually found in the sn-1 position and an unsaturated acid in the sn-2 position. However, the actual fatty acids incorporated into phospholipids and triacylglycerols may differ depending on tissue variation, species variation, or environmental factors such as diet. Depending on the degree of unsaturation or the chain length, fatty acids may behave differently with respect to their involvement in metabolic processes resulting in differential metabolism.

It has been found that dietary lipids can induce extensive modifications in the fatty acid composition of tissue membranes. Such modifications have been shown to lead to a variety of functional changes, including membrane fluidity, ion transport, cellular responses as well as the biosynthesis of eicosanoids. For instance, upon fish oil supplementation in human and animal feeding trials (Careaga-Houck and Sprecher, 1989; Abeywardena et al, 1987; Urakeze et al, 1987; Schick et al, 1990; Gibney and Bolton-Smith, 1988; Mori et al, 1987), it was observed that EPA can replace, in part, 20:4(n-6), the major precursor of eicosanoids (Figure 1.4), in platelet phospholipids. This outcome has a major impact on platelet functions such as platelet aggregation. Figure 1.5 illustrates the synthesis of different thromboxanes from different fatty acid substrates. The presence or absence of one double bond in the side chain can make a significant



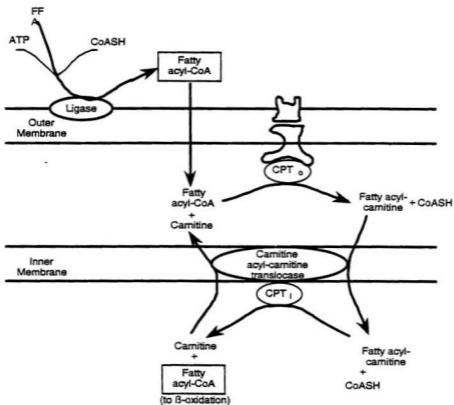
**Figure 1.4** Synthesis of Eicosanoids From Arachidonic Acid (20:4, n-6)  
(Adapted from Mori et al, 1987).



**Figure 1.5** Synthesis of Thromboxanes From Fatty Acid Substrates  
(Adapted from Mascioli, 1989).

difference in the physiological function of a particular eicosanoid (Mascioli, 1989). When 20:4(n-6) is the substrate, thromboxane A<sub>2</sub> (TxA<sub>2</sub>) is synthesized by platelets. TxA<sub>2</sub> has two double bonds in its side chain and is a potent vasoconstrictor and platelet aggregator. However, thromboxane A<sub>3</sub> (TxA<sub>3</sub>), synthesized from EPA, has three double bonds and is a platelet antiaggregatory agent. Consequently, it has been suggested that diets high in fish oils may lead to a synthesis of the 3-series eicosanoids, replacing the platelet-reactive eicosanoids of the 2-series. The resultant shift in the balance of proaggregatory to antiaggregatory compounds could then lead to a decrease in thrombotic tendency (Mori et al, 1987). However, the extent to which the membrane composition must be altered in order to affect platelet function (i.e., the EPA/20:4(n-6) ratio) remains unknown.

Differential metabolism with respect to fatty acids' involvement in energy production has also been demonstrated. Figure 1.6 shows the process of activating fatty acids in the cytosol to their correspondent fatty acyl CoAs prior to being transport across the mitochondrial membrane into the mitochondrial matrix. Once inside the matrix these fatty acyl CoAs participate in  $\beta$ -oxidation. Long chain fatty acyl CoAs require the carnitine enzyme system for transport across the mitochondrial membrane. However, McGarry et al (1977) observed that the transport of medium chain fatty acyl CoAs, containing 8-10 carbons was carnitine independent.



**Figure 1.6** Interconversion of Fatty Acyl Coenzyme As and Fatty Acyl Carnitines (Adapted from Halperin and Rolleston, 1990). Abbreviations are: FF=Free Fatty Acid; CPT<sub>o</sub>=Carnitine palmitoyl transferase outer mitochondrial membrane; CPT<sub>i</sub>=Carnitine palmitoyl transferase inner mitochondrial membrane.

Many investigations have examined preferential oxidation of fatty acids (Leyton et al, 1987; Mead et al, 1956; Cenedella and Allen, 1969; Jones et al, 1985; Willebrands, 1964; Jones, 1994). Leyton and coworkers (1987) reported preferential oxidation of 18:1(n-9) and 18:3(n-3) over other long chain fatty acids such as 18:2(n-6) and the 20 carbon unsaturated fatty acids. This group of investigators examined whole body fatty acid oxidation in rats by comparing the tracer appearance rates in the form of expired CO<sub>2</sub> from the labelled fatty acid. Rats that were previously fed chow received an oral dose of 5-6  $\mu$ Ci of a labelled fatty acid dissolved in olive oil. The animals were then placed in metabolic chambers and the expired <sup>14</sup>CO<sub>2</sub> was collected for a period of 24 hours. From their data, Leyton and coworkers (1987) observed more expired <sup>14</sup>CO<sub>2</sub> from rats that received either 18:1(n-9) or 18:3(n-3) than the other fatty acids examined. Consequently, they concluded that these two fatty acids were preferentially oxidized. However, this study has been criticized for not correcting for the specific activity of the labelled precursor, resulting in a variation in the enrichment of the endogenous fatty acid pools. In essence, this study did not measure the absolute rates of oxidation of each fatty acid and thus, the data cannot be used to assign relative rates of oxidation.

In order to rectify this problem, Jones (1994), in a recent study, determined whole body fatty acid oxidation but he controlled the amount of dietary fatty acids the rats consumed as well as the endogenous pools. He did this by feeding



animals for ten weeks diets that contained identical amounts of the three 18-carbon unsaturated fatty acids; i.e., 18:1(n-9), 18:2(n-6), and 18:3(n-3). After the ten week feeding period, he gave the rats 20  $\mu$ Ci of the labelled fatty acid in question in a bolus dose of oil also containing identical amounts of these three fatty acids. Jones (1994) observed no difference among the oxidation of these fatty acids. In fact, the curves were almost superimposed upon each other and thus, he concluded that there was no preferential oxidation with regards to the 18-carbon unsaturated fatty acids.

### 1.3 n-3 FATTY ACIDS

#### 1.3.1 WHY THE INTEREST IN n-3 FATTY ACIDS?

A great deal of interest has been generated concerning dietary fish and fish oils since epidemiological evidence suggested a high intake of fish correlated with a low incidence of cardiovascular disease (CVD) and thrombotic disorders. The beneficial effects of fish oils have been attributed to the actions of the long chain n-3 fatty acids, EPA and DHA.

In addition, evidence suggests that feeding dietary fish oil favours energy substrate oxidation reducing the fraction of metabolizable energy partitioned for storage (Jones, 1988). Jones (1988) further states that this finding supports the notion that the selection of dietary fat alters the efficiency of energy substrate deposition and may play a role in the pathogenesis of obesity.

EPA and DHA have been reported to have a wide range of important biological and physiological effects. In their classic epidemiological studies, Bang and Dyerberg (1972, 1986) noted that the prevalence of CVD in the Inuit community of West Greenland was lower than that of the Danes despite a diet as high in fat and cholesterol as that of the Danes. The most striking difference between the diets was in the type of fats consumed (Table 1.1). The authors evaluated the diet of 130 Inuits and found that their diets had high levels of long chain polyunsaturated n-3 fatty acids (Bang and Dyerberg, 1972). Interestingly, the Danes' diet contained twice as much saturated fat and more n-6 polyunsaturated fatty acids than the Inuit diet (Dyerberg, 1972). It was observed that the Greenland Inuit had lowered levels of serum cholesterol, LDL, and VLDL, high HDL concentrations, prolonged bleeding times, easy bruisability, decreased number of platelets as well as a reduction in platelet aggregation. All of these factors have been linked to a low rate of coronary thrombosis.

Hirai et al (1980) found similar results as Bang and Dyerberg (1972) when they compared the diet and blood lipids of Japanese fishermen who consumed 2.6 g EPA/d with those of Japanese farmers (0.9 g EPA/d). They found a lower mortality rate from ischemic heart disease and cerebrovascular disorders in the

**Table 1.1 Dietary Fats in Inuit and Danish Food Intake Computed on a Daily Energy Consumption of 3000 kcal (Adapted from Dyerberg, 1986).**

Dietary Fats		Inuit	Danes
Fat energy	%	39	42
Saturated:	12:0	1.1	5.9
	14:0	3.7	7.5
	16:0	13.6	25.5
	18:0	4.0	9.5
	20:0	0.1	4.3
	% Total fats	23	53
Monoenes:	16:1	9.8	3.8
	18:1	24.6	29.2
	20:1	14.7	0.4
	22:1	8.0	1.2
	% Total fats	58	34
Polyenes:	18:2 n-6	5.0	10.0
	18:3 n-3	0.6	2.0
	20:5 n-3	4.6	0.5
	22:5 n-3	2.6	0
	22:6 n-3	5.9	0.3
	% Total fats	19	13
P/S Ratio		0.84	0.24
n-3 PUFAs (g/day)		14	3
n-6 PUFAs (g/day)		5	10
Cholesterol (g/day)		0.79	0.42

fishing village than the farming village and related this to a higher consumption of fish.

Retrospective epidemiological studies from some Western countries during World War II infer that a high intake of fish and fish products was associated with a reduction in thrombotic disorders. In Norway, Jensen and colleagues (1952) reported that mortality from coronary heart disease (CHD) as well as the incidence of thrombotic and embolic diseases decreased dramatically during the war. At the same time, due to food shortages, people had a reduced caloric intake and were forced to eat fish and fish products which resulted in an estimated three to four fold increase in intake of this particular food. Thus, the authors concluded that the fall in cardiovascular mortality was due to the cholesterol lowering effect of fish in the diet. In agreement, Bang and Dyerberg (1981) presented retrospective evidence of a relationship between long chain n-3 fatty acids and CVD in Oslo during the second world war. These authors calculated that this population consumed about 4-5 g of EPA a day. After the war, when the nutritional situation returned to normal, the prevalence of thrombotic diseases in Oslo increased to the pre-war level.

In a longitudinal study of risk factors and their relationship to chronic diseases, Kromhout et al (1985a, 1985b) recorded the dietary habits of a group of men in the town of Zutphen, Netherlands and followed its mortality over a 20 year period. They examined risk ratios for mortality from CHD in relation to the

amount of fish eaten and found that an inverse dose-response relationship was observed between fish consumption in 1960 and death from CHD during the 20 years of follow-up. Mortality from CHD was more than 50% less among those who consumed at least 30 g fish/d (less than 0.5 g EPA) than among those who did not eat fish, suggesting that the consumption of as little as one or two dishes per week may be of preventive value with regards to CHD. However, these investigators concluded that some element other than n-3 fatty acids was cardioprotective since there was such a low consumption of EPA by this population. In a critical review of the literature, Harris (1989) commented that there were drawbacks to this report such as the failure to continue prospective dietary surveys, the use of a single dietary survey without follow-up, and failure to report the fish intake of those with preexisting coronary disease who died.

The results of the Western Electric Study demonstrated the same inverse relationship between coronary death and the amount of fish eaten, supporting the observation by Kromhout et al (1985a, 1985b). Shekelle et al (1985) carried out this cohort study among 2000 middle-aged men employed by the Western Electric Company in Chicago, starting in 1957 and following this population for 25 years. The authors remarked that "although a biologic explanation for this association is not yet clearly established, the evidence supports the hypothesis that something associated with regular consumption of fish may be helpful in preventing CHD".

However, studies done in Norway (Vollset et al, 1985; Nordøy et al, 1987) and Hawaii (Curb and Reed, 1985) did not find this relationship. Vollset et al (1985) noted no such relation in the analysis of their follow-up study in Norway of 17,000 respondents to a postal delivery survey. Curb and Reed (1985) examined the relationship of reported fish consumption to total and fatal CHD over a 12 year follow-up period on 7615 Japanese men without prevalent atherosclerotic disease, as part of the Honolulu Heart Program. The apparent trends were not statistically significant when looking at the 12 year incidence rate for total and fatal CHD in relation to fish consumption. In rebuttal, Kromhout (1985b) commented that there was variation in the results of these studies because of the methods used to obtain the fish consumption data. The dietary reporting methods were similar in the Western Electric Study and the Zutphen Study. The investigators used extensive cross-check dietary histories, providing information on usual food intake. In contrast, Vollset et al (1985) collected information from a postal survey. They collected the information on the basis of responses to 3 questions about fish intake. From these questions a fish index was derived but, as Kromhout (1985b) remarks, it is not clear what amount of fish was consumed by the persons in the different categories of fish consumption. Curb and Reed (1985) conducted food frequency questionnaires along with 24 hour dietary recall surveys. These methods can result in errors in the collection and recording of food consumption data including respondent biases, i.e., over-

reporting 'good' foods and under-reporting those foods considered 'bad', memory lapses, and incorrect estimation of portion sizes.

Nordøy and coworkers (1987) commented that in a coastal community in Northern Norway, a traditionally high intake of fish was not sufficient to induce platelet and plasma lipids similar to what had been reported from Greenland and Japan. These investigators conducted a study in Northern Norway investigating the mortality from CHD and comparing the dietary lipid and hemostatic parameters in subgroups of the population in two communities. One group was located on the coast where the majority of the population was employed in the fishing industry and the other was a typical inland farming community. The fish consumption was approximately 2.5 times higher in the coastal area with two thirds of the intake being of a lean variety. The daily intake of EPA was 0.25 g for the inland area and 0.90 g for the coastal community. They found that the coastal region had higher plasma triacylglycerol levels and no significant differences in the other lipid fractions when compared to the inland group. Bleeding times were also similar in the two groups. In addition, a higher mortality for both men and women was observed in the coastal community. Nordøy et al (1987) concluded that "unknown potent thrombogenic factors may mask possible effects of a rather high intake of n-3 fatty acids." However, the coastal group's EPA intake in this study was not quantitatively different from the intake of the farmers in Japan (Hirai et al, 1980) or that of the Danish population

studied by Bang and Dyerberg (1972). Therefore, it is not surprising that Nordøy and coworkers observed similar results in the coastal and inland populations.

The epidemiological evidence for the beneficial CVD effects of dietary fish oils has been supported by data obtained by numerous animal and human feeding trials. The underlying mechanisms for reduced incidence of CVD by n-3 fatty acids have focused on lipid and lipoprotein metabolism.

A number of reports have shown that the consumption of fatty fish, marine oils rich in n-3 fatty acids or n-3 fatty acid supplements lower serum triacylglycerol concentrations compared to control diets in both human and animal investigations (Weiner et al, 1986; Garg et al, 1989; Singer et al, 1986; Fehily et al, 1983; Goodnight et al, 1982; Saynor et al, 1984; Schmidt et al, 1993; Phillipson et al, 1985; Harris et al, 1990; Harris et al, 1991; Simons et al, 1985). Lipoproteins that transport triacylglycerol, especially VLDL and IDL, have likewise been lowered (Weiner et al, 1986; Saynor et al, 1984; Nestel et al, 1984; Harris et al, 1991). There is overwhelming evidence that fish oils decrease both triacylglycerol and VLDL concentrations in a clear dose dependent fashion in normolipidemic as well as hyperlipidemic subjects. According to Nestel (1993), the average reduction in triacylglycerols seemed to be 40-50% and the minimal effective dose of n-3 fatty acids appeared to be about 1 g daily with a plateau in the concentration reached when the dose was between 5-10 g.



The triacylglycerol-lowering effect of n-3 fatty acids appears to be due to a decrease in fatty acid synthesis (Herzberg and Rogerson, 1988; Iritani et al, 1979; Iritani et al, 1980; Yang and Williams, 1978), a reduction in hepatic synthesis of triacylglycerols and the secretion of VLDL (Herzberg and Rogerson, 1988; Wong et al, 1984; Mizuguchi et al, 1993; Nestel et al, 1985; Harris et al, 1984; Nestel et al, 1984; Sanders et al, 1985; Connor, 1986), an increase in the clearance of triacylglycerol-containing lipoproteins (Herzberg and Rogerson, 1989; Baltzell et al, 1991; Herzberg et al, 1990; Mizuguchi et al, 1993; Goodnight et al, 1982), and perhaps, to a lesser extent, an increase in fatty acid oxidation in the liver (Wong et al, 1984) as well as the peripheral tissues. Decreased absorption of dietary fish oil does not appear to contribute to its hypotriacylglycerolemic effect (Chernenko et al, 1989; Herzberg et al, 1991; Thomson et al, 1988).

There is more uncertainty about the effects of EPA and DHA on plasma cholesterol, LDL, and HDL. LDL cholesterol has been found either to increase (Weiner et al, 1986; Saynor et al, 1984; Harris et al, 1991), decrease (Singer et al, 1986; Nestel et al, 1985), or not change (Fehily et al, 1983), despite diminished cholesterol absorption, decreased cholesterol synthesis, and increased sterol excretion (Mizuguchi et al, 1993). A minor increase in HDL cholesterol could generally be demonstrated (Singer et al, 1986; Schmidt et al, 1993; Harris et al, 1991), but could also decrease (Davis et al, 1987) or not change (Fehily et al, 1983; Goodnight et al, 1982; Saynor et al, 1984).

Studies have also examined the role of n-3 fatty acids in reducing the development of thrombotic disorders. Since thrombotic events include platelet activation as well as the explosive biosynthesis of the eicosanoid, thromboxane, investigations have focused on changes in fatty acid content of phospholipids following dietary fish oil supplementation (Abeywardena et al, 1987; Careaga-Houck and Sprecher, 1989; Heemskerk et al, 1989; Urakeze et al, 1987; Schick et al, 1990; Gibney and Bolton-Smith, 1988; Mori et al, 1987; Piche and Mahadevappa, 1990) as well as the effects of dietary fish oils on total phospholipids in platelet membranes (Abeywardena et al, 1987; Careaga-Houck and Sprecher, 1989; Heemskerk et al, 1989; Aukema and Holub, 1989), platelet function (Urakeze et al, 1987; Schick et al, 1990; Salonen et al, 1987; Gibney and Bolton-Smith, 1988; Nagakawa et al, 1983) and mechanisms which may alter platelet function (Heemskerk et al, 1989; Gibney and Bolton-Smith, 1988; Sanders et al, 1980; Lands et al, 1973; Culp et al, 1979; Corey et al, 1983; Hwang et al, 1988; Swann et al, 1989).

Evidently, diet manipulation with fish oils has a definite effect on platelet membrane fatty acid composition and, more than likely, platelet function. Fish oil supplementation does not seem to affect the relative proportions of the individual platelet phospholipids; i.e., total phosphatidylcholine (PC), phosphatidylethanolamine (PE), phosphatidylinositol (PI), phosphatidylserine (PS), and sphingomyelin (SM) (Abeywardena et al, 1987; Careaga-Houck and Sprecher,

1989; Heemskerk et al, 1989). Aukema and Holub (1989) also found that there was no marked change in the relative proportions of phospholipid subclasses, alkenylacyl PE and diacyl PE, in platelets over a 12 week experimental period. However, in both animal and human feeding trials, there is a change in the fatty acid composition of these phospholipids upon fish oil supplementation (Careaga-Houck and Sprecher, 1989; Abeywardena et al, 1987; Urakeze et al, 1987; Schick et al, 1990; Gibney and Bolton-Smith, 1988; Mori et al, 1987). A decrease in 20:4(n-6) with a concomitant rise in EPA in total phospholipids was seen upon fish oil supplementation. However, contradictory results were found with the accumulation of DHA or other n-3 polyunsaturated fatty acids in PC and PE; the fatty acid content of PS, PI, and SM; and the effect of diet-induced changes on platelet function.

The relationship between fish oil supplementation and platelet aggregation has been studied using platelet-rich plasma to which various concentrations of aggregating substances (i.e., collagen, ADP, and thrombin) have been added (Urakeze et al, 1987; Schick et al, 1990; Salonen et al, 1987; Gibney and Bolton-Smith, 1988). The results of several reports have shown that the consumption of fish oil can significantly decrease platelet aggregation (Urakeze et al, 1987; Schick et al, 1990; Nagakawa et al, 1983). These observations are of interest because platelet aggregation is considered to be involved in the development of arterial thrombosis after the formation of atherosclerotic plaques.

Several mechanisms have been proposed to explain diet-induced alterations in platelet function. First, many authors have suggested that fish oil feeding may alter membrane fluidity, and changes in fluidity may have a role in the activation process of blood platelets (Heemskerk et al, 1989; Gibney and Bolton-Smith, 1988). However, these investigations did not show any significant effects of fish oil supplementation on membrane fluidity measured by fluorescence polarization. In fact, Heemskerk et al (1989) suggested their results indicated that changes in platelet responsiveness to thrombin and  $\text{TxA}_2$ , rather than membrane fluidity, may be responsible for the effects of dietary fatty acids on rat platelet aggregability. Second, n-3 fatty acids may serve to promote platelet disaggregability through substrate competition, displacing 20:4(n-6) from tissue phospholipid pools and consequently, reducing the availability of 20:4(n-6) for thromboxane synthesis. It has been suggested that a decreased 20:4(n-6)/EPA ratio in platelet phospholipids may be responsible for decreased platelet aggregation after the consumption of fish oil (Sanders et al, 1986; Schick et al, 1990; von Schacky et al, 1985). A third mechanism involves the ability of EPA and DHA to competitively inhibit cyclooxygenase which would result in a decrease in  $\text{TxA}_2$  synthesis. It has been shown that n-3 polyunsaturated fatty acids can bind to the active site of this enzyme with affinities equal to or greater than that for 20:4(n-6) and therefore are effective inhibitors (Lands et al, 1973; Culp et al, 1979). Additional mechanisms that may explain the effect of fish oils on platelet lipid composition and function include 1) the possibility that long

chain n-3 fatty acids inhibit  $\Delta 6$ -desaturase and thus, the conversion of 18:2(n-6) to 20:4(n-6) (Hwang et al, 1988) and/or 2) that EPA and DHA may interfere with the binding of TxA<sub>2</sub> to the TxA receptor in platelets (Swann et al, 1989).

### **1.3.2 EICOSAPENTAENOIC ACID [EPA, 20:5(n-3)] AND DOCOSAHEXAENOIC ACID [DHA, 22:6(n-3)]**

The long chain n-3 fatty acids, EPA and DHA, appear to favourably modify more than one factor implicated in the pathogenesis of atherosclerosis and thrombosis. These fatty acids are involved in hypolipidemic effects, platelet effects, viscosity effects, blood pressure effects, and so on. However, questions still remain involving the nature and metabolism of these two fatty acids.

The n-3 fatty acids belong to a series of polyunsaturated fatty acids characterized by the first double bond at the third position from the methyl end whereas the n-6 fatty acids' first double bond is at the sixth position. Figure 1.7 illustrates the structural formula of the main n-3 and n-6 fatty acids in the human body. n-3 and n-6 fatty acids are not interconvertible (Figure 1.3). They form a significant part of cell membranes.

18:3(n-3) is found in some vegetable oils especially linseed, flaxseed and soybean oils. Fatty fish like mackerel, herring and salmon that live in the North Atlantic and marine mammals such as seal are particularly rich in DHA and EPA (Nordøy, 1991). The n-3 fatty acids in marine animals are exclusively 20 and 22 carbon fatty acids, probably because of the low temperature of the animal's environment which demands that their lipids include more highly unsaturated

molecules (Dyerberg, 1986). Table 1.2 summarizes the amount of n-3 fatty acid in different varieties of fish oil. A few terrestrial plants (some mosses and ferns) and range-fed nonruminant game animals are also sources of EPA and DHA (Tinoco, 1982).

The n-3 fatty acids are primarily found in biological tissues esterified to phospholipids, triacylglycerols, and cholesterol. In humans, n-3 fatty acids are present in all cell membranes but brain, retina, and reproductive organs are particularly rich in DHA, accounting for 15-25% of the total amount of DHA found in the body (Benolken et al, 1973; Lampty, 1976; Tinoco, 1979; Salem et al, 1986). DHA appears to be the principal n-3 fatty acyl component found in cells; 18:3(n-3) and EPA are usually only found in trace amounts in most tissues, often as metabolic intermediates (Salem et al, 1986). Of special interest, it appears that the removal of n-3 fatty acids from the diet of adult rats has little effect on the DHA content of the brain or retina. Since adult brain is resistant to DHA content loss, a deficient state can only be achieved by depriving an animal of n-3 fatty acid sources at an early stage of development or by depriving the female during pregnancy. Studies have shown that tissues high in DHA tenaciously retain it in the face of dietary challenge and replace it with other 20 or 22 carbon polyunsaturated fatty acids only when necessary (Salem et al, 1986). These investigations suggest that there is a critical period early in development when DHA is taken up from the diet and incorporated into phospholipids and



$\alpha$  -Linolenic acid (C18:3, n -3)



Eicosapentaenoic acid (C20:5, n-3)



Docosahexaenoic acid (C22:6, n-3)



Arachidonic acid (C20:4, n-6)



Linoleic acid (C18:2, n-6)

**Figure 1.7 Structures of the Main n-3 and n-6 Fatty Acids.**

**Table 1.2** n-3 Fatty Acid Content in Common Marine Oils (g/100 g fat).

Oils	18:3(n-3)	EPA (20:5, n-3)	DHA (22:6, n-3)
Cod Liver	0.7	9.0	9.5
Herring	0.6	7.1	4.3
Menhaden	1.1	12.7	7.9
Salmon	1.0	8.8	11.1
maxEPA (concentrate from Menhaden)	2.4	17.8	11.6



possibly that elongation and desaturation systems are more active during fetal or early developmental stages.

EPA and DHA have not only been shown to have similar biological actions such as their role in reducing platelet aggregability but, in addition, have been found to individually possess unique properties or functions. For instance, DHA clearly inhibits prostaglandin synthesis and has its own platelet-modifying actions separate from EPA but has little influence, unlike EPA, over leukotriene pathways (Gorlin, 1988). However, it is apparent that DHA has specific roles in visual acuity and brain development in the growing infant. It has been generally assumed that the various cardioprotective effects attributed to dietary fish and fish oils are due to EPA because it acts as a precursor of some of the eicosanoids.

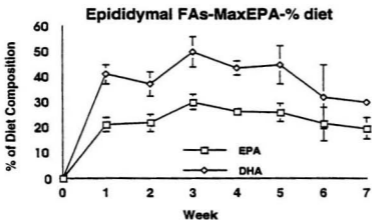
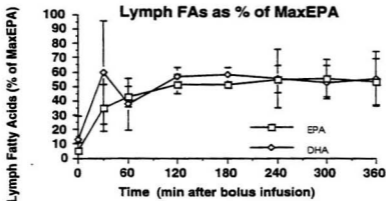
#### **1.4 THE PROBLEM STATEMENT-EPA IS PREFERENTIALLY METABOLIZED RELATIVE TO DHA.**

##### **1.4.1 RATIONALE**

Many investigators have suggested that EPA is preferentially metabolized compared to DHA, thus, implying that EPA may be the principal component in marine oils responsible for the beneficial CVD and antithrombotic effects. In addition, EPA may alter energy substrate utilization in such a way that it has a possible role in long term energy balance. Studies have shown an enrichment of DHA in tissues such as adipose tissue or skeletal muscle relative to EPA (Sheppard and Herzberg, 1992; Lin and Connor, 1990; Jandacek et al, 1991;

Raclot and Groscolas, 1994). Sheppard and Herzberg (1992) examined the effect of dietary fish oil and corn oil on the fatty acid composition in adipose tissue, muscle and liver for a period of seven weeks in young, growing rats. Their results clearly showed that the triacylglycerol composition of the tissues studied was influenced by the fatty acid composition of the dietary fat. They demonstrated that DHA was deposited in adipose tissue at a concentration similar to that at which it is absorbed. Figure 1.8 shows that the proportion of DHA absorbed is similar to the amount that is deposited in the epididymal fat pads of rats fed diets that contain fish oil (Herzberg, 1991). EPA, in adipose tissue, is considerably less than DHA and in the lymph during fish oil absorption.

Consequently, EPA is greatly underrepresented in adipose tissue compared with the amount of EPA absorbed from the diet. Similar results were observed in adipose tissue of rats studied by Jandacek et al (1991) and Raclot and Groscolas (1994) as well as in adipose tissue of rabbits (Lin and Connor, 1990). This difference in the n-3 fatty acid content of triacylglycerols is also seen in skeletal muscle and liver but it is most dramatic in the liver where DHA is present at nearly twice its content in the diet and nearly 50% more than EPA (Sheppard and Herzberg, 1992). These results are consistent with those reported by Yeo and Holub (1990) for liver triacylglycerols.



**Figure 1.8** Lymph Fatty Acids as Percentage of MaxEPA and Epididymal Fatty Acids-MaxEPA-Percentage of Diet. (Adapted from Herzberg, 1991).

#### 1.4.2 OVERALL HYPOTHESIS

The reason for the underrepresentation of EPA in adipose tissue is still unknown. This underrepresentation is not due to differential intestinal absorption because, previously in our laboratory, it has been shown that both of these fatty acids are absorbed to the same extent in rats (Chernenko et al, 1989). We hypothesize that EPA is preferentially utilized relative to DHA by peripheral tissues and that is why relatively less EPA is stored. Three possible mechanisms to explain this overall hypothesis of preferential utilization include:

Mechanism #1: EPA is preferentially oxidized relative to DHA in muscle.

Mechanism #2: EPA is preferentially released relative to DHA from circulating triacylglycerols.

Mechanism #3: EPA is preferentially secreted into bile relative to DHA.

#### 1.4.3 PRIMARY OBJECTIVES OF THE STUDY

Mechanism #1: EPA is preferentially oxidized relative to DHA in muscle.

Objectives:

- 1.1 To examine the oxidation of EPA and DHA by soleus muscle homogenates from rats fed fish oil containing diets.
- 1.2 To examine the oxidation of EPA and DHA by the intact soleus muscle of rats fed fish oil containing diets.
- 1.3 To examine the oxidation of EPA and DHA by cardiac myocytes of rats fed fish oil containing diets.

Mechanism #2: EPA is preferentially released relative to DHA from circulating triacylglycerols.

Objective:

2.1 To investigate the rate of hydrolysis of EPA and DHA from triacylglycerols found in chylomicrons.

Mechanism #3: EPA is preferentially secreted relative to DHA in bile.

Objective:

3.1 To investigate the biliary secretion of EPA and DHA in phospholipids from rats fed fish oil containing diets.

Chapter 2 of this report discusses the oxidation studies which examined the hypothesis that enhanced oxidation of EPA relative to DHA in the peripheral tissues; i.e., skeletal muscle and cardiac muscle, results in less EPA available for storage (Objectives 1.1, 1.2, 1.3). Chapter 3 covers the research that considered the question of selective release of EPA from triacylglycerols (Objective 2.1). These investigations employed heart lipoprotein lipase as the enzyme and chylomicrons isolated from lymph as the substrate. Lastly, Chapter 4 deals with the secretion of EPA and DHA into bile using bile cannulated rats as the animal model (Objective 3.1).

#### 1.4.4 SECONDARY OBJECTIVES OF THE STUDY

Previous work in our laboratory, as well as by others, compared the differing effects of the n-3 and n-6 series of fatty acids on lipid metabolism. Consequently, we decided it would be of interest and value to use the same comparisons in the feeding experiments reported in this thesis.

In addition, the experimental design of this study allowed us to investigate the effect of dietary fat composition, i.e., n-3 and n-6 fatty acids, on fatty acid oxidation and on bile phospholipid composition. Even though there is some evidence that a high fat diet has an effect on bile flow and the secretion of biliary lipids (Knox et al, 1991; Balasubramaniam et al, 1985; Ramesha et al, 1980; Turley and Dietschy, 1979), there are few data on the effect of diets on the composition of biliary phospholipids. We were interested in examining this effect because it has been suggested that bile lipids contribute to the composition of lipid in lymph.

Consequently, rats were fed either a diet containing 10% corn oil or 8% MaxEPA oil plus 2% corn oil as the fat source to investigate the following objectives:

- Objective 1.1.1 To determine whether the rates of oxidation of EPA and DHA by rat soleus muscle homogenates are affected by diets rich in either n-6 fatty acids or n-3 fatty acids.

- Objective 1.3.1 To determine whether the oxidation of EPA and DHA by rat cardiac myocytes is affected by diets rich in either n-6 fatty acids or n-3 fatty acids.
- Objective 3.1.1 To determine whether the composition of biliary phospholipids could be altered by feeding rats diets rich in either n-6 fatty acids or n-3 fatty acids.
- Objective 3.1.2 To determine whether diets rich in n-6 fatty acids or n-3 fatty acids affect the rate of bile flow as well as the biliary secretion of phospholipids, cholesterol, and bile acids.
- Objective 3.1.3 To determine if feeding a meal rich in n-3 or n-6 fatty acids could induce short-term changes in the fatty acid composition of biliary phospholipids after rats have been fed diets containing either fish oil or corn oil.
- Objective 3.1.4 To determine whether diets rich in n-6 fatty acids or n-3 fatty acids affect the rate of bile flow as well as the biliary secretion of phospholipids, cholesterol, and bile acids after an infusion of fish oil or corn oil.

## CHAPTER 2.0

### FATTY ACID OXIDATION IN SKELETAL AND CARDIAC MUSCLE

#### 2.1 INTRODUCTION

While studying the mechanism(s) for the triacylglycerol-lowering effect of dietary fish oil, Wong and her colleagues (1984) found that not only did fish oil feeding result in a decrease in the synthesis and secretion of VLDL by isolated perfused rat livers, but that this decrease in synthesis and secretion was also accompanied by an increase in ketogenesis, suggesting an increase in hepatic fatty acid oxidation. Aarsland et al (1990) investigated whether the stimulation of fatty acyl CoA oxidase and carnitine palmitoyltransferase (CPT) activities, the key enzymes in peroxisomal and mitochondrial oxidation of fatty acids, respectively, might contribute to the triacylglycerol-lowering effect of fish oils in rats. Their data support the concept that long chain n-3 fatty acids from fish oils act by partitioning free fatty acids away from triacylglycerol synthesis toward fatty acid oxidation (especially peroxisomal oxidation) in the liver. Furthermore, Gavino and Gavino (1991) determined that CPT was more reactive with the fatty acyl CoA of EPA than the fatty acyl CoA of DHA in liver mitochondria. These results are consistent with increased oxidation of EPA relative to DHA in liver.

Herzberg and Rogerson (1989) argued that if enhanced oxidation is to play a role in the hypotriacylglycerolemic effect of fish oils, then there should be



a change in the activity of lipoprotein lipase (LPL) in peripheral tissues to allow for the increased delivery of fatty acids for oxidation. They determined the activity of LPL in muscle (i.e., hindlimb and heart) and adipose tissue of rats fed diets containing corn oil, tallow and marine oil as their fat source for a period of 2 weeks. These authors found that adipose tissue LPL activity was unaltered by dietary fat but muscle LPL activity was increased in animals fed fish oil (Figure 2.1) as they hypothesized. This observation has been confirmed by Baltzell et al (1991) who found that the activity of LPL was higher in the soleus muscle of rats fed menhaden oil compared with corn oil, although there was no effect on hepatic lipase.

Subsequently, Herzberg et al (1990) examined the clearance of EPA and 18:1(n-9) by perfused hindquarters of rats fed either a corn oil or fish oil based diet (Figure 2.2). They found that the clearance of both fatty acids was higher in rats consuming the fish oil containing diet. In addition, with either diet, the clearance of EPA was greater than 18:1(n-9). Thus, they concluded that there may be preferential removal of EPA compared with 18:1(n-9) regardless of the dietary fat but that the removal of either fatty acid was enhanced in animals fed fish oil. In human studies, it has been shown that EPA disappears faster than DHA from plasma or erythrocytes after fish oil supplementation (Hodge et al, 1993; Brown et al, 1991). From the clearance data, we presumed that perhaps more EPA is available to peripheral tissues; i.e., skeletal muscle and heart, to take

part in various metabolic processes such as oxidation, thus making it less available for storage in adipose tissue.

These observations plus the fact that EPA is underrepresented in adipose tissue triacylglycerols (Figure 1.8) compared to DHA led us to hypothesize that EPA is oxidized at a faster rate in muscle than DHA. Thus, to investigate this proposal, fatty acid oxidation studies were conducted using soleus muscle homogenates, intact soleus muscle and cardiac myocytes. The purpose of the experiments discussed in this chapter (section 2.3 to section 2.6) was to examine preferential fatty acid oxidation, particularly oxidation of the EPA and DHA, in skeletal and cardiac muscle.

The intent of the next section (2.2) is to describe the pathway of  $\beta$ -oxidation of long chain fatty acids in muscle (Figure 2.3) and to review the current literature on its regulation. It should be noted that there is a scarcity of information available on the regulation of fatty acid oxidation in skeletal muscle since most studies have been done with the isolated perfused rat heart. This model is used often because it is a convenient, highly controlled and viable organ system (Ontko, 1986).

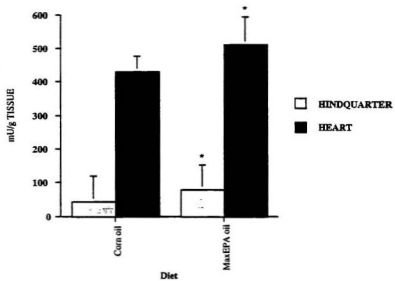


Figure 2.1 Muscle Lipoprotein Lipase Activity (Adapted from Herzberg and Rogerson, 1989). \* denotes a significant difference due to diet.

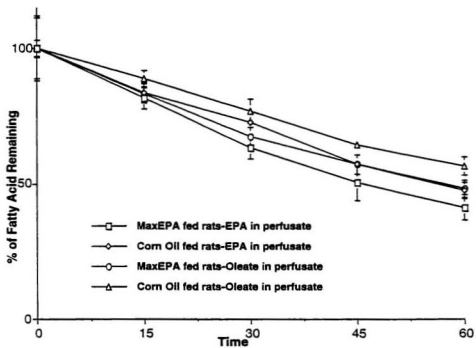


Figure 2.2 Hindquarter Fatty Acid Clearance (Adapted from Herzberg et al, 1990).

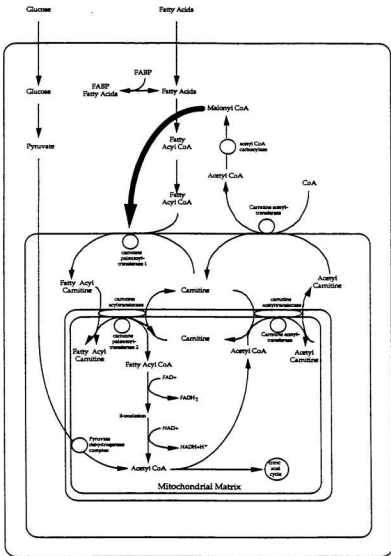


Figure 2.3 β-oxidation of Long Chain Fatty Acids in Heart (Adapted from Lopaschuk et al, 1994).

## 2.2 $\beta$ -OXIDATION OF FATTY ACIDS IN MUSCLE

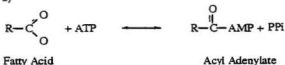
Fatty acid oxidation is a major energy source for some tissues (i.e. cardiac and skeletal muscle) in the body. The degree of fatty acid utilization depends upon the metabolic state of the body and becomes significant when an individual is fasting, exercising, or on a high fat diet. Fatty acid oxidation is quantitatively important in muscle due to the body's large muscle mass (Bremer, 1983). Fatty acids are degraded by the oxidation of the  $\beta$ -carbon, and may be oxidized in the mitochondrial or peroxisomal matrix. Peroxisomes appear to have a role in chain shortening of very long chain fatty acids (Singh et al, 1987).

The regulation of fatty acid oxidation in muscle appears to be a complicated interplay of many factors such as the availability of energy-yielding substrates, the need for ATP, the acetyl CoA:CoA ratio, the level of malonyl CoA and so on. In muscle, the overall rate of fatty acid oxidation is controlled by the supply of free fatty acids to the tissue and the need for energy. By comparison, the key control in liver is a low plasma glucose concentration. When glucose levels are low, there is a decrease in insulin secretion resulting in a decrease in intracellular malonyl CoA and a rise in fatty acid oxidation (Halperin and Rolleston, 1990).

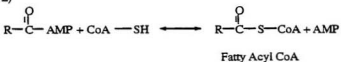
## 2.2.1 THE PATHWAY OF MITOCHONDRIAL $\beta$ -OXIDATION OF FATTY ACIDS

The initial step in fatty acid metabolism is the activation of fatty acids to their corresponding fatty acyl CoAs. This activation takes place in the cytosol prior to their entry into the mitochondrial matrix. The activation reaction, catalyzed by acyl CoA synthetase, is the summation of two steps:

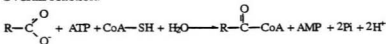
1)



2)



Overall reaction:



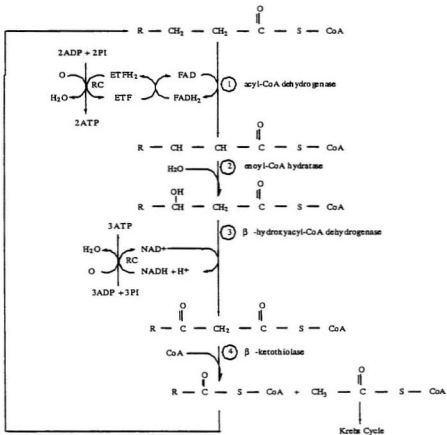
The reaction is driven forward since inorganic pyrophosphate is hydrolyzed by a pyrophosphatase. The hydrolysis of two high energy compounds makes this overall reaction essentially irreversible.

Long chain fatty acids require carnitine for transport into the mitochondrial matrix (Figure 1.6) whereas medium chain (C8-C10) acyl CoAs are carnitine independent (McGarry et al, 1977). McGarry et al (1977) used the fact that the transport of medium chain acyl CoAs was carnitine independent when malonyl CoA was found to potently suppress the oxidation of 18:1(n-9) in rat

liver homogenates while having no effect on the oxidation of octanoic acid or octanoylcarnitine. Four components are presumed to be involved in the transport system (Halperin and Rolleston, 1990); 1) the malonyl CoA regulatory protein of carnitine palmitoyltransferase (CPT) on the outer mitochondrial membrane (Murthy and Pande, 1987) 2) the CPT on the inner aspect of the outer mitochondrial membrane (CPT<sub>o</sub> or CPT<sub>1</sub>) which converts external acyl CoA to acylcarnitine (Murthy and Pande, 1987), 3) a translocase which exchanges mitochondrial carnitine for cytoplasmic fatty acyl-carnitine (Noel et al, 1985), and 4) the CPT on the inner mitochondrial membrane (CPT<sub>i</sub> or CPT<sub>2</sub>) which regenerates fatty acyl CoA inside the mitochondria (Figure 1.6).

Saturated acyl CoAs (for example, 16:0) are then oxidized by a recurring sequence of four reactions (Figure 2.4): 1) an oxidation reaction linked to FAD, 2) a hydration step, 3) a second oxidation reaction linked to NAD<sup>+</sup>, and 4) the thiolysis of CoA. The electron-transferring flavoprotein (ETF) shown in Figure 2.4 is an intermediate in the transfer of electrons from acyl CoA dehydrogenase to the respiratory chain. The  $\beta$ -oxidation of 16:0 requires 7 sequential cycles and yields 8 acetyl CoA molecules, 7 FADH<sub>2</sub>, and 7 NADH per molecule of the fatty acid. The oxidation of even chain unsaturated fatty acids follows the same sequence but requires two additional reactions involving an isomerase and reductase. If odd chain fatty acids are oxidized, a propionyl CoA is generated in the final thiolysis step.





**Figure 2.4 Fatty Acid  $\beta$ -oxidation in the Mitochondrial Matrix (Adapted from Ontko, 1986).**

## 2.2.2 PEROXISOMAL $\beta$ -OXIDATION OF FATTY ACIDS

Peroxisomal  $\beta$ -oxidation occurs by reactions which are similar to those of mitochondrial fatty acid oxidation. As with mitochondrial  $\beta$ -oxidation, peroxisomal  $\beta$ -oxidation proceeds via four consecutive reactions that take place in the peroxisomal matrix (Reddy and Mannaerts, 1994; Schulz, 1990). However, there are definite differences between the fatty acid oxidation in these two organelles. The differences between the two pathways include the following points:

- Very long chain acyl CoA synthetase, the enzyme responsible for the activation of very long chain fatty acids (chain length of 20 carbons or more), is present in peroxisomes and endoplasmic reticulum but not in mitochondria (Singh and Poulos, 1988). This may explain why long chain fatty acids are oxidized predominantly in peroxisomes.
- The first reaction in peroxisomal  $\beta$ -oxidation (desaturation of acyl CoA) is catalyzed by an FAD-containing fatty acyl CoA oxidase which is presumed to be the rate-limiting enzyme whereas an acyl CoA dehydrogenase is the first enzyme in the mitochondrial pathway.
- Peroxisomal  $\beta$ -oxidation is not directly coupled to an electron transfer chain that conserves energy by means of oxidative

phosphorylation. Electrons generated in the first oxidation step are transferred directly to molecular oxygen yielding  $H_2O_2$  that is disposed of by catalase. However, energy produced in the second oxidation step ( $NAD^+$  reduction) is conserved in the form of high energy level electrons of NADH

- The second (hydration) and third ( $NAD^+$ -dependent dehydrogenation) steps in peroxisomes are catalyzed by a multifunctional protein which also displays  $\Delta^3$ ,  $\Delta^2$ -enoyl CoA isomerase activity required for oxidation of unsaturated fatty acids (Reddy and Mannaerts, 1994). On the other hand, it is proposed that all the enzymes in the mitochondrial pathway are organized into a multienzyme complex (Stanley and Tubbs, 1975; Srere, 1980).
- Peroxisomal  $\beta$ -oxidation does not go to completion but catalyzes a limited number of  $\beta$ -oxidation cycles and thus, acts as a chain shortening system. The enzymes have virtually no activity towards short chain fatty acyl CoA esters.
- Acetyl CoA generated by mitochondrial  $\beta$ -oxidation enters the Krebs cycle for further oxidation or condenses to keto acids in the liver. Peroxisomes lack the Krebs cycle and ketogenic enzymes, thus the fate of the acetyl units produced by the peroxisomal  $\beta$ -oxidation is unknown. Either they are further oxidized in mito-

chondria or used for biosynthetic purposes (Reddy and Mannaerts, 1994).

- The mechanism of fatty acid entry into peroxisomes still remains unclear. The common belief that the uptake of fatty acyl substrates into the peroxisomal matrix was carnitine independent has been challenged by recent evidence. An enzyme (CPT<sub>p</sub>) which shares a number of properties with mitochondrial CPT<sub>o</sub> has been identified in peroxisomes (Vamecq, 1987; Derrick and Ramsay, 1989; Guzman and Geelen, 1993).

### 2.2.3 REGULATION

The overall factors which determine the rate of fatty acid oxidation in muscle are substrate availability and the rate of energy utilization. The supply of fatty acids to muscle cells depends on the composition of the diet, the concentration of VLDL in the circulation, the concentration of plasma fatty acids complexed to albumin, and the cellular uptake of free fatty acids from the circulation.

Dietary long chain fatty acids enter the circulation as triacylglycerols in chylomicrons and fatty acids become available to the muscle cell after the hydrolysis of the triacylglycerols by LPL. If the diet is low in fat, then there is a rapid rate of *de novo* synthesis of fatty acids in the liver from carbohydrate precursors (Ontko, 1986). Fatty acids are then transported to the muscle in

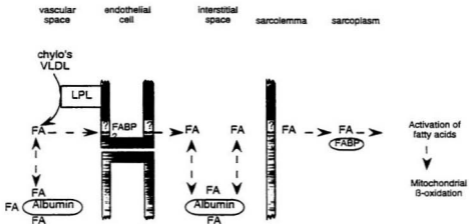
triacylglycerol-rich lipoproteins, VLDL. It is believed that increased insulin levels due to carbohydrate intake may promote LPL activity in adipose tissue which is responsible for the hydrolysis of triacylglycerols at the plasma membrane (Robinson, 1963).

Fatty acids can also be mobilized from adipose tissue to the muscle in calorie-restricted, diabetic, postabsorptive and fasting conditions. This is an important regulatory process with respect to rates of fatty acid oxidation in many animal tissues. It has been postulated that the supply of fatty acids in these conditions is mainly controlled by the activity of hormone-sensitive lipase (HSL) which is responsible for the hydrolysis of triacylglycerol within the adipocyte (Stralfors et al, 1987; Halperin and Rolleston, 1990). This enzyme is subject to regulation by covalent modification, specifically phosphorylation/dephosphorylation. When insulin levels are low, as in the case of fasting or diabetes, HSL is phosphorylated resulting in a rise in activity and therefore, an increase in triacylglycerol hydrolysis.

Normally, the tissue level of fatty acids in the heart is very low. However, oxygen deprivation to cardiac cells as in the case of ischemia, will diminish or completely abolish mitochondrial  $\beta$ -oxidation, the Krebs cycle and respiratory chain activity and hence, accumulation of fatty acids and their metabolic derivatives occurs (Van Der Vusse et al, 1992). According to Van Der Vusse et al (1992), in the initial phase of ischemia, when hardly any irreversible cell damage

occurs, the rate of the so-called triacylglycerol-fatty acid cycle (i.e., simultaneous hydrolysis and resynthesis of triacylglycerol) is enhanced, leading to wasteful energy consumption.

The route of fatty acid transport from the vascular space to the cytoplasm of the cardiomyocytes comprises a sequence of events and, unlike other organs such as liver, is much more complicated due to the presence of closed fenestrae between the endothelial cells (Van Der Vusse et al, 1992). The cellular uptake of fatty acids may involve facilitated transport via a fatty acid binding protein (FABP) but this hypothesis is still debatable since other studies claim that the uptake occurs by spontaneous diffusion (Schulz, 1994). Van Der Vusse et al (1992) states that "After translocation through the luminal membrane of the endothelial cell, diffusion of fatty acids occurs through the interstitial space between the endothelial and parenchymal cells of the heart and is most likely mediated by albumin" (Figure 2.5). The sarcolemma is crossed either passively or facilitated by specific membrane proteins identified as plasma membrane FABPs. Three tissue specific FABPs have been isolated in the cytosol and it has been suggested that these proteins are responsible for transporting fatty acids within the cytoplasm to the mitochondrial membrane (Ockner et al, 1972; Bremer, 1983; Schulz, 1994).



**Figure 2.5** Transport of Fatty Acids in Heart Tissue (Adapted from Van Der Vusse, 1992). Abbreviations are: FA=fatty acid; FABP=fatty acid binding protein; LPL=lipoprotein lipase.

The need for ATP required for muscle work also influences the rate of fatty acid oxidation. In muscle tissues, which lack ketogenesis, Bremer (1983) indicated that  $\beta$ -oxidation must be tightly coupled to the Krebs cycle through the common mitochondrial pool of CoA, especially under conditions in which, for example, the heart uses fatty acid almost exclusively for its energy needs. Furthermore, he suggested that feedback mechanisms must exist by which a variable use of acetyl CoA in mitochondria can adjust the rate of fatty acid uptake, activation, and acylcarnitine formation in the extramitochondrial compartment (Bremer, 1983).

#### 2.2.3.1 ENZYMATIC REGULATION

The conversion of fatty acids to acetyl CoA consists of three major stages: 1) activation of fatty acids to form acyl CoA, 2) formation and translocation of acylcarnitine and regeneration of acyl CoA in the matrix, and 3) the  $\beta$ -oxidation sequence.

The activation reaction is catalyzed by the enzyme, acyl CoA synthetase. It is not clear to what extent the synthetase reaction is rate-limiting, if at all, in the oxidation of long chain fatty acids. It has been suggested that the rate-limiting step for very long chain fatty acids is the chain shortening system which is attributed to the peroxisomes (Singh et al, 1987). The activation reaction appears to be effectively controlled by the cytoplasmic acyl CoA:CoA ratio as well as the



total concentration of CoA and is inhibited by its reaction products, inorganic phosphate and AMP (Van Der Vusse et al, 1992).

Acyl CoA synthetases appear to differ in their specificities with regards to the chain length of fatty acids (Lazo et al, 1990). For instance, myocardial tissue contains short chain, medium chain, and long chain acyl CoA synthetases. The long chain acyl CoA synthetase is predominantly localized on the outer side of the mitochondrial outer membrane in the heart but probably also to some extent at the sarcoplasmic reticulum (Van Der Vusse et al, 1992). Furthermore, long chain acyl CoA synthetases such as palmitoyl CoA synthetase have been shown to be present in mitochondria, peroxisomes and microsomes (Miyazawa et al, 1985) and immunological evidence suggests that the palmitoyl CoA synthetases located in these three organelles are identical (Miyazawa et al, 1985). Lazo et al (1990) observed that lignoceroyl CoA synthetase, a very long chain acyl CoA synthetase, and palmitoyl CoA synthetase are two distinct enzymes and that mitochondria lack the former enzyme. This data further supports acyl CoA synthetases' substrate specificity and subcellular regulation in fatty acid metabolism.

Suzuki et al (1990) provided evidence for the stimulation of long chain acyl CoA synthetase in rat liver by diet at the pretranscriptional level. They observed that long chain acyl CoA synthetase mRNA is expressed in liver, heart, and epididymal adipose tissue and to a much lesser extent, in brain, small

intestine, and lung. The level of long chain acyl CoA synthetase mRNA increased seven to eight fold in rat liver by feeding a diet high in carbohydrate or fat.

CPT<sub>o</sub> and CPT<sub>i</sub> catalyze the interconversion of fatty acyl CoAs to fatty acylcarnitines (Figure 1.6) and play a role in mitochondrial transport of fatty acyl CoAs. The formation of acylcarnitines commits the fatty acid to the oxidative pathway. This step is considered by some investigator as being rate-limiting. McGarry et al (1978, 1977) proposed that CPT<sub>o</sub> was the malonyl CoA-sensitive enzyme and the key regulatory site for fatty acid oxidation in rat liver mitochondria whereas CPT<sub>i</sub> appeared to be the malonyl CoA-insensitive enzyme. It is assumed that malonyl CoA interacts competitively with palmitoyl CoA causing a conformational change in the catalytic component and thus, the loss of activity of CPT<sub>o</sub>. In 1983, these researchers studied the response of CPT<sub>o</sub> to carnitine in mitochondria isolated from various tissues in experimental animals and man (McGarry et al, 1983). In non-lipogenic tissues (i.e. cardiac and skeletal muscle), they found a marked sensitivity of CPT<sub>o</sub> to malonyl CoA inhibition. However, in contrast to liver, the activity of CPT<sub>o</sub> in heart, and its sensitivity toward malonyl CoA, does not appear to change in response to fasting (Mynatt et al, 1992; Cook and Lappi, 1992). Cook and Lappi (1992) suggested that changes in fatty acid oxidation in the heart are probably due to changes in malonyl CoA concentrations or to other inhibitors as opposed to

altered sensitivity to the inhibition in response to dietary states such as fasting. Thus, possible control of myocardial fatty acid oxidation via the regulation of CPT<sub>1</sub> by malonyl CoA remains an unresolved issue.

Veerkamp and Van Moerkerk (1985) compared the effects of carnitine omission and of various inhibitors (i.e. malonyl CoA, tetradecylglycidic acid, and mersalyl) on fatty acid oxidation by homogenates of rat liver, rat skeletal muscle and human skeletal muscle as well as rat muscle mitochondria. They also reevaluated the effects of nutritional state, palmitate/albumin ratio and pH on malonyl CoA sensitivity of palmitate oxidation. Inhibitors of mitochondrial fatty acid transport and the omission of carnitine decreased oxidation more strongly with muscle than with liver homogenates. The effect on malonyl CoA sensitivity was dependent on nutritional state, pH, and palmitate/albumin ratio in liver homogenates but only the latter parameter with muscle homogenates.

Surprisingly, malonyl CoA was found to be present in significant amounts in rat heart and skeletal muscle (McGarry et al, 1978). Malonyl CoA is synthesized from acetyl CoA by the enzyme, acetyl CoA carboxylase (ACC), and it appears that in the heart the primary role of ACC is in regulating fatty acid oxidation (Lopaschuk et al, 1994). Bianchi et al (1990) identified an unique biotin-containing cytosolic protein of molecular mass 280 kDa expressed in rat cardiac and skeletal muscle that was coexpressed with the 265 kDa protein in rat liver, mammary gland, and brown adipose tissue. They concluded that the 280

kDa protein is an isoform of ACC, distinct from the previously cloned 265 kDa species. Its presence in cardiac and skeletal muscle, where fatty acid synthesis rates are low, suggest that it might play alternative roles in these tissues such as in the regulation of fatty acid oxidation or microsomal fatty acid elongation. Saddik et al (1993) investigated the role of ACC in regulating fatty acid oxidation in isolated, fatty acid perfused working rat hearts. The overall fatty acid oxidation rates were determined by the addition of 1.2 mM [ $^3\text{H}$ ]palmitate to the perfusate of hearts in which the endogenous triacylglycerol pool was prelabelled with [ $^{14}\text{C}$ ]palmitate. Rates of both exogenous and endogenous fatty acid oxidation were measured by simultaneous measurement of  $^3\text{H}_2\text{O}$  and  $^{14}\text{CO}_2$  production, respectively. They found that ACC is an important regulator of fatty acid oxidation in the heart and that acetyl CoA supply is a key determinant of heart ACC activity. Furthermore, Awan and Saggerson (1993) examined malonyl CoA metabolism in viable myocytes obtained from rat hearts and concluded that malonyl CoA can be synthesized within cardiac myocytes and that the level of this metabolite can be acutely regulated. As acetyl CoA levels increase, ACC is activated resulting in an increase in malonyl CoA and thus malonyl CoA inhibition of fatty acid oxidation.

A great deal of work has focused on the characterization of the CPT enzyme system. Difficulties in the characterization of these enzymes have been due to the fact that the readily purified, catalytically active form of CPT isolated

from detergent extracts of mitochondria represents only CPTi and not CPTo. CPTo seems to lose its activity when released from its membrane environment. It is not clear whether CPTo and CPTi result from the same mitochondrial CPT protein and this has limited the attempts at molecular characterization of CPT regulation.

To answer the question of whether CPTo and CPTi represent the same or distinct proteins, two models have been postulated (Figure 2.6) (McGarry et al, 1990). Model 1 suggests that they are the same protein but CPTo has a regulatory unit. Using detergents to solubilize the proteins is assumed to disrupt the link between the regulatory and catalytic units in CPTo and consequently, releases the enzyme from inhibitory control. The second model suggests that there are two distinct proteins. Murthy and Pande (1990) presented evidence that supported the concept of model 2. They were able to obtain a solubilized malonyl CoA-sensitive CPTo from the outer membranes of rat liver mitochondria by using octyl glucoside in the presence of glycerol and were also able to separate CPTo from CPTi using HPLC on a hydroxyapatite column. Their results indicated that CPTo and CPTi are distinct proteins and that a subunit of 90 kDa for liver and 86 kDa for muscle constituted a component of their respective CPTo systems while the 66 kDa subunit of CPTi did not. Their most convincing evidence for this conclusion involved a polyclonal antibody

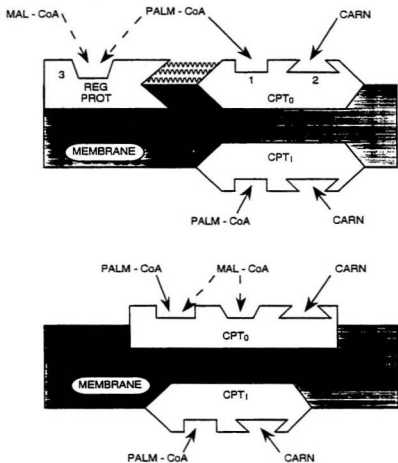


Figure 2.6 Possible Schemes for Malonyl CoA Inhibition of CPT<sub>0</sub> (Adapted from McGarry et al, 1990). Model 1 is represented on top and Model 2 on the bottom of the diagram. Abbreviations are: CPT<sub>0</sub> (same as CPTI)=carnitine palmitoyl transferase o (I); CPT<sub>i</sub> (same as CPTII)=carnitine palmitoyl transferase i (II); Mal-CoA=malonyl CoA; Palm-CoA=palmitoyl CoA; CARN=carnitine.

which was raised against CPTI. This antibody precipitated the CPTi activity but showed no reactivity with the CPTo fractions. Other investigators (Declercq et al, 1987; Woeltje et al, 1990) have also observed a protein in rat liver and muscle mitochondria of 94 kDa and 86 kDa, respectively. Furthermore, a protein of smaller mass (about 70 kDa) has been observed in rat liver and muscle (Woeltje et al, 1987; Woeltje et al, 1990). Recently, CPTo and CPTi have been cloned providing further evidence that they are two different proteins (Esser et al, 1993a; Esser et al, 1993b).

The  $\beta$ -oxidation pathway in mitochondria is primarily governed by the rate of regeneration of the nucleotide substrates for acyl CoA dehydrogenase (FAD) and  $\beta$ -hydroxyacyl CoA dehydrogenase (NAD<sup>+</sup>) (Figure 2.4) (Ontko, 1986; Wang et al, 1991). However, the detailed mechanism of this regulation is not known. It has been suggested that the  $\beta$ -oxidation enzymes in mitochondria are organized in a multienzyme complex but this complex has not been isolated (Stanley and Tubbs, 1975; Srere, 1980). One feature which contributes to the complexity in this area of study is the existence of multiple enzyme forms exhibiting different chain length specificities (Thorpe, 1989).

Three distinct acyl CoA dehydrogenases with different fatty acid chain length specificities have been isolated from hepatic mitochondria (Ikeda et al, 1985). These enzymes have four presumably identical subunits, and each subunit contains one noncovalently bound FAD which functions as an electron acceptor

in the dehydrogenation reaction. Two enoyl CoA hydratases have been identified in pig heart mitochondria (Fong and Schulz, 1981) with short and long chain specificity.  $\beta$ -hydroxyacyl CoA dehydrogenase has broad chain length specificity but a long chain specific enzyme has been isolated by El-Fakhri and Middleton (1982). The essential function of the long chain enoyl CoA hydratase and  $\beta$ -hydroxyacyl dehydrogenase remains to be established.

The equilibrium is far to the product side in the thiolysis reaction which pulls the  $\beta$ -oxidation cycle to completion. Two thiolases have been identified; the 3-ketoacyl CoA thiolase is believed to be involved in  $\beta$ -oxidation and has broad chain specificity while acetoacetyl CoA thiolase functions in ketone body metabolism (Middleton, 1975). If the essential sulfhydryl group of the thiolase is oxidized or blocked, the enzyme becomes inactive. Thiolases are sensitive to oxygen, alkylating agents and heavy metal ions (Schulz, 1990).

According to Schulz (1994), "it is proposed that the flux of fatty acids through  $\beta$ -oxidation in heart is controlled by the mitochondrial ratio of acetyl CoA:CoASH. This ratio is determined by the activity of the Krebs cycle and reflects the energy state of mitochondria and ultimately of the whole tissue. The site of this control is the thiolase-catalyzed last step of  $\beta$ -oxidation". Studies have demonstrated that both the activity of 3-ketoacyl CoA thiolase and the rate of fatty acid oxidation, at sufficiently high levels of fatty acids, are inversely related to the mitochondrial ratio of acetyl CoA:CoASH (Latipaa, 1989; Wang et



al, 1991; Olowe and Schulz, 1980). Wang et al (1991) studied the mechanism by which the rate of fatty acid oxidation is tuned to the energy demand of the heart by studying the effects of changing intramitochondrial ratios of [acetyl CoA/CoASH] and [NADH/NAD<sup>+</sup>] on the rate of  $\beta$ -oxidation. They concluded that the rate of  $\beta$ -oxidation can be regulated by the intramitochondrial acetyl CoA/CoASH ratio which reflects the energy demands of the heart. The thiolytic cleavage catalyzed by 3-ketoacyl CoA thiolase may be the site at which  $\beta$ -oxidation is controlled by this ratio. Schulz (1993) notes that this regulatory mechanism is not effective in liver, in which the regeneration of CoASH from acetyl CoA is facilitated not only by the Krebs cycle but also by ketone body synthesis.

### 2.3 PURPOSE OF EXPERIMENTS

The primary objectives (1.1, 1.2, and 1.3) of the experiments described in this chapter examine the first proposed mechanism; i.e., EPA is preferentially oxidized relative to DHA in muscle. The secondary objectives (1.1.1 and 1.3.1) addressed the effect of dietary fat composition, i.e., n-3 and n-6 fatty acids on fatty acid oxidation.

- |               |   |
|---------------|---|
| Objective 1.1 | To examine the oxidation of EPA and DHA by soleus muscle homogenates from rats fed fish oil containing diets. |
|---------------|---|

- Objective 1.1.1 To determine whether the rates of oxidation of EPA and DHA by rat soleus muscle homogenates are affected by diets rich in either n-6 fatty acids or n-3 fatty acids.
- Objective 1.2 To examine the oxidation of EPA and DHA by the intact soleus muscle of rats fed fish oil containing diets.
- Objective 1.3 To examine the oxidation of EPA and DHA by cardiac myocytes of rats fed fish oil containing diets.
- Objective 1.3.1 To determine whether the oxidation of EPA and DHA by rat cardiac myocytes is affected by diets rich in either n-6 fatty acids or n-3 fatty acids.

## **2.4 MATERIALS AND METHODS**

### **2.4.1 CHEMICALS**

Unless otherwise stated, all chemicals were purchased from Sigma Chemical Company (St. Louis, Mo). Organic solvents, acids, and toluene were obtained from Fisher Scientific (Dartmouth, N.S.) while Ready Safe™ came from Beckman (Fullerton, Ca.), diethyl ether from BDH (Toronto, Ont.), NCS (tissue solubilizer) from Amersham (Oakville, Ont.), and omnifluor from New England Nuclear (Boston, Mass). Radiolabelled materials were purchased from Dupont, New England Nuclear (Mississauga, Ont.). For the myocyte preparations;

collagenase (Worthington type II) was purchased from Worthington Biochemical (Freehold, N.J.) and the Joklik-MEM media (Gibco 410-2300EB) from Gibco Ltd. (Burlington, Ont.).

The components for the animals' diets excluding the fat sources were ordered from ICN (Costa Mesa, Ca.). Mazola™ corn oil was purchased from a local grocery store and MaxEPA oil was obtained as a gift from R.P. Scherer, Windsor, Ont.

#### 2.4.2 ANIMALS

These experiments were carried out in accordance with the guidelines of the Canadian Council of Animal Care. Male Sprague-Dawley rats from Charles River Company (LaPrairie, Quebec) weighing initially 200-250 g were used for skeletal muscle homogenates and cardiac myocyte preparations while those initially weighing 160-190 g were used for the intact muscle experiments. Animals were housed individually in plastic cages in a room maintained at 12 h light-dark cycles and a constant temperature (~20°C). The animals were acclimatized for about 1 week under these conditions before the start of the experiment. The animals were then fed one of two basic diets for two weeks; a diet containing 10% corn oil or 8% MaxEPA oil plus 2% corn oil as the fat source.

The diets were essentially modified AIN-76A diets containing 10% fat with the following composition (g/kg): glucose-600; casein-200; fat-100; cellulose-50; AIN mineral mix-35; AIN vitamin mix-10; methionine-3; choline

chloride-2; TBHQ-0.02. Diets were prepared and stored as to minimize oxidation (Fritsche and Johnston, 1988). The corn oil containing diets were stored under nitrogen at 4°C and the MaxEPA oil containing diets were stored under nitrogen at -20°C. The fatty acid composition of the oils and diets was determined by GLC and the results shown in Table 2.1. Any oxidation of the diets was checked by analyzing the fatty acid composition of the diets at various times during the feeding period.

#### 2.4.3 SKELETAL MUSCLE HOMOGENATE PREPARATION AND INCUBATION

After 2 weeks on the diet, rats were fasted for 24-28 hours. Soleus muscle homogenates were prepared using a method adapted from Zuurveld et al (1985) and total fatty acid oxidation was examined. The homogenization buffer consisted of 250 mM sucrose, 2 mM EDTA and 10 mM Tris (pH 7.4). The incubation medium (pH 7.4) contained, at a final concentration, the following; 25 mM sucrose, 30 mM KCl, 10 mM KH<sub>2</sub>PO<sub>4</sub>, 5 mM MgCl<sub>2</sub>, 1 mM EDTA, 0.025 mM cytochrome c, 75 mM Tris, 5 mM ATP, 1 mM NAD, 0.1 mM CoA, 0.5 mM L-carnitine, and 0.5 mM L-malic acid. After the pH was adjusted, 0.1 mM fatty acid free albumin and 0.5 mM [1-<sup>14</sup>C]fatty acid were added.

The two soleus muscles weighing ~0.30 g together were removed from a cervically dislocated rat and homogenized in a potter Elvehjem tissue grinder for

**Table 2.1 Fatty Acid Composition of the Diets and Oils (% of Total Weight). Values are mean weight percent of each fatty acid  $\pm$  S.D. for three samples of each diet.\***

Fatty Acid	MaxEPA Diet	Corn Oil Diet	MaxEPA Oil	Corn Oil
14:0	0	0	8.05 $\pm$ 0.20	0
16:0	18.13 $\pm$ 1.05	10.63 $\pm$ 0.63	16.02 $\pm$ 0.20	11.66 $\pm$ 0.11
16:1 (n-7)	8.51 $\pm$ 0.13	0.06 $\pm$ 0.08	11.39 $\pm$ 0.96	0.52 $\pm$ 0.17
18:0	2.95 $\pm$ 0.20	1.77 $\pm$ 0.07	2.65 $\pm$ 0.13	1.68 $\pm$ 0.09
18:1 (n-9)	13.45 $\pm$ 1.00	28.28 $\pm$ 0.35	5.25 $\pm$ 0.28	26.55 $\pm$ 0.07
18:1 (n-7)	0	0	6.45 $\pm$ 0.35	0
18:2 (n-6)	13.28 $\pm$ 0.79	55.51 $\pm$ 0.43	1.38 $\pm$ 0.03	58.73 $\pm$ 0.13
18:3 (n-3)	0.69 $\pm$ 0.02	0.85 $\pm$ 0.02	0.52 $\pm$ 0.07	0.90 $\pm$ 0.03
18:4 (n-3)	2.34 $\pm$ 0.24	0	3.01 $\pm$ 0.49	0.25 $\pm$ 0.05
20:1 (n-9)	0	0	0.13 $\pm$ 0.07	0
20:4 (n-6)	0.64 $\pm$ 0.03	0	0.69 $\pm$ 0.05	0
20:5 (n-3)	11.48 $\pm$ 0.94	0	18.07 $\pm$ 0.39	0
22:1 (n-11)	0	0	1.49 $\pm$ 0.14	0
22:5 (n-3)	1.34 $\pm$ 0.03	0	1.57 $\pm$ 0.11	0
22:6 (n-3)	7.31 $\pm$ 0.40	0	10.74 $\pm$ 0.08	0

\*Fatty acid composition was determined by Gas Liquid Chromatography using a Supelcowax 60 m capillary column in a Hewlett Packard 3365 Series II GC. Oven temperature was 190°C ramped 5°C/min to 210°C and remained there for an additional 12 min. The injection port and flame ionization detector oven temperatures were 230°C. The fatty acids were identified by comparison of retention times with known standards from Sigma Chemical Co. Peak areas were integrated using Hewlett Packard 3365 Series II Chemstation Software.

3 min in 10.5 mL of the homogenization buffer. Fatty acid oxidation was measured by adding 200  $\mu$ L of the homogenate in 800  $\mu$ L of the incubation medium containing either 0.5 mM [1- $^{14}$ C]-EPA or [1- $^{14}$ C]-DHA. For the sake of comparison the oxidation of other fatty acids was also determined and these fatty acids included 16:0, 18:1(n-9), 18:2(n-6) and 20:4(n-6).

Incubations were carried out in 25 mL Erlenmeyer flasks in a shaking water bath at 37°C. Reactions were started by the addition of the homogenate, and the flask was sealed with a stopper holding a centre well containing a piece of folded filter paper. Incubations were carried out for 30 or 60 min. The incubation was terminated by the injection of 0.2 mL of 3 M perchloric acid into the medium.  $^{14}$ CO<sub>2</sub> was collected by adding 0.3 mL of NCS (tissue solubilizer) to the centre well. The flasks were shaken for an additional two hours following which the centre wells were removed and added to a scintillation vial containing 10 mL of omnifluor-toluene. Radioactivity was determined in a Beckman LS 7500 liquid scintillation counter using external standard quench correction. The rate of  $^{14}$ CO<sub>2</sub> production was linear for the one hour incubation.

#### 2.4.4 INTACT SKELETAL MUSCLE PREPARATION AND INCUBATION

After a 24 hour fast, rats were anaesthetized with sodium pentobarbital (6.5 mg/100 g body weight). To maintain muscles at their *in situ* resting length, the soleus muscles were exposed by blunt dissection and mounted on surgical stainless-steel wire supports (Ethicon, size 5) before the tendons were cut. The

tendons were then cut and the muscles preincubated in 4.5 mL Krebs Ringer Bicarbonate buffer for 30 min at 37°C. The medium contained the following: 10 mM glucose; 0.10 unit/mL insulin, 0.1 mM fatty acid free albumin, and 0.5 mM [1-<sup>14</sup>C]fatty acid. The medium was equilibrated with O<sub>2</sub>/CO<sub>2</sub> (95%:5%) before use and flasks were continuously gassed throughout the preincubation period. Muscles were then transferred to fresh medium of the same composition, saturated with O<sub>2</sub>/CO<sub>2</sub> (95%:5%). A centre well with a piece of folded filter paper was placed in the flask and the flask stoppered. After a 30 min incubation at 37°C, the reaction was stopped with the injection of 0.2 mL of 30 % perchloric acid into the medium. NCS (0.3 mL) was added to the centre well in order to collect <sup>14</sup>CO<sub>2</sub>. The flasks were shaken for an additional hour following which the centre wells were removed and added to a scintillation vial containing 10 mL of omnifluor-toluene. Radioactivity was determined in a Beckman LS 7500 liquid scintillation counter using external standard quench correction. The rate of <sup>14</sup>CO<sub>2</sub> production was linear for the 30 min incubation.

Since a number of reports (Bonen et al, 1994; Palmer et al, 1981; Maltin and Harris, 1985; Segal and Faulkner, 1985) suggest that the functional integrity and viability of incubated muscles decrease with time, the viability of the intact soleus muscle preparation during the incubation period was assessed by measuring muscle ATP enzymatically according to the method by Lamprecht

and Trauttschold (1981). The following experiments were performed using the ATP concentration of freeze-clamped soleus muscles (*in vivo*) ( $23.51 \mu\text{mol/g}$  dry weight  $\pm 2.92$ ,  $n=15$ ) as an index. In each set of experiments, from the same rat, one muscle was treated one way while the contralateral muscle was treated a second way. Using the paired Student's t-test, comparisons were made to see if there were significant differences. First, intact muscles on the stainless steel support (clipped) were continuously gassed with  $\text{O}_2/\text{CO}_2$  (95%:5%) for 60 min ( $20.64 \mu\text{mol/g}$  dry weight  $\pm 5.82$ ,  $n=4$ ) compared to noncontinuously gassed ( $14.70 \mu\text{mol/g}$  dry weight  $\pm 4.61$ ). Second, clipped muscles were continuously gassed for 30 min ( $18.29 \mu\text{mol/g}$  dry weight  $\pm 4.43$ ,  $n=11$ ) versus those noncontinuously gassed ( $20.84 \mu\text{mol/g}$  dry weight  $\pm 4.61$ ). And lastly, clipped muscles were noncontinuously gassed for 30 min ( $18.10 \mu\text{mol/g}$  dry weight  $\pm 3.84$ ,  $n=6$ ) compared to those freeze-clamped ( $25.60 \mu\text{mol/g}$  dry weight  $\pm 6.98$ ). In the last two approaches there were no significant differences. Thus, the method used to determine fatty acid oxidation in the intact soleus muscle as explained in the previous paragraph was a result of these observations.

#### 2.4.5 PREPARATION OF CARDIAC MYOCYTES AND INCUBATION

Cardiac myocytes were isolated from rat hearts using an adaptation of the procedures described by Kryski et al (1985) and Rodrigues et al (1992). After an overnight fast, rats were injected intraperitoneally with 2 U/g body weight of heparin (Solopak Lab, Elk Grove Village, Ill.) one hour prior to sacrifice. The



animals were anaesthetized with a ketalean-40 mg/kg (MTC Pharmaceuticals, Cambridge, Ont.) and xylazine-10 mg/kg (MTC Pharmaceuticals, Cambridge, Ont.) mixture and the heart was then quickly removed. The heart was placed for 10 sec in a 50 mL beaker filled with  $\text{Ca}^{2+}$ -free Joklik Medium supplemented with 1.2 mM  $\text{MgSO}_4$  and 1.0 mM dl-carnitine (Solution A). This solution had previously been equilibrated with  $\text{O}_2/\text{CO}_2$  (95%:5%) for 30 min, the pH adjusted to 7.4 and warmed to 37°C. The heart was then transferred to a large weigh boat containing warm Solution A and as much fat and membrane tissue as possible were removed. Using small forceps, the aorta was positioned on a cannula with a second person securely tying it in place. The above procedure was performed in less than two minutes.

The heart was perfused retrograde for 5 min in a non-recirculating system with Solution A. Following, for approximately 15 min, it was perfused with Solution B at a flow rate of 6-8 mL/min. Solution B contained Solution A, 25  $\mu\text{M}$   $\text{Ca}^{2+}$ , 0.1% fatty acid free albumin and 100 U/mL Collagenase. The ventricles were isolated from the perfusion apparatus, sliced with scissors and then incubated with 15 mL of Solution C in a 37°C waterbath shaking at 120-150 cycles/min for 10 min. Solution C contained Solution A, 25  $\mu\text{M}$   $\text{Ca}^{2+}$  and 1.0 % fatty acid free albumin.

Damaged and dead cells were removed by aspiration and the remaining cells were incubated with 15 mL of Solution B for 7 min at 37°C under O<sub>2</sub>/CO<sub>2</sub> (95%:5%) gas at 140 cycles/min. Dispersed cells were decanted into a 50 mL plastic centrifuge tube. The residual tissue was washed twice with 10 mL of Solution C containing 250 µM Ca<sup>2+</sup> to dislodge more myocytes, which were also added to the centrifuge tube. These pooled cells were centrifuged at 45 g for 90 sec. The pellet was washed with 20 mL of Solution C containing incremental Ca<sup>2+</sup> concentrations of 250 µM, 500 µM, and 1 mM and then, resuspended with 20 mL of 1 mM Ca<sup>2+</sup> Solution C. Myocytes were filtered through a 200 µM silkscreen mesh into a 50 mL plastic centrifuge tube. The cells were allowed to settle for 15 minutes and then the medium was removed via aspiration. Subsequently, the cells were resuspended in 1:20 dilution (w/v) of Krebs-Henseleit buffer containing 1.0 mM CaCl<sub>2</sub> and 1.25% fatty acid free albumin.

Cell number and viability were determined microscopically by counting samples from the final cell suspension using a Neubauer hemocytometer. Only elongated (rod shaped) cells which excluded trypan blue were considered viable. The following calculation determined the number of live cells per mL as well as per heart:

$$\frac{\text{Cell count} \times \text{Dilution factor}}{4 \times 10^{-4}} = \text{Cells/mL}$$

(Chamber volume)

$$\text{Cells/mL} \times \text{Volume of cell suspension} = \text{Live cells obtained}$$

from one heart

To ensure that the cells were respiring, the rate of oxygen consumption was measured with a Clark electrode for cells isolated from rats on either diet. The substrate used for these experiments was 0.5 mM 18:1(n-9).

To determine fatty acid oxidation, incubations were carried out in 25 mL plastic Erlenmeyer flasks in a shaking bath at 37°C. Cardiac myocytes were incubated in Krebs-Henseleit buffer containing 1.0 mM CaCl<sub>2</sub>, 1.25% fatty acid free albumin, 0.1 mM [1-<sup>14</sup>C] oleic acid (18:1, n-9) plus 0.2 mM or 0.4 mM unlabelled fatty acid. The unlabelled fatty acid was either 18:1(n-9), 20:5(n-3) or 22:6(n-3). Peroxisomal oxidation was determined by adding 20 mM KCN to the medium prior to the addition of the myocytes (n=4). Two hundred (200) microlitres of cells were incubated in 800 μL of medium, saturated with O<sub>2</sub>/CO<sub>2</sub> (95%:5%), for 60 min in a temperature controlled (37°C) shaking bath. At the end of the incubation, 0.2 mL of 30% perchloric acid were injected into the medium to stop the reaction. The <sup>14</sup>CO<sub>2</sub> was collected and counted by liquid scintillation spectrometry as described for the intact muscle preparations. The acid soluble contents left in the flasks were placed in a 1.5 mL eppendorf conical tube and

centrifuged for 5 min. The supernatant was neutralized with 3 M  $K_3PO_4$  and 200  $\mu L$  were added to a scintillation vial containing 10 mL of an aqueous scintillation solvent and subsequently counted. The rate of  $^{14}CO_2$  production was linear for the 60 min incubation period and with the volume of cells used in the reaction.

#### 2.4.6 STATISTICAL ANALYSIS

Demographic data such as grams of food that the animals ate, weight of muscle tissue, and weight gain of animals was compared using the Student's t-test. Paired comparisons were made between the contralateral intact soleus muscles of the same rat. Statistical analysis employed the paired Student's t-test. Fatty acid oxidation by muscle homogenates and cardiac myocytes was analyzed by a two-way ANOVA (factors were diet and fatty acid). Differences between means were determined using Duncan's new multiple range test. Data presented are means  $\pm$  S.D. Differences were considered significant if  $p < 0.05$ .

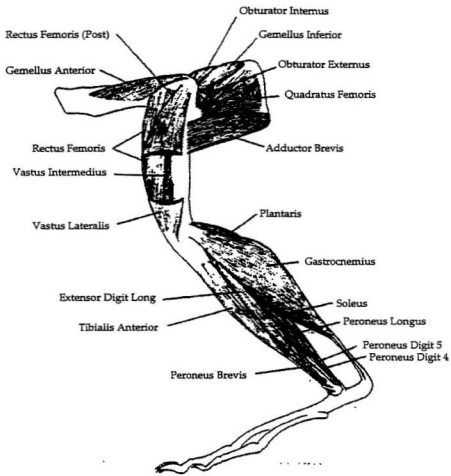
### 2.5 RESULTS

#### 2.5.1 OXIDATION OF FATTY ACIDS IN SKELETAL MUSCLE HOMOGENATES

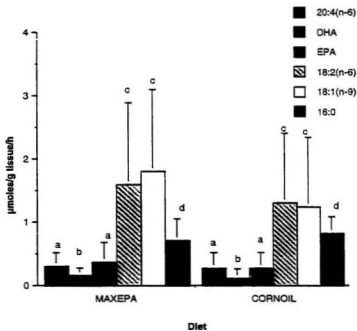
Food consumption was similar in each experimental group irrespective of dietary regime, indicating that appetite was not affected and diets were well tolerated. After two weeks on the diets the animals in both groups had similar weight gain; 67.6 g  $\pm$  13.0 (n=10) for the MaxEPA oil fed group and 68.3 g  $\pm$  12.4 (n=10) for the corn oil fed group. Rat soleus muscle (Figure 2.7) was used for

these preparations because it is a red, aerobic muscle, easily exposed and has a well-defined tendon so that the muscle can easily be removed without damage. The weight of the two soleus muscles from an individual animal used in the preparation were similar in both groups;  $0.30 \text{ g} \pm 0.03$  ( $n=10$ ) and  $0.28 \text{ g} \pm 0.04$  ( $n=10$ ) for the fish oil and corn oil fed groups, respectively. Oxidation of fatty acids by soleus muscle homogenates was not affected by diet (Figure 2.8). In rats fed either diet, EPA was utilized at a significantly higher rate than DHA. For MaxEPA fed animals, EPA was oxidized at a rate of  $0.379 \text{ } \mu\text{mol/g tissue/h} \pm 0.299$  and DHA was oxidized at a rate of  $0.168 \text{ } \mu\text{mol/g tissue/h} \pm 0.108$ . For corn oil fed animals, the rates for EPA and DHA were  $0.316 \text{ } \mu\text{mol/g tissue/h} \pm 0.222$  and  $0.119 \text{ } \mu\text{mol/g tissue/h} \pm 0.129$ , respectively.

In addition, 18:1( $n=9$ ) and 18:2( $n=6$ ) were oxidized at a greater rate than the other fatty acids examined (Figure 2.8). The two 20 carbon fatty acids, 20:4( $n=6$ ) and EPA, were oxidized at similar rates. From these results, it is evident that fatty acids are preferentially oxidized by soleus homogenates.



**Figure 2.7** Deeper Muscles of the Rat Hindlimb (Adapted from Hebel and Stromberg, 1976).



**Figure 2.8** Fatty Acid Oxidation By Soleus Muscle Homogenates. Results are means  $\pm$  S.D. for 10 muscle preparations except for 16:0 where n=5. Means not sharing a common superscript are significantly different.

## 2.5.2 OXIDATION OF FATTY ACIDS IN INTACT SKELETAL MUSCLE

### 2.5.2.1 VIABILITY OF INTACT MUSCLE

In hindquarter perfusions, Herzberg et al (1990) demonstrated that EPA was removed from the perfusate at a greater rate than 18:1(n-9) (Figure 2.2). However, in the soleus muscle homogenates, 18:1(n-9) was shown to be oxidized at a faster rate than DHA and EPA (Figure 2.8). In addition, EPA appears to be oxidized at twice the rate of DHA under these conditions. Due to these observations and the fact that any regulatory effects of the plasma membrane are absent in the muscle homogenates used for the oxidation study, fatty acid oxidation in the intact muscle next was examined.

Rat soleus muscle was used for the intact muscle preparations in order to compare the oxidation results discussed in Section 2.5.1. In addition, it has been recognized that because of the well-defined tendon, the soleus muscle can be attached to clips or supports for incubation *in vitro* relatively easily. Maintaining the muscle at resting length can positively affect metabolism by decreasing the risk of hypoxia.

According to Bonen et al (1994), the basic principle of this *in vitro* procedure is that individual muscles can be placed in small vessels and that the oxygenation and content of the incubation medium can be controlled. Additionally, contralateral muscles from the same animals can be used for comparisons. Furthermore, an advantage of the incubated muscle preparation is



that differences in muscle capillarization are circumvented because oxygen and substrate enter the muscle exclusively via diffusion from the incubation medium. However, one potential disadvantage is that if incubating conditions are not controlled properly, diffusion of these substances may be inadequate and muscle viability will then be compromised (Bonen et al, 1994).

Recent studies have provided evidence that hypoxia may occur in conventionally incubated rat muscles; i.e., rat muscles which are not supported and thus, are not at their resting length. For example, lactate levels and lactate:pyruvate ratios in incubated rabbit muscles were twice those observed in freshly dissected tissues (Palmer et al, 1981). Similarly, isolated soleus and extensor digitorum longus (EDL) muscles from young rats showed a central loss of glycogen and  $\alpha$ -glycan phosphorylase activity (Maltin and Harris, 1985; Segal and Faulkner, 1985). These changes were progressive with the time of incubation, and occurred more rapidly at higher temperatures. Tissue in the centre of incubated rat muscles had a lowered rate of incorporation of labelled amino acids, suggesting that oxygen diffusion to the tissue core was insufficient (Maltin and Harris, 1985). Baracos et al (1989) found that maintenance of maximal  $O_2$  saturation of the medium by continuous aeration with  $O_2/CO_2$  (95%:5%) stimulated protein synthesis by 20%, providing further evidence that the supply of oxygen is limiting in conventionally incubated muscles.

Newsholme et al (1986) challenged the suggestion that their muscle preparations were not viable. In their experiments, muscles (soleus and EDL) were isolated and preincubated for 30 min. Preincubation medium was equilibrated with O<sub>2</sub>/CO<sub>2</sub> (95%:5%) immediately before use and the flasks were gassed with O<sub>2</sub>/CO<sub>2</sub> throughout this period. Muscles were then transferred to fresh medium (O<sub>2</sub> saturated) and the gassing continued for the initial 15 min of the 60 min incubation period. They found that the concentration ratios, i.e., ATP/ADP and ATP/AMP, were similar in muscles freeze-clamped *in situ* compared to those incubated for 60-90 min *in vitro*. Furthermore, the rates of glycogenolysis were low, indicating an absence of hypoxic stress. The rates of glucose transport, glycolysis, and glycogen synthesis in these muscle preparations were linear with time over a 60 min incubation, indicating there was no significant development of hypoxia during the time course of the incubation. Finally, electron micrographs of stripped soleus muscle, which had been incubated for 60 min, indicated a normal mitochondrial morphology. It is important to note that much of the work conducted by Newsholme's group employed stripped muscle treatments. However, when criticizing intact muscle preparations in terms of optimal viability, Maltin and Harris (1986) were referring essentially to whole muscle preparations and not stripped muscles.

Studies have shown that during incubation of whole muscles there was a decrease in ATP and phosphocreatine concentrations (Goldberg et al, 1975;

Bonen et al, 1994). If a muscle is not kept at its resting length then oxygen may not be able to diffuse to the core of the muscle. Consequently, there may be insufficient oxygen to sustain aerobic metabolism. Thus, muscles must be kept extended or at resting length by placing them on some kind of support bridge. Nevertheless, even when the muscle is on a support there are problems of not enough oxygen getting to the centre of the tissue for aerobic metabolism during incubations greater than 60 minutes. This is due to what has been coined the "core effect". Muscles stained histochemically for such substances as glycogen or phosphorylase activity after 60 minutes of incubation have shown the development of a "core" (the absence of stainable glycogen in the core) (Goldberg et al, 1975). This "core" implies that oxygen has been deficient and that glycogen has been metabolized anaerobically to supply energy for processes including protein synthesis. Such a deficiency would also exclude fatty acid oxidation as an energy source.

"Core" formation and diffusion of oxygen are influenced by tissue thickness and the metabolic rate of the donor animal. Bonen et al (1994) suggested that oxygenation of the incubating medium occurs via continuous bubbling of O<sub>2</sub>/CO<sub>2</sub> (95%:5%) through the medium or by saturating the oxygen content of the buffer. They found that the latter method can more than adequately maintain the oxygen during experiments for  $\leq 90$  min duration. Consequently, Bonen et al (1994) states that the problem with the *in vitro*

preparation is not the adequacy of the oxygen in the medium surrounding the muscles, but rather whether the oxygen can penetrate to all the muscle fibres.

Goldberg et al (1975) suggested continuous aeration and ensuring that the cross-sectional diameter of the tissue is  $\leq 1.5$  mm, found in an animal weighing 60 g, to guarantee viability. In other words, the use of younger animals with smaller, thinner muscles or reducing the diffusion distance by taking small muscle strips from a larger muscle would result in a viable preparation.

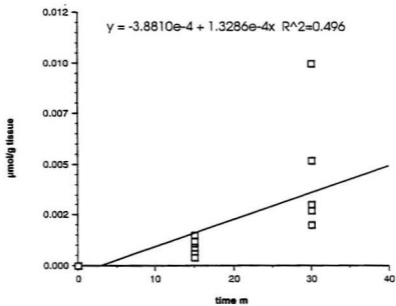
However, in the experiments reported in this thesis, continuous gassing was not possible because of the closed system used to capture the labelled  $\text{CO}_2$ . The animals were on diets for 2 weeks and thus, weighed 250-300 g when the muscle was excised. In order to develop a model of intact muscle to use to obtain results that were meaningful for the situation *in vivo*, it was essential that the physiological viability and integrity of the muscle be retained. Thus, the viability of the isolated muscle during the intended incubation period was assessed using ATP levels as an index for viability as described and reported in Section 2.4.4.

#### **2.5.2.2 FATTY ACID OXIDATION RESULTS IN INTACT SKELETAL MUSCLE**

The weight gain for the animals on both diets was similar with the MaxEPA oil fed animals gaining  $92.44 \pm 7.89$  g ( $n=4$ ) while the corn oil fed animals gained  $84.16 \pm 8.95$  g ( $n=4$ ). The initial weights of the rats ranged from 160-190 g.

To determine if the rate of fatty acid oxidation was linear, muscles from the same rat were incubated for 15 or 30 min using 0.5 mM of unlabelled 18:1(n-9) as the substrate. Figure 2.9 shows the time course resulting from five experiments. It is evident that the time course is not linear. Indeed there is a substantial lag. The problem may involve transport mechanisms and thus, I added labelled substrate to the preincubation medium in order to allow translocation of the substrate to take place and equilibration of tissue pools with the label. This treatment caused the rate of oxidation not only to become more linear with time but also to increase tenfold (Figure 2.10). Consequently, labelled fatty acid was added to the preincubation medium for this procedure as discussed in Section 2.4.4.

There was no effect of diet when comparing the rates of oxidation of 18:1(n-9) and EPA (Figure 2.11). However, it is apparent that 18:1(n-9) was oxidized at 1.4-2.3 times greater a rate than EPA, regardless of diet in the intact soleus muscle preparation. It is interesting to note that the rates of oxidation in this model are markedly less than observed for the muscle homogenates by at least nine times for EPA and about 25 times for 18:1(n-9) (Figures 2.11 and 2.8). The reason for the differences in the rates of oxidation could be a consequence of the complex transport system involving the transfer of the substrate from the



**Figure 2.9** Time Course for Oleic Acid Oxidation in Isolated Soleus Muscle Pre-Incubated Without and Incubated With Labeled Oleic Acid (1-[<sup>14</sup>C]18:1, n-9).

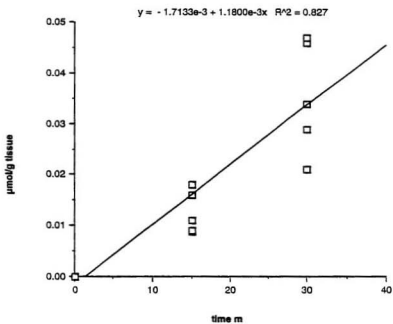
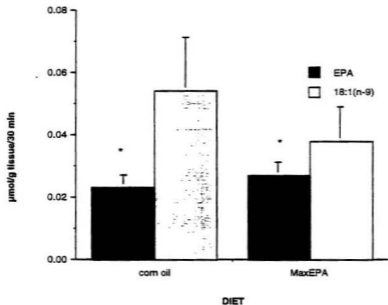


Figure 2.10 Time Course for Oleic Acid Oxidation in Isolated Soleus Muscle Preincubated and Incubated With Labeled Oleic Acid (1-[<sup>14</sup>C]18:1, n-9).

### Oleic Acid vs EPA Oxidation in Intact Soleus Muscle



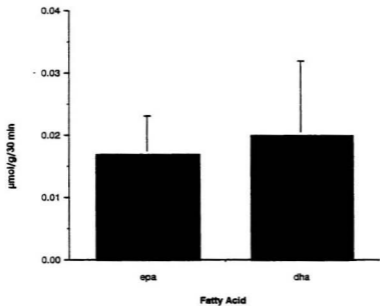
**Figure 2.11 Oxidation of Oleic Acid and EPA in Intact Soleus Muscle.** Results are means  $\pm$  S.D. for 4 intact muscle preparations. \*Significant difference in rate of oxidation between the 2 fatty acids, regardless of diet ( $p < 0.05$ ).



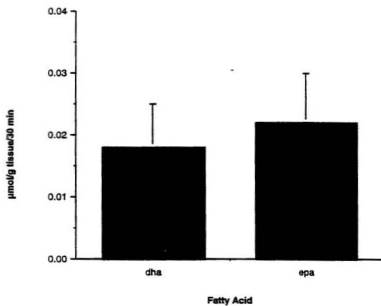
incubation medium into the mitochondrial matrix (Refer to Figure 2.5), a diffusion problem, or due to the fact that in the homogenate experiments all the cofactors necessary for oxidation and the Krebs cycle are added to the incubation medium. Thus, the mitochondria are exposed to optimal conditions for oxidation. Furthermore, the intact muscle model maintains the muscle at its resting length and it is possible that the muscle does not use fuel efficiently when resting. This could be a critical factor when examining the differentiation of oxidation among varying substrates.

Since there was no effect of diet in the experiments using soleus muscle homogenates or intact muscles, the oxidation rates of EPA versus DHA were first compared using chow fed animals (n=8). As illustrated in Figure 2.12, there was no significant difference in the rate of oxidation of either fatty acid with EPA being oxidized at a rate of  $0.017 \pm 0.005$   $\mu\text{mol/g tissue}/30$  min while DHA oxidized at a rate of  $0.019 \pm 0.011$   $\mu\text{mol/g tissue}/30$  min.

We also examined the rates of oxidation of EPA and DHA in the intact soleus muscle of rats fed fish oil containing diets since we were interested in the effects of fish oil feeding on fatty acid oxidation. The animals gained  $82.72 \text{ g} \pm 15.23$  (n=7) after 2 weeks on the diet. There was no significant difference between the rates of oxidation for the 2 fatty acids with the rates of oxidation for EPA and DHA being  $0.022 \pm 0.008$   $\mu\text{mol/g tissue}/30$  min and  $0.018 \pm 0.007$   $\mu\text{mol/g tissue}/30$  min, respectively (Figure 2.13).



**Figure 2.12** Oxidation of EPA and DHA in Chow Fed Rats. Results are means  $\pm$  S.D. for 8 intact muscle preparations. No significant difference between the 2 fatty acids.



**Figure 2.13** Oxidation of EPA and DHA in Intact Soleus Muscle of Fish Oil Fed Rats. Results are means  $\pm$  S.D. for 7 intact muscle preparations. No significant difference between the 2 fatty acids.

### 2.5.3 OXIDATION OF FATTY ACIDS IN CARDIAC MYOCYTES

Over the two week feeding period, the two groups of animals had similar weight gains with the MaxEPA fed rats gaining  $73.9 \pm 24.6$  g (n=10) and the corn oil fed rats gaining  $70.3 \pm 23.9$  g (n=10). The initial weights ranged from 236-305 g for the corn oil fed animals and 237-315 g for the fish oil fed group while the final weights ranged from 307-367 g and 320-382 g, respectively.

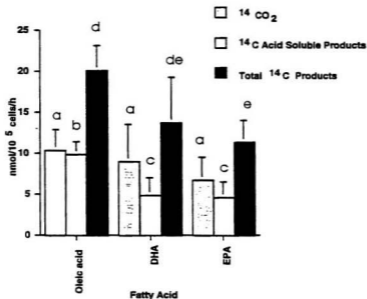
The viability of the cell preparations for the corn oil fed group was 76.6%  $\pm$  6.6% (n=10) and 73.0%  $\pm$  8.7% (n=10) for the fish oil fed rats. The yield expressed as  $10^7$  cells/heart was  $1.03 \pm 1.23$  (Range=0.14-3.74  $\times 10^7$  cells/heart) and  $1.88 \pm 2.10$  (Range=0.30-6.10  $\times 10^7$  cells/heart) for the MaxEPA and corn oil groups, respectively. It is important to note that the yield only takes into account the live cells (refer to formula in Section 2.4.5). The oxygen consumption results were  $7.9 \pm 5.9$  nmol O<sub>2</sub> consumed/min/ $10^5$  cells (n=5) and  $7.4 \pm 3.8$  nmol O<sub>2</sub> consumed/min/ $10^5$  cells (n=6) for the fish oil and corn oil fed animals, respectively.

The experiments with cardiac myocytes were carried out as competition experiments. In each incubation the label was in oleate regardless of which fatty acid was added. Therefore, for the oxidation results, a lower apparent rate indicates that the added fatty acid was oxidized at a greater rate than oleate or it inhibited oleate oxidation. The rates of oxidation for 0.1 mM 1-[<sup>14</sup>C]18:1(n=9)

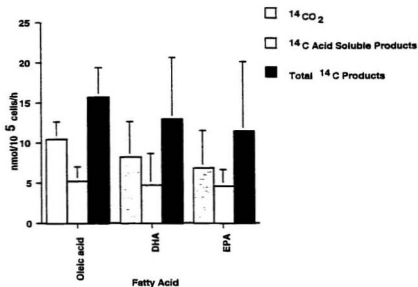
were extrapolated from the data and the results for the oxidation of 0.2 mM and 0.4 mM 18:1(n-9) were adjusted accordingly and plotted.

In the experiments conducted with skeletal muscle, oxidation rates were based on the measurement of  $^{14}\text{C}\text{CO}_2$  production. Since  $^{14}\text{C}\text{CO}_2$  forms only a fraction of the oxidation products from  $^{14}\text{C}$ -labelled fatty acids, the more accurate procedure is to measure both the  $^{14}\text{C}\text{CO}_2$  and  $^{14}\text{C}$ -labelled acid-soluble products produced. Consequently, in the following text, [ $^{14}\text{C}$ ]fatty acid oxidation will refer to its conversion into the sum of  $^{14}\text{C}\text{CO}_2$  and  $^{14}\text{C}$ -labelled acid-soluble products. The latter represented in the corn oil fed group; about 33-53% of the total  $^{14}\text{C}$  products for flasks with only 18:1(n-9), 35-43% for flasks containing unlabelled DHA and 38-41% for flasks containing unlabelled EPA and for the fish oil fed group; 50% for 18:1(n-9), 36-39% for DHA and 36-42% for EPA (Figures 2.14, 2.15, 2.16 and 2.17).

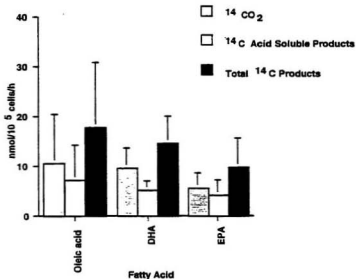
We hypothesized that we would observe a lower rate of oleate oxidation with flasks incubated with EPA compared to DHA, suggesting that less 18:1(n-9) is being oxidized when EPA is added to the medium compared to DHA. However, Figures 2.14, 2.15, 2.16 and 2.17 illustrate that there was no difference in the oxidation of 18:1(n-9) when either EPA or DHA was added to the incubation medium, regardless of the concentration of the added fatty acid or the diet. It is apparent that 18:1(n-9) is the preferred substrate of the heart cells when 0.2 mM of the fatty acids were added to the medium for the animals fed fish oil containing diets.



**Figure 2.14** <sup>14</sup>C Production in Cardiac Myocytes of Fish Oil Fed Rats Using 0.2 mM Fatty Acid. These experiments are competition experiments because in each incubation the label was in oleate regardless of which fatty acid was added. Cardiac Myocytes were incubated in Krebs-Henseleit buffer containing 1.0 mM CaCl<sub>2</sub>, 1.25% fatty acid free albumin, 0.1 mM [1-<sup>14</sup>C] oleic acid (18:1, n-9) plus 0.2 mM unlabelled 18:1(n-9), EPA or DHA. Results are means ± S.D. for 10 myocyte preparations. Means not sharing a common superscript are significantly different.



**Figure 2.15**  $^{14}\text{C}$  Production in Cardiac Myocytes of Corn Oil Fed Rats Using 0.2mM Fatty Acid. These experiments are competition experiments because in each incubation the label was in oleate regardless of which fatty acid was added. Cardiac Myocytes were incubated in Krebs-Henseleit buffer containing 1.0 mM  $\text{CaCl}_2$ , 1.25% fatty acid free albumin, 0.1 mM [1- $^{14}\text{C}$ ] oleic acid (18:1, n-9) plus 0.2 mM unlabelled 18:1(n-9), EPA or DHA. Results are means  $\pm$  S.D. for 10 myocyte preparations. No significant difference was observed among the rates of oxidation when either fatty acid was added to the medium.



**Figure 2.16** <sup>14</sup>C Production in Cardiac Myocytes of Fish Oil Fed Rats Using 0.4 mM Fatty Acid. These experiments are competition experiments because in each incubation the label was in oleate regardless of which fatty acid was added. Cardiac Myocytes were incubated in Krebs-Henseleit buffer containing 1.0 mM CaCl<sub>2</sub>, 1.25% fatty acid free albumin, 0.1 mM [1-<sup>14</sup>C] oleic acid (18:1, n-9) plus 0.4 mM unlabelled 18:1(n-9), EPA or DHA. Results are means ± S.D. for 10 myocyte preparations. No significant difference was observed among the rates of oxidation when either of the fatty acids was added to the medium.



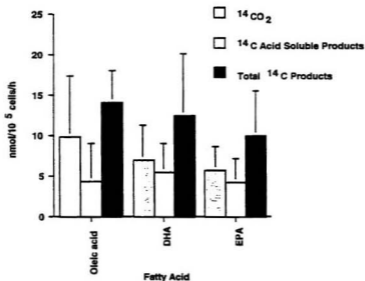


Figure 2.17  $^{14}\text{C}$  Production in Cardiac Myocytes of Corn Oil Fed Rats Using 0.4 mM Fatty Acid. These experiments are competition experiments because in each incubation the label was in oleate regardless of which fatty acid was added. Cardiac Myocytes were incubated in Krebs-Henseleit buffer containing 1.0 mM  $\text{CaCl}_2$ , 1.25% fatty acid free albumin, 0.1 mM [1- $^{14}\text{C}$ ] oleic acid (18:1, n-9) plus 0.4 mM unlabelled 18:1(n-9), EPA or DHA. Results are means  $\pm$  S.D. for 10 myocyte preparations. No significant difference was observed among the rates of oxidation when either of the fatty acids was added to the medium.

## 2.6 DISCUSSION

This study appears to be the only investigation to date examining the differences in the oxidation of EPA and DHA in skeletal and cardiac muscle. However, differential oxidation of these two fatty acids has been studied in liver (Gavino and Gavino, 1991; Herzberg et al, 1996). Furthermore, others have determined preferential utilization of long chain fatty acids in muscle tissue but were more concerned with comparing saturated versus unsaturated fatty acids or the differences between the metabolism of the 18 and 20 carbon fatty acids and consequently, omitted the use of DHA in their experiments (Okano and Shimojo, 1982; Hagve and Sprecher, 1989).

Okano and Shimojo (1982) determined the utilization of long chain fatty acids in white and red muscle slices prepared from quadriceps femoris muscle of rats, using labelled 16:0 and 18:2(n-6) as substrates. This study showed that the utilization of fatty acid did depend on muscle fibre type and that each fatty acid was oxidized to CO<sub>2</sub> and esterified to lipid esters to a different extent by the skeletal muscles examined. Higher rates of fatty acid oxidation were observed in the red muscle which is consistent with the fact that red muscle has a higher respiratory capacity and has higher activities of the  $\beta$ -oxidation enzymes. These authors also found that the incorporation rates of fatty acid into triacylglycerols and phospholipids were greater in red muscle than those in white muscle. The rates of oxidation and esterification of 18:2(n-6) in both types of muscle were less

than 16:0. Total uptake of 18:2(n-6) by the two muscles studied was estimated to be as low as 35-51% of that of 16:0. Fractional uptakes of 18:2(n-6) into CO<sub>2</sub>, triacylglycerols, and phospholipids also differed from those with 16:0. Surprisingly, Okano and Shimojo (1982) used muscle slices weighing 250 mg. Due to the size of the muscle and the fact that they did not maintain their muscles at their resting length, there may have been problems with the viability of the muscle samples and thus the interpretation of their results.

Huxtable and Wakil (1971) reported that beef heart mitochondria oxidized [U-<sup>14</sup>C]16:0 faster than [U-<sup>14</sup>C]18:2(n-6). Okano and Shimojo (1982) commented that the data from this investigation as well as their study suggest that the isomerase and/or epimerase reaction at the double bonds of unsaturated fatty acids caused a delay in β-oxidation compared with saturated fatty acids.

Hagve and Sprecher (1989) investigated the integrated metabolism including oxidation, esterification, and the conversion of polyunsaturated fatty acids of both the n-6 and n-3 series (i.e., 18:3(n-3), 18:2(n-6), 18:3(n-6), 20:3(n-6), 20:4(n-6), 20:5(n-3)) in isolated rat cardiac myocytes and in the perfused heart. They found that myocytes were able to take up and metabolize both the n-6 and n-3 fatty acids. However, the uptake of 18:3(n-6) and EPA was significantly lower than that for the other fatty acids studied. These authors remarked that in other studies done with hepatocytes incubated with 18:3(n-3) and EPA, the lipoproteins secreted contained EPA (Hagve and Christophersen, 1983). Thus,

they were surprised that EPA was not efficiently taken up by the heart even though it is available to this tissue. Of all the fatty acids examined, the rate of oxidation of 18:3(n-6), as measured by  $^{14}\text{CO}_2$  production from the labelled fatty acid, was the greatest. From their data, it is evident that the other fatty acids were oxidized at similar rates, implying that the majority of n-3 and n-6 fatty acids found in tissues do not undergo preferential oxidation in the heart. In addition, Hagve and Sprecher (1989) were unable to detect any products of unsaturation or chain elongation when appropriate n-6 and n-3 fatty acids were incubated with myocytes or when the heart was perfused with  $[1-^{14}\text{C}]18:2(\text{n}-6)$ . Since it appears that the heart is unable to elongate 18 carbon fatty acids to their corresponding 20 or 22 carbon fatty acid, they suggested that heart phospholipid composition must, in part, be regulated by specific mechanisms in removing fatty acids from the circulation.

We compared the oxidation of EPA and DHA in rat soleus muscle homogenates, intact soleus muscle and rat cardiac myocytes (Table 2.2). Furthermore, the oxidation of 18:1(n-9) was studied for each model whereas the oxidation of 16:0 and the n-6 fatty acids was only investigated in the homogenate experiments. Our results obtained from the homogenate experiments support the first proposed mechanism; i.e., that EPA is preferentially oxidized relative to

**Table 2.2 Summary of Primary and Secondary Objectives and Results for Mechanism #1**

<b>Mechanism #1: EPA is preferentially oxidized relative to DHA in muscle.</b>	
<b>Objective</b>	<b>Result</b>
1.1 To examine the oxidation of EPA and DHA by soleus muscle homogenates from rats fed fish oil containing diets.	EPA was oxidized at a significantly greater level than DHA by soleus muscle homogenates.
1.1.1 To determine whether the rates of oxidation of EPA and DHA by rat soleus muscle homogenates are affected by diets rich in either n-6 fatty acids or n-3 fatty acids.	No significant difference due to diet.
1.2 To examine the oxidation of EPA and DHA by the intact soleus muscle of rats fed fish oil containing diets.	No significant difference between the rate of oxidation of EPA and DHA by the intact soleus muscle.
1.3 To examine the oxidation of EPA and DHA by cardiac myocytes of rats fed fish oil containing diets.	No significant difference in the rate of oxidation of 18:1(n-9) by cardiac myocytes when EPA or DHA were added to the incubation medium.
1.3.1 To determine whether the oxidation of EPA and DHA by rat cardiac myocytes is affected by diets rich in either n-6 fatty acids or n-3 fatty acids.	No significant difference due to diet.

DHA in muscle. In fact, EPA was oxidized at twice the rate of DHA by the skeletal muscle homogenates. However, this phenomenon was not seen in the intact muscle or in the cardiac myocytes. In addition, 18:1(n-9) was oxidized at a greater rate than the n-3 fatty acids in all three experiments and thus provides evidence that there is differential oxidation of fatty acids.

The rat soleus muscle homogenate experiments provided evidence that the rate of oxidation for EPA was faster when compared to the rate for DHA regardless of diet. However, Herzberg et al (1996) commented that since they previously observed that there was greater lipoprotein lipase activity in heart and skeletal muscle of fish oil compared to corn oil fed rats, it is possible that there is a net effect of diet on the oxidation of these fatty acids because of more rapid lipolysis of triacylglycerol-rich lipoproteins in fish oil fed animals.

The finding that EPA was oxidized at a faster rate than DHA by muscle homogenates is consistent with the data obtained by Herzberg et al (1996) when they studied the fatty acid oxidation of EPA and DHA in rat hepatocytes. The experiment with hepatocytes was a competition experiment similar to the one used for the heart cell investigations. Of the added fatty acids only one, EPA, was oxidized at a significantly greater rate than oleate. This evidence that EPA was oxidized at a greater rate than the other fatty acids was confirmed by the ketoacid production. Both acetoacetate and 3-hydroxy butyrate syntheses were greater with EPA than for any other added fatty acid. Furthermore, Gavino and

Gavino (1989) found that CPT<sub>1</sub> in liver mitochondria had a higher activity with EPA-CoA than DHA-CoA, implying that EPA is preferred for oxidation compared to DHA in the liver. These researchers also obtained similar results when the mitochondria were incubated with the free nonesterified fatty acids.

However, when we choose the more physiological approach by examining fatty acid oxidation in the intact soleus muscle or cardiac myocytes, we did not find differences between DHA and EPA (Table 2.2). These results indicate that the long chain n-3 fatty acids are oxidized to a similar extent in these two systems and thus, are not differentially oxidized. The experimental design of these oxidation studies used *in vitro* models. It would be more physiological to examine *in vivo* rates of oxidation using the approach suggested by Jones (1994). In the experiments outlined in this chapter, the animals consumed diets that contained different amounts of specific fatty acids resulting in a variation in the enrichment of the endogenous fatty acid pools. Thus, according to Jones (1994) "endogenous pools of specific fatty acids which are targeted for oxidation will likely be depleted or expanded in response to the exogenous fatty acid blend delivered by feeding the diet" or the exogenous fatty acid added to the medium as in the case of our experiments. The amount of labelled fatty acid would likely be diluted by the amount of tissue fatty acids (i.e., endogenous fatty acids). For this reason, interpretation of the results remains difficult. In order to rectify this problem, it would be reasonable to control the

amount and blend of dietary fatty acids the rats consume as well as the endogenous pools.

Although EPA was cleared faster than 18:1(n-9) in the perfused hindquarter (Herzberg et al, 1990), we observed a greater oxidation rate for this monounsaturated fatty acid in the three muscle experiments. In addition, we found that 18:2(n-6) was oxidized at a similar rate to 18:1(n-9). Other investigators (Leyton et al, 1987; Mead et al, 1956; Cenedella and Allen, 1969; Jones et al, 1985; Willebrands, 1964) have reported preferential oxidation of 18:1(n-9) over other long chain fatty acids in mice, rats, and humans. In fact, Willebrands (1964) showed a greater uptake rate for 18:1(n-9) versus 18:2(n-6) and 18:0 in perfused heart studies. Leyton et al (1987) commented that the relatively high oxidation rate for 18:1(n-9) is probably due to the fact that it is preferentially incorporated into triacylglycerols and thus, is a ready source of energy. However, the work of Leyton and others may be uninterpretable since they did not correct for the varying amounts of fatty acids found in the tissue pools. Jones (1994) recently observed no preferential oxidation with regards to whole body oxidation of the three unsaturated 18 carbon fatty acids, i.e., 18:1(n-9), 18:2(n-6), and 18:3(n-3), in a study in which he controlled the amount of dietary fatty acids consumed by the rats and the endogenous pools of these fatty acids. However, Clouet et al (1989) studied the mitochondrial oxidation of 18:3(n-3), 18:2(n-6) and 18:1(n-9) in rat liver. Their results showed that the rate of



oxidation of 18:3(n-3) in liver mitochondria was the highest, implying that this fatty acid is preferentially oxidized.

It has been shown previously that 20 carbon fatty acids have a slow rate of oxidation (Coots, 1965; Sinclair, 1974). In the homogenate experiments, we observed that EPA and 20:4(n-6) were oxidized at similar rates and that these rates were lower than the 18 carbon unsaturated fatty acids, regardless of the diet. Two reasons have been given for this lower oxidative rate; these fatty acids are initially oxidized by the peroxisomal pathway which functions by chain shortening to 18 carbon fatty acids which in turn enter mitochondria for subsequent further oxidation (Lazarow and deDube, 1976) and that they are mainly incorporated into phospholipids (Coots, 1965; Sinclair, 1974).

Many studies have examined the influence of diet on peroxisomal  $\beta$ -oxidation. Interestingly, the relative contribution of peroxisomes to the total oxidation capacity in the rat heart has been estimated to be 10-30% for common fatty acids but up to 45% for some fatty acids with a chain length exceeding 22 carbons (Van Der Vusse et al, 1992). However, Chu et al (1994) estimated the contribution of peroxisomes to palmitate  $\beta$ -oxidation in rat heart homogenates by measuring the activity of acyl CoA oxidase, the enzyme presumed to catalyze the rate limiting step of peroxisomal  $\beta$ -oxidation. Based on an estimated palmitoyl CoA oxidase activity of 0.3 nmol/min/mg protein, the contribution of peroxisomes to palmitate oxidation would maximally be 4%.

Several investigators used unhydrogenated marine oils to study the effects on n-3 fatty acids on peroxisomal activity ( Aarsland et al, 1990; Vamecq et al, 1993; Decraemer et al, 1994). Aarsland and coworkers (1990) investigated whether stimulation of fatty acyl CoA oxidase and CPT activities occurs in the heart and liver from rats after the administration of purified EPA (ethyl ester). The activities of CPT, fatty acyl CoA oxidase and peroxisomal fatty acid oxidation were increased in the liver homogenates but not in the heart homogenates when compared with rats receiving palmitic acid for 5 days.

Vamecq et al (1993) studied peroxisomal and mitochondrial  $\beta$ -oxidation rates in liver and heart from animals given high fat diets for 8 weeks according to various n-3 or n-6 fatty acid ratios. Their data support the occurrence of peroxisomal proliferation upon n-3 fatty acid enriched (salmon oil) diets in both tissues tested. In the liver, they found an increase in the activities of acyl CoA oxidase and carnitine acyl transferase but no significant difference for the mitochondrial enzyme, acyl CoA dehydrogenase, with increasing content of salmon oil as compared to the activity of this enzyme in rats fed the control, low fat diet. In the heart, there was a increase in activity of the three enzymes examined in animals fed the highest amount of n-3 fatty acids (i.e., n-3/n-6 fatty acid ratio of 10). Vamecq and colleagues (1993) explain that since n-3 polyunsaturated fatty acids are effectively absorbed from the intestine and transported via the blood to other tissues, then the induction of cardiac enzymes,

especially in rats with the n-3/n-6 ratio of 10, may be directly related to the higher supply of DHA and EPA in the blood of these animals. DHA and EPA increase the activities of the three enzymes examined and thus, appear to stimulate mitochondrial and peroxisomal  $\beta$ -oxidation.

DeCraemer et al (1994) examined peroxisomes in liver, heart and kidney of mice fed a commercial fish oil preparation for 3 weeks. They observed hepatomegaly and increased activities of two peroxisomal enzymes, catalase and fatty acyl CoA oxidase, in the liver. In addition, the number of peroxisomes and cyanide-insensitive fatty acyl CoA oxidation were increased. In the heart, there was an increase in catalase activity and the peroxisomal number. These authors suggested that these results were probably due to the increase DHA and EPA in the diet.

The mechanisms by which dietary fish oil elicits an induction of peroxisomes in liver and heart is not clear. Vamecq et al (1993) feel that the mechanism involves the peroxisome proliferator activated receptor (PPAR) and the n-3 polyunsaturated fatty acids. The PPAR was recently identified by Issemann and Green (1990). This receptor is a member of the steroid hormone superfamily of the putative ligand-activated transcription factors. PPAR has been well characterized and, in fact, a high level of expression of mouse PPAR mRNA has been found in liver, kidney and heart (Reddy and Mannaerts, 1994). However, the natural ligand which binds to PPAR remains unknown.

Peroxisome proliferators activate PPAR (Reddy and Mannaerts, 1994). Fatty acids such as 20:4(n-6), 12:0, and 18:2(n-6) have been shown to activate this receptor (Reddy and Mannaerts, 1994). Vamecq et al (1993) speculate that the natural ligand is likely to be a physiological metabolite whose cellular concentration increases upon exposure to peroxisome proliferators. These authors suggest that the natural ligand of PPAR belongs to the family of the n-3 fatty acids or is generated from the n-3 fatty acids. The ligand may be the CoA esters of EPA and DHA as suggested by Bremer and Norum (1982) in their mechanism for the increase in peroxisomal proliferation seen when animals are fed fish oils. Bremer and Norum (1982) proposed that the accumulation of CoA esters of very long chain unsaturated fatty acids which are poorly oxidized by mitochondria trigger this process. In fact, Osmundsen et al (1985) found that DHA was a potent inhibitor of mitochondrial  $\beta$ -oxidation and this finding may be relevant to the mechanism speculated by Bremer and Norum (1982).

The incorporation into phospholipids may explain the fate of EPA in muscle tissues and the reason for preferential oxidation of 18:1(n-9). While studying the independent effects of individual n-6 and n-3 polyunsaturated fatty acids on LDL metabolism, Spady (1993) observed that 18:3(n-3) is absorbed well and is found in the triacylglycerols of liver and adipose tissue but appears to be preferentially oxidized rather than incorporated into membrane phospholipids.

However, EPA and DHA increased the total n-3 fatty acid content of liver phospholipids by three to six fold.

In summary, then, our findings indicate that even though the rate of oxidation of EPA over DHA was doubled in the experiments which employed soleus muscle homogenates, there was no differential oxidation between DHA and EPA in muscle when these fatty acids were incubated with either the intact soleus muscle or cardiac myocytes (Table 2.2). Since the latter two experiments may be more representative of the physiological state, it appears that these results may not support our first postulated mechanism that EPA is preferentially oxidized compared to DHA by muscle. Due to the fact that there are discrepancies in the results obtained from the three oxidation studies, more investigative work should be done to determine the question of preferential oxidation of EPA relative to DHA. However, it is evident from the data that preferential oxidation of fatty acids does occur. In all three experimental approaches, 18:1(n-9) was a preferred substrate for oxidation.

## CHAPTER 3.0

### HYDROLYSIS OF CHYLOMICRON TRIACYLGLYCEROL BY MUSCLE

#### LIPOPROTEIN LIPASE

##### 3.1 INTRODUCTION

It is known that lipoprotein lipase (LPL) activity is affected by the amount of dietary fat as well as the type of dietary fat. High fat diets appear to increase LPL activity in muscle (Smolin et al, 1986; Pederson et al, 1980). Similarly, dietary fish oil enhances muscle LPL activity (Herzberg et al, 1989; Baltzell et al, 1991; Anil et al, 1992). From these studies conducted with marine oils, researchers have suggested that there is a shift from fatty acids being deposited to being used for cellular metabolic processes such as oxidation. Furthermore, LPL exhibits substrate specificity. For instance, longer chain fatty acids seem to be hydrolyzed at slower rates than short chain fatty acid esters (Wang et al, 1993; Wang, 1994; Melin et al, 1991).

We suggested that EPA is preferentially hydrolyzed compared to DHA from circulating triacylglycerols by muscle LPL with the hypothesis that if more EPA is released to the peripheral tissues for metabolism then less would be available for storage in adipose tissue. Consequently, our second hypothesis to explain the underrepresentation of EPA in tissue triacylglycerols compared to DHA is that EPA is preferentially released from circulating triacylglycerol

compared to DHA. Therefore, chylomicrons were incubated with cardiac LPL to determine if there was selective release of EPA. To gain further understanding and insight into this question, a review of LPL in myocytes, including its synthesis, transport, regulation and substrate specificity, is presented in the next section.

### 3.2 LIPOPROTEIN LIPASE IN MYOCYTES

LPL is the major enzyme responsible for hydrolysis of triacylglycerols in chylomicrons and VLDL and provides free fatty acids and sn-2 monoacylglycerols as its principal products for tissue utilization. This enzyme shows a low degree of chemical substrate specificity since it can hydrolyze long and short chain triacylglycerols, diacylglycerols, monoacylglycerols as well as long and short chain phosphatidylcholines (Olivecrona and Bengtsson-Olivecrona, 1987). LPL catalyzes not only the cleavage of ester bonds but also their formation. Consequently, LPL also acts as a transacylase (Bengtsson and Olivecrona, 1980). Monoacylglycerols and diacylglycerols are efficient acyl acceptors and fatty acids can be used as substrates as shown by the incorporation of labelled oleate into diacylglycerols and triacylglycerols in studies conducted by Bengtsson and Olivecrona (1980).

For maximal activity, LPL requires the presence of a cofactor, apoprotein CII, a protein component present at the surface layer of the triacylglycerol-rich lipoproteins (Nilsson-Ehle, 1987; Bensadoun, 1991). Apoprotein CII, a 9000 Da

peptide present in HDL, VLDL, and chylomicrons, is most frequently provided *in vitro* by the addition of whole serum. This serum is pretreated with heat at 62°C for 10 min to abolish endogenous lipase activity and can be kept at -20°C for at least a year without the loss of activating ability (Nilsson-Ehle, 1987).

The high sensitivity of LPL to product inhibition makes it necessary to sequester the fatty acids during incubation experiments to prevent their accumulation at the surface of the emulsion particles. Thus, albumin is an essential component to obtain maximal enzyme activity. In the absence of a fatty acid carrier such as albumin, fatty acids and monoacylglycerols accumulate at the site of triacylglycerol hydrolysis and inhibit the hydrolytic reaction (Nilsson-Ehle, 1987; Olivecrona et al, 1987). However, Wang et al (1993) discovered that not only is albumin a fatty acid acceptor but also acts as an inhibitor by its direct interaction with short and medium chain triacylglycerols. Thus, in the presence of apoprotein CII and albumin, there is a preferential activation effect of LPL for the hydrolysis of long chain triacylglycerols. It is interesting to note that the role of apoprotein CII in activating the enzyme and the role of albumin in accepting the long chain fatty acids are important for optimum LPL catalysis in the hydrolysis of long chain triacylglycerols.

LPL is synthesized in most tissues including adipose tissue, heart, lung, mammary gland, skeletal muscle, kidney, ovary, testes, spleen, and small intestine (Braun and Severson, 1992; Bensadoun, 1991). Adipose tissue, heart



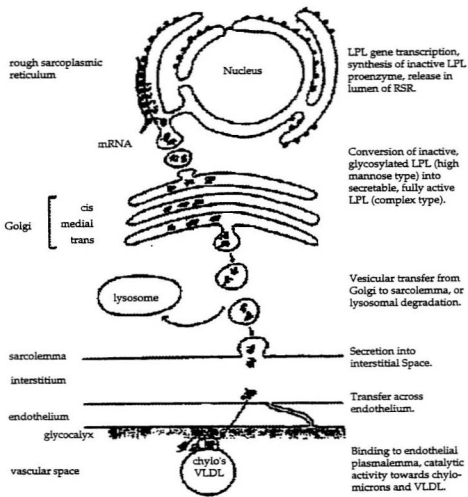
and lactating mammary gland have the highest transcriptional and catalytic activity (Braun and Severson, 1992). LPL belongs to the gene family that includes hepatic and pancreatic lipases. In fact, human LPL is 46% homologous with rat hepatic lipase and 28% homologous with porcine pancreatic lipase (Bensadoun, 1991). However, it has no homology with lingual lipase or hormone sensitive lipase.

Skeletal muscle LPL is significantly higher in the fast twitch red and slow twitch red fibres than in the fast twitch white fibres. Since muscles are made up of a mixture of fibre types, LPL activity depends on whether the muscle has predominantly red or white fibres. In the rat, skeletal muscle forms approximately 45% of the body weight and about one third of the muscle mass is made of red fibres (Borensztajn, 1987). Consequently, the total LPL activity in this tissue is substantial (Borensztajn, 1987). In contrast, heart LPL accounts for only a small fraction of the total enzyme activity present in extrahepatic tissues and makes a quantitatively minor contribution to the catabolism of plasma triacylglycerol-rich lipoproteins. However, more attention and interest has been generated in studying cardiac LPL rather than skeletal muscle LPL because the heart can be isolated intact and the vascular bed can be perfused with relative ease.

In muscle, as well as other tissues, the site of action of LPL is the endothelial surface to which the enzyme is bound. However, these cells are

incapable of synthesizing LPL. LPL is synthesized in both myocytes and nonmuscle cells and is distributed throughout the tissue in several compartments. Blanchette-Mackie et al (1989) used electron microscopy to study the immunolocalization of LPL in the hearts of young mice. They found that in the fed state, 78% of LPL was localized in the myocytes, 3-6% in extracellular space and 18% in capillary endothelium. Interestingly, however, LPL appears to undergo developmental regulation (Braun and Severson, 1992). For instance, in the neonatal heart, the majority of LPL is found in the mesenchymal cells whereas the cardiac myocyte represents the predominant source in the adult heart (Bagby and Coril, 1989).

The synthesis, transport and site of action of LPL in the heart is schematically represented in Figure 3.1. As depicted in the diagram, LPL is synthesized as an inactive glycosylated proenzyme in the lumen of the rough sarcoplasmic reticulum. After the trimming of high mannose N-oligosaccharides, activation and modification of LPL takes place in the Golgi system where progressive N-linked glycosylation, required for catalytic activity, occurs. As the glycoprotein moves through the Golgi processing stacks by vesicular transport from the cis- to the trans-cisternae, the oligosaccharide is further modified by processing enzymes. Glycoproteins processed by the Golgi are sorted in the trans-Golgi network for i) delivery to lysosomes for degradation, ii) incorporation into secretory vesicles (regulated mechanism), or iii) delivery to



**Figure 3.1** Synthesis, Transport and Site of Action of Lipoprotein Lipase (Adapted from Van Der Vusse, 1992).

the plasma membrane (constitutive or spontaneous mechanism). The constitutive mechanism refers to a process in which proteins are secreted as they are synthesized, without any intracellular accumulation. The regulated mechanism refers to the process in which newly synthesized proteins are stored in secretory vesicles and then released when the cell receives a stimulus from an appropriate secretagogue (Braun and Severson, 1992).

The majority of cardiac LPL is found in secretory vesicles of myocytes. In the presence of secretagogues active LPL is transported and secreted. If not, degradation of LPL takes place by lysosomes that fuse with the secretory vesicles. After secretion, LPL is transported across the endothelium by an unknown mechanism and is fixed at the luminal extent of the glycocalyx, which is anchored at the basement membrane of endothelial cells. Little information is known about the translocation of LPL from the sites of synthesis, across the interstitial spaces and to the luminal surface of capillary endothelial cells. Blanchette-Mackie et al (1989) proposed that LPL is transferred along bridges of heparan sulphate proteoglycan molecules that connect the cell surfaces of cardiac myocytes and capillary endothelial cells in the heart.

The rate of hydrolysis of triacylglycerols in the circulating lipoproteins is regulated by the plasma concentration of triacylglycerols, the amount of LPL attached to the endothelial luminal surface, and the presence of specific activator proteins (i.e., apoprotein CII) in the coat of the lipoprotein particles (Van Der

Vusse et al, 1992). In addition, LPL activity is responsive to tissue-specific regulation. The targeting of triacylglycerol-rich lipoproteins to specific tissues for storage or oxidation depends on the energy needs of that particular tissue or the nutritional status of the organism (Sugden et al, 1993). For instance, in fasting or starvation, muscle LPL activity seems to increase while the activity of adipose tissue LPL decreases (Nilsson-Ehle et al, 1976; Cryer et al, 1976; Borensztajn and Robinson, 1970). It has been suggested that this phenomenon occurs to divert circulating triacylglycerols from adipose tissue to muscle where they are needed and utilized.

Sugden et al (1993) assessed whether changes in LPL activities in adipose tissue and muscle are reciprocally and coordinately regulated to gain insight into the potential relative importance of adipose tissue and muscle as major sites of plasma triacylglycerol clearance during continuous or interrupted feeding. LPL activities in parametrial and interscapular adipose tissue, soleus and adductor longus muscles and hearts of female rats were measured during progressive starvation, chow re-feeding after 24 h of starvation and throughout dark and light phases in rats permitted unrestricted access to chow. These authors showed a progressive fall in adipose tissue LPL activities during the 24 h of starvation, a dramatic increase in skeletal muscle LPL between 9 and 12 h of starvation, and a 2.5-fold raise in cardiac LPL activities within 6 h of starvation reaching a maximum after 12 h. Upon refeeding chow *ad libitum*, they found that the

activity of adipose LPL increased rapidly within 2 h. Even though adipose LPL activity was higher than muscle LPL activities, Sugden and coworkers (1993) observed increases in both cardiac and skeletal oxidative muscle LPL activities after refeeding and throughout the whole 6 h refeeding period. In addition, adipose tissue LPL activities exceeded those of cardiac and skeletal muscle throughout both light and dark phases. The lowest adipose tissue LPL activities were observed at 9 h into the dark phase. Cardiac LPL activity declined throughout the dark phase, with a minimum at 9 h into the dark phase. No such variation was observed for skeletal muscle LPL. The authors found that a diurnal nadir in plasma triacylglycerol concentrations coincided with the peak in cardiac LPL activities. The results demonstrate that, during unrestricted feeding and refeeding after prolonged starvation, changes in skeletal muscle and adipose tissue LPL activities are neither reciprocal nor co-ordinate. Furthermore, Sugden et al (1993) commented that the regulation of cardiac LPL activity during the diurnal cycle may be an important aspect of both cardiac fuel selection and whole body triacylglycerol metabolism.

There have been a number of studies investigating the effects of hormones and diet on LPL activity. The effects of hormones on LPL activity have been reported for a variety of tissues. After a meal, the main site of triacylglycerol hydrolysis is adipose tissue where LPL is increased by insulin, the effect being increased by glucocorticoids (Vance and Vance, 1991). In fact, the activity of

muscle LPL is relatively low when compared with that in adipose tissue when insulin is effectively regulating metabolism. According to Cryer (1981), muscle lipase activity is not maintained by insulin but rather by glucocorticoids, with the possible involvement of glucagon, catecholamines and thyroid hormones. Cardiac myocytes isolated from diabetic rat hearts have decreased cellular LPL activity and reduced release of LPL in response to heparin which could be the cause of the fall in functional LPL activity in the whole heart. Administration of insulin *in vivo* rapidly reversed the effects of diabetes on LPL in cardiac myocytes. However, incubations of control and diabetic myocytes with insulin *in vitro* had no effect on either cellular or heparin releasable LPL activities. Thus, additional factors active *in vivo* may be required for insulin to be effective in an *in vitro* incubation or the decrease in LPL activity may not be due to insulin deficiency directly, but instead be secondary to one or more of the multiple metabolic factors that are altered in acute models of diabetes (Braun and Severson, 1992).

Norepinephrine and glucagon perfusion of isolated rat heart have been shown to increase the functional activity of LPL attached to the luminal side of the endothelium (the heparin-releasable fraction) with a concomitant and quantitatively comparable decrease in the activity of the non-heparin releasable enzyme (Stam and Hülsmann, 1980). According to Van der Vusse et al (1992), "These inverse changes in LPL activity favour a hormone induced stimulation of

lipase transport from the intracellular compartment to the vascular endothelial site of enzyme action".

Feeding a high carbohydrate or high fat diet affects LPL activity. The consumption of carbohydrate causes muscle LPL activity to be maintained at low levels. When animals are deprived of food, muscle LPL activity is increased. Carbohydrate feeding caused a rapid decline in activity when glucose was used as the carbohydrate source (Pederson and Schotz, 1980). Feeding a diet containing saturated fat for 2 weeks stimulated skeletal muscle LPL activity and depressed the activity in adipose tissue compared to feeding a diet high in carbohydrate (Linder et al, 1976; DeGasquet et al, 1977; Delhorme and Harris, 1975). Brown and Layman (1988) used varying amounts of fat in the diet to examine the relationships of changes in tissue LPL activity with plasma clearance and tissue uptake of fatty acids. They fed female rats diets which contained either 12% kJ from fat or 72% kJ from fat for a period of eight weeks. Animals fed the high fat diet had higher levels of fasting plasma triacylglycerols and lower LPL activities in the heart, renal adipose tissue and post-heparin plasma. LPL activities in skeletal muscle varied with higher values found in the soleus and plantaris (red slow twitch muscles) and no differences observed in the gastrocnemius. Furthermore, they found that only the lowered renal adipose tissue LPL activity was associated with a lower uptake of fatty acids from  $^{14}\text{C}$ -labelled chylomicron triacylglycerols and concluded that, in general, tissue and plasma



LPL activities were not a direct index of the uptake of fatty acids by tissues or the clearance of chylomicron triacylglycerols.

Similarly, others have demonstrated the potential for high fat feeding to decrease adipose LPL activity (Delorme and Harris, 1975). In addition, when animals were fed fat enriched diets for 10 days, heart LPL activity either increased (Delorme and Harris, 1975) or was not different (Alousi and Mallov, 1964) from the controls who were fed a carbohydrate-rich diet. Acute feeding of fat (i.e., Wesson Oil™) to starved or fed rats has been reported to result in no change in heart LPL activity (Alousi and Mallov, 1964). However, Pederson et al (1981) reported that one hour after the acute feeding of fat to starved rats, the heart LPL fraction that is readily releasable by heparin was significantly increased. Smolin et al (1986) found that in rats fed a single test meal containing 70% kcal as vegetable oil, epididymal and retroperitoneal fat LPL activities were less and cardiac LPL activity greater when compared to that of rats fed a single high carbohydrate meal (70% kcal as cornstarch). However, the activity of the red gastrocnemius and soleus muscles were unaltered by single test meals.

The type of fat in the diet may affect LPL activity as well. For instance, Marette and coworkers (1990) compared the effects of dietary saturated and polyunsaturated fats on adipose tissue LPL activity. Rats were fed for 4 weeks a purified high fat diet (60% of energy as fat) either composed of lard or corn oil. They found that epididymal adipose tissue LPL activity was lower in rats fed

corn oil diets and suggested that this finding may relate to the higher concentration of lipid peroxides measured in this tissue of these rats. Other investigations (Herzberg and Rogerson, 1989; Baltzell et al, 1991; Anil et al, 1992; Haug and Hostmark, 1987; Otto et al, 1992; Groot et al, 1989; Huff et al, 1993; Murphy et al, 1993) have shown that diets containing fish oils affect the activity of tissue LPL. Upon feeding with fish oils, muscle LPL activity was either enhanced (Herzberg and Rogerson, 1989; Baltzell et al, 1991; Anil et al, 1992) or did not change (Otto et al, 1992).

In addition to the synthesis and regulation of this enzyme, many investigators have been interested in examining the substrate specificity of LPL (Wang et al, 1993; Wang, 1994; Bauer, 1988; Meilin et al, 1991; Nilsson et al, 1987). From their data, Wang et al (1993) showed that tributyrilglycerol represented the best substrate for LPL, and the LPL preferential reactivity followed the order of: C4>C6>C8>C10>C12>C18:1, which is also the order of solubility. More recently, Wang (1994) utilized chromogenic short chain esters of p-nitrophenol as substrates for probing the active site of LPL. The results indicated that there is a consistent trend in the decrease of the Michaelis-Menten constant with increasing acyl chain length. It was concluded that the decrease in reactivity with increasing chain length is probably not a consequence of a lower affinity of the substrate for the enzyme. Furthermore, Wang (1994) states that the reason that butyrate ester has the optimum acyl chain length to be a substrate of LPL can be attributed to

its chain length being long enough for optimum interaction with the active site His-Ser-Asp triad in forming the transition state complex, yet it is short enough to provide freedom for optimum positioning of the ester bond for transition state complex formation.

Bauer (1988) performed substrate specificity studies of partially purified rabbit heart LPL. Both saturated and unsaturated fatty acid chain hydrolysis were investigated using synacyl and mixed acyl triacylglycerol emulsion substrates. It was found that trans, monounsaturated and some saturated fatty acids were more favourably hydrolyzed than polyunsaturated cis fatty acids. Bauer (1988) concluded that these findings may be of physiological significance and may relate to the production of lipoprotein remnant particles relatively enriched in polyunsaturated fatty acids, especially when consumed in the diet, and the subsequent preferential delivery of these fatty acids to the liver.

### 3.3 PURPOSE OF EXPERIMENT

The experiment outlined in this chapter examine the second proposed mechanism; i.e., EPA is preferentially released relative to DHA from circulating triacylglycerols. The objective is as follows:

- Objective 2.1      To investigate the rate of hydrolysis of EPA and DHA from triacylglycerols found in chylomicrons.

### 3.4 MATERIALS AND METHODS

#### 3.4.1 CHEMICALS

Unless otherwise stated, all chemicals were purchased from Sigma Chemical Company (St. Louis, Mo). Monoheptadecanoin, diheptadecanoin, and triheptadecanoin were ordered from NuChek Prep (Elysian, MN.). Organic solvents and acids were obtained from Fisher Scientific (Dartmouth, N.S.) while diethyl ether was from BDH (Toronto, Ont.). MaxEPA oil was obtained as a gift from R.P. Scherer, Windsor, Ont.

#### 3.4.2 CANNULATION OF THE MAIN INTESTINAL LYMPH DUCT AND CHYLOMICRON COLLECTION

Male, Sprague-Dawley rats weighing ~350 g were obtained from the Charles River Company (Laprairie, Quebec). They were housed in plastic cages and maintained on a 12 hour light/12 hour dark cycle at an ambient temperature of 22°C. These animals were fed standard laboratory chow. Prior to cannula-

tion, animals were given an oral dose of MaxEPA oil to aid in the visualization of the main intestinal lymph trunk.

Rats were fitted with exteriorized cannulas in the duodenum and the main intestinal lymphatic trunk by the method described in Chernenko et al (1989). The animals were anaesthetized intramuscularly with a ketalean-40 mg/kg (MTC Pharmaceuticals, Cambridge, Ontario) and xylazine-10 mg/kg (MTC Pharmaceuticals, Cambridge, Ontario) mixture. A laparotomy with a midline incision was performed on the rats. The duodenum and small intestine were deflected to expose the mesenteric artery and superior intestinal lymphatic trunk. The overlying connective tissue was dissected away from the lymphatic trunk and a small incision was made. A cannula of polyethylene tubing (PE 50, Clay Adams) was inserted into the incision, and after a good flow had been established, this was secured using a drop of cyanobutylacrylate (Krazy Glue™, The Borden Co., Ltd., Willowdale, Ont.). The lymphatic cannula was exteriorized through a stab wound in the right flank.

The duodenum was cannulated with a 5 French infant nasogastric feeding tube, in a caudal direction, through a small incision about 1 cm distal to the pylorus. This cannula was also secured with a drop of glue. The duodenal cannula was exteriorized through a stab wound in the left flank. The laparotomy was closed by suturing the muscle layer, then the skin using 4-0 silk.

Following surgery, the rats were immobilized in Bollman restraint cages and placed in a warm, dark room. Lymph flow was promoted by the continuous infusion of saline through the duodenal cannula (2.5 mL/h). Coagulation of lymph was prevented by the addition of heparin to the lymph collecting flasks. Each rat was given intraduodenally a 1.0 mL bolus dose containing 0.5 mL of MaxEPA oil plus 0.5 mL of 20 mM sodium taurocholate three times during the 24 hour collection of lymph. The oil and sodium taurocholate were sonicated just before dosing to ensure homogeneity.

#### 3.4.3 ISOLATION OF CHYLOMICRONS

This isolation of chylomicrons was modified from the procedure described by Lindgreen et al (1972). Fresh lymph was centrifuged for 90 min at 60,000 g at 18°C in a Beckman ultracentrifuge using an 80 Ti rotor. The chylomicrons were then removed and layered into the bottom of a centrifuge tube containing 6 mL of 1.0063 g/L (0.195 M NaCl) density solution. The chylomicrons were centrifuged once again at 60,000 g for 90 min. Chylomicrons were then transferred to a screw-capped vial and stored in the refrigerator until assayed for total triacylglycerol concentration. Triacylglycerol concentration of the chylomicrons was determined enzymatically using a Triglyceride-UV Kit from Sigma Diagnostics (Procedure No. 334-UV). This method involves four enzymatic steps. First triacylglycerols are hydrolyzed to glycerol and free fatty acids by lipase. Second, glycerol is phosphorylated by ATP in a reaction catalyzed by glycerol kinase.

Third, ATP is then regenerated in a reaction catalyzed by pyruvate kinase between ADP and phosphoenol pyruvate. And lastly, the resulting pyruvate from the previous step is reduced to lactate while NADH is oxidized to NAD by lactate dehydrogenase. The decrease in absorption of NADH is measured at 340 nm since this decrease in absorption is directly proportional to the triacylglycerol concentration in the sample. The assay was linear with time and the amount of chylomicrons.

#### **3.4.4 PREPARATION OF CARDIAC LIPOPROTEIN LIPASE**

The rats were anaesthetized intramuscularly with a ketalean-40 mg/kg (MTC Pharmaceuticals, Cambridge, Ontario) and xylazine-10 mg/kg (MTC Pharmaceuticals, Cambridge, Ontario) mixture and the heart was quickly excised. Acetone powders were prepared from the heart by homogenizing the tissue in 100 mL of acetone in a Waring Blender for 1 min. The homogenate was filtered onto Whatman no. 5 filter paper and washed briefly with additional aliquots of acetone and ethyl ether in order to further delipidate. The air-dried acetone powders were stored at -70°C until extraction.

The acetone powders were solubilized in a buffer containing 1.0 M ethylene glycol, 0.05 M Tris, and 0.125% deoxycholate, pH 8.4. Extracts were prepared by homogenizing the powder in the buffer at a 1:10 dilution for 2 min and then filtering through a polyethylene mesh. One (1) mL of the filtrate was

used for the incubation experiments. The filtrate contained both the intra- and extra-cellular pools of LPL.

#### 3.4.5 INCUBATION OF CHYLOMICRONS WITH LIPOPROTEIN LIPASE

The hydrolysis of triacylglycerol in chylomicrons isolated from lymph by cardiac LPL was conducted according to a procedure adapted from Ekström et al (1989). Chylomicrons containing 70 mg of triacylglycerols were incubated at 37°C in 10 mL of a 40 mM HEPES buffer solution (pH 7.4) containing 5 mM CaCl<sub>2</sub> and 0.6 g fatty acid free bovine serum albumin. To this medium, 1 mL of rat serum that was heated for 10 min at 62°C (source of apoprotein CII) and 1 mL of the enzyme filtrate were added to start the reaction. At times 0, 5, 15, 30, 60, and 120 min, 1 mL aliquots of the incubation medium were taken and immediately mixed with chloroform:methanol (2:1) containing hydroquinone and C17 internal standards for monoacylglycerol, diacylglycerol, triacylglycerol, and the free fatty acid.

Lipids were then extracted by the method of Folch et al (1957). The lipid fractions were separated by thin layer chromatography on silica gel G using hexane:diethyl ether:glacial acetic acid (80:20:2). The lipid spots were visualized with iodine and identified by comparison with known standards. The monoacylglycerol, diacylglycerol, triacylglycerol, and fatty acid spots were scraped off, eluted with chloroform-methanol and the dried eluate transmethylated as previously described (Keough and Kariel, 1987). The fatty



acid methyl esters were separated by GLC using a Supelcowax 60 m capillary column in a Hewlett Packard 3365 Series II GC. Oven temperature was 190°C ramped 5°C/min to 210°C and remained there for an additional 12 min. The injection port and flame ionization detector oven temperatures were 230°C. The fatty acids were identified by comparison of retention times with known standards from Sigma Chemical Co.. Peak areas were integrated using Hewlett Packard 3365 Series II Chemstation Software.

#### 3.4.6 STATISTICAL ANALYSIS

The significance of differences in the distribution of individual fatty acids among different lipids was calculated using repeated measures of analysis (time and fatty acid were the factors).  $p < 0.05$  was the cut-off used to determine significance.

### 3.5 RESULTS

The main fatty acids found in the chylomicron triacylglycerols included 14:0, 16:0, 16:1(n-7), 18:0, 18:1(n-9), 18:2(n-6), EPA and DHA (Table 3.1). 18:3(n-3), 18:4(n-3), 20:4(n-6), and 22:5(n-3) were minor contributors to the fatty acid content of the triacylglycerols found in the extracted chylomicrons (Table 3.1).

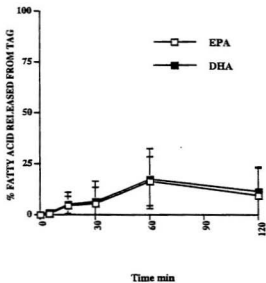
When chylomicrons were incubated with LPL, triacylglycerol was degraded and monoacylglycerols, diacylglycerols and free fatty acids were generated. Figures 3.2, 3.3, and 3.4 represents the percentage of the fatty acids, DHA and EPA, found in the monoacylglycerol, diacylglycerol and free fatty acid

fractions that were released from the original chylomicron triacylglycerols over the two hour time course. Figure 3.5 depicts the proportion of these two fatty acids remaining in the triacylglycerol component. The fatty acid composition of the different lipids changed with incubation times. However, the relative release and accumulation of EPA and DHA in the four lipids followed the same pattern and did not differ significantly. The same observations were seen when 18:1(n-9) and 18:2(n-6) (Figures 3.6 and 3.7) were included in the analysis even though the actual amounts of these two fatty acids were greater in the chylomicron triacylglycerols than were the long chain n-3 fatty acids and consequently, more substrate was available to the enzyme.

**Table 3.1 Fatty Acid Composition of Chylomicron Triacylglycerols (weight %, Values are means  $\pm$  S.D.)**

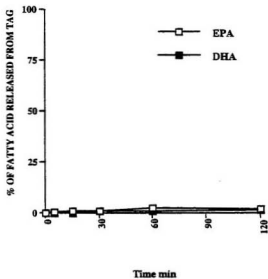
Fatty Acid	% of Total Fatty Acids
14:0	6.3 $\pm$ 1.3
16:0	24.2 $\pm$ 0.6
16:1 (n-7)	9.4 $\pm$ 1.7
18:0	6.2 $\pm$ 0.7
18:1 (n-9)	16.9 $\pm$ 1.1
18:2 (n-6)	14.6 $\pm$ 3.0
18:3 (n-3)	1.5 $\pm$ 0.1
18:4 (n-3)	1.9 $\pm$ 0.3
20:4 (n-6)	1.6 $\pm$ 0.2
EPA (20:5, n-3)	8.9 $\pm$ 1.0
22:5 (n-3)	1.5 $\pm$ 0.1
DHA (22:6, n-3)	7.0 $\pm$ 0.7

### MONOACYLGLYCEROL



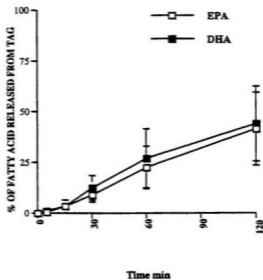
**Figure 3.2** The Proportion of EPA and DHA in the Original Chylomicron Triacylglycerols Found in Monoacylglycerols. Results are means  $\pm$  S.D. for 5 experiments. No significant difference between the 2 fatty acids over time.

### DIACYLGLYCEROL



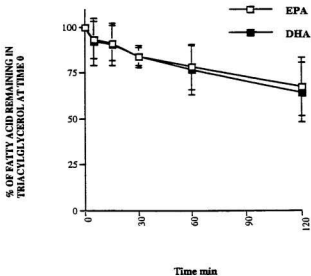
**Figure 3.3** The Proportion of EPA and DHA in the Original Chylomicron Triacylglycerols Found in Diacylglycerols. Results are means  $\pm$  S.D. for 5 experiments. No significant difference between the 2 fatty acids over time.

### FATTY ACID

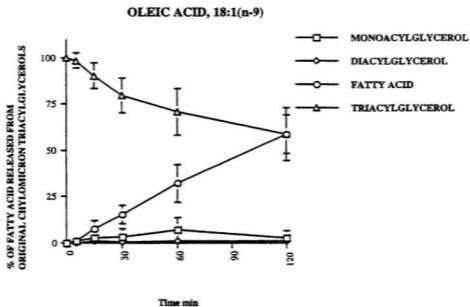


**Figure 3.4** The Proportion of EPA and DHA in the Original Chylomicron Triacylglycerols Released as Free Fatty Acids. Results are means  $\pm$  S.D. for 5 experiments. No significant difference between the 2 fatty acids over time.

### TRIACYLGLYCEROL



**Figure 3.5** The Proportion of EPA and DHA in the Original Chylomicron Triacylglycerols Remaining in the Triacylglycerols. Results are means  $\pm$  S.D. for 5 experiments. No significant difference between the 2 fatty acids over time.



**Figure 3.6** The Proportion of Fatty Acid From the Original Chylomicron Remaining in Triacylglycerols or Accumulating in Monoacylglycerols, Diacylglycerols, or Free Fatty Acids. Results are means  $\pm$  S.D. for 5 experiments.



LINOLEIC ACID, 18:2(n-6)

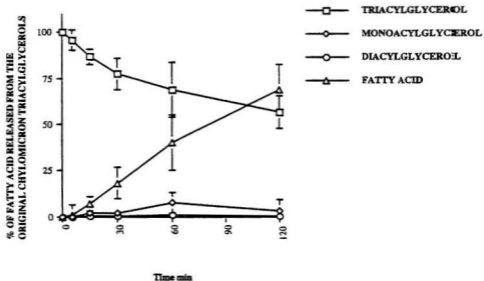


Figure 3.7 The Proportion of Fatty Acid From the Original Chylomicron Remaining in Triacylglycerols or Accumulating in Monoacylglycerols, Diacylglycerols, or Free Fatty Acids. Results are means  $\pm$  S.D. for 5 experiments.

### 3.6 DISCUSSION

We examined the lipolysis of chylomicron lipids with cardiac LPL to see whether EPA and DHA exhibited different rates of hydrolysis. It is assumed that if fatty acids are released from chylomicron triacylglycerols at different rates, then the tissue distribution of the fatty acids could be influenced by this event. This study demonstrated no difference in the hydrolysis pattern of the two n-3 fatty acids and thus the data does not support the second proposed mechanism (Table 3.2). In fact, the pattern resembled that of two predominant fatty acids found in chylomicron triacylglycerols, i.e., 18:1(n-9) and 18:2(n-6).

Most of the research concerning fish oils and LPL has dealt with the effect on LPL activities of peripheral tissues upon fish oil feeding. Groot et al (1989) measured plasma lipoprotein levels and LPL activities in post-heparin serum after a 24 h fast in pigs that had been fed a diet containing either 21% energy from mackerel oil or lard fat. After 8 weeks, both the plasma triacylglycerol and cholesterol levels were lower in the mackerel oil fed group of animals. Moreover, LPL activity in post-heparin serum taken 6 h after a meal, was decreased by 31% in the fish oil fed pigs. Similarly, Huff et al (1993) studied the effects of fish oil and corn oil on different parameters including the lipolytic enzymes, LPL and hepatic lipase. These researchers fed miniature pigs diets containing supplements of corn oil or MaxEPA oil for 3 to 6 weeks. The fish oil diet significantly reduced post-heparin plasma LPL and hepatic lipase activities,

**Table 3.2 Summary of Primary Objective and Result for Mechanism #2.**

<b>Mechanism # 2: EPA is preferentially released relative to DHA from circulating triacylglycerols.</b>	
<b>Objective</b>	<b>Result</b>
2.1 To investigate the rate of hydrolysis of EPA and DHA from triacylglycerols found in chylomicrons.	No significant difference observed with regards to the proportion of EPA or DHA released from triacylglycerols in chylomicrons.

which the authors suggested may be an adaptive response to the low concentration of substrates for these enzymes. In contrast, Harris et al (1988) found no effect of a fish oil diet on the LPL and hepatic lipase activity of post-heparin plasma measured *in vitro* while examining the effects of n-3 fatty acids on chylomicron formation and metabolism in healthy volunteers.

As already cited in Section 2.1, Herzberg and Rogerson (1989) examined the activity of LPL in adipose tissue, heart and skeletal muscle of rats fed diets containing fish oil, corn oil or tallow. Adipose tissue LPL activity was unaffected by dietary fat; however, heart and skeletal muscle LPL activity was higher in animals fed fish oil. Herzberg and Rogerson (1989) remarked that these results are not inconsistent with the findings observed by Harris et al (1988). Post-heparin plasma LPL activity represents both muscle and adipose tissue activity. The difference in heart and muscle LPL activities could be masked by the contribution of adipose tissue activity to the total measured. Accordingly, Baltzell and colleagues (1991) found similar results to Herzberg and Rogerson (1989) when they investigated the role of LPL and hepatic lipase on the triacylglycerol-lowering effect of fish oil. These researchers fed rats 12.5 % by weight of lard, corn oil or menhaden oil as the primary fat source in otherwise identical diets for 2 weeks. Soleus muscle LPL was greatest for the fish oil fed group whereas adipose tissue LPL did not differ between groups. There was no difference in hepatic lipase between the oil fed groups. However, the lard group

had elevated hepatic lipase. From their data, Baltzell et al (1991) concluded that increased soleus LPL, decreased fat weight and therefore total adipose LPL, along with a decreased plasma triacylglycerol suggest a shift from fat deposition to oxidation with menhaden oil feeding. Furthermore, the lack of response of hepatic lipase to fish oil feeding suggested that this enzyme did not contribute to the fish oil-stimulated lowering of plasma triacylglycerol. However, in a subsequent study, the same investigators showed contrasting results with respect to the effects of dietary fish oil to LPL activity (Otto et al, 1992). These authors found that feeding rats low fat (50 g/kg diet) or medium fat (95 g/kg) menhaden oil supplemented diets, as opposed to the high fat diets, had no effect on skeletal muscle or epididymal adipose tissue LPL activity. Thus, Otto et al (1992) commented that the catabolism of triacylglycerol-rich lipoproteins contributes little, if any, to the fish oil reductions of triacylglycerol or free fatty acids in plasma. Furthermore, they suggested that the results from this study indicate that the apparent direct inhibition of triacylglycerol secretion by fish oil imposes a rate limitation only when feeding high fat diets. At lower fat concentrations, hepatic triacylglycerol synthesis appears to limit secretion.

Interestingly, Anil and coworkers (1992) found the activity of LPL in both adipose tissue and aorta was significantly higher in rats fed 10% (w/w) sardine oil than in rats fed groundnut oil. They suggested that this result may be the cause for increased clearance of triacylglycerol-rich lipoproteins from circulation.

When 22% of the diet contained fish oil for 4 weeks, adipose tissue LPL activity was less than that found in rats given an equal amount of coconut oil (Haug and Hostmark, 1987).

Little research has been done to determine the processes by which EPA and DHA are transported to different tissues and the factors that control their uptake and incorporation into tissue lipids. However, there have been a few investigations that compared the hydrolysis of polyenoic fatty acids with particular attention to the two eicosanoid precursors, 20:4(n-6) and EPA. Nilsson et al (1987b) found that during the lipolysis of rat chylomicrons with LPL, [<sup>3</sup>H]-20:4(n-6) esters in triacylglycerol were hydrolyzed at a slower rate than [<sup>14</sup>C]-18:2(n-6) esters. When they added antiserum against hepatic lipase to the postheparin plasma which contains both LPL and hepatic lipase, these authors found that the hydrolysis of 20:4(n-6) was less efficient, suggesting that these two enzymes may interact in the hydrolysis of these esters. However, we found the rate of hydrolysis of EPA and DHA (consisting of 20 and 22 carbons, respectively) from chylomicron triacylglycerols was similar to the rate of hydrolysis of 18:2(n-6).

Previously, these same authors (Nilsson et al, 1987a) demonstrated a preferential incorporation of dietary 20:4(n-6) into chyle lipoprotein phospholipids, a relative resistance of 20:4 esters of chyle triacylglycerol to hydrolysis by LPL, a preferential release of 20:4(n-6) for phospholipid acylation,

and a low rate of oxidation of this fatty acid. They suggested that these factors may contribute to the differences seen in the incorporation into tissue lipids between the absorbed 20:4(n-6) and the predominant dietary 16 and 18 carbon fatty acids.

In 1991, Nilsson's group examined the lipolysis of rat chylomicron polyenoic fatty acid esters with bovine milk LPL and human hepatic lipase *in vitro* (Melin et al, 1991). Chylomicrons obtained after feeding fish oil or soy bean oil emulsions were used as substrates. LPL hydrolyzed EPA and 20:4(n-6) at a slower rate than 14 and 18 carbon acid esters. More EPA and 20:4(n-6) accumulated in the remaining triacylglycerols and diacylglycerols. When added together with LPL, hepatic lipase increased the rate of lipolysis of the 20 carbon polyunsaturates of both diacylglycerols and triacylglycerols. They suggested that the tri- and di-acylglycerol species containing these fatty acids may accumulate at the surface of the remnant particles and act as substrates for hepatic lipase during a concerted action of this enzyme and LPL.

In the present study, 20:4(n-6) accounted for an extremely small proportion of the chylomicron triacylglycerol content and therefore, the hydrolysis of this fatty acid could not be compared to the major components such as EPA and DHA. The two long chain n-3 fatty acids demonstrated the same hydrolysis pattern as the major 18 carbon fatty acids and there was no significant difference in their rate of release from triacylglycerols. This finding

suggests that 20 and 22 carbon polyunsaturates behave similarly to 18 carbon fatty acids in contrast to the results obtained in the investigations of Nilsson and his colleagues. The investigations by Nilsson and his colleagues showed different hydrolysis patterns for 18 and 20 carbon n-6 polyunsaturates. The discrepancies between the present study and those conducted by Nilsson's group include the fact that they compared 20:4(n-6) with 18:2(n-6) and we looked at the long chain n-3 fatty acids. In addition, they looked at the rate of hydrolysis and we examined the per cent of fatty acid removed from circulating triacylglycerol. And finally, they used purified milk LPL and not LPL from heart .

To conclude, we found no significant difference between the percentage of EPA and DHA removed from triacylglycerols found in lymph chylomicrons, suggesting there is no preferential release of these fatty acids relative to each other. Thus, preferential release of EPA from chylomicrons by LPL does not appear to explain the lower storage of EPA in adipose tissue. However, to further explore the question of preferential release of EPA relative to DHA from circulating triacylglycerols similar studies could be done examining the metabolism of VLDL in relation to the effect of lipoprotein lipase.



## CHAPTER 4.0

### SECRETION OF FATTY ACIDS IN BILE

#### 4.1 INTRODUCTION

Bile, a green/yellow viscous fluid, functions in both a secretory and excretory capacity in our bodies. It has a role in fat digestion and absorption and, through the synthesis of bile acids from cholesterol coupled with their subsequent fecal loss, represents the major route of cholesterol excretion in the body (Coleman and Rahman, 1992; Vance and Vance, 1991).

Bile is secreted by the liver into small ducts called bile canaliculi. The canaliculi drain into the biliary tree of the portal tract which consists of the canals of Hering, bile ductules and bile ducts. In the rat, the bile ducts flow together in the portal area to form the hepatic duct, a tube that is 12-45 mm in length with a diameter of 1 mm (Hebel and Stromberg, 1976). The duct crosses the beginning of the duodenum dorsally and runs among the lobules of the pancreatic body toward its opening which lies 7-35 mm distal to the pylorus. In many species bile can be redirected into the gall bladder where it is concentrated (by the removal of water and salts) and stored. However, the rat has no gall bladder and consequently, studies done with this animal examine only hepatic bile (Coleman and Rahman, 1992).

The three main biliary lipids are bile acids, cholesterol, and phospholipids. In fact, in humans, bile contains per 100 mL about 1 g of bile acids conjugated to taurine or glycine, 100 mg of free cholesterol, and 300 mg of phospholipids (Vance and Vance, 1991). Bile acids are formed in the liver via the rate-limiting initial hydroxylation of free cholesterol at the 7  $\alpha$  position by cholesterol 7  $\alpha$ -hydroxylase (Hayes et al, 1992). The primary precursor pool for bile acid synthesis is thought to be lipoprotein cholesterol but the exact mechanism of cholesterol delivery is unclear.

Biliary phospholipids are predominantly phosphatidylcholine (PC) which comprise between 80-90% of the total phospholipids in rat bile (Coleman and Rahman, 1992; Hayes et al, 1992). The remainder is composed of sphingomyelin and phosphatidylethanolamine. The fatty acid pattern of biliary PC is largely 1-palmitoyl, 2 linoleyl (16:0-18:2(n-6)) and 1-palmitoyl, 2-oleoyl (16:0-18:1(n-9)). Hepatic synthesis of PC is the major source of this phospholipid. Studies in man (Coleman and Rahman, 1992) suggest that phospholipid secretion in bile is mainly regulated by the intrahepatic pool of this lipid and is only partially influenced by its hepatocellular uptake (Balint et al, 1967). In fact, the immediate source of biliary PC appears to be from a preformed hepatic pool, mainly from the membranes of the endoplasmic reticulum and bile canaliculi of hepatocytes.

Biliary cholesterol is almost exclusively nonesterified and is the least concentrated lipid in bile, representing <1.0 mol% in most mammalian biles

(Hayes et al, 1992). Biliary cholesterol appears to be derived from both *de novo* (16-20%) and preformed sources, i.e., cholesterol in membranes of liver cells, from the uptake and processing of lipoproteins, and that released from its esterified form in hepatocytes. (Coleman and Rahman, 1992).

There appears to be a relationship between the secretion of bile acids and the other two biliary lipids both in terms of total amount of bile acids as well as the effectiveness of individual bile acids. If bile acid secretion is low, as in the case of fasting, then biliary lipid secretion is low and vice versa. Bile acids which are more hydrophobic such as deoxycholic acid are more effective in provoking lipid secretion than those acids which are hydrophilic (Coleman and Rahman, 1992).

The secretion of bile acids is now well understood (Small, 1972). Bile acids undergo efficient enterohepatic circulation, and the rate of bile acid secretion is almost entirely dependent on the recycling frequency of preformed bile acids. The secretion of cholesterol in bile seems to depend on the coordinated and simultaneous secretion of PC and bile acids. According to Hayes et al (1992), PC is secreted in the form of lamellae or together with free cholesterol as vesicles, via the smooth endoplasmic reticulum and Golgi apparatus of hepatocytes. Bile acids are secreted separately into the bile canaliculi, whereupon they disperse the lamellae and vesicles to form the micelles necessary for solubilizing and absorbing fat in the small intestine (Hayes et al, 1992).

Most of the processes of bile formation are due to the activities of hepatocytes (Coleman and Rahman, 1992). As the bile travels through the canaliculi in the liver, modification of its composition may occur in the ductules and ducts depending on various factors such as diet, drugs, and so on. Interestingly, Sheppard and Herzberg (1992) found that the long chain n-3 fatty acids are enriched in hepatic triacylglycerols of fish oil fed rats, suggesting an increased availability of these fatty acids in the liver. This increased supply is a possible source for bile phospholipid synthesis. Correspondingly, to account for the underrepresentation of EPA compared to DHA in adipose tissue, we propose that supplementation of fish oil in the diet results in more EPA being available for hepatic phospholipid synthesis and consequently, more EPA being secreted by the liver. In this part of the investigation, we determined the fatty acid profile as well as the proportion of fatty acids of phospholipids secreted in the bile of rats being fed a diet containing MaxEPA oil as its primary fat source.

#### **4.2 EFFECT OF DIETARY FAT ON BILE PHOSPHOLIPID COMPOSITION**

The experimental design of this study also allowed us to investigate the effect of dietary fat composition, i.e., n-3 and n-6 fatty acids, on bile phospholipid composition. We were interested in examining this effect because it has been suggested by previous work done in our laboratory that bile lipids contribute to the composition of lipid in lymph.

Herzberg et al (1992) found an effect of prior diet on the lipid composition of lymph. Rats fed a diet containing 10% fish oil for a period of two weeks had a higher proportion of EPA in lymph lipids than those fed corn oil containing diets. Corn oil fed animals had a higher percentage of 18:2(n-6). Thus it was concluded that endogenous lipid made a significant contribution to the composition of lipid in lymph. Indeed, Bergstedt et al (1990) showed that endogenous lipids accounted for a significant proportion (25-50%) of lymph lipid. Baxter (1966) estimated that 50% of this endogenous contribution came from bile lipid.

While conducting experiments in rats to determine the role of luminal PC in the lymphatic transport of fat, Tso et al (1977, 1981) concluded that the fatty acid composition of lymph did reflect the composition of bile phospholipid. Subsequently, Herzberg and coworkers (1992) suggested that differences seen in the pre-infusion lymph composition of 18:2(n-6), 20:1(n-9), EPA, and DHA reflect differences seen in the fatty acid composition of bile phospholipids.

Thus, it is conceivable that feeding diets with different fats may induce changes to the fatty acid profile of biliary phospholipids that could account for the differences seen in lymph composition. Robins et al (1986, 1991) have shown that it is possible under certain circumstances to change the composition of bile phospholipids. In a first set of experiments, Robins and Patton (1986) continuously fed rats fatty acids that were more or equally hydrophilic than the

fatty acids that are ordinarily prevalent in bile PC. Bile became highly enriched in new molecular species of PC that contained the particular fatty acid that was fed. In a second set of studies, Robins and coworkers (1991) attempted to acutely change the composition of biliary PC by perfusing isolated livers with a variety of single albumin-bound fatty acids. Their data showed short-term changes with respect to biliary PC composition with a greater utilization of shorter chain than longer chain fatty acids.

Even though there is some evidence that a high fat diet has an effect on bile flow and the secretion of biliary lipids (Knox et al, 1991; Balasubramaniam et al, 1985; Ramesha et al, 1980; Turley and Dietschy, 1979), there are few data on the effect of diets, especially those rich in n-3 and n-6 fatty acids, on bile phospholipid composition. We undertook studies to determine the following; 1) whether the composition of biliary phospholipids could be altered by feeding rats diets rich in either n-6 fatty acids or n-3 fatty acids, 2) whether a single intraduodenal infusion of fat rich in n-3 or n-6 fatty acids could induce changes in the fatty acid composition of biliary phospholipids after the rats had been fed diets containing MaxEPA or corn oil, and 3) if these different dietary fats affect the rate of bile flow and the secretion of phospholipids, cholesterol, and bile acids.

#### 4.3 PURPOSE OF EXPERIMENTS

The primary objective (3.1) of the experiments outlined in this chapter examine the third proposed mechanism; i.e., EPA is preferentially secreted relative to DHA in bile. The secondary objectives (3.1.1, 3.1.2, 3.1.3, and 3.1.4) addressed the effect of dietary fat composition, i.e., n-3 and n-6 fatty acids on bile flow and composition.

- Objective 3.1            To investigate the biliary secretion of EPA and DHA in phospholipids from rats fed fish oil containing diets.
- Objective 3.1.1        To determine whether the composition of biliary phospholipids could be altered by feeding rats diets rich in either n-6 fatty acids or n-3 fatty acids.
- Objective 3.1.2        To determine whether diets rich in n-6 fatty acids or n-3 fatty acids affect the rate of bile flow as well as the biliary secretion of phospholipids, cholesterol, and bile acids.
- Objective 3.1.3        To determine if feeding a meal rich in n-3 or n-6 fatty acids could induce short-term changes in the fatty acid composition of biliary phospholipids after rats have been fed diets containing either fish oil or corn oil.

Objective 3.1.4 To determine whether diets rich in n-6 fatty acids or n-3 fatty acids affect the rate of bile flow as well as the biliary secretion of phospholipids, cholesterol, and bile acids after an infusion of fish oil or corn oil.

#### **4.4 MATERIALS AND METHODS**

##### **4.4.1 CHEMICALS**

Unless otherwise stated, all chemicals were purchased from Sigma Chemical Company (St. Louis, Mo). Organic solvents and acids were obtained from Fisher Scientific (Dartmouth, N.S.) while diethyl ether was from BDH (Toronto, Ont.).

The components for the animals' diets excluding the fat sources were ordered from ICN (Costa Mesa, Ca.). Mazola™ corn oil was purchased from a local grocery store and MaxEPA oil was obtained as a gift from R.P. Scherer, Windsor, Ont.

##### **4.4.2 ANIMALS**

Male, Sprague-Dawley rats (250-300 g) were obtained from Charles River Company (LaPrairie, Quebec). They were maintained for two weeks on diets containing either 10% corn oil, or 8% MaxEPA oil plus 2% corn oil. The diets had the following composition (g/kg): glucose-600; casein-200; fat-100; cellulose-50; AIN mineral mix-35; AIN vitamin mix-10; methionine-3; choline chloride-2; TBHQ-0.02. Diets were prepared and stored so as to minimize oxidation (Fritsche



and Johnston, 1988). The corn oil containing diets were stored under nitrogen at 4°C and the MaxEPA oil containing diets were stored under nitrogen at -20°C. The fatty acid composition of the oils and diets was determined by GLC and the results shown in Table 2.1. Any oxidation of the diets was checked by analyzing the fatty acid composition of the diets at various times during the feeding period.

It is important to note that MaxEPA oil does contain about 0.6% (w/v) cholesterol (Balasubramaniam et al, 1985), resulting in the MaxEPA oil diet containing about 0.09% (w/w) cholesterol. Since this was a small proportion of the total diet, supplemental cholesterol was not added to the corn oil diet.

#### **4.4.3 CANNULATION OF THE BILE DUCT**

At the end of the two week feeding period, rats were fitted with exteriorized cannulas in the duodenum and common bile duct. Rats were anesthetized with ketalean-40 mg/kg (MTC Pharmaceuticals, Cambridge, Ontario) and xylazine-10 mg/kg (MTC Pharmaceuticals, Cambridge, Ontario) mixture and their abdomen was opened with a midline incision. The common bile duct was exposed and cannulated using a PE 10 (Clay Adams) cannula. The cannula was secured in place by two 4-0 silk ties above the cannulation site and the common duct tied off below. The bile cannula was exteriorized through a stab wound in the right flank. The duodenum was exposed and cannulated using a 5 French Pediatric Feeding Tube (UNO Plastics Ltd., Denmark) cut to approximately 20 cm in length. The cannula was inserted 1 cm distal to the

pylorus. The cannula was secured using 2 drops of cyanoacrylate adhesive (Krazy Glue™, The Borden Co., Ltd., Willowdale, Ontario) and patency was checked by observing for leakage after infusing 0.5 mL of normal saline. The duodenal cannula was exteriorized through a stab wound in the left flank. The laparotomy was closed by suturing the muscle layer, then the skin, using 4-0 silk. Immediately following surgery, the animals were immobilized in Bollman restraint cages. 5% glucose in normal saline was infused through the duodenal cannula at 3.0 mL/h for the duration of the experiment.

#### **4.4.4 BILE COLLECTION TO EXAMINE THE EFFECT OF DIET ON BILE OUTPUT AND COMPOSITION**

Immediately after the surgery, bile was collected at 60 minute intervals for six hours. At the end of the collection period, the collection test tube was weighed and the bile output was obtained by subtracting the weight of the previously weighed empty test tube. Portions of the bile were prepared for lipid analysis (0.2 mL for phosphorus and cholesterol assays and 0.3 mL for total fatty acid analysis of biliary phospholipids) and the remainder stored at -20°C for bile acid determination. Missing values in the phospholipid and total bile acids data in both parts of the experiment were due to contamination or insufficient sample, respectively. This part of the experiment determined the effects of diet on biliary flow and composition and consequently, there were two groups studied, i.e., the MaxEPA oil and the corn oil fed groups.

#### **4.4.5 BILE COLLECTION TO EXAMINE THE EFFECT OF DIET AND FAT INFUSED ON BILEOUTPUT AND COMPOSITION**

Following an overnight recovery, some of the rats were given intraduodenally a 1.0 mL bolus dose containing 0.5 mL of MaxEPA oil or corn oil plus 0.5 mL of 20 mM sodium taurocholate. The oil and sodium taurocholate were sonicated just before infusion to ensure homogeneity. Consequently, there were four groups studied to examine not only the effect of diet on biliary flow and composition but to also determine the effects of an infusion of dietary fat; **Group 1**, designated **MdMi**, was fed a diet (d) with MaxEPA oil (M) and received an infusion (i) of MaxEPA oil, **Group 2** or **MdCi** was fed a diet with MaxEPA oil and received an infusion of corn oil (C), **Group 3** or **CdCi** was fed a diet with corn oil and received an infusion of corn oil, and **Group 4** or **CdMi** was fed a diet with corn oil and received an infusion of MaxEPA oil.

Bile was again collected at 60 minute intervals for six hours. At the end of the collection period, the same procedure for portioning out the bile was followed as described in section 4.4.4.

#### **4.4.6 ANALYSIS OF BILIARY LIPIDS**

Lipids were extracted from bile by the method of Folch et al (1957). Phospholipids were separated by thin layer chromatography on silica gel G using hexane:diethyl ether:glacial acetic acid (80:20:2). The phospholipid spot was visualized with iodine and identified by comparison with known standards from Sigma Chemical Co.. The phospholipid spot was scraped off, eluted with

chloroform-methanol and the dried eluate transmethylated as previously described (Keough and Kariel, 1987). The fatty acid methyl esters were separated by GLC using a Supelcowax 60 m capillary column in a Hewlett Packard 3365 Series II GC. Oven temperature was 190°C ramped 5°C/min to 210°C and remained there for an additional 12 min. The injection port and flame ionization detector oven temperatures were 230°C. The fatty acids were identified by comparison of retention times with known standards from Sigma Chemical Co. Peak areas were integrated using Hewlett Packard 3365 Series II Chemstation Software.

Lipid phosphorus content was measured by the method of Bartlett (1959) using 25  $\mu$ L of the lipid extract. Cholesterol was measured in 50  $\mu$ L samples of the bile lipid extracts by the method of Zlatkis and Zak (1969). The procedures for determining phosphorus and cholesterol are based on colorimetry. The analysis of phosphorus in the sample is based on the reduction of phosphomolybdate produced by heating the phosphorus reaction mixture in sulfuric acid. The absorption of the resultant blue colour is measured at 830 nm and is proportional to the concentration of phosphorus up to 1.5  $\mu$ M in the reaction mixture. The determination of cholesterol is based on the reaction of cholesterol with *o*-phthalaldehyde in an acetic acid-sulfuric acid medium resulting in a stable pink colour with an absorbance read at 550 nm.

Bile acid concentration was determined using 3  $\alpha$ -hydroxysteroid dehydrogenase in the presence of NAD. The production of NADH was quantified spectrophotometrically at 340 nm (Stempfel and Sidbury, 1964).

#### 4.4.7 STATISTICAL ANALYSIS

The data were analyzed by a two factor (time and diet) ANOVA when only the effect of diet was examined whereas a three factor (time, diet and fat infused) ANOVA was employed when both the effects of diet and oil infused were studied. The pooled totals of bile output and biliary lipids were analyzed by a two factor (diet and meal infused) ANOVA. The fatty acid composition data were arcsin transformed before the analysis of variance to correct for the non-normal distribution of percentage data (Zar, 1984). Effects were considered significant if  $p < 0.05$ , n.s. indicates an effect was not significant. General trends over time were examined in these experiments and not comparisons at individual time periods. Thus, multiple comparisons of the means were not estimated.

### 4.5 RESULTS

#### 4.5.1 EFFECT OF FISH OIL DIET ON EPA AND DHA SECRETION IN BILE

Rats fed fish oil containing diets did not show a significance difference in the proportion of EPA and DHA ( $F_{1,72} = 0.60$ , n.s.), as a percentage of total fatty acids, in biliary phospholipids (Table 4.2). In the 6 hourly collections, EPA accounted for 2-3% of the total fatty acids and DHA accounted for 1-3%. From

this data, it does not appear that EPA is preferentially secreted relative to DHA in bile and, thus, refuting the third mechanism.

#### 4.5.2 EFFECT OF DIETARY FISH OIL AND CORN OIL ON BILE OUTPUT AND COMPOSITION

**Bile Output** Bile output during the six hours collection is shown in Figure

4.1. There was a decrease in flow with time ( $F_{5,174}=6.42$ ,  $p<0.0001$ ) for both groups with an apparent plateau in secretion beginning at hour 3. The MaxEPA oil fed animals had a greater output at each time ( $F_{1,174}=45.04$ ,  $p<0.0001$ ).

Table 4.1 depicts the pooled 6 hour values for bile output as well as the biliary lipids. When time is removed as a factor, there is still a significant difference of bile secretion between the 2 dietary groups ( $F_{1,27}=8.29$ ,  $p=0.0077$ ).

**Table 4.1 Total Amount of Bile Flow and Biliary Lipids in 6 Hours, mean  $\pm$  S.D. (n).**

Group	Bile Flow mL	Bile Acids $\mu$ mol	Cholesterol $\mu$ mol	Phospholipid $\mu$ mol
MaxEPA oil	4.33* $\pm$ 0.55 (15)	133.16 $\pm$ 32.75 (7)	1.68* $\pm$ 0.49 (15)	6.98* $\pm$ 1.71 (8)
Corn oil	3.37 $\pm$ 1.10 (14)	111.60 $\pm$ 40.94 (6)	1.15 $\pm$ 0.52 (13)	3.98 $\pm$ 1.39 (6)

\* denotes a significant difference between groups,  $p<0.05$ .

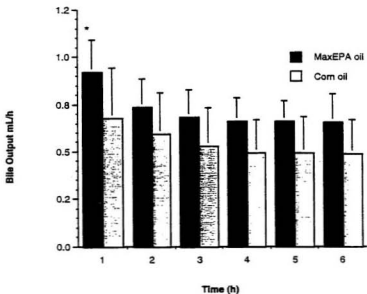
**Biliary Lipids** Figure 4.2 illustrates the effect of fat prefeeding on biliary bile acid secretion. The concentration of bile acids in bile was the same in rats consuming the two diets ( $F_{1,73}=3.98$ , n.s.). Similarly, there was no significant difference when time was removed as a factor (Table 4.1) ( $F_{1,11}=0.94$ , n.s.). As expected because of the interruption of the enterohepatic circulation, continued

bile acid drainage resulted in a decrease in output with time for both groups ( $F_{5,73}=7.73$ ,  $p<0.0001$ ).

The effect of fat prefeeding on the concentration of biliary cholesterol ( $F_{1,174}=1.02$ , n.s.) and phospholipid ( $F_{1,72}=0.97$ , n.s.) is shown in Figures 4.3 and 4.4, respectively. No significant difference due to diet was found. Nevertheless, the rats fed MaxEPA oil had a greater total secretion of both lipids (Table 4.1) because of the greater volume of bile (cholesterol,  $F_{1,26}=7.04$ ,  $p=0.0134$ ; phospholipids,  $F_{1,12}=10.62$ ,  $p=0.0069$ ). Furthermore, the concentration did not significantly change with time for either group of animals (cholesterol,  $F_{5,174}=0.49$ , n.s.; phospholipids,  $F_{5,72}=0.70$ , n.s.).

**Fatty Acid Composition and Distribution in Biliary Phospholipids** The fatty acid composition of biliary phospholipids is presented in Table 4.2. The results indicate an effect of prior diet. The MaxEPA oil fed rats had significantly higher proportions of 18:1(n-9) ( $F_{1,84}=9.93$ ,  $p=0.0023$ ), EPA ( $F_{1,84}=59.04$ ,  $p<0.0001$ ), and DHA ( $F_{1,84}=15.13$ ,  $p=0.0002$ ) than the corn oil fed group. On the other hand, animals fed corn oil had substantially more 20:4(n-6) ( $F_{1,84}=22.11$ ,  $p=0.0004$ ) than those fed fish oil. Surprisingly, the concentration of 18:2(n-6) ( $F_{1,84}=0.15$ , n.s.) did not differ between the two diets although 18:2(n-6) intake was much greater in the corn oil fed rats.

The pattern and distribution of the fatty acids in biliary phospholipids of MaxEPA fed rats are illustrated in Table 4.2. The predominant fatty acids are 16:0, 18:0, 18:1(n-9), and 18:2(n-6), which make up approximately 71% of the total

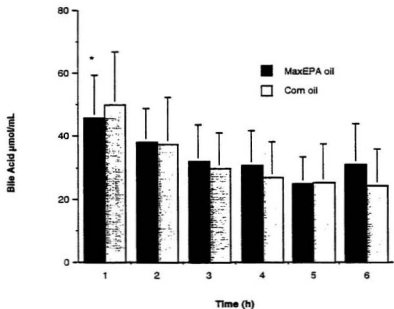


**Figure 4.1** Bile output in rats fed diets containing MaxEPA or Corn Oil. Results are means  $\pm$  S.D. for 16 animals. \*There was a significant difference due to diet and time ( $p < 0.0001$ ), with the MaxEPA group having a greater output.

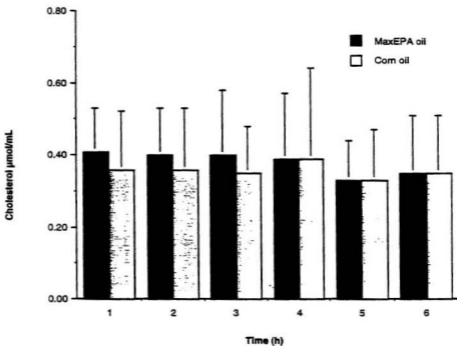


**Table 4.2 Fatty Acid Composition of Bile Phospholipids (% of Total, mean  $\pm$  S.D.). \*denotes significant difference due to diet ( $p < 0.05$ ). No significant difference due to time for all fatty acids.**

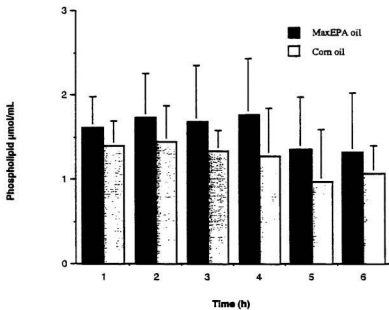
Group	Time h (n)	16:0	18:0	18:1 (n-9)*	18:2 (n-6)	18:3 (n-3)	20:4 (n-6)*
MaxEPA	1 (8)	34.16 $\pm$ 9.03	13.51 $\pm$ 2.77	9.96 $\pm$ 5.39	13.41 $\pm$ 5.34	0.27 $\pm$ 0.66	2.99 $\pm$ 2.10
	2 (7)	33.23 $\pm$ 7.23	14.34 $\pm$ 3.01	11.07 $\pm$ 7.81	11.47 $\pm$ 6.73	0.40 $\pm$ 0.70	2.85 $\pm$ 1.86
	3 (7)	31.61 $\pm$ 5.72	12.89 $\pm$ 3.05	10.70 $\pm$ 5.53	12.03 $\pm$ 5.87	0.07 $\pm$ 0.16	4.34 $\pm$ 2.39
	4 (8)	34.87 $\pm$ 3.45	12.82 $\pm$ 3.30	10.23 $\pm$ 4.61	13.57 $\pm$ 5.67	0.0 $\pm$ 0.0	3.68 $\pm$ 2.26
	5 (7)	31.58 $\pm$ 8.56	15.27 $\pm$ 5.66	9.22 $\pm$ 4.96	13.26 $\pm$ 4.29	0.08 $\pm$ 0.20	3.23 $\pm$ 1.24
	6 (6)	31.68 $\pm$ 8.56	12.72 $\pm$ 3.06	12.11 $\pm$ 5.40	13.78 $\pm$ 7.06	0.73 $\pm$ 1.64	3.64 $\pm$ 2.47
Com Oil	1 (9)	30.59 $\pm$ 8.18	14.76 $\pm$ 4.06	8.01 $\pm$ 3.93	14.65 $\pm$ 6.76	1.14 $\pm$ 2.14	10.74 $\pm$ 5.70
	2 (9)	29.90 $\pm$ 5.10	17.04 $\pm$ 5.68	7.83 $\pm$ 6.63	10.33 $\pm$ 8.62	0.21 $\pm$ 0.57	6.54 $\pm$ 7.63
	3 (10)	28.80 $\pm$ 5.29	15.50 $\pm$ 3.34	7.18 $\pm$ 2.18	14.59 $\pm$ 5.48	0.30 $\pm$ 0.84	10.08 $\pm$ 4.74
	4 (10)	30.68 $\pm$ 5.13	13.31 $\pm$ 3.68	7.71 $\pm$ 2.28	13.46 $\pm$ 5.99	0.24 $\pm$ 0.47	9.21 $\pm$ 4.76
	5 (9)	27.32 $\pm$ 9.92	14.22 $\pm$ 6.15	6.00 $\pm$ 4.78	12.74 $\pm$ 5.72	0.11 $\pm$ 0.32	6.45 $\pm$ 5.16
	6 (7)	32.55 $\pm$ 5.14	13.45 $\pm$ 2.85	6.12 $\pm$ 2.75	17.10 $\pm$ 7.39	0.0 $\pm$ 0.0	9.80 $\pm$ 5.18
Group	Time h (n)	EPA (20:5, n-3)*	22:5 (n-3)	DHA (22:6, n-3)*	Total %	n-3 %	n-6 %
MaxEPA	1 (8)	3.21 $\pm$ 2.70	0.29 $\pm$ 0.58	2.69 $\pm$ 1.80	80.5	6.5	16.4
	2 (7)	2.33 $\pm$ 2.08	0.0 $\pm$ 0.0	1.40 $\pm$ 1.39	77.1	4.1	14.3
	3 (7)	2.89 $\pm$ 2.10	0.04 $\pm$ 0.11	3.00 $\pm$ 2.05	77.6	6.0	16.4
	4 (8)	2.74 $\pm$ 2.20	0.09 $\pm$ 0.24	2.39 $\pm$ 1.75	80.4	5.2	17.3
	5 (7)	2.18 $\pm$ 1.81	0.0 $\pm$ 0.0	1.80 $\pm$ 1.54	76.6	4.1	16.5
	6 (6)	1.86 $\pm$ 1.58	0.0 $\pm$ 0.0	0.57 $\pm$ 0.63	77.0	3.2	17.4
Com Oil	1 (9)	0.43 $\pm$ 1.22	0.0 $\pm$ 0.0	1.30 $\pm$ 1.78	81.6	2.9	25.4
	2 (9)	0.0 $\pm$ 0.0	0.0 $\pm$ 0.0	0.79 $\pm$ 1.15	72.6	1.0	16.9
	3 (10)	0.27 $\pm$ 0.81	0.0 $\pm$ 0.0	0.51 $\pm$ 0.94	77.2	1.1	24.7
	4 (10)	0.0 $\pm$ 0.0	0.05 $\pm$ 0.14	0.73 $\pm$ 0.60	75.4	1.0	22.7
	5 (9)	0.31 $\pm$ 0.86	0.0 $\pm$ 0.0	0.73 $\pm$ 1.06	67.9	1.2	19.2
	6 (7)	0.0 $\pm$ 0.0	0.0 $\pm$ 0.0	0.34 $\pm$ 0.60	79.4	0.3	26.9



**Figure 4.2** Bile acid concentrations in bile of rats fed diets containing MaxEPA or Corn Oil. Results are means  $\pm$  S.D. for 8 or 9 animals. \*There was a significant difference with time ( $p < 0.0001$ ), with the concentrations decreasing over time. No significant difference due to diet.



**Figure 4.3** Cholesterol concentrations in bile of rats fed diets containing MaxEPA or Corn Oil. Results are means  $\pm$  S.D. for 15 or 16 animals. No significant differences due to diet and time.



**Figure 4.4** Phospholipid concentrations in bile of rats fed diets containing MaxEPA or Corn Oil. Results are means  $\pm$  S.D. for 6 or 8 animals. No significant difference due to diet and time.

fatty acid composition. The remaining fatty acids are essentially 18:3(n-3), 20:4(n-6), EPA, 22:5(n-3), and DHA. EPA and DHA account for 2.5% and 2% of the total, respectively. The n-3 fatty acids made up about 5% (range 3.2-6.5%) of the total fatty acids in the 6 hour collection period whereas the n-6 fatty acids accounted for 16.5% (range 14.3-17.4%). For all the fatty acids the proportions remained relatively constant throughout the entire experimental period (16:0,  $F_{5,84}=0.37$ , n.s.; 18:0,  $F_{5,84}=0.81$ , n.s.; 18:1(n-9),  $F_{5,84}=0.39$ , n.s.; 18:2(n-6),  $F_{5,84}=1.09$ , n.s.; 18:3(n-3),  $F_{5,84}=0.61$ , n.s.; 20:4(n-6),  $F_{5,84}=1.57$ , n.s.; EPA,  $F_{5,84}=0.33$ , n.s.; 22:5(n-3),  $F_{5,84}=1.74$ , n.s.; DHA,  $F_{5,84}=1.32$ , n.s.).

The pattern and distribution of the fatty acids in biliary phospholipids of corn oil fed animals are shown in Table 4.2. Similar to the MaxEPA fed rats, the predominant fatty acids were 16:0, 18:0, 18:1(n-9), and 18:2(n-6). However, in this case, 18:1(n-9) accounts for about 7% of total fatty acids as compared to 11% observed in the bile of those fed MaxEPA. Moreover, 20:4(n-6) makes up a considerable proportion, approximately 9% of the total compared to 3.5% for the fish oil fed animals. The predominant fatty acids contribute nearly 75% of the total fatty acid composition. The balance of fatty acids is mostly 18:3(n-3), DHA and to a much lesser extent, EPA. EPA accounted for 0.3-0.4% of the total and was only detected at hours 1, 3, and 5 whereas DHA contributed 1.3% of the total in the first hour and declined steadily to about 0.3% by the last hour of the study. In this case, the n-3 fatty acids made up about 1% (range 0.3-2.9%) of the total

fatty acids while the n-6 fatty acids accounted for 21% (range 16.9-26.9%). There was no significant change with time for any of the fatty acids analyzed.

#### 4.5.3 EFFECTS OF A SINGLE INTRADUODENAL INFUSION OF FISH OIL OR CORN OIL ON BILE OUTPUT AND COMPOSITION AFTER ADAPTATION TO DIETS CONTAINING FISH OIL OR CORN OIL

**Bile Output** The bile output during the six one-hour collection periods is shown in Figure 4.5. There were independent effects of diet ( $F_{1,218}=71.6$ ,  $p<0.0001$ ) and oil infused ( $F_{1,218}=4.84$ ,  $p<0.05$ ) on bile flow. Animals fed MaxEPA containing diets and infused with MaxEPA oil had the greatest output at all collection points whereas those fed corn oil and given an infusion of corn oil had the lowest. In rats previously fed corn oil, the infusion of fish oil increased bile flow. Conversely, in rats fed fish oil, a meal of corn oil lowered bile secretion. Bile flow did not change in any individual group during the collection period ( $F_{5,218}=0.94$ , n.s.).

Table 4.3 presents the total volume of bile over the entire collection period. When time was removed as a factor, only the diet had a significant effect on bile secretion with MaxEPA fed rats having a larger output ( $F_{1,31}=21.21$ ,  $p<0.0001$ ). The fat infused did not alter total bile secreted ( $F_{1,31}=3.63$ , n.s.).

**Biliary Lipids** Figures 4.6, 4.7, and 4.8 illustrate the effects of diet and infused fat on the concentrations of biliary cholesterol, phospholipids, and bile

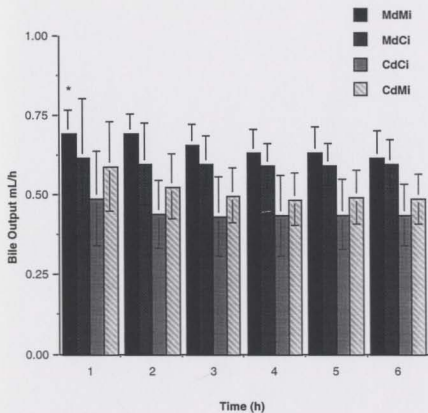
**Table 4.3 Total Bile Flow and Biliary Lipids Secreted in 6 Hours, mean  $\pm$  S.D. (n).**

Group	Bile Flow mL	Bile Acids $\mu\text{mol}^+$	Cholesterol $\mu\text{mol}^{++}$	Phospholipid $\mu\text{mol}$
MdMi	3.91* $\pm$ 0.39 (9)	25.38 $\pm$ 2.03 (5)	0.88 $\pm$ 0.35 (10)	3.17 $\pm$ 0.93 (4)
MdCi	3.59* $\pm$ 0.47 (7)	42.37 $\pm$ 15.01 (4)	0.59 $\pm$ 0.31 (9)	1.75 $\pm$ 0.95 (3)
CdCi	2.66 $\pm$ 0.70 (8)	32.93 $\pm$ 7.64 (5)	0.71 $\pm$ 0.37 (8)	3.64 $\pm$ 0.93 (3)
CdMi	3.07 $\pm$ 0.55 (10)	43.45 $\pm$ 11.04 (5)	0.53 $\pm$ 0.33 (10)	2.08 $\pm$ 1.62 (4)

\*denotes a significant difference ( $p < 0.05$ ) due to diet. Thus, the MaxEPA oil-fed groups had a higher bile flow than the Corn oil-fed groups.

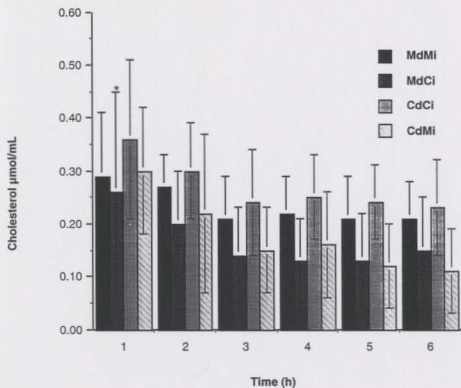
+a significant interaction between the oil infused and diet; i.e., amount of bile acids increased significantly when the oil infused differed from the fat source in the diet.

++a significant interaction between the oil infused and diet; i.e., cholesterol levels decreased significantly when the oil infused differed from the fat source in the diet.

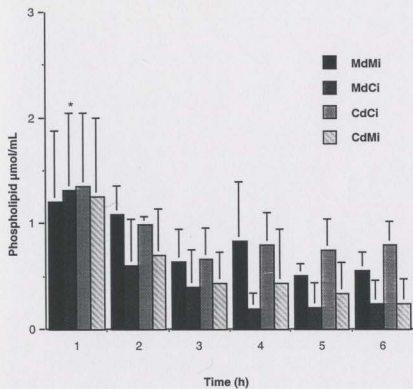


**Figure 4.5** Bile output in rats fed diets containing MaxEPA or Corn Oil and given an infusion of either oil. Results are means  $\pm$  S.D. for 8 to 10 animals in each group. \*Significant effect of diet and oil infused ( $p < 0.05$ ), with MdMi having the greatest output. No significant difference due to time.

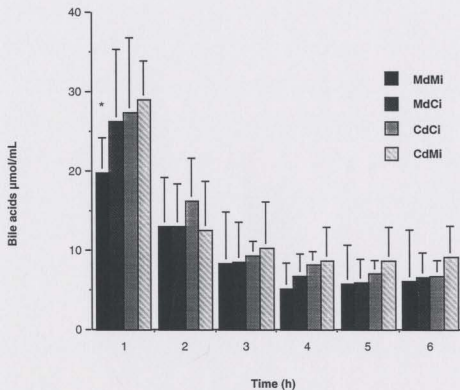




**Figure 4.6** Cholesterol concentrations in bile of rats fed diets containing MaxEPA or Corn Oil and given an infusion of either oil. Results are means  $\pm$  S.D. for 8 or 10 animals in each group. \*Significant interaction between prior diet and fat infused when fat infused differed from fat in diet ( $p < 0.0001$ ). Time had a significant effect for all groups ( $p < 0.0001$ ).



**Figure 4.7** Phospholipid concentrations in bile of rats fed diets containing MaxEPA or Corn Oil and given an infusion of either oil. Results are means  $\pm$  S.D. for 3 or 4 animals in each group. \*Significant interaction between prior diet and fat infused when fat infused differed from fat in diet ( $p=0.0002$ ). Time had a significant effect for all groups ( $p=0.0008$ ).



**Figure 4.8** Bile acid concentrations in bile of rats fed diets containing MaxEPA or Corn Oil and given an infusion of either oil. Results are means  $\pm$  S.D. for 5 to 9 animals in each group. \*Significant effect of diet ( $p=0.0118$ ) and time ( $p<0.0001$ ).

acids, respectively. There was a significant interaction between the effects of diet and infused fat on the concentrations of cholesterol ( $F_{1,217}=34.2$ ,  $p<0.0001$ ) and phospholipids ( $F_{1,68}=15.13$ ,  $p=0.0002$ ). When the animals were given an infusion of oil that differed from the fat source in their diet, the level of both biliary lipids decreased. For the bile acid concentration, there was an effect of diet ( $F_{1,164}=6.49$ ,  $p=0.0118$ ) but not infused fat ( $F_{1,164}=0.69$ , n.s.).

In response to either oil infusion, which contained 20 mM taurocholate, the bile acid concentration was highest in the first hour for all four groups. Over time, there was a decline in bile acid levels. The concentration of all three lipids decreased significantly with time for all four groups, an effect that was independent of both the diet and the fat infused (cholesterol,  $F_{5,217}=9.87$ ,  $p<0.0001$ ; bile acids,  $F_{5,164}=51.29$ ,  $p<0.0001$ ; phospholipids,  $F_{5,68}=4.84$ ,  $p=0.0008$ ).

Table 4.3 indicates the total amounts of these three lipids over the six hour collection period. When time was eliminated as a factor, the following were observed; 1) a significant interaction between the oil infused and diet with respect to cholesterol ( $F_{1,36}=4.87$ ,  $p=0.0337$ ) and bile acids ( $F_{1,15}=6.71$ ,  $p<0.021$ ); i.e., cholesterol levels decreased and the amount of bile acids increased when the oil infused differed from the fat source in the diet and, 2) an independent effect of diet ( $F_{1,10}=2.84$ , n.s.) and infused meal ( $F_{1,10}=0.009$ , n.s.) on total

phospholipids; i.e., no differences were demonstrated when the fat infused differed from the dietary fat source.

**Fatty Acid Composition and Distribution in Biliary Phospholipids** The fatty acid composition of biliary phospholipids is presented in Table 4.4. The highest proportions for all n-3 and n-6 fatty acids were observed in the first hourly collection of bile. The percent of the total for both series of fatty acids declined rapidly. The results indicate a significant interaction between the effects of prior diet and fat infused for 18:1(n-9) ( $F_{1,181}=6.36$ ,  $p=0.0125$ ), EPA ( $F_{1,181}=20.68$ ,  $p<0.0001$ ), and DHA ( $F_{1,181}=20.90$ ,  $p<0.0001$ ). **MdMi** had the highest proportions of EPA and DHA. The proportions of EPA and DHA decreased after corn oil was infused into rats previously consuming a diet containing fish oil (**MdCi**). No increase of either of the long chain n-3 fatty acids was observed after fish oil was infused in animals that were previously fed corn oil for 2 weeks (**CdMi**).

The fat infused had a significant effect on 20:4(n-6) ( $F_{1,181}=4.05$ ,  $p<0.05$ ), but previous diet did not ( $F_{1,181}=1.64$ , n.s.). When comparing **MdMi** and **MdCi**, there appears to be a relatively greater decrease with time of 20:4(n-6) in the **MdMi** rats even though the actual proportion of this fatty acid is larger in **MdMi** animals at each time point. Furthermore, there is a greater decline of 20:4(n-6) in **CdCi** as compared to **CdMi**. This observation was similar when examining the proportion of 18:2(n-6) in **CdCi** and **CdMi**. Linoleic acid (18:2, n-6) also had a

similar reduction with time in the **MdCi** animals when compared to **MdMi**. The proportion of 16:0 remained relatively constant over time for all four groups, making up about 35-40% of the total. Over the six hour study interval, the proportions of 18:1(n-9) ( $F_{5,181}=20.90$ ,  $p=0.0005$ ), 18:2(n-6) ( $F_{5,181}=8.00$ ,  $p<0.0001$ ), 20:4(n-6) ( $F_{5,181}=9.59$ ,  $p<0.0001$ ), and EPA ( $F_{5,181}=2.52$ ,  $p=0.0311$ ) decreased for all 4 groups whereas the amount of 18:0 ( $F_{5,181}=4.24$ ,  $p<0.0001$ ) increased. It appears that 18:1(n-9) and 18:2(n-6) were replaced by 18:0.

The predominant fatty acids in biliary phospholipids of **MdMi** rats are 16:0, 18:0, and 18:2(n-6), making up approximately 74% of the total fatty acid composition (Table 4.4). EPA and DHA account for 4% of the total in the first hour of collection and 1% in the sixth hour. The n-6 fatty acids accounted for 26% in hour 1 and declined to 16% by hour 6.

The major and minor fatty acids in biliary phospholipids of **MdCi** rats are similar to those seen in **MdMi** animals (Table 4.4). However, after the corn oil infusion there was a greater decline in the two major n-3 as well as the major n-6 fatty acids by the sixth hour. In the first hour, n-3 and n-6 fatty acids made up 2% and 19% of the total, respectively.

16:0, 18:0, and 18:2(n-6) are the major fatty acids and 18:1(n-9) and 20:4(n-6) are minor components in the biliary phospholipids of the **CdCi** and **CdMi** animals (Table 4.4). The long chain n-3 fatty acids are either not present in the case of EPA or account for less than 1% of the total for DHA. The infusion of

MaxEPA oil did not increase the proportions of these two fatty acids. Furthermore, a relatively larger decline with time was seen in the total percentage of n-6 fatty acids after the infusion of corn oil compared to marine oil.

**Table 4.4 Fatty Acid Composition of Bile Phospholipids (weight %, mean  $\pm$  S.D.) \* denotes significant interaction between prior diet and fat infused ( $p < 0.05$ ). #denotes significant effect of only fat infused ( $p < 0.05$ ). +denotes significant effect due to time ( $p < 0.05$ ).**

Group	Time h (n)	16:0	18:0+	18:1(n-9)*+	18:2(n-6)+	20:4(n-6)#+
MdMi	1 (9)	39.38 $\pm$ 3.36	15.1 $\pm$ 6.24	6.11 $\pm$ 1.53	19.62 $\pm$ 5.15	6.11 $\pm$ 2.49
	2 (9)	41.01 $\pm$ 3.78	15.77 $\pm$ 8.01	6.00 $\pm$ 1.52	17.39 $\pm$ 6.34	4.50 $\pm$ 2.65
	3 (9)	34.45 $\pm$ 8.92	19.38 $\pm$ 11.6	5.12 $\pm$ 2.64	12.49 $\pm$ 8.74	4.05 $\pm$ 4.84
	4 (8)	34.66 $\pm$ 7.65	22.63 $\pm$ 10.8	4.19 $\pm$ 2.50	11.96 $\pm$ 9.29	2.10 $\pm$ 2.48
	5 (8)	36.94 $\pm$ 7.84	25.15 $\pm$ 11.7	4.03 $\pm$ 2.41	12.45 $\pm$ 9.57	2.39 $\pm$ 2.68
	6 (9)	39.90 $\pm$ 8.75	25.80 $\pm$ 12.9	3.18 $\pm$ 3.62	13.58 $\pm$ 10.2	2.21 $\pm$ 3.14
MdCi	1 (7)	36.46 $\pm$ 7.49	19.60 $\pm$ 10.5	4.15 $\pm$ 2.47	15.65 $\pm$ 6.42	3.78 $\pm$ 3.43
	2 (8)	35.64 $\pm$ 8.26	26.59 $\pm$ 11.5	2.78 $\pm$ 2.17	11.38 $\pm$ 7.10	2.67 $\pm$ 2.28
	3 (8)	35.26 $\pm$ 8.72	28.14 $\pm$ 9.46	1.88 $\pm$ 2.09	7.07 $\pm$ 5.91	0.98 $\pm$ 1.27
	4 (7)	31.55 $\pm$ 17.1	30.92 $\pm$ 14.1	1.17 $\pm$ 1.49	4.34 $\pm$ 5.44	1.12 $\pm$ 1.62
	5 (7)	33.30 $\pm$ 4.48	33.26 $\pm$ 9.56	2.52 $\pm$ 2.52	5.27 $\pm$ 5.88	1.56 $\pm$ 2.47
	6 (7)	35.19 $\pm$ 8.25	30.67 $\pm$ 14.0	2.93 $\pm$ 2.00	6.14 $\pm$ 5.58	1.70 $\pm$ 2.07
Group	Time h (n)	EPA (20:5, n-3)*+	DHA (22:6, n-3)*	Total %	n-3 %	n-6 %
MdMi	1 (9)	1.68 $\pm$ 1.33	2.14 $\pm$ 1.92	90.1	3.8	25.7
	2 (9)	1.60 $\pm$ 1.24	2.11 $\pm$ 1.61	88.4	3.7	21.9
	3 (9)	1.01 $\pm$ 1.23	1.78 $\pm$ 1.80	78.3	2.8	16.5
	4 (8)	0.74 $\pm$ 1.11	1.90 $\pm$ 3.05	78.2	2.6	14.1
	5 (8)	0.81 $\pm$ 1.19	1.18 $\pm$ 1.71	83.0	2.0	14.8
	6 (9)	0.59 $\pm$ 1.17	0.41 $\pm$ 1.08	85.7	1.0	15.8
MdCi	1 (7)	0.88 $\pm$ 1.17	1.08 $\pm$ 1.71	81.6	2.0	19.4
	2 (8)	0.09 $\pm$ 0.22	0.15 $\pm$ 0.38	79.3	0.2	14.1
	3 (8)	0.0 $\pm$ 0.0	0.0 $\pm$ 0.0	73.3	0.0	8.1
	4 (7)	0.0 $\pm$ 0.0	0.0 $\pm$ 0.0	69.1	0.0	5.5
	5 (7)	0.0 $\pm$ 0.0	0.0 $\pm$ 0.0	75.9	0.0	6.8
	6 (7)	0.20 $\pm$ 0.49	0.19 $\pm$ 0.47	77.0	0.3	7.8



Group	Time h (n)	16:0	18:0+	18:1(n-9)*+	18:2(n-6)+	20:4(n-6)*+
CdCl	1	38.89±3.64	20.68±11.1	3.03±2.74	21.33±9.03	8.56±4.05
	(7)					
	2	39.91±6.79	24.97±8.96	2.08±1.79	17.71±8.60	2.70±2.47
	(6)					
	3	38.60±2.41	23.12±9.04	2.53±2.89	18.08±9.49	4.66±5.24
	(6)					
CdMi	4	40.40±7.89	28.40±13.4	0.73±1.23	13.61±12.3	2.93±4.69
	(6)					
	5	36.92±9.73	22.48±9.44	2.03±2.38	9.32±11.8	1.82±4.45
	(7)					
	6	37.88±8.92	31.66±8.78	0.80±1.79	4.35±9.72	2.26±5.04
	(6)					
CdMi	1	35.66±5.19	17.68±6.29	2.87±1.05	20.44±4.42	11.05±5.83
	(10)					
	2	37.78±12.4	27.20±11.8	1.98±1.67	13.43±9.36	4.30±3.74
	(10)					
	3	40.11±13.5	31.53±13.7	1.70±1.37	9.61±6.88	3.28±3.15
	(10)					
CdMi	4	37.25±10.1	34.12±16.8	1.90±3.71	7.41±6.80	1.68±2.96
	(10)					
	5	33.53±4.49	30.74±12.5	1.61±1.71	8.56±6.22	2.76±4.09
	(9)					
	6	34.62±3.77	33.12±15.4	1.02±1.20	8.57±7.09	3.95±4.10
	(9)					
Group	Time h (n)	EPA (20:5, n-3)*+	DHA (22:6, n-3)*	Total %	n-3 %	n-6 %
CdCl	1	0.0±0.0	0.34±0.83	92.8	0.3	29.9
	(7)					
	2	0.0±0.0	0.0±0.0	87.4	0.0	20.4
	(6)					
	3	0.0±0.0	0.13±0.30	87.1	0.1	22.7
	(6)					
CdMi	4	0.0±0.0	0.12±0.28	86.2	0.1	16.5
	(6)					
	5	0.0±0.0	1.43±2.33	74.0	1.4	11.2
	(7)					
	6	0.0±0.0	0.0±0.0	77.0	0.0	6.6
	(6)					
CdMi	1	0.0±0.0	0.30±0.70	88.0	0.3	31.5
	(10)					
	2	0.0±0.0	0.0±0.0	84.7	0.0	17.7
	(10)					
	3	0.0±0.0	0.0±0.0	86.2	0.0	12.9
	(10)					
CdMi	4	0.0±0.0	0.16±0.49	82.5	0.2	9.1
	(10)					
	5	0.0±0.0	0.0±0.0	77.2	0.0	11.3
	(9)					
	6	0.0±0.0	0.0±0.0	81.3	0.0	12.5
	(9)					

## 4.6 DISCUSSION

### 4.6.1 BILIARY SECRETION OF EPA AND DHA

This study was conducted to compare the secretion of DHA and EPA in the bile of rats fed a diet containing fish oil. We hypothesized that EPA would be preferentially secreted compared to DHA, and thus, partially explain why relatively more DHA is stored in triacylglycerols of tissues than EPA. Even though biliary phospholipids are enriched in the long chain n-3 fatty acids found in dietary fish oils, no significant difference in the relative proportions of EPA (2-3% of the total fatty acids) and DHA (1-3% of the total) was observed. Berr et al (1993) found similar results in Syrian hamsters fed chow supplemented with MaxEPA oil for 3 weeks. However, Balasubramaniam et al (1985) found that the bile phospholipids contained approximately 4% EPA and 10% DHA in rats fed MaxEPA oil for 2 weeks with relatively the same proportions of the long chain n-3 fatty acids in their experimental diet as we had.

The differential storage of DHA compared to EPA is thus, not due to the selective secretion of EPA into bile by the liver.

### 4.6.2 BILE OUTPUT AND COMPOSITION

**Bile Output** Previous studies have shown that feeding a high fat diet had an effect on bile flow (Turley and Dietschy, 1979; Chautan et al, 1990; Knox et al, 1991). Knox et al (1991) fed rats either chow or chow mixed with 20% (w:w) glyceryltriolate for 7-10 days. They found bile flow was higher in the chow fed

animals than in the fat preferred group during glucose-saline infusion. Similarly, Turley and Dietschy (1979) collected bile for 2 hours from female rats weighing between 190-230 g and found that bile flow was between 0.76 -0.99 mL/h for those animals on laboratory chow while those on a cholesterol feed (2% cholesterol and 10% corn oil) for 12 days had a lower flow ranging between 0.72 and 0.87 mL/h. Conversely, Chautan et al (1990) reported a flow of 0.65 mL/h for their low fat group and 0.80-1.10 mL/h for animals receiving diets containing 10% fat.

The feeding of polyunsaturated compared to saturated lipids has also been shown to have an effect on the rate of bile flow. Ramesha et al (1980) fed rats diets containing 10% safflower oil, coconut oil or hydrogenated vegetable oils for 30 days, after which hepatic cholesterol and bile acid synthesis and their excretion through the bile and feces were studied. They found the rate of bile flow was appreciably higher in the rats receiving the diet containing safflower oil ( $0.54 \text{ mL/h} \pm 0.02$ ) than in those receiving coconut oil ( $0.45 \pm 0.02$ ) or those receiving a commercial preparation of hydrogenated vegetable oil ( $0.44 \pm 0.02$ ).

In this investigation, we observed an effect of diet on bile output, with the MaxEPA fed group having a greater flow. This result is not in agreement with Chautan et al (1990). When studying animals on diets supplemented with 10% salmon oil, 10% corn oil or 6% corn oil and 4% salmon oil for a period of 4 weeks, these authors found that bile output did not differ between the fish oil and corn

oil fed animals. They observed that salmon oil ingestion (by itself or in combination with corn oil) led to a substantial increase in flow rate of bile over the low fat diet (containing 2.3% corn oil and 2.2% lard). In contrast, corn oil ingestion only slightly affected this rate. However, Chautan and coworkers (1990) only collected bile for 90 minutes, unlike our study in which we obtained hourly collections for a 6 hour period.

In the second part of this study, we found that prior diet and meal infused independently affected the rate of bile secretion. Rats fed a diet enriched in n-3 fatty acids had a greater flow rate than those consuming an n-6 enriched diet. Furthermore, when MaxEPA oil was infused intraduodenally to animals that were previously fed corn oil, there was an increase in their bile flow. The reverse holds true in animals fed fish oil and then given a meal of corn oil. The reason for the difference in bile output is not known.

**Bile Acids** Endogenous bile acids provide the primary stimulus for bile flow and facilitate the secretion of lipids into bile (Turley and Dietschy, 1982). If a treatment or condition causes bile acid secretion to be low, then presumably biliary lipid secretion is low and vice versa. In our investigation the recirculation of bile acids is surgically interrupted and one would expect a decline in the bile acid output along with a decrease in biliary lipid concentrations. Even though we did observe a decrease in bile acid levels with time, there was not an accompanying fall in biliary cholesterol or phospholipids concentration in bile in

the first part of the experiment when only the effect of prior diet was investigated.

We found an increase in the total quantity of bile acids secreted in rats fed MaxEPA oil compared to corn oil fed animals. This increase occurred concomitantly with an increase in biliary phospholipid and cholesterol secretion. However, the concentration of bile lipids did not differ.

When the effects of an infused dietary fat rich in n-3 or n-6 fatty acids were examined in rats previously fed diets containing either corn oil or maxEPA oil, there was a decline in bile acid levels with time along with an accompanying fall in cholesterol and phospholipid concentrations. We demonstrated an independent effect of diet and oil infused on the amount of bile acids secreted per hour. However, when we examined the total amount of bile acids secreted in the six hour collection, we found a significant interaction between diet and infused fat. When a different oil than found in the diet is infused, there is an increase in bile acid secretion.

Interestingly, Balasubramaniam et al (1985) found there was no difference in the bile acid pool size or synthetic rate of bile acids between animals fed a saturated fat and diets rich in n-6 or n-3 fatty acids, a finding similar to our data involving the effect of diet only. Choi et al (1989) have shown that the activity of cholesterol 7  $\alpha$ -hydroxylase is not altered by fish oil feeding, suggesting that the synthesis of bile acids is not changed in rats fed fish oil.

**Biliary Cholesterol** Previously, diets enriched with n-6 fatty acids have been shown to stimulate cholesterol secretion into bile (Balasubramaniam et al, 1985 ; Ramesha et al, 1980). Balasubramaniam et al (1985) found a twofold increase in biliary secretion of cholesterol when n-6 fatty acids replaced saturated fats. Similarly, Ramesha et al (1980) observed that the concentration of cholesterol in bile was markedly higher in safflower oil fed rats than in coconut oil fed or hydrogenated vegetable oil fed rats. In contrast, Chautan and coworkers (1990) reported that corn oil ingestion only moderately affected biliary cholesterol level in rats when compared to the level in animals on a low fat diet. As well, Turley and Dietschy (1979) found little change in rats fed a diet supplemented with 2% cholesterol and 10% corn oil with regards to the secretion of biliary cholesterol during a two hour collection period when compared to the group fed chow. In fact, these investigators demonstrated that cholesterol output and the molar percentage of cholesterol in bile was essentially the same in female rats subjected to diurnal light cycling, fasting for 48 hours, intravenous administration of chylomicrons, and diets containing either cholestyramine, cholesterol and corn oil or bile acid. They concluded that the rate of hepatic cholesterol synthesis, level of hepatic cholesteryl esters, and the amount of cholesterol absorbed from the diet played no role in determining the rate of biliary cholesterol secretion. Consequently, increasing the availability of cholesterol in the hepatocyte did not influence the amount of cholesterol secreted

into bile. However, Coleman and Rahman (1992) stated that there is recent evidence suggesting that all of the preformed free cholesterol in the liver is in a single pool and is potentially available for secretion into bile. The large pool of free cholesterol is found in hepatocyte membranes and its size is partly regulated (and hence the secretion of biliary cholesterol is regulated) by the extent of cholesterol esterification (Coleman and Rahman, 1992). Thus, if the free cholesterol pool expands then there is an increase in biliary cholesterol secretion. In accordance with this idea, Robins et al (1993) recently examined biliary lipid secretion in conjunction with hepatic cholesterol synthesis in rats during normal growth. These authors observed that when cholesterol synthesis was at its high point (during mid-dark cycle) there was a strong linear relationship between hepatic cholesterol synthesis and biliary cholesterol secretion. Their data suggest that increased biliary cholesterol secretion at mid-dark occurred in response to increased hepatic cholesterol synthesis. Robins and coworkers (1993) attributed the differences in their results from Turley and Dietschy (1979) to methodological differences. Turley and Dietschy (1979) used the administration of a bile acid-binding resin to increase hepatic cholesterol synthesis but these bile acid-binding resins also increase bile acid synthesis and do not result in either an increase in newly synthesized cholesterol or total cholesterol in bile. Moreover, the infusion of lipoprotein-cholesterol was used to suppress hepatic cholesterol synthesis and although synthesis was suppressed, an increase in hepatic cholesterol promotes

cholesteryl ester formation and may not result in an increase in hepatic pool of unesterified cholesterol that is used for biliary secretion.

Since diets rich in n-3 fatty acids have been found to lower plasma lipids even more than diets containing n-6 fatty acids in rats (Herzberg and Rogerson, 1988; Balasubramaniam et al, 1985; Chautan et al, 1990), it was postulated that these diets may result in an increase in biliary cholesterol output. Balasubramaniam et al (1985) reasoned that an increase in biliary cholesterol transferred to bile during ingestion of a diet rich in n-3 fatty acids might increase the lithogenic properties of bile, increasing the chance of gallstone formation in man. However they further stated that the "absence of an excess incidence of gallstones in populations habitually consuming quantities of n-3 fatty acids suggests increased solubility of cholesterol in bile, perhaps due to a change in the fatty acid composition of biliary phospholipids or an increase in the phospholipid concentration in the bile". Paul et al (1980) remarked that the fatty acid composition of biliary phospholipids is modified by dietary fat and thus, the solubility of cholesterol in bile may be better when phospholipids contain very unsaturated fatty acids, thus avoiding the production of lithogenic bile. In agreement, Berr et al (1992), while studying whether dietary supplementation of EPA and DHA decreases cholesterol saturation and prevents the formation of cholesterol crystals in bile of patients with gallstones, concluded that cholesterol saturation can be influenced by the fatty acid composition of



phosphatidylcholines secreted in bile. They found that an intake of 3.75 g of the long chain n-3 fatty acids per day increased the amounts of EPA and DHA in biliary phospholipids while reducing or displacing 18:2(n-6) and 20:4(n-6). From their data, it was evident that the molar ratio of cholesterol to phospholipid declined and, as a result, the cholesterol saturation index was reduced by 25%. Likewise, Tierney et al (1993) studied the effects of fish oil on human gallbladder bile. Their data suggested that fish oil reduced gallbladder bile cholesterol, did not alter the molar per cent total phospholipids, and delayed cholesterol crystal appearance time in humans with cholesterol gallstones. They suggested that fish oil may be of benefit in preventing and/or dissolving cholesterol gallstones. In addition, studies conducted with experimental animals have demonstrated that fish oil exerts a protective effect against gallstones (Dam, 1971; Booker et al, 1990; Scobey et al, 1991).

We found no difference in biliary cholesterol concentration between the corn oil fed and MaxEPA oil fed groups. However, due to the greater bile flow in fish oil fed rats, these animals had a greater total cholesterol excretion in bile. Similarly, Chautan et al (1990) observed no difference in biliary cholesterol output when they compared their data from corn oil fed and salmon oil fed rats. However, they reported an enhancement of biliary cholesterol secretion due to the salmon oil diet when comparing this group to the animals receiving the low fat diet. These authors estimated the amount of cholesterol secreted in reference

to bile flow per hour. If their data are adjusted per millilitre of bile secreted per hour, then the cholesterol output becomes 0.34, 0.33, 0.33, and 0.31  $\mu\text{mol}/\text{mL}$  in the low fat diet, corn oil diet, corn and salmon oil combination diet and the salmon oil diet, respectively. Therefore, it appears that there was no difference in total cholesterol secreted per hour.

On the other hand, Balasubramaniam et al (1985) found twice as much cholesterol in a 10 hour pooled bile sample from fish oil fed rats compared to safflower oil fed animals, but these investigators did not report the volume of bile collected. Thus we cannot determine the actual concentration of cholesterol in the secreted bile. In addition, these researchers suggested that decreases in the LDL and HDL cholesterol seen in their rats related to the increase in the cholesterol secretion. As well, Smit and coworkers (1994) demonstrated that feeding fish oil causes changes in intrahepatic cholesterol transport and the hypersecretion of cholesterol, in association with an increase in bile acids and phospholipids, into bile in rats. These authors surmised that this increase in the disposition of cholesterol into bile was potentiated by a bile acid dependent secretion, presumably by facilitating the recruitment of bile destined cholesterol. However, in our study the rise in cholesterol output seems to pertain to the increase in bile output which may be a result of the differing fatty acid profile seen in the phospholipids of rat bile.

Berr et al (1993) examined the excretory pathways for cholesterol in Syrian hamsters. They fed these animals diets that were enriched with n-3 or n-6 fatty acids for a period of 3 weeks. Surprisingly, and in contrast to the other investigations, they found that the n-6 polyunsaturated fatty acids were responsible not only for an increase in the synthesis of the bile acid, cholic acid, but also for the biliary secretion of cholesterol while the n-3 fatty acids did not enhance either parameter. Furthermore, they, too, commented that the differences in biliary secretion of cholesterol were associated with the diet-induced alterations of the fatty acid pattern of phospholipids secreted in bile but the differences in secretion are contradictory to what we observed, i.e., that the amount of cholesterol was increased in fish oil fed animals.

Chautan et al (1990) found that in rats fed fish oil, the hepatic acyl-CoA cholesterol acyltransferase (ACAT) activity and biliary cholesterol secretion were enhanced. Thus, they concluded that there was an increase in the production of cholesteryl ester and hence, an increase in cholesterol storage. They further stated that this apparent overload of cholesterol in hepatocytes would trigger both the mechanism of cholesterol esterification and secretion in bile in order to maintain intracellular cholesterol homeostasis. However, Rustan et al (1988) reported that EPA could inhibit ACAT activity. These authors studied the effects of EPA, DHA, 18:1(n-9), 16:0 and 18:0 on the synthesis and secretion of cholesterol and cholesterol esters by cultured rat hepatocytes and microsomes.

They found that EPA and DHA decreased the synthesis and secretion of cholesterol ester by inhibiting ACAT activity while the other fatty acids examined had the opposite effect. In addition, EPA decreased HMG CoA reductase activity in hepatic microsomes (Mizuguchi et al, 1993). These authors assumed that the reduced activity was due to an increase in microsomal free cholesterol and the change in fatty acid composition of membrane phospholipids. In contrast, Field et al (1987) found that the regulation of HMG CoA reductase and ACAT in the liver and phospholipids was most likely related to the degree of fat saturation in the membrane and not necessarily to the specific class of polyunsaturates in the membrane.

Interestingly, in the part of the study examining the effect of prior diet and meal, we observed that the level of cholesterol did not differ between the MdMi and CdCi groups. However, there was a significant interaction between the diet and the infused meal. Thus, when the infused oil differed from the fat found in the diet, the cholesterol concentration declined. These results suggest that the infusion of the different fat emptied the biliary pool of this lipid rapidly as illustrated in Figure 4.6. As yet, the consequence of this event has not been elucidated. In addition, when we removed the influence of time and pooled the total amounts of the biliary lipids throughout the study period, the significant interaction of diet and infused oil for cholesterol remained.

Although there have been a number of studies examining continuous fat feeding on biliary lipids, only one other study looked at the effects of supplying a single dose of fatty acid on cholesterol secretion. This was done using perfused liver and using single albumin-bound 16:1 and 18:1 (Robins et al, 1991). Robins and coworkers (1991) observed an increase in biliary cholesterol secretion relative to PC when the population of PCs that was newly formed included more hydrophilic molecular species of PC than are present in native bile. This observation was only seen with the perfusion of 16:1.

**Biliary Phospholipid** Mansbach and Arnold (1986) previously reported that prefeeding fat to rats increased the concentration of triacylglycerol in lymph by 50% over chow fed controls. Considering that fat feeding increases circulating secretin levels which would increase biliary flow, they hypothesized that fat prefeeding in some way altered bile composition or flow so that more PC is delivered to the intestine of the fat pre-fed animals as compared to chow fed controls. These authors found that up to two hours after bile duct cannulations in rats, PC was greater in the fat pre-fed group (Knox et al, 1992). However, they also observed a more sustained increase in PC secretion into bile in the chow fed group.

Due to greater bile flow, we observed greater phospholipid output in the MaxEPA fed animals. However, there was no effect of diet or time on the actual concentration of phospholipid in the bile of either group. Chautan et al (1990)

obtained similar results. Balasubramaniam and coworkers (1985) also observed a greater output in fish oil fed animals than in the safflower oil group in their 10 hour pooled samples ( $26.7 \mu\text{mol}/10 \text{ h} \pm 3.5$  and  $23.1 \pm 3.1$ , respectively).

Similarly to the results observed for cholesterol, there was no significant difference in the phospholipid concentration between the MdmI and CdCi groups but there was a significant interaction between the diet and oil infused. We postulate that this is a result of the flux through the hepatic pool of phospholipids available for bile secretion rapidly increasing when the fat infused was different than that found in the diet. The biochemical basis for this increase is unknown. In contrast to biliary cholesterol, when the factor of time was eliminated, the interaction of diet and infused fat disappeared for phospholipids.

#### Fatty Acid Composition and Distribution in Biliary Phospholipids

There are two main sources of biliary phospholipids; *de novo* synthesis which may contribute only 3% of biliary PC secretion (Robins and Brunengraber, 1982) and a preformed hepatic pool. Coleman and Rahman (1992) stated that "the preformed pool probably involves contributions from many of the membranes of the hepatocyte, especially those of the endoplasmic reticulum and bile canaliculus. This PC pool clearly encompasses pre-existing PC but may possibly draw on 'remodelled' PC produced from the larger pool by acyltransferase action".

Many authors (Robins et al, 1991; Robins et al, 1986; Yousef and Fisher, 1976; Cohen et al, 1990) have provided clear evidence that phospholipids are selectively synthesized as well as selectively remodelled. Consequently, particular molecular species of phospholipids may be preferentially solubilized in bile salt micelles. Biliary phospholipids tend to be primarily phosphatidylcholine containing 16:0 in the sn-1 position and 18:2(n-6) or 18:1(n-9) in the sn-2 position (Yousef and Fisher, 1976; Robins et al, 1991). Robins et al (1986) undertook studies to determine if selective secretion of PC in bile might reflect a predominantly "physical process" in which intrahepatic PCs which were the most hydrophilic were the most readily solubilized by bile salts and thus, the most readily secreted into bile. When these authors chronically fed rats fatty acids that were more or equally hydrophilic than the fatty acids that are ordinarily prevalent in bile PC, bile became highly enriched in new molecular species of PC that contained the particular fatty acid that was fed. In contrast, when a fatty acid was fed that was less hydrophilic than those that ordinarily comprise biliary PC, the composition of biliary PC was not changed.

Biliary secretion of phospholipid appears to be dependent on the secretion of bile acids. During bile formation, bile acids stimulate hepatocellular secretion of PC and cholesterol from hepatocytes (Cohen et al, 1990). However, the relationship between the biliary transport of phospholipids and cholesterol remains unclear. Cohen and coworkers (1990) suggested that physical-chemical

mechanisms play a role in stimulating bile acids to select PCs with the appropriate fatty acid profile from the hepatic pool. In agreement, Yousef and Fisher (1976) suggested that biliary secretion of phospholipids might involve the physical dissection of phospholipids from the bile canalicular membrane by bile acids being transported across that membrane. Indeed, they demonstrated that, in contrast to their effect on microsomes and plasma membranes, bile acids can selectively solubilize from the bile canalicular membrane phospholipids whose molecular species and fatty acid composition are similar to those present in bile.

In our study, when only examining the effects of prior diet, the major fatty acids in the biliary phospholipids of rats fed diets containing either corn or fish oil included 16:0, 18:0, and 18:2(n-6), a finding that partially supports the evidence found by other researchers (Robins and Patton, 1986; Robins et al, 1991; Yousef and Fisher, 1976; Cohen et al, 1990). These authors have shown that 16:0 and 18:2(n-6) are major fatty acids in bile but Robins and Patton (1986) reported that biliary phospholipids have low amounts of 18:0. We found that 18:0 was a significant component of these phospholipids, accounting for more than 10% of the total fatty acid composition.

Furthermore, we also observed that the fatty acid composition of the phospholipids in bile did reflect the diet. The MaxEPA fed animals had a higher proportion of n-3 fatty acids whereas the corn oil fed rats had more n-6 fatty acids, particularly 20:4. Since corn oil contains 53% by weight of 18:2(n-6) and no



20:4(n-6), we expected to observe a higher percentage of 18:2(n-6) in the phospholipids of the rats receiving corn oil diets, similar to the findings of Balasubramaniam et al (1985) and Berr et al (1993) when they compared safflower oil fed and fish oil fed animals. However, there was no difference in the proportion of 18:2(n-6) in the phospholipids of either treatment group.

Arachidonic acid (20:4, n-6) is an important component of phospholipids contributing to the structural integrity of membranes and is the primary precursor of several classes of oxygenated derivatives with a variety of biological activities (Vance and Vance, 1991). This fatty acid can be formed from 18:2(n-6) by the alternating sequence of  $\Delta 6$  desaturation, chain elongation to the 18:3(n-6) intermediate, and  $\Delta 5$  desaturation of 20:3(n-6). It appears that the increase of n-3 fatty acids in the bile of fish oil fed animals that we observed is probably at the expense of 20:4(n-6). Nassar et al (1986) demonstrated that fish oil inhibits liver  $\Delta 6$ - and  $\Delta 5$ -desaturation of n-6 polyunsaturated fatty acids. It is probable that the 67% reduction of 20:4(n-6) in the MaxEPA oil fed rats seen in our study is due to the inhibition of enzymes responsible for desaturation of the n-6 fatty acids.

We observed a higher proportion of 18:1(n-9) in the MaxEPA group. Balasubramaniam et al (1985) reported a similar finding after feeding rats safflower oil containing diets. In addition, Choi and coworkers (1989) observed a similar phenomenon in the fatty acid compositions of liver microsomal PC in young and adult rats fed different fats. The reason for this higher proportion of

18:1(n-9) is unclear. It is possible that more 18:1(n-9) is used in the synthesis of biliary phospholipids to make up for the decrease in the total amount of n-6 fatty acids in the fish oil fed animals.

When we examined the effects of both the diet and the oil infused, we found that 18:2(n-6) is a major constituent of biliary phospholipids regardless of the type of fat in the diet or oil infused. This supports the concept that phospholipids are selectively synthesized.

Not only the previous diet but also the fatty acid composition of infused fat played a role in determining the fatty acid profile of phospholipids. The results indicate an effect of prior diet and fat infused for 18:1(n-9), EPA, and DHA. Furthermore, the fat infused had a significant effect on 20:4(n-6), independent of prior diet. As expected, MdMi had the highest proportion of long chain n-3 fatty acids whereas CdCi had the most n-6 fatty acids until, at least, the fifth hour of bile drainage. However, the infusion of corn oil caused a greater decline over time of n-6 fatty acids than the fish oil, regardless of the former diet, for reasons unknown. Interestingly, when a bolus of corn oil was given to animals fed MaxEPA oil in their diets, EPA and DHA disappeared by the second hour of bile flow, suggesting a relatively quick turnover of these fatty acids. Due to the small proportion the n-3 fatty acids represented in bile phospholipids, it is difficult to identify what fatty acid(s) replaced DHA and EPA in the MdCi group. When MaxEPA oil was infused into rats fed corn oil

containing diets, there was no increase in the amounts of the n-3 fatty acids. More than likely, the amount of EPA and DHA in the fish oil (Table 2.1) was not sufficient to induce a change.

Robins and Patton (1986) have previously reported that the contribution of newly synthesized PCs to biliary secretion is only about 3% of the total PC output. In a more recent study Robins et al (1991) contradicted this finding since their results showed that when the liver is perfused with certain unsaturated fatty acids, a number of new diunsaturated PCs may be formed in relatively large amounts and these are preferentially secreted in bile. They suggested that the most likely mechanism to explain this phenomenon is one that is dependent on the physical characteristics of the particular hepatic PCs that are available for biliary secretion when bile acid is being perfused. They concluded that when new PCs were synthesized or when PCs are available from a preformed pool, those with relatively short acyl chains are favoured for secretion in bile. However, as stated earlier, we observed an appreciable amount of long chain n-3 fatty acids in the bile of rats fed MaxEPA oil, suggesting a greater supply of these fatty acids available in the hepatic pool.

#### **4.6.3 CONCLUSION**

The results of the experiments described in this Chapter are outlined in Table 4.5. We have shown that EPA is not selectively secreted into bile by the liver compared to DHA in fish oil fed rats. In addition, dietary fatty acid

composition and infused fat can alter bile flow and composition. Specifically, feeding a diet containing fish oil or infusing a meal of fish oil can increase bile flow. Due to the greater flow in animals fed fish oil containing diets, an accompanying increase in total biliary lipid secretion was observed, although the concentration of biliary lipids did not significantly change. Furthermore, a reduction in the levels of biliary phospholipids and cholesterol was demonstrated when a fat different than the one found in the diet was infused. This effect was not seen for bile acids.

We also observed a difference due to diet and oil infused on the fatty acid composition of biliary phospholipids. The fatty acid composition of biliary phospholipids in rats fed MaxEPA oil showed enrichment with n-3 fatty acids. It is possible this change in fatty acid composition may be responsible for the increased bile output, resulting in greater excretion of cholesterol in the form of free cholesterol and in the form of bile acids. Further work is needed to determine the significance for the changes in bile flow, whether the n-3 fatty acids play a role in this increased output, and whether emptying the biliary pools by infusing a fat meal different from the main fat in the diet has physiological importance.

**Table 4.5 Summary of Primary and Secondary Objectives and Results for Mechanism #3.**

<b>Mechanism #3: EPA is preferentially secreted relative to DHA in bile.</b>	
<b>Objectives</b>	<b>Result</b>
3.1 To investigate the biliary secretion of EPA and DHA in phospholipids from rats fed fish oil containing diets.	No significant difference observed.
3.1.1 To determine whether the composition of biliary phospholipids could be altered by feeding rats diets rich in either n-6 fatty acids or n-3 fatty acids.	Rats fed a fish oil containing diet had significant higher levels of 18:1(n-9), EPA and DHA while rats fed corn oil containing diets had higher levels of 20:4(n-6).
3.1.2 To determine whether diets rich in n-6 fatty acids or n-3 fatty acids affect the rate of bile flow as well as the biliary secretion of phospholipids, cholesterol, and bile acids.	Fish oil fed animals had significant greater bile flow. The concentration of biliary bile acids, cholesterol and phospholipids did not change due to diet. But fish oil fed rats had a greater total secretion of lipids because of the greater bile flow.
3.1.3 To determine if feeding a meal rich in n-3 or n-6 fatty acids could induce short-term changes in the fatty acid composition of biliary phospholipids after rats have been fed diets containing either fish oil or corn oil.	The fatty acid profile of biliary phospholipids; i.e., 18:1(n-9), EPA and DHA, can be significantly altered by the prior diet as well as the dietary fat infused.
3.1.4 To determine whether diets rich in n-6 fatty acids or n-3 fatty acids affect the rate of bile flow as well as the biliary secretion of phospholipids, cholesterol, and bile acids after an infusion of fish oil and corn oil.	Over time, the prior diet and fat infused can significantly alter bile secretion but the infused fat did not have an effect when time was removed as a factor. Prior diet and infused fat had a significant effect on the levels of cholesterol and phospholipids whereas the effect of prior diet was independent of infused fat for bile acids. In fact, there was a reduction in the levels of cholesterol and phospholipids when a fat different than the one found in the diet was infused.

## CHAPTER 5.0

### GENERAL DISCUSSION AND CONCLUSION

#### 5.1 GENERAL DISCUSSION

The long chain n-3 fatty acids, DHA and EPA, have sparked a great deal of interest since epidemiological and clinical evidence suggested that these two fatty acids are responsible for various health benefits. The general hypothesis that EPA is preferentially utilized relative to DHA may play a role in minimizing the risk of cardiovascular disease, thrombosis as well as obesity. As a result, investigators have been interested in determining whether both fatty acids behave similarly or are metabolized differently.

More DHA appears to be present in various mammalian tissues than EPA. Even though both fatty acids are absorbed to the same extent, several researchers have demonstrated that less EPA is stored in adipose tissue than DHA (Sheppard and Herzberg, 1992; Lin and Connor, 1990; Janadeczek et al, 1991; Raclot and Groscolas, 1994). Raclot and Groscolas (1994) found that adipose tissue stores and releases n-3 fatty acids efficiently but differentially. They found that of their total ingested mass 13% of EPA, 18% of 18:4(n-3), 22% of DHA and 32% of 22:5(n-3) were stored in adipose tissue at the end of a 4 week feeding period. Thus, in agreement with others (Herzberg and Sheppard, 1992; Lin and Connor, 1990; Jandacek et al, 1991), Raclot and Groscolas (1994) suggested that there was

preferential storage of certain n-3 polyunsaturated fatty acids. Similar differential storage was observed on a low fat diet as well as the fish oil based diet. This finding supports the view that differential storage results from intrinsic metabolic properties of individual n-3 fatty acids, and is unrelated to the amount of dietary intake. In addition, Raclot and Groscolas (1994) were the first to show that individual n-3 fatty acids are differentially released from two adipose tissues differing by both their location and their size.

Accordingly, many investigators have questioned the reasons why EPA is underrepresented in tissues such as adipose tissue relative to DHA. We hypothesized that EPA is preferentially metabolized in muscle and thus, less of this acid is available for storage. The three proposed mechanisms investigated to explain how EPA is preferentially utilized included; 1) EPA is oxidized at a greater rate relative to DHA in skeletal and cardiac muscle, 2) EPA is preferentially hydrolyzed from circulating triacylglycerols in muscle, and 3) EPA is selectively secreted in bile by the liver.

From our data, we were able to conclude that the suggested mechanisms may not be responsible for the preferential metabolism of EPA relative to DHA. We did find that EPA was oxidized at a greater rate than DHA in soleus muscle homogenates. However, when potentially more physiological models were used, i.e., cardiac myocytes or the intact skeletal muscle, there were no differences in the oxidation of either of these fatty acids. Furthermore, we

determined that EPA and DHA were released from triacylglycerols in lymph-derived chylomicrons at similar rates and that both fatty acids were secreted in bile to the same extent.

Other mechanisms have been proposed. The following theories have been suggested to explain why the ratio of DHA/EPA in the tissue exceeds the amount that is absorbed from the diet; 1) EPA is preferentially oxidized by the liver compared to DHA, 2) EPA is converted to DHA for storage, 3) EPA is preferentially mobilized from storage, and/or 4) EPA is preferentially used for the synthesis of membrane phospholipids.

## 5.2 OXIDATION OF EPA BY LIVER

Even though preferential oxidation of EPA relative to DHA was not observed in skeletal and cardiac muscle, it has been speculated that EPA is preferentially oxidized in the liver. Previous work has shown increased hepatic ketogenesis and fatty acid oxidation upon fish oil feeding (Wong et al, 1984; Aarsland et al, 1990). Two investigations in recent years have provided evidence to support the supposition that EPA is oxidized at a greater rate in the liver compared with DHA (Gavino and Gavino, 1991; Herzberg et al, 1996).

Gavino and Gavino (1991) examined the activity of CPT<sub>o</sub> in liver mitochondria. They found that CPT<sub>o</sub> had a higher activity with the fatty acyl CoA of EPA than the fatty acyl CoA of DHA. These authors observed similar



results when mitochondria were incubated with free fatty acids. These data suggest that EPA is more readily available for fatty acid oxidation in liver.

In agreement, Herzberg et al (1996) found a greater rate of ketogenesis when hepatocytes were incubated with EPA compared to DHA. The experiments with hepatocytes were competition experiments because in each incubation the radioactive label was in 18:1(n-9) regardless of which fatty acid was added. Therefore, for the oxidation results, a lower apparent rate indicated that the added fatty acid was oxidized at a greater rate than 18:1(n-9). Of the added fatty acids only EPA was oxidized at a significantly greater rate than 18:1(n-9). This evidence that EPA was oxidized at a greater rate than the other fatty acids, including DHA, is confirmed by the ketoacid production. Both acetoacetate and 3-hydroxy butyrate syntheses were greater for added EPA than any other added fatty acid including DHA. Consequently, these authors provided evidence suggesting that EPA was oxidized at a faster rate in liver compared to other fatty acids including DHA. Further investigative work is needed to confirm these studies. It would be of interest to determine the rates of fatty acid oxidation using the labelled free fatty acid and to compare the results to these competition studies.

### 5.3 INTERCONVERSION OF N-3 FATTY ACIDS

Interconversions of long chain n-3 fatty acids could potentially contribute to their net differential storage. It is possible that EPA could be converted to

DHA since it is the precursor of DHA in the n-3 synthetic pathway and thus, account for less EPA being stored. Consequently, DHA may serve as a reservoir for EPA and when needed for eicosanoid synthesis or oxidation, DHA may be retroconverted to EPA, resulting in the mobilization of EPA to the tissues of need. Even though interconversions during absorption have been found to be negligible (Nilsson et al, 1992; Chernenko et al, 1989), some interconversions have been reported in such tissues as the liver and the retina (Gronn et al, 1988; Voss et al, 1991; Voss et al, 1992; Lin and Connor, 1990; Christensen et al, 1986). However, the factors regulating these interconversions are poorly understood.

There is evidence supporting the conversion of EPA to DHA (Christensen et al, 1986; Anderson et al, 1990, Lin and Connor, 1990). Christensen et al (1986) observed rapid elongation of EPA to DHA in hepatocytes from fed but not fasted rats. Lin and Connor (1990) cited studies that demonstrated that when chicks were fed EPA, the formation of DHA in the retina and brain resulted (Anderson et al, 1990). Similar presumed conversion was observed in adipose tissue and atherosclerotic plaques of humans fed fish oil (Rapp et al, 1989; Leaf et al, 1988). Hagve and Christopherson (1984) studied the desaturation, chain elongation, and esterification of 1-<sup>14</sup>C- EPA, 20:4(n-6), 20:3(n-6), 18:3(n-3), and 18:2(n-6) in isolated liver cells. Rats were fed diets containing 15% hydrogenated coconut oil, 15% hydrogenated marine oil, 15% soybean oil or standard pellets with 6% fat. They found that the elongation to 22 carbon fatty acids was efficient with EPA.

However, with 20:4(n-6), there was little recovery of longer products. In addition, this investigation revealed that EPA is rapidly esterified into triacylglycerols and phospholipids and then liberated by hydrolysis and converted to 22:5(n-3). The esterification of 1-<sup>14</sup>C EPA in phospholipids decreased in the order of marine oil>coconut oil>standard pellet>soybean oil. The specificity of lipases liberating 18:3(n-3) and EPA in preference to 18:2(n-6) and 20:4(n-6) and specificity of elongation enzymes for EPA compared to 20:4(n-6) are of importance for the biosynthesis of n-3 fatty acids, mainly to 22 carbon fatty acids in animal tissues.

Hagve and Sprecher (1989) were unable to detect any products of unsaturation or chain elongation when appropriate n-6 and n-3 fatty acids were incubated with myocytes or when the heart was perfused with [1-<sup>14</sup>C]18:2(n-6). Since heart is unable to elongate 18 carbon fatty acids to their corresponding 20 or 22 carbon fatty acid, they suggested that heart phospholipid composition must, in part, be regulated by specific mechanisms in removing fatty acids from the circulation.

Animal and human studies have shown that DHA can be retroconverted to EPA. Investigators suggest that the retroconversion probably occurs via one step of  $\beta$ -oxidation and then the saturation of the resulting trans double bond (Schlenk, 1969; von Schacky and Weber, 1985; Fischer et al, 1987). Voss and colleagues (1991) have shown that 22:4(n-6), 22:5(n-6), 22:5(n-3), and DHA are all

substrates for retroconversion to yield either 20:4(n-6) or EPA. Voss et al (1992) further stated that "since 20:4(n-6) and EPA are also metabolized to 22:5(n-6) and DHA, it is apparent that a cycle exists for converting 20-22 carbon fatty acids as well as the reverse process". Hagve and Christophersen (1986) provided evidence for peroxisomal retroconversion of 22:4(n-6) and DHA to 20:4(n-6) and EPA, respectively, in isolated liver cells. Due to this evidence and the fact that the retroconversion is deficient in fibroblast cultures from patients with peroxisomal diseases (Zellweger syndrome and neonatal adrenoleukodystrophy), Gronn and colleagues (1991) were convinced that retroconversion in the liver was a peroxisomal function. Subsequently, Gronn et al (1991) studied the regulation of the retroconversion of DHA to EPA and the metabolism of the EPA formed in isolated rat liver cells. They found that 20% of DHA was retroconverted to EPA in control cells by one cycle of  $\beta$ -oxidation with  $\Delta 4$  enoyl CoA reductase and  $\Delta 3, \Delta 2$  enoyl CoA isomerase as auxillary enzymes (compared to 10% in human fibroblasts) and commented that retroconversion was indeed a peroxisomal function. The resultant EPA was rapidly incorporated into triacylglycerols, phosphatidylcholine and phosphatidylethanolamine fractions. During longer incubations EPA was removed from phosphatidylcholine fractions, chain elongated to 22:5(n-3) and this product was then incorporated into triacylglycerols.

Fischer et al (1987) demonstrated that DHA is retroconverted in man to EPA, which is then quickly transformed to prostaglandin I<sub>3</sub>. In a 24 hour as well as a week long dietary intervention study, purified DHA or EPA ethyl ester were given to healthy male volunteers. Endogenous prostaglandin formation of the two and three series was then analyzed by measuring the main urinary metabolites, prostaglandin I<sub>2</sub>-M and prostaglandin I<sub>3</sub>-M. After the ingestion of either fatty acid, a rapid formation of prostaglandin I<sub>3</sub> was observed, implying that DHA was retroconverted to EPA. Consequently, EPA was available for prostaglandin synthesis. Furthermore, von Schacky and Weber (1985) found that after the ingestion of purified DHA, EPA levels rose in the plasma of volunteers. On the other hand, they observed that the consumption of EPA increased its own level in phospholipids as well as its elongation product, 22:5(n-6). However, further desaturation to DHA did not occur (Croset and Lagarde, 1986).

Yorek et al (1984) utilized the Y-79 retinoblastoma cell, a cultured human line derived from the retina, as a model for investigating the metabolism of n-3 polyunsaturated fatty acids in neural tissue. Regardless of which fatty acid was provided, 65-75% of the total uptake accumulated in phosphatidylethanolamine and ethanolamine plasmalogen, suggesting that these phospholipids play an important role in n-3 fatty acid metabolism. A small amount of DHA was converted to EPA, which was recovered in phosphatidylinositol and phosphatidylserine. Therefore, these authors suggested that one metabolic

function of DHA may be to serve as an intracellular storage pool for the formation of EPA through retroconversion. When any of the n-3 fatty acids were available, the main fatty acid that accumulated in cell phospholipids was DHA. The extent to which DHA accumulated, however, depended on the particular n-3 fatty acid that was available. This suggests that the DHA content of neural cells and any cellular function dependent on DHA content, may be regulated by changes in the type of n-3 fatty acids available to the nervous system. Other systems in which retroconversion has been observed include human smooth muscle cells as well as fibroblasts. These cells have been shown to convert 20:3(n-6) to 18:3(n-6) ( Tinoco et al, 1979) plus 22:4(n-6) to 20:4(n-6) and 18:3(n-6) (Gavino et al, 1981).

It would be interesting to conduct further studies on the interconversions of the long chain n-3 fatty acids in adipose tissue and muscle tissue. Even though Hagve and Sprecher (1989) did not find any elongation products when n-3 and n-6 fatty acids were incubated with cardiac myocytes, it would be interesting to see if the same phenomenon is observed with adipose tissues and skeletal muscles.

#### **5.4 SELECTIVE MOBILIZATION OF EPA**

If differential mobilization of fatty acids from tissues exists, then this could affect the qualitative supply of tissues and organs with fatty acids in the post absorptive state and situations of negative energy balance such as fasting.

This event might prove to be very significant in the case of 20:4(n-6) and EPA, since they are necessary for the integrity of cell membranes and for the biosynthesis of eicosanoids.

Gavino and Gavino (1992) showed the preferential release of 18:3(n-3) and 20:4(n-6) over 16:0, 18:1(n-9), 18:2(n-6). Jones et al (1992) have shown that polyunsaturated fatty acids are oxidized as fuel sources more rapidly and are less stored than are saturated long chain fatty acids. Cunnane (1989) demonstrated that there is selective utilization of EPA and selective retention of DHA in liver triacylglycerols during fasting regardless of whether n-3 or n-6 fatty acids were the dominant essential fatty acids in the diet. However, the mechanism remains to be determined.

Raclot and Groscolas (1993, 1994) have done extensive research in the area of preferential storage as well as mobilization of the n-3 fatty acids in adipose tissue. Firstly, they examined differential mobilization of white adipose tissue fatty acids according to chain length, unsaturation, and positional isomerism (Raclot and Groscolas, 1993). Their study aimed at determining whether, and how, molecular structure of fatty acids influences their mobilization from fat cells. The *in vitro* mobilization of 52 fatty acids ranging in chain length from 12-24 carbon atoms, in unsaturation from zero to six double bonds, and including 23 pairs of positional isomers was examined. From their results, they concluded that under conditions of stimulated lipolysis individual fatty acids are more

readily mobilized from fat cells when they are short and unsaturated and when their double bonds are closer to the methyl end of the chain. Therefore, fatty acids are not mobilized from fat cells in direct proportion to their content in triacylglycerols, but differentially according concurrently to chain length, unsaturation, and positional isomerism. Furthermore, fatty acids with 22 carbons were not preferentially released. Fatty acids were either preferentially (20:5, 18:4), equivalently (22:5, 22:6) or less (20:1, 22:1) released in comparison to total fatty acids. The authors stated that it is very likely that the basis of differential mobilization of fatty acids is due to a differential aqueous solubility or, in more broad terms, a differential physiochemical property. From their results, Raclot and Groscolas (1993) commented that "Differential mobilization probably affects the storage of individual fatty acids. This could partly explain the observation that the partitioning of dietary fatty acids between storage and oxidation varies according to chain length and unsaturation".

Further to their 1993 investigation, Raclot and Groscolas (1994) studied whether dietary n-3 fatty acids were selectively mobilized from stores with the assumption that preferential mobilization of EPA could contribute to its maintenance in the circulation after fish oil feeding. These authors investigated storage in and mobilization from rat adipose tissue of EPA, DHA, 22:5(n-3), and 18:4(n-3). After fish oil feeding, substantial amounts of these fatty acids were stored. The *in vivo* relative incorporation (% in triacylglycerol/% in diet)



increased significantly with EPA<18:4(n-3)<DHA<22:5(n-3). The *in vitro* relative mobilization (% in free fatty acid/% in triacylglycerol) decreased significantly with EPA>18:4(n-3)>DHA>22:5(n-3). The major finding was that individual n-3 polyunsaturated fatty acids characteristic of fish oil are efficiently but differentially incorporated into and mobilized from various adipose tissues, i.e., the abdominal (retroperitoneal) and nonabdominal (subcutaneous) adipose tissue. These authors suggest that the differential loss of n-3 fatty acids during lipolysis, because of their differential mobilization, contributes to the explanation of differential net storage. This possibility is further supported by the demonstration of an inverse relationship between the relative mobilization of n-3 fatty acids *in vitro* and their relative incorporation *in vivo*.

More recently, Connor et al (1995, accepted for publication) studied the relative mobilization of adipose tissue fatty acids under *in vivo* conditions. They wanted to find out whether different fatty acids are mobilized into plasma proportional to their concentrations in adipose tissue triacylglycerols. They fed weanling rabbits a special diet to label the fat stores with a variety of dietary fatty acids. The composition of the plasma free fatty acid fraction before and after hormone-induced lipolysis and the fatty acids of adipose tissue triacylglycerols were analyzed. Their results indicate that the mobilization of fatty acids into plasma was not proportional to their content in adipose tissue, but rather was influenced by their molecular structure. EPA and 20:4(n-6) were

the fatty acids with the highest mobilization into the plasma. Connor and coworkers concluded that the preferential release of these two fatty acids is to respond to the need for prostaglandins following the proposed stress. DHA was among the most poorly mobilized fatty acids. Since DHA is incorporated into the membrane phospholipids of cells, these authors suggested that DHA would not be expected to be utilized for energy purposes or in prostaglandin synthesis.

#### 5.5 PREFERENTIAL INCORPORATION OF EPA INTO PHOSPHOLIPIDS

The underrepresentation of EPA relative to DHA in triacylglycerols may result from remodeling prior to the synthesis of phosphatidic acid in the common pathway of triacylglycerols and phospholipids. If more EPA is diverted to the synthesis of phospholipids than triacylglycerol synthesis, then this could explain why less EPA is stored in triacylglycerols. Importantly, EPA is a precursor of the eicosanoids like 20:4(n-6) and thus, could be diverted to the pathway responsible for the synthesis of membrane phospholipids for incorporation.

Benner et al (1990) studied the differential effects of 18:1(n-9) and EPA in cultured rabbit hepatocytes on the synthesis of hepatocyte triacylglycerols and phospholipids. They speculated that since EPA was a precursor for the biologically potent eicosanoids, then EPA may be preferentially incorporated into phospholipids rather than stimulating hepatocyte triacylglycerol synthesis and secretion. This concept could partially explain the mechanism for the

decrease in triacylglycerol secretion and synthesis which is one of the mechanisms proposed to explain the hypotriacylglycerolemic effect of fish oils. Benner and his coworkers (1990) found that their data agreed with this hypothesis, with EPA avidly incorporated into phospholipids while 18:1(n-9) predominantly became esterified in triacylglycerols. In addition, they observed that in the presence of supplemental EPA, there was an increased synthesis of 22:5(n-3) and DHA. DHA was found particularly in the phosphatidylcholine fraction and not in phosphatidylinositol or phosphatidylserine. Furthermore, they commented that "It is possible that longer incubation of hepatocytes with n-3 fatty acids, or long-term feeding experiments would result in more extensive phospholipid replacement by n-3 fatty acids, including the chain-elongation products of EPA". This conversion of EPA to its longer metabolites further supports the theory of interconversion of n-3 fatty acids presented in Section 5.3 and perhaps the view that DHA may act as a reservoir of EPA. However, when von Schacky and Weber (1985) gave volunteers 6 g of EPA, EPA appeared in plasma free fatty acids and plasma phospholipids after four hours and was not incorporated into platelet phospholipids (i.e., phosphatidylcholine and phosphatidylethanolamine) until day six, suggesting that platelet fatty acid composition does not immediately reflect that of the surrounding plasma milieu, but rather may be determined during megakaryocyte maturation. After dietary EPA,

22:5(n-3) increased in plasma and platelet phospholipids but DHA levels were unaltered.

However, Yeo and Holub (1990) found that the enrichment of DHA relative to EPA was even greater in hepatic phosphatidylcholine and phosphatidylethanolamine than it was in the triacylglycerol pools. Enrichment of DHA relative to EPA has also been observed in the plasma phospholipids of humans fed cod liver oil (von Schacky et al, 1985). These findings add further confusion and queries as to why EPA is underrepresented in tissue triacylglycerol stores and to what pathways it is being directed. In contrast, Harris et al (1982) demonstrated that proportionately more DHA compared to EPA was found only in plasma triacylglycerols and not phospholipids in a study in which they gave volunteers salmon and salmon oil. Furthermore, Harris et al (1989) conducted a dose response study in which 3-12 g of fish oil/d were given to hyperlipidemic patients for six months. They found an increase in plasma phospholipid EPA levels which reflected intake; however, DHA levels were less affected.

Hagve and Sprecher (1989) studied the uptake and integrated metabolism of n-3 and n-6 fatty acids in the isolated rat cardiac myocytes and in the perfused heart. These authors stated that "In rat hepatocytes the partitioning of labelled fatty acids between phospholipid and triacylglycerol biosynthesis and oxidation has been shown to be dependent on the chain length and the degree of

unsaturation of the fatty acid substrate. Previously it has been shown that rat heart microsomes convert small amounts of 18:2(n-6) to 18:3(n-6). It was not, however, established whether this  $\Delta 6$ -desaturase activity was localized in myocytes or other cells". In this investigation, Hagve and Sprecher (1989) were unable to detect any products of desaturation or chain elongation when appropriate n-6 and n-3 fatty acids were incubated with cardiac myocytes or when heart was perfused with [1- $^{14}$ C]18:2(n-6). Heart appears to obtain its 20 and 22 carbon polyunsaturated fatty acids from the circulation. This would lend support to the idea that when needed these fatty acids are released from stores such as adipose tissue and exported to other cells and tissues. These authors conclude that "heart phospholipid composition must in part be regulated by specificities in removing fatty acids from the circulation since they lack the ability to metabolize 18- carbon (n-6) and (n-3) polyunsaturated fatty acids to longer polyenes". Our results did not show any selective release of any fatty acid by heart LPL acting on circulating triacylglycerols.

Hagve and Christophersen (1983) studied 18:3(n-3) desaturation and chain elongation and rapid turnover of phospholipid n-3 fatty acids in isolated liver cells from rats fed a diet deficient in essential fatty acids. All n-3 fatty acids were formed. EPA was found mainly in phospholipids whereas 22:5(n-3) and DHA were found in both phospholipids and triacylglycerols. During long incubation periods, continued after nearly all the 1- $^{14}$ C 18:3(n-3) substrate had been

metabolized either by esterification or by oxidation, the phospholipid content of labelled 18:3(n-3) and 18:4(n-3) decreased while the content of EPA, 22:5(n-3), and DHA increased markedly, suggesting a remodeling of the phospholipids' n-3 fatty acid content by a series of deacylation-reacylation reactions. The n-3 fatty acid pattern in triacylglycerols changed little.

There are many discrepancies in the results regarding the preferential incorporation of EPA into phospholipids compared to DHA. It is apparent that more work is needed in this area to sort out this puzzle.

## 5.6 CONCLUSION

There is evidence for some of the alternative mechanisms to explain the phenomenon that EPA is preferentially utilized relative to DHA. There is support that EPA is preferentially oxidized relative to DHA in the liver, that it is selectively mobilized from adipose tissue for export to other cells and tissues and that interconversions of the n-3 fatty acids may enable DHA to serve as a storage depot for EPA and thus, be retroconverted to EPA when there is a need for this fatty acid for various metabolic processes. There are discrepancies in relation to the hypothesis that there is preferential incorporation of EPA into phospholipids, making it less available for storage and more available for its structural role in the membrane and its role as a precursor for eicosanoids synthesis.

Raclot and Groscolas (1994) provided strong evidence that adipose tissue stores and releases dietary n-3 fatty acids efficiently but differentially. They

provided support that differential mobilization is one of the mechanisms that control the proportions in which exogenous fatty acids are stored in adipose tissue. Their results suggest structure-dependent discrimination of the n-3 fatty acids for mobilization versus retention in adipose tissue, with EPA being stored less than DHA and mobilized to a greater extent. Thus, long term feeding of n-3 fatty acids, EPA and DHA, could influence n-3 fatty acid concentrations in adipose tissue. The reservoir of these fatty acids could ensure their availability for meeting the metabolic requirements of individuals during periods of need.

These findings may have physiological significance to the pathogenesis of obesity as well as thrombosis. Jones (1988) reported that feeding dietary fish oil to hamsters, compared with corn oil, favoured energy substrate oxidation reducing the fraction of metabolized energy partitioned for storage. Furthermore, Jones et al (1992) observed that, in obesity, whole-body postprandial disposal of dietary fat was influenced by the long chain fatty acid composition. These authors concluded that overweight individuals partitioned less dietary saturated fat for oxidation postprandially, compared with individuals of normal body weight. Thus, the fatty acid blend of dietary fat may be an important determinant in altering energy substrate utilization and long term body weight balance.

More investigative work is necessary to further study the incorporation of EPA into phospholipids in various tissues and to affirm the differential

metabolism in liver. The role of EPA and DHA on major pathways of phospholipid metabolism; i.e., phospholipids in various liver membranes and various fractions of serum lipoproteins, should be further studied. Studies on the phospholipid turnover and exchange of phospholipids between membranes and serum lipoproteins are profoundly important in cardiovascular disease and thrombotic disorders. It is important to increase our understanding to provide insight into the control of the partitioning and channelling of fatty acids by various tissues. Furthermore, it would be interesting to determine the availability of the n-3 fatty acids that are stored in tissue triacylglycerol when the dietary source is no longer available.

In addition, the suggestion of differential absorption to explain preferential utilization of EPA relative to DHA should be revisited. In section 1.4 of Chapter 1.0, it was stated that the underrepresentation of EPA relative to DHA was "not due to differential intestinal absorption because it has been shown that both of these fatty acids are absorbed to the same extent in rats (Chernenko et al, 1989)". However, a recent report by Degrace et al (1996) compared the lymphatic absorption of a variety of oils including synthetic mixtures of DHA and EPA in rats. The data showed increased proportional mesenteric absorption of DHA versus EPA from menhaden oil and cod liver oil, perhaps providing evidence of enhanced intestinal availability of DHA at initial periods of absorption. The higher frequency of DHA at the sn-2 position of triacylglycerols in these oils was



cited as a reason for its improved absorption. It is possible then, that this is evidence that differential absorption could contribute to the observation of differential partitioning of these two fatty acids.

To explain the underrepresentation of EPA relative to DHA in tissue triacylglycerols, several mechanisms have been proposed. We suggested that EPA was preferentially utilized by skeletal and heart muscle, that EPA was preferentially hydrolyzed from circulating triacylglycerols making it more available for various metabolic processes in peripheral tissues, and that EPA was selectively secreted in bile compared with DHA. Except for a twofold difference in the rate of oxidation of EPA relative to DHA by soleus muscle homogenates, there were no significant differences found with regards to the oxidation rates in intact skeletal muscle or cardiac myocytes or with regards to preferential hydrolysis in chylomicron triacylglycerols and selective secretion in bile. It is apparent that the findings, except the data from the homogenate experiments, invalidate our hypothesis. However, the results from the homogenate experiments both in muscle and liver suggest that more investigative work in the area of these proposed mechanisms should be explored before closing the book on the overall hypothesis.

## CHAPTER 6.0

### REFERENCES

- Aarsland A, Lundquist M, Borretsen B, Berge RK. 1990. On the effect of peroxisomal  $\beta$ -oxidation and carnitine palmitoyltransferase activity by eicosapentanoic acid in liver and heart from rats. *Lipids* 25:546-548.
- Abeywardena MY, McLennan PL, Charnock JS. 1987. Long-term saturated fat supplementation in the rat causes an increase in PGI<sub>2</sub>/TxB<sub>2</sub> ratio of platelet and vessel wall compared to n-3 and n-6 dietary fatty acids. *Atherosclerosis* 66:181-189.
- Alousi AA, Mallov S. 1964. Effects of hyperthyroidism, epinephrine, and diet on heart lipoprotein lipase activity. *Am J Physiol* 206:603-609.
- Anil K, Abraham R, Kumar GS, Sudhakaran PR, Kurup PA. 1992. Metabolism of very low density lipoproteins-effect of sardine oil. *Ind J Exp Biol* 30(6):518-522.
- Aukema HM, Holub BJ. 1989. Effect of dietary supplementation with a fish oil concentrate on the alkenylacyl class of ethanolamine phospholipid in human platelets. *J Lipid Res* 30:59-64.
- Awan MM, Saggerson ED. 1993. Malonyl CoA metabolism in cardiac myocytes and its relevance to the control of fatty acid oxidation. *Biochem J* 295(pt1):61-66.
- Bagby GJ, Coril CB. 1989. Comparison of lipoprotein lipase activity in heart myocytes and perfused hearts. *J MOL Cell Cardiol* 21(3):253-262.
- Balasubramaniam S, Simons LA, Chang S, Hickie JB. 1985. Reduction in plasma cholesterol by a diet rich in n-3 fatty acids in rats. *J Lipid Res* 26:684-689.
- Balint JA, Beeler DA, Treble DH. 1967. Studies in the biosynthesis of hepatic and biliary lecithins. *J Lipid Res* 8:486-493.
- Baltzell JK, Wooten JT, Otto DA. 1991. Lipoprotein lipase in rats fed fish oil: apparent relationship to plasma insulin levels. *Lipids* 26(4):289-294.
- Bang HO, Dyerberg J. 1972. Plasma lipids and lipoproteins in Greenlandic West Coast Eskimoes. *Acta Med Scan* 192:85-94.

- Bang HO, Dyerberg J. 1981. Personal reflections on the incidence of ischaemic heart disease in Oslo during the second World War. *Acta Med Scand* 210:245-248.
- Baracos VE, Langman M, Mak A. 1989. An in vitro preparation of the extensor digitorum communis muscle from the chick (*Gallus domesticus*) for studies of protein turnover. *Comp Biochem Physiol* 92A(4):555-563.
- Bartlett GR. 1959. Phosphorus assay in column chromatography. *J Biol Chem* 234:466-468.
- Bauer JE. 1988. Substrate specificity studies of partially purified rabbit heart lipoprotein lipase. *Artery* 15(5):272-291.
- Baxter JN. 1966. Origin and characteristics of endogenous lipid in thoracic duct lymph in rat. *J Lipid Res* 7:158-166.
- Bengtsson G, Olivecrona T. 1980. Lipoprotein lipase mechanism of product inhibition. *Eur J Biochem* 106:557-562.
- Benolken RM, Anderson RD, Wheeler TG. 1973. Membrane fatty acids associated with the electrical response in visual excitation. *Science* 182:1253-1254.
- Bensadoun A. 1991. Lipoprotein Lipase. *Annu Rev Nutr* 11:217-237.
- Bergstedt SE, Hayashi H, Kritchevsky D, Tso P. 1990. A comparison of absorption of glycerol tristearate and glycerol trioleate by rat small intestine. *Am J Physiol* 259(3):G386-G393.
- Berr F, Holl J, Jungst D, Fischer S, Richter WO, Seiffert B, Paumgartner G. 1992. Dietary n-3 polyunsaturated fatty acids decrease biliary cholesterol saturation in gallstone disease. *Hepatology* 16:960-967.
- Berr F, Goetz A, Schreiber E, Paumgartner G. 1993. Effect of dietary n-3 versus n-6 polyunsaturated fatty acids on hepatic excretion of cholesterol in the hamster. *J Lipid Res* 34:1275-1284.
- Bianchi A, Evans JL, Iverson AJ et al. 1990. Identification of an isozymic form of acetyl CoA carboxylase. *J Biol Chem* 265(3):1502-1509.
- Blanchette-Mackie EJ, Masuno H, Dwyer NK, Olivecrona T, Scow RO. 1989. Lipoprotein lipase in myocytes and capillary endothelium of heart: immunocytochemical study. *Am J Physiol* 256(6 pt1):E818-E828.

- Bonen A, Clark MG, Henriksen EJ. 1994. Experimental approaches in muscle metabolism: hindlimb perfusion and isolated muscle incubations. *Am J Physiol* 266:E1-E16.
- Booker ML, Scott TE, La Morte WW. 1990. Effects of dietary fish oil on biliary phospholipids and prostaglandin synthesis in the cholesterol-fed prairie dog. *Lipids* 25:27-32.
- Borensztajn J. Heart and Skeletal Muscle Lipoprotein Lipase. In: *Lipoprotein Lipase*. Ed: Borensztajn J. Chicago: Evener Publishers Inc, 1987.
- Borensztajn J, Robinson DS. 1970. The effect of fasting on the utilization of chylomicron triglyceride fatty acid in relation to clearing factor lipase (lipoprotein lipase) releasable by heparin in the perfused rat heart. *J Lipid Res* 11:111-117.
- Braun JEA, Severson DL. 1992. Regulation of the synthesis, processing and translocation of lipoprotein lipase. *Biochem J* 287:337-347.
- Bremer J. 1983. Carnitine-Metabolism and functions. *Physiol Rev* 63:1420-1480.
- Bremer J, Norum KR. 1982. Metabolism of very long-chain monounsaturated fatty acid (22:1) and the adaptation to their presence in the diet. *J Lipid Res* 23:243-256.
- Brown AJ, Pang E, Roberts DC. 1991. Persistent changes in the fatty acid composition of erythrocyte membranes after moderate intake of n-3 polyunsaturated fatty acids: study design implications. *Am J Clin Nutr* 54:668-673.
- Brown CM, Layman DK. 1988. Lipoprotein lipase activity and chylomicron clearance in rats fed a high fat diet. *J Nutr* 118:1294-1298.
- Careaga-Houck M, Sprecher H. 1989. The effect of a fish oil diet on the fatty acid composition of individual phospholipids and eicosanoid production by rat platelets. *Lipids* 24(6):477-481.
- Cenedella JR, Allen A. 1969. Differences between the metabolism of linoleic and palmitic acid: utilization for cholesterol synthesis and oxidation to respiratory CO<sub>2</sub>. *Lipids* 4:155-158.

- Chautan M, Chanussot F, Portugal H, Pauli AM, Lafont H. 1990. Effects of salmon oil and corn oil on plasma lipid level and hepato-biliary cholesterol metabolism in rats. *Biochim Biophys Acta* 1046:40-45.
- Chernenko GA, Barrowman JA, Kean K, Herzberg GR, Keough KMW. 1989. Intestinal absorption and lymphatic transport of fish oil (MaxEPA) in the rat. *Biochim Biophys Acta* 1004:95-102.
- Choi Y-S, Goto S, Ikeda I, Sugano M. 1989. Effect of dietary n-3 fatty polyunsaturated fatty acids on cholesterol synthesis and degradation in rats of different ages. *Lipids* 24(1):45-50.
- Chu C, Mao LF, Schulz H. 1994. Estimation of peroxisomal  $\beta$ -oxidation in rat heart by a direct assay of acyl CoA oxidase. *Biochem J* 302(pt1):23-29.
- Clouet P, Niot I, Bezard J. 1989. Pathway of alpha-linolenic acid through the mitochondrial outer membrane in the rat liver and influence on the rate of oxidation. *Biochem J* 263:867-873.
- Cohen DE, Angelico M, Carey MC. 1990. Structural alterations in lecithin-cholesterol vesicles following interactions with monomeric and micellar bile salts: physical-chemical basis for subselection of biliary lecithin species and aggregative states of biliary lipids during bile formation. *J Lipid Res* 31:55-70.
- Coleman R, Rahman K. 1992. Lipid flow in bile formation. *Biochim Biophys Acta* 1125:113-133.
- Connor WE. 1986. Hypolipidemic effects of dietary omega-3 fatty acids in normal and hyperlipidemic human: effectiveness and mechanisms. In: *Health effects of polyunsaturated fatty acids in seafood*. Ed: Simopoulos AP, Kifer RR, Martin RE. Orlando, Florida: Academic Press, 1986.
- Connor WE, Lin DS, Colvis C. 1995. The differential mobilization of fatty acids from adipose tissue. Accepted for publication.
- Cook GA, Lappi MD. 1992. Carnitine palmitoyltransferase in the heart is controlled by a different mechanism than the hepatic enzyme. *Mol Cell Biochem* 116(1-2):39-45.
- Cook HW. Fatty acid desaturation and chain elongation in eucaryotes. In: *Biochemistry of Lipids, Lipoproteins and Membranes*. Ed: Vance DE and Vance J. New York: Elsevier, 1991.

- Coots RH. 1965. Metabolism of arachidonic acid-1-<sup>14</sup>C in the rat. *J Lipid Res* 6:494-497.
- Corey EJ, Shih C, Cashman JR. 1983. Docosahexaenoic acid is a strong inhibitor of prostaglandin but not leukotriene biosynthesis. *Proc Natl Acad Sci USA* 80:3581-3587.
- Cryer A. 1981. Tissue lipoprotein lipase activity and its action on lipoprotein metabolism. *Int J Biochem* 13:525-541.
- Cryer A, Riley SE, Williams ER, Robinson DS. 1976. Effect of nutritional status on rat adipose tissue, muscle and post-heparin plasma clearing factor lipase activities: their relationship to triglyceride fatty acid intake by fat-cells and to plasma insulin concentrations. *Clin Sci Mol Med* 50:213-221.
- Culp BR, Titus BG, Lancis WEM. 1979. Inhibition of prostaglandin biosynthesis by eicosapentanoic acid. *Prostaglandins Med* 3:269-278.
- Cunnane SC. 1988. Differential utilization of long chain fatty acids during triacylglycerol depletion. II. Rat liver after starvation. *Lipids* 23:372-374.
- Curb JD, Reed DM. 1985. Fish consumption and mortality from coronary heart disease (Letter). *N Engl J Med* 313:821.
- Dam H. 1971. Determinates of cholesterol cholelithiasis in man and animals. *Am J Med* 51:596-613.
- Davis HR, Bridenstine RT, Vesselinovitch D, Wissler RW. 1987. Fish oil inhibits development of atherosclerosis in rhesus monkeys. *Arteriosclerosis* 7:441-449.
- De Craemer D, Vamecq J, Roels F, Vallee L, Pauwels M, van den Branden C. 1994. Peroxisomes in liver, heart, and kidney of mice fed a commercial fish oil preparation: original data and review on peroxisomal changes induced by high-fat diets. *J Lipid Res* 35(7):1241-1250.
- Declercq PE, Falck JR, Kuawajima M, Tyminski M, Foster DW, McGarry JD. 1987. Characterization of the mitochondrial carnitine palmitoyltransferase enzyme system. I. Use of inhibitors. *J Biol Chem* 262:9812-9821.

- Degasquet P, Griglio S, Pequignot-Planche E, Malewiak MI. 1977. Diurnal changes in plasma and liver lipids and lipoprotein lipase activity in heart and adipose tissue in rats fed high and low fat diets. *J Nutr* 107:199-212.
- Degrace P, Caselli C, Rayo JM, Bernard A. 1996. Intestinal lymph absorption of butter, corn oil, cod liver oil, menhaden oil, eicosapentaenoic and docosahexaenoic ethyl esters in rats. *Lipids* 31:405-414.
- Delhorme CL, Harris KL. 1975. Effects of diet on lipoprotein lipase activity in the rat. *J Nutr* 105:447-451.
- Derrick JP, Ramsay RR. 1989. L-carnitine acyltransferase in intact peroxisomes is inhibited by malonyl CoA. *Biochem J* 262:801-806.
- Dyerberg J. 1986. Linoleate-derived polyunsaturated fatty acids and prevention of atherosclerosis. *Nutr Rev* 44(4):125-134.
- Ekstrom B, Nilsson A, Akesson B. 1989. Lipolysis of polyenoic fatty acid esters of human chylomicrons by lipoprotein lipase. *Eur J Clin Invest* 19:259-264.
- El-Fakhri M and Middleton B. 1982. The existence of an inner-membrane-bound, long acyl-chain-specific 3-hydroxyacyl-CoA dehydrogenase in mammalian mitochondria. *Biochim Biophys Acta* 713:270-279.
- Esser V, Britton CH, Weis BC et al. 1993b. Cloning, sequencing, and expression of a cDNA encoding rat liver CPTL. *J Biol Chem* 268:5817-5822.
- Esser V, Kuwajima M, Britton CH et al. 1993a. Inhibitors of mitochondrial CPTI limit the action of proteases on the enzyme. *J Biol Chem* 268:5810-5816.
- Fehily AM, Burr ML, Phillips KM et al. 1983. The effect of fatty fish on plasma lipid and lipoprotein concentrations. *Am J Clin Nutr* 38:349-351.
- Field FJ, Albright EJ, Mathur SN. 1987. Effect of dietary n-3 fatty acids on HMG CoA reductase and ACAT activities in liver and intestine of the rabbit. *J Lipid Res* 28:50-58.
- Folch J, Lees M, Sloan-Stanley GH. 1957. A simple method for the isolation and purification of total lipids from animal tissues. *J Biol Chem* 226:497-509.
- Fong JC and Schulz H. 1981. Short-chain and long-chain enoyl CoA Hydratases from pig heart muscle. *Methods Enzymol* 71:390-398.

- Fritsche KL, Johnston PV. 1988. Rapid autoxidation of fish oil in diets without added antioxidants. *J Nutr* 118:425-426.
- Garg ML, Thomson ABR, Clandinin MT. 1989a. Hypotriglyceridemic effect of dietary n-3 fatty acids in rats fed low versus high levels of linoleic acid. *Biochim Biophys Acta* 1006:127-130.
- Garg ML, Wierzbicki AA, Thomson ABR, Clandinin MT. 1989b. omega-3 fatty acids increase the arachidonic acid content of liver cholesterol ester and plasma triacylglycerol fractions in the rat. *Biochem J* 261:11-15.
- Gavino GR, Gavino VC. 1991. Rat liver outer mitochondrial carnitine palmitoyltransferase activity towards long-chain polyunsaturated fatty acids and their CoA esters. *Lipids* 26:266-270.
- Gibney MJ, Bolton-Smith C. 1988. The effect of a dietary supplement of n-3 polyunsaturated fat on platelet lipid composition, platelet function and platelet plasma membrane fluidity in healthy volunteers. *Br J Nutr* 60:5-12.
- Goldberg AL, Martel SB, Kushmeric MJ. 1975. In vitro preparation of the diaphragm and other skeletal muscles. *Methods Enzymol* 39:82-94.
- Goodnight SH, Harris WS, Connor WE, Illingworth DR. 1982. Polyunsaturated fatty acids, hyperlipidemia, and thrombosis. *Arteriosclerosis* 2(2):87-113.
- Goodridge AG. Fatty acid synthesis in eucaryotes. In: *Biochemistry of Lipids, Lipoproteins and Membranes*. Ed: Vance DE and Vance J. New York: Elsevier, 1991.
- Gorlin R. 1988. The biological actions and potential clinical significance of dietary n-3 fatty acids. *Arch Intern Med* 148:2043-2048.
- Groot PH, Scheek LM, Oubelaar ML, Verdouw PD, Hartog JM, Lamers JMJ. 1989. Effects of diets supplemented with lard fat or mackerel oil on plasma lipoprotein lipid concentrations and lipoprotein lipase activities in domestic swine. *Atherosclerosis* 77(1):1-6.
- Gurr MI, Harwood JL. *Lipid Biochemistry, An introduction*. New York: Chapman and Hall, 1991.
- Guzman, Geelen. 1993. Regulation of fatty acid oxidation in mammalian liver. *Biochim Biophys Acta* 1167:227-241.



- Hagve TA, Christophersen BO. 1983. Linoleic acid desaturation and chain elongation and rapid turnover of phospholipid n-3 fatty acids in isolated rat liver cells. *Biochim Biophys Acta*. 753:339-349.
- Hagve TA, Sprecher H. 1989. Metabolism of long-chain polyunsaturated fatty acids in isolated cardiac myocytes. *Biochim Biophys Acta* 1001:338-344.
- Halperin ML, Rolleston FS. *Biochemical Detective Stories*. Neil Patterson Publishers, Burlington, 1990.
- Harris WS. 1989. Fish oils and plasma lipid and lipoprotein metabolism in humans: a critical review. *J Lipid Research* 30:785-807.
- Harris WS, Connor WE, Inkeles SB, Illingworth DR. 1984. Dietary omega-3 fatty acids prevent carbohydrate-induced hypertriglyceridemia. *Metab Clin Exp* 33:1016-1019.
- Harris WS, Connor WE, Alam N, Illingworth DR. 1988. Reduction of postprandial triglyceridemia in humans by dietary n-3 fatty acids. *J Lipid Res* 29(1):1451-1460.
- Harris WS, Rothrock DW, Fanning A, Inkeles SB, Goodnight SHJ, Illingworth DR, Connor WE. 1990. Fish oils in hypertriglyceridemia: a dose-response study. *Am J Clin Nutr* 51:399-406.
- Harris WS, Windsor SL, Dujovne CA. 1991. Effects of four doses of n-3 fatty acids given to hyperlipidemic patients for six months. *J Am Coll Nutr* 10(3):220-227.
- Haug A, Hostmark AT. 1987. Lipoprotein lipases, lipoproteins and tissue lipids in rats fed fish oil or coconut oil. *J Nutr* 117:1011-1017.
- Hayes KC, Livingston A, Trautwein EA. 1992. Dietary impact on biliary lipids and gallstones. *Annu Rev Nutr* 12:299-326.
- Health Effects of Polyunsaturated Fatty Acids in Seafoods. Ed: Simopoulos AP, Kifer RR, Martin RE. Academic Press Inc: New York, 1986.
- Hebel R, Stromberg MW. *Anatomy of the Laboratory Rat*. Baltimore: The Williams and Wilkins Co., 1976.

- Heemskerk JWM, Feijge MAH, Kalafusz R, Hornstra G. 1989. Influence of dietary fatty acids on membrane fluidity and activation of rat platelets. *Biochim Biophys Acta* 1004:252-260.
- Herzberg GR. 1991. The 1990 Borden Award Lecture. Dietary regulation of fatty acid and triglyceride metabolism. *Can J Physiol Pharmacol* 69:1637-1647.
- Herzberg GR, Rogerson M. 1988a. Hepatic fatty acid synthesis and triglyceride secretion in rats fed fructose- or glucose-based diets containing corn oil, tallow or marine oil. *J Nutr* 118:1061-1067.
- Herzberg GR, Rogerson M. 1988b. Interaction of dietary carbohydrate and fat in the regulation of hepatic and extrahepatic lipogenesis in the rat. *Brit J Nutr* 59:233-241.
- Herzberg GR, Rogerson M. 1989. The effect of dietary fish oil on muscle and adipose tissue lipoprotein lipase. *Lipids* 24:351-353.
- Herzberg GR, MacCharles G, Rogerson M. 1990. Fatty acid clearance by isolated perfused hindquarters of rats fed fish oil. *FASEB J* 4:A797.
- Herzberg GR, Kean K, Chernenko G, Barrowman JA, Keough KMW. 1991. Intestinal absorption of fish oil in rats prefed diets containing corn oil or fish oil. *FASEB J* 5:A1301.
- Herzberg GR, Chernenko GA, Barrowman JA, Kean K, Keough KMW. 1992. Intestinal absorption of fish oil in rats previously adapted to diets containing fish oil or corn oil. *Biochim Biophys Acta* 112:190-194.
- Herzberg GR, Skinner CT, Levy R. 1996. Eicosapentaenoic acid is oxidized more rapidly than docosahexaenoic acid by muscle and liver. *Nutr Res* 16(4):639-644.
- Hirai A, Hamazaki T, Terano T, Nisnikawa R, Tamara Y, Kumagi A, Sajiki J. 1980. Eicosapentaenoic acid and platelet function in Japanese. *Lancet* 2:1132.
- Hodge J, Sanders K, Sinclair AJ. 1993. Differential utilization of eicosapentaenoic acid and docosahexaenoic acid in human plasma. *Lipids* 28:525-531.
- Huff MW, Telford DE, Edmonds BW, McDonald CG, Evans AJ. 1993. Lipoprotein lipases, lipoprotein density gradient profile and LDL receptor activity in miniature pigs fed fish oil and corn oil. *Biochim Biophys Acta* 1210(1):113-122.

- Huxtable, Wakil. 1971. Comparative mitochondrial oxidation of fatty acids. *Biochim Biophys Acta* 239:168-177.
- Hwang DH, Boudreau M, Chanmugam P. 1988. Dietary linolenic acid and longer chain n-3 fatty acids: comparisons of effects on arachidonic acid metabolism in rats. *J Nutr* 118:427-437.
- Ikeda Y, Okamura-Ikeda K, Tanaka K. 1985. Purification and characterization of short-chain, medium-chain, and long-chain acyl-CoA dehydrogenases from rat liver mitochondria. *J Biol Chem* 260:1311-1325.
- Iritani N, Fukuda E, Inoguchi K. 1979. Influences of oyster or clam feeding on lipid metabolism in rats. *J Nutr Sci Vitaminol* 25:205-211.
- Issemann I, Green S. 1990. Activation of a member of the steroid hormone receptor superfamily by peroxisome proliferators. *Nature* 347:645-650.
- Jandacek RJ, Hollenback EJ, Holcombe BN, Kuehlthau CM, Peters JC, Taulbee JD. 1991. Reduced storage of dietary eicosapentaenoic and docosahexaenoic acids in the weanling rat. *J Nutr Biochem* 2:142-149.
- Jensen RA. 1952. *Acta Med Scand* 103:263-271.
- Jones PJH. 1994. Dietary Linoleic, alpha-linolenic and oleic acids are oxidized at similar rates in rats fed diet containing these acids in equal proportions. *Lipids* 29:491-495.
- Jones PJH, Ridgen JE, Phang PT, Birmingham CL. 1992. Influence of dietary fat polyunsaturated to saturated ratio on energy substrate utilization in obesity. *Metabolism* 41(4):396-401.
- Jones PJH. 1988. Effect of fatty acid composition of dietary fat on energy balance and expenditure in hamsters. *Can J Physiol Pharmacol* 67:994-998.
- Jones PJH, Pencharz PB, Clandinin MT. 1985. Whole body utilization of dietary fatty acids: implications for energy utilization. *Am J Clin Nutr* 42:769-777.
- Keough KMW, Kariel N. 1987. Differential scanning calorimetric studies of aqueous dispersions of phosphatidylcholines containing two polyenoic chains. *Biochim Biophys Acta* 902:11-18.

- Knox R, Stein I, Levinson D, Tso P, Mansbach CM. 1991. Effect of fat pre-feeding on bile flow and composition in the rat. *Biochim Biophys Acta* 1083:65-70.
- Kromhout D. 1985. Fish consumption and mortality from coronary heart disease (Letter). *N Engl J Med* 313:822.
- Kromhout D, Bosschieter EB, De Lezenne Coulander C. 1985. The inverse relation between fish consumption and 20-year mortality from coronary heart disease. *N Engl J Med* 312:1205-1209.
- Kryski A, Kenno KA, Severson DL. 1985. Stimulation of lipolysis in rat heart myocytes by isoproterenol. *Am J Physiol* 248:H208-H216.
- Lamprecht W, Trautshold I. 1981. Adenosine-5'-triphosphate. Determination with Hexokinase and Glucose-6-Phosphate Dehydrogenase. In: *Methods of Enzymatic Analysis*, Volume 4. Ed: Hans Ulrich Bergmeyer. Deerfield Beach, Florida: Verlag Chemie International.
- Lamprey MS, Walker, BL. 1976. A possible essential role for dietary linolenic acid in the development of the young rat. *J Nutr* 106:86.
- Lands WEM. 1992. Biochemistry and physiology of n-3 fatty acids. *FASEB J* 6:2530-2536.
- Lands WEM, LeZellier PR, Rome LH, Vanderhock JY. 1973. Inhibition of prostaglandin biosynthesis. *Adv Biosci* 9:1527.
- Latipaa PM. 1989. Energy-linked regulation of mitochondrial fatty acid oxidation in the isolated perfused rat heart. *J Mol Cell Cardiol* 21:765-771.
- Lazarow PB, deDuve C. 1976. A fatty acyl-CoA oxidizing system in rat liver peroxisomes: enhancement by clofibrate, a hypolipidemic drug. *Proc Natl Acad Sci USA* 73:2043-2046.
- Lazo O, Contreras M, Yoshida Y, Singh AK, Stanley W 1990. Cellular oxidation of lignoceric acid is regulated by the subcellular localization of lignoceroyl-CoA ligases. *J Lipid Res* 31:585-595.
- Leyton J, Drury PJ, Crawford MA. 1987. Differential oxidation of saturated and unsaturated fatty acids in vivo in the rat. *Br J Nutr* 57:383-393.

- Lin DS, Connor WE. 1990. Are the n-3 fatty acids from dietary fish oil deposited in the triglyceride stores of adipose tissue? *Am J Clin Nutr* 51(4):535-539.
- Linder C, Chernick SS, Fleck TR, Scow RO. 1976. Lipoprotein lipase and uptake of chylomicron triglyceride by skeletal muscle of rats. *Am J Physiol* 231:860-864.
- Lindgreen F, Jensen LC, Hatch F. Isolation and analysis of serum lipoproteins. In: *Blood Lipids and Lipoproteins Quantitation, Composition, and Metabolism*. Ed: Thelson, G., 1972.
- Lopaschuk GD, Belke DD, Gamble J, Itoi T, Schonekass BO. 1994. Regulation of fatty acid oxidation in the mammalian heart in health and disease. *Biochim Biophys Acta* 1213:263-276.
- Maltin CA, Harris CL. 1985. Morphological observations and rates of protein synthesis in rat muscles incubated in vitro. *Biochem J* 232:927-930.
- Mannaerts GP, Debeer LJ, Thomas J, DeSchepper PJ. 1979. Mitochondrial and peroxisomal fatty acid oxidation in liver homogenates and isolated hepatocytes from control and clofibrate-treated rats. *J Biol Chem* 254:4585-4595.
- Mansbach CM, Arnold A. 1986. Steady-state kinetic analysis of triacylglycerol delivery into mesenteric lymph. *Am J Physiol* 250:G263-269.
- Marette A, Gavino VC, Nadeau MH. 1990. Effects of dietary saturated and polyunsaturated fats on adipose tissue lipoprotein lipase activity. *Nutr Res* 10:683-695.
- McGarry JD, Foster DW. 1980. Regulation of hepatic fatty acid oxidation and ketone body production. *Ann Rev Biochem* 49:395-420.
- McGarry JD, Mannaerts GP, Foster DW. 1977. A possible role for malonyl CoA in the regulation of hepatic fatty acid oxidation and ketogenesis. *J Clin Invest* 60:265-270.
- McGarry JD, Leatherman GF, Foster DW. 1978. Carnitine palmitoyltransferase I. The site of inhibition of hepatic fatty acid oxidation by malonyl CoA. *J Biol Chem* 253(12):4128-4136.
- McGarry JD, Mills SE, Long CS, Foster DE. 1983. Observations on the affinity for carnitine and malonyl CoA sensitivity of carnitine palmitoyltransferase I in

animal and human tissues. Demonstration of the presence of malonyl CoA in non-hepatic tissues of the rat. *Biochem J* 214:21-28.

- McGarry JD, Woeltje KF, Schroeder JG. 1990. Carnitine palmitoyltransferase-structure/function/regulatory relationships. In: *Fatty Acid Oxidation; Clinical, Biochemical, and Molecular Aspects*. Ed: Tanaka K and Coates PM. Alan R. Liss, Inc., New York, 1990.
- Mead JF, Slaton WH, Decker AB. 1956. Metabolism of essential fatty acids. II. The metabolism of stearate, oleate, and linoleate by fat-deficient and normal mice. *J Biol Chem* 218:401-407.
- Melin T, Qi C, Bengtsson-Olivecrona G, Akesson B, Nilsson A. 1991. Hydrolysis of chylomicron polyenoic fatty acid esters with lipoprotein lipase and hepatic lipase. *Biochim Biophys Acta* 1075(3):259-266.
- Middleton B. 1975. 3-ketoacyl-CoA thiolases of mammalian tissues. *Methods Enzymol* 35:128-135.
- Miyazawa S, Hashimoto T, Yokota S. 1985. Identity of long chain acyl coenzyme A synthetase of microsome, mitochondria, and peroxisomes in rat liver. *J Biochem* 98:723-733.
- Mizuguchi K, Yano T, Tanaka Y, Ishibashi M, Masada A, Mizota M, Fukutale K, Saito Y. 1993. Mechanism of the lipid lowering effect of ethyl all-cis-5, 8, 11, 14, 17-icosapentaenoate. *Eur J Pharmacol* 231:121-127.
- Mori TA, Codde JP, Vandongen R, Beilin LJ. 1987. New findings in the fatty acid composition of individual platelet phospholipids in man after dietary fish oil supplementation. *Lipids* 22(10):744-750.
- Morita I, Saito Y, Chang WC, Murota S. 1983. Effects of purified eicosapentaenoic acid on arachidonic acid metabolism in cultured murine aortic smooth muscle cells, vessel walls and platelets. *Lipids* 18:42-49.
- Murphy MC, Zampelas A, Puddicombe SM, Furlonger NP, Morgan LM, William CM. 1993. Adipose tissue site specificity of lipoprotein lipase mRNA expression in rats fed diets containing different fatty acid compositions. *Biochem Soc Trans* 21(2):145S.

- Murthy MSR, Pande SV. 1987. Malonyl CoA binding site and the overt carnitine palmitoyltransferase activity reside on the opposite sides of the outer mitochondrial membrane. *Proc Natl Acad Sci USA* 84:378-382.
- Murthy MSR, Pande SV. 1990. Characterization of a solubilized malonyl CoA-sensitive carnitine palmitoyltransferase from the mitochondrial outer membrane as a protein distinct from the malonyl CoA-insensitive carnitine palmitoyltransferase of the inner membrane. *Biochem J* 268:599-604.
- Mynatt RL, Lappi MP, Cook GA. 1992. Myocardial CPT of the mitochondrial outer membrane is not altered by fasting. *Biochim Biophys Acta* 1128:105-111.
- Nagakawa Y, Orimo H, Harasawa M, Morita I, Yashiro K, Murota S. 1983. Effect of eicosapentaenoic acid on the platelet aggregation and composition of fatty acid in man. *Atherosclerosis* 47:71-75.
- Nassar BA, Huang YS, Manku MS, Das UN, Morse N, Horrobin DF. 1986. The influence of dietary manipulation with n-3 and n-6 fatty acids on liver and plasma phospholipids fatty acids in rats. *Lipids* 21:652-656.
- Neat CE, Thomassen MS, Osmundsen H. 1981. Effects of hgh-fat diets on hepatic fatty acid oxidation in the rat. *Biochem J* 196:149-159.
- Nestel PJ. 1993. Effects on n-3 fatty acids on lipoproteins and atherosclerosis. In: *Omega-3 fatty acids: Metabolism and Biological Effects*. Ed: Drevon CA, Baksas I, Krokan HE. Basel: Birkhauser Verlag.
- Nestel PJ, Connor WE, Reardon MF, Connor S, Wong S, Boston R. 1984. Suppression by diets rich in fish oil of very low density lipoprotein production in man. *J Clin Invest* 74:82-89.
- Newsholme EA, Leighton B, Challiss RAJ, Lozeman FJ. 1986. Assessment of biochemical viability of isolated incubated muscle preparations. *Biochem J (Letters)* 238:621.
- Nilsson A, Landin B. 1988. Metabolism of chylomicron arachidonic and linoleic acid in the rat. *Biochim Biophys Acta* 159:288-295.
- Nilsson A, Melin T. 1988. Absorption and metabolism of orally fed arachidonic acid and linoleic acid in the rat. *Am J Physiol* 255:G612-G618.

- Nilsson A, Landin B, Jensen E, Alesson B. 1987a. Absorption and lymphatic transport of exogenous and endogenous arachidonic acid and linoleic acid in the rat. *Am J Physiol* 252:G817-G824.
- Nilsson A, Landin B, Schotz MC. 1987b. Hydrolysis of chylomicron arachidonate and linoleate ester bonds by lipoprotein lipase and hepatic lipase. *J Lipid Res* 28:510-517.
- Nilsson-Ehle P. 1987. Measurements of lipoprotein lipase activity. In: *Lipoprotein Lipase*. Ed: Borensztajn J. Chicago: Evener Publishers Inc.
- Nilsson-Ehle P, Schotz MC. 1976. A stable, radioactive substrate emulsion of assay of lipoprotein lipase. *J Lipid Res* 17:536-541.
- Noel H, Goswami T, Pande SV. 1985. Solubilization and reconstitution of rat liver mitochondrial carnitine acylcarnitine translocase. *Biochemistry* 24:4504-4509.
- Nordoy A. 1991. Is there a rational use for n-3 fatty acids (fish oils) in clinical medicine? *Drugs* 42(3):331-342.
- Nordoy A, Simonsen T. 1987. Dietary n-3 fatty acids, experimental thrombosis and coronary heart disease in man. In: *Polyunsaturated Fatty Acids and Eicosanoids*. Ed: Lands WEM. American Oil Chemists' Society: Chicago.
- Ockner RK, Manning JA, Poppenhausen RB, Ho WK. 1972. A binding protein for fatty acids in cytosol of intestinal mucosa, liver, myocardium and other tissues. *Science* 177:56-58.
- Okano G Shimojo T. 1982. Utilization of long chain free fatty acids in white and red muscle of rats. *Biochim Biophys Acta* 710(2):122-127.
- Olivecrona T, Bengtsson-Olivecrona G. Lipoprotein lipase from milk-the model enzyme in lipoprotein lipase research. In: *Lipoprotein Lipase*. Ed: Borensztajn J. Chicago: Evener Publishers Inc, 1987.
- Olowe Y, Schulz H. 1980. Regulation of thiolases from pig heart. Control of fatty acid oxidation in heart. *Eur J Biochem* 109:425-429.
- Ontko JA. Lipid metabolism in muscle. In: *Myology*. Ed: Engel AG and Banker BQ. McGraw Hill Book Co., Toronto, 1986.



- Osmundsen H, Bjornstad K. 1985. Inhibitory effects of some long-chain unsaturated fatty acids on mitochondrial  $\beta$ -oxidation. *Biochem J* 230:329-337.
- Otto DA, Baltzell JK, Wooten JT. 1992. Reduction in triacylglycerol levels by fish oil correlates with free fatty acid levels in ad libitum fed rats. 27(2):1013-1017.
- Palmer RM, Reeds PJ, Atkinson T et al. 1983. The influence of changes in tension on protein synthesis and prostaglandin release in isolated rabbit muscles. *Biochem J* 214:1011-1041.
- Palosaari PM, Hiltunen JK. 1990. Peroxisomal bifunctional protein from rat liver is a trifunctional enzyme possessing 2-enoyl-CoA hydratase, 3-hydroxy-acyl-CoA dehydrogenase and  $d^2, d^3$ -enoyl-CoA isomerase activities. *J Biol Chem* 265:2446-2449.
- Paul R, Ramesha CS, Ganguly J. 1980. On the mechanism of hypocholesterolemic effects of polyunsaturated lipids. *Adv Lipid Res* 17:155-171.
- Pedersen ME, Schotz MC. 1980. Changes in rat heart lipoprotein lipase activity after feeding carbohydrate. *J Nutr* 110:481-487.
- Phillipson BE, Rothrock DW, Connor WE, Harris WS, Illingworth DR. 1985. Reduction of plasma lipids, lipoproteins, and apoproteins by dietary fish oils in patients with hypertriglyceridemia. *N Engl J Med* 312:1210-1216.
- Piche LA, Mahadevappa VG. 1990. Modification of rat platelet fatty acid composition by dietary lipids of animal and vegetable origin. *J Nutr* 120:444-449.
- Raclot T, Groscolas R. 1993. Differential mobilization of white adipose tissue fatty acids according to chain length, unsaturation, and positional isomerism. *J Lipid Res* 34:1515-1526.
- Raclot T, Groscolas R. 1994. Individual fish-oil n-3 polyunsaturated fatty acid deposition and mobilization rates for adipose tissue of rats in a nutritional steady state. *Am J Clin Nutr* 60:72-78.
- Ramesha CS, Paul R, Ganguly J. 1980. Effect of unsaturated oils on the biosynthesis of cholesterol, and on biliary and fecal excretion of cholesterol and bile acids in rats. *J Nutr* 110:2149-2158.

- Reddy JK, Mannaerts GP. 1994. Peroxisomal Lipid Metabolism. *Ann Rev Nutr* 14:343-370.
- Robins SJ, Brunengraber H. 1982. Origin of biliary cholesterol and lecithin in the rat: contribution of new synthesis and preformed hepatic stores. *J Lipid Res* 23:604-608.
- Robins SJ, Patton GM. 1986. Separation of phospholipid molecular species by high performance liquid chromatography: potentials for use in metabolic studies. *J Lipid Res* 27:131-139.
- Robins SJ, Fasulo JM, Robins VF, Patton GM. 1991. Utilization of different fatty acids for hepatic and biliary phosphatidylcholine formation and the effect of changes in phosphatidylcholine molecular species on biliary lipid secretion. *J Lipid Res* 32:985-992.
- Robins SJ, Fasulo JM, Lessard PD, Patton GM. 1993. Changes in biliary lipid secretion during normal development and diurnal cycling in the rat. *J Lipid Res* 34:1445-1450.
- Robins SJ, Fasulo JM, Lessard PD, Patton GM. 1993. Hepatic cholesterol synthesis and the secretion of newly synthesized cholesterol in bile. *Biochem J* 289:41-44.
- Robinson DS. 1963. The clearing factor lipase and its action in the transport of fatty acids between the blood and the tissues. *Adv Lipid Res* 1:133.
- Rodriguez B, Spooner M, Severson DL. 1992. Free fatty acids do not release lipoprotein lipase from isolated cardiac myocytes or perfused hearts. *Am J Physiol* 262:E216-E223.
- Rustan AC, Nossen JO, Christiansen EN, Drevon CA. 1988a. Eicosapentaenoic acid reduces hepatic synthesis and secretion of triacylglycerol by decreasing the activity of acyl-coenzyme A:1,2 diacylglycerol acyltransferase. *J Lipid Res* 29:1417-1426.
- Rustan AC, Nossen JO, Osmundsen H, Drevon CA. 1988b. Eicosapentaenoic acid inhibits cholesterol esterification in cultured parenchymal cells and isolated microsomes from rat liver. *J Biol Chem* 263 (17):8126-8132.
- Rustan AC, Hustvedt B-E, Drevon CA. 1993. Dietary supplementation of very long-chain n-3 fatty acids decreases whole body lipid utilization in the rat. *J Lipid Res* 34:1299-1309.

- Saddik M, Gamble J, Witters LA, Lopaschuk GD. 1993. Acetyl CoA carboxylase regulation of fatty acid oxidation in the heart. *J Biol Chem* 268(34):25836-25845.
- Salem N, Kim H-Y, Yeigey JA. Docosahexaenoic acid: membrane function and metabolism. In: Simopoulos AP, Kifer RR, Martin RE. Ed: *Health effects of polyunsaturated fatty acids in seafood*. Orlando, Florida: Academic Press, 1986.
- Salonen R, Nikkari T, Seppanen K, Valalainen JM, Ihanainen M, Rissanen V, Rauramaa R, Salonen JT. 1987. Effect of omega-3 fatty acid supplementation on platelet aggregability and platelet produced thromboxane. *Throm Haem* 57(3):269-272.
- Sanders TAB, Naismith DJ, Haines DJ et al. 1980. Cod-liver oil, platelet fatty acids, and bleeding time. *Lancet* i:1189.
- Sanders TAB, Sullivan DR, Reeve J, Thompson GR. 1985. Triglyceride-lowering effect of marine polyunsaturates in patients with hypertriglyceridemia. *Arteriosclerosis* 5:459-465.
- Saynor R, Verel D, Gillot T. 1984. The long-term effects of dietary supplementation with fish lipid concentrate on serum lipids, bleeding time, platelets and angina. *Atherosclerosis* 50:3-10.
- Schick PK, Menon S, Wojenski C. 1990. Effects of marine-oil enriched diets on guinea pig megakaryocyte and platelet lipids; effects on thromboxane synthesis and platelet function. *Biochim Biophys Acta* 1022:49-56.
- Schmidt EB, Moller JM, Dyerberg J. Omega-3 fatty acids, combined with hyperlipemia and atherosclerosis with special reference to patients with the atherogenic-syndrome. In: *Omega-3 fatty acids: Metabolism and Biological Effects*. Ed: Drevon CA, Baksaas I, Krokan HE. Basel: Birkhauser Verlag, 1993.
- Schulz H. 1994. Regulation of fatty acid oxidation in heart. *J Nutr* 124(2):165-171.
- Schulz H. Mitochondrial  $\beta$ -oxidation. 1990. In: *Fatty Acid Oxidation: Clinical, Biochemical, and Molecular Aspects*. Ed: Tanaka K and Coates PM. Alan R. Liss, Inc., New York.
- Scobey MW, Johnson FL, Parks JS. 1991. Dietary fish oil effects on biliary lipid secretion and cholesterol gallstone formation in the African green monkey. *Hepatology* 14:679-684.

- Segal SS, Faulkner JA. 1986. Temperature-dependent physiological stability of rat skeletal muscle in vitro. *Am J Physiol* 248:C265-C270.
- Shekelle R, Missell L, Paul O, Shryock AM. 1985. Fish consumption and mortality from coronary heart disease (Letter). *N Engl J Med* 313:820.
- Sheppard K, Herzberg GR. 1992. Triacylglycerol composition of adipose tissue, muscle, and liver of rats fed diets containing fish oil or corn oil. *Nutr Res* 12:1405-1418.
- Simons LA, Hickie JB, Balasubramaniam S. 1985. On the effects of dietary n-3 fatty acids (MaxEPA) on plasma lipids and lipoproteins in patients with hyperlipidemia. *Atherosclerosis* 54:75-88.
- Sinclair. 1974. Fatty acid composition of liver lipids during development of rat. *Lipids* 9:807-818.
- Singer P, Berger I, Luck K, Taube E, Neumann E, Godicke W. 1986. Long-term effect of mackerel diet on blood pressure, serum lipids and thromboxane formation in patients with mild essential hypertension. *Atherosclerosis* 62:259-265.
- Singh H, Poulos A. 1988. Distinct long chain and very long chain fatty acyl CoA synthetase in rat liver peroxisomes and microsomes. *Arch Biochem Biophys* 259:383-390.
- Singh H, Derwas N, Poulos A. 1987. Very long chain fatty acid  $\beta$ -oxidation by rat liver mitochondria and peroxisomes. *Arch Biochem Biophys* 259:382-390.
- Small DM, Dowling RH, Redinger RN. 1972. The enterohepatic circulation of bile acids. *Arch Intern Med* 130:552-573.
- Smolin LA, Surh DM, Brasel JA, Glick Z. 1986. Meal induced changes in lipoprotein lipase in brown fat and other tissue of rats. *J Nutr* 116:429-434.
- Spady DK. 1993. Regulatory effects of individual n-6 and n-3 polyunsaturated fatty acids on LDL transport in the rat. *J Lipid Res* 34:1993.
- Srere PA. 1980. The infrastructure of the mitochondrial matrix. *TIBS* 5:120.
- Stam H, Hulsmann WC. 1981. Release of lipolytic products from rat heart. Hormonal stimulation, intracardial origin and pharmacological modification. *Biochem Intern* 2:477-484.

- Stam H, Hulsmann WC. 1984. Effects of hormones, amino acids, and specific inhibitors on rat heart during lipoprotein lipase and tissue lipase activities during long-term perfusion. *Biochim Biophys Acta* 794:72-82.
- Stanley KK, Tubbs PK. 1975. The role of intermediates in mitochondrial fatty acid oxidation. *Biochem J* 150:77.
- Stempfel RS, Sidbury JB. 1964. Studies with the hydroxysteroid dehydrogenases: I. A simplified method for the enzymatic estimation of 3- and 17-hydroxysteroids. *J Clin Endocrinol* 24:367-374.
- Strom A, Jensen RA. 1951. Mortality from circulatory disease in Norway 1940-1950. *Lancet* 1:126-130.
- Sugden MC, Holness MJ, Howard RM. 1993. Changes in lipoprotein lipase activities in adipose tissue, heart and skeletal muscle during continuous or interrupted feeding. *Biochem J* 292:113-119.
- Suzuki H, Kawarabayasi Y, Kondo J, Abe T, Nishikawa K, Kimura S, Hashimoto T, Yamamoto T. 1990. Structure and regulation of rat long-chain acyl CoA synthetase. *J Biol Chem* 265(15):8681-8685.
- Swann PG, Venton DL, LeBreton GC. 1989. Eicosapentaenoic and docosahexanoic acid are antagonists at the thromboxane A/prostaglandin H2 receptor in human platelets. *FEBS Lett* 243:244-247.
- Thompson GA. *The Regulation of Membrane Lipid Metabolism*. Ann Arbor: CRC Press, 1992.
- Thomson ABR, Keelan MT, Garg ML, Clandinin MT. 1988. Dietary effects of omega-3 fatty acids on intestinal transport function. *Can J Physiol Pharm* 66:985-992.
- Thomson ABR, Keelan M, Garg ML, Clandinin MT. 1989. Influence of dietary fat composition on intestinal absorption in the rat. *Lipids* 24:494-501.
- Thorpe C. 1989. Green enzymes and suicide substrates: a look at the acyl-CoA dehydrogenases in fatty acid oxidation. *TIBS* 14:148-151.
- Tierney S, Ahrendt SA, Fox K, Talbot ML, Booker HA, Pitt HA, LaMorte WW, Lillemueh KD. 1993. Fish oil reduces biliary cholesterol and prolongs nucleation of human gallbladder bile. *Gastroenterology* 104(4):A380.

- Tinoco J. 1982. Dietary requirements and functions of alpha-linolenic acid in animals. *Prog Lipid Res* 21:1-45.
- Tinoco J, Babcock R, Hincenbergs J, Medwadowski B, Miljanich P, Williams MA. 1979. Linolenic acid deficiency. *Lipids* 14:166-173.
- Tso P, Balint JA, Simmonds WJ. 1977. Role of biliary lecithin in lymphatic transport of fat. *Gastroenterology* 73:1362-1367.
- Tso P, Kendrick H, Balint JA, Simmonds WJ. 1981. Role of biliary phosphatidylcholine in the absorption and transport of dietary triolein in the rat. *Gastroenterology* 80:60-65.
- Turley SD, Dietschy JM. 1979. Regulation of biliary cholesterol output in the rat: dissociation from the rate of hepatic cholesterol synthesis, the size of the hepatic cholesteryl ester pool, and the hepatic uptake of chylomicron cholesterol. *J Lipid Res* 20:923-934.
- Unsaturated Fatty Acids. Nutritional and physiological significance. The report of the British Nutrition Foundation's Task Force. The British Nutrition Foundation. London: Chapman and Hall, 1992.
- Urakaze M, Hamazaki T, Makuta M, Ibuki F, Kobayashi S, Yano S, Kumagai A. 1987. Infusion of fish oil emulsion: effects on platelet aggregation and fatty acid composition in phospholipids of plasma, platelets, and red blood cell membranes in rabbits. *Am J Clin Nutr* 46:936-940.
- Vamecq J. 1987. Chlorpromazine and carnitine-dependency of rat liver peroxisomal  $\beta$ -oxidation of long chain fatty acids. *Biochem J* 241:783-791.
- Vamecq J, Vallee L, Lechene de la Porte P, Fontaine M, deCraemer D, van den Branden C, Lafont H, Grataradi R, Nalbome G. 1993. Effect of various n-3/n-6 fatty acid ratio contents of high fat diets on rat liver and heart peroxisomal and mitochondrial  $\beta$ -oxidation. *Biochim Biophys Acta* 1170:151-156.
- Van Der Vusse GJ, Glatz JFC, Stam HCG, Reneman RS. 1992. Fatty acid homeostasis in the normoxic and ischemic heart. *Physiol Rev* 72(4):881-940.
- Vance DE, Vance J. *Biochemistry of Lipids, Lipoproteins and Membranes*. New York: Elsevier, 1991.

- Veerkamp JH, Van Moerkerk HTB. 1985. Effect of various agents and conditions on palmitate oxidation by homogenates of rat liver and rat and human skeletal muscle. *Int J Biochem* 17:1163-1169.
- Vollset SE, Heuch I, Bjelke E. 1985. Fish consumption and mortality from coronary heart disease (Letter). *N Engl J Med* 313:820-821.
- Von Schacky C, Fischer S, Weber PC. 1985. Long-term effects of dietary marine omega-3 fatty acids upon plasma and cellular lipids, platelet function, and eicosanoid formation in humans. *J Clin Invest* 76:1626-1631.
- Wang CS. 1994. Probing of active site structure of lipoprotein lipase: contribution of activation entropy in the catalysis. *Biochim Biophys Acta* 1212(1):67-72.
- Wang CS, Bass H, Whitmer R, McConathy WJ. 1993. Effects of albumin and apolipoprotein C-II on the acyl-chain specificity of lipoprotein lipase catalysis. *J Lipid Res* 34(12):2091-2098.
- Wang HY, Baxter CF, Schulz H. 1991. Regulation of fatty acid beta-oxidation in rat heart mitochondria. *Arch Biochem Biophys* 289(2):274-280.
- Weiner BH, Ockene IS, Levine PH, Cuenoud HF, Fisher M, Johnson BF, Daoud AS, Jarmolych J, Hosmer D, Johnson MH, Natale A, Vaudreuil CH, Hoogasien JJ. 1986. Inhibition of atherosclerosis by cod-liver oil in a hyperlipidemic swine model. *N Engl J Med* 315:841-846.
- Willebrands. 1964. Utilization of individual non-esterified fatty acids by the isolated perfused rat heart. *Biochim Biophys Acta* 84:607-610.
- Woeltje KF, Kuwajima M, Foster DW, McGarry JD. 1987. Characterization of the mitochondrial carnitine palmitoyltransferase enzyme system. II. Use of detergents and antibodies. *J Biol Chem* 262:9822-9827.
- Wong SH, Nestel PJ, Trimble RP, Storer GB, Illman RJ, Topping DL. 1984. The adaptive effects of dietary fish and safflower oil on lipid and lipoprotein metabolism in perfused rat liver. *Biochim Biophys Acta* 792:103-109.
- Yang YT, Williams MA. 1978. Comparison of C18-, C20-, and C22-unsaturated fatty acids in reducing fatty acid synthesis in isolated rat hepatocytes. *Biochim Biophys Acta* 531:133-140.

- Yeo YK, Holub BJ. 1990. Influence of dietary fish oil on the relative synthesis of triacylglycerol and phospholipids in rat liver in vivo. *Lipids* 25:811-814.
- Yousef IM, Fisher MM. 1976. In vitro effect of free bile acids on the bile canalicular membrane phospholipids in the rat. *Can J Biochem* 54:1040-1046.
- Zar JH. *Biostatistical Analysis* 2nd ed. Toronto: Prentice Hall Canada Inc., 1984.
- Zeman FJ. *Clinical Nutrition and Dietetics*, 2nd edition. Toronto: MacMillian Publishing Co., 1991.
- Zlatkis A, Zak B. 1969. Study of a new cholesterol reagent. *Anal Biochem* 29:143-148.
- Zuurveld JGEM, Oosterhof A, Veerkamp JH, van Moerkerk HTB. 1985. Oxidative metabolism of cultured human skeletal muscle cells in comparison with biopsy material. *Biochim Biophys Acta* 844:1-8.









