

Modified Design of Pin-on-Ring Tribometer for Hip Joint Prostheses Measurement; Case Study on Salat Activity

by Sulardjaka Sulardjaka

Submission date: 09-Aug-2018 02:08PM (UTC+0700)

Submission ID: 988666324

File name: Artikel.pdf (391.62K)

Word count: 2952

Character count: 15137

1 Modified Design of Pin-on-Ring Tribometer for Hip Joint Prostheses Measurement; Case Study on Salat Activity

Muhammad Khafidh^{1*}, Jamari², Sulardjaka², Mohamad Tauviqirrahman², and Emile van der Heide³

1. Industrial Technology Faculty, Mechanical Engineering Department, Universitas Islam Indonesia, Yogyakarta 55584, Indonesia

2. Engineering Faculty, Mechanical Engineering Department, Universitas Diponegoro, Semarang 50725, Indonesia

3. Engineering Technology Faculty, Surface Technology and Tribology, University of Twente, Postbox 217, 7500 AE Enschede, Netherlands

*e-mail: khafidh@uii.ac.id

Abstract

1 Total hip replacement (THR) is one of the most successful orthopedic surgical procedures for replacing a broken hip joint. In THR, wear may occur at the articulating surface of the acetabular cup and the femoral head. In Indonesia, the country with the largest Muslim population in the world, most of the inhabitants do salat (praying) every day. THR users are banned from doing salat for fear it will damage the hip joint prostheses. The previous wear calculation methods on the hip joint prostheses use the gravimetric, coordinate measuring machine (CMM), profiler, and geometric method. The disadvantages of the previous methods are that the geometry of the wear patch and the wear volume are only known at the end of the experiment, so they cannot be used to calculate the specific wear rate values in real time. So far, in every modeling of the hip joint prostheses, the values of the specific wear rate are assumed to be constant. This paper reports on the design modification of a pin-on-ring tribometer that is used to measure the wear volumes in hip joint prostheses. The result shows that modifications of the femoral head holder, reciprocating motion, elastic joint, and extra displacement transducer is needed to get the specific wear rate value. The calculation method to find the delta volume that is the value of displacement less than the displacement minimum (δ_{\min}) is based on a graph, while the calculation method to find the delta volume that is the value of displacement that is more than the displacement minimum (δ_{\min}) is based on an equation. In the salat test protocol, the longest test time was during the sujud (prostration) motion, which took 1034.17 minutes in the experiment.

Abstrak

Desain Modifikasi Tribometer Pin-on-Ring untuk Pengukuran Tulang Pinggul Buatan: Studi Kasus pada Gerakan Shalat. Total hip replacement (THR) adalah salah satu solusi bedah ortopedi yang paling sukses untuk mengganti tulang pinggul yang rusak. Dalam THR, aus akan terjadi pada permukaan acetabular cup dan femoral head. Indonesia, negara dengan penduduk muslim terbesar di dunia, kebanyakan penduduknya mengerjakan shalat setiap hari. Pengguna THR dilarang mengerjakan shalat karena dikhawatirkan akan merusak tulang pinggul buatan. Metode perhitungan aus sebelumnya pada tulang pinggul buatan menggunakan metode gravimetric, Coordinate Measuring Machine (CMM), profiler dan geometric. Kekurangan dari metode-metode sebelumnya adalah bentuk aus dan volume aus hanya dapat diketahui ketika pengujiannya selesai, sehingga tidak dapat digunakan untuk menentukan nilai specific wear rate secara kontinyu. Sampai sejauh ini, setiap pemodelan dari tulang pinggul buatan menggunakan nilai specific wear rate yang konstan. Makalah ini melaporkan desain modifikasi tribometer pin-on-ring untuk mengukur volume aus pada tulang pinggul buatan. Hasil dari penelitian ini menunjukkan bahwa untuk mendapat nilai spesifik *wear rate* dibutuhkan modifikasi pada *femoral head holder*, gerak *reciprocating, elastic joint*, dan penambahan *displacement transducer*. Metode perhitungan untuk menghitung volume aus dimana perpindahan kurang dari *displacement* minimum (δ_{\min}) menggunakan grafik, sedangkan metode perhitungan untuk menghitung volume aus dimana perpindahan lebih dari *displacement* minimum (δ_{\min}) menggunakan rumus. Dalam prosedur tes untuk gerakan shalat, waktu terpanjang adalah gerakan sujud yang mencapai 1034,17 menit.

Keywords: hip joint prostheses, pin-on-ring tribometer, specific wear rate, test protocol

1. Introduction

Total hip replacement (THR) is one of the most successful orthopedic surgical procedures for replacing the broken hip joint [1]. The total hip replacement (THR) system consists of a femoral stem, femoral head, femoral neck, acetabular shell, and acetabular cup [2]. All employed materials are biocompatible. The previous research on THR materials reported that many materials have been combined for the acetabular cup and the femoral head to obtain the best performance of THR, e.g. Metal-on-Plastic (MoM), Metal-on-Metal (MoM), Ceramic-on-ceramic (CoC), etc. [3-6].

Indonesia is the country with the largest Muslim population in the world. Islam has some characteristic religious activities, one of which is the prayer ritual called salat. In Indonesia, THR users have been banned from doing salat for fear it will damage the hip joint prostheses. Research on the range of motion in religious activities has been conducted by Saputra [7].

In the previous research, it was difficult to determine the wear volumes that occur in the hip joint prostheses in real time. The wear volumes and the geometry of the wear path that occurs were analyzed only at the end of the experiment. The geometry of the wear path is influenced by the direction of the load [8]. Finite element method calculations to determine the geometry of the wear path were carried out by Sfantos [8] by using equation (1):

$$x_i^w = \frac{x_i}{|x_i \ x_o|} \cdot (|x_i \ x_o| + h(x_i)) \quad (1)$$

$$h(x, s) = kp(x, s)s$$

In equation (1), the specific wear rate (k) values are assumed to have a constant value. In fact, the value of the specific wear rate (k) is always changing in every sliding distance during the running-in phase [9].

The previous wear calculation methods on the hip joint prostheses are the gravimetric, geometric, coordinate measuring machine (CMM), and most recently, profiler method [10-13]. The disadvantage of these methods is that the geometry of the wear paths and the wear volumes are only known at the end of the experiment, so they cannot be used for calculating the specific wear rate value. To determine the specific wear rate value, it is necessary to know the wear volumes of each sliding distance.

This study will focus on the design modification of a pin-on-ring tribometer that is used to measure the wear volumes of every sliding distance. The wear volumes of each sliding distance can be used to determine the value of the specific wear rate. The tribometer test protocol for measuring the specific wear rate of salat motion with

dimensions according to the Indonesian people will also be conducted in this study.

2. Methods

The pin-on-ring tribometer equipment used was located in the Engineering Design and Tribology Laboratory at Diponegoro University as depicted in Figure 1. In the present pin-on-ring tribometer, the functions of the tribometer were to measure the friction coefficient and create a Stribeck curve. The pin-on-ring tribometer was controlled by a computer. The data acquisition and amplifiers used to record the signal from the pin-on-ring tribometer were read by a computer. A work schematic of the pin-on-ring tribometer is provided in Figure 2.

The pin-on-ring tribometer should be modified to be used as a hip joint tribometer that is capable of producing the hip joint specific wear rate values formulated by Archad (2):

$$k = \frac{V}{f_n \cdot s} \quad (2)$$

In this modification, only flexion-extension motion can be analyzed. The geometric method was applied to calculate the wear volumes in this study. A morphological analysis was used to obtain the optimal design for each modification. The acetabular cup and femoral head dimensions according to the Indonesian people were $R_1 = 14$ mm, $R_2 = 14.024$ mm, and $R_3 = 17.5$ mm [7].

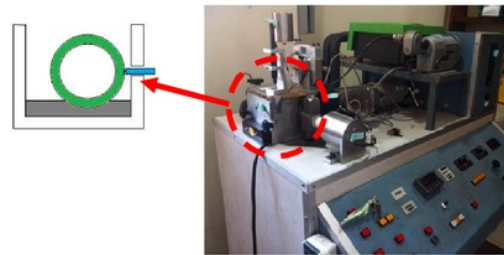

Figure 1. Pin-on-ring Tribometer

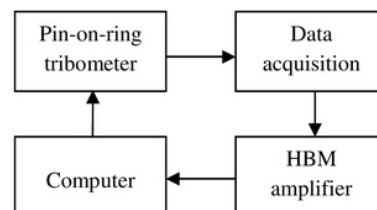

Figure 2. Work Schematic of Pin-on-Ring Tribometer

1 To modify the design of the pin-on-ring tribometer to be used as a hip joint tribometer, some important things must be considered, such as the reciprocating motion in the hip joint; the size of the femoral head, which must be smaller than the ring in the previous tribometer; the holder of the cup and the head must be different from the holder of the pin and ring; and the mechanism in the tribometer has to measure the wear volumes of every sliding distance. To solve these problems, some modifications are required, as follows.

Reciprocating motion. In the previous pin-on-ring tribometer, the motion is rotational, whereas the motion that occurs at the hip joint is a reciprocating motion. Therefore, a modification is needed to convert the rotational motion into reciprocating motion. During daily activities, every motion of the leg has a different angle. A tribometer should be able to produce a precise result in the small angle and in the large angle. In general, converting the rotational motion into reciprocating motion has two solutions: a mechanical solution and an electronic solution.

Elastic joint. In principal, the center of the upper bearing has to be above the contact. If not, some additional frictional movement will occur, resulting in an oscillation of the forces during a test. Due to wear, this oscillation will occur anyhow, but it should be kept to a minimum. Therefore, the geometry of each hip joint requires a different position for the elastic joint.

Femoral head holder. In the previous tribometer, the pin and ring are used to analyze the friction. In the new tribometer, the femoral head and the acetabular cup are used. The holders between the ring and the femoral head are different. Therefore, modifications of the holders are needed. The femoral head holder must have a strong grip and minimize the detached probability between the holder and the femoral head.

Displacement transducer mechanism. This is an important part of measuring the wear on hip joint prostheses during an experiment. Based on the displacement of the hip joint prostheses position, the wear volumes that occur during experiments can be calculated. The displacement must be known in real time so that it can be used to calculate the value of the specific wear rate. The displacement must eliminate the effect of increases in the length of the material due to heat and moisture during an experiment.

3. Results and Discussion

1 **Design modification of pin-on-ring tribometer.** To convert the rotational motion into reciprocating motion with an electronic solution is using an AC servo motor. For this solution, the moment of inertia, rotational

speed, and torque must be considered. An electronic solution has a high initial cost, but the results are precise and maintenance is easier. During daily activities, every motion of the leg has a different angle from the small angle to the large angle. An AC servo motor can produce a highly accurate reciprocating motion in the mechanism.

The elastic joint requires high accuracy due to the fact that displacement at the point of contact in the variety of hip joint geometries is very small. Therefore, it takes a small shift to get the right results. Figure 3 shows the design using a crank tab to minimize the motion of the arm twist due to the load, and this crank tab can change the position of the elastic joint piecemeal.

Displacement transducers were used to determine the displacement in the acetabular during the experiment, which is caused by the wear on the cup. Things to be considered are the effects of thermal expansion and moisture in the materials. Figure 4 shows that there are two transducers to measure the displacement of the material. Displacement transducer I produces displacement caused by the wear of the material and the effect of extension due to temperature and moisture. Displacement transducer II produces displacement caused by expansion due to the influence of temperature and moisture. Thus, the results that represent displacement caused by wear were obtained.

The geometry of the dummy femoral head material is not the same as the original femoral head, and the geometry of the dummy cup material is not the same as the original acetabular cup. But the same material and the same horizontal length will minimize the error that may happen because of the influence of temperature and moisture. The shaft, femoral head, and dummy femoral head material have the same material, i.e., Stainless Steel 316L. The acetabular cup and dummy cup have the same material, i.e., Ultra High Molecular Weight Polyethylene (UHMWPE).

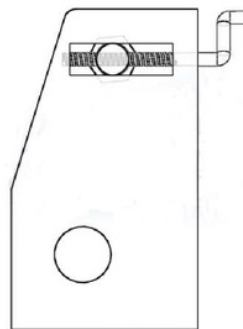

Figure 3. Elastic Joint Structure

The optimal design of the femoral head holder can be seen in Figure 5. When the femoral head has a reciprocating motion, the most important design criteria is that the femoral head does not slip and come off. This can happen when a polygon shaped holder is used. With this design, the installation is also easier.

Method for measuring wear volumes. The measurement of the wear volumes was calculated from the displacement of the acetabular cup that occurred during the experiments. This study, using geometric method assumptions [10], assumed that the geometry of the wear path is equal to the shape of the femoral head. Wear that occurs only in the acetabular cup due to the acetabular cup material (UHMWPE) is softer than in the femoral head material (ST-316L). Figure 6(a) shows an overview of the assumptions in this study. Figure 6(b) shows the point of contact where the vertical radius of the femoral head is touching the surface of the acetabular cup, called minimum displacement (δ_{min}). The wear volume in the range of displacement is less than the displacement minimum (δ_{min}) for geometric formulas of $R_1= 17.5$ mm, $R_2= 14.024$ mm, and $R_3= 14$ mm can be found using the graph in Figure 7. This graph was obtained from a SolidWorks simulation. Figure 6(c) shows that the wear continues after the process in Figure 6(b). To determine the wear volumes in Figure 6(c), equation (3) can be applied. This equation can be applied to various dimensions of the hip joint.

$$V_{wear_{total}} = V_{wear_1} + V_{wear_2}$$

$$= \frac{1}{2} \left[2 R_3^2 \cdot 2 R_2^2 + 2 (\delta_{min} +)^2 \right]$$

$$\left\{ \frac{1}{3} \left(R_2 - R_2 \cos \frac{1}{2} \right)^2 (2R_2 + R_2 \cos \frac{1}{2}) \right\}$$

$$+ \frac{2}{3} R_3^3 \cdot \frac{2}{3} \left(R_2^2 (\delta_{min} +)^2 \right) (R_3 - \min)$$

where

$$= Tg^{-1} \frac{(\delta_{min} +)}{\sqrt{R^2 - (\delta_{min} +)^2}} Tg^{-1} \frac{\delta_{min}}{R_3}$$

(3)

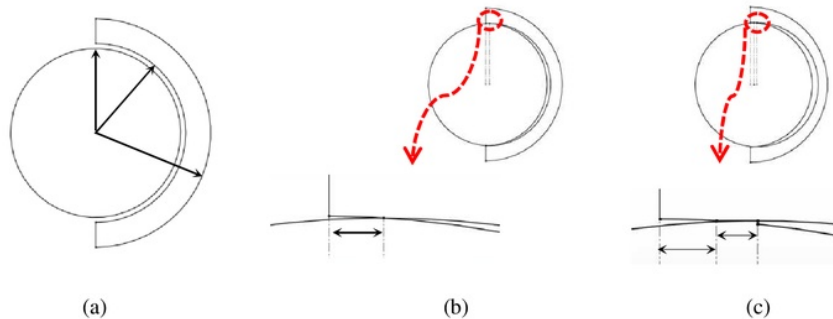

Figure 6. Assumptions of Wear Path Geometry

Test protocol for salat motion. The test protocol used to obtain the specific wear rate of the salat motion can be seen in Table 1. Each motion contributes to the whole motion of salat and has a different rotational speed. The experiment used times for a year of salat motion that are different for every motion of salat. The longest time in the experiment was for the **sujud (prostration) motion, which needs 1034.17 minutes.** Calculating the value of the specific wear rate for each leg can be done with equations (4) and (5). The optimal design of the hip joint tribometer can be seen in Figure 8.

$$\sum k_R = c_B \cdot k_B + c_p \cdot k_p + c_{SR} \cdot k_{SR} + c_{TR} \cdot k_{TR} \quad (4)$$

$$\sum k_L = c_B \cdot k_B + c_p \cdot k_p + c_{SL} \cdot k_{SL} + c_{TL} \cdot k_{TL} \quad (5)$$

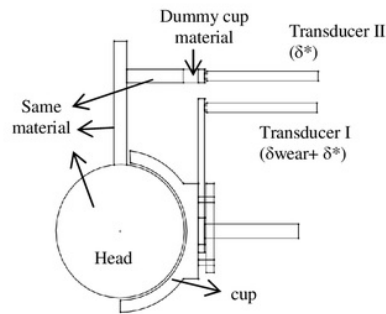

Figure 4. Displacement Transducer Mechanism

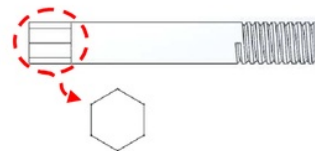

Figure 5. Femoral Head Holder

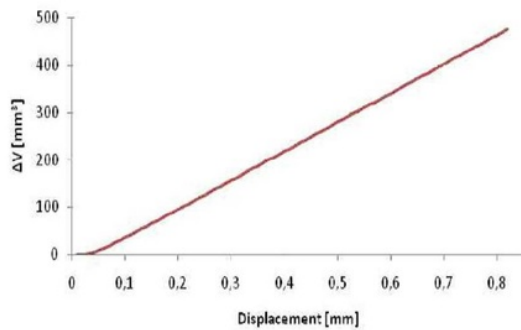

Figure 7. Delta Volume-Displacement Diagram

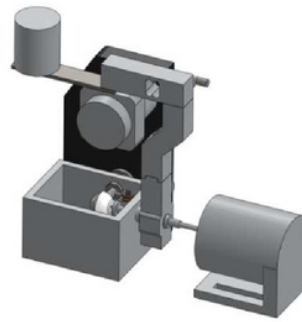

Figure 8. Optimal Design of Tribometer

Table 1. Test Protocol for Salat Motion

Prayer Activities	Cycles/year	Slid. Distance/year [mm]	Contribution [%]	Rotational Speed [cycle/s]	Time for 1 year [minutes]
Standing			62.01		
Bowing (ruku')	6205	263.713	5.35	0.33	313.38
Prostration (sujud)	12410	663.19	10.69	0.20	1034.17
Sitting			12.52	0.33	313.38
a. Right Leg	6205	235.17			
b. Left Leg	6205	242.91			
Sitting (tahiyat)			9.43	0.33	313.38
a. Right Leg	6205	241.25			
b. Left Leg	6205	252.17			

4. Conclusions

The conclusion can be summarized as follows: 1) To obtain the value of the specific wear rate in the hip joint prostheses, modifications of the femoral head holder, reciprocating motion, and the addition of a displacement transducer and elastic joint are needed; 2) Wear volumes are measured by displacement transducers using a geometric method; 3) To calculate the specific wear rate for the whole salat motion, the test protocol for the new tribometer consists of the rotation speed, the amount of time required for a year of salat motion, and the contribution of each motion to salat.

Acknowledgements

We would like to acknowledge the Direktorat Jendral Pendidikan Tinggi (DIKTI) for the Fasttrack Scholarship, and the Laboratory for Surface Technology and Tribology at the University of Twente, which facilitated the research.

References

- [1] M.S. Uddin, L.C. Zhang, *Wear* 301 (2013) 192.
- [2] L. Mattei, F. Di Puccio, B. Piccigallo, E. Ciulli, *Tribol. Int.* 44/5 (2011) 532.

- [3] D. Dowson, *Wear* 190/2 (1995) 171.
- [4] D. Dowson, C. Hardaker, M. Flett, G.H. Isaac, J. *Arthroplast.* 19/8 Suppl. (2004) 118.
- [5] H.J. Cho, W.J. Wei, H.C. Kao, C.K. Cheng, *Journal of Materials: Chemical Physics* 88/1 (2004) 9.
- [6] P.J. Firkins, J.L. Tipper, E. Ingham, M.H. Stone, R. Farrar, J. Fisher, *J. Biomech.* 34/10 (2001) 1291.
- [7] E. Saputra, I.B. Anwar, Jamari, E. Van Der Heide, *Procedia Eng.* 68 (2013) 102.
- [8] G.K. Sfantos, M.H. Aliabadi, *J. Biomech.* 40/2 (2007) 378.
- [9] D.J. Schipper, S. Odi-Owei, *Tribol. Int.* 25/3 (1992) 169.
- [10] M. Tuke, A. Taylor, A. Roques, C. Maul, *Precis. Eng.* 34/4 (2010) 777.
- [11] X.Q. Hu, C.M. Han, R.J.K. Wood, *Wear* 271/11-12 (2011) 2775.
- [12] D. Dowson, C. Hardaker, M. Flett, G.H. Isaac, *J. Arthroplast.* 19/8 Suppl. (2004) 124.
- [13] S. Carmignato, M. Spinelli, S. Affatato, E. Savio, *Wear* 270/9-10 (2011) 584.

Modified Design of Pin-on-Ring Tribometer for Hip Joint Prostheses Measurement; Case Study on Salat Activity

ORIGINALITY REPORT

19%

SIMILARITY INDEX

17%

INTERNET SOURCES

4%

PUBLICATIONS

2%

STUDENT PAPERS

PRIMARY SOURCES

1	uad.portalgaruda.org Internet Source	16%
2	Submitted to Universitas Diponegoro Student Paper	1%
3	Jin, Z., and J. Fisher. "Tribology in joint replacement", Joint replacement technology, 2008. Publication	1%
4	Leondes, Cornelius T. "TRIBOLOGY OF METAL-ON-METAL ARTIFICIAL HIP JOINTS", Biomechanical Systems Technology, 2009. Publication	1%
5	Paik, P.. "Thermal degradation kinetics and estimation of lifetime of polyethylene particles: Effects of particle size", Materials Chemistry & Physics, 20090215 Publication	1%

Exclude quotes Off

Exclude matches < 1%

Exclude bibliography Off