



# **Anti-Muslim Backlash and Changing Political Ideologies. The Consequences of Perceived Threat from Islamist Terrorism**

Dissertation

zur Erlangung des Doktorgrades

der Naturwissenschaften

(Dr. rer. nat.)

dem

Fachbereich Psychologie

der Philipps-Universität Marburg

vorgelegt

von

Dipl.-Sozialwiss. Stefan Thörner

aus Lich

Marburg/Lahn im April 2014

Diese Arbeit wurde gefördert durch ein Promotionsstipendium des DFG-Graduiertenkollegs „Gruppenbezogene Menschenfeindlichkeit“ (GRK 884) an den Universitäten Marburg und Bielefeld.

**Anti-Muslim Backlash and Changing Political Ideologies. The Consequences of  
Perceived Threat from Islamist Terrorism**

Dipl.-Sozialwiss. Stefan Thörner

Am Fachbereich Psychologie der Philipps-Universität Marburg (Hochschulkennziffer 1080)  
am 15.04.2014 als Dissertation eingereicht.

Erstgutachter: Prof. Dr. Ulrich Wagner (Philipps-Universität Marburg)

Zweitgutachter: Prof. Dr. Peter Schmidt (Justus-Liebig-Universität Gießen)

Tag der mündlichen Prüfung (Disputation): 30.06.2014

## Table of Contents

<b>1. Introduction</b> .....	1
1.1 Historical Background .....	3
1.2 Theoretical Background.....	4
1.2.1 Terrorist Threat .....	4
1.2.2 The Psychology of Terrorism .....	5
1.2.3 Integrated Threat Theory (ITT) .....	6
1.2.4 Terror Management Theory (TMT).....	8
1.3 The Present Research.....	9
1.3.1 Manuscript #1 .....	9
1.3.2 Manuscript #2 .....	11
1.3.3 Manuscript #3 .....	12
1.4 References.....	16

### **Manuscript #1:**

Terrorist Threat, Prejudice, and Anti-Muslim Backlash. A Cross-National Poll Review for a Decade of Terrorism .....	21
---	----

### **Manuscript #2:**

What comes first: threat or prejudice? Perceived terrorist threat and the derogation of Muslims in Germany.....	74
---	----

**Manuscript #3:**

Conservative Shift or Ideological Intensification? The Impact of the 2004 Madrid Bombings  
on Germany..... 102

**2. Final Discussion..... 123**

    2.1 Perceived Terrorist Threat and Anti-Muslim Backlash..... 123

    2.2 Perceived Terrorist Threat and Changing Political Ideologies ..... 126

    2.3 Anti-Muslim Backlash and Ideological Intensification – A Contradiction? ..... 128

**3. Outlook..... 130**

    3.1 References..... 133

Zusammenfassung..... 137

Danksagung..... 142

Angaben zur Person ..... 143

Erklärung des Autors ..... 144

## 1. Introduction

Undoubtedly, for the so called Western World, the terrorist attacks on September 11, 2001 (9/11), were among the most important events in the first decade of the 21<sup>st</sup> century<sup>1</sup>. In the style of many speeches held by politicians on 9/11 and thereafter, Thomas Birkland (2004) titled a research paper “*The World Changed Today*” (p. 179). In fact, the world changed in various aspects: The US and allies went to the “war on terror” against the Taliban in Afghanistan and against the Saddam-Regime in Iraq (e.g., Stone & Rizova, 2007). Furthermore, security measures and intelligence service activities were increased up to a level of total surveillance, which has just recently been discovered by the public (e.g., Gellman & Soltani, 2014). At least some of these measures were applied to regain security for the US and its citizens – an aspect massively under threat by the attacks.

The terrorists of 9/11 proved awareness of psychological mechanisms and mass media functioning (Breckenridge & Zimbardo, 2007; Shurkin, 2007). With this knowledge, they were highly successful in spreading terror. Besides the rather small group of directly affected individuals, they reached and – more importantly – affected millions of people who followed the events via TV in the US and around the world (Carey, 2003; Oswald, 2005; Reuband, 2010). Opinion polls in the US and Europe found that the attacks and their broadcasting induced a state of perceived threat and insecurity (European Commission, 2002; Huddy, Khatib, & Capelos, 2002; Smith, Rasinski, & Toce, 2001; Traugott et al., 2002). Ahern, Galea, Resnick, and Vlahov (2004) emphasize how strong individuals have been indirectly affected. They showed that the probability of facing post-traumatic stress disorder symptoms increased with the duration of TV consumption in the week after 9/11 (see also Marshall et al., 2007). To sum up, for the Western World a new, pervasive threat was initiated on September 11, 2001.

---

<sup>1</sup> This work is written from a Western perspective. Thus, whenever I write about ‘citizens’, ‘people’, and ‘individuals’ in an unspecific manner, I refer to individuals from the so called Western World.

This threat was kept alive or reactivated by several more Islamist terrorist attacks, failed or foiled trials, terror warnings, and other terror related events (Nacos, Bloch-Elkon, & Shapiro, 2007). Even today, – more than ten years later – the perception of terrorist threat has not yet disappeared fully. Importantly, it can be re-triggered rapidly by a new event. Therefore, I aim to further our knowledge about the phenomenon of perceived terrorist threat and its social psychological and societal consequences. I will investigate the consequences of terrorism for Muslims living in Western countries as well as the changes of political ideologies<sup>2</sup> in response to a terrorist attack.

In the social scientific research field of intergroup relations, threat plays a pivotal role. Threat in various forms (e.g., realistic, symbolic, collective, individual) is known to increase prejudice against outgroups (Stephan & Stephan, 2000; for an overview and meta-analysis, see Riek, Mania, & Gaertner, 2006). The strongest effect can be expected against the group which is allegedly the source of threat/s (LeVine & Campbell, 1972). Thus, in case of Islamist terrorism, a derogation of Muslims is expected. I will evaluate this assumption in Manuscripts #1 and #2. Especially in Manuscript #1, I aim to answer the research question whether the post 9/11 anti-Muslim backlash can be explained by a social-psychological threat-prejudice-discrimination model (for an overview of research questions, see Table 1 at the end of this chapter). Additionally, I will evaluate whether this model holds true for other major and minor terrorist events in different countries over a time-span from 2001 to 2011. The research of Manuscript #2 is concerned with the antecedence of terrorist threat and prejudice. I will test competing theories about the temporal association of terrorist threat and anti-Muslim prejudice in Germany. Thus I will answer the question whether terrorist threat produces prejudice or whether the expression of existing prejudice is legitimated by terrorist

---

<sup>2</sup> The working definition of the term “ideology” for this thesis is that individuals possess a core belief system (e.g., conservatism) that is shared with a group and gives meaning to political thinking and behavior (for an overview, see Jost, 2006).

threat. This is especially important due to the fact that the majority of immigrants in Germany have been Muslims long before 9/11.

Besides its' hypothesized enhancement of anti-Muslim prejudice, perceived terrorist threat is also supposed to have an influence on political ideologies. The following sums up the theorized mechanism: perceived terrorist threat increases the salience of one's own death (called mortality salience; Landau et al., 2004). Mortality salience increases the desire of being part of a meaningful community sharing a worldview which outlasts one's own death (Castano & Dechesne, 2005). Therefore, a major terrorist attack is assumed to lead to worldview defense, meaning that prior ideologies (e.g., political ideologies) are amplified (Pyszczynski, Solomon, & Greenberg, 2003)<sup>3</sup>. In Manuscript #3, I will test this hypothesis against an alternative which postulates that all individuals generally become more conservative after a terrorist attack (Jost, Glaser, Kruglanski, & Sulloway, 2003).

In the following I present a short overview of the historical context and provide an introduction to the psychology of terrorism. I continue with the two most relevant theories for this thesis and previous research where these theories were applied in context of terrorism. Then, I expand on the present research, by sketching the aims of the three manuscripts this thesis is built upon.

## **1.1 Historical Background**

Preceding last decade's Islamist terrorism in the Western World, there has been a long-lasting latent conflict mainly between the US and the people of the Islamic World. A possible explanation for this conflict is described by McCauley (2007): the Western world supports

---

<sup>3</sup> For worldview defense in context of political ideologies, Huddy & Feldman (2011) introduced the term "ideological intensification".

governments of Islamic countries which, however, suppress their own citizens. This, amongst other factors, may have induced Islamist terrorism by fundamentalist groups deriving from suppressed people. Yet, the history of this conflict and the multiple causes of last decades' terrorism are much more complex (for an overview, see Halliday, 2002).

On September 11, 2001 (9/11), Al-Qaeda terrorists hijacked four airplanes. Two of them hit the World Trade Center (WTC) in New York City, the third one the Pentagon in Arlington and the fourth one crashed on a field near Pittsburgh. All passengers died, together with hundreds of people in the WTC and the Pentagon. Altogether, about three thousand people lost their life and around six thousand were injured due to the immediate attacks on 9/11 (Li, Kelley, & Kennedy, 2003; Woods, 2011).

Since 9/11, Islamist terrorism or its countermovement, "the war on terror", have been on the agenda in Western countries (for an overview, see Manuscript #1). To mention only a few events: in 2003 the so called "coalition of the willing" went to war against the regime in Iraq. A year later, Islamist terrorists killed 191 commuters in the morning of March 11, 2004 in Madrid, Spain. On July 7, 2005, 52 people died in another horrific attack on public transport vehicles, in London, UK. The second half of the decade was characterized by failed or foiled attacks and the ongoing wars. For some people a decade of terrorism ended with the assassination of Osama bin Laden in May 2011 (Gollwitzer et al., 2014). In fact, the perception of terrorist threat has diminished – after a peak in response to bin Laden's assassination – in the last years (Manuscript #1). However, it can be reactivated rapidly.

## **1.2 Theoretical Background**

### **1.2.1 Terrorist Threat**

Fritsche, Jonas, and Kessler (2011) define threat as the individual's expectation that something aversive is going to happen, especially if this coincides with a sense of losing



control. Stephan and Renfro (2002) locate threat on a cognitive level: *“From our perspective, threat is a cognitive appraisal and fear is a common emotional response to this appraisal.”* (p. 197)

Last decades’ Islamist terrorism threatened many individuals to expect and fear further attacks. This threat about future attacks can be further differentiated. Scholars distinguish between collective and individual threat (e.g., Stephan & Renfro, 2002). In the context of terrorism, the wording collective and personal threat is common (Huddy, Feldman, Capelos, & Provost, 2002): Collective terrorist threat is often operationalized as perceiving danger for one’s own country or one’s superior ingroup. If individuals perceive (physical) danger for themselves, this is interpreted as personal threat. This differentiation is useful because collective and personal threat can have different consequences on psychological variables like authoritarianism (Asbrock & Fritsche, 2013).

### **1.2.2 The Psychology of Terrorism**

Commonly, terrorists aim to induce political changes with their attacks<sup>4</sup> (Abrahms, 2006). Not the attacks themselves, but threat in large parts of the population as psychological consequence forces target governments to react (Friedland & Merari, 1985). To spread threat, terrorists often try to kill as many people as possible. This is to gain maximum attention and to create the impression that everyone could fall victim. Another aspect is the choice of target cities and buildings or traffic systems. In case of 9/11, national symbols were targeted (WTC, Pentagon) to humiliate the US and to emphasize their vulnerability. By doing so, terrorists proved a vast knowledge of psychological mechanisms (Breckenridge & Zimbardo, 2007; Huddy, Feldman, & Cassese, 2009).

---

<sup>4</sup> In case of 9/11 however, there is no final clarity about the concrete political aims of the attackers (McCauley, 2007)

Furthermore, choosing cities like New York, Madrid and London as targets ensured that camera teams would be on scene within minutes and broadcast their pictures around the world (Carey, 2003; Shurkin, 2007). This proved again terrorists' ability to spread threat on a large scale because especially the live coverage of the happenings in New York City on September 11, 2001, was highly traumatizing and threatening to television viewers (Marshall et al., 2007). To sum up, last decades' Islamist terrorists knew how to receive attention and how to convey terror and threat into every household in the US and beyond.

The psychological consequences of terrorist threat are multifarious (for overviews, see Morgan, Wisneski, & Skitka, 2011; Woods, 2011). The crucial one for this work is the prejudice- and discrimination- increasing function of terrorist threat and its impact on political ideologies. Two theories seem especially appropriate to consider in these contexts: first, Integrated Threat Theory (ITT; Stephan & Stephan, 2000), and second Terror<sup>5</sup> Management Theory (TMT; Greenberg et al., 1990).

### **1.2.3 Integrated Threat Theory (ITT)**

ITT is an integration of threat accounts (Stephan & Stephan, 2000). It derives from the hypothesis, included in many classic studies of intergroup relations, that threat creates prejudice (Adorno, Frenkel-Brunswik, Levinson, & Sanford, 1950; Allport, 1979/1954; Blumer, 1958; LeVine & Campbell, 1972; Sherif, 1966). ITT considers realistic threat, symbolic threat, intergroup anxiety and negative stereotyping to explain the occurrence of prejudice (Stephan & Renfro, 2002). Importantly, the mere perception of threat is the crucial condition for prejudice to occur.

---

<sup>5</sup> "Terror" describes a state of threat and is not equivalent with terrorism. Thus, TMT is a more general theory that focuses not specifically on terrorism. German translation of "terror" = "Schrecken, Entsetzen".

Realistic threats, as formulated in Sherif's (1966) realistic group conflict theory, are those resulting from competition for scarce resources between groups (see also Blumer, 1958). Because this definition is relatively narrow, Stephan and Stephan (2000) enlarged the concept of realistic threat to any threat posed to the wellbeing of the whole group or its members (see also Stephan & Renfro, 2002; Stephan, Renfro, & Davis, 2008). Terrorist attacks fulfill this concept. If the source of threat can be traced to a specific group it will cause hostility to that group (LeVine & Campbell, 1972; see also Allport, 1979/1954; Glick, 2002, 2005). Thus, the occurrence of terrorist threat should lead to an increase in prejudice, especially against Muslims.

Several studies combined perceived terrorist threat with ITT. Huddy et al. (2005) found in a large post 9/11 survey that individuals who felt threatened supported the invasion of Afghanistan and the discrimination of Muslims in terms of surveillance and special airport security checks and restrictions on visas, amongst other anti-terrorism policies. Doosje et al. (2009) analyzed a cross-sectional mixed European survey which covered the perception of terrorist threat, anti-Muslim prejudice and discriminatory intentions. The authors were able to show that all these variables are interrelated, supporting the ITT view. In the same way, Oswald (2005) demonstrated that perceived terrorist threat was associated with anti-Arab<sup>6</sup> prejudice and discriminatory intention.

The fact that the terrorists have been Muslims seems having a general skepticism against that group and its members induced (Yum & Schenck-hamlin, 2005). Muslims suddenly posed a perceived threat although only a few individuals of that group were actual terrorists (Cesari, 2004; Welch, 2006).

A limiting factor of earlier research is its selectivity for specific attacks (mainly 9/11) and single countries (mainly the US) which restricts external validity of the results. To

---

<sup>6</sup> In the US, the term "Arabs" is used to describe individuals mainly from Middle Eastern descent. The majority of Arabs are of Muslim faith (Shaheen, 2003).

overcome this shortcoming, I include an overview paper about perceived terrorist threat, anti-Muslim prejudice and discrimination in several countries, covering a full decade of terrorist attacks and terror related events (Manuscript #1).

Another shortcoming of previous research is that most studies are cross-sectional which allows no conclusions about the direction of causality for the portrayed variables. Therefore, in Manuscript #2 I will test whether the theorized temporal sequence of ITT is superior over alternative causations.

#### **1.2.4 Terror Management Theory (TMT)**

The theory connecting terrorist threat with changes in political ideology is called TMT (Pyszczynski et al., 2003). The basic idea behind TMT is that humans are aware of their mortality but refuse to accept their transience (Becker, 1997/1973). Contemplating one's death, which TMT researchers call mortality salience, induces a state of threat (Greenberg et al., 1990). Individuals oppose that threat by strengthening their worldview (e.g., political ideology)<sup>7</sup> and their group affiliation. Belonging to a larger entity means being part of something lasting longer than oneself which creates a sense of immortality (Castano & Dechesne, 2005; Castano, Yzerbyt, & Paladino, 2004). Of course, this is a symbolic form of immortality but it can buffer the threat of mortality salience (Greenberg, Solomon, & Pyszczynski, 1997).

Previous Research connecting TMT with terrorism showed impressively that triggering thoughts about 9/11 experimentally increased participants' level of mortality salience (Landau et al., 2004). Thus, terrorist attacks can indeed pose an existential threat. As mentioned above, according to TMT, individuals react with worldview defense if their mortality is salient. Therefore, Pyszczynski and colleagues (2003) hypothesized that terrorist

---

<sup>7</sup> Worldview defense can be captured on various dimensions (for an overview, see Solomon, Greenberg, and Pyszczynski, 2004).

attacks also lead to worldview defense. In a later study, Pyszczynski et al. (2006) found that college students in a mortality salience condition showed on mean level higher support for extreme military interventions by American forces although they would cause thousands of civilian victims. As expected, this was moderated by respondents' political ideology, supporting the worldview defense hypothesis. Only conservatives increased in support for the military intervention. Thus, individuals' political ideology may influence reactions to mortality salience. This, however, is the topic of controversial debate, on which Manuscript #3 will focus (see Burke, Kosloff, & Landau, 2013; Jost, 2006).

Previous research on TMT in context of terrorism is mainly experimental laboratory research. Thus, it has high internal validity but is not able to capture the complexity of real world terrorism. To overcome this shortcoming, natural quasi-experiments with real world terrorism could further our knowledge about the consequences of terrorist attacks on individuals' worldviews. Echebarria-Echabe and Fernández-Guede (2006) provide such a design on the Madrid Bombings in 2004. However, they use independent pre-post attack samples. Therefore, in Manuscript #3 I will provide an analysis of a pre-post Madrid Bombing panel dataset, to reveal intraindividual change in worldviews (political ideology) in response to a real world terrorist attack.

## **1.3 The Present Research**

### **1.3.1 Manuscript #1**

Thörner, S., Schmidt, P., & Gosen, S. (2014, submitted). Terrorist Threat, Prejudice, and Anti-Muslim Backlash. A Cross-National Poll Review for a Decade of Terrorism.

Point of departure for Manuscript #1 was the observation that a wave of violent backlash against Muslims occurred in the US after 9/11 (e.g., Ibish, 2003). The arising

research question is therefore whether this macro phenomenon can be explained by a social-psychological threat-prejudice-discrimination model (for an overview of research questions and major theoretical constructs in this thesis, see Table 1). I will derive such a model from ITT and research connecting prejudice with discrimination (for an overview, see Dovidio & Gaertner, 1986; for meta-analyses, see Schütz & Six, 1996; Talaska, Fiske, & Chaiken, 2008). To investigate the generality of the model, I will apply this model to different countries and different major and minor terrorist attacks and terror related events. One further aspect under scrutiny is the strength and sustainability of spillover effects from terror related events in one country to others countries.

To answer the research questions, I review polls and reports about perceived terrorist threat, anti-Muslim prejudice and discrimination for the US, Spain, UK, and Germany for a period from 2000 to 2012<sup>8</sup> (for an overview of research designs, data and methods, see Table 2 at the end of this chapter). Most of that data is only available as mean scores and not as individual level data. Furthermore, the datasets available on individual level do not comprise all variables under research here. Therefore, I create timelines of mean scores for perceived terrorist threat, anti-Muslim prejudice and discrimination. With this data, no test of causality is possible. The model is supported if threat, prejudice and discrimination increase in response to a terror related event. Thus, I theorize a micro-level mechanism which can only be observed on macro-level with the available data. To connect both levels, I refer to Coleman's (Coleman, 1986, 1987) micro-macro theory and model.

Where individual data or at least distribution measures are available, I will test for mean differences within time series (e.g., time series of anti-Muslim prejudice<sup>9</sup> in the US). For Germany, one available dataset allows for working with latent means. In this case, I apply

---

<sup>8</sup> The events considered happened between 2001 and 2011. Therefore, I used the term "a decade of terrorism". However, the data captures a somewhat longer period: 2000 to 2012.

<sup>9</sup> During my dissertation I discovered the controversy about the term "Islamophobia" (e.g., Imhoff and Recker, 2012). Therefore, I switched to the term "anti-Muslim prejudice". However, Manuscript #1 comprehends the word Islamophobia.

Confirmatory Factor Analysis (CFA) and measurement invariance testing (Meredith, 1993).

Measurement invariance is a statistical procedure which checks whether the meaning of a factor remains the same over time which is a condition for latent mean testing.

Depending on the results, I aim to derive marginal conditions for the functioning of the model between events and between countries. This has far-reaching practical implications, because it allows to develop intervention strategies which could be used to decrease the probability of anti-Muslim backlash after a terror related event.

### **1.3.2 Manuscript #2**

Thörner, S. & Kauff, M. (2014, submitted). What comes first: threat or prejudice? Perceived terrorist threat and the derogation of Muslims in Germany.

Whereas the data in Manuscript #1 allows for a macro-level perspective on the connection of perceived terrorist threat and derogation of Muslims, Manuscript #2 tests this connection on micro-level. In this manuscript, my focus is on the specific situation in Germany where Muslims have been the largest immigrant group for decades and prejudice against immigrants existed long before 9/11 occurred (e.g., Jonker, 2005). Thus, from a modern prejudice perspective (e.g., Gaertner & Dovidio, 1986; see also Crandall & Eshleman, 2003) it is conceivable, that terrorist threat is used as a legitimization strategy to express existing prejudice (Allen, 2004). The opponent hypothesis derived from ITT is that threat produces prejudice. The specific research question is therefore, whether perceived terrorist threat releases existing prejudice, produces new prejudice, or if both mechanisms occur simultaneously.

To test these hypotheses against each other, I conducted a two wave online-panel with N = 88 respondents that participated in both panel waves. The panel consists mainly of

young, highly educated individuals. I test the hypotheses against each other by applying latent variable cross-lagged modeling (Jöreskog, 1979). Working with latent variables goes along with higher reliabilities of connections between variables due to consideration of measurement error on factor level (Kline, 2011). Furthermore, latent variable modeling allows for invariance testing of measurement models, which is a central assumption in working with panel data (Little, Preacher, Selig, & Card, 2007). Cross-lagged models are suited to reveal the antecedence of variables, questioning which variable predicts the other over time under consideration of autocorrelations within constructs (Finkel, 1995).

An additional aim of this manuscript is to explore whether perceived collective and personal terrorist threat create differential effects on anti-Muslim prejudice and discrimination. This is because previous research revealed rather contrary results about differential effects (Asbrock & Fritsche, 2013; Huddy et al., 2002).

Understanding the causal antecedence between perceived terrorist threat and derogation of Muslims is important because it allows the development of appropriate intervention strategies to diminish prejudice and discrimination.

### **1.3.3 Manuscript #3**

Thörner, S. (2014, submitted). Conservative Shift or Ideological Intensification? The Impact of the 2004 Madrid Bombings on Germany.

As mentioned above, in Manuscript #3 I consider the consequences of perceived terrorist threat from a somewhat different angle as in the first two manuscripts. The dependent variable under research is change in political ideology. Like in Manuscript #2 I test two competing hypotheses against each other. The first hypothesis is derived from Jost and colleagues' research on conservatism as motivated social cognition (Jost et al., 2003).



The authors suggest that threat, including mortality salience, leads to a conservative shift in terms of political ideologies. This means that all individuals become more conservative when confronted with existential threat. TMT researchers, however, argue that mortality salience leads to worldview defense (ideological intensification), meaning that previous ideologies are strengthened (Pyszczynski et al., 2003). Thus, the research question of this manuscript is whether a terrorist attack leads to a conservative shift or to ideological intensification.

To answer that research question, I reanalyze a representative German panel dataset which was conducted a year prior and a few weeks after the terrorist attacks on Madrid in March 2004. I apply a design suggested by Castano et al. (2011) to this data. Here, I consider the political self-positioning at t1 to explain the intraindividual change in a proxy measure of conservatism. I do this firstly in the same manner as Castano and colleagues and calculate residual change scores. Second, I apply an elaborated change score procedure from the family of longitudinal latent variable models (McArdle, 2009) called latent true change modeling (Steyer, Eid, & Schwenkmezger, 1997).

Table 1. Overview of research questions and major theoretical constructs.

Manuscript	Research Question	Major Theoretical Constructs
#1 Terrorist Threat, Prejudice, and Anti-Muslim Backlash. A Cross-Country Poll Review for a Decade of Terrorism.	Can the 9/11 anti-Muslim backlash in the US be explained by a threat-prejudice-discrimination account? How strong and sustainable are spillover effects on other countries? Does such a model hold true for the attacks on Spain and the UK? What are the marginal conditions of backlash?	Time series of terrorist events, perceived terrorist threat, Islamophobia, discrimination
#2 What comes first: threat or prejudice? Perceived terrorist threat and the derogation of Muslims in Germany	Does perceived terrorist threat lead to the derogation of Muslims, is terrorist threat used as a legitimation of expressing existing prejudice against Muslims or is a hybrid of this two models appropriate? Are there differential effects for personal and collective terrorist threat?	Perceived collective terrorist threat, perceived personal terrorist threat, prejudice against Muslims, discriminatory intentions against Muslims
#3 Conservative Shift or Ideological Intensification? The Impact of the Madrid Bombings in 2004 on Germany.	Did the Madrid Bombing lead to a conservative shift or to ideological intensification in Germany? Is the change in conservatism after a terrorist attack dependent on the political self-categorization at t1?	Time (pre & post terrorist attack), authoritarianism (proxy of conservatism), prejudice

Table 2. Overview of research designs, data and methods of data analysis.

Manuscript	Research Design	Data	Method
#1 Terrorist Threat, Prejudice and Anti-Muslim Backlash. A Cross-Country Poll Review for a Decade of Terrorism.	Poll review, time series	Multiple general population samples time series (cross-national)	ANOVA, confirmatory factor analysis, multiple group invariance testing, latent mean comparisons
#2 What comes first: threat or prejudice? Perceived terrorist threat and the derogation of Muslims in Germany	Two-wave panel	Online panel	Confirmatory factor analysis, longitudinal invariance testing, latent autoregressive cross-lagged structural equation modeling
#3 Conservative Shift or Ideological Intensification? The Impact of the Madrid Bombings in 2004 on Germany.	Natural experiment (Panel including a terrorist attack)	General population panel	Change scores, confirmatory factor analysis, longitudinal invariance testing, latent true change modeling

## 1.4 References

- Abrahms, M. (2006). Why Terrorism Does Not Work. *International Security*, 31(2), 42–78. Retrieved from <http://www.jstor.org/stable/4137516>
- Adorno, T. W., Frenkel-Brunswik, E., Levinson, D., & Sanford, N. (1950). *The authoritarian personality*. New York: Harper.
- Ahern, J., Galea, S., Resnick, H., & Vlahov, D. (2004). Television Images and Probable Posttraumatic Stress Disorder After September 11. *The Journal of Nervous and Mental Disease*, 192(3), 217–226. doi:10.1097/01.nmd.0000116465.99830.ca
- Allen, C. (2004). Justifying Islamophobia: A Post 9/11 Consideration of the European Union and British Contexts. *The American Journal of Islamic Social Sciences*, 21(3), 1–25. Retrieved from [http://i-epistemology.net/attachments/847\\_Ajiss21-3%20-%20Allen%20-%20Justifying%20Islamophobia.pdf](http://i-epistemology.net/attachments/847_Ajiss21-3%20-%20Allen%20-%20Justifying%20Islamophobia.pdf)
- Allport, G. W. (1979/1954). *The Nature of Prejudice* (25th ed.). Reading, Mass: Perseus Books.
- Asbrock, F., & Fritsche, I. (2013). Authoritarian reactions to terrorist threat: Who is being threatened, the Me or the We? *International Journal of Psychology*, 48(1), 35–49. doi:10.1080/00207594.2012.695075
- Becker, E. (1997/1973). *The denial of death*. New York: Free Press Paperbacks.
- Birkland, T. A. (2004). "The World Changed Today": Agenda-Setting and Policy Change in the Wake of the September 11 Terrorist Attacks. *Review of Policy Research*, 21(2), 179–200. doi:10.1111/j.1541-1338.2004.00068.x
- Blumer, H. (1958). Race Prejudice as a Sense of Group Position. *The Pacific Sociological Review*, 1(1), 3–7.
- Breckenridge, J. N., & Zimbardo, P. G. (2007). The Strategy of Terrorism and the Psychology of Mass-Mediated Fear. In B. M. Bongar, L. M. Brown, L. E. Beutler, J. N. Breckenridge, & P. G. Zimbardo (Eds.), *Psychology of terrorism* (pp. 116–133). Oxford, New York: Oxford University Press.
- Burke, B. L., Kosloff, S., & Landau, M. J. (2013). Death Goes to the Polls: A Meta-Analysis of Mortality Salience Effects on Political Attitudes. *Political Psychology*, 34(2), 183–200. doi:10.1111/pops.12005
- Carey, J. (2003). The Functions and Uses of Media during the September 11 Crisis and its Aftermath. In A. M. Noll (Ed.), *Crisis communications. Lessons from September 11* (pp. 1–16). Lanham, Md: Rowman & Littlefield.
- Castano, E., & Dechesne, M. (2005). On defeating death: Group reification and social identification as immortality strategies. *European Review of Social Psychology*, 16(1), 221–255. doi:10.1080/10463280500436024
- Castano, E., Leidner, B., Bonacossa, A., Nikkah, J., Perrulli, R., Spencer, B., & Humphrey, N. (2011). Ideology, Fear of Death, and Death Anxiety. *Political Psychology*, 32(4), 601–621. doi:10.1111/j.1467-9221.2011.00822.x
- Castano, E., Yzerbyt, V., & Paladino, M.-P. (2004). Transcending Oneself through Social Identification. In J. Greenberg, S. L. Koole, & T. A. Pyszczynski (Eds.), *Handbook of experimental existential psychology* (pp. 305–321). New York: Guilford Press.
- Cesari, J. (2004). *When Islam and democracy meet: Muslims in Europe and in the United States* (1st ed.). Basingstoke: Palgrave Macmillan.

- Coleman, J. S. (1986). Social Theory, Social Research, and a Theory of Action. *American Journal of Sociology*, 91(6), 1309–1335. doi:10.1086/228423
- Coleman, J. S. (1987). Microfoundations and Macrosocial Behavior. In J. C. Alexander, B. Giesen, R. Münch, & N. J. Smelser (Eds.), *The Micro-Macro Link* (pp. 153–176). Berkeley: University of California Press.
- Crandall, C. S., & Eshleman, A. (2003). A justification-suppression model of the expression and experience of prejudice. *Psychological Bulletin*, 129(3), 414–446. doi:10.1037/0033-2909.129.3.414
- Doosje, B., Zimmermann, A., Küpper, B., Zick, A., & Meertens, R. L. (2009). Terrorist Threat and Perceived Islamic Support for Terrorist Attacks as Predictors of Personal and Institutional Out-Group Discrimination and Support for Anti-Immigration Policies: Evidence from 9 European Countries. *Revue Internationale de Psychologie Sociale*, 22(3), 203–233.
- Dovidio, J. F., & Gaertner, S. L. (Eds.). (1986). *Prejudice, discrimination, and racism*. San Diego: Academic Press.
- Echebarria-Echabe, A., & Fernández-Guede, E. (2006). Effects of terrorism on attitudes and ideological orientation. *European Journal of Social Psychology*, 36(2), 259–265. doi:10.1002/ejsp.294
- European Commission. (2002). *Eurobarometer: Public Opinion in the European Union*. Report Number 57. Retrieved from [http://ec.europa.eu/public\\_opinion/archives/eb/eb57/eb57\\_en.pdf](http://ec.europa.eu/public_opinion/archives/eb/eb57/eb57_en.pdf)
- Finkel, S. E. (1995). *Causal analysis with panel data*. Sage university papers series. *Quantitative applications in the social sciences: no. 07-105*. Thousand Oaks, Calif: Sage Publications.
- Friedland, N., & Merari, A. (1985). The Psychological Impact of Terrorism: A Double-Edged Sword. *Political Psychology*, 6(4), 591. doi:10.2307/3791018
- Fritsche, I., Jonas, E., & Kessler, T. (2011). Collective Reactions to Threat: Implications for Intergroup Conflict and for Solving Societal Crises. *Social Issues and Policy Review*, 5(1), 101–136. doi:10.1111/j.1751-2409.2011.01027.x
- Gaertner, S. L., & Dovidio, J. F. (1986). The aversive form of racism. In J. F. Dovidio & S. L. Gaertner (Eds.), *Prejudice, discrimination, and racism* (pp. 61–89). San Diego: Academic Press.
- Gellman, B., & Soltani, A. (2014, March 18). NSA surveillance program reaches 'into the past' to retrieve, replay phone calls. *The Washington Post*. Retrieved from [http://www.washingtonpost.com/world/national-security/nsa-surveillance-program-reaches-into-the-past-to-retrieve-replay-phone-calls/2014/03/18/226d2646-ade9-11e3-a49e-76adc9210f19\\_story.html](http://www.washingtonpost.com/world/national-security/nsa-surveillance-program-reaches-into-the-past-to-retrieve-replay-phone-calls/2014/03/18/226d2646-ade9-11e3-a49e-76adc9210f19_story.html)
- Glick, P. (2002). Sacrificial lambs dressed in wolves' clothing: Envious prejudice, ideology, and the scapegoating of Jews. In L. S. Newman & R. Erber (Eds.), *Understanding genocide. The social psychology of the Holocaust* (pp. 113–142). New York: Oxford University Press.
- Glick, P. (2005). Choice of Scapegoats. In J. F. Dovidio, P. S. Glick, & L. A. Rudman (Eds.), *On the nature of prejudice. Fifty years after Allport* (pp. 244–261). Malden, MA: Blackwell Pub.
- Gollwitzer, M., Skitka, L. J., Wisneski, D., Sjoström, A., Liberman, P., Nazir, S. J., & Bushman, B. J. (2014). Vicarious Revenge and the Death of Osama bin Laden. *Personality and Social Psychology Bulletin*. doi:10.1177/0146167214521466

- Greenberg, J., Pyszczynski, T., Solomon, S., Rosenblatt, A., Veeder, M., Kirkland, S., & Lyon, D. (1990). Evidence for terror management theory II: The effects of mortality salience on reactions to those who threaten or bolster the cultural worldview. *Journal of Personality and Social Psychology*, *58*(2), 308–318. doi:10.1037/0022-3514.58.2.308
- Greenberg, J., Solomon, S., & Pyszczynski, T. (1997). Terror Management Theory of Self-Esteem and Cultural Worldviews: Empirical Assessments and Conceptual Refinements. *Advances in Experimental Social Psychology*, *29*, 61–139. doi:10.1016/S0065-2601(08)60016-7
- Halliday, F. (2002). *Two hours that shook the world: September 11, 2001: causes and consequences*. London: Saqi.
- Huddy, L., & Feldman, S. (2011). Americans respond politically to 9/11: Understanding the impact of the terrorist attacks and their aftermath. *American Psychologist*, *66*(6), 455–467. doi:10.1037/a0024894
- Huddy, L., Feldman, S., Capelos, T., & Provost, C. (2002). The Consequences of Terrorism: Disentangling the Effects of Personal and National Threat. *Political Psychology*, *23*(3), 485–509. doi:10.1111/0162-895X.00295
- Huddy, L., Feldman, S., & Cassese, E. (2009). Terrorism, anxiety, and war. In W. G. K. Stritzke (Ed.), *Terrorism and torture. An interdisciplinary perspective* (pp. 290–312). Cambridge, UK, New York: Cambridge university press.
- Huddy, L., Feldman, S., Taber, C., & Lahav, G. (2005). Threat, Anxiety, and Support of Antiterrorism Policies. *American Journal of Political Science*, *49*(3), 593–608. doi:10.1111/j.1540-5907.2005.00144.x
- Huddy, L., Khatib, N., & Capelos, T. (2002). The Polls-Trends: Reactions to the Terrorist Attacks of September 11, 2001. *Public Opinion Quarterly*, *66*(3), 418–450. doi:10.1086/341395
- Ibish, H. (2003). *Report on Hate Crimes and Discrimination Against Arab Americans: The Post - September 11 Backlash*. Washington, DC, US. Retrieved from <http://www.adc.org/PDF/hcr02.pdf>
- Imhoff, R., & Recker, J. (2012). Differentiating Islamophobia: Introducing a New Scale to Measure Islamoprejudice and Secular Islam Critique. *Political Psychology*, *33*(6), 811–824. doi:10.1111/j.1467-9221.2012.00911.x
- Jonker, G. (2005). From 'Foreign Workers' to 'Sleepers': The Churches, the State and Germany's 'Discovery' of its Muslim Population. In J. Cesari & S. McLoughlin (Eds.), *European Muslims and the secular state* (pp. 113–128). Aldershot, Hants, England, Burlington, VT: Ashgate Pub. Co.
- Jöreskog, K. G. (1979). Statistical estimation of structural models in longitudinal development investigations. In J. R. Nesselroade & P. B. Baltes (Eds.), *Longitudinal research in the study of behavior and development* (pp. 303–352). New York: Academic Press.
- Jost, J. T. (2006). The end of the end of ideology. *American Psychologist*, *61*(7), 651–670. doi:10.1037/0003-066X.61.7.651
- Jost, J. T., Glaser, J., Kruglanski, A. W., & Sulloway, F. J. (2003). Political conservatism as motivated social cognition. *Psychological Bulletin*, *129*(3), 339–375. doi:10.1037/0033-2909.129.3.339
- Kline, R. B. (2011). *Principles and practice of structural equation modeling* (3rd ed.). *Methodology in the social sciences*. New York: Guilford Press.

- Landau, M. J., Solomon, S., Greenberg, J., Cohen, F., Pyszczynski, T. A., Arndt, J., ... (2004). Deliver us from Evil: The Effects of Mortality Salience and Reminders of 9/11 on Support for President George W. Bush. *Personality and Social Psychology Bulletin*, 30(9), 1136–1150. doi:10.1177/0146167204267988
- LeVine, R. A., & Campbell, D. T. (1972). *Ethnocentrism: theories of conflict, ethnic attitudes, and group behavior*. New York: Wiley.
- Little, T. D., Preacher, K. J., Selig, J. P., & Card, N. A. (2007). New developments in latent variable panel analyses of longitudinal data. *International Journal of Behavioral Development*, 31(4), 357–365. doi:10.1177/0165025407077757
- Li, W., Kelley, D., & Kennedy, J. (2003). *Summary of Vital Statistics 2002*. New York. Retrieved from <http://www.nyc.gov/html/doh/downloads/pdf/vs/2002sum.pdf>
- Marshall, R. D., Bryant, R. A., Amsel, L., Suh, E. J., Cook, J. M., & Neria, Y. (2007). The psychology of ongoing threat: Relative risk appraisal, the September 11 attacks, and terrorism-related fears. *American Psychologist*, 62(4), 304–316. doi:10.1037/0003-066X.62.4.304
- McArdle, J. J. (2009). Latent Variable Modeling of Differences and Changes with Longitudinal Data. *Annual Review of Psychology*, 60(1), 577–605. doi:10.1146/annurev.psych.60.110707.163612
- McCauley, C. (2007). Psychological Issues in Understanding Terrorism and the Response to Terrorism. In B. M. Bongar, L. M. Brown, L. E. Beutler, J. N. Breckenridge, & P. G. Zimbardo (Eds.), *Psychology of terrorism* (pp. 13–31). Oxford, New York: Oxford University Press.
- Meredith, W. (1993). Measurement invariance, factor analysis and factorial invariance. *Psychometrika*, 58(4), 525–543. doi:10.1007/BF02294825
- Morgan, G. S., Wisneski, D. C., & Skitka, L. J. (2011). The expulsion from Disneyland: The social psychological impact of 9/11. *American Psychologist*, 66(6), 447–454. doi:10.1037/a0024772
- Nacos, B. L., Bloch-Elkon, Y., & Shapiro, R. Y. (2007). Post-9/11 Terrorism Threats, News Coverage, and Public Perceptions in the United States. *International Journal of Conflict and Violence*, 1(2), 105–126.
- Oswald, D. L. (2005). Understanding Anti-Arab Reactions Post-9/11: The Role of Threats, Social Categories, and Personal Ideologies. *Journal of Applied Social Psychology*, 35(9), 1775–1799. doi:10.1111/j.1559-1816.2005.tb02195.x
- Pyszczynski, T., Abdollahi, A., Solomon, S., Greenberg, J., Florette, C., & Weise, D. R. (2006). Mortality Salience, Martyrdom, and Military Might: The Great Satan Versus the Axis of Evil. *Personality and Social Psychology Bulletin*, 32(4), 525–537. doi:10.1177/0146167205282157
- Pyszczynski, T., Solomon, S., & Greenberg, J. (2003). *In the Wake of 9/11: The Psychology of Terror*. Washington, DC, US: American Psychological Association.
- Reuband, K.-H. (2010). How People Learned About the September 11 Terrorist Attack and How It Affected Them: A Study in News Diffusion and Psychosocial Reactions in Germany. In T. Beckers, K. W. Birkelbach, J. Hagenah, & U. Rosar (Eds.), *Komparative empirische Sozialforschung. Anwendungsfelder und aktuelle Methoden in Best Practice-Studien* (1st ed., pp. 437–466). Wiesbaden: VS Verlag für Sozialwissenschaften.
- Riek, B. M., Mania, E. W., & Gaertner, S. L. (2006). Intergroup Threat and Outgroup Attitudes: A Meta-Analytic Review. *Personality and Social Psychology Review*, 10(4), 336–353. doi:10.1207/s15327957pspr1004\_4

- Schütz, H., & Six, B. (1996). How Strong is the Relationship Between Prejudice and Discrimination? A Meta-Analytic Answer. *International Journal of Intercultural Relations*, 20(3), 441–462.
- Shaheen, J. G. (2003). Reel Bad Arabs: How Hollywood Vilifies a People. *The Annals of the American Academy of Political and Social Science*, 588(1), 171–193.  
doi:10.1177/0002716203588001011
- Sherif, M. (1966). *In common predicament: Social psychology of intergroup conflict and cooperation*. Boston: Houghton Mifflin.
- Shurkin, J. N. (2007). Terrorism and the Media. In B. M. Bongar, L. M. Brown, L. E. Beutler, J. N. Breckenridge, & P. G. Zimbardo (Eds.), *Psychology of terrorism* (pp. 81–86). Oxford, New York: Oxford University Press.
- Smith, T. W., Rasinski, K. A., & Toce, M. (2001). *America Rebounds: A National Study of Public Response to the September 11th Terrorist Attacks*. Chicago. Retrieved from <http://www3.norc.org/NR/ronlyres/51AA73B5-EB68-4E2A-AC63-75D652AA7D41/0/pubresp.pdf>
- Solomon, S., Greenberg, J., & Pyszczynski, T. (2004). The Cultural Animal: Twenty Years of Terror Management Theory and Research. In J. Greenberg, S. L. Koole, & T. A. Pyszczynski (Eds.), *Handbook of experimental existential psychology* (pp. 13–34). New York: Guilford Press.
- Stephan, W. G., & Renfro, C. L. (2002). The Role of Threat in Intergroup Relations. In D. M. Mackie & E. R. Smith (Eds.), *From prejudice to intergroup relations. Differentiated reactions to social groups* (pp. 109–208). Hove: Psychology Press.
- Stephan, W. G., Renfro, C. L., & Davis, M. D. (2008). The Role of Threat in Intergroup Relations. In U. Wagner, L. R. Tropp, G. Finchilescu, & C. Tredoux (Eds.), *Social issues and interventions. Improving intergroup relations. Building on the legacy of Thomas F. Pettigrew* (pp. 55–72). Malden, MA, Oxford: Blackwell Pub.
- Stephan, W. G., & Stephan, C. W. (2000). An integrated threat theory of prejudice. In S. Oskamp (Ed.), *Reducing prejudice and discrimination* (pp. 23–45). Mahwah, N.J: Lawrence Erlbaum Associates.
- Steyer, R., Eid, M., & Schwenkmezger, P. (1997). Modeling True Intraindividual Change: True Change as a Latent Variable. *Methods of Psychological Research Online*, 2(1), 21–33.
- Stone, J., & Rizova, P. (2007). Re-thinking racial conflict in an era of global terror. *Ethnic and Racial Studies*, 30(4), 534–545. doi:10.1080/01419870701355959
- Talaska, C. A., Fiske, S. T., & Chaiken, S. (2008). *Legitimizing Racial Discrimination: Emotions, Not Beliefs, Best Predict Discrimination in a Meta-Analysis*.
- Traugott, M., Brader, T., Coral, D., Curtin, R., Featherman, D., Groves, R. (2002). How Americans Responded: A Study of Public Reactions to 9/11/01. *PS: Political Science & Politics*, 35(03). doi:10.1017/S1049096502000768
- Welch, M. (2006). *Scapegoats of September 11th: Hate crimes & state crimes in the war on terror*. New Brunswick, N.J: Rutgers University Press.
- Woods, J. (2011). The 9/11 effect: Toward a social science of the terrorist threat. *The Social Science Journal*, 48(1), 213–233. doi:10.1016/j.soscij.2010.06.001
- Yum, Y.-o., & Schenck-hamlin, W. (2005). Reactions to 9/11 as a Function of Terror Management and Perspective Taking. *The Journal of Social Psychology*, 145(3), 265–286. doi:10.3200/SOCP.145.3.265-286



**Manuscript #1:**

**Terrorist Threat, Prejudice, and Anti-Muslim Backlash. A Cross-National Poll Review for a Decade of Terrorism**

Stefan Thörner

Philipps-University Marburg, Germany

Peter Schmidt

Justus-Liebig-University Gießen, Germany and National Research University Higher

School of Economics, Moscow, Russia

Stefanie Gosen

Philipps-University Marburg, Germany

Submission date: March 19, 2014

Under review in *Journal of Social and Political Psychology*

**Abstract**

After the terrorist attacks of September 11, 2001 (9/11), many Muslims in the US became victims of a wave of backlash hate crime including arson attacks on mosques, violent discrimination and even murders. Based on social psychological threat theories, we derived a model hypothesizing that terrorist threat leads to prejudice and discrimination of Muslims. We applied this model to those three Western countries which faced major terrorist attacks in the last decade (US, Spain, UK) and one yet unaffected country (Germany). We reviewed various data sources, mainly opinion polls, covering the years 2000 to 2012, to assess the impact of major terrorist attacks and minor terrorist events on threat perceptions and scapegoating of Muslims. Results showed that the 9/11 attacks led to international spillover effects with increasing threat perceptions and derogation of Muslims in all focus countries. The attacks on the UK in 2005 induced a substantial increase in Islamophobia in all European countries considered. Nevertheless, the global pattern of results indicated that the predictions of the model were subject to marginal conditions on country level. We discuss those marginal conditions that inhibit or facilitate scapegoating of Muslims and gather promising strategies to avoid backlash in case of further terrorist attacks.

**Keywords:** 9/11, Backlash, Poll Review, Terrorism, Threat, Islamophobia, Discrimination

*“Some Muslims blew up the Twin Towers. [...]*

*You are kidding me. [...]*

*No, I’m not kidding you. You Muslims blew up the Twin Towers.”*(Barkdull et al., 2011, p. 144)

The consequences of the terrorist attacks on September 11, 2001 (9/11), were devastating and wide-reaching for US citizens as well as the international community. Sharing the attackers’ religion, the effect on Muslims of the Western World was immense on an entirely different level, when the association of Islam and Terrorism was made (Allen & Nielsen, 2002; Barkdull et al., 2011; Doosje, Zebel, Scheermeijer, & Mathyi, 2007; Sheridan, 2006). The outgroup ‘Muslims’ became an easy target as scapegoats for the attacks. An increase in hate crimes against Muslims in the US of about 1,600% was registered in 2001 (FBI, 1998-2011). This backlash included arson attacks against mosques, violent assaults, and climaxed in several murders (Ibish, 2003; Kaplan, 2006).

A number of consequences of last decades’ Islamist terrorism for Western societies are well researched (see Morgan, Wisneski, & Skitka 2011 and Woods 2011 for an overview in social sciences). The psychological fields of interest included posttraumatic stress (e.g., Galea et al., 2002; Laugharne, Janca, & Widiger, 2007; Marshall et al., 2007; Rubin et al., 2007), developments in political attitudes concerning support for war, increased security and anti-terror measures and support for President Bush (e.g., Huddy & Feldman, 2011; Huddy, Feldman, Taber, & Lahav, 2005; Landau et al., 2004), the role of the mass media (e.g., Birkland, 2004; Carey, 2003), and the media’s impact on perceived threat and prejudice (Das, Bushman, Bezemer, Kerkhof, & Vermeulen, 2009; Nacos, Bloch-Elkon, & Shapiro, 2007). Although some substantial research (Oswald, 2005) and documentation about anti-Muslim

backlash (Ibish, 2003; Kaplan, 2006; Panagopoulos, 2006) is available, no overview about attitude and behavior changes towards Muslims in Western societies is accessible. We want to close this gap with this poll review.

Terrorism is a form of communication aiming to create a climate of threat by randomly attacking civilians (Weimann, 2008). Terrorists make use of people's vulnerability and mass media's distribution of violence to spread threat (Breckenridge & Zimbardo, 2007; Nacos et al., 2007; Shurkin, 2007). The role of threat is well researched and is expressed for example in Integrated Threat Theory (ITT; Stephan & Renfro, 2002; Stephan & Stephan, 2000): it leads to ingroup favoritism and increased prejudice in general (Riek, Mania, & Gaertner, 2006). The threat occurring in mainstream society through Islamist terrorism and its broadcasting may thus create or deepen existing prejudices against Muslims (Das et al., 2009). Furthermore, as theorized by Stephan & Renfro (2002) 'prejudice' is also predictor of the behavior 'discrimination' (Dovidio, Brigham, Johnson, & Gaertner, 1996; Schütz & Six, 1996; Talaska, Fiske, & Chaiken, 2008). The violent backlash against Muslims after 9/11 may thus be the product of the described threat-prejudice-discrimination process (Oswald, 2005).

Figure 1. Perceived threats in the EU before and after 9/11

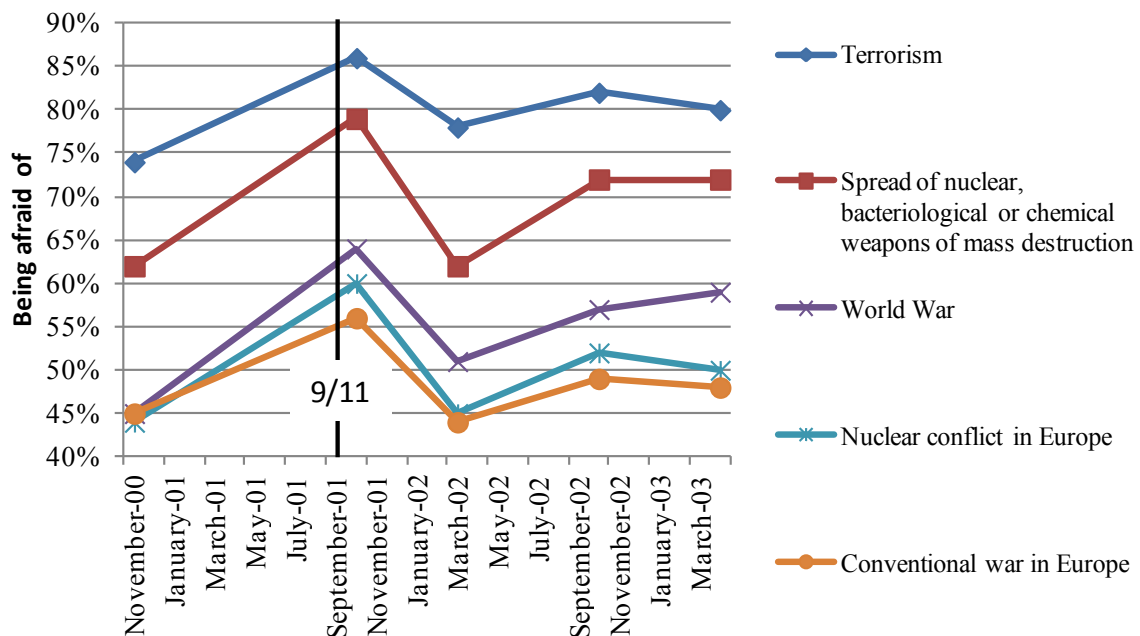

*Note.* Data source: Eurobarometer (54, 56-59). Cross-sectional, EU (15) averaged, adult population data. Question Wording: Here is a list of things that some people say they are afraid of. For each of these, please tell me if, personally, you are afraid of it, or not?

Figure 1 shows the development of EU-citizens' fear of terrorism and war. The clear-cut peak in October 2001 emphasizes that Europeans also felt a massive threat from the new phenomenon of international Islamist terrorism. Thus, the questions arises whether 9/11 initiated the above theorized process in the US and likewise in European countries and whether this effect can also be found for other terror related events. Therefore, our main research question is whether we can find parallel fluctuations on aggregate mean level over time in perceived terrorist threat, anti-Muslim prejudice and (violent) discrimination across different countries and different major Islamist terrorist attacks and minor terrorist related events. We focused on the major terrorist attacks of September 11, 2001 (9/11) in the United States of America (US), March 11, 2004 (11-M) in Spain, July 7, 2005 (7/7) in the United Kingdom (UK) and several minor terror related events. In addition to the target countries US,

Spain and UK, Germany was chosen to evaluate the effects on a country that faced no major attack yet.

This paper reexamines and reviews various public opinion polls, scientific polls, official- and NGO-reports, and several studies from the US and Europe. We provide a number of time series, covering the years 2000 to 2012. These time series enable us to analyze the strength of impact and its longevity, which often has to remain unconsidered in experimental and cross-sectional research.

**Major Islamist Terror-Attacks.** Although the US has previously been victim of different forms of terrorism, the attacks on September 11, 2001 (9/11) were unique in their magnitude. Four airplanes were hijacked by Al-Qaeda terrorists. Two planes crashed into the World Trade Center (WTC) in New York City, one into the Pentagon in Arlington and another one crashed on a field near Pittsburgh. Approximately three thousand people were killed on that day (Li, Kelley, & Kennedy, 2003; Woods, 2011). A second major attack in the Western World targeted Madrid, the capital of Spain. Ten bomb blasts in four commuter trains left 191 people dead and 2051 injured on March 11, 2004 (11-M). A third major Islamist terror-attack hit London on July 7, 2005 (7/7). Four suicide bombers attacked three underground trains and a double-decker bus. In total, 52 civilians were killed and more than 700 were injured.

### **Theory Overview**

**Scapegoating of Minorities.** When the Black Death broke out in Europe in the 14th century, Jews were suspected of poisoning food and drinking water. The fact that Jews also died from the plague did not convince the majority to stop victimizing Jews as the scapegoats: Across Western Europe, Black Death pogroms against Jews took place (Cohn, 2007). This can be explained by a general need to envision a collective enemy. Often, this is a preformed

group that can be held responsible. Becker, Wagner, & Christ (2011) demonstrate this phenomenon as a consequence of the 2008 worldwide economic crisis. They show that threat, elicited by the crisis, is related to ethnic prejudice when respondents believe immigrants are the cause, and prejudice against Jews when respondents believe bankers and speculators to be the cause. Likewise Allport (1979/1954) explains the choice of a group as “the scapegoats” by contemporary circumstances (see also Glick, 2002, 2005). Consequently, current events and problems of the majority need to be considered. On September 11, 2001, pictures of Palestinians who allegedly celebrated the death of thousands of Americans were broadcasted all over the world (FoxNews.com, 2001). Fueled with the knowledge of the terrorists being Muslims, these pictures deepened the negative image of citizens with Islamic faith in general. Thus, Muslims became the scapegoats of the attacks (Cesari, 2004; Welch, 2006).

**Terrorist Attacks, their Broadcasting and Perceived Threat.** The broadcasting of the 9/11 disaster was unique in its international broadcasting. Already seven minutes after the first tower was targeted, the media broadcasted live pictures in Germany (Reuband, 2010). Pictures of help-seeking people on the floors above the impact and falling bodies were made public. The whole world followed this horrifying situation via television. When the first tower collapsed, viewers realized that hundreds of people were dying that very minute. The news of the attack spread rapidly. For both, the US and Germany, data suggests that two hours after the first attack, 90% of respondents in flash polls had heard about the catastrophe (Carey, 2003; Reuband, 2010).

No media templates existed for such a happening as 9/11 (Hoskins, 2006). Media templates are attempts to classify the current incident in context of previous events. Neither the media nor the citizens had means of comparison for 9/11, rescaling their experience of evilness. Especially the post-attack insecurity was unparalleled. Major concerns were: “Are there more attacks to come? Was it only the beginning of a war against the US or even against

the whole Western World? Are we facing a World War? Do terrorists have weapons of mass destruction?" (see also Figure 1 for Europe). Consequently, the attacks and their broadcasting caused a climate of insecurity, fear and threat (Huddy, Feldman, Lahav, & Taber, 2003; Nacos et al., 2007). The impact of TV broadcasting in these days can be grasped by the fact that the exposure rate to television news in the week after 9/11 proved to be a predictor of experiencing posttraumatic stress disorder (Ahern, Galea, Resnick, & Vlahov, 2004). However, not only posttraumatic stress can be the consequence of terrorist news reports, also increased prejudice against outgroups can occur (Das et al., 2009).

**Threat, Prejudice, and Discrimination.** *"One of the most pervasive and powerful effects of threat is to increase intolerance, prejudice, ethnocentrism, and xenophobia, regardless of whether threat is defined as a widely acknowledged external force or a subjective, perceived state."* (Huddy et al., 2005, p. 594)

Several theories are built on the idea of intergroup threat creating hostility and bias between groups (see Riek et al. 2006 for a meta-analysis). Realistic group conflict theory (RCT; Sherif & Sherif, 1969) is one of the first theories to consider intergroup threat as a predictor for intergroup conflict (see also (Blumer, 1958). RCT focuses on the competition between groups concerning scarce resources. If a dominant ingroup feels that a subordinate outgroup increases its demands, the ingroup reacts with a devaluation of the outgroup in terms of negative attitudes.

Stephan and Stephan (2000) incorporated several threats into their integrated threat theory (ITT). This theory considers realistic and symbolic threat and stereotypes to explain the emergence of prejudices (see also Stephan & Renfro, 2002). In ITT realistic threat is understood as any threat to the welfare of the group or its members (Stephan & Stephan, 2000, p. 25). This broader definition also covers the threat imposed by terrorism. Furthermore, Islamist terrorism increases the salience of differences between Western and



Islamic cultures which produces symbolic threat. Additionally, Muslims suffer from the negative portrayal in mass media in Western countries, which leads to a socialization of negative stereotypes in the autochthonous majority (Jaspal & Cinnirella, 2010; Shaheen, 2003).

In addition to the well-established link between threat and prejudice, we refer to the link between the attitude ‘prejudice’ and the behavior ‘discrimination’ (see Schütz & Six, 1996; Talaska et al., 2008, for meta-analyses; Dovidio et al., 1996). Pereira, Vala and Costa-Lopes (2010) find threat to mediate the link between prejudice and discrimination. They conclude that threat is a legitimization and justification to discriminate others (see also Pereira, Vala, & Leyens, 2009). In the same way, Wagner and Christ (2007) show that prejudice is an important determinant of readiness of violence and that this effect is mediated and moderated by anger and fear.

Figure 2. Theoretical macro-micro model.

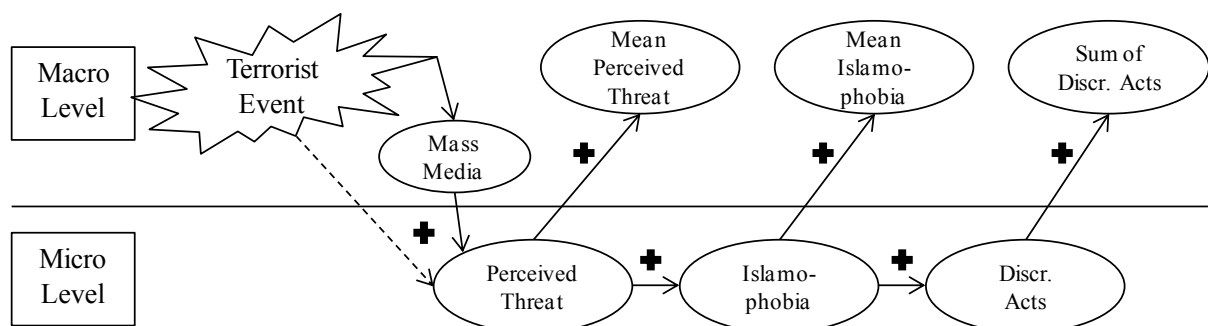

*Note.* This model is not tested in this study. The focus lies on the outcome measures on the macro level (mean perceived threat, mean Islamophobia, and sum of discriminatory acts).

In summary, as the backlash showed, the outgroup ‘Muslims’ became the scapegoats after 9/11 because of their similarity to the attackers. In Figure 2, we conceptualized a simplified heuristic model showing the assumed relations. On the macro level threat was

spread via nonpareil broadcasting of the attacks. What followed was a situation of general insecurity. Prevailing psychological theorizing on micro level suggests that threat, prejudice and discrimination are intertwined, with threat being the cause and prejudice and discrimination the consequences. These assumed changes on individual level should cause a measurable effect on aggregate mean (macro) level (see Coleman, 1986, 1987 for a micro-macro theory and model).

In the four studies of this paper, we listed the terrorist events of each country, analyzed the available, independent, aggregate level time series of terrorist threat, Islamophobia (prejudice) and discrimination, and checked whether the occurring patterns fit our heuristic model. However, a strict test of the model was not realizable with the available data.

### **Study 1: United States**

The US faced several terrorist attacks before 9/11. For instance, in early 1993 a car bomb exploded in the underground garage of the WTC. Six people were killed that day. In April 1995, autochthonous terrorists destroyed the Murrah Federal Building in Oklahoma and left 168 people dead. However, the attacks of 9/11 were unprecedented in their magnitude. Our time series start in the year 2000. The events considered as threat-trigger are in chronological order: 9/11 (September 2001), the intrusion into Iraq (March 2003), the Madrid Bombings 11-M (March 2004), the London attacks 7/7 (July 2005) and the assassination of Osama Bin-Laden (May 2011). Referring to our heuristic model, we assume these events and their broadcasting to increase terrorist threat, anti-Muslim prejudice and violent discrimination of Muslims, at least temporarily.

Table 1. Data Time Series US

Dimension	Data Source	Time Span Used (Measurement Points)	Kind of Data	Applicable Analysis
Threat:	USA Today/ Gallup Personal Threat	Apr. 2000 – Aug. 2011 (40)	quantitative	descriptive
	USA Today/ Gallup Collective Threat	Sept. 2001 – Aug. 2011 (29)	quantitative	descriptive
Islamophobia:	Princeton Survey Research Associates (PSRA)	Aug. 2000 – June 2003 (5)	quantitative	ANOVA
	The PEW Forum on Religion and Public Life (PEW)	Mar. 2004 – Mar. 2011 (7)	quantitative	ANOVA
Discriminatory Acts:	Federal Bureau of Investigation (FBI)	Annual sum 1998-2011 (12)	quantitative	descriptive

**Data and Methods.** Table 1 gives an overview about the data used to create the time series figures for the US. In some cases there is data available earlier conducted than the year 2000, which is not considered here for reasons of space. This is the case for terrorist threat monitoring, where Gallup and USA Today started to investigate concerns for terrorism in the population after the terrorist attacks on the Murrah Federal Building in Oklahoma in April 1995 (USA Today/Gallup Poll, 2011): “Now, thinking for a moment about terrorism, how worried are you that you or someone in your family will become a victim of terrorism - very worried, somewhat worried, not too worried, or not worried at all?” This question covers personal terrorist threat. The data includes also the aspect of collective terrorist threat which is the degree of agreement to the question “how likely is it that there will be acts of terrorism in the United States over the next several weeks - very likely, somewhat likely, not too likely, or not at all likely?” Sample sizes are  $N \approx 1000$  each. For both questions Gallup provides the distributions of these four categories. Thus, we were able to calculate means. The scale ranged from 1 to 4 and was recoded to transform high threat perceptions into high scores.

We correlated collective and personal threat time series to see whether they show the same developmental pattern. Only aggregate scores for polls conducted on approximately the

same dates were considered for this analysis. This resulted in N=20 simultaneous measurement points that could be correlated over time. The time series correlate with  $r=.549$ ,  $p<.01$ . We conclude personal and collective terrorist threat to be sufficiently equal on aggregate level over time. Thus, we refer in the results part to ‘threat’ only and do not differentiate between personal and collective threat (but see Asbrock & Fritsche, 2013; Huddy, Feldman, Capelos, & Provost, 2002, for studies differentiating personal and collective terrorist threat on individual level).

Princeton Survey Research Associates (PSRA) provide data on the unfavorability of Muslim-Americans (see Panagopoulos, 2006). Their question wording is: “Is your overall opinion of Muslim Americans, very favorable, mostly favorable, unfavorable, or very unfavorable?” Five measurement points are available, starting in August 2000, thus providing a pre-9/11 measure. The last data point is in March 2003. The Ns range from 2799 to 1500 (average N = 2069). Data is weighed to be representative for the national adult population. Since the distributions of the data are available we were able to compute means and confidence intervals and apply variance analyses with Bonferroni post-hoc tests.

The PEW Global Attitudes Project asks for the favorability of religious groups in several countries including the US (PEW Global Attitudes Project, 2004-2011; PEW Global Attitudes Project, 2008). For the US-American, adult population, cross-sectional probability samples were drawn starting in 2004 with an approximate N of 1000. Data was either representative for the 18+ adult population or weighed to be representative. The question wording was: “Please tell me if you have a very favorable, somewhat favorable, somewhat unfavorable or very unfavorable opinion of Muslims.” Raw data was provided on the PEW homepage ([www.pewglobal.org/category/datasets](http://www.pewglobal.org/category/datasets)) which enabled us to compute variance analyses with Bonferroni post-hoc tests.

Due to different question wording in the PSRA data (target group: Muslim Americans) and PEW data (target group: Muslims), the timelines are not comparable in terms of their absolute level. Hence, we test for mean differences within the PSRA times series and within PEW time series but do not compare the level of agreement between PSRA and PEW data.

The “Hate Crime Statistics” of the FBI, which also records Anti-Islamic hate crimes (FBI, 1998-2011), provides a valuable database for discrimination occurrence. ‘Hate Crime’ is defined here as “criminal offense against a person or property motivated in whole or in part by an offender’s bias against a race, religion, disability, ethnic origin or sexual orientation.” (FBI, 2013) From this data we created a time series. A limiting factor is that only aggregate data per year is provided. Thus, no short-term fluctuations are observable. Further data is provided by NGOs: the American-Arab Anti-Discrimination Committee (Ibish, 2003; Ibish, 2008) and the Human Rights Watch (2002).

For all data throughout this paper, cross correlations between the independent time series of threat, prejudice and discrimination but also time series modeling (e.g., Box, Jenkins, & Reinsel, 2008) were inappropriate analysis methods because of different times of conduction and varying time lags.

## **Results**

**Threat.** Figure 3 shows the time series of personal and collective threat as well as the unfavorability of Muslims and Muslim-Americans, respectively. The pre-post 9/11 comparison revealed a massive shift towards a threatening climate. Also, the intrusion into Iraq led to an increase in threat. No polls were available for the immediate phase after 11-M and the four months after. The increase in threat in response to 7/7 was also consistent with our model. Since then the measurement points have been scarce with the last peak in the direct aftermath of the assassination of Bin-Laden.

Figure 3. Time series of terrorist threat and Islamophobia in the US

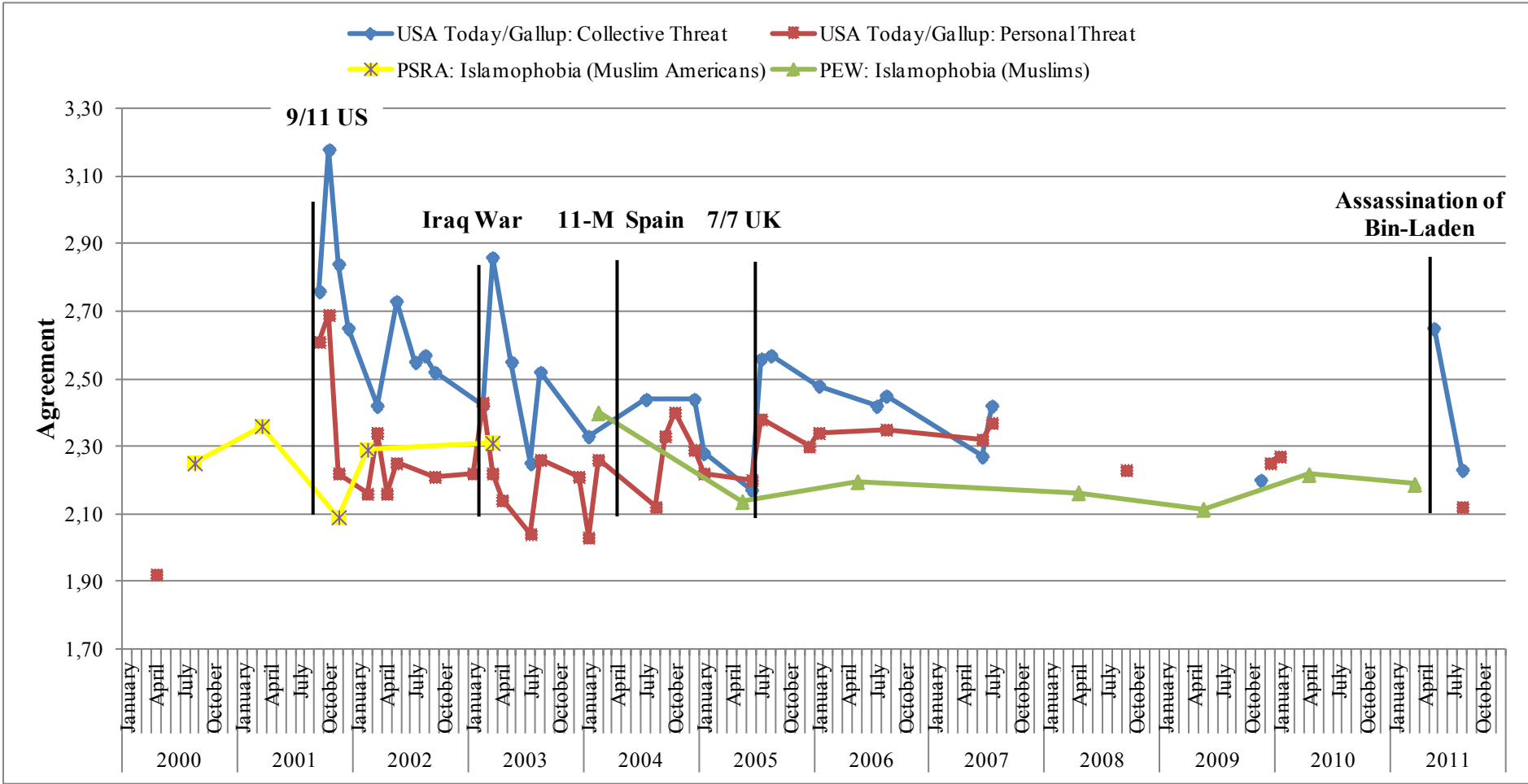

Note. Data source: Gallup time series of terrorist threat and PSRA & PEW unfavorability of Muslims. Cross-sectional, adult population data.

Gaps in threat data of more than one year are not connected with lines.

**Prejudice.** We tested whether changes in prejudice were in line with the fluctuations in threat. Two PSRA pre-9/11 measures of unfavorability of Muslim Americans were available. Both were on a higher level than the first post-9/11 measure in November 2001. Thus, contrary to the development of threat, Islamophobia decreased in response to 9/11 (March-01 vs. November-01;  $p < .001$ ). In February 2002, however, the score increased to the pre-9/11 level again (November-01 vs. February-02;  $p < .001$ ). No fluctuation can be seen in response to the intrusion into Iraq (February-02 vs. March-03;  $p > .05$ ) although threat was increased. The PEW data starting point in 2004 shows the highest level of unfavorability in that time series. Since 11-M is not covered in terms of threat monitoring, we had no assumption about the development of Islamophobia in the post 11-M measure 2005. We found prejudice decreased (February-04 vs. April-05;  $p < .001$ ) followed by a small but insignificant increase in the year after 7/7 (April-05 vs. April-06;  $p > .05$ ). After that point, prejudice remained mainly stable until 2011.

Figure 4. Number of registered anti-Islamic hate crimes in the US 1998-2011

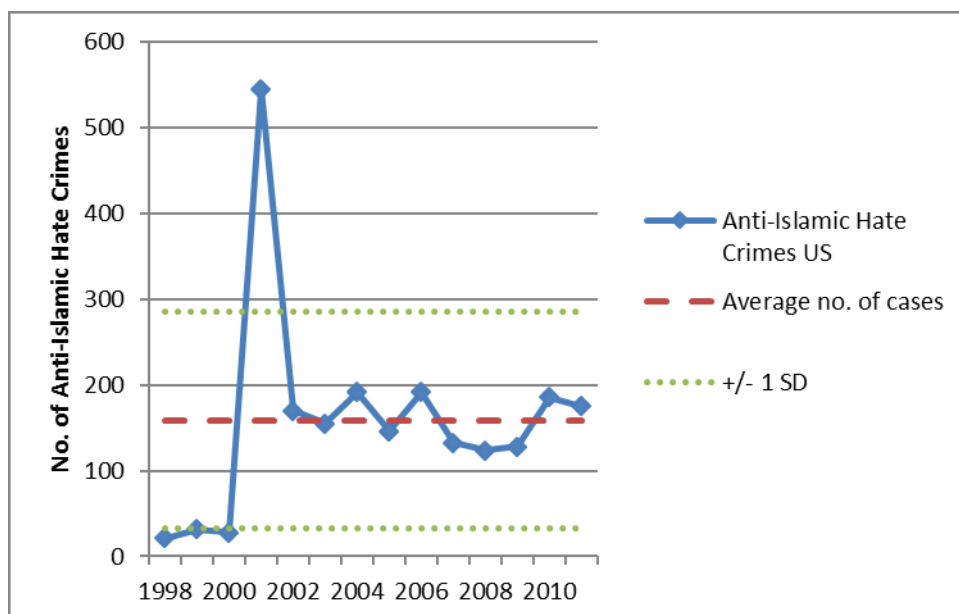

*Note.* Data source: FBI hate crime statistics (FBI, 1998-2011)

**Discrimination.** The third variable in our model supposedly affected by the attacks is discrimination. We plotted the number of Anti-Islamic hate crimes and their standard deviation to Figure 4 in order to visualize deviations. Anti-Islamic hate crimes were isolated cases prior to 9/11. In 2001 a massive increase in anti-Islamic hate crimes occurred compared to 2000. Although we could not find the supposed increase in prejudice, a clear-cut increase in violent discrimination took place. More than five hundred cases were registered for 2001 in the FBI database. Human Rights Watch stated: *"Over the past twenty years backlash hate crimes against Arabs and Muslims in the United States have become predictable, triggered by conflict in the Middle East and acts of terrorism associated with Arabs or Muslims. The hate crimes that followed the September 11 attacks nonetheless were unique in their severity and extent."* (Human Rights Watch, 2002, p. 3) The American-Arab Anti-Discrimination Committee reported on more than 700 violent incidents targeting Arab Americans, Arabs, Muslims and those who were perceived to belong to these groups in the first nine weeks after 9/11. More than a hundred attacks against mosques and even four murders were registered; seven more murders of Muslims are suspected to be directly related to the attacks (Ibish, 2003).

In 2002, the number of incidents decreased to a lower but still increased level, compared to the years prior. Interestingly, the score remained on that level without any substantial deviations. This is the reason why we do not discuss these minor deviations for the following terrorist events separately. We conclude that only 9/11 led to an increase in hate crimes. These results were emphasized by the fact that no report mentions a further violent backlash in the US in response to another terrorist event.

**Summary and Discussion.** We theorized a model in which perceived terrorist threat, anti-Muslim prejudice and discrimination should increase in response to terror related events. We found perceived terrorist threat reaching its peak after 9/11. However, anti-Muslim



prejudice did not follow the pattern of threat. Even an opposite effect as theorized was measured in response to 9/11. We believe the significant decrease in unfavorability to be a short- to mid-term consequence of President Bush's speech on September 20, 2001 where he called for differentiation: *"The enemy of America is not our many Muslim friends. It is not our many Arab friends. Our enemy is a radical network of terrorists and every government that supports them."* (CNN, 2001). A PEW report reveals that after the speech, the strongest shift towards favorability was seen amongst conservative republicans (PEW Research Center, 2001). Whereas in March only 35% conservatives republicans had a favorable image of Muslim-Americans, in November 64% (+29%) positioned themselves that way. That Bush's speech led to a short- to mid-term effect was further supported by the fact that aggregated unfavorability returned to a significantly higher level in February 2002. In terms of violent discrimination, 9/11 led to a massive backlash against Muslims and people who looked similar (Kaplan, 2006). The pattern of increased threat, decreased prejudice and increased discrimination does not fit our model. We refer to this pattern in our general discussion.

The Iraq invasion had no impact on prejudice, although threat perceptions increased. Discrimination was not elevated in that year. This can be explained by the fact that the US was not directly threatened at that point but was attacking another country. Thus, the situation was not as emotional as the victim role after 9/11. The terrorist attacks on Spain did not affect Americans as much, either. Prejudice, measured with a large gap, shows a significant decrease in 2005, almost a year after 11-M. The fact that the poll institutions did not survey terrorist threat after 11-M is already an indication for the modest public interest in the happenings in Spain. Accordingly, no increase in discrimination was registered.

Since the link between the US and UK is stronger than between the US and Spain, the 7/7 consequences were polled and revealed a local peak in threat. The pre-post 7/7 measure of prejudice showed indeed a modest increase, which however, reached no significance.

Furthermore, the FBI hate crime statistics showed a level of anti-Muslim crime below the average. Thus, again no violent backlash was observed.

## Study 2: Spain

Spain was the first European country subjected to a massive Islamist terrorist attack. One has to consider, however, the existence of an active separatist terror organization in Spain (Euskadi Ta Askatasuna (ETA) = Basque Fatherland and Liberty). Consequently, terrorist threat cannot always be allocated to Islamist terror.

In March 2003, the ‘Coalition of the Willing’, including Spain, marched into Iraq. In fall 2010, a terror warning for central Europe, mainly France, the UK and Germany was issued by officials (Der Spiegel, 2010; Tisdall, 2010). Since terror warnings have not been as common as in the US, we assume the warning to have triggered perceived terrorist threat. Further expected threat triggers were 9/11 (Sept. 2001), 11-M (Mar. 2004), 7/7 (July 2005) and the assassination of Bin-Laden (May 2011).

Table 2. Data Time Series Spain

Dimension	Data Source	Time Span Used (Measurement Points)	Kind of Data	Applicable Analysis
Threat:	Eurobarometer Threat Old	Nov. 2000 – Apr. 2003 (5)	quantitative	descriptive
	Eurobarometer Threat New	Apr. 2003 – Nov. 2012 (20)	quantitative	descriptive
Islamophobia:	Echabarria-Echabe & Fernández-Guede 2006	Feb. 2004 – Mar. 2004 (2)	quantitative	narrative
	The PEW Forum on Religion and Public Life (PEW)	May. 2005 – Mar. 2011 (6)	quantitative	ANOVA
Discriminatory Acts:	European Monitoring Center on Racism and Xenophobia (EUMC)	Sept. 2001 – Dec. 2001 July 2005 – Sept. 2005	qualitative	narrative

**Data.** Since 1973, the European Commission has ordered public opinion reports. The so called Eurobarometer is conducted two times per year (European Commission, 1995-2012) and consists of approximately one thousand face-to-face interviews with a representative 15+ aged sample of each country of the EU. Among standard questions, there is also space for situation specific questions like current fears and problems. Two time series were created from Eurobarometer Interactive Search System data (European Commission, 2013): first, data about Europeans' fear of terrorism, spread of weapons of mass destruction, a world war, a nuclear or conventional conflict in Europe (see Figure 1 for EU level results), reaching from 2000 to 2003 (labeled 'threat old'), thus covering 9/11; second, the well-known Gallup question "what is the most important problem facing the nation" with the possible answer 'terrorism' (labeled 'threat new'). The data concerning this question is available from 2003 until 2012 and hence covers 11-M and 7/7. Both aspects serve as proxies for terrorist threat. The Eurobarometer no. 61 provides particularly important data because the time of data conduction includes 11-M. However, only 73 respondents were surveyed after the attack (vs. 927 before). We nevertheless provide results for both groups (pre & post) because they do not differ systematically in terms of socio demographics which means that also the post-sample is representative (Perrin & Smolek, 2009). Generally, we had to transform Eurobarometer data linearly to fit it to our 1 to 4 scale. Threat 'new' and 'old' are not comparable in terms of mean level.

As for the US (Study 1), Islamophobia is covered by PEW data that measures the unfavorability of Muslims (PEW Global Attitudes Project, 2004-2011; PEW Global Attitudes Project, 2008). They only deviate from the US data in terms of smaller sample sizes. Number of observations range from 750 to 1000 (average  $N = 831$ ; for further information and question wording see the PEW data description in Study 1). Monitoring of unfavorability of Muslims started in Spain in 2005, the year after 11-M. Thus, no pre-post attack comparisons

can be made for Spain with PEW data. However, Echebarria-Echabe and Fernández-Guede (2006) provide a pre-post 11-M design with Islamophobia as a dependent variable.

The European Monitoring Centre for Racism and Xenophobia (EUMC; since 2007 European Union Agency for Fundamental Rights; FRA) recognized the seriousness of the 9/11 attacks in terms of consequences for Muslims in Europe. Therefore, it ordered reports from its Racism and Xenophobia Network (RAXEN), mainly built upon nongovernmental organizations (Allen & Nielsen, 2002; EUMC, 2001). A similar study is available for the impact of the 7/7 attacks on Muslim communities (EUMC, 2005).

Due to different definitions of hate crimes in the EU member states and a resistance to collect data about religious identity is gathering official racist or hate crime data a difficult undertaking in the EU (see e.g., EUMC, 2006). Existing data is not specific for religion, except for anti-Semitic incidents (FRA - European Union Agency for Fundamental Rights, 2012) and some time series are not reliable due to changes in data collection. Only qualitative data is provided by several NGOs applying their own standards on discrimination and hate crimes (e.g., Human Rights Watch, 2005). As a consequence of the different definitions of hate crime and the unsystematic data collection in the EU countries, no national hate crime or discrimination time series could be generated.

## Results

Figure 5. Time series of terrorist threat and Islamophobia in Spain

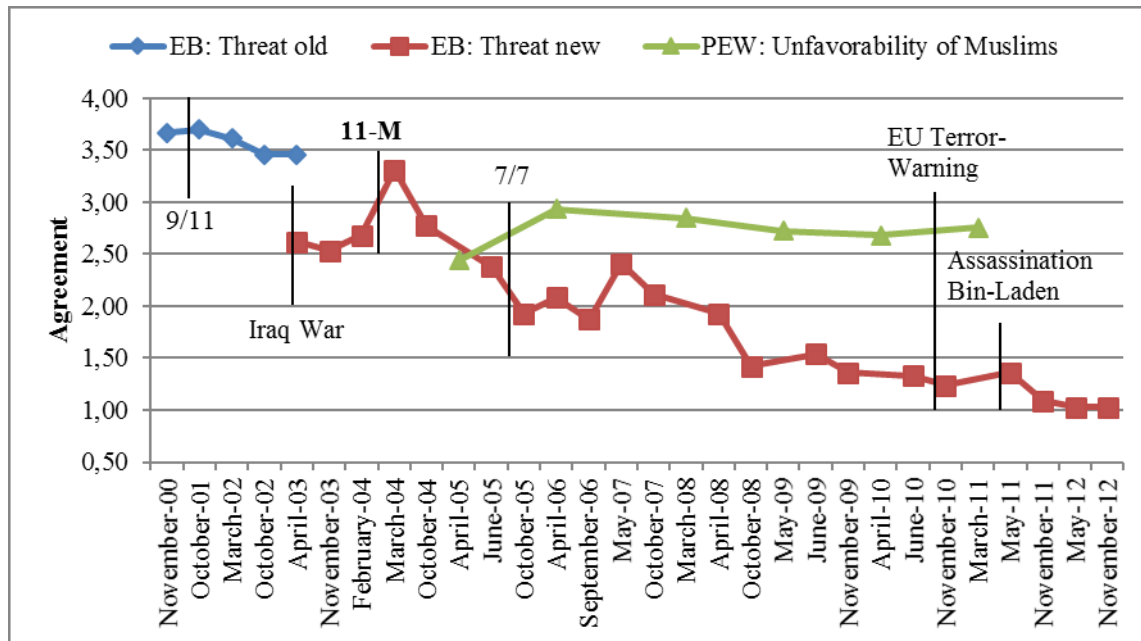

*Note.* Data source: Eurobarometer threat measures and PEW unfavorability of Muslims measures. Cross-sectional, adult population data.

**Threat.** Figure 5 shows the time series of old and new terrorist threat and of unfavorability of Muslims. Congruent with our hypothesis, an increase in threat was observed after 9/11. This increase does not seem to be a short-term effect since the score remained on a higher level until the last measurement point of ‘old threat’ in April 2003. The intrusion into Iraq led to no change in threat. In consequence of 11-M, threat peaked but was decreased again in October 2004. Since then, the scores have been on a lower level, unaffected by 7/7. Apart from an increase in May 2007, the threat level decreased until 2010. No effect in response to the EU terror-warning was measured while there was a small increase after the assassination of Bin-Laden.

**Prejudice.** No systematic Islamophobia monitoring can be found in Spain before 2005, thus we could not test for the impact of 9/11 and the intrusion into Iraq. This was also the case for the attack on Spain, 11-M. However, Echebarria-Echabe and Fernández-Guede (2007) coincidentally tested a new Islamophobia scale shortly before the attacks. By replicating the sample after 11-M, they created a natural quasi-experiment and showed a significantly increased score for Islamophobia post 11-M (Echebarria-Echabe & Fernández-Guede, 2006). Representative PEW measures did not start until 2005. We expected to find an increased level in the post 11-M year, followed by a declining trend, especially because this was the developmental pattern of threat. In contrast to this expectation, the value peaked in 2006 (April-05 vs. April-06;  $p < .001$ ). A declining trend started afterwards, discontinued by a negligible increase in 2011 after the EU terror warning (April-10 vs. March-11;  $p > .05$ ).

**Discrimination.** Due to the lack of systematic data, only qualitative results gathered from reports can be presented here. The EUMC *Summary Report on Islamophobia in the EU after 11 September 2001* (Allen & Nielsen, 2002) reveals an increase in prejudice and discrimination, mostly lacking concrete numbers. Allen and Nielsen (2002) reported attacks on mosques, Muslims and even one murder, whereas a direct link to 9/11 is unclear. Thus, the impact of 9/11, in terms of discrimination of Muslims in Spain, remains vague. Since threat and prejudice (Echebarria-Echabe & Fernández-Guede, 2006) increased after 11-M, we expected to find an anti-Muslim backlash. In fact, a EUMC report (2006, pp. 71–72) reveals several violent acts on persons and property (but see Human Rights Watch, 2005). The magnitude of the backlash, however, was not comparable to that of 9/11 in the US. Several minor attacks took place, but serious crimes, mostly committed by Neo-Nazis, were also registered. Whereas threat decreased and prejudice increased after 7/7, no hints of anti-Muslim backlash can be found.

**Summary and Discussion.** We applied our heuristic model to Spain, facing not only the first Islamist terror attack on European ground but also the danger of an autochthonous terror organization. In terms of terrorist threat, we find an increase after 9/11, as expected. In concordance with our model qualitative reports indicate increases in prejudice and discrimination against Muslims. In contrast to the immediate backlash in the US, the reported increases in prejudice and discrimination in Spain were registered with some delay. The first EUMC report (2001), covering the period from September 11 to late November 2001, shows no anti-Islamic reactions. The summary report of May 2002, however, states an increase in prejudice and discrimination (Allen & Nielsen, 2002). Even one murder is believed to be a backlash hate crime of 9/11.

Threat peaked after 11-M. In terms of prejudice, we have to rely on the finding of Echebarria-Echabe and Fernández-Guede (2006) who report not only an increase in Islamophobia but also in anti-Semitism and general authoritarian tendencies. This suggests a general devaluation of outgroups in response to the attacks. However, their small and unrepresentative sample renders a limiting factor.

Spain remained unaffected by 7/7 in terms of threat. However, a contrary development for prejudice was observed. The first measure after 7/7, in April 2006, reveals a significantly increased level of Islamophobia (April-05 vs. April-06;  $p < .001$ ). An increase in hate crimes could not be found in this context.

### **Study 3: United Kingdom**

The UK, United States' closest ally in the war against terror became the third target of a major Islamist terror attack in July 2005 (7/7). Furthermore, the UK faced another serious terror attempt in August 2006, when Islamist terrorists tried to smuggle explosives into ten

planes in London. The Police was able to avert this plan and arrest the terrorists (BBC News, 2006). Nevertheless, we assume this foiled attack induced threat in the still traumatized country. Chronologically, we suppose 9/11 (Sept. 2001), the intrusion into Iraq (March 2003), 11-M (March 2004), 7/7 (July 2005), the Airline terror plot (Aug. 2006), the EU terror warning (Oct. 2010) and the assassination of Bin-Laden (May 2011) to have triggered perceived threat and subsequently anti-Muslim prejudice and discrimination in the UK.

Table 3. Data Time Series UK

Dimension	Data Source	Time Span Used (Measurement Points)	Kind of Data	Applicable Analysis
Threat:	Eurobarometer Threat Old	Nov. 2000 – Apr. 2003 (5)	quantitative	descriptive
	Eurobarometer Threat New	Apr. 2003 – Nov. 2012 (20)	quantitative	descriptive
Islamophobia:	The PEW Forum on Religion and Public Life (PEW)	Mar. 2004 – Mar. 2011 (7)	quantitative	ANOVA
Discriminatory Acts:	European Monitoring Center on Racism and Xenophobia (EUMC)	Sept. 2001 – Dec. 2001 July 2005 – Sept. 2005	qualitative	narrative
	London Metropolitan Police (MET)	Jun. 2005 – Sept. 2005 (13)	quantitative	descriptive

**Data.** For the UK, mainly the same database was used as for Spain. Threat old and new was extracted from Eurobarometer data. The main difference to Spanish threat data from Eurobarometer is, that no pre-post comparison of 11-M is possible with the UK data because the post sample differs in terms of sociodemographics from the pre-sample, meaning that the post-sample is not representative.

Anti-Muslim prejudice data was derived from PEW data (see chapter Data in Study 2 for question wording and further information). The number of cases in PEW surveys ranged



from 500 to 1000 (average N = 773; see Chapter Data in Study 1 for question wording and further information). Since no national anti-Muslim hate crime statistic is available, we make our case here with (faith) hate crime data provided by London Metropolitan Police (EUMC, 2005). Their definition of hate crime and faith crime is as follows: “*Hate crime incidents are crime reports that have been flagged as faith, race, anti-Semitic, anti-Islamic and homophobic crimes. Faith crimes are a count of crime reports flagged specifically as faith hate.*” (EUMC, 2005, p. 13) This data shows results only for the larger London area. We used data from end of June 2005 up to end of September 2005 to show the immediate dynamics after 7/7. Since the faith hate crime data is not specific for religion no time series for Islamophobic faith crimes can be extracted.

### Results

Figure 6. Time series of terrorist threat and Islamophobia in the UK

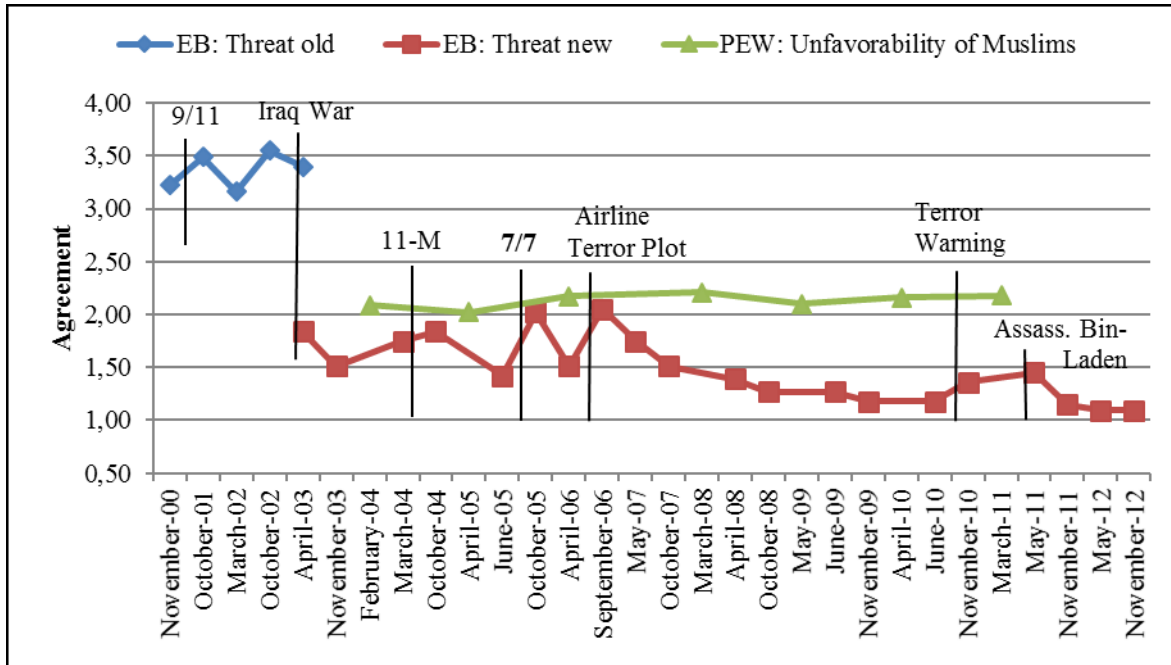

Note. Data source: Eurobarometer threat measures and PEW unfavorability of Muslims measures. Cross-sectional, adult population data.

**Threat.** We found 9/11 leading to a peak in perceived threat. The intrusion into Iraq, however, resulted in no increase. Threat new did not cover the immediate 11-M dynamics. However, the first measure after the attack in October 2004 reveals a slightly increased score. The attack on the UK led to another peak measured in October 2005, followed by a phase of relaxation. The above mentioned airline terror plot increased threat perceptions again. Since then, threat has been decreasing, which was only interrupted by the EU terror warning and the assassination of Bin-Laden. Thus, we find almost all our expectations concerning threat confirmed.

**Prejudice.** No systematic Islamophobia monitoring for the UK was found concerning a period before 2004. Thus, a description of the immediate 9/11 dynamics was not available. For 11-M, pre and post data was available, which showed a small decrease (February-04 vs. April-05;  $p > .05$ ) instead of the expected increase in the post measure. The next pre-post consideration, with 7/7 as trigger showed a significant increase (April-05 vs. April-06;  $p < .05$ ). Since then only minor fluctuations below the threshold of significance occurred. The level, however, remained constantly increased compared to 2005.

**Discrimination.** For the UK, there is no hate crime statistic for the whole time span that includes data for specific religious target groups. Referring to the post 9/11 EUMC report (EUMC, 2001), the British media reported an increased number of attacks against Muslims in the aftermath of 9/11 without presenting concrete numbers. The incidents comprehended violence against persons and property including firebomb and arson attacks against mosques, violent assault, spat on and verbal abuse, mainly targeting on easily identifiable Muslims – women who wore the hijab.

Figure 7. Number of hate crimes and faith hate crimes in the London area before and after 7/7

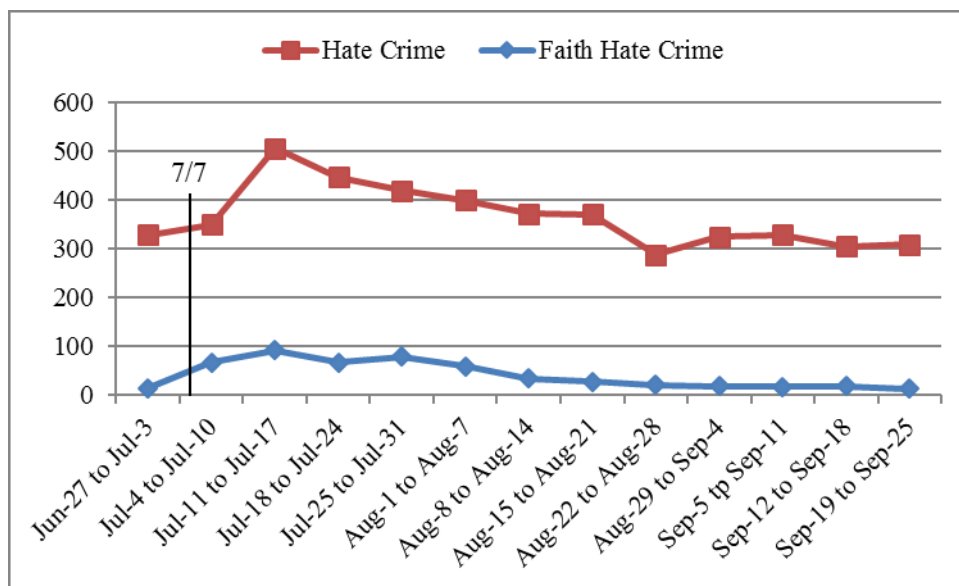

*Note.* Data source: EUMC report (2005) on the impact of 7/7 on Muslim communities in the EU. Period June-September 2005.

Anti-Muslim discrimination in consequence of 11-M has not been documented for the UK. However, there was a sharp increase of hate crimes in London following 7/7, similar to the 9/11 backlash (EUMC, 2005). Figure 7 shows the increase in (faith) hate crimes. Fifteen faith hate crimes were registered in the week prior to 7/7, 68 in the week of the happenings followed by 92 in the week after. The same development can be seen for general hate crimes where a peak of more than five hundred incidents was registered in the week after the attacks. It took about six weeks until the number of incidents fell back to a pre-7/7 level. The time series of faith hate crimes and hate crimes in Figure 7 correlate with  $r=.877$ ,  $p<.001$ . Not only for the London area but also for other parts of the country, NGOs reported an increased hostility against Muslims and those appearing as such (e.g., Sikh people; Allen, 2004; EUMC, 2005).

**Summary and Discussion.** We applied our heuristic model to the closest ally of the US in the war against terror, the UK. The 9/11 attacks also led to an expected peak in threat in

the UK. No statement based on quantitative Islamophobia and discrimination monitoring could be made concerning 9/11 but sufficient evidence for a backlash was gathered by the EUMC (Allen & Nielsen, 2002). Muslims, especially women wearing the hijab, became victim to assault and verbal abuse. Arson attacks against mosques were registered as well.

No appropriate data was available to describe the situation of threat in the UK after 11-M. No consequences in prejudice were measured after 11-M. Data concerning discriminatory acts are not available and there were no hints for a violent backlash at all. The attack on the UK itself, however, initiated a full confirmation of our model. Not only threat but also prejudice and discriminatory acts increased substantially in the post-7/7 measures. Interestingly, faith hate crimes and general hate crimes correlate almost perfectly ( $r=.877$ ,  $p<.001$ ) in the time series covered in Figure 7. Thus, not only hate crimes against Muslims but also against other outgroups increased dramatically in this period.

The airline terror plot, as well as the EU terror warning and the assassination of Bin-Laden led to an increased threat level but no consequences in prejudice and discrimination were registered. The threat, prejudice, discrimination connection seems to be subject to marginal conditions in these complex real world scenarios. We enlarge on these conditions, which facilitate the occurrence of a violent backlash, in our general discussion.

#### **Study 4: Germany**

Germany is the only researched country in this paper that has not yet been target of a major terrorist attack. However, also Germany faced two incidences that showed its vulnerability to terrorism. On July 31 in 2006, two men of Middle Eastern origin attempted an attack on trains in Cologne, one of Germany's largest cities. They deposited suitcases containing bombs, which failed to detonate. The second incident happened in September

2007, when a whole terror-cell was arrested while planning attacks and building bombs (Kulish, 2009). In addition, for Germany we assume the major events 9/11 (September 2001), 11-M (March 2004), 7/7 (July 2005), the EU terror warning (October 2010) and the assassination of Bin-Laden (May 2011) to have triggered threat.

Table 4. Data Time Series Germany

Dimension	Data Source	Time Span Used (Measurement Points)	Kind of Data	Applicable Analysis
Threat:	Eurobarometer Threat Old	Nov. 2000 – Apr. 2003 (5)	quantitative	descriptive
	Eurobarometer Threat New	Apr. 2003 – Nov. 2012 (20)	quantitative	descriptive
	Politbarometer Most Important Problem - Terrorism	Jan. 2001 – Dec. 2010 (120; monthly averages)	quantitative	descriptive
	Politbarometer	Sept. 2001 – Nov. 2010 (18)	quantitative	descriptive
	Allensbach	Dec. 2001 – Sept. 2009 (12)	quantitative	descriptive
	R+V Insurance	July 2001 – July 2012 (13)	quantitative	descriptive
Islamophobia:	Group Focused Enmity (GFE)	Apr. 2003 – June 2011	quantitative	latent means
	The PEW Forum on Religion and Public Life (PEW)	Mar. 2004 – Mar. 2011 (7)	quantitative	ANOVA
Discriminatory Acts:	European Monitoring Center on Racism and Xenophobia(EUMC)	Sept. 2001 – Dec. 2001 July 2005 – Sept. 2005	qualitative	narrative

**Data and Methods.** As table 4 shows, a larger database was available for Germany compared to the former countries. Beyond more aggregate level data, also individual data was accessible. Like for Spain and the UK, threat was extracted from Eurobarometer data (see chapter Data in Study 2 for question wording and further information) but also from additional data sources described below. As it was the case for the UK, no pre-post data conducted shortly before 11-M was available in the Eurobarometer.

Anti-Muslim prejudice was measured, like in the other focus countries, by PEW data (see chapter Data in Study 1 for question wording and further information). The number of cases in PEW surveys ranged from 500 to 1001 (average  $N=772$ ). Furthermore another data source for Islamophobia was available, which is described below. No national anti-Muslim hate crime statistic exists. Therefore, we had to rely on qualitative NGO reports again (Allen & Nielsen, 2002; EUMC, 2005).

The additional time series of threat was created from data by the institute for public opinion research Allensbach (Institut für Demoskopie Allensbach, 2001a; 2001b; 2004; 2006; Köcher, 2009), the Forschungsgruppe Wahlen/ZDF Politbarometer (Forschungsgruppe Wahlen, 2000-2010; data provided by GESIS Central Archive Cologne) and the "Fears of Germans Survey" by the R+V Insurance (Roemstedt, 2011, 2012). With the exception of the R+V insurance survey, the data was produced for newspapers and television news, and is in most cases available as aggregated percent values only.

The R+V insurance has a time series of annual repeated cross-sections, which was conducted face-to-face with representative samples of 14+ aged Germans with  $N\approx 2500$  respondents. Respondents rated several items on a 7-point Likert scale. The item wording was: "Please tell me how threatening the following scenarios are for you personally." The terror item is: "...that terrorist unions commit attacks." The scores 5, 6 and 7 are interpreted as "high threat". The surveys were always conducted from mid-June to mid-July and not in response to events. The only exception was an additional survey in 2005, conducted because of 7/7. In Figure 8, for reasons of feasibility we placed the scores of the annual survey to June 2005 (instead of July) and the post 7/7 poll to July 2005.

ZDF Politbarometer also provides representative samples of the adult German population which are conducted via computer assisted telephone interviews (CATI). The samples consist mostly of  $N\approx 1000$  respondents or more seldom of  $N\approx 500$  respondents. Item

wording examples are “Do you worry about similar terrorist attacks to occur in Germany as seen in the US?” or „During the previous week, terror attacks occurred in Madrid. Do you worry that there will be terrorist attacks in Germany in the near future?“.

Allensbach data consists of representative samples ( $N \geq 2000$ ) of the 16+ adult population. Question wording was “Are you afraid of terrorist attacks to occur in Germany in the near future?”.

The additional Islamophobia time series was created out of adult population data from the project “Group Focused Enmity in Germany” (GFE; Zick et al., 2008). The measure for anti-Muslim sentiments is based on two items of the annual cross-sections from 2003 to 2011. Each cross-section builds upon approximately 2000 respondents (average  $N = 1953$ ). The first item is “with so many Muslims in Germany, one feels increasingly like a stranger in one’s own country”, the second one reads “immigration to Germany should be forbidden for Muslims.” To ensure the invariance of this measure over time, multiple group confirmatory factor analyses were conducted (see e.g., Brown, 2006, pp. 266–304) via the Software Mplus 6 (Muthén & Muthén, 2012). The robust maximum-likelihood-estimation was used to correct for any deviations from normality in the data. Missing values are considered via Full-Information-Likelihood-Estimation (FIML; Arbuckle, 1996). Partial scalar invariance was reached, resulting in a good model fit ( $\chi^2=8.554$ ,  $df=8$ ,  $p=.381$ ,  $CFI=1.00$ ,  $RMSEA=.006$ ,  $SRMR=.014$ ). Thus, the factor structure, factor loadings and intercepts are sufficiently equal in order to compare latent means over time (Byrne, Shavelson, & Muthén, 1989). One specialty when comparing latent means over time is that the mean of t1 is set to zero as a reference point. To transform the data back to the original scale (1 to 4), we added the manifest level of Islamophobia t1 to all measurement points. This transformation is practicable since comparisons are only made within the time series and not between them.

Figure 8. Time series of terrorist threat in

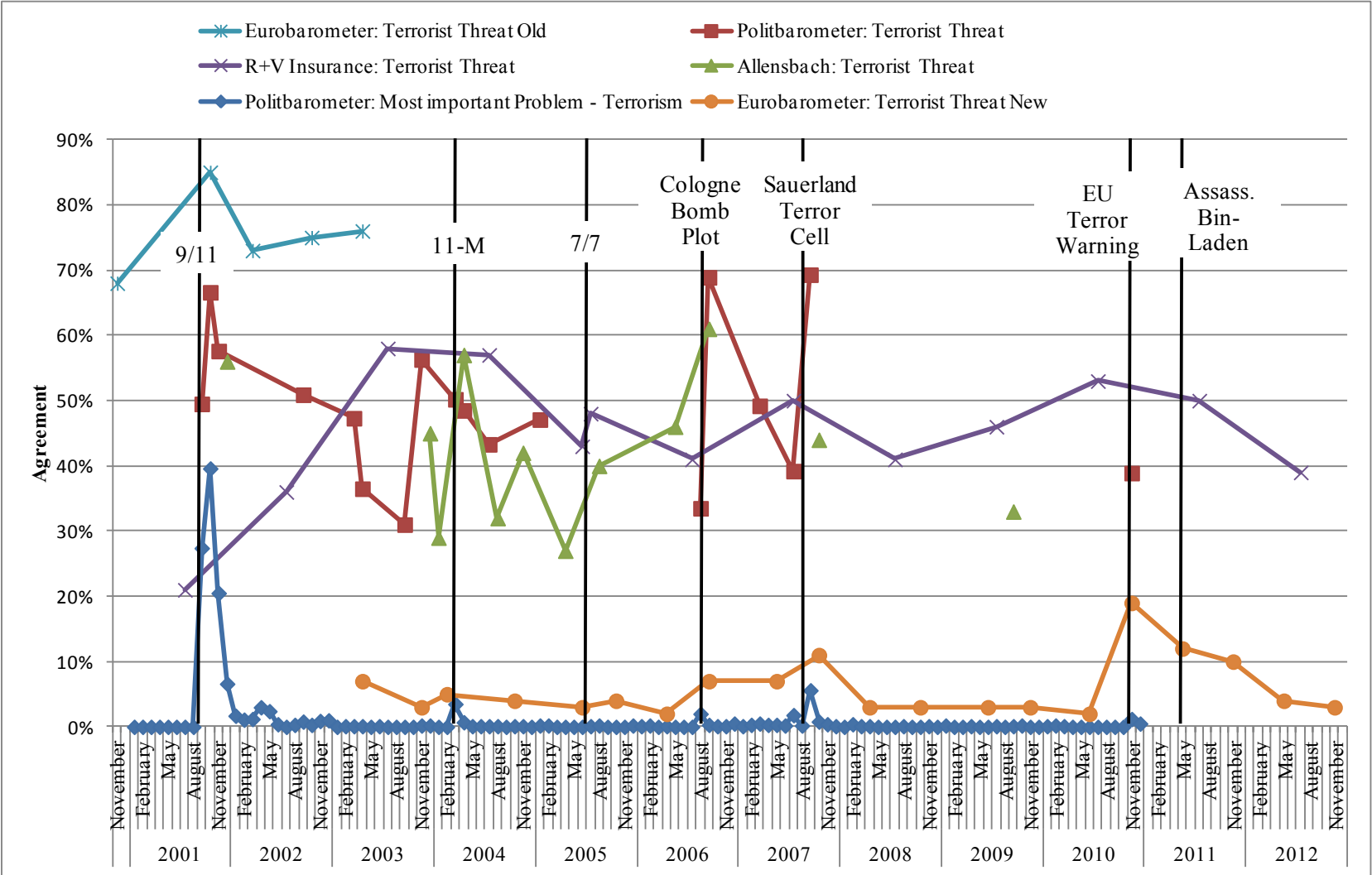

Germany

Note. Cross-sectional, adult population data. Gaps of more than one year are not connected.



## Results

**Threat.** Figure 8 shows an increase in all available threat measures in response to 9/11. Almost 40% of Politbarometer respondents believed terrorism to be the most important issue facing the country in October 2001 and more than 65% expected terrorist attacks to occur in Germany, too. Except for the annual R+V survey which showed an increasing trend until 2003, the threat level measured by other institutes subsided in the months after the attacks. The Madrid Bombings, 11-M, led to a clear-cut increase in threat perceptions in Allensbach data. The Politbarometer most important issue-question reveals a local peak. No increase at all was seen in the Politbarometer terrorist threat measure. Again, somewhat differing results are found for 7/7. Whereas R+V and Allensbach data revealed an increase, only negligible change happened in Euro- and Politbarometer data. The first terror bomb plot to Germany itself, in Cologne, led to an increase in all threat measures. Once again, Euro- and Politbarometer indicated an increase when the Sauerland terror cell was arrested while planning attacks and building bombs. Since then, Politbarometer and Allensbach did not gather data about terrorist threat on a regular basis. Eurobarometer data showed a sharp increase in threat in response to the EU terror warning and a slightly delayed decrease in the relaxation phase due to Bin-Laden's assassination. Thus, although not every measure detected every event, all events induced increased measurable threat perceptions in one or more of the available time series.

Figure 9. Time series of Islamophobia in Germany

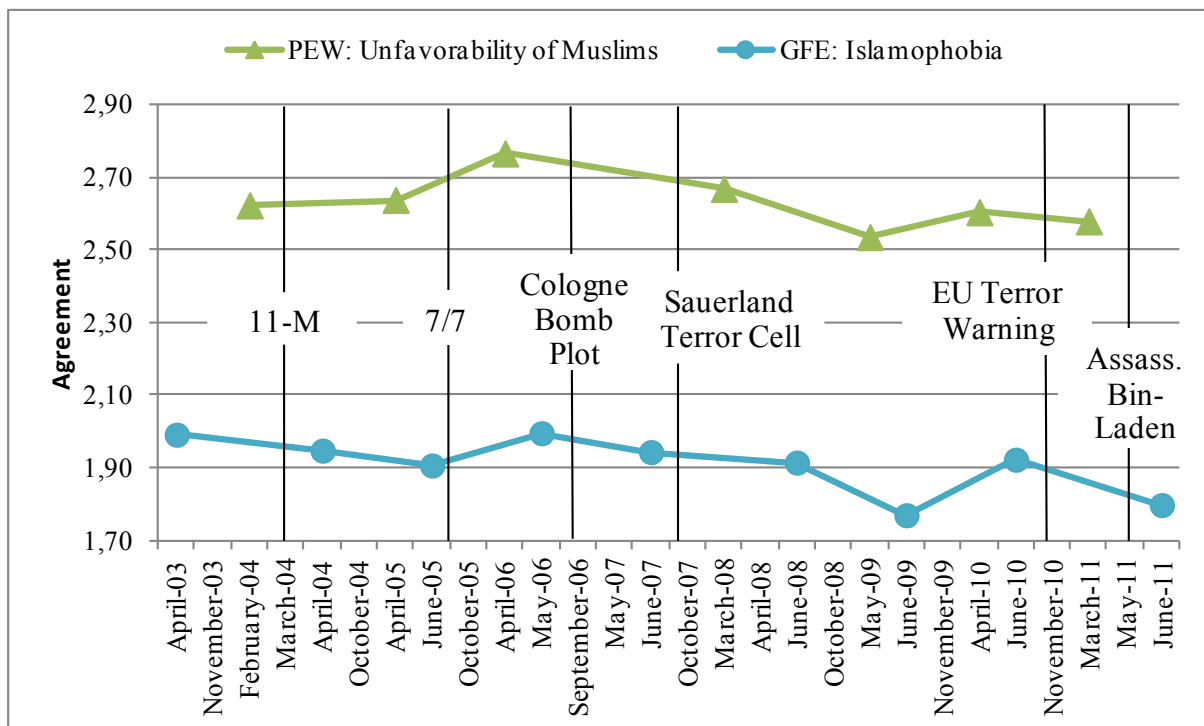

*Note.* Data source: PEW unfavorability of Muslims measures and GFE Islamophobia measures. Cross-sectional, adult population data.

**Prejudice.** Given that Islamophobia monitoring started in Germany in 2003 (GFE) and 2004 (PEW), respectively, no data covers 9/11. There was only one poll in the immediate aftermath of 9/11 that asked for the direct connection of terrorism to Muslims, which showed that 19% of the respondents reported to be more skeptical against Muslims since the attacks (Der Spiegel, 2001).

Pre-Post 11-M comparisons revealed no significant increase in prejudice (GFE: April-03 vs. April-04;  $p > .05$ ; PEW: February-04 vs. April-05;  $p > .05$ ). A significant increase, however, was documented in PEW data post-7/7 (April-05 vs. April-06;  $p < .05$ ). The same trend was seen in GFE data but without reaching significance (June-05 vs. May-06;  $p > .05$ ). Since then, in both time series a slightly decreasing trend was observed until 2009. In 2010

the values increased again but independently from the events considered. The last possible pre-post comparisons included the EU terror warning (GFE, PEW) and the assassination of Bin-Laden (GFE). In PEW data almost no movement was observed in that time span (April-10 vs. March-11;  $p > .05$ ). Again, no increase but even a decrease of prejudice was measured in GFE data (June-10 vs. June-11;  $p < .001$ ).

**Discrimination.** Low levels of physical assault were reported for Germany after 9/11 (EUMC, 2001). Nevertheless, verbal insults and even attacks like spitting on Muslims and tearing down the hijab occurred but no statistics were available for these mistreatments. Allen and Nielsen (2002) identified Muslim women and children to be the most prevalent targets. After 11-M and 7/7 no incidents of backlash in Germany were registered (EUMC, 2005).

The only crime in Germany associating discrimination with terrorism was a murder in Dresden in 2009, where Marwa El Sherbini was stabbed to death in a courtroom (Martinez, 2009). Out of hatred against Muslims, a man killed this Muslim woman and called her “a terrorist”. In 2011, a case of three right-wing terrorists gained attention; they had murdered ten people since 2000, nine of which had immigrant background (Pidd, 2011). The murders never occurred in direct response to Islamist terror attacks and their motive was considered to be xenophobia and not revenge for Islamist terror.

**Summary and Discussion.** We applied our heuristic model to Germany, which faced no attack yet but was shown to be vulnerable to terrorism as well. We find only partial confirmation for our model. A clear-cut peak in threat was measured in response to 9/11 but the supposed increase in Islamophobia cannot be confirmed since no data was available. Only hints but no statistics were available for an increase in discriminatory acts against Muslims. These cases comprehended no major assaults. 11-M led in most of our measures to an increase in threat but not in prejudice and discrimination. Not only increased threat but also a significant increase in prejudice was measured in response to 7/7. Significance, however, was

reached only in one of our two Islamophobia data sets (PEW). Nevertheless, the other data set (GFE) showed the same pattern. Indications for a backlash after 7/7 were not registered. The Cologne bomb plot and the arrest of the Sauerland terror cell left people threatened but did not induce a backlash in terms of anti-Muslim prejudice and discrimination. The same was true for the EU terror warning and Bin-Laden's death. The fact that Germany was only indirectly affected by major terrorist attacks and that attempted terror attacks on Germany were unsuccessful or foiled, probably inhibited an escalation in prejudice and discrimination.

### **Summary Table**

Table 5 documents the results of our poll review. In classified order, the reactions in threat, Islamophobia and discrimination are presented for each country. Threat is the most volatile of the three. Islamophobia and discrimination measures were influenced by major terrorist attacks only, not by minor events.

Table 5. Summary of Results

<b>Event:</b>	9/11	Intrusion in Iraq	11-M	7/7	Cologne Bomb Plot	London Airline Terror Plot	Sauer- land Terror Cell Arrested	EU Terror Warning	Assass- ination of Bin- Laden
<b>Year:</b>	2001	2003	2004	2005	2006	2006	2007	2010	2011
<b>US</b>	Threat	+	+	/	+				+
	Islamophobia	-	0	0	0				/
	Discriminatory Acts	+	0	0	0				0
<b>Spain</b>	Threat	+	0	+	-			0	+
	Islamophobia	/	/	nat-exp +	+			0	/
	Discriminatory Acts	qual. (+)	/	qual. (+)	/			/	/
<b>UK</b>	Threat	+	0	+	+	+		+	+
	Islamophobia	/	/	0	+	0		0	/
	Discriminatory Acts	qual. +	/	/	+	/		/	/
<b>Germany</b>	Threat	+		+	+	+	+	+	0
	Islamophobia	/		0	+	0	0	0	-
	Discriminatory Acts	qual. (+)		0	0	/	/	/	/

*Note.* + = increase, (+) = minor increase, - = decrease, 0 = unaffected, / = not measured, nat-exp. = pre-post natural experiment, qual. = qualitative report, empty cell = not relevant for that country.

## General Discussion

In this paper we tried to explain the massive violent backlash against Muslims in the US after 9/11 from a social psychological perspective. We created a model based on media research (Nacos et al., 2007) and integrated threat theory (Stephan & Renfro, 2002; Stephan & Stephan, 2000). The full heuristic model (Figure 2) implies that, on the micro level, Islamophobia and discriminatory acts against Muslims were the consequence of perceived terrorist threat. Threat itself, on the micro level, is the product of a threatening climate induced by major terrorist attacks and their media broadcasting on the macro level. Since 9/11 led to a shift towards perceived terrorist threat in Europe as well, we applied the model to a cross-country poll-review focusing on the US, Spain, the UK and Germany. For all countries we considered the major terrorist attacks 9/11, 11-M and 7/7. In addition, we looked at country specific terror related events. One general finding is that prejudice and discrimination increase in response to threat only if an event reaches the magnitude of a major terrorist attack. Therefore, we discuss our model only for the major terrorist events 9/11, 11-M and 7/7.

Our expectation that the unprecedented increase in discriminatory acts in the US after 9/11 was a product of increased prejudice mean level cannot be confirmed with our data. However, the measurement of prejudice in the aftermath of 9/11 was obviously influenced by President Bush's call for differentiation. Other researchers find in their pre-post 9/11 studies hints of a shift towards authoritarian tendencies in the aftermath phase (Nagoshi, Terrell, & Nagoshi, 2007; Nail & McGregor, 2009). Unfortunately, none of these pre-post 9/11 studies included Islamophobia as a dependent variable. Nevertheless, the authoritarian tendencies they found commonly appear together with increased devaluation of outgroups (e.g., Altemeyer, 1998; Duckitt, 2001). Further indications for increased prejudice are found in Panagopoulos' (2006) poll review. He shows indications for increased subtle prejudice

against Muslims in general and Arabs in particular. This subtle prejudice manifested itself in substantial agreement to questions containing the demand to treat Muslims differently and to put them under special surveillance.

As expected, we find massive spillover effects of 9/11 in terms of threat on Spain, the UK and Germany. The reason for the worldwide impact of 9/11 is that no media templates existed for such a happening (Hoskins, 2006). Media templates are attempts to classify the current incident in context of previous events. Neither the media nor the citizens had means of comparison for 9/11, rescaling their experience of evilness. Thus, 9/11 created a benchmark of terrorist threat. Unfortunately, no systematic measurement of Islamophobia is available for that time in our European focus countries. Nevertheless, some studies give at least hints for an increase in prejudicial tendencies. For instance, Echebarria-Echabe and Fernández-Guede (2007) developed their new Islamophobia scale in response to increased prejudice against Muslims after 9/11. However, they do not provide evidence for the claim that Islamophobia was increased in general since 9/11. In the UK, the same increase in Islamophobia is claimed but again no systematic measurement is available (Allen, 2004; Poynting & Mason, 2007). For Germany, some pre-post 9/11 data sets were analyzed by Brosig & Brähler (2002) that find social distance against Muslims but also against Jews to be increased. An analysis of the German Socio-Economic Panel 2001 reveals an increase in negativity towards immigration and a decrease in concerns over xenophobic hostility in German society (Schüller, 2012).

According to Smith and colleagues (2001), the primary reaction to the 9/11 attacks was anger in 73% of the respondents in New York and 65% of the respondents across the United States (see also Back, Kufner, & Egloff, 2010). Since most of the hate crimes against Muslims, especially the severe ones, were committed in the very days after 9/11, it seems plausible that the backlash was a product of immediate arousal. Furthermore, Ibish (2003) reports that bigots may have seen their chance to abuse the state of emergency in order to

scapegoat Muslims. This hints at a legitimating role of threat in the prejudice discrimination relation as suggested by Pereira et al. (2010) and Wagner & Christ 2007; see also Dasgupta, DeSteno, Williams, & Hunsinger, 2009). Thus, it is not clear whether terrorist threat produced prejudice which in turn led to discrimination or whether prejudiced individuals used threat as legitimation to express their sentiments and aggression.

Morgan and colleagues (2011) conclude that punishing supposed ethnic ingroup members of the attackers is a form of displaced aggression (for a review, see Marcus-Newhall, Pedersen, Carlson, & Miller, 2000) where the need to punish proxies is especially high when the original attacker (Osama Bin-Laden) went unpunished (see also Goldberg, Lerner, & Tetlock, 1999). Interestingly, violent anti-Muslim backlash after 9/11 was reported across all focus countries. These hate crimes reached an alarming level in terms of severity, especially in the UK.

Our model proves to be true for 11-M in Spain. Threat increased when prejudice and discrimination increased as well, although the violent backlash was minor. For 7/7 in the UK, we find our full model supported. Since the backlashes vary enormously in their extent, the question occurs which marginal conditions on country level facilitate or impede such a rebound effect? First of all, the probability of a backlash is, of course, higher in the country where the attack occurred. Second, the main media stereotype of 'a Muslim' is relevant. Whereas in the US and the UK the stereotype of a Muslim is characterized by fanaticism and terrorism, the stereotype of Muslims in Spain and Germany is mainly that of a labor immigrant (Jaspal & Cinnirella, 2010; Poole & Richardson, 2006; Shaheen, 1997, 2003). Connected to this, the third aspect is the similarity of a country's Muslim population to the main media stereotype. We believe that if Muslims are visible as such and stereotyped as 'terrorists', the probability of scapegoating increases. Sheridan and Gillett (2005) find in a UK post 9/11 foreigner sample that 68% of Muslims who became hate crime victims describe



themselves as visible members of their religious groups. Their self-descriptive degree of visibility was significantly higher than that of Jews and Hindus. Visibility is often connected to specific symbols. In a shooter bias paradigm, Unkelbach and colleagues could show a higher frequency of gunfires against a man wearing a turban compared to the same man without a turban (Unkelbach, Forgas, & Denson, 2008). In line with this finding is that Muslim women who wore the hijab were the most common victim to hate crimes in Europe after 9/11 (Allen & Nielsen, 2002). In the US and the UK, Sikh men became repeatedly hate crime victims since their traditional costume is somewhat similar to Arab men's traditional dress (Kaplan, 2006). The fourth important aspect is the elite reaction to attacks. An immediate call for differentiation by leading politicians and clerics can inhibit or at least limit the strength of backlash. In the US, this call for differentiation was announced ten days after the attacks. Since most of the severe attacks against Muslims and Mosques happened in the very days after 9/11, we assume an earlier intervention by President Bush could have relaxed the situation (see also Kaplan, 2006). However, even though the elite reaction in the UK was exemplary and harsh punishment for backlash crimes was announced (EUMC, 2005), violence against Muslims after 7/7 could not be prevented. This can be explained by the massive Islamophobic tension in the UK that lately surfaced again, after two Muslims committed manslaughter to a British soldier in London (Obeidallah, 2013).

When we write about the numbers of hate crimes one has to consider that hate crimes in police reports are only the tip of the iceberg. A representative poll among Muslims in the greater London area revealed that only 11% of racist attacks in the aftermath of 7/7 have been reported to the police (see EUMC, 2005, p. 15). Thus, the actual number of backlash hate crimes is likely to be much higher.

**Limitations and Future Research.** Some limitations of our poll review need to be considered. Since this is a poll review, we deal with independent time series. Hence, we monitor our dependent variables in different data sets and on aggregate level. Thus, causality cannot be proven but only theorized. Not all data presented come from continuous monitoring projects. This lack in systematic and continuous data emphasizes the importance of prejudice monitoring. Based on such data researchers can figure out which minorities are endangered and politics can intervene. Several time series were conducted as response to 9/11. Hence, pre 9/11 data on our variables are rare. Consequently, especially in the case of Islamophobia, we cannot be sure that 9/11 led to an uncovered increase in Spain, the UK and Germany. The possibility that the little movement in Islamophobia in our data is due to a constantly increased level since 9/11 cannot be excluded. However, the fact that the level of Islamophobia in the US, where pre- and post-data are available, is not constantly increased speaks against this argument.

Another issue is our use of the aggregate mean level, especially because there is an ongoing debate (e.g., Burke, Kosloff, & Landau, 2013; Huddy & Feldman, 2011) about the effects of terrorist threat on political ideologies (ideological intensification vs. conservative shift) which is also connected to the devaluation of foreigners. Whereas Jost and colleagues (2007; 2003) suggest a collective conservative shift in response to terrorist threat, Pyszczynski, Solomon and Greenberg (2003) argue that an intensification in preexisting individual ideologies (also left-wing) occurs which would lead to an attenuation or nullification of effects on aggregate level. However, Greenberg and Jonas (2003) argue that in most capitalist nations the left-wing ideology is not as prominent as the right-wing ideology. Thus, even if a polarization happens in response to threat, the right-wing shift would be observed on aggregate level due to a higher quantity of right-wingers in society. To add to the aforementioned debate and to avoid that aggregate level limitation, future research needs to

consider intraindividual change to get insights into the process of terrorist-threat imposed attitude change.

Furthermore, not all considered time-series fulfill scientific conditions of data gathering. Especially media related poll-institutions tend to adapt question wording to current events which challenges the equivalence of questions over time that is needed to build reliable time series. Furthermore, media related poll-institutions ask more often about issues whenever they are on the current agenda. This leads to differing time lags. The general problem of different time lags and non-simultaneous data points inhibited the use of advanced time series modeling.

Another aspect future research needs to clarify is the question of causality between terrorist threat and outgroup derogation. In this paper we focused on the ITT perspective that threat produces prejudices (e.g., Stephan & Stephan, 2000). However, also an alternative model is conceivable: prejudiced individuals take the chance to express their prejudices, because terrorist threat legitimizes such an expression. This latter explanation is in accordance with modern racism theories (e.g., aversive racism; Gaertner & Dovidio, 1986)

**Conclusion and Implications.** Even though our poll review reveals derogation and violence, we want to stress that by understanding the psychological processes and the temporal trajectory of backlash we create knowledge that can help to prevent threat to be transformed into prejudice and discrimination. Although, solving the primary conflict leading to Islamist terror attacks would be preferable, we can offer suggestions for a kind of symptomatic treatment (prevent backlash) when the conflict becomes salient again in shape of a new attack.

The easiest and most immediate step to stop the cycle of threat, prejudice, and discrimination is a call for differentiation by political elites. If people understand that attacks are a cruelty of some fanatics and that they do not have backing in the Muslim community, backlash can be lessened. However, right-wing radicals will always use the immediate state of emergency in the aftermath of attacks to discriminate minorities. Therefore, another step is to avoid the upcoming of such a state of emergency where people believe laws were repealed.

Furthermore, practices in contemporary media should be challenged (Poole, 2002; Poole & Richardson, 2006; Richardson, 2009/2004; Shaheen, 2003). Especially since the need for a story led to the worldwide broadcasting of celebrating Muslims in response to 9/11 (FoxNews.com, 2001) which however, was proven to be old video material enriched with an artificial scene created by journalists who paid those Muslims for celebrating (Erdmann, 2001; Snow & Taylor, 2006). A more balanced and differentiating reporting about terrorism and Islam as, for instance, delivered by the newspaper El Pais in Spain (see Allen & Nielsen, 2002), could reduce scapegoating.

Finally, everyone should invest in good minority-majority relations since this would be an important first step to prevent individuals from radicalization which is probably the best way to diminish the problem of terrorism.

**Acknowledgements**

The authors thank Britta Sommer (Institut für Demoskopie Allensbach) and Brigitte Römstedt (R+V Insurance) for the provision of data. Moreover, we are thankful for consultation and provision of data from Evelyn Brislinger, Monika Langhans, Sophia Katz, Insa Bechert (GESIS, Leibniz Institute for the Social Sciences). Furthermore, we thank Ulrich Wagner, Frank Asbrock, Jan Weber and the members of the graduate school ‘Group-Focused Enmity’ for their helpful comments on an earlier draft of this article.

**Funding**

This research was conducted in the context of the Graduiertenkolleg (research training group) “Group Focused Enmity” located at the Universities of Marburg and Bielefeld, Germany, funded by the Deutsche Forschungsgemeinschaft (Graduiertenkolleg 884). The research of Peter Schmidt was supported by the basic research program of the State Research University Higher School of Economics (HSE) in Moscow.

## References

- Ahern, J., Galea, S., Resnick, H., & Vlahov, D. (2004). Television Images and Probable Posttraumatic Stress Disorder After September 11. *The Journal of Nervous and Mental Disease, 192*(3), 217–226
- Allen, C. (2004). Justifying Islamophobia: A Post 9/11 Consideration of the European Union and British Contexts. *The American Journal of Islamic Social Sciences, 21*(3), 1–25. Retrieved from [http://i-epistemology.net/attachments/847\\_Ajiss21-3%20-%20Allen%20-%20Justifying%20Islamophobia.pdf](http://i-epistemology.net/attachments/847_Ajiss21-3%20-%20Allen%20-%20Justifying%20Islamophobia.pdf)
- Allen, C., & Nielsen, J. S. (2002). Summary Report on Islamophobia in the EU after 11 September 2001. Retrieved from [http://fra.europa.eu/sites/default/files/fra\\_uploads/199-Synthesis-report\\_en.pdf](http://fra.europa.eu/sites/default/files/fra_uploads/199-Synthesis-report_en.pdf)
- Allport, G. W. (1979/1954). *The Nature of Prejudice* (25th ed.). Reading, Mass: Perseus Books.
- Altemeyer, B. (1998). The Other "Authoritarian Personality". In M. P. Zanna (Ed.), *Advances in experimental social psychology* (pp. 47–92). San Diego: Academic Press.
- Arbuckle, J. L. (1996). Full information estimation in the presence of missing data. In G. A. Marcoulides & R. E. Schumacker (Eds.), *Advanced structural equation modeling. Issues and techniques* (pp. 243–277). Mahwah, N.J: L. Erlbaum Associates.
- Asbrock, F., & Fritsche, I. (2013). Authoritarian reactions to terrorist threat: Who is being threatened, the Me or the We? *International Journal of Psychology, 48*(1), 35–49
- Back, M. D., Kufner, A. C. P., & Egloff, B. (2010). The Emotional Timeline of September 11, 2001. *Psychological Science, 21*(10), 1417–1419
- Barkdull, C., Khaja, K., Queiro-Tajalli, I., Swart, A., Cunningham, D., & Dennis, S. (2011). Experiences of Muslims in Four Western Countries Post--9/11. *Affilia, 26*(2), 139–153
- BBC News (2006, August 10). 'Airlines terror plot' disrupted. Retrieved from [http://news.bbc.co.uk/2/hi/uk\\_news/4778575.stm](http://news.bbc.co.uk/2/hi/uk_news/4778575.stm)
- Becker, J. C., Wagner, U., & Christ, O. (2011). Consequences of the 2008 financial crisis for intergroup relations: The role of perceived threat and causal attributions. *Group Processes & Intergroup Relations, 14*(6), 871–885
- Birkland, T. A. (2004). "The World Changed Today": Agenda-Setting and Policy Change in the Wake of the September 11 Terrorist Attacks. *Review of Policy Research, 21*(2), 179–200
- Blumer, H. (1958). Race Prejudice as a Sense of Group Position. *The Pacific Sociological Review, 1*(1), 3–7.
- Box, G. E. P., Jenkins, G. M., & Reinsel, G. C. (2008). *Time series analysis: Forecasting and control* (4th ed.). Wiley series in probability and statistics. Hoboken, N.J: John Wiley.
- Breckenridge, J. N., & Zimbardo, P. G. (2007). The Strategy of Terrorism and the Psychology of Mass-Mediated Fear. In B. M. Bongar, L. M. Brown, L. E. Beutler, J. N. Breckenridge, & P. G. Zimbardo (Eds.), *Psychology of terrorism* (pp. 116–133). Oxford, New York: Oxford University Press.
- Brosig, B., & Brähler, E. (2002). Die Angst vor dem Terror - Daten aus deutschen Repräsentativerhebungen von und nach dem 11. September: (The Fear of Terror - Data from German Representative Surveys Before and After September 11). *Journal of Conflict*

- and Violence Research*, 4(2), 77–94. Retrieved from [https://www.uni-bielefeld.de/ikg/jkg/2-2002/brosig\\_braehler.pdf](https://www.uni-bielefeld.de/ikg/jkg/2-2002/brosig_braehler.pdf)
- Brown, T. A. (2006). *Confirmatory factor analysis for applied research*. New York: Guilford Press.
- Burke, B. L., Kosloff, S., & Landau, M. J. (2013). Death Goes to the Polls: A Meta-Analysis of Mortality Salience Effects on Political Attitudes. *Political Psychology*, 34(2), 183–200
- Byrne, B. M., Shavelson, R. J., & Muthén, B. O. (1989). Testing for the Equivalence of Factor Covariance and Mean Structures: The Issue of Partial Measurement Invariance. *Psychological Bulletin*, 105(3), 456–466. Retrieved from [http://www.statmodel.com/bmuthen/articles/Article\\_027.pdf](http://www.statmodel.com/bmuthen/articles/Article_027.pdf)
- Carey, J. (2003). The Functions and Uses of Media during the September 11 Crisis and its Aftermath. In A. M. Noll (Ed.), *Crisis communications. Lessons from September 11* (pp. 1–16). Lanham, Md: Rowman & Littlefield.
- Cesari, J. (2004). *When Islam and democracy meet: Muslims in Europe and in the United States* (1st ed.). Basingstoke: Palgrave Macmillan.
- CNN. (2001). *Transcript of President Bush's address to a joint session of Congress on Thursday night, September 20, 2001*. Retrieved from <http://archives.cnn.com/2001/US/09/20/gen.bush.transcript/>
- Cohn, S. K. (2007). The Black Death and the Burning of Jews. *Past & Present*, 196(1), 3–36
- Coleman, J. S. (1986). Social Theory, Social Research, and a Theory of Action. *American Journal of Sociology*, 91(6), 1309–1335
- Coleman, J. S. (1987). Microfoundations and Macrosocial Behavior. In J. C. Alexander, B. Giesen, R. Münch, & N. J. Smelser (Eds.), *The Micro-Macro Link* (pp. 153–176). Berkeley: University of California Press.
- Das, E., Bushman, B. J., Bezemer, M. D., Kerkhof, P., & Vermeulen, I. E. (2009). How terrorism news reports increase prejudice against outgroups: A terror management account. *Journal of Experimental Social Psychology*, 45(3), 453–459
- Dasgupta, N., DeSteno, D., Williams, L. A., & Hunsinger, M. (2009). Fanning the flames of prejudice: The influence of specific incidental emotions on implicit prejudice. *Emotion*, 9(4), 585–591
- Der Spiegel (2001, September 23). Zwischen Krieg und Frieden [Between War and Peace], p. 13. Retrieved from <https://wissen.spiegel.de/wissen/image/show.html?did=20184249&aref=image026/E0135/SCSP200103900130013.pdf&thumb=false>
- Der Spiegel (2010, November 17). Cause for Concern: German Government Issues 'Concrete' Terror Warning. Retrieved from <http://www.spiegel.de/international/germany/cause-for-concern-german-government-issues-concrete-terror-warning-a-729635.html>
- Doosje, B., Zebel, S., Scheermeijer, M., & Mathyi, P. (2007). Attributions of Responsibility for Terrorist Attacks: The Role of Group Membership and Identification. *International Journal of Conflict and Violence*, 2(1), 127–141. Retrieved from <http://www.ijcv.org/index.php/ijcv/article/viewFile/11/11>
- Dovidio, J. F., Brigham, J. C., Johnson, B. T., & Gaertner, S. L. (1996). Stereotyping, Prejudice, and Discrimination: Another Look. In C. N. Macrae, C. Stangor, & M. Hewstone (Eds.), *Stereotypes and Stereotyping* (pp. 276–322). New York [u.a.]: Guilford Press.

- Duckitt, J. (2001). A dual-process cognitive-motivational theory of ideology and prejudice. In M. P. Zanna (Ed.), *Advances in experimental social psychology* (pp. 41–113). San Diego ... [etc.]: Academic Press.
- Echebarria-Echabe, A., & Fernández-Guede, E. (2006). Effects of terrorism on attitudes and ideological orientation. *European Journal of Social Psychology*, 36(2), 259–265
- Echebarria-Echabe, A., & Fernández-Guede, E. (2007). A New Measure of Anti-Arab Prejudice: Reliability and Validity Evidence. *Journal of Applied Social Psychology*, 37(5), 1077–1091
- Erdmann, L. (2001). *Die Macht der TV-Bilder: Was ist die Wahrheit?: [The Power of Pictures in TV: What's the Truth?]*. Retrieved from <http://www.spiegel.de/politik/ausland/die-macht-der-tv-bilder-was-ist-die-wahrheit-a-158625.html>
- EUMC. (2001). *Anti-Islamic reactions in the EU after the terrorist acts against the USA: A collection of country reports from RAXEN National Focal Points*. Vienna. Retrieved from [http://fra.europa.eu/sites/default/files/fra\\_uploads/216-Nat-Report-291101.pdf](http://fra.europa.eu/sites/default/files/fra_uploads/216-Nat-Report-291101.pdf)
- EUMC. (2005). *The Impact of 7 July 2005 London Bomb Attacks on Muslims Communities in the EU*. Vienna. Retrieved from [http://fra.europa.eu/sites/default/files/fra\\_uploads/197-London-Bomb-attacks-EN.pdf](http://fra.europa.eu/sites/default/files/fra_uploads/197-London-Bomb-attacks-EN.pdf)
- EUMC. (2006). *Muslims in the European Union: Discrimination and Islamophobia*. Vienna: European Monitoring Centre on Racism and Xenophobia, EUMC.
- European Commission. (1995-2012). *Public Opinion: Eurobarometer*. Retrieved from [http://ec.europa.eu/public\\_opinion](http://ec.europa.eu/public_opinion)
- European Commission. (2013). *Eurobarometer Interactive Search System*. Retrieved from [http://ec.europa.eu/public\\_opinion/cf/index\\_en.cfm](http://ec.europa.eu/public_opinion/cf/index_en.cfm)
- FBI. (1998-2011). *Uniform Crime Reports: Hate Crime Statistics*. Retrieved from <https://www.fbi.gov/about-us/cjis/ucr/ucr>
- FBI. (2013). *Hate Crime - Overview*. Retrieved from [http://www.fbi.gov/about-us/investigate/civilrights/hate\\_crimes/overview](http://www.fbi.gov/about-us/investigate/civilrights/hate_crimes/overview)
- Forschungsgruppe Wahlen. (2000-2010). *Politbarometer*. Retrieved from <http://www.gesis.org/en/elections-home/politbarometer/study-overview/>
- FoxNews.com. (2001). *Arafat Horrified by Attacks, but Thousands of Palestinians Celebrate: Rest of World Outraged*. Retrieved from <http://www.foxnews.com/story/0,2933,34187,00.html>
- FRA - European Union Agency for Fundamental Rights. (2012). *Antisemitism: Summary overview of the situation in the European Union 2001-2011*. Retrieved from [https://fra.europa.eu/fraWebsite/attachments/FRA-2012-Antisemitism-update-2011\\_EN.pdf](https://fra.europa.eu/fraWebsite/attachments/FRA-2012-Antisemitism-update-2011_EN.pdf)
- Gaertner, S. L., & Dovidio, J. F. (1986). The aversive form of racism. In J. F. Dovidio & S. L. Gaertner (Eds.), *Prejudice, discrimination, and racism* (pp. 61–89). San Diego: Academic Press.
- Galea, S., Ahern, J., Resnick, H., Kilpatrick, D., Bucuvalas, M., Gold, J., & Vlahov, D. (2002). Psychological Sequelae of the September 11 Terrorist Attacks in New York City. *New England Journal of Medicine*, 346(13), 982–987
- Glick, P. (2002). Sacrificial lambs dressed in wolves' clothing: Envious prejudice, ideology, and the scapegoating of Jews. In L. S. Newman & R. Erber (Eds.), *Understanding genocide. The social psychology of the Holocaust* (pp. 113–142). New York: Oxford University Press.



- Glick, P. (2005). Choice of Scapegoats. In J. F. Dovidio, P. S. Glick, & L. A. Rudman (Eds.), *On the nature of prejudice. Fifty years after Allport* (pp. 244–261). Malden, MA: Blackwell Pub.
- Goldberg, J. H., Lerner, J. S., & Tetlock, P. E. (1999). Rage and reason: the psychology of the intuitive prosecutor. *European Journal of Social Psychology*, 29(5-6), 781–795
- Greenberg, J., & Jonas, E. (2003). Psychological and political orientation--The left, the right, and the rigid: Comment on Jost et al. (2003). *Psychological Bulletin*, 129(3), 376–382
- Hoskins, A. (2006). Temporality, Proximity and Security: Terror in a Media-Drenched Age. *International Relations*, 20(4), 453–466
- Huddy, L., & Feldman, S. (2011). Americans respond politically to 9/11: Understanding the impact of the terrorist attacks and their aftermath. *American Psychologist*, 66(6), 455–467
- Huddy, L., Feldman, S., Capelos, T., & Provost, C. (2002). The Consequences of Terrorism: Disentangling the Effects of Personal and National Threat. *Political Psychology*, 23(3), 485–509
- Huddy, L., Feldman, S., Lahav, G., & Taber, C. (2003). Fear and Terrorism: Psychological Reactions to 9/11. In P. Norris, M. Kern, & M. R. Just (Eds.), *Framing Terrorism. The News Media, the Government and the Public* (pp. 255–278). New York ;, London: Routledge.
- Huddy, L., Feldman, S., Taber, C., & Lahav, G. (2005). Threat, Anxiety, and Support of Antiterrorism Policies. *American Journal of Political Science*, 49(3), 593–608
- Human Rights Watch. (2002). *"We Are Not the Enemy": Hate Crimes Against Arabs, Muslims, and Those Perceived to be Arab or Muslim after September 11*. New York. Retrieved from <https://www.hrw.org/reports/2002/usahate/usa1102.pdf>
- Human Rights Watch. (2005). *Setting an Example? Counter-Terrorism Measures in Spain*. Retrieved from <https://www.hrw.org/reports/2005/spain0105/spain0105.pdf>
- Ibish, H. (2003). *Report on Hate Crimes and Discrimination Against Arab Americans: The Post - September 11 Backlash*. Washington, DC, US. Retrieved from <http://www.adc.org/PDF/hcr02.pdf>
- Ibish, H. (2008). *Report on Hate Crimes and Discrimination Against Arab Americans 2003-2007*. Washington, DC, US. Retrieved from <http://www.adc.org/PDF/hcr07.pdf>
- Institut für Demoskopie Allensbach. (2001a). *Terror in Amerika: Die Einschätzungen in Deutschland* (Allensbacher Berichte No. 21/2001). Allensbach am Bodensee. Retrieved from [http://www.ifd-allensbach.de/uploads/tx\\_reportsndocs/prd\\_0121.pdf](http://www.ifd-allensbach.de/uploads/tx_reportsndocs/prd_0121.pdf)
- Institut für Demoskopie Allensbach. (2001b). *Stimmung zum Jahreswechsel verhalten: Aber das Stimmungstief nach den Terroranschlägen ist überwunden* (Allensbacher Berichte No. 28/2001). Allensbach am Bodensee. Retrieved from [http://www.ifd-allensbach.de/uploads/tx\\_reportsndocs/prd\\_0128.pdf](http://www.ifd-allensbach.de/uploads/tx_reportsndocs/prd_0128.pdf)
- Institut für Demoskopie Allensbach. (2004). *Mehr als jeder Zweite befürchtet einen Terroranschlag in Deutschland [More than every other one fears a terrorist attack in Germany]* (Allensbacher Berichte No. 7/2004). Allensbach am Bodensee. Retrieved from [http://www.ifd-allensbach.de/uploads/tx\\_reportsndocs/prd\\_0407.pdf](http://www.ifd-allensbach.de/uploads/tx_reportsndocs/prd_0407.pdf)
- Institut für Demoskopie Allensbach. (2006). *Terroranschläge in Deutschland?: Die Mehrheit ist besorgt* (Allensbacher Berichte No. 14/2006). Allensbach am Bodensee. Retrieved from [http://www.ifd-allensbach.de/uploads/tx\\_reportsndocs/prd\\_0614.pdf](http://www.ifd-allensbach.de/uploads/tx_reportsndocs/prd_0614.pdf)
- Jaspal, R., & Cinnirella, M. (2010). Media representations of British Muslims and hybridised threats to identity. *Contemporary Islam*, 4(3), 289–310

- Jost, J. T., Glaser, J., Kruglanski, A. W., & Sulloway, F. J. (2003). Political conservatism as motivated social cognition. *Psychological Bulletin*, *129*(3), 339–375
- Jost, J. T., Napier, J. L., Thorisdottir, H., Gosling, S. D., Palfai, T. P., & Ostafin, B. (2007). Are Needs to Manage Uncertainty and Threat Associated With Political Conservatism or Ideological Extremity? *Personality and Social Psychology Bulletin*, *33*(7), 989–1007
- Kaplan, J. (2006). Islamophobia in America?: September 11 and Islamophobic Hate Crime. *Terrorism and Political Violence*, *18*(1), 1–33
- Köcher, R. (Ed.). (2009). *Die Berliner Republik: Allensbacher Jahrbuch der Demoskopie 2003-2009*. Berlin: de Gruyter [u.a.].
- Kulish, N. (2009, April 22). Trial Opens in Germany for 4 Suspected of Plotting Bombings. *The New York Times*. Retrieved from <https://www.nytimes.com/2009/04/23/world/europe/23germany.html>
- Landau, M. J., Solomon, S., Greenberg, J., Cohen, F., Pyszczynski, T. A., Arndt, J., ... (2004). Deliver us from Evil: The Effects of Mortality Salience and Reminders of 9/11 on Support for President George W. Bush. *Personality and Social Psychology Bulletin*, *30*(9), 1136–1150
- Laugharne, J., Janca, A., & Widiger, T. (2007). Posttraumatic stress disorder and terrorism: 5 years after 9/11. *Current Opinion in Psychiatry*, *20*(1), 36–41
- Li, W., Kelley, D., & Kennedy, J. (2003). *Summary of Vital Statistics 2002*. New York. Retrieved from <http://www.nyc.gov/html/doh/downloads/pdf/vs/2002sum.pdf>
- Marcus-Newhall, A., Pedersen, W. C., Carlson, M., & Miller, N. (2000). Displaced aggression is alive and well: A meta-analytic review. *Journal of Personality and Social Psychology*, *78*(4), 670–689
- Marshall, R. D., Bryant, R. A., Amsel, L., Suh, E. J., Cook, J. M., & Neria, Y. (2007). The psychology of ongoing threat: Relative risk appraisal, the September 11 attacks, and terrorism-related fears. *American Psychologist*, *62*(4), 304–316
- Martinez, E. (2009, October 1). Marwa Ali El Sherbini: Trial Set for Alleged Neo-Nazi Accused of Killing Pregnant Muslim Woman. *CBS News*. Retrieved from [http://www.cbsnews.com/8301-504083\\_162-5356022-504083.html](http://www.cbsnews.com/8301-504083_162-5356022-504083.html)
- Morgan, G. S., Wisneski, D. C., & Skitka, L. J. (2011). The expulsion from Disneyland: The social psychological impact of 9/11. *American Psychologist*, *66*(6), 447–454
- Muthén, L. K., & Muthén, B. O. (2012). *Mplus User's Guide: Seventh Edition*. Los Angeles, CA: Muthén & Muthén.
- Nacos, B. L., Bloch-Elkon, Y., & Shapiro, R. Y. (2007). Post-9/11 Terrorism Threats, News Coverage, and Public Perceptions in the United States. *International Journal of Conflict and Violence*, *1*(2), 105–126.
- Nagoshi, J. L., Terrell, H. K., & Nagoshi, C. T. (2007). Changes in authoritarianism and coping in college students immediately after the terrorist attacks of September 11, 2001. *Personality and Individual Differences*, *43*(7), 1722–1732
- Nail, P. R., & McGregor, I. (2009). Conservative Shift among Liberals and Conservatives Following 9/11/01. *Social Justice Research*, *22*(2-3), 231–240
- Obeidallah, D. (2013, May 29). Anti-Muslim Backlash in England, but not here. *CNN.com*. Retrieved from <http://edition.cnn.com/2013/05/29/opinion/obeidallah-muslim-backlash-us-uk/index.html>
- Oswald, D. L. (2005). Understanding Anti-Arab Reactions Post-9/11: The Role of Threats, Social Categories, and Personal Ideologies. *Journal of Applied Social Psychology*, *35*(9), 1775–1799

- Panagopoulos, C. (2006). The Polls-Trends: Arab and Muslim Americans and Islam in the aftermath of 9/11. *Public Opinion Quarterly*, 70(4), 608–624
- Pereira, C., Vala, J., & Costa-Lopes, R. (2010). From prejudice to discrimination: The legitimizing role of perceived threat in discrimination against immigrants. *European Journal of Social Psychology*, 40(7), 1231–1250
- Pereira, C., Vala, J., & Leyens, J. P. (2009). From infra-humanization to discrimination: The mediation of symbolic threat needs egalitarian norms. *Journal of Experimental Social Psychology*, 45(2), 336–344
- Perrin, A. J., & Smolek, S. J. (2009). Who trusts? Race, gender, and the September 11 rally effect among young adults. *Social Science Research*, 38(1), 134–145
- PEW Global Attitudes Project. (2004-2011). *Datasets*. Retrieved from <http://www.pewglobal.org/category/datasets/>
- PEW Global Attitudes Project. (2008). *Unfavorable Views of Jews and Muslims on the Increase in Europe*. Retrieved from <http://www.pewglobal.org/files/pdf/262.pdf>
- PEW Research Center. (2001). *Post 9-11 Attitudes: Religion More Prominent, Muslim-Americans More Accepted*. Washington, DC, US. Retrieved from <http://www.people-press.org/files/legacy-pdf/144.pdf>
- Pidd, H. (2011, November 16). Neo-Nazi terror scandal grows in Germany: Further evidence emerges of German security service failures that let far-right terrorists commit 10 murders. *The Guardian*. Retrieved from <http://www.guardian.co.uk/world/2011/nov/16/german-neo-nazi-security-service-scandal>
- Poole, E. (2002). *Reporting Islam: Media representations of British Muslims*. London, New York, New York: I.B. Tauris; In the United States of America and Canada distributed by Palgrave Macmillan.
- Poole, E., & Richardson, J. E. (2006). *Muslims and the news media*. London, New York: I.B. Tauris.
- Poynting, S., & Mason, V. (2007). The resistible rise of Islamophobia: Anti-Muslim racism in the UK and Australia before 11 September 2001. *Journal of Sociology*, 43(1), 61–86
- Pyszczynski, T., Solomon, S., & Greenberg, J. (2003). *In the Wake of 9/11: The Psychology of Terror*. Washington, DC, US: American Psychological Association.
- Reuband, K.-H. (2010). How People Learned About the September 11 Terrorist Attack and How It Affected Them: A Study in News Diffusion and Psychosocial Reactions in Germany. In T. Beckers, K. W. Birkelbach, J. Hagenah, & U. Rosar (Eds.), *Komparative empirische Sozialforschung. Anwendungsfelder und aktuelle Methoden in Best Practice-Studien* (1st ed., pp. 437–466). Wiesbaden: VS Verlag für Sozialwissenschaften.
- Richardson, J. E. (2009/2004). *(Mis)representing Islam: The racism and rhetoric of British broadsheet newspapers. Discourse approaches to politics, society, and culture: Vol. 9*. Amsterdam, Philadelphia, PA: John Benjamins Pub.
- Riek, B. M., Mania, E. W., & Gaertner, S. L. (2006). Intergroup Threat and Outgroup Attitudes: A Meta-Analytic Review. *Personality and Social Psychology Review*, 10(4), 336–353
- Roemstedt, B. (2011). *Die Ängste der Deutschen 2011: Top-Angst Lebenshaltungskosten - Furcht vor Arbeitslosigkeit gering wie nie*. Wiesbaden. Retrieved from <http://www.ruv.de/de/presse/download/pdf/aengste-der-deutschen-2011/20110908-aengste-der-deutschen-grafiken-bundesweit.pdf>

- Roemstedt, B. (2012). *Die Ängste der Deutschen 2012: Eine Studie des Infocenters R+V Versicherung*. Retrieved from [http://www.ruv.de/de/presse/r\\_v\\_infocenter/studien/aengste-der-deutschen.jsp](http://www.ruv.de/de/presse/r_v_infocenter/studien/aengste-der-deutschen.jsp)
- Rubin, G. J., Brewin, C. R., Greenberg, N., Hughes, J. H., Simpson, J., & Wessely, S. (2007). Enduring consequences of terrorism: 7-month follow-up survey of reactions to the bombings in London on 7 July 2005. *The British Journal of Psychiatry*, *190*(4), 350–356
- Schüller, S. (2012). *The effects of 9/11 on attitudes toward immigration and the moderating role of education*. Discussion Paper Series (No. 7052). Retrieved from <http://hdl.handle.net/10419/69432>
- Schütz, H., & Six, B. (1996). How Strong is the Relationship Between Prejudice and Discrimination? A Meta-Analytic Answer. *International Journal of Intercultural Relations*, *20*(3), 441–462.
- Shaheen, J. G. (1997). *Arab and Muslim Stereotyping in American Popular Culture*. Washington, DC, US. Retrieved from [http://www12.georgetown.edu/sfs/docs/Jack\\_J\\_Shaheen\\_Arab\\_and\\_Muslim\\_Stereotyping\\_in\\_American\\_Popular\\_Culture\\_1997.pdf](http://www12.georgetown.edu/sfs/docs/Jack_J_Shaheen_Arab_and_Muslim_Stereotyping_in_American_Popular_Culture_1997.pdf)
- Shaheen, J. G. (2003). Reel Bad Arabs: How Hollywood Vilifies a People. *The Annals of the American Academy of Political and Social Science*, *588*(1), 171–193
- Sheridan, L. P. (2006). Islamophobia Pre- and Post-September 11th, 2001. *Journal of Interpersonal Violence*, *21*(3), 317–336
- Sheridan, L. P., & Gillett, R. (2005). Major world events and discrimination. *Asian Journal Of Social Psychology*, *8*(2), 191–197
- Sherif, M., & Sherif, C. W. (1969). Ingroup and intergroup relations: Experimental analysis. In M. Sherif & C. W. Sherif (Eds.), *Social Psychology* (pp. 221–266). New York: Harper & Row.
- Shurkin, J. N. (2007). Terrorism and the Media. In B. M. Bongar, L. M. Brown, L. E. Beutler, J. N. Breckenridge, & P. G. Zimbardo (Eds.), *Psychology of terrorism* (pp. 81–86). Oxford, New York: Oxford University Press.
- Smith, T. W., Rasinski, K. A., & Toce, M. (2001). *America Rebounds: A National Study of Public Response to the September 11th Terrorist Attacks*. Chicago. Retrieved from <http://www3.norc.org/NR/rdonlyres/51AA73B5-EB68-4E2A-AC63-75D652AA7D41/0/pubresp.pdf>
- Snow, N. & Taylor, P. M. (2006). *The Revival of the Propaganda State: US Propaganda at Home and Abroad since 9/11*.
- Stephan, W. G., & Renfro, C. L. (2002). The Role of Threat in Intergroup Relations. In D. M. Mackie & E. R. Smith (Eds.), *From prejudice to intergroup relations. Differentiated reactions to social groups* (pp. 109–208). Hove: Psychology Press.
- Stephan, W. G., & Stephan, C. W. (2000). An integrated threat theory of prejudice. In S. Oskamp (Ed.), *Reducing prejudice and discrimination* (pp. 23–45). Mahwah, N.J: Lawrence Erlbaum Associates.
- Talaska, C. A., Fiske, S. T., & Chaiken, S. (2008). *Legitimizing Racial Discrimination: Emotions, Not Beliefs, Best Predict Discrimination in a Meta-Analysis*.
- Tisdall, S. (2010, October 14). US state department defends Europe-wide terror alert. *The Guardian*. Retrieved from <http://www.guardian.co.uk/world/2010/oct/14/us-state-department-defends-europe-terror-alert>

- Unkelbach, C., Forgas, J. P., & Denson, T. F. (2008). The turban effect: The influence of Muslim headgear and induced affect on aggressive responses in the shooter bias paradigm. *Journal of Experimental Social Psychology, 44*(5), 1409–1413
- USA Today/Gallup Poll. (2011). *Americans' Fear of Terrorism in U.S. Is Near Low Point: Trust in U.S. government to protect citizens from terrorism remains subdued*. Retrieved from <http://www.gallup.com/poll/149315/Americans-Fear-Terrorism-Near-Low-Point.aspx>
- Wagner, U., & Christ, O. (2007). Intergroup Aggression and Emotions: A Framework and First Data. In G. Steffgen & M. Gollwitzer (Eds.), *Emotions and aggressive behavior* (pp. 133–148). Toronto: Hogrefe & Huber.
- Weimann, G. (2008). The Psychology of Mass-Mediated Terrorism. *American Behavioral Scientist, 52*(1), 69–86
- Welch, M. (2006). *Scapegoats of September 11th: Hate crimes & state crimes in the war on terror*. New Brunswick, N.J.: Rutgers University Press.
- Woods, J. (2011). The 9/11 effect: Toward a social science of the terrorist threat. *The Social Science Journal, 48*(1), 213–233
- Zick, A., Wolf, C., Küpper, B., Davidov, E., Schmidt, P., & Heitmeyer, W. (2008). The Syndrome of Group-Focused Enmity: The Interrelation of Prejudices Tested with Multiple Cross-Sectional and Panel Data. *Journal of Social Issues, 64*(2), 363–383

**Manuscript #2:**

**What comes first: threat or prejudice? Perceived terrorist threat  
and the derogation of Muslims in Germany**

Stefan Thörner

Philipps-University Marburg, Germany

Mathias Kauff

Philipps-University Marburg, Germany

Submission date: April 11, 2014

Under Review in *Ethnic and Racial Studies*

**Abstract**

Prejudice against Muslim immigrants in the Western world has existed long before 9/11. However, since then Muslims face more blatant devaluation, discrimination, and violence in the US and several European countries. This is also true for Germany, where the largest population of foreigners is of Muslim faith. According to modern racism theories (e.g., aversive racism) the autochthonous population could utilize perceived terrorist threat as a legitimation to express already existing prejudices. On the other hand, contemporary threat theories (e.g., Integrated Threat Theory; ITT) argue that threat produces prejudice. Thus, the question is what comes first – threat or prejudice? We apply this question to perceived terrorist threat and the devaluation of Muslims in Germany. Indications for causal antecedence are derived from a panel with two time points (N=88), analyzed with latent variable cross-lagged models. Results indicate that terrorist threat produces prejudice and discriminatory intentions against Muslims, thus supporting the ITT view. We discuss theoretical and practical implications of our results.

**Keywords:** Germany, terrorism, threat, aversive racism, anti-Muslim prejudice, Islamophobia, cross-lagged model

## Introduction

More than ten years ago three planes crashed into the World Trade Center in New York City and the Pentagon in Arlington. Not only the United States (US), but also large parts of the so called Western world were shocked and affected by this historic incident (e.g., Stone and Rizova 2007). Following 9/11, individuals' subjective perception of terrorist threat<sup>1</sup> was frequently triggered by both minor incidents, such as attempted terrorist plots in Germany<sup>2</sup>, and two major attacks on Spain and the United Kingdom (UK). Especially shocking for Germany was the fact that Mohammed Atta, the head of the 9/11 terror cell, and other attackers lived and studied in Hamburg, Germany, until 2000 (Jonker 2005). In consequence, a fair amount of Germans raised their general scepticism against Muslims (Der Spiegel 2001)<sup>3</sup>. Although a small circle of radical fundamentalists led the attacks, the blame was partially assigned to Muslims in general (Doosje et al. 2007).

In the aftermath of the major terrorist attacks of the last decade, Muslims and citizens appearing as such experienced devaluation, discrimination, and violence especially in the target countries but also beyond (Allen and Nielsen 2002; Kaplan 2006). Although a higher occurrence of terrorist threat seems to be related to an increased devaluation of Muslims, it is unclear how threat and devaluation are related over time. Two alternative models and a hybrid of both are considered as explanations: first, contemporary threat theories (e.g., Stephan and Stephan 2000) argue that prejudice develops in consequence of perceived threat. Ingroup bias and outgroup derogation occur as defence mechanisms when individuals feel personally or collectively threatened (Stephan, Renfro, and Davis 2008). Second, other theorists (e.g., Gaertner and Dovidio 1986) suggest that threat could be used as a legitimization

---

<sup>1</sup> The perception of 'terrorist threat' is primarily an intraindividual state of perceiving oneself or one's country in danger. This concept is not equivalent to an objective state of terror alarm.

<sup>2</sup> On July 31, 2006, two Islamist terrorists placed bombs in trains in Cologne, Germany. However, the bombs failed to detonate. Furthermore, an Islamist terror cell was arrested in September 2007 while planning attacks.

<sup>3</sup> 19 per cent affirmed the question "Do you feel more skeptical about Muslims since the attacks in the US". NFO-Infratest poll (N≈1000) commissioned by Der Spiegel.



to express existing prejudice. According to this line of theory, individuals feel a strong social norm to hide their prejudices and thus search for situations in which expressing their bias feels adequate. This seems true if outgroups can be observed while misbehaving (e.g., committing terrorist attacks). This kind of theorizing is worth of consideration for Germany, because most immigrants to Germany are of Muslim faith (e.g., Cesari 2011), prejudice against immigrants existed already before 9/11 (e.g., Pettigrew 1998), and there is a strong general social norm to not express prejudice openly, particularly due to Germany's Nazi history (e.g., Heyder, Iser, and Schmidt 2005). The third possible explanation is a hybrid form of the former two mechanisms, which is a bidirectional causal relation between threat and prejudice.

Previous studies analyzing the relation of perceived terrorist threat, anti-Muslim prejudice, and discriminatory intentions (Doosje et al. 2009; Oswald 2005) adopted the predominant view that threat creates prejudice. However, most of these studies are cross-sectional and thus cannot ensure whether their theoretical account is appropriate. Therefore, we investigated which theoretical perspective applies to the case of perceived terrorist threat and the derogation of Muslims in Germany. Instead of implementing a cross-sectional design, we used longitudinal data, which have the advantage of indicating the causal antecedence of the constructs under research (Finkel 1995). We used latent variable analysis, which considers measurement error leading to more reliable relations between variables (Kline 2011). By applying cross-lagged models, we simultaneously test whether the devaluation of Muslims goes back to perceived terrorist threat, whether terrorist threat is the consequence (legitimation) of prejudice, or whether a hybrid model is most appropriate<sup>4</sup>.

---

<sup>4</sup> For a conceptually similar study but in the context of general group threat, see Schlueter, Schmidt, and Wagner (2008).

## Theoretical background

**Terrorist threat.** Threat can be defined as the expectation of something aversive to happen (Fritsche, Jonas, and Kessler 2011; see also Stephan and Renfro 2002). Fritsche et al. (2011) describe terrorist threat as a ‘double threat’ because it can be perceived on group level (collective threat) and on individual level (personal threat; see also Huddy et al. 2002): terrorists attack national symbols to humiliate their target nations and they kill civilians to emphasize that everyone could become victim.

The primary weapon of terrorists to reach their political goals is to spread threat (e.g., Huddy, Feldman, and Cassese 2009). Regarding this, Breckenridge and Zimbardo (2007) stated: *‘Terrorists appear to have a keen, intuitive appreciation of psychological mechanisms that spread the effects of terror well beyond their primary victims and amplify the perception of risk and vulnerability far out of proportion to reasonable probabilities.’* (p. 116)

**Islam and terrorism.** Nowadays, in Western countries ‘terrorism’ is by default interpreted as ‘Islamist terrorism’ (Allen 2004). This emphasizes the close association that is made between terrorism and Islam in general. An indicator of this subjective close connection was the spontaneous biased accuse of Islamists as perpetrators when in July 2011 an autochthonous Norwegian terrorist committed a bomb plot in Oslo (Sehgal 2011; see also Rytter and Holm Pedersen 2013).

A high portion of individuals in Europe imputes a sympathy with terrorists to Muslims (for an overview, see Zick, Küpper, and Hövermann 2011). For Germany, Leibold and Kühnel (2006) revealed in a representative survey from 2005<sup>5</sup> that over 60 per cent of respondents ‘agreed’ or ‘rather agreed’ with the statements: ‘Islamist terrorists enjoy backing of Muslims’ and ‘Islamist terrorists are adored as heroes by many Muslims’. Thus, the majority of Germans believes that Muslims endorse Islamic terrorism. The resulting question

---

<sup>5</sup> The period of data gathering was May until June 2005. Thus, the data conduction was finished before the London Bombing (7/7) occurred.

is whether Muslims are perceived as a real threat to Germany and its citizens or whether this new facet of the stereotype of Muslims (terrorism) is used as legitimation to express already existing prejudice.

**Previous research.** Several cross-sectional studies found terrorist threat and derogation of Muslims to be connected. For instance, Oswald (2005) tried to capture various correlates of anti-Arab reactions after 9/11. She discovered that perceived terrorist threat was significantly connected to prejudicial and discriminatory reactions towards Arabs. Doosje and colleagues (2009) analyzed a mixed European survey that included items about perceived terrorist threat, perceived Muslims' support for terrorism, anti-Muslim prejudice and approval to discrimination of Muslims. The authors showed that perceived terrorist threat was connected to anti-Muslim prejudice and approval of discrimination.

In the context of the Madrid Bombings in 2004, Echebarria-Echabe and Fernández-Guede (2006) delivered unique insights. They conducted a survey to test their scale of anti-Arab prejudice coincidentally shortly before the attacks happened. Afterwards, they decided to repeat the survey with a similar sample. Prejudice against Arabs was significantly higher in the post sample compared to the pre sample. However, the mechanism underlying this increase in prejudice remains unclear.

To our knowledge, the only panel analysis in the context of terror and outgroup derogation was conducted by Skitka, Bauman, and Mullen (2004). They analyzed a panel dataset which was conducted in September 2001 (t1) and January 2002 (t2). T1 comprised measures of anger and fear and t2 captured, among others, perceived threat, outgroup derogation, and political tolerance. The authors showed that fear and threat were significantly associated with outgroup derogation and political intolerance. However, because this study did not measure the constructs under research at both times, the possibility to derive causal antecedence is limited (Finkel 1995).

Experimental research revealed that increased salience of terror led to increased prejudice (Das et al. 2009). However, a simple threat manipulation<sup>6</sup> does not reveal whether individuals increase in prejudice or whether the expression of existing prejudice increases.

In summary, several studies assume threat to produce prejudice without validating this assumption. To our knowledge, there is no study that provides appropriate data for testing the causal direction of terrorist threat and the derogation of Muslims’.

**Competing models.** Previous research and the observable anti-Muslim backlash following major terrorist attacks allow for the conclusion that terrorist threat is associated with prejudice and discrimination. However, the temporal sequence of perceived terrorist threat and outgroup derogation is unclear. Three models are available explaining this phenomenon: first, threat produces prejudice, second, prejudice is legitimated by threat, or third, both mechanisms occur simultaneously.

*Threat model.* Terrorism can induce collective and personal threat (e.g., Huddy et al. 2002; Fritsche, Jonas, and Kessler 2011). Both aspects are related to prejudice against ‘others’. On an intergroup level, there is a long history of threat theories showing that threat is connected to prejudice (Blumer 1958; Sherif and Sherif 1969; Quillian 1995). More recently, Stephan and Stephan (2000) formulated an Integrated Threat Theory (ITT) which includes not only several forms of threat on an intergroup level but also on an individual level (see also Stephan and Renfro 2002; Stephan, Renfro, and Davis 2008). According to ITT, exclusionary attitudes, discriminatory intentions and behaviour are the consequence of the perceived presence of an outgroup that is connected to negative consequences for oneself or ones ingroup (Stephan and Renfro 2002). Threat in general is supposed to induce ingroup bias and outgroup derogation, while threat stemming from one specific group increases hostility especially towards that group (LeVine and Campbell 1972). If Muslims are perceived as

---

<sup>6</sup> In this specific case a mortality salience manipulation.

being connected to terrorism, they will pose a threat to Germans' and their country, which should in turn produce prejudice against Muslims.

*Legitimation model*<sup>7</sup>. Allen (2004) argued that the upcoming of Islamist terrorism legitimized the expression of long-cherished prejudice against Muslims: '[...] 9/11 has made Islamophobia more acceptable, which has enabled its expressions, inferences, and manifestations to locate a newer and possibly more prevalent societal resonance and acceptability.' (p. 2) This argumentation is in line with newer prejudice theories (Gaertner and Dovidio 1986; McConahay 1986). They argue that prejudice exists in individuals but is hidden by social norms and personal egalitarian beliefs unless there is a justification (e.g., terrorist attack) to express it<sup>8</sup> (see also Crandall and Eshleman 2003).

*Hybrid model*. Since both models are plausible, a combination of both mechanisms is also conceivable (Wilson 2001). Thus, derogation of Muslims would on the one hand be produced by perceived terrorist threat whereas on the other hand perceived terrorist threat would be used as a legitimation of earlier derogation of Muslims. Such an effect could be the result of either intraindividual bidirectional causality between terrorist threat and prejudice or contrary effects in subpopulations of the sample.

## **The German context**

**History of immigration.** In the 1960s Germany arranged the so called 'Gastarbeiterprogramm', a cooperation with Turkey, Italy, Morocco, and Yugoslavia enabling migration of guest workers from these countries to Germany (Herbert 2001). Because the workers were assumed to leave when their work force was no longer needed, no integration measures were initiated (Cesari 2011). However, those who worked in Germany

<sup>7</sup> See Schlueter et al. (2008) for a somewhat different conceptualization of such a model.

<sup>8</sup> This process may be conscious or unconscious. Either, individuals consciously increase their scores of perceived terrorist threat to legitimate prejudice or they increase in threat perception unconsciously. A full discussion of conscious and unconscious processes, however, would be beyond the scope of this paper.

for more than five years were offered the opportunity to stay infinitely (Castles 1986). Many guest workers - especially from Turkey - took this chance and initiated reunions with their families in Germany. In consequence, already in the 1970s, 1.5 million Turkish immigrants lived in Germany.

This development was considered undesirable among many autochthonous Germans (Jonker 2005), which became more imminent in the 70s during the oil crisis and in the 90s because of a huge debate about asylum seekers (Kurthen, Bergmann, and Erb 1997; Lubbers and Scheepers 2001). In 1990, over 30 per cent of autochthonous Germans in the general social survey agreed with the statement that guest workers should be sent back to their native countries if jobs get scarce (Bergmann 1997, 30). Thus, rejection and prejudice against guest workers existed long before 9/11.

**Today's demographics and media image of Muslims.** Today, around four million people (about five per cent of Germany's population) are of Islamic faith. Turks are the largest immigrant group (about 70 per cent). The remaining 30 per cent root from South Eastern Europe, the Middle East and North Africa (Archick et al. 2011). Due to the lack of integration measures in the first guest worker generation, Muslims still face a higher risk of being unemployed, poor, and low-educated (Archick et al. 2011).

The picture of Islam in the German media is mostly negative and associated with immigration issues, radicalization, fundamentalism, and terrorism (Hafez and Richter 2007). Media reports about Turks in particular cover negative aspects of immigration like high unemployment, crime rates, and the lack of acculturation (Halm 2013). In the past twenty years, largely negatively biased debates about immigration, radicalization, the building of mosques, wearing the hijab, honour killings, and pretended foreign infiltration took place (e.g., Sarrazin 2010).

### The present research

This study aims at answering the question which of the three theorized models, *threat model*, *legitimation model* or *hybrid model* is most appropriate for the situation in Germany, where Muslims have been the largest immigrant group for almost half a century. Therefore, we apply latent variable cross-lagged modelling to a panel dataset gathered in Germany in 2011. We measured perceived terrorist threat and derogation of Muslims twofold. This is because, as mentioned above, terrorist threat can be perceived on a collective and a personal level (e.g., Huddy et al. 2002) and derogation of Muslims can happen on attitudinal and behavioural level (e.g., Doosje et al. 2009).

Whether collective and personal threat create differential effects is left open for exploration since earlier studies delivered contradictory results (Asbrock and Fritsche 2013; Huddy et al. 2005). To capture outgroup derogation of Muslims twofold, the panel included items that should measure prejudice and discriminatory intentions. Thus, we enlarge on Doosje and colleagues' (2009) work showing terrorist threat to be connected to discriminatory intentions against Muslims.

Regarding the context of the survey, it is important to state that two events happened close to the field period of this study. First, the German minister of internal affairs released an official terror warning for Germany two month before the field period began (Der Spiegel 2010). Second, Bin-Laden was assassinated between t1 and t2. Thus, terrorism was on the agenda of mass media when this study was conducted, meaning it is likely that all participants were aware of the events. The mean score of participants' perceived terrorist threat remained stable across t1 and t2<sup>9</sup>.

---

<sup>9</sup> Means: collective terrorist threat t1=3.18, t2=3.33,  $\Delta M=.15$  ( $p>.05$ ); personal terrorist threat t1=2.15, t2=2.20,  $\Delta M=.05$  ( $p>.05$ ).

Figure 1. Theoretical autoregressive model with potential cross-lagged paths

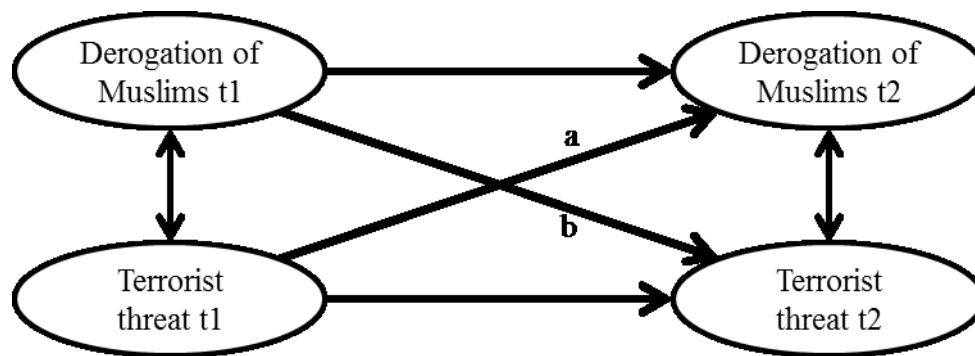

**Hypotheses.** Figure 1 translates the theories above into a testable model. It shows a cross-lagged model with the theorized potential cross-lagged paths. If path ‘a’ reached significance, the *threat model* – threat creates devaluation – would be supported. A significant path ‘b’ would speak for a *legitimation model* – prejudices are legitimated by threat. A *hybrid model* would be supported if both paths (a & b) reach significance.

## Methods

**Statistical procedure.** Confirmatory Factor Analysis (CFA) and Structural Equation Modelling (SEM) were used. The application of these procedures, especially if combined, is highly advantageous since measurement error is considered and modelled separately, leading to highly reliable estimates of relationships between constructs (Kline 2011).

We deployed a robust maximum likelihood estimator in the software Mplus 7 (Muthén and Muthén 2012). This estimator corrects standard errors for non-normality of the data but also corrects chi-square and model fit. Hence, an adaptation of the chi-square difference test for nested model comparisons is needed (Satorra and Bentler 2001). Missing data were handled via Full Information Maximum Likelihood (FIML) estimation (Arbuckle 1996). However, since the panel attrition was large, only those who participated in both waves are considered for longitudinal analysis.



The specific longitudinal data modelling technique used is called autoregressive cross-lagged structural equation analysis (Jöreskog 1979). This model contains two or more variables with at least two measurement points (see Figure 1 for an example). The time ordering, meaning the independent variable being conducted before the dependent variable, is one of the central conditions to draw causal inferences from non-experimental data (Finkel 1995). In a two-wave (t1 & t2), two variables example (Figure 1), both t2 variables are regressed on itself (autoregression) at t1 and the second variable at t1 (cross-lagged effects a & b). If some of the variance left in a t2 variable, after controlling for its autoregression, is explained by the second variable at t1, can this be interpreted as a causal link. However, the claim of causality depends on the assumption that the effect is not produced by a third variable (Finkel 1995).

**Sample.** T1 measurement was conducted in January 2011. The invitation to participate in the online questionnaire was distributed via university email lists and social networks. The sample was split<sup>10</sup>. The relevant split for this study included N=755 cases. Because of insufficient data and migration background of participants, 193 cases had to be excluded, leaving a net sample of N<sub>t1</sub>=562. The sample consisted of 59 per cent females, the average age was 28 years (SD=9.29) and the average education 7.22 (SD=.649), on a 1='no school-leaving qualifications' up to 8='university degree' scale, indicating a very high educational level.

At the end of the questionnaire, respondents had the possibility to leave their email address for being invited to participate in a second wave of that questionnaire and to create a unique, anonymous code that enabled us to merge t1 and t2 data later on. 267 participants (35.3 per cent) provided their email addresses.

---

<sup>10</sup> The survey included also several other research projects than the current one.

In June 2011, we invited the respondents via email to fill out the t2 questionnaire. The response rate was rather low with 40.3 per cent, leaving an N of 98 cases that answered t2. After excluding participants with migration background, a net sample of  $N_{t2}=88$  remained.

A logistic regression, including socio-demographics and the constructs relevant for this paper<sup>11</sup> revealed that only age influenced the probability of participating in the second wave significantly. With increasing age, the probability of participating increased slightly (odds ratio = 1.025,  $p < .05$ ,  $CI_{95} = 1.003/1.047$ ). However, this is not an issue since later third variable analyses in the cross-lagged models of terrorist threat and Muslims' derogation revealed no effects of age.

**Measures.** Collective and personal terrorist threat were measured by two items each. The items were created by ourselves or partially derived from Frindte and Haußecker (2010, 136). Collective terrorist threat was measured with the items: 'Terror will find its way into Germany' and 'I think it is just a matter of time before Germany also becomes a scene of massive terrorist attacks'. Personal terrorist threat was measured by the agreement to the following statements: 'I personally feel threatened by terrorist attacks' and 'I am scared of terrorist attacks here in Germany'.

The items measuring derogation of Muslims were derived from Leibold and Kühnel (2006, 142–44). We were careful in choosing items that do not trigger an association between terrorist threat and anti-Muslim prejudice.

The items designated to measure anti-Muslim prejudice were: 'Because of the many Muslims here, I sometimes feel like a stranger in my own country', 'Muslims should not be allowed to immigrate to Germany' and 'The many mosques in Germany show that here, too, Islam strives to extend its clout'. Discriminatory intention against Muslims was operationalized by three items: 'I would just as well enrol my child in a school where a

---

<sup>11</sup> Sociodemographics: age, gender, education; Other constructs: perceived personal & collective terrorist threat, derogation of Muslims.

Muslim woman teaches wearing a headscarf”, ‘I would have problems to move to an area where many Muslims live’ and ‘I will only vote for those parties that are against further immigration of Muslims’ (for a study using a similar operationalization of discriminatory intention see Doosje et al. 2009).

All items were answered on a 1 = ‘fully agree’ to 7 = ‘fully disagree’ scale. Most of the items had to be recoded so that high scores consistently depict high threat, prejudice, or discriminatory intention.

## Results

**Personal and collective terrorist threat.** Collective and personal terrorist threat are assumed to be distinct constructs, which was examined via CFA. A two factor model ( $\chi^2_{\text{corrected}}=3.835$ ,  $df=1$ ,  $p=.0502$ ,  $CFI=.997$ ,  $RMSEA=.069$ ,  $SRMR=.009$ ) fit the data clearly better than a one factor solution ( $\chi^2_{\text{corrected}}=44.207$ ,  $df=2$ ,  $p=.00$ ,  $CFI=.939$ ,  $RMSEA=.187$ ,  $SRMR=.043$ ; for model fit recommendations see Schermelleh-Engel, Mosbrugger, and Müller 2003). Although the two factor solution is more appropriate, the high correlation between collective and personal threat ( $r=.809$ ,  $p<.001$ ) is highly probable to induce multicollinearity issues in terms of unreliable estimates (Grewal, Cote, and Baumgartner 2004). Therefore, we analyzed the effects of personal and collective terrorist threat separately.

**Anti-Muslim prejudice and discriminatory intention.** Since we wanted to analyze the connection of terrorist threat with prejudice and also with discriminatory intention, we tested whether prejudice and discrimination are separable factors in our data. This proved to be untrue. The significant chi-square of the two factor solution ( $\chi^2_{\text{corrected}}=28.762$ ,  $df=8$ ,  $p=.00$ ,  $CFI=.984$ ,  $RMSEA=.068$ ,  $SRMR=.02$ ) indicated an insufficient fit. The two factors correlated with  $r=.989$  ( $p<.001$ ). This almost perfect correlation clearly spoke for a one factor

solution. Hence, we decided to proceed with a conglomerate factor of prejudice and discriminatory intention<sup>12</sup>. This factor accounts for the finding that respondents did not distinguish between prejudicial attitudes and discriminatory intentions. In the process of forming this factor, one item<sup>13</sup> had to be excluded due to causing various modification indices in the model. The final factor consisted of five items and reached a very good model fit ( $\chi^2_{\text{corrected}}=4.539$ ,  $df=5$ ,  $p=.47$ ,  $CFI=1.00$ ,  $RMSEA=.00$ ,  $SRMR=.012$ ).

Table 1. Latent Means, Reliability, Correlations of Latent Factors at t1

Construct	Latent Mean (SD)	1	2	3
1. Collective terrorist threat	3.416 (1.577)	$\alpha = .762$ inter-item $r=.626$	.809***	.555***
2. Personal terrorist threat	2.264 (1.415)		$\alpha = .820$ inter-item $r=.736$	.389***
3. Prej. & discr. Intention against Muslims	2.857 (1.948)			$\alpha = .813$

*Note.* Collective and personal terrorist threat are measured with two items each. Therefore, inter-item correlations are presented in addition to Cronbach's Alpha coefficient. Model fit of the simultaneous confirmatory factor analysis:  $\chi^2_{\text{(corrected)}}=28.504$ ,  $df=24$ ,  $p=.24$ ,  $CFI=.997$ ,  $RMSEA=.019$ ,  $SRMR=.021$ .

Table 1 shows the latent means, internal consistencies, and factor correlations of collective terrorist threat, personal terrorist threat, and prejudice & discriminatory intentions against Muslims at t1. Cronbach's alpha coefficients and inter-item correlations indicated satisfactory reliability of the factors. Latent means and correlations are based on a simultaneous CFA. Personal and collective terrorist threat were substantially correlated with

<sup>12</sup> We refer to this single factor measure as 'prejudice & discriminatory intention'.

<sup>13</sup> 'Muslims should not be allowed to immigrate to Germany'.

the factor prejudice & discriminatory intentions. The effect size of collective threat was somewhat higher than that of personal threat.

**Longitudinal analysis.** As a precondition of longitudinal structure and mean modelling, the measurement model needs to remain invariant over time (Byrne, Shavelson, and Muthén 1989). All models reached scalar invariance (e.g., equal structure, factor loadings, intercepts): Collective terrorist threat ( $\chi^2_{\text{corrected}}=4.415$ ,  $df=4$ ,  $p=.35$ ,  $CFI=.998$ ,  $RMSEA=.036$ ,  $SRMR=.032$ ), personal terrorist threat ( $\chi^2_{\text{corrected}}=6.468$ ,  $df=4$ ,  $p=.17$ ,  $CFI=.985$ ,  $RMSEA=.084$ ,  $SRMR=.053$ ), and prejudice & discriminatory intention against Muslims ( $\chi^2_{\text{corrected}}=43.553$ ,  $df=33$ ,  $p=.10$ ,  $CFI=.977$ ,  $RMSEA=.057$ ,  $SRMR=.054$ ). Hence, the condition to compare structural paths and also latent means is fulfilled (Byrne, Shavelson, and Muthén 1989).

**Cross-lagged models.** We calculated separate models for collective and personal terrorist threat due to collinearity issues<sup>14</sup>.

Figure 2. Cross-lagged model with collective terrorist threat

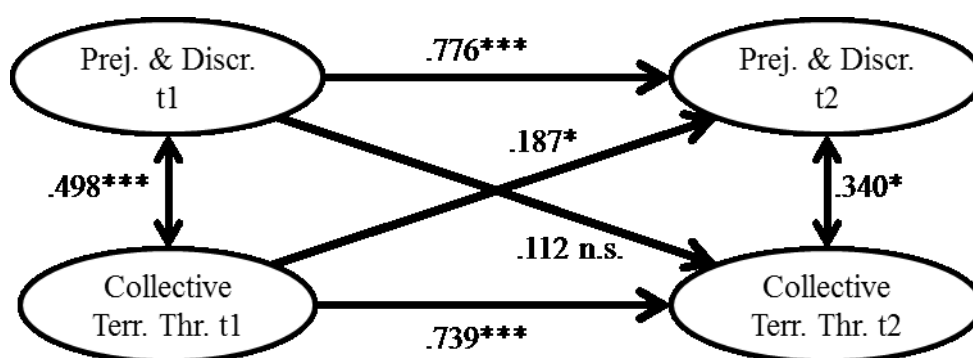

*Note.* Measurement Models not shown. Standardized robust maximum likelihood coefficients. Model fit:  $\chi^2_{(\text{corrected})} = 91.15$ ,  $df = 76$ ,  $p = .11$ ,  $CFI = .975$ ,  $RMSEA = .051$ ,  $SRMR = .063$ .

<sup>14</sup> The attempt to calculate a cross-lagged model including simultaneously collective and personal threat as well as the factor prejudice & discriminatory intention failed, as assumed, due to collinearity issues. Resulting regression weights and standard errors showed strong signs of unreliability.

Figure 2 shows the cross-lagged model of collective terrorist threat and anti-Muslim prejudice & discrimination. The autocorrelations of both factors were fairly high suggesting a rather low amount of change over time. As the *threat model* hypothesized, only the cross-lagged path from collective terrorist threat to anti-Muslim prejudice and discriminatory intention reached significance ( $\beta=.187, p<.05$ ). Hence, perceiving collective terrorist threat at t1 predicts being prejudiced at t2. Alternative hypotheses are not supported.

Figure 3. Cross-lagged model with personal terrorist threat

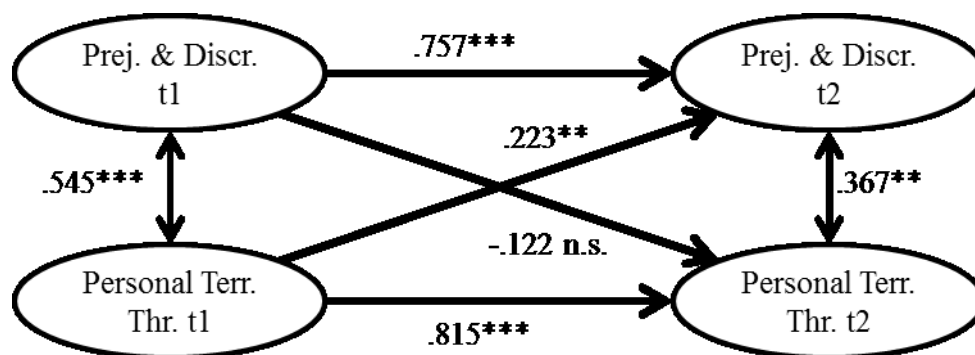

*Note.* Measurement Models not shown. Standardized robust maximum likelihood coefficients. Model fit:  $\chi^2_{(\text{corrected})} = 84.955, df = 71, p = .2118, CFI = .984, RMSEA = .042, SRMR = .076$ .

Identical testing for personal terrorist threat (Figure 3) revealed congruent results. Personal terrorist threat was also antecedent to anti-Muslim prejudice and discrimination.

Since no differential effects of personal and collective threat occurred, we created a second order factor of terrorist threat. Due to the rather small sample size, we aimed at reducing the complexity of the model and therefore decided to create composite measures (so called parcels; see Little et al. 2002) of collective and personal terrorist threat. They were then used as indicators for the higher-level terrorist threat factor. Next we tested whether

longitudinal invariance was given, which proved to be true (scalar invariance:

$\chi^2_{\text{corrected}}=2.648$ ,  $df=4$ ,  $p=.62$ ,  $CFI=1.00$ ,  $RMSEA=.00$ ,  $SRMR=.031$ ).

Figure 4. Cross-lagged model with terrorist threat (second order)

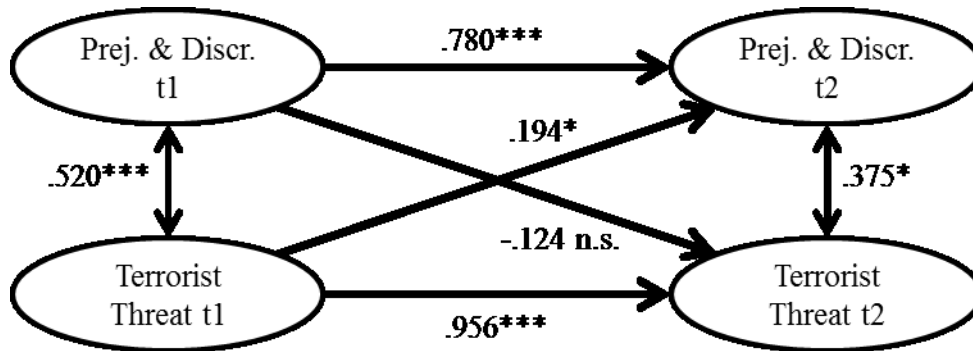

*Note.* Measurement Models not shown Standardized robust maximum likelihood coefficients.

Model fit:  $\chi^2_{\text{(corrected)}} = 93.640$ ,  $df = 74$ ,  $p = .613$ ,  $CFI = .969$ ,  $RMSEA = .059$ ,  $SRMR = .07$ .

Figure 4 shows that the model with the parcelled second order factor of terrorist threat replicates the finding that terrorist threat is antecedent to prejudice and discriminatory intention. To reduce the probability of a third-variable effect we included the control variables gender, age, and education into the model. The cross-lagged effects remained robust against those controls but the model fit became worse ( $\chi^2_{\text{corrected}}=121.138$ ,  $df=88$ ,  $p=.011$ ,  $CFI=.95$ ,  $RMSEA=.07$ ,  $SRMR=.063$ ). None of the control variables had a significant influence on the dependent variables at t2.

In summary, the *threat model* hypothesis that terrorist threat is antecedent to prejudice & discriminatory intention against Muslims is supported for collective and personal terrorist threat separately and for a parcelled second order factor of terrorist threat. No indications for a *legitimation model* or a *hybrid model* were found.

## Discussion

In this research, we aimed at clarifying the temporal antecedence of perceived terrorist threat and derogation of Muslims in the German context. In addition, we were interested in the role of the subcomponents of terrorist threat (personal and collective) and derogation of Muslims (prejudice and discriminatory intention). In a first step we studied the cross-sectional relations of these variables and figured out that terrorist threat and Muslims' derogation are substantially correlated. For testing the longitudinal antecedence, we derived three testable models from theory. The *threat model hypothesis*, saying that terrorist threat is causally antecedent to prejudice & discriminatory intention, was supported. No support for the *legitimation model* – meaning that terrorist threat is used as legitimation for expressing existing prejudice – was found, although it seemed to be a conceivable model for the specific situation in Germany. The theorized *hybrid model* was not supported either. Thus, anti-Muslim prejudice and the intention to discriminate Muslims in Germany are at least partially driven by the relatively new phenomenon of perceived terrorist threat. We conclude that terrorist threat is primarily perceived as a real threat, triggering outgroup derogation as a defence mechanism.

In this study, personal and collective terrorist threat had no differential effects on derogation of Muslims. Huddy and colleagues (2005), however, reported an association of anti-Arab policy preferences only for collective threat, not for personal threat<sup>15</sup>. Asbrock and Fritsche (2013) showed in an experimental study that personal, but not collective threat was connected with ethnocentric reactions. In another context, Pettigrew, Christ, Wagner, and Stellmacher (2007) found that the effect of personal threat on prejudice was fully mediated by collective threat. Those diverse results clearly indicate that more research needs to be done to clarify structure and effects of terrorist threat.

---

<sup>15</sup> Personal threat is called 'anxiety' in their study but the factor includes items that are similar or same to those capturing personal terrorist threat.



**Limitations and future research.** We acknowledge several shortcomings of this study. Our sample consisted mainly of highly educated young respondents, which could limit the generalizability of our findings. Future research should therefore try to replicate our findings in representative samples. Another improvement could be reached by conducting more than two measurement waves, which would also allow for testing longitudinal mediation.

Longitudinal data are clearly better suited to reveal causal relations of constructs than cross-sectional data. However, one of the conditions to test causal directions of relationships within a longitudinal model is that a possible third-variable effect can be excluded (Finkel 1995). This condition can never be guaranteed due to the infinite number of third variables. It can only be minimized by considering theoretically relevant variables. The amount of third variables was rather limited in this study. Future studies should either consider more third variables or make use of experimental designs to substantiate our finding of terrorist threat being the cause for the devaluation of Muslims.

Another shortcoming is that prejudice and discriminatory intention are not discriminant in this study as for instance hypothesized by the theory of planned behaviour (Ajzen and Fishbein 1977). This could be the consequence of the question wording for discriminatory intentions against Muslims, which may have been too similar to attitude items. To legitimate the claim that our results are also valid for discriminatory intention we calculated another cross-lagged model, using terrorist threat and the strongest behavioural intention item ‘I will only vote for those parties that are against further immigration of

Muslims'. Only the cross-lagged path from terrorist threat to anti-Muslim immigration voting reached significance<sup>16</sup>, supporting our claim.

Furthermore, future research should deal with the change in quality of stereotypes. The assumption is that the stereotypes of Muslims have changed vastly in response to 9/11. Such a phenomenon was observed for Americans' stereotypes of Japanese, when Japan attacked Pearl Harbor in World War II (Seago 1947).

**Implications.** Because terrorist threat is antecedent of Muslims' derogation, the perception of threat needs to be reduced (e.g., Breckenridge and Zimbardo 2007). Sunstein (2003, 121) stated: *'When strong emotions are involved, people tend to focus on the badness of the outcome, rather than on the probability that the outcome will occur.'* Therefore, it is one approach to educate citizens about the low probability of becoming a victim of a terrorist attack. This, however, is a difficult undertaking, especially in the aftermath of an attack.

A different approach is to inform people about the causes of Islamist terrorism which enables them making sense out of the negative experience (Fischer et al. 2011). Fischer and colleagues experimentally manipulated terrorist threat and the provision of background information about terrorists' motives. If meaning was provided in the high threat condition, participants felt less threatened.

Jonas and Fritsche (2013) suggest to strengthen cultural environments (subjectively meaningful groups, volunteer organizations) since they can buffer threat. Fischer and colleagues (2006) argue in the same manner that intrinsic religiousness decreases threat perceptions. They showed that experimentally induced terrorist threat affected only non-religious individuals' mood. This effect was mediated by self-efficacy.

In addition to reducing and buffering the perception of threat, the association of 'Muslims' and 'terrorism' needs to be diminished. This aim can only be reached if mass

---

<sup>16</sup> Beta=.164,  $p < .05$ ; Model fit:  $\chi^2_{(\text{corrected})} = 6.327$ ,  $df = 8$ ,  $p = .6106$ ,  $CFI = 1.00$ ,  $RMSEA = .00$ ,  $SRMR = .029$ . Full model results upon request.

media stops presenting Muslims primarily in the context of fanaticism and terrorism (e.g., Shaheen 2003). Furthermore, opinion leaders need to emphasize the inadmissibility of the existing association between Muslims and terrorism (Allen 2004).

**Acknowledgements**

We thank Ulrich Wagner, Peter Schmidt, Frank Asbrock, Jan Weber, Sarina Schäfer and Christoph Butenschön for their helpful comments on an earlier draft of this article. This work was supported by the interdisciplinary Research Training School ‘Group Focused Enmity’ located in Marburg and Bielefeld, Germany, funded by the Deutsche Forschungsgemeinschaft (GRK 884).

## References

- Ajzen, Icek, and Martin Fishbein. 1977. "Attitude-behavior relations: A theoretical analysis and review of empirical research." *Psychological Bulletin* 84 (5): 888–918. doi: 10.1037/0033-2909.84.5.888.
- Allen, Christopher. 2004. "Justifying Islamophobia: A Post 9/11 Consideration of the European Union and British Contexts." *The American Journal of Islamic Social Sciences* 21 (3): 1–25.
- Allen, Christopher, and Jørgen S. Nielsen. 2002. "Summary Report on Islamophobia in the EU after 11 September 2001." [http://fra.europa.eu/sites/default/files/fra\\_uploads/199-Synthesis-report\\_en.pdf](http://fra.europa.eu/sites/default/files/fra_uploads/199-Synthesis-report_en.pdf). Accessed November 17, 2012.
- Arbuckle, J. L. 1996. "Full information estimation in the presence of missing data." In *Advanced structural equation modeling: Issues and techniques*. Edited by George A. Marcoulides and Randall E. Schumacker, 243–77. Mahwah, N.J: L. Erlbaum Associates.
- Archick, Kristin, Paul Belkin, Christopher M. Blanchard, Carl Ek, and Derek E. Mix. 2011. "Muslims in Europe: Promoting Integration and Countering Extremism." Unpublished manuscript, last modified March 14, 2013. <https://www.fas.org/sgp/crs/row/RL33166.pdf>.
- Asbrock, Frank, and Immo Fritsche. 2013. "Authoritarian reactions to terrorist threat: Who is being threatened, the Me or the We?" *International Journal of Psychology* 48 (1): 35–49. doi: 10.1080/00207594.2012.695075.
- Bergmann, Werner. 1997. "Antisemitism and Xenophobia in Germany since Unification." In *Antisemitism and xenophobia in Germany after unification*. Edited by Hermann Kurthen, Werner Bergmann, and Rainer Erb, 21–38. New York [u.a.]: Oxford Univ. Press.
- Blumer, Herbert. 1958. "Race Prejudice as a Sense of Group Position." *The Pacific Sociological Review* 1 (1): 3–7.
- Breckenridge, James N., and Philip G. Zimbardo. 2007. "The Strategy of Terrorism and the Psychology of Mass-Mediated Fear." In *Psychology of terrorism*. Edited by Bruce M. Bongar, Lisa M. Brown, Larry E. Beutler, James N. Breckenridge, and Philip G. Zimbardo, 116–33. Oxford, New York: Oxford University Press.
- Byrne, Barbara M., Richard J. Shavelson, and Bengt O. Muthén. 1989. "Testing for the Equivalence of Factor Covariance and Mean Structures: The Issue of Partial Measurement Invariance." *Psychological Bulletin* 105 (3): 456–66. [http://www.statmodel.com/bmuthen/articles/Article\\_027.pdf](http://www.statmodel.com/bmuthen/articles/Article_027.pdf). Accessed March 27, 2013.
- Castles, Stephen. 1986. "The Guest-Worker in Western Europe - An Obituary." *International Migration Review* 20 (4): 761. doi: 10.2307/2545735.
- Cesari, Jocelyne. 2011. "Islamophobia in the West: A comparison between Europe and the United States." In *Islamophobia: The challenge of pluralism in the 21st century*. Edited by John L. Esposito and İbrahim Kalın, 21–46. Oxford; New York: Oxford University Press.
- Crandall, Christian S., and Amy Eshleman. 2003. "A justification-suppression model of the expression and experience of prejudice." *Psychological Bulletin* 129 (3): 414–46. doi: 10.1037/0033-2909.129.3.414.
- Das, Enny, Brad J. Bushman, Marieke D. Bezemer, Peter Kerkhof, and Ivar E. Vermeulen. 2009. "How terrorism news reports increase prejudice against outgroups: A terror

- management account.” *Journal of Experimental Social Psychology* 45 (3): 453–59. doi: 10.1016/j.jesp.2008.12.001.
- Der Spiegel. 2001. “Zwischen Krieg und Frieden [Between War and Peace].” September 23. 39. Accessed January 15, 2013.  
<https://wissen.spiegel.de/wissen/image/show.html?did=20184249&aref=image026/E0135/SCSP200103900130013.pdf&thumb=false>.
- . 2010. “Cause for Concern: German Government Issues 'Concrete' Terror Warning.” November 17. Accessed March 20, 2013.  
<http://www.spiegel.de/international/germany/cause-for-concern-german-government-issues-concrete-terror-warning-a-729635.html>.
- Doosje, Bertjan, Sven Zebel, Marieke Scheermeijer, and Pauline Mathyi. 2007. “Attributions of Responsibility for Terrorist Attacks: The Role of Group Membership and Identification.” *International Journal of Conflict and Violence* 2 (1): 127–41.  
<http://www.ijcv.org/index.php/ijcv/article/viewFile/11/11>. Accessed August 30, 2013.
- Doosje, Bertjan, Anja Zimmermann, Beate Küpper, Andreas Zick, and Rod L. Meertens. 2009. “Terrorist Threat and Perceived Islamic Support for Terrorist Attacks as Predictors of Personal and Institutional Out-Group Discrimination and Support for Anti-Immigration Policies: Evidence from 9 European Countries.” *Revue Internationale de Psychologie Sociale* 22 (3): 203–33.
- Echebarria-Echabe, Agustín, and Emilia Fernández-Guede. 2006. “Effects of terrorism on attitudes and ideological orientation.” *Eur. J. Soc. Psychol.* 36 (2): 259–65. doi: 10.1002/ejsp.294.
- Finkel, Steven E. 1995. *Causal analysis with panel data*. Sage university papers series. Quantitative applications in the social sciences no. 07-105. Thousand Oaks, Calif: Sage Publications.
- Fischer, P., T. Postmes, J. Koepl, L. Conway, and T. Fredriksson. 2011. “The Meaning of Collective Terrorist Threat: Understanding the Subjective Causes of Terrorism Reduces Its Negative Psychological Impact.” *Journal of Interpersonal Violence* 26 (7): 1432–45. doi: 10.1177/0886260510369137.
- Fischer, Peter, Tobias Greitemeyer, Andreas Kastenmüller, Eva Jonas, and Dieter Frey. 2006. “Coping With Terrorism: The Impact of Increased Salience of Terrorism on Mood and Self-Efficacy of Intrinsically Religious and Nonreligious People.” *Personality and Social Psychology Bulletin* 32 (3): 365–77. doi: 10.1177/0146167205282738.
- Frindte, Wolfgang, and Haußecker Nicole, eds. 2010. *Inszenierter Terrorismus. Mediale Konstruktionen und individuelle Interpretationen [Staged Terrorism. Media constructs and individual interpretations]*. 1st ed. Politische Psychologie. Wiesbaden: VS, Verl. für Sozialwiss.
- Fritsche, Immo, Eva Jonas, and Thomas Kessler. 2011. “Collective Reactions to Threat: Implications for Intergroup Conflict and for Solving Societal Crises.” *Social Issues and Policy Review* 5 (1): 101–36. doi: 10.1111/j.1751-2409.2011.01027.x.
- Gaertner, Samuel L., and John F. Dovidio. 1986. “The aversive form of racism.” In *Prejudice, discrimination, and racism*. Edited by John F. Dovidio and Samuel L. Gaertner, 61–89. San Diego: Academic Press.

- Grewal, Rajdeep, Joseph A. Cote, and Hans Baumgartner. 2004. "Multicollinearity and Measurement Error in Structural Equation Models: Implications for Theory Testing." *Marketing Science* 23 (4): 519–29. doi: 10.1287/mksc.1040.0070.
- Hafez, Kai, and Carola Richter. 2007. "Das Islambild von ARD und ZDF [The Image of Islam in ARD and ZDF]." *Aus Politik und Zeitgeschichte* (26-27): 40–46. <https://www.bpb.de/system/files/pdf/GB72LS.pdf>. Accessed April 06, 2013.
- Halm, Dirk. 2013. "The Current Discourse on Islam in Germany." *Journal of International Migration and Integration* 14 (3): 457–74. doi: 10.1007/s12134-012-0251-7.
- Herbert, Ulrich. 2001. *Geschichte der Ausländerpolitik in Deutschland: Saisonarbeiter, Zwangsarbeiter, Gastarbeiter, Flüchtlinge [The History of Policy on Foreigners in Germany: Seasonal Worker, Forced Laborer, Guest Worker and Refugees]*. München: Beck.
- Heyder, Aribert, Julia Iser, and Peter Schmidt. 2005. "Isrealkritik oder Antisemitismus? Meinungsbildung zwischen Öffentlichkeit, Medien und Tabus [Criticism of Israel or anti-Semitism? Forming opinions between the public sphere, the media and taboos]." In *Deutsche Zustände. Folge 3 [German States. Volume 3]*. Edited by Wilhelm Heitmeyer, 144–70. Edition Suhrkamp. Frankfurt am Main: Suhrkamp.
- Huddy, Leonie, Stanley Feldman, Theresa Capelos, and Colin Provost. 2002. "The Consequences of Terrorism: Disentangling the Effects of Personal and National Threat." *Political Psychology* 23 (3): 485–509. doi: 10.1111/0162-895X.00295.
- Huddy, Leonie, Stanley Feldman, and Erin Cassese. 2009. "Terrorism, anxiety, and war." In *Terrorism and torture: An interdisciplinary perspective*. Edited by Werner G. K. Stritzke, 290–312. Cambridge, UK, New York: Cambridge university press.
- Huddy, Leonie, Stanley Feldman, Charles Taber, and Gallya Lahav. 2005. "Threat, Anxiety, and Support of Antiterrorism Policies." *Am J Political Science* 49 (3): 593–608. doi: 10.1111/j.1540-5907.2005.00144.x.
- Jonas, Eva, and Immo Fritsche. 2013. "Destined to die but not to wage war: How existential threat can contribute to escalation or de-escalation of violent intergroup conflict." *American Psychologist* 68 (7): 543–58. doi: 10.1037/a0033052.
- Jonker, Gerdien. 2005. "From 'Foreign Workers' to 'Sleepers': The Churches, the State and Germany's 'Discovery' of its Muslim Population." In *European Muslims and the secular state*. Edited by Jocelyne Cesari and Seán McLoughlin, 113–28. Aldershot, Hants, England, Burlington, VT: Ashgate Pub. Co.
- Jöreskog, Karl G. 1979. "Statistical estimation of structural models in longitudinal development investigations." In *Longitudinal research in the study of behavior and development*. Edited by John R. Nesselroade and Paul B. Baltes, 303–52. New York: Academic Press.
- Kaplan, Jeffrey. 2006. "Islamophobia in America? September 11 and Islamophobic Hate Crime." *Terrorism and Political Violence* 18 (1): 1–33. doi: 10.1080/09546550500383209.
- Kline, Rex B. 2011. *Principles and practice of structural equation modeling*. 3rd ed. Methodology in the social sciences. New York: Guilford Press.
- Kurthen, Hermann, Werner Bergmann, and Rainer Erb, eds. 1997. *Antisemitism and xenophobia in Germany after unification*. New York [u.a.]: Oxford Univ. Press.

- Leibold, Jürgen, and Steffen Kühnel. 2006. "Islamophobie. Differenzierung tut not [Islamophobia. Differentiation is necessary]." In *Deutsche Zustände. Folge 4 [German States. Volume 4]*. Edited by Wilhelm Heitmeyer, 135–55. Edition Suhrkamp 2454. Frankfurt am Main: Suhrkamp.
- LeVine, Robert A., and Donald T. Campbell. 1972. *Ethnocentrism: theories of conflict, ethnic attitudes, and group behavior*. New York: Wiley.
- Little, Todd D., William A. Cunningham, Golan Shahaar, and Keith F. Widaman. 2002. "To Parcel or Not to Parcel: Exploring the Question, Weighing the Merits." *Structural Equation Modeling: A Multidisciplinary Journal* 9 (2): 151–73. doi: 10.1207/S15328007SEM0902\_1.
- Lubbers, M., and Peer Scheepers. 2001. "Explaining the Trend in Extreme Right-Wing Voting: Germany 1989-1998." *European Sociological Review* 17 (4): 431–49. doi: 10.1093/esr/17.4.431.
- McConahay, John B. 1986. "Modern racism, ambivalence, and the Modern Racism Scale." In *Prejudice, discrimination, and racism*. Edited by John F. Dovidio and Samuel L. Gaertner, 91–125. San Diego: Academic Press.
- Muthén, Linda K., and Bengt O. Muthén. 2012. *Mplus User's Guide: Seventh Edition*. Los Angeles, CA: Muthén & Muthén.
- Oswald, Debra L. 2005. "Understanding Anti-Arab Reactions Post-9/11: The Role of Threats, Social Categories, and Personal Ideologies." *J Appl Social Psychol* 35 (9): 1775–99. doi: 10.1111/j.1559-1816.2005.tb02195.x.
- Pettigrew, Thomas F. 1998. "Reactions Toward the New Minorities of Western Europe." *Annu. Rev. Sociol.* 24 (1): 77–103. doi: 10.1146/annurev.soc.24.1.77.
- Pettigrew, Thomas F., Oliver Christ, Ulrich Wagner, and Jost Stellmacher. 2007. "Direct and indirect intergroup contact effects on prejudice: A normative interpretation." *International Journal of Intercultural Relations* 31 (4): 411–25. doi: 10.1016/j.ijintrel.2006.11.003.
- Quillian, Lincoln. 1995. "Prejudice as a Response to Perceived Group Threat: Population Composition and Anti-Immigrant and Racial Prejudice in Europe." *American Sociological Review* 60 (4): 586–611. Accessed November 18, 2013.
- Rytter, Mikkel, and Marianne Holm Pedersen. 2013. "A decade of suspicion: Islam and Muslims in Denmark after 9/11." *Ethnic and Racial Studies*, 1–19. doi: 10.1080/01419870.2013.821148.
- Sarrazin, Thilo. 2010. *Deutschland schafft sich ab: Wie wir unser Land aufs Spiel setzen*. 2nd ed. München: DVA.
- Satorra, Albert, and Peter M. Bentler. 2001. "A scaled difference chi-square test statistic for moment structure analysis." *Psychometrika* 66 (4): 507–14. doi: 10.1007/BF02296192.
- Schermelleh-Engel, Karin, Helfried Mosbrugger, and Hans Müller. 2003. "Evaluating the Fit of Structural Equation Models: Tests of Significance and Descriptive Goodness-of-Fit Measures." *Methods of Psychological Research Online* 8 (2): 23–74. [http://www.cob.unt.edu/slides/Paswan./BUSI6280/Y-Muller\\_Erfurt\\_2003.pdf](http://www.cob.unt.edu/slides/Paswan./BUSI6280/Y-Muller_Erfurt_2003.pdf). Accessed January 23, 2014.
- Schlueter, E., P. Schmidt, and U. Wagner. 2008. "Disentangling the Causal Relations of Perceived Group Threat and Outgroup Derogation: Cross-national Evidence from German



- and Russian Panel Surveys.” *European Sociological Review* 24 (5): 567–81. doi: 10.1093/esr/jcn029.
- Seago, Dorothy W. 1947. “Stereotypes: Before Pearl Harbor and After.” *The Journal of Psychology* 23 (1): 55–63. doi: 10.1080/00223980.1947.9917320.
- Sehgal, Ujala. 2011. “Media Reacts to News That Norwegian Terror Suspect Isn't Muslim.” *The Atlantic Wire*, July 23. Accessed March 08, 2013. <http://www.theatlanticwire.com/global/2011/07/media-reacts-news-norwegian-terror-suspect-isnt-muslim/40322/>.
- Shaheen, Jack G. 2003. “Reel Bad Arabs: How Hollywood Vilifies a People.” *ann am acad polit ss* 588 (1): 171–93. doi: 10.1177/0002716203588001011.
- Sherif, Muzafer, and Carolyn W. Sherif. 1969. “Ingroup and intergroup relations: Experimental analysis.” In *Social Psychology*. Edited by Muzafer Sherif and Carolyn W. Sherif, 221–66. New York: Harper & Row.
- Skitka, Linda J., Christopher W. Bauman, and Elizabeth Mullen. 2004. “Political Tolerance and Coming to Psychological Closure Following the September 11, 2001, Terrorist Attacks: An Integrative Approach.” *pers soc psychol bull* 30 (6): 743–56. doi: 10.1177/0146167204263968.
- Stephan, Walter G., and C. L. Renfro. 2002. “The Role of Threat in Intergroup Relations.” In *From prejudice to intergroup relations: Differentiated reactions to social groups*. Edited by Diane M. Mackie and Eliot R. Smith, 109–208. Hove: Psychology Press.
- Stephan, Walter G., C. L. Renfro, and Mark D. Davis. 2008. “The Role of Threat in Intergroup Relations.” In *Improving intergroup relations: Building on the legacy of Thomas F. Pettigrew*. Edited by Ulrich Wagner, Linda R. Tropp, Gillain Finchilescu, and Colin Tredoux, 55–72. Social issues and interventions. Malden, MA, Oxford: Blackwell Pub.
- Stephan, Walter G., and Cookie W. Stephan. 2000. “An integrated threat theory of prejudice.” In *Reducing prejudice and discrimination*. Edited by Stuart Oskamp, 23–45. Mahwah, N.J: Lawrence Erlbaum Associates.
- Stone, John, and Polly Rizova. 2007. “Re-thinking racial conflict in an era of global terror.” *Ethnic and Racial Studies* 30 (4): 534–45. doi: 10.1080/01419870701355959.
- Sunstein, Cass R. 2003. “Terrorism and Probability Neglect.” In *The Risks of Terrorism*. Edited by W. K. Viscusi, 23–38. Boston, MA: Springer US.
- Wilson, Thomas C. 2001. “American's View of Immigration Policy: Testing the Role of Threatened Group Interests.” *Sociological Perspectives* 44 (4): 485–501. doi: 10.1525/sop.2001.44.4.485.
- Zick, Andreas, Beate Küpper, and Andreas Hövermann. 2011. *Die Abwertung der Anderen. Eine europäische Zustandsbeschreibung zu Intoleranz, Vorurteilen und Diskriminierung [The devaluation of others. An European description of the state of intolerance, prejudice and discrimination]*. Berlin: Friedrich-Ebert-Stiftung, Forum Berlin.

**Manuscript #3:**

**Conservative Shift or Ideological Intensification? The Impact of  
the 2004 Madrid Bombings on Germany**

Stefan Thörner

Philipps-University Marburg, Germany

Submission date: February 19, 2014

Under review in *Political Psychology*

**Abstract**

This research contributes to the debate whether real world terrorist threat leads to a conservative shift (conservative shift hypothesis) or to an intensification of preexisting political ideologies (ideological intensification hypothesis). I applied a research design suggested by Castano et al. (2011; Study 1) to a representative panel data set (t1=April 2003; t2=April 2004) that contained the Madrid Bombings of March 2004. The analysis of residual and latent true change scores reveals that change in authoritarian submission, one facet of right-wing authoritarianism, and prejudice, depend on political self-placement at t1. No mean shift at all occurs but leftists get less authoritarian and less prejudiced whereas centrists and rightists increase in these attitudes. These results support the ideological intensification hypothesis. However, they show also that centrists – the largest group of Germans – are getting more conservative after an attack. Thus, ideological intensification does occur, whereas there is also a high potential for a conservative shift on mean level.

**Keywords:** Madrid Bombings, terrorism, conservative shift, worldview defense, latent true change modeling

**Introduction.** After the attacks on the US in September 2001 (9/11) a shock went through the Western World. Facilitated by the mass media, terrorists succeeded in spreading a climate of threat by increasing the salience of death (Breckenridge & Zimbardo, 2007). Shortly after the attacks, pollsters measured an increase of threat perceptions even in countries other than the US (e.g., European Commission, 2002; Noelle-Neumann, 2002). The same spillover effect was observed in Germany when on March 11, 2004, several train-bombings occurred in Spain's capital, Madrid, leaving 191 dead and more than two thousand injured. In consequence, a month after the attack, 57% of respondents were afraid of possible terrorist attacks in Germany, compared to only 29% in January 2004 (e.g., IFD Allensbach, 2004, see also Forschungsgruppe Wahlen, 2004a, 2004b).

Terrorist threats like these trigger individuals to contemplate their death (Das, Bushman, Bezemer, Kerkhof, & Vermeulen, 2009; Landau et al., 2004) causing a possible shift in their political ideological beliefs. This research note analyzes how a major terrorist attack affects ideological beliefs within individuals. Several scholars hypothesize a conservative shift to occur after a major terrorist attack (e.g., Bonanno & Jost, 2006). Examining whether the entire society makes a shift to the right after a geographically close, major terrorist attack does not only make a contribution to an ongoing scientific debate. It is particularly important since especially right-wing ideologies are highly connected to the devaluation of minorities (e.g., Altemeyer, 1998) which can lead, in the context of terrorism, to pro-war and anti-immigrant attitudes (Huddy, Feldman, Taber, & Lahav, 2005) or even backlash hate crimes, as seen in the US after 9/11 (e.g., Kaplan, 2006).

In this paper I connect to a debate occurring between *Conservatism as Motivated Social Cognition* (MSC) researchers (e.g., Jost, Glaser, Kruglanski, & Sulloway, 2003) and *Terror Management Theory* (TMT) advocates (e.g., Greenberg, et al., 1990). Whereas Jost and colleagues (Bonanno & Jost, 2006; Jost et al., 2003) suggest a collective conservative shift to

occur after a major terrorist attack, Pyszczynski, Solomon and Greenberg (2003) argue that the existential threat imposed by terrorism intensifies preexisting ideologies on the individual level which can lead to a nullification of effects on the aggregate level (see also Huddy & Feldman, 2011).

Until now, only a few studies have examined changes in ideological beliefs in response to major terrorist attacks. Furthermore, this is only done for countries that faced an attack themselves (Echebarria-Echabe & Fernández-Guede, 2006; Nagoshi, Terrell, & Nagoshi, 2007; Nail & McGregor, 2009). I extend the existing literature by building on previous experimental research (Castano et al., 2011) applied to a real-world event that increases death-salience. Several aspects of this paper need to be emphasized. In terms of content, conservatism and prejudice are examined. I use a large scale representative panel data set where the second wave of conduction occurred a month after the Madrid Bombings. Furthermore, results of the initial analysis are replicated and confirmed by using an elaborated longitudinal latent variable approach.

### **Theory and Previous Research.**

**Conservatism.** The idea that conservatism as a political ideology is better suited to deal with threat and uncertainty goes back to Adorno and colleagues (Adorno, Frenkel-Brunswik, Levinson, & Sanford, 1950, p. 2). This thought was recently refined in Jost and colleagues' *motivated social cognition model of conservatism* where they proposed that "*conservatism [...] serves to reduce fear, anxiety, and uncertainty; to avoid change, disruption, and ambiguity*" (Jost et al., 2003, p. 340). In their theory, the authors stress that conservatism is not a personality variable only but includes also dynamic aspects, especially when it comes to contextual threat. They assume contextual threat leading to cognitive simplicity, appearing as conservative black and white thinking. Thus, conservatism is suggested to be a strategy to

deal with threat. The expected outcome of broadly perceived external threat, e.g., induced by a major terrorist attack, should be a *conservative shift* (Bonanno & Jost, 2006; Nail & McGregor, 2009).

Adorno and colleagues' as well as Jost and colleagues' work has been sharply criticized for their suggestion that conservatism is individuals' universal solution in dealing with threat and uncertainty (Eysenck, 1999/1954; Greenberg & Jonas, 2003). The major criticism is, in a nutshell, that liberal or left-wing political orientations can serve the same purposes in coping with threat and uncertainty as conservatism does. An external, threatening event could consequently lead to ideological intensification on both sides, which could nullify each other out on mean level. This view is also shared by most scholars of terror management theory.

**Terror Management Theory (TMT)** is a threat theory coping with the existential fear to die, also called mortality salience. TMT goes back to the observation that every living creature has a will to survive but only humans are aware of the finiteness of life (Becker, 1997/1973). This knowledge is highly threatening. Being part of a meaningful shared reality with homogenous ideologies can then be an anxiety buffer. After contemplating their own death, people increase their faith in their worldview (Greenberg et al., 1990), which means an intensification of preexisting political ideologies (Greenberg, Simon, Pyszczynski, Solomon, & Chatel, 1992). In the following, I refer to the *worldview defense view* as *ideological intensification hypothesis* (see Huddy & Feldman, 2011).

**Previous Research.** The conservative shift vs. the ideological intensification debate produced a plethora of studies (see Burke, Kosloff, & Landau, 2013, for a meta-analysis). For instance, Jost and colleagues (2007) showed in three cross-sectional, correlational studies that death anxiety contributes to conservatism only; the authors could not show support for alternative models like the ideological intensification hypothesis. On the other hand

McGregor and colleagues (1998) showed experimentally that mortality salience led to a derogation and even aggression against people with opposed political ideologies. This aggression was expressed in form of the allocation of vile hot sauce which was significantly higher for people having an opposite ideology. The list of studies supporting each side could be further prolonged. However, even the above mentioned meta-analysis by Burke et al. (2013) delivered no clear-cut support for one of the hypotheses. The authors gathered 31 experimental studies where participants in the experimental conditions contemplated their own death. The dependent measures included, among others, support for conservative leaders, use of military force, and conservative policies and attitudes. Although the average effect size of the ideological intensification hypothesis was larger ( $r=.35$ ), compared to conservative shift ( $r=.22$ ), they did not differ significantly.

The controversy of conservative shift versus ideological intensification was empirically conducted primarily on the basis of studies focusing on mortality salience in general. Only a few papers examined in the first place the impact of terrorist attacks on political ideologies (Bonanno & Jost, 2006; Huddy & Feldman, 2011; Nail & McGregor, 2009). Some more studies (Echebarria-Echabe & Fernández-Guede, 2006; Fischer, Greitemeyer, Kastenmüller, Frey, & Oßwald, 2007; Nagoshi et al., 2007) measured Right-Wing Authoritarianism (RWA; Altemeyer, 1998) as dependent variable, which is often used as a proxy for conservatism (e.g., Castano et al., 2011; Jost, Fitzsimons, & Kay, 2004), were conducted coincidentally before, after, or while an attack happened. For instance, Nail and McGregor (2009) found in independent samples, one conducted pre 9/11, the other post 9/11, that the attitudes in the post sample were more pro Bush and pro increasing military spending. Echebarria-Echabe and Fernandez-Guede (2006) present the same design with the Madrid Bombings enclosed. They find RWA and several prejudice measures increased in the post-attack sample. Most of the results of studies conducted in the context of terror can be interpreted as showing a

conservative shift. Only Huddy and Feldman (2011) interpret their analysis of the 2000 vs. 2002 US General Social Survey as counterargument for a conservative shift since they found no indications for increased conservatism in 2002. However, with their cross-sectional data, they can only show that no sustainable conservative shift occurred. They cannot support the ideological intensification hypothesis. Therefore, within subject designs are needed to uncover the process of ideological intensification.

Castano et al. (2011; Study 1 & 2) run experiments with liberal undergraduates to see how their ideological beliefs change when they are confronted with death thoughts. Participants first had to position themselves politically on a liberal to conservative scale. The few that positioned themselves as center or right were excluded from the analysis and the remaining respondents filled in a RWA measure as a proxy for conservatism. Then they were allocated to either the experimental condition where they answered questions about their own death (mortality salience) or the control condition. Afterwards all participants were asked to fill in the RWA scale again because the data was allegedly lost by a computer error. The data analysis was done with the residuals of  $t_2$  regressed on  $t_1$ , meaning the change of RWA between the time points. Respondents in the mortality salience condition had a negative sum of residuals which implies that their RWA scores decreased over time. Furthermore, this score was significantly lower in the treatment condition compared to the control condition, which indicates that the respondents became more liberal due to the mortality salience manipulation. In a conceptual replication with specific policies being surveyed, Castano et al. showed that participants (only liberals again) in the mortality salience condition displayed less support for conservative policies compared to the control condition.

I extend the literature by applying Castano et al.'s (2011) within-subject panel design (but without control condition) to a large scale, representative panel data set where the post measure was conducted soon after one of the major terrorist attacks of the last decade. This is



unique, since previous research on terrorist attacks as natural experiments had to face several shortcomings in data quality or timing. Either they were convenient samples or consisted entirely of students (Echebarria-Echabe & Fernández-Guede, 2006; Fischer et al., 2007; Nagoshi et al., 2007; Nail & McGregor, 2009) or, if representative surveys were available, scholars had to accept cross-sectional designs and large gaps between the measurement points and the event (e.g., Huddy & Feldman, 2011; Kam & Kinder, 2007).

### **The Present Research**

**Conservative Shift vs. Ideological Intensification.** In the present research, I examined whether the Madrid Bombings led to a conservative shift or ideological intensification in Germany. Like Castano et al. (2011) I use RWA as a proxy for conservatism (see also Jost et al., 2003, 2004). Furthermore, this analysis is enlarged upon prejudice, in order to explore whether terrorist threat manifests itself in the devaluation of foreigners.

In terms of data analysis, I first applied T-tests to look for a mean shift in RWA. Second, I calculated and analyzed residuals as change scores. Third, to check for the robustness of the findings of step 2, I applied Latent True Change (LTC) modeling, which creates difference scores that are free of measurement error.

Since the dataset comprehends not only left-wingers, as was the case in Castano et al.'s (2011) data, I categorized respondents across their political self-positioning at t1 (left, center, right). A conservative shift would express itself in a significantly increased sample mean of RWA over time (H1). The ideological intensification hypothesis would be supported if no mean shift occurs and left-wingers residual scores are negative and right-wingers are positive (H2).

**Data.** Data from the project 'Group Focused Enmity in Germany' (GFE; Zick et al., 2008) were used. Sample size was  $N_{t1} = 1140$  in 2003, and  $N_{t2} = 804$  (70% of the 2003

sample) in 2004. Panel mortality was unsystematic (Christ, 2006). Data conduction took place from mid-April until mid-June via computer-assisted telephone interviews. The oversampling of the smaller eastern part of Germany is corrected via weighing. After weighing, the sample is representative for the 16 years and older German autochthonous society.

**Measures.** Respondents positioned themselves on a left (1) to right (5) scale, which is comparable to the American liberal to conservative dimension. For reasons of simplicity, the 1 to 5 scale was condensed to 1=left, 2=center, 3=right<sup>1</sup>. The dataset comprised two aspects of RWA (Altemeyer, 1998) measured by two items each: authoritarian submission, which is the unconditional subordination to ingroup authorities (“One of the most important attitudes that someone should have is obedience and respect for superiors”; “We should be grateful for leading heads who tell us what to do”); and authoritarian aggression, which reflects the need to punish those deviating from ingroup norms (“Crime should be punished more harshly”; “To keep order, one should take more rigorous action against outsiders and trouble makers”). Prejudice was measured by two items: “There are too many foreigners living in Germany” and “When jobs get scarce, the foreigners living in Germany should be sent (back) home”. The response scale reached from 1 = ‘fully agree’ to 4 = ‘fully disagree’.

**Procedure.** Respondents participated in a panel study in April 2003 and April 2004 that included questions about various topics. The attacks on Madrid happened in March 2004 and were still salient when t2 was conducted (e.g., IFD Allensbach, 2004). The panel comprised the three constructs introduced above. Except the fact that in a natural experiment no control group is available, the existing data enabled me to replicate the design of study 1 from Castano et al.’s (2011) paper. At t1, participants positioned themselves politically and

---

<sup>1</sup> Left (1) and rather left (2) were summarized as left. Center (3) remained center. Rather right (4) and right (5) were summarized as right.

responded to RWA and prejudice items. At t2, shortly after the bombing, participants again responded to RWA and prejudice items.

## Results

A Confirmatory Factor Analysis (CFA) of RWA revealed that a two-factor solution ( $\chi^2_{\text{corrected}}=2.158$ ,  $df=1$ ,  $p=.14$ ,  $CFI=.999$ ,  $RMSEA=.031$ ,  $SRMR=.007$ ) is clearly preferable over one factor ( $\chi^2_{\text{corrected}}=128.842$ ,  $df=2$ ,  $p=.00$ ,  $CFI=.859$ ,  $RMSEA=.232$ ,  $SRMR=.065$ ). Thus, authoritarian aggression (t1:  $\alpha=.778$ ,  $r=.641$ ; t2  $\alpha=.779$ ,  $r=.639$ ) and authoritarian submission (t1:  $\alpha=.671$ ,  $r=.507$ ; t2:  $\alpha=.714$ ,  $r=.557$ ) are analyzed separately in further steps (referred to as  $RWA_{\text{Aggr}}$  and  $RWA_{\text{Subm}}$ ). The prejudice scale reached satisfactory reliability (t1:  $\alpha=.774$ ,  $r=.635$ ; t2:  $\alpha=.768$ ,  $r=.628$ ).

Figure 1. Distribution of left-right self-positioning

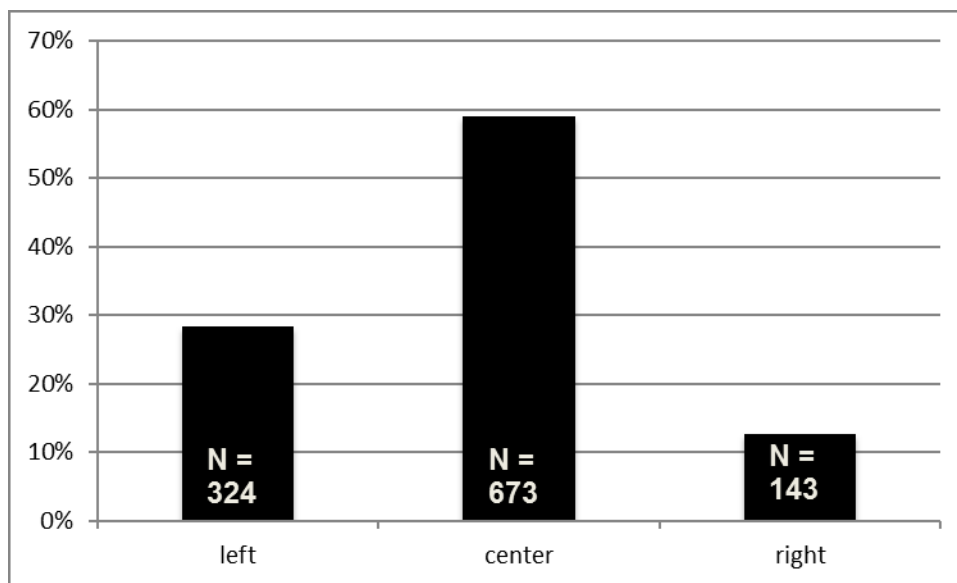
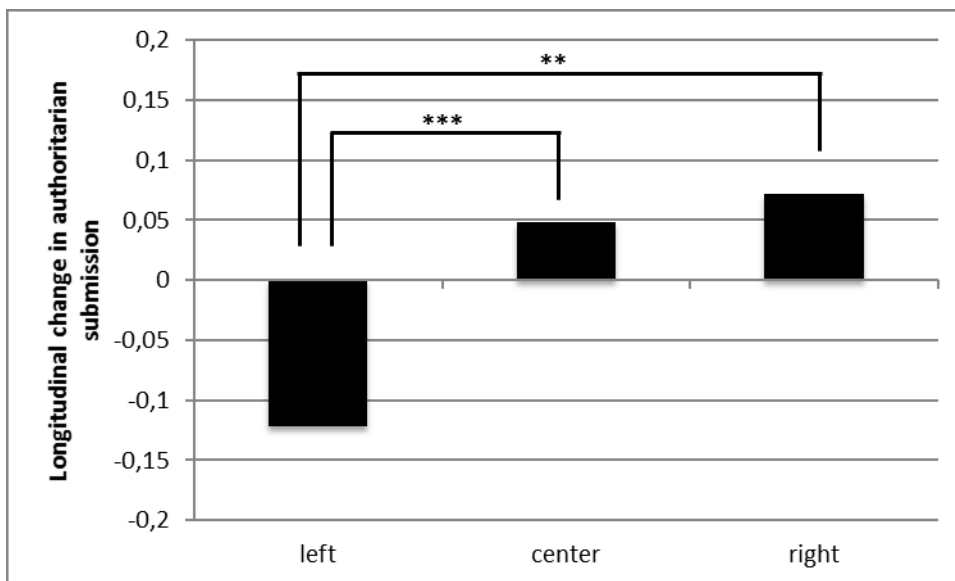

Figure 1 shows the distribution of the political self-positioning. More than half of the respondents (59%) considered themselves to be centrist, 28.4% said they were left-wing and only 12.6% said they were right-wing.

First, T-tests were calculated to estimate overall mean change in authoritarianism. No such change was found for  $RWA_{Subm}$  ( $\Delta M = -.004$ ,  $t(810) = -.212$ ,  $p > .05$ ) and  $RWA_{Aggr}$  ( $\Delta M = .022$ ,  $t(806) = 1.117$ ,  $p > .05$ ). The same was true for prejudice ( $\Delta M = -.027$ ,  $t(808) = 1.337$ ,  $p > .05$ ). This speaks against a conservative shift (H1).

Figure 2. Longitudinal change in authoritarian submission



*Note.* The figure shows only the middle section of the y-axis. The full range of residual scores is -2.53 to 1.73. Post-hoc tests with Bonferroni correction. \*\* $p < .01$ , \*\*\* $p < .001$ .

Next I calculated change scores (unstandardized residuals) by running  $t_2$  on  $t_1$  regressions for each factor. Figure 2 shows the residual means for the left, center, and right. As predicted by the ideological intensification hypothesis, leftists decreased in  $RWA_{Subm}$ , whereas rightists increased,  $F(2, 799) = 8.843$ ,  $p < .001$ . Centrists showed almost the same effect as rightists did. This pattern speaks for an ideological intensification in authoritarian submission (H2).

Figure 3. Longitudinal change in authoritarian aggression

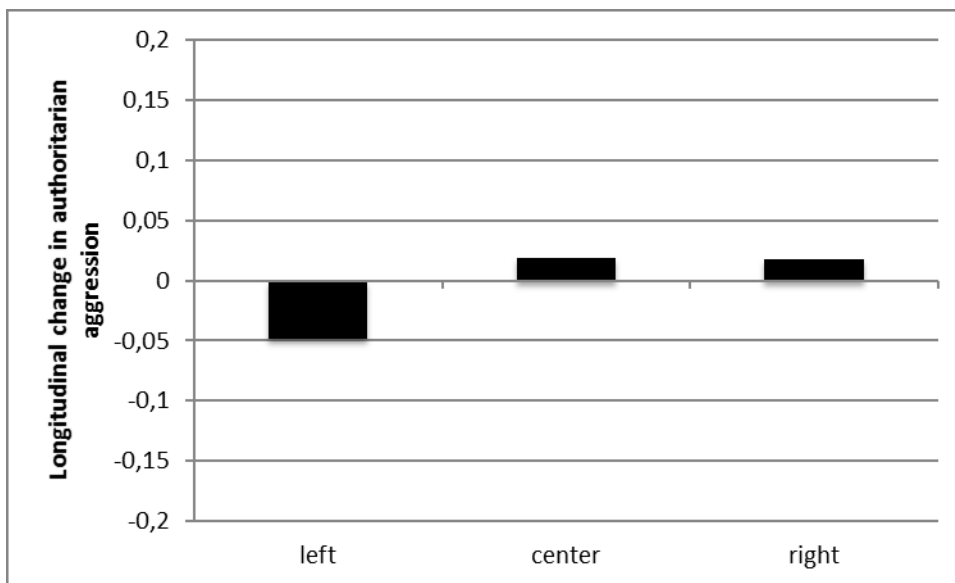

Note. The figure shows only the middle section of the y-axis. The full range of residual scores is -2.26 to 1.46. No significant differences found.

A similar pattern occurred for  $RWA_{Aggr}$  (see Figure 3) but without reaching significance,  $F(2, 795)=1.362, p>.05$ . Thus, ideological intensification did not apply to both aspects of RWA.  $RWA_{Aggr}$  was therefore not included in further analysis.

Prejudice showed the same pattern as  $RWA_{Subm}$  and reached significance,  $F(2, 796)=5.442, p<.01$ . Since the results in both  $RWA_{Subm}$  and prejudice were not different for centrists and rightists, further analysis considered only two categories of political self-placement (left vs. center-right).

To check the robustness of these findings, I applied a more elaborated procedure in dealing with longitudinal differences, called Latent True Change (LTC) modeling (McArdle & Hamagami, 2001; Steyer, Eid, & Schwenkmezger, 1997). The model estimation was done with the software Mplus 7 (Muthén & Muthén, 2012) using a robust maximum likelihood

estimator. Missing values were considered via Full-Information-Likelihood-Estimation (FIML; Arbuckle, 1996).

The basis of the model is a time-invariant latent factor. Invariance means that the measurement model remains stable across time (Meredith, 1993). Therefore, a simultaneous confirmatory factor analysis with the two measurement points of the same factor is run. Autocorrelations of measurement errors are modeled as indicator specific error factors (Eid, Schneider, & Schwenkmezger, 1999). The well-fitting factors of authoritarian submission ( $\chi^2_{\text{corrected}}=2.354$ ,  $df=4$ ,  $p=.67$ ,  $CFI=1.00$ ,  $RMSEA=.00$ ,  $SRMR=.009$ ) and prejudice ( $\chi^2_{\text{corrected}}=1.307$ ,  $df=4$ ,  $p=.86$ ,  $CFI=1.00$ ,  $RMSEA=.00$ ,  $SRMR=.014$ ) reached strict scalar invariance which is the best of three possible stages of invariance. In a next step, a simple restatement of the model creates the latent true change factor. The t2 variable is perfectly regressed on the t1 variable and the LTC factor. Thereby, the intraindividual variance as well as the mean vector of change are redirected into the LTC factor. The mean of the LTC factor is the latent mean difference between t1 and t2 and the variance is the intraindividual latent change.

Figure 4. Latent true change model of  $RWA_{\text{Subm}}$  predicted by political ideology

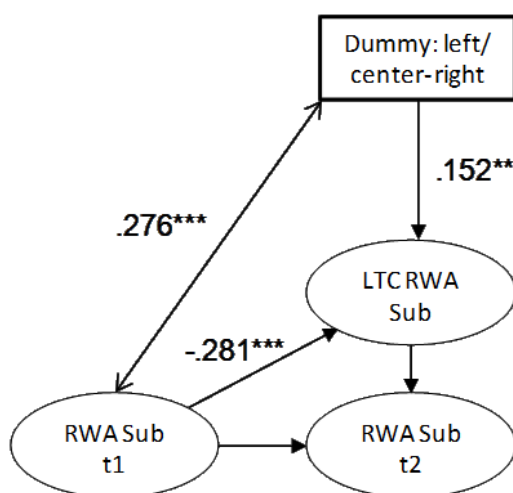

Note. Y-variable standardized robust maximum likelihood estimator. Model fit:

$\chi^2_{\text{corrected}}=3.758$ ,  $df=6$ ,  $p=.71$ ,  $CFI=1.00$ ,  $RMSEA=.00$ ,  $SRMR=.01$ .

Figure 5. Latent true change model of prejudice predicted by political ideology

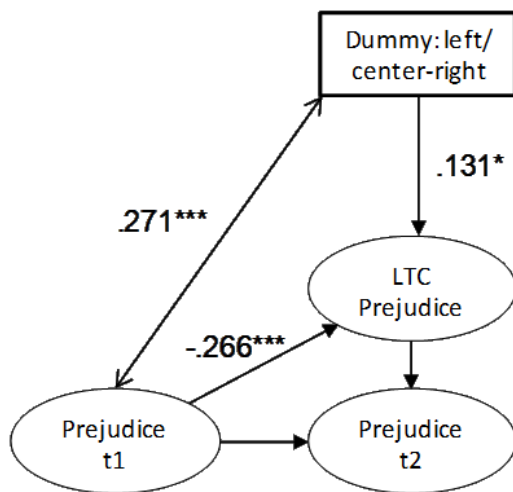

Note. Y-variable standardized robust maximum likelihood estimator. Model fit:

$\chi^2_{\text{corrected}}=5.25$ ,  $df=6$ ,  $p=.51$ ,  $CFI=1.00$ ,  $RMSEA=.00$ ,  $SRMR=.012$

The mean difference of  $RWA_{\text{Subm}}$  between t1 and t2 was  $\Delta M=.00$ ,  $p>.05$ . The significant variance of the change factor ( $\sigma^2=.178$ ;  $p<.001$ ) indicated that there was intraindividual movement over time. Figure 4 shows the LTC model with the left vs. center-right dummy included. The correlation between  $RWA_{\text{Subm}}$  at t1 and the ideological dummy variable ( $r=.276$ ,  $p<.001$ ) indicated that the initial level of  $RWA_{\text{Subm}}$  and political self-placement are positively connected. The structural path of  $RWA_{\text{Subm}}$  t1 on its LTC factor ( $\beta=-.281$ ,  $p<.001$ ) indicated that high initial values are connected to less change, which is pretty common in such models. Finally, the dummy variable had a significant effect on the LTC of  $RWA_{\text{Subm}}$  ( $\beta=.152$ ,  $p<.01$ )<sup>2</sup>. This can be interpreted as a moderation effect, meaning political self-placement moderated the direction of change in  $RWA_{\text{Subm}}$ . When holding the effect of  $RWA_{\text{Subm}}$  t1 constant, the latent mean for leftists is  $-.100$  and for center-rightists  $.044$  with the difference ( $b=.144$ ,  $p<.01$ ) being significant. Exactly the same model description held for

<sup>2</sup> Mplus offers the possibility to standardize dependent variables only for cases in which dummy variables are used as independent variables. Beta is the standardized change in y if the dummy changes from 0 to 1 (see Muthén and Muthén, 2012, pp. 721–724).

the LTC of prejudice (Figure 5). No shift in mean ( $\Delta M = .036$ ,  $p > .05$ ) but significant variance over time ( $\sigma^2 = .178$ ;  $p < .001$ ), which is partly explained by the political self-placement dummy ( $\beta = .131$ ,  $p < .01$ ). The latent mean for leftists is  $-.095$  and for rightists  $.036$  with  $b = .131$ ,  $p < .05$ . Thus, the application of measurement error free LTC modeling strongly supported former findings.

## Discussion

In this research I contributed to the debate whether a major terrorist attack leads to a conservative shift or ideological intensification. I applied the research design of Castano and colleagues (2011; Study 1) to a large scale representative German panel dataset that included the Madrid Bombings in between the two measurement occasions. Castano et al. found in their exclusively liberal sample that those exposed to mortality salience decreased in authoritarianism. This result could be replicated in this study. Furthermore, this study shows that right-wingers and also centrists develop in the opposed direction compared to leftists, leaving the sample mean stable. Thus, this effect can only be captured with longitudinal and experimental designs but remains unnoticed in all large scale, cross-sectional surveys (e.g., Huddy & Feldman, 2011).

The fact that rightists and centrist show a similar development is highly interesting because, consequently, the group of those becoming more conservative after an attack is much larger than the group of those becoming less conservative. This fits Greenberg and Jonas' (2003) idea that today's capitalist states have much more right-wing than left-wing potential. According to the authors, this increases the probability that an ideological intensification remains unnoticed and a conservative shift is measured instead, simply due to the numerical superiority of center-rightists. Although the group of center-rightists is much



larger in this representative German sample, the sample mean remains stable. This is because the effect in leftists is stronger than in center-rightists.

It is somewhat astonishing that no effects in change of authoritarian aggression could be measured since other researchers found a strong link of terrorist threat and the need to punish others (e.g., Fischer et al., 2007). Researchers should in general check the factorial structure of RWA and look for differential effects of the RWA components (see Duckitt & Bizumic, 2013)<sup>3</sup>. Nevertheless, the effect in authoritarian submission is perfectly plausible. Whereas center-rightists may wish to have a strong leader in a situation of crisis, leftists may worry about the abuse of the increased power that political leaders have in these periods.

### **Limitations**

The possibility that the intraindividual change over time is due to other events or developments in that period cannot be fully excluded. Anyhow, with 11-M being the first major Islamist terrorist attack close to Germany and with terrorist threat measures showing increased scores during the time of conduction (Forschungsgruppe Wahlen, 2004a, 2004b; IFD Allensbach, 2004), it seems highly plausible that the attacks caused the systematic variance revealed in this paper.

Like Castano et al., 2011, this paper faces the critique that RWA is not a perfect measurement of conservatism (e.g., Crowson, Thoma, & Hestevold, 2005). We acknowledge this shortcoming but point to the fact that this is a secondary analysis of an available dataset.

Moreover, additional research needs to be done to figure out how the effect looks like immediately after an attack, how long-lasting such an effect is and if it generalizes across

---

<sup>3</sup> In terms of data analysis, processing RWA as a single factor (in opposite to the results of the CFA) would have shown a significant effect from political self-placement to the change in RWA. This effect however, was driven only by authoritarian submission as the subsequent separate analysis showed.

countries. Furthermore the question comes up whether the same pattern would occur if the focus country itself was hit by a major attack.

### **Conclusion**

Three conclusions can be drawn from the present study. First, the results of Castano et al., 2011 hold even true in a large scale, representative panel data set. This means that 11-M led to an ideological intensification instead of a conservative shift in Germany. Second, those categorizing themselves as centrists, which is the largest group of Germans in this sample, react in the same way as rightists do – they are getting more conservative after an attack. Thus, the potential for a conservative shift on average mean level is pretty high. Third, the effect of ideological intensification is stronger in leftists.

**Acknowledgements**

I thank Ulrich Wagner, Frank Asbrock, Jan Weber and the members of the graduate school ‘Group-Focused Enmity’ for their helpful comments on an earlier draft of this article. This work was supported by the interdisciplinary Research Training Group ‘Group Focused Enmity’ located in Marburg and Bielefeld, Germany, funded by the Deutsche Forschungsgemeinschaft (GRK 884).

## References

- Adorno, T. W., Frenkel-Brunswik, E., Levinson, D., & Sanford, N. (1950). *The authoritarian personality*. New York: Harper.
- Altemeyer, B. (1998). The Other "Authoritarian Personality". In M. P. Zanna (Ed.), *Advances in experimental social psychology* (pp. 47–92). San Diego: Academic Press.
- Arbuckle, J. L. (1996). Full information estimation in the presence of missing data. In G. A. Marcoulides & R. E. Schumacker (Eds.), *Advanced structural equation modeling. Issues and techniques* (pp. 243–277). Mahwah, N.J: L. Erlbaum Associates.
- Becker, E. (1997/1973). *The denial of death*. New York: Free Press Paperbacks.
- Bonanno, G. A., & Jost, J. T. (2006). Conservative Shift Among High-Exposure Survivors of the September 11th Terrorist Attacks. *Basic and Applied Social Psychology*, 28(4), 311–323
- Breckenridge, J. N., & Zimbardo, P. G. (2007). The Strategy of Terrorism and the Psychology of Mass-Mediated Fear. In B. M. Bongar, L. M. Brown, L. E. Beutler, J. N. Breckenridge, & P. G. Zimbardo (Eds.), *Psychology of terrorism* (pp. 116–133). Oxford, New York: Oxford University Press.
- Burke, B. L., Kosloff, S., & Landau, M. J. (2013). Death Goes to the Polls: A Meta-Analysis of Mortality Salience Effects on Political Attitudes. *Political Psychology*, 34(2), 183–200
- Castano, E., Leidner, B., Bonacossa, A., Nikkah, J., Perrulli, R., Spencer, B., & Humphrey, N. (2011). Ideology, Fear of Death, and Death Anxiety. *Political Psychology*, 32(4), 601–621
- Christ, O. (2006). *Systematischer Ausfall im GMF-Panel für die ersten drei Wellen [Systematic loss in the GMF Panel for the first three waves of measurement]*. Unpublished manuscript.
- Crowson, H. M., Thoma, S. J., & Hestevold, N. (2005). Is Political Conservatism Synonymous With Authoritarianism? *The Journal of Social Psychology*, 145(5), 571–592
- Das, E., Bushman, B. J., Bezemer, M. D., Kerkhof, P., & Vermeulen, I. E. (2009). How terrorism news reports increase prejudice against outgroups: A terror management account. *Journal of Experimental Social Psychology*, 45(3), 453–459
- Duckitt, J., & Bizumic, B. (2013). Multidimensionality of Right-Wing Authoritarian Attitudes: Authoritarianism-Conservatism-Traditionalism. *Political Psychology*, 34(6), 841–862
- Echebarria-Echabe, A., & Fernández-Guede, E. (2006). Effects of terrorism on attitudes and ideological orientation. *European Journal of Social Psychology*, 36(2), 259–265
- Eid, M., Schneider, C., & Schwenkmezger, P. (1999). Do you feel better or worse? The validity of perceived deviations of mood states from mood traits. *European Journal of Personality*, 13(4), 283–306
- European Commission. (2002). *Eurobarometer: Public Opinion in the European Union*. Report Number 57. Retrieved from [http://ec.europa.eu/public\\_opinion/archives/eb/eb57/eb57\\_en.pdf](http://ec.europa.eu/public_opinion/archives/eb/eb57/eb57_en.pdf)
- Eysenck, H. J. (1999/1954). *The psychology of politics: With a new introduction by the author*. New Brunswick, NJ: Transaction Publ.
- Fischer, P., Greitemeyer, T., Kastenmüller, A., Frey, D., & Oßwald, S. (2007). Terror salience and punishment: Does terror salience induce threat to social order? *Journal of Experimental Social Psychology*, 43(6), 964–971

- Forschungsgruppe Wahlen. (2004a). *Politbarometer März II 2004: Repräsentative Umfrage - Kalenderwoche 12 [Representative Survey - Calendar Week 12]*. Mannheim. Retrieved from [http://bankenverband.de/downloads/politbarometer/2004/PB\\_BZ190304.pdf](http://bankenverband.de/downloads/politbarometer/2004/PB_BZ190304.pdf)
- Forschungsgruppe Wahlen. (2004b). *Politbarometer April I 2004: Repräsentative Umfrage - Kalenderwoche 14 [Representative Survey - Calendar Week 14]*. Mannheim. Retrieved from [http://bankenverband.de/downloads/politbarometer/2004/PB\\_BZ020404.pdf](http://bankenverband.de/downloads/politbarometer/2004/PB_BZ020404.pdf)
- Greenberg, J., & Jonas, E. (2003). Psychological and political orientation--The left, the right, and the rigid: Comment on Jost et al. (2003). *Psychological Bulletin*, *129*(3), 376–382
- Greenberg, J., Pyszczynski, T., Solomon, S., Rosenblatt, A., Veeder, M., Kirkland, S., & Lyon, D. (1990). Evidence for terror management theory II: The effects of mortality salience on reactions to those who threaten or bolster the cultural worldview. *Journal of Personality and Social Psychology*, *58*(2), 308–318
- Greenberg, J., Simon, L., Pyszczynski, T., Solomon, S., & Chatel, D. (1992). Terror management and tolerance: Does mortality salience always intensify negative reactions to others who threaten one's worldview? *Journal of Personality and Social Psychology*, *63*(2), 212–220
- Huddy, L., & Feldman, S. (2011). Americans respond politically to 9/11: Understanding the impact of the terrorist attacks and their aftermath. *American Psychologist*, *66*(6), 455–467
- Huddy, L., Feldman, S., Taber, C., & Lahav, G. (2005). Threat, Anxiety, and Support of Antiterrorism Policies. *American Journal of Political Science*, *49*(3), 593–608
- IFD Allensbach. (2004). *Mehr als jeder Zweite befürchtet einen Terroranschlag in Deutschland [More than every other one fears a terrorist attack in Germany]* (Allensbacher Berichte No. 7/2004). Allensbach am Bodensee. Retrieved from [http://www.ifd-allensbach.de/uploads/tx\\_reportsndocs/prd\\_0407.pdf](http://www.ifd-allensbach.de/uploads/tx_reportsndocs/prd_0407.pdf)
- Jost, J. T., Fitzsimons, G., & Kay, A. C. (2004). The Ideological Animal: A System Justification View. In J. Greenberg, S. L. Koole, & T. A. Pyszczynski (Eds.), *Handbook of experimental existential psychology* (pp. 263–283). New York: Guilford Press.
- Jost, J. T., Glaser, J., Kruglanski, A. W., & Sulloway, F. J. (2003). Political conservatism as motivated social cognition. *Psychological Bulletin*, *129*(3), 339–375
- Jost, J. T., Napier, J. L., Thorisdottir, H., Gosling, S. D., Palfai, T. P., & Ostafin, B. (2007). Are Needs to Manage Uncertainty and Threat Associated With Political Conservatism or Ideological Extremity? *Personality and Social Psychology Bulletin*, *33*(7), 989–1007
- Kam, C. D., & Kinder, D. R. (2007). Terror and Ethnocentrism: Foundations of American Support for the War on Terrorism. *The Journal of Politics*, *69*(02)
- Kaplan, J. (2006). Islamophobia in America?: September 11 and Islamophobic Hate Crime. *Terrorism and Political Violence*, *18*(1), 1–33
- Landau, M. J., Solomon, S., Greenberg, J., Cohen, F., Pyszczynski, T. A., Arndt, J., ... (2004). Deliver us from Evil: The Effects of Mortality Salience and Reminders of 9/11 on Support for President George W. Bush. *Personality and Social Psychology Bulletin*, *30*(9), 1136–1150
- McArdle, J. J., & Hamagami, F. (2001). Latent difference score structural models for linear dynamic analyses with incomplete longitudinal data. In L. M. Collins & A. G. Sayer (Eds.), *New methods for the analysis of change* (pp. 139–175). Washington, DC, US: American Psychological Association.

- McGregor, H. A., Lieberman, J. D., Greenberg, J., Solomon, S., Arndt, J., Simon, L., & Pyszczynski, T. (1998). Terror management and aggression: Evidence that mortality salience motivates aggression against worldview-threatening others. *Journal of Personality and Social Psychology, 74*(3), 590–605
- Meredith, W. (1993). Measurement invariance, factor analysis and factorial invariance. *Psychometrika, 58*(4), 525–543
- Muthén, L. K., & Muthén, B. O. (2012). *Mplus User's Guide: Seventh Edition*. Los Angeles, CA: Muthén & Muthén.
- Nagoshi, J. L., Terrell, H. K., & Nagoshi, C. T. (2007). Changes in authoritarianism and coping in college students immediately after the terrorist attacks of September 11, 2001. *Personality and Individual Differences, 43*(7), 1722–1732
- Nail, P. R., & McGregor, I. (2009). Conservative Shift among Liberals and Conservatives Following 9/11/01. *Social Justice Research, 22*(2-3), 231–240
- Noelle-Neumann, E. (2002). Terror in America: Assessments of the Attacks and Their Impact in Germany. *International Journal of Public Opinion Research, 14*(1), 93–98
- Pyszczynski, T., Solomon, S., & Greenberg, J. (2003). *In the Wake of 9/11: The Psychology of Terror*. Washington, DC, US: American Psychological Association.
- Steyer, R., Eid, M., & Schwenkmezger, P. (1997). Modeling True Intraindividual Change: True Change as a Latent Variable. *Methods of Psychological Research Online, 2*(1), 21–33.
- Zick, A., Wolf, C., Küpper, B., Davidov, E., Schmidt, P., & Heitmeyer, W. (2008). The Syndrome of Group-Focused Enmity: The Interrelation of Prejudices Tested with Multiple Cross-Sectional and Panel Data. *Journal of Social Issues, 64*(2), 363–383

## **2. Final Discussion**

As outlined in the introduction, a new threat to Western countries and their citizens arose with 9/11. With their terrorist attacks on the World Trade Center towers and the Pentagon, Islamist terrorists killed thousands of people and destroyed landmarks of Western capitalism and power. By doing so, they conveyed terror far beyond those directly affected by the attacks (Breckenridge & Zimbardo, 2007). The new threat posed by Islamist terrorism had far reaching consequences for politics (e.g., Huddy, Feldman, & Weber, 2007) but also for individuals' psychological health (Ahern, Galea, Resnick, & Vlahov, 2004; Marshall et al., 2007). The present research aimed at shedding light onto further consequences of Islamist terrorism and the resulting threat: first, consequences for intergroup relations between Western majority societies and Muslim immigrants (Manuscripts #1 and #2) and second, changes in political ideologies in response to a major terrorist attack (Manuscript #3). In the following section, I discuss theoretical, empirical, and methodological advances as well as the potential for practical interventions following from the results. Thereafter, I give an outlook on future research.

### **2.1 Perceived Terrorist Threat and Anti-Muslim Backlash (Manuscripts #1 & #2)**

In this research, my co-authors and I were able to show that perceived terrorist threat on a micro level leads to derogation of Muslims (Manuscript #2). Furthermore, this micro-level process can become an anti-Muslim backlash on a macro level, if specific marginal conditions are given (Manuscript #1). In the first manuscript, we theorized a model from Integrated Threat Theory (ITT; Stephan & Stephan, 2000) and research connecting prejudice with discrimination (e.g., Talaska, Fiske, & Chaiken, 2008). However, that model was not testable with the available data. Therefore, we tested in Manuscript #2 the connection of perceived terrorist threat and derogation of Muslims on a micro-level. In addition to simply testing the

connection of those two variables, we delivered evidence for the causal antecedence of perceived terrorist threat to derogation of Muslims. The finding from that study that perceived terrorist threat predicts anti-Muslim prejudice is in line with ITT. It furthermore supports Levine and Campbell's (1972) assumption that the hostility of the majority is directed to the perceived source of threat, which is also concordant with several scapegoating approaches (Allport, 1979/1954; Glick, 2002, 2005).

The aforementioned test of causal antecedence of perceived terrorist threat and derogation of Muslims is unique, to our knowledge. Several studies (Das, Bushman, Bezemer, Kerkhof, & Vermeulen, 2009; Doosje, Zimmermann, Küpper, Zick, & Meertens, 2009; Oswald, 2005) adopted the view that perceived terrorist threat produces prejudice against Muslims but none of them validated that assumption. Ibish (2003) assumed that the 9/11 backlash was an expression of existing prejudice. In the same way, Allen (2004) argued that Islamist terrorism is used as justification to express existing prejudice (for a theoretical account, see Crandall & Eshleman, 2003; Gaertner & Dovidio, 1986). Das et al. (2009) showed that an experimental terrorist threat manipulation led to increased prejudice. However, this design was not able to answer the question if individuals really increased in prejudice or if only the expression of existing prejudice increased. We closed this gap by applying latent variable cross-lagged models (Jöreskog, 1979) to that research question (Manuscript #2). The results clearly indicate that perceived terrorist threat produces prejudice and discriminatory intention against Muslims. An answer to that research question was especially important because it allows to develop appropriate intervention strategies. In Manuscript #2, some promising strategies are discussed to diminish the perception of terrorist threat. In a nutshell, individuals need to be aware about the low probability of becoming a victim (Breckenridge & Zimbardo, 2007; Sunstein, 2003), they should learn more about the motives of terrorists (Fischer, Postmes, Koepl, Conway, & Fredriksson, 2011), and they



should be embedded in subjectively meaningful groups because this can buffer threat (Jonas & Fritsche, 2013).

A shared implication from Manuscript #1 and #2 is the demand that mass media needs to stop associating Muslims with terrorism (Poole & Richardson, 2006; Richardson, 2009/2004; Shaheen, 2003). In Manuscript #1, we derived this implication from the assessment that the probability of threat becoming prejudice and discrimination is higher in countries where Muslims are mainly presented in the context of terrorism in mass media. Another implication of Manuscript #1 is that a call for differentiation between peaceful living Muslims and terrorists by political and religious elites can prevent backlash. However, in case of 9/11 in the US, Presidents Bush's call for differentiation led to decreased prejudice against Muslims but did not prevent violence against them. One reason for this fact is that Bush made his call for differentiation ten days after 9/11 and most of the violent discrimination against Muslims happened already in the very days after 9/11. When the attacks on the UK occurred on July 7, 2005 (7/7), an immediate call for differentiation could not prevent an increase in prejudice and discrimination (EUMC, 2005). Thus, in case of 7/7 in the UK our theorized model fit the data insofar as threat, prejudice and discrimination increased. A similar pattern with only slight increases in reported discriminatory acts was found for the Madrid Bombings on March 11, 2004 (11-M) in Spain. Hence, the macro development of perceived terrorist threat, anti-Muslim prejudice and discrimination after a major attack can be predicted by a social psychological micro level model if several marginal conditions are fulfilled. For all minor events considered in Manuscript #1 only increases in threat but no consequences in prejudice and discrimination were recorded. Additional interesting findings are that 9/11 led to increases in discrimination against Muslims across all focus countries in terms of spillover effects (Allen & Nielsen, 2002) and that 7/7 led to increases in anti-Muslim prejudice in all European focus countries.

Time series analyses (e.g., ARIMA; Box, Jenkins, & Reinsel, 2008) were not applicable to the data in Manuscript #1 mainly due to the irregularity of conduction. Furthermore, using stochastic differential equations (e.g., Reinecke, Schmidt, & Weick, 2005) was also not possible with this kind of data. Only one of the repeated cross-section time series provided two items measuring anti-Muslim prejudice. We used this surplus in data quality and tested the invariance of the measurement (Byrne, Shavelson, & Muthén, 1989; Meredith, 1993). By doing so, we determined that the meaning of anti-Muslim prejudice remained stable in Germany between 2003 and 2011. Thus, neither 11-M, 7/7, nor any other terror related event changed the factor structure of anti-Muslim prejudice. To our knowledge, there is no other study showing measurement invariance of anti-Muslim prejudice over such a time span. However, it would have been highly interesting to have a latent measurement of anti-Muslim prejudice in Germany pre and post 9/11. If this had been the case, we would have been able to evaluate whether the mean and/or the full measurement model changed due to 9/11. However, to our knowledge, no such data set exists.

## **2.2 Perceived Terrorist Threat and Changing Political Ideologies (Manuscript #3)**

By choosing New York, Madrid, and London as target cities, last decade's terrorists ensured not only that many people fell victim but also that camera teams were at the scene within minutes (Shurkin, 2007). The pictures of falling bodies and the crashing towers as happened on 9/11 were repeated in news media in an uncountable amount. Also the pictures of shredded trains and body bags after 11-M, as well as the exploded bus in London, were frequently circulated in the months after the attacks. Therefore, it is not astonishing that terrorist attacks have the power to increase the salience of mortality in general which in turn leads individuals to contemplate their own death (Landau et al., 2004).

When individuals contemplate their death, scholars of Terror Management Theory (TMT) hypothesize that worldview defense occurs. In context of worldview defense on

political ideologies (e.g., conservatism), Huddy and Feldman (2011) introduced the term ideological intensification. Ideological intensification means that individuals increase their conviction of their political view. Pyszczynski, Solomon, and Greenberg (2003) hypothesized worldview defense to occur also in context of major terrorist attacks. That is what I found in German data, for a period when the Madrid Bombing occurred: leftists became less conservative and centrists and rightists more conservative.

With this finding, I make a contribution to an ongoing debate about the appropriateness of two competing theories: On the one hand, there is TMT with the ideological intensification hypothesis (Castano et al., 2011; Pyszczynski et al., 2006; Pyszczynski et al., 2003), on the other hand, conservatism as motivated social cognition theory (Jost et al., 2007; Jost, Glaser, Kruglanski, & Sulloway, 2003) whose advocates argue that threat, especially mortality salience, leads to a conservative shift. A conservative shift means that all individuals react with conservatism to existential threat. Recently, Burke, Kosloff, and Landau (2013) delivered a meta-analysis on this debate. The authors analyzed more than thirty experiments. However, the meta-analysis delivered no clear cut result about the superiority of one perspective over the other. Therefore, the results of Manuscript #3 are an important contribution to the research field because they are built on a large, representative panel dataset that covers a major terrorist attack. This increases external validity of the worldview defense hypothesis. On the other hand, this goes along with limitations of internal validity. However, the fact that the post-attack data was conducted only a few weeks after 11-M, when perceived terrorist threat was still increased, downgrades that limitation.

A similar study covering a real world terrorist event is available by Echebarria-Echabe and Fernández-Guede (2006). However, they have only non-representative, independent pre-post samples which allows no insights into the intraindividual process of ideology change.

In terms of methodology, Manuscript #3 is to my knowledge the first one in that specific research field and in general one of the very rare manuscripts that applied latent true change

modeling (McArdle, 2009; Steyer, Eid, & Schwenkmezger, 1997). This method produces measurement error free change scores and is therefore highly advantageous compared to other change and difference scores.

### **2.3 Anti-Muslim Backlash and Ideological Intensification – A Contradiction?**

An additional finding in Manuscript #3 was that prejudice (xenophobia) changed in the same ideology intensifying way as authoritarian submission did. Those on the left became less prejudiced whereas centrist and rightists increased in prejudice. On mean level, prejudice remained stable. With these results in mind, the question arises whether the same pattern would have been observable if the variable under scrutiny was anti-Muslim and not general prejudice. On the one hand, this makes sense as general prejudice and anti-Muslim prejudice share substantial variance, at least when measured in Germany (see Zick et al., 2008). On the other hand, according to Levine and Campbell (1972) it is probable that the reaction to the specifically threatening group is different than to unspecific foreigners (see also Fritsche, Jonas, & Kessler, 2011; Sides & Gross, 2013). Thus, one has to ask whether leftists defend primarily the Western World or their political ideology if a terrorist attack occurs. In this line, Jonas and Fritsche (2013) point to the flexibility of the worldviews defended, depending on the activated ingroup identity. Most of the research in the area of worldview defense (ideological intensification) showed that worldview defense occurred against individuals of the national ingroup with a contrary political ideology (Castano et al., 2011; Greenberg, Simon, Pyszczynski, Solomon, & Chatel, 1992; McGregor et al., 1998) and not against ethnic outgroup members (but see Das et al., 2009; for an overview, see Greenberg & Kosloff, 2008). The question is therefore whether a terrorist attack activates the ingroup identity

“German”<sup>1</sup> which would lead to worldview defense against “Muslims” or if one’s own political ideology is activated. The latter would lead to worldview defense against national ingroup members with a different political ideology. A third possibility is that both processes happen but in a sequential order. First, the ingroup “Germans” is activated and with decreasing emotionality one’s own political ideology gains attention. However, this is rather speculative which emphasizes the need for future research on worldview defense when it comes to real world terror.

Finally, considering the large potential of centrists and rightists due to their mere quantitative superiority, it is conceivable that anti-Muslim prejudice increases on mean level, even if leftists would decrease in prejudice (see Greenberg & Jonas, 2003). The discussion shows that anti-Muslim backlash and ideological intensification are not necessarily contradictory.

---

<sup>1</sup> Also the ingroup „Westerners“ could be activated if an attack hits an allied country. When 9/11 occurred, the German parliamentary leader of the Social Democratic Party said: “today, we are all Americans” (Freeman, 2001) which emphasizes that the definition of the ingroup depends on situations.

### 3. Outlook

The attacks on 9/11 gained as much attention in the research community as they did in news media. Thousands of research papers from various disciplines are dedicated to the attacks that shocked the so called Western World. In this research, my co-authors and I demonstrated that perceived terrorist threat has far reaching consequences for a) Muslims in Western countries and b) for changes in political ideologies. These results make a valuable contribution to contemporary research on perceived terrorist threat. However, further research may provide new perspectives on the topic and cover the shortcomings of the present studies.

An assumption throughout the thesis was that the quality of the Western stereotype of Muslims changed with 9/11. I argued that the facet “terrorist” was strengthened (e.g., US) or added (e.g., Germany) which made Muslims more threatening than before the attacks. To my knowledge, there is no such pre-post comparison for 9/11 (for a close approach, see Kalkan, Layman, & Uslander, 2009). Seago (1947) delivers such a comparison for the Japanese attack on Pearl Harbor in 1941 (see also Meenes, 1943). This study used the Katz and Braly’s (1935) method of ascertaining national and racial stereotypes. Study participants received a list of 84 adjectives and had to allocate them to national groups. Seago (1947) revealed that the stereotypes versus Japanese changed dramatically in a negative direction after the attacks.

From a modern stereotype content view, Sides and Gross (2013) demonstrated that Muslims in the US are perceived as violent and untrustworthy. Furthermore, they found that individuals who see Muslims in that way also rather support several aspects of the war on terror. Thus, there are hints for an integration of violent concepts into the stereotype of Muslims but there is no clear cut indication that this is caused by terrorist attacks. Therefore, further research should answer the question if stereotypes against Muslims are the same in terrorist threat and non-threat periods and how this affects attitudes and behavior towards

Muslims. One method to answer that question is continuous and frequent terrorist threat and Muslim stereotype monitoring. Such a dataset would also be appropriate to examine the impact of the mass media on perceived threat, as theorized in Manuscript #1. Moreover, insights into the process of specific activation of facets of the stereotype of Muslims by terrorist threat could be reached by running experiments. Terrorist threat could be experimentally manipulated and stereotype content then analyzed as outcome measure.

Personality attributes that favor the perception of terrorist threat remained largely unconsidered in this thesis due to a different research focus. Huddy et al. (2005) provide an overview of predictors of terrorist threat. Gender (female) and authoritarianism are related to higher threat perceptions, whereas higher education reduces the perception of terrorist threat.

In Manuscript #1, I derived a model from theory that predicted perceived terrorist threat becomes anti-Muslim prejudice, and prejudice then becomes discrimination. However, I could not validate this assumption: in Manuscript #1 the data was not appropriate for such an analysis and in Manuscript #2, anti-Muslim prejudice and discrimination happened to be indistinct constructs. Therefore, further research should clarify this mediation, ideally by means of experimental terrorist threat manipulations and the measurement of real discriminatory behavior in the laboratory. In such a research design, the search for moderators of the assumed threat-prejudice-discrimination mediation should also be included.

To get closer to the discussed mechanism of ideological intensification in case of anti-Muslim prejudice (see chapter 2.3), I would suggest a two-stage research plan. First, the underlying processes need to be examined as thoroughly as possible in laboratory experimental research (for an overview, see Jonas & Fritsche, 2013). One of the crucial questions to answer is if worldview defense in response to terrorism differs depending on the activated ingroup identity (e.g., German vs. leftist). The second stage should then monitor individuals (political) ideologies and the relevant variables derived from stage one at regular

intervals (e.g., monthly)<sup>1</sup>. Such a panel design would enable researchers to study fluctuations of the constructs under research in a real world context. It would also allow to evaluate the above conceived idea of sequentiality, that individuals first defend their larger ingroup (e.g. country) and afterwards their political ideology. In terms of methodology, such a design would allow to analyze the data with elaborated methods from the family of longitudinal latent variable modeling (McArdle, 2009) and stochastic differential equations (Reinecke et al., 2005).

Finally, I hope that the manuscripts of this thesis reach practitioners who develop more specific intervention programs to minimize the perception of terrorist threat and its consequences. Furthermore, I appeal to the mass media to start presenting Muslims not only in negative contexts but as peaceful members of today's multicultural Western societies. The association of Muslims with terrorism needs to be cut.

What gives me hope is the fact that the attacks on the Boston Marathon in April 2013 did not lead to an anti-Muslim backlash. It seems as political and religious leaders learned from past mistakes and are now well prepared to react immediately in case of a new attack to avoid backlash. However, as stated in Manuscript #1 all these measures are rather symptomatic treatments for a long-lasting world conflict that unfortunately seems unsolvable, still.

---

<sup>1</sup> However, such a frequent panel design could introduce issues in terms of learning effects (Tourangeau, Rips, & Rasinski, 2000).



### 3.1 References

- Ahern, J., Galea, S., Resnick, H., & Vlahov, D. (2004). Television Images and Probable Posttraumatic Stress Disorder After September 11. *The Journal of Nervous and Mental Disease*, *192*(3), 217–226. doi:10.1097/01.nmd.0000116465.99830.ca
- Allen, C. (2004). Justifying Islamophobia: A Post 9/11 Consideration of the European Union and British Contexts. *The American Journal of Islamic Social Sciences*, *21*(3), 1–25. Retrieved from [http://i-epistemology.net/attachments/847\\_Ajiss21-3%20-%20Allen%20-%20Justifying%20Islamophobia.pdf](http://i-epistemology.net/attachments/847_Ajiss21-3%20-%20Allen%20-%20Justifying%20Islamophobia.pdf)
- Allen, C., & Nielsen, J. S. (2002). Summary Report on Islamophobia in the EU after 11 September 2001. Retrieved from [http://fra.europa.eu/sites/default/files/fra\\_uploads/199-Synthesis-report\\_en.pdf](http://fra.europa.eu/sites/default/files/fra_uploads/199-Synthesis-report_en.pdf)
- Allport, G. W. (1979/1954). *The Nature of Prejudice* (25th ed.). Reading, Mass: Perseus Books.
- Box, G. E. P., Jenkins, G. M., & Reinsel, G. C. (2008). *Time series analysis: Forecasting and control* (4th ed.). *Wiley series in probability and statistics*. Hoboken, N.J: John Wiley.
- Breckenridge, J. N., & Zimbardo, P. G. (2007). The Strategy of Terrorism and the Psychology of Mass-Mediated Fear. In B. M. Bongar, L. M. Brown, L. E. Beutler, J. N. Breckenridge, & P. G. Zimbardo (Eds.), *Psychology of terrorism* (pp. 116–133). Oxford, New York: Oxford University Press.
- Burke, B. L., Kosloff, S., & Landau, M. J. (2013). Death Goes to the Polls: A Meta-Analysis of Mortality Salience Effects on Political Attitudes. *Political Psychology*, *34*(2), 183–200. doi:10.1111/pops.12005
- Byrne, B. M., Shavelson, R. J., & Muthén, B. O. (1989). Testing for the Equivalence of Factor Covariance and Mean Structures: The Issue of Partial Measurement Invariance. *Psychological Bulletin*, *105*(3), 456–466. Retrieved from [http://www.statmodel.com/bmuthen/articles/Article\\_027.pdf](http://www.statmodel.com/bmuthen/articles/Article_027.pdf)
- Castano, E., Leidner, B., Bonacossa, A., Nikkah, J., Perrulli, R., Spencer, B., & Humphrey, N. (2011). Ideology, Fear of Death, and Death Anxiety. *Political Psychology*, *32*(4), 601–621. doi:10.1111/j.1467-9221.2011.00822.x
- Crandall, C. S., & Eshleman, A. (2003). A justification-suppression model of the expression and experience of prejudice. *Psychological Bulletin*, *129*(3), 414–446. doi:10.1037/0033-2909.129.3.414
- Das, E., Bushman, B. J., Bezemer, M. D., Kerkhof, P., & Vermeulen, I. E. (2009). How terrorism news reports increase prejudice against outgroups: A terror management account. *Journal of Experimental Social Psychology*, *45*(3), 453–459. doi:10.1016/j.jesp.2008.12.001
- Doosje, B., Zimmermann, A., Küpper, B., Zick, A., & Meertens, R. L. (2009). Terrorist Threat and Perceived Islamic Support for Terrorist Attacks as Predictors of Personal and Institutional Out-Group Discrimination and Support for Anti-Immigration Policies: Evidence from 9 European Countries. *Revue Internationale de Psychologie Sociale*, *22*(3), 203–233.
- Echebarria-Echabe, A., & Fernández-Guede, E. (2006). Effects of terrorism on attitudes and ideological orientation. *European Journal of Social Psychology*, *36*(2), 259–265. doi:10.1002/ejsp.294

- EUMC. (2005). *The Impact of 7 July 2005 London Bomb Attacks on Muslims Communities in the EU*. Vienna. Retrieved from [http://fra.europa.eu/sites/default/files/fra\\_uploads/197-London-Bomb-attacks-EN.pdf](http://fra.europa.eu/sites/default/files/fra_uploads/197-London-Bomb-attacks-EN.pdf)
- Fischer, P., Postmes, T., Koepl, J., Conway, L., & Fredriksson, T. (2011). The Meaning of Collective Terrorist Threat: Understanding the Subjective Causes of Terrorism Reduces Its Negative Psychological Impact. *Journal of Interpersonal Violence, 26*(7), 1432–1445. doi:10.1177/0886260510369137
- Freeman, A. (2001, September 13). 'Today we are all Americans' - NATO allies pledge support. *The Globe and Mail*. Retrieved from [http://v1.theglobeandmail.com/special/attack/pages/worldreactions\\_article12.html](http://v1.theglobeandmail.com/special/attack/pages/worldreactions_article12.html)
- Fritsche, I., Jonas, E., & Kessler, T. (2011). Collective Reactions to Threat: Implications for Intergroup Conflict and for Solving Societal Crises. *Social Issues and Policy Review, 5*(1), 101–136. doi:10.1111/j.1751-2409.2011.01027.x
- Gaertner, S. L., & Dovidio, J. F. (1986). The aversive form of racism. In J. F. Dovidio & S. L. Gaertner (Eds.), *Prejudice, discrimination, and racism* (pp. 61–89). San Diego: Academic Press.
- Glick, P. (2002). Sacrificial lambs dressed in wolves' clothing: Envious prejudice, ideology, and the scapegoating of Jews. In L. S. Newman & R. Erber (Eds.), *Understanding genocide. The social psychology of the Holocaust* (pp. 113–142). New York: Oxford University Press.
- Glick, P. (2005). Choice of Scapegoats. In J. F. Dovidio, P. S. Glick, & L. A. Rudman (Eds.), *On the nature of prejudice. Fifty years after Allport* (pp. 244–261). Malden, MA: Blackwell Pub.
- Greenberg, J., & Jonas, E. (2003). Psychological and political orientation--The left, the right, and the rigid: Comment on Jost et al. (2003). *Psychological Bulletin, 129*(3), 376–382. doi:10.1037/0033-2909.129.3.376
- Greenberg, J., & Kosloff, S. (2008). Terror Management Theory: Implications for Understanding Prejudice, Stereotyping, Intergroup Conflict, and Political Attitudes. *Social and Personality Psychology Compass, 2*(5), 1881–1894. doi:10.1111/j.1751-9004.2008.00144.x
- Greenberg, J., Simon, L., Pyszczynski, T., Solomon, S., & Chatel, D. (1992). Terror management and tolerance: Does mortality salience always intensify negative reactions to others who threaten one's worldview? *Journal of Personality and Social Psychology, 63*(2), 212–220. doi:10.1037/0022-3514.63.2.212
- Huddy, L., & Feldman, S. (2011). Americans respond politically to 9/11: Understanding the impact of the terrorist attacks and their aftermath. *American Psychologist, 66*(6), 455–467. doi:10.1037/a0024894
- Huddy, L., Feldman, S., Taber, C., & Lahav, G. (2005). Threat, Anxiety, and Support of Antiterrorism Policies. *American Journal of Political Science, 49*(3), 593–608. doi:10.1111/j.1540-5907.2005.00144.x
- Huddy, L., Feldman, S., & Weber, C. (2007). The Political Consequences of Perceived Threat and Felt Insecurity. *The ANNALS of the American Academy of Political and Social Science, 614*(1), 131–153. doi:10.1177/0002716207305951
- Ibish, H. (2003). *Report on Hate Crimes and Discrimination Against Arab Americans: The Post - September 11 Backlash*. Washington, DC, US. Retrieved from <http://www.adc.org/PDF/hcr02.pdf>

- Jonas, E., & Fritsche, I. (2013). Destined to die but not to wage war: How existential threat can contribute to escalation or de-escalation of violent intergroup conflict. *American Psychologist*, *68*(7), 543–558. doi:10.1037/a0033052
- Jöreskog, K. G. (1979). Statistical estimation of structural models in longitudinal development investigations. In J. R. Nesselroade & P. B. Baltes (Eds.), *Longitudinal research in the study of behavior and development* (pp. 303–352). New York: Academic Press.
- Jost, J. T., Glaser, J., Kruglanski, A. W., & Sulloway, F. J. (2003). Political conservatism as motivated social cognition. *Psychological Bulletin*, *129*(3), 339–375. doi:10.1037/0033-2909.129.3.339
- Jost, J. T., Napier, J. L., Thorisdottir, H., Gosling, S. D., Palfai, T. P., & Ostafin, B. (2007). Are Needs to Manage Uncertainty and Threat Associated With Political Conservatism or Ideological Extremity? *Personality and Social Psychology Bulletin*, *33*(7), 989–1007. doi:10.1177/0146167207301028
- Kalkan, K. O., Layman, G. C., & Uslaner, E. M. (2009). “Bands of Others”? Attitudes toward Muslims in Contemporary American Society. *The Journal of Politics*, *71*(03), 847. doi:10.1017/S0022381609090756
- Katz, D., & Braly, K. W. (1935). Racial prejudice and racial stereotypes. *The Journal of Abnormal and Social Psychology*, *30*(2), 175–193. doi:10.1037/h0059800
- Landau, M. J., Solomon, S., Greenberg, J., Cohen, F., Pyszczynski, T. A., Arndt, J., ... (2004). Deliver us from Evil: The Effects of Mortality Salience and Reminders of 9/11 on Support for President George W. Bush. *Personality and Social Psychology Bulletin*, *30*(9), 1136–1150. doi:10.1177/0146167204267988
- LeVine, R. A., & Campbell, D. T. (1972). *Ethnocentrism: theories of conflict, ethnic attitudes, and group behavior*. New York: Wiley.
- Marshall, R. D., Bryant, R. A., Amsel, L., Suh, E. J., Cook, J. M., & Neria, Y. (2007). The psychology of ongoing threat: Relative risk appraisal, the September 11 attacks, and terrorism-related fears. *American Psychologist*, *62*(4), 304–316. doi:10.1037/0003-066X.62.4.304
- McArdle, J. J. (2009). Latent Variable Modeling of Differences and Changes with Longitudinal Data. *Annual Review of Psychology*, *60*(1), 577–605. doi:10.1146/annurev.psych.60.110707.163612
- McGregor, H. A., Lieberman, J. D., Greenberg, J., Solomon, S., Arndt, J., Simon, L., & Pyszczynski, T. (1998). Terror management and aggression: Evidence that mortality salience motivates aggression against worldview-threatening others. *Journal of Personality and Social Psychology*, *74*(3), 590–605. doi:10.1037/0022-3514.74.3.590
- Meenes, M. (1943). A Comparison of Racial Stereotypes of 1935 and 1942. *The Journal of Social Psychology*, *17*(2), 327–336. doi:10.1080/00224545.1943.9712287
- Meredith, W. (1993). Measurement invariance, factor analysis and factorial invariance. *Psychometrika*, *58*(4), 525–543. doi:10.1007/BF02294825
- Oswald, D. L. (2005). Understanding Anti-Arab Reactions Post-9/11: The Role of Threats, Social Categories, and Personal Ideologies. *Journal of Applied Social Psychology*, *35*(9), 1775–1799. doi:10.1111/j.1559-1816.2005.tb02195.x
- Poole, E., & Richardson, J. E. (2006). *Muslims and the news media*. London, New York: I.B. Tauris.
- Pyszczynski, T., Abdollahi, A., Solomon, S., Greenberg, J., Florette, C., & Weise, D. R. (2006). Mortality Salience, Martyrdom, and Military Might: The Great Satan Versus the

- Axis of Evil. *Personality and Social Psychology Bulletin*, 32(4), 525–537.  
doi:10.1177/0146167205282157
- Pyszczynski, T., Solomon, S., & Greenberg, J. (2003). *In the Wake of 9/11: The Psychology of Terror*. Washington, DC, US: American Psychological Association.
- Reinecke, J., Schmidt, P., & Weick, S. (2005). Dynamic Modeling with Structural Equations and Stochastic Differential Equations: Applications with the German Socio-economic Panel. *Quality & Quantity*, 39(4), 483–506. doi:10.1007/s11135-005-0239-x
- Richardson, J. E. (2009/2004). *(Mis)representing Islam: The racism and rhetoric of British broadsheet newspapers. Discourse approaches to politics, society, and culture: Vol. 9*. Amsterdam, Philadelphia, PA: John Benjamins Pub.
- Seago, D. W. (1947). Stereotypes: Before Pearl Harbor and After. *The Journal of Psychology*, 23(1), 55–63. doi:10.1080/00223980.1947.9917320
- Shaheen, J. G. (2003). Reel Bad Arabs: How Hollywood Vilifies a People. *The Annals of the American Academy of Political and Social Science*, 588(1), 171–193.  
doi:10.1177/0002716203588001011
- Shurkin, J. N. (2007). Terrorism and the Media. In B. M. Bongar, L. M. Brown, L. E. Beutler, J. N. Breckenridge, & P. G. Zimbardo (Eds.), *Psychology of terrorism* (pp. 81–86). Oxford, New York: Oxford University Press.
- Sides, J., & Gross, K. (2013). Stereotypes of Muslims and Support for the War on Terror. *The Journal of Politics*, 75(3), 583–598. doi:10.1017/S0022381613000388
- Stephan, W. G., & Stephan, C. W. (2000). An integrated threat theory of prejudice. In S. Oskamp (Ed.), *Reducing prejudice and discrimination* (pp. 23–45). Mahwah, N.J: Lawrence Erlbaum Associates.
- Steyer, R., Eid, M., & Schwenkmezger, P. (1997). Modeling True Intraindividual Change: True Change as a Latent Variable. *Methods of Psychological Research Online*, 2(1), 21–33.
- Sunstein, C. R. (2003). Terrorism and Probability Neglect. In W. K. Viscusi (Ed.), *The Risks of Terrorism* (pp. 23–38). Boston, MA: Springer US.
- Talaska, C. A., Fiske, S. T., & Chaiken, S. (2008). *Legitimizing Racial Discrimination: Emotions, Not Beliefs, Best Predict Discrimination in a Meta-Analysis*.
- Tourangeau, R., Rips, L. J., & Rasinski, K. A. (2000). *The psychology of survey response*. Cambridge, U.K. ;, New York: Cambridge university press.
- Zick, A., Wolf, C., Küpper, B., Davidov, E., Schmidt, P., & Heitmeyer, W. (2008). The Syndrome of Group-Focused Enmity: The Interrelation of Prejudices Tested with Multiple Cross-Sectional and Panel Data. *Journal of Social Issues*, 64(2), 363–383.  
doi:10.1111/j.1540-4560.2008.00566.x

## Zusammenfassung

Am 11. September 2001 veränderte sich die Welt, als die Großmacht USA von islamistischen Terroristen attackiert wurde. Mehr als 3000 Menschen starben durch die Attacken und mehrere Wahrzeichen amerikanischer Macht wurden zerstört. Diese Ereignisse versetzten Millionen von Menschen in der sogenannten westlichen Welt in Angst und Schrecken, was dazu führte, dass Islamistischer Terrorismus plötzlich eine ernstzunehmende Bedrohung darstellte. Viele Menschen in den USA und weiten Teilen Europas befürchteten, dass ihr Land aber auch sie selber Opfer von Terroranschlägen werden könnten. Bedingt durch immer neue Anschläge oder Anschlagversuche, ist dieses Bedrohungsgefühl bis heute, mehr als ein Jahrzehnt später, nicht wieder komplett verschwunden. Daher widme ich mich in meiner hier vorliegenden Dissertation dem Phänomen der *wahrgenommenen Terrorbedrohung* und den resultierenden Konsequenzen. Konkret befaße ich mich einerseits mit den Konsequenzen des Terrors für die in westlichen Ländern lebenden Muslime und andererseits mit den Änderungen politischer Ideologien infolge von Anschlägen.

Bedrohungen, gleich ob realistischer oder symbolischer Art, sind im Kontext von Intergruppenbeziehungen dafür bekannt, Vorurteile und Diskriminierung gegenüber Fremdgruppen zu verstärken (z.B. Integrated Threat Theory; Stephan & Stephan, 2000). Am stärksten richtet sich ein solcher Effekt der Mehrheitsbevölkerung gegenüber der Minderheit, von der die vermeintliche Bedrohung ausgeht (LeVine & Campbell, 1972). Islamistische Terroranschläge müssten dementsprechend zur Abwertung von Muslimen führen. Die Manuskripte #1 und #2 beschäftigen sich mit dieser Annahme.

*Wahrgenommene Terrorbedrohung* kann dazu führen, dass bei Personen Gedanken über den eigenen Tod salient werden (Landau et al., 2004). Die Salienz des eigenen Todes weckt den Wunsch, Teil einer Gemeinschaft und einer Weltanschauung zu sein, welche das eigene Ableben überdauert (Terror Management Theory; Greenberg, Pyszczynski, Solomon,

Rosenblatt, & et al, 1990). Aus diesem Grund wird vermutet, dass Terroranschläge dazu führen, dass Individuen ihre Weltanschauung stärker vertreten (Pyszczynski, Solomon, & Greenberg, 2003). Mit dieser Hypothese befasst sich Manuskript #3.

Die Ausgangsbeobachtung für Manuskript #1 war, dass es nach den Anschlägen vom 11. September 2001 zu einer Welle von Hassverbrechen gegen Muslime in den USA kam. Die abgeleitete Forschungsfrage war daher, ob diese Hassverbrechen mit einem sozialpsychologischen Modell erklärt werden können, welches postuliert, dass *wahrgenommene Terrorbedrohung* zu Vorurteilen und Vorurteile wiederum zu Diskriminierung führen. Um die externe Validität des Modells zu prüfen, wurde es auf verschiedene Länder (USA, Spanien, UK, Deutschland) und verschiedene Terroranschläge (New York, Madrid, London etc.) angewendet. Die Datengrundlage bildete eine groß angelegte Recherche von Meinungsumfragen und Berichten zu den drei genannten Komponenten des Modells für einen Zeitraum von 2000 bis ca. 2012. Für jedes Land wurde also überprüft, ob nach einem Terroranschlag die *wahrgenommene Terrorbedrohung*, sowie Vorurteile und Diskriminierung gegenüber Muslimen messbar anstiegen. Die Allgemeingültigkeit des Modells konnte nicht gezeigt werden. Dies geht auf die vielen Kontextfaktoren in den einzelnen Ländern zurück. Einige dieser Faktoren werden im Hinblick darauf diskutiert, wie der Teufelskreis von *wahrgenommener Terrorbedrohung* und Gewalt gegen Muslimen durchbrochen werden kann.

Während die Datenlage in Manuskript #1 eine Makro-Perspektive auf die Verknüpfung von *wahrgenommener Terrorbedrohung* und Abwertung von Muslimen bot, wurde der postulierte Zusammenhang in Manuskript #2 auf Mikro-Ebene überprüft. Dieses Manuskript ging der Frage nach, ob *wahrgenommene Terrorbedrohung* tatsächlich Vorurteile produziert oder ob *wahrgenommene Terrorbedrohung* lediglich als Legitimation zur Äußerung bestehender Vorurteile genutzt wird. Auch eine Kombination der beiden Wirkrichtungen wurde in Erwägung gezogen. Die Datengrundlage stellte eine Panelstudie mit N = 88

autochthonen Deutschen dar. Die Daten wurden mit latenten, kreuzverzögerten Modellen (Cross-Lagged Modellen; Jöreskog, 1979) analysiert, um die zeitliche Abfolge des Prozesses bestimmen zu können. Die Ergebnisse zeigten, dass die *wahrgenommene Terrorbedrohung* Vorurteile über die Zeit vorhersagt. Dementsprechend sind Vorurteile gegenüber Muslimen ein Produkt von *wahrgenommener Terrorbedrohung*, wie es in der Integrated Threat Theory postuliert wird (Stephan, Renfro, & Davis, 2008). Folglich gilt es Bedrohungsgefühle zu reduzieren und die (mediengemachte) Verknüpfung zwischen Islam und Terrorismus zu schwächen.

Manuskript #3 befasste sich mit der Auswirkung der Anschläge von Madrid (März 2004) auf politische Ideologien in Deutschland. Wie oben bereits angedeutet, wurde die Hypothese getestet, ob sich Individuen nach einem Anschlag in ihrer politischen Ideologie – einem Aspekt ihrer Weltsicht – verstärken (Castano et al., 2011). Die alternative Hypothese lautete, dass alle Individuen gleichermaßen auf Terroranschläge reagieren und konservativer werden (Jost, Glaser, Kruglanski, & Sulloway, 2003). Ein für die deutsche Bevölkerung (16+) repräsentativer Paneldatensatz, der ein Jahr vor und wenige Wochen nach den Anschlägen erhoben wurde, bildete die Datengrundlage. Die Analysen, die unter anderem mit Latent Change Modellen (Steyer, Eid, & Schwenkmezger, 1997) durchgeführt wurden, zeigten, dass Menschen die sich zu t1 als politisch links einordneten nach den Anschlägen (t2) noch weniger konservativ wurden. Individuen, die sich hingegen zu t1 in der politischen Mitte oder rechts davon verorteten, wurden konservativer zu t2. Das gleiche Muster fand sich auch für Fremdenfeindlichkeit. Diese Ergebnisse bestätigten die Vorhersage der Terror Management Theory (Pyszczynski et al., 2003). Ein praxisrelevante Tatsache bei diesem Befund war, dass das quantitative Potential für einen konservativen Schwung weit höher ist, da die Gruppe der sich politisch in der Mitte oder rechts Einordnenden weit größer war, als die Gruppe derjenigen, die sich links verorteten.

Zusammengenommen weisen die Befunde der drei Manuskripte auf die weitreichenden Folgen von *wahrgenommener Terrorbedrohung* hin. Vor allem aber bietet das tiefere Verständnis der beschriebenen Phänomene die Möglichkeit effektive Handlungsstrategien abzuleiten, damit friedliebende Muslime in Zukunft nicht mehr die Sündenböcke für die Taten weniger Terroristen werden.



**Literatur**

- Castano, E., Leidner, B., Bonacossa, A., Nikkah, J., Perrulli, R., Spencer, B., & Humphrey, N. (2011). Ideology, Fear of Death, and Death Anxiety. *Political Psychology*, 32(4), 601–621. doi:10.1111/j.1467-9221.2011.00822.x
- Greenberg, J., Pyszczynski, T., Solomon, S., Rosenblatt, A., & et al. (1990). Evidence for terror management theory II: The effects of mortality salience on reactions to those who threaten or bolster the cultural worldview. *Journal of Personality and Social Psychology*, 58(2), 308–318. doi:10.1037/0022-3514.58.2.308
- Jöreskog, K. G. (1979). Statistical estimation of structural models in longitudinal development investigations. In J. R. Nesselroade & P. B. Baltes (Eds.), *Longitudinal research in the study of behavior and development* (pp. 303–352). New York: Academic Press.
- Jost, J. T., Glaser, J., Kruglanski, A. W., & Sulloway, F. J. (2003). Political conservatism as motivated social cognition. *Psychological Bulletin*, 129(3), 339–375. doi:10.1037/0033-2909.129.3.339
- Landau, M. J., Solomon, S., Greenberg, J., Cohen, F., Pyszczynski, T. A., Arndt, J., ... (2004). Deliver us from Evil: The Effects of Mortality Salience and Reminders of 9/11 on Support for President George W. Bush. *Personality and Social Psychology Bulletin*, 30(9), 1136–1150. doi:10.1177/0146167204267988
- LeVine, R. A., & Campbell, D. T. (1972). *Ethnocentrism: theories of conflict, ethnic attitudes, and group behavior*. New York: Wiley.
- Pyszczynski, T., Solomon, S., & Greenberg, J. (2003). *In the Wake of 9/11: The Psychology of Terror*. Washington, DC, US: American Psychological Association.
- Stephan, W. G., Renfro, C. L., & Davis, M. D. (2008). The Role of Threat in Intergroup Relations. In U. Wagner, L. R. Tropp, G. Finchilescu, & C. Tredoux (Eds.), *Social issues and interventions. Improving intergroup relations. Building on the legacy of Thomas F. Pettigrew* (pp. 55–72). Malden, MA, Oxford: Blackwell Pub.
- Stephan, W. G., & Stephan, C. W. (2000). An integrated threat theory of prejudice. In S. Oskamp (Ed.), *Reducing prejudice and discrimination* (pp. 23–45). Mahwah, N.J: Lawrence Erlbaum Associates.
- Steyer, R., Eid, M., & Schwenkmezger, P. (1997). Modeling True Intraindividual Change: True Change as a Latent Variable. *Methods of Psychological Research Online*, 2(1), 21–33.

## Danksagung

Mein besonderer Dank gilt meinem Anleiter Prof. Dr. Uli Wagner, der mir zuverlässig mit seiner Expertise und seiner immensen Erfahrung unterstützend zur Seite stand. Besonderer Dank gilt auch meinem Zweitgutachter, Prof. Dr. Peter Schmidt, der vor allem meine methodologisch-wissenschaftliche Ausrichtung entscheidend geprägt und diese Dissertation von Anbeginn begleitet hat.

Danken möchte ich auch den Mitgliedern des Graduiertenkollegs „Gruppenbezogene Menschenfeindlichkeit“ für die gegenseitige Unterstützung und den regen Austausch in dem anfangs unüberschaubaren Prozess des Promovierens. Vor allem aber auch für die vielen tollen Momente auf Summer-Schools oder internationalen Konferenzen. Insbesondere mit meiner langjährigen Kommilitonin und guten Freundin Stefanie Gosen habe ich viele interessante Länder und Städte bereist. Das war eine tolle Zeit die ich nicht missen möchte. Außerdem möchte ich der Arbeitseinheit Sozialpsychologie für die gute Unterstützung danken, die ich genieße, seitdem ich in die „Zentrale“ gezogen bin. Ich habe die tolle Arbeitsatmosphäre, den regen Gedankenaustausch und das gemeinsame Mittagessen sehr zu schätzen gelernt. Besonderer Dank gilt den beiden Post-Docs Mathias Kauff und Frank Asbrock, die für die schnelle Rückfrage zwischendurch immer ein offenes Ohr und meistens auch eine Antwort parat hatten. Danke auch an die Hilfskräfte für das Anfertigen von Grafiken und das Korrekturlesen von Texten. Auch meinen „Büro-Insassen“ Christoph Butenschön und Sarina Schäfer möchte ich für die tolle gemeinsame Zeit und für die geteilte Vorliebe für schlechte Wortwitze danken.

Mein persönlicher Dank gilt schließlich meiner Familie und meinen Freunden, auf deren Unterstützung und Zuspruch ich durchgehend zählen konnte. Insbesondere möchte ich auch Ann-Sophie - der Frau in meinem Leben - danken, die mich stets unterstützte und motivierte, besonders wenn die Arbeit kräftezehrend war und endlos erschien. Danke dafür!



## **Erklärung des Autors**

Ich versichere, dass ich meine Dissertation „Anti-Muslim Backlash and Changing Political Ideologies. The Consequences of Perceived Threat from Islamist Terrorism“ selbstständig, ohne unerlaubte Hilfe angefertigt habe und mich dabei keiner anderen als der von mir ausdrücklich bezeichneten Quellen und Hilfen bedient habe.

Die Dissertation wurde in der jetzigen oder einer ähnlichen Form noch bei keiner anderen Hochschule eingereicht und hat noch keinen Prüfungszwecken gedient.

\_\_\_\_\_  
(Ort / Datum)

\_\_\_\_\_  
Stefan Thörner