

An investigation of relationships between Approach Motivation, Attentional Bias to Positive Stimuli, and Hypomanic Personality

Submitted by Michael Patrick Begley to the University of Exeter
as a thesis for the degree of
Doctor of Philosophy in Psychology
March 2017

This thesis is available for Library use on the understanding that it is copyright material and that no quotation from the thesis may be published without proper acknowledgement.

I certify that all material in this thesis which is not my own work has been identified and that no material has previously been submitted and approved for the award of a degree by this or any other University.

Signature:

Dedicated to my late parents

Malachy and Geraldine Begley

who, one way and another, both suffered

at the hands of this illness.

Acknowledgements

First and foremost, I would like to express my deepest gratitude to Kim Wright for her unwavering support, saintly patience, and caring nature over the years. Thank you Kim. Also, I would like to thank Ed Watkins for his keen experimental eye.

I'm indebted to Claire Harries for her assistance with study 5. I also give a big shout out to key friends I have made at Exeter Uni: Hansy, Kat and Jaydo, but also to my sources of support from further afield, particularly my good mates Luke and PJ.

A final thank you goes to my partner, Hannah, for her patience, encouragement, smoothies and general all-round greatness.

Abstract

Underpinned by the Behavioural Approach System (BAS) dysregulation theory of bipolar disorder (BD), five studies were conducted in non-clinical samples to; refine the measurement of state Approach Motivation (AM); measure minor increases in AM; and then finally, to investigate how this relates to attentional biases for emotional stimuli.

Study 1 attempted to clarify the phenomenology of state AM and revealed four separable factors that emerged from pooled AM questionnaire items. These structures loosely mapped on hypothesized components of the BAS (Depue & Iacono, 1989) that pertain to; cognitive elements of approach motivation (feeling determined and inspired); an energized, activated state; an affective structure relating to positive mood and outlook; and finally to feelings of excitement. Studies 2 and 3 investigated the validity of the four derived factors and their parent scales against a reward-oriented laboratory induction, a psychophysiological marker of AM, and a test of the discriminative power. The validity results suggested that the most well-established of the scales, the PANAS-PA, slightly outperformed the other measures by showing the greatest response to an AM induction. A second aim was to explore the substructure of a valid measure of mania risk - the hypomanic personality scale (HPS: Eckblad & Chapman, 1986) – in relation to AM responsiveness. Unexpectedly, individuals who endorsed unpredictable and changeable moods (mood volatility) displayed elevated sympathetic arousal in response to control task.

On this basis, and with a view to exploring the role selective attentional processes as a mediator of AM dysregulation that is relevant to bipolar disorder, study 4 and 5 utilised PANAS-PA to replicate a bi-directional congruency-effect found in the literature between elevations in AM and attentional information-processing biases to reward-related stimuli. Results in general did not support a causal influence of AM on attentional biases, nor did the attempted manipulation of attentional biases affect downstream AM. However, there was evidence that within a stratified sample of participants who reliably responded to the AM and control conditions, those at greater risk to mania exhibited an attentional bias for both positive and negative stimuli, relative those at lower risk to mania.

Thesis overview

In this thesis two strands of research were undertaken to better understand psychological processes relevant to the development of mania. The first was concerned with the measurement of AM, a construct governed by the BAS and hypothesized to be dysregulated in Bipolar Disorders (BD). The second strand investigated links between AM dysregulation consistent with BD and reward-related information processing biases.

An enhanced understanding of the cognitive and bio-behavioural processes that contribute to dysregulated AM that is thought central to the ascent in to mania is impeded by the absence of a psychometrically sound self-report instrument for the subjective experience of AM. To identify a gold standard state self-report measure of AM, a literature review of measurement of AM was conducted and subsequently three studies were designed and conducted to i) characterise the latent structure of existing self-report measures of AM, ii) assess the construct, convergent and discriminative validity of these measures. Integrating these findings within the wider literature informed how best to measure the subjective experience of AM. In the second strand of research a measure of AM, as informed by studies 1-3, was utilised to measure AM alongside attentional bias. It was hypothesized that experimental elevation of AM would bias selective attention towards positive information. Furthermore, it was predicted that vulnerability to mania would moderate this relationship. Finally study 5 was designed and implemented to examine the malleability of attentional biases for positive information and the downstream influence these might have on mania-related cognition and emotion.

Chapter 1 provides background to BD, and the prominent aetiological and maintenance models of mania, with a focus on the BAS dysregulation theory (Depue & Iacono, 1989). Following the empirical chapters, the results are integrated in the context of processes related to bipolar vulnerability. It is concluded that future measurement of AM, improved understanding of trait vulnerability to mania and attentional biases, can all benefit from considering relations between the underlying components of these constructs.

Table of Contents

1. Chapter One: Introduction to Bipolar Disorder.....	16
1.1	16
1.2 Overview of Bipolar Disorder.....	16
1.2.1 Illness Classification.....	19
1.2.2 The Treatment of Bipolar Disorder	31
1.3 Aetiological perspectives of bipolar disorder	34
1.4 Biological and Environmental Risk factors in BD	35
1.4.1 Biological Risk Factors	35
1.4.2 Environmental.....	39
1.5 Explanatory theories of bipolar disorder	43
1.5.1 Manic Defence/Depression Avoidance Hypothesis	43
1.5.2 Circadian Rhythms and Social Zeitgebers	44
1.5.3 Cognitive Models of Bipolar Disorder	45
2. Chapter 2: The Behavioural Approach System (BAS) Theory and its relationship to Bipolar Disorder	50
2.1.1 The BAS	52
2.1.2 BIS and BAS measured as Personality Traits	55
2.1.3 The BIS and BAS, and Psychopathology	61
2.1.4 BAS and Bipolar Disorder	63
2.1.5 The Structure of Mania in relation to the BAS.....	66
2.2 Bipolar Vulnerability: Evidence from the BAS and Hypomanic Personality Scales.....	70
2.2.1 The Substructure of the Hypomanic Personality Scale	73
2.3 Evidence of Reward Dysregulation in Bipolar Disorder	77
2.3.1 Anticipatory Reward.....	77
2.3.2 Consummatory Reward.....	80
2.3.3 Reward Recovery	81
2.3.4 Significance of Reward Recovery for the current Investigations	83
2.4 Conceptualisation of Experiential Approach Motivation.....	85
2.4.1 Approach Motivation and Positive Affect	86

2.4.2	Measures of Subjective AM	91
2.5	Biological Correlates of Approach Motivation.....	96
2.5.1	Spontaneous Eye-blink rate (SEBR) and frontal asymmetry	97
2.5.2	Autonomic Nervous Activity: Cardiac Pre Ejection Period.....	99
2.6	BAS input/ Approach Triggers.....	100
2.6.1	Considerations for the elicitation of elevated AM.....	100
2.6.2	Summary and objective for strand one.....	104
3.	Chapter 3: Cognitive mechanisms in AM regulation	105
3.1	Cognitive Biases in Psychopathology.....	107
3.2	Attentional Biases	108
3.2.1	Attentional biases in bipolar disorder.....	114
3.2.2	Depression-related biases.....	115
3.2.3	Mania-relevant biases.....	116
3.2.4	Impact of positive affective state on selective attention to reward:.....	118
3.3	Manipulation of Selective Attention towards positive stimuli in the General population....	121
3.4	Strand two: rationale for studies 4 and 5	122
4.	Chapter 4: Measuring Approach Motivation at State Level: Exploratory Factor Analysis. 123	
4.1	Method	128
4.1.1	Measures.....	128
4.1.2	Procedure.....	131
4.2	Results.....	136
4.3	Discussion	143
4.3.1	Four factor structure in relation to BAS theory	145
4.3.2	The Structure of PANAS-PA.....	146
4.3.3	Limitations.....	147
5.	Chapter 5: Convergent validity of AM scales against a psychophysiological indicator of Approach Motivation	150
5.1	Method	152
5.2	Materials	154
5.2.1	AM induction.....	157
5.2.2	Neutral induction	158
5.2.3	Cardiac Activity Measurement.....	158
5.3	Procedure.....	159
5.4	Results.....	166

5.5	Discussion	182
6.	Chapter 6: A test of the Discriminant validity of Approach Motivation scales.....	187
6.1	Method	188
6.2	Materials	190
6.3	Procedure.....	191
6.4	Results.....	192
6.5	Discussion	195
7.	Chapter 7: The influence of Approach Motivation on Attentional Bias to Positive Information	201
7.1	Method	205
7.2	Materials	209
7.3	Procedure.....	212
7.4	Results.....	215
7.5	Discussion	231
8.	Chapter 8: Manipulation of selective attention towards positive stimuli: effects on mania relevant variables	236
8.1	Method	242
8.2	Materials	243
8.3	Procedure.....	252
8.4	Results.....	254
8.5	Discussion	264
9.	Chapter 9: General Discussion	268
9.1	Summary of Purpose, Methodology and findings of the Thesis.....	268
9.2	Strand One: Limitations of the AM measurement research.....	271
9.3	Implications for the measurement of AM	273
9.4	Strand Two: Limitations and implications for attentional bias measurement.	277
9.5	Implications for the measurement of vulnerability to bipolar disorder.....	281
9.6	+Conclusions	284
10.	10Appendix I	313
10.1	Figure 26 Positive Activation Rating Scale (Morrone et al. 2000)	313
10.2	Figure 27 PANAS-PA (Watson et al. 1988).....	314
10.3	Figure 28 BES (Krauss et al. 1988)	315
10.4	Figure 29 AMSAM (Wright unpublished)	316
11.	11Appendix II	317

11.1	Figure 30 Study 1 Information Sheet.....	317
11.2	Figure 31 Study 2 info sheet	318
11.3	Figure 32 study 3 info sheet	319
11.4	Figure 33 Study 4 info sheet	320
11.5	Figure 34 study 5 info sheet	323
11.6	Figure 35. Descriptive Statistics for 17 AM items.....	325
12.	12Appendix III	325
12.1	Distributions for the 17 AM items	326
13.	13Appendix IV	338
13.1	Table 29. Independent Samples T-Test comparing AM measures between N conditions immediately prior to first induction.....	341
13.2	Deconstruction of Family ANOVA test to assess AM measures against the inductions ...	343
14.	14Appendix V	345
14.1.1	345
14.2	Figure 39. Descriptives Study 3	346
14.3	Figure 40. Negative Valence High Arousal IAPS images (FEAR).....	347
14.4	Figure 15. Positive Valence High Arousal IAPS images (FEAR)	348
14.5	Figure 41. Positive Valence Low Arousal IAPS images (Calm Positive Affect).....	350
15.	15Appendix VI	352
15.1	AM induction instructions	352
15.2	Figure 42. Word Stimuli for study 4.....	353
16.	16Appendix VII	354
16.1	Figure 43 Goal Setting	354
16.2	Figure 44 Success Expectancy.....	354
16.3	Figure 45 Thought Speed.....	355
16.4	Figure 46 Self-Esteem	355
16.5	Figure 47 Word Stimuli for study 5.....	356
17.	17Appendix VIII	357

List of Tables

Table 1. Spectrum of bipolar disorders.....	22
Table.2. Eigenvalues and total variance for the four AM scales.....	137
Table 3. Correlation Matrix for the 17 AM items	139
Table 4. Factor Matrix of the final four factor solution	140
Table 5. Pearson's Correlations for the four factors	141
Table 6. Factor Item Reliability	142
Table 7. Comparing PANAS-PA dimension reduction studies	143
Table 8. Sample and Baseline Characteristics	166
Table 9. Cardiac Pre-Ejection Period between the groups, pre-post inductions.....	168
Table 10. Paired Samples T-Test pre to post AM induction for PARS and PANAS-PA	171
Table 11. Paired Samples T-Test pre to post AM induction for the AM factor subscales	175
Table 12. AM measures predicting PEP: model characteristics for Linear Mixed Models of interest.....	176
Table 13. Factor scales predicting PEP: model characteristics for Linear Mixed Models of interest.....	177
Table 14. Mixed-ANOVA results for Hypomanic Personality subscales	181
Table 15. Repeated measures ANOVA results for moderation effect of Hypomanic Personality subscales	Error! Bookmark not defined.
Table 16. Sample and Baseline Characteristics	193
Table 17. Paired Samples T-Test for Factor Scales within Calm Positive Affect.....	Error!
	Bookmark not defined.
Table 18. Characteristics of the Participants at baseline.....	216
Table 19. Repeated measures ANCOVA results for Hypomanic Personality subscales.....	218
Table 20. Attentional bias, reaction times, and error rates for both conditions	220

Table 21. Pearson Correlations for between HPS, AM attentional bias to positive words....	221
Table 22. Sample Characteristics for reliable change sub-sample.....	225
Table 23. RCI moderations results for Hypomanic Personality subscales	229
Table 24. Study 5 Sample Characteristics.....	254
Table 25. Descriptives and Plots for Success Inductions.....	255
Table 26. Descriptive statistics and one-way between subjects ANOVA results for baseline mania-relevant variables	255
Table 27 Correlation Matrices	256
<i>Table 28. Reaction Times and Attentional Bias to Positive scores</i>	<i>260</i>
Table 1. Independent Samples T-Test comparing AM measures betweenN conditions immediately prior to first induction	341

List of Figures

Figure 1 Gray'reinforcement sensitivity model (extracted from McNaughton & Corr, 2014)	51
Figure 2 Gray and Eysenck's model of personality	56
Figure 3. Corr's Joint Subsystem interpretation of the revised RST (from Corr, 2004)	59
Figure 4. BAS dysregulation theory of bipolar spectrum disorders (Depue & Iacono, 1989)	64
Figure 5. factor structure of mania.....	67
Figure 6 Watson and Tellegen's (1985) two factor model of affect.....	88
Figure 7. Carver and Sheier's (1998) bipolar affective dimensions	90
Figure 8 Scree plot.....	138
Figure 9 Path diagram of factor structure	141
Figure 10. Flow diagram of study procedure.....	153
Figure 11 Pots for PEP pre to post inductions.	167
Figure 12. Plots for SAM Activation and Valence for each condition.....	169

Figure 13. Figure. Mean self-report scores for the 4 AM measures pre and post first induction for experimental (1) and control condition (2).	172
Figure 14. Plots for the factor scales.....	174
Figure 15. Behavioural Engagement Scale (BES) plots for participants assigned to the control	Error! Bookmark not defined.
Figure 16. Cardiac Pre-Ejection Period (PEP) plots for low and high Mood Volatility groups	Error! Bookmark not defined.
Figure 17. Plots for PARS and PANAS scorers pre to post AM.....	195
Figure 18. Mean self-report for the 4 AM measures pre and post first induction for Calm Positive Affect (1) Approach Motivation (2) Fear (3) conditions . Error bars represent 95% Confidence Intervals	Error! Bookmark not defined.
Figure 19. Plots for the 4 factor scales, pre to post AM imagery	Error! Bookmark not defined.
<i>Figure 20. Flowchart of study procedure</i>	213
Figure 21. Plot graph for PANAS pre-post induction.....	217
Figure 22 a) and b) General Positive Bias Plots for positive and negative attentional bias scores in a) the AM induction b) Neutral induction for high HPS scorers	228
Figure 23. Screen shot showing positive feedback participants received and example anagram	247
Figure 24 Flow Diagram of Study 5	251
Figure 25 Pre-post training effects for Success Expectancy.....	261
Figure 1 Positive Activation Rating Scale (Morrone et al., 2000).....	313
Figure 2 PANAS-PA (Watson et al., 1988)	314
Figure 3 BES (Krauss et al., 1988)	315
Figure 4 AMSAM (Wright unpublished).....	316

Figure 5 Study 1 Information Sheet.....	317
Figure 6 Study 2 info sheet.....	318
Figure 7 study 3 info sheet.....	319
Figure 8 Study 4 info sheet.....	320
Figure 9 study 5 info sheet.....	323
Figure 10. Descriptive Statistics for 17 AM items.....	325
Figure 11 Principal Axis Factoring Solution	335
Figure 12 EFA ML with outliers removed.....	336
Figure 13 Study 2 descriptives.....	340
Figure 14. Descriptives Study 3.....	346
Figure 15. Negative Valence High Arousal IAPS images (FEAR).....	347
Figure 16. Positive Valence Low Arousal IAPS images (Calm Positive Affect).....	350
Figure 17. Word Stimuli for study 4	353
Figure 18 Goal Setting.....	354
Figure 19 Success Expectancy.....	354
Figure 20 Thought Speed.....	355
Figure 21 Self-Esteem	355
Figure 22 Word Stimuli for study 5	356

1 Chapter One: Introduction to Bipolar Disorder

1.1 Overview of Bipolar Disorder

Bipolar disorder (BD) is a mental health condition characterised by episodes of extreme mood and high or low activation levels. It is often chronic and debilitating with potential for long term emotional, social and occupational impairment (Ketter, 2010). BD is responsible for high levels of disability through periods of illness, periods of subsyndromal presentations and during remission (Huxley & Baldessarini, 2007). It is the 5th leading cause of disability worldwide (Murray & Lopez, 1996) and aside from emotional distress for the individual and the family members involved, the economic cost for society is high with estimates suggesting it costs the UK government £4.9 billion a year (Fajutrao et al., 2009). In terms of current classification, BD is currently deemed to represent a range of separable condition - bipolar spectrum disorders - which vary by severity of symptomatology but which all include degrees of pathologic mood elevation known as hypomania and mania. Despite being associated with such disability, it is important to note that some individuals with BD experience a more benign course and are high achievers (Johnson, 2005).

A lack of consensus on the nosology of bipolar spectrum disorders (Akiskal & Pinto, 1999; Ghose, Sanches, Zunta-Soares, Swann & Soares, 2013) is evident by the recent revision of the criteria for a diagnosis of hypomania and mania by the American Psychiatric Association's (APA) fifth edition of the Diagnostic and Statistical Manual of mental disorders (DSM-V) which emphasizes changes in activity and energy as well as mood, a revision pertinent to the theoretical position of this thesis which is discussed later (DSM-V: APA, 2013). A problem for the accurate diagnosis of BD is widespread comorbidity. For example, roughly 65% of individuals with BD have comorbidities with other axis I disorders such as an

anxiety, addiction or eating disorders (McElroy *et al.*, 2001). Comorbidity between BD, Attention Deficit Hyperactivity Disorder (ADHD), and obsessive compulsive disorder, which has been purported to reflect shared brain-derived neurotrophic factor (BDNF) suggesting a higher order biological factor (Muller *et al.*, 2005).

Throughout this thesis BD will be used to refer to all bipolar spectrum disorders¹, as described by the DSM-V (APA, 2013). With respect to the course of illness, there is an oscillating nature to BD, typified by extreme shifts in mood and energy from periods of euthymic mood to hypo/manic or depressive states, with time spent in an acute mood episode varying from individual to individual but generally ranging from several days to several months (Goodwin & Jamison, 1990). Individuals with BD can expect a 9.2 year reduction in expected life span and in clinical samples half of individuals diagnosed had a history of suicide attempts (Jamison, 2000). BD boasts the highest suicide attempt rate (29%) of all psychiatric disorders (Rihmer, 2005).

BD is viewed by some researchers to be a multi-systemic disorder in which individuals experience disturbances not only in emotion and behaviour but also to other aspects of physiological functioning; 20 – 30 percent of BD individuals are affected by metabolic syndrome and the risk of mortality associated with obesity exceeds that for suicide (Leboyer *et al.*, 2012). Disruption to cognition is also a characteristic of BD, with psychoses a cardinal feature of mania in BD type I, often in the form of delusions of grandeur.

Furthermore, mild to moderate cognitive deficits such as impaired verbal learning, memory, and executive function can be present even when patients are euthymic, and may lead to impaired functioning, although side effects of medication can interfere with execute functions

¹ Throughout this report BD will be used to refer to individuals who have received a diagnosis of one of the forms (BD type 1 BD type II, Cyclothymic Disorder – described later). There is an argument for specifying subtype but theorists generally agree that the spectrum diagnoses share underlying core mechanisms. Therefore this thesis will work on the assumption that they share this core underlying pathology and thus can be validly collapsed under one term.

also (Bearden, Hoffman & Cannon, 2001). Despite psychiatric drug treatment, 73% of individuals with BD relapse within five years from initial remission and as many as 50% of bipolar patients have been found to relapse within 2 years (Gitlin, Swendsen, Heller & Hammen, 1995). Lifetime prevalence rates in the literature vary with estimates of this for BD type I being between 1-1.5% for the general population (Alonso et al., 2011) and up to 5% when considering all bipolar spectrum disorders (Lewisohn, Klein & Seeley, 1995).

BD is deemed a lifelong illness with periods of mood episode interspersed between periods of partial or full symptom remission. Current treatments, both pharmacological and psychosocial do not achieve complete remission of symptoms and have been found to become progressively worse over time (Phillips & Kupfer, 2013). This is paralleled by evidence that milder forms of BD often develop in to more serious forms of the illness (Akiskal et al. 1977). It should be acknowledged at this point that there is great heterogeneity in the course of illness over time (Johnson & Leary, 2005).

Despite general agreement that BD is a multi-factorially determined condition with biopsychosocial factors affecting multiple systems of the body, historically there has been a focus upon biological causes, including genetic risk factors. Current consensus is that a complex interplay of environmental factors shapes genes to confer risk to BD. As such it is acknowledged that a "range of genetic and non-genetic research approaches is needed to help us better understand the major biological, psychological, and social processes that contribute to bipolar disorder" (Craddock & Sklar, 2013 pg. 154). Furthermore, important as biologically orientated research may be, progress requires integration of both biological and psychosocial research because despite the former informing who is at risk, the latter is vital in revealing how the course of the disorder unravels. A detailed biological account of BD is beyond the remit of this thesis but a brief overview is provided before a theoretical and evidence-based critique of the psychosocial theories. This culminates in comprehensive

account of the bio-behavioural theory of BD guiding this thesis. First a thorough background to the disorder describing classification, illness course and treatment is given.

1.1.1 Illness Classification

Kraepelin (1921) viewed mania and depression to be part of one underlying organic disease. He coined the name Manic-depressive illness as an umbrella term for all disorders of affect, and believed it manifested itself in even the “the slightest forms...which run their course outside of institutions” (p.132). Since Kraepelin’s era there has been much reconceptualization. Today there are two dominant classification systems in use, the World Health Organisation’s (WHO) International Classification of Disease, currently in its 10th edition (WHO, 1993), and the APA’s DSM-V (APA, 2013). The latter publication emphasises a distinction from unipolar disorders by organising depressive disorders and BD in separate sections. This is in contrast to the previous edition, DSM-IV-TR, which categorised them together under one title: mood disorders (APA, 2000). Although there is considerable congruence in approach to diagnosis between them, the ICD system permits a more discrete diagnosis for the clinician whilst the DSM is deemed more useful for classification in research settings (Tyrer, 2014). Both the DSM-V and ICD-10 utilise features relating to the individual’s current or most recent episode. Additionally, DSM-V identifies several (see table 1.1) bipolar and related disorders whereas the ICD-10 recognises bipolar affective disorder with additional information regarding symptom severity.

To receive a diagnosis of a BD under DSM-V criteria² an individual must meet criteria for either a manic or hypomanic episode. Because the DSM-V is prominent in research contexts, the following section describes diagnostic criteria for BD as they are stated in DSM-V (APA, 2013) alongside the other aspects of diagnosis.

Manic Episode

Mania is the cardinal symptom of BD and is defined as abnormally and persistently elevated, expansive or irritable mood. According to DSM-V, a manic episode is a period of time consisting of elevated, expansive or unusually irritable mood in addition to notably abnormal and persistent goal-directed activity which lasts a minimum of one week and are present most of the day, nearly every day (APA, 2013). The exception to a minimum time length criteria is in cases where the individual is required to be hospitalised. For a diagnosis of a manic episode to be made the individual must also present with at least three additional symptoms.

The additional symptoms are:

- Inflated self-esteem or grandiosity.
- Decreased need for sleep (e.g., one feels rested after only 3 hours of sleep).
- More talkative than usual or pressure to keep talking.
- Flight of ideas or subjective experience that thoughts are racing.
- Attention is easily drawn to unimportant or irrelevant items.
- Increase in goal-directed activity (either socially, at work or school; or sexually) or psychomotor agitation.

² The focus here will on DSM-V (APA, 2013) criteria given its predominance in research contexts.

- Excessive involvement in pleasurable activities that have a high potential for painful consequences (e.g., engaging in unrestrained buying sprees, sexual indiscretions, or foolish business investments).

In addition the symptoms should be observable by others and not be deemed the result of a general medical condition or substance abuse or medication.

1.1.1.1 Hypomanic episode

Hypomania is essentially low-level mania. In diagnostic terms, this is reflected by two important differences:

1. Mood is not usually severe enough to impair interpersonal or occupational functioning.
2. There is an absence of psychotic features.

Furthermore, the period of elevated, expansive or irritable mood with abnormally and persistently increased goal-directed activity or energy is less than that required of a manic episode; it needs to last at least four days and, as is the case with a manic episode, be present most of the day, nearly every day. As with a manic episode at least three of the additional symptoms listed above are required.

1.1.1.2 Depressive episode

A major depressive episode in BD is not diagnostically distinct from a unipolar major depressive episode. The cardinal symptoms are depressed mood and loss of interest pleasure in daily activities. In addition to either of these symptoms, individuals are required to present with four of the following additional symptoms: weight change or change in appetite, change in sleep, and change in activity, fatigue, guilt/worthlessness, concentration and suicidality. It is generally agreed that depression, experienced as part of BD is difficult to differentiate from

that experienced by an individual diagnosed with major depressive disorder (Akiskal, 1995; Bowden, 2005; Ghaemi et al., 2000), although some differences have been observed (Satterthwaite et al., 2015).

1.1.1.3 DSM-V Bipolar Subtypes

Table 1. Spectrum of bipolar disorders.

severity 		
Cyclothymic Disorder	Bipolar II Disorder	Bipolar I Disorder
Recurrent Depressive and Hypomanic Symptoms	Major Depression and Hypomanic Episodes	Manic Episode
No Major Depression or Manic Episode	No Manic Episode	Major Depression Episode Not Necessary for Diagnosis

Note. Bipolar-like phenomena that do not fulfil the diagnostic criteria for bipolar spectrum disorders are summarized under the label “other specified bipolar and related disorders”.

What follows is a brief summary of BD subtypes as described in DSM-V (APA, 2013):

Bipolar disorder type I is characterised by manic episodes which lasts at least a week, or by symptoms so severe that an individual is required to be hospitalised. Bipolar type I is distinct from the other bipolar subtypes by the incidence of at least one full manic episode. Lifetime prevalence rates vary from 0.4-1.6% in community samples (Kessler, Rubinow, Holmes, Abelson & Zhao, 1997), and up to 3.3% in an epidemiological study (Grant et al., 2005).

Bipolar II disorder (BD type II): consists of depressive and hypomanic episodes which alternate and are typically less severe than seen in type I. Hence the diagnosis is based on the absence of manic episodes and the presence of at least one episode of hypomania.

Bebbington and Ramana (1995) report prevalence estimates from between 0.5% and 1.4% for bipolar type II.

Cyclothymic disorder: a cyclic disorder that causes brief episodes of hypomania and depression that are not as extensive or as long-lasting as seen in full hypomanic episodes or full depressive episodes but which have to have been present for two years. Furthermore the individual must not have been in remission for longer than two months within the two year period. Cyclothymic disorder is reported in some studies as high as 5–6% of the population (Berk & Dodd, 2005) but as low as 0.4 – 1% others (Regeer et al., 2004).

Other Specified Bipolar and Related Disorder: The diagnosis was designed to capture individuals whose symptomatology does not fall in the above mentioned categories. For example, individuals with a past history of major depressive disorder who meet all criteria for hypomania except the duration criterion. A second instance where the category *other specified bipolar and related disorder* would be applied is if too few hypomanic symptoms are present to meet criteria for the full BD type II syndrome, although the length of symptoms is sufficient at four or more days.

1.1.1.4 Mixed Episodes

Although traditionally conceptualised as opposite poles of the same underlying illness, manic and depressive symptoms often co-occur, giving rise to what is referred to as mixed states. Mixed Episode was a term used in DSM publications up to DSM-IV-TR (APA, 2000) and referred to symptoms of mania and depression that occur at the same time or in rapid sequence. To reflect research suggesting higher than previously estimated prevalence rates for Mixed Episodes, DSM-V has replaced Mixed Episodes with “with mixed features” specifiers which have been created to make it easier to diagnose depressive features which are present in mania or hypomania and alternatively when manic symptoms feature in a depressive episode within an individual diagnosed with BD or unipolar depression.

1.1.1.5 The Bipolar Spectrum

What becomes apparent from the DSM-V categorisation of BD is the varying degree to which mania is reflected in a spectrum of subtypes (see table 1); BD I is the only form of illness including full mania whereas BD II encapsulates hypomania, whilst cyclothymic disorder reflects a milder presentation of hypomania. In more broad terms, the notion of a spectrum of experience and behaviour stems from Eysenck's (1960) research on the biological basis of normal personality variation. Specifically, Eysenck (1960) proposed psychopathology merely reflects extremities of normally distributed personality characteristics. The concept of BD as a range of illnesses on a continuum of severity is gaining growing support (e.g. Merikangas et al., 2011). Indeed, the DSM-V has acknowledged that psychiatric classification in general needs to move towards a spectrum approach, reflected by the use of a hybrid approach in DSM-5 which includes both categories and dimensions (Henry & Etain, 2010).

Bipolar spectrum disorders refers to BDI and BDII, cyclothymic disorder and subthreshold cases in which individuals experience clinical impairment and distress but the symptoms fail to meet hypomanic episode criteria. This parallels the Kraepelinian concept of one unifying illness encompassing both affective extremes alluded to above. In addition, the spectrum approach suggests that milder aspects of BD phenomenology are distributed across the general population and that these are theoretically relevant to understanding psychological processes that contribute to the aetiology of mania.

However, this dimensional approach of BD in its current form is the subject of some debate (Mailhi, 2010). Most controversy relates not to the existence of, but to how the BD continuum should be best conceptualised. For instance, the current method of differentiating between individuals who experience subthreshold hypomanic symptoms and those with a BD diagnosis is drawn rather arbitrarily by the subjective duration and multitude of symptoms

(Akiskal, 2000). Furthermore the number of distinct subtypes described by DSM-V has been widely contested with some arguing for the existence of up to seven subtypes (Akiskal & Pinto, 1999). There is also the reported existence of pure hypomania, speculation that this is under-recognised, and questions about whether it should be included within the clinical spectrum even if little impairment is apparent (Beesdo et al., 2009).

Another challenge involves delineating distinct subtypes of BD whilst accounting for within individual variation in cyclic course of the illness. For example, in a 20 year longitudinal study of weekly symptoms from individuals diagnosed with BD II, it was found that a diagnosis of a sub-threshold mood condition was appropriate for approximately half the duration of the study, indicating a disorder of chronic flux and illustrating the importance of examining the complex time course of BD (Judd et al., 2003). This is mirrored by research showing that around 5% of BD type II and cyclothymic individuals later obtain a type I diagnosis and around 25% with cyclothymic disorder switch to BDII (Akiskal et al., 1977; Coryell et al., 1995). Moreover, other challenges in accurately describing BD as a spectrum are present in problematic differentiation of hypomanic personality traits from milder BD variants and specifically where to distinguish between BD and unipolar disorder (Perugi et al., 2009). Such problems regarding the phenomenology of BD should perhaps be best interpreted as symptoms surrounding the complexity of the illness, an era of medicalisation, and the contemporary limitations of diagnostic tools and research methods.

In support of the spectrum approach is little suggestion in the literature that the causal mechanisms differ substantially across subtypes. For example, a review of BD neurobiology found little evidence for the distinction between BD type I and BD type II (McGrath, Wessels, Bell, Ulrich & Silverstone, 2004). This is supported by evidence that milder forms of BD often develop in to more serious forms of the illness and personality traits linked to

BD are prospectively linked to bipolar spectrum symptoms (e.g. Akiskal et al., 1977; Kwapil et al., 2000; Quilty et al., 2009).

Because this thesis is concerned with detecting processes associated with bipolar personality traits in the general population, rather than diagnosable BD, the next section will provide a rationale for the validity of this approach to understanding processes related to mania BD research.

1.1.1.6 The Bipolar Personality

The DSM-V description of BD as representing a range illness types is often questioned (Kuiper et al., 2012; Akiskal, 2007). However, and as discussed previously, the focus has been on how to best describe the bipolar spectrum, rather than questioning the existence of a continuum of bipolar symptomatology. The current diagnostic criteria does not speak to a broader continuum. One which is inclusive of periods of high activity and mood experienced by individuals which interferes with functioning but which would not meet diagnostic criteria for a BD. This is despite some evidence for a broader conceptualisation (e.g. Akiskal, Bourgeois, Angst, Post, Möller, & Hirschfeld, 2000). Indeed, there is now considerable evidence that mania can be considered the extreme end of a continuum which includes normal experiences relating to cycles in mood and activity (Jones & Bentall, 2006; Walsh, Royal, Brown, Barrantes-Vidal & Kwapil, 2012). Therefore measures of bipolar-like personality traits are important for identifying factors associated with BD.

The use of such measures is important in understanding BD for two reasons. Firstly, studying individuals at risk to BD but who have not experienced mania allows for the identification of premorbid dysregulation. Manic episodes in of themselves are likely to perturb BAS regulation, making it difficult to disentangle phenomena which reflect risk to BD and that which reflects the bio-behavioural consequences of a previous manic episode. For example, greater goal pursuit in individuals diagnosed with BD could be explained by

attempts to compensate *for* the deleterious consequence of previous manic episodes.

Secondly, study participants diagnosed with BD are often prescribed medication that can affect brain functioning; anti-psychotics have been shown to dampen neural responses to reward in individuals diagnosed with BD (Abler et al., 2008). Therefore studying individuals likely to be at elevated risk for BD but who have not yet been diagnosed and prescribed medication, represents an opportunity to understand premorbid processes related to the ascent into mania.

1.1.1.7 The Advantages and Disadvantages of the Hypomanic Personality Scale

In this thesis the focus will be upon one measure specifically developed to identify dispositional traits relating to mania, the Hypomanic Personality Scale (HPS: Eckblad & Chapman, 1986). Eckblad and Chapman (1986) developed the HPS as a 48 item questionnaire designed to detect vulnerability to BD in the general population through personality items relating to mania such as hyperactive, ambitious, and exhibitionistic behaviours as well as feelings of euphoria and flights of thought. According to Eckblad and Chapman (1984) individuals with hypomanic personalities can be described as energetic, ambitious, positive, and sociable. A critique of the HPS as a continuous measure of vulnerability to BD is now provided below.

An often cited strength of the HPS is the evidence it has accrued for its concurrent validity which was achieved against a contemporary structured diagnostic interview tool described below. The HPS developers reported 77% of a large (n = 1519) sample of undergraduates who scored in the top 3%³ also met criteria for a hypomanic episode (Eckblad & Chapman, 1986). These extreme high scorers also self-reported more depressive episodes and schizotypal features, illustrating how the HPS related to multiple aspects of BD phenomenology. A limitation of this supportive evidence is an implied lack of specificity – as

³ (a score of 36 or higher out of 48) Eckblad and Chapman, (1986).

schizotypy is regarded as a personality dimension relating to a diagnosis of schizophrenia (genetic evidence for a substantial overlap between BD and schizophrenia complicates this matter, e.g. Craddock & Sklar, 2013) Moreover, the HPS has been associated with narcissistic personality (Fulford, Johnson & 2007; Stanton et al. 2016) yet a counter-argument to this comes from evidence that narcissism and mania genuinely overlap, as has been found in a clinical sample; individuals with BD were more likely to be diagnosed with narcissistic personality disorder during manic states (Stormberg et al. 1998).

Another criticism levelled at the validity of the HPS centres on its development and predominant usage in non-clinical university settings, meaning it has not been thoroughly tested in clinical samples. Originally, The HPS was tested for concurrent validity by estimating convergence with the Schedule for Affective Disorders and Schizophrenia – Lifetime Version (Endicott & Spitzer, 1978) but this measure, despite being well-validated, has been criticised for low interrater and test-retest reliability (Andreason et al. 1981). If the instrument through which the HPS is itself not psychometrically sound then this clearly creates issues for the validity of the HPS as a measure of BD vulnerability. A more fundamental problem here is that diagnostic tools produce binary outcomes and so expecting a measure that identifies individuals vulnerable to certain phenomenological features of BD along a continuous scale to be validated against such diagnostic tools is incongruous. The following predictive validity evidence somewhat offsets this problem.

In a 13 year follow-up to the original validation study conducted by Eckblad and Chapman (1986), 28% of the high HPS scorers of the original sample, compared to 3% of the low scoring group, met criteria for a hypomanic episode within two years preceding clinical research interview (Kwapil et al., 2000). This is impressive evidence for the predictive ability of the HPS but it does not speak to full BD diagnoses instead relying on presence of mood episodes only. There is a paucity of follow-up research that has investigated the ability of the

HPS to concurrently detect a BD diagnosis. One such study, using an unmodified version of the Structured Clinical Interview for DSM-IV (SCID: First & Gibbon, 2004) and the HPS in a large sample of undergraduates stratified for BD proneness, found the HPS to detect between half and two thirds of BD cases (Miller, 2006) suggesting there is an aspect of diagnosable BD outside the reach of the HPS. This finding is unsurprising when remembering the aforementioned point that these instruments are fundamentally different in their level of measurement (categorical versus continuous designs). Parker, Fletcher, McGraw and Hong (2014), in one of the few patient-HPS studies, administered the HPS to a sample of individuals with BD and found congruency between the emergent principal components and those originally reported by Eckblad and Chapman (1986). The authors suggest this means the HPS measures normative dimensions that underpin BD. However this finding is complicated by an association between BD symptoms and the HPS suggesting the HPS is partially related to morbid rather than merely premorbid processes.

An examination of how item content of the HPS differs from diagnostic instruments can shed light on the limitations of the HPS as a continuous measure of BD vulnerability. As mentioned, differences in the information gathered from these measures illustrate how the HPS is qualitatively distinct from diagnostic tools. Firstly, the dichotomous item format of the HPS prevents information regarding symptom-like severity being gathered. Secondly, the HPS provides no indication of symptom-like duration and thirdly, the HPS does not provide information that relates to social or occupational impairment, a requirement for a clinical diagnosis. These problems with disparities between measurement tools are not easily overcome because there is no accepted standard for assessing vulnerability factors, largely due to a lack of consensus on the essence of psychopathologies as continuous constructs (Watson & Clark, 2006).

Nevertheless, proxy evidence that the HPS detects valid risk factors for later BD has been established (see section 2.2 for more detailed discussion of HPS research). Recent research has utilised experience sampling methods to compare high risk (high HPS) versus low risk (low HPS) groups, and so does allow a test of the sensitivity of the HPS to temporal changes in mood and energy characteristic of BD. Kwapil et al. (2011) found high HPS scorers, compared to low scorers, displayed greater energetic-enthusiasm, irritability, dysphoria, mild grandiosity, risk-taking over time. High HPS was also associated with greater variability in positive and negative affect, but because no clinical interviews were conducted, diagnosable BD could have been overrepresented in the sample (Kwapil et al., 2011). A criticism here is that this research speaks only to the oscillating rather than episodic aspect of BD.

The same research team conducted a replication study in which 145 undergraduates were interviewed for detection of BD before experience sampling was taken from the same participants (Walsh, Royal, Brown, Barrantes-Vidal & Kwapil, 2012). Findings from the interviews revealed expected association between the HPS and DSM interview ratings for BD (18 participants met criteria for diagnosis of BD). When experiences were sampled 8 times a day over 7 days, the HPS was associated with grandiosity, risk taking, negative affect and thought disturbance, independent of a diagnosis of BD. This is important because it goes some way to illustrating that the HPS captures features of BD in a non-clinical sample using naturalistic data. Finally Walsh et al. (2015) followed-up 112 of the original 145 individuals three years later in a separate study: 58% of high (upper quartile) HPS scorers met criteria for a BD diagnosis and the HPS predicted new cases of BD, with a 14% transition rate over 3 years.

It is worth noting that further validity evidence for the HPS as a measure of mania risk has been provided by other researchers (e.g. Meyer & Hautzinger, 2003, Hofmann

& Meyer, 2005; Johnson & Jones, 2009) and that in addition to it prospectively predicting risk for mania, it also correlates with current manic symptoms (Kwapil et al., 2000).

The research cited here, particularly that produced by Kwapil and colleagues, goes some way to addressing the aforementioned criticisms of the HPS as nonspecific and inseparable from clinical presentation and provides support for the HPS as a measure of bipolar vulnerability. That said, a constraint here is our current lack of consensus as to what constitutes vulnerability markers of BD and the extent to which these are continuous within the general population. Overall, the evidence is in favour of the HPS as a best available, valid measure of proneness to later bipolar symptomatology and thus this provides a rationale for using the HPS in the current set of investigations that probe processes associated with the ascent into mania. Before the theoretical background to the studies is delineated, a summary of the treatment of BD is provided.

1.1.2 The Treatment of Bipolar Disorder

According to National Institute of Clinical Excellence (NICE) anti-psychotic and mood stabilising medication are primarily recommended for the management of BD (NICE, 2014). Antipsychotic drugs are effective for remitting the symptoms of mania whilst Lithium (an organic mood stabilising medication) has the best evidence with respect to long-term relapse prevention. However, 75% of individuals diagnosed with BD relapse despite pharmacological medication (Gitlin, Swendsen, Heller, & Hammen, 1995). This evidence highlights the need for alternative treatment options. Because this thesis is focussed on psychological processes involved in the ascent into mania, more attention is given to psychosocial treatment of BD. National guidelines have emphasised psychosocial treatments adjunct to medication for optimal management of BD (NICE, 2014). The importance of psychosocial stressors in

triggering and maintaining mood episodes underpins such treatment which most often comes in the form of psychoeducation and psychotherapy.

1.1.2.1 Psychoeducation

Psychoeducation can be delivered individually or to groups and targets various aspects of the illness such as adherence to medication (a problem in roughly 60% of acute BD episodes Strakowski et al. (1998), sources of family stress, negative and positive life events, or life events that disrupt circadian rhythms. Colom et al. (2009) conducted a randomised trial comparing psychoeducation with unstructured support in medicated euthymic BD individuals (type I and II). At five year follow-up, relapse rate and time spent in a mood episode were significantly lower in the psychoeducation group. However a recent systematic review of psychosocial treatment studies found evidence only supports the use of psychoeducation for those in the early phase of the disorder (Miziou et al., 2015).

1.1.2.2 Interpersonal and social rhythm therapy (IRST)

IRST is a behaviour-focussed therapy that emphasises regularity of routine and stability in relationships with a focus on the role played by dysregulation of circadian rhythms in BD (Frank et al., 2005). Support for this theory comes from an evidence base showing bidirectional relationship between circadian rhythms and mood instability (Harvey, 2011). ISRT encourages BD individuals to keep regular sleep wake cycles but also acknowledges the importance of stable interpersonal relationships in contributing to mood episode onset by adopting elements from psychoeducation and Interpersonal Psychotherapy, an empirically supported psychotherapy for depression that employs elements of attachment theory and follows the structured approach of cognitive therapy (Cuijpers et al., 2011). Some encouraging evidence in support of ISRT comes from a study which found improved ability to regulate sleep wake cycles predicted longer relapse rates (Frank et al., 2005)

1.1.2.3 Cognitive behavioural therapy (CBT)

CBT is a well-established intervention based on the notion that often fundamental to many mental disorders are irrational and maladaptive patterns of cognition and behaviour that are critically intertwined with emotion. CBT is partly based on Beck's cognitive theory of depression that dysfunctional core beliefs relating to the self, the world and the future lead to and maintain negative emotions which in turn affect behaviour to produce a depressive state (Beck, 1987). The aim of the therapy is therefore to improve symptoms by helping the patient elucidate the relationship between thoughts, feelings and behaviours and challenging the rationality of cognitions by offering alternative interpretations alongside targeting behavioural change in a brief structured, problem focussed therapeutic programme. Hoffman, Asnaani, Vonk, Sawyer and Vonk (2013) revealed a small to medium effect size for the attenuation of both manic and depressive symptoms in a meta-analytic study. The authors of the review point to weaker effects at long term follow-up and caution that there is evidence to support it as an adjunct to psychotropic treatment only. Furthermore, research is required to disentangle the active ingredient in CBT for BD. This is because it involves a combinative approach utilising aspects of both psychoeducational and cognitive-behavioural theory (Hoffman et al., 2013). As will be seen, an important aspect of CBT is the notion that affective dysregulation can be partly understood through identifying biased information processing that serves to maintain mood episodes.

1.1.2.4 Family focussed therapy

Expressed emotion (Brown, 1958), the long recognised negative impact of criticism and hostility in the family environment of severe mental illness sufferers, has spawned a family-focussed therapy designed specifically for BD which aims to improve family relations through communication and problem-solving skills and psychoeducation (Miklowitz, 2008). It is usually conducted with spouses or parents/caregivers. Evidence for its effectiveness is provided by a randomised controlled trial which found relapse rates decline by approximately a third compared to case management (Miklowitz, George, Richards, Simoneau & Suddath, 2003). Barriers to the effectiveness of this type of therapy include willingness of family members to participate and their ability to engage.

1.1.2.5 Interim Summary

BD can be considered a spectrum of closely related, complex illnesses. As a spectrum (under DSM-V), BD occurs in between 1-5 percent of the general population, is often chronically disabling and as a consequence poses significant personal and wider social and economic burden. Pathologic elevation in mood and energy is the defining feature of BD, although a broad range of symptoms are experienced with significant overlap with other mental disorders. Therapeutic interventions, both biological and psychosocial, have been outlined. The latter part of chapter 1 focuses on explanatory psychological models of BD with an emphasis on one particularly promising bio-behavioural theory.

1.2 Aetiological perspectives of bipolar disorder

Because this thesis is focussed on psychological processes relevant to mania development, what follows is first a brief review of biological and environmental risk factors associated with BD before a focus on psychological models. The dominant explanatory theories will be overviewed, culminating in a detailed discussion of the main model of BD which underpins the current research.

1.3 Biological and Environmental Risk factors in BD

A risk factor in the context of BD, as defined by Alloy et al. (2005), needs to meet two criteria. Firstly, it is a variable that precipitates either a mood episode or an escalation in symptoms. Secondly, a risk factor is a variable that does not merely co-occur with symptoms but instead displays independence from symptomatology. Biological and environmental risk factors are parsed in the following sections for clarity but it is acknowledged that it is highly unlikely that any one risk factor acts in isolation to generate the expression of BD.

1.3.1 Biological Risk Factors

1.3.1.1 Genetics

One important characteristic of BD is its high prevalence in the offspring, parents and siblings of those affected; only autism reliably returns higher heritability estimates (Burmeister, McInnis, & Zöllner, 2008). The percent of the variation in the disorder that can be explained by additive genetic factors is estimated to be between 60% and 85% (Burmeister et al., 2008), with 85% the heritability estimate coming from a study of dizygotic and monozygotic twins (McGruffin et al., 2003). Early genetic notions proposing a single causal gene have long since been abandoned in favour of the notion of multiple genes interacting in

complex ways with environmental inputs to cause BD. Thus a focus has been on identifying candidate risk genes.

A recent review of BD genetics, which appraised the many chromosomal areas and candidate risk genes studied, suggested 19 candidate genes have been identified (Craddock & Sklar, 2013). However genetic linkage studies are inconsistent, exemplified by a recent, very large large genome wide association study failing to identify a large effect of any loci of interest. Craddock and Sklar (2013) cite this as evidence favouring the notion that many risk alleles of small effect confer risk to BD. Other research suggests heterogeneous genetic risk with different BD families possessing different risk alleles (Segurado et al., 2003) and the picture is further complicated by substantial overlap in polygenetic contribution for BD and schizophrenia and the burgeoning field of epigenetics. However, variants within the genes labelled CACNA1C, ODZ4, and NCAN have repeatedly and robustly been found in genome wide association BD studies (Kerner, 2014). Kerner (2014) concedes that pathogenesis of BD is poorly understood and calls for investment in molecular genetic research methods to allow integration of genetic data with knowledge of gene regulation, protein expression and epigenetic factors to gain a much better understanding to allow better diagnosis and treatment.

1.3.1.2 Neurobiological

Structural and functional abnormalities of the brain have been consistently found in BD. Increased volume of lateral ventricles, globus pallidus and high rates of deep white matter hyper-intensities have been identified in meta-analyses of structural magnetic resonance imaging (MRI) studies of individuals diagnosed with BD (Kempton, Geddes, Ettinger, & Williams, 2008; Arnone, Cavanagh, Gerber, Lawrie, Ebmeier, & McIntosh, 2009). A functional magnetic resonance imaging (fMRI) review of BD research suggested poor emotion regulation and extreme mood symptoms are characteristic of the illness and are

related to abnormal modulation between limbic and ventral prefrontal brain regions (Strakowski *et al.*, 2012). Strakowski *et al.* (2012) found disruption in white matter connectivity and prefrontal pruning in early development within limbic regions, especially the amygdala, and ventral regions. As such, in mania disruptive limbic networks are thought to impair the modulation of related networks. However, it should be noted that the dynamic complexity of brain function is far from understood and such models of emotional networks in BD need refinement through, for example, longitudinal brain imaging studies (Strakowski *et al.* (2012)

1.3.1.3 *Neurochemical*

Dopamine (DA) is often suggested to be the main neurotransmitter of interest in BD with glutamatergic, gamma-aminobutyric acid (GABAergic), serotonergic and noradrenergic systems all also implicated to a lesser extent (Maletic & Raison, 2014). Historically, psychopharmacological research has uncovered these relationships by extrapolating from response to medications in BD (e.g. ‘switching’ from depression to mania by antidepressant medication) but the fact that antipsychotics, mood stabilisers and antidepressants, which work on various sites of neurotransmission restricts clarity.

DA has been shown to increase in transmission during manic episodes (Salvadore *et al.*, 2010). Evidence from animal models shows depression-like states are associated with reduced DA and this state seems to be reversed by increasing dopaminergic activity (D’Aquila *et al.*, 2003). This has prompted a neurobiological DA hypothesis which implicates DA in both poles of the disorder, however as with neuro-imaging research there is much research to be conducted before a robust evidence base illuminates the precise DA mechanisms at work.

With respect to other neurotransmitters, during mania increased levels of glutamate – the brain’s central excitatory neurotransmitter - in the left dorsolateral prefrontal cortex have

been found to dissipate on remission of symptoms (Michael et al., 2003). Gamma-Aminobutyric-acid (GABA) - the brain's central inhibitory neurotransmitter - has been implicated in BD and schizophrenia by potentially causing early developmental disturbances in cell migration, and lamination of brain structures related to the cerebral cortex (Benes & Berretta, 2001).

Higher norepinephrine levels during manic than during depressed or euthymic periods have been reported (Maletic & Raison, 2014). However, this is complicated by evidence of a similar relationship between norepinephrine and anxiety disorders, suggesting high arousal, common to both psychopathologies may underlie this (Freeman, Freeman, & McElroy, 2002). Most discussion about the role serotonin in BD relates to the controversial role of selective-serotonin-reuptake-inhibitor (SSRI) antidepressants in switching to mania (Ghaemi, 2006; Goldberg et al., 2007; Holmes, Geddes, Colom, & Goodwin, 2008; Truman et al., 2007). Brain imaging data has highlighted the serotonin transporter (5HTT) in the pathophysiology of BD yet overall studies have returned mixed findings (Maletic & Raison, 2014).

1.3.1.4 Summary of Biological Risk Factors

In summary, a wealth of data has been collected over the last few decades from myriad methodologies in an effort to elucidate the biology of BD. The results cover many aspects of BD symptomatology which relate to disturbance in autonomic, neuroendocrine, immune and circadian systems. The symptomatology of BD is argued to better correspond to dysfunction of interconnected brain networks rather than change in the function or structure of particular brain regions (Maletic & Raison, 2014). Such networks are only beginning to be understood. Significant heterogeneity and a classification system that does not map well onto putative biomarkers impedes progress. A provisional unifying theory of BD presented by Maletic and

Raison (2014) and based on the extant biological literature, characterizes it as a set of inheritable neurodevelopmental phenomena with interrelated functional abnormalities that are chronic, deteriorate with time, and produce diverse biological manifestations.

However, biologically-oriented research has thus far failed to illuminate the causal mechanisms with any degree of certainty (Frey et al., 2013). This has paved the way for increased interest in potential environmental and psychological factors, and spurred the treatments discussed above. It is argued that psychosocial treatments are built on relatively unsubstantiated theoretical models and a sparse evidence base (Geddes & Miklowitz, 2013). In particular a theory is required to explain both affective poles of BD. Because processes leading to the onset of depression are relatively well understood, explaining mania has become a research priority for psychopathology researchers. There is a particular need to explain the ascent to mania. This need has been met with an upsurge in BD research that seeks to better understand psychological processes which lead to the genesis of hypomanic and manic symptoms, and their maintenance.

1.3.2 Environmental

Partly in acknowledgement that biological factors are inadequate in explaining the expression of BD, and partly in recognition that side effects compromise pharmacotherapy effectiveness, the question as to how environmental factors interact with genetic predisposition in BD has emerged as an increasingly important one to address. Psychosocial factors related to the emergence, course and severity of the illness has become a focus of research efforts in the previous two decades. Such research - guided by the stress-diathesis model of psychopathology (Zubin & Spring, 1977) - can inform the development of better psychosocial treatments in addition to aiding the general understanding of the illness.

Environmental factors are varied. Those that have received the most attention are life events, early life experiences, and social support.

1.3.2.1 Life events

Individuals diagnosed with BD experience increased stressful life events both prior and subsequent to diagnosis (Johnson & Roberts, 1995; Alloy et al. 2005). Late adolescence seems to be a period of heightened vulnerability to the effects of stressful life events (Goodwin, 2012) and indeed there is evidence this also represents a sensitive time for the development of comorbid substance abuse (Wilens et al., 1999). The extent to which these events are related to an individual's behaviour, as compared to events that are independent (i.e. unpredictable events) has not been differentiated in the research. It is known, however, that positive and negative life events predict manic and depressive symptoms, respectively (Johnson et al., 2000, 2008). Moreover, recent reviews suggest both positive and negative life events trigger hypomania and even mania, whereas only negative events seem to predict depression (Alloy et al., 2005; Johnson, 2005). Empirically valuable prospective studies have found support for a relationship between adverse events and relapse at 6 month and 24 month follow-up (Hammen & Gitlin, 1997; Hammen, Ellicott, & Gitlin, 1992) but greater emphasis has been on investigating how positive life events are tied to the emergence symptoms of both polarities. The latter research will be returned to later, alongside the theoretical position posited to explain it.

1.3.2.2 Early life experiences

Compared to a non-psychiatric sample, individuals with BD reported more stressful events in their childhood. This was found to be particularly evident for events not resulting

from a child's behaviour but rather from a harsh environment (Miklowitz & Chang, 2008). Traumatic/abusive events are self-reported in up to half of individuals diagnosed with BD (Brietzke et al., 2012). When emotional trauma is experienced early in life there is a general increased risk for psychopathology. In BD, childhood abuse is associated with poorer clinical outcomes, particularly physical and sexual types (Leverich et al., 2002). Emotional abuse has been found to predict vulnerability to mania (Reid, 2005). Despite this, relatively less research has examined the impact of adverse early experiences on the bipolar trajectory as compared to other mental disorders. However, it has been reported that abuse in childhood is associated with lifetime substance abuse, rapid-cycling and increased suicidality (Brietzke et al., 2012). The effects of verbal abuse, usually overshadowed by other forms of abuse that appear more severe, have been recently revealed in large retrospective study of adults diagnosed with BD. Similar relations emerged as found with other contact (physical/sexual) forms of abuse; increased substance abuse, rapid cycling and a deteriorating course of illness was associated with verbal abuse in the quartile of individuals sampled who reported a history of verbal abuse alone (Post et al., 2015).

1.3.2.3 Social Support

Social support usually comes in the form of empathic and compassionate friends and relatives. Supportive bonds serve adaptive purposes and have mental and physical health benefits across primates (Brent, Chang, Gariépy, & Platt, 2014). It is thought that social support protects against the impact of stressful life events in BD (Alloy et al., 2005). Poor social support can take the form of the mere absence of friend and relatives, whilst harmful relationships are thought to aggravate symptoms. Expressed Emotion is the term given to measures tapping critical, hostile and over-involved attitudes in family members of psychiatric patients. High quality longitudinal evidence has been accumulating that seeks to

explore both the benefits of support, deleterious consequences of its absence, and the problems associated with Expressed Emotion. For instance, Johnson et al. (2000) and Johnson et al. (2009) found poorer social support to predict delayed recovery and prospective depressive, but not manic symptoms.

The findings from three prospective researches converge to suggest that high Expressed Emotion reliably predicts a poor course in BD (Miklowitz, Goldstein, Nuechterlein, Snyder, & Mintz, 1988; Priebe & Wildgrube, 1989; Rosenfarb et al., 2001). Rosenfarb et al.'s study in particular, sheds light on this relationship. The affective style of communication of individuals with BD was assessed within their families over a nine month period. Notably, the results showed both supportive and critical communication was elevated in those relatives of those who had relapsed relative to those patients who had not. Furthermore, in the group that relapsed there was a positive association between self-reported unusual thoughts and criticism received from relatives.

Overall, the research on early experiences in BD is consistent with a large body of research from across a range of research designs which implicates a causal pathway between childhood adversity and risk for psychosis (Varese et al., 2012). With childhood trauma commonly linked to PTSD, childhood abuse is strongly correlated with borderline personality disorder, and both disorders are thought to share transdiagnostic processes with BD (Holmes et al., 2011; Akiskal, 2004), overall it is clear much research is to be conducted in order to understand under what genetic conditions does a certain type of early adversity set a trajectory that ends in clinical presentation of traumatic, psychotic or affective disturbance in adulthood.

To summarise, the literature on environmental risk factors BD, much like the evidence regarding unipolar depression (e.g Hammen et al. 1991), implicates stressful life events, poor social support, and negative early experience as predictors of mood episodes. Unique to BD however is evidence that negative events can also predict mania (Johnson, 2005). Research implies adverse childhood experiences might shape underlying diatheses for BD whilst good social support may represent a protective factor. A better understanding of the relationships between genetic vulnerability and environmental risk factors and the psychological mechanisms is needed (Alloy et al. 2005).

1.4 Explanatory theories of bipolar disorder

The first explanation for mania described here is also the one of the earliest proposed. The depression avoidance hypothesis is a successor from the psychodynamic heyday put forward at the start of the last century. As paradigms shifted and psychology advanced, the study of emotion, cognition and behaviour, at various levels of analysis, became sources for conceptual development of explanatory model of psychopathology. These are overviewed with an emphasis on pertinent cognitive models, as a common element of these partly guides the research questions of this thesis.

1.4.1 Manic Defence/Depression Avoidance Hypothesis

A modern interpretation of a psychoanalytic theory of mania put forward initially by Abraham (1911) and later by Dooley (1921) and others, argues that mania is the result of

attempts to prevent depressive thoughts entering conscious awareness. This view was propounded by Neale's (1988) depression avoidance theory in which mania is viewed as reactions to life events that destabilise a fragile self-esteem in individuals with BD. It is argued that underlying both poles of bipolar mood states are depressogenic cognitive style whereby grandiose cognitions are purported to be the result of reactions to negative life events. These defensive reactions serve to protect conscious awareness from otherwise depressive schema. The nature of psychodynamic theory makes evidence to support this hypothesis difficult to acquire but researchers have designed tasks aimed at differentiating between explicit and implicit cognitions in attempt to do so, with some degree of success. For example, individuals experiencing mania reported higher self-esteem than unipolar depressed and depressed individuals with BD on explicit measures but implicit measures revealed low self-worth in mania comparable to the depressed groups (Lyon, Startup & Bentall, 1999). Overall the theory has not attracted much interest recently, partly due to difficulties in explaining how such a mechanism might operate and under what circumstances an individual might succeed or fail in avoiding depressive states.

1.4.2 Circadian Rhythms and Social Zeitgebers

Sleep disturbance or disturbance in circadian rhythm has been labelled the “hallmark of manic symptoms” (Wehr, Sack, & Rosenthal, 1987, p.89). Circadian rhythm is partly regulated by social zeitgebers, environmental cues which our body detects, the light/dark cycle being the most prominent of these. As stated Interpersonal and social rhythm therapy (ISRT) is based on the theory that disturbances in zeitgebers (e.g. change of sleep-wake patterns) provokes change in many of the body's system (e.g. altered melatonin, cortisol, body temperature) resulting in a disrupted circadian rhythm, leading to the emergence of BD

symptoms. Broad ranging evidence to support a relationship between BD and circadian rhythm comes from physiological and pharmacological research suggesting circadian disruption, which affects multiple biological systems, has been found to be present even during all phases of the disorder, even euthymic periods (Salvatore et al., 2008). The relationship is thought to be bidirectional; sleep disturbance is thought to initiate manic symptoms and mania is thought to exacerbate sleep problems but a causal relationship is yet to be clearly delineated (Harvey, 2008). However, research has yet to clearly delineate the pathway from circadian disruption to the emergence of manic symptoms.

Researchers have probed psychological processes related to physiological changes in sleep-wake cycles in an effort to reveal how biology and cognition interact to manifest manic symptoms. Harvey et al. (2005) found that BD individuals who indicated poor sleep regulation also felt they had little control over their sleep and reported worrying that this could lead to relapse of mania or depression. Healy and Williams (1989) suggest misinterpretation of the behavioural and physiological effects of circadian disturbance plays a role in the generation of manic symptoms. Similarly, Jones (2001) hypothesizes that appraisals relating to disturbed circadian rhythms are interpreted in such a way that they influence the triggering of manic symptoms more than circadian disruption itself.

1.4.3 Cognitive Models of Bipolar Disorder

The cognitive revolution of the 1950s and 1960 spawned perhaps the important contributor to psychological treatment of mental disorder. Aaron Beck's highly influential cognitive model of depression was part of wider departure away from basic behavioural models, and towards research that sought to understand how we perceive, attend to, classify, store and remember information (Boden, 2006). According to Beck, activation of dysfunctional latent schema

about the self by congruent trigger events leads to depressogenic thoughts, feeling and behaviour (Beck, 1976). Schemata, which can be defined as patterns of thought that organise categories of information and the relationships among them (Georgeon & Ritter, 2012), can vary in many aspects of their structure, including valence (i.e. pleasant or unpleasant). Beck states that schemata in depressed individuals tend towards a negative valence and pervade three areas of thinking, the negative triad: negative thoughts about the self, the world, and the future (Beck, 1976). Furthermore, individuals vulnerable to depression possess two main types of interrelated dysfunctional schema, negative core beliefs and negative automatic thoughts. Negative core beliefs such as “I am worthless” or “I am unlovable”, are deemed rigid, somewhat latent and developed in childhood. Negative automatic thoughts (e.g. “why does this always happen to me?”) are automatic, spontaneous and transient. Beck proposes that negative automatic thoughts, are partly generated by underlying dysfunctional core beliefs, represent biased information processing which impacts emotional and behavioural functioning in a way that resembles depression. A depressive state and the core beliefs that underlie it are maintained by biased information processing which in turn reinforces the negative triad (Beck, 1976).

Cognitive-behaviour techniques based on this theory have proved very effective in relieving a wide range of clinical symptoms (Hofmann, Asnaani, Vonk, Sawyer, & Fang, 2013) by essentially identifying dysfunctional schemata and offering alternative interpretations alongside behavioural strategies. One aspect of Beck’s model, biased information processing, has become the target of modification across mental disorders and a catalyst to the transdiagnostic movement. This is pertinent to the current research which will be returned to later.

According to a recent meta-analysis of BD trials, cognitive-behavioural therapy adjunctive to pharmacotherapy has a small effect on depressive and manic symptoms (Gregory, 2010a,

2010b). CBT is not without criticism. A commonly raised issue for CBT is a lack of consensus on the key mechanism of change. To improve the effectiveness of cognitive-behavioural techniques for BD, theorists have set about developing models to explain how dysfunctional schemata can generate hypo/manic symptoms.

The interacting cognitive subsystems model attempts to refine understanding of mood-dependant cognition by treating the interaction of emotion and cognition with more sophistication. Generated from neuropsychological findings and Baddeley's model of working memory (e.g. Baddeley, 1983), ICST proposes a multi-level landscape of cognitive networks or subsystems which are interconnected and integrated for the processing information cognitively or affectively. The ICS framework has been applied to the understanding of personality disorders, schizophrenia, and depression, and is the theoretical basis of mindfulness-based cognitive therapy for depression, an effective treatment in preventing relapse (see Powers & Dalgleish, 2015; Kuyken et al., 2002). Therapeutic targets suggested by this approach include the control of arousal and nurturing a strong sense of self.

The application of ICS theory to BD was first outlined by Barnard (2001) and refined by Jones (2001). There has been little empirical testing of ICS theory to BD and despite it representing a detailed model of cognition, it has been criticized for not providing a sophisticated model of emotion (Power, 2005). It clearly needs refinement to adequately account for the development of mania.

An alternative multi-level theory of cognition and emotion that proposes four levels of representation is the schematic, propositional, analogical, associative representation systems (SPAARS) approach. The model has been applied to BD with more precision (Jones, 2001) and integrates the known contribution of circadian sensitivity to mania with SPAARS to

provide an explanatory model of mania. The therapeutic implications of this model centres on the manipulation of appraisals and related cognitive biases pertaining to positive events, and in this sense is similar to information-processing models of mood disorders (Leppanen, 2006). Like ICS theory, The application of SPAARS approach to BD has been relatively limited but Banks, Lobban, Fanshawe and Jones (2016) did find individuals diagnosed with BD and those vulnerable to BD to self-report a stronger tendency to form internal appraisals of both positive and negative experiences as compared with non-clinical controls and fibromyalgia patients, in a cross sectional design.

The final cognitive model of BD discussed here is the Integrative Cognitive Model of Mood Swings (Mansell, Morrison, Reid, Lowens, & Tai, 2007). Like the SPAARS model it too has cognitive appraisal as key to the ascent in to mania but where Jones (2001) specifies that mania-relevant internal states are brought about by trigger event, Mansell et al. emphasizes a role for metacognition in the direction internal states, whether manic or depressive. A central tenet of the theory is that individuals with BD generate extreme appraisals of internal states which prompt counterproductive self-regulation strategies that contribute to destabilised mood. Two regulatory strategies that are thought critical to this process are ascent behaviours such as risk-taking which serve to increase activation levels and descent behaviours such as social withdrawal are aimed at decreasing activation levels (Mansell & Lam, 2003).

Mansell's model has parallels with Beck's (1967) model depression in their shared assumption that individuals possess a set of beliefs that influences how current events are appraised. With the exception of the early manic defence hypotheses the theoretical offerings that comprise this section have schemata at their core yet differ in their conceptualisation of how schema contribute to mania.

1.4.3.1 Summary

This chapter introduced this chapter introduced Bipolar Disorder and psychological explanations for mania and other models purported to feature across psychopathology. A general shortcoming of these cognitive models is that they do not account for the more biological aspects of BD. In particular dysfunction of the reward system in BD, which is now widely accepted (Depue & Iacono, 1989; Urosevic Johnson, Edge, Holmes, & Carver, 2012), is not directly addressed.

A key theme common to cognitive theories is the role of information-processing biases. Beck's (1967) cognitive theory first outlined the importance of understanding how information is processed in emotional disorders and how this has consequences for onset of, and maintenance and recovery from mood episodes. Consequently information-processing biases in mood disorders have become a major area of research, spanning the study of biases in attention, reason and memory. However this research has overwhelmingly focussed on disorders characterised by negative affectivity. The current thesis extends this work by examining positive information processing bias in relation to hypomanic personality and approach motivation. Research seeking to elucidate information-processing biases in BD will be explored later. Attention now turns the dominant theory of BD which underpins this thesis.

2 Chapter 2: The Behavioural Approach System (BAS) Theory and its relationship to Bipolar Disorder

A vulnerability-stress theory of BD which has attracted considerable attention in recent years is the Behavioural Approach System⁴ (BAS) dysregulation theory (Depue & Iacono, 1989). Driven by the animal learning work of Gray (1976, 1981, 1994) discussed below, the theory posits that underlying the extreme highs and lows of mood and energy that characterize BD is a dysfunctional motivational system with a locatable biological substrate (Fowles, 1980; Depue & Iacono, 1989). Before this is introduced, it is necessary to inspect basic aspects of the overarching theory and highlight important features of the BAS, before overviewing how this hypothetical system has influenced the study of personality, emotion, and psychopathology, and crucially, how they intersect.

Gray, who thought the mammalian brain was concerned with novelty and error (Gray, 2004), built on the work of others that asserted a biological dichotomy of motivational direction - to avoid or approach - which exists across species (e.g. Lewin, 1935; Schneirla, 1959; Mowrer, 1960). Based on extensive animal research over decades Gray refined a sophisticated model positing three main bio-behavioural systems that mediate response to reward and punishment and which produce separable emotional states. According to Gray (1991) the Behavioural Approach System (BAS) regulates and generates motivation to

⁴ Other researchers have used different terms for essentially the same bio-behavioural system with the same hypothesized primary function – to facilitate reward (behavioural activation, behavioural engagement and behavioural facilitation (Fowles, 1980; Cloninger, 1987).

approach reward. It is thought to govern the mobilization of behaviour necessary for the anticipation and consumption of reward but also actively avoiding punishment. The Flight-or-Flight-or-Freeze System (FFFS) is primarily concerned with threat and panic. The Behavioural Inhibition System (BIS) induces anxiety and, in a revision to the theory is said to govern risk assessment (through a conflict comparator system - see figure 1), and inhibit response when competing signals are detected by the BAS and FFFS⁵ (Gray & McNaughton, 2000). More recently the role of the BIS been extended to include a non-affective behavioural constraint. Figure 1 shows a current schematic interpretation of how information might be processed through pathways linking Gray's motivational and comparator systems (Corr, 2013). Corr's contribution to this field of enquiry is expanded upon later.

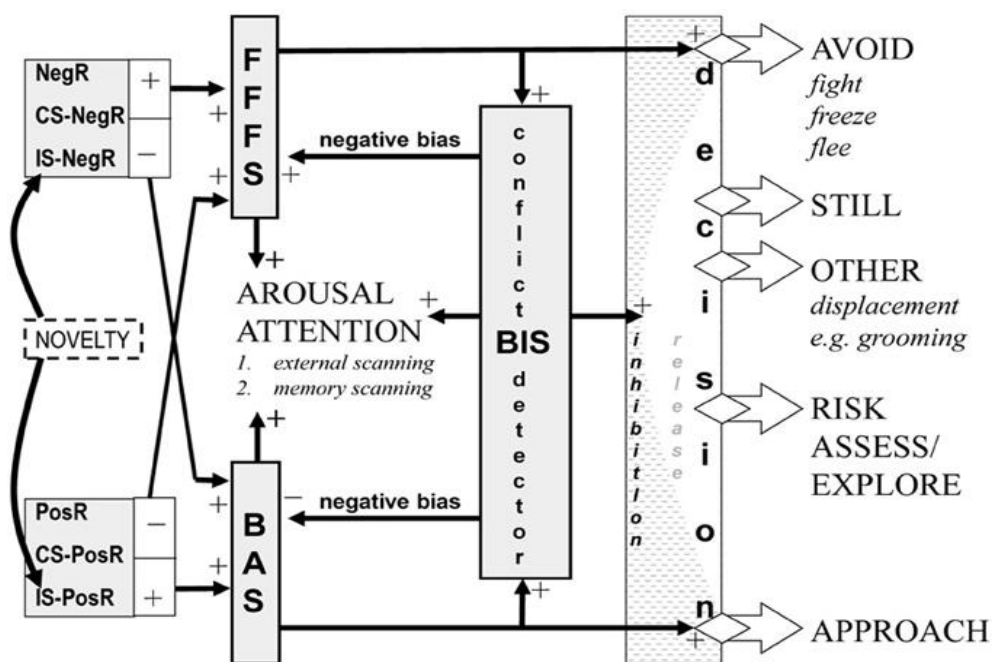

Figure 1 Gray's reinforcement sensitivity model (extracted from McNaughton & Corr, 2014)

⁵ For example, assessing if the stimuli is rewarding or threatening, or how appetitive versus how aversive it is. It should be acknowledged that firm conclusions about the neurobiological basis of the conflict comparator aspect of the BIS have yet to be drawn (McNaughton & Corr, 2014). According to current consensus the primary role of the BIS is to regulate avoidance responses to punishment, novelty, uncertainty, and non-rewarding stimuli (Gray & McNaughton, 2000). The FFFS mediates reactions of rage and panic from unconditioned stimuli (Gray, 1991). The BAS is responsive to reward cues that are both conditioned and unconditioned (Gray, 1991).

2.1.1 The BAS

Attention will now focus on the BAS and its intricate relationship with reward, the ways this has been studied, and in particular how it has been studied in humans⁶.

In broad neurobiological terms, the cerebral cortex, thalamus, and particularly the striatum, that comprise the cortico-basal ganglia-thalamo-cortical loop, are the prominent brain structures associated with the reward system (Yager, Garcia, Wunsch, & Ferguson, 2015). It is suggested that when incentive stimuli are detected the BAS engages these systems to generate positive affect, feelings of approach such as enthusiasm, and approach behaviour that facilitate reward.

The level of dopaminergic transmission into a particular substructure of the ventral part of the striatum, the nucleus accumbens shell, is highly correlated with the saliency of BAS relevant stimuli (Berridge, 2012). This is one recent research finding that is consistent with the notion of dopamine as a biomarker of the BAS (Depue & Iacono, 1989; Depue, 1995). However, the picture is complicated by the apparent ubiquitous function of dopamine (see - Bressan & Crippa, 2005).

Recent research has illustrated a specialised role for dopamine in the BAS. Gray (1991) hypothesized the BAS to be sensitive to consumption of reward *and* the preceding activation of reward facilitating processes subsequent to detection appetitive stimuli⁷. As such, dopamine would be expected to be involved in both processes if it represents a valid

⁶ The study of reward in rodents can be applied to the study of reward in humans on account of the fact that the reward system produces similar changes, and so is prominent, in both mammalian brains (Berridge and Kringelbach, 2008).

⁷ The BAS can also be activated by aversive stimuli (e.g Carver & Harmon-Jones) this will be returned in the discussion of subjective experience of BAS output.

global BAS biomarker. However, neuroscience has recently cast doubt on this assertion. Strong evidence showing that dopamine is not causally related to the pleasure-related component of reward led the pre-eminent researcher on the topic to reflect that the “most popular brain neurotransmitter candidate for pleasure two decades ago, turns out not to cause pleasure or 'liking' at all. Rather dopamine more selectively mediates a motivational process” (Berridge & Kringelbach, 2013 p. 303).

Whilst the distinction between ‘wanting’ and ‘liking’ has been informative in psychopathological research (e.g. informing study of the molecular basis of addiction) it represents only one line of division when thinking about deconstructing reward processes. Essential regulatory mechanisms of reward, when looked at temporally, start with the availability of reward, the valuation of the reward, approach behaviour (wanting), followed by a hedonic response (liking), subsequent to learning which alters future response to stimuli associated with the reward (Berridge & Kringelbach, 2013). In this context, the BAS is viewed as a ‘broadband’ system with specialised components for each of these processes that correspond to affect, cognition, arousal, locomotor activity and incentive reward activation (Johnson, Edge, Holmes & Carver, 2012). Others (e.g. Carl, Soskin, Kerns & Barlow, 2013) suggest that reward processing can be understood within general emotion regulation mechanisms proposed by Gross (1998).

Of course, the characteristics of any chain of events that stem from BAS activation always depend on context and environment. Nonetheless, consideration of how the BAS processes reward and where emotional and motivational distinctions can be made is illuminative for both trait and state features, including normal and abnormal expression. Indeed, the psychometric characterisation of how the BAS is subjectively experienced in the moment is a focal point for this thesis, as is the proposed dysfunction of this system in individuals diagnosed with BD.

A vast body of research spanning across various domains of study has supported the idea of the BIS and BAS as biologically based systems that dictate mammalian learning, behaviour, motivation and emotion. Accordingly, a lot of research has been devoted to understanding the two main motivational systems, the BIS and the BAS. In particular, how they manifest normal and abnormal aspects of human experience has been a major area of interest. Prior to elaborating on these, some caveats will be addressed.

Translating Gray's work, mostly conducted on rodents, to human functioning presents numerous challenges. For example, in animal paradigms the motivational properties of stimuli that motivate behaviour are signalled by clear and present saliencies (e.g. presentation of a food pellet subsequent to lever press). In humans, stimuli that motivate approach (or BAS input) can be both internally and externally generated, in myriad ways. It can be represented by schema that is tangible or abstract, temporally diverse and contaminated by both motivational directions in complex ways (e.g. a past bet loss would predict less anticipation of future reward). The behavioural response (of the stimulus-response contingency) in animal paradigms upon which theory was developed was primarily inferred from measurable behaviour subsequent to stimulus presentation. Whereas response in human psychology is understood within a cascade of behavioural, cognitive, physiological and emotional inputs⁸, processes and outputs. This complicates the translation to humans. With this in mind the literature concerning the application of Gray's findings to BAS functioning in humans are reviewed in terms of stable patterns of behaviour (traits), everyday outputs (states), and psychopathology with a strong emphasis on the BAS on account of its purported role in BD.

⁸ A note on how the encoding of BAS-relevant stimuli is differentiated, paraphrased from (Schultz, 2015). Stimuli that are naturally pleasurable, are thus attractive, and are known as intrinsic rewards, whereas stimuli that are attractive and motivate approach behaviour, but are not inherently pleasurable, are termed extrinsic rewards. Extrinsic rewards (e.g., money) are rewarding as a result of a learned association with an intrinsic reward. That is, extrinsic rewards function as motivational magnets that elicit "wanting", but not "liking" reactions once they have been acquired.

2.1.2 BIS and BAS measured as Personality Traits

In Gray's Reinforcement Sensitivity Theory (RST) of personality he hypothesises the BIS and BAS to be reflected by individual differences in sensitivity to positive and negative reinforcement (Gray, 1970, 1982, 1991). In RST the BIS is represented as a dimension of dispositional anxiety linked with avoidance and punishment, whilst the BAS is reflected in individual variation in the propensity to pursue goals and achieve success and is linked with sensitivity to reward and reflected in impulsivity. Whilst the relation between BIS and anxiety is comparatively well understood, the BAS is less well understood. Other theorists have taken up the challenge of translating BIS-BAS theory developed from animal models to the understanding of stable human characteristics.

Most theorists conceive of the BAS as a multi-component structure (Panksepp, 1998; Corr & Cooper 2016; Berridge & Robinson; 1998). Depue and Collins (1999) argued that the dominant behavioural output of the BAS represented extraversion rather than impulsivity and that this explained the lack of empirical support for Gray's proposed personality dimensions. Impulsivity⁹, according to Depue and Collins (1999), is a lower-order component of extraversion alongside sociability. Others have argued that novelty-seeking is central to BAS functioning (Cloninger, 1993). Corr (2001) took an interactive approach to explaining the how the BAS relates to variation in human behaviour by suggesting that both the BIS and BAS are interdependent, with both systems mediating both reward and punishment. For example according to Corr (2001) BAS behaviour (or output) is facilitated by impulsivity (BAS) yet antagonised by anxiety (BIS). This relationship is mirrored for BIS behaviour – withdrawal is facilitated by anxiety but antagonised by impulsivity. As such, any given

⁹ Gray (1987) interpreted impulsivity as a trait level manifestation of the BAS, which mediates reward sensitivity, and consequently impulsivity and reward have often been treated as interchangeable with many authors reporting self-report correlations between them (e.g. Miller, Joseph & Tudway, 2004; Quilty & Oakman, 2004; Smillie & Jackson, 2006). Yet others have provided evidence supporting a distinction between them (e.g. Franken & Muris, 2006), and argue they should not be treated as interchangeable (Corr, 2008).

individual's pattern of behaviour is dependent on two things: the motivational properties of current stimuli (how appetitive relative to aversive it is) and the individual's genetically determined propensity to be anxious (trait BIS level) and impulsive (trait BAS level).

Despite the lack of consensus regarding exactly how the BAS manifests in human behaviour reliably over time, two constructs – extraversion and impulsivity – have been consistently implicated in theory.

Under Trait theory, habitual patterns of behavioural, cognitive, and emotional output that resemble enthusiasm, sociability, gregariousness and energetic behaviour have generally been referred to as extraversion and have been understood using both biologically-driven and lexically-driven hypotheses (Eysenck, 1951; Norman, 1963). However Eysenck also had a lower-order conceptual space for impulsivity whereby reward sensitivity was hypothesized to underpin elevated impulsivity seen in neurotic extraverts. For Gray (1991), impulsivity was the core feature of the BAS and correspondingly punishment sensitivity reflected the BIS. This was similar to Eysenck's idea of two higher order components, neuroticism and extraversion. The relationship between Eysenck's two-factor theory of personality and Gray's two dimensions from which RST stemmed are present in figure 2.

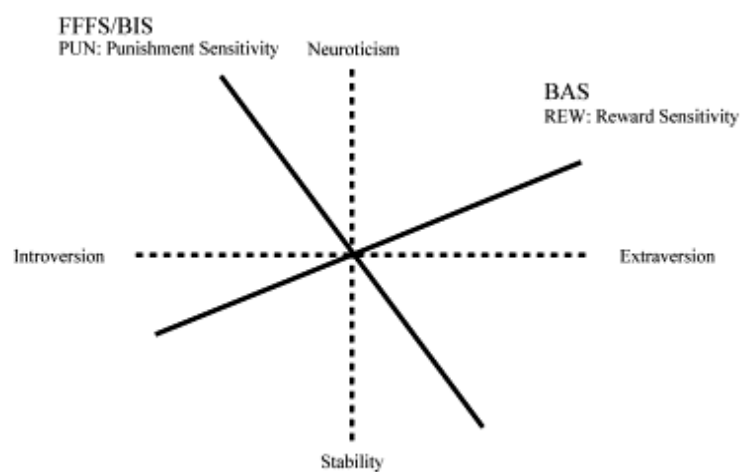

Figure 2 Gray and Eysenck's model of personality

Figure 2 depicts the factor space of Eysenck's Extraversion-Neuroticism dimensions in broken lines and Gray's punishment sensitivity (PUN) and reward sensitivity (REW) in unbroken lines (extracted from Corr, 2004). Gray argued that Eysenck's dimensions needed to be rotated 30 degrees to more closely map the more fundamental reinforcement systems that underlie personality. Note that in Gray's final theoretical revision (Gray & McNaughton, 2000) BIS and FFFS are both subsumed under general punishment sensitivity that reflects fear and anxiety, a proposition that has been hard to empirically support in personality research (Matthews & Gilliland, 1999).

Another key aspect of Gray's theory of personality was an intricate relationship between an individual's sensitivity to the receipt of rewards and their propensity to be motivated to approach reward (and likewise for punishment sensitivity and avoidance motivation) (Gray, 1991). Individuals who characteristically respond to reward with greater responses were referred to as having a higher BAS sensitivity. That is, the intensity to which individuals differ in BAS output to BAS inputs (congruent stimuli) is their BAS sensitivity level¹⁰. BAS outputs refers to the multifaceted outputs which have been variously described as centrally relating to extraversion, impulsivity, novelty-seeking but also include arousal, motor activity, confidence, positive affect and anger (Depue & Collins, 1999; Carver, 2004).

Carver and White (1994) provided the first well validated reliable psychometric tool to operationalise BAS sensitivity. Their self-report measure of BAS sensitivity was derived from three empirically and conceptually distinct factor structures. Carver and White (1994) generated statements of subjective experience and overt behaviour that were thought to map on to BAS output. They are as follows: BAS drive – motivation to pursue goals, BAS reward responsiveness - tendency to react to reward with enthusiasm and energy, and BAS fun-seeking – tendency to chase positive experiences irrespective of possible threats or costs (Carver & White, 1994). Carver and White also developed a corresponding scale of BIS sensitivity, together they are known the BIS/BAS. As a trait measure, the BAS scale has

¹⁰ A note on BAS terminology as defined by Johnson *et al* (2012). BAS inputs refer to (or Bas-relevant) stimuli that are cues for goal-directed behaviour. BAS (outputs or functioning) activity, arousal, elation, confidence refers to the dimension by which individuals vary in their intensity of BAS out for any given BAS input.

demonstrated excellent reliability and a wealth of evidence have supported its validity in relation to its sensitivity to conceptual components of BAS functioning (Brown, 2007).

For example, high BAS scorers compared to low scorers, displayed greater high-arousal positive affect during a goal-striving paradigm (Heponiemi, Keltikangas-Järvinen, Puttonen, & Ravaja, 2003). The BAS scale is also a predictor of greater reactivity upon receipt of reward, as measured by self-reported positive affect (De Pascalis, Varriale, & D'Antuono, 2010) confidence (Meyer, Barton, Baur, & Jordan, 2010) and neural activity (Beaver et al., 2006). That the BAS scale is sensitive of both the anticipation and receipt of reward, reflects Gray (1991) prediction.

The BAS scale has also been found to predict risky behaviour in adolescence, a period marked by heightened reward-related brain activity (Galván, 2013). As would be expected, the fun-seeking subscale, which aligns to impulsive behaviour, showed strong positive associations with many risky health behaviours pertaining to sex, alcohol and drug-use. Furthermore, a recent review of reward sensitivity across various research methods concluded that trait BAS sensitivity impacts “a range of cognitive-emotive processes, influencing how individuals attend to, process, remember, learn, and react to emotional events” (Harmon-Jones et al., 2013, p.341). This emphasizes the BAS scale's breadth of influence.

Carver and White's (1994) BIS/BAS scales were developed before Gray's final theoretical contribution to the field. This has had implications for the operationalisation of the BAS, despite the BAS receiving the least revision by Gray and McNaughton (Corr & Cooper, 2012). In the revision to RST, environmental cues with properties that make them salient to both the BAS and FFFS (analogous to a risky decision in human experience for example) make BAS and FFFS behaviour pre-potent (i.e. getting ready to approach or retreat) but are inhibited by the BIS, which determines response via a conflict comparator system. These more complex interactions between the BIS, BAS and FFFS inferred from Gray's revision

has significant ramifications for theory and measurement of the BAS, one interpretation of this for RST is represented schematically in figure 3 below (Corr, 2004).

The proposed inhibition of BAS activity by the BIS has led other theorists to argue that the BIS scale should comprise of BAS subscales pertaining to reward reactivity and rash impulsiveness (Smillie, Jackson, & Dalgleish, 2006). The absence of the conflict system in the BIS/BAS scales has been another criticism (Dawe, Gullo, & Loxton, 2004), whilst other researchers, in response to RST revision, have developed a subscale aimed at detecting reinforcement sensitivity that includes dual activation of the BIS and BAS labelled frustrative non-reward (Wright, Lam, Brown, 2005).

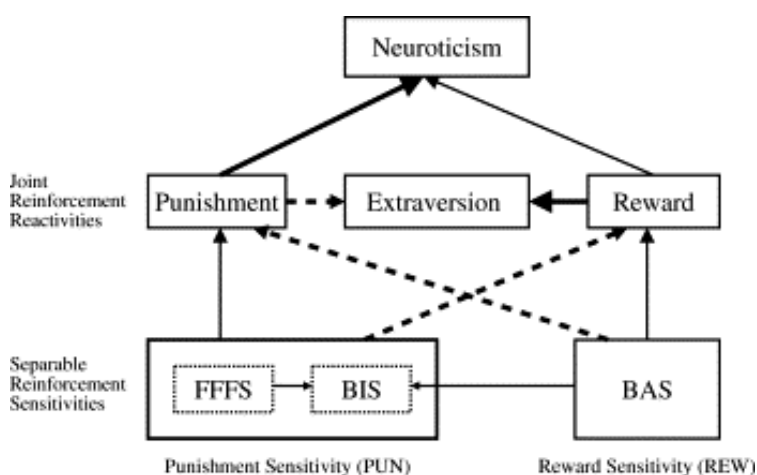

Figure 3. Corr's Joint Subsystem interpretation of the revised RST (from Corr, 2004)

These criticisms, alongside the need to develop a trait measure that more closely resembles Gray's revised RST, prompted a recent exploratory factor analysis, populated by approach and defensive scenarios modelled from rodent etho-experimental situations, rather than researcher generated items (BIS/BAS scales) (Corr & Cooper, 2016). The results revealed a latent structure of behaviour corresponding to BIS, BAS and FFFS that comprised 6 robust factors and which was supported by confirmatory factor analysis (Corr & Cooper,

2016). Two factors were loaded with distinctive defensive items pertaining to anxiety (BIS) and fear (FFFS) and the remaining four were deemed representative of BAS components. These were labelled reward interest, goal-drive persistence, reward reactivity, and impulsivity. The study suggests a slightly different structure to stable approach behaviour with four rather than three underlying factors to BAS presented by Carver and White (1994). Corr and Cooper (2016) claim the findings support their hypotheses that any operationalisation of stable approach output needs to include temporal influences on the stimulus-reward process that is: planning (reward interest), temporal bridging (goal-drive persistence), non-planning (impulsivity) and pleasure (reward reactivity). Corr and Cooper's (2016) research attempts to characterise BAS output more systematically by parsing the process in to distinct functional components. Reliability and validity research alongside expected correlations with biopsychological proxies of BAS output will be necessary in any effort to supersede the BAS scale as the gold standard measure of trait BAS sensitivity.

Despite some unresolved theoretical issues which ensued from Gray and McNaughton's (2001) revision to RST, and the ramifications they have for the subjective measurement of approach behaviour, the bulk of evidence supports the existence of an approach system with "subgoal scaffolding" and distinct mechanisms designed to facilitate reward learning, which can be captured by three factor-analytically derived traits (Corr, 2008, p.4). Whether there are three or four latent factors to trait BAS sensitivity is a matter to be judged by future research. It is noteworthy that 66% of Carver and White's, and 75% of Corr and Cooper's BAS factor space correspond to 'wanting' rather than 'liking'. This convergence, from diverse methods (theory generated items versus animal paradigm generated items), suggests a primacy for goal-pursuit descriptors (e.g. drive, enthusiastic) over goal-attainment-related descriptors (joyful, pride) best explains the latent structure of stable BAS activity.

The breadth of research that has attempted to understand the influence of individual differences in trait BAS activity has not been paralleled by attempts at describing the landscape of BAS outputs in the here and now. The research described suggests that BAS at the trait level might closely map onto state outputs of the BAS in a measurable way (e.g. trait BAS predicts high arousal positive affect after reward) (Heponiemi et al., 2003). However, there is no corresponding gold standard self-report measure of state BAS output that can be said to be both sensitive and specific. The current thesis seeks to address this gap in the literature in order to facilitate the study of BAS dysregulation in psychological disorders.

2.1.3 The BIS and BAS, and Psychopathology

Etiological processes that give rise to psychopathology have been implicated in RST since its inception (Pickering & Gray, 1999). The theory predicts the sensitivity to BIS and BAS to be associated with individual differences in two corresponding dimensions of affect, positive and negative affect, and by extension are related to clinical disorders where mood is affected. What follows is clinical evidence (excluding BD) from a range of methodologies that have predominantly employed Carver and White's BIS/BAS scales (or similar proxy measures), they vary in research quality, are mostly correlational and therefore do not permit causal conclusions but together illustrate the importance of RST in clinical research nonetheless.

To summarise the findings, high BIS sensitivity has been found to be related to generalised anxiety disorder and obsessive –compulsive disorder (Zingar & Yoon, 2008), low BIS levels to have been linked to psychopathy (Fowles, 1980). ADHD, a disorder of executive function dysregulation, has been characterised by an overactive BIS and BAS

(Barkley, 1997; Quay, 1988a, 1988b). The FFFS has been related to panic and phobic disorders (McNaughton & Corr, 2008). Extremely high BAS sensitivity is characteristic of individuals with BD (elaborated upon later), ADHD, and bulimia, while extremely low BAS often characterizes individuals with anhedonic depression. It has been suggested that BIS and BAS may differentiate, between sub-types of both eating disorder and depression (Bijttebier, Beck, Claes, & Vandereycken, 2009).

Schizophrenia is a disorder that has also been linked to reward dysfunction. For example individuals with negative symptoms are under-responsive to situations involving potential rewards (Herbener and Harrow, 2004). In addition, the inability to savour positive events and negative schizotypy were positively associated in a large community sample (Appelgate, El-Deredy, & Bentall, 2009), suggesting reward dysfunction to be a risk factor.

BAS dysfunction has also been suggested as a causal mechanism behind addiction, where behaviour (drug-seeking) is persistent even when the reward is devalued (lack of satiety) (Franken et al. 2006). Unipolar depression has been linked to low BAS engagement (Henriques, Glowacki, & Davidson, 1994; Depue & Iacono, 1989; Henriques & Davidson, 2000). Furthermore, low BAS predicted slower recovery within unipolar depression (Kasch, Rottenberg, Arnow, & Gotlib, in press).

Diagnostically and etiologically these latter disorders can be linked to BD and BAS-related processes. To add further weight to the notion of the BAS as a system that can manifest as dysregulation in positive affect and reward, the emergence of a new paradigm for researching psychopathology along dimensions of observable behaviour and neurobiological measures identifies a positive valence system which might unite diverse diagnostic labels through similarities in BAS dysfunction (Insel et al. 2010).

2.1.4 BAS and Bipolar Disorder

When the BAS is considered as a system responsible for the regulation of positive affect, arousal and confidence (Gray, 1991), alongside a description of manic symptoms which includes elated mood, hyperactivity, and grandiosity, it becomes clear why Depue & Iacono (1989) hypothesized a relationship between the BAS and BD. They proposed that when BAS outputs are extremely excessive, this resembles mania: “hypomania represents an elevated, at times excessive state of engagement in rewarding experiences” (pg. 473).

Over the last 20 years this theory has garnered broad empirical support from a number of methodologies. Before assessing studies that have directly examined hypotheses stemming from Depue and Iacono’s (1989) theory, the similarities between clinical observations of mania and the BAS will be explored in terms of the three primary diagnostic domains of the DSM-5 – 1. elevated energy and overactivity, 2. elated, euphoric mood, and 3. irritable mood. Studies that have attempted to identify the structure of the presentation of mania are then evaluated with a view to shedding light on the dimensionality of mania in terms of BAS output.

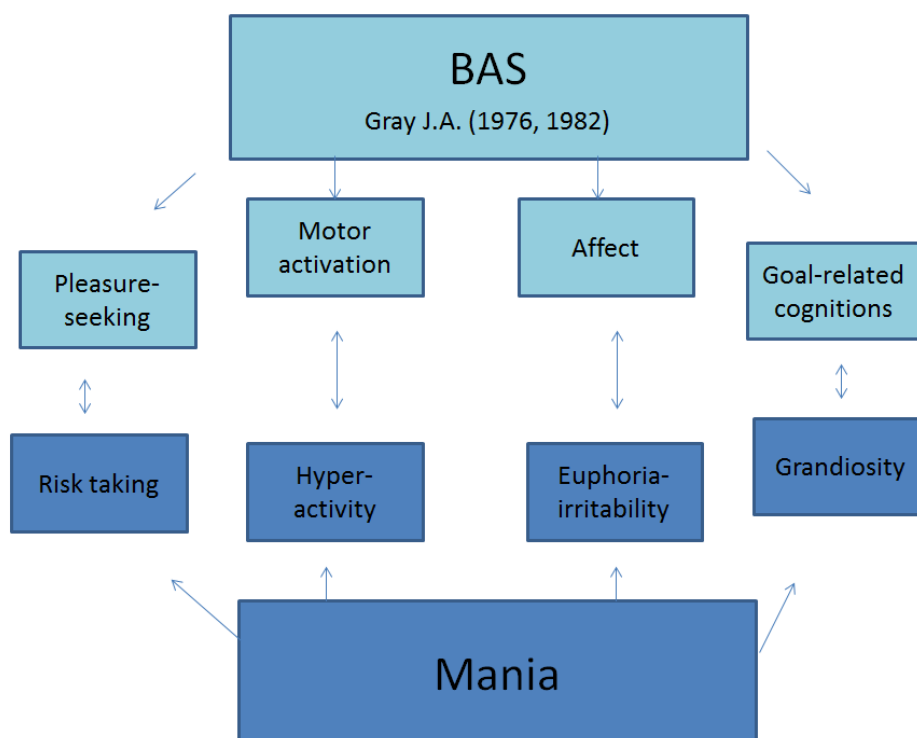

Figure 4. BAS dysregulation theory of bipolar spectrum disorders (Depue & Iacono, 1989)

2.1.4.1 Over-activity/Energy

Depue and Iacono (1989) argued that motor activation (initiation of locomotor activity) is central to mania, a claim which echoes Kraepelin's assertion that "increased busyness" was the most striking feature of mania (Kraepelin, 1921). An early study which evidenced heightened motor activity in mania supports this idea. Wehr and Wierz-Justice (1982) reported motor activity to be highly positively associated with mania symptoms, when measured over several days using actigraphy. These researchers also found motor activity to predict shifts in observed manic symptoms, when hourly actigraphy and hourly clinical observations were examined, thus suggesting a prodromal role for energy and activation, both aspects of the BAS. Indeed, as previously cited, over half of a sample of individuals with BD type 1 reported increased goal-directed activity as preceding their mania (Lam & Wong, 1997). Akiskal and Benazzi (2005) argued for increased behavioural activation as a better diagnostic marker than change in mood, and as also mentioned earlier the most recent

revision to the DSM added increased energy or activity added as a primary diagnostic criterion alongside elevated, expansive, or irritable mood (APA, 2013).

2.1.4.2 *Elated/euphoric mood*

Regarding extreme mood as a primary diagnostic criterion, this has been linked to the BAS outputs that include positive and negative emotions (Depue & Iacono, 1989). In RST theory, positive emotions broadly function to indicate opportunities for, or attainment of, reward (Gray, 1987), and can be defined as “positively-valenced affective states that involve coordinated subjective, physiological, and behaviour changes and motivate goal directed behaviour” (Du Pont et al. 2016, p. 3). Euphoric mood has also has long history in the description of BD - e.g. Robertson’s (1890) description of hilarious mania – and is perhaps the most salient aspect of the general public’s conception of BD. Prospective research has found elevated levels of positive emotion to predict a more severe illness course and greater relapse rates in BD (Johnson, 2005). Positive emotion disturbance has been argued to cross three domains relating to the degree, the context, and specificity of positive emotion disturbance in BD (Gruber, 2011). Thus it is a clear that abnormal levels of positive affect, a key output of the BAS, are a central characteristic of BD.

2.1.4.3 *Irritable mood*

Irritable in BD can be conceptualised as a form of negative affect high in activation. It is closely related to anger (Pasquini et al. 2004), a less obvious component of BAS activation, which has been linked to BD when operationalized as physical fighting and violent offending in epidemiological studies (Corrigan & Watson, 2005; Casiano et al. 2008). In terms of its emotive outputs, BAS theory has predominantly specified a role for positive rather than negative affect. However, there a growing evidence that anger can be viewed as BAS response to reward obstruction (Carver, 2004; Harmon-Jones, 2009).

2.1.5 The Structure of Mania in relation to the BAS

The current core diagnostic criterion for a diagnosis of mania (elevated activity and irritable or euphoric mood) parallels hypothesized outputs of the BAS when activated. Because the BAS can be tied to many lower-order BD symptoms, but also to other disorders (e.g. impulsivity and ADHD, Singh, et al. 2008), it is important to characterise the most and least prominent features of mania, and how distinct or related they are in order to get a picture of which might be most relevant the BAS.

To profile the landscape of mania, Scott et al. (2017) pooled the results from 23 factor analytic studies which have attempted to reveal the underlying structures of the symptomatology of mania. They distinguished between mania and mixed state mania in the presence of mixed symptoms (the former is focus of interest here) in their analysis.

Results showed there was a median of 5 factors (median variance 52%) estimated across the 13 studies that included pure mania. As illustrated in figure 5, activation (which corresponds to energy and activity) was the factor that explained the most mania variance: 5 of 13 studies had activation as the primary factor. In contrast, elated mood did not feature uniquely as the first factor at all, but was a second factor in one study and combined with activation and elation was the first factor in two studies. Psychoticism – a feature of mania that is difficult to incorporate within the BAS model of BD - as a factor, explained the second highest amount of variance.¹¹

¹¹ Manic Defence theory devotees will be interested to see depression and dysphoria also feature heavily in latent analyses both in pure mania (distinguished from mania with mixed features - which predictably had a predominately depressive latent structure).

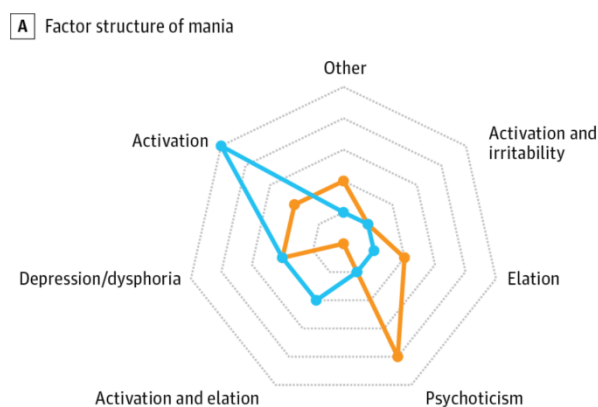

Figure 5. factor structure of mania

Note. Spider Diagram of the Factor Structure of Mania Primary and secondary dimensions are reported in 13 studies of mania and 7 studies of mixed states and mania. The unit of measurement in the spider diagram is the number of studies. Extracted from Scott et al (2017).

The main implication of Scott et al.'s study for BAS theory is that in mania, activation is the most dominant factor, and it is separable from positive mood and activation, and therefore might represent distinct two distinct BAS components. However there are a number of limitations to this study. Importantly, activation was defined broadly by Scott et al. with terms ranging from *novelty-seeking* to *approach motivation* used as descriptors. Activation was understood as “emerging from physiological change and having related subjective energy levels” (Scott et al. p.191). Scott et al. also cannot inform on relationships between factors (rotations employed by the studies were not indicated), nor does it distinguish between contemporaneous and retrospective mania (temporal proximity to manic episode [or current mood] might influence how is it described). Perhaps most problematic was the lack of standardised measures; a wide range of both self-report and clinical interview methods were used across the 23 studies. Confirmatory analyses, which help to clarify factor solutions, were omitted.

Interestingly, one of only two studies that produced a first factor that integrated positive mood and activation was also one of the most methodologically robust. Unlike most other factor analyses of mania, Ruggero et al. (2014) utilised an interview method which

entailed expanded DSM-5 mania symptom content but was designed to be compatible with dimension reduction methods. Furthermore, Ruggero and colleagues (2014) also utilised two adequate samples; one consisting of mania patients ($n = 422$), the other 306 undergraduates awaiting psychiatric assessment. Exploratory factor analysis was conducted on the student sample. The resultant model was then tested with confirmatory factor analysis in the BD sample. Euphoric activation (e.g. unusually happy, more energy) explained the most variance, followed by hyperactive cognition (e.g racing thoughts), reckless overconfidence and irritability. In confirmatory analyses, Ruggero et al. (2014) attempted to fit their data to a one factor, two-factor, and five-factor solutions informed by previous literature and the DSM. Their initial four factor model sampled from non-BD was the best fit. Notably, it was a better fit than the five factor model which parsed activation and elated mood as distinct factors (these correlated at .92 which suggested very high overlap). Ruggero et al.'s findings are relevant for two reasons: Firstly it throws caution on Scott et al.'s assertion that positive mood and activation can be understood in separable terms. Indeed a recent experience sampling study showed self-reported energy and mood ratings to correlate over time in both individuals diagnosed with BD and healthy control (Johnson, Gershon, & Starov, 2015).

Secondly, and also pertinent to the current investigations which seek to understand mania-related processes in a student population, the stability of Ruggero et al.'s factor solution from a non-BD undergraduate to a sample individuals diagnosed with BD suggests, a degree of continuity between the experience of mania in BD and mania-like experience in the general population (although this sample were seeking psychiatric assessment). Taken together, this analysis supports the idea that elation and activation, prominent in mania and hypomania, may form a core single construct, and may be observable in this structure in general population.

Identifying the dimensionality of mania is informative for understanding the aetiology of BD. Pathophysiological studies which have treated mania as unidimensional have been inconsistent (Scott et al. 2017). Ruggero et al.'s findings mirror the recent DSM revision to the diagnosis of mania which necessitates the existence of one of two cardinal symptoms: extreme activity or mood (APA, 2013). Despite some debate as to whether activation alone, or activation combined with elevated positive affect dominate the experience of mania, both are key BAS components.

Finally, it should be noted that comparing factor structures of trait BAS sensitivity described above, with the factor structure of manic symptoms is limited. Both are multi-dimensional but both have also not achieved consensus on their respective number of components. The studies also utilise various measurements and methodologies. Essentially they tap different aspects of the BAS: a tendency towards BAS activation, the appearance of an extreme BAS state (mania). Nevertheless, it is useful to compare structures across clinical and general population samples, both in present subjective experience and as stable tendencies in over time. Recent advancements in the treatment have been presented as a result of parsing underlying dimensions (Treadway & Zald, 2011).

2.1.5.1 Interim summary

This section has introduced the state of mania as one resembling two prominent components of the BAS, activation and affect, with other symptoms of mania showing phenomenological correspondence to BAS outputs. Some studies of the components of mania indicate that positive mood is strongly related to activation (within the factor euphoric activation), which is also indicated by the requirement for both mood and activation symptoms to be present for a diagnosis of mania in the recently revised DSM diagnostic criteria. This reflects claims that activation and euphoria are the hallmark of mania (Ruggero

et al.; Angst et al., 2003; Benazzi, 2007). In this section it has been suggested that euphoric activation is likely prominent in less extreme BAS states (hypomania) and that, as a factor, it is duplicable in a non-BD sample. In the next section cross-sectional and longitudinal research that has explored how trait BAS sensitivity is related to BD is reviewed.

2.2 Bipolar Vulnerability: Evidence from the BAS and Hypomanic Personality Scales

A ‘gold standard’ measure of trait BAS sensitivity, Carver and White’s BAS scale (Carver & White, 1994) and its three subcomponents – fun-seeking, drive, and reward-responsivity – have been described. Despite some question marks over its incomplete correspondence to underlying psychobiological processes (Corr & Cooper, 2012), it is a well-validated tool used to understand how the BAS relates to BD. However, the Hypomanic Personality Scale (HPS) has also been validated as an instrument to detect vulnerability to BD (Eckblad & Chapman, 1986 –see section 1.6). The following section summarizes the key research that has used each of these measures in the context of BD. Because this thesis sought to explore the influence of underlying facets of the HPS relate to reward-related processes, there is a focus on the factor structure of the HPS.

To begin with, cross-sectional studies have found elevated BAS sensitivity to be more elevated during a manic episode than compared to euthymic state in BD (Meyer et al. 2001). Two studies have found BAS to be elevated in euthymic BD individuals as compared to controls, supporting a trait role for BAS sensitivity (Alloy et al. 2008; Salavert et al. 2007). A similar trait BAS scale not reviewed above, the Sensitivity to Reward Scale (Torrubia et al. 1995) found individuals with BD to displayed elevated reward sensitivity compared to healthy controls. Two studies have found levels of BAS drive and fun-seeking to correlate with severity of manic symptoms (Alloy et al. 2008; Van der Gucht et al. 2009). High BAS

sensitivity also discriminates BD patients from patients with unipolar depression (Quilty, Mackew, & Bagby, 2014). Thus a stable correlation between BA and mania is evident, however cross-sectional analyses do not have much explanatory power.

Longitudinal designs have helped elucidate how BAS sensitivity relates to BD overtime; whether BAS hypersensitivity is a feature of BD outside of mood episodes, for example. Meyer et al. (2001) found BAS scores to remain stable over time despite substantial fluctuations in manic symptoms and after controlling for baseline symptoms, suggesting elevated BAS is not an artefact of mania. Furthermore, fun-seeking BAS sensitivity levels predicted a greater risk for individuals diagnosed with cyclothymia to progress to BD type II (Alloy et al. 2011) and individuals diagnosed with BD type II progressing to BD type I (Alloy et al 2011). Because the distinguishing feature of BD type II is predominant depression this study implies a greater BAS has a detrimental effect on the depressive pole of BD but research has not corroborated this (Johnson et al. 2012)¹². In a prospective study of 136 cyclothymic patients BAS sensitivity predicted shorter time to onset of manic and hypomanic episodes (Alloy et al. 2012). However, the research base does not unequivocally support a link between BD and BAS sensitivity; in a matched (BD type I versus healthy controls) follow-up design no relationship emerged between BAS and onset of manic symptoms (Salavert et al. 2007).

Finally, other recent longitudinal research has demonstrated BAS sensitivity can predict BD. For example, prospective study which found non-clinical individuals who self-report high BAS sensitivity to be at increased risk for developing a first onset episode of BD (Alloy et al. 2008). Furthermore, in a cohort of 60 undergraduates, those with extreme BAS sensitivity were the most likely to be diagnosed with BD type I, even after controlling for current bipolar

¹² Indeed some research suggests bipolar depression is characterised by a threat sensitivity which therefore implicates the BIS and FFFS systems (Meyers, Johnson & Winters, 2011)

symptoms, family history of BD and the length of follow-up (Alloy *et al.* 2012). These findings support the notion that individuals who describe themselves as BAS sensitive, that is, highly reactive to rewarding events and goals in their life, and prone to positive moods, are more likely to develop BD than those who do not.

As described earlier, the Hypomanic Personality Scale (HPS), like the BAS scale, has also been used extensively to understand risk to BD, and has also accrued related predictive validity evidence (Kwapil *et al.* 2000). However, only a few studies have included both measures in their design. In two non-clinical correlational studies, the BAS scale, which was not designed to measure BAS dysregulation related to BD but rather was designed as a marker of BAS sensitivity, and the HPS, which was designed to detect vulnerability to mania, were found to consistently correlate with each other (Carver and Johnson, 2009). In this study the strongest correlations were found for the Drive and Fun-seeking subscales, with Reward-Responsiveness correlating more weakly with the HPS. In earlier research, which also used a non-clinical sample, non-disordered high HPS scorers and individuals diagnosed with BD had significantly higher scores on the BAS reward responsiveness scale than age-matched controls (Meyer *et al.* 1999). These associations have been replicated in a longitudinal study. Meyer and Hoffman (2005) followed 60 participants over 28 days to assess the contribution of the BAS scale and the HPS to variability in mood symptoms in a non-clinical population. The results indicated overlap between the measures in that they both predicted elevated affect but the HPS was much more sensitive to instability of positive and negative affect, with the authors suggesting the HPS is a better measure for detecting dysfunction in the BAS (Meyer & Hoffman, 2005). The researchers reported moderate positive associations between the HPS and BAS subscales, consistent with Carver and Johnson (2009). Therefore there is evidence that the HPS as a vulnerability measure of BD is also sensitive to aspects of the BAS.

The good predictive validity of the HPS has resulted in its widespread use in analogue samples that seek to test hypotheses of the BAS hypersensitivity theory of BD. For example, high HPS scores have been associated with greater impulsivity (Johnson, Carver, Mulé, & Joorman, 2013), increased positive affect (Gruber, Oveis, Keltner, & Johnson, 2008) and sensitivity to positive stimuli (Trevisani, Johnson, & Carver, 2008). Furthermore, cognitions thought to be important to BAS dysregulation, such as ambitious goal-setting and achievement-focussed, have been reported in high HPS scorers (Carver & Johnson, 2009), whilst Meyer and colleagues has demonstrated that the HPS is associated with a tendency to set approach goals rather than avoidance goals, and that high HPS scorers report goal scenarios as more appealing (Meyer et al. 2004; Meyer et al. 2007). Psychophysiological evidence of elevated reward sensitivity has also been found by using the HPS; in individuals at-risk to BD (high HPS scorers), relative to low risk (low HPS scorers) (Mason, O'Sullivan, Bentall, & El-Deredy, 2012).

Whilst this research has proved fruitful, the HPS also correlates with measures of substance abuse, borderline personality, depression and anxiety (Eckblad & Chapman, 1986; Klein, Lewisohn & Seeley, 1996; Kwapil et al. 2000). This implies it taps a wide range of functioning that is not exclusive to BD and therefore it may be comprised of multiple facets.

2.2.1 The Substructure of the Hypomanic Personality Scale

In the last five years researchers have sought to further understand risk to BD by explicating the structure of the HPS. Their work is based on a recent methodologically robust study investigated the uni-dimensionality versus multi-dimensionality of the HPS in 884 undergraduate participants. These researchers employed a type of hierarchical cluster analysis to overcome problems associated with dichotomous (true/false) variables which previous dimension reduction studies of the HPS neglected (Schalet, Durbin, & Revelle, 2011). The analysis returned a robust three-factor model of the HPS. The factors were moderately

correlated yet conceptually distinct; they displayed differential relations with other psychopathology and personality measures (Schalet et al. 2011). Furthermore, the factor subscales displayed good internal consistency (roughly equal to total score), supporting the future use of subscales in addition to a total score. The three factors are as follows: *Social Vitality* (example item: “*In unfamiliar surroundings, I am often so assertive and sociable that I surprise myself*”) which the authors describe as representing social potency and vivaciousness (Schalet et al. 2011); *Mood Volatility* (example item: “*I seem to be a person whose mood goes up and down easily*”), described as tapping negative and unpredictable mood states and hypomanic cognition; *Excitement* (example item: “*I often feel excited and happy for no apparent reason*”), explained as tapping energetic and highly cheerful mood (Schalet et al. 2011).

To assess the criterion validity of the factor subscales zero-order correlations were conducted with measures of positive and negative emotionality, social adjustment and personality factors. After controlling for shared variance between the HPS factor subscales, strong unique positive associations were revealed between Mood Volatility and both externalising and internalising symptoms, whereas Social Vitality and Excitement did not relate to negative emotionality in general. Differential relations which would be obscured by using total HPS score were also evident. Excitement showed small but unique negative associations with measures of negative emotionality including depression – which positively related to Mood Volatility (Schalet et al. 2011). Mood Volatility was negatively associated with positive emotionality whereas positive emotionality was positively associated with Excitement and Social Vitality subscales. Again, total HPS scores cannot detect such nuances.

Schalet et al. (2011) interpreted the general pattern of correlations between the factor subscales and measures of psychopathology and general functioning as illustrative of the HPS being composed of conceptually separable factors. Mood Volatility was most associated with

psychopathology, particularly emotional and behavioural symptoms related to borderline personality disorder such as irritability and mood dysregulation. Social Vitality had associations with measures indicative of both normal and pathological functioning, correlating with risk-taking (sexual activity and drug use), dominance, exhibitionism, and entitlement. Finally Excitement tended to be associated with more adaptive traits, correlating positively with a range of positive emotionality traits (e.g. closeness) that corresponded to extraversion rather than dominance. Overall this study provides preliminary evidence for the HPS subscales as representing distinct aspects of vulnerability with tentative evidence that Mood Volatility represents greater risk for emotion dysregulation.

Subsequent to Schalet et al.'s findings, researchers have attempted to clarify distinctions between the HPS subscales. In a study assessing hypomanic personality as a risk factor for deficits in Theory of Mind, Terrien et al. (2014) found only the Mood Volatility scale to predict social cognitive deficits. The authors refer to positive correlations between Mood Volatility and social difficulties reported by Schalet et al. and suggest high Mood Volatility might better explain irritability, mood dysregulation and impaired social relations seen in individuals at-risk to BD better than Excitement and Social Vitality (Terrien et al. 2014). A caveat to the findings was the lack of a validated measure for social functioning, meaning the relationship needs further empirical support.

In a cross-sectional sample, Mood Volatility, but not Excitement and Social Vitality, was associated with depressive symptoms whilst all three subscales were associated with manic symptoms (Ford, Mauss, & Gruber, 2015). These results are broadly consistent with Schalet et al.'s findings and are somewhat mirrored by a recent correlational study of the HPS subscales and the big five personality dimensions (Costa & McCrae, 1992) in which Mood Volatility was uniquely moderately associated with Neuroticism whereas Social Vitality and Excitement were both moderately associated with Extraversion. Social Volatility was also

distinct in that it also correlated with Openness (Watson & Naragon-Gainey, 2014) – a trait often associated with motivation to approach new experiences, creativity, fantasy and ideas which could be tied to manic symptoms/cognitions. With Mood Volatility emerging from this early data as a risk factor for negative affect regulation and Excitement and Social Vitality both related to reward, the former with positive affectivity, the latter through social engagement but also propensity, this is preliminary evidence to suggest that the facets of the HPS might hold important information about risk to BD. With the data thus far being only correlational, it is unknown to what extent differences on these subscales predict change in reward-related processes relevant to mania under experimental settings.

Hence these findings justify the use of the subscales in the current set of investigations as a means of exploring differentiated influences of three aspects of BD vulnerability on emotional and attentional BAS-relevant processes. Since no experimental work has to date been conducted using the HPS subscales, the scales were analysed as an exploratory aspect to the overarching aims of the thesis. In chapter 5 the scales were used to explore the relationship BD vulnerability traits in self-report and psychophysiological responses to BAS versus non-BAS inductions. In chapter 6 the subscales were used to test for differentiated responses to BAS relevant versus BAS irrelevant positive affective imagery, whilst in chapter 7 and 8 the subscales were used to test for differentiated changes in cognitive processes (elaborated upon in Chapter 3) theorized to be important in BAS regulation. Therefore, alongside the use of the HPS total score to give a continuous measure of overall BD vulnerability, three subscale scores were computed based on the component items for Mood Volatility (13 items), Social Vitality (19 items) and Excitement (7 items) to make these tests possible. See Appendix VIII for the item composition of each scale.

2.3 Evidence of Reward Dysregulation in Bipolar Disorder

The reward system (or BAS) is highly-complex and multi-faceted. Efforts have been made to establish if BD is characterised by global reward dysregulation, or alternatively if there only certain facets of the BAS that are compromised in BD. The following section will organise varied evidence of reward dysregulation in BD by temporal components of reward: anticipatory reward ('wanting'), reward receipt ('liking'), reward recovery. Both these components that are of relevance to this thesis as they inform hypotheses in studies 2, 3, 4, and 5. As noted earlier in this chapter, neurobiological research has found strong evidence to parse the reward process in to temporal components: wanting (anticipatory processes) and liking (consummatory processes) (Berridge, 2007).

2.3.1 Anticipatory Reward.

What follows is research that addresses various aspect of anticipatory reward in individuals diagnosed with BD. In broad terms, there is evidence that individuals diagnosed with BD exhibit a cognitive style that highly values achieving ambitious goals (see review, Johnson, 2005). Furthermore, there is evidence that goal attainment is viewed as particularly important to self-worth in individuals diagnosed with BD (Lam, Wright & Sham, 2005). Thus there is self-report evidence that BD is characterised by stable tendency to put a high value on goal-attainment.

Related to high valuation of reward is the tendency to devalue potential losses in reward decision-making, or risk-taking, as it is often referred to. One method of experimentally assessing dysfunction of anticipatory processes in BD research is to employ

risk-taking paradigms. For example, in the manic phase of the disorder, individuals with BD have been found to exhibit greater willingness to take risks, compared to healthy controls (Clark et al. 2001; Rubinstein et al. 2001). Another study found that individuals with BD made riskier decisions than did healthy controls, irrespective of phase of illness (Adide et al. 2011), although it should be noted that other studies have failed to find differences in risk-taking between euthymic BD samples and healthy controls (Rosier et al. 2009; Clark et al. 2002). Furthermore, Murphy et al. (2001) showed that hospitalized manic patients were more likely to choose an option with a low probability of winning on a decision-making task. Taken together, the evidence that BD is characterised by risk-taking in the manic and euthymic phase is mixed.

A related aspect of reward valuation which does not involve valuing loss concerns the degree of effort individuals expend in pursuing goals. An example of a study that assessed willingness to expend effort in BD comes from Hayden and colleagues (2008) who compared the speed at which individuals diagnosed with BD and healthy controls sorted cards to earn a reward. In a separate condition the participants were requested to sort cards without incentive. Individuals diagnosed with BD and controls did not differ in card-sorting speed. However, within the reward condition, individuals with BD made significantly quicker responses than healthy controls. In research using a psychophysiological index of BAS activity (left frontal asymmetry), Harmon-Jones et al. (2008) found individuals with BD during a euthymic phase to display sustained effort (indexed by greater left-frontal EEG activity) in conditions where reward was difficult to achieve, as compared to scenarios when the task was rated as of medium or easy difficulty. Other neurobiological evidence is consistent with this, showing that during euthymic individuals display greater activation in the orbitofrontal cortex than healthy controls during the anticipation of reward (Nusslock et al. 2012). These findings have been extended by research that has shown that, compared

healthy controls, individuals with BD are more likely to sustain goal-striving when progress towards reward is going unexpectedly well (Fulford, Johnson, Llabre, & Carver, 2010). Thus there is behavioural and psychophysiological evidence that BD is marked by elevated effort in the pursuit of goals.

Like risk-taking, impulsivity is another construct related to pre-reward processes that is represented in diagnostic criteria for a manic episode: involvement in pleasurable activities that have a high potential for painful consequences (APA, 2013). Impulsivity can be defined as a tendency toward rash, unplanned behaviour without consideration for future consequence and was first linked to the BAS by Gray who viewed it as a trait level manifestation of the BAS (Gray, 1987). Impulsivity, as measured through self-report, has been found to be elevated in BD across mood episodes (Swann, Dougherty, Pazzaglia, Pham, & Moeller, 2004). Impulsivity, operationalised by reward-delay tasks, where a preference for a small immediate reward over a larger delayed reward is defined as impulsivity, has been found to be elevated in euthymic individuals diagnosed with BD, as opposed to other tasks that operationalise impulsivity in terms of response disinhibition (Strawkowski et al. 2009). Another study employed a reward-delay task and found that individuals diagnosed with BD, as compared to controls, exhibited an inability to delay responding for rewards on a behavioural task (Swann, Lijffijt, Lane, Steinberg, & Moeller, 2009). These latter findings have been replicated in high risk design (high versus low HPS scores) (Mason, O'Sullivan, Blackburn, Bentall, & El-Deredy, 2012). Overall, the limited research that has assessed impulsivity indicates that BD might be characterised by dysfunction in reward valuation such that there are difficulties in delaying reward. Further research is needed to understand the context in which impulsivity might contribute to BAS dysregulation or whether it is merely an epiphenomenon.

2.3.2 Consummatory Reward.

In contrast to anticipatory reward, research that has investigated BAS dysregulation in terms of initial response to the receipt or consumption of reward (consummatory reward) in BD has not found marked associations. An fMRI study examining brain activity of individuals in a manic state in response to monetary reward showed that in comparison to healthy controls and individuals with schizophrenia, manic individuals displayed different activity in the nucleus accumbens upon receipt of reward (Ablner et al. 2007). However most research that has addressed reactions to reward has done so by measuring affective responses and these findings are not consistent with those of Ablner et al (2007). For example, Farmer et al (2006) reported no differences in self-reported positive activation after success feedback between individuals with BD and healthy controls. However, research that has employed the analogue mania samples (including use of the HPS) has found evidence to support increased BAS activity in response to success. Johnson, Ruggero and Carver (2005) found hypomanic symptoms and trait vulnerability to mania to predict the degree to which individuals expected to perform successfully on an upcoming task, only after success feedback. Hypomanic symptoms predicted greater positive affect after reward, but trait vulnerability did not. However, trait vulnerability, as indexed by the HPS, was associated with setting more difficult goals after reward (Johnson et al. 2005). Therefore, despite the lack of evidence to suggest dysfunction in hedonic reactions to reward in individuals diagnosed with BD, there is evidence from samples not confounded by problems associated with recruiting patient samples (i.e. analogue samples), that cognition following reward, in the form of elevated confidence and ambitious goal-setting, might be disrupted following receipt of reward. This is pertinent to studies 4 and 5 and is linked to the next section which reviews research that addresses processes following reward beyond initial hedonic responses.

2.3.3 Reward Recovery

A final aspect of the reward process that may be disrupted in BD is affective, cognitive and behavioural response involved in the recovery from reward receipt. This area has received relatively less research interest, despite very early reward sensitivity research suggesting that recovery from BAS activation in BD is abnormally prolonged. From a theoretical perspective Depue and Monroe (1986) argued that if BD represents a dysregulated reward system then characteristics of dysfunction in other biological systems should be reflected in BD. One such prediction stated that if BD represents a dysregulated BAS, slow homeostatic return to baseline after BAS activation (often referred to a delayed or prolonged emotion recovery) should be present.

Early research to test for delayed recovery of the BAS used a stress task rather than a reward task. Depue and Colleagues sought to test this prediction of dysregulated BAS in analogue samples of mania by recruiting cyclothymic individuals. Using both diary and laboratory studies, the researchers investigated purported bio-behavioural correlates of BAS e.g. cortisol, and reactivity to light, and self-reported behaviour that correspond to energy, mood and optimism. Depue and colleagues reported disturbance in cyclothymic individuals as compared to healthy controls that they argued supported the delayed recovery hypothesis. Specifically, after a stress induction cortisol levels of cyclothymic individuals took longer to return to baseline compared to controls, (Depue, Kleiman, Davis, Hutchison & Krauss, 1985). However, there were a number of caveats to this early study. Perhaps most importantly the relationship of cortisol to the BAS was not explicitly stated (cortisol secretion indicates a nonspecific stress response and is hyper-secreted in unipolar depression and BD, Depue & Kleiman, 1979). Significantly, this finding was replicated using self-report methods, when self-reported behavioural engagement was operationalised as BAS activity (Behavioural

Engagement Scale; discussed later) in a diary study comparing variation in self-reported BAS activity in individuals diagnosed with BD and healthy controls. This study found individuals with BD to take a longer time to recover to baseline after an unpleasant event (Krauss et al. 1992). Again, this study found slow recovery in the context of negative environmental input, not reward. More recently, two studies in naturalistic and laboratory settings have found further support for this hypothesis and importantly this has been in the context of reward.

Firstly, a 28 day diary study found evidence for prolonged high levels of behavioural engagement following a challenge (Wright, Lam, & Brown, 2008). Wright et al. (2008) found an association between number of manic episodes and prolonged elevation of behavioural engagement levels following reward for individuals diagnosed with BD type I. However life time diagnosis did not relate to delayed recovery in that there were no differences between the BD group and healthy controls in time taken for BAS levels to recover. A second study which employed a more tightly controlled method to provide further support for delayed recovery of the BAS following reward: Farmer et al. (2006) found euthymic individuals with BD had a prolonged duration of self-reported positive affect following a positive mood induction, as compared to healthy controls. Taken together, there is some initial evidence that individuals with BD exhibit difficulties recovering to baseline.

This research highlights that the prediction of BAS dysregulation, in terms of delayed recovery following a BAS input, has found some support. However, one of these studies employed a measure of behavioural engagement based on BD symptomatology, whilst the other used a measure primarily used to measure positive affect, but neither of these measures has been rigorously validated as a measure of state BAS level. Therefore there is a need to explore the validity and sensitivity of these and other measures designed to measure state BAS. This was a primary objective of strand one of the current research,

2.3.4 Significance of Reward Recovery for the current Investigations

This section has reviewed biological and behavioural research implicating BAS dysregulation in individuals diagnosed with BD. Studies employing behavioural tasks were highlighted that demonstrated BD is associated with ambitious goal-setting, success expectancy, risk-taking and impulsivity. There is also psychophysiological and neurobiological evidence to support the notion that anticipatory reward is poorly regulated in BD. In contrast, less evidence was provided that the hedonic phase of reward is disrupted in BD. Finally, evidence from four studies was provided that support the hypothesis that BD is characterised by delayed recovery from BAS-relevant events, including reward.

This findings for delayed recovery from reward, taken together with evidence cited that reward produces increased confidence in individuals prone to mania, are crucial as they may represent causal factors in the development of manic symptoms. Indeed, in real-world research, number of goal attainment life events has been found to predict an increase in hypomanic and manic symptoms and episodes over time (Johnson, et al. 2008; Nusslock, Abramson, Harmon-Jones, Alloy & Hogan, 2007). Therefore further research is required to causally explain how a hypersensitivity to reward results in sustained, extreme BAS output. In other words, research is needed that identifies factors that mediate the pathway from initial exposure to reward to heightened and prolonged BAS activation.

A common explanation put forward to explain how delayed recovery results in an upward spiral towards mania, is that small increases in BAS activity subsequent to reward are maintained by cognitive and bio-behavioural processes that act to increase activation further (Johnson, 2005; Mansell, Morrison, Reid, Lowens & Tai, 2007; Ursosovic et al. 2008). One of the advantages of the BAS theory is its compatibility with cognitive and other explanatory models. In particular, recent efforts have been made to integrate the circadian system and the

reward system in explaining the genesis of mania. In a BD vulnerability sample, Alloy and colleagues (2016) found that social rhythm disruption mediated the relationship between BAS activating events and bipolar symptoms, suggesting an interplay between the two systems which manifests further dysregulation. Other researchers have looked to the possible interplay between BAS-relevant states and extreme cognitive appraisals of internal states to explain the ascent in to mania (Mansell et al. 2007). This account is consistent with research showing vulnerability to BD predicts greater success expectancy (Stern & Berrenberg, 1977; Johnson et al. 2005).

Overall, very little is currently known about mechanisms that sustain the BAS once becomes activated, yet understanding these is important because elucidation of the mediators of sustained BAS activity could lead to successful interventions aimed at curtailing such dysregulation. As an initial step in this field of research, an objective of the current work was to explore a potential cognitive mediator of prolonged BAS activity. First, however a prerequisite to understanding mediators of temporal changes in BAS activity is the availability of sensitive and valid measurement tools. Therefore a second objective was to address a gap in the literature regarding the valid measurement of in the moment BAS activity;

In the next section, literature pertaining to the measurement of BAS activation is reviewed. Literature will be reviewed pertaining to BAS output and the induction of this. It will end with the rationale for the first of strand of enquiry investigated here (presented in empirical chapters 1, 2 and 3). Following this, candidate processes that might contribute to the maintenance of elevated BAS activity are outlined. This literature will form the rationale for the second strand of research, reported in empirical chapters 4 and 5.

2.4 Conceptualisation of Experiential Approach Motivation

For the present research a widely cited definition of AM was adapted. Eliot defines AM as “the energization of behaviour by, or the direction of behaviour toward, positive stimuli (objects, events, possibilities)” (Eliot, 2008, pg111). Two adaptations will be made. First, consistent with the position of Carver and Schieir (1998) and Harmon-Jones et al (2013) who evidenced that AM can be evoked by negative stimuli, “positive stimuli” will be replaced with “the urge to move toward reward-related stimuli”. Second, Eliot’s definition refers to “behaviour” but neglects cognitive, biological and emotional aspects of AM. Therefore, where the current project is concerned the following definition will be used to define AM:

Approach motivation is the energization or generation of physiological activity, emotions, cognitions, and behaviours by or towards reward-related stimuli (objects, events, possibilities).

This definition of AM is purposefully broad to capture multiple outputs of the BAS in addition to reflecting the current lack of consensus on the topic. An important consideration in the measurement of AM is determining the extent to which the subjective experience of BAS activation is manifest as the outputs described by described by Depue and Iacono, (1987). That is, to what extent is AM experienced as positive emotions (joy), relative to other components such as approach-related cognitions (desires, determination, confidence), incentive reward motivation (interest), and physiological activation (active, energised). As a preliminary step in reviewing the AM measurement literature, expert opinion of key researchers in this field of study was sought in relation to self-reported AM. Richard Depue

stated that positive affect is a marker for BAS sensitivity and therefore suggested that the PANAS (Watson, Clark & Tellegen, 1988) scale as valid measure of AM but also recommended a single item scale he had developed the Positive Activation Rating Scale (Morrone et al. 2000) (personal communication, 2011). In contrast Eddie Harmon-Jones communicated doubt as to whether self-report measures can accurately measure AM (personal communication, 2011). Charles Carver stated that it had been a research goal of his to modify the instructions of the BAS scales to capture current AM, (personal communication, 2011). The implication is that state AM should closely mirror the three components that underlie the Carver and White's (1994) BAS scale, impulsiveness (fun-seeking), reward responsiveness, and drive to obtain reward (drive). However as described in section 2.1.2, this account has been challenged, with Corr and Cooper finding a fourth factor to stable BAS - Interest.

The absence of a gold standard measure of AM, and indeed, the lack of consensus on the key components of state AM provided the rationale for Study 1, which sought to address this question by assessing the underlying structure of available AM measures. Before these are considered, it necessary to elaborate on the relationship between AM and positive mood in particular.

2.4.1 Approach Motivation and Positive Affect

How AM conceptually relates to positive emotion is particularly relevant here. Depue et al. (1987) viewed positive affect as an important output of the BAS, and as described, the phenomenology of mania is dominated by elated mood and activation (whether they are separable seemingly depends on the study).

How emotion and motivation relate has been studied by many researchers (e.g. Frijda, 1986; Lazarus, 1991) both those who subscribe to discrete theories wherein emotions are biologically-fixed discrete categories (fear, disgust e.g. Elkman, 1992 Tomkins) and proponents of dimensional models where emotion is represented along continuum of valence (pleasantness) and arousal (bodily activation) (Barrett, 1998; Russell, 1980). It is the dimensional mode of affect that is subscribed to here as it provides the clearest and strongest link between emotional and motivational behaviour. Furthermore, the bulk of evidence across experiential, physiological and behavioural measures is also in favour of the dimensional model of emotion (Mauss & Robinson, 2009).

What follows is a brief outline of various theoretical positions taken to explain the relationship between AM and positive emotion/affect, followed by a review of AM measures. This will inform how AM is defined in the upcoming studies.

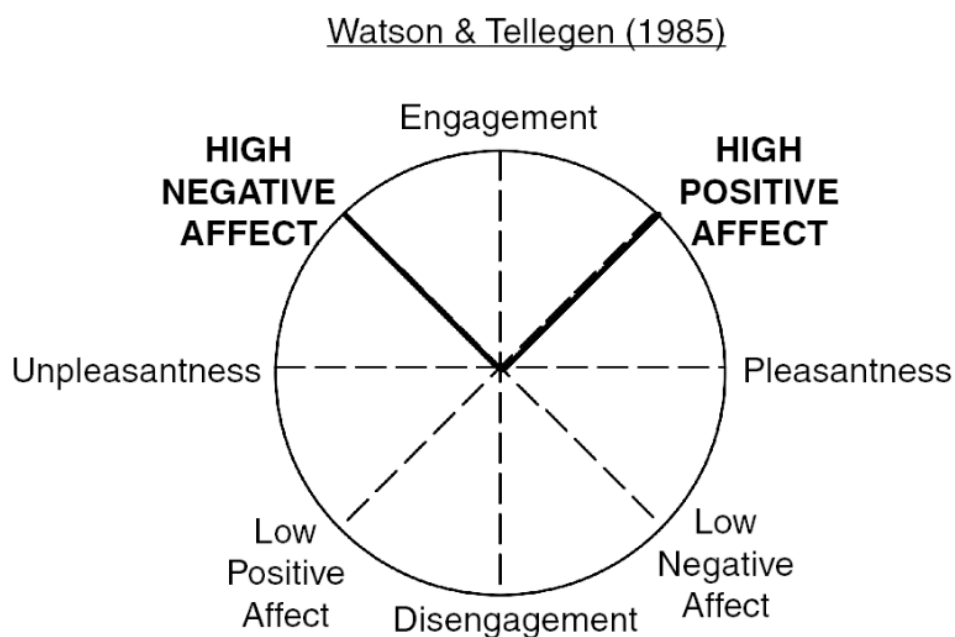

Figure 6. Watson and Tellegen's (1985) two factor model of affect

Individual differences research generated a theory which was important for understanding affective space and was later integrated with the concepts of the BIS and BAS in humans. Watson and Tellegen (1985) produced an influential series of factor analyses which empirically supported Zevon and Tellegen's (1982) theory that affect consists of two unipolar dimensions which are relatively independent of each other, positive affect and negative affect. According to this perspective, high negative affect refers to the extent someone reports feeling bad, upset, or unpleasantly engaged with their environment, whereas high positive affect represents the extent to which an individual feels good, peppy, and engaged with their environment (Zevon and Tellegen, 1982). As these are unipolar dimensions, low levels of positive or negative affect are reflected by the absence of these feelings. Watson and Tellegen (1985) PANA model spawned one of the mostly widely used instruments in psychology (cited over 24,000 times: Google Scholar, March 2017), the Positive Affect Negative Affect schedule (PANAS) which will be reviewed shortly. NA has been linked to the personality trait of neuroticism (emotional instability) whilst PA has been most associated with Extraversion

and notably Carver and White's (1994) BAS scale and the HPS (Eckblad & Chapman, 1986). More recently Watson and others have come to view PA and NA as being grounded in approach and avoidance, respectively (Watson 1999; Cacioppo, Gardner, Bernston, 1999). In this view, the subjective experience of AM consists of feelings of positive activation which correspond to the euphoric activation factor derived from the analysis of manic symptoms by Ruggero and colleagues, cited in section 2.1.5.

This view of positive emotion exclusively tied to BAS is consistent with early conceptualisations; Gray thought that positive emotions were related to the BAS and negative emotions such as anxiety and depression were associated with the BIS (Gray, 1982). PA was first incorporated into BAS theory by Depue et al. (1987) who concluded that the PA dimension was loaded with a combination of locomotion, motivation, energy and mood items (e.g. example PA items: active, strong, elated), with mood loading lowest.

To recap, many researchers converge on notion there is a dimension of positive affect and a separate dimension of negative affect. Each are unipolar - low levels indicate absence, high levels indicate elevated affect. However, Carver and Scheier (1998) made an important theoretical contribution which has two distinct implications for the measurement of subjective AM – and therefore the present research.

Firstly, Carver and Scheier (1998) argue negative affect is elicited when goal pursuit is unsuccessful. Therefore sadness, frustration and anger that arise from failure to attain goals are mediated by the BAS and consequently the BAS should be seen as a bipolar dimension ranging from feelings associated with goal pursuit, goal attainment such as elation and enthusiasm but also feelings associated with goal-obstruction and failure such as anger and depression (Carver & Scheier, 1998). The relationship between anger and AM has been studied most and has found support from observational studies in children (Deater-Deckard et al. 2010) and behavioural studies of mice (Kazlauckas et al. 2005).

Secondly they argue positive affect is linked to the avoidance system through low activation feelings of serenity and contentment that are associated with absence or removal of threat or punishment. Importantly evidence has supported Carver and Scheier's (1998) theory. For example, a series of studies showed that under situations of frustrative non-reward reports of feeling sad and frustrated were associated with BAS sensitivity but did not relate to the BIS scale (Carver, 2004).

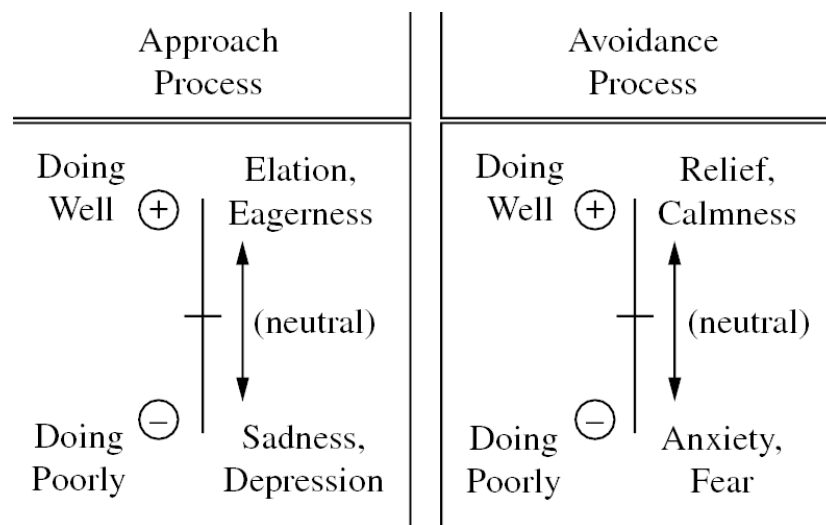

Figure 7. Carver and Scheier's (1998) bipolar affective dimensions

The implications of Carver and Scheier's (1998) theory for the research here, which seeks to identify a valid state measure AM, are as follows:

1. Positive affect that is low in activation is not relevant to the phenomenology of AM.
2. Some aspects of negative affect are relevant to AM, especially those associated with goal-obstruction.

This suggests a valid measure of AM needs to demonstrate it is sensitive to anger but can also discriminate between BAS-relevant and BAS-irrelevant positive affect.

2.4.2 Measures of Subjective AM

According to Lang and colleagues (1997) all approach and avoidance driven emotions have correlates in other response domains including physiology, cognition and behaviour but are most saliently represented in subjective states (reported via self-report). As has been identified, self-report scales measuring trait BAS, which assess a stable tendency to experience certain AM states, have been a research priority to the detriment of state measures, which assess present-moment AM state. From a comprehensive literature search, and informed from personal communications from prominent researchers, three measures were identified for evaluation, to address this gap in the literature. It is worth noting that because no direct measure of AM exists the construct validity can only be gauged through face and construct validity evidence stemming from previous AM research that has employed the scales.

Behavioural Engagement Scale (BES: The BES is a brief self-report measure of current behavioural engagement. It was developed to capture five components of BAS activity as described by Depue et al. (1987) : energy, thought liveliness, interest/excitement, mood and optimism. High scores on the BES indicate high levels of AM and low scores correspond to low levels of activity. In a factor analysis of the BES, its five items were found to define a dimension separate from activated negative affect (irritability, hostility¹³). The BES has been shown to have high internal consistency and has demonstrated high internal consistency across 28 time points, ($\alpha = 0.85-0.94$, Wright, Lam & Brown, 2008). Furthermore, this study found that trait reward sensitivity, as measured by BIS/BAS-F scale (Wright et al. 2008), was related to AM in that the interaction between BAS sensitivity and reward/frustration experienced predicted BES level.

¹³ Whilst emotion associated with frustrative non-reward is BAS relevant and therefore should be considered, the focus here is on reward related processes rather than those associated with reward obstruction.

Wright, Brown and Newsom-Davis (2005) found the BES to be sensitive to everyday changes in affect in both BD and healthy individuals whereby significant changes were found in the expected direction following positive and negative mood inductions. Furthermore, a second laboratory study found evidence for construct validity in a non-clinical sample. Finally, Lowenstein, Wright, Taylor and Moberly (2015) found the BES scores to become elevated for participants who underwent an AM induction that had been previously used to successfully induce feelings of high energy, power, creativity, grandiosity and perceived increased thinking speed (Pronin, & Wegner, 2006).

Together then, despite a paucity of studies, there is evidence that the BES is reliable and retains some construct validity both in naturalistic and laboratory settings. In terms of face validity, the measure seems to correspond to BAS output, as proposed by Depue and colleagues (1987). However, there has been no robust investigation of the validity of the measure, such as evidence of convergent validity with non-self-report measures of AM. Furthermore only a few studies have employed it, limiting its generalisation to wider populations.

2.4.2.1 The Positive Activation subscale (PANAS-PA) of the Positive Affect and Negative Affect Schedule (PANAS: Watson, Clark & Tellegen, 1988)

The PANAS includes 10 positive affect adjectives (e.g., attentive, interested) and 10 negative affect words (e.g., jittery, upset), rated on a 5-point Likert scale (1 not at all; 5 very much). Originally labelled the positive affect subscale to indicate its function as a measure of the positive affective dimension of Watson and Tellegen's (1985) two-factor model of affect, the PA items of the PANAS were later renamed¹⁴ positive activation to reflect theoretical

¹⁴ The 10 positive activation adjectives that comprise this subscale items henceforth will be referred to as PANAS-PA.

alignment with the BAS (Watson et al. 1999). In contrast to the other measures evaluated here, the PANAS is one of the most widely utilised instruments in psychology¹⁵. However it should be noted that it is often used to capture positive mood and happiness rather than AM. It has also been adapted to capture positive affect across various time periods in addition to the “right now” - the version which is of interest here. Because the PANAS scale has been so widely used its factor structure has been heavily studied. Initially deemed a unidimensional construct (Zevon & Tellegen, 1985), follow-up analyses have converged on a four factor structure (Crawford & Henry, 2004; Crocker, 1997 – elaborated upon in Chapter 4). Despite the scale as a whole accruing strong reliability and validity evidence, as a measure of positive affect (Watson et al. 1988; Gray & Watson, 2007) its employment in the context of approach-motivated affect is of primary interest here. Depue’s assertion that the PANAS-PA is a marker of BAS activity provides face validity evidence for the scale. This is bolstered by the scale developer’s selection of only the highest loading adjectives that capture “a state of high energy, full concentration, and pleasurable engagement” (Watson et al. 1988, pg.1063) and therefore includes those which closely resemble how AM has been defined, again at face value. Furthermore, it has concurrent validity in the form of positive correlations with the BAS scales (Carver & White, 1994). Importantly it has been shown to be sensitive to changes in AM state in the context of laboratory reward tasks in BD and healthy control samples (Farmer et al. 2006).

Convergent validity evidence for the PANAS-PA comes from studies which have found it correlates with left frontal asymmetry, a biomarker of BAS activity reviewed within section 2.5. This represents an advantage the PANAS-PA has over other measures. As does evidence that the PABAS-PA is sensitive to anger, a high activation emotional state of negative valence (Harmon-Jones, 2003). However, a disadvantage of the PANAS-PA noted

¹⁵ 24092 current citations of the original validation study: Watson, et al 1988 as of March 2017

by Edmunsen (2007) is that some items are redundant or vague (e.g. ‘strong’). A furthermore complication to validity of the PANAS-PA as a valid measure of AM emerges from research that suggests underlying facets differ markedly in the extent and direction of change measured across time. Specifically, only two of three PA subscales derived from previous factor analyses (e.g. Crocker, 1997) increased in response to a validated success induction (Egloff, Schumkle, Burns, Kohlman & Hock, 2003). This is a concern for the use of the PANAS-PA as a specific measure of AM. As is the case with all four measures, further evidence of construct validity of the PANAS-PA is warranted.

2.4.2.2 *Positive Activation Rating Scale (Morrone, Depue, Schere & White, 2000)*

A third state measure of AM, designed by Richard Depue and colleagues, is the Positive Activation Rating Scale (PARS: Morrone et al. 2000). This is a single rating scale of 10 anchored double-adjective items that consists of a graduated range of affective and activation adjectives. It is similar in origin to the PANAS-PA in that it is comprised of high loading adjectives from the Positive Activation factor described by Watson and Tellegen’s (1985) two-dimensional model. Because the PARS was designed for a specific study it has not been widely used and therefore is not validated outside two studies (Morrone, Depue, Scherer, & White, 2000; Morrone-Strupinsky & Depue, 2004). Correlations between trait extraversion and the PARS scores provide concurrent validity evidence. Furthermore, the research in question found the PARS to be sensitive to film clips selected for incentive motivation-positive activation eliciting properties (Morrone et al. 2000; Morrone-Strupinsky & Depue, 2004). It must be stated that there is a danger of circular argument here, when neither measure or task can claim to be truly valid.

2.4.2.3 *AMSAM (Approach Motivation Self-Assessment Manikin)*

Because the above measures all contain a positive affect component it was thought important to include a scale that solely attempted to capture motivational/arousal aspects of AM. The

evidence to support the use of a non-verbal most notably stems from the Self-Assessment Manikin (SAM: Bradley & Lang, 1994) upon which the novel scale was based. The SAM is a reliable, validated, non-verbal pictorial assessment technique that measures self-reported valence, activation, and dominance (omitted) associated with a person's affective reaction to a wide variety of stimuli (Bradley & Lang, 1994). Each SAM depicts 5 human figures graded by intensity. Participants were asked to circle a number 1-9 beneath the figure which best corresponded to current level of “valence (negative – positive)” for the valence SAM and “activation (calm-excited)” for the activation SAM. The ASMAM mirrors the design of the original but with a focus on depicting increasing motivation to approach (it was accompanied by instructions – see appendix I for all four state AM measures). Because the measure was developed by the research team, it is untested.

2.4.2.4 *Interim Summary*

To summarise, three existing measures used in the context of AM research were identified that all possess face validity as measures of AM. Each was shown to possess varying evidence speaking to overall construct validity. In lieu of robust convergent validity (the extent to which a measure is associated with theoretically aligned measures) and discriminative/divergent validity (the extent to which a measure is unrelated to measure it should not be related), only tentative conclusions should be drawn about the validity of these scales as specific and sensitive measures of AM. On account of the convergent evidence with a biological index of AM, the PANAS-PA seems to represent the best candidate measure. That said, its broad usage in positive psychology research that examined the responsiveness of it to broad positive emotions suggests that it may lack specificity. This partly provides a rationale for study 2 which sought to acquire convergent validity evidence for the putative AM measures (BES, PARS, AMSAM and PANAS-PA) by cross-validating them against a biological correlate of AM. Secondly, a prerequisite to identifying a valid measure is

ascertaining its discriminative validity. That is because, as noted, AM is often thought of in terms of positive valence and high arousal, it needs to be shown that these measures are sensitive specifically to AM stimuli and not just to stimuli high in positive valence or high in arousal. The next section briefly reviews the evidence regarding biological indices, with a view to identifying the best available proxy measure of AM against which to validate the scales.

2.5 Biological Correlates of Approach Motivation

Because the experience of high and low levels of AM is thought to be governed by the BAS there is an implicit suggestion that BAS activity can be captured using biological measures. Biological indices of AM are summarised below with a view to identifying an appropriate biological proxy of AM that can be used to ascertain convergent validity for AM self-report measures. This is important because biological and psychological processes relevant to the BAS need to be measured simultaneously in order to be applied clinically, especially as self-report and psychophysiological measures are commonly dissociated in research (Johnson 2005; Harmon-Jones et al. 2008).

Approach Motivation has biological correlates that are directly observable. The neurotransmitter dopamine is the most likely biomarker candidate (e.g. Depue & Iacono, 1989; Berridge & Robinson, 1998). Pharmacologic interventions for BD implicate dopamine in mania. Lithium, the oldest and still one of the most efficacious treatments for mania, is an indirect dopamine agonist, has also been shown to treat presentations of amphetamine use, a state which has been argued as analogous to mania (Cousins, Butts, & Young, 2009).

For example, amphetamine abuse which elevates the amount of dopamine available in the synapse resembles the phenomenology of mania, such that risk-taking, quicker speech, exploration, grandiosity and euphoria seen in amphetamine use mirrors key symptoms of mania (Cousins et al. 2007). Genetic and molecular research has also linked dopamine

synthesis to cognitive and affective dysfunction in BD (Smoka et al. 2005; Camara et al. 2010) and suggests dopamine is a central mediator of mania and depression. Impaired attention in BD is consistent with the view that the regulation of attentional processes is closely associated with dopamine activity (Goodwin et al. 2008).

Evidence that ties dopamine more directly to BAS dysregulation comes from altered dopamine-mediated reward pathways evident in individuals with BD (Abler et al. 2008). Furthermore, a role for trait self-report BAS measures as a marker of dopamine activity has been suggested with evidence that higher scores on the drive and fun-seeking (but not reward responsiveness) scales correlate with elevated dopamine activity (Reuter, Schmitz, Corr, & Hennig, 2006). This speaks to the notion that dopamine primarily influences approach toward rewards and reward related cues rather than liking, however it should also be acknowledged that dopamine is involved in many brain functions, and disorders, and therefore lacks specificity (Bressan & Crippa, 2005).

Dopamine is not directly observable and no tool has yet been provided that measures dopamine activity outside of neuroscience.

2.5.1 Spontaneous Eye-blink rate (SEBR) and frontal asymmetry

Because dopamine activity has been difficult to measure attempts have been made to find a valid proxy. SEBR, a measure of spontaneous eye blinking, has been linked with dopamine for over thirty years (e.g. Karson, 1983) and in that time has both been put forward to reflect both short-term changes in dopamine function and even stable individual differences (Bacher & Smotherman, 2004). These propositions were based on observations of increased SEBR in clinical populations and in primates administered with dopamine agonists and antagonists. However little progress has been made in understanding the precise substrates of SEBR thus the validity of SEBR as a correlate of AM has not been conclusively established (Bressan &

Crippa, 2005), although it has been successfully measured in the context of AM dysregulation in BD.

One correlate of AM that has proved a valid proxy is left relative to right frontal asymmetry activity. Left frontal cortical activity, as measured by electroencephalogram (EEG), has shown a significant positive association with both self-reported trait AM (BAS scale) and experimentally manipulated AM states (Harmon-Jones & Allen, 1997; Sutton & Davidson, 1997). According to the approach-avoidance theory of frontal asymmetry increased activity in the left frontal cortex is associated with increases in appetitive, approach-related behaviour (Sutton & Davidson, 1997). Despite there being an abundance of literature supporting this, some questions have been raised surrounding methodology. Hagemann et al. (1998) found that depending on the data-analytic approach, EEG can positively, negatively, or not all correlate with affective reactivity, and, importantly, asymmetry of approach-avoidance tendencies are not as strongly supported when tested using other imaging techniques (Murphy et al. 2003).

Most evidence for left frontal activity as a marker of AM comes from studies that have found associations between resting asymmetry measured via EEG and trait BAS measures, and it is noteworthy that the PANAS-PA, in its trait format, is one such measure (Harmon-Jones, Gable, & Peterson, 2010). Finally, a link between AM and mania is made through studies that have measured frontal asymmetry in individuals diagnosed with or at risk to BD. For example, Kano et al. (1992) found increased left frontal activity in individuals experiencing mania. However a caveat to these methodological problems, such as small samples sizes, is evidence that suggests it might also correlate with a non-BAS emotion, guilt (Harmon-Jones et al. 2013). There is also a general scarcity of data examining state changes. Together this prevents firm conclusions about the exact relationship between frontal asymmetry and AM being made.

2.5.2 Autonomic Nervous Activity: Cardiac Pre Ejection Period

Obrist (1976, 1981) first operationalised motivational intensity in terms of cardiac output, whilst Fowles (1988) identified autonomic correlates of the BAS. One measure of sympathetic nervous system activity in particular, cardiac pre-ejection period (PEP) - the time interval between the onset of the ventricular depolarisation and ejection of blood into the aorta - has been suggested as a superior index of AM (Brenner, Beauchaine & Sylvers, 2005). The validity of PEP as an index of sympathetic-linked cardiac activity has been established via pharmacologic manipulation (see Sherwood et al. 1990). In addition to this, PEP has been found to correlate positively with trait levels of AM (Brenner et al, 2005) and shorten in response to an experimentally manipulated AM condition (Tomaka & Palacios-Esquivel, 1997). Importantly, a linear increase in PEP reactivity across three levels of monetary reward has been demonstrated (Richter & Gendolla, 2009). Furthermore Brenner et al. (2005) found evidence for its discriminative validity: PEP increase was found to be particularly sensitive to reward rather than absence of a punishment, indicating that it is not merely a non-specific marker of emotionality. Brenner et al. (2009) states that “PEP reactivity to reward may be a more valid index of the neurobiological underpinnings of reward sensitivity than any self-report scale” (pg. 632). Based on this evidence, and the fact that impedance measurement facilities were available and holding the findings of Brenner and colleagues in mind, PEP was utilised in the current thesis as a valid biological index of AM with which to test the convergent validity of the AM self-report measures against.

2.6 BAS input/ Approach Triggers

Just as self-report measurement of AM that is sensitive to temporal change has been understudied, laboratory techniques for inducing BAS activation have been somewhat neglected. The majority of research conducted has sought to measure discrete emotion in the lab and not the activity of the underlying motivational system per se. What follows are some important considerations for the experimental elicitation of emotion in general, and AM more specifically. First though, a reminder as to why environmental input is relevant.

In accordance with stress-diathesis models, according to Depue and Iacono (1989) relevant environmental input exhibits a direct influence on the expression of BAS output (AM). Observational evidence for this is provided by longitudinal studies which suggest goal-attainment life events prospectively relate to manic symptoms at 2 month and 18 month follow-up (Johnson et al. 2000, Johnson et al. 2008). Furthermore, Johnson et al. (1999) found achievement but not general pleasant events to predict manic symptoms. This research conceives BAS input in terms of significant real life reward but BAS input can also be in the form of stimuli that serve as cues of reward in controlled laboratory conditions.

2.6.1 Considerations for the elicitation of elevated AM

To induce affective states in experimental conditions researchers have historically employed three techniques: guided autobiographical memory, imaginary vignettes, auditory (music) and visual (film clips stimuli). A recent meta-analysis of the effectiveness of general mood induction procedures identified video inductions to produce the greatest effect sizes (Ferrer et al. 2015). Some argue that laboratory inductions are probably inevitably limited in their ability to recreate the life events that precede onset of symptoms, therefore generalisation

should be conservative (Edge, 2014). Despite this, there is much evidence to support the use of laboratory inductions as analogous of everyday and clinical states. For instance, neurobiological evidence suggests induced moods recruit the same neural substrates (Mayberg et al. 1999; Mitchell & Phillips, 2007) as moods state in affective disorders. Supportive of the methods applied in both strands of this research, there is also evidence that such induced moods states have comparable impacts upon cognition (Clark et al. 2001; Robinson & Sahakian 2009), pharmacology (Mitchell & Phillips 2007) and psychophysiology (Clark et al. 2001; Robinson et al. 2011) to those found in emotional disorders.

2.6.1.1 Study 2: Novel AM induction

For study 2¹⁶ the objective was to induce as powerful a AM state as possible to be confident that construct validity could be claimed. A review of the mood induction procedure literature was conducted, guided by the definition of AM provided. Overall this did not provide much instruction. Experimental induction of states relevant to the BAS are commonly confounded by the research context. For instance, researchers have developed paradigms for measuring behavioural risk-taking and behavioural impulsivity. A problem with some of these tasks is that they contain an element of punishment (e.g. loss is an outcome in gambling tasks, immediate small reward rather than delayed reward incurs a cost in impulsivity tasks) which might activate the BIS. Indeed research that utilised these tasks in BD samples has returned mixed findings (Johnson et al. 2012). To induce a state that is uncontaminated by stimuli salient to punishment is a construct validity requirement of an AM induction task.

¹⁶ Studies 3-5 also required effective experimental inductions of an AM state. However there were methodological constraints imposed on the mode of AM induction for these studies (e.g. closely replicate previous findings). Therefore study 2 was the only study which presented a novel AM induction.

To consider anticipatory and hedonic components of reward is also important, although it is acknowledged that some forms of positive affect likely accompany both components of reward (Carver and Scheier, 1998). For example, enthusiasm promotes pursuit whilst joy and pride concern response to reward and achievement (Gruber, 2011). Parsing liking from wanting in experimental conditions is therefore a complicated matter and few studies have specifically attempted to do so. Researchers have designed tasks based on reward learning contingencies (Mason et al. 2014). Overall the literature search revealed a paucity of empirically-validated methods for experimentally inducing AM. Therefore, a novel AM induction was sought for study 1. To facilitate the identification of a valid AM induction criteria were drawn from the hypothesized outputs of the BAS as described by Depue and Iacono (1989): 1. The maximum strength of response 2. Produce striving behaviour towards an incentive (engagement) 3. Physiological activation (arousal) 4. Approach-motivated positive affect (valence) 5. Salient stimuli unrelated to the BIS or FFFS. These criteria were used to inform the induction of AM for study 2. Further information on the selection of the AM induction for this study is detailed in section 5.1.

2.6.1.2 *Study 3: Images*

Presentation of images, commonly photographs, is also used to elicit emotional reactions. The most commonly used pictures come from the International Affective Pictures System (IAPS; Bradley & Lang, 2007; Lang, 1995), a set of pictures that have been standardized on valence, arousal, and dominance dimensions. Cited advantages of IAPS images include; intuitively effective; simple to administer - the procedure for viewing them can be standardized across participants (Bradley & Lang, 1994). Validity evidence (see chapter 6) is of particular relevance to study 3, the normed ratings for valence and arousal dimensions of IAP pictures provide an opportunity to systematically compare images that were matched on one dimension but diametrically opposed on another.

2.6.1.3 *Study four: 4 film clips*

As noted at the top of this section, movie clips have been demonstrated as the most powerful elicitors of emotion. Most evidence regarding the use of film material is related to the intensity of experienced emotion as measured by self-reports. This supports the use of film in relation to measuring induced AM. However, most of this research has focussed on discrete emotions. It is largely unknown how well film elicits change in AM and related processes. One study was identified that piloted film clips for AM content. Morrone, Depue, Scherer and White (2000) investigated the validity of film for inducing motivational and positive activation type states by evaluating many movie clips. Morrone et al. (2000) reported that a film with a sole protagonist in a competitive goal-striving context that ultimately leads to goal attainment produced the greatest increased high activation positive affect. Based on this, and the decision to employ a film in study 4, this movie clip was utilised. A considered issue was difficulty in finding an appropriate control task that did not produce any emotional or motivational effects.

2.6.1.4 *Study 5: Real-Life Success Manipulations*

Success or failure tasks typically expose participants to tests of sham intelligence or cognitive ability which are either manipulated by altering the difficulty of the task or the performance feedback (Nummenmaa & Niemi, 2004). Such tasks have the obvious advantages that they produce more active responses rather than passive watching of stimuli (picture/film). This has implications for the induction of AM, as defined previously. Engaging individuals in a challenge is consistent with activation of the BAS. In the current thesis, a success experience task was used primarily out of a desire to closely replicate and extend a previous study to the context of AM.

2.6.2 Summary and objective for strand one.

A measure of state AM should capture in-the-moment subjective experience related to energization or generation of physiological states, emotions, cognitions, and behaviours by or towards reward-related stimuli. Following a literature review of attempts to measure AM in the moment through biological indices of BAS activation, it was shown that these tools are often confounded, either by a lack of specificity or unreliable findings. Two biological correlates of AM that appear most promising are frontal asymmetry and cardiac impedance. Because of technical limitations (EEG was not available within the context of this research) cardiac pre-ejection period (PEP) was identified as the best available proxy of AM.

Trait measures of the BAS are designed to be sensitive to variation in dispositional positive affect and approach behaviour which has a suspected biological basis (Hasler et al 2010). In contrast, a state BAS measure should capture variation between individuals in subjective feelings such as activation and valence which stem from energization of AM. A valid state AM measure should also be sensitive to changes in these subjective experiences that arise from situational factors. Based on a review of the AM literature it was determined that BAS outputs are relatively understudied, despite being deemed critical in understanding the unfolding of AM in individuals over time. Furthermore, surveying the evidence revealed little robust psychometric evidence supporting the validity of existing scales as state AM measures. As such, there is a need to develop a gold standard self-report measure of AM. Three empirical assumptions were generated to guide empirical evaluation of the validity of the four AM measures described: PANAS-PA, BES, PA, and the AMSAM. These assumptions underpin studies 1, 2 and 3. They are as follows

1. The underlying structure of pooled state AM inventories will be theoretically and empirically consistent with the definition of AM adopted for this research; it will be a multi-dimensional construct with some degree of resemblance to both trait BAS and symptoms of mania.
2. A valid measure of AM will converge with a psychophysiological proxy of BAS activity and be sensitive to BAS triggers.
3. A valid AM measure can discriminate between approach and non-approach related positive affect, such that items are more sensitive to positive affect that is high in activation (e.g. excitement) rather than low in activation (e.g. compassion, contentment).

This chapter has provided an overview of the BAS as a ‘broadband’ system which has several outputs which facilitate reward, collectively known as AM. It illustrated how AM is measurable in subjective experience and indicated by certain biological correlates, including a measure of sympathetic activity. A review of the existing self-report measures highlighted the need for a validated measure of AM that is sensitive to BAS-relevant input, and that can discriminate between BAS-relevant and BAS-irrelevant positive affect. The chapter then concluded with a rationale for the selection of cardiac pre-ejection period as a valid proxy of BAS activity. The findings from studies 1 – 3 were applied to the second strand of research. That is, the self-report measure with the best psychometric profile ascertained from strand one was utilised to measure reactivity and recovery of AM in response to experimental inductions.

3 Chapter 3: Cognitive mechanisms in AM regulation

The second strand of this thesis built upon the work of the first by exploring a potential mechanism by which elevated AM might become sustained over time.

Research described thus far has addressed the BAS dysregulation theory of BD only in terms of demonstrating that stable tendencies towards excessive AM is a vulnerability factor linked to onset, course and severity of mania (e.g. Alloy et al. 2016). These correlational and prospective studies are important because they demonstrate that people who are prone to mania possess a hypersensitive BAS which may represent an endophenotype of BD (Hasler et al. 2010). However, this research does not speak to mechanisms by which AM becomes dysregulated in BD. Research will now be stated that has examined the nature of said hypothesized dysregulation and then an argument will be made to suggest that biases in information-processing may contribute to the upward spiral symptoms seen in the ascent to hypomania and mania.

As a background to strand two, chapter 2 introduced cognitive models of mood dysregulation where transdiagnostic information-processing biases were highlighted as potential mechanisms underlying such dysregulation. Regarding BA dysregulation in BD, little is known about psychological mechanisms that might explain how initial increases in AM might become intensified and sustained. One possibility is that AM associated changes in cognition may act to perpetuate heightened reward sensitivity. Information processing models, as will be seen, are useful for explaining both normal and abnormal regulation of affect and behaviour. Therefore, to ask whether one important form of information processing – selective attentional biases - contributes to elevated AM, was an objective of the second strand of research presented here. The relationship between cognition and attention, and particularly attention and emotion will be outlined. Then the rationale for studies 4 and 5 will be described.

3.1 Cognitive Biases in Psychopathology

Advancement of the BAS dysregulation theory requires an understanding of the interrelationship between AM and other aspects of cognition (e.g. self-worth, thought speed) that are important in bipolar disorder. An advantage of BAS dysregulation theory is that it does not compete with other models, rather it can be integrated with other explanatory models to refine understanding of causal and maintaining mechanisms, as has been illustrated by a recent study that looked at moderating effects of circadian disruption on AM events in individuals with high BAS sensitivity (Alloy, Nusslock, & Boland, 2015).

How information is processed by individuals with psychopathology has been long theorised to have a role in the emergence and maintenance of symptoms. According to Beck, in depression schemas are concerned with failure and loss, and in anxiety, threat or danger. Beck proposed that selective processing of information that is congruent with these dysfunctional schemata reinforces depressive and anxious states (Beck, 1976). Decades of research has identified biased selective processing in three main domains of cognition: reasoning, memory and attention, all which appear to contribute to psychopathology. For example, vulnerability to and diagnosis of depression or anxiety disorder is characterised by biased interpretations of ambiguous events or information, disproportionate recall of negative events, and biased allocation of selective attention toward negative information (e.g. Beck & Clark, 1997; Eysenck, Derakshan, Santos, & Calvo, 2007; Williams, Watts, MacLeod, & Mathews, 1997).

3.2 Attentional Biases

Attention is crucial to the processing of potentially relevant information. Selective attention can be defined as the selection of certain more salient information, over other less relevant stimuli (Yiend, Barnicot, & Koster, 2013). It is proposed to depend on both bottom up and top down processing (Robinson & Sahakian, 2009; Bishop, 2007) and to consist of sub-processes involving the engagement and disengagement of attention. Emotionally salient information is understood to possess automaticity, a concept which refers to quick, efficient, uncontrollable and preconscious selection. To measure variation in selective attention appropriate measures that can capture these attributes are required. To determine the extent to which individuals preferentially attend to certain stimuli, experimental selective attention paradigms are often utilised. In these tasks¹⁷, trials typically consist of the simultaneous presentation of emotional and non-emotional stimuli which forces preferential recruitment of attention. The stimuli is then replaced with a probe in the locus of either the emotional and non-emotional stimuli that previously occupied the visual space (computer screen), which participants are required to respond to (key press) as quickly as possible. Over many trials where the probe is placed in the locus of emotional and non-emotional stimuli with equal frequency, the distribution of an individual's attention between these competing stimuli can be assessed by comparing reaction times to probes in locus of emotional stimuli with reaction times to probes in the locus of non-emotional stimuli. This permits the calculation of an individual's tendency to selectively attend to certain information relative to other information. One of the most commonly used variants` of these tasks is the dot probe visual task developed by MacLeod, Mathew and Tata (1986): this is described in more detail below. Furthermore, these tasks have been adapted in efforts to experimentally manipulate the

¹⁷ These tasks predominately address selective attention to visual stimuli, although other tasks have been developed to capture other modalities e.g. the dichotic listening task where each ear is presented with competing stimuli (e.g. left ear – neutral information, right ear – negative information) Werzel, (2006).

degree to which the individual preferentially attends to certain stimuli. These attentional bias modification procedures alter the contingency between the location of probe and the valence of the stimuli that vacated that location to guide attention away from certain classes of stimuli. These have proved critical in demonstrating the causal influence of modified attentional bias on emotional and motivational states.

Over the last 30 years clinically relevant research has accumulated that has employed this paradigm or variants of it. The central thesis is a model of emotional disorders which states that individuals differ in their allocation of attention to emotional stimuli, and that biased attention to certain emotional stimuli may causally contribute to both the aetiology and maintenance of emotional dysregulation (Bar-Haim, 2007). Broadly, research has sought to determine if a) attentional biases are associated with psychopathology b) if such biases can be experimentally modified to affect clinical outcomes. Before turning to research that has investigated bias to positive information the key literature pertaining to attentional bias and psychopathology will be summarised illustrating how 1) attentional biases to negative stimuli are associated with diagnosis of anxiety; 2) experimentally induced anxiety state increases bias to threat stimuli, in both healthy individuals and those with an anxiety condition; 3) systematic experimental manipulation (training) of attentional bias towards threat stimuli results in increased levels of state anxiety in response to a stressor; 4) Training of attentional bias away from threat stimuli results in less increase in state anxiety in response to a stressor in both clinical and normal populations and has led to the initial development of potential therapeutic interventions.

Selective attention research has demonstrated threat-related attentional biases are associated with anxiety. In the visual dot probe task (MacLeod et al. 1986) negatively-valenced stimuli and emotionally neutral stimuli are very briefly (e.g. 500 ms) simultaneously presented to different visual areas of a screen before they are replaced by a visual probe (e.g. a black dot) which is positioned in the location vacated by one of the previous stimuli. Participants are instructed to make a manual response (e.g. key press) to indicate the location of the probe (behind the negative or neutral word) as quickly as possible. The relative speed with which individuals attend to negative or neutral stimuli provides an index of the degree to which attention is selectively oriented to negative stimuli. The application of this task in clinically anxious individuals as compared to healthy controls has robustly demonstrated that the former group displays faster reaction reactions to threat related stimuli indicating an attentional bias towards threat. This appears characteristic of anxiety disorders and has been evidenced in spider phobias, PTSD, panic disorder (MacLeod, et al. 1986; Mogg, Bradley, & Williams, 1992; see Bar-Haim, 2007, for a meta-analytic review) and has been evidenced in individuals with high trait anxiety. Overall evidence suggests there is an overriding emphasis on threat detection in anxious individuals.

A problem arising from this research that has tested for attentional biases in individuals diagnosed with anxiety disorders is difficulty disentangling state and from trait influences (patients often have elevated levels of current symptoms compared to controls). This is important because biased attention that is the result of an anxious state needs to be distinguished from attentional bias to threat that marks a vulnerability to psychopathology. This is because the latter represents a clinical mechanism whilst the former pertains to normative adaptive processes. To overcome this problem experimenters often induce anxious states and measure the effects on attentional bias to threat. Studies that induce stress in non-clinical samples have demonstrated increased bias to threat stimuli, as compared to

individuals who underwent a neutral mood induction, and importantly this has been replicated in clinical samples (e.g. Edwards, Burt & Lipp, 2006; Edwards et al. 2010). Furthermore, self-reported state anxiety is robustly associated with magnitude of bias to threat (Bar-Haim et al. 2007). More recently, Nelson, Purdon Quigley, Carriere and Smilek (2014) utilised eye tracking measures to establish that state anxiety, and not trait anxiety, predicted bias to threat stimuli. Overall this suggests that in addition to bulk of research supporting an association between attentional bias to threat and diagnosis of an anxiety disorder, emotional states at baseline or those experimentally induced using laboratory procedures, are associated with self-reported state anxiety.

Experimental manipulation (training) of attentional bias appears to result in increased state anxiety but only after exposure to a stressor, suggesting that it heightens vulnerability to external stressors rather than directly influencing anxiety. MacLeod and Colleagues (2002) employed an attentional bias modification procedure like that described above where one group received a dot-probe task in which the probe was always behind threat stimuli whilst another group received a dot-probe task where the probe always appeared in the place of a neutral stimuli. The aim was to induce diverging transient changes in attentional selection of negative information and examine the extent to which these changes influenced state anxiety and changes in anxiety in response to a stressor. The manipulation was successful; the toward-threat condition served to increase bias towards negative stimuli and the avoid-threat condition served to decrease negative bias. Interestingly, the effects of attentional training had no effect on state anxiety measured immediately after training but did influence response to a stressor. Individuals who were trained to attend to threat displayed elevated anxiety in response to the stressful task, as compared to those whose attention was trained away from threat. Thus this study illustrates that, instead of being an epiphenomenon of the system that mediates anxiety, selective attention may increase vulnerability to stressors, and therefore

may be involved in the development and maintenance of anxiety disorders (MacLeod et al. 2002). It also provided a paradigm to manipulate visual selective attention which has been well replicated and extended to pictorially-valenced stimuli (Eldar, Ricon, & Bar-Haim, 2008) and with depression-related stimuli (Dandeneau & Baldwin, 2009).

By employing similar bias modification procedures attentional biases can be reduced to build resilience to stressors, and by addressing concerns about longevity of effects, attentional bias reduction can produce prolonged reduction of anxiety levels in both clinical (Schmidt et al. 2009) and non-clinical analogue populations (See et al. 2009). Recent advancements have seen the development of cognitive bias modification of attention.

Cognitive bias modification of attention for depression relevant stimuli, which often involve stimuli relating to loss and failure, has been studied much less, although associations between bias for negative stimuli and depressive symptoms have been evidenced. Currently, there is more evidence to support experimental modification of interpretative biases in depression (MacLeod & Clarke, 2013).

To summarise, biases in information processing exist across diagnostic categories which exist in interpretation, memory and attention. It has been demonstrated how attentional biases to threat stimuli are robustly associated with state, trait and clinical presentations of anxiety in a variety of methodologies, and how these biases are malleable. Modification of attentional processing biases has been translated in to interventions with some success (MacLeod & Clarke, 2013). This research has been paralleled by similar programmes of experimentation that have resulted in bias modification programmes for memory bias (Tran, Hertel & Joorman, 2011) and interpretative bias (White et al. 2011). However, it should be noted that early assessment of the efficacy of attentional bias modification for alleviating symptoms has produced mixed findings. A recent meta-analysis suggests bias modification

effect sizes are small in both depression and anxiety disorders with only modest therapeutic benefits (Cristea, Kok, & Cuijpers, 2015). Nonetheless, there is compelling evidence that attentional biases to negative stimuli causally contribute to vulnerability to emotional disorders. What follows is a summary of how motivational systems have been implicated in cognitive biases characteristic of psychopathology.

The research described on anxiety has strayed from the key focus of this thesis. However when anxiety is viewed as manifestations of excessive avoidance motivation (Dickson & MacLeod, 2004), and biased processing is deemed a transdiagnostic process then attentional biases to approach-related stimuli transpire as an ideal candidate to test for processes that contribute to excessively elevated and maintained AM levels as predicted by BAS dysregulation theory of BD. Evidence that individual differences in BIS sensitivity moderate selective attention for threat detection such that those with a vulnerability to anxiety (high BIS) attend to threat stimuli quicker than those with low BIS (Williams, Watts, MacLeod, and Mathews, 1997) has prompted interest in attentional biases related to trait BAS sensitivity.

Some theoretical explanations of emotion and selective attention suppose that motivational systems underlie these relationships (Van der Heijden, 1992). Indeed, Robinson and Berridge (1993) viewed attentional bias as an output of the reward-seeking neural structures.

Alternative explanations posit that two orthogonally related dimensions of valence and engagement underpin selectivity of attention (e.g. high arousal indicative of engagement with environment) (Lang, Bradley, & Cuthbert, 2008). Crucially, these accounts offer different predictions of how trait BAS sensitivity relates to preferences for negative information. A valence model would view trait anger as a dispositional affect and therefore predict it to be associated with biased attention toward threat, whereas a motivational account would not predict this as threat hypothesized to be BIS-mediated. In support of the motivational model,

Ford, Tamir, Brunye, Shirer, Mahoney and Taylor (2010) found that trait anger correlated with attentional bias for reward-related stimuli but not threat-related stimuli. This demonstrates that biases for threat stimuli evident in trait BIS sensitivity is mirrored by biases for reward stimuli in trait BAS sensitivity.

Comparatively, very little research has been conducted on attentional biases for reward or positive information, particularly with respect to state influences. This is important because understanding how early stage emotional regulation (outside awareness) is key to mapping the trajectories of induced/positive mood AM states. To address this gap in research, studies 4 and 5 test how variation in Hypomanic Personality Scale moderate the impact of induced AM upon attention to reward-related stimuli, and then how manipulating biases for reward-related stimuli affects AM. Research that has tested for attentional biases in approach-congruent stimuli will be reviewed to form the rationale for studies 4 and 5, after a more broad summary of the cognitive bias research that has been conducted in relation to BD.

3.2.1 Attentional biases in bipolar disorder

A complication to characterising selective attention for emotional material in BD is that most individuals with this diagnosis are likely to have problematic positive and negative mood states and attentional dysfunction may be present in both. Historically, research has mostly concentrated on attentional processes related to negative mood and stimuli in BD. Key studies will be briefly described before more recent and relevant literature relating to biases for positive or reward-related information is reviewed. It should be noted that a lot of the following studies employed relatively indirect measures of attentional bias, limiting firm conclusions from being made.

3.2.2 Depression-related biases

Bentall and Thompson (1990) and French, Richards, and Scholfield (1996) demonstrated that both manic and hypomanic bipolar patients show an attentional bias for negative material, with Lyon, Startup and Bentall (1999) replicating this finding in patients in the depressive phase of the illness. In a construct similar to selective attention, Murphy et al. (1999) reported significantly impaired ability to shift the focus of attention away from negative stimuli in depressed patients and positive stimuli in manic patients. A shortcoming of these studies is their use of a task that measures attentional interference (Stroop) and shifting rather than selective attention. Only a handful of studies to date have investigated attentional bias in BD using a pure measure of selective attention (dot probe task). A study that did measure selective attention directly assessed bias to positive and negative stimuli in bipolar depressed, bipolar euthymic and healthy controls (Jongen, Smulders, Ranson, Arts, & Krabbendam 2007). As compared to healthy controls, the sample of depressed bipolar patients displayed a bias away from both negative and positive words. A second finding of this study found an attentional bias away from positive stimuli in euthymic individuals (Jongen et al. 2007). Thus, it appears that biases towards negative information are evident across phases of the illness as detected by indirect and direct measures of selective attention but unsurprisingly bias towards negative stimuli is more characteristic of depressive states. Negative biases in BD corresponding to those in unipolar depression would be expected, as depressive processes in unipolar and bipolar depression are thought to share some etiological features (Treadway & Zald, 2011). Jongen et al.'s finding that biased processing away from positive stimuli was present in euthymic individuals is of theoretical interest when considering tentative finding that a bias towards positive material is associated with mania (Murphy et al. 1999). What is surprising is that only a few studies have more systematically

tested for biased attentional selection of positive material that might help explain processes relevant to the development of mania.

3.2.3 Mania-relevant biases.

Before considering the literature on reward-related biases it is worth stressing that from a broad theoretical perspective, it is unclear at what stimulus presentation duration the mutually causal relationships seen between avoidance and early attentional processes should be mirrored with respect to reward. Some suggest that selective attentional processes relevant to the avoidance system are more easily detected than those related to approach due to a greater threat to survival that FFFS and BIS – relevant stimuli represent (Mogg & Bardley, 1998).

In a previously cited neuropsychological investigation of ability to shift attention away from emotional material, currently manic and depressed individuals displayed biases for positive and negative stimuli respectively (Murphy et al. 1999). The finding that individuals in a manic state showed poorer ability to shift attention away from positive stimuli suggests a state-dependant attentional preference for positive material that contrasts with Jongen et al.'s evidence for a bias away from positive in euthymic individuals with BD. However, comparisons are restricted by use of tasks that tap different aspects of attentional deployment.

A study that measured eye-tracking on 20 second presentations of happy, sad and neutral images allowed comparisons between phase of illness on initial orienting, engagement and overall attentional allocation (García-Blanco, Salmerón, Perea, & Livianos, 2014). No differences were revealed between depressed, euthymic and manic individuals orienting speed. However, speed of orienting - which is most akin to attentional detection without competition for selection - towards positive information was slower for depressed individuals compared to healthy controls (Garcia-Blanco et al. 2014). This result is consistent with

evidence supporting an avoidance of positive material in depression but is inconsistent with biased attention away from positive stimuli found in euthymic individuals by Jongen et al. (2007). It also does not align with tentative evidence for a positive attentional bias in mania (Murphy et al. 1999).

The absence of evidence for reward-related biases in euthymic states might be surprising given that cognitive style has been found to be overly-positive (highly ambitious, elevated success expectancy) in BD (Johnson, Ruggero, & Carver, 2005; Wright et al. 2005). Rather, it is feasible that biases in early processing emerge after certain BAS-activating events (this point is theoretically developed below). The best designed study to date of attentional bias in BD sought to explore this hypothesis in relation to positive material by investigating attentional biases subsequent to an induced AM state in 90 euthymic BD individuals, compared to 91 healthy controls (Pickford, Johnson, & Gotlib, 2015).

Subsequent to AM mood induction selective attention was assessed by an adapted dot probe task which used affective faces as stimuli (happy versus neutral faces, sad versus neutral faces). The induction was successful in elevating mood in both groups but no differences in attentional biases between the BD group and controls were found, for either valence (happy or sad). This result is consistent with another study that failed to find any differences in attentional biases between euthymic and healthy controls (Jabben et al. 2012). Pickford et al.'s results extend this finding to suggest these biases do not arise even when mood is elevated. However, a significant methodological shortcoming in Pickford et al.'s study was that the between subject study design only allowed conclusions to be made against control participants. Thus this design does not permit conclusions to be drawn about the influence of mood induction upon change in attentional bias within participants.

There is therefore a need to investigate if selective attention for positive information changes in response in AM state. It could be the case that baseline bias away from positive (e.g. Jongen et al. 2007) could mask the lack of difference produced by elevated mood. Although Pickford et al. went to great efforts to stratify their sample in order to reduce the influence of confounds, the extent to which residual symptoms and medications influence results could not be fully discerned. As discussed previously, analogue samples of individuals who differ in vulnerability to BD provide a useful window into premorbid characteristics that bypasses said issues with patient samples. The only previous BD vulnerability study of selective attention assessed baseline biases for positive stimuli only. This study failed to find differences in selective attention when comparing high risk versus low risk groups (Rock, Goodwin, & Harmer, 2010). In short, Pickford and colleagues' attentional bias study within a clinical group did not explore change in bias as a result of induced AM, whereas Rock and colleagues (2010) analogue sample study did allow for baseline comparisons to be made between BD vulnerable and non-vulnerable individuals, but did not permit inferences about the effects of elevating mood. Given these design caveats, and the aforementioned advantages of analogue samples, there is a clear need to address these gaps in knowledge by employing within-between subjects designs that can disentangle change in attentional bias.. This partly forms the rationale for study 4 (chapter 7), whilst a second aim of this study is to investigate the relationship between AM states and attentional bias in the general population. Attention will now turn to this literature.

3.2.4 Impact of positive affective state on selective attention to reward:

The literature pertaining to early attentional processing of positive information is relatively sparse compared to the negative stimuli literature. The most influential programme of research that tested for associations and causal relations between AM/positive mood states and selective biases to positive material was conducted by Tamir and Robinson (2007). In an

initial study an association was found between high positive mood ratings (measured 35 times over 7 days using an experience sampling method) and greater tendency to selectively attend to reward words. Therefore, naturalistic positive mood but not negative mood correlated with bias towards reward. It should be noted that experience sampling mood adjectives corresponded both to AM related high activation positive affect (enthusiastic, excited) and positive affect not relevant to AM (calm, relaxed). Whereas, the word stimuli used in the dot probe task were selected for their closely related to AM.

A second study manipulated autobiographical memory to induce a positive, neutral and sad mood states in order to test for causal influences of mood on bias. Compared to neutral and sad mood states, positive mood led to preferential selection of rewarding stimuli, emulating the congruency seen between negatively-valenced states and biased attention for negative stimuli. Moreover, the effect was found in both shorter (300 millisecond) and longer presentations times, suggesting the effects occurs across early processing (study 1 used 500 ms presentations only) (Tamir & Robinson, 2007).

A third study replicated the previous study but sought to find differential changes in bias. Because depressive states are inconsistent in eliciting attentional bias (Williams et al. 1997) but anxious material more reliably biases attention towards negative stimuli, in study 3 Tamir and Robinson (2007) compared positive with anxious mood induced through a different modality, imaginary vignettes. Results did mimic study 2 in that positive mood served to bias attention toward reward stimuli relative to neutral stimuli. Furthermore, by using induced anxious states as a comparison, the researchers extend the second study's findings that sad and neutral states do not bias attention towards reward.

In study 4, Tamir and Robinson (2007) again used imagination vignettes. This time the researchers induced positive versus neutral mood states but refined their selection of dot probe stimuli to tests for differences between AM-relevant and AM-irrelevant stimuli. BAS

theory would suggest attentional selectivity that favours positive stimuli associated with reward rather than positive stimuli that might reflect other underlying motivations (e.g. BIS/FFFS). Results showed that as predicted, positive mood state produced a bias for reward words only, and not low activation words. The researchers suggested the findings might be interpreted as indicative of dopaminergic ‘wanting’ process driving preferences for reward and not mere stimuli of a general positive valence. To replicate and extend their findings in studies 1 - 4, Tamir and Robinson (2007) conducted a final study in which these ruled out semantic priming causing their previous findings by using lyric-free musical mood indications. Previously validated positive music did serve to bias attention in favour of reward stimuli relative to neutral stimuli and so provided evidence that verbal priming was not responsible for Tamir and Robinson’s (2007) earlier findings.

Overall, this systematic series of experiments provides strong initial results to support the claim that positive affect relative to neutral or negative affective states, serves to make reward stimuli in particular more salient, as measured by word-pair dot probe tasks. At the start of this chapter it was suggested that biases in selective attention for emotional material might be present predominantly for threatening information as a consequence of adaptive/survival pressures. Tamir and Robinson (2007) have demonstrated that such biases for positive information are associated with naturalistically measured positive mood. Critically, they have also demonstrated discriminative validity in that only positive mood states (as compared to neutral and negative states) bias attention towards positive stimuli and that this effect is limited to BAS-relevant (i.e. rewarding) positive stimuli.

3.3 Manipulation of Selective Attention towards positive stimuli in the General population

Very few studies to date have investigated whether the causal influence of positive mood states on selective attention of positively-valenced is bi-directional. This is of obvious importance given the evidence that attentional processing of negative stimuli has been shown to be malleable to the extent that reducing negative biases has downstream effects on anxious and depressive symptoms (MacLeod & Clarke, 2013). Furthermore, the early clinical evidence suggests such modification might, with refinement, be translated into effective therapeutic interventions, (Mogoşe, David, & Koster, 2014).

Two studies to date have attempted train selective attention for stimuli of a positive valence, both of which used dot-probe tasks. Firstly Goetz, Robinson and Meier (2008) demonstrated that it is possible to successfully train selective attention towards positive stimuli in the general population. By systematically training attentional bias, either towards or away from positive stimuli, the researchers found the positive bias training led to greater approach-related intentions (the extent to which individuals were likely to engage in approach behaviour), and approach behaviour (a dichotomous free-choice measure: whether participants took the opportunity to chocolate take confectionary at the end of the experiment), although no differences in self-reported affect was found between the groups. A caveat to this study was the lack of dot-probe assessment to ascertain if attention had successfully been manipulated

Secondly, Grafton, Ang and Macleod (2012) employed a more experimentally robust design to investigate a similar hypothesis, namely whether attentional would serve to increase sensitivity in response to a success experience. The researchers also built in dot-probe

assessment tasks pre and post training to directly ascertain the effectiveness of training on baseline selective attention to positive stimuli. Grafton et al. (2012) reported a differential effect of training attention towards positive words relative to training attention away from positive words. Moreover, individuals reported a greater elevation in positive affect after a success experience when they were trained to selectively attend to positive information, as compared to individuals whose attention was trained to selectively attend to neutral information. However Grafton et al. stratified their sample so as to exclude individuals with extreme (high and low) trait levels of positive affectivity. This sample does not inform on the relationship between positive biases and extreme personality traits.

3.4 Strand two: rationale for studies 4 and 5

Overall then there is some initial support for the hypothesis that bi-directional relations exist between attentional biases and positive mood. However, this area of study is only recently attracting attention. Little is known about the relevance of these relations for BD. Theory suggests that attentional processing of reward stimuli is governed by the BAS (Gray, 1970). Overall attentional bias research in BD samples has returned mixed results. Only one study was identified that directly investigated the congruency effect for elevated mood on attentional bias to reward. This study found that bias for positive stimuli subsequent to a mood induction did not differ between individuals diagnosed with BD and healthy controls (Pickford et al., 2015). There is need to investigate this relationship in a sample not compromised by the confounds of patient samples and by using experimental designs that can directly assess manipulation-related change. Furthermore, the reversal of this relationship – the extent to which biases for reward influence AM – is key to understanding the therapeutic implications relevant to the ascent in to mania.

The evidence presented in this chapter provides a rationale for studies 4 and 5. Directly following on from the findings of Tamir and Robinson (2007), Goetz et al. (2008) and Grafton et al. (2012), the studies ask two important questions relevant to BD. Firstly, stemming from Tamir and Robinson's (2007) evidence that positive mood increases positive bias. It is unknown whether individual differences in vulnerability to mania moderate the relationship reported by increased attentional bias for positive stimuli when AM is elevated. It is also not known if individuals with a higher risk to mania, as compared to low risk individuals selectively attend to reward when AM is elevated.

Secondly, and from initial support for the bi-directionality of positive attention and positive mood effect, it is important to know if the malleability of the attentional bias for positive stimuli reported by Grafton et al. and Goetz et al. is present when compared to unaltered selective attention (a condition with no probe contingency) ii) exerts differential downstream effects on mania-relevant variables.

In this thesis, the research stemming from these two objectives (strand two) can only be interpreted with confidence if the measure of AM detects what it is intended to do. In other words, a prerequisite to drawing accurate conclusions about the relationship between AM and attentional bias is a requirement for a sensitive and valid self-report measure of AM. What follows are three investigations designed to help identify such a measure.

4 Chapter 4: Measuring Approach Motivation at State Level: Exploratory Factor Analysis

As discussed in the literature review, whilst the theorized structure of the BAS has been explored in terms of stable trait characteristics and represented psychometrically, most notably by the BAS subscale of the BIS/BAS measures (Carver & White, 1994), there is little consensus on the structure of the BAS in terms of experiential outputs (AM) which are sensitive to temporal variability, measured via self-report.

Several measures have been developed to measure approach motivation (AM) in the moment but little is known about their underlying structure. A literature review was conducted to identify existing state AM measures. Only three self-report scales were identified that attempt to capture subjective AM. The Behavioural Engagement Scale (BES: Krauss, 1988) is a five time measure with 10-point fully anchored scales. It was developed to capture subjective components of AM as described by Depue, Krauss and Spont (1987) : energy, thought liveliness, interest/excitement, mood and optimism. The scale was designed so that extreme scores represented moderate levels of hypomania and depression (Krauss, 1988). The measure has been used in a small number of studies involving BD patients (e.g. Wright, Lam, & Evan-Davis, 2005) and the general population (Lowenstein, Wright, Taylor & Moberly, 2015).

The Positive Activation subscale (PANAS-PA) of the Positive Affect and Negative Affect Schedule (PANAS: Watson, Clark & Tellegen, 1988) is, in contrast, one of the most widely utilised¹⁸ instruments designed to measure two-dimensional model of affect and has predominately been used to measure positive affect but has also been widely employed to measure approach-related affect. The 20 adjectives that make up the PANAS items stemmed from Zevon and Tellegen's (1982) theory that affect consists of two unipolar dimensions. The PANAS scales were renamed positive and negative activation to indicate that they reflect underlying motivational systems (Watson et al. 1988). According to Watson et al. (1988)

¹⁸ 24092 current citations of the original validation study: Watson, et al 1988 as of March 2017

“high PA is a state of high energy, full concentration, and pleasurable engagement” (pg.1063). However, recent research indicates that anger, an affective state negative in valence, correlates with the PANAS-PA suggesting it may reflect a measure of approach related affect rather than merely high activation positive affect (Harmon-Jones, Harmon-Jones, Abramson, & Peterson, 2009). Furthermore, because it is so widely used, the PANAS-PA has accrued substantial evidence for its reliability and validity (Gray & Watson, 2007). Confirmatory factor analyses of the state¹⁹ PANAS is consistent with a two factor structure of the trait version (Crocker, 1997; (Terraciano, McCrae, & Costa Jr, 2003). Crawford and Henry (2004), using the “within the last week” version of the PANAS found the higher order PA structure to be made up of four sub-components (Interested items: interested, alert and attentive), and Excited, (items: excited, enthusiastic, inspired, Proud/Determined and Strong/Act,ive). This structure has been replicated in subsequent confirmatory analyses used this time frame (Tuccitto, Giacobbi, & Leite, 2010a). The two studies that used the state (“right now”) version of the PANAS did not explore substructure within the two higher-order factors PA and NA because a two-factor model was the best fit of the data (Crocker, 1997; Terraciano et al., 2003). And although state and trait PANAS structures converge on the two-factor model, it is not known if the four factor structure found in the “in general” (trait) and “within the last week” timeframes emerges in the state version. However, it should be bore in mind that when Watson and Clark (1994) systematically explored the substructure of trait PANAS, PA emerged as a single dimension. This is contrary to the only study that specifically explored the PANAS-PA. A hierarchical cluster analysis of the state version of PANAS-PA measured repeatedly over at four times during a student exam period (Egloff, Schmulke, Bruns,

¹⁹ Watson and Clark’s (1994) PANAS-X provided eight different timeframes by which to capture affect by prefixing the instruction. For example, “in general how do you feel..” is the instruction for the trait version and “right now how do you feel..” prefixes the state version.

Kohlman & Hock, 2003). Egloff et al. (2003) found PA to represent three clusters²⁰: Joy (Excited, Proud, Enthusiastic) Interest (Interested, Strong, Determined) Activation (Active, Alert, Attentive, Inspired).

A third state measure of AM is the Positive Activation Rating Scale (PARS: Morrone, Depue, Scherer & White, 2000). This is a single rating scale of 10 anchored double-adjective items that consists of a graduated range of affective and activation adjectives. The scale is comprised of high loading adjectives from the Positive Activation factor described by Watson and Tellegen (1985)'s two-dimensional model. The 10 positively-valenced adjectives and 10 adjectives representing subjective energy state were paired off using factor loadings from Watson and Tellegen (1985) to form a graduated scale. The scale was designed specifically to represent a broad continuum of positive activation ranging from extreme low to extreme high activation. Because the PARS was designed for a specific study it has not been widely used and therefore is not validated outside two studies (Morrone, Depue, Scherer, & White, 2000; Morrone-Strupinsky & Depue, 2004).

A final measure included was a novel single item pictorial scale developed for two reasons. Firstly, the other measures all contain a positive affect component and although the literature review acknowledged that affect is a major component aspect of the BAS, it was thought important to include a scale that attempts to capture valence-free approach motivation. Secondly, because the PANAS-PA, BES and PARS are all lexical in design yet non-verbal pictorial scales have been shown to be valid and reliable (Bradley & Lang, 1994) it was thought important to include a measure that did not rely on verbal processing. The evidence to support the use of non-verbal self-report measures of emotion most notably stems from the Self-Assessment Manikin (SAM: Bradley & Lang, 1994) upon which the novel scale was

²⁰ Cluster analysis can be thought of a dimension reduction technique that clusters items into relatively homogeneous groups, in contrast factor analysis reduces items by common features to reveal latent structures (Lee & Verleysan, 2007)

based. It is a valid and reliable measure that is commonly used in psychological research (to date the original SAM paper has been cited over 4,000 times: Google Scholar). The SAM measure has three subscales: affect, arousal and dominance. However, none of these specifically tap AM. The research team adopted the SAM for AM (Approach Motivation Self-Assessment Manikin: AMSAM see appendice I for all four AM measures). It was hypothesized to capture non-affective feelings of approach (e.g. drive, determination, activation).

In short, the BES represents a comprehensive yet invalidated AM measure, whilst the PANAS-PA is comprehensive in terms of psychometric attributes, and it has been argued that it is a pure measure of AM (Harmon-Jones, Harmon-Jones, Abramson, & Peterson, 2009a), although there are concerns that it is biased towards affective elements of AM. In contrast the PARS was designed to give equal precedence to adjectives that represent positive affect and activation in a single rating scale. A final one-item measure was developed to capture AM activation rather than affective elements of AM in the form a pictorial rating scale (AMSAM).

Dimension reduction analyses of trait BAS measures suggest a multi-dimensional structure to AM that reflects both pre and post reward attainment processes (Carver & White, 1994; Cooper & Corr, 2016). As yet, little is known about the factor structure of state AM measures. Thus, there is a need to characterise the underlying structure of these measures in order to inform future development of a gold standard measure of state AM. With this in mind, the objective of study 1 was to employ exploratory factor analysis to between-subject variation on the total 17 items that comprise the aforementioned scales.

Based on the literature cited, it was hypothesized that a multi-dimensional structure, with dimensions cutting across measures, would be found as has been the case in factor studies of trait BAS measures (Carver & White, 1994; Cooper & Corr, 2016) and in pathologically

elevated AM, as mania is conceptualised here (Johnson et al. 2012; Depue & Iacono, 1989).

As a secondary analysis, the factor structure of PANAS-PA was explored to see whether a one (Watson & Clark, 1994) three (Tuccitto, et al. 2010) or four (Egloff et al. 2003) factor structure emerges for state PA.

4.1 Method

Participants

Data from 418 students was opportunistically sampled from four contexts within the University of Exeter. 245 participants were voluntarily recruited immediately prior to an undergraduate Psychology lecture on two separate occasions (1st cohort, n = 101, 2nd cohort, n = 144), the remaining data was taken from baseline AM scale responses from studies 2 (n = 120) and 3 (n = 52) of this thesis. Of the whole sample 324 (78%) were female and the mean age of participants was 20 years (SD = 3.4, median = 19, range = 17-58). The only inclusion/exclusion criterion was that participants were 18 years or above. Sample size was informed by recommendations from Comrey and Lee (1992) who put forward the following guidelines for conducting EFA: a sample of 300, *good* and a sample of 500 *very good*; the sample should consist of 5 cases per variable as a minimum and 20 cases per variable as ideal. The current study had 24 cases per variable.

4.1.1 Measures

The Behavioral Engagement Scale (BES: Krauss et al., 1992).

The BES is a five-item self-report measure devised to measure current (state) behavioural engagement level. The five items are rated on 10-point, fully anchored scales, and the items

address energy, thought liveliness, interest and excitement, and mood and optimism, which are viewed as key components of the behavioural engagement dimension (Krauss et al. 1992). Higher scores were indicative of higher AM levels. Evidence speaking to the psychometric properties of the BES is sparse. In a factor analysis of the BES, Krauss (1988) found the five items to define one dimension distinct from irritability. Wright, Lam and Brown (2008) in a diary study measuring 28 time points in a sample of both remitted BD individuals and healthy controls reported high internal consistency, with a mean Cronbach's Alpha of 0.90 (SD 0.03). Furthermore, this study found that trait reward sensitivity, as measured by BIS/BAS-F scale (Wright et al. 2008), was related to AM in that the interaction between BAS sensitivity and reward/frustration experienced predicted BES level. Wright, Brown and Newsom-Davis (2005) found it to be sensitive to everyday changes in affect in both BD and healthy individuals whereby significant changes were found in the expected direction following positive and negative mood inductions. In the current dataset, Cronbach's alpha was 0.84 (See Appendix I for all AM measures).

Positive Affect Negative Affect Schedule – Positive Activation items only (PANAS-

PA; Watson, Clark, & Tellegen, 1988): The PANAS- includes 10 positive affect words (e.g., attentive, interested) and 10 negative affect words (e.g., jittery, upset), rated on a 5-point Likert scale (1 not at all; 5 very much) for the degree to which participants “currently feel” each emotion. It is used widely in emotion research and there has been much analysis of its latent structure (see section 4.3). For the purposes of this research only the 10 positive items are used but it is still referred to as the PANAS-PA to avoid confusion with Positive Activation Scale (described below). It should be noted that there are various versions of the PANAS. The current research employed a state version where participants were asked to rate

items based on how they felt 'right now'. With respect to reliability, Watson et al. (1988) administered the PANAS with time-frames ranging from 'right now' to 'during the last year' to a large student sample. The reliability of the PA scale from other studies ranges from .86 to .90 (Jolly et al. 1994; Mehrabian, 1998; Roesch, 1998). Cronbach's Alpha value of PA items for this dataset is 0.87.

Regarding construct validity, Watson (2000) argued that the PA and NA items, as well as measuring overt positive and negative affect, also reflect dimensions of approach and withdrawal behaviour. This is important for the current investigation, where the aim is to identify aspects of AM which are not confined to positive affect alone. An example of evidence for the PA items of the PANAS being a valid measure of positive affect comes from Kahn, Tobin, Massey, and Anderson (2007), who found that relative to a neutral film, a comedy film increased PANAS-PA. Evidence for the validity of the measure with respect to AM in general comes from Harmon-Jones, Harmon-Jones, Abramson and Peterson (2009) who found Anger, an approach-related emotion, to be positively related to the PA items of the PANAS-PA.

Positive Activation Rating Scale (Morrone, Depue, Scherer & White, 2000): This 10-point single rating scale was designed to measure incentive motivation–positive activation (initially measured in response to watching film clips). Each of the ten points were anchored using empirically-derived adjectives that represent both positive emotional feelings and positive incentive motivational feelings. Morrone Depue, Scherer & White, 2000) inspected factor loadings from the Positive Activation factor of Watson and Tellegen's (1985) two-factor model to identify prominent emotional and motivational adjectives and then evaluated their

psychometric performance in other research (Watson, et al. 1988; Krauss, Depue, Spoon, 1985), to construct a scale comprised of 10 paired-adjectives possessing “excellent internal consistencies, retest reliabilities, and factor homogeneity.” (Morrone et al. (2000), pg 1272). Against the other scales employed, the PARS is unique in its explicit attempt to capture both positive affect and AM within one item.

Approach Motivation Self-Assessment Manikin (AMSAM) Additionally, a forth measure has been developed by the research team to offer a valence free non-verbal assessment of AM. This measure has been adapted from the well-established Self-Assessment Manikin (SAM: Lang, 1980; Hodes, Cook, & Lang, 1985) which measures pleasure, arousal, and dominance in a one-item pictorial format. The AMSAM depicts 5 human figures graded by level of AM so that the first figure has his eyes closed and arms folded and the ninth has his eyes wide open and is reaching for the sky. Participants were asked to circle a number 1-9 beneath the figure which best corresponded to their current state of “motivation, driven, and ready to act”.

4.1.2 Procedure

Ethical approval was granted for the study by the University of Exeter ethics committee before data collection. For the 245 participants whose data was collected in the lecture theatre immediately prior to class, the measures were administered to two different undergraduate Psychology cohorts on separate occasions. Before providing consent participants were informed their data would be anonymised, and that the nature of the study was to investigate properties of four questionnaires about positive mood. Age and gender were requested on the first sheet. Therein the order in which the participants completed the questionnaires was counterbalanced.

For the remaining 168 participants, the measures were administered after providing consent to participate in experimental research investigating positive mood and part of the baseline state AM measurements for studies 2 and 3 of this thesis. The order by which the measures were presented was also randomised in these studies.

Approach to Statistical Analysis

The programmes SPSS v.22 and JASP version 8.0.0 were used to perform the statistical analyses. The following statistical tests and procedures were employed: exploratory factor analysis (EFA), Bartlett's test of Sphericity, the Kaiser-Meyer-Olkin (KMO) test of sampling adequacy, Parallel Analysis, Cronbach's alpha, and bivariate correlational analyses (Pearson's r). Broadly there are three dimension reduction techniques: Principal Component Analysis, EFA and Confirmatory Factor Analysis. The latter tests the correlational structure of a dataset when a factor structure has been approximated or hypothesized. It is essentially a verification method. In contrast, Principal Component Analysis and EFA are procedures aimed at summarising and exploring a correlational dataset. Principal Component Analysis does not differentiate between common and unique variance, whereas EFA attempts to omit unique variance and in doing so allows the identification of latent variables which are contributing to the common variance (Fabrigar, Wegener, MacCallum, & Strahan, 1999). Because AM may represent a construct with multiple underlying components related to BAS theory, EFA was deemed more applicable. Prior to analysis, all values for the 17 AM items were transformed into z-scores in an attempt to limit similarities and differences in how the scales were constructed (e.g. Likert scales) being reflected in the derived factor solutions.

Statistical Assumptions for EFA

Prior to parametric analysis, EFA assumptions were checked. Histograms and Skewness and Kurtosis values for the AM items were inspected for normality of distribution (see Appendices III). Visual inspection of histograms suggested roughly normal distributions for most variables. This was corroborated by skewness and kurtosis values that fell between -2 and +2, the acceptable range within which a normal univariate distribution can be claimed (George & Mallery, 2010). Although EFA is fairly robust against violations of the normality assumption (Loehlin, 1998), the roughly normal distribution of most of the AM variables provided an indicator as to which was the preferred mathematical solutions to select to calculate the factor loadings; factor solutions are enhanced when a normal distribution across variables is evident (Loehlin, 1998).

In addition to normality of distribution and aforementioned sample size requirements, EFA requires an assumption of linearity and a process for dealing with outliers²¹. On the presumption that the 17 items, at a broad level, reflect a unitary concept, namely AM, the assumption of linearity was predicted to be met unilaterally. Visual inspection of paired scatter plots of variables confirmed this.

Determining the Number of Factors to Extract. Determining the number of factors to extract from a dataset is an important decision to make when conducting EFA. Incorrect extraction critically affects the outcome, obscuring the true latent structure (Goodwin & Goodwin, 1999). Indeed it has been empirically shown that extracting too many or too few components has deleterious consequences (Fava & Velicer, 1996).

²¹ EFA was conducted on the dataset when data from 4 participants with outlying data were removed. There was no significant difference in this factor solution from that which included the outliers. Therefore, outliers were deemed to represent true data points and therefore retained for analysis. See Appendix III for the solution with outliers omitted.

To determine the most accurate number of factors to extract, researchers have historically relied upon a visual examination of the inflexion point - the point at which the gradient of the slope markedly changes - of a scree plot (Cattell, 1960) or the use of a threshold where an eigenvalue of 1 or above represents enough variation to justify a significant factor (Kaiser, 1960).

Parallel Analysis, a Monte-Carlo estimation method where computational algorithms are ran on large simulated datasets to approximate a solution to a numerical problem, is a now popular approach, which can overcome the ambiguity produced by a lack of convergence between Kaiser/Cattell methods here (Ledesma, Rubén & Valero-Mora, 2007). Parallel Analysis compares uncorrelated randomly generated variables with observed eigenvalues from the correlation matrix (Horn 1965) and offers the most accurate number of factors to retain according to a comparison of various methods (Zwick & Velicer, 1986). To ensure thoroughness, Cattell and Kaiser methods in addition to Parallel Analysis were considered before deciding how many factor to extract.

Factor Rotation and Item Pruning Process

There are two basic types of rotation method employed in EFA. Orthogonal rotations produce factors which are not correlated whereas Oblique rotations permit correlations between factors (Loehlin, 1998). The latter was deemed more applicable to the current dataset; it was predicted that underlying components of AM would not be independent of each other and so an Oblique rotation (direct oblimin, $D = 0$) was used to improve interpretability. Another method of aiding interpretation involved refining solutions using criteria to justify the inclusion or removal of factor loadings. Such criteria, recommended by Fabrigar et al. (1999), were considered here and are as follows:

1. Each factor is identified by loadings greater than .40. Items below this value are deemed irrelevant and are not retained.
2. The solution contained no Heywood cases; Items that produce a problematically high level of common variance.
3. The magnitude of the overall variance explained by the solution. 50% - 70% of the variance is the range commonly deemed adequate.
4. Items which failed to load on any factor and items with substantial ($>.40$) cross loadings are referred to as redundant or unclear, and are not retained.

Type of Factor Extraction

Various EFA extraction methods exist. Because visual inspection of variable histograms (see appendix III) suggested the data to be normally distributed, the initial decision was taken to extract the factor solution using Maximum Likelihood, a method deemed to achieve the most statistically robust structure in relatively normally distributed data (Fabrigar et al. 1999).

However, initial analysis indicated that Maximum Likelihood was not appropriate because of elevated communalities - also known as quasi-Heywood cases (Comrey & Lee, 1993). Quasi-Heywood cases are often attributed to poorly distributed data (Comrey & Lee, 1993). This prompted further analysis of the distribution of the variables. Kolmogorov–Smirnov tests revealed normality had been violated on a number of the variables. As a result, alternative EFA methods were considered. Firstly, Principal Axis Factoring, a common EFA technique which is robust to violations of normality was employed. However, communalities remained high and the final solution produced was difficult (appendix III) to interpret; it suggested an over-extraction of factors. Minimum Residuals (sometimes referred to as Unweighted or Ordinary Least Squares) is an extraction method different to Maximum Likelihood and

Principal Axis Factoring in that communalities are not estimated but instead are derived from the solution (Comrey & Lee, 1993). This was deemed beneficial for the current dataset in which a problematically high proportion of variance in some variables was being explained by the factor solution generated by Maximum Likelihood and Principal Axis Factoring. The decision to use Minimum Residuals was further supported by evidence suggesting it is robust to non-normally distributed data, as Principal Axis Factoring is, yet has a tendency to produce better solutions than Principal Axis Factoring as a product of generating smaller residuals (Comrey & Lee, 1993). Minimum Residuals is the default extraction method of the JASP statistical programme (based on the code of *R* programme) and has a Parallel Analysis engine built-in which corresponds to the algorithm of this method (Love et al. 2015).

4.2 Results

Of the 418 participants, 31 participants returned data with missing values. Because EFA cannot handle missing values their data were omitted, leaving a dataset of responses to 17 state AM items from 387 participants to be analysed. Table 2 shows the correlation matrix for the 17 items. As can be seen all items correlated with each other indicating the data exhibited factorability. All correlations were significant at $p < .001$. Extreme multicollinearity was not present due to the determinant value of the correlation matrix being greater than 0.00001 thus meeting the criteria for performing EFA. The Kaiser-Meyer-Olkin (KMO) test of sampling adequacy returned a value of .923 indicating a factor solution that could yield reliable and distinct factors. Bartlett's test of Sphericity produced a Chi-Square value of 2931.70 ($df = 136, p < .001$) suggesting factor analysis to be appropriate due the presence of a

statistical relationship between the variables²². Unrotated EFA using Minimum Residuals revealed three factors with eigenvalues greater than 1 (see Table 2) accounting for 57% of the total variance. Figure 8 depicts the scree plot produced following EFA using Minimum Residuals.

Table.2. Eigenvalues and total variance for the four AM scales

Factor	Initial Eigenvalues			Extraction Sums of Squared Loadings		
	Total	% of Variance	Cumulative %	Total	% of Variance	Cumulative %
1	7.262	42.72	42.72	6.759	39.757	39.757
2	1.436	8.448	51.167	0.987	5.804	45.562
3	1.046	6.151	57.319	0.513	3.017	48.578
4	0.857	5.044	62.362			
5	0.799	4.699	67.061			
6	0.765	4.5	71.562			
7	0.63	3.706	75.268			
8	0.607	3.569	78.837			
9	0.55	3.238	82.074			
10	0.487	2.865	84.939			
11	0.469	2.759	87.698			
12	0.453	2.666	90.364			
13	0.374	2.197	92.561			
14	0.359	2.112	94.673			
15	0.349	2.054	96.727			
16	0.319	1.875	98.602			
17	0.238	1.398	100			

Note. Unrotated Extraction Method: Minimum Residuals.

Whilst adherence to the Kaiser (1960) approach indicated the extraction of three factors, as shown in table 2, examination of the scree plot (figure 6) following Cattell's criteria suggested a factor extraction either before the 3rd and 4th factor or before 6th or 7th factor, three or six factors. Parallel Analysis was then performed. Parallel Analysis for the 95th percentile of a random dataset for a Minimum Residuals extraction method suggested a five

²² Footnote: where subsequent EFA was conducted, these parameters were inspected once more. Any violations of the assumptions of EFA are reported in the text.

factor solution. Because the evidence favours Parallel Analysis a decision was then taken to extract five factors (Zwick & Velicer, 1986). Employing the item pruning process outlined earlier, the initial five factor solution extracted by Minimum Residuals with an Oblimin rotation required a further iteration because the PANAS-PA items Strong, Interested, Alert and Attentive failed to load on any factor above the .04 cut off.

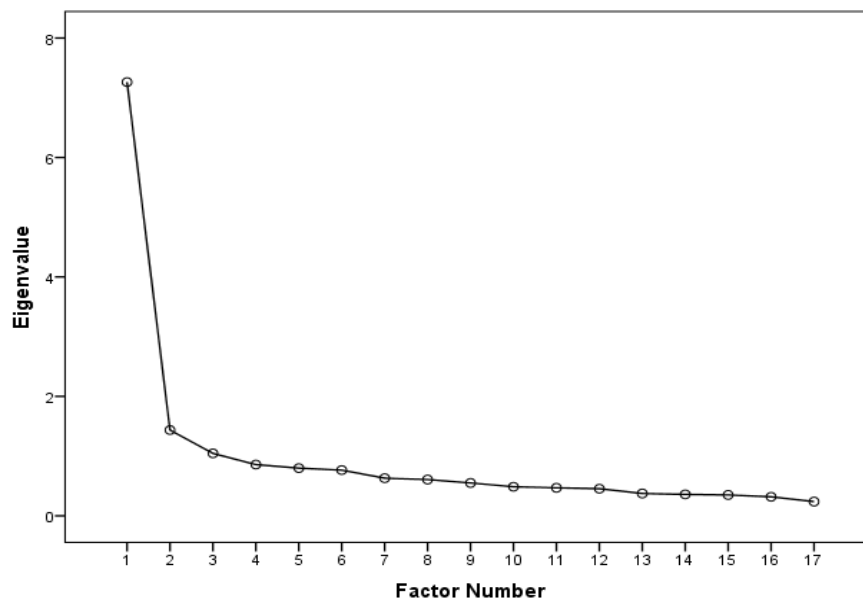

Figure 8 Scree plot

Once these items were removed, a second Parallel Analysis suggested a three factor solution. A three factor solution was produced and resulted in the items AMSAM and Current Alertness failing to load above .04, forcing their removal. Subsequent Parallel Analysis suggested a four factor solution to best fit the data. A four factor solution did not require further iteration and is presented in table 3. To explore the consistency of the final solution split-half analysis was conducted whereby the dataset was randomly divided in to two roughly equal sub-samples.. Following the same protocol taken to arrive at the final solution each sample was subjected to Minimum Residuals with Oblimin rotation. Overall, the primary factors derived mirrored those found in the full sample in terms of content (see Appendix III)

Table 3. Correlation Matrix for the 17 AM items

	C. energy	C. optimism	C. mood	C. alertness	C. enthusiasm	Interested	Excited	Strong	Enthusiastic	Proud	Alert	Inspired	Determined	Attentive	Active	Motivation	Positive Activation
C. energy	1	0.466	0.571	0.451	0.475	0.331	0.277	0.344	0.369	0.354	0.382	0.285	0.289	0.29	0.51	0.36	0.506
C. optimism	0.466	1	0.634	0.397	0.556	0.388	0.289	0.379	0.393	0.443	0.288	0.342	0.315	0.246	0.301	0.411	0.33
C. mood	0.571	0.634	1	0.473	0.649	0.435	0.409	0.426	0.496	0.414	0.31	0.309	0.341	0.293	0.398	0.383	0.505
C. alertness	0.451	0.397	0.473	1	0.56	0.352	0.248	0.264	0.326	0.294	0.312	0.3	0.248	0.286	0.405	0.403	0.43
C. enthusiasm	0.475	0.556	0.649	0.56	1	0.475	0.361	0.37	0.458	0.34	0.313	0.396	0.341	0.325	0.41	0.505	0.407
Interested	0.331	0.388	0.435	0.352	0.475	1	0.397	0.347	0.487	0.376	0.349	0.495	0.439	0.398	0.366	0.424	0.386
Excited	0.277	0.289	0.409	0.248	0.361	0.397	1	0.404	0.539	0.376	0.221	0.413	0.371	0.338	0.372	0.354	0.367
Strong	0.344	0.379	0.426	0.264	0.37	0.347	0.404	1	0.505	0.476	0.345	0.411	0.403	0.293	0.377	0.34	0.383
Enthusiastic	0.369	0.393	0.496	0.326	0.458	0.487	0.539	0.505	1	0.391	0.449	0.5	0.484	0.483	0.425	0.44	0.402
Proud	0.354	0.443	0.414	0.294	0.34	0.376	0.376	0.476	0.391	1	0.235	0.461	0.523	0.295	0.381	0.369	0.373
Alert	0.382	0.288	0.31	0.312	0.313	0.349	0.221	0.345	0.449	0.235	1	0.323	0.261	0.454	0.385	0.233	0.294
Inspired	0.285	0.342	0.309	0.3	0.396	0.495	0.413	0.411	0.5	0.461	0.323	1	0.631	0.432	0.423	0.362	0.336
Determined	0.289	0.315	0.341	0.248	0.341	0.439	0.371	0.403	0.484	0.523	0.261	0.631	1	0.489	0.443	0.45	0.307
Attentive	0.29	0.246	0.293	0.286	0.325	0.398	0.338	0.293	0.483	0.295	0.454	0.432	0.489	1	0.491	0.307	0.229
Active	0.51	0.301	0.398	0.405	0.41	0.366	0.372	0.377	0.425	0.381	0.385	0.423	0.443	0.491	1	0.371	0.412
Motivation	0.36	0.411	0.383	0.403	0.505	0.424	0.354	0.34	0.44	0.369	0.233	0.362	0.45	0.307	0.371	1	0.365
Positive Activation	0.506	0.33	0.505	0.43	0.407	0.386	0.367	0.383	0.402	0.373	0.294	0.336	0.307	0.229	0.412	0.365	1

Note. All correlations sig at $p < .001$

Table 4. Factor Matrix of the final four factor solution

	Factor 1	Factor 2	Factor 3	Factor 4
Current energy			0.79	
Current enthusi- asm		0.52		
Current mood		0.63		
Current optimism		0.81		
Active			0.56	
Determined	0.76			
Enthusiastic				0.56
Excited				0.54
Inspired	0.69			
Proud	0.48			
PARS			0.48	

Note: Extraction Method: Minimum Residuals with Oblimin Rotation. Items prefixed with Current are BES items. Others belong PANAS-PA except PARS (Positive Activation Rating Scale).

Factor 1 consisted of three items from PANAS-PA that appeared to resemble a higher-order goal-orientated theme. It was labelled Motivation. Factor 2, consisted of BES items only and appeared to capture items pertaining to a positive outlook. It was labelled Optimism. Factor 3 captured items relating to activation and therefore it was labelled Positive Activation. Factor 4 captured only two items – PANAS-PA Excited and Enthusiasm – that that did not appear conceptually distinct from the other factors. It was labelled Excited (enthusiastic/enthusiasm was present in two factors). Bivariate correlational analyses were used to explore the relationships between the four factors, displayed in table 3, which are schematically represented in Figure 7.

Table 5. Pearson's Correlations for the four factors

	Motivation (1)	Optimism (2)	Positive Activation (3)	Excited (4)
Motivation (1)	1	.	.	.
Optimism (2)	0.47	1	.	.
Positive Activation (3)	0.56	0.75	1	.
Excited Enthusiasm (4)	0.75	0.61	0.68	1

Note. All correlations are significant at <.001

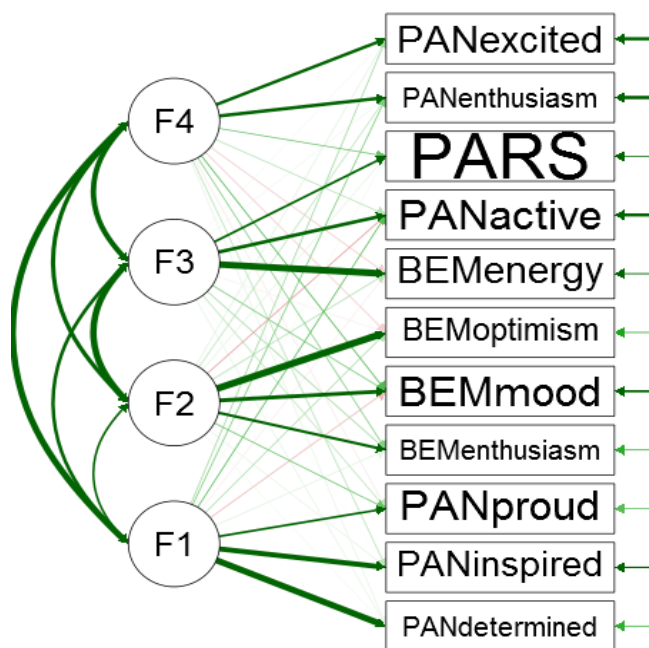

Figure 9 Path diagram of factor structure

Note. F1 is Motivation. F2 is Optimistic. F3 is Positive Activation. F4 is Excited Enthusiasm. The thickness of the lines represents the strength of the correlation between the factors. The thicknesses of the arrows protruding from the right of the variable boxes represent the strength of the factor loading. Green arrows indicate positive relationships. Red arrows indicate negative relationships.

Each factor's internal consistency can be examined if an item from the factor were omitted.

When reliability analysis was conducted, removing items did not affect overall Alpha value in any case. Nunally (1978) recommends alpha values of .7 and above for early scale development, therefore the factor alpha values are generally high enough to permit the factors to be used as a reliable scales, providing justification for use in follow-up studies.

Table 6. Factor Item Reliability

<i>Factor</i>	<i>α</i>	<i>Item (factor loading)</i>	<i>If item dropped Cronbach's α</i>
Motivation	0.77	Inspired (.69)	0.61
		Determined (.76)	0.67
		Proud (.48)	0.77
Optimism	0.83	Current optimism (.81)	0.79
		Current mood (.61)	0.73
		Current enthusiasm (.52)	0.78
Positive Activation	0.74	Current energy (.79)	0.6
		Active (.56)	0.67
		PARS (.48)	0.68
Excited Enthusiasm (.69)	0.69	Enthusiastic (.56)	.
		Excited (.54)	.

Note. α (Cronbach's Alpha value)

A secondary analysis explored how the structure of PANAS-PA corresponds to; a one factor dimension revealed using EFA (Watson & Clark, 1994); four factors revealed using confirmatory factor analysis (Tuccitto et al. 2010a); three factors as suggested by hierarchical cluster analysis (Egloff et al. 2003). The same protocol was applied as described for the main analysis. After three iterations, minimum residuals returned a three factor structure.

Table 7. Comparing PANAS-PA dimension reduction studies

PANAS-PA EFA structure from current dataset			
Determined(.86)	Active (.44)	Proud (.50)	
Inspired (.51)	Alert (.65)	Strong (.69)	
	Attentive (.67)		
Egloff et al. 2003 hierarchical cluster analysis			
Interest	Activation	Joy	
Determined	Active	Excited	
Interested	Inspired	Proud	
Strong	Attentive	Enthusiastic	
	Alert		
Crawford and Henry (2004) and Tuccitto et al (2010) four factor structure			
Determined	interested	Excited	Strong
Proud	alert	Inspired	Active
	attentive	Enthusiastic	

Note. The current study employed exploratory factor analysis (EFA). Egloff derived three clusters from seven measurement point over a month. Crawford and Henry (2004) and Tuccitto et al.(2010) derived four factors from confirmatory factor analysis of the "within the last week" PANAS-PA timeframe

To utilise the factors in subsequent analysis, factor scores were computed using the mean of the standardised scores of the relevant items for each factor. Justification for the use of a two-item scale in follow-up research is provided in subsequent sections.

4.3 Discussion

To reiterate, the aim of this study was to explore the underlying composition of state AM as indicated by existing self-report instruments. As predicted, a multi-dimensional structure with four correlated factors emerged from the data. Using Minimum Residuals extraction method, three iterations were required to achieve a clean solution that explained a large portion of the variance and was somewhat consistent with the substructure of PANAS-PA in confirmatory factor analyses (Crawford & Henry, 2004; Tuccitto et al. 2010) and bared some resemblance to a longitudinal cluster analysis of PANAS-PA (Egloff et al. 2003). The final four factor solution explained 72% of the total variance, with Cognitive AM explaining 47 %, Optimism 11%, Positive Activation 7.4% and Excited 6.9%. The internal consistency of the four factors was generally acceptable, according to the standard required for early scale development (Nunally, 1974). The fourth factor, Excited, was comprised of only two items, but was retained because it explained nearly as much variance as the third factor, Positive Activation, and appeared important to previous temporal analysis of PANAS-PA (Egloff et al. 2003).

The solution was fairly stable, particularly Optimism (BES items: optimism, mood, enthusiasm) and Cognitive AM factors (PANAS items: Determined, Inspired, Proud), which both emerged from split-half analysis. Six items were dropped from the initial 17 items (AMSAM, PANAS-PA items - interested, strong, attentive, alert and BES-alertness).

The findings will be discussed in the context of the structure of AM and in relation to previous dimension reduction analyses of the PANAS-PA, in light of little factor evidence pertaining to the other measures.

4.3.1 Four factor structure in relation to BAS theory

Early theory on the structure of state AM conceptualised a unidimensional structure that corresponded to the Positive Activation (PANAS-PA) factor described by Watson and Tellegen (1988). Depue (1987) proposed the underlying structure of PANAS –PA to represent a single dimension loaded with a combination of locomotion, energy and mood which covary together cohesively. Later, Depue stated four processes underlie facilitation of reward: locomotor activity, incentive-reward, affect, complex cognition (Depue & Collins, 1999). The current factor structure suggests the presence of three of these: complex cognition (Cognitive AM :determined, inspired, proud:) locomotor activity (Positive Activation: feeling energetic, active, positively activated) and affect (Optimism: optimism, mood, enthusiasm). According to Depue et al. (1987) incentive-reward is manifested as interest. This seems to resemble the interested, attentive, alert factor found previously, that did not emerge from the current analysis. However this structure was reported using the “within the last week” timeframe (Crawford & Henry, 2004; Tuccitto et al. 2010). The only evidence speaking to the interested item in a state context is the Interested facet (interested, determined, strong) reported by Egloff et al. (2003). The three clusters identified in this research were derived from dynamic changes in the ten PANAS-PA items over time. It is possible that such a component is only detectable in individuals in the context of reward (i.e. working towards a goal) and so it is plausible that it did not emerge in the current data because the majority of participants were assessed on a single measurement point, in which the current motivational/affective state of the participants was unknown.

4.3.2 The Structure of PANAS-PA.

Various factor analyses of the PANAS have been conducted, although most prioritise investigating the stability of Watson and Tellegen's (1985) two-factor model of affect. Of those, only two used the state version, both of which did not report on the substructure as results supported the two higher-order dimensions of NA and PA (e.g. Crocker 1997; Terraciano et al. 2003). Therefore the only information available on the structure of state PANAS-PA comes from the four factor structure which emerged from the "within the last week" timeframe version (Crawford and Henry, 2004; Tuccitto et al. 2010), and from the three clusters reported from analysis of dynamic change in PANAS-PA over a four week study (Egloff et al. 2003). To assess convergence between analysis of temporal change in and recent retrospective rating (within last week) of PANAS-PA, factor analysis was conducted on just PANAS-PA. A three factor structure emerged which showed a degree of consistency with the other solutions. The determined item was a stable feature across studies, although it loaded with different items in each study. Excited and enthusiastic together, which was also the fourth factor of the main analysis here, was a feature of both dynamic PANAS-PA and recent retrospective PANAS_PA, but was not retained in the current PANAS-PA analysis. Importantly, alert and attentive together was feature of all analyses. These items did not survive the main analysis. Because Egloff et al. (2003) investigated temporal change in clusters over the course of naturally occurring stress (exam period) these findings are most pertinent to the broader thesis. The differences between Egloff et al. dynamic clusters and the dimensions found at one measurement point in the current analysis suggest that the PANAS-PA are considerable although the difference in methodology are also stark, especially when considering that items were pruned in the current analysis. Two potentially important similarities emerge: 1. Determined and Proud both load on separate facets, although

alongside different items in each analysis 2. Alert and Attentive covary together on the same facet.

With respect to the main analysis this implies the additional variance brought from the PARS, BES and AMSAM significantly diversifies state AM item structure. Encouragingly, the Excited scale, which with only two items and the smallest shared variance was considered least significant, featured in the temporal analysis of PANAS-PA. This, alongside acceptable reliability, justifies the use of a two item Excited scale in follow-up research although proud was grouped in this cluster, whereas it loaded on the Cognitive AM factor in the main analysis reported here. Furthermore, the absence of a dimension reflecting alertness and attention, but the existence of this pair in both the temporal cluster analysis and recent retrospective analysis suggests a caveat to main findings. Overall, the lack of convergence gives reason to be cautious in making firm conclusions on the structure of state AM. That said, the robustness of Egloff et al.'s (2003) three clusters might be questioned due to a small sample size (35).

4.3.3 Limitations

There are many limitations to the current study. Firstly, although raw scores were standardised it was not possible to fully eliminate the influence of scale design being reflected in the factor structure. Although the Positive Activation factor consisted of items from three different scales, Cognitive AM and Optimism were wholly composed of PANAS-PA and BES items, respectively. Furthermore, two items that reflect enthusiasm (BES-enthusiasm and PANAS-PA-enthusiastic) did not load on the same dimension, as would be expected if differences in scale design were not a concern. Nevertheless the four factor

structure does seem to offer fairly separable components of AM worthy of further investigation.

Secondly the undergraduate, predominantly female participant sample cannot be said to be highly representative of the general population, although the imbalanced gender ratio may not have been a problem as Crawford and Henry(2004) found the structure PANAS not to differ between genders. Furthermore, a valid measure of AM should be sensitive to individual variation in response to AM triggers. The cross-sectional design only permits between-individual variation in AM to be gauged.

Thirdly, firm conclusions on the structure of AM are further restricted by the lack of a priori theory. Depue et. al (1987) suggested a single dimension represented by aspects of PANAS-PA. However, the BES which was developed by collaborator of Depue (Krauss, 1988) presents a broader interpretation of AM in that it incorporates bipolar scales²³ (scoring the lowest on optimism requires endorsing “ everything seems bleak and futile, feel totally inept”). Conceptually, such feelings are consistent with a depressive state and is in contrast to the PANAS which does not incorporate negative affectivity but rather absence of highly-activated positive affect. Although hypoactivity of the BAS is theorised to be important in depressive states (e.g. Alloy et al. 2015), the development of a scale to measure AM for the study of mania is not as concerned with being sensitive to lower ends of BAS output, as it is with capturing the subjective experience of elevated AM. Another prominent AM theorist believes motivational feelings are difficult measure with self-report (Harmon-Jones, 2013). The current study, and the findings of Egloff et al. (2003) suggest state AM is separable, but further research is needed in order claim that the reported component(s) actually measure the energization of emotional, cognitive and bio-behavioural processes by or towards reward-related stimuli, as AM is defined here.

²³ In both senses of the word (affectively and opposing entities along the one dimension)

To summarise, factor analyses of existing state self-report AM items measured at a single measurement point revealed a four factor structure corresponding to complex cognition (Cognitive AM :determined, inspired, proud:) locomotor activity (Positive Activation: feeling energetic, active, positively activated) affect (Optimism: optimism, mood, enthusiasm) and Excitement (excited, enthusiastic). A potential caveat, was the absence of a dimension representative of interest, attention , and alertness and a design that did not allow information about the temporal variability of these factors. Studies 2 and 3 extended these findings by testing the factor scales for differentiated responses to AM and control inductions.

5 Chapter 5: Convergent validity of AM scales against a psychophysiological indicator of Approach Motivation

According to the BAS dysregulation theory of bipolar disorder (Depue & Iacono, 1989) individuals with BD demonstrate excessive increases in Approach Motivation (AM) in response to signals of potential reward. Thus far, the testing of this theory has relied heavily on trait measures of propensity to approach reward. As a result, there is a paucity of literature pertaining to the validation of brief state measures of AM. Indeed multiple authors in the field of BD research have called for refinement of self-report measure (Johnson, 2005, Scott et al. 2017). Scott et al. in particular highlights a need for biological and self-report indices of the BAS to converge. The development of a validated state AM scale is necessary to accurately explain processes that contribute to AM regulation. Furthermore, it would allow state AM to be longitudinally measured in bipolar disorder populations within natural settings. In doing so, this would enable researchers to better investigate the hypothesized excessive responses to reward that are implicated in the ‘ascent into mania’. Therefore the purpose of this study was to help identify such a measure by validating existing self-report items of state AM against a proxy psycho-physiological measure of AM, within a non-clinical population (undergraduate students). As discussed in Chapter 2, cardiac pre-ejection period (PEP) appeared to represent the best available biological marker of AM (e.g. Brenner, Beauchaine, & Sylvers, 2005) when acknowledging what was technically feasible.

This study had four objectives. The first objective was to examine the performance of self-report measures of AM and the factor subscales derived from study 1 in response to a

face valid AM induction²⁴ relative to a neutral control condition in the lab. Comparing the self-report measures against an empirically supported psychophysiological marker of AM to test convergent validity was the second objective. A third objective was to replicate previous research (e.g. Sutton & Johnson, 2002; Gruber, Johnson, Oveis, Keltner, 2008) implicating heightened AM reactivity as measured through both self-report and via psychophysiology in individuals vulnerable to BD. Finally, to examine the possibility that relationships between HPS and AM are nuanced according to different aspect of hypomanic personality (Schalet et al. 2011), these relations were inspected by three subscales (see section 2.2.1): mood volatility, social vitality and excitement. The current study pursued these four objectives under primary hypotheses that tested two assumptions of validity, and secondary hypotheses regarding the relationship between hypomanic personality and AM.

Primarily, the four AM scales and the four subscales generated from study 2 were evaluated as measures of state AM against the following assumptions:

1. A valid measure of AM will increase in response to an experimentally induced AM state relative to a control condition.
2. A valid measure of AM will covary significantly and negatively with cardiac PEP activity within participants across time, such that high self-reported AM will be associated with shorter cardiac PEP.

The following secondary hypotheses were also tested:

H1: Total Hypomanic Personality score will moderate response to the AM condition relative to the control condition such that individuals who score high on the HPS will exhibit elevated psychophysiological and self-report responses to the AM induction.

²⁴ Well-established measures of pure valence and pure activation arousal, Valence and Activation Self-Assessment Manikins (Bradley & Lang, 1994) were included to check that the AM induction was empirically valid. That is, a valid AM manipulation would expect to produce elevated valence and arousal.

H2: The HPS sub-scales of Mood Volatility, Social Vitality and Excitement were submitted to analysis to also test for a moderation effect on AM. However, due to the novelty of this question (HPS subscales have hitherto only been tested in correlational research) these analyses were exploratory in nature.

5.1 Method

Participants and Design

A sample of 52 University of Exeter students (34 female) volunteered to participate in exchange for either course credit or payment (£5 cash). They were recruited from the psychology department via a database of individuals who wished to be informed of opportunities to participate in research in the department. The mean age of the sample was 21 years ($M = 21$ $SD = 3.1$ range = 18-36). Apart from a requirement to be 18 years of age, there were no exclusion criteria. Ethical approval was granted by the department ethics committee.

The design of the study was between-within subjects, with repeated measurements (labelled Time in statistical analysis) of state self-report AM and PEP as dependant variables and experimental condition (AM induction or Neutral mood induction) as the between subjects variables. A second aspect of the design was the inclusion of 4 measurements interspersed across two induction phases, per condition, which were included to provoke variation in AM activity. Because the design included four measurement points per individual this represented nested data, this therefore allowed multi-level analysis techniques to be performed that are optimal in accounting for both within and between subject variation.

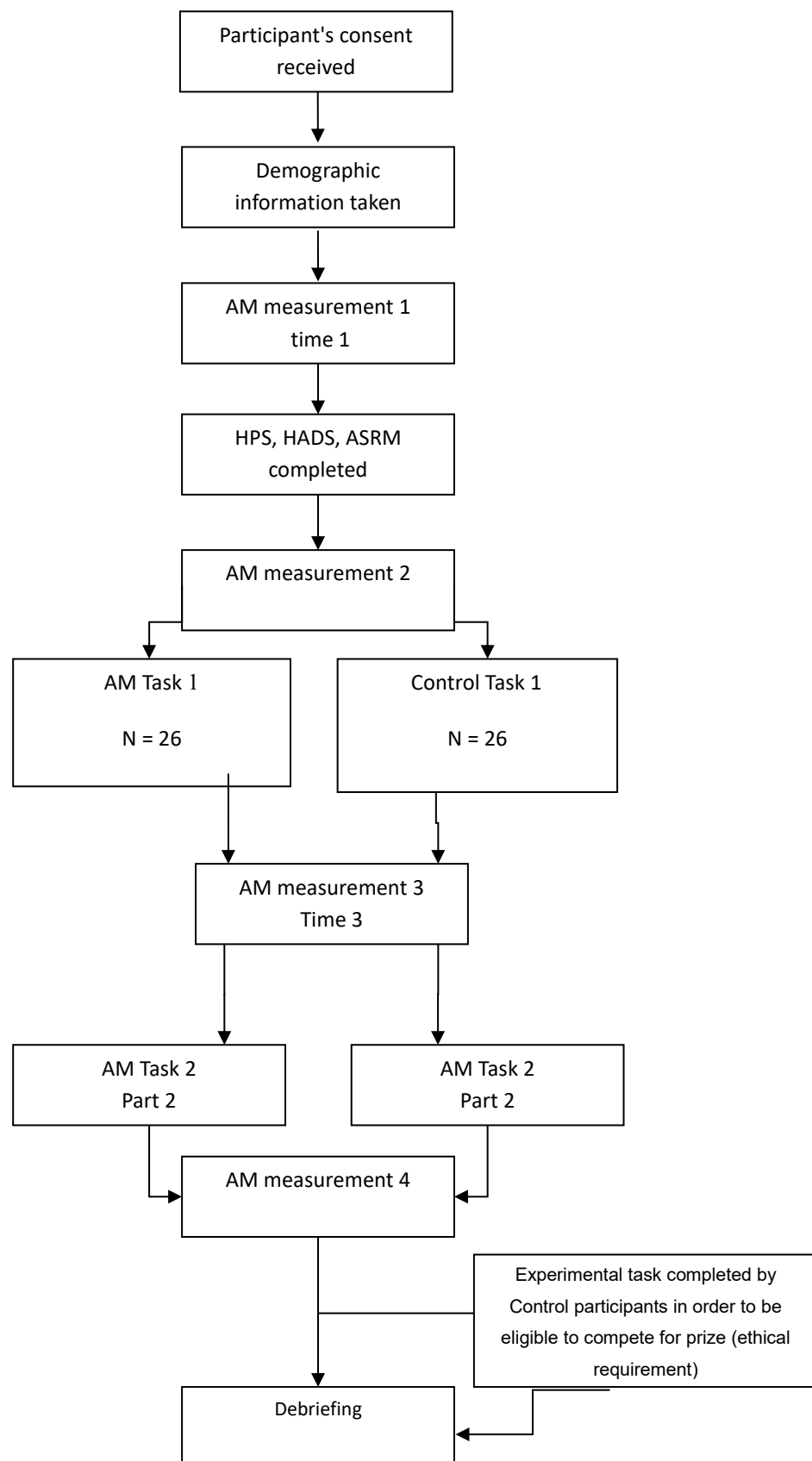

Figure 10. Flow diagram of study procedure

Note. Measurement time consisted of self-report PANAS, AMSAM, BES, PA, STAI and 30 second PEP data measured concurrently

Sample Size Calculations

Assumption 1: Because the study was designed to produce marked differences in response on self-report measures between the two conditions, a medium effect size was predicted. Using the program G*Power 3 (Faul, Erdfelder, Lang, & Buchner, 2007), a total sample size of 44 was calculated ($f= 0.25$, $\alpha=0.05$, power =0.95) for a repeated measures within-between analysis of variance model meaning a minimum of 22 individuals per condition would be required to detect a medium effect size for assumption

Assumption 2: the minimum sample for testing the effect of a level-1 variable is 50 (Maas & Hox, 2005). This is irrespective of the observations per individual (4 in the current study). Therefore, a sample size of at least 55 was aimed for to allow for loss of psychophysiological data²⁵.

For hypothesis 1, which predicted a moderation of HPS on AM responses, the sample size required was based on a high-risk design study of hypomanic personality (Sutton & Johnson, 2002). The researchers psycho-physiological differences between high and low HPS scores in response to positive imagery were small-to-moderate, $f= .20$. Using G*Power a sample of 52 was calculated ($f= 0.20$, $\alpha=0.05$, power =0.80) for a repeated measures mixed ANOVA model in order to test hypothesis 1.

5.2 Materials

Hypomanic Personality Scale (HPS: Eckblad & Chapman, 1986)

The HPS is a 48 item self-report questionnaire designed to measure individual variation in hypomania by capturing episodic shifts in emotions, behaviour, and energy. It

²⁵ 57 participants were recruited. 5 participants data were lost due to a technical fault and a further three participant's psychophysiological data was unavailable due to poor signal.

contains 48 true-false self-report items (e.g. “There have often been times when I had such an excess of energy that I felt little need to sleep at night”). It has a range of score from 0 to 48. The HPS has high internal consistency ($\alpha = .87$, in the current study $\alpha = .74$) and good test-retest reliability 15 weeks later ($r = .81$) (Eckblad & Chapman, 1986). There is a substantial literature base supporting the validity of the HPS both as a vulnerability measure for mania and as a measure tapping an aspect of personality (see section 2.2). Regarding the former, two of the most important studies were conducted by the scale’s developers. Firstly, Eckblad and Chapman (1986) found that 75% of individuals from the general population who scored very highly (above 36) also met criteria for a BD diagnosis at the same time. Secondly, a longitudinal research found college students who exhibited HPS scores above 36 were significantly more likely to develop BD at 13 year follow-up from (Kwapil et al. 2000). It has also been found to correlate with sub-clinical BD measures (e.g. hypomania, hyperthymic temperament) and conceptually related scales (e.g. impulsivity, irritability scale, borderline traits, depressive symptoms), further evidence relating to its validity as a measure sensitive to the bipolar spectrum (Walsh, Royal, Brown, Barrantes-Vidal & Kwapil, 2012). HPS scores are associated with BD phenomena including impulsivity (Johnson, Carver, Mulé, & Joorman, 2013), increased positive affect (Gruber, Oveis, Keltner, & Johnson, 2008) and sensitivity to positive stimuli (Trevisani, Johnson, & Carver, 2008). Recently, it had been robustly demonstrated that the factor structure of the HPS consists of three elements which uniquely relate to other psychopathological constructs (Schalet et al. 2011 – see section 2.2.1). They are as follows;

Social Vitality (example item: “In unfamiliar surroundings, I am often so assertive and sociable that I surprise myself”) which the authors of the factor analysis describe as representing social potency and vivaciousness (Schalet et al. 2011). The alpha value for the social vitality subscale in the current study was .63.

Mood Volatility (example item: “When I feel an emotion, I usually feel it with extreme intensity”) is described as tapping negative and unpredictable mood states and hypomanic cognition). The alpha value for the social volatility subscale in the current study was .65.

Excitement (example item: “I often feel excited and happy for no apparent reason”) explained as tapping energetic and highly cheerful mood. The alpha value for the excitement subscale in the current study was .64.

The Hospital Anxiety and Depression Scale (HADS: Zigmond and Snaith, 1983)

The HADS is a 14-question scale developed by Zigmond and Snaith (1983) to provide a brief state measure of both anxiety (seven questions) and depression (seven questions). Cronbach’s alpha for HADS-Anxiety varied from .68 to .93 and for HADS-Depression from .67 to .90, denoting good overall reliability (Bjelland et al. 2002). This review also reported acceptable validity for both HADS subscales. The alpha value for the current study was .77. for anxiety, and .75 for the depression subscale.

AM measures: The Behavioral Engagement Scale (BES: Krauss, 1988), Positive Activation Rating Scale (PARS: Morrone et al. 2000), Positive Activation items from the PANAS (PANAS-PA: Watson et al. 1988) and the Approach Motivation Self-Assessment Manikin (AMSAM) have been described in study 1 (section 4.1).

State-Trait Anxiety Inventory (Spielberger, Gorsuch, & Lushene, 1970)

Because PEP indices sympathetic nervous system activity at a broad level, it was deemed important to include a state measure designed to be sensitive to high arousal states negative in valence. Therefore, the STAI was included as a state measure to allow us to control for any

influence of subjective anxiety on sympathetic activity. The STAI was selected for its good reliability and validity (Tilton, 2008). The alpha value for the current study was .74.

The Self-Assessment Manikin (SAM) Valence and Activation (Bradley & Lang, 1994)

The Self-Assessment Manikin (SAM) is a reliable, validated, non-verbal pictorial assessment technique that measures self-reported valence, activation, and dominance (omitted) associated with a person's affective reaction to a wide variety of stimuli (Bradley & Lang, 1994). Each SAM depicts 5 human figures graded by intensity. Participants were asked to circle a number 1-9 beneath the figure which best corresponded to current level of “valence (negative – positive)” for the valence SAM and “activation (calm-excited)” for the activation SAM. The SAM was included as a manipulation check of activation and valence consistent with AM.

5.2.1 AM induction

A review of the mood induction procedure literature revealed a paucity of empirically-validated methods for experimentally inducing approach-like states. There were even fewer accounts of experimental manipulations that specifically focused on psychophysiological responses related to AM. Therefore, a novel AM induction was sought. Primary criteria, informed from BAS theory, guided the identification of a valid induction. They were as follows: 1. The maximum strength of response 2. Produce striving behaviour towards an incentive (engagement) 3. Physiological activation (arousal) 4. Approach-motivated positive affect. An internet search was conducted to identify as internet-based computer game which at face value was as a means of evoking extreme AM²⁶ Candidate games were piloted and through feedback one game was chosen to induce AM. The game

²⁶ Secondary criteria which the putative AM inductor needed to meet included positively-valenced audio and visual stimuli, an indicator of subjective performance, relative ease to perform, a clear relationship between performance and performance feedback, high frequency motor activity, a specific high value incentive – highest point reward with £50 prize.

chosen, Doeo, was selected because it contained many features that are theoretically consistent with the elicitation of excited goal-directed behaviour and emotion (AM); it was colourful, fast moving and was accompanied by lively music. The appearance of numbers indicating progress to reward that allowed an unspecified amount of success-feedback to occur. Also, the game could be set to ‘easy’ and therefore allow a wide range of individuals to perform sufficiently well. However, because there was a financial reward for the highest score, the game was still challenging, despite perhaps being easy to perform for some. Crucially, the Doeo game did not include overt threat of punishment. The Doeo game²⁷ requires the participant to move the cursor (controlled by the mouse) over pink square shapes that appear on a colourful screen momentarily on the computer screen. The aim is to click as many of the shapes as possible as they pop up on the screen. After a 2 min period, points are totalled for the number of pink shapes the participant ‘hit’ with the mouse. The task was performed twice (see procedure in section 5.3).

5.2.2 Neutral induction

The control task was designed to be a neutral task where participants were asked to look at an ‘x’ centred on a sky blue screen (deemed to reduce physiological arousal e.g. Gerrard, 1958) for two minutes, having been instructed to move the mouse randomly and continuously (to mimic motor movement produced by the experimental condition but without any reward of goal-striving element). This task was also performed twice.

5.2.3 Cardiac Activity Measurement

The autonomic nervous system measures described below were recorded using a BIOPAC™ MP150 system connected to a PC running commercially available software, AcqKnowledge 4.2 (BIOPAC Systems; Goleta, CA), with acquisition sampling rate of

² The game can be found at <http://www.doeogame.com/>. However the version in the experiment differed from the internet version by way of the omission of stimuli that corresponded to punishment.

2000Hz. These data were filtered and corrected offline using specialized analysis programmes within the AcqKnowledge 4.2 software; as described below.

Participants wore two spot and four strip electrodes on the neck and torso (Sherwood et al., 1990), and during the experiment electrocardiography (ECG) and noninvasive impedance cardiography (ICG) were constantly monitored.

PEP was calculated according to the equation proposed by Kubicek et al. (1966). Raw ICG and ECG signals were cleaned using both automated scripts and manual checking. Relevant points in the signals were detected using a similar process. As outlined in figure 10 there were four measurement points of interest (baseline, pre induction, post induction, post-second induction) when participants self-reported their AM scores. Data from these 30 second time periods of the ICG and ECG data were inspected and outliers removed. For 47 of the 52 participants cardiac data was of sufficient quality to survive the data cleaning process and thus be used in further analysis. Mean PEP was then calculated for each 30 second epoch, for each participant. Finally, the resulting PEP values were inspected for outliers across the sample. Two steps were taken to deal with extreme values. For each 30 second time period, for each participant, values 2 SD above or below mean for that particular time period were treated as outliers and removed. Mean PEP was then calculated for each individual time period. All of the means for the measurement points were then examined within participants, and remaining extreme values above and below their individual PEP mean were replaced with their respective 95th and 5th percentile values. Individual means between participants were also examined for outliers and the same technique was used where applicable.

5.3 Procedure

Participants, who were recruited from responses to an email advertising a study investigating *mood and physiological responses*, attended the bio-behavioural lab at the Mood Disorders Centre, University of Exeter, individually. Prior to commencing the study, a

random number generator was used to assign the participants either the experimental or control condition. Participants were informed that the best overall performances across two computer games would be reward with a £50 cash prize. For ethical reasons participants in the control condition were informed that at the end of the experiment they would be given an opportunity to play a computer game in order to have a chance of winning the cash prize.

Each condition consisted of 4 self-report measurement points, although cardiac activity was measured throughout. A marker in the cardiac data was used to indicate when the participant started and ended each self-report measurement point. The first two measurements served as baseline measures (the second of which also represented the baseline from which to measure AM change in later analysis). The third measurement²⁸ was taken immediately subsequent task 1 (and was examined alongside the second baseline to assess reactivity). The fourth measurement was taken immediately subsequent to task 2 and the signalled the end of it and the end of the experiment.

On providing informed consent, all participants were fitted with electrodes for cardiac pre-ejection period (PEP) measurement. The experiment commenced with a brief demographic questionnaire. Participants then completed the AM measures²⁹ (time 1) on-screen, then paper and pencil versions of the HPS, HADS and ASRM, followed by a second round of AM measures (time 2 pre-induction) before doing either the two- minute long AM or Neutral inductions. This was immediately followed by a third set of AM measures (time 3- post induction) , before repeating the inductions (also two minutes long), which was followed by a final battery of the AM measures (time 4), after which participants in the experimental condition were debriefed. Control participants completed the Doeo game (AM induction) twice after time 4 and then they were debriefed.

²⁸ The third measurement point was inserted between the two tasks and was designed to extra provoke variation in PEP by a second period of goal-striving in the AM condition (the first being between time 2 and 3).

²⁹ the order in which each AM measure was presented on-screen was distributed evenly e.g 1, 2,3,4, 2,3,4,1, 3,4,1,2 etc.

Approach to Statistical Analysis

In order to test the assumption of multivariate normality, histograms plots were assessed visually. Only one variable, current depressive symptoms, was not normally distributed. Transformations were unsuccessful so this variable was submitted to non-parametric analysis. The assumption of homogeneity of variance was met for all analyses as indicated by levene's tests. When the assumption of sphericity was violated Greenhouse-Geisser corrections were applied. An alpha level of $p = .05$ was adopted. To examine model fit, models were estimated separately for each repeated measurement per test. The residuals were inspected by plotting histograms of models.

Assumption 1: A valid measure of AM will increase in response to an experimentally induced AM state relative to a control condition.

A mixed design Analysis of Variance (ANOVA) family test was employed to test whether in general the AM induction served to increase self-reported AM relative to the control condition, and to also identify potential differences in response between the measures. There were two within-subjects factors, self-reported AM (four levels: BES, PANAS-PA, PARS, AMSAM) and Time (pre-induction 1, post-induction 1). The between-subjects factor was condition (AM [experimental] versus Neutral [control])³⁰. Significant interactions were systematically deconstructed by removing measures and conditions to reveal the patterns of response. The same approach was repeated for the four factor scales.

For Assumption 2: A valid measure of AM will covary significantly and negatively with cardiac PEP activity within participants across time, such that high self-reported AM is associated with shorter cardiac PEP.

³⁰ The experimental design offered two opportunities to test the effects of the induction, between time point 2 and 3, and between 3 and 4. However, the focus of analysis will be on the first induction only as the second is potentially subject to repetition effects (the primary purpose of multiple times point was to create nested data to allow for multi-level model analysis).

The predicted negative associations between AM measures and PEP were investigated both between participants and within participants over the four time points. Because such observations occurred within participants they were not independent of one another. This poses a problem for standard analysis of variance and regression techniques, which assume data points are independent. Therefore, to allow for clustering within participants, Linear Mixed Models (LMM) analysis, which consider hierarchical aspects of the data and permit a wide variety of correlation patterns to be explicitly modelled, were applied to the data. The LMM approach utilises both fixed and random effects in the same analysis. LMMs also have the advantage of handling missing data with ease and not requiring the assumptions of homogeneity-of-regression slopes that is required by ANCOVA. Another advantage LMM has over general linear models is their ability to investigate variability in regression coefficients (random slopes) across higher level units in the data (Heck, Thomas, & Tabata, 2013). Such 'cross-level' interactions consider the effects of higher level units (e.g. Condition: AM or Neutral) of the hierarchical data structure on lower level units (nested individual PEP values). LMMs also permit both the intercept and the slope of the regression line to vary between lower level units. This means specific parameters, slopes and/or intercepts, can be set as 'randomly varying' - meaning model estimates are allowed to vary across units of measurement (Heck et al. 2013).

The current dataset permitted a 2-level LLM where the upper level (referred to as level-2 variables) of the dataset consisted of the following explanatory variables of interest: condition, gender, baseline anxiety (STAI), the lower level of data in the LMMs of the current data was the repeated observations of self-reported AM clustered within participants. With respect to the current study this means that LMMs could be specified that allowed the intercept and slope of the regression line to account for variation within and between participants.

Furthermore, the inter-correlations between these repeated measurements vary as a function of time. For example, for any given individual, time 1 observation is likely to be more closely related to time 2 than time 4. To estimate a covariance structure which corresponded the repeated measures nature of the data, an auto-regressive (AR1) structure, in which observations were correlated by temporal proximity but where observation variability is held constant irrespective of its temporal position, was selected (Heck et al. 2013).

The data was restructured in long format in SPSS v 22 to accommodate a two-level hierarchy for the LMM analysis. The level 1 AM predictor variables were BES, PANAS-PA, PA, AMSAM, plus STAI at each of the four observation point (see figure 10). The level 2 covariates were Gender and Condition. PEP was the dependent variable. Group mean centring was applied to the level 1 variables (Heck et al. 2013).

Maximum Likelihood was the parameter estimation method chosen as this allows comparison between models. Bayesian information criterion (BIC) is a criterion for model selection among a finite set of models. Lower values for the BIC are preferred because its BIC value is increased by the number of predictor variables and unexplained variation in the outcome variable therefore lower BIC values are preferential. For example, if a model returns a lower BIC than a previous model this implies fewer predictor variables or a better model or both. Kass and Raftery (1995) produced guidelines which were adhered to whereby if the BIC is lower than the compared model by 2 whole numbers is it deemed positive evidence, if it is lower by 6 it is deemed strong evidence and if it is lower by 10 it is deemed very strong evidence of an improved model.

It is considered appropriate to begin model building process simply, adding complexity in a trial and error fashion (Field, 2009). When a parameter improves the BIC by greater than 2 whole numbers it is retained, if not it is removed. A preliminary model estimated the relationship between predictor AM (BEM, PARS, PANAS-PA, AMSAM)

measures and PEP with no random effects and without autoregressive structure - therefore not accounting for within-person variability and the effects of temporal proximity (the equivalent of a linear regression). A second model added random effects for the intercept value of the predictor variable. Third, a model with both a random intercept and random slope was specified. Next the auto-regressive covariance structure was added. A fifth consideration was to co-vary for level 2 influence from Gender and Condition on the relationship between AM measure and PEP. A final step in the process was the addition of level 1 covariate STAI to investigate the extent to which the relationship between the AM measures and PEP was explained by anxiety. Level 1 and 2 covariates were retained irrespective of BIC because of their expected relationship with PEP (Freydefont, Gollwitzer, & Oettingen, 2015). A final model included all the AM measures to assess the relative strength of the each measure in predicting PEP. Residuals were examined using histogram plots to test model fit. Where there were violations of the assumptions of normal (distribution these are indicated by footnotes, as is the process used to deal with them.

The equation for the random intercept and slope model for the current data is given below:

$$(PEP)_{ij} = \beta_{0i} + \sum \beta_q \chi_{qij} \text{ (level 1- AM SCALE)} + \sum \beta_r \chi_{ri} \text{ (level 2 - VARIABLE)} + e_{ij}$$

Where $(PEP)_{ij}$ denotes cardiac-pre-ejection period for participant i at measurement point j . The intercept in the model is denoted as β_{0i} and the error term as e_{ij} . χ_{qij} denotes the level-1 (e.g. AM) variable (χ_q) with its corresponding coefficient β_q . χ_{ri} denoting a level-2 (e.g. Gender) variable (χ_r) with its corresponding coefficient β_r . The intercept (β_{0i}) was specified as randomly varying at the participant level, thus modelling the assumption that measurements tend to be more similar if taken from the same participant. In this model, the level 1 variable

of AM was also randomly varying at the participant level allowing for the relationship between AM scale and PEP to be different between participants.

Secondary Hypotheses

H1 & H2 : Total and subscale Hypomanic Personality score will moderate response to the AM condition relative to the control condition such that individuals who score high on the HPS will exhibit elevated responses to the AM induction.

To test secondary hypotheses, initially a mixed design repeated measures ANOVA was employed with the within subjects factor measures (pre – post scores for BES, AMSAM, PANAS-PA and PARS), condition (AM, Neutral) as the between-subjects factor and HPS total score entered as a predictor. An additional three ANOVAs were conducted to explore if HPS subscales Mood Volatility, Excitement, Social Vitality moderated response to the AM induction. Holm-Bonferroni corrections were applied to correct for the effects of multiple testing (these were not applied to assumptions 1 and 2 due to these containing a priori predictions concerning how the measures should respond to the inductions and relate to PEP).

5.4 Results

Table 8 displays baseline characteristics of the sample. Parametric and non-parametric tests (as appropriate) revealed no differences in baseline characteristics of age, gender, depression and anxiety symptoms level and trait hypomania.

Table 8. Sample and Baseline Characteristics

	N	Female N (%)	Age <i>M (SD)</i>	Anx <i>M (SD)</i>	Dep <i>M (SD)</i>	HPS <i>M (SD)</i>
Experimental	26	18 (61%)	21.88 (3.95)	6.34 (3.21)	3.03 (2.52)	17.84 (9.99)
Control	26	16 (69%)	21.26 (1.95)	6.96 (3.36)	3.65 (2.91)	17.35 (8.58)

Note: N = no. of participants. *M* (Mean). *SD* (Standard Deviation). Anx, Dep (Hospital Anxiety and Depression subscales). HPS (Hypomanic Personality Scale).

Manipulation Check

Because the experimental design consisted of two induction points and the fact that the second induction was expected to be prone to repetition effects, the first induction only was selected for analysis to test assumption 1. In order to test assumption 1 it was first necessary to test the assumption that the Doeo game is a valid task for inducing increased AM. Therefore it was expected that AM levels, as measured via self-report (SAM: valence, arousal) and psychophysiological marker (PEP), would heighten in response to a face valid high-activation positive valence video game, relative to the Neutral condition.

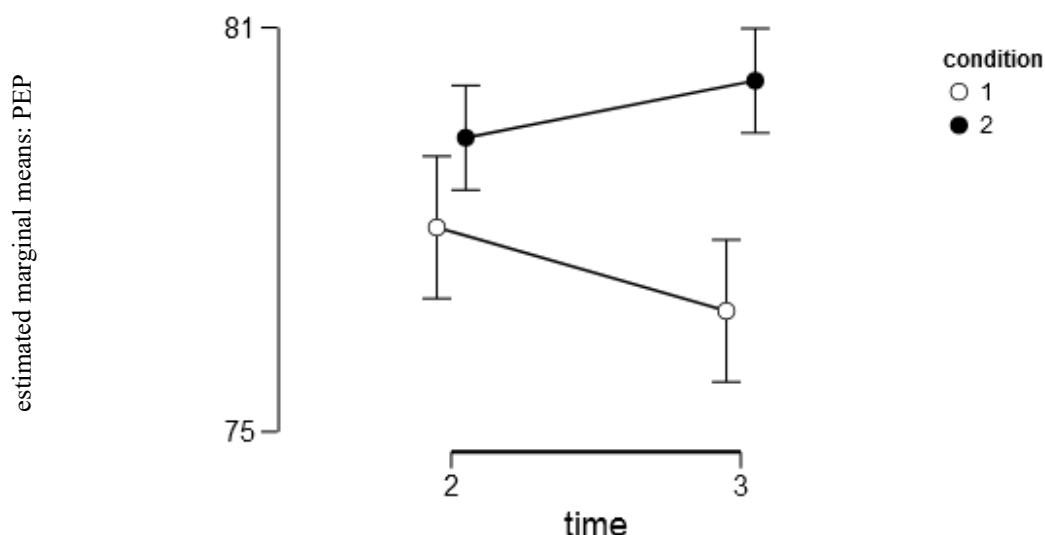

Figure 11. Pots for PEP pre to post inductions.

Note. Y axis PEP estimated marginal means (covariate included in model), X axis measurement point. 1 = Doeo, 2 = Control. Error bar representing 95% confidence interval.

Initial independent samples t-tests confirmed no significant differences in PEP between the conditions at both measurement points that occurred prior to mood induction, times 1 and 2, as expected³¹. A mixed design (within and between subjects) repeated measures analysis of covariance (ANCOVA) with PEP at time 1 entered as covariate to control for any differences at baseline was performed to establish if there were any significant differences between the experimental and control conditions in PEP before (pre-induction) and after (post-induction) the first induction. There was no main effect of time, $F(1,44) = 0.55, p = .45, \eta^2 = .01$, and no main effect of condition ($F(1,44) = .61, p = .43, \eta^2 = .00$), but a significant interaction between time and condition, $F(1,44) = 6.1, p = .01, \eta^2 = .11$. As can be seen in table 9 the PEP score decreased pre to post induction indicating increased sympathetic arousal indicative of AM increase.

³¹ See Appendix IV for a table of descriptive statistics for each measure by condition and corresponding independent t-tests.

Table 9. Cardiac Pre-Ejection Period between the groups, pre-post inductions

	Group	N	Mean	SD
pre-induction	AM	22	78.03	4.01
	Neutral	25	79.37	5.26
post-induction	AM	22	76.79	5.02
	Neutral	25	80.21	5.06

Note higher PEP score indicate less sympathetic activity. Also 5 participants did not return PEP meaning a n of 47 for PEP analysis

Secondly, validity was assessed by evaluating change in SAM ratings. Relative to a neutral induction, a valid AM induction would be expected to increase SAM arousal ratings. Because the AM induction was aimed at eliciting arousal that is not negative the Valence SAM ratings were not expected to decrease. Independent t-test found no differences in SAM Valence or Arousal at time baseline 1 or baseline 2 (pre-induction). Following this, the effects of the inductions were revealed by a 2 (AM, Neutral) x 2 (Valence, Arousal) repeated measures ANOVA. There was no main effect of time, $F(1, 50) = .17, p = .67$ a main effect of condition, $F(1, 50) = 12.03, p < .001, \eta^2_p = .19$, and a significant three way interaction between time, condition and SAM measure, $F(1, 50) = 12.03, p = .005, \eta^2_p = .14$. To deconstruct this a mixed design ANCOVA with time (pre, post induction) as the within subjects factor and condition (AM, Neutral) as the between subjects factor ANCOVA was performed for Arousal and Valence measures separately. SAM rating at time 1 was entered as covariate to control for any differences at baseline. For SAM Arousal, there was a main effect of time, $F(1, 49) = 8.35, p = .006, \eta^2_p = .19$, a main effect of Condition, $F(1, 49) = 11.91, p < .001, \eta^2_p = .19$, and a significant interaction between Time and Condition, $F(1, 49) = 31.10, p < .001, \eta^2_p = .06$. For SAM Valence, there was no effect of Time, an effect of Condition, $F(1, 49) = 11.68, p < .001, \eta^2_p = .19$, and a trend towards an interaction between Time and

Condition, $F(1, 49) = 3.12, p = .08, \eta^2 = .06$. (see Figures X and Y). Paired t-tests showed that from pre to post AM induction, arousal ratings significantly increased, $t(25) = -.20, p = .84$. Valence ratings did not significantly change, $t(25) = -.20, p = .84$, and a paired t-test conducted within the neutral condition showed both valence, $t(25) = 2.21, p = .03$, and arousal ratings, to significantly decrease, $t(25) = 2.21, p = .03$.

Overall, there was evidence from SAM self-report and physiological measures that the Doco game produced effects consistent with an elevated AM state

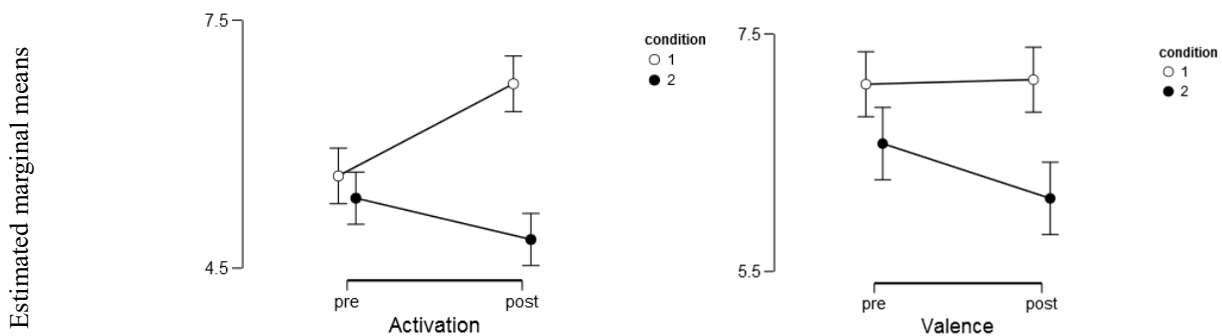

Figure 12. Plots for SAM Activation and Valence for each condition

Note. Y-axis self-reported SAM rating, X-axis, pre – post induction 1 = AM condition. 2 = Control condition

Prior to testing assumption 1, independent samples t-tests were conducted on pre-induction AM scores between the conditions to establish that randomisation had been successful. There were no significant differences between the groups. (see appendix IV for t-test, means and standard deviations).

Approach Motivation Scales

Assumption 1: A valid measure of AM will increase in response to an experimentally induced AM state relative to a control condition.

A mixed design ANOVA family test with time (pre, post) and measure (BES, AMSAM, PANAS-PA, PARS) as a within-subjects factors and condition (AM, Neutral) as

between-subjects factor was initially conducted. A time by condition interaction would indicate the measures discriminated between the conditions over time, whilst a three-way interaction between time, condition, and measure, would indicate differential responses between the AM measures. There was no main effect of time, $F(1, 49) = 3.02$ $p = n/s$, a main effect of measure, $F(3, 114) = 1246.07$, $p = <.001$, $n^2_p = .96$, and a main effect of condition, $F(1, 49) = 12.75$ $p = n/s$, $n^2_p = .21$. There was a significant interaction between time and condition, $F(1, 49) = 25.64$, $p = <.001$, $n^2_p = .34$, indicating that overall the measures discriminated between the AM and neutral mood induction, and thus met assumption 1 (see appendix IV for means, see figures 13 for plotted patterns of responding). These effects should be considered in the context of a three way interaction between time, condition and measure, $F(1.98, 92.22) = 17.96$ $p < .001$, $n^2_p = .26$, indicating differentiated responses of the factor scales to the inductions, from pre to post induction. To deconstruct this, the AM scales were removed in a systematic manner and further mixed design ANOVAs were conducted to reveal where the differences between the measures lay. the details of the process of breaking down this significant three way interaction are reported in Appendix IV. In summary PANAS-PA was found to behave differently to the other measures within both the AM and Neutral condition. For participants assigned to the neutral condition, PANAS-PA scores decreased significantly. AMSAM, PARS, and BES scores did not change. For participants in the AM condition PANAS-PA showed an increase greater than that found for the other measures.

Table 10 below illustrates how all measures significantly increased after playing the Doeo game (AM induction) and shows PANAS-PA to have the largest effect size, indicating it displayed the greatest increase.

Table 10. Paired Samples T-Test pre to post AM induction for PARS and PANAS-PA

			<i>T</i>	df	<i>p</i>	Cohen's d
PARS pre induction	-	PARS post induction	-3.47	25	< .001	-0.68
AMSAM pre induction	-	AMSAM post induction	-3.59	25	< .001	-0.71
BES pre induction	-	BES post induction	-3.06	25	0.003	-0.6
PANAS-PA pre induction	-	PANAS post induction	-4.95	25	< .001	-0.97

Note. All tests, hypothesis is measurement one less than measurement two. Effect size is Cohen's d

To summarise, as a whole, the measures differed in response to AM as compared to the neutral induction (figure 13 illustrates the directions of these changes were in the hypothesized direction); all measures met assumption 1. However, the measures did not perform equally, as evidenced by the three way interaction between time, condition and measure. Systematic deconstruction of the family tests showed that PANAS-PA differed for the other measures. This difference was evident in both the neutral condition where PANAS-PA scores significantly decreased and in response to the AM condition where PANAS-PA scores showed greater elevation, compared to BES, PARS and AMSAM scores. Indeed the PANAS-PA scale produced the largest effect size in participants who played the Doeo game.

Approach Motivation, Attentional Bias, Positive Stimuli, and Hypomanic Personality.

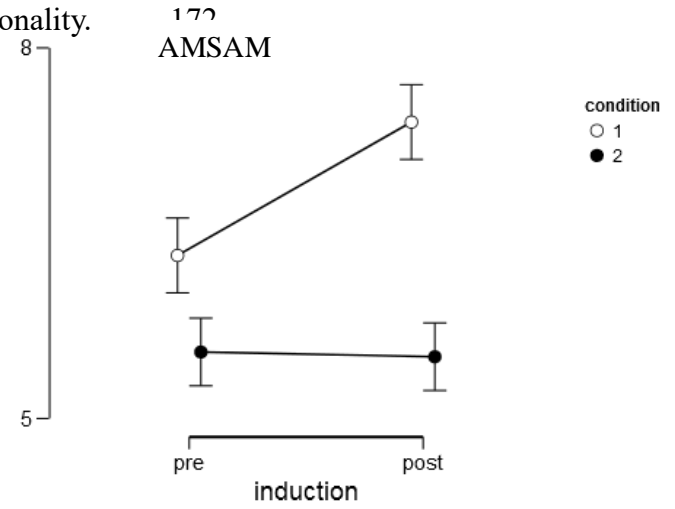
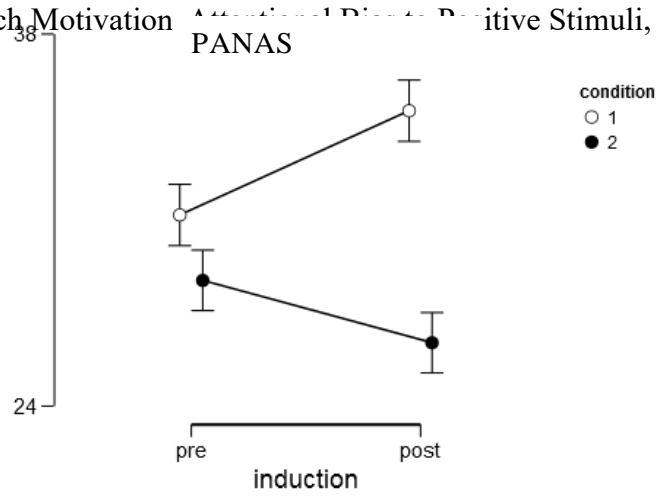

Time

Time

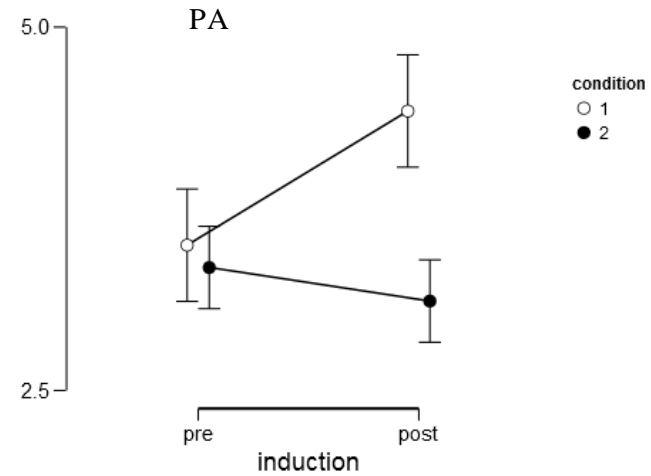
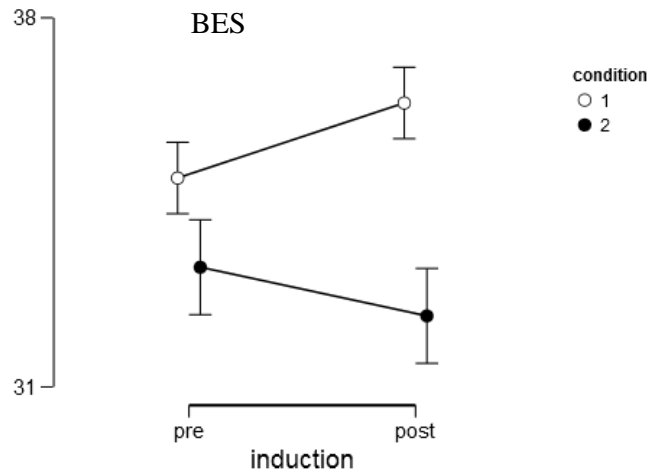

Time

Time

Figure 13. Figure. Mean self-report scores for the 4 AM measures pre and post first induction for experimental (1) and control condition (2).

Approach Motivation: Factor-analytic subscales

Assumption 1: A valid measure of AM will increase in response to an experimentally induced AM state relative to a control condition.

Study 1 investigated the latent structure of the 17 items that comprise PANAS-PA, BES, PARS and AMSAM. It was of theoretical interest to examine the validity of the four factors derived from EFA by examining their performance against the experimental procedures (assumption 1). Scores for the four factor scales were computed by averaging standardised values for scale composite items. Scale reliability was ascertained through inspections of alpha values (all deemed satisfactory to .7 according to literature guidelines - Nunally, 1974). Normality of the subscale distribution was assessed. One scale, Cognitive AM, was successfully transformed using logarithmic transformations.

Prior to testing the factor scales against assumption 1, independent samples t-tests were conducted on pre-induction factor scale scores between the conditions to establish that randomisation had been successful. There were no significant differences between the groups. (see appendix IV for t-test, means and standard deviations)

An initial family test was conducted. A mixed design ANOVA test with time (pre, post) and factor measure (Cognitive AM, Optimism, Positive Activation, Excited) as a within-subjects factors and condition (AM, Neutral) as between-subjects factor revealed no main effect of time, $F(1, 50) = 1.57$ $p = n/s$ no main effect of factor scales, $F(2.6, 138) = 1.3$, $p = n/s$, and a significant main effect of condition, $F(1, 50) = 8.98$, $p = .03$, $\eta^2 = .15$. There was a two-way interaction between time and condition, $F(1, 50) = 22.42$, $p < .001$, $\eta^2 = .31$, indicating that in general responses differed between the conditions from pre to post induction. The factor scales increased in response to the AM induction, as compared to scores for the participants in the neutral mood induction. As such, all factor scales can be said to have met assumption 1. Figure 14 below shows the relative effectiveness of the AM induction

in elevating factor subscale responses from baseline to immediately after playing the doeo game. However, the family test did not reveal a significant interaction between time, condition and scale, $F(2.6, 138) = 2.6, p = n/s$, and therefore the subscales can be said to have behaved similarly in response to both the AM and Neutral conditions.

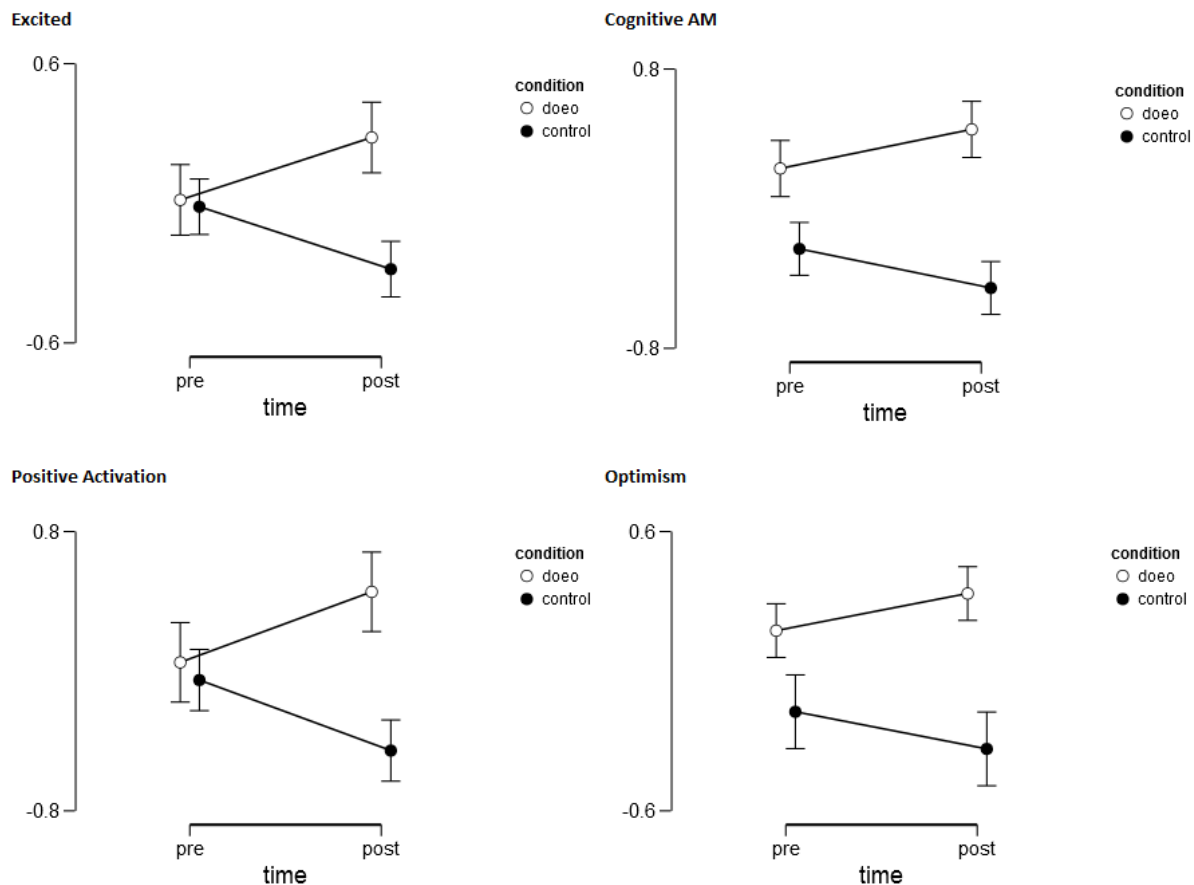

Figure 14. Plots for the factor scales

Note. Y-axis – estimated marginal means self-report scores for the 4 factor subscales pre and post first induction for experimental (1) and control condition (2). Error bars represent 95% CI.

To examine the relative degree to which the AM induction served to increase factor subscale scores, paired t-tests were conducted to compare effects sizes. As can be seen from Table 11, Positive Activation and Excited subscale produced the large increases. Of note, the effects for the subscales were substantially smaller than those found for the AM measures. To summarise, all factor subscales increased in response to an experimentally induced AM state

relative to a control condition, and therefore met assumption 1. The subscales did differ significantly amongst themselves in their response to the inductions.

Table 11. Paired Samples T-Test pre to post AM induction for the AM factor subscales

			<i>t</i>	df	<i>p</i>	Cohen's <i>d</i>
Optimism pre induction	-	Optimism post induction	-2.01	25	0.028	-0.39
Positive Activation pre induction	-	Positive Activation post induction	-2.58	25	0.008	-0.5
Cognitive AM pre induction	-	Cognitive AM post induction	-2.02	25	0.027	-0.39
Excited pre induction	-	Excited post induction	-2.57	25	0.008	-0.5

Note. All tests, hypothesis is measurement one less than measurement two. Effect size is Cohen's *d*

Approach Motivation Scales

Assumption 2: A valid measure of AM will covary significantly and negatively with cardiac PEP activity within participants across time, such that high self-reported AM is associated with shorter cardiac PEP.

To examine the relationship between PEP and each of the AM measures LMM was conducted in accordance with the steps outlined in section 5.2.1. Table 12 summarises the LMM results of each step in the model building process. The random slope models were omitted because for each measure the BIC failed to fall below the stated threshold. The improved BIC values for each measure when repeated measurements were added to the model indicated this provided the best fit of the data. Here the PA, BEM and PANAS-PA significantly predicted PEP and AMSAM exhibited a trend towards significance. When level 2 covariates were added to examine the relationship between AM measures and PEP when controlling for Gender and Condition, the same relationships held. When state anxiety,

measured concurrently with PEP and AM, was added, the relationships remained with the addition of a significant relationship between PEP and AMSAM. A final random intercept with repeated measures model (not reported in the table) including all four AM measures with level 2 gender and condition and level 1 state anxiety was conducted. In this model only PA came out as statistically significant ($F(1, 122) = 4.31, p = .04$) suggesting PA captures additional variance not accounted for by other measures.

Table 12. AM measures predicting PEP: model characteristics for Linear Mixed Models of interest

model	Approach Motivation Scale			
	PARS	BES	PANAS-PA	AMSAM
regression				
BIC	1125	1133	1083	1134
$F(df)$	1.50 (1,187)	1.27 (1, 188)	0.66 (1, 180)	2.20 (1, 188)
p	0.223	0.266	0.418	0.503
with random intercept				
BIC	963.56	968	930	972
$F(df)$	7.4 (1, 139)	6.41 (1, 141)	3.19 (1, 135)	2.20 (1, 141)
p	0.007	0.012	0.076	1.29
random intercept with repeated measurements				
BIC	956	964	925	967
$F(df)$	10.87 (1, 137)	6.51 (1, 116)	4.70 (1, 100)	3.19 (1, 140)
p	0.001	0.012	0.032	0.076
as above with intercept with gender & condition (Level 2)				
BIC	963	971	932	974
$F(df)$	10.86 (1, 137)	6.48 (1, 116)	4.62 (1,100)	3.16 (1, 140)
p	0.001	0.012	0.034	0.077
as above with intercept with state anxiety (Level 1)				
BIC	929	937	937	939
$F(df)$	9.38 (1, 131)	5 (1, 116)	4.85 (1,101)	2.76 (1, 135)
p	0.012	0.02	0.03	0.099

Approach Motivation: Factor analytic subscales

Assumption 2: A valid measure of AM will covary significantly and negatively with cardiac PEP activity within participants across time, such that high self-reported AM is associated with shorter cardiac PEP

The LMM analyses were repeated but using the four factor subscales from study 1 rather than the AM scales as the predictor variables. These were added to the restructured dataset to explore how each performed when submitted to the same LMM analysis process. Table 13 displays the LMM for the Factor scales. As in table 12 models of randomly varying slopes were omitted due to poor fit. As was the case with the AM measures, an improved BIC value for each factor scale when random intercepts and repeated measurements were included in the model indicates that this model provided the best fit of the data .

Table 13. Factor scales predicting PEP: model characteristics for Linear Mixed Models of interest

<i>model</i>	Factor Scales			
	Motivation	Positive Activa- tion	Optimism	Excitement
regression				
BIC	1134	1133	1134	1133
<i>F (df)</i>	0.24 (1,188)	1.02 (1, 88)	.67 (1, 188)	.80 (1, 88)
<i>p</i>	0.62	0.31	0.41	0.37
with random intercept				
BIC	973	970	971	971
<i>F (df)</i>	1.19 (1, 141)	5.07 (1, 141)	3.31 (1,141)	3.99 (1, 141)
<i>p</i>	0.27	0.02	0.071	0.048
random intercept with repeated measurements				
BIC	969	962	966	966
<i>F (df)</i>	.88 (1, 146)	8.69 (1, 139)	3.98 (1, 125)	4.12 (1, 133)
<i>p</i>	0.34	0.004	0.048	0.044
as above with intercept with gender & condition				
BIC	976	969	973	973
<i>F (df)</i>	.88 (1, 131)	8.87 (1, 139)	3.96 (1, 125)	4.42 (1, 133)

p	0.34	0.004	0.049	0.046
as above with anxiety				
BIC	981	974	978	978
$F (df)$.92 (1, 132)	8.78 (1, 139)	4.40 (1, 128)	4.06 (1, 134)
p	0.33	0.004	0.038	0.046

Within this model Positive Activation, Optimism, Excitement and Motivation all significantly predicted PEP. These relationships held when level 2 covariates Gender and Condition were added to the model, and when the level 1 state anxiety was added. When all the factor scales were added as covariates to a random intercept model with level 2 Gender and condition and level 1 state anxiety only Positive Activation came out as statistically significant predictor, $F(1, 135) = 5.15, p = .025$.

Secondary Hypotheses

Hypothesis 1: Total Hypomanic Personality score will moderate self-reported response to the AM condition relative to the control condition such that increase in AM is greater for those who score high on the HPS.

A preliminary family test was conducted to investigate the influence of HPS on the AM responses. Within the model, time x condition x AM scale interaction terms were specified in the mixed model ANOVA. A significant three way interaction between time, condition and HPS emerged, $F(3, 41) = 7.80, p = .008, \eta^2 = .16$, indicating HPS moderated the relationship between time and condition. This must be considered in the light of a four-way interaction which emerged between time, condition, scale and HPS, $F(3, 41) = 3.65, p = .03, \eta^2 = .08$, indicating a differentiated HPS influence on the AM measures.

In order to understand whether high or low HPS scorers show different reactions, HPS was broken down by high versus low score (median split) and the above family tests (time x condition x measure) were ran again for high and low scorers separately. For low HPS scorers, there was a trend towards a three way interaction between time, condition and

measure, $F(3, 21) = 2.94, p = .06, \eta^2 = .29$, and a significant three way interaction for high HPS scorers, $F(1, 17) = 3.65, p = .005, \eta^2 = .55$. The contrast in effect sizes and p-values indicated the moderation effect predominantly lay within high HPS scorers.

To further explore this effect a mixed ANOVAs were conducted each AM scale. In these tests condition was the between subjects factor, time (pre, post) was the within subjects factor, and HPS total was entered as a predictor. To test the moderation hypothesis a three way (time x condition x HPS interaction) terms were specified. Holm-bonferroni corrections were applied where appropriate to correct for multiple testing.

Hypothesis 2: Hypomanic Personality subscale score will moderate self-reported response to the AM condition relative to the control condition such that increase in AM is greater for those who score high on the HPS.

This approach was applied to explore the influence of HPS subscales; 4 four mixed ANOVA tests were conducted for each of mood volatility, social vitality and excitement subscales. Holm corrections were applied to each set of HPS subscale ANOVA. Table 14 presents HPS interactions with time (pre, post induction), condition (AM, Neutral) and time and condition. After holm corrections were applied³² only one three way interaction between HPS total, time and condition for the BES scale emerged as statistically significant, $F(1, 41) = 7.80, p = .005, \eta^2 = .18$. To test the influence of the three underlying components of the HPS (mood volatility, social vitality, and excitement) separate ANOVAs were conducted for each HPS subscale. Therefore 8 tests were conducted per subscale (for comparison HPS total ANOVA results are reported in table 14). Again, Holm-Bonferroni corrections were applied for each set of HPS subscale tests. As can be seen in table 14, HPS subscales did not moderate the relationship between condition and time. Therefore, the only evidence to support hypothesis 1 stems from the three way interaction between time, condition and total

³² Holm method: they were four tests per moderator (HPS scale) therefore the most significant p must be less than $.05/4 = .013$

HPS for the BES scale. To unpack this HPS total was transformed from a continuous variable to a categorical variable by way of a median-split (median = 18). ANOVAs were then conducted on each subset of data: High HPS scorers only, then Low HPS scorers only (AM v Neutral as between-subjects factor in both), AM participants only, then Control participants in isolation (high v low HPS score as between-subjects factor).

Table 14. Mixed-ANOVA results for Hypomanic Personality subscales

<i>repeated measure</i>	Hypomanic Personality (total)			Social Vitality			Excitement			Mood Volatility		
	<i>F</i> (1, 41)	<i>p</i>	η^2_p	<i>F</i> (1, 41)	<i>p</i>	η^2_p	<i>F</i> (1, 41)	<i>p</i>	η^2_p	<i>F</i> (1, 41)	<i>p</i>	η^2_p
PARS												
HPSxtime	1.51	0.22	0.03	1.17	0.28	0.03	0.27	0.61	0.007	0.61	0.43	0.01
HPSxcondition	9.32	0.004	0.18	7.35	0.01	0.15	1.63	0.21	0.03	9.53	0.004	0.19
HPSxtime x condition	3.2	0.08	0.72	4.72	0.03	0.1	1.84	0.18	0.04	0.44	0.51	0.01
PANAS-PA												
HPSxtime	1.17	0.71	0.001	0.41	0.52	0.01	5.81	0.98	0	0.004	0.94	0
HPSxcondition	0.14	0.72	0.004	0.4	0.53	0.01	0.51	0.48	0.01	0.34	0.56	0.008
HPSxtime x condition	4.95	0.03	0.11	2.22	0.14	0.05	2.49	0.12	0.05	6.6	0.01	0.14
AMSAM												
HPSxtime	0.24	0.44	0.51	0.32	0.57	0.008	0.54	0.46	0.01	1.42	0.23	0.01
HPSxcondition	1.06	0.31	0.02	0.51	0.47	0.01	0.4	0.53	0.01	2.4	0.12	0.05
HPSxtime x condition	1.7	0.19	0.04	1.33	0.25	0.03	1.11	0.29	0.02	1.12	0.29	0.03
BES												
HPSxtime	0.18	0.67	0.004	1.27	0.26	0.03	0.1	0.74	0.003	0.87	0.35	0.02
HPSxcondition	4.14	0.04	0.09	4.31	0.04	0.09	0.68	0.41	0.01	2.8	0.1	0.06
HPSxtime x condition	8.98	0.005*	0.18	6.2	0.01	0.13	3.17	0.08	0.07	6.59	0.01	0.13

Note. When Holm corrections were applied to the subscales the threshold was $p < .004$ ($12/.05$) the only interaction that supported hypothesis 1, is indicated in bold

5.5 Discussion.

This study assessed the construct and convergent validity of four self-report measures of approach motivation. Broadly both assumptions were met. For assumption one, all AM scales and factor subscales increased in response to an AM induction relative to a control task, providing construct validity for their use. For assumption two, all self-report measures and subscales converged with a psychophysiological index of AM over the four measurement points of the experiment, except one of the factor subscales from study 1, Cognitive Approach Motivation. Finally, and contrary to predictions, there was evidence that participants at higher risk of mania showed a greater reduction in behavioural engagement during the control task relative to the approach task, as compared to those less vulnerable to mania (on account of lower HPS score). Interestingly this effect was in the opposing direction for the biological index of AM with individuals endorsing negative and unpredictable moods relevant to bipolar vulnerability (mood volatility) displaying increased sympathetic arousal in response to the control task, as compared to individuals low on this trait.

Prior to testing the validity assumptions, it was first necessary to ascertain whether the inductions were successful. It was demonstrated that an incentivised reaction-time video game (Doeo) produced mostly intended responses relative to baseline and relative to responses on a task designed to maintain baseline state, as indicated by elevated self-reported arousal and shortened cardiac pre-ejection period (PEP). That the Doeo game did not produce any decrease in self-reported valence but did increase arousal and reduce PEP, suggests the task represented a valid AM induction with minimal affective content. Because valence did

not increase it might be argued that the arousal effect represents non-specific arousal. The lack of score indicates that the increased sympathetic activity indicated by shortened PEP was not related to the BIS or FFFS. Thus there was strong evidence that it induced AM.

It was also important to evaluate the control task employed in the current study. Significant decreases in activation, arousal, and longer PEP from pre to post neutral induction suggested the task served to reduce AM. As such, the experimental design might be better discussed in terms of high versus low approach motivation, rather than high AM versus the absence of high AM. Because there were no changes in state anxiety pre to post control task, it is safe to assume the task did not induce avoidance motivation.

With regards to hypothesis 1, PANAS-PA exhibited responses to the AM induction that differed significantly from the other measure responses. The significant difference in response to the Doeo game between BES, PARS, ASMAM, and PANAS-PA, with the latter measure producing the greatest pre-post effect size leads to the conclusion that PANAS-PA might represent the most sensitive measure of AM. Another interpretation is that PANAS-PA, as a validated measure of positivity, explains most variance corresponding to valence and therefore the neutral task served to reduce positive affect rather than AM. When all AM scales were considered together over time in relation to PEP, PARS was the only measure to significantly predict PEP, suggesting it captured additional variance not accounted for by the other measures.

It is unclear why the PARS should do so as it is similar in origin and content to the PANAS-PA in that they were derived from the same positive activation factor dimension (Watson & Tellegen, 1985). An explanation may lie in findings found for the factor subscales that emerged from study 1. Interestingly, the Cognitive Approach Motivation factor, named so due to its items corresponding to PANAS-PA items connotative of higher-order approach feelings was the only factor subscale to not predict PEP. This suggests that this dimension,

which performed similarly to the scales in response to the AM induction, should be considered separately from AM associated with increased sympathetic activity. This finding for divergent responding within the PANAS-PA goes against Harmon-Jones (2013) assertion that PANAS-PA is a unidimensional measure of “pounce affect”, a term used to capture the action tendency aspect of AM. If it is taken that any action tendency is precipitated by mobilisation of energy via increased sympathetic activity then all facets of the PANAS-PA would be expected to converge with PEP. Rather these results suggest that Cognitive Approach Motivation represents a different aspect of the BAS and is more aligned with Egboff et al (2003) account of PANAS-PA as representing three separable components.

The rationale for using PEP is based on a few key studies (Brenner, Beauchaine, & Sylvers, 2005) measuring PEP in the context of striving for monetary reward. In this sense the current study replicates these findings and adds further evidence for PEP as a marker of AM. Of note, Brenner et al. (2005) found PEP did not correlate with trait BAS sensitivity. This suggests that PEP is uniquely associated with situationally induced variation in AM rather than trait AM sensitivity. More broadly, the convergence found between self-report measurement and psychophysiology speaks to the coherence of cardiac pre-ejection period (PEP) as a measure that, to some degree, corresponds to subjective experience via self-report. However, the specificity of PEP has been questioned as it has been shown correlate with sadness, amusement and happiness (Kreibig, 2010). Accordingly, the convergence between PEP and the AM measures should not be interpreted as alignment with a validated biomarker. It is a challenge for the field of emotion psychophysiology to refine methods in order to understand the organisation of autonomic responses with respect to emotion and motivation. Future research should cross-validate other biological proxies of AM (SEBR, frontal asymmetry) with the AM measures.

This study found a unique relationship between mood volatility and PEP that was not detected in total hypomanic score. The moderation effect suggested that the control task, relative to the AM task, evoked greater sympathetic activity associated with AM with individuals high in mood volatility. The lack of specificity surrounding PEP does not allow more precise conclusions. Only two studies were identified that elicited psychophysiological differences using the HPS. Sutton and Johnson (2002) found a more pronounced startle response after viewing positive pictures in high HPS scorers compared to low HPS scores. Gruber et al. (2006) found that vulnerability to mania was related to elevated cardiac vagal tone, a measure of parasympathetic activity associated with broader positive emotionality, across, positive, negative and neutral film clips. This latter finding is particularly relevant as a greater autonomic responsivity to a neutral task was related to BD in this study, albeit with a measure of sympathetic activity. Of note, Gruber et al. found their result with HPS total score. No study prior to the current investigation seems to have explored the dimensions of the HPS in experimental settings. Although the result is not easily interpretable; it is consistent with a study conducted within a patient study which found a higher level of arousal in euthymic individuals than compared to healthy controls (M'Bailara et al. 2007). This finding was interpreted as representing fundamental emotional hypersensitivity in BD. It is possible that the mood volatility scale taps this aspect of BD that is commonly linked to emotional lability and mixed states. The mood volatility scale seems worthy of further investigation.

At this point other limitations of the study should be acknowledged. As with other studies reported in this thesis, the sample was not very representative on account of the predominance of female participants. Gender differences in autonomic activity are common but no such differences were detected in the current study. The study lacked a comprehensive negative affectivity measure which might help explain the effects of the control tasks.

To conclude, study 2 found that each existing measure and a novel affect-free pictorial scale all met a basic construct validity assumption, and more importantly, all provided convergent validity evidence with a biological correlate of AM. An exception to this pattern was the PANAS-PA subscale Cognitive Approach Motivation – this measure did not correlate with PEP. More validation is required to ascertain whether the scales and subscales perform similarly under tests of discriminant validity.

6 Chapter 6: A test of the Discriminant validity of Approach Motivation scales.

Study 2 provided evidence of convergent validity between a psychophysiological proxy measure of AM and the four self-report measures plus the three factor subscales which stemmed for study 1. The next logical step in validating the AM measures is to test their discriminative validity. That is, because AM is often thought of in terms of positive valence and high arousal it needs to be shown that these measures are sensitive specifically to AM stimuli and not just to stimuli high in positive valence or high in arousal. The conceptual background to this is outlined in section 2.4. To summarise, according to dimension models of affect (Russell, 2003; Watson & Tellegen, 1985) AM represents the upper ends of dimensions of valence and arousal. Under this framework the spectrum of emotional experience can be understood by a combination of these basic dimensions. Carver and Scheier (1998) proposed that positive affect is associated with contentment and serenity, states not relevant to the BAS system, instead they asserted that positive affect is marked by feelings of enthusiasm and excitement, and is relevant to the BAS. Therefore, a valid measure of AM should be able to discriminate between high arousal positive affect relevant to the BAS from low-arousal types of positive affect.

In addition to providing support for the validity of the AM measures, study 2 also included a measure of bipolar vulnerability, the HPS, to test for relations between trait mania proneness and magnitude of AM change, based on previous literature (e.g. Meyer & Bauer, 2009). The results showed HPS moderated the effect of AM induction on self-reported AM, however this was explained by a decrease in AM in the control condition in those scoring high on the HPS. This finding of no clear increase in AM for high HPS scorers in the AM induction condition could have been an anomalous result when considering that evidence supports heightened positive emotional responsivity in those with hypomanic personality

(Johnson, Gruber & Eisner, 2007). Therefore, in the current study, it was hypothesized that HPS would moderate response to inductions representing two forms of Positive Affect: high valence low arousal and high valence high arousal. There is also evidence that reactivity to negative stimuli is disrupted in bipolar although this evidence comes from studies conducted on individuals diagnosed with BD (Gruber et al., 2008; Gruber, Harvey & Purcell, 2011) using induction of low arousal negative affect. As such, no prediction was made with regards to HPS and negative affect. As with study 2, the HPS was utilized both as a single total score and by using its three subscales (see section 2.2.1) to test secondary hypotheses regarding moderation effect on responses to AM condition (positive valence/high arousal stimuli) only.

In summary, this study primarily investigated the properties of the AM state measures and the factor-analytic subscales in relation to the following assumptions:

1. A valid measure of state AM will show a greater increase following exposure to positive valence/high arousal stimuli than following exposure to negative valence/high arousal stimuli.
2. A valid measure of state AM will show a greater increase following exposure to positive valence/high arousal stimuli than following exposure to positive valence/low arousal stimuli.

The secondary hypotheses were as follows:

Hypothesis 1: HPS total score will moderate response to the high valence / high arousal stimuli such that change in AM is greater for those who score high on the HPS.

Hypothesis 2: HPS subscales will moderate response to the high valence / high arousal stimuli such that change in AM is greater for those who score high on the HPS. (Due to the lack of prior experimental evidence speaking to the facets of the HPS this prediction is more tentative.)

6.1 Method

Participants and Design

The sample of 120 University of Exeter students volunteered to participate in exchange for either course credit or entry into a prize draw for £50. Ethical approval was granted by the Psychology ethics committee. Participants were recruited from the psychology department or via a database of individuals who wished to be informed of opportunities to participate in research in the department. There were two criteria to meet in order to participate in the study. First participants were required to be 18 years of age. Secondly, due to the slightly distressing nature of the images that made up the low valence/high arousal condition, precautionary measures were taken to avoid distress in individuals exhibiting substantial depressive or anxious symptoms³³

Sample size calculation.

For Assumptions 1 and 2, because the difference between the two high valence conditions (CPA and AM conditions) was expected to be minimal, using a mixed design repeated measures model, a small effect size was predicted in the current study. Using the program G*Power 3 (Faul, Erdfelder, Lang, & Buchner, 2007), a total sample size of 90 was calculated ($f = 0.15$, $\alpha = 0.05$, power = 0.8) meaning a minimum of 30 individuals were recruited per condition.

For hypothesis 3, a literature search was conducted in order to derive an effect size to inform the sample size. No research which used HPS as a continuous predictor of mood change in an experimental design was uncovered. However, M'Bailara et al. (2008) conducted a study whereby individuals diagnosed with BD ($n = 90$) reported greater affective change in terms of their self-reported affect from before to after viewing IAPS pictures (from the same set as utilised in this study) corresponding to three affective conditions – positive,

³³ All participants were informed of the distressing nature of the induction via the information sheet. HADS subscales were tallied before the experiment commenced. Individuals with a pre-defined standardised cut-off score of greater than 9 on either of the HADS subscales (Bjelland *et al* 2002) were informed that they could not participate.

negative and neutral – as compared to healthy controls. Because of the similarity in the inductions this study was used as a guide to test for a moderating influence of HPS. The researchers reported a medium effect of $f = .25$ but considering differences between the sample (BD sample versus analogue sample) a conservative effect size, $f = .15$ was entered in to G*Power 3. A total sample size of 108 was calculated ($f = 0.15$, $\alpha = 0.05$, power = 0.8) meaning a minimum of 36 individuals were recruited per condition.

A between-within subjects design was employed where participants completed the AM measures pre and post mood induction. Participants were randomly assigned to one of three mood conditions:

1. Positive valence/ high arousal (AM)
2. Positive valence/ low arousal (calm positive affect: CPA)
3. Negative valence/high arousal (Fear)

6.2 Materials

Self-report measures:

Baseline anxious and depressive mood was assessed via the Hospital and Anxiety Depression Scale (HADS: Zigmond & Snaith, 1983). Participants also completed the HPS at baseline to assess vulnerability to mania. For details on the AM measures (BES, PARS, PANAS and AMSAM) and the derived factor subscales (Cognitive Approach Motivation, Optimism, Positive Activation and Excited) see sections 4.1.1 and 4.2.

Inductions

Thirty six photographs (see appendix V) from the IAPS International Affective Picture Schedule (IAPS: Bradley, Lang & Cuthbert, 1997), were selected to produce the mood inductions (12 photographs in each condition). The selection was based upon the published norms for arousal and valence (Lang, Bradley & Cuthbert, 2008). Selection of photographs was conducted such that normative ratings of arousal and valence levels were matched between conditions where appropriate, for example, the positive valence / high

arousal (AM) pictures are matched to the valence / low arousal (CPA) pictures in terms of valence, and the negative valence / high arousal (Fear) pictures in terms of arousal. This meant that any effects seen could not be argued to be down one set of pictures being more salient than any other on the dimension not being manipulated. The photos were pasted into a separate Microsoft PowerPoint corresponding to each condition and presented in a slideshow which resulted in each photo being viewed twice amounting to a total viewing time of 2 minutes 48 seconds (7 seconds per photo viewing) per condition.

6.3 Procedure

The experiment was conducted in a standard testing room and participants were tested individually. On providing informed consent, participants completed the HADS (described in study 2) which was scored immediately. As noted above, participants scoring 9 or greater on either the depression or anxiety subscale were excluded from the experiment. Participants then completed the HPS and baseline AM measures (the order which these were presented was randomised). The participants were then instructed to read the instructions telling them to “totally immerse themselves in the pictures they are about to view” before clicking the mouse to start the slideshow. Participants then completed the state AM measures a second time before being debriefed.

Approach to Statistical Analysis

To test the assumption of multivariate normality, histogram plots were assessed visually (see Appendix V). One variable, PARS, was skewed, at both time points, logarithmic transformations improved the distribution and were utilised in subsequent analysis. The assumption of homogeneity of variance was met for all analyses as indicated by levene’s tests. When the assumption of sphericity was violated Greenhouse-Geisser corrections were applied. Model fit was examined through inspection of residual distribution. An alpha level of $p = .05$ was adopted unless holm corrections were applied.

Assumption I & II: A repeated measures Analysis of Variance (ANOVA) family test was conducted to test for initial differences. Two sets of follow-up ANOVAs were conducted to test whether each AM measure differed following exposure to high valence/high arousal imagery (AM), high valence/low arousal imagery (CPA) and low valence/high arousal imagery (Fear), one for each assumption: 1). AM groups versus FEAR, 2). AM versus CPA. In the initial ANOVAs conducted, there was a within-subjects factor labelled time (pre – post induction) and a within-subjects factor labelled measure (BES, AMSAM, PANAS-PA and PARS), with condition (AM v CPA or AM v FEAR) as the between-subjects factor. Significant interactions were systematically deconstructed by removing measures and conditions to reveal the patterns of response. The same approach was repeated for the four factor scales.

To test hypothesis 1 and 2 a mixed design repeated measures ANOVA was employed with the within subjects factor measures (pre – post scores for BES, AMSAM, PANAS-PA and PARS), condition (AM, CPA, FEAR) as the between-subjects factor and HPS entered as a predictor. An additional three ANOVAs were conducted to explore if HPS subscales Mood Volatility, Excitement, Social Vitality moderated response to the positive valence conditions. Holm-bonferroni corrections were applied to correct for multiple testing where appropriate.

6.4 Results

The median age of the sample was 19 (SD 2.04) and 75% were female. The 120 students who participated in the study were randomly allocated to the three conditions; AM (n = 37), CPA (n = 40) and Fear (n = 43). As can be seen from table 16 below, participants did not differ across the three conditions in terms of age, $F(2, 110) = 1.54, p = .21$, gender $\chi^2(2, 120)$

= .59, $p = .74$, or current depressive, $F(2, 117) = .02$, $p = .98$ or anxiety symptoms, $F(2, 117) = .34$, $p = .71$ or hypomanic personality score, $F(2, 112) = .01$, $p = .98$.

Table 15. Sample and Baseline Characteristics

	N	Female N (%)	Age <i>M (SD)</i>	Anx <i>M (SD)</i>	Dep <i>M (SD)</i>	HPS <i>M (SD)</i>
CPA	40	29 (72%)	19.9 (2.1)	4.9 (2.0)	3.0 (2.6)	14.4 (8.7)
AM	37	27 (73%)	19.1 (1.8)	4.7 (1.8)	2.9 (1.7)	14.0 (8.3)
Fear	43	34 (79%)	19.6 (2.3)	5.0 (1.9)	3.0 (2.2)	14.3 (7.5)

Note: N = no. of participants. *M* (Mean). *SD* (Standard Deviation). Anx, Dep (Hospital Anxiety and Depression subscales). HPS (Hypomanic Personality Scale). CPA (Clam Positive Affect). AM (Approach Motivation).

For the four measures, there were no differences in baseline scores across the three conditions, $F(2, 144) = .43$, $p = .70$. Appendix V displays means and standard deviations before and after the mood inductions for each condition

Assumption I & II: AM Scales

A mixed design ANOVA family test with time (pre, post) and measure (BES, AMSAM, PANAS-PA, PARS) as a within-subjects factors and condition (AM, FEAR, CPA) as between-subjects factor was conducted. There was a main effect of time, $F(1, 144) = 6.9$, $p = .01$, $\eta^2_p = .06$, a main effect of measure, $F(3, 114) = 2452.95$, $p = <.001$, $\eta^2_p = .95$, and no main effect of condition, $F(2, 114) = 1.75$, $p = n/s$. These effects should be considered in the context of a three way interaction between time, condition and measure, $F(6, 223) = 7.26$, $p < .001$, $\eta^2_p = .11$, indicating differentiated responses of the factor scales to the IAPS conditions, from pre to post induction.

Two sets of mixed design ANOVAs tests were conducted to test the performance of the factor scales in discriminating between high arousal, positive valence imagery from high arousal, negative stimuli (assumption 1: AM versus FEAR) and then to examine their performance in relation to discriminating positive valence imagery that is high in arousal from positive valence imagery that is low in arousal (assumption 2: AM versus Calm Positive Affect: CPA). For brevity, only the statistics for the key differences between will be stated.

Assumption 1: A valid measure of state AM will show a greater increase following exposure to high arousal imagery positive in valence (AM) than following exposure to high arousal imagery negative in valence (FEAR).

The AM and FEAR conditions were entered (CPA omitted) as between-subjects factors in to a mixed design ANOVA with time (pre, post) and factor measure (four levels, as above) as the within-subjects factors. Firstly, a two way interaction between time and condition, $F(1, 76) = 34.30, p < .001, \eta^2_p = .31$, provided evidence that, in general, the measures discriminated between FEAR and AM over time.

A significant three way interaction also emerged, $F(2, 152) = 15.51, p < .001, \eta^2_p = .17$. This indicated different responses between the measures to AM and FEAR imagery from baseline to post induction. To deconstruct this, the AM scales were removed in a systematic manner to reveal where the differences lay.

PARS was removed first, and the subsequent ANOVA did not reveal a significant three way interaction, $F(1.5, 115) = 1.67, p = n/s$, between time (pre-post), condition (AM, FEAR) and measure (BES, AMSAM, PANAS-PA), demonstrating that BES, PANAS-PA and AMSAM behaved similarly. On account of the three-way interaction found above when PARS was included, it was concluded that PARS differed from the other measures.

Because BES, PANAS-PA and AMSAM were undifferentiated in their responsiveness to AM and FEAR, only one (PANAS-PA) measure was compared with PARS to establish if they differed in response to FEAR or AM images. A mixed ANOVA revealed a significant three

way interaction between measure (PARS, PANAS-PA), time (pre, post), and condition (AM, FEAR) was revealed $F(1, 77) = 13.53, p < .001, \eta^2_p = .15$. Therefore, PARS and PANAS-PA differed over time and between these conditions.

To unpack this each of the FEAR and AM conditions were examined in isolation. When pre to post PANAS-PA and PARS responses were compared from participants who viewed the FEAR images, a mixed (2 x 2) ANOVA revealed no interaction between time and measures, $F(1, 42) = 1.94, p = n/s$. The difference between PANAS-PA and PARS, therefore, was expected to be found within the AM condition. Indeed, a significant two-way interaction between measure and time was found, $F(1, 35) = 12.93, p < .001, \eta^2_p = .27$. The responses for PANAS-PA displayed a greater increase within the AM condition than compared to PARS responses. Thus, on account of no interaction being found between PANAS-PA, BES and AMSAM, it can be concluded that these measures were better than the PARS scale in discriminating AM from FEAR. Figure 17 illustrates the greater elevation in AM displayed by PANAS-PA compared to the PARS scale.

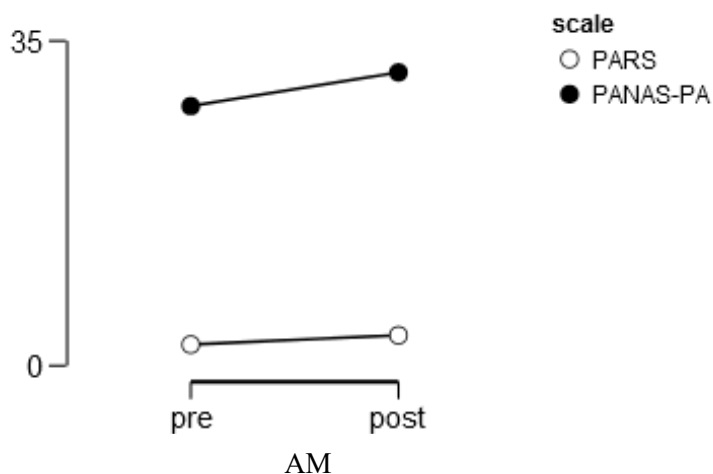

Figure 15. Plots for PARS and PANAS scorers pre to post AM

Note. Y-axis estimated marginal means; contrast explained by the measures being scaled differently. Time x Measure interaction revealing PANAS-PA to be the more sensitive measure.

A valid self-report measure of AM should be able to discriminate BAS – relevant imagery from similar but conceptually distinct imagery. This study tested the ability of AM measures to discriminate between three standardised sets of emotion eliciting stimuli underpinned by the valence-arousal model of affect (IAPS: Bradley & Lang, 1994). High arousal and high positive valence imagery relevant to AM was matched with imagery that 1) shared high arousal eliciting content but contrasted in valence content (Fear imagery) and 2) shared high positive valence eliciting content but which contrasted in arousal level (Calm Positive Affect imagery).

To summarise the results, with respect to assumption one, all four AM measures discriminated between positive and negative images despite them being matched on levels of arousal. This result was arguably more likely to emerge clearly due to stark conceptual distinctions in negative and positive valence. With respect to assumption two, no AM measure, and only one of the total eight scales - the Excited factor subscale - produced evidence to suggest it discriminated between Calm Positive Affect and AM.

Despite the measures all behaving similarly when AM imagery was compared with Fear imagery, within the AM condition PARS showed a weaker response to AM than AMSAM, PARS and PANAS-PA. It is not clear what might explain this. One possibility is the scaling of the measure. The PARS is the only single-item verbal measure. It is hard to provide a reason why this would inhibit responses to high arousal/high positive valence stimuli. This is especially the case when considering that the AMSAM scale is also a single item rating scale.

With respect to the four factor subscales and assumption one, it was found that Optimism, Positive Activation, and Excited discriminated high arousal positively-valenced images from high arousal negatively-valenced images with roughly equal effectiveness. The Cognitive AM scale still differentiated between these conditions, but to a lesser extent.

With respect to the four AM scales and assumption two, the results showed that AM levels increased from pre to post induction in response to both the approach motivation and calm positive affect conditions in an undifferentiated fashion and therefore the AM scales failed to meet assumption two. From a conceptual point of view assumption two was a more stringent test of discriminant validity. Watson and Tellegen's (1985) influential factor analyses robustly demonstrate that negative and positive affect load on two distinct dimensions. In contrast, arousal is commonly viewed as a unidimensional and nonspecific, receiving inputs from both the BAS and the BIS (Gray, 1969). Hence, the CPA versus AM assumption required self-report items to distinguish between opposing ends of the same dimension, whilst the AM versus Fear assumption merely required the self-report items to distinguish between stimuli underpinned by two functionally independent dimensions.

However, for the factor subscales and assumption two, the Excited subscale (PANAS-PA items Excited/Enthusiastic) did discriminate between CPA and AM, with scores significantly increasing from baseline in response to AM imagery and no change in score across time points within the CPA condition. This finding suggests that of the four dimensions found in study 1, two items of the PANAS-PA, which only account for 6.4% of the factor variance in study 1, measure an aspect of subjective response that is sensitive only to positively-valenced stimuli that is high in arousal. At first glance this suggests that the Excited factor may be a superior measure of AM.

But when assessing the results from study 2 and study 3 it appears that different measures of AM appear to have particular advantages when put to different tests. Study 2

suggested that the PARS scale was the closest correlate of psychophysiological index of AM but it did perform poorer in a test of discriminant validity. Whilst study 3 suggests the Excited subscale is the best scale in terms of discriminatory power.

The temptation is to conclude that PARS and Excited scales correspond to two elements especially representative of AM, however it is important to assess the AM induction procedures used in both studies. The Doeo game was untested, and based on theoretically derived criteria with the primary aim of producing maximal AM. The IAPS pictures in contrast are standardised images derived from extensive normative testing. Crucially the IAPS images did not engage behaviour directed towards a tangible reward like the Doeo game but rather the participants were encouraged to “immerse” themselves in the content of photos. As such, it is probable that each AM induction recruited the BAS at differing intensities. Indeed, a common criticism of the IAPS mood induction procedures is their lack of potency, with some researchers pointing to desensitization resultant from the unfiltered ubiquity of emotionally evocative screen-based imagery in everyday life (Betella & Verschure, 2016). It is possible that the measures may discriminate between BAS-relevant and BAS-irrelevant positive affect when evoked with greater intensity. An interesting potential future test of discrimination for AM measures would be to measure attentional scope concurrently to AM self-report and in response to calm positive affect versus approach motivation induction. This is based on research that has found narrowing of attentional scope to be linked to approach states whilst a broadening of attentional scope is associated with low AM positive affect (contentment, serenity) (Gable & Harmon-Jones, 2010).

Based on the reservation about the effectiveness of the stimuli and the findings of study 1, 2, 3, it is concluded that further validation research is required to confidently identify the most valid AM measure. It might be particularly informative to validate the measures in a

more generalizable sample, in naturalistic settings where real-world BAS activating events might attest to the ecological validity of the scales as AM valid.

At this juncture, it was necessary to select a measure of state AM to use in the subsequent studies. It was decided to select PANAS-PA: this was due to the findings of studies 2 and 3 and corroborative evidence to support it as measure of AM. The PANAS-PA produced the greatest response to the Doeo game in study 2, and a facet of it discriminated between approach and non-approach-related positive affect. Therefore, it outperformed the PARS overall. Other evidence for PANAS-PA as a measure of AM stems from the study of anger, an approach-motivated emotion associated with reward obstruction (Carver, 2004). Harmon-Jones assessed PANAS-PA in response to an anger manipulation and found that elevated scores on the items active, alert, determined, proud and strong were particularly associated with anger (Harmon-Jones, Vaughn-Scott, Mohr, Sigelman, & Harmon-Jones, 2004). Total score PANAS-PA was associated with anger in a replication study where the possibility that shared arousal was explaining the effect was eliminated (Harmon-Jones, 2009). Taken together this suggests that the PANAS-PA captures AM of opposing valences. This does not work against its favour but instead suggests it taps comprehensive features of the BAS.

A novel item two-item factor-based scale uniquely discriminated between positive affect conditions in the current study. Due to issues with reliability and a preference to attempt capture broader AM, this scale was not deemed suitable³⁴. Finally a hypothesis that vulnerability to mania would moderate responses to IAPS conditions, was not supported. Previous research employed IAPS stimuli in relation to BD has returned mixed findings with one study findings no groups differences using a high-risk HPS design (Malhi et al. 2004;

³⁴ Exploratory analysis was conducted with the PANAS-PA and subscales CogAM and Excited in subsequent studies (4 & 5). These results are not reported as there was little evidence for differentiation in response to AM conditions of these studies.

Sutton & Johnson, 2002), although in the latter study HPS did moderate startle response to positive pictures. Taken together, the results of the study suggest that IAPS images were not ideal for producing AM that can be subjectively captured by self-report.

7 Chapter 7: The influence of Approach Motivation on Attentional Bias to Positive Information

As mentioned in Chapter 2.4, BD has been found to be associated with heightened approach-related emotions and difficulties in emotion regulation (e.g. Gruber, Johnson & Harvey, 2009). BD has also been found to be specifically associated with positive emotions related to reward and achievement at both the trait and state level (Gruber & Johnson, 2009; Gruber Johnson, Oveis, & Keltner, 2008). These findings are consistent with the BAS theory of BD (Depue & Iacono, 1989) which posits that BAS-relevant triggers (rewarding events/stimuli) lead to dysregulation such as heightened AM (Urosevic et al. 2008) and delayed recovered of AM after reward (Wright, Lam, & Brown, 2008; Farmer et al. 2006). Where Gruber et al. (2008) has provided evidence of heightened AM reactivity in BD, evidence for a delayed recovery comes from Wright et al. (2008) who reported a greater number of previous BD episodes predicted a slower recovery to baseline from BAS activity following in a diary study of individuals diagnosed with type 1 BD. In general, little is known about the cognitive processes that contribute to heightened reactivity and delayed recovery.

One cognitive-emotional process that might contribute to BAS dysregulation is information processing, and specifically biases in selective attention. It has been repeatedly demonstrated that mood states bias attentional processing to mood-congruent stimuli and that such biases can play important roles in the maintenance of negative affective states.

Furthermore, experimental studies have found negative attentional biases are malleable by tasks that serve to direct attention away from negative stimuli (MacLeod & Mathews, 2010).

This work is of particular clinical importance because experimental reduction of attentional biases for negative stimuli has been shown to reduce corresponding symptoms (MacLeod & Mathews, 2010). However, the majority of this research has focussed on attentional biases

pertaining to material concerning negative emotionality with a paucity of research concerning relationships between positively-valenced attentional processes and AM states. A series of experiments conducted in non-clinical samples have explored such relations. In a series of word-dot probe studies, Tamir and Robinson (2007) first demonstrated an association between positive affect and attentional bias for positive stimuli in an experience sampling methodology. In a second study, the researchers replicated this association through experimentally induced positive mood. A third, fourth, and fifth study replicated the finding further and demonstrated attentional bias for positive stimuli is specific to positive mood (see Chapter 3). Therefore, Tamir and Robinson (2007) provide good initial evidence that the relationship between negative mood states and attentional biases for negative information is, to some extent at least, mirrored for positive mood/attention. Consistent with this finding, Mauer and Borkenau (2007) and Segerstrom (2001) found relations between attentional preference for positive information and personality traits associated with AM (extraversion), but these studies deployed a less robust Stroop-type task.

Chapter 3 spelt out a need to understand how attentional processes might contribute to AM dysregulation in BD. The purpose of the current investigation was to extend Tamir and Robinson's (2007) research to the context of bipolar vulnerability. Specifically, the current study examined the potential relationship between attentional processing of positive emotional stimuli and risk of mania (as measured by the Hypomanic Personality Scale: HPS) through measuring the effect of inducing AM states versus no mood induction on attentional preference for positive words (versus neutral words). From literature showing experimentally induced anxiety is associated with threat-related attentional biases in individuals high in trait vulnerability to anxiety as compared to low scorers (Richards, French, Johnson, Naparstek, & Williams, 1992), it was predicted that increased AM would elicit attentional bias for positive

stimuli in individuals with congruent trait vulnerability as measured by the HPS.

Furthermore, some evidence suggests BAS dysregulation in BD might be characterised by heightened responsivity to reward (Trevisani, Johnson, & Carver, 2008) and delayed recovery to baseline after reward (Wright, Lam, & Brown, 2008; Farmer et al. 2006). In the current study AM levels from pre to post induction and from post- induction to immediately post subsequent dot-probe task were taken as a measure of reactivity and recovery, to the test heightened reward sensitivity predictions in trait vulnerability to BD (measured by HPS). Furthermore, to test the contribution of attentional bias to the maintenance of elevated AM, it was speculated that individuals with a greater sensitivity to reward stimuli, as indicated by degree of bias change, would exhibit a slower recovery to baseline.

A second way in which the current study extended previous research was with a focus on AM, rather than non-specific positive mood, which was the independent variable of interest in Tamir and Robinson's (2007) work. To induce AM, participants were asked to "totally immerse" themselves in an achievement/success themed movie clip (Morrone et al. 2004). The PANAS-PA was the preferred self-report measure of AM, based on accrued validity evidence from study 2 and 3 and elsewhere (Harmon-Jones et al. 2009). Finally, HPS subscales (section 2.2.1) have been suggested to be conceptually distinct, therefore in the current study the HPS was analysed both by total and subscale score (Schalet et al. 2011). In sum, this study had two broad primary objectives – to investigate moderation effects of HPS on changes in AM and changes in selective attention to positive stimuli (hypotheses 1 – 3). A secondary exploratory objective (hypothesis 4) was to replicate these analyses using the subscales of the HPS. Specifically, the following predictions were made:

Hypothesis 1.

a) Hypomanic Personality will predict the effectiveness of the AM induction such that those scoring higher on the HPS will show a larger increase in self-reported AM

b) HPS will predict recovery from high activation positive mood such that those scoring higher on the HPS will show a smaller decrease in self-reported AM during the period following positive mood induction.

Hypothesis 2.

a) Baseline attentional bias to positive stimuli will predict the effectiveness of the AM induction such that those with most preference for positive stimuli at baseline will show a larger increase in self-reported AM.

b) The degree of positive bias change post high activation positive mood induction will predict mood recovery such that those with higher levels of positive bias will show a smaller decrease in self-reported AM during the period following positive mood induction.

Hypothesis 3.

a) There will be an increase in bias toward positive stimuli following AM induction relative to a neutral induction, and this will be specific to bias towards positive stimuli (as compared to bias towards general emotional or negative stimuli)

b) HPS score will moderate the effect of AM induction upon bias to positive stimuli, such that those individuals scoring higher on the HPS will display greatest preference for positive stimuli following the positive versus neutral mood induction.

Secondary Hypothesis: Hypothesis 4:

The HPS sub-scales of Mood Volatility, Social Vitality and Excitement were submitted to analysis to test hypotheses involving the HPS, to allow differential influence of HPS subscales on attentional bias to be investigated. These analyses were exploratory in nature.

7.1 Method

Participants

142 undergraduate students (110 female, 32 male) from the University of Exeter, aged between 18 and 43 years of age (Median = 20, range = 18 - 43) participated in the experiment. The only inclusion criterion was that participants be 18 years old prior to starting recruitment. Ethical approval was sought and granted from the Research Ethics Committee at the School of Psychology, University of Exeter. Participants were recruited from the Psychology department or via a database of individuals who wished to be informed of opportunities to participate in research in the department. In return for participation participants received either course credit or £5.

As noted above, recruitment for the study was non-selective. However, in the latter stages of testing, in order to achieve as broad distribution as possible on the HPS, a subset of participants with 'high' HPS scores were preferentially recruited using an online database where potential participants initially completed the HPS online. Eckblad and Chapman (1986) report an upper-decimal cut-off score of 36 (1.67 standard deviations above the mean) and above as reflecting potential vulnerability to developing BD. To avoid a bimodal distribution, individuals scoring greater than 25 were invited to participate (see table 18 for sample characteristics).

Design

The study was a within-between-subjects design. The between-subjects factor was valence of induction and within-subjects variables were positive / negative bias, and AM level measured at four time points.

Sample Size

Necessary sample sizes were calculated based on each hypothesis to be tested.

H1. a) Hypomanic Personality will predict the effectiveness of the AM induction such that those scoring higher on the HPS will show a larger increase in self-reported AM.

.b) HPS will predict recovery from high activation positive mood such that those scoring higher on the HPS will show a smaller decrease in self-reported AM during the period following positive mood induction.

Study 2 found a large ($\eta^2_p = .19$) moderating effect of HPS on AM responses (BES) in a two cell repeated measures design but to be conservative the current study was powered to detect a moderate to small effect size ($f = .10$). With $\alpha = .05$ and power = .95, a sample of 132 would be required to detect this effect

There were no directly comparable studies upon which to base effect size for 1b.. Based upon one study in which bipolar vulnerability in terms of number of previous manic episodes was found to predict recovery of AM following reward (Wright et al., 2008), a large effect size (Cohen's $d = 0.81$) was expected. Using linear regression analysis to detect an effect size of this magnitude a sample size of 40 was required to give power = .95 with alpha set at .05. It should be noted that this sample size applies only to the number of people needed in the AM induction condition.

H2.

a) Baseline attentional bias to positive stimuli will predict the effectiveness of the AM induction such that those with most preference for positive stimuli at baseline will show a larger increase in self-reported AM.

b) The degree of positive bias change post high activation positive (AM) mood induction will predict mood recovery such that those with higher levels of positive bias will show a smaller decrease in self-reported AM during the period following positive mood induction.

There are no directly comparable studies in the area of positive emotional bias research, therefore a likely effect size was derived from the a literature search on the relationship between the existing attentional bias to threat stimuli, and magnitude of subsequent threat response (e.g. MacLeod & Hagan, 1992). On this basis, and using a linear regression, to detect an effect size of $f = .35$ with alpha $.05$ and power = $.95$ a sample of 24 was required to test hypothesis 2a and a sample of 40 was required to test 2b. It should be noted that the sample size for hypothesis 2b applies only to the number of people needed in the AM induction condition.

H3.

a) There will be an increase in bias toward positive stimuli following AM induction relative to a neutral induction, and this will be specific to bias towards positive stimuli (as compared to bias towards general emotional or negative stimuli).

b) HPS score will moderate the effect of AM induction upon bias to positive stimuli, such that those individuals scoring higher on the HPS will display greatest preference for positive stimuli following the positive versus neutral mood induction.

3a). Based on the effect size found by Tamir and Robinson (2007), where the effects of positive mood on positive bias were examined, a medium effect size ($f=.30$) was assumed. Using a repeated measures within-between subjects analysis of variance model in order to detect this magnitude of effect with alpha = $.05$ and power = $.95$, 32 individuals would be required.

Regarding hypothesis 3b, a literature search did not reveal previous experimental research investigating attentional biases and vulnerability to bipolar disorder. In the anxiety disorder literature one study was identified (French, Johnson, Naparsek & Williams, 1992) that tested whether high trait psychopathology (anxiety) score predicted attentional bias

(towards threat) after a negative mood induction versus a positive mood induction in students and found a large effect size. However to be conservative, and using a repeated measures within-between subjects analysis of variance model, the current study was powered to detect a moderate to small effect size ($f=.10$). With $\alpha = .05$ and power =.95, a sample of 132 would be required to detect this effect. Therefore a sample of 132 participants was taken to be the required sample size to address all hypotheses.

7.2 Materials

Self-report

The following measures, used in studies 2 and 3, were included: Hypomanic Personality Scale (HPS: Eckblad & Chapman, 1986), Hospital Anxiety and Depression Scale (HADS: Zigmond & Snaith, 1983). The HADS was used to allow for the potential influence of depression and anxiety symptoms on attentional biases and self-report AM to be examined. As explained in the discussion section of Chapter 6 the PANAS-PA, employed in studies 1, 2 and 3, was utilised as the preferred measure of state AM.

The Altman Self-Rating Mania Scale (ASRM; Altman, Hedeker, Peterson, Davis, 1997) is a five item measure for rating symptoms of mania with each item scaled from 0-4. Higher scores reflect increased symptom severity. The measure was included to control for potential effects of baseline mania-like symptoms. It was intended to capture elevated/euphoric mood, increased self-esteem, decreased need for sleep, pressured speech and psychomotor agitation. It has been shown to perform better than other self-report measures in screening for manic symptoms (Altman, Hedeker, & Peterson, 2001). In the current study the ASRM obtained a coefficient alpha reliability of 0.66.

Inductions

A film-based mood induction was used to induce AM in the current study as opposed to a task or game such as that used in study 2. This was because it did not require any active pursuit of reward, which may have confounded interpretation of between condition differences on the dot probe task. Furthermore, Westermann, Stahl and Hesse (1996) found film procedures to produce the biggest effect sizes in a meta-analytic review of mood

induction procedures. Specifically, Morrone, Depue, Scherer and White (2000) investigated the validity of film for inducing motivational and positive activation type states by evaluating a number of movie clips. Based on Morrone et al. (2000) findings that a film with a sole protagonist in a competitive goal-striving context that ultimately leads to goal attainment evokes the largest response in terms of increased incentive motivation and positive activation (as measured by the PARS utilised in studies 1 and 2), a film clip from the collection they evaluated was identified as the best available option for the current investigation. This clip was approximately 10 minutes in length and portrayed a young man hoping to achieve his dream of playing American football for his local university team in the season's final game. The clip was extracted from the 1993 motion picture Rudy (copyright permission gained through the British Universities and Colleges Film and Video Council). In line with Morrone et al. (2000) and throughout the study, participants received a short written synopsis of the plot before watching the film in which they were informed that the film was based on a true story and encouraged to immerse themselves in as much as possible (see appendix VI for instructions). To create a control condition in which mood does not substantially change, Morrone et al. successfully used a nature documentary, also approximately 10 minutes long. The current study employed similar footage but did not use the same material due to it being unavailable. The nature clip used here was a 10 minute section from a nature film titled *The Living Planet: A Portrait of the Earth* (1984). Participants received no written instructions. The experimenter did provide verbal information: "you are now going to watch a nature documentary".

Dot Probe Paradigm.

The dot probe task was first designed by Posner, Snyder and Davidson (1980) to measure shifts in selective attention. It was then later modified by MacLeod, Mathews and Tata (1986) in order to examine visual attentional biases. The dot-probe task used in the current study was based on the paradigm employed by Tamir and Robison (2007). Participants were asked to focus on a black 2cm x 2cm cross in the centre of the screen for 1000ms (milliseconds). This was followed by a 40ms blank screen and then word pairs appeared. The words were centrally aligned, using Courier New font, size 18. The word pairs appeared for a period of 750ms, in line with findings that attentional biases to positive stimuli are evident in both short (300 ms) and longer (900 ms) exposure durations (Tamir & Robison, 2007). A 0.5cm black circular dot then appeared directly in place of either the top or bottom word and participants were asked to be as accurate and as fast as possible in pressing 'T' if the dot was at the top or 'V' if the dot was at the bottom. The dot did not disappear until either the 'T' or 'V' key was pressed. There was then a 1000ms pause before the next trial began.

There were three types of trial within the task, neutral-negative word pairs and neutral-positive word pairs and, neutral-neutral word pairs, used as a measure of reaction time unaffected by emotional word content. Word selection was based on the validated word pairs used by Tamir and Robison (2007) which were previously tested for their valence content (Bradley & Lang, 1999). Three tasks were developed, a practise task and two bias assessment tasks, pre and post induction. For each assessment task, there were 10 positive words (of which five were success-themed words and five were generally positive words) and 10 negative words (five were failure-themed words, five were generally negative words). There was a specific neutral word matched in word length to each emotional word and each pair would be seen four times in each task. There were also 11 pairs of neutral words that appeared four times per pair. In total there were 124 trials, consisting of all possible

combinations of word and dot positions to account for attention bias to the top or bottom of the screen. Trials were ordered using a random number generator to prevent participants using any learned pattern of response; all participants completed the task in the same randomised order.

The practice task consisted of only five trials of neutral word pairs. These words were not repeated in either of the main tasks. This practice task was developed to ensure that participants understood what the task required. The practice task data were not used in any data analyses. The two assessment tasks (Dot Probe A and Dot Probe B) were identical in every feature except in choice of words which were counterbalanced; there were 10 positive words per task. The words used were matched in word length. All of the words and trial numbers for each word used are included in Appendices VI. Half of the participants undertook Dot Probe 1 then Dot Probe 2; the other half undertook them in reverse order.

Apparatus

A 22-inch computer monitor and a standard two-button mouse were used to show the films and present the dot probe stimuli. Participants wore headphones when watching the film and filled out self-report measures via paper and pen.

7.3 Procedure

On arriving at the testing session but before providing informed consent, participants were informed that the study was about “how certain aspects of mood and attention relate to another in response to film stimuli” and were then provided with basic information about how the study would proceed. On providing informed consent the participants completed baseline measures (HPS, HADS, ASRM), then a practise dot probe task, a pre-induction dot probe task, then watched a film clip (randomised to Experimental or Neutral condition) then finally a second dot probe task before being debriefed. AM measures were interspersed between tasks as illustrated in figure 20

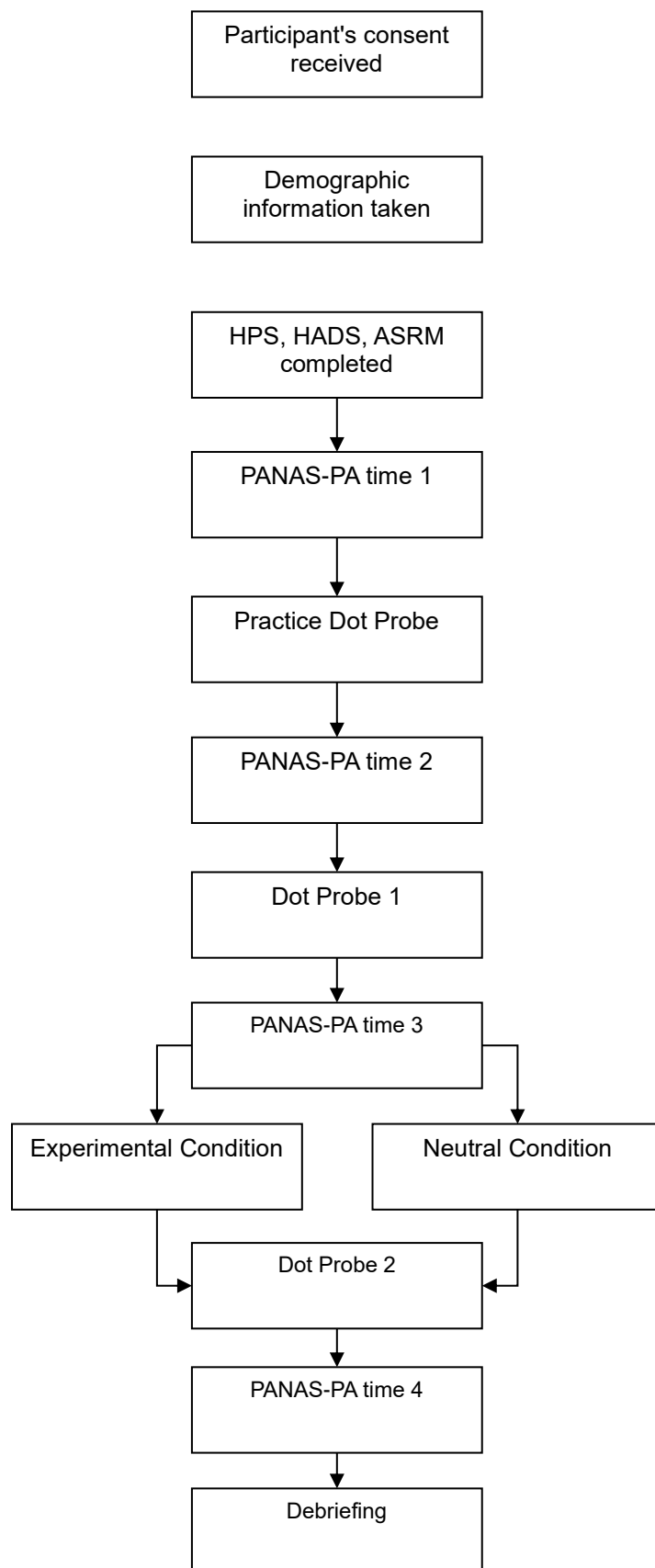

Figure 16. Flowchart of study procedure

Data Preparation and Analysis

Analysis was conducted using SPSS v.23 and JASP 8.0.0. Statistical tests included Chi-square, bivariate correlations, independent and paired t-tests, and repeated measures ANOVA and ANCOVA were used to test the main hypotheses. In order to test the assumption of multivariate normality histograms plots were assessed visually. Histograms of residuals were inspected for normality to assess model fit. Only two variables, current depressive symptoms and ASRM, were not normally distributed. Transformations were unsuccessful so these variables were submitted to non-parametric analysis. An alpha level of $p = .05$ was adopted.

Dot Probe data preparation

The dot probe task data were prepared for analysis by inspecting error rates and outliers. Firstly, reaction times (RTs) for incorrect probe responses (errors) were removed. The number of errors made by participants ranged from 0 to 18 ($M = 2.69$, $SD = 3.02$). Individual trial error rates outside 95% confidence intervals were removed resulting in removal of dot probe RTs for four participants. Two steps were taken to deal with extreme values within each participant's RT data. Firstly, individual extreme values were defined as RTs two standard deviations above and below their individual dot probe mean. These were replaced with their respective 95th and 5th percentile values. Secondly, general extreme values were dealt with by removing very short ($< 200\text{ms}$) and very long RTs ($> 750\text{ms}$) in the whole data set. Finally, two further participants' data was absent due to a computer error during testing. This method is based on recommendations from prior dot probe research (Tamir and Robinson, 2007; Ratcliffe, 1996).

Dot Probe Bias Calculation: The latency to respond to the dot (in milliseconds) and whether the correct response was made was recorded by the software (E-Prime v.1) and was used directly for analysis. For each type of emotional word (negative or positive), a bias score was calculated using the formula from MacLeod and Matthews (1988):

$$\text{Attentional Bias to Emotional Information Index} = \text{RT for probes in neutral word locus} - \text{RT for probes in emotion (positive or negative word) locus:}$$

Attentional bias to positive information index will be referred to as POSBIAS and attentional bias to negative information index will be referred to as NEGBIAS. A positive POSBIAS score reflects a selective attention towards the positive stimuli relative to the neutral stimuli. A negative POSBIAS score reflects a selective attention away from the word (avoidance) relative to the neutral stimuli. Finally, bias scores were calculated for word type. Bias score was calculated for success words, general positive words, failure words, and general negative words.

7.4 Results

Baseline Measures

Participants did not differ across the two conditions in terms of age (see table 18). However, anxiety symptoms differed between the groups, $t(138) = 2.3, p = .038$, with participants in the experimental condition exhibiting higher scores than those in the control group (Anxiety was added as a covariate in all subsequent between group analyses). For depressive

symptoms and the ASRM, Mann-Whitney U tests revealed no differences. Pearson's correlations revealed expected positive associations between HPS and anxiety, $r = .33$, $p < .001$ and depression, $r = .25$, $p < .01$. State positive activation items from the PANAS (Watson & Tellegen, 1988) measured at baseline correlated positively with the HPS, $r = .2$, $p < .05$, but current manic symptoms measured by the ASRM did not. At the personality level, research has shown hypomania to be associated with elevated levels of neuroticism and extraversion (Schalet, Durbin, & Revelle, 2011), whilst at the state level the HPS is commonly associated state negative affect (Kawpil et al. 2000). Based on a recommendation in the literature concerning improper statistical correction of meaningful relationship between variables (Miller & Chapman, 1992), the decision was take not to control the effects for these associated variables. However, due to the group differences in anxiety symptoms anxiety was controlled for on later analyses.

Table 16. Characteristics of the Participants at baseline

	N	Female N (%)	Age <i>M (SD)</i>	Anx <i>M (SD)</i>	Dep <i>M (SD)</i>	HPS <i>M (SD)</i>	ASRM <i>M (SD)</i>
Experimental	69	55 (80%)	21.8 (3.9)	7.6 (3.8)	3.3 (3.1)	20.6 (12.0)	5.5 (3.3)
Control	69	54 (78%)	21.2 (1.9)	6.2 (3.6)	2.4 (2.1)	20 (11.6)	6.6 (3.7)

Note: N = no. of participants. *M* (Mean). *SD*(Standard Deviation. Anx, Dep (Hospital Anxiety and Depression subscales). HPS (Hypomanic Personality Scale)

In order to test the hypotheses it was first necessary to check whether the experimental condition was successful in increasing AM levels relative to the neutral induction. Independent samples t-test confirmed no differences between the groups prior to induction (time 2). Anxiety (HADS-A) was entered as covariate to repeated measures

ANOVA³⁵ to establish if there were any significant differences between the experimental and control conditions (between subjects factor) in PANAS-PA score before (time 2) and after (time 3) (within-subjects) the induction. There was a main effect of time, $F(1, 134) = 6.93$, $p = .009$, $\eta^2_p = .05$, no main effect of condition, $F(1, 134) = .53$, $p = n/s$, yet a significant interaction between time and condition, $F(2, 134) = 17.56$, $p < .001$, $\eta^2_p = .11$. As figure 21 illustrates, the manipulations were successful in differentially inducing AM.

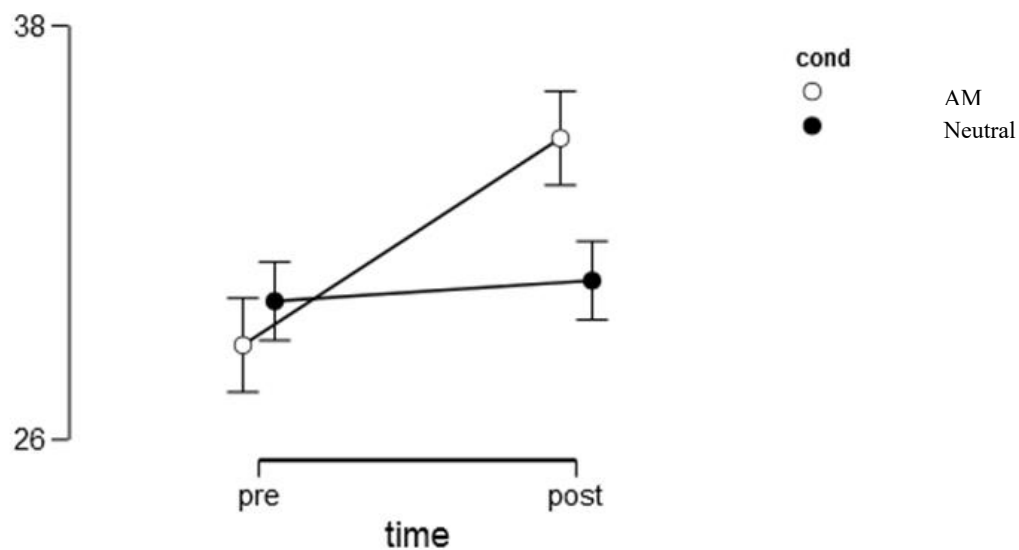

Figure 17. Plot graph for PANAS pre-post induction

Note: Y axis PANAS-PA estimated marginal means (covariate included in model), X. Error bar represent

Hypothesis1(a). Hypomanic Personality will predict the effectiveness of the AM induction such that those scoring higher on the HPS will show a larger increase in self-reported AM

To test hypothesis 1a a repeated measures ANCOVA with PANAS-PA pre - post induction (labelled Time) as the within-subjects factor and condition (AM versus Neutral) as between-subjects factor, was performed. Anxiety was entered as a covariate and HPS was included as a predictor in a three-way interaction term (HPS x time x condition). HPS did not interact with time, $F(1, 130) = 2.3$, $p = .99$, nor with condition $F(1, 130) = .07$, $p = .79$, and

³⁵ Hitherto all tests referred to as ANCOVAs are repeated measures (labelled Time) ANOVAs with Anxiety as a covariate to control for baseline differences between the groups.

there was no interaction between time and condition, $F(1, 130) = .29, p = .58$. Thus HPS did not predict the effectiveness of the AM induction.

A simple linear regression was conducted on individuals in the experimental condition to determine if AM recovery (PANAS-PA time 4 - PANAS-PA time 3) could be predicted by HPS. The overall model was not significant, $F(1, 67) = 3.2, p = .08, R^2 = .04$, however there was a trend for HPS to predict AM recovery scores, $\beta = -.34, t(67) = 1.80, p = .08$. HPS consists of three lower-order components: Social Vitality, Excitement, Mood Volatility (Schalet et al. 2011). As secondary analyses, scores were calculated to create HPS-component variables in order to investigate differential effects per hypothesis. To test hypothesis 1(a) the subscales was added as a predictors to a Time (pre, post) x Condition (AM, Neutral) ANCOVAs. No significant results emerged. The null findings are reported in table 19 revealing no three way interaction, no effect of Time yet there was a main effect of Condition, $F(1, 130) = 5.68, p = .02, \eta^2_p = .03$.

Table 17. Repeated measures ANCOVA results for Hypomanic Personality subscales

<i>repeated measure</i>	Mood Volatility			Social Vitality			Excitement		
	$F(1, 130)$	p	η^2_p	$F(1, 130)$	p	η^2_p	$F(1, 130)$	p	η^2_p
PEP									
time	4.94	0.47	0.004	0.62	0.43	0	0.26	0.61	0.002
condition	0.81	0.44	0.01	0.52	0.48	0.004	0.59	0.44	0.005
time x condition	0.54	0.57	0.008	0.06	0.81	0	1.46	0.99	0

Note. For each test interactions are reported with HPS subscale and time, HPS subscale and condition & HPS subscale and time x condition.

Hypothesis 1(b): HPS will predict recovery from high activation positive mood such that those scoring higher on the HPS will show a smaller decrease in self-reported AM during the period following positive mood induction.

For hypothesis 1 (b) the HPS component variables were independently entered as predictors in a simple linear regression. Neither Social Vitality, $\beta = .09$, $t(68) = .75$, $p = .45$, nor Excitement, $\beta = .19$, $t(68) = 1.65$, $p = .10$, predicted recovery from high-activation positive mood. However for Mood Volatility, the overall model was significant, $F(1, 68) = 7.6$, $p = .007$, $R^2 = .10$; this component significantly predicted AM recovery scores, $\beta = -.34$, $t(68) = 2.76$, $p = .007$, whereby 10% of the variance in AM recovery was accounted for by Mood Volatility such that those scoring higher showed a larger decrease in self-reported AM. To account for multiple comparisons in this secondary analysis, Holm Bonferroni corrections were applied. The relationship between Mood Volatility and AM recovery remained significant, as it was below the corrected cut-off of $p < .017$.

With respect to baseline dot probe task results, there were no differences between the groups in baseline RT to neutral stimuli (when both word pairs were neutral), $t(136) = 1.56$, $p = .12$, nor were there differences in overall RT (pre and post- induction taken together), $t(136) = 1.18$, $p = .23$. There were no differences in error (incorrect response) rate between the groups at baseline, $t(136) = .61$, $p = .54$. Importantly, there were no differences between conditions in bias towards positive stimuli relative to neutral (POSBIAS), $t(136) = 1.04$, $p = .91$ or towards negative relative to neutral stimuli pre-induction (NEGBIAS), $t(136) = .01$, $p = .98$. Pearson's correlations were conducted between HPS and error rate prior to the induction, after the induction, and between HPS and baseline RT and revealed no significant associations.

Table 18. Attentional bias, reaction times, and error rates for both conditions

Characteristic	<i>n</i>	AM (68) <i>M (sd)</i>	Control (67) <i>M (sd)</i>
Baseline RT		421.1 (61.85)	403.9 (67.13)
Overall Mean RT		407.2 (51.50)	394.5 (56.85)
Error Rate			
pre		1.24 (1.56)	1.35 (1.86)
post		0.98 (1.00)	1.79 (2.14)
Attentional Bias Score			
Positive (posbias)			
pre		18.26 (210.04)	19.39 (192.22)
post		32.04 (191.31)	-6.16 (179.17)
Negative (negbias)			
pre		-17.80 (180.45)	-19.21 (175.83)
post		2.16 (203.01)	10.14 (215.33)

Note. Baseline RT - mean reaction to dot in trials where both words are neutral. Overall Mean RT - mean reaction time for all trials pre and post. Error rate - count of instances when incorrect key pressed.

Hypothesis2 (a): Attention to positive stimuli as a predictor of the effectiveness of the AM induction

Prior to testing the hypothesis, Pearson's correlations revealed no significant associations between AM level (PANAS-PA) at each time point (time 1 - 4) and pre-induction or post-induction attentional bias for positive words score (referred to as POSBIAS pre and

post³⁶). Nor were there any significant relations between pre or post POSBIAS and baseline measures, as can be seen in table 21.

Table 19. Pearson Correlations for between HPS, AM attentional bias to positive words

	Posbias -pre	Posbias -post	AM-pre	AM-post	HPS
Posbias-pre	—	-0.03	-0.006	-0.049	-0.028
Posbias-post		—	0.003	0.076	-0.009
AM-pre			—	0.475 ***	0.216 *
AM-post				—	0.151
HPS					—

Note. correlations are non-significant unless indicated by asterisk * $p < .05$, ** $p < .01$, *** $p < .001$ AM (PANAS-PA)

Hypothesis 2(b): the degree of positive bias change post high activation positive mood induction will predict mood recovery such that higher levels of positive bias will show a smaller decrease in self-reported AM during the period following positive mood induction.

A repeated measures ANCOVA with PANAS-PA pre - post induction (labelled time) as the within-subjects factor, condition (AM induction, Neutral induction) as the between-subjects factor, and POSBIAS entered as a predictor in a three-way interaction term (POSBIAS x time x condition), was performed to test hypothesis 2a. POSBIAS did not predict the effectiveness of the mood induction, $F(1, 133) = .09, p = .75$. A simple linear regression was conducted on individuals in the experimental condition to determine if AM recovery (PANAS-PA 4 - PANAS-PA 3) could be predicted by POSBIAS, but was non-significant, $\beta = .03, t(68) = -.27, p = .78$.

³⁶. POSBIAS refers to attentional bias to positive stimuli relative to neutral stimuli, NEGBIAS refers to attentional bias to negative stimuli relative to neutral stimuli. Higher POSBIAS/NEGBIAS and POSBIAS/NEGBIAS change scores represent selective biases favouring positive or negative stimuli, relative to neutral.

Hypothesis 3 (a): There will be an increase in bias toward positive stimuli following the AM induction relative to a neutral induction, and this will be a specific bias towards positive stimuli (as compared to bias towards a general emotional or negative stimuli)

As it was important to establish if the AM induction produced a general or valence-specific bias, an initial family test was conducted to test the effect of the inductions on attentional bias for general emotion words. A three way interaction between valence, condition and time would indicate an effect of the AM manipulations on either POSBIAS or NEGBIAS, whilst a two-way interaction between time and condition would indicate an effect of the induction on bias for general emotion words. The family test revealed no significant interaction, between, valence, time and condition, $F(1, 133) = .10, p = .75$, and no significant two-way interaction between time and condition, $F(1, 133) = .04, p = .83$. Thus there was evidence to support hypothesis 3a.

Hypothesis 3 (b): HPS score will moderate the effect of AM induction upon bias to positive stimuli, such that those individuals scoring higher on the HPS will display greatest preference for positive stimuli following the positive versus neutral mood induction

To test hypothesis 3b HPS was added to the family test and a four –way interaction term was specified (HPS x valence x condition x time). HPS did not influence attentional bias for emotional words over time, $F(1, 128) = .12, p = .72$, between conditions, $F(1, 128) = .93, p = .33$, nor did HPS influence the relationship between time (pre, post) and condition (AM, Neutral), $F(1, 128) = .84, p = .72$. Nor was there an interaction between HPS and valence (POSBIAS, NEGBIAS), $F(1, 128) = .50, p = .47$. Unsurprisingly, no four significant four-way interaction emerged, $F(1, 128) = .96, p = .32$. Therefore there was no support for hypotheses 3a and b.

Secondary Analysis: Success versus Failure words

As a secondary analysis word type was compared; success versus failure words, and separately, general positive versus general negative words. A 2 (success, failure) x 2 (AM, Neutral) repeated measures (time: pre, post) ANOVA test found no significant interaction between time, condition and word type, $F(1, 128) = .23, p = .72$. HPS was added to make a four way interaction but no moderation effect was found, $F(1, 128) = .82, p = .36$.

Success versus failure word bias scores were replaced with general positive and negative word bias scores and the ANOVA model rerun. No significant interaction between time, condition and word type emerged, $F(1, 128) = .05, p = .82$. HPS was added to make a four way interaction but no moderation effect was found, $F(1, 128) = .06, p = .80$. Thus no effects of word type were evident.

Reliable Change Index

The hypotheses of the current study hinge upon predicted group differences in self-reported AM between the positive and neutral inductions. A disadvantage of the method employed is that individual differences in AM responsivity are obscured by the general linear model. Refining the sample by identifying and then excluding individuals who did not respond to the inductions in the hypothesized directions is one way of overcoming this problem (Morley & Dowzer, 2014). One method of inferring the degree to which a change in symptoms (although not exclusive to symptom measures) is meaningful is the Reliable Change Index (RCI, e.g. Morley & Dowzer, 2014). The RCI is a statistical tool that produces a threshold value, derived through estimates of observed change in score relative to measurement error, which reflects outcome scores that can be deemed to have reliably increased (or decreased or not changed, depending on the hypothesis). The RCI was employed in the current dataset guided by the rationale that hypothesized effects of HPS and induced AM on selective attention will be observed only in those who experience a reliable

increase in PANAS-PA following positive mood induction, compared to those who did not experience reliable change following neutral mood induction.

RCI was calculated on both conditions independently using a macro-enabled Excel document provided by the University of Leeds (Morley & Dowzer, 2014). Standard deviations of PANAS –PA pre and post induction and median Cronbach's Alpha values across the four measurement points of the study (AM = .91, Control = .90) were used to compute the RCI for each condition (AM = .68, Control = -.07). The RCI for the AM condition was 7.3 and for the control condition it was 7.29, meaning that only PANAS-PA change scores above these thresholds could be said to have reliably increased (in the case of AM participants) or reliably not changed (in the case of participants in the Neutral condition). Hence participants in the AM condition with PANAS change scores less than 8 were excluded from future analyses. Similarly, participants in the neutral control condition who reliably increased or decreased from pre to post induction were excluded. Thus participants in the neutral condition with PANAS change scores equal to or greater than 8 either direction (increased or decreased) were excluded. Of 69 participants in the AM condition this resulted in 37 participants displaying no change, 4 deteriorating in score, and 28 improving. For the control condition, 18 participants improved, 9 deteriorated and 41 did not change and so 28 and 41 participants from each condition respectively were retained for analysis. Table 22 shows sample characteristics for the updated groups. Parametric assumptions were checked as detailed previously with particular attention paid to the assumption of homogeneity which was not violated despite unequal group sizes.

Table 20. Sample Characteristics for reliable change sub-sample

	N	Female N (%)	Age <i>M (SD)</i>	Anx <i>M (SD)</i>	Dep <i>M (SD)</i>	HPS <i>M (SD)</i>	ASRM <i>M (SD)</i>
Experimental	28	18 (80%)	20.1 (2.1)	8.5 (3.7)	3.4 (3.2)	20.6 (12)	5.2 (2.7)
Control	41	16 (20%)	20.3 (3.01)	6.3 (3.6)	2.3 (2.1)	20 (11.6)	6.4 (3.4)

Note: N = no. of participants. *M* (Mean). *SD* (Standard Deviation). Anx, Dep (Hospital Anxiety and Depression subscales). HPS (Hypomanic Personality Scale)

There were significant differences in Anxiety symptoms, $t(67) = 2.4, p = .01$, as was the case in the full sample. There were no other differences between the groups. However independent samples t-test confirmed significant differences between the groups prior to induction at time 2, $t(67) = 2.8, p < .001$, with AM group ($M = 28.25, sd = 6.31$) exhibiting lower PANAS-PA scores than the control the group ($M = 32.63, sd = 6.32$). PANAS at time 1 and Anxiety (HADS-A) were entered as covariates to repeated measures ANCOVAs to establish if there were any significant differences between the experimental and control conditions in PANAS score before (time 2) and after (time 3) the induction. There was a main effect of time, $F(1, 67) = 216.3, p < .001, \eta^2_p = .45$, no main effect of condition, $F(1, 67) = .44, p = .59$, yet a significant interaction between time and condition, $F(2, 67) = 194.4, p < .001, \eta^2_p = .41$. The AM induction was therefore successful in this subsample, as expected. To investigate the effect of refining the sample, via assessing reliable change, the analyses conducted previously to test hypotheses 1-3 were repeated with this subset of participants. The results did not change (these results can be found in the appendices V), other than with respect to hypothesis 3a and 3b:

Hypothesis 3 (a): There will be an increase in bias toward positive stimuli following the AM induction relative to a neutral induction, and this will be a specific bias towards positive stimuli (as compared to bias towards a general emotional or negativestimuli).

A 2 (Valence: POSBIAS, NEGBIAS) x 2 (Time: pre - post) x 2 (Condition: AM, Neutral) ANCOVA was conducted to test hypothesis 3a. No four or three way interaction was revealed to support the hypothesis, although there was an interaction between Time and Valence, $F(1, 67) = 4.95, p = .03, \eta^2_p = .07$, suggesting a change in bias to a particular valence over time and irrespective of condition.

Hypothesis 3 (b): Relative to the neutral condition, HPS score will moderate the effect of induction condition upon bias to positive stimuli, such that those individuals scoring higher on the HPS will display greatest preference for positive stimuli.

To test hypothesis 3b, a moderating effect of HPS on attentional bias in the AM condition relative to the neutral condition, HPS total score was added to the omnibus test. There was no four way interaction but there was significant three way interaction between HPS, Time and Condition, $F(1, 65) = 4.85, p = .03, \eta^2_p = .07$, indicating a moderating effect of HPS on attentional bias for general emotion words (i.e. for both positive and negative words).

To deconstruct this effect, a median split was conducted on HPS (median = 22). Valence was taken out of the model as a within-subjects factor, and then a two-way (time x high-low hps) repeated measures ANOVA was conducted within each condition. This was followed up by time x condition ANOVA tests on those scoring low on HPS (range 0-22, mean = 13) and then on high HPS scorers (range,23- 43 mean = 34). No interactions were revealed between time and high-low HPS within the AM condition, $F(1, 19) = 1.13, p = .30$, or Neutral condition $F(1, 43) = 1.28, p = .26$.

For the low HPS scorers, there was a trend towards an interaction between time and condition, $F(1, 31) = 3.2, p = .08, \eta^2_p = .07$, whilst for high HPS scorers there was a

significant interaction between time and condition, $F(1, 31) = 6.59, p = .01, \eta^2_p = .21$.

Therefore, a moderation effect was found when the groups were refined via the RCI. The two way interaction depicted in figure 22 illustrates the effect. Individuals scoring higher on the HPS were found to increase in terms of attentional bias to emotional stimuli in the AM induction versus the neutral induction. A final test was to explore the effect of word-types: reward – general positive, failure – general negative. To test effects of word type, separate comparisons were run between success/failure and general negative/general positive bias scores. A 2 (success, failure) x 2 (AM, Neutral) repeated measures (time: pre, post) ANOVA test found a trend towards a three-way interaction, $F(1, 67) = 3.14, p = .08$. HPS was added to make a four way interaction but no moderation effect was found, $F(1, 65) = .55, p = .46$. When words that were generally positive or negative in meaning were compared, the three-way interaction was non-significant, $F(1, 67) = .03, p = .85$, HPS was added to make a four way interaction but no moderation effect was found, $F(1, 65) = .08, p = .77$.

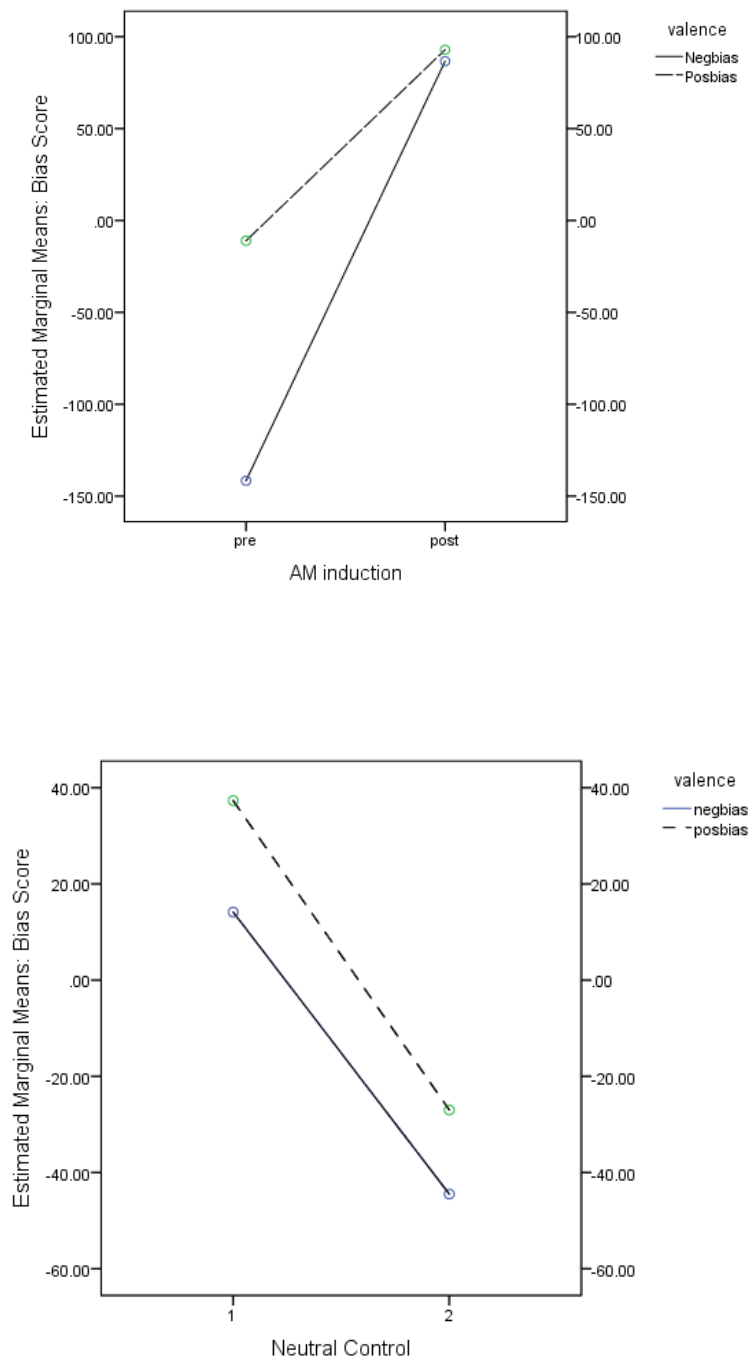

Figure 18 a) and b) General Positive Bias Plots for positive and negative attentional bias scores in a) the AM induction b) Neutral induction for high HPS scorers

Secondary Hypothesis::H4: Exploring the differential effect of the HPS Subscales on attentional biases.

To test the moderation effect of the HPS subscales (Mood Volatility, Social Vitality, Excitement) on attentional bias three separate mixed ANOVAs were conducted and holm-bonferroni corrections were applied post-hoc. A 2 (Valence: POSBIAS, NEGBIAS) x 2 (Time: pre - post) x 2 (Condition: AM, Neutral) ANOVA was specified for each subscale in which the subscale (mood volatility, social vitality, and excitement) was entered as a predictor. No three way (time x condition x HPS subscale) interactions were revealed. Table 23 displays the results for the series of repeated measures ANOVAs conducted for each HPS subscale. The p-values in the table are uncorrected. With holm corrections applied, the three and four way interactions need to reach a corrected significance threshold of $p < .017$. As can be seen from the table 23, it can be concluded that the subscales did not uniquely moderate attentional bias.

Table 21. RCI moderations results for Hypomanic Personality subscales

moderation in- teraction terms	Mood Volatility			Social Vitality			Excitement		
	$F(1, 66)$	p	η^2_p	$F(1, 66)$	p	η^2_p	$F(1, 66)$	p	η^2_p
HPS scale * time * condition	1.3	0.25	0.02	4.38	0.04	0.06	5.84	0.018	0.08
HPS scale * time * condi- tion*valence	0.04	0.83	0.001	0.08	0.77	0.001	1.35	0.25	0.02

Note. Time (pre induction, post induction within-subjects factor) Condition (AM, Neutral) Valence (POSBIAS, NEGBIAS)

7.5 Discussion

This study attempted to replicate Tamir and Robinson's (2007) research which demonstrated associations and causal relations between positive mood states and selective biases to positive material and extend this by testing the influence of mania proneness on these relations. In an effort to extend these findings to the context of AM dysregulation in bipolar vulnerability, the study was geared towards reward rather than general positive mood. Informed by studies 2 and 3 and the wider literature base (Harmon-Jones et al. 2013), PANAS-PA was used to measure AM. Secondly a goal-attainment movie clip previously found to increase AM³⁷ (Morrone et al. 2000, Morrone-Strupinsky et al. 2004) was used to generate an elevated approach-state. On the whole, the results did not replicate those found by Tamir and Robinson (2007), however a tentative novel finding of this study was an increase in bias to emotional stimuli in those with a trait vulnerability to BD following induction of AM, where this induction had been successful.

When compared against responses to neutral mood induction, and baseline levels of AM, an elevated AM was successfully induced. Subsequent to this, the main hypotheses were tested. Little support emerged for the congruency-effect of induced AM on selective attention for positive stimuli. Nor did a moderation effect emerge for hypomanic personality on bias or AM response. Additionally, bias to reward was not associated with baseline mood, current AM, hypomanic personality or current mania symptoms. Furthermore the hypothesis that risk of mania would predict recovery to baseline was not supported. Conversely, a small significant effect suggested accelerated recovery of AM back to baseline was evidenced in individuals who endorsed changeable and unpredictable moods on the HPS (mood volatility subscale). 10% of the variance in AM recovery was accounted for by Mood Volatility such

³⁷ as measured by the PARS which closely corresponds to PANAS-PA.

that those scoring higher on this HPS subscale showed a larger decrease in self-reported AM, a finding contrary to that hypothesized for total HPS scores.

Because mood inductions might work for some and not for others yet this can be obscured by analysis of means, this opens the possibility that biasing of attention would only be seen in individuals in which AM was effectively induced. The reliable change analysis allowed for a stratified sample for the experimental condition that consisted only of individuals whose AM reliably increased. Accordingly, the neutral condition only consisted of individuals whose AM did not change.

This is a common practice which is argued to be under-utilised (Zahra & Hedge, 2010). It was shown to be fruitful in the current study as a significant moderation effect for HPS was revealed; following AM induction, relative to neutral, individuals at higher risk to mania exhibited greater elevation in attentional bias for general emotional stimuli. Biased information-processing in the context of BD has been understudied in comparison to other emotional disorders. There is some evidence that elevated mood in BD is characterised by preferential processing of both negative and positive material (Bentall & Thompson, 1990; Murphy, 1999). More research is required to disentangle these effects, as they would be critical to explaining the development of symptoms. There is evidence from clinical studies, that during manic episodes individuals display a bias toward positive (e.g. Murphy et al. 1999) but this study used a less-direct measure of attentional bias. This thesis is more concerned with mechanisms of change that might operate to escalate or sustain heightened AM and therefore to help explain the ascent to mania rather than information-processing biases evident when AM is already extreme. In this sense, only one study was identified that directly relates. Peckham et al. (2015) induced elevated positive mood and measured subsequent attentional biases (positive, neutral, negative material) yet did not find any differences between individuals diagnosed with BD as compared to healthy controls. It is

possible that the general emotional bias found in an elevated AM state represents a premorbid risk factor. Replication is required, possibly utilising a high risk (stratified – high versus low HPS) design.

The moderation effect found for HPS should be interpreted in light of the general failure to replicate affect-attention congruency effects reported by Tamir and Robinson (2007). Moreover, the current study design closely corresponded to that of Tamir and Robinson (2007) with the same stimuli set used to assess attentional bias. These researchers found attentional biases to positive stimuli evident in both short (300 ms) and longer (900 ms) exposure durations (Tamir & Robinson, 2007). The decision to choose a middle-ground exposure time of 500ms was designed to roughly fall between these values and it is the most commonly used in the wider attentional bias literature (Pool, Broshch, Delplanque & Saner, 2014).

One explanation why induced AM did not produce a bias relates to the variant of the dot-probe task used. Grafton (2016) suggests that the type of task used in the current study and therefore the dot-probe used by Tamir and Robinson (2007) also, is a flawed measure of attentional bias. This task required participants to be able to discriminate probe location (locus of emotion word or non-emotion). This discrimination invokes the possibility that the location of probe stimuli could be identified without the need for participants to attend to location where the probe appeared. This does not allow for the confident conclusion that effects reported by Tamir and Robinson (2007) were driven by an attentional bias favouring reward over neutral stimuli. This caveat was addressed in study 5 (Chapter 8) by requiring the participant to instead discriminate the probe³⁸ (rather than location of the probe).

³⁸ To achieve this participants are required to discriminate whether one dot probe or two dot probes (presented with equal frequency) were in the locus of the word.

Another limitation of the current study was the questionable effectiveness of the Rudy clip as a powerful AM induction. The selection of an achievement-focussed movie clip was an empirically-supported decision (Morrone-Strupinsky et al. 2004) but the RCI showed that roughly two thirds of participants in the experimental did not show reliable increases in AM, therefore suggesting the induction lacked strong AM eliciting features.

On account of the effects found in study two, the Doeo task was considered for the current study but concerns about the differential effects of the Doeo task versus control tasks on visual attention meant the film clip was deemed more appropriate. The AM clip, set in the context of success within American football, was validated in a U.S. undergraduate sample. There might have been an oversight here regarding generalizability to a U.K. undergraduate sample.

In sum, this study, despite the aforementioned methodological issues, provided tentative evidence that experimentally induced elevations in AM are associated with biased attentional processing of emotional stimuli for individuals endorsing hypomanic traits. Study 5 sought to test the malleability of attentional bias to positive stimuli, and the potential downstream effects this has on AM.

To summarise, the current study employed a less than optimal mood induction procedure which appeared to have been responsible for the failure to produce significant congruency effects between mood states and attentional bias for positive stimuli. Partial support emerged for the second aim of the study which tested the moderating influence of hypomanic personality on AM-attention congruency. However the causal influence of AM on attentional bias was only seen in participants who exhibited a reliable increase in AM, furthermore this effect was seen for both negative and positive stimuli, rather than just positive stimuli as was hypothesized. Despite the failure to replicate Tamir and Robinson's

(2007), it was still important to test the bi-directionality between AM and selective attention for reward. Study 5 sought to investigate this.

8 Chapter 8: Manipulation of selective attention towards positive stimuli: effects on mania relevant variables

Study 4 of this thesis (Chapter 7) attempted to replicate previous research demonstrating a relationship between an induced state of heightened AM and increased preference for positive information, in addition to testing for the influence of hypomanic personality traits on this relationship. Despite failing to replicate this relationship which has been reliably evident in previous studies (Tamir & Robinson, 2007), study 4 did provide tentative evidence for a moderating influence of hypomanic personality on attentional preference for general emotional stimuli in response to an induced AM state relative to a control condition where AM remained stable. Despite the lack of congruence between AM state and attentional bias specific to reward in study 4, it was still of theoretical interest to understand if attentional bias for reward causally influences AM. Very little research has addressed this.

Two studies to date have attempted to train selective attention for stimuli of a positive valence, both of which used dot-probe tasks. Firstly Goetz, Robinson and Meier (2008) demonstrated that it is possible to successfully train selective attention towards positive stimuli in the general population. By systematically training attentional bias, either towards or away from positive stimuli, the researchers found the positive bias training led to greater approach-related intentions, and approach behaviour but no differences in self-reported affect was found between the groups (Goetz et al. 2008). A caveat to this study however, was the lack of dot-probe assessment to ascertain if attention had been successfully manipulated.

Grafton, Ang and Macleod (2012) extended this research with a more experimentally robust design to investigate a similar hypothesis, namely whether attentional training to positive stimuli would serve to increase sensitivity in response to a success experience. The researchers built in dot-probe assessment tasks to directly ascertain the effectiveness of

Approach Motivation, Attentional Bias to Positive Stimuli, and Hypomanic Personality.

training on baseline selective attention to positive stimuli. Grafton et al. reported a differential effect on bias scores of training attention towards positive words relative to training attention away from positive words. Moreover, individuals reported a greater elevation in positive affect after a success experience when they were trained to selectively attend to positive information prior to the success, as compared to individuals whose attention was trained to selectively attend to neutral information. The current study sought to extend these findings in three ways.

Firstly, both the Grafton et al. (2012) and Goetz. et al. (2008) studies compared two active training conditions. This design does not allow clear examination of the differential effects of training either toward or away from positive. The omission of an inactive control condition without an attentional modification contingency did not permit a direct test of whether training towards or away from positive stimuli could explain the reported effects. This is of potential clinical relevance. If it was demonstrated, for example, that it is possible to elicit downstream changes in AM from increasing attentional bias for positive stimuli but not from reducing positive bias (i.e. decreasing positive bias does not lower AM sensitivity), then this would not be helpful in the development of interventions aimed at deescalating AM. Therefore, to unpack differences between training attention towards and away from positive material, the current study included a condition in which attention was trained towards positive stimuli, a condition in which attention was trained towards neutral stimuli, and importantly, a control condition where no attentional training occurred (referred to as the *no training* condition).

The second extension pertains to the application of this research to AM regulation in a non-clinical sample and vulnerability to mania. Regarding the latter, Grafton et al. (2012)'s findings are consistent with previous research into anxiety disorders which has demonstrated that manipulation of threat-based selective attention elevates state anxiety but only after

Approach Motivation, Attentional Bias to Positive Stimuli, and Hypomanic Personality.

exposure to negative exposure (MacLeod et al. 2002). Grafton et al.'s findings say little about clinically relevant attentional biases for two reasons. Firstly no clinical variables were measured and secondly, the use of a stratified sample excluded individuals with extreme (high and low) trait levels of positive affectivity, or BAS sensitivity (if it assumed Watson et al.'s (1988) trait Positive Affectivity Scale taps the BAS). In light on research demonstrating heightened sensitivity and responsivity to positive stimuli following mood increase in individuals at risk to BD (Trevisani et al. 2008), it seems important to understand attentional biases present at the higher end of trait vulnerability to mania. Therefore, the current study sought to investigate whether the impact of attentional bias to reward on AM responsivity following a success induction was moderated by risk to mania (measured via HPS) in a non-clinical sample.

Furthermore, because BAS theory proposes that individuals with BD have a BAS that is overly sensitive to reward (Depue & Iacono, 1989), but that Goetz et al. (2008) and Grafton et al. (2012) demonstrated that BAS relevant processes can be shaped by selective attention, it is then conceivable that modification of early attentional processing of reward might perturb the BAS in ways that resemble mania not considered by this previous research. It is of theoretical interest whether the increased positive response to success following bias modification reported by Grafton et al. represents a heightened period of AM that goes beyond positive affect to resemble mania-like symptoms more closely. The current study therefore examined the impact of manipulating reward-related attentional bias on the degree of AM and mania-like expression following BAS activation (success induction) displayed in a non-clinical sample. Five mania-relevant variables of interest were identified from both the research literature and the DSM diagnostic criteria that might be influenced by biased attentional processing for reward: success expectancy, goal setting, self-esteem, thought speed and impulsivity

Approach Motivation, Attentional Bias to Positive Stimuli, and Hypomanic Personality.

Success Expectancy. Increased confidence was a cognitive aspect of BAS dysregulation theory posited by Depue and Iacono (1989) and grandiosity as a diagnostic marker for mania reflects this. One aspect of this studied in individuals vulnerable to BD is success expectancy. Two studies have shown that vulnerability to BD predicted greater expectancy of future success (Stern & Berrenberg, 1977, Johnson, Carver, and Ruggero, 2005). The latter study found this effect following an AM induction, therefore it represented a good candidate variable.

Goal Setting. Heightened goal setting is associated with success (Sitzmann & Ely, 2011). There is evidence that BD is characterised by willingness to expend more effort towards a goal (Johnson et al. 2012). This was also tested by Johnson et al. (2005) by asking participants to choose the difficulty level of an upcoming cognitive task. Individuals at risk for mania (HPS) chose a more difficult task for themselves than did those at low risk.

Thought Speed. Racing thoughts, a clinical symptom of mania, have been relatively understudied. However, a series of studies recently demonstrated that inducing fast thought elevated self-reported AM (as measured by the PANAS-PA) (Pronin, Jacobs and Wegner, 2008). Little is known about the bi-directionality of this relationship, or if it might be influenced by biased information processing.

Self-Esteem: Grandiosity is also a diagnostic marker for BD and in the euthymic phase of illness self-esteem has been found to be more unstable as compared to healthy controls and individuals with unipolar depression (Knowles et al. 2007; Van der Gucht et al. 2009). It has been suggested that dysregulated responses to success might be mediated by unstable self-esteem and a recent study reported greater affective and increased self-esteem in response to induced success in individuals diagnosed with BD as compared to healthy controls (Pavlova, Uhera, Dennington, Wright & Donaldson, 2011).

Approach Motivation, Attentional Bias to Positive Stimuli, and Hypomanic Personality.

Impulsivity: risk-taking and impulsivity are related to each other in BD through the diagnostic criterion: Involvement in pleasurable activities that have a high potential for painful consequences (APA, 2013). Reward delay tasks have been used to demonstrate diagnosis and vulnerability to BD are related to inability to delay responding for reward (Mason, O’Sullivan, Blackburn, Bentall, & El-Deredy, 2012). The results of Mason et al.’s (2012) findings suggested an early-stage attentional bias for immediate reward as measured by an EEG. No study to date has measured delay discounting subsequent to induced mood in the context of BD vulnerability. Nor has the relationship between selective attention for positive information and reward-related impulsivity been explicitly examined, according to the literature.

A final aspect of the study tested the temporal effects of attentional bias training on mania-relevant variables. It is of clinical utility to understand how long the effects of training can be detected for. Bias modification of negative attentional biases has been shown to exert robust effects on anxiety symptoms at four month follow-up (Schimdt, Richey, Buckner, & Timpano, 2009). Given the paucity of research on positive biases, a conservative 24 hour symptom follow-up was conducted in the current study. By assessing self-reported manic symptoms 24 hours following experimentation (via an emailed questionnaire) a prediction was made that attentional training would predict mania-relevant symptoms such that attention trained towards reward would be associated with greater self-reported manic symptoms.

Because of the paucity of research that speaks to modification of positive attentional biases, findings from the threat-bias literature informs the direction of effects predicted. That is, from research that showed training attention away from threat stimuli resulted in reduced anxiety (Salamink, et al. 2009) considered alongside related research conducted on biases for positive stimuli (Grafton et al. 2012; Goetz et al. 2008), the current study primarily predicted that compared to the no training condition, training towards positive material (towards-

Approach Motivation, Attentional Bias to Positive Stimuli, and Hypomanic Personality.

positive condition) would increase positive bias scores and training away from positive (avoid-positive condition) would decrease positive bias scores and that these changes would be reflected in respective increases and decreases in AM and mania-relevant variables following success induction. A secondary prediction was that vulnerability to mania would moderate these relations between attention and AM, such that higher risk to mania would correspond to greater increase in AM and mania-relevant variables following positive bias training.

Primary Hypotheses:

1.
 - a. *Relative to the no training condition, training away from positive stimuli will reduce bias towards positive stimuli*
 - b. *Relative to the no training condition, training towards positive stimuli will increase bias towards positive stimuli*
2.
 - a. *Attention biased towards positive stimuli will increase AM responsiveness to success and elevate scores on mania-relevant variables (including at 24 hour follow-up), as compared to the control conditions.*
 - b. *Attention biased away from positive/reward stimuli will decrease scores on mania-relevant variables*

Secondary Hypothesis

3.
 - a. *HPS will moderate response to baseline success induction such that high scorers will show elevated levels of AM scores after success experiences.*
 - b. *HPS will moderate the relationship described in 2a, such that higher scores on HPS will be associated with greater increase in mania related variables following training towards positive stimuli, relative to control conditions.*

8.1 Method

A sample of 92 University of Exeter students (79 female) volunteered to participate in exchange for either course credit or payment (£5 cash). Participants were recruited from the Exeter university psychology department via advertisement of the study on an online research management system (SONA). The mean age of the sample was 19 years ($M = 21$ $SD = 3.4$ range = 18-43). Apart from a requirement to be 18 years of age, there were no exclusion criteria. Ethical approval was sought from and granted by the Research Ethics Committee at the School of Psychology, University of Exeter.

Design

The study was a within-between-subjects design. The between-subjects factor was training condition (towards positive, away from positive or no training contingency [control condition]) and within-subjects variables included self-reported AM responsivity, scores on mania relevant variables and attentional bias to positive words relative to neutral words.

Sample Size

For hypotheses 1 and 2, sample size was estimated based on Grafton *et al.* who found medium effect ($f = 0.20$,) sizes for the effect of training (toward positive versus avoid positive³⁹) on attentional bias to positive stimuli. Using the program G*Power 3 (Faul *et al.* 2007), a total sample size of 81 was calculated for a within-between subjects ANOVA ($f = 0.20$, $\alpha = 0.05$, power = 0.95). To allow for the loss of data due to poor performance on the attentional task, 90 participants in total were recruited.

³⁹ Grafton *et al* effect sizes were based on comparing attend to positive with attend away from positive. No research on bias modification of positive stimuli was uncovered that employed a no training control condition sample size calculation. Therefore effect sizes from Grafton *et al* were used to inform the current study.

8.2 Materials

Self-report

Baseline anxious and depressive mood was assessed via the Hospital and Anxiety Depression Scale (HADS) Participants also completed the HPS at baseline to assess vulnerability to mania (for details on these measures see materials section of Chapter 5), along with a state measure of manic symptoms (ASRM- see Chapter 7 for details). The PANAS-PA (see Chapter 4 for details) was the state AM measure.

The Internal State Scale (ISS; Bauer et al. 1991)

This 17-item scale was developed to assess affective symptomatology in BD. It was developed to allow participants to respond to each item using a 100–mm visual analogue scale (VAS). There are four empirically derived subscales: Activation, Well-Being, Perceived Conflict, and Depression Index. The Activation subscale (five items) assesses racing thoughts and behavioural activation, specifically feeling restless, sped-up, overactive, and impulsive. According to Bauer, Vojta, Kinosian, Altshuler, and Glick (2000) the activation scale captures general arousal and symptoms of mania. The overall scale has demonstrated correlations with other measures of mania and is sensitive to depressive symptom decrease during treatment (Altman et al. 2001; Bauer et al. 1991; Cooke et al. 1996). The ISS was designed to be sensitive to changes in internal state researched in longitudinal designs, therefore it was deemed a suitable instrument to administer at 24 hours following attentional training.

Thought Speed (Pronin & Wagner, 2006)

A numbered Visual Analogue Scale (VAS) ranging from 1 (very slow) to 9 (very fast) was used to measure subjective perception of thought speed. This measure has been successfully used previously by Pronin and Wegner (2006) who demonstrated thought speed

Approach Motivation, Attentional Bias to Positive Stimuli, and Hypomanic Personality.

may play a causal role in the emergence of mania-like symptoms. (see Appendix VII for mania-relevant measures employed in this study).

Goal-setting (Johnson, Ruggero & Carver, 2005)

Johnson et al. (2005) asked participants to select a difficulty level for upcoming task that they were informed was correlated with desirable attributes. The participants made a selection on a scale ranging from 0 to 9. The instructions were adapted for use in the current study and were as follows: “In an upcoming task, we are interested in how quickly you are able to respond to visual displays. Previous research has shown this correlates highly with both intelligence and athletic ability. There are several versions of this task that are available to you. One is very easy, one is very hard, and several are graded in between. You are free to choose which version you use during this segment of the experiment.” The message was a mild deception in the sense that the upcoming tasks (dot-probe, two-choice impulsivity) were unrelated to these attributes. Johnson et al. (2012) found individuals at risk for mania (HPS) chose a more difficult task for themselves than did those at low risk.

Success expectancy (Johnson et al. 2005)

This one item VAS measure this item was created by Johnson, Ruggero and Carver (2005). In this study vulnerability to BD (HPS) predicted greater expectancy of future success using this one item scale. Participants read - “How successful do you think you will be on the next task (place a mark on the scale below)?” Participants placed an × on a 100 mm line with a range from “0 not successful” to “100 very successful.” The participants were informed that the upcoming task would assess aptitude associated with cognitive and athletic ability. Participant were informed at the end of the study that this was a mild deception.

Approach Motivation, Attentional Bias to Positive Stimuli, and Hypomanic Personality.

Self-Esteem (Pavlova, Uhera, Dennington, Wright & Donaldson, 2011)

Self-esteem was measured using an adapted version of a state version of the Rosenberg Self-Esteem Scale (Rosenberg, 1965) whereby a single VAS was used to report self-esteem ranging from (VAS: 'I am much better than other people'–'I am much worse than other people'). This version was adapted by Pavlova et al. who found it to be sensitive to self-esteem fluctuations in both the general population and BD samples.

Behavioural Impulsivity: Two-Choice Impulsivity Task (Dougherty et al. 2005)

The Two-Choice Task is a computerised task developed by Dougherty et al. (2005) which captures individual variation in preference for immediate gratification relative to delayed reward, or delay discounting, one aspect of behavioural impulsivity. That is, the task provides a metric for the relative frequency with which a participant chooses a small immediate reward (computerised points) over a larger delayed reward. Over fifty free-choice trials, the task measures the participant's relative frequency to choose between a smaller-sooner reward and a larger-later reward. In each trial, a circle and a square (each 2 cm in diameter) appeared together on the screen in black against a white background. The orientation (left vs. right side) of the two shapes was randomly determined for each trial. Participants made 50 choices to add points to their total point score by either clicking on a circle to earn 5 points after waiting 5 seconds or clicking on a square to earn 15 cents after waiting 15 seconds. After clicking on one of the two shapes, the other shape disappeared from the screen and the chosen shape faded to grey. After the delay elapsed, the shape resumed its black colour and flashed for 500 milliseconds once per second, at which time the participant clicked on the shape a second time to add its respective reward to their counter. Participants were instructed as to which mouse button to use and that there was two types of shapes for them to choose between by clicking on the shape. They were told that each shape

Approach Motivation, Attentional Bias to Positive Stimuli, and Hypomanic Personality.

must be clicked on twice, once to choose the shape, and once again after the shape begins to blink to add the funds to their counter. Participants were not informed about the length of the delay intervals or the respective rewards earned for each shape. However, this information can be deduced by the participant during a practice session before testing, during which the circle option appears alone for five trials followed by the square option alone for five trials. The primary dependent measure of impulsive responding on this task is the total number of short-delay choices made out of the fifty choices during the session. The two choice task has been used in a BD sample, where it was found individuals with a diagnosis of BD made more immediate reward choices than healthy controls (Swann, Lijffijt, Lane, Steinberg & Moeller, 2009) and the general population (Reynolds, Penfold & Patak, 2008). Furthermore it has been used in the context of trait vulnerability to BD (Mason, O'Sullivan, Blackburn, Bentall, & Wael El-Deredy, 2011) where it has been reported that high HPS scorers displayed an inability to delay reward (more immediate reward choices relative to delayed reward choices) as compared to low HPS scorers.

False-Success feedback Anagram Task

The anagram success task was delivered twice, once prior to and once following completion of the attentional training task to include success-feelings associated with AM. The task was developed and validated by Grafton et al. who used it to effectively boost self-reported positive mood measured via a computerised visual analogue scale, delivered immediately before and after the task was completed. In the task the participants were required to solve a series of 120 three and four four-letter anagrams presented on the screen. In the task, participants were provided with false feedback indicating that they performed particularly well, irrespective of actual performance. Elevated mood was achieved by two

Approach Motivation, Attentional Bias to Positive Stimuli, and Hypomanic Personality.

means; easy anagrams (described below) and a deceptive bar chart presented on-screen which suggested superior performance for the participant compared to previous average participant performance. The bar chart had two bars. Participants were falsely informed that the red bar indicated their own performance whilst the yellow bar was the average for previous participants. At the start of the task both bars were at zero. The task was programmed so that as the participant solved the anagrams their red bar increased along with percentile rank values whilst the yellow bar was programmed to not keep up with the red bar. As the discrepancy between both bars widened, the percentile label changed accordingly, indicating a progressively higher percentile rank for the participant. All participants finished with a percentile rank that read 'Upper 10%', as illustrated below in figure 23.

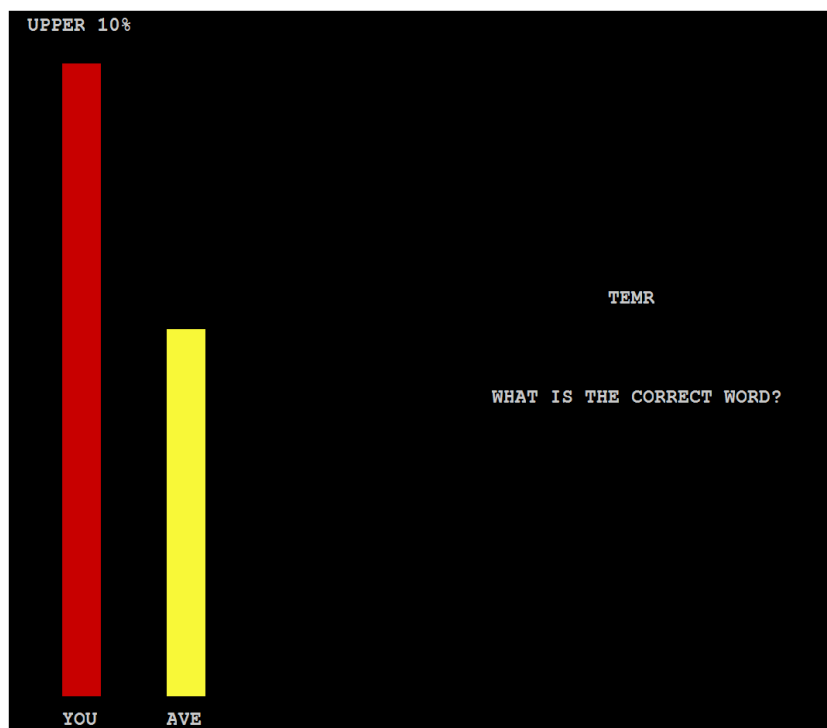

Figure 19. Screen shot showing positive feedback participants received and example anagram

A set of 120 letter strings was generated for use in the anagram success task. Each letter string was a solvable anagram; letters could be rearranged to form legitimate common English words, either three or four letter strings long - to ensure anagrams were easy to solve.

Approach Motivation, Attentional Bias to Positive Stimuli, and Hypomanic Personality.

This set of 120 letter strings was divided into two subsets, each containing 60 letter strings.

Each subset comprised 35 three-letter strings and 25 four-letter strings.

Dot Probe Task

The dot probe task used in the current study took two forms, assessment trials (three blocks of 96 trials) and training trials (one block of 672 trials), and was based on that employed by Grafton *et al.*. All dot probe trials shared the following attributes. Each trial commenced with the presentation of the words “next trial” in the centre of the screen for 500 ms as a fixation point. This was followed by a 40ms blank screen after which word pairs appeared for 500ms. All word pairs consisted of one positive word and one neutral word. The words were centrally aligned, using Courier New font, size 18. The position (top or bottom) of the positive word was random. After 500ms the word pairs disappeared, and either one or two 0.5cm black circular dots appeared directly in place of either the top or bottom word. The frequency with which one or two dots were presented was equal in all trials as was the frequency of the position of the probes (top or bottom). Participants were asked to be as accurate and as fast as possible in indicating the identity of the probe by clicking the left or right mouse button to indicate whether a single or double dot probe was present. The probes remained onscreen until the mouse was clicked. Probe latency was recorded and the next trial begun, following a 500ms pause.

Each participant performed an initial 96 assessment trials, then 672 training trials in which an additional 96 manipulation checks were embedded (described below), followed by another 96 assessment trials, before a final block of 96 assessment trials. Throughout there was only one type of word-pair used – neutral-positive. In the 288 assessment trials the probes were presented in the locus of positive and neutral words with equal frequency, for all

Approach Motivation, Attentional Bias to Positive Stimuli, and Hypomanic Personality.

participants. In the 672 training trials the position of the probe was determined by experimental condition. In the toward-positive condition the probes appeared in the locus of the positive word 100% of the time. In the avoid-positive condition the probes appeared in the position of the neutral word in all trials. For the control condition, there was a 50:50 ratio which meant the probe appeared behind each word type with equal frequency. As a form of manipulation check⁴⁰, 96 'check' trials were interspersed amongst the training trials. In these trials there was no probe following presentation of the words but instead participants were required to indicate the tone of the previous word-probe trial (positive or neutral) by clicking left or right on the mouse. A paper and pencil manipulation check was administered at the end of the experiment. This asked participants about their perception of the dot-probe task, and in particular to what extent they thought the probe was behind positive and neutral words. This was deemed necessary as the current study employed a 100% training contingency (dot always behind emotion word); it is more common for the ratio to be less obvious to the participant (80:20) (Browning, Holmes, & Harmer, 2010).

Dot Probe Words

Grafton et al. conducted a preliminary study to create a sample of validated positive-neutral word pairs. 200 candidate word pairs were whittled down to final 96 on the basis of valence ratings. The words pairs were equal in length and frequency. T-tests confirmed statistically significant differences in valence ratings between positive and neutral words. Because the training was successful in modifying attentional bias in the study by Grafton et al. the same word-pairs were used in the current study (see appendix VII for word stimuli)

⁴⁰ No data was recorded about the extent to which participants correctly indicated the emotional tone of the previous trial. As recommended by Koster et al. (2010) the trials were included in an attempt to enhance attention to emotional content (rather than to measure it).

Approach Motivation, Attentional Bias to Positive Stimuli, and Hypomanic Personality.

For the training trials the words were split in to two subsets of 48 word pairs (The two subsets of word pairs did not differ significantly in terms of their emotional characteristics, word lengths or frequencies). If a participant was presented with one subset in the assessment blocks they received the other subset in the training block. In the training block each of the 48 word pairs was presented 14 times in total to make up the 672 trials. The order in which each word pair was presented was randomised with the constraint that any given word pair was not presented twice until all others were presented first, and a word pair could not be presented for a third time until all other word pairs had been presented twice, and so on.

In Grafton et al.'s procedure, the 96 assessment trial blocks consisted of a counterbalanced presentation of two 48 pair subsets which meant that any word pair that had a probe in the locus a positive word initially would have a probe behind a neutral word the second time it was presented in the same assessment block, and vice versa. This introduced the possibility of a learned contingency effect; a probe behind a positive word could be anticipated by a probe behind a neutral word the previous time the same word-pair was presented. Here the presentation of the word pairs was less predictable, to make the contingency more difficult to learn. The 96 word pairs were split in to four sets of 24 word pairs rather than two sets of 48 and presented four times in an assessment block; therefore the probe was located behind each word twice rather than once.

Apparatus

A 22-inch computer monitor and a standard two-button mouse were used to deliver the anagram, dot prove and impulsivity tasks. All self-report measures were administered through pencil and paper.

Approach Motivation, Attentional Bias to Positive Stimuli, and Hypomanic Personality.

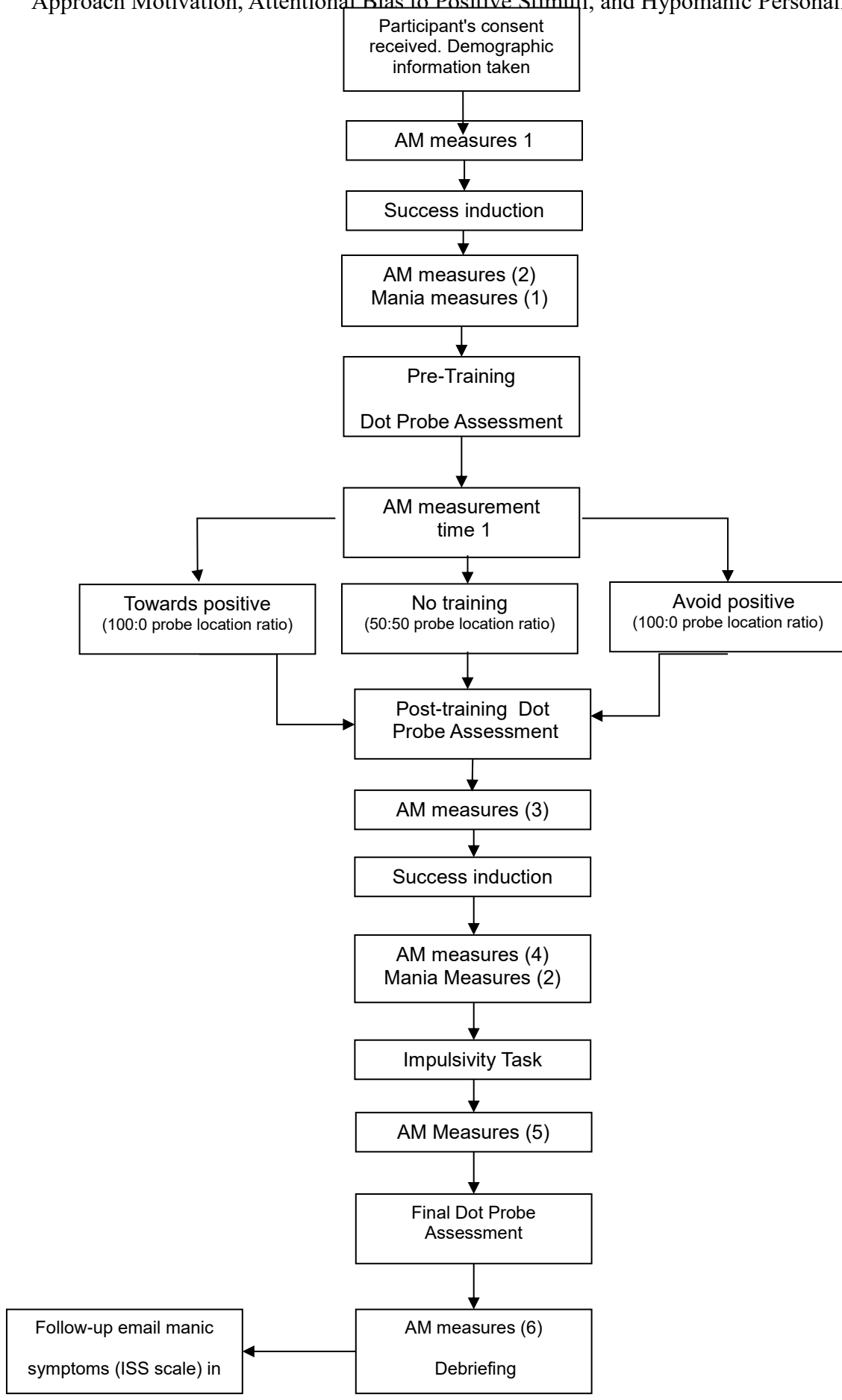

Figure 20 Flow Diagram of Study 5

8.3 Procedure

On arriving at the testing session but before providing informed consent, participants were informed that the study was about “the relationship between positive mood and attention tasks” and were then provided with basic information about how the study would proceed. On providing informed consent the participants commenced the study. See figure 24 for the sequence of computer tasks interspersed with self-report measures. After completing the study participants were debriefed about the purpose of the study and informed about the mild deception regarding the anagram task false-success feedback) and deceptive information about an upcoming task that measured intellectual ability (success expectancy/goal setting measure).

Data preparation and Analysis

Analysis was conducted using SPSS v.23 and JASP 8.0.0. Statistical tests included Chi-square, bivariate correlations, simple linear regression, independent and paired t-tests. Repeated measures ANOVA and ANCOVA were used to test the main hypotheses. To test the assumption of multivariate normality histograms plots of variable distributions were assessed visually. The assumption of homogeneity of variance was assessed via levene’s tests. Model fit was examined through inspection of residual distribution. Histograms of residuals were inspected for normality to assess model fit. An alpha level of $p = .05$ was adopted unless holm corrections were applied.

Dot Probe Preparation

Approach Motivation, Attentional Bias to Positive Stimuli, and Hypomanic Personality.

The dot probe task data were prepared for analysis by inspecting incorrect response rates and outliers of assessment trials. Firstly, reaction times (RTs) for incorrect probe responses (errors) were removed. The number of errors made by participants ranged from 0 to 26 ($M = .29$, $SD = 2.16$). The vast majority of participants made no errors. For the whole sample, error rates outside 95% confidence intervals were removed resulting in removal of one participant's RT data. A second individual's data was omitted from analysis due to computer error during testing, leaving an attentional bias sample of 90.

As in study 4, two steps were taken to deal with extreme values. Firstly, individual extreme values were defined as RTs two standard deviations above and below an individual's dot probe mean. These were replaced with their respective 95th and 5th percentile values. Secondly, general extreme values were dealt with by removing very short ($< 200\text{ms}$) and very delayed RTs ($> 750\text{ms}$) in the whole data set. For the assessment trials, the latency to respond (reaction times: RTs) to the dot or dots (in milliseconds) and whether the correct response was made was recorded by the software (E-Prime v.2). With incorrect responses omitted, an attentional bias score for positive information relative to neutral was calculated using a simple formula:

$$\text{Bias to positive score} = \text{RT for probes in locus of neutral word} - \text{RT for probes in locus of positive word}$$

A *bias to positive* score, referred to as *posbias* henceforth, on this index reflected a greater attentional bias towards positive, relative to neutral, stimuli. A positive *posbias* score reflects a selective attention towards positive stimuli relative to the neutral stimuli. A negative bias score reflects a selective attention away from the word relative to the neutral stimuli.

8.4 Results

Baseline Measures

There were no significant differences between the three conditions (toward-pos, avoid-pos, and control) in terms of baseline characteristics, displayed in table 24 below. Pearson's correlations revealed no relationship between total HPS score and anxiety or depression. One-way ANOVA tests with condition as the between subjects factors also revealed no difference between the groups in self-reported PANAS-PA,

Table 22. Study 5 Sample Characteristics

	N	Female N	Age <i>M (SD)</i>	Anx <i>M (SD)</i>	Dep <i>M (SD)</i>	HPS <i>M (SD)</i>	ASRM <i>M (SD)</i>
Toward-Positive	31	27	19.29 (1.32)	7.61 (3.57)	3.04 (2.53)	17.42 (7.52)	5.58 (3.83)
Avoid-Positive	31	27	20.23 (4.80)	6.81 (3.73)	3.52 (2.69)	13.55 (7.93)	4.56 (2.96)
Control	30	25	20.07 (3.30)	7.37 (3.72)	3.23 (2.47)	16.97 (8.12)	4.82 (3.27)

Note: N = no. of participants. *M* (Mean). *SD* (Standard Deviation). Anx, Dep (Hospital Anxiety and Depression subscales). HPS (Hypomanic Personality Scale).

Prior to testing the influence of the bias modification procedures, it was first necessary to check whether the success induction effectively induced an AM state. Paired *t*-tests conducted on PANAS-PA scores pre to post anagram task, both prior to and subsequent to attentional training revealed no significant change prior to training yet a highly significant increase in scores from pre to post anagram task post-training, $t(91) = -6.89$, $p < .001$. The failure of PANAS-PA scores to significantly increase in the pre-training anagram task suggests the mood induction may not have been successful at this point.

Approach Motivation, Attentional Bias to Positive Stimuli, and Hypomanic Personality.

Table 23. Descriptive and Plots for Success Inductions

Descriptives for PANAS-PA pre to post success induction both before and after attentional training

Pre-Training	N	M (SD)	Post- Training	M (SD)
pre	92	30.14 (7.51)	pre	23.28 (7.73)
post	92	30.86 (7.45)	post	27.13 (8.34)

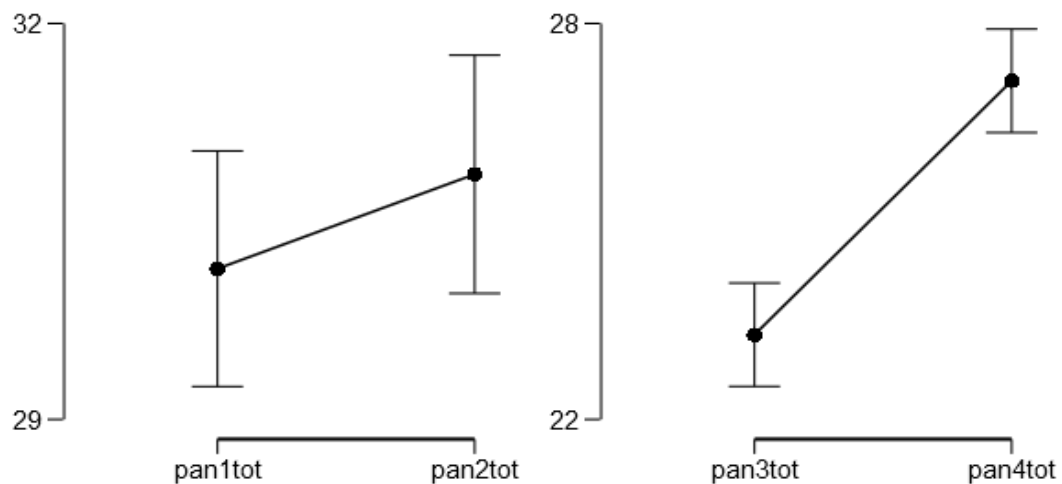

Mania-relevant measures were administered after both success inductions and between the training procedures and included thought speed, self-esteem, goal-setting, success expectancy. One-way ANOVAs showed the mania-relevant variables to not differ across condition at baseline.

Table 24. Descriptive statistics and one-way between subjects ANOVA results for baseline mania-relevant variables

condition	AM		Self-esteem		Success Expectancy		Thought Speed		Goal-Setting	
	m(sd)	m(sd)	m(sd)	m(sd)	m(sd)	m(sd)	m(sd)	m(sd)	m(sd)	
avoid positive	30.23	[8.62]	7.94	[1.86]	8.09	[1.79]	5.61	[1.47]	4.58	[1.37]
towards positive	30.35	[7.51]	7.75	[1.82]	7.41	[2.16]	5.29	[1.81]	5.07	[1.18]
control	29.83	[6.44]	8.08	[1.61]	7.79	[1.97]	5.32	[1.78]	5.15	[.89]
ANOVA										
F (2, 92) =	0.03		0.26		0.99		0.36		0.87	
p	0.96		0.96		0.37		0.69		0.42	

Approach Motivation, Attentional Bias to Positive Stimuli, and Hypomanic Personality.

Table 25 Correlation Matrices

Table * a. Pearson Correlations for Aspects of hypomania, baseline mood, and Pre-training AM reponsivity, Mania-relevant measures, and baseline attentional bias for positive stimuli

	HPS total	HPS Social vitality	HPS Mood Volatility	HPS Excitement	ASRM	Anxiety	Depression	AM baseline	Self esteem 1	Success expectancy 1	Thought Speed 1	Goal setting 1	Posbias baseline
Hpstots	—	0.639 ***	0.691 ***	0.677 ***	0.392 ***	0.084	0.136	0.233 *	-0.009	0.058	0.08	0.013	-0.136
HPS Social vitality		—	0.364 ***	0.459 ***	0.268 *	-0.091	-0.053	0.309 **	0.198	0.316 **	0.209 *	0.184	0.004
HPS Mood Volatility			—	0.536 ***	0.312 **	0.523 ***	0.417 ***	0.065	-0.095	-0.004	0.025	-0.197	-0.021
HPS Excitement				—	0.419 ***	0.108	0.091	0.232 *	-0.013	0.058	-0.004	0.148	-0.109
ASRM					—	0.025	-0.136	0.374 ***	0.121	0.049	0.204	0.151	-0.039
Anxiety						—	0.671 ***	-0.163	-0.235	-0.301 *	0.084	-0.401 *	-0.126
Depression							—	-0.288 *	-0.232	-0.183	0.054	-0.277	-0.016
AM baseline								—	0.199	0.186	0.369 ***	0.6 ***	0.03
Self esteem 1									—	0.39 ***	0.404 ***	0.398 *	-0.001
Success expectancy 1										—	0.373 ***	0.463 **	0.043
Thought Speed 1											—	0.372 *	-0.035
Goal setting 1												—	0.157
Posbias baseline													—

* p < .05, ** p < .01, *** p < .001 ASRM Altman Self-Rating Scale. AM (PANAS-PA)

Table * b. Pearson Correlations for aspects of hypomanic personality, baseline mood, and self-reported bipolar symptoms (ISS) at 24hr follow-up

	HPS total	Social Vitality	Mood Volatility	Excitement	Anxiety	Depression	Posbias Change	issact24	isscon24	isswell24	issdep24	issTOT24
HPS total	—	0.639 ***	0.691 ***	0.677 ***	0.084	0.136	0.104	0.197	0.174	0.072	0.165	0.163
Social Vitality		—	0.364 ***	0.459 ***	-0.091	-0.053	-0.1	0.123	0.094	0.039	0.104	0.095
Mood Volatility			—	0.536 ***	0.523 ***	0.417 ***	0.093	0.201	0.194	0.06	0.182	0.17
Excitement				—	0.108	0.091	0.114	0.149	0.121	0.061	0.116	0.12
Anxiety					—	0.671 ***	0.241 *	-0.02	-0.027	-0.114	-0.035	-0.044
Depression						—	0.262 *	-0.014	-0.019	-0.127	-0.011	-0.039
Posbias Change							—	-0.183	-0.168	-0.142	-0.179	-0.172
issact24								—	0.982 ***	0.918 ***	0.973 ***	0.991 ***
isscon24									—	0.922 ***	0.992 ***	0.994 ***
isswell24										—	0.906 ***	0.95 ***
issdep24											—	0.986 ***
issTOT24												—

* p < .05, ** p < .01, *** p < .001

Table * above, depicts correlations between total HPS, HPS components, state self-reported mania (ASRM), depression (HAD-D) and anxiety (HADS-A) symptoms, and mania-relevant variables immediately post-anagram success task (1) but prior to attentional training. Table (*) left depicts relations between trait vulnerability to mania (HPS), mood at baseline and self-reported bipolar symptoms for the 24 hrs following the experiment. Table * depicts relations between hypomanic personality, mood and mania-relevant variables post training, immediately after second success induction.

Note. The significance threshold for the reported correlations was set at .001 ISScon (constraint subscale) ISSwell (well-being subscale) ISSact (activation subscale) ISSdep (depression subscale) ISStot (total score)

Approach Motivation, Attentional Bias to Positive Stimuli, and Hypomanic Personality.

Table * b. Pearson Correlations for Aspects of hypomania, baseline mood, and Post-training AM reponsivity, Mania-relevant measures, behavioural impulsivity, and self-reported racing thoughts at 24hr follow-up

	HPS total	HPS Social vitality	HPS Mood Volatility	HPS Excitement	Anxiety	Depression	AM change 2	Self esteem 2	Success expectancy 2	Thought speed 2	Goal setting 2	Behavioral Impulsivity	Racing thoughts 24hr
HPS total	—	0.639 ***	0.691 ***	0.677 ***	0.084	0.136	0.204	-0.01	0.103	0.076	0.15	0.042	0.199
HPS Social vitality		—	0.364 ***	0.459 ***	-0.091	-0.053	0.229 *	0.264 *	0.292 **	0.197	0.466 **	0.039	0.119
HPS Mood Volatility			—	0.536 ***	0.523 ***	0.417 ***	0.087	-0.16	0.065	0.043	-0.023	-0.059	0.209
HPS Excitement				—	0.108	0.091	0.094	0.006	0.196	0.051	0.235	0.073	0.182
Anxiety					—	0.671 ***	-0.067	-0.304 *	-0.166	0.077	-0.345	-0.111	-0.038
Depression						—	0.016	-0.132	-0.074	0.164	-0.072	-0.173	-0.025
AM change 2							—	0.356 ***	0.211 *	0.173	-0.017	0.12	-0.095
Self esteem 2								—	0.551 ***	0.45 ***	0.417 **	0.11	0.008
Success expectancy 2									—	0.417 ***	0.37 *	0.072	-0.056
Thought speed 2										—	0.467 **	0.007	0.121
Goal setting 2											—	-0.092	0.243
Behavioral Impulsivity												—	0.331 **
Racing thoughts 24hr													—

Note. * p < .05, ** p < .01, *** p < .001 note that the mania-relevant variables suffixed with - 2 are those measured directly after the post-attentional training success induction (pre - in table above refers to pre-training success responses) Behavioral Impulsivity (Two-choice task: score reflects frequency of immediate reward choice over delayed (larger) reward.

Approach Motivation, Attentional Bias to Positive Stimuli, and Hypomanic Personality.

Correlations

Correlation matrices are displayed above (table 27) for aspects of hypomanic personality and mania-relevant variables, both pre and post attentional training. With a stringent significance threshold applied (.001), moderate positive correlations were found for mood volatility subscale and anxiety and depression symptoms. No such relations were found between anxiety and depression scores and the other two HPS components, social vitality and excitement, nor were they associated with HPS total score, suggesting a unique relationship between mood volatility and state negative affect. Furthermore, mood volatility was the only HPS scale (inclusive of total score) that was not associated with baseline AM, although these latter relations did not reach statistical significance. Positive associations emerged between the social vitality component of HPS and mania-relevant variables which were not evident in the total or other subscales, although these did not reach the set significance threshold.. Social vitality was positively associated with thought speed (pre training), success expectancy (pre and post training), goal-setting post training, and self-esteem post training. To summarise, unique relations transpired for HPS components, with social vitality linked to mania-relevant variables, and mood volatility significantly linked with baseline negative affect.

Attentional Bias Hypotheses

Prior to testing the effectiveness of the training procedures baseline posbias scores were examined using one-way ANOVA. There were no differences between the groups in overall mean RT at the baseline assessment $F(1, 88) = .35, p = .51$. Nor were there any differences in error rate at baseline, $F(1, 88) = 1.87, p = .16$. For baseline posbias, the groups (toward-positive, avoid-positive and no training) did not differ significantly, $F(1, 88) = .13, p = .87$. Overall the randomisation of participants was successful with all three groups not

Approach Motivation, Attentional Bias to Positive Stimuli, and Hypomanic Personality.

displaying any baseline differences in self-report and attentional bias measures. Table 28 displays the overall RT and posbias scores for each condition and at each assessment point.

Primary Hypotheses:

- Hyp: 1. a. Relative to the control (no training) condition, training away from positive stimuli will reduce bias to towards positive stimuli*
b. Relative to the no training condition, training towards positive stimuli will increase bias towards positive stimuli

A repeated measures ANOVA with condition (toward-positive, control and avoid-positive) as the between-subjects factor, time (pre-post training) as the within-subjects factor and posbias was the dependant variable, was conducted to test hypotheses 1 a and b. There was no main effect of time, $F(1, 88) = 1.01, p = .13$, or condition, $F(1, 88) = 1.01, p = .13$. nor was there an interaction between the two, $F(2, 88) = 1.01, p = .13$. Thus, no evidence was found to support hypothesis 1. Despite the lack of statistically significant support for the effect of attentional bias training on Posbias scores, the remaining hypotheses were investigated as it was conceivable that the attentional training could still exert differential effects on mood and mania-relevant variables, as has been found in attentional bias for threat literature (DeBaert et al. 2010). It was possible that despite the lack of evidence for successful bias modification, hypomanic vulnerability could moderate relations between the training condition and these outcome variables.

Table 26. Reaction Times and Attentional Bias to Positive scores

Characteristic	<i>n</i>	toward-positive	control	avoid-positive
		90 <i>M (sd)</i>	90 <i>M (sd)</i>	90 <i>M (sd)</i>
Baseline RT (ms)		444.47 (48.73)	454.23 (54.17)	454.90 (62.02)
Posbias				
pre-training		-.01 (21.30)	2.50 (12.39)	1.58 (19.48)
post-training		5.82 (16.96)	1.32 (18.98)	4.26 (16.31)
recovery		4.04 (12.71)	.83 (16.80)	4.87 (15.61)

Note. Mean and Standard Deviation for baseline RTs for when the probe was in the locus of neutral word (50%) and positive (50%). Posbias (Mean Neutral RT - Mean Positive RT) scores given for each phase of assessment

- Hyp:2 a. *Training Attention towards positive stimuli will increase AM responsiveness to success⁴¹ and elevate scores on mania-relevant variables, as compared to the control conditions.*
 b. *Training Attention away from positive/reward stimuli will decrease scores on clinically relevant variables*

To test hypotheses 2 a and b, separate repeated measures -ANOVA tests with condition (toward-positive, control and avoid-positive) as the between subjects factor and pre-training to post-training score as the within-subjects factor was conducted for each of the mania-relevant variables and AM responsiveness. Significant interactions between time and condition would indicate initial evidence to support hypothesis 2. No statistically significant two way interaction emerged for self-esteem, $F(2, 88) = .57, p = .56$, AM responsivity to success, $F(2, 88) = .41, p = .66, \eta^2_p = .12$, thought speed, $F(2, 88) = .88, p = .41$, and goal setting⁴², $F(1, 88) = .52, \eta^2_p = .59$. Although significant main effects of time emerged for AM

⁴¹ By subtracting PANAS-PA pre-anagram task from PANAS-PA scores post-anagram, a AM responsivity to success variable was created. Higher scores on this reflect heightened tendency to respond to the success with greater elevation of AM.

Approach Motivation, Attentional Bias to Positive Stimuli, and Hypomanic Personality.

responsivity to success, $F(1, 88) = 12.02, p < .001, \eta^2_p = .12$, thought speed, $F(1, 88) = 10.41, p = .002, \eta^2_p = .11$, and goal setting, $F(1, 88) = 4.63, p = .04, \eta^2_p = .04$, these effects might be best explained by the relative effectiveness of the pre-training and post-training anagram task, as only the latter successfully elevated self-reported AM (described above).

However, for success expectancy, time and condition did interact significantly, $F(2, 88) = 3.43, p = .03, \eta^2_p = .07$, with no main effects of time and condition present. To deconstruct the interaction found for success expectancy, two mixed ANOVA tests were conducted, one comparing the train towards positive condition with no training condition, and another comparing the avoid-positive condition with the no-training control condition. A significant interaction emerged between time and condition when training towards positive stimuli was compared with no-training condition, $F(1, 59) = 4.63, p = .04, \eta^2_p = .08$, whereas when the attentional training away from positive was compared with no training no differences were found, $F(1, 59) = .004, p = .94$.

Figure 25 illustrates the significant impact of condition on success expectancy over time, whereby change in success expectancy increases in the towards positive group and declines in both the control condition and avoid positive condition.

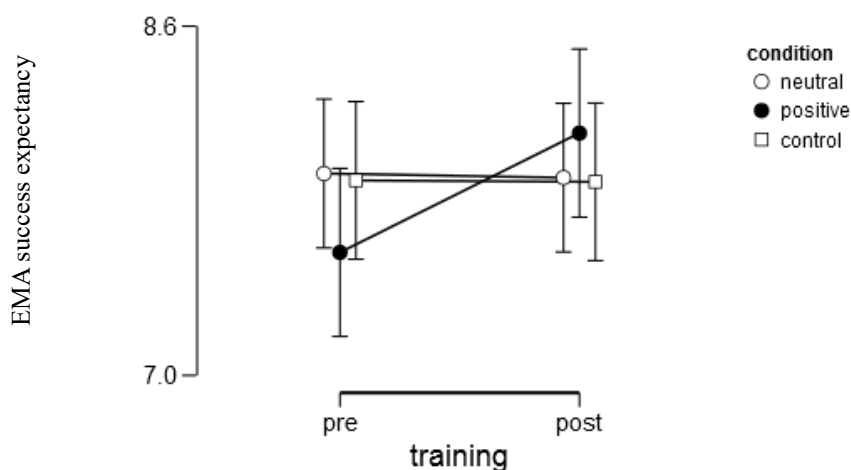

Figure 21 Pre-post training effects for Success Expectancy

Note. Y-axis – mean success expectancy

Approach Motivation, Attentional Bias to Positive Stimuli, and Hypomanic Personality.

A final mania-relevant variable of interest was impulsivity as measured via a behavioural task, the two-choice impulsivity task. The outcome variable produced by the task is number of immediate small reward choices relative to delayed large reward choices. It was predicted that training towards positive stimuli results in more immediate reward choices as compared to the control condition. A one-way ANOVA with Condition as the between subjects factor and number of immediate choices as the dependant variable revealed no effects, $F(2, 85) = .004, p = .15$. Overall then, the experimental training conditions were ineffective in influencing both attentional bias for positive information and mania-relevant variables. One finding was contrary to this conclusion; the effect of condition on expectancy, such that individuals assigned to the towards-positive training displayed greater expectancy of success in a later task of ability.

As a secondary analysis, pre to post attentional training posbias scores were submitted to a reliable change analysis (see study 4, chapter 7) in order to identify participants across conditions who displayed greater attention towards positive post-dot-probe training. The RCI for posbias change (posbias-post – posbias-pre) was 21.11, meaning posbias change score greater than this reflected scores that can be deemed to have reliably increased. According to the RCI, from the whole attentional bias sample ($n=88$), 59 individuals displayed no change in posbias change score, 13 reliably deteriorated, and 16 displayed score greater than 21.11 and were therefore were deemed to reliably changed.

Secondary Hypothesis:

- 3 a. *HPS will moderate response to success induction such that high scorers will show elevated self-reported AM.*
- b. *HPS will moderate the relationship between bias change and clinically relevant variable score.*

Approach Motivation, Attentional Bias to Positive Stimuli, and Hypomanic Personality.

To test 3a. a change score was calculated (post-anagram AM – pre-anagram AM) to index AM responsivity prior to attentional training, this was then correlated with HPS total score. There was a significant relationship between HPS and AM success responsivity, $r = .18, p = .14$ To test 3b. a 2 (pre, post training) x 2 (towards-positive, avoid-positive, no training control) x 2 (self-esteem, success expectancy, thought speed, goal-setting and AM responsivity) family test ANOVA was conducted with HPS total score as a moderating variable. A non-significant three way interaction between HPS, condition and time, $F(6, 96) = .49, p = .81$, indicated no support for hypothesis 3. This was in the context of a non-significant 4 way interaction that included measure type, $F(6, 96) = .87, p = .51$.

As a manipulation check, at the end of the study, participants were asked via self-report if they thought there was a pattern to the positioning of the probe during the dot probe tasks. This was to assess whether the 100:0 training contingency would be detected for those assigned to the training conditions. Because the check was qualitative, the researcher assessed responses. Only 1 participant correctly realised that the dot would be in the place of a positive word. Hence, it did not seem to be the case that the failure to train bias could be explained by participant knowledge.

8.5 Discussion

This study attempted to extend previous evidence that biased attention for positive stimuli increases positive affectivity by testing its impact on AM and mania-relevant variables. The results showed no evidence to suggest the attentional training procedures successfully manipulated selective attention towards or away from positive information. Furthermore the attempt to gauge the effects of attentional training upon changes in affective state was complicated by an inability of the success task to elevate AM and mania-relevant responses pre-training. Overall, with respect to the hypotheses, the study produced inconclusive findings.

The current study also sought to extend Gratton et al. (2012) with the inclusion of no-training contingency condition designed to differentiate between training attention towards and away from positive material. The pattern of change was not consistent with that found by Gratton et al (2012) which found the toward-positive and avoid-positive training conditions to diverge. However, this effect was relative to each of the two conditions. In the design of the current study training procedures displayed a non-significant increase in bias score from baseline relative to the condition in which the probes were instead behind neutral and positive words with equal frequency (no-training condition). It is unclear why this effect emerged. With little research to relate the findings to it is difficult to explain this effect, especially as the Gratton et al. (2012) study found differences in baseline attentional biases for positive between the two groups.

Both training conditions consisted of 100:0 ratio word-type probe contingences, whilst the no training condition consisted of a 50:50 ratio. It is suggested that this single similarity between the training procedures served to set these two conditions apart from the no-training condition such that this somehow exerted more influence on selective attention to positive words than the single manipulated difference between the train towards-positive and

Approach Motivation, Attentional Bias to Positive Stimuli, and Hypomanic Personality.

avoid-positive conditions i.e. the probe was always in the locus of a positive word in the train-towards condition and vice versa for the avoid- positive condition. This meant that participants in the training conditions learned a contingency, whilst the no-training did not. It is tentatively suggested that learning occurred that overrode the contingences to minimally elevate bias to positive in both trainings conditions. Clearly, replication is required to address the inconsistency of this finding against that reported by Grafton et al.(2012). More broadly, the malleability of attentional processes for positively-valenced stimuli needs further investigation. It might be the case that due to the distribution of positive affect which is more normally distributed than measures of negative affectivity in the general population (generally negatively skewed) makes it more difficult to evidence shifts in positive bias.

Success expectancy was elevated for those in positive training conditioning, despite no evidence that this manipulation changed baseline bias rates. That this sole mania-relevant variable would produce an effect represents anomaly, especially as the other measures were moderately correlated with success expectancy, particularly goal-setting - which was also a future-orientated measure. Consideration of the wording of the post-success measures might help explain this finding. Thought-speed, self-esteem, goal-setting and even the PANAS-PA to some extent are constructed without the inclusion of a highly salient reward word. It is suggested that this difference word saliency explains the effect.⁴³

A recent study tested the influence of inducing different mood states on the speed of encoding (Goetz & Robinson, 2007). The research found induced positive mood did not influence encoding speed but did produce a priming effect for positively-valenced words. In the current study, the word pair "successes - frequency" was one of the 48 word pairs repeated across the three conditions, however only in the positive training was attentional probe

⁴³ The scale read: How successful do you think you will be on the next task (place a mark on the scale below)? 0 not successful - 100 very successful.

Approach Motivation, Attentional Bias to Positive Stimuli, and Hypomanic Personality.

always in the locus of "successes". It is suggested that this served to prime attention in such a way that the individuals allocated to the positive training were more likely to endorse greater success expectancy. Alternatively, this was a chance effect. Also, because the mania measures appeared conceptually distinct corrections for multiple testing were not applied. As such the findings should be interpreted tentatively and further replication is suggested.

In relating the findings back to the literature there are only two studies that closely relate to the current study and both provide reason to be cautious in claiming causality (Goetz et al. 2008; Grafton et al. 2012). Although both studies found effects of positive bias training on AM, the robustness of this effect is called in to question by methodological issues. Goetz et al. (2008) did not assess the effectiveness of attentional training so the true influence of training cannot be ascertained. It is noteworthy that other bias modification research has demonstrated reductions in depressive symptoms despite failure of training procedures to affect bias (Baert, DeRaedt, Schacht, & Koster, 2010). Secondly, Grafton's findings were confounded by baseline differences between the groups in bias for positive stimuli. These caveats make it difficult to draw firm conclusions about the null findings of the current study. One possible explanation stems from large standard deviations in bias scores at baseline. It is plausible that large variation in baseline attention to positive stimuli made it difficult to evidence shift biases from pre to post training.

Of note, aspects of hypomanic personality appeared differentially related to mood symptoms. Consistent with Schalet et al.'s findings that Mood volatility was most associated with psychopathology, in the current dataset mood volatility was uniquely and significantly strongly correlated with anxiety and depression symptoms. Mood volatility was also the only HPS scale (inclusive of total HPS score) that did not correlate with AM at baseline (although these relations were not significant at $p < .001$). Schalet et al. found Social Vitality had

Approach Motivation, Attentional Bias to Positive Stimuli, and Hypomanic Personality.

associations ($<.05$) with measures indicative of both normal and pathological functioning, and correlated with risk-taking. In the current analyses social vitality was the only measure to positively correlate with mania variables. Goal setting was not associated with social vitality at baseline but was moderately associated with goal setting post training. This effect is probably explained by the fact that only the second success induction significantly elevated AM. Conversely, a significant weak association between social vitality and thought speed at baseline disappeared at time two. These relations are not given much weight due them not meeting the .001 significance threshold applied. HPS total score did not correlate with the post-success mania variables at either time point, nor did the subscales mood volatility and excitement. These findings alongside the unique relations between mood volatility and increased sympathetic arousal in response to control task found in study two, are supportive of Schalet's (2011) assertion that important information is lost by analysing by total HPS score only.

To summarise this study, it failed to produce evidence that attentional biases for positive stimuli can be modified. This runs against most cognitive bias modification research, but due to their being few studies that have investigated training of positive biases and some problems with the studies that have it is difficult to extrapolate these results. A recent review of attentional biases for positive information at baseline suggested that baseline (non-training studies) positive biases are more detectable earlier than the standard 500ms exposure (Poole, Tobias, Delplanque, & Sander, 2014). Future research seeking to manipulate attentional biases for positive stimuli should investigate the effects of various exposure times.

9 Chapter 9: General Discussion

9.1 Summary of Purpose, Methodology and findings of the Thesis

This thesis had two purposes. The first was to evaluate the validity of four existing self-report measures of AM. This was first achieved by first characterising the latent structure of state AM items and then testing the construct, convergent and discriminant validity of the derived factor subscales and their parent instruments. The most valid self-report measure of AM, as determined by studies 1-3, was utilised for studies 4 and 5. This second strand of research was focussed on the experimental manipulation of AM and attentional biases to test for the bi-directionality of congruency effects between these constructs in the context of the BAS dysregulation theory of bipolar disorder. Positive mood inductions consistent with the elicitation of AM were employed alongside control conditions to both validate the self-report scales and trigger changes in AM and attentional biases to reward which were hypothesized to be causally interrelated in a way that promotes AM dysregulation. Furthermore, the influence of individual differences in vulnerability to mania on AM and selective attention was investigated across studies 2-5. The findings of the thesis have implications for three aspects research.

The first concerns the valid measurement of state AM. The factor analysis of study 1 revealed a multi-dimensional latent structure to the phenomenology of subjectively experienced AM, as predicted, and which was somewhat empirically and conceptually consistent with BAS trait sensitivity (Corr & Cooper, 2016) and BAS theory (Depue & Iacono, 1989). The pattern of results stemming from study 2 and 3 suggested that two facets of the most widely used AM measure, PANAS-PA (Watson & Tellegen, 1988), have distinct sensitivities. The factor labelled Cognitive AM (consisting of PANAS-PA items: determined,

Approach Motivation, Attentional Bias to Positive Stimuli, and Hypomanic Personality.

inspired, proud) was the only AM measure or subscale not to correlate with cardiac pre-ejection (PEP). Similarly, a two-item factor labelled Excited (PANAS-PA: excited, enthusiastic) was the only subscale or AM measure to differentiate between BAS-relevant and BAS-irrelevant IAPS stimuli high in positive valence. Therefore, two facets of PANAS-PA showed contrasting validity credentials with respect to convergent and discriminant validity. Nonetheless, when these facets were combined with the remaining PANAS-PA items (total PANAS-PA) this emerged as the most valid measure from study 2 and 3. This was on account of the fact that all four AM measures demonstrated construct validity and convergent validity, the only evidence that transpired to set the measures apart was the greatest elevation in self-report responses to a reward-oriented laboratory induction in study 2 for total PANAS-PA, and the aforementioned discriminant validity attained by the Excited facet of PANAS-PA. The failure of Cognitive AM to converge with the psychophysiological index of AM was not considered an issue for the use of the PANAS-PA because a) PANAS-PA still correlated with PEP b) the true specificity of PEP reactivity as a gauge of AM is yet to be ascertained. All AM measures predicted PEP within linear mixed models. Interestingly, one single item measure, similar in origin to the PANAS-PA, PARS (Morrone et al. 2000) captured additional variance not accounted for by the other measures. The PARS did not perform so well in study 3 as evidenced by its reduced ability to distinguish BAS-relevant arousal from BAS-irrelevant arousal, as compared to the other AM measures (AMSAM, PANAS-PA, and BES), therefore it was not considered a superior measure of AM. Overall then the main conclusion from the psychometric strand of the thesis was that PANAS-PA, a multi-dimensional construct marginally emerged as the most valid AM measure and was thus employed in the attentional bias experiments, studies 4 and 5.

Approach Motivation, Attentional Bias to Positive Stimuli, and Hypomanic Personality.

The second area of research that the results of this thesis spoke to was the malleability of selective attention for emotional stimuli. Overall the findings of study 4, which attempted to replicate causal influence of AM on attentional biases for positive words, and study 5, which attempted to replicate the reversal of this relationship, both produced null findings in this respect. The extent to which these null findings should be interpreted as a rejection of the research hypothesis, or as due to an inadequate test of the theory, is assessed shortly.

The third and final area of research the current findings have implications for is personality characteristics associated with mania in non-clinical samples. Individual differences in vulnerability to mania as indicated by HPS total and subscale score were used to test for a moderation effect on the reactivity and subsequent recovery of AM, and biases to emotional stimuli in study 2-5. No effect emerged in study 3 and 5, but effects were revealed for study 2 and 4. In study 2, the results were not as predicted. Compared to low scorers, high scorers showed greater divergence of AM scores following the doeo game versus the control task, with a significant decrease in AM following the control task. A second HPS finding which complicated interpretation of the latter result saw high mood volatility, a component of the HPS most associated with emotional instability, scorers display greater cardiac sympathetic arousal indicative of elevated AM in response to the neutral mood task, as compared to individuals who scored low on mood volatility. In study 4 a moderating influence of total HPS score on the effect of AM induction upon attentional bias for emotional stimuli, in which those at greater risk to mania displayed an attentional bias for both positive and negative stimuli following AM induction was at least partially consistent with the a priori prediction. Yet a significant caveat to this finding was that the effect was only visible for individuals whose self-reported AM (PANAS-PA) had significantly increased relative to individuals whose AM level did not change.

Approach Motivation, Attentional Bias to Positive Stimuli, and Hypomanic Personality.

To summarise studies 1, 2 and 3 were most fruitful, and produced findings relevant to the future measurement of AM and hypomanic personality. In contrast, null findings and anomalies characterised study 4 and 5, and consequently invoke questions over methodology and replicability. The studies will now be individually assessed in terms of limitations and implications. Note that sample sizes are not attended to because each of the studies was well powered. At this point it is also worth pointing out this point that the sample limitations commonly associated with university based psychology research (late-adolescent, predominantly female) apply to all the studies of this thesis. As a reminder, the non-clinical samples recruited limited generalisability to diagnosable bipolar disorder populations.

9.2 Strand One: Limitations of the AM measurement research

In methodological terms, the most prominent concern about study 1 was the inability to fully eliminate the influence of scale design being reflected in the factor structure. Raw scores were standardised and this seemed to have been somewhat successful as indicated by the presence of at least one scale comprised of items from the BES, PARS and PANAS-PA, although two of the four factor subscales were purely comprised of BES and PANAS-PA items. The factor solutions required only a few iterations, once the most applicable extraction technique for the data was applied. This fact, alongside the emergence of a factor solution that seemed to resemble BAS theory (Depue & Iacono, 1989) was suggestive of a reasonably clean solution. Justification for the use of a two-item scale Excited/Enthusiastic was based on a dynamic cluster analysis of PANAS-PA (Egloff et al. 2003). Alignment between the Excited/Enthusiastic subscale found in study 1 and a three item facet labelled Joy (Excited, Enthusiatic, Proud) by Egloff et al. (2003) that was shown to display a different trajectory over time to two other PA subscales suggested this scale was worthy of further research.

Approach Motivation, Attentional Bias to Positive Stimuli, and Hypomanic Personality.

Some limitations of study 1 should be acknowledged. Firstly, factor analysis has a subjective element to it and is therefore somewhat flawed method in this respect. Also the opportunistic sampling method employed, alongside aforementioned under-representativeness of a student sample, represent further limitations.

Regarding study 2, it should be acknowledged that claiming construct validity for putative AM measures against an invalidated AM reduction might represent a circular argument. However, the interaction between the AM and neutral task groups over time, in the expected direction, for both PEP and SAM arousal scales, alongside the careful theoretical consideration that went in to selecting the Doeo game negates against this potential criticism. This was bolstered by controlling for anxiety, which did not change in the AM condition. Indeed, it is suggested that the Doeo game might represent a good laboratory induction of AM for future research. Difficulties in interpreting the effects produced by the control task, particularly the divergence within hypomanic personality on cardio and self-report measures, hinder strong conclusions being made.

With respect to study 3, it was also clear that comparing IAPS images that shared arousal level but diverged on valence was a somewhat easy test of discrimination for the measures. By the same token, comparing IAPS images that shared valence but diverged on arousal was much more difficult. This reflects a combination of stark contrasts in conceptual distance between positive and negative valence that is not mirrored between high and low levels of activation. That does not mean the hypothesis was not testable. Rather the IAPS pictures themselves are more likely to be incapable of eliciting a strong enough reward response to enable differences in response to stimuli of the same valence, but different levels of arousal, to be seen. Utilising more powerful induction techniques, such as film, might overcome this but the problem arises regarding standardization, which is more difficult to achieve with film (Westerman, 1996).

Approach Motivation, Attentional Bias to Positive Stimuli, and Hypomanic Personality.

This limitation of study 3 considered alongside the well-known validity issues that revolve around self-report (e.g. influence of beliefs about emotions and the self - Robinson & Feldman, 2009), suggest that more robust tests of discrimination are required. A strength of the IAPS is that they have been standardised in a large broad population (Lang, Bradley, Cuthbert, 2008) and extensive psychophysiological and neuroscience research has been conducted to link responses to viewing pictures with the biological underpinnings of aversive and appetitive systems. Therefore, the test of discrimination between AM and Fear images was appropriate. The test for discrimination between AM and calm positive affect was also theoretically sound (Carver & Scheier, 1998). It is suggested that the IAPS pictures were most likely not strong enough elicitors to produce differentiation between these states via self-report . Evidence suggests Attentional scope has been proposed to differ by the motivational intensity of positive affect. This may represent an interesting or better way of inferring discriminant validity between BAS-relevant and BAS-irrelevant positive information (Gable & Harmon-Jones, 2008) .

9.3 Implications for the measurement of AM

The four factors derived from study 1 proved informative in study 2 and 3 and therefore supported the prediction that AM consists of components that display differential patterns of response to both convergent and divergent validity tests. This is consistent with Corr's (2016) concept that the BAS consists of sub-goal scaffolding that perform separate functions. That said, little can be drawn from study 2 and 3 in respect to the functionality of these factors, and this is something future research should consider. The parsing of reward has been mentioned at multiple points in this thesis but no specific predictions were made that pre-attainment and post-attainment structures would be reflected in the AM items, largely because the AM scale

Approach Motivation, Attentional Bias to Positive Stimuli, and Hypomanic Personality.

designers (Watson & Tellegen, 1988; Morrone et al. 2000; Krauss et al. 1987; Wright, 2010) were not focussed on this distinction but equally because of an inability of factor analysis conducted on a single measurement point to be able to address this. Egblöff's et al. (2003) hierarchical cluster analysis of PANAS-PA facets over time was a better test of this. Future research should seek to conduct a fine-grained analysis of the stable and dynamic facets of PANAS-PA. Confirmatory factor analytic approaches could be used to a) test the factor subscales reported here temporally using hierarchical analysis b) test the robustness of Egblöff's clusters against latent rather than cluster analysis procedure to be able to provide more definitive conclusions about the phenomenology of AM. PANAS-PA items Excited and Enthusiastic, are of particular interest. As is the pride item. It remains to be seen whether pride should be considered alongside Excited and Enthusiatic (Egblöff et al. 2003) or whether it is more appropriate to group it with inspired and determined (study 1).

Of note, in a review by Kriebig (2010), pride was found to be unrelated to PEP. This neatly corresponds to the current finding that the Cognitive AM factor (PANAS-PA: inspired, determined, and proud) was the one of eight measures/subscales not to correlate with shortened PEP. This subscale was named so to distance it from the other factors which seemed to reflect either affect or activation. Pride is more commonly understood as a social emotion, whilst inspiration is linked to in the moment of creativity (Frederickson, 2002). Another component of Cognitive AM - determination - might reflect something different altogether, such as willingness to pursue difficult challenges, a construct thought to be elevated in BD (Johnson et al. 2012). Future research should clarify this effect and measure the PANAS-PA more robustly in relation to AM construct validity.

Approach Motivation, Attentional Bias to Positive Stimuli, and Hypomanic Personality.

The current evidence implicating PEP as a valid marker of BAS activity is not clear-cut. The findings from study 2 that showed PEP to behave as expected in response to the inductions, to correlate as expected with purported AM measures and to relate more strongly to SAM arousal than SAM valence. When taken together, these findings strengthen this case. Specifically, the results for PEP adds to evidence from previous research that found PEP reactivity to correlate positively with trait levels of AM (Brenner et al. 2005), incentive value (Richter & Gendolla, 2009) and an experimentally manipulated AM condition (Tomaka & Palacios-Esquivel, 1997). Tentative evidence exists that increased beta-adrenergic activity measured through (shortened) PEP as found in study 2 in response to AM, is also associated with sadness, amusement and happiness (Kreibig, 2010). According to Kreibig (2010) these emotions can be linked with AM through success or failure. A complicating matter is the previously reported finding that decreased sympathetic activity (longer PEP) and anger (approach-related emotion) are associated (Kreibig, 2010).

These results serve to highlight the general problem of non-specificity in cardiac impedance measurement (Gruber, 2011). There is a need to disentangle positive valence emotions such as amusement and happiness from more approach-related emotions like enthusiasm and excitement. Nevertheless the findings of study 2 add to the literature that broadly implicates PEP in reward processing.

To summarise, strand one provided preliminary evidence that AM is measurable via self-report. There has been a call for better measurement of the correlates of AM (Johnson (2005); Harmon-Jones, et al. 2008; Scott et al. 2017). Study 1 suggested there are distinct facets to state AM, whilst triangulation between AM measures, biological correlates of AM, and theoretically-driven AM induction evident in study 2, supports the conclusions this was a successful investigation of artificially invoked AM. Study 3 confirmed that PANAS-PA and the Excited and Enthusiastic items to be of particular relevance to AM. These findings,

Approach Motivation, Attentional Bias to Positive Stimuli, and Hypomanic Personality.

considered with Harmon-Jones et al.'s (2013) linking of AM to PANAS-PA through the study of anger suggests PANAS-PA should be the focus of further validation. Future research should employ a more comprehensive multi-method investigation of the biological correlates of AM alongside self-report. PEP should perhaps be measured alongside frontal asymmetry in conjunction with self-report measurement. Ecological validity concerns could be addressed by adopting naturalistic methods, perhaps comparing high trait sensitivity (either an analogue or a patient sample) with responsiveness to the facets of state AM in the face of BAS-activating/de-activating events. It is particularly important for ecological validity that the measures are against real-world AM activation setting (e.g. working towards important goals, major personal successes – both associated with onset to mania – Johnson, 2005), although it is acknowledged that in research there is often a trade-off between ecological validity and the degree of experimental control.

9.4 Strand Two: Limitations and implications for attentional bias measurement.

Study 4 did not find evidence to replicate the Tamir and Robinson's (2007) findings that induced positive mood biases selective attention for positive stimuli. Because the study was closely based on Tamir and Robinson (2007) - by using the same pre-post between subjects design and the same dot-probe paradigm - a clue to the null finding may lie in the inductions used. The Reliable Change Index showed that roughly two thirds of participants in the experimental did not reliably increase in AM following watching an achievement-focussed film clip that they were encouraged to immerse themselves in. A fundamental issue here, despite the clip being previously shown to elevate AM (PARS measure: Morrone et al. 2004), was that it did not produce the desired subjective experience to produce changes in attentional processing detectable by the dot-probe task. Interestingly, Tamir and Robinson did find such effects by inducing general positive emotions using autobiographical recall, guided imagery and music. The decision to use a film was based on evidence suggesting it is one of the stronger induction techniques. But also because film was thought to be a good mode for triggering an AM state (Morrone et al. 2004). The Doeo game was considered but it was decided that it, versus a control task, could produce differential effects on visual attention. In the absence of any other research that has specifically investigated the effects of artificially induced positive mood on selective attention to positive stimuli, it is suggested that study 4 was not a solid test of the congruency hypothesis.

A second caveat applies to both study 4 and Tamir et al's findings. Both were confounded by the fact it was possible for participants to identify the location of the probe by at location of probe without having attend to location where the probe appeared (Grafton & MacLeod, 2016) . This, alongside evidence from an eye-tracking bias study that

Approach Motivation, Attentional Bias to Positive Stimuli, and Hypomanic Personality.

suggested positive mood was not associated with initial orientation bias (i.e. first fixation), for positive stimuli (Sanchez & Vasquez, 2014), calls in to question the ability of these studies to confidently conclude that elevated positive mood causally biases attention to reward.

Study 5 addressed the discrimination problem by using a variant of the dot-probe task that required participants to execute a discriminatory response based on probe identity (one dot or two dots). Despite this, study 5 failed to effectively manipulate selective attention and as such could not replicate Grafton et al.'s findings. Grafton et al.'s study was compromised by significant differences between the train-positive and avoid-positive groups at baseline. And because there is a paucity of research that has attempted to train selective attention towards positive information, it is therefore difficult to draw conclusions as to whether selective attention can be trained with the same effectiveness as that found with negative information. The literature base does suggest that, in very broad terms, training attention to positive information influences affective-cognitive outcomes. Dandeneau et al. (2007) repeatedly trained attentional processes for positive information over a number of days and found this to exert downstream improvements in emotion regulation outcomes (Dandeneau et al. 2007). Only one other study which found training attention to positive stimuli reduces attention to negative information (Wadlinger & Issacowitz, 2008), was identified that relates to study 5. It is clear that much more research is needed to understand the processes related to attentional processing governed by the BAS.

A second issue for study 5 was the failure of the baseline success induction to significantly elevate AM. Irrespective of the effectiveness of attentional training, the hypothesis that biasing attention towards positive stimuli would elevate AM and mania relevant variables following a success experience was hindered by the inability to manipulate

Approach Motivation, Attentional Bias to Positive Stimuli, and Hypomanic Personality.

AM at baseline. Despite this, success-feedback anagram task was effective in Grafton et al.'s study, and post-training in study 5, an effect probably due to practice effects. This form of mood induction has received criticism for lacking realism with (Nummenmaa & Niemi, 2004) suggesting that many participants are not likely to believe they score within the top 10% and that demand characteristics might come in to play, although the latter point might be applied to all mood inductions that rely on self-report.

A general issue that applies to study 4 and 5, but also Tamir et al. and Grafton et al.'s work is the use of a standard stimuli exposure time of 500 milliseconds. The exposure latency is crucial as it has been demonstrated that subcomponents of attentional bias operate at different stages of attentional deployment. In the early attentional bias studies in depression it was thought that depressive states were not associated with attentional biases for negative stimuli (Williams et al. 1997). However later studies inspected biases temporally and found that when negative stimuli was presented longer than 500 milliseconds an association emerged (Mogg & Bradley, 2005). Emotional biases for positive information have been relatively neglected until recently. A recent review of attentional biases for positive information at baseline suggested that baseline (non-training studies) positive biases are more detectable earlier than the standard 500ms exposure (Poole, Tobias, Delplanque, & Sander, 2014). Clearly then the research reported here and the experimentation that formed the basis of study 4 and 5 only speak to a very specific time-point in the attentional deployment process at the edge of this apparent threshold. There is also the complication that biases detected from exposure times later than 200ms are associated with difficulty disengaging attention (Theeuwes, 2010). Future replication is therefore suggested using paradigms that can separate orienting mechanisms from disengagement mechanisms.

Approach Motivation, Attentional Bias to Positive Stimuli, and Hypomanic Personality.

It should be noted that, despite over thirty years of research, a lot is still unknown about information-processing biases. Brosch et al. (2011) proposed that exogenous attention, endogenous attention, and emotional attention have an additive influence on attentional selection.

From a wider perspective, the existence of cognitive biases across domains of cognitive (attention, reasoning, memory) transdiagnostic research has led theorists to consider how the interplay between information-processing biases might be important in symptom generation (Hirsh, Clark, & Mathews, 2006). Recent evidence suggests that mental imagery biases amplify emotion in BD, might it be that attentional biases are only triggered when biases in other cognitive networks are activated? As speculative as this is, in general it is clear there is much more to learn about information-processing biases in BD.

9.5 Implications for the measurement of vulnerability to bipolar disorder

The HPS is one of a few measures designed to tap susceptibility to mania. It has established predictive validity in terms of onset of bipolar disorder (e.g. Kwapil et al. 2000) and as such has been used as a window in to premorbid processes that might help explain mania. Two notable findings emerged from the thesis regarding the hypomanic personality scale. Firstly, individuals with a greater propensity to experience changeable and unpredictable mood (by way of a high score on the mood volatility subscale) displayed increased sympathetic arousal in response to the control task as compared to individuals low on this trait. Also contrary to predictions, there was evidence that participants at higher risk of mania (total HPS score) showed a greater reduction in behavioural engagement during the control task relative to the approach task, as compared to those less vulnerable to mania (on account of lower HPS score).

It appears anomalous that only one of three the underlying structures to hypomanic personality displayed a differential pattern of responding to the total HPS score. The result implies that by using HPS total score important relationships that different aspects of hypomanic personality have with other variables may be obscured. This was the rationale, informed the work of Schalet et al. (2011), behind analysing HPS by subscale. This finding is most curious because PEP and BES were tested for convergence under the assumption that, at a broad level they tap the same construct. The result suggests that areas of divergence between BES and PEP are being picked up by aspects of aspects of hypomania in a task designed to keep AM stable. Previous research using the HPS has found that high HPS scorers to produce both greater self-reported positive emotion, cardiac vagal tone (a

Approach Motivation, Attentional Bias to Positive Stimuli, and Hypomanic Personality.

parasympathetic correlate of broad positive emotionality) and irritability in response to neutral film clips (Gruber, Johnson, Oveis, & Keltner, 2008). The lack of specificity here makes the finding difficult to interpret but because irritability is an item of the mood volatility scale then in this respect perhaps the increased sympathetic arousal represented irritability in these individuals (anger has been associated with PEP - Kreibig, 2010), and this may have been driving the effect seen in Gruber et al.'s (2008) study. This is suggested very tentatively⁴⁴; more research is required to understand mood volatility as across the studies it was the HPS component most associated with negative affect (anxiety and depression) and this which replicates previous research (Schalet et al. 2011). The study 4 finding that mood volatility predicted a quicker recovery to baseline post-AM induction is consistent with Schalet et al's (2011) assertion that this structure represents affective lability that BD shares with borderline personality disorder, and therefore this may be separate to the poorly understood BAS mechanism that is hypothesized to delay recovery in BD.

The second finding was partially consistent with what was predicted. Firstly the effect was only found in a stratified sample for participants who exhibited reliable increases in AM. Secondly, rather than an AM state biasing attention to congruent positive stimuli more in mania-prone individuals, the results indicated that, following AM as compared to neutral induction, attention was biased towards both positive and negative words, in high HPS scorers relative to low HPS scores. At first sight this finding aligns with the conceptualisation of BD as a disorder marked by disturbance in opposing poles of affect. In general, the few selective attention studies with individuals diagnosed with BD have been somewhat inconsistent but there is evidence of biases to both valences.

⁴⁴ During the control task participants spent two minutes staring at a light blue screen whilst aimlessly moving a cursor around the screen – at face value this would elicit tedious feelings in most but perhaps irritation in others. Goetz et al. (2014) found evidence to differentiate types of boredom along dimensions of valence and arousal.

Approach Motivation, Attentional Bias to Positive Stimuli, and Hypomanic Personality.

Studies that employed less direct measures of selective attention found elevated mood in BD is characterised by preferential processing of both negative and positive material (Bentall & Thompson, 1990; Murphy, 1999). Only two studies have used visual dot probe tasks. Using words as stimuli, Jongen et al. (2007) found an attentional bias away from both positive and depression-related words in mildly depressed patients. This is preliminary evidence for a general emotional bias in BD that might be oriented away from both valences in euthymia and towards both valences in an elevated mood. However the only study that directly measured selective attention (dot-probe) following a positive mood induction did not find any results. An fMRI study found individuals with diagnosed BD displayed elevated activity in the amygdala as compared to healthy controls in response to positive stimuli (Berpohl et al. 2009). This is consistent with the notion that BD is characterised by fundamental emotion sensitivity (M'Bailara et al. 2000). The finding of study 4 is somewhat consistent with this. Replication of this study would be required to clarify the relationship between mood state and associated attentional biases. It would be beneficial to employ a more powerful, stratified high-risk design.

At this point it should also be pointed out that the vast majority of studies utilising the HPS use a proper high-risk design where those at greater risk (commonly a score greater than >30) are compared to individuals at lower risk. Except from study four which preferentially recruited high scorers, there was no stratification of the samples. Of the four studies, reported aimed at detecting (roughly) normally distributed individual differences in mania vulnerability, two produced moderating effects on autonomic nervous activity and attentional processing. This is testament to the HPS as useful measurement tool, but also highlights the influence of random variation among the samples.

9.6 +Conclusions

Understanding approach motivation in non-clinical samples is important, not only because processes related to premorbid, pre-medicated propensity for mania can be inferred, but also because investigations can also shed light on psychological processes related to underlying regulatory systems in the general population.

The first strand of research reported here suggests it is important to continue researching the positive activation items of the PANAS in order to delineate it precise it measures. Although this research did not tackle the question, it seems important to look at the facets of the PANAS at both the ‘wanting’ and ‘liking’ stages of reward (both are disrupted in BD – Johnson et al. 2012).

The second strand of research returned inconclusive findings. This is consistent with the call for the field of attentional bias research to refine its measurement techniques (MacLeod & Clarke, 2013).

Finally, the studies reported here suggests the components of hypomanic personality scale, particularly mood volatility with its close association to affective instability, are important considerations for future research investigating risk factors associated with the ascent in to mania.

Approach Motivation, Attentional Bias to Positive Stimuli, and Hypomanic Personality.

.

- Abraham, K. (1911). Notes on the psycho-analytical investigation and treatment of manic-depressive insanity and allied conditions. *Selected Papers on Psychoanalysis*, 137–156.
- Abreu, T. (2016). Cognitive-behavioral therapy for bipolar disorder. *European Psychiatry*, 33, S556.
- Acta Psychiatrica Scandinavica, & Akiskal, H. S. (2004). Demystifying borderline personality: critique of the concept and unorthodox reflections on its natural kinship with the bipolar spectrum. *Acta Psychiatrica Scandinavica*, 110(6), 401–407.
<https://doi.org/10.1111/j.1600-0447.2004.00461.x>
- Akiskal, H. S., Azorin, J. M., & Hantouche, E. G. (2003). Proposed multidimensional structure of mania: beyond the euphoric-dysphoric dichotomy. *Journal of Affective Disorders*, 73(1–2), 7–18.
- Akiskal, H. S., Bourgeois, M. L., Angst, J., Post, R., Möller, H.-J., & Hirschfeld, R. (2000). Re-evaluating the prevalence of and diagnostic composition within the broad clinical spectrum of bipolar disorders. *Journal of Affective Disorders*, 59, S5–S30.
- Akiskal, H. S., & Pinto, O. (1999). The evolving bipolar spectrum: prototypes I, II, III, and IV. *Psychiatric Clinics of North America*, 22(3), 517–534.
- Alloy, L. B., Abramson, L. Y., Urosevic, S., Walshaw, P. D., Nusslock, R., & Neeren, A. M. (2005). The psychosocial context of bipolar disorder: environmental, cognitive, and developmental risk factors. *Clinical Psychology Review*, 25(8), 1043–1075.
- Alloy, L. B., Nusslock, R., & Boland, E. M. (2015). The development and course of bipolar spectrum disorders: An integrated reward and circadian rhythm dysregulation model. *Annual Review of Clinical Psychology*, 11, 213–250.

Approach Motivation, Attentional Bias to Positive Stimuli, and Hypomanic Personality.

Altman, E. G., Hedeker, D., Peterson, J. L., & Davis, J. M. (1997). The Altman self-rating mania scale. *Biological Psychiatry*, *42*(10), 948–955.

Altman, E., Hedeker, D., Peterson, J. L., & Davis, J. M. (2001). A comparative evaluation of three self-rating scales for acute mania. *Biological Psychiatry*, *50*(6), 468–471.

Anxiety. (n.d.). Retrieved from

https://books.google.co.uk/books/about/Anxiety.html?id=uUu1aFkq_h0C

Applegate, E., El-Deredy, W., & Bentall, R. P. (2009). Reward responsiveness in psychosis-prone groups: hypomania and negative schizotypy. *Personality and Individual Differences*, *47*(5), 452–456.

Arnone, D., Cavanagh, J., Gerber, D., Lawrie, S. M., Ebmeier, K. P., & McIntosh, A. M. (2009). Magnetic resonance imaging studies in bipolar disorder and schizophrenia: meta-analysis. *The British Journal of Psychiatry*, *195*(3), 194–201.

<https://doi.org/10.1192/bjp.bp.108.059717>

Aronson, T. A., Shukla, S., & Hoff, A. (1987). Continuation therapy after ECT for delusional depression: a naturalistic study of prophylactic treatments and relapse. *The Journal of ECT*, *3*(4), 251–259.

Association, A. P. (2000). *Diagnostic criteria from dsM-iV-tr*. American Psychiatric Pub.

Association, A. P. (2013). *DSM 5*. American Psychiatric Association.

Baddeley 1983.pdf. (n.d.). Retrieved from

<http://www2.psych.ubc.ca/~pgraf/Psy583Readings/Baddeley%201983.pdf>

Baddeley, A. (1992). Working Memory and Conscious Awareness. *Theories of Memory*, 11–20.

Baert, S., De Raedt, R., Schacht, R., & Koster, E. H. (2010). Attentional bias training in depression: therapeutic effects depend on depression severity. *Journal of Behavior Therapy and Experimental Psychiatry*, *41*(3), 265–274.

Approach Motivation, Attentional Bias to Positive Stimuli, and Hypomanic Personality.

Baker, J. G., Zevon, M. A., & Rounds, J. B. (1994). Differences in positive and negative affect dimensions: Latent trait analysis. *Personality and Individual Differences, 17*(2), 161–167.

Banks, F. D., Lobban, F., Fanshawe, T. R., & Jones, S. H. (2016). Associations between circadian rhythm instability, appraisal style and mood in bipolar disorder. *Journal of Affective Disorders, 203*, 166–175. <https://doi.org/10.1016/j.jad.2016.05.075>

Barnard: Interacting cognitive subsystems: A systemic... - Google Scholar. (n.d.). Retrieved 19 February 2017, from https://scholar.google.com/scholar?cites=6204722150453967680&as_sdt=2005&scioldt=0,5&hl=en

Barnard, P. J., & Teasdale, J. D. (1991). Interacting cognitive subsystems: A systemic approach to cognitive-affective interaction and change. *Cognition & Emotion, 5*(1), 1–39. <https://doi.org/10.1080/02699939108411021>

Bauer, M. S., Crits-Christoph, P., Ball, W. A., Dewees, E., McAllister, T., Alahi, P., ... Whybrow, P. C. (1991). Independent assessment of manic and depressive symptoms by self-rating: Scale characteristics and implications for the study of mania. *Archives of General Psychiatry, 48*(9), 807–812.

Beauchaine, T. (2001). Vagal tone, development, and Gray's motivational theory: Toward an integrated model of autonomic nervous system functioning in psychopathology. *Development and Psychopathology, 13*(02), 183–214.

Beaver, J. D., Lawrence, A. D., van Ditzhuijzen, J., Davis, M. H., Woods, A., & Calder, A. J. (2006). Individual differences in reward drive predict neural responses to images of food. *Journal of Neuroscience, 26*(19), 5160–5166.

Beck, A. T. (1967). *Depression: Clinical, experimental, and theoretical aspects*. University of Pennsylvania Press.

Beck, J. S. (1979). *Cognitive therapy*. Wiley Online Library.

Approach Motivation, Attentional Bias to Positive Stimuli, and Hypomanic Personality.

Benes, F. M., & Berretta, S. (2001). GABAergic interneurons: implications for understanding schizophrenia and bipolar disorder. *Neuropsychopharmacology*, *25*(1), 1–27.

Bentall, R. P., & Thompson, M. (1990). Emotional Stroop performance and the manic defence. *British Journal of Clinical Psychology*, *29*(2), 235–237.

Berk, M., & Dodd, S. (2005). Bipolar II disorder: a review. *Bipolar Disorders*, *7*(1), 11–21.
<https://doi.org/10.1111/j.1399-5618.2004.00152.x>

Berpohl, F., Dalanay, U., Kahnt, T., Sajonz, B., Heimann, H., Ricken, R., ... Adli, M. (2009). A preliminary study of increased amygdala activation to positive affective stimuli in mania. *Bipolar Disorders*, *11*(1), 70–75.

Berridge, K. C. (2007). The debate over dopamine's role in reward: the case for incentive salience. *Psychopharmacology*, *191*(3), 391–431.

Berridge, K. C., & Kringelbach, M. L. (2013). Neuroscience of affect: brain mechanisms of pleasure and displeasure. *Current Opinion in Neurobiology*, *23*(3), 294–303.

Betella, A., & Verschure, P. F. M. J. (2016). The Affective Slider: A Digital Self-Assessment Scale for the Measurement of Human Emotions. *PLOS ONE*, *11*(2), e0148037.
<https://doi.org/10.1371/journal.pone.0148037>

Bijttebier, P., Beck, I., Claes, L., & Vandereycken, W. (2009). Gray's Reinforcement Sensitivity Theory as a framework for research on personality–psychopathology associations. *Clinical Psychology Review*, *29*(5), 421–430.

Boden, M. A. (2006). *Mind as machine: A history of cognitive science*. Clarendon Press.

Bradley, M. M., & Lang, P. J. (1994). Measuring emotion: the self-assessment manikin and the semantic differential. *Journal of Behavior Therapy and Experimental Psychiatry*, *25*(1), 49–59.

Brenner, S. L., Beauchaine, T. P., & Sylvers, P. D. (2005). A comparison of psychophysiological and self-report measures of BAS and BIS activation. *Psychophysiology*, *42*(1), 108–115.

Approach Motivation, Attentional Bias to Positive Stimuli, and Hypomanic Personality.

Brent, L. J., Chang, S. W., Gariépy, J.-F., & Platt, M. L. (2014). The neuroethology of friendship.

Annals of the New York Academy of Sciences, 1316(1), 1–17.

Brietzke, E., Sant'anna, M. K., Jackowski, A., Grassi-Oliveira, R., Bucker, J., Zugman, A., ...

Bressan, R. A. (2012). Impact of childhood stress on psychopathology. *Revista Brasileira de Psiquiatria*, 34(4), 480–488.

Browning, M., Holmes, E. A., & Harmer, C. J. (2010). The modification of attentional bias to

emotional information: A review of the techniques, mechanisms, and relevance to emotional disorders. *Cognitive, Affective, & Behavioral Neuroscience*, 10(1), 8–20.

Burmeister, M., McInnis, M. G., & Zöllner, S. (2008). Psychiatric genetics: progress amid

controversy. *Nature Reviews Genetics*, 9(7), 527–540. <https://doi.org/10.1038/nrg2381>

Carver, C. S., & White, T. L. (1994). Behavioral inhibition, behavioral activation, and affective

responses to impending reward and punishment: The BIS/BAS Scales. *Journal of Personality and Social Psychology*, 67(2), 319.

Clark, D. A., Beck, A. T. M., & Alford, B. A. (1999). *Scientific Foundations of Cognitive Theory*

and Therapy of Depression. New York: John Wiley & Sons, Inc.

Comrey, A. L., & Lee, H. B. (2013). *A first course in factor analysis*. Psychology Press.

Corr, P. J. (2004). Reinforcement sensitivity theory and personality. *Neuroscience &*

Biobehavioral Reviews, 28(3), 317–332. <https://doi.org/10.1016/j.neubiorev.2004.01.005>

Corr, P. J., & Cooper, A. J. (2016). The Reinforcement Sensitivity Theory of Personality

Questionnaire (RST-PQ): Development and validation. *Psychological Assessment*, 28(11), 1427.

Coryell, W., Endicott, J., Maser, J. D., Keller, M. B., Leon, A. C., & Akiskal, H. S. (1995). Long-

term stability of polarity distinctions in the affective disorders. *American Journal of Psychiatry*, 152(3), 385–390.

Approach Motivation, Attentional Bias to Positive Stimuli, and Hypomanic Personality.

Craddock, N., & Sklar, P. (2013). Genetics of bipolar disorder. *The Lancet*, *381*(9878), 1654–1662. [https://doi.org/10.1016/S0140-6736\(13\)60855-7](https://doi.org/10.1016/S0140-6736(13)60855-7)

Crocker, P. R. (1997). A confirmatory factor analysis of the Positive Affect Negative Affect Schedule (PANAS) with a youth sport sample. *Journal of Sport & Exercise Psychology*.

Cuijpers, P., Geraedts, A. S., van Oppen, P., Andersson, G., Markowitz, J. C., & van Straten, A. (January 3). Interpersonal Psychotherapy for Depression: A Meta-Analysis. *The American Journal of Psychiatry*, *168*(6), 581–592. <https://doi.org/10.1176/appi.ajp.2010.10101411>

Davidson, R. J. (1999). Neuropsychological perspectives on affective styles and their cognitive consequences.

Dawe, S., Gullo, M. J., & Loxton, N. J. (2004). Reward drive and rash impulsiveness as dimensions of impulsivity: implications for substance misuse. *Addictive Behaviors*, *29*(7), 1389–1405.

De Pascalis, V., Varriale, V., & D'Antuono, L. (2010). Event-related components of the punishment and reward sensitivity. *Clinical Neurophysiology*, *121*(1), 60–76.

Depue, R. A., & Collins, P. F. (1999). Neurobiology of the structure of personality: Dopamine, facilitation of incentive motivation, and extraversion. *Behavioral and Brain Sciences*, *22*(03), 491–517.

Depue, R. A., & Iacono, W. G. (1989). Neurobehavioral aspects of affective disorders. *Annual Review of Psychology*, *40*(1), 457–492.

Depue, R. A., Krauss, S. P., & Spoont, M. R. (1987). A two-dimensional threshold model of seasonal bipolar affective disorder.

Depue, R. A., Krauss, S., Spoont, M. R., & Arbisi, P. (1989). General behavior inventory identification of unipolar and bipolar affective conditions in a nonclinical university population. *Journal of Abnormal Psychology*, *98*(2), 117.

Approach Motivation, Attentional Bias to Positive Stimuli, and Hypomanic Personality.

Depue, R. A., & Monroe, S. M. (1986). Conceptualization and measurement of human disorder in life stress research: The problem of chronic disturbance. *Psychological Bulletin*, *99*(1), 36.

Dooley, L. (1921). A psychoanalytic study of manic-depressive psychoses. *The Psychoanalytic Review (1913-1957)*, *8*, 38.

Dougherty, D. M., Mathias, C. W., Marsh, D. M., & Jagar, A. A. (2005). Laboratory behavioral measures of impulsivity. *Behavior Research Methods*, *37*(1), 82–90.

du Pont, A., Welker, K., Gilbert, K. E., Gruber, J., & Gruber, J. (2016). The emerging field of positive emotion dysregulation. *Handbook of Self-Regulation: Research, Theory and Applications*, 364–379.

Egloff, B., Schmukle, S. C., Burns, L. R., Kohlmann, C.-W., & Hock, M. (2003). Facets of Dynamic Positive Affect: Differentiating Joy, Interest, and Activation in the Positive and Negative Affect Schedule (PANAS). *Journal of Personality and Social Psychology*, *85*(3), 528–540. <https://doi.org/10.1037/0022-3514.85.3.528>

Evans, D. L., Charney, D. S., Lewis, L., Golden, R. N., Gorman, J. M., Krishnan, K. R. R., ... Coyne, J. C. (2005). Mood disorders in the medically ill: scientific review and recommendations. *Biological Psychiatry*, *58*(3), 175–189.

Faul, F., Erdfelder, E., Lang, A.-G., & Buchner, A. (2007). G* Power 3: A flexible statistical power analysis program for the social, behavioral, and biomedical sciences. *Behavior Research Methods*, *39*(2), 175–191.

Ford, B. Q., Mauss, I. B., & Gruber, J. (2015). Valuing happiness is associated with bipolar disorder. *Emotion*, *15*(2), 211–222. <https://doi.org/10.1037/emo0000048>

Frank, E., Kupfer, D. J., Thase, M. E., Mallinger, A. G., Swartz, H. A., Fagiolini, A. M., ... Thompson, W. (2005). Two-year outcomes for interpersonal and social rhythm therapy in individuals with bipolar I disorder. *Archives of General Psychiatry*, *62*(9), 996–1004.

Approach Motivation, Attentional Bias to Positive Stimuli, and Hypomanic Personality.

Franken, I. H., Muris, P., & Georgieva, I. (2006). Gray's model of personality and addiction.

Addictive Behaviors, 31(3), 399–403.

Fredrickson, B. L. (2002). Positive emotions. *Handbook of Positive Psychology*, 120–134.

Freeman, M. P., Freeman, S. A., & McElroy, S. L. (2002). The comorbidity of bipolar and anxiety disorders: prevalence, psychobiology, and treatment issues. *Journal of Affective Disorders*, 68(1), 1–23.

Frey, B. N., Andreatza, A. C., Houenou, J., Jamain, S., Goldstein, B. I., Frye, M. A., ... Lopez-Jaramillo, C. (2013). Biomarkers in bipolar disorder: a positional paper from the International Society for Bipolar Disorders Biomarkers Task Force. *Australian and New Zealand Journal of Psychiatry*, 47(4), 321–332.

Fulford, D., Johnson, S. L., Llabre, M. M., & Carver, C. S. (2010). Pushing and coasting in dynamic goal pursuit coasting is attenuated in bipolar disorder. *Psychological Science*.

Gable, P. A., & Harmon-Jones, E. (2008). Approach-Motivated Positive Affect Reduces Breadth of Attention. *Psychological Science*, 19(5), 476–482. <https://doi.org/10.1111/j.1467-9280.2008.02112.x>

Gable, P., & Harmon-Jones, E. (2010). The motivational dimensional model of affect: Implications for breadth of attention, memory, and cognitive categorisation. *Cognition and Emotion*, 24(2), 322–337. <https://doi.org/10.1080/02699930903378305>

Galván, A. (2013). The teenage brain sensitivity to rewards. *Current Directions in Psychological Science*, 22(2), 88–93.

García-Blanco, A., Salmerón, L., Perea, M., & Livianos, L. (2014). Attentional biases toward emotional images in the different episodes of bipolar disorder: An eye-tracking study. *Psychiatry Research*, 215(3), 628–633.

Geddes, J. R., & Miklowitz, D. J. (2013). Treatment of bipolar disorder. *The Lancet*, 381(9878), 1672–1682.

Approach Motivation, Attentional Bias to Positive Stimuli, and Hypomanic Personality.

Gelman, A., & Park, D. K. (2012). Splitting a predictor at the upper quarter or third and the lower quarter or third. *The American Statistician*.

Georgeon, O. L., & Ritter, F. E. (2012). An intrinsically-motivated schema mechanism to model and simulate emergent cognition. *Cognitive Systems Research*, 15, 73–92.

Gigante, A. D., Barenboim, I. Y., Dias, R. da S., Toniolo, R. A., Miranda-Scippa, Â., Kapczinski, F. P., & Lafer, B. (2015). Rapid cycling bipolar disorder is associated with a higher lifetime prevalence of migraine. *Acta Psychiatrica Scandinavica*, 132(4), 308–309.
<https://doi.org/10.1111/acps.12450>

Gilbert, K. E., Nolen-Hoeksema, S., & Gruber, J. (2016). I don't want to come back down: Undoing versus maintaining of reward recovery in older adolescents. *Emotion*, 16(2), 214–225. <https://doi.org/10.1037/emo0000128>

Gitlin, M. J., Swendsen, J., Heller, T. L., & Hammen, C. (1995). Relapse and impairment in bipolar disorder. *The American Journal of Psychiatry*, 152(11), 1635.

Goetz, M. C., Goetz, P. W., & Robinson, M. D. (2007). What's the use of being happy? Mood states, useful objects, and repetition priming effects. *Emotion*, 7(3), 675–679.
<https://doi.org/10.1037/1528-3542.7.3.675>

Goetz, P. W., Robinson, M. D., & Meier, B. P. (2008). Attentional training of the appetitive motivation system: Effects on sensation seeking preferences and reward-based behavior. *Motivation and Emotion*, 32(2), 120–126.

Goetz, T., Frenzel, A. C., Hall, N. C., Nett, U. E., Pekrun, R., & Lipnevich, A. A. (2014). Types of boredom: An experience sampling approach. *Motivation and Emotion*, 38(3), 401–419.
<https://doi.org/10.1007/s11031-013-9385-y>

Goodwin, G. M. (2012). Bipolar disorder. *Medicine*, 40(11), 596–598.
<https://doi.org/10.1016/j.mpmed.2012.08.011>

Approach Motivation, Attentional Bias to Positive Stimuli, and Hypomanic Personality.

Grafton, B., Ang, C., & MacLeod, C. (2012). Always look on the bright side of life: The attentional basis of positive affectivity. *European Journal of Personality, 26*(2), 133–144.

Gray, E. K., & Watson, D. (2007). Assessing positive and negative affect via self-report. *Handbook of Emotion Elicitation and Assessment, 171–183.*

Gray, J. A. (1987). Perspectives on anxiety and impulsivity: A commentary. *Journal of Research in Personality, 21*(4), 493–509.

Gray, J. A. (1990). Brain systems that mediate both emotion and cognition. *Cognition & Emotion, 4*(3), 269–288.

Gray, J. A. (2004). *Consciousness: Creeping up on the hard problem*. Oxford University Press, USA.

Gray, J. A., van Goozen, S. H. M., Van de Poll, N. E., & Sergeant, J. A. (1994). Framework for a taxonomy of psychiatric disorder. *Emotions: Essays on Emotion Theory, 29–59.*

Gregory, V. L. (2010a). Cognitive-Behavioral Therapy for Depression in Bipolar Disorder: A Meta-Analysis. *Journal of Evidence-Based Social Work, 7*(4), 269–279.

<https://doi.org/10.1080/15433710903176088>

Gregory, V. L. (2010b). Cognitive-Behavioral Therapy for Mania: A Meta-Analysis of Randomized Controlled Trials. *Social Work in Mental Health, 8*(6), 483–494.

<https://doi.org/10.1080/15332981003744388>

Gruber, J., Harvey, A. G., & Johnson, S. L. (2009). Reflective and ruminative processing of positive emotional memories in bipolar disorder and healthy controls. *Behaviour Research and Therapy, 47*(8), 697–704.

Hammen, C., Ellicott, A., & Gitlin, M. (1992). Stressors and sociotropy/autonomy: A longitudinal study of their relationship to the course of bipolar disorder. *Cognitive Therapy and Research, 16*(4), 409–418.

Approach Motivation, Attentional Bias to Positive Stimuli, and Hypomanic Personality.

Hammen, C., & Gitlin, M. (1997). Stress reactivity in bipolar patients and its relation to prior history of disorder. *The American Journal of Psychiatry*, *154*(6), 856.

Harmon-Jones, E., Abramson, L. Y., Nusslock, R., Sigelman, J. D., Urosevic, S., Turonie, L. D., ... Fearn, M. (2008). Effect of bipolar disorder on left frontal cortical responses to goals differing in valence and task difficulty. *Biological Psychiatry*, *63*(7), 693–698.

Harmon-Jones, E., Gable, P. A., & Peterson, C. K. (2010). The role of asymmetric frontal cortical activity in emotion-related phenomena: A review and update. *Biological Psychology*, *84*(3), 451–462.

Harmon-Jones, E., Harmon-Jones, C., Abramson, L., & Peterson, C. K. (2009a). PANAS positive activation is associated with anger. *Emotion*, *9*(2), 183.

Harmon-Jones, E., Harmon-Jones, C., Abramson, L., & Peterson, C. K. (2009b). PANAS positive activation is associated with anger. *Emotion*, *9*(2), 183–196.

<https://doi.org/10.1037/a0014959>

Harmon-Jones, E., Harmon-Jones, C., & Price, T. F. (2013). What is Approach Motivation? *Emotion Review*, *5*(3), 291–295. <https://doi.org/10.1177/1754073913477509>

Harvey, A. G. (2011a). Sleep and circadian functioning: critical mechanisms in the mood disorders? *Annual Review of Clinical Psychology*, *7*, 297–319.

Harvey, A. G. (2011b). Sleep and circadian functioning: critical mechanisms in the mood disorders? *Annual Review of Clinical Psychology*, *7*, 297–319.

Hays, J. C., Krishnan, K. R. R., George, L. K., & Blazer, D. G. (1998). Age of first onset of bipolar disorder: Demographic, family history, and psychosocial correlates. *Depression and Anxiety*, *7*(2), 76–82. [https://doi.org/10.1002/\(SICI\)1520-6394\(1998\)7:2<76::AID-DA5>3.0.CO;2-3](https://doi.org/10.1002/(SICI)1520-6394(1998)7:2<76::AID-DA5>3.0.CO;2-3)

Health, N. C. C. for M. (2006). Bipolar disorder: The management of bipolar disorder in adults, children and adolescents, in primary and secondary care. British Psychological Society.

Approach Motivation, Attentional Bias to Positive Stimuli, and Hypomanic Personality.

- Heck, R. H., Thomas, S. L., & Tabata, L. N. (2013). *Multilevel and longitudinal modeling with IBM SPSS*. Routledge.
- Heponiemi, T., Keltikangas-Järvinen, L., Puttonen, S., & Ravaja, N. (2003). BIS/BAS sensitivity and self-rated affects during experimentally induced stress. *Personality and Individual Differences, 34*(6), 943–957.
- Hofmann, S. G., Asnaani, A., Vonk, I. J. J., Sawyer, A. T., & Fang, A. (2012). The Efficacy of Cognitive Behavioral Therapy: A Review of Meta-analyses. *Cognitive Therapy and Research, 36*(5), 427–440. <https://doi.org/10.1007/s10608-012-9476-1>
- Holmes, E. A., Deepro, C., Fairburn, C. G., Wallace-Hadrill, S. M., Bonsall, M. B., Geddes, J. R., & Goodwin, G. M. (2011). Mood stability versus mood instability in bipolar disorder: a possible role for emotional mental imagery. *Behaviour Research and Therapy, 49*(10), 707–713.
- Insel, T., Cuthbert, B., Garvey, M., Heinssen, R., Pine, D. S., Quinn, K., ... Wang, P. (2010). *Research domain criteria (RDoC): toward a new classification framework for research on mental disorders*. Am Psychiatric Assoc.
- Johnson, S. L. (2005). Mania and dysregulation in goal pursuit: A review. *Clinical Psychology Review, 25*(2), 241–262.
- Johnson, S. L., Carver, C. S., Mulé, S., & Joormann, J. (2013). Impulsivity and risk for mania: Towards greater specificity. *Psychology and Psychotherapy: Theory, Research and Practice, 86*(4), 401–412.
- Johnson, S. L., Cueller, A. K., Ruggero, C., Winett-Perlman, C., Goodnick, P., White, R., & Miller, I. (2008). Life events as predictors of mania and depression in bipolar I disorder. *Journal of Abnormal Psychology, 117*(2), 268–277. <https://doi.org/10.1037/0021-843X.117.2.268>

Approach Motivation, Attentional Bias to Positive Stimuli, and Hypomanic Personality.

Johnson, S. L., Edge, M. D., Holmes, M. K., & Carver, C. S. (2012). The behavioral activation system and mania. *Annual Review of Clinical Psychology, 8*, 243–267.

Johnson, S. L., Gershon, A., & Starov, V. (2015). Is energy a stronger indicator of mood for those with bipolar disorder compared to those without bipolar disorder? *Psychiatry Research, 230*(1), 1–4. <https://doi.org/10.1016/j.psychres.2015.06.016>

Johnson, S. L., Ruggero, C. J., & Carver, C. S. (2005). Cognitive, behavioral, and affective responses to reward: Links with hypomanic symptoms. *Journal of Social and Clinical Psychology, 24*(6), 894–906.

Johnson, S. L., Sandrow, D., Meyer, B., Winters, R., Miller, I., Solomon, D., & Keitner, G. (2000). Increases in Manic Symptoms After Life Events Involving Goal Attainment. *Journal of Abnormal Psychology, 109*(4), 721–727.

Jones, S. H. (2001). Circadian rhythms, multilevel models of emotion and bipolar disorder—an initial step towards integration? *Clinical Psychology Review, 21*(8), 1193–1209.

Judd, L. L., Akiskal, H. S., Schettler, P. J., Endicott, J., Maser, J., Solomon, D. A., ... Keller, M. B. (2002). The long-term natural history of the weekly symptomatic status of bipolar I disorder. *Archives of General Psychiatry, 59*(6), 530–537.

Kahn, J. H., Tobin, R. M., Massey, A. E., & Anderson, J. A. (2007). Measuring emotional expression with the Linguistic Inquiry and Word Count. *Am J Psychol, 120*(2), 263–86.

Karnegis, J., Kubicek, W., Mattson, R., Patterson, R., & Witsoe, D. (1966). Development and evaluation of an impedance cardiac output system.

Kass, R. E., & Raftery, A. E. (1995). Bayes factors. *Journal of the American Statistical Association, 90*(430), 773–795.

Kempton, M. J., Geddes, J. R., Ettinger, U., Williams, S. C. R., & Grasby, P. M. (2008). Meta-analysis, Database, and Meta-regression of 98 Structural Imaging Studies in Bipolar

Approach Motivation, Attentional Bias to Positive Stimuli, and Hypomanic Personality.

Disorder. *Archives of General Psychiatry*, 65(9), 1017.

<https://doi.org/10.1001/archpsyc.65.9.1017>

Kerner, B. (2014). Genetics of bipolar disorder. *The Application of Clinical Genetics*, 33.

<https://doi.org/10.2147/TACG.S39297>

Kessing, L. V., Hansen, H. V., Hvenegaard, A., Christensen, E. M., Dam, H., Gluud, C., ...

Group, E. I. A. D. T. (2013). Treatment in a specialised out-patient mood disorder clinic v. standard out-patient treatment in the early course of bipolar disorder: randomised clinical trial. *The British Journal of Psychiatry*, 202(3), 212–219.

Kessler, R. C., Rubinow, D. R., Holmes, C., Abelson, J., & Zhao, S. (1997). The epidemiology of DSM-III-R bipolar I disorder in a general population survey. *Psychological Medicine*, 27(05), 1079–1089.

Ketter, T. A. (2010). Diagnostic features, prevalence, and impact of bipolar disorder. *J Clin Psychiatry*, 71(6), e14.

Kreibig, S. D. (2010). Autonomic nervous system activity in emotion: A review. *Biological Psychology*, 84(3), 394–421.

Kuyken, W., Byford, S., Taylor, R. S., Watkins, E., Holden, E., White, K., ... Teasdale, J. D.

(2008). Mindfulness-based cognitive therapy to prevent relapse in recurrent depression. *Journal of Consulting and Clinical Psychology*, 76(6), 966–978.

<https://doi.org/10.1037/a0013786>

Kwapil, T. R., Barrantes-Vidal, N., Armistead, M. S., Hope, G. A., Brown, L. H., Silvia, P. J., &

Myin-Germeys, I. (2011). The expression of bipolar spectrum psychopathology in daily life. *Journal of Affective Disorders*, 130(1–2), 166–170.

<https://doi.org/10.1016/j.jad.2010.10.025>

Lang, P. J., Bradley, M. M., & Cuthbert, B. N. (2008). International affective picture system

(IAPS): Affective ratings of pictures and instruction manual. *Technical Report A-8*.

Approach Motivation, Attentional Bias to Positive Stimuli, and Hypomanic Personality.

Lee, C.-T., Zhang, G., & Edwards, M. C. (2012). Ordinary Least Squares Estimation of Parameters in Exploratory Factor Analysis With Ordinal Data. *Multivariate Behavioral Research*, *47*(2), 314–339. <https://doi.org/10.1080/00273171.2012.658340>

Lee, J. A., & Verleysen, M. (Eds.). (2007). *Nonlinear Dimensionality Reduction*. New York, NY: Springer New York. <https://doi.org/10.1007/978-0-387-39351-3>

Leppänen, J. M. (2006). Emotional information processing in mood disorders: a review of behavioral and neuroimaging findings. *Current Opinion in Psychiatry*, *19*(1), 34–39.

Leverich, G. S., McElroy, S. L., Suppes, T., Keck, P. E., Denicoff, K. D., Nolen, W. A., ... Post, R. M. (2002). Early physical and sexual abuse associated with an adverse course of bipolar illness. *Biological Psychiatry*, *51*(4), 288–297.

Loehlin, J. C. (1998). *Latent variable models: An introduction to factor, path, and structural analysis*. Lawrence Erlbaum Associates Publishers.

Looking for bipolar spectrum psychopathology: identification and expression in daily life - 061 Walsh CompPsy 2012.pdf. (n.d.). Retrieved from http://labs.psychology.illinois.edu/kwapil_lab/061%20Walsh%20CompPsy%202012.pdf

Lowenstein, J. A. S., Wright, K., Taylor, A., & Moberly, N. J. (2015b). An investigation into the effects of different types of exercise on the maintenance of approach motivation levels. *Mental Health and Physical Activity*, *9*, 24–34.

Lowenstein, J. A. S., Wright, K., Taylor, A., & Moberly, N. J. (2015a). An investigation into the effects of different types of exercise on the maintenance of approach motivation levels. *Mental Health and Physical Activity*, *9*, 24–34.

<https://doi.org/10.1016/j.mhpa.2015.08.002>

Lowenstein, J. A. S., Wright, K., Taylor, A., & Moberly, N. J. (2015c). *Mental Health and Physical Activity*.

Approach Motivation, Attentional Bias to Positive Stimuli, and Hypomanic Personality.

Lyon, H. M., Startup, M., & Bentall, R. P. (1999). Social cognition and the manic defense:

Attributions, selective attention, and self-schema in bipolar affective disorder. *Journal of Abnormal Psychology, 108*(2), 273.

Maas, C. J., & Hox, J. J. (2005). Sufficient sample sizes for multilevel modeling. *Methodology, 1*(3), 86–92.

MacLeod, C., & Mathews, A. (1988). Anxiety and the allocation of attention to threat. *The Quarterly Journal of Experimental Psychology, 40*(4), 653–670.

Maletic, V., & Raison, C. (2014). Integrated Neurobiology of Bipolar Disorder. *Frontiers in Psychiatry, 5*. <https://doi.org/10.3389/fpsyt.2014.00098>

Malhi, G. S., Chengappa, K. N. R., Gershon, S., & Goldberg, J. F. (2010). Hypomania: hype or mania? *Bipolar Disorders, 12*(8), 758–763. <https://doi.org/10.1111/j.1399-5618.2010.00872.x>

Mansell, W., & Lam, D. (2003). Conceptualizing a cycle of ascent into mania: a case report. *Behavioural and Cognitive Psychotherapy, 31*(03), 363–367.

Mansell, W., Morrison, A. P., Reid, G., Lowens, I., & Tai, S. (2007). The interpretation of, and responses to, changes in internal states: an integrative cognitive model of mood swings and bipolar disorders. *Behavioural and Cognitive Psychotherapy, 35*(05), 515–539.

Mason, L., O'Sullivan, N., Blackburn, M., Bentall, R., & El-Deredy, W. (2012). I Want It Now! Neural Correlates of Hypersensitivity to Immediate Reward in Hypomania. *Biological Psychiatry, 71*(6), 530–537. <https://doi.org/10.1016/j.biopsych.2011.10.008>

Matthews, G., & Gilliland, K. (1999). The personality theories of HJ Eysenck and JA Gray: A comparative review. *Personality and Individual Differences, 26*(4), 583–626.

Mauer, N., & Borkenau, P. (2007). Temperament and early information processing:

Temperament-related attentional bias in emotional Stroop tasks. *Personality and Individual Differences, 43*(5), 1063–1073.

Approach Motivation, Attentional Bias to Positive Stimuli, and Hypomanic Personality.

Mauss, I. B., Tamir, M., Anderson, C. L., & Savino, N. S. (2011). Can seeking happiness make people unhappy? Paradoxical effects of valuing happiness. *Emotion, 11*(4), 807.

M'Bailara, K., Demotes-Mainard, J., Swendsen, J., Mathieu, F., Leboyer, M., & Henry, C. (2009). Emotional hyper-reactivity in normothymic bipolar patients. *Bipolar Disorders, 11*(1), 63–69. <https://doi.org/10.1111/j.1399-5618.2008.00656.x>

McGuffin, P., Rijdsdijk, F., Andrew, M., Sham, P., Katz, R., & Cardno, A. (2003). The heritability of bipolar affective disorder and the genetic relationship to unipolar depression. *Archives of General Psychiatry, 60*(5), 497–502.

McNaughton, N., & Corr, P. J. (2014). Approach, avoidance, and their conflict: the problem of anchoring.

Meyer, T. D., Barton, S., Baur, M., & Jordan, G. (2010). Vulnerability factors for bipolar disorders as predictors of attributions in ability-based and chance-based tests. *Journal of Individual Differences.*

Meyer, T. D., & Hautzinger, M. (2003). Screening for bipolar disorders using the Hypomanic Personality Scale. *Journal of Affective Disorders, 75*(2), 149–154.

Meyer, T. D., & Hofmann, B. U. (2005). Assessing the dysregulation of the behavioral activation system: The hypomanic personality scale and the BIS–BAS scales. *Journal of Personality Assessment, 85*(3), 318–324.

Michael, N., Erfurth, A., Ohrmann, P., Gössling, M., Arolt, V., Heindel, W., & Pfeleiderer, B. (2003). Acute mania is accompanied by elevated glutamate/glutamine levels within the left dorsolateral prefrontal cortex. *Psychopharmacology, 168*(3), 344–346.

Miklowitz, D. J., & Chang, K. D. (2008). Prevention of bipolar disorder in at-risk children: theoretical assumptions and empirical foundations. *Development and Psychopathology, 20*(03), 881–897.

Approach Motivation, Attentional Bias to Positive Stimuli, and Hypomanic Personality.

Miklowitz, D. J., Goldstein, M. J., Nuechterlein, K. H., Snyder, K. S., & Mintz, J. (1988). Family factors and the course of bipolar affective disorder. *Archives of General Psychiatry*, *45*(3), 225–231.

Mindfulness-based cognitive therapy. (2016, November 21). In *Wikipedia*. Retrieved from https://en.wikipedia.org/w/index.php?title=Mindfulness-based_cognitive_therapy&oldid=750684369

Mogoşe, C., David, D., & Koster, E. H. W. (2014). Clinical Efficacy of Attentional Bias Modification Procedures: An Updated Meta-Analysis: Clinical Efficacy of Attention Retraining. *Journal of Clinical Psychology*, *70*(12), 1133–1157.
<https://doi.org/10.1002/jclp.22081>

Morrison, A. P., Peyton, J., & Nothard, S. (2003). Beliefs about depression and anti-depressive behaviour: Relationship to depressed mood and predisposition to mania in non-patients. *Personality and Individual Differences*, *35*(7), 1601–1613.

Morrone, J. V., Depue, R. A., Scherer, A. J., & White, T. L. (2000). Film-induced incentive motivation and positive activation in relation to agentic and affiliative components of extraversion. *Personality and Individual Differences*, *29*(2), 199–216.

Morrone-Strupinsky, J. V., & Depue, R. A. (2004). Differential relation of two distinct, film-induced positive emotional states to affiliative and agentic extraversion. *Personality and Individual Differences*, *36*(5), 1109–1126.

Müller, D. J., & Kennedy, J. L. (2005). Recent advances in genetics of bipolar disorder. *Bipolar Disorder: The Upswing in Research and Treatment*. London: Taylor and Francis, 77–92.

Muris, P., & Field, A. (2013). Information processing biases. *The Wiley-Blackwell Handbook of the Treatment of Childhood and Adolescent Anxiety*, 141–156.

Murphy, F. C., Sahakian, B. J., Rubinsztein, J. S., Michael, A., Rogers, R. D., Robbins, T. W., & Paykel, E. S. (1999). Emotional bias and inhibitory control processes in mania and

Approach Motivation, Attentional Bias to Positive Stimuli, and Hypomanic Personality.

depression. *Psychological Medicine*, 29(6), 1307–1321.

<https://doi.org/10.1017/S0033291799001233>

Murray, C. J., & Lopez, A. D. (1996). Evidence-based health policy--lessons from the Global Burden of Disease Study. *Science*, 274(5288), 740.

Neale, J. M. (1988). Defensive functions of manic episodes.

Nummenmaa, L., & Niemi, P. (2004). *Inducing affective states with success-failure manipulations: a meta-analysis*. American Psychological Association.

Nunally, J. C., & Bernstein, I. H. (1978). *Psychometric theory*. New York: McGraw-Hill.

Nusslock, R., Almeida, J. R., Forbes, E. E., Versace, A., Frank, E., LaBarbara, E. J., ... Phillips, M. L. (2012). Waiting to win: elevated striatal and orbitofrontal cortical activity during reward anticipation in euthymic bipolar disorder adults. *Bipolar Disorders*, 14(3), 249–260.

Organization, W. H. (1993). The ICD-10 classification of mental and behavioural disorders: diagnostic criteria for research.

Overview of Beck's Cognitive Theory of Depression. (n.d.). Retrieved 12 February 2017, from <http://www.personalityresearch.org/papers/allen.html>

Pavlova, B., Uher, R., Dennington, L., Wright, K., & Donaldson, C. (2011). Reactivity of affect and self-esteem during remission in bipolar affective disorder: An experimental investigation. *Journal of Affective Disorders*, 134(1), 102–111.

Peckham, A. D., Johnson, S. L., & Gotlib, I. H. (2016). Attentional bias in euthymic bipolar I disorder. *Cognition and Emotion*, 30(3), 472–487.

<https://doi.org/10.1080/02699931.2015.1014313>

Perugi, G., Fornaro, M., & Akiskal, H. S. (2011). Are atypical depression, borderline personality disorder and bipolar II disorder overlapping manifestations of a common cyclothymic diathesis? *World Psychiatry*, 10(1), 45–51.

Approach Motivation, Attentional Bias to Positive Stimuli, and Hypomanic Personality.

Piccinelli, M., & Wilkinson, G. (2000). Gender differences in depression. *The British Journal of Psychiatry*, *177*(6), 486–492.

Pickering, A. D., & Gray, J. A. (1999). The neuroscience of personality. *Handbook of Personality: Theory and Research*, *2*, 277–299.

Post, R. M., Altshuler, L. L., Kupka, R., McElroy, S. L., Frye, M. A., Rowe, M., ... Nolen, W. A. (2015). Verbal abuse, like physical and sexual abuse, in childhood is associated with an earlier onset and more difficult course of bipolar disorder. *Bipolar Disorders*, *17*(3), 323–330. <https://doi.org/10.1111/bdi.12268>

Power, M. J. (2005). Psychological approaches to bipolar disorders: A theoretical critique. *Clinical Psychology Review*, *25*(8), 1101–1122.

Priebe, S., & Wildgrube, C. (1989). Lithium prophylaxis and expressed emotion. *The British Journal of Psychiatry*, *154*(3), 396–399.

Pronin, E., & Jacobs, E. (2008). Thought speed, mood, and the experience of mental motion. *Perspectives on Psychological Science*, *3*(6), 461–485.

Pronin, E., Jacobs, E., & Wegner, D. M. (2008). Psychological effects of thought acceleration. *Emotion*, *8*(5), 597–612. <https://doi.org/10.1037/a0013268>

Rae, M., Tompson, M., Miklowitz, D., Goldstein, M., Hwang, S., & Mintz, J. (2003). Family focused treatment vs individual treatment for bipolar disorder: results of a randomised clinical trial. *J Consult Clin Psychol*, *71*, 482–492.

Ratcliff, R., & McKoon, G. (1996). Bias effects in implicit memory tasks. *Journal of Experimental Psychology: General*, *125*(4), 403.

Reynolds, B., Penfold, R. B., & Patak, M. (2008b). Dimensions of impulsive behavior in adolescents: laboratory behavioral assessments. *Experimental and Clinical Psychopharmacology*, *16*(2), 124.

Approach Motivation, Attentional Bias to Positive Stimuli, and Hypomanic Personality.

Reynolds, B., Penfold, R. B., & Patak, M. (2008a). Dimensions of impulsive behavior in adolescents: laboratory behavioral assessments. *Experimental and Clinical Psychopharmacology*, *16*(2), 124.

Reynolds, B., Penfold, R. B., & Patak, M. (2008c). Dimensions of impulsive behavior in adolescents: laboratory behavioral assessments. *Experimental and Clinical Psychopharmacology*, *16*(2), 124.

Richards, A., French, C. C., Johnson, W., Naparstek, J., & Williams, J. (1992). Effects of mood manipulation and anxiety on performance of an emotional Stroop task. *British Journal of Psychology*, *83*(4), 479–491.

Rihmer, Z. (2005). Prediction and prevention of suicide in bipolar disorders. *Clin Neuropsychiatry*, *2*(1), 48–54.

Robinson, M. D., & Barrett, L. F. (2010). Belief and Feeling in Self-reports of Emotion: Evidence for Semantic Infusion Based on Self-esteem. *Self and Identity*, *9*(1), 87–111. <https://doi.org/10.1080/15298860902728274>

Rock, P. L., Goodwin, G. M., & Harmer, C. J. (2010). The common adolescent bipolar phenotype shows positive biases in emotional processing: Emotional processing in bipolar phenotype. *Bipolar Disorders*, *12*(6), 606–615. <https://doi.org/10.1111/j.1399-5618.2010.00859.x>

Rosenfarb, I. S., Miklowitz, D. J., Goldstein, M. J., Harmon, L., Nuechterlein, K. H., & Rea, M. M. (2001). Family transactions and relapse in bipolar disorder. *Family Process*, *40*(1), 5–14.

Roybal, K., Theobald, D., Graham, A., DiNieri, J. A., Russo, S. J., Krishnan, V., ... Birnbaum, S. (2007). Mania-like behavior induced by disruption of CLOCK. *Proceedings of the National Academy of Sciences*, *104*(15), 6406–6411.

Approach Motivation, Attentional Bias to Positive Stimuli, and Hypomanic Personality.

Rush, J., & Hofer, S. M. (2014). Differences in within- and between-person factor structure of positive and negative affect: Analysis of two intensive measurement studies using multilevel structural equation modeling. *Psychological Assessment, 26*(2), 462–473.

<https://doi.org/10.1037/a0035666>

Russell, J. A. (2003). Core affect and the psychological construction of emotion. *Psychological Review, 110*(1), 145–172. <https://doi.org/10.1037/0033-295X.110.1.145>

Salemink, E., van den Hout, M., & Kindt, M. (2009). Effects of positive interpretive bias modification in highly anxious individuals. *Journal of Anxiety Disorders, 23*(5), 676–683.

Salvadore, G., Quiroz, J. A., Machado-Vieira, R., Henter, I. D., Manji, H. K., & Zarate, C. A. (2010). The Neurobiology of the Switch Process in Bipolar Disorder: A Review. *The Journal of Clinical Psychiatry, 71*(11), 1488–1501.

<https://doi.org/10.4088/JCP.09r05259gre>

Sanchez, A., & Vazquez, C. (2014). Looking at the eyes of happiness: Positive emotions mediate the influence of life satisfaction on attention to happy faces. *The Journal of Positive Psychology, 9*(5), 435–448.

Schalet, B. D., Durbin, C. E., & Revelle, W. (2011). Multidimensional structure of the Hypomanic Personality Scale. *Psychological Assessment, 23*(2), 504.

Schultz, W. (2015). Neuronal reward and decision signals: from theories to data. *Physiological Reviews, 95*(3), 853–951.

Seegerstrom, S. C. (2001). Optimism and attentional bias for negative and positive stimuli. *Personality and Social Psychology Bulletin, 27*(10), 1334–1343.

seguardo 2003 - Google Scholar. (n.d.). Retrieved 11 February 2017, from

https://scholar.google.co.uk/scholar?hl=en&q=seguardo+2003&btnG=&as_sdt=1%2C5&as_sdtp=

Approach Motivation, Attentional Bias to Positive Stimuli, and Hypomanic Personality.

Segurado, R., Detera-Wadleigh, S. D., Levinson, D. F., Lewis, C. M., Gill, M., Nurnberger Jr., J.

I., ... Akarsu, N. (2003). Genome Scan Meta-Analysis of Schizophrenia and Bipolar Disorder, Part III: Bipolar Disorder. *The American Journal of Human Genetics*, 73(1), 49–62. <https://doi.org/10.1086/376547>

Sidor, M. M., & MacQueen, G. M. (2012). An update on antidepressant use in bipolar depression.

Current Psychiatry Reports, 14(6), 696–704.

Sitzmann, T., & Ely, K. (2011). *A meta-analysis of self-regulated learning in work-related*

training and educational attainment: What we know and where we need to go. American Psychological Association.

Smillie, L. D., Jackson, C. J., & Dalgleish, L. I. (2006). Conceptual distinctions among Carver and White's (1994) BAS scales: A reward-reactivity versus trait impulsivity perspective.

Personality and Individual Differences, 40(5), 1039–1050.

Soreca, I. (2014). Circadian rhythms and sleep in bipolar disorder: implications for pathophysiology and treatment. *Curr Opin Psychiatry*, 27(6), 467–71.

<https://doi.org/10.1097/ycp.0000000000000108>

Spielberger, C. D., Gorsuch, R. L., & Lushene, R. E. (1970). Manual for the state-trait anxiety inventory.

Stern, G. S., & Berrenberg, J. L. (1977). Biofeedback training in frontalis muscle relaxation and enhancement of belief in personal control. *Biofeedback and Self-Regulation*, 2(2), 173–

182.

Strakowski, S. M., Adler, C. M., Almeida, J., Altshuler, L. L., Blumberg, H. P., Chang, K. D., ...

Townsend, J. D. (2012). The functional neuroanatomy of bipolar disorder: a consensus model: Functional neuroanatomy of bipolar disorder. *Bipolar Disorders*, 14(4), 313–325.

<https://doi.org/10.1111/j.1399-5618.2012.01022.x>

Approach Motivation, Attentional Bias to Positive Stimuli, and Hypomanic Personality.

Strakowski, S. M., Keck, P. E., McElroy, S. L., West, S. A., Sax, K. W., Hawkins, J. M., ...

Bourne, M. L. (1998). Twelve-month outcome after a first hospitalization for affective psychosis. *Archives of General Psychiatry*, 55(1), 49–55.

Tamir, M., & Robinson, M. D. (2007). The happy spotlight: Positive mood and selective attention to rewarding information. *Personality and Social Psychology Bulletin*, 33(8), 1124–1136.

Terraciano, A., McCrae, R. R., & Costa Jr, P. T. (2003). Factorial and construct validity of the Italian Positive and Negative Affect Schedule (PANAS). *European Journal of Psychological Assessment*, 19(2), 131.

Terrien, S., Stefaniak, N., Blondel, M., Mouras, H., Morvan, Y., & Besche-Richard, C. (2014). Theory of mind and hypomanic traits in general population. *Psychiatry Research*, 215(3), 694–699.

Terrien, S., Stefaniak, N., Morvan, Y., & Besche-Richard, C. (10). Factor structure of the French version of the Hypomanic Personality Scale (HPS) in non-clinical young adults. *Comprehensive Psychiatry*, 62, 105–113.

<https://doi.org/10.1016/j.comppsy.2015.07.001>

The Risk of Switch to Mania in Patients With Bipolar Disorder During Treatment With an Antidepressant Alone and in Combination With a Mood Stabilizer | American Journal of Psychiatry. (n.d.). Retrieved 7 March 2017, from <http://ajp.psychiatryonline.org/doi/abs/10.1176/appi.ajp.2014.13111501>

Tilton, S. (2008). Review of the state-trait anxiety inventory (STAI). *News Notes*, 48(2), 1–3.

Trevisani, D. P., Johnson, S. L., & Carver, C. S. (2008). Positive Mood Induction and Facial Affect Recognition among Students at Risk for Mania. *Cognitive Therapy and Research*, 32(5), 639–650. <https://doi.org/10.1007/s10608-007-9140-3>

Approach Motivation, Attentional Bias to Positive Stimuli, and Hypomanic Personality.

Tuccitto, D. E., Giacobbi, P. R., & Leite, W. L. (2010a). The Internal Structure of Positive and

Negative Affect: A Confirmatory Factor Analysis of the PANAS. *Educational and*

Psychological Measurement, 70(1), 125–141. <https://doi.org/10.1177/0013164409344522>

Tuccitto, D. E., Giacobbi, P. R., & Leite, W. L. (2010b). The Internal Structure of Positive and

Negative Affect: A Confirmatory Factor Analysis of the PANAS. *Educational and*

Psychological Measurement, 70(1), 125–141. <https://doi.org/10.1177/0013164409344522>

Tyrer, P. (2014). A comparison of DSM and ICD classifications of mental disorder. *Advances in*

Psychiatric Treatment, 20(4), 280–285.

Urošević, S., Abramson, L. Y., Harmon-Jones, E., & Alloy, L. B. (2008). Dysregulation of the

behavioral approach system (BAS) in bipolar spectrum disorders: Review of theory and evidence. *Clinical Psychology Review*, 28(7), 1188–1205.

<https://doi.org/10.1016/j.cpr.2008.04.004>

Varese, F., Smeets, F., Drukker, M., Lieverse, R., Lataster, T., Viechtbauer, W., ... Bentall, R. P.

(2012). Childhood Adversities Increase the Risk of Psychosis: A Meta-analysis of Patient-

Control, Prospective- and Cross-sectional Cohort Studies. *Schizophrenia Bulletin*, 38(4),

661–671. <https://doi.org/10.1093/schbul/sbs050>

Vieta, E., & Valentí, M. (5). Mixed states in DSM-5: Implications for clinical care, education, and

research. *Journal of Affective Disorders*, 148(1), 28–36.

<https://doi.org/10.1016/j.jad.2013.03.007>

Voigt, D. C., Dillard, J. P., Braddock, K. H., Anderson, J. W., Sopory, P., & Stephenson, M. T.

(2009). BIS/BAS scales and their relationship to risky health behaviours. *Personality and*

Individual Differences, 47(2), 89–93.

Watson, D. (2000). *Mood and temperament*. Guilford Press.

Watson, D., & Clark, L. A. (1999). The PANAS-X: Manual for the positive and negative affect schedule-expanded form.

Approach Motivation, Attentional Bias to Positive Stimuli, and Hypomanic Personality.

Watson, D., Clark, L. A., & Tellegen, A. (1988). Development and validation of brief measures of positive and negative affect: the PANAS scales. *Journal of Personality and Social Psychology*, *54*(6), 1063–1070.

Watson, D., & Tellegen, A. (1985). Toward a consensual structure of mood. *Psychological Bulletin*, *98*(2), 219.

Wehr, T. A., Sack, D. A., & Rosenthal, N. E. (1987). Sleep reduction as a final common pathway in the genesis of mania. *The American Journal of Psychiatry*.

Weinstock, L. M., Gaudiano, B. A., Epstein-Lubow, G., Tezanos, K., Celis-deHoyos, C. E., & Miller, I. W. (2014). Medication burden in bipolar disorder: a chart review of patients at psychiatric hospital admission. *Psychiatry Research*, *216*(1), 24–30.

Weissman, M. M. (1996). Cross-National Epidemiology of Major Depression and Bipolar Disorder. *JAMA: The Journal of the American Medical Association*, *276*(4), 293.
<https://doi.org/10.1001/jama.1996.03540040037030>

Westermann, R., STAHL, G., & Hesse, F. (1996). Relative effectiveness and validity of mood induction procedures: analysis. *European Journal of Social Psychology*, *26*, 557–580.

Wilens, T. E., Biederman, J., Millstein, R. B., Wozniak, J., Haheesy, A. L., & Spencer, T. J. (1999). Risk for Substance Use Disorders in Youths With Child- and Adolescent-Onset Bipolar Disorder. *Journal of the American Academy of Child & Adolescent Psychiatry*, *38*(6), 680–685. <https://doi.org/10.1097/00004583-199906000-00014>

Wright, K. A., Lam, D., & Brown, R. G. (2008). Dysregulation of the behavioral activation system in remitted bipolar I disorder. *Journal of Abnormal Psychology*, *117*(4), 838–848.
<https://doi.org/10.1037/a0013598>

Yager, L. M., Garcia, A. F., Wunsch, A. M., & Ferguson, S. M. (2015). The ins and outs of the striatum: role in drug addiction. *Neuroscience*, *301*, 529–541.

Approach Motivation, Attentional Bias to Positive Stimuli, and Hypomanic Personality.

Yatham, L. N., Kennedy, S. H., Parikh, S. V., Schaffer, A., Beaulieu, S., Alda, M., ... Sharma, V.

(2013). Canadian Network for Mood and Anxiety Treatments (CANMAT) and International Society for Bipolar Disorders (ISBD) collaborative update of CANMAT guidelines for the management of patients with bipolar disorder: update 2013. *Bipolar Disorders*, 15(1), 1–44.

Zahra, D., & Hedge, C. (2010). The reliable change index: Why isn't it more popular in academic psychology. *Psychology Postgraduate Affairs Group Quarterly*, 76(76), 14–19.

Zubin, J., & Spring, B. (1977). Vulnerability: A new view of schizophrenia. *Journal of Abnormal Psychology*, 86(2), 103.

10 Appendix I

Approach Motivation Scales

<i>Positive Activation</i>									
depressed	dull	pleasant	cheerful	delighted	enthused	thrilled	exuberant	elated	ecstatic
sluggish	tired	fresh	lively	energetic	peppy	strong	vigorous	exhilarated	invincible
0	1	2	3	4	5	6	7	8	9

Fig. 1.

The 10-point rating scale of positive activation used to rate film clips, which anchors each point to empirically-derived adjectives that represent both positive emotional feelings (top row of adjectives) and positive incentive motivational feelings (bottom row).

10.1 Figure 22 Positive Activation Rating Scale (Morrone et al. 2000)

Approach Motivation, Attentional Bias to Positive Stimuli, and Hypomanic Personality.

Directions

This scale consists of a number of words that describe different feelings and emotions. Read each item and then circle the appropriate answer next to that word. Indicate to what extent you feel this way right now, that is, at the present moment.

Use the following scale to record your answers.

- (1) = very slightly or not at all
- (2) = A little
- (3) = Moderately
- (4) = Quite a bit
- (5) = Extremely

	Very slightly or not at all	A little	Moderately	Quite a bit	Extremely
Interested	1	2	3	4	5
Excited	1	2	3	4	5
Strong	1	2	3	4	5
Enthusiastic	1	2	3	4	5
Proud	1	2	3	4	5
Alert	1	2	3	4	5
Inspired	1	2	3	4	5
Determined	1	2	3	4	5
Attentive	1	2	3	4	5
Active	1	2	3	4	5

10.2 Figure 23 PANAS-PA (Watson et al. 1988)

Behavioural Engagement Measure

Instructions:

From each of the five groups of statements, please select one statement that best describes how you feel right now.

A

1. Exuberant vitality, surging with energy
2. Vigorous, extremely energetic
3. Active, lively, animated
4. Fresh, slightly energetic
5. Fairly fresh, adequate energy
6. Slightly tired, somewhat lacking in energy
7. Rather tired, lethargic, not much energy
8. Very fatigued, sluggish
9. Tremendously weary, hard to keep going
10. Utterly exhausted, entirely worn out, practically at a standstill

B

1. Everything is possible for me
2. Extremely optimistic
3. Very confident about things
4. Feel self-assured, things seem good
5. Feel adequate about myself and prospects
6. Slightly discouraged about things
7. Little confidence in things, about my abilities
8. Feel inadequate, nothing seems to be going right
9. Extremely pessimistic about everything
10. Everything seems bleak and futile, feel totally inept

E

1. Passionately absorbed in the world's excitement
2. Excited, stimulated, great zest for life
3. Enthusiastic about life
4. Motivated and interested in things
5. Somewhat interested in things
6. Not very enthusiastic about things
7. Generally unenthusiastic about life
8. Apathetic, unmotivated
9. No real interest or desire for anything
10. Nothing is interesting – not even family or friends

C

1. Elated, euphoric, ecstatic
2. Tremendous delight and happiness
3. Cheerful, in high spirits
4. Pretty good
5. O.K.
6. A little bit low
7. In low spirits, somewhat sad and blue
8. Clearly depressed
9. Very depressed, feels painful
10. Utter depression and gloom

D

1. Thoughts are literally racing through my head
2. I have rapid, penetrating ideas
3. Thoughts come quickly and effortlessly
4. Thoughts are fairly quick and clear
5. My mind is alert
6. Not particularly alert
7. Thoughts are slow, takes longer to pick up on things
8. Thought are sluggish
9. My mind feels dull and monotonous
10. My mind is stagnant, dead, nothing moves

10.3 Figure 24 BES (Krauss et al. 1988)

Approach Motivation, Attentional Bias to Positive Stimuli, and Hypomanic Personality.

There are times when we feel motivated, driven and ready to strive to get what we want. Sometimes we feel this way when we are in the middle of working towards a goal that is important to us, but we might also feel this way when we are not actively working towards anything.

Please use the scale below to indicate how much you feel this way right now. Remember that we are not asking you to tell us whether you are actually working towards a goal right now. Instead we would like you to indicate how much you feel an internal sense of motivation, drive, and readiness to strive.

At one extreme end of the scale you do not feel motivated, driven, striving. At the other end of the scale you feel completely motivated, driven, striving. Circle a number which corresponds to the picture which best describes how you feel now. Note that some numbers fall between the two pictures.

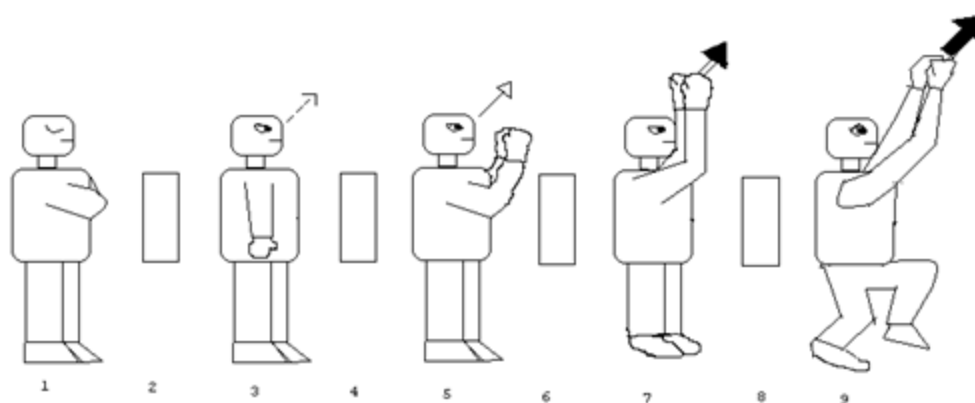

10.4 Figure 25 AMSAM (Wright unpublished)

11 Appendix II

Information sheet

Participant Information Sheet

Validating Measures of Approach Motivation

Researcher: Michael Begley

Supervisor: Dr Kim Wright

Details of our study

We would like to invite you to take part in an experiment examining responses to reward-related tasks.

What is involved?

You will be asked to complete a series of computer-related tasks, a series of short questionnaires, whilst continuous measurements of heart rate and eye movement will be taken. In all, the experiment should take about an hour.

Are there any benefits to taking part?

There are no direct benefits to taking part, but you should find the process interesting and the findings may help us to understand why some people behave differently to others in response to rewarding. You will also receive 1 course credit for your time.

Are there any risks

We do not anticipate any risks from taking part in this study. However, some may be uncomfortable with electrodes being attached to their body. If you start completing the tasks but decide that you do not want to take part after all, you can withdraw at any point.

Will my taking part in the study be kept confidential?

All information collected during the course of the research will be kept strictly confidential.

What will happen to the results of the research study?

We will analyse and report our findings as part of a PhD. It is also possible that the data will be reported in scientific journal publications. However, the names of the participants will not be included in any report.

Further information

If you require any further information please contact Dr Kim Wright (K.A.Wright@exeter.ac.uk).

|

11.1 Figure 26 Study 1 Information Sheet

INFORMATION SHEET AND CONSENT FORM

Mood and physiological responses

PURPOSE OF STUDY

The purpose of this study is to explore how our mood and certain aspects of our physiological (bodily) responses relate to one another.

PROCEDURES

Participation in the study will involve attending for a testing session, which will last around 45 minutes.

During the testing session you will be asked to do several different things;

- You will complete several very short questionnaires, which ask about how you currently feel. You will do this several times
- You will complete a longer questionnaire about how you usually think, feel and behave in certain situations.
- You will be asked to complete number of computer-based tasks.
- We will also measure your heart activity and aspects of your eye responses. Measuring heart activity will require you to wear electrodes taped to your neck and torso area. Eye response measurement is done by a computer-mounted eye tracking device.

REMUNERATION

Participation will be remunerated by a small payment of 5 pounds. First year undergraduate psychology students may opt to take course credit in lieu of payment.

POTENTIAL RISKS AND ETHICAL CONSIDERATION

Although the questionnaires in the study do not ask about highly personal topics, it is possible that you may experience discomfort when answering some of these. You do not have to answer any question you do not wish to, and you are free to leave the study at any time. One questionnaire will ask about whether you are experiencing significant levels of depressed or anxious mood at the time of the experiment.

The recordings of heart activity are not uncomfortable. However, because we will ask to attach some electrodes to your torso and neck area you may need to remove or rearrange some clothing. We recommend that you wear a loose T-shirt, vest top or shirt. All-in-one dresses or other outfits are not recommended.

Eye responses are measured by a remote, computer-mounted eye tracking device. This procedure does not involve having any equipment or sensors attached to your face.

No other risks are known to the investigator at this time.

BENEFITS

In addition to the remunerative payment of 5 pounds or appropriate course credit for participation, there is also an opportunity to win 50 pounds cash. Performance on the computer-based tasks will be recorded and, at the end of the study, the participant who attains the highest score overall will win the cash prize.

11.2 Figure 27 Study 2 info sheet

INFORMATION SHEET AND CONSENT FORM

Emotional responses to Pictures

PURPOSE OF STUDY

The purpose of this study is to explore how certain aspects of our mood responds to pictorial stimuli.

PROCEDURES

Participation in the study will involve attending for a testing session, which will last around 20 minutes. During the testing session you will be asked to do a few things; You will complete several very short questionnaires, which ask about how you currently feel, you will then view a series of pictures which you will be asked to immerse yourself in. Finally, you will complete more short questionnaires.

REMUNERATION

Participants will be entered into a prize draw with a first prize of £50, a second prize of £30 and a third prize of £20.

POTENTIAL RISKS AND ETHICAL CONSIDERATION

Although the questionnaires in the study do not ask about highly personal topics, it is possible that you may experience discomfort when answering some of these. You do not have to answer any question you do not wish to, and you are free to leave the study at any time. One questionnaire will ask about whether you are experiencing significant levels of depressed or anxious mood at the time of the experiment.

It is possible that during the testing session you will experience some negative feelings. However, these are no more distressing than those that might be within an 18-rated movie. However, it is important to remember that you are free to leave the study at any time.

No other risks are known to the investigator at this time.

BENEFITS

No direct benefits from this study to participants are intended, other than the opportunity to win cash prizes.

CONFIDENTIALITY

The information you give which is recorded will be kept strictly confidential, except as may be required by the law or professional guidelines for psychologists. All information will be identified by an identification code, not your name. Any form that requires your name (e.g., this consent form) will be stored separately from the other material. Your name or other identifying information will never be associated with any research reports or publications that use the results of your questionnaires or interviews.

WITHDRAWAL/PREMATURE COMPLETION

Your participation in this study is entirely voluntary, and you may discontinue at any time, without prejudice. Although you will be asked to complete questionnaires without omitting items, if you do not wish to answer a question you may omit it.

11.3 Figure 28 study 3 info sheet

Investigation of Approach Motivation and Attention

Purpose of the Study

The purpose of this study is to explore how certain aspects of mood and attention relate to one another in response to film stimuli.

Procedures

Participation in the study will involve attending a testing session. During the session you will answer several questionnaires which ask about your current mood, past mood extreme states and how you usually think and feel. You will also watch a film clip, complete several computer-related tasks (in these tasks you will be asked to respond to events on the screen). The session will take approximately an hour to complete.

Finally, a few weeks from now, you will be asked via email to complete a questionnaire about how you have felt in the time since you completed this study.

Remuneration

All participants will be offered into a prize draw to win **£50 Amazon voucher**. First year psychology undergraduates will be offered course credit for participation or the opportunity to be included in the prize draw.

Benefits

Other than the opportunity to win the **£50 Amazon voucher** or to gain **1 course credit**, no direct benefits from this study to the participant are intended.

Ethical Considerations

Although the questionnaires in the study do not ask about highly personal topics, they do ask about your current mood state and how you usually feel and act, and as such it is possible that you may experience discomfort when answering some of these. You do not have to answer any question you do not wish to, and you are free to leave the study at any time. One questionnaire will ask about whether you are experiencing significant levels of depressed or anxious mood at the time of the experiment

Confidentiality

The information you give which is recorded will be kept strictly confidential, except as may be required by the law or professional guidelines for psychologists. All information will be identified by an identification code, not your name. Any form that requires your name (e.g., this consent form) will be stored separately from the other material. Your name or other identifying information will never be associated with any research reports or publications that use the results of your questionnaires or interviews.

11.4 Figure 29 Study 4 info sheet

Approach Motivation, Attentional Bias to Positive Stimuli, and Hypomanic Personality.



The relationship between positive mood and attention tasks

Information and Consent Form

Purpose of the Study

The purpose of this study is to explore how certain aspects of mood and attention relate to one another in response to various computer tasks.

Procedures

Participation in the study will involve attending a testing session. During the session you will answer several questionnaires which ask about your current mood, past extreme mood states, personal goals and how you usually think and feel. You will also complete several computer-related tasks (in these tasks you will be asked to respond to events on the screen), including solving some word puzzles. The session will take a maximum of 60 minutes to complete. On the day following participation you will be asked to complete some questionnaires similar to those you will complete during the study. This will be done via email.

Remuneration

All participants will be offered into a prize draw to win a £50 voucher. First year psychology undergraduates will be offered course credit for participation or the opportunity to be included in the prize draw.

Benefits

Other than the opportunity to win the £50 voucher or to gain course credit, no direct benefits from this study to the participant are intended.

Potential Risks and Ethical Considerations

Although the questionnaires in the study do not ask about highly personal topics, they do ask about your current mood state and how you usually feel and act, and as such it is possible that you may experience discomfort when answering some of these. You do not have to answer any question you do not wish to, and you are free to leave the study at any time. One questionnaire will ask about whether you are experiencing significant levels of depressed or anxious mood at the time of the experiment.

Approach Motivation, Attentional Bias to Positive Stimuli, and Hypomanic Personality.

11.5 Figure 30 study 5 info sheet

Approach Motivation, Attentional Bias to Positive Stimuli, and Hypomanic Personality.

		M inimum	M aximum	Mean	Std Deviation	S kewness	K urtosis
Current energy	15	1	10	.97	1.28	-0.26	0.47
Current optimism	15	2	10	.41	1.29	-0.28	1.49
Current mood	15	2	10	.74	1.09	-0.97	1.73
Current alertness	15	2	10	.15	1.33	-0.04	0.97
Current enthusiasm	15	2	10	.73	1.16	-0.74	2.56
Interested	16	1	5	.43	0.81	-0.74	0.24
Excited	16	1	5	.55	1.06	0.16	-0.68
Strong	16	1	5	.66	1.01	-0.03	-0.68
Enthusiastic	16	1	5	.94	0.99	-0.28	-0.67
Proud	16	1	5	.7	1.14	-0.04	-0.96
Alert	16	1	5	.9	0.98	-0.10	-0.48
Inspired	16	1	5	.83	1.06	-0.07	-0.75
Determined	15	1	5	.22	0.99	-0.34	-0.37
Attentive	16	1	5	.2	0.87	-0.35	-0.27
Active	16	1	5	.78	1.05	-0.09	-0.76

Approach Motivation, Attentional Bias to Positive Stimuli, and Hypomanic Personality.

AMSAM	94	1	9	.56	1.56	-0.50	0.10
PARS	13	0	8	.9	1.51	0.86	0.41

11.6 Figure 31. Descriptive Statistics for 17 AM items

12 Appendix III

Note: Variables prefixed with 'Current' represent BES items. All other items denote PANAS-PA items except AMSAM and

12.1 Distributions for the 17 AM items

Distribution Plots

Zscore: Current energy

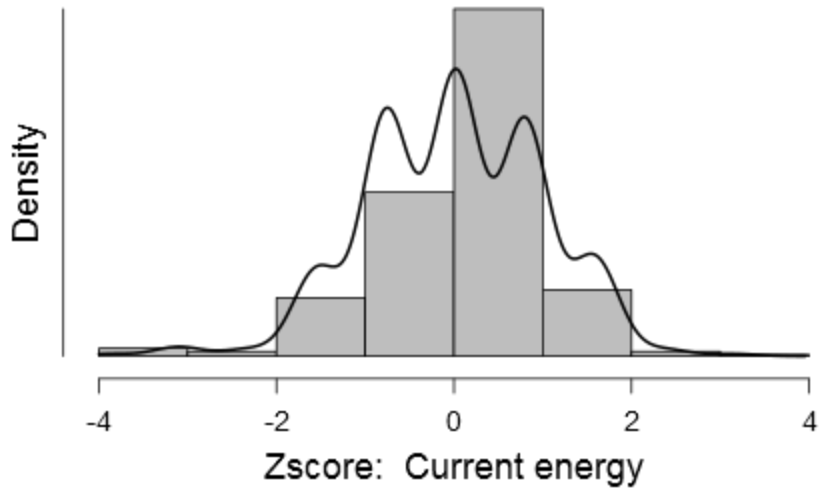

Zscore: Current optimism

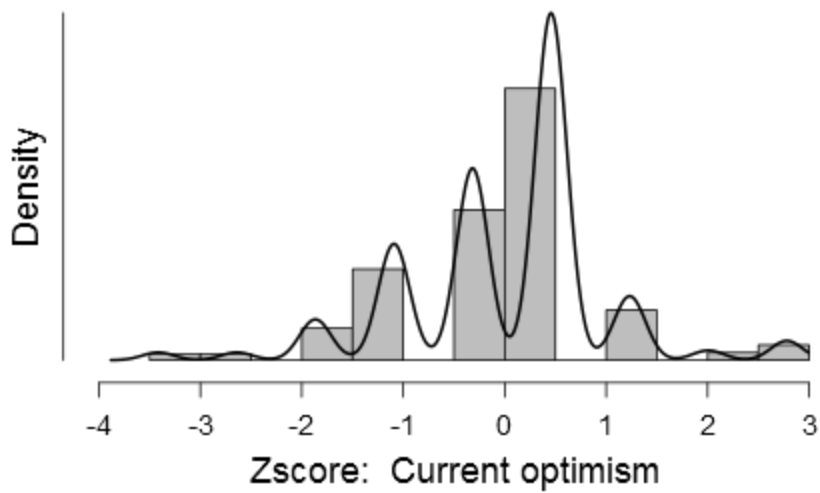

Zscore: Current mood

Approach Motivation, Attentional Bias to Positive Stimuli, and Hypomanic Personality.

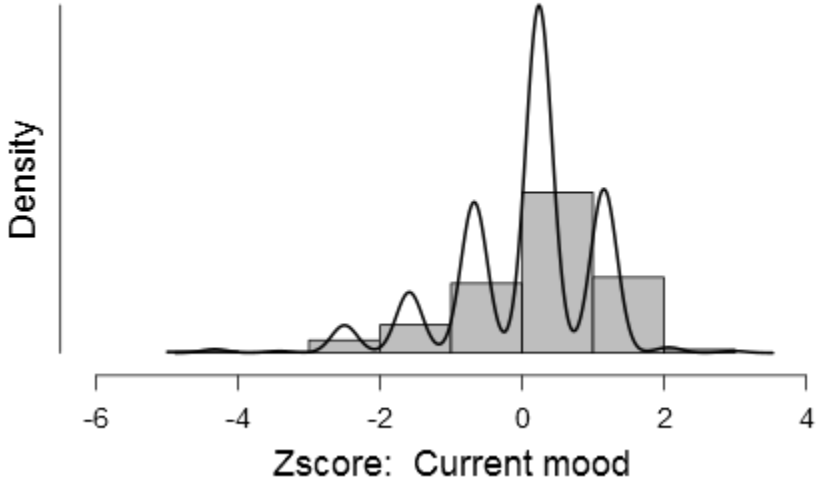

Zscore: Current alertness

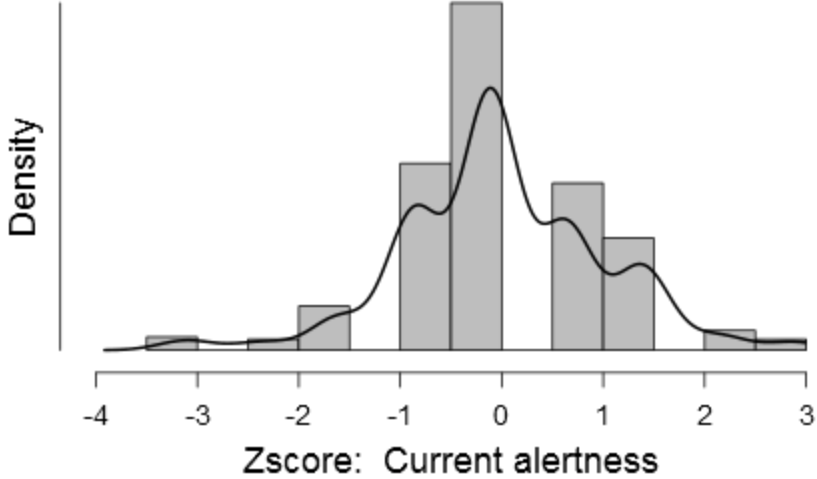

Zscore: Current enthusiasm

Approach Motivation, Attentional Bias to Positive Stimuli, and Hypomanic Personality.

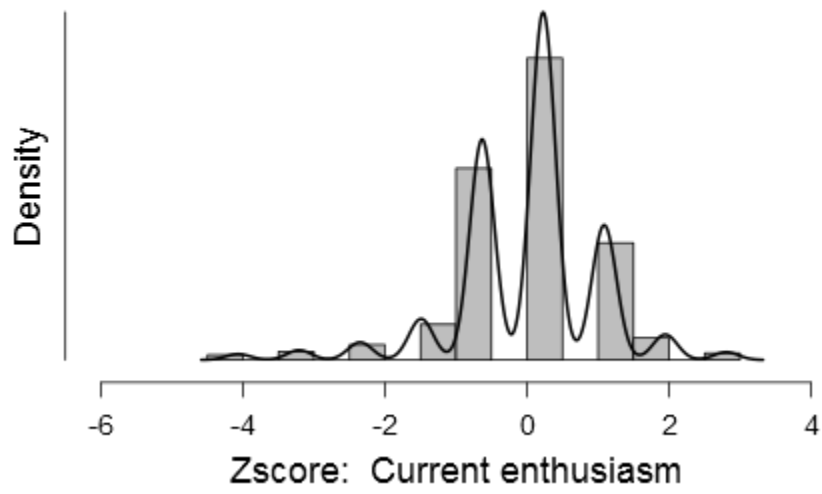

Zscore: Interested

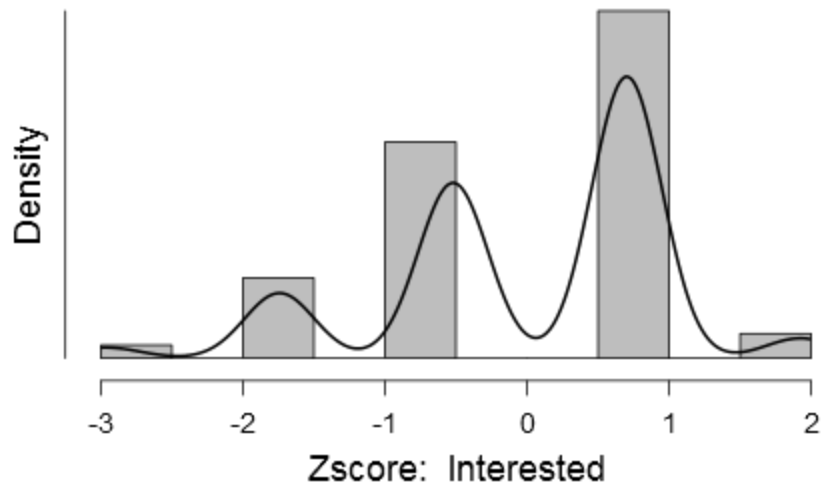

Zscore: Excited

Approach Motivation, Attentional Bias to Positive Stimuli, and Hypomanic Personality.

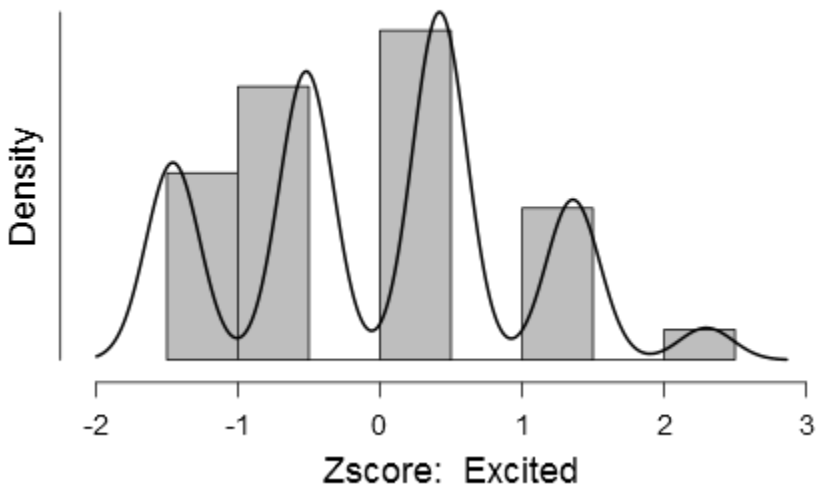

Zscore: Strong

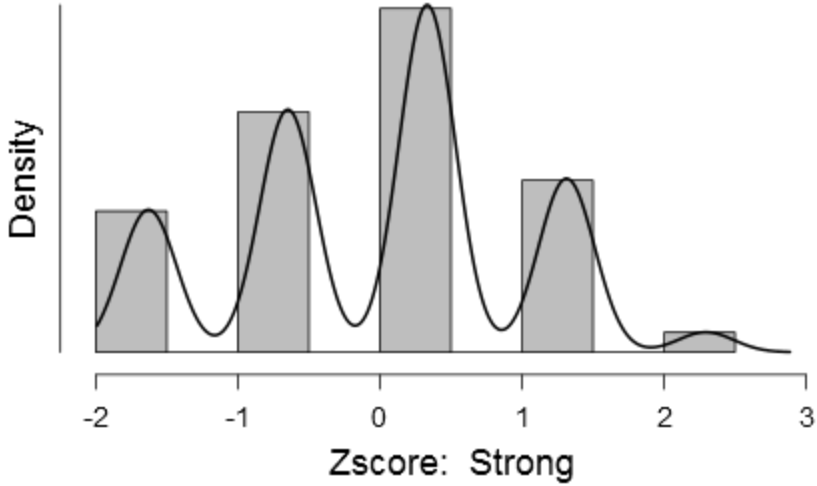

Zscore: Enthusiastic

Approach Motivation, Attentional Bias to Positive Stimuli, and Hypomanic Personality.

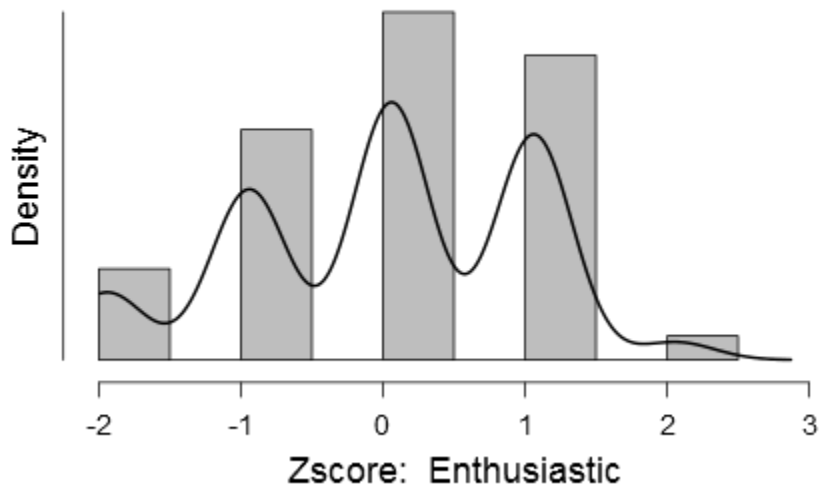

Zscore: Proud

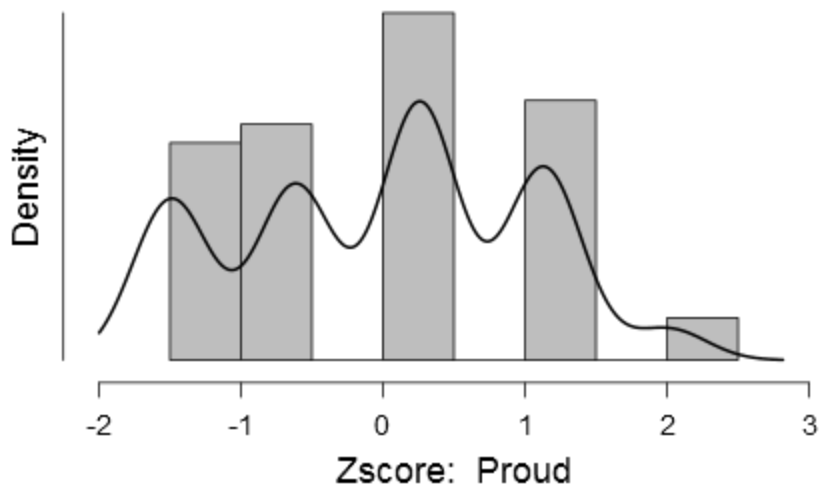

Zscore: Alert

Approach Motivation, Attentional Bias to Positive Stimuli, and Hypomanic Personality.

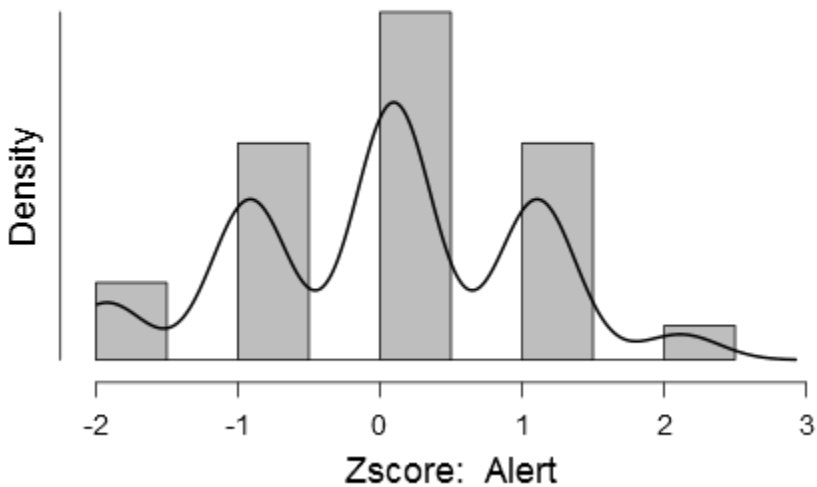

Zscore: Inspired

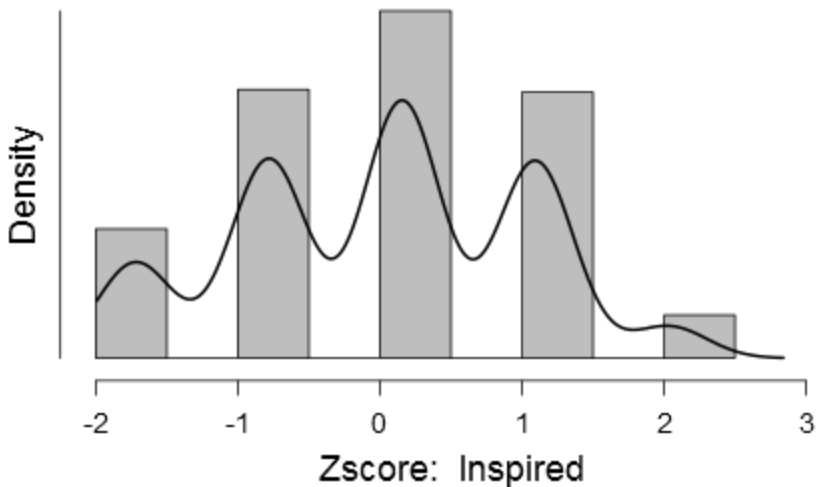

Zscore: Determined

Approach Motivation, Attentional Bias to Positive Stimuli, and Hypomanic Personality.

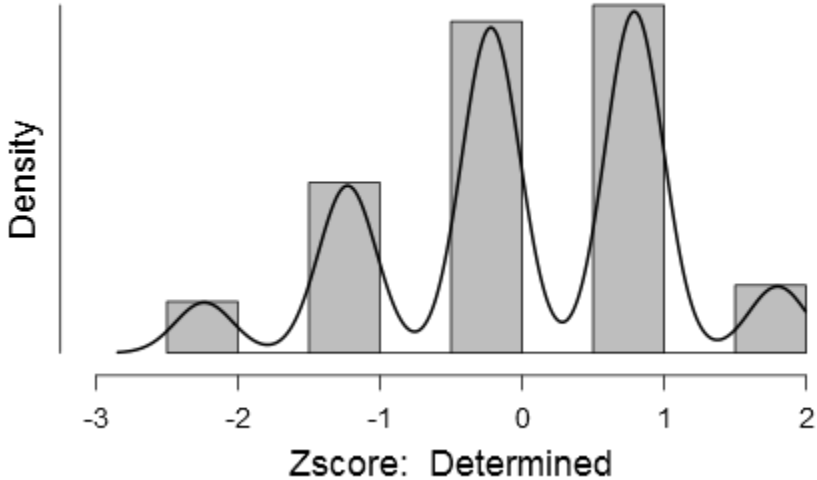

Zscore: Attentive

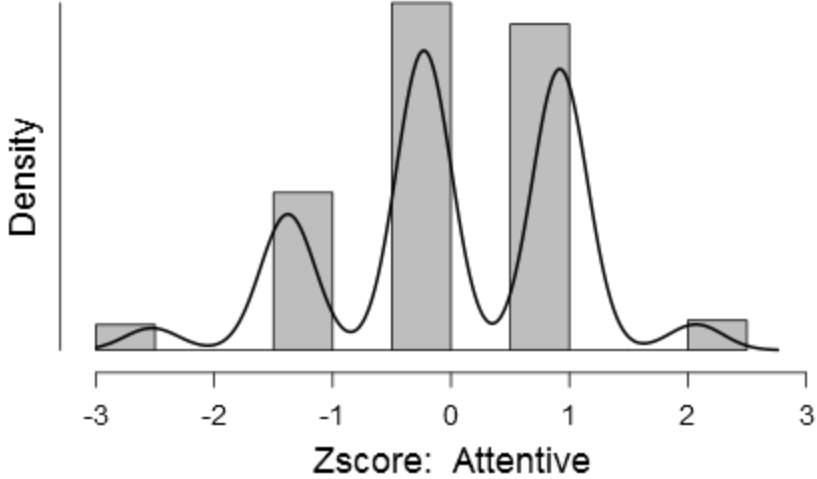

Zscore: Active

Approach Motivation, Attentional Bias to Positive Stimuli, and Hypomanic Personality.

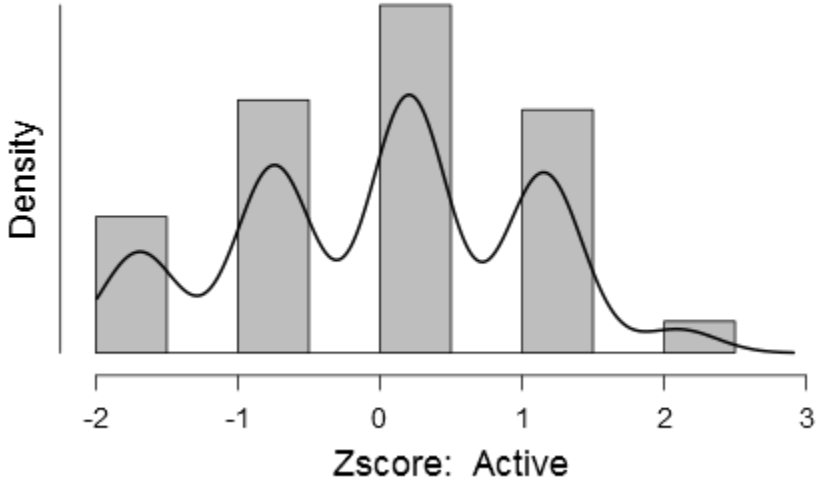

Zscore: AMSAM

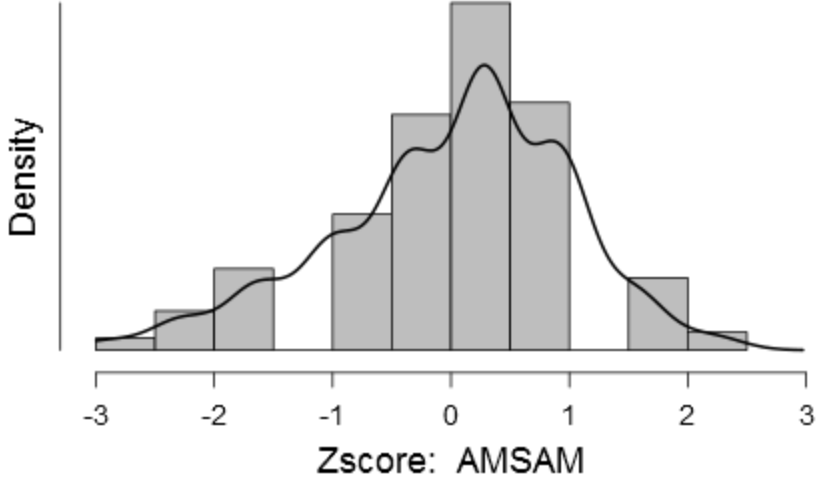

Zscore: Positive Activation

Approach Motivation, Attentional Bias to Positive Stimuli, and Hypomanic Personality.

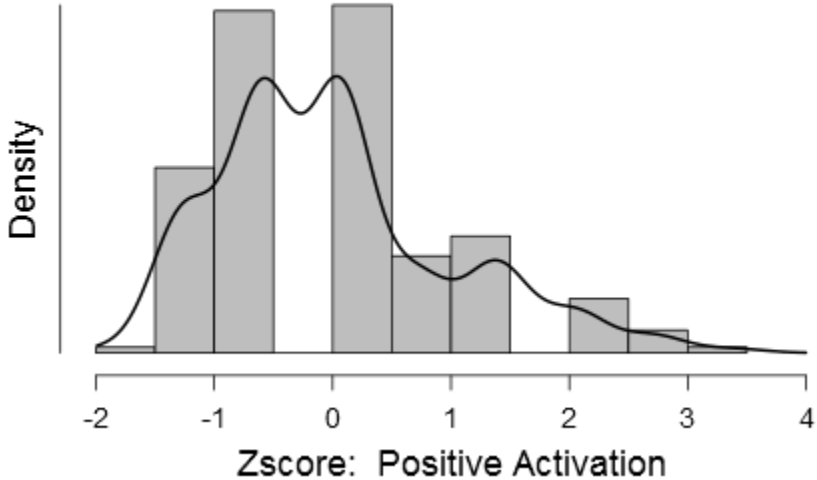

Approach Motivation, Attentional Bias to Positive Stimuli, and Hypomanic Personality.

Pattern Matrix^a

	Factor					
	1	2	3	4	5	6
Current optimism	.767					
Current mood	.414					
Determined		.821				
Inspired		.619				
Proud		.483				
Alert			.700			
Attentive			.426			
Positive Activation				.688		
Current energy				.422		
Enthusiastic					-.677	
Excited					-.603	
Current enthusiasm						-.901
Current alertness						-.425

Extraction Method: Principal Axis Factoring.

Rotation Method: Oblimin with Kaiser Normalization.

a. Rotation converged in 10 iterations.

Figure 32 Principal Axis Factoring Solution

Exploratory Factor Analysis

Factor Solution: Minimum Residuals with 4 (ID: 25, 102, 315, 383) outlying cases removed.

Factor Loadings					
	Factor 1	Factor 2	Factor 3	Factor 4	Uniqueness
Zscore: Active	.	0.563	.	.	0.501
Zscore: Current energy	.	0.793	.	.	0.346
Zscore: Current enthusiasm	.	.	0.452	.	0.484
Zscore: Current mood	.	.	0.529	.	0.294
Zscore: Current optimism	.	.	0.799	.	0.340
Zscore: Determined	0.750	.	.	.	0.363
Zscore: Enthusiastic	.	.	.	0.568	0.435
Zscore: Excited	.	.	.	0.550	0.571
Zscore: Inspired	0.690	.	.	.	0.408
Zscore: Positive Activation	.	0.479	.	.	0.553
Zscore: Proud	0.468	.	.	.	0.569

Chi-squared Test			
	Value	df	p
Model	42.494	17	< .001

Figure 33 EFA ML with outliers removed

Approach Motivation, Attentional Bias to Positive Stimuli, and Hypomanic Personality.

13 Appendix IV

Descriptives

Means and Standard deviations across the four timepoints for all state measures

Group Descriptives	G	N	M	S	S
	roup		ean	D	E
pep1	1	2	7	4	0
		2	6.828	.348	.927
	2	2	7	4	0
		5	8.828	.403	.881
pep2	1	2	7	4	0
		2	8.034	.018	.857
	2	2	7	5	1
		5	9.365	.268	.054
pep3	1	2	7	5	1
		2	6.794	.022	.071
	2	2	8	5	1
		5	0.212	.067	.013
pep4	1	2	7	4	0
		2	8.164	.568	.974
	2	2	8	4	0
		5	0.290	.464	.893
pan1tot	1	2	3	5	0
		6	2.923	.083	.997
	2	2	3	6	1
		6	0.308	.012	.179
pan2tot	1	2	3	6	1
		6	1.192	.106	.197
	2	2	2	7	1
		6	8.731	.153	.403
pan3tot	1	2	3	6	1

Approach Motivation, Attentional Bias to Positive Stimuli, and Hypomanic Personality.

		6	5.115	.575	.289
	2	2	2	7	1
		6	6.385	.985	.566
pan4tot	1	2	3	6	1
		6	4.538	.906	.354
	2	2	2	8	1
		6	3.231	.622	.691
amsam1	1	2	6	1	0
		5	.520	.418	.284
	2	2	5	1	0
		6	.654	.198	.235
amsam2	1	2	6	1	0
		5	.320	.030	.206
	2	2	5	1	0
		6	.538	.240	.243
amsam3	1	2	7	1	0
		5	.400	.118	.224
	2	2	5	1	0
		6	.500	.208	.237
amsam4	1	2	7	1	0
		5	.120	.236	.247
	2	2	5	1	0
		6	.038	.483	.291
BEM1tot	1	2	3	3	0
		6	5.154	.484	.683
	2	2	3	3	0
		6	4.115	.788	.743
BEM2tot	1	2	3	3	0
		6	4.962	.779	.741
	2	2	3	3	0
		6	3.269	.832	.752
BEM3tot	1	2	3	4	0
		6	6.385	.355	.854
	2	2	3	3	0
		6	2.346	.566	.699

Approach Motivation, Attentional Bias to Positive Stimuli, and Hypomanic Personality.

BEM4tot	1	2	3	4	0
		6	6.654	.681	.918
	2	2	3	3	0
		6	0.615	.971	.779
pa1	1	2	3	1	0
		6	.615	.023	.201
	2	2	3	0	0
		6	.500	.906	.178
pa2	1	2	3	1	0
		6	.500	.030	.202
	2	2	3	0	0
		6	.346	.797	.156
pa3	1	2	4	1	0
		6	.423	.362	.267
	2	2	3	1	0
		6	.115	.143	.224
pa4	1	2	4	1	0
		6	.077	.383	.271
	2	2	2	1	0
		5	.880	.130	.226

Figure 34 Study 2 descriptives

13.2 Deconstruction of Family ANOVA test to assess AM measures against the inductions

PANAS- PA was removed first, and the subsequent ANOVA did not reveal a significant three way interaction, $F(2, 100) = 2.87, p = n/s$, between time (pre-post), condition (AM, Neutral) and measure (BES, AMSAM, PARS), demonstrating that BES, PARS and AMSAM behaved similarly. On account of the three-way interaction found above when PANAS-PA was included, it was concluded that PANAS-PA differed from the other measures. Because BES, PARS and AMSAM were undifferentiated in their responsiveness to the inductions, only one (PARS) measure was compared with PANAS-PA to establish differences in response to either the AM or Neutral inductions. A mixed ANOVA revealed a significant three way interaction between measure (PARS, PANAS-PA), time (pre, post), and condition (AM, Neutral) was revealed $F(1, 50) = 26.46, p < .001, \eta^2_p = .34$. To deconstruct this interaction, PARS and PANAS were subsequently examined within each condition separately. First the measures were compared within the Neutral condition. A mixed ANOVA revealed a significant two way interaction between measure (PARS, PANAS-PA), and time (pre, post) was revealed $F(1, 77) = 13.53, p < .001, \eta^2_p = .15$. Therefore PARS and PANAS-PA differed over time within the Neutral condition. Paired t-test conducted with the Neutral condition revealed a pre, $M = 28.73, SD = 7.1$, to post, $M = 26.38, SD = 7.9$ induction decrease, $t(25) = 3.01, p = .006$, for PANAS-PA. Whereas PARS did not significantly vary from pre to post neutral induction, $t(25) = 1.18, p = n/s$.

It was also important to establish if PANAS-PA behaved differently to the other measures within the AM condition. Again PARS was used as a comparison, as PARS, BES and AMSAM did not differ from each other evidence by a non-significant time, condition, measure interaction

Approach Motivation, Attentional Bias to Positive Stimuli, and Hypomanic Personality.

described above . A mixed ANOVA revealed a significant two way interaction between measure (PARS, PANAS-PA), and time (pre, post) was revealed $F(1, 77) = 16.16, p < .001, \eta^2_p = .39$.

Therefore PANAS-PA also differed from the other measures in response to the AM induction.

14 Appendix V

14.1.1

induction	measure	con d	Mean	SD	
pre	AMSAM	CPA 1	6.154	1.424	9
		AM 2	5.889	1.582	6
		FEAR 3	5.786	1.690	2
	PARS	1	2.667	1.305	9
		2	2.278	1.085	6
		3	2.833	1.591	2
	PANAS-PA	1	29.436	7.029	9
		2	27.972	5.814	6
		3	28.833	6.782	2
	BES	1	21.462	4.303	9
		2	22.694	3.568	6
		3	21.881	5.018	2
post	AMSAM	1	6.513	1.537	9
		2	6.250	1.680	6
		3	5.643	1.722	2
	PARS	1	3.103	1.789	9
		2	3.278	1.846	6
		3	2.333	1.525	2

14.1.1

induction	measure	con d	Mean	SD	
	PANAS-PA	1	31.026	8.76 7	9
		2	31.611	8.86 5	6
		3	27.381	7.69 5	2
	BES	1	20.410	5.25 5	9
		2	20.278	4.89 7	6
		3	23.952	5.04 6	2

14.2 Figure 35. Descriptives Study 3

14.3 Figure 36. Negative Valence High Arousal IAPS images (FEAR)

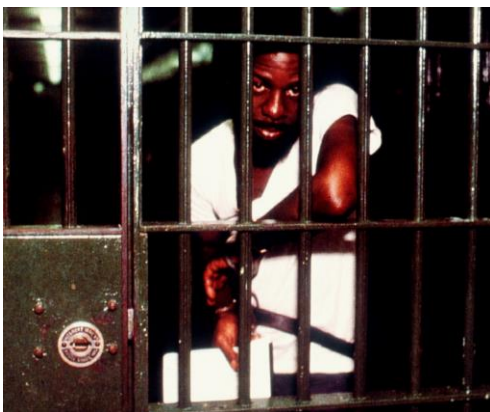

Approach Motivation, Attentional Bias to Positive Stimuli, and Hypomanic Personality.



14.4 Figure 15. Positive Valence High Arousal IAPS images (FEAR)

Approach Motivation, Attentional Bias to Positive Stimuli, and Hypomanic Personality.



Approach Motivation, Attentional Bias to Positive Stimuli, and Hypomanic Personality.



14.5 Figure 37. Positive Valence Low Arousal IAPS images (Calm Positive Affect)



Approach Motivation, Attentional Bias to Positive Stimuli, and Hypomanic Personality.



15 Appendix VI

15.1 AM induction instructions

You are about to watch a film clip about the **true** story of a young man named Rudy whose lifelong desire has been to go to Notre Dame University and play American football. He is far too small to play football but out of sheer determination he makes the team but only as a practise player. He successfully convinces the coach to let him dress in kit (he wears shirt number 45) for the last, hugely important, game of his final year but the coach has no intention of actually putting him in the game. As you watch that last game and the remarkable events that transpire please try to totally immerse yourself in the film.

Put yourself in his shoes as much as possible!

Words

Reward: reward, victory, success, fun, happiness, pleasure, praise, love

Neutral: document, situation, moment, history, pencil, sound, table, plate, theory, square, apartment, method

Reward: reward, victory, success, fun, happiness, pleasure, praise, love

Neutral: document, situation, moment, history, pencil, sound, table, plate, theory, square, apartment, method

Negative: punishment, enemies, pain, rejection, insult, conflict, misery, failure

Reward: admired, cheerful, happy, fame, affection, kiss, fun, passion, sexy, success

Neutral: Basket, engine, theory, industry, street, circle, method, lamp, chair, window, history, pencil, table, moment, plant, fabric, elbow, wagon, custom, museum

Negative: abuse, agony, assault, cancer, danger, horror, disaster, pain, mutilate, violence

Reward: sexy, kiss, passion, ski jump, erotic, desire, holiday, adventure

Neutral: stove, truck, avenue, barrel, basket, circle, column, cork, corridor, curtains, elbow, elevator, engine, egg, fabric,

fork, glacier, golfer, hairpin, cabinet, journal, kettle, lamp, metal, museum, paint, pencil, phase, poster, sphere, spray,

statue, taxi, tool, tower, truck, umbrella, vest, wagon, yellow, contents, glass, icebox, iron, stomach, storm, tank

Pleasant: comfort, carefree, warm, cozy, secure, gentle, safe, wise

Reward: pleasure, love, gifts, success

Neutral: geology, event, hall, land, plant, chair, fabric, board, elbow, symbol, collection, metal, land, green, circle,

couch, string, situation, square, afternoon, ankle, clock, sauce, stone

Pleasant: enjoyment, friendship, delight, reward

15.2 Figure 38. Word Stimuli for study 4

16 Appendix VII

Please choose the difficulty level for this task on a scale from 0 to 9:

1 * 2 * 3 * 4 * 5 * 6 * 7 * 8 * 9

16.1 Figure 39 Goal Setting

How successful do you think you will be on the next task (place a mark on the scale below)?



16.2 Figure 40 Success Expectancy

Approach Motivation, Attentional Bias to Positive Stimuli, and Hypomanic Personality.

Think about the speed of your thoughts as you were reading the instructions on the screens

Now use the scale below to report the speed of your thoughts... 1 (very slow), 5 (moderate speed), and 9 (very fast)

1 * 2 * 3 * 4 * 5 * 6 * 7 * 8 * 9

16.3 Figure 41 Thought Speed

By marking an 'X' on the ruler below please indicate how you feel
RIGHT NOW, AT THE PRESENT MOMENT.



16.4 Figure 42 Self-Esteem

Approach Motivation, Attentional Bias to Positive Stimuli, and Hypomanic Personality.

Subset A		Subset B	
<i>Positive word</i>	<i>Neutral word</i>	<i>Positive word</i>	<i>Neutral word</i>
Docile	Awhile	Casual	Trucks
Controlled	Represents	Certainty	Telegraph
Nonchalant	Tabernacle	Placid	Wallet
Imperturbable	Residentially	Relieve	Statute
Unflinching	Thermoplastic	Daring	Manned
Extrovert	Regrouped	Unruffled	Scorecard
Fearless	Registry	Snug	Mead
Safe	Hole	Secure	Reveal
Restful	Pointer	Lively	Quoted
Buoyant	Spinach	Brightness	Respective
Accomplish	Functional	Comfortable	Profession
Calm	Knee	Contented	Inaugural
Favourable	Transition	Gregarious	Modulation
Soothing	Explorer	Happier	Consult
Pleased	Whereas	Fun	Cup
Enchanting	Delivering	Friendly	Contract
Peaceful	Narrative	Tranquil	Motorist
Glad	Pont	Rejoice	Focally
Carefree	Sideline	Heroic	Taylor
Excited	Plaster	Passionate	Nomination
Ecstatic	Mixtures	Jovial	Cohere
Exuberant	Inference	Confident	Passenger
Blissful	Dispense	Cheerful	Segments
Successes	Frequency	Elated	Kernel
Bold	Loop	Stable	Buying
Harmless	Pantheon	Undisturbed	Occupations
Unwavering	Biomolecular	Unconcerned	Supplements
Resting	Cottage	Poised	Ballot
Steady	Tissue	Keen	Pump
Unstressed	Decorators	Assured	Allotment
Assertive	Propeller	Protected	Recording
Ease	Wire	Composed	Treasury
Charisma	Flitting	Eager	Refer
Cosy	Digs	Warmly	Themes
Serene	Entity	Sociable	Instancy
Zeal	Dock	Energetic	Criterion
Gentle	Mirror	Proudly	Resembles
Enjoy	Acres	Satisfaction	Jurisdiction
Zest	Bean	Enthusiastic	Illustration
Outgoing	Reversed	Achieving	Alongside
Merry	Ankle	Brave	Tubes
Rewarding	Logistics	Fulfilled	Generated
Relaxed	Habitat	Courageous	Supersonic
Thrilled	Equating	Triumphs	Outfield
Enjoyment	Temporary	Glee	Cues
Jubilant	Impresario	Euphoric	Citywide
Pleasure	Speaking	Delighted	Maintains
Overjoyed	Applicant	Joy	Bob

16.5 Figure 43 Word Stimuli for study 5

17 Appendix VIII

HPS subscale items indicated in bold (extracted from Schalet et al. 2011)

Three-Cluster Model of the Hypomanic Personality Scale

Scale item	Social Vitality	Mood Volatility	Excitement
42. I seem to have an uncommon ability to persuade and inspire others.	0.69	0.22	0.30
40. At social gatherings, I am usually the "life of the party."	0.67	0.24	0.45
6. When with groups of people, I usually prefer to let someone else be the center . . .	-0.64	-0.27	-0.45
25. When I go to a gathering where I don't know anyone, it usually takes me a while . . .	-0.59	-0.09	-0.31
7. In unfamiliar surroundings, I am often so assertive and sociable that I surprise . . .	0.58	0.21	0.36
29. I have often persuaded groups of friends to do something really adventurous or crazy.	0.56	0.32	0.40
16. I can't imagine that anyone would ever write a book about my life.	-0.55	-0.16	-0.17
26. I think I would make a good actor, because I can play many roles convincingly.	0.55	0.33	0.33
39. I am so good at controlling others that it sometimes scares me.	0.54	0.28	0.22
2. It would make me nervous to play the clown in front of other people.	-0.53	-0.14	-0.31
4. I think I would make a good nightclub comedian.	0.53	0.23	0.25
34. There are so many fields I could succeed in that it seems a shame to have to pick . . .	0.53	0.19	0.18
1. I consider myself to be pretty much an average kind of person.	-0.52	-0.20	-0.14
36. I find it easy to get others to become sexually interested in me.	0.52	0.14	0.25
47. I would rather be an ordinary success in life than a spectacular failure.	-0.49	-0.30	-0.23
30. I would really enjoy being a politician and hitting the campaign trail.	0.48	0.06	0.15
23. I expect that someday I will succeed in several different professions.	0.47	0.18	0.19
13. People often come to me when they need a clever idea.	0.46	0.13	0.15
19. I have such a wide range of interests that I often don't know what to do next.	0.46	0.37	0.32
48. A hundred years after I'm dead, my achievements will probably have been forgotten.	-0.45	-0.11	-0.22
27. I like to have others think of me as a normal kind of person.	-0.44	-0.33	-0.30
14. I am no more self-aware than the majority of people.	-0.31	-0.17	-0.16
44. I frequently get into moods where I feel very speeded-up and irritable.	0.12	0.70	0.32
38. I frequently find that my thoughts are racing.	0.31	0.67	0.40
21. My moods do not seem to fluctuate any more than most people's do.	-0.23	-0.65	-0.41
20. There have often been times when I had such an excess of energy that I felt little . . .	0.26	0.64	0.51
37. I seem to be a person whose mood goes up and down easily.	-0.02	0.63	0.23
8. There are often times when I am so restless that it is impossible for me to sit still.	0.20	0.61	0.48
35. I often get into moods where I feel like many of the rules of life don't apply to me.	0.39	0.59	0.30
5. Sometimes ideas and insights come to me so fast that I cannot express them all.	0.35	0.58	0.35
31. I can usually slow myself down when I want to.	-0.22	-0.57	-0.38
45. I have often felt happy and irritable at the same time.	0.19	0.55	0.26
10. When I feel an emotion, I usually feel it with extreme intensity.	0.19	0.55	0.40
22. I very frequently get into moods where I wish I could be everywhere and do everything . . .	0.40	0.55	0.46
9. Many people consider me to be amusing but kind of eccentric.	0.28	0.54	0.44
43. I have often been so excited about an involving project that I didn't care about eating . . .	0.28	0.53	0.34
41. I do most of my best work during brief periods of intense inspiration.	0.20	0.51	0.28
32. I am considered to be kind of a "hyper" person.	0.37	0.48	0.82
33. I often get so happy and energetic that I am almost giddy.	0.35	0.46	0.83
3. I am frequently so "hyper" that my friends kiddingly ask me what drug I'm taking.	0.33	0.54	0.79
11. I am frequently in such high spirits that I can't concentrate on any one thing for too . . .	0.33	0.54	0.79
46. I often get into excited moods where it's almost impossible for me to stop talking.	0.32	0.57	0.68
17. I am usually in an average sort of mood, not too high and not too low.	-0.44	-0.42	-0.66
15. I often feel excited and happy for no apparent reason.	0.25	0.25	0.62
18. I often have moods where I feel so energetic and optimistic that I feel I could . . .	0.52	0.38	0.59
12. I sometimes have felt that nothing can happen to me until I do what I am meant to . . .	-0.25	0.28	0.21
24. When I feel very excited and happy, I almost always know the reason why.	0.14	-0.28	-0.36
28. I frequently write down the thoughts and insights that come to me when I am thinking . . .	-0.24	0.36	0.20

Approach Motivation, Attentional Bias to Positive Stimuli, and Hypomanic Personality.