



Citation for published version:

Yan, X, Gu, C, Li, F & Xiang, Y 2018, 'Network pricing for customer-operated energy storage in distribution networks', *Applied Energy*, vol. 212, pp. 283-292. <https://doi.org/10.1016/j.apenergy.2017.12.060>

DOI:

[10.1016/j.apenergy.2017.12.060](https://doi.org/10.1016/j.apenergy.2017.12.060)

Publication date:

2018

Document Version

Peer reviewed version

[Link to publication](#)

Publisher Rights

CC BY-NC-ND

University of Bath

General rights

Copyright and moral rights for the publications made accessible in the public portal are retained by the authors and/or other copyright owners and it is a condition of accessing publications that users recognise and abide by the legal requirements associated with these rights.

Take down policy

If you believe that this document breaches copyright please contact us providing details, and we will remove access to the work immediately and investigate your claim.

Network Pricing for Customer-Operated Energy Storage in Distribution Networks

Xiaohe Yan^a, Chenghong Gu^a, Furong Li^a, and Yue Xiang^b

a: Dept. of Electronic and Electrical Eng., University of Bath, Bath, BA2 7AY, U.K

b: Dept. of Electrical Eng., Sichuan University, Chengdu 610065, China

Abstract—Network pricing is essential for electricity system operators to recover investment and operation costs from network users. Current pricing schemes are only for generation and demand that purely withdraws or injects power from/into the system. However, they cannot properly price energy storage (ES), which has the dual characteristics of injecting and withdrawing power and is playing an important role in the system.

This paper develops a novel pricing scheme for ESs in distribution systems operated by customers to reflect their impact on network planning and operation. First of all, a novel charging and discharging methodology is designed for the ESs, which respond to time of use (ToU) tariffs for maximising electricity bill savings. The long-term incremental cost for ES is designed by evaluating the difference between future reinforcement horizon of network assets with and without storage. The short operation cost is quantified by system congestion. Then, a novel pricing scheme for ES is designed by evaluating its impacts on long-term network investment by integrating investment cost and congestion cost. The pricing signals can guide storage operation to benefit both distribution network operators and ES owners. The new methodology is demonstrated on a small system with an ES of different features and then on a practical Grid Supply Point (GSP) area to illustrate the impacts of ESs on network investment.

Keywords — Network pricing, energy storage, charging and discharging strategy, investment cost.

1. INTRODUCTION

Energy storage (ES) plays a significant role in maintaining a resilient and robust electricity system by improving grid operating capability, lowering operation cost, and deferring/reducing network investments. In addition, because of the continuous growth of intermittent renewable energy, ES systems can improve system reliability and flexibility to accommodate more renewable energy, particularly wind and solar power [1, 2]. For example, the current capacity of ES is less than 200MW in the UK, which may increase to 1.6GW by 2020 according to the forecast in [3].

A large volume of research has quantified the benefits from ES for different market players and designed various ES charging and discharging (C/D) strategies for various purposes. Papers [4-7] evaluate the costs and profits of ES, where the four main costs are: investment, operation, maintenance, and energy purchasing. The savings are from network upgrade deferral and ancillary services [8-11]. Paper [5] discusses the social costs and benefits from wind-based energy storage are identified by determining financial incentives for energy storage. The benefits from arbitrage for energy storage is investigated in [6, 7]. In these papers, ES is assumed to be owned by customers and responding to spot prices in the day-ahead. Based on real-time tariffs, paper [10] purposes a load shaping method to incentivise customers to store energy at low energy price periods so that the stored energy can be used during high price periods. Paper [12-15] discuss the C/D method

for different storage technologies such as multi-tank thermal energy storage, lithium-ion storage, and gas-hydrate cool storage. The ES operation is investigated with tariff reward is discussed in Paper [15]. Paper [16, 17] investigates the collaborative operation of ES and renewables. Paper [16] discusses the objective that to increase wind penetration. Paper [17] provides the market equilibrium interactions between ES and wind generators. But, these papers have not considering the economic impacts of ES to electricity networks.

There are still several barriers [18, 19] obstructing the development and future penetration of ESs, which have been explored and emphasized by many academic and governmental reports [20-22]. Generally, in the order of perceived importance, the major barriers are:

- Network pricing
- Network connections
- Final consumption levies
- Planning Regulatory clarity

In terms of network pricing, it is the strategy to recover the investment cost and operation cost of networks from network users. The cost is allocated to all customers based on their contributions to network investment and congestion. Currently, two pricing methods are widely used on UK distribution networks: Long-run incremental cost (LRIC) [23] in extra-high voltage distribution networks and Distribution Reinforce Model (DRM) [24] in high voltage and low voltage distribution networks. However, they are only for traditional network users, generation and demand, which purely inject into or withdraw energy from networks strategies, but not applicable to ES considering its dual features (both importing and exporting energy). The development of technologies is far ahead of pricing method for ES [21]. The pricing for ES should be able to guide ES operation by setting appropriate price signals that reflect its impacts on networks. Thus, it is essential to develop appropriate pricing approaches that can be utilised by network operators to recover the network cost from ES.

The impacts on distribution networks from ES vary with C/D methods and ownership, which in turn affect network pricing for ES. There are three typical ES ownerships, customers, DNOs, and the third party [18, 22, 25]. If ES is owned by customers, it is normally used in responding to tariffs to reduce electricity bills or increase the bill saving resulting from ES operation. On the other hand, ES can also reduce use-of-system charges and congestion cost to improve network flexibility if appropriate ToU tariffs are designed. If ES is owned by DNOs, it can be used to benefit network infrastructures such as lowering line losses, minimising system operation costs, and reducing renewable curtailment and load disconnection. In papers [26-28], ES is utilised to mitigate network congestions by considering the charging control of electric vehicles. Papers [29-32] discuss C/D methodologies by setting different objectives, such as minimising line losses of distribution systems, minimising operation costs of electric vehicles, and reducing generation curtailment. Paper [32] uses ESs to manage power consumption of demand response. If ES is owned by the third party, it will be operated to respond to pricing signals of different purposes, such as ancillary services, retail market, to generate profits. However, these methods only analyse energy cost but ignore network costs that ES need to pay, thus not reflecting its impact on network investment.

This paper proposed a novel C/D strategy and pricing approach for customer-operated ESs. Customer-operated ES means that the storage installed in the households and operated by domestic customers, which should be operated to maximise the profits via electricity bill saving through energy price arbitrage. Firstly,

the C/D method for ESs is developed in response to ToU tariffs, where Binary Search method (BSM) is utilised to adjust the state of charge (SoC) to maximise bill savings. Then, a pricing scheme for ESs is developed by using the core concept of LRIC, considering that: i) network price signals should reflect the impacts of ES on future network reinforcement; ii) the advantages of LRIC in generating locational forward signals. The new pricing method integrates system short-run congestion cost and long-run investment cost and then the impacts from ES on network investment and operation are converted into price signals. In the short-term daily operation, the ES is operated to maximise the profits from energy arbitrage in response to ToU. This operation can help to reduce system peak loading which reduces either the investment cost or system congestion cost simultaneously. In order to design a more cost-reflective tariff for ES, the savings from the reduction of investment cost and congestion cost should also be converted into the pricing signals. The long-term investment cost savings are allocated to the short-term operation by divide this savings to each discharge period based on the mitigated congestion levels. In each operation period, the congestion cost savings and the investment cost savings combined together as new pricing signals to the ES which is the impact on the networks. This new tariff can give a better incentive for the ES. The impacts of different features of ESs on new system peak demand are also examined by sensitivity analysis which is demonstrated on a small system with various ES features. Then it is extrapolated to a real distribution system. Results illustrate its effectiveness in pricing ESs.

2. IMPORTANCE OF PRICING FOR ES

ES is a key enabler to improve the balancing of generation and consumption, maximise the low carbon energy consumption and optimise the investment in infrastructure [33]. Although ES exists for many years, there are no pricing methods, especially for customer owned ESs, which normally sits behind the meter. Without appropriate pricing methods, there is a risk of competition distortion and a lack of level playing field for those using the network to deliver flexibility.

Currently, ES is treated as a non-intermittent generation in the UK system [19], but the guidance for charging method is an absence. In addition, the flexible connection of ESs cannot ensure their immediate actions, which means ESs are ignored in network pricing although it exports power at peak load times. As it ‘consumes’ energy and store it and then passes the energy to end consumers, the same electricity will be double counted from the payment of levies by both the storage providers and the consumers.

With the pricing method, an economic signal will be sent to ES if it can release network congestions and defer needed investment. Otherwise, it should be penalised if causing network problems, such as increasing system congestion.

The flowchart in Fig. 1 depicts the process of designing network pricing scheme, including two main steps.

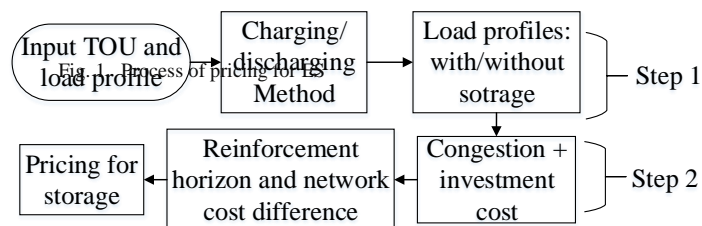

- The first step is to design the C/D method for customer owned ES responding to ToU tariffs. The impacts of ES operation is reflected by the power flow change along network branches. The details are described in Section 3.
- In the second step, based on the contributions of ES to branch power flows, the investment cost and congestion cost of branches are calculated respectively for the with/without ES cases. Accordingly, pricing is designed based on the difference of network costs with and without ES operation. The details are given in Sections 4 and 5.

3. MODELS OF CHARGING AND DISCHARGING METHODOLOGY

ES is assumed to be controlled by customers in response to ToU tariffs to maximise profits (EP) from bill saving. The constraints are the power flow constraint, and node AC power flow constraint in (4-5). Constraint (6) is the conservation of energy constraints of ES operation. The capacity balance between two dispatch intervals is in (6a), and the capacity constraints for discharging and charging are in (6b) and (6c) respectively. The C/D rate constraints are in (6d) and (6e). The constraints of C/D cycles are provided in (6f) and (6g) denotes the SoC constraints. The problem can be modelled as the following optimisation:

Objective:

$$EP = \text{Max} \sum_{t=1}^{24} (Rd_t \times TOU_t - Rc_t \times TOU_t) \quad (1)$$

$$\text{st.} \quad |pf_t| < C_l \quad (2)$$

$$P_k^G - P_k^L = \sum_{i=1}^N V_k V_i [G_{ki} \cos(\theta_k - \theta_i) + B_{ki} \sin(\theta_k - \theta_i)] \quad (3a)$$

$$Q_k^G - Q_k^L = \sum_{i=1}^N V_k V_i [G_{ki} \sin(\theta_k - \theta_i) + B_{ki} \cos(\theta_k - \theta_i)] \quad (3b)$$

$$\left\{ \begin{array}{l} \sum_{t=1}^{24} \sum_{l=1}^n (CES_{tl}) = \sum_{t=1}^{24} \sum_{l=1}^n (DES_{tl}) \quad (4a) \\ \sum_{t=1}^{24} \sum_{l=1}^n (DES_{tl}) \leq \text{CapaES} \quad (4b) \\ \sum_{t=1}^{24} \sum_{l=1}^n (CES_{tl}) \leq \text{CapaES} \quad (4c) \\ \sum_{t=1}^{24} \sum_{l=1}^n (CES_{tl}) \leq \text{Crate} \quad (4d) \\ \sum_{t=1}^{24} \sum_{l=1}^n (DES_{tl}) \leq \text{Crate} \quad (4e) \\ \text{cycle} \leq \text{maxdc} \quad (4f) \\ \text{minSoC} \leq \text{SoC} \leq \text{maxSoC} \quad (4g) \end{array} \right.$$

where, Rc_t and Rd_t are the charging and discharging rate at time t ; pf_t is the power flow on branch l . P_k^G , P_k^L , Q_k^G and Q_k^L are the active and reactive power for generation and load at node k , where $i, k \in N$ (N is node number); V is the node voltage with angle θ ; CapaES is ES capacity and CES_{tl} and DES_{tl} are charged and discharged energy; Crate is the hourly maximum C/D rate constraint; cycle is the daily cycle for ES and maxdc is the maximum cycle times for ES. minSoC and maxSoC are the SoC status level constraints of ES.

There are two steps in designing the C/D depicted in Fig. 2:

- Firstly, the threshold tariff (td) for ES operation is set as a base price based on ToU tariffs. The settlement periods of the day who's ToU at time i (Ti) is higher than td are chosen as discharging candidate periods and the periods with ToU lower than td are charging candidate periods. Then, the real operation periods for C/D are selected among these candidates and C/D energy amount in each time step can be determined by step ii).
- Secondly, the time of C/D and energy amount in each C/D time step are decided to maximise the ES profits for customers by the following two principles:

- if the C/D duration is longer than the candidates' duration, the time to charge is driven by the load level which covers the periods with the lowest load level, whilst the time to discharge is the periods covering the highest load level.
- if the C/D duration is shorter than the C/D candidates' durations. The equation discharged amount, which is adjusted

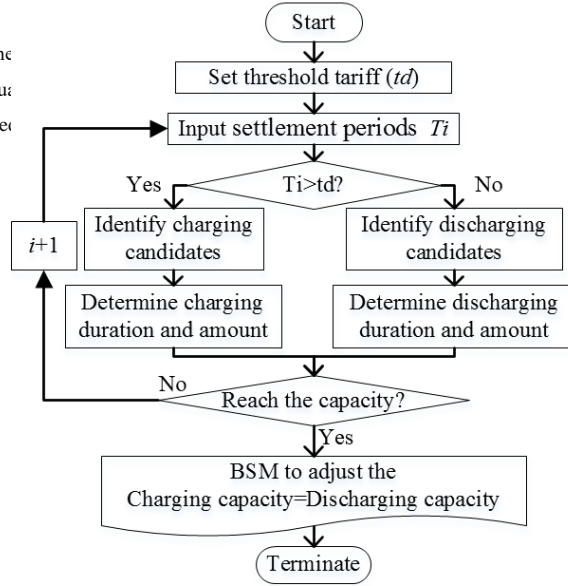
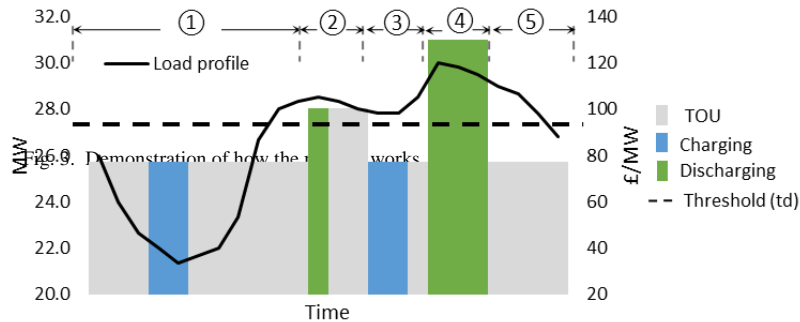

Fig. 2. Flow chart of charging and discharging process

Fig. 3 briefly illustrates how the C/D method works. Firstly, td is set as the average value of the tariff, which is the dashed horizontal line. The periods ② and ④ are discharging candidates because their ToU tariffs are higher the threshold (td), and others are charging candidates. Thereafter, the charging and discharging durations are selected from the candidates according to Equations (1-4) based on BSM. To assign the charging and discharging period, the loading level is involved to help the charging and discharging period choosing. If the operation candidates is longer than the operation period, for example, the discharging candidates is longer than the discharging period in ②. The discharging period is selected from discharging candidates from highest loading level. For the charging period selection, the charging period is selected from charging candidates with lowest loading level.



4. MODEL OF OPERATION COST

The pricing for ES is derived by examining its impact on network investment and operation cost. The operation cost is considered as network congestion cost. There are two subsections here: to identify nodal power injection to branch flows and to quantify the congestion cost.

4.1 Impact of Nodal Power on Branch Flow

The impact of nodal demand/generation change on branch flows can be quantified by the Power Transfer Distribution Factor (PTDF) matrix. AC Power Transfer Distribution Factors (AC_PTDF) [35, 36] is introduced to select the branch l that has the largest impact on energy change resulted from ES. If the power change at bus m is P_k and a part of this transaction power (ΔP_k) carried by line l between busbar m and n is ΔP_{ES} , the AC_PTDF can be denoted as:

$$AC_PTDF_l = \frac{\Delta P_{mn}}{\Delta P_k} \quad (5)$$

Therefore, the operation of ES in busbar k is highly associated from the load level of line l . Accordingly, the load change or generation change (ΔP_k) in node i resulting from nodal power flow change (ΔP_l) is

$$\Delta P_l = AC_PTDF_l \times \Delta P_k \quad (6)$$

4.2 Congestion Cost Quantification

Assuming that the number of distributed generators in the system is nG , the congestion cost at the settlement period T is [37]:

$$CC_t = \sum_{i=1}^{24} \sum_{j=1}^{nG} p_{it} \times (P_{Git} - P_{Git}') \quad (7)$$

$$p_{it} = a_i P_{Git}^2 + b_i P_{Git} + c_i \quad (8)$$

where p_{it} is the energy cost for generator G_i at time t ; P_{Git} and P_{Git}' is the power output without and with network constraints; a_i, b_i and c_i are the coefficients of generation cost at bus i .

Total Congestion Cost (TC) in one year:

$$TC = \sum_{t=1}^{8760} \sum_{i=1}^{nG} C_{it} \times p_{it} \times (LF_{it} - LF_{it}') \times dt \quad (9)$$

where C_{it} is the installed capacity of G_{it} at time t , LF_{it} is the load factor without any constraints, and LF_{it}' is the actual load factor which means the transmission constraints are considered.

Load factors specified for time t reflects generator's contribution to different levels of system congestions during different times. The load factor of generator i , LF_{it} , is calculated as [38, 39]:

$$LF_{it} = \frac{\sum_{t=1}^T GP_{it}}{C_{Gi} \times SP} \quad (10)$$

where, $\sum_{t=1}^T GP_{it}$ is the sum of outputs of generator k for the time in period T ; C_{Gi} stands for the capacity of generator i ; SP is the number of time periods (0.5h) contained.

For a specific generator i , the total congestion cost is:

$$TC_i = \sum_{t=1}^{8760} [C_{it} \times p_{it} \times (LF_{it} - LF_{it}')] \quad (11)$$

The congestion cost is allocated to branch l , based on PTDF, represented as:

$$TC_{il} = AC_PTDF_l \times TC_i \quad (12)$$

The total congestion cost for branch l is:

$$CC_l = \sum_i^{n_G} (AC_PTDF_l \times TC_i) \quad (13)$$

5. NETWORK PRICING FOR ES

The pricing scheme for ES is designed based on the core concept of LRIC. The difference of system LRIC with and without ES operation is treated as the network price for ES. The operation of ES can reduce network flow at peak period, which will lead to congestion cost reduction and investment cost deferral. The original reinforcement horizon n_l will be deferred by n_c years to n_{inv} . This horizon will be deferred longer time from n_{inv} to n_{invS} by ns years if the ES involved.

5.1 LRIC with Congestion Management (LRIC_l)

LRIC with network congestion management is used here, which integrates the short-run congestion cost with long-run investment cost [40]. If congestion occurs at n_l , it might be cheaper to pay congestion cost rather than investing the network. Assuming n_c is the period before the annual congestion cost exceeding annualised investment cost, the time to reinforce with congestion management (n_{inv}) is [23]:

$$n_{inv} = n_l + n_c \quad (\text{When } ACC_l^{n_{inv}} > APV_l^{n_{inv}}) \quad (14)$$

where, $APV_l^{n_{inv}}$ is the annuitised present value of investment cost and $ACC_l^{n_{inv}}$ is the annuity congestion cost in year n_{inv} with a given load growth rate r .

$$PV_l = \frac{Asset_l}{(1+d)^{n_{inv}}} \quad (15)$$

$$APV_l^{n_{inv}} = PV_l \times AnnuityFactor \quad (16)$$

$$ACC_l^{n_{inv}} = \frac{CC_l^{n_{inv}}}{(1+d)^{n_{inv}}} \quad (17)$$

where $Asset_l$ is the modern equivalent value for branch l ; $CC_l^{n_{inv}}$ is the congestion cost for branch l at year n_{inv} ; and d is the discount rate .

As a result of a nodal injection ΔP_{kN} at busbar k , ΔP_{kl} is assumed to be the power flow change along the circuit. With the power flow change, there will be a new reinforcement horizon ($n_{inv,new}$)

$$n_{inv,new} = n_{c,new} + n_{l,new} \quad (18)$$

$$PV_{l,new} = \frac{Asset_l}{(1+d)^{n_{inv,new}}} \quad (19)$$

$$APV_l^{n_{inv,new}} = PV_{l,new} \times AnnuityFactor \quad (20)$$

$$ACC_l^{n_{inv,new}} = \frac{CC_l^{n_{inv,new}}}{(1+d)^{n_{inv,new}}} \quad (21)$$

Thus, the long-run incremental cost (LRIC_l) for branch l with ES is presented as:

$$APV_l = APV_l^{n_{inv,new}} - APV_l^{n_{inv}} \quad (22)$$

$$LRIC_l = \frac{APV_l}{\Delta P_{KN}} \quad (23)$$

5.2 Network Cost with ES

When the ES is used for peak shaving, more load can be accommodated with the same network capacity, which means the investment of the system will be deferred. It is assumed that the ES can discharge ES_{Sp} energy during the peak period which can be determined in Equation (1-4).

Due to ES operation, the reinforcement horizon can be defer n_s years from n_{inv} to n_{invs} . The reinforcement horizon for the system (n_{invs}) is represented as:

$$n_{invs} = n_l + n_c + n_s \quad (\text{if } ACC_l^{n_{invs}} > APV_l^{n_{invs}}) \quad (24)$$

$$n_s = \frac{\log P_l - \log(P_l - \alpha \times ES_{Sp})}{\log(1+r)} \quad (25)$$

where, $APV_l^{n_{invs}}$ is the annuitised present value of investment cost and $ACC_l^{n_{invs}}$ is the annuity congestion cost in year n_{invs} . α is the coefficient factor from PTDF matrix, which is the contribution of ES to branch flow.

As a result of a nodal injection ΔP_{iN} at node i , the new investment horizon (n_{invs_new}), with ES_{Sp} load level decreasing at the peak, can be determined. Correspondingly, the new annuitised present value of investment cost and the new annuity congestion cost will change to $APV_l^{n_{invs_new}}$ and $ACC_l^{n_{invs_new}}$.

The LRIC for branch l ($LRIC_{ls}$) with ES is

$$APV_{ls} = APV_l^{n_{invs_new}} - APV_l^{n_{invs}} \quad (26)$$

$$LRIC_{ls} = \frac{APV_{ls}}{\Delta P_{iN}} \quad (27)$$

Therefore, the long-run incremental cost for ES ($LRICs$) is the difference of the costs with and without it

$$LRICs = \frac{APV_l - APV_{ls}}{\Delta P_{iN}} = LRIC_{ls} - LRIC_l \quad (28)$$

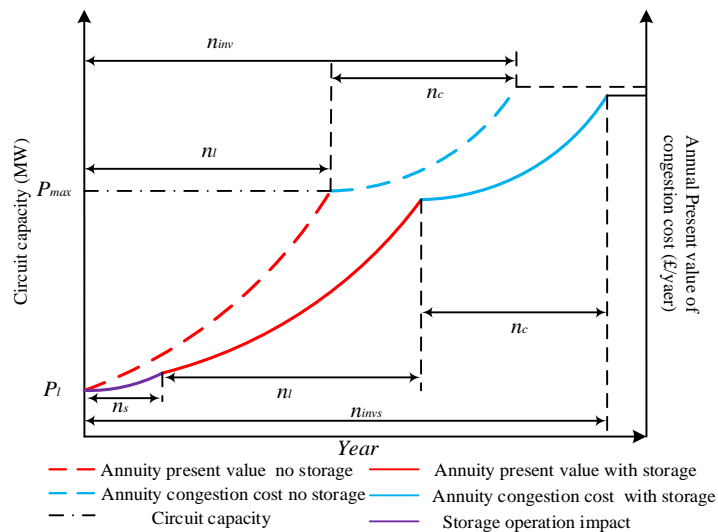

Fig.4 Horizon to reinforcement of circuit l in transmission network

Based on the proposed C/D strategy, the impacts on network investment cost resulting from ES at different loading levels are plotted in Fig. 4. The red and blue dashed lines are the original time to reinforcement without ES operation but with congestion management (load/generation curtailment). The ES can add n_c years to the total reinforcement horizon, deferring the horizon with congestion management from year n_{inv} to n_{invs} .

6. CASE STUDY

The proposed C/D method and pricing scheme is demonstrated on a two-busbar network in Fig. 5, with typical winter weekend load profile at busbar 2 [23]. In simplify the analysis, the following assumptions are adopted: i) the losses of energy storage is zero; ii) the minimum and maximum SOC levels are 0% and 100% respectively; iii) the daily storage cycle is one.

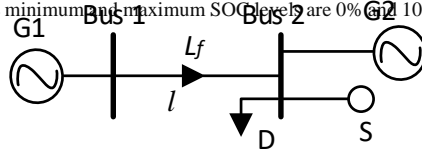

Fig. 5. Two-busbar network

It is assumed that the capacity of branch l , connecting busbars 1 and 2, is 45 MW, with asset costs £3193400 at its modern equivalent asset value. The lifespan is 40 years and annuity factor is 0.0831 [23]. The load growth of 2% and the discount rate of 5.6% are chosen. The capacity of the ES is 20MWh and its hourly max output power is 5MW. As it is a two-busbar network, the coefficient factor (α) in PTDF is 1. It is also assumed that the C/D operation rates are constant.

The energy cost model for the two generators is

$$G_1 = 0.02P_1^2 + 20P_1 (0 \leq P_1 \leq 50\text{MW}) \quad (29)$$

$$G_2 = 0.01P_2^2 + 30P_2 (0 \leq P_2 \leq 50\text{MW}) \quad (30)$$

6.1 The Application of Charging and Discharging Methods

The system demand is from the historical data on winter weekend during 2014~2015. The original load profile of the peak day is the green curve in Fig. 6.

The peak demand occurs around 19:15 and the valley period is in the morning at 5 am. It is assumed that the ES works under maximum C/D rate and td is the average tariff in a day (the dash line). From 16:00 to 22:00, the tariff is higher than td , indicating the period is discharging candidate and other periods are charging candidates. With the proposed method, the ES system discharges in the peak period during 17:00 to 20:00 and charge from 03:00 to 06:00 based on the lowest loading level. The new load profile is much smoother depicted by the blue.

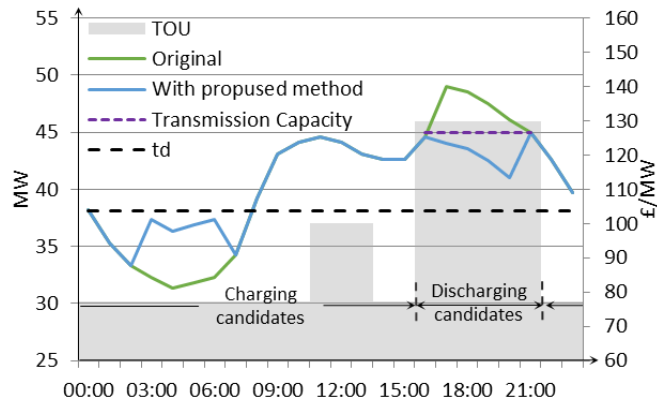

Fig.6. New load profile with proposed charging method.

6.2 The Impact of Different Operation Methods

This section evaluates the impacts of two different operation methods: 1) the proposed methods (ES discharges during peak periods and charges during off-peak periods); 2) the contrary method (ES charges during peak periods and discharges during off-peak periods).

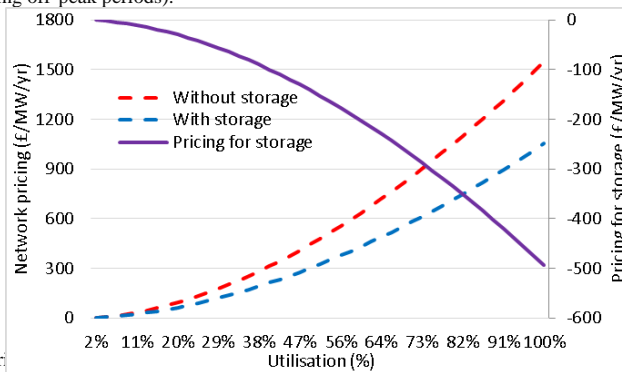

Fig.7. Pr

With the proposed method, the difference of total network cost, investment and operation, between the cases with and without ES (the red and blue dashed curves) is the pricing signals for ES (in purple in Fig.7). When it negative, it means the ES can generate profits, which actually is benefit. It can be observed that the benefit for ES increases dramatically as the branch utilisation level increases. The reinforcement horizon is deferred because network congestion is released because of ES discharging. The horizon of future investment is deferred by around 5-year with the ES.

With the contrary method, the ES charges in the peak period and thus the loading level will rise, causing congestion to be more serious. It means that the ES advances network investment and thus is punished for paying more network costs.

6.3 The Impact of High C/D Rate VS. Low C/D Rate

It is assumed that the ES is fully charged or discharged at high C/D rate (C-rate), and half charged or discharged under low C-rate. By implementing the proposed methodology, the impact of its operation on the load profile is shown in Fig. 8. The ES system with higher C-rate contributes more to peak reduction, 4MW for high C-rate and 2.5MW for low C-rate, indicating that high C-rate could lead to larger investment deferral

than the lower.

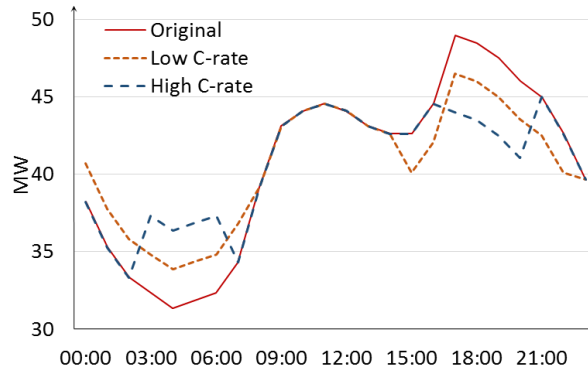

Fig. 8. Reformed load profile with different C-rates

Table I: Pricing for ES with proposed method under different C-rates

Load	20MW	40MW	45MW	50MW
Low C-rate (£/MW/year)	-198	-666	-818	-2625
High C-rate (£/MW/year)	-214	-718	-882	-3705

Table I shows the price signals to the ES with different branch utilisation levels. The signal is the difference between the cost without and with ES operation under high C-rate/low C-rate. If the C-rate is high, the ES can achieve much more profits from network cost savings. With increasing utilisation, the difference between high and low C-rate increases. For example, if the load level doubles from 20MW to 40MW, the reward for ES with high C-rate changes from £214/MW/year to £718/MW/year.

6.4 The Impact of Different Capacity of ES

In this subsection, it is assumed that the ES has the same C/D rate (5MW/h), but the capacity of ES are 20MWh and 30MWh respectively. The new load profiles in the two scenarios are in Fig. 9. With different ES capacities, the C/D durations are different, which produce different peaks. When the ES capacity is 20 MWh, the system peak occurs at 21:00 with the amount of 45MW. The peak appears at 11:00 with the amount of 44MW when the capacity is 30MWh. Although the capacity of the ES increases 50%, the peak only reduces 2% because the peak has already been shifted to another time period.

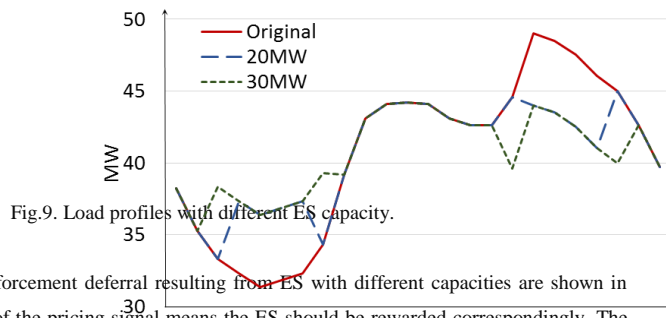

Fig.9. Load profiles with different ES capacity.

The price signals and reinforcement deferral resulting from ES with different capacities are shown in Table II. The negative value of the pricing signal means the ES should be rewarded correspondingly. The benefit climbs swiftly when the load exceeds branch capacity and the benefit for 30MWh ES is higher than

that for the 20MWh case. For example, at the peak time, the benefit is £205.2/MW/yr for the 30MWh case at load level 20MW, which increases almost 7 times to £1491.7/MW/yr at load level 60MW. In terms of reinforcement deferral, the 20MWh case can defer 5.6 years while with the case of 30MWh it can defer 6.3 years.

Table II: Pricing ES with Different Capacity (£/MW/yr)

Load (MW)	20MWh case	30MWh case
20	-174.5	-205.2
40	-586.2	-689.5
45	-720.3	-847.2
50	-866.2	-1018.7
60	-1191.7	-1401.6

7. PRACTICAL NETWORK DEMONSTRATION

The proposed pricing method for ESs is demonstrated on a practical GSP area taken from the U.K. distribution network in Fig.10 [41]. This study modifies busbars 1007 and 1006 by adding ESs at the two busbars. It is assumed that both ES capacities are 12MWh and the maximum hourly C/D rate is 3MW. The annuity factor, load growth, and disco

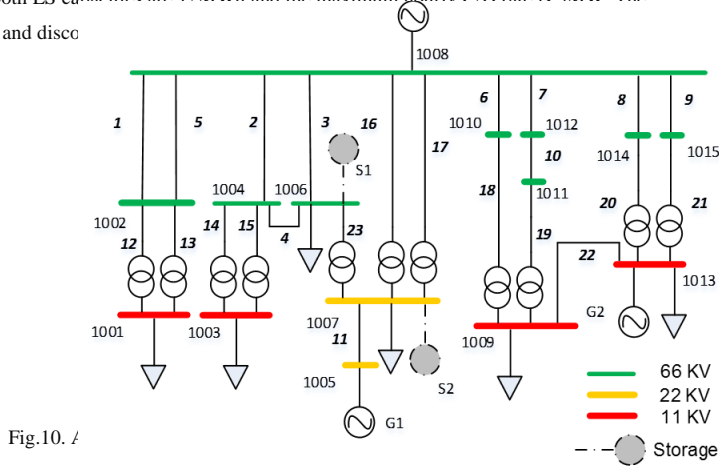

Fig.10. /

Table III: The PDTF Matrix for GSP System

Node	1006	1007	Node	1006	1007
Branch No.2	0.76	0.24	Branch No. 16	0.02	0.34
Branch No.3	0.85	0.27	Branch No. 17	0.02	0.31
Branch No.4	0.81	0.27	Branch No. 23	0.07	0.26

Due to the big size of PDTF matrix, here only those of busbars 1007 and 1006 with respect to corresponding branches are given in Table III. It can be observed that branch No.4 is highly impacted by the load at bus 1006 and branch No.3 is highly impacted by node change at bus 1007.

By flow analysis, overloading only appears at branches No.3, No.16 and No.23, shown in Fig.11. The ToU tariff is shown in the same figure and td is selected based on the average tariff of the day. With selected threshold, the C/D candidates can be determined. There are two peaks in the tariff during 08:00~12:00 and 16:00~20:00, which are discharging candidate periods (② and ④) and others are charging candidates. It is

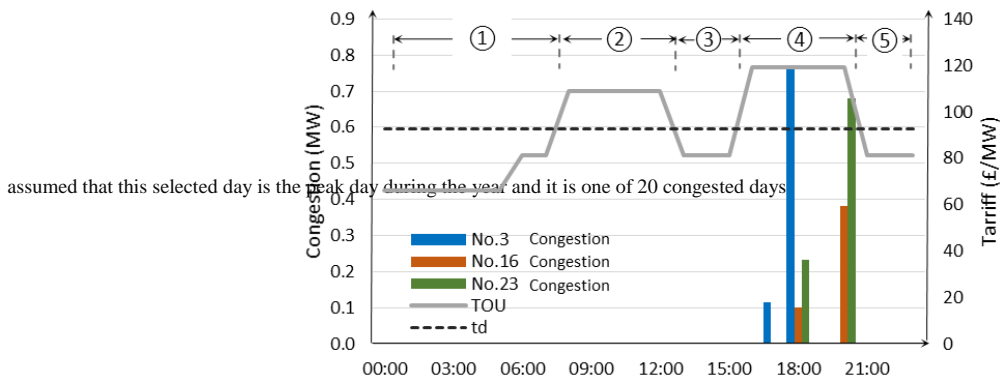

Fig.11. ToU tariff, the charging candidates' period and congested load

Line No.	Line No.1	Line No.2	Line No.3	Line No.4	Line No.5
Line No.1					
Line No.2					
Line No.3					
Line No.4					
Line No.5					
Sum	-	-	-	8	6.9

In this distribution system with limited generation, the congestion cost mainly comes from load curtailment. Accordingly, the load curtailment cost is £5.3k/MWh [42]. The impact of ES operation to these three overloading lines and other branches are analysed and listed in Table IV.

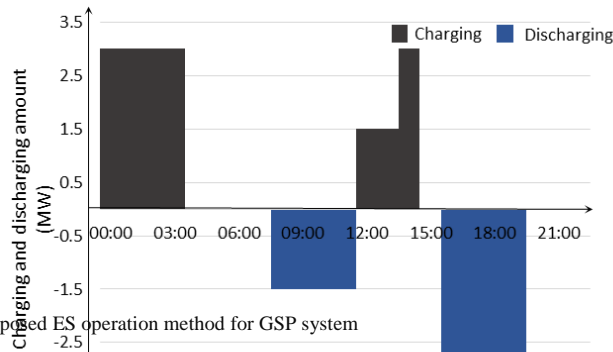

Fig. 12. Proposed ES operation method for GSP system

Responding to the same ToU tariffs, the ESs locating at busbars 1006 and 1007 have the same C/D time and durations, shown in Fig.12. With the proposed operation method, ESs discharge during 9:00 to 12:00 and 17:00 to 20:00, which covers the two peak periods. They charge during 1:00 to 4:00 and 13:00 to 15:00. During 1:00 to 4:00 and 17:00 to 20:00, the ESs work at the maximum C-rate (3MW/h). Since the tariffs are not the highest, the ESs should not fully discharge during the middle day in order to reserve enough capacity for the highest pricing periods to ensure the maximum profits. Therefore, the ESs operate under low C-rate (1.5MW/h) during this period.

7.2 Case of ES Located at Busbar 1006

The original load profile at bus 1006 is represented by the dashed line in Fig.13. With the proposed method, the new profile is the blue line, whose peak appears around 15:00. The changes of power flow in the three overloading lines are shown in Fig.14. It can be observed that the peaks of branches 1006-1008 and 1008-1007 both decrease from 55.3MW to 52.6MW and from 25.6MW to 25.5MW respectively. However, ES operation poses opposite impact on branch 1006-1007 because discharging at busbar 1006 increases its flow, with the peak increasing from 17.4MW to 17.6MW.

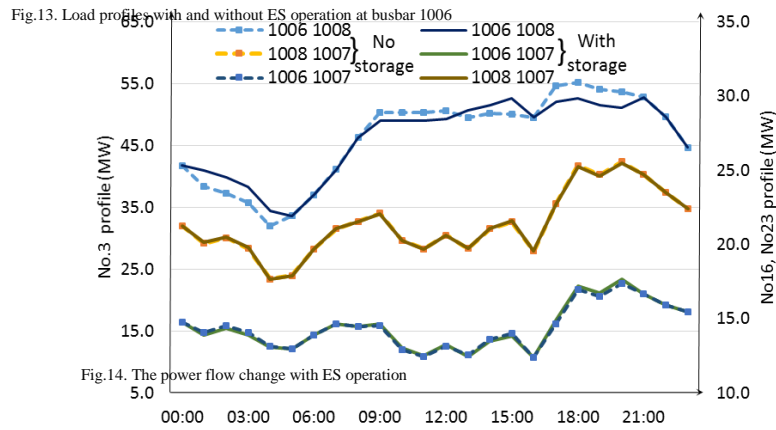
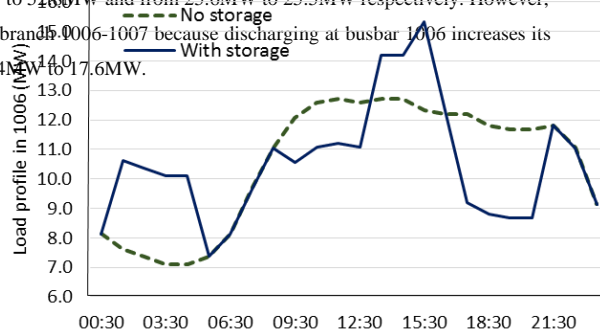

Table V shows the impacts from ES located at bus 1006 in terms of investment cost and congestion cost with ES operation, which decrease for all branches except branch 1006-1007. The peak load on branch 1006-1007 increases by 0.2MW. Therefore, the price for ES is positive, £2.3/MW/year, which means the ES is punished for increasing the peak. The prices from other branches are rewards to ES, and thus in total, ES should be rewarded under the proposed C/D method.

Table V: The Impact to Different Lines from ES at Busbar 1006

Branch	Peak↓ (MW)	Time deferral (yr)	Congestion cost (£k)	Network charges with ES (£/MW/yr)	Price for ES (£/MW/yr)
No.3	2.5	-4.2	0	7073.4	-472.1
No.16	0.1	-0.2	31.8	15.8	-0.2
No.23	-0.2	1.2	159	55.7	2.3
Other	0.4	6.5	95.4	7386.9	-519.0

7.1 Case of ES Located at Busbar 1007

The load profile at bus 1007 is the dashed curve in Fig.15, which has two high loading periods around 4:00 and 14:00. The new load profile with ES is the solid curve.

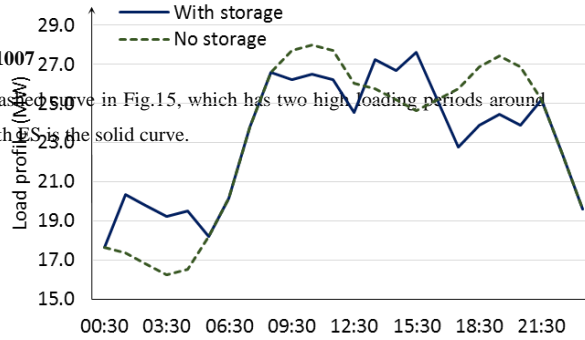

Fig.15. Load profiles with and without ES operation at busbar 1007

The power flow changes resulting from ES operation in branches No.3 and No.16 have the similar trend, compared to the case with the ES at 1006, which is shown in Fig. 16. The peaks on these two branches decrease from 55.3MW to 54.4MW on No.3 and from 25.6MW to 24.7MW on No.16. The peak load changes from 17.4MW to 16.7MW for branch No.23. It can be seen that the peaks of the three lines all drop below their capacity, indicating that congestion cost decreases to zero.

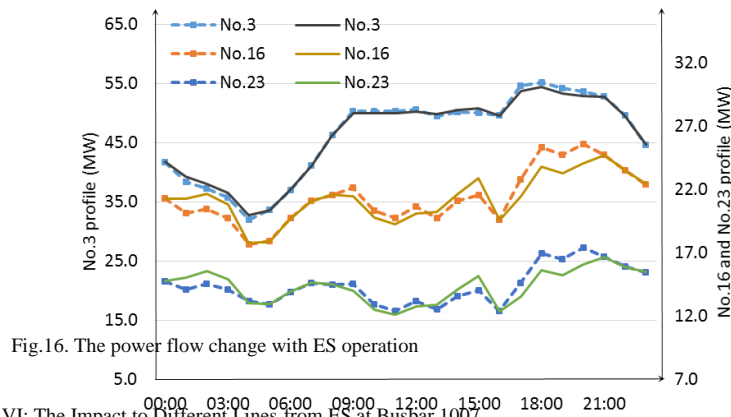

Fig.16. The power flow change with ES operation

Table VI: The Impact to Different Lines from ES at Busbar 1007

Branch	Peak↓ (MW)	Congestion cost (£k)	Network charges no ES (£/MW/yr)	Network charges with ES (£/MW/yr)	Price for ES (£/MW/yr)
No.3	0.8	0	2352.5	2304.6	-48.0
No.16	0.9	0	303.9	265.1	-38.7
No.23	0.7	0	265.5	227.0	-38.6
Other	3.3	0	3002.6	2872.3	-130.3

Table VI shows the impacts from ES operation in terms of network investment cost and congestion cost, both of which decrease for all branches. Since all branch overloadings are removed, the congestion cost changes to zero after ES operation. Although the ES can produce 0.9MW peak reduction on branch No.16,

the price for ES is -38.7 £/MW/yr which is less than that from branch No.3. Because the asset cost of No.3 is larger than that of No.16, the ES can obtain more incentives if it contributes more to the peak reduction.

Compared with the ES at bus 1006, there are fewer benefits from branch No.3 due to the less peak reduction compared to the case when the ES locates at bus 1006.

7.3 The tariff for the ES at busbar 1006 and 1007

Figs. 17 and 18 show the tariff for ES at busbar 1006 and 1007. The pricing signal only exists during the ES operation when it impacts the overloading on the branches. Therefore, the ES get rewarded during its discharging period for its overloading reduction and punished if it increases the overlandings.

The tariff for ES at busbar 1006 is depicted in Fig. 17. The positive value means that the ES should be punished resulting from its discharging and negative for rewards. ES is rewarded around £1200/MW at 18:00 and punished around £200/MW at 20:00. The punishment comes from the loading level increase on branches No.4, and No.23 and the congestion costs increase on these branches are essential.

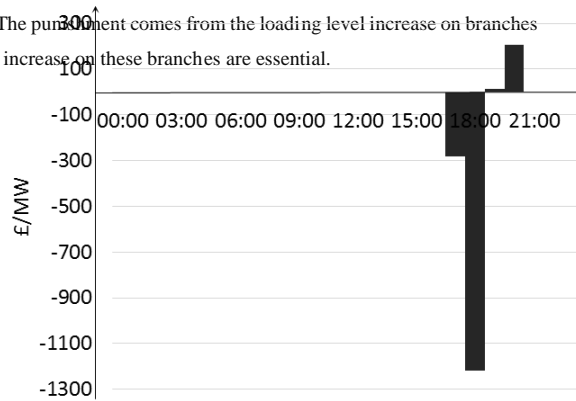

Fig.17. The tariff for ES at busbar 1006

Fig 18 shows the tariff for ES at busbar 1007, the ES will get more than £600/MW incentives at 18:00 and 20:00 and lesser at other times.

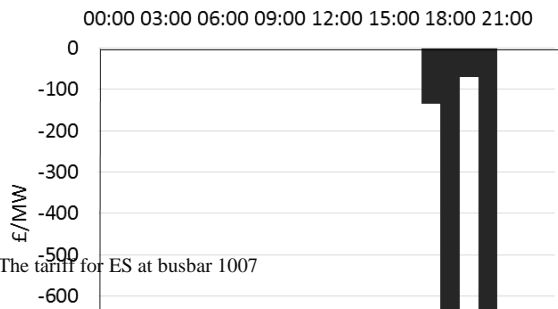

Fig.18. The tariff for ES at busbar 1007

Table VII shows the impacts from ES located at busbar 1006 and 1007 in terms of reinforcement horizon. For branch No.3, the ES located at bus 1007 could bring 0.8 years deferral which is smaller than that resulting from ES at busbar 1006 (2.5 years). Especially, the impacts to No.23 are totally different from location

difference, where the ES at bus 1007 defers 3.7 years and the ES at bus 1006 brings it 0.7 years forward.
The branch No.4 contributes more to other branches' reinforcement horizon change.

Table VII: The Impact to Different Lines in Time to Reinforcement (year)

Branch	No.3	No.16	No.23	Other
ES 1006 Deferral	-2.5	-0.1	0.7	6.5
ES 1007 Deferral	-0.8	-2.8	-3.7	-0.4

Normally, in real applications, energy storage operators, only have the information of ToU tariffs from system operators and the charging and discharging methods are defined day ahead to maximise energy cost savings in response to ToU tariffs. In addition, ES can bring benefits to the networks, such as reduced network congestion and investment, which means the positive impacts should be converted into pricing signals to incentive ES. The proposed approach in this paper provides price signals for ES based on the impacts on network congestion and reinforcement costs. Network operators can broadcast the signals to ES by calculating the congestion cost and investment cost savings, and then convert these savings into economic signals to ES. With these signals, ES owners will easily see more profits by responding to network conditions as well, apart from responding to ToU tariffs. Although ES owners can choose operation periods, the new pricing signals will provide them more opportunities to help resolve network congestion and investment issues so as to obtain more profits.

8. CONCLUSIONS

This paper designs a novel pricing scheme for ESs to reflect its impact on networks so that network operator can reward or penalise them accordingly. Through extensive demonstration, the following key findings are obtained:

- In terms of C/D methods, appropriate operational methods will defer future network reinforcement horizon and benefits network investment. Otherwise, the ES will increase system overloading and ES should be penalised.
- In terms of capacity, larger ES may not reduce peak loading level effectively because the peak may shift to another period. It means the investment cost does not change and the benefits are only from congestion costs change. ES will achieve more benefits from network cost saving if it locates nearby expensive branches.
- In terms of C-rate, the peak loading level decreases more under higher C-rate, which means ESs can obtain more incentives from congestion and investment cost savings.

Future research will be dedicated to understanding the impact of efficiency, losses and other different characteristics of ES and the siting and sizing to future investment and operation. Thus, more cost-effective pricing schemes can be designed to reflect ES impact on network investment and operation. ESs owned by customers operated to mitigate renewable output will be also investigated in the future work.

REFERENCES

- [1] S. Teleke, M. E. Baran, S. Bhattacharya, and A. Q. Huang, "Optimal control of battery energy storage for wind farm dispatching," *IEEE Transactions on Energy Conversion*, vol. 25, pp. 787-794, 2010.

- [2] D. Wu, F. Tang, T. Dragicevic, J. C. Vasquez, and J. M. Guerrero, "Autonomous active power control for islanded AC microgrids with photovoltaic generation and energy storage system," *IEEE Transactions on Energy Conversion*, vol. 29, pp. 882-892, 2014.
- [3] BusinessGreen, "UK energy storage tipped to exceed 1.6GW by 2020," <http://www.businessgreen.com/bg/analysis/2442158/uk-energy-storage-tipped-to-exceed-16gw-by-2020>, 2016.
- [4] X. Han, H. Zhang, X. Yu, and L. Wang, "Economic evaluation of grid-connected micro-grid system with photovoltaic and energy storage under different investment and financing models," *Applied Energy*, vol. 184, pp. 103-118, 12/15/ 2016.
- [5] D. Zafirakis, K. J. Chalvatzis, G. Baiocchi, and G. Daskalakis, "Modeling of financial incentives for investments in energy storage systems that promote the large-scale integration of wind energy," *Applied Energy*, vol. 105, pp. 138-154, 2013/05/01/ 2013.
- [6] A. Shcherbakova, A. Kleit, and J. Cho, "The value of energy storage in South Korea's electricity market: A Hotelling approach," *Applied Energy*, vol. 125, pp. 93-102, 2014/07/15/ 2014.
- [7] D. Zafirakis, K. J. Chalvatzis, G. Baiocchi, and G. Daskalakis, "The value of arbitrage for energy storage: Evidence from European electricity markets," *Applied Energy*, vol. 184, pp. 971-986, 2016/12/15/ 2016.
- [8] H. Akhavan-Hejazi and H. Mohsenian-Rad, "A stochastic programming framework for optimal storage bidding in energy and reserve markets," in *Innovative Smart Grid Technologies (ISGT), 2013 IEEE PES*, 2013, pp. 1-6.
- [9] B. Daryanian, R. E. Bohn, and R. D. Tabors, "Optimal demand-side response to electricity spot prices for storage-type customers," *IEEE Transactions on Power Systems*, vol. 4, pp. 897-903, 1989.
- [10] T. Jiang, Y. Cao, L. Yu, and Z. Wang, "Load shaping strategy based on energy storage and dynamic pricing in smart grid," *IEEE Transactions on Smart Grid*, vol. 5, pp. 2868-2876, 2014.
- [11] I. Papic, "Simulation model for discharging a lead-acid battery energy storage system for load leveling," *IEEE Transactions on Energy Conversion*, vol. 21, pp. 608-615, 2006.
- [12] R. M. Dickinson, C. A. Cruickshank, and S. J. Harrison, "Charge and discharge strategies for a multi-tank thermal energy storage," *Applied Energy*, vol. 109, pp. 366-373, 2013/09/01/ 2013.
- [13] C. Zhang, J. Jiang, Y. Gao, W. Zhang, Q. Liu, and X. Hu, "Charging optimization in lithium-ion batteries based on temperature rise and charge time," *Applied Energy*, vol. 194, pp. 569-577, 2017/05/15/ 2017.
- [14] Y. Bi, T. Guo, L. Zhang, L. Chen, and F. Sun, "Entropy generation minimization for charging and discharging processes in a gas-hydrate cool storage system," *Applied Energy*, vol. 87, pp. 1149-1157, 2010/04/01/ 2010.
- [15] A. Sani Hassan, L. Cipcigan, and N. Jenkins, "Optimal battery storage operation for PV systems with tariff incentives," *Applied Energy*, vol. 203, pp. 422-441, 2017/10/01/ 2017.
- [16] S. Teleke, M. E. Baran, A. Q. Huang, S. Bhattacharya, and L. Anderson, "Control strategies for battery energy storage for wind farm dispatching," *IEEE Transactions on Energy Conversion*, vol. 24, pp. 725-732, 2009.
- [17] A. Shahmohammadi, R. Sioshansi, A. J. Conejo, and S. Afsharnia, "Market equilibria and interactions between strategic generation, wind, and storage," *Applied Energy*.
- [18] Gov.uk, "Energy storage use cases (DNV GL for BEIS)," https://www.gov.uk/government/uploads/system/uploads/attachment_data/file/554467/Energy_Storage_Use_Cases.pdf, 2016.
- [19] Ofgem, "A smart, flexible energy system," <https://www.gov.uk/government/consultations/call-for-evidence-a-smart-flexible-energy-system>, 2016.
- [20] E.-f. project, "Regulatory barriers to energy storage deployment: the UK perspective," <http://www.restless.org.uk/>, 2016.
- [21] U.S. Department of Energy "Grid energy storage," <https://energy.gov/>, 2013.
- [22] E. Parliament, "Energy storage: Which market designs and regulatory incentives are needed?," [http://www.europarl.europa.eu/RegData/etudes/STUD/2015/563469/IPOL_STU\(2015\)563469_EN.pdf](http://www.europarl.europa.eu/RegData/etudes/STUD/2015/563469/IPOL_STU(2015)563469_EN.pdf), 2015.
- [23] F. Li and D. L. Tolley, "Long-run incremental cost pricing based on unused capacity," *Power Systems, IEEE Transactions on*, vol. 22, pp. 1683-1689, 2007.
- [24] U. K. London, "Review of distribution use of system charging methodology," *Frontier Economics Ltd*, 2008.
- [25] U. P. NETWORKS, "The business case of storage," <http://innovation.ukpowernetworks.co.uk/innovation/en/>, 2016.
- [26] C. Shao, X. Wang, M. Shahidepour, X. Wang, and B. Wang, "Partial decomposition for distributed electric vehicle charging control considering electric power grid congestion," *IEEE Transactions on Smart Grid*, vol. 8, pp. 75-83, 2017.
- [27] S. Huang, Q. Wu, L. Cheng, Z. Liu, and H. Zhao, "Uncertainty management of dynamic tariff method for congestion management in distribution networks," *IEEE Transactions on Power Systems*, vol. 31, pp. 4340-4347, 2016.
- [28] J. D. Lyon, K. W. Hedman, and M. Zhang, "Reserve requirements to efficiently manage intra-zonal congestion," *IEEE Transactions on Power Systems*, vol. 29, pp. 251-258, 2014.
- [29] J. H. Teng, S. W. Luan, D. J. Lee, and Y. Q. Huang, "Optimal charging/discharging scheduling of battery storage systems for distribution systems interconnected with sizeable pv generation systems," *IEEE Transactions on Power Systems*, vol. 28, pp. 1425-1433, 2013.
- [30] R. C. Leou, "Optimal charging/discharging control for electric vehicles considering power system constraints and operation costs," *IEEE Transactions on Power Systems*, vol. 31, pp. 1854-1860, 2016.
- [31] L. Zhou, F. Li, C. Gu, Z. Hu, and S. L. Blond, "Cost/benefit assessment of a smart distribution system with intelligent electric vehicle charging," *IEEE Transactions on Smart Grid*, vol. 5, pp. 839-847, 2014.
- [32] Z. Wang, F. Li, and Z. Li, "Active household energy storage management in distribution networks to facilitate demand side response," in *2012 IEEE Power and Energy Society General Meeting*, 2012, pp. 1-6.
- [33] W. P. Distribution, "Energy storage growth scenarios and operating modes," <https://www.westernpower.co.uk/>, 2017.
- [34] F. K. Hanna and A. K. Misra, "Hardware realisation of binary search algorithm," *IEE Proceedings E - Computers and Digital Techniques*, vol. 127, pp. 148-151, 1980.
- [35] S. C. S. Ashwani Kumar, "AC power transfer distribution factors for allocating power transactions in a deregulated market," *IEEE Power Engineering Review*, vol. 22, pp. 42-43, 2002.
- [36] A. K. Sharma and J. Kumar, "ACPTDF for multi-transactions and ATC determination in deregulated markets," *International Journal of Electrical and Computer Engineering*, vol. 1, p. 71, 2011.
- [37] L. Jiangtao and L. Furong, "A congestion index considering the characteristics of generators & networks," ed, 2012, pp. 1-6.
- [38] J. Li and F. Li, "A congestion index considering the characteristics of generators & networks," in *Universities Power Engineering Conference (UPEC), 2012 47th International*, 2012, pp. 1-6.
- [39] J. Li, "Phd thesis: Transmission Use of System Charges for a System with Renewable Energy," http://opus.bath.ac.uk/45264/1/Jiangtao_Li_095902333.pdf%20, 2015.
- [40] Z. Li, F. Li, and Y. Yuan, "Transmission use of system charges based on trade-offs between short-run operation cost and long-run investment cost," *IEEE Transactions on Power Systems*, vol. 28, pp. 559-561, 2013.

- [41] C. Gu, F. Li, and Y. He, "Enhanced long-run incremental cost pricing considering the impact of network contingencies," *Power Systems, IEEE Transactions on*, vol. 27, pp. 344-352, 2012.
- [42] E. N. West, "The value of lost load methodology statement," <http://www.enwl.co.uk/docs/default-source/future-voll/voll-methodology-statement-version-1.pdf?sfvrsn=10>, 2016.