



*Citation for published version:*

Enang, W & Bannister, C 2017, 'Modelling and control of hybrid electric vehicles (a comprehensive review)', *Renewable and Sustainable Energy Reviews*, vol. 74, RSER-D-16-01913R1, pp. 1210-1239.  
<https://doi.org/10.1016/j.rser.2017.01.075>

*DOI:*

[10.1016/j.rser.2017.01.075](https://doi.org/10.1016/j.rser.2017.01.075)

*Publication date:*

2017

*Document Version*

Peer reviewed version

[Link to publication](#)

*Publisher Rights*

CC BY-NC-ND

## University of Bath

**General rights**

Copyright and moral rights for the publications made accessible in the public portal are retained by the authors and/or other copyright owners and it is a condition of accessing publications that users recognise and abide by the legal requirements associated with these rights.

**Take down policy**

If you believe that this document breaches copyright please contact us providing details, and we will remove access to the work immediately and investigate your claim.

# MODELLING AND CONTROL OF HYBRID ELECTRIC VEHICLES (A COMPREHENSIVE REVIEW)

Wisdom Enang<sup>1\*</sup>

(1) University of Bath, Bath, UK

(\*) Corresponding Author (wpe20@bath.ac.uk, wisdom\_enang@yahoo.co.uk)

## ABSTRACT

The gradual decline in global oil reserves and presence of ever so stringent emissions rules around the world, have created an urgent need for the production of automobiles with improved fuel economy. HEVs (hybrid electric vehicles) have proved a viable option to guarantying improved fuel economy and reduced emissions. The fuel consumption benefits which can be realised when utilising HEV architecture are dependent on how much braking energy is regenerated, and how well the regenerated energy is utilized. The challenge in developing an HEV control strategy lies in the satisfaction of often conflicting control constraints involving fuel consumption, emissions and driveability without over-depleting the battery state of charge at the end of the defined driving cycle.

To this effect, a number of power management strategies have been proposed in literature. This paper presents a comprehensive review of theses literatures, focusing primarily on contributions in the aspect of parallel hybrid electric vehicle modelling and control. As part of this treatise, exploitable research gaps are also identified. This paper prides itself as a comprehensive reference for researchers in the field of hybrid electric vehicle development, control and optimization.

*Index Terms:* - Heuristic control, Hybrid electric vehicle, Regenerative braking, Optimization of brake energy recovery, dynamic programming, optimal control, HEV control, vehicle modelling, Parallel HEV, ECMS, Model predictive control, GPS

# 1 INTRODUCTION

The gradual decline of global oil reserves, in addition to stringent emission regulations around the world, has made even more critical the need for improved vehicular fuel economy [1-3]. In recent years, the scientific community and industries alike have proposed a variety of innovations to face this challenge, coming up with new solutions from the viewpoint of hybrid powertrain architectures. Hybrid electric vehicles (HEVs) are able to address this problem by introducing a powertrain with an additional propulsion system, which consists in its simplest form of an electrical energy storage unit (an electric battery), an electric torque actuator (an electric motor) and a device which couples together the electric driveline and the thermal driveline. The additional driveline allows for greater flexibility in engine use while ensuring fulfilment of the power request at the wheels.

In comparison to conventional vehicles, HEVs offer a number of advantages. The most popular of such advantages is the possibility of downsizing the original internal combustion engine whilst meeting the power demand at the wheels. This advantage is brought about by the capability of the hybrid powertrain to deliver power to the wheels from both the internal combustion engine and the electric motor at the same time, thus resulting in reduced fuel consumption [4, 5]. The introduction of an electric driveline in an HEV also allows for the regeneration of kinetic braking energy, which would otherwise be lost to mechanical brakes in conventional vehicles.

Crucial to achieving the aforementioned advantages is a real time control strategy capable of coordinating the on-board power sources in order to maximise fuel economy and reduce emissions. To date, a number of energy management strategies have been proposed in literature. This treatise presents a comprehensive review of these literatures, focusing primarily on contributions in the aspect of parallel hybrid electric vehicle modelling and control. As part of this treatise, exploitable research gaps are also identified.

The contributions in this paper are elucidated as follows: First, investigations are made in to emergence of HEVs with particular emphasis on: the factors driving its development, its industrial evolution and advantages. Next, several HEV configurations are discussed in light of their characteristics and applications. Thereafter, HEV modelling techniques are briefly discussed with a view to highlighting the relative importance of each approach. Afterwards, HEV control strategies are reviewed at depth on two main tiers: HEV offline control strategies and HEV online control strategies. This detailed appraisal is aimed at highlighting the control structure of the reviewed techniques, its novelty, as well as contributions

towards the satisfaction of several optimisation objectives, which includes but are not limited to: reduction of fuel consumption and emissions, charge sustenance, optimisation of braking energy regeneration, and improvement of vehicle drivability. Finally, exploitable research gaps which form the main inspiration for the studies contained in this thesis are identified and discussed.

## **2 EMERGENCE OF HYBRID ELECTRIC VEHICLES**

In recent years, several determinants including stringent emission regulations and limitation in conventional vehicles have created an eminent and urgent need for the production of automobiles such as hybrid electric vehicles with improved fuel economy.

To contextualise the transition from conventional vehicles to HEVs, this section investigates the emergence of HEVs with particular emphasis on: the factors driving its development, its industrial evolution and advantages.

### **2.1 Vehicle emission regulations**

Increasing concerns of fossil fuels availability in the long term and environmental pollution have focused considerable attention on the problem of efficient energy utilisation in automobiles [7-11]. In response to these concerns, regulators around the world have set out various stringent emissions targets to curb regulated emissions (hydrocarbons, nitrogen oxides, carbon monoxide and particulate matter). Figure 1 provides a comparison of the EU CO<sub>2</sub> passenger car standards with similar regulations around the world. This chart converts all regulatory programs to the European test cycle (NEDC – New European Driving Cycle) for comparative reasons.

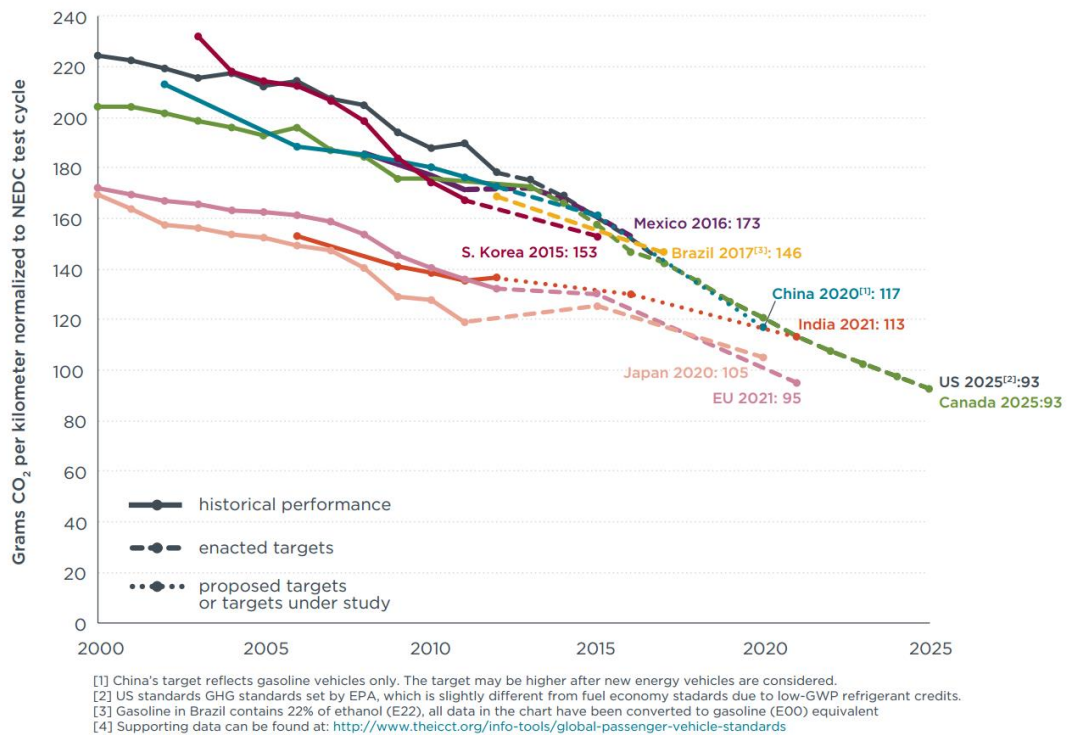

**Figure 1: Comparison of global CO<sub>2</sub> regulations for passenger cars, in terms of NEDC gCO<sub>2</sub>/km (Source: [12])**

According to Figure 1, Europe has the most progressive emissions legislation to date with an intended target of 95 grams of CO<sub>2</sub> per km in 2020. This figure represents a 27% reduction from the 2015 level and a 50% reduction from the 2010 level. In the US, a CO<sub>2</sub> target of 109 grams per km is intended for 2020 (~ 50% of the level in 2010). Similar targets have also been set in Asian countries: Japan (105 g/km by 2020), China (117 g/km by 2020) and India (113 g/km by 2020).

Meeting these standards is non-trivial, and requires the adoption of new technologies to reduce energy loss and increase efficiency within the internal combustion engine and vehicle powertrain. Over the last 20 years, the scientific community and industries alike have proposed a variety of innovations to face this challenge, developing solutions such as turbo chargers to improve fuel efficiency and catalytic converters to remove harmful gases. Whilst these technologies have directly contributed to huge improvements in automotive technology, the ever rising emissions levels (due to the increasing number of cars on the road) necessitates a new and drastic technology, with the potential to:

1. Optimise existing internal combustion engines without compromising on the performance of the vehicle [13].

2. Optimise energy demand for operation of the vehicle accessory system (42-volt electric system, low energy lighting, etc.) [14].
3. Reduce losses due to aerodynamic drag, rolling resistance and braking losses due to vehicle inertia [13].

## 2.2 Limitations in baseline vehicles

Conventional vehicles powered by internal combustion engines have dominated ground transport due to their long driving range, fuelling ease, ease of extraction and low cost compared to other vehicular technologies [15]. In recent years, internal combustion engines have achieved thermal efficiencies up to 25% for spark-ignition engines and 30% for compression-ignition engines [5]. However, internal combustion engines seldom operate at their peak efficiencies (located in the low engine speed, high engine torque area), for the following reasons:

1. Energy losses within the engine itself: The theoretical peak efficiency of a heat engine is limited by the air standard cycle, which employs the Otto cycle for reciprocating the engine. Attaining the theoretical peak efficiency is practically impossible for **at least** two reasons; the first being the loss of heat through the walls of the cylinder and the second being the compression of fuel at limited compression ratios due to knock.
2. Highly dynamic utilisation which is typical of road cycles, where vehicle speed and torque request vary continuously and rapidly.
3. Working gas is air
4. Inertia effects

The resultant effect of these shortcomings results in **less than optimal** fuel consumption and increased emissions, which is harmful to health.

HEVs are able to compensate for some of these shortcomings of the internal combustion engine, and simultaneously meet the requirements for vehicle performance and environmental protection, by introducing a powertrain with an additional propulsion system, constituted in its simplest form by an electric energy storage unit (electric battery), an electric torque actuator (electric motor) and a device which couples together the electric and thermal drivelines. It is a culmination of mechanical, electrical, electronic and power engineering technologies embracing the best of both conventional ICE vehicles and electric vehicles (EVs). The additional driveline allows for greater flexibility in engine use, while ensuring the fulfilment of the power request at the wheels.

## 2.3 Industrial evolution of hybrid electric vehicles (HEVs)

The development of the first hybrid car is reported to be in 1899 by the Pieper establishment of Liege, Belgium [16]. In 1900, Dr Ferdinand Porsche developed the world's first series hybrid electric vehicle where 2 water-cooled combustion engines with a cumulative capacity of 5 hp were used to generate electricity to run the wheel hub motors. The main aim of these motors was to assist the weakly powered gasoline engines. This concept was however short-lived due to the associated cost. In 1995, hybrid electric vehicles experienced a renewed interest from competing manufactures, owing to its potential for fuel and emissions reduction. As a result, several variations to the hybrid electric vehicle technology, as explained below, were developed: micro HEVs, mild HEVs, full HEVs and plug-in HEVs [17].

1. Micro HEVs: In micro HEVs, the electric motor, in the form of a small integrated alternator / starter, is used to shut down the engine when the vehicle comes to a complete stop, and start it up when the driver releases the brake pedal. Once in motion, the vehicle is propelled by the internal combustion engine (ICE). Examples of micro HEVs on the road today are the BMW 1 and 3 series, Fiat 500, SMART car, Peugeot Citroen C3, Ford Focus and Transit, and Mercedes-Benz A-class [18].
2. Mild HEVs: The mild HEV is very similar to a micro HEV, but with an increased size of the integrated alternator / starter motor and a battery which permits power assist during vehicle propulsion. Typical fuel efficiency increase for mild HEVs are around 20 - 25% for real-world driving compared to a non-hybrid. Examples of mild HEVs on the market include the BMW 7 Series ActiveHybrid, Buick LaCrosse with eAssist, Chevrolet Malibu with eAssist, Honda Civic and Insight Hybrid, and the Mercedes-Benz S400 BlueHybrid [18].
3. Full HEVs: In full HEVs, the electric motor and batteries are significantly bigger than that of the micro HEVs and mild HEVs. As such, depending on the vehicle power demand, the electric motor can be used as the sole power source. Compared to micro HEVs and mild HEVs, full HEVs have much smaller engines and require more sophisticated energy management systems. Typical fuel efficiency increase for full HEVs are around 40 - 45% for real-world driving compared to a non-hybrid. Examples of full HEVs on the road today are the

Chevrolet Tahoe Hybrid, Toyota Prius and Camry Hybrid, Ford C-Max, Honda CR-Z, and Kia Optima Hybrid.

4. Plug-in HEVs (PHEVs): PHEVs essentially possess the same configuration as full HEVs but with the addition of an external electric grid charging plug, much bigger electrical components (electric motor and battery) and a downsized engine. Owing to the high capacity electrical components, PHEVs are able to run on electric power for long periods of time. Examples of PHEVs on the road today are the Chevy Volt, Ford C-Max Energi and Fusion Energi, Fisker Karma, Porsche Panamera S E-Hybrid, and Toyota Prius Plug-in.

In December 1997, the Toyota Prius became the first mass-produced hybrid electric passenger vehicle in the world [19]. Being one of the most successful HEVs in the market, Toyota Prius uses a complex hybrid powertrain called the Toyota hybrid system. Since its original introduction, Toyota Prius has undergone several improvements in engine and powertrain. For example, in 2004 the highly efficient THS II Prius was introduced with an efficient gasoline engine which runs on the Atkinson cycle as well as a powerful permanent magnet AC synchronous motor. With a combined parallel and series hybrid configuration, Toyota Prius utilises the advantages of both the series and parallel systems [20]. In 2010, Toyota Prius was equipped with an improved drivetrain called the Toyota hybrid synergy drivetrain which showed better fuel economy and driving performance as compared to its predecessors [19]. In the Toyota hybrid synergy drivetrain, the primary motor acts as a mechanical assist to the ICE and also as a generator to recharge the batteries during regenerative braking. The secondary motor acts as a generator that extracts power from the engine to trickle charge the batteries. The resultant power split system is known as the electronic continuously variable transmission because of its ability to shift gears and drive wheels without the use of clutches or hydraulic systems.

## **2.4 Advantages of hybrid electric vehicles (HEVs)**

In comparison to conventional vehicles, HEVs offer a number of advantages. One of such advantage is the possibility of downsizing the original internal combustion engine whilst still meeting the power demand at the wheels. This advantage is brought about by the capability of the hybrid powertrain to deliver power to the wheels from both the internal combustion engine and the electric motor at the same



time, thus resulting in reduced fuel consumption [4, 5]. The introduction of an electric driveline in an HEV also allows for:

1. The regeneration of kinetic braking energy, which would otherwise be lost as heat to mechanical brakes in conventional vehicles [21-23].
2. The possibility of powering the wheels through the electric propulsion system alone when the torque request at the wheels is low.

In full HEVs, fuel consumption during idling can be eliminated by use of the engine shut off/start up feature [24].

Aside from fuel consumption related advantages, HEVs also present the possibility of cranking the engine with the electric motor, which allows for the removal of the starter motor from the powertrain. This new cranking procedure allows for a faster, smoother and a more improved cranking technique, as in the case of inertia cranking [6].

Crucial to achieving the aforementioned advantages is a real-time control strategy capable of **coordinating** the on-board power sources in order to maximise fuel economy and reduce emissions.

### **3 HEV CONFIGURATIONS**

In principal today, there are two types of hybrid electric system configurations (“series hybrid” and “parallel hybrid”) currently in use by automotive engineers [25, 26]. The dissimilarities that separate HEVs into these categories lie in the design of the power flow from the sources of energy. Power flow in series HEV is passed down to the transmission only over a single path (electrical path) [27]. Parallel HEVs allow power flow through two paths (electrical and mechanical path) from the energy sources to the transmission [27].

#### **3.1 Series hybrid electric vehicle**

The series hybrid electric system is a classification given to vehicles where an energy transformer is placed in series with one or more electric motors for traction of the vehicle. The main function of the internal combustion engine in this case is to generate electricity for the battery, which in turn feeds power to the traction motor either directly or via an electric generator. This HEV configuration permits no direct mechanical connection between the internal combustion engine and the propelling wheels. Consequently, the **internal combustion engine (ICE)** can be controlled

independent of the vehicle power demand and close to its peak-efficiency region. The series hybrid electric vehicle could thus be described as being powered primarily by the electric motor and secondarily by the internal combustion engine. Detailed in Figure 2 is a schematic of the series HEV configuration.

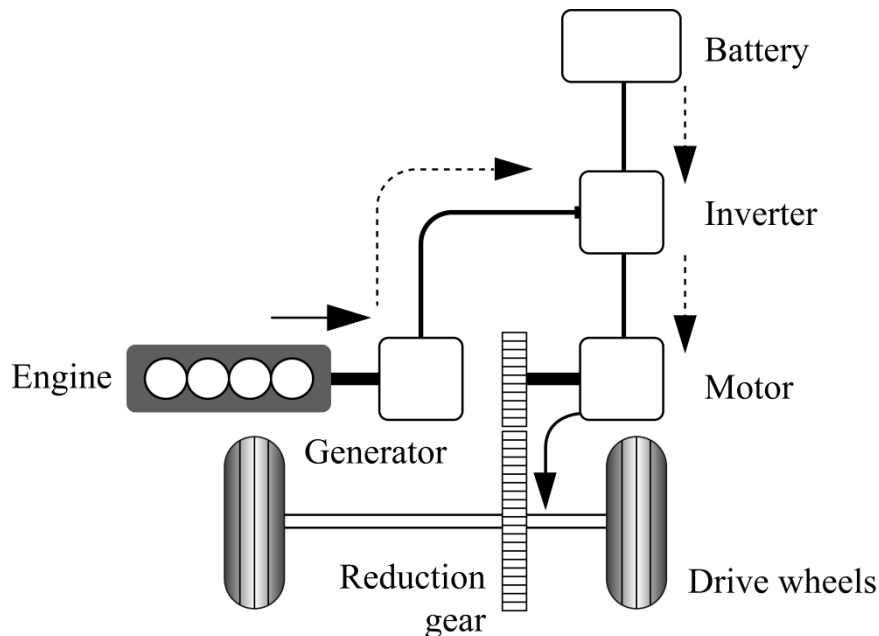

Figure 2: Series hybrid electric vehicle

Internal combustion engines used in series HEVs are generally small compared to those used in conventional vehicles and only account for less than 50% of the maximum power needed for propelling the vehicle. Several automotive companies e.g. Mitsubishi, Volvo and BMW, have explored the possibility of series hybrid electric vehicle development. Despite these in-depth researches, commercial application of the series hybrid electric vehicle development is still very limited to heavy duty vehicles. Although series hybrid electric vehicles tend to have a high efficiency at its engine operation, this benefit is quickly outweighed when we consider the fact that it often requires very powerful and expensive batteries, with a high energy density to operate. The powerful batteries are needed because in most cases, the motor may have to produce 50% of the required total power demand on its own [27, 28].

### 3.2 Parallel hybrid electric vehicle

In the parallel HEV configuration, both the engine and the electric motor are able to work independently or co-operatively to provide traction. In this configuration, the engine is mechanically connected to the driving wheels via a gearbox. In this

instance, the electric motor is used to support the engine during accelerations. Depending on the power of the motor, it could also be used as the sole power source of the vehicle in idling situations and during start-ups. The engine used in the parallel hybrid electric vehicle configuration is usually bigger than those used in the series configuration, while the electric motor is comparatively smaller and less powerful. The possibility for direct energy flow from the ICE to the wheels enables the parallel HEV to switch to the most efficient operating point by using the ICE, whenever it can operate around the peak-efficiency region. This is due to the parallel connection between the electric motor and the internal combustion engine, which implies that the capacities of the ICE and the electric motor can be varied, without changing the total driving capacity of the vehicle [28]. Detailed in Figure 3 is a schematic of the parallel HEV configuration. Parallel HEVs come in two sub configurations: the pre-transmission parallel and the post-transmission parallel.

In the pre-transmission parallel HEV configuration, the gearbox is located on the main drive shaft, which implies that the gear speed ratios do apply to both the engine and the electric motor. In this configuration, the power summation occurs at the gear box. Consequently, torque from the electric motor is added to the engine torque at the input shaft of the gearbox. In the post transmission parallel HEV configuration, the gearbox is situated on the engine shaft before the torque splitter and the electric motor. This implies that the gear speed ratios only apply to the engine. In this configuration, the electric motor torque is usually added to the engine torque at the output shaft of the gearbox. If a motor only transmission is required on a parallel HEV configuration, the use of a disconnecting device such as a clutch can be employed to disengage the gear, while running the electric motor independently.

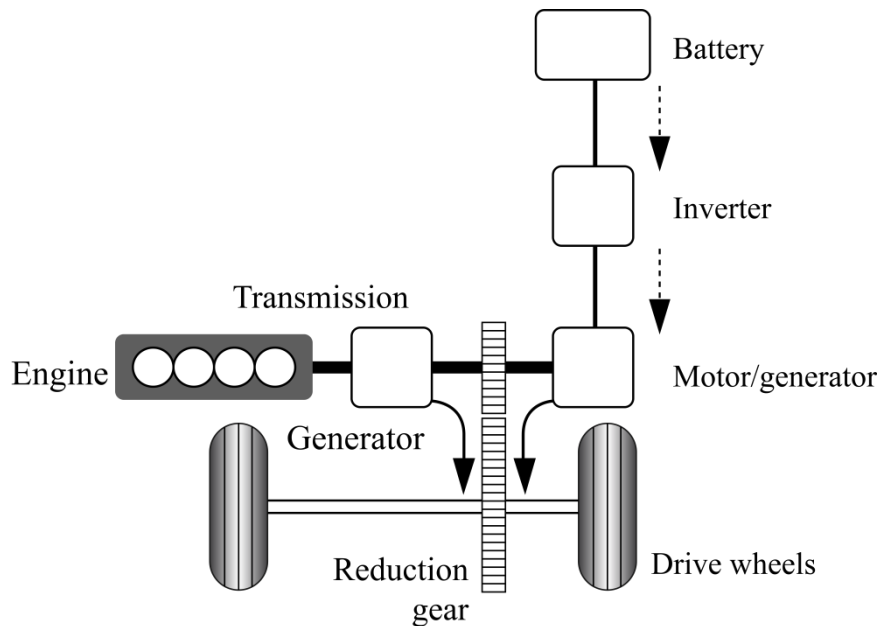

Figure 3: Parallel hybrid electric vehicle

### 3.3 Recent developments in hybrid power trains

HEV development today is mostly aimed towards the use of series hybrid electric systems in heavy-duty vehicles, primarily in buses and the use of parallel hybrid electric systems for light duty vehicles. Specifically, the development of parallel hybrid electric vehicles have focused on implementation of optimal and sub-optimal control algorithms which enable the internal combustion engine to run only in areas of high efficiency, thus mitigating the lack of ICE speed controllability, due to its mechanical connection with the wheels.

In a comparative sense, parallel HEVs have received more research attention compared to series HEVs and this is as a result of the flexibility in its powertrain design as well as the elimination of the need for a large traction motor in the parallel HEV configuration. One of such development has been the implementation of the parallel hybrid technology on an all-wheel drive vehicle, as shown in Figure 4. This sort of application is most beneficial if the internal combustion engine is used to power the rear wheels, while the electric motor is used to power the front wheels. Configuring the setup this way means that the high vehicle weight borne by the front wheels of the vehicle is used advantageously during regenerative braking, thus leading to high braking energy recapture.

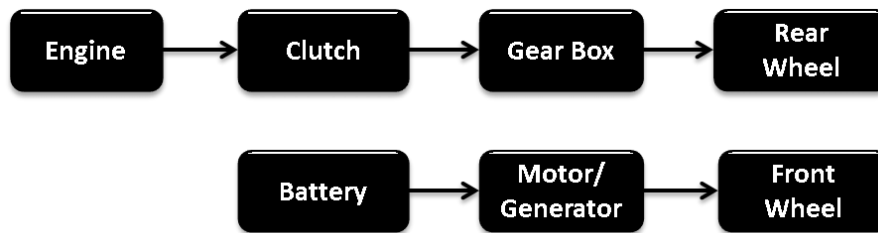

Figure 4: All wheel drive parallel hybrid electric vehicle

The all-wheel drive parallel hybrid electric vehicle configuration also offers an advantage with respect to vehicle longitudinal stability control in slippery conditions. Another recent product of parallel HEV research and development is the series-parallel hybrid electric vehicle configuration. This design depends primarily on the presence of two electric motors and a connection between both, which can be either mechanical or electrical. Where mechanical connections are used between the electric motors, this is done using a planetary gear power splitting device. The series-parallel configuration offers the advantage and possibility of having the engine completely decoupled from the vehicle, thus making it possible for the vehicle to be powered using just the electric motors [29]. It also offers the possibility of operating the ICE around its peak-efficiency region due to flexibility in both torque and speed changeability at the ICE output. These advantages become partially offset when energy losses during conversion of mechanical energy to electrical energy is taken into account. Although there exist a number of series-parallel hybrid electric vehicle configurations, it is worth highlighting the Toyota THS design which was first pioneered on the Toyota Prius, as shown in Figure 5.

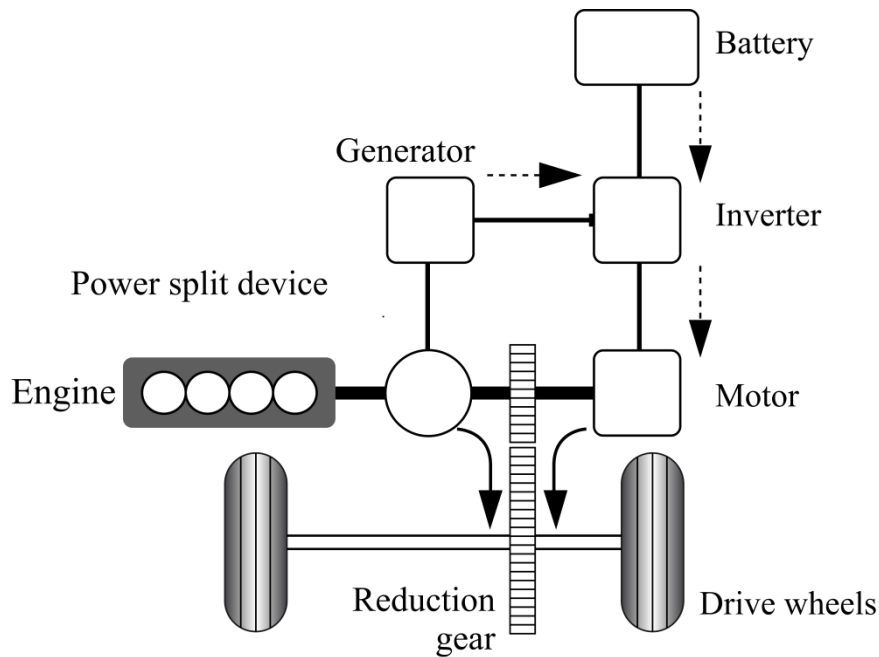

Figure 5: Series-Parallel hybrid electric vehicle

#### 4 HEV MODELLING APPROACHES

There exist at least 3 main stages of computational modelling currently employed in the development of HEVs. These stages are:

- Detailed Modelling which is performed during the research and early development stages of the HEV. This sort of modelling centres mainly on single powertrain components such as internal combustion engine and electric motor. This type of modelling is aimed at providing detailed information about specific characteristics of the component being modelled.
- Software in the Loop (SIL) modelling which is carried out at a later stage of the HEV development cycle, but usually before any hardware production is made. The employment of SIL today has become popular in HEV control system development.
- Hardware in the loop (HIL) modelling, which is carried out once the production of controllers has been completed and validated.

Three typical approaches exist for HEV modelling at the detailed modelling stage of the development process: the kinematic or backward approach, the quasi static or forward approach, and the dynamic approach [26].

## 4.1 Kinematic approach

The kinematic approach as shown in Figure 6, is a backward methodology where the input variables are the speed of the vehicle and the grade angle of the road. In this method, the engine speed is determined using simple kinematic relationships starting from the wheel revolution speed and the total transmission ratio of the driveline. The tractive torque that should be provided to the wheels to drive the vehicle according to the chosen speed profile can be calculated from the main vehicle characteristics e.g. (vehicle mass, aerodynamic drag and rolling resistance).

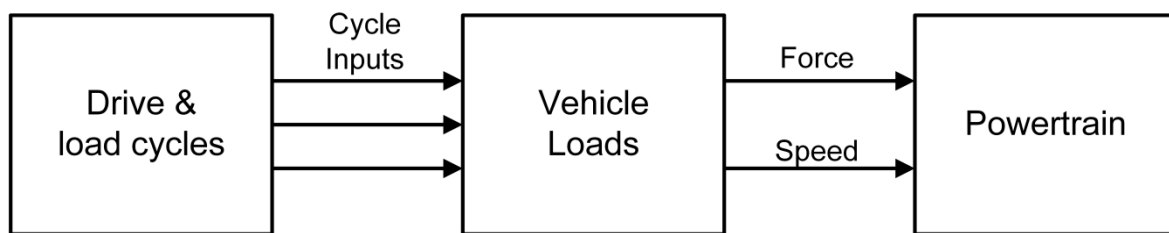

Figure 6: Information flow in a kinematic or backward HEV model. Source [26]

The calculated engine torque and speed is then used alongside with a statistical fuel consumption model to produce an instantaneous fuel consumption or emissions rate prediction [30]. The kinematic approach assumes that the vehicle meets the target performance, so that the vehicle speed is supposedly known a priori; thus enjoying the advantage of simplicity and low computational cost [31]. The backward or kinematic modelling method ensures that the driving speed profile will be exactly followed. However, there exist no guarantees that the given vehicle will actually be able to meet the desired speed trace, since the power request is directly computed from the speed and not checked against the actual powertrain capabilities. Typically in simulation, the kinematic approach includes a “fail-safe” feature which stops the simulation run if the required torque exceeds the maximum torque available (from the electric motor and engine). Another flaw of this modelling technique is its negligence of thermal transient behaviour of engines which are noticeable after an engine cold start.

The simplification of transient conditions as a sequence of stationary states limits this modelling method to an option considerable mainly for preliminary estimation of vehicle fuel consumption and emissions [26].

### 4.1.1 Quasi static approach

The quasi-static approach of HEV modelling as shown in Figure 7 makes use of a driver model typically a PID which compares that target vehicle speed (driving cycle speed), with the actual speed profile of the vehicle and then generates a power demand profile which is needed to follow the target vehicle speed profile. This power demand profile is generated by solving the differential motion equation of the vehicle [31]. Once the propulsion torque and speed of the engine have been determined, instantaneous fuel consumption can be estimated using a statistical engine model as already explained in the kinematic or backward approach.

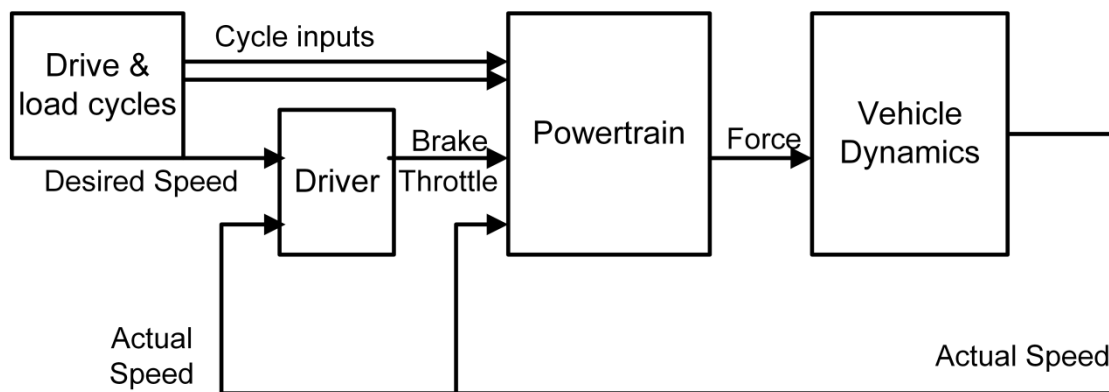

Figure 7: Information flow in a quasi-static powertrain model. Source [26]

The suitability and accuracy of the quasi-static modelling approach depends very much on **the** nature of simulation studies to be conducted. The quasi-static modelling approach provides reasonable accuracy when it comes to the evaluation of the fuel consumption and NOx of a vehicle equipped with conventional powertrain. For pollutants like soot, the acceleration transients and related “turbo-lag” phenomena significantly contribute to the cycle cumulative emissions, thus necessitating a more detailed engine simulation model which is capable of properly capturing engine transient behaviour in more detail [32].

### 4.1.2 Dynamic modelling approach

In the dynamic modelling approach, the internal combustion engine behaviour during transients is also modelled in addition to the longitudinal vehicle dynamics. The engine transient behaviour is modelled by means of a detailed one dimensional fluid dynamic model. For example, the intake and exhaust systems of the internal combustion engine in the dynamic modelling approach are represented as a network of ducts connected by the junctions that represent either physical joints between the



ducts, such as area changes or volumes or subsystems such as the engine cylinder. Solutions to the equations governing the conservation of mass, momentum and energy flow for each element of the network can then be obtained using a finite difference technique. This makes it possible for highly dynamic events such as abrupt vehicle accelerations to be properly and reliably simulated with reasonable accuracy. The implementation of dynamic modelling comes with a huge time and computational burden and as such its application is often limited to research areas which deal with internal combustion engine development [33], [34], [35].

From a control development stand point, the quasi-static approach is preferred since it maintains the physical causality of the vehicle system, and allows for the possibility of using the same controller inputs/outputs in the simulator as well as on the real vehicle.

## 5 HEV CONTROL STRATEGIES

HEVs have been shown to significantly improve automotive fuel economy and reduce emissions, whilst still meeting the vehicle power demand, maintaining satisfactory vehicle performance, and driver-feel [36]. Regardless of the HEV configuration in question, employing the right power split between the energy sources (ICE and electric motor) is crucial to the achievement of an improved fuel economy and reduced emissions. To this endeavour, several power split control strategies have been proposed, evaluated and employed to different HEV configurations. Typically, inputs to the power-split controller of HEVs often include vehicle power demand, vehicle speed or acceleration, battery state of charge, present road load, and on occasion, "intelligent" future traffic conditions from the Global Positioning System (GPS). The controller outputs signal contains a set of control decisions which specify whether the HEV should operate in any of the following modes:

1. Engine only mode (ICE operates alone)
2. Assist mode (ICE and electric motor operates)
3. Electric motor only mode (Electric motor operates alone)
4. Regenerative mode (Electric motor is used for kinetic energy recovery)
5. Trickle charge mode (Engine produces power used in charging the battery)

Minimisation of fuel consumption and emissions without a compromise of vehicle performance, and battery state of charge are often the main control objectives of most HEV control strategies. HEV control strategies can be broadly classified into

online control strategies and offline control strategies as shown in the control strategy classification chart in Figure 8.

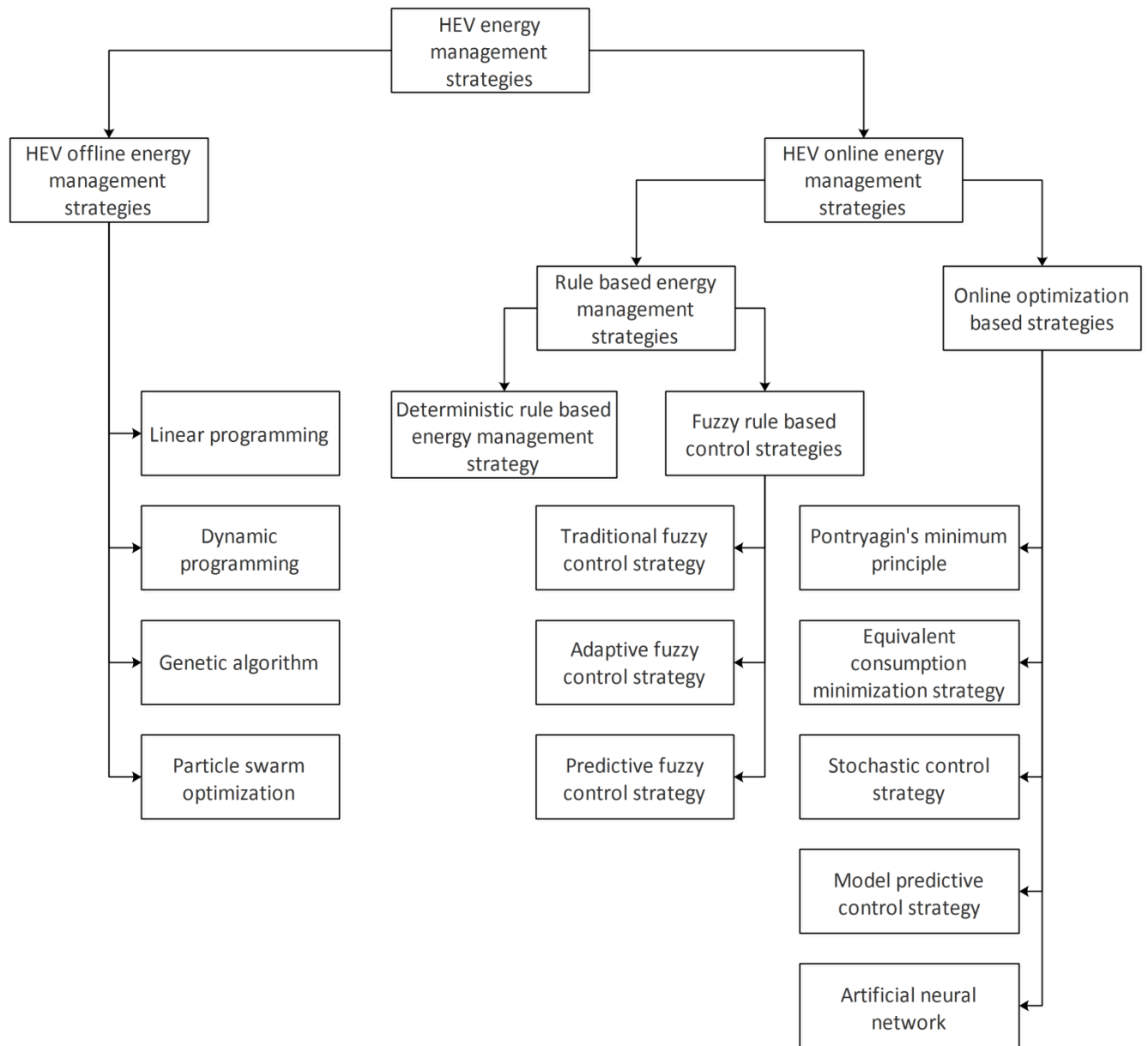

Figure 8: HEV control strategy classification

Although there have been several papers and research publications which have contributed to the compilation of reviews on HEV control strategies, this area of research is continuously advancing and with the introduction of newer techniques, there is need for an up to date review. The main objective of this section is not only to contribute to the growing list of review discussions, but also to identify relevant research gaps in the field.

## 5.1 HEV offline control strategies

Optimisation based control strategies decide the control signals either by minimising the sum of the objective function over time (global optimisation) or by instantaneously minimising the objective function (local optimisation).

The effectiveness of a global optimal control technique relies solely on the knowledge of the entire driving cycle a priori, and since this is usually difficult to determine in real-time, global optimal techniques are usually referred to as “non-causal” which cannot be applied in real-time, but are useful as a control benchmark to which all other causal real-time controllers can be compared. Linear programming, dynamic programming and genetic algorithms etc., have been applied as global optimisation techniques for optimal energy management of HEVs.

### 5.1.1 Linear programming

Using linear programming, the non-linear fuel consumption model of an HEV is approximated and solved for a global optimal solution [37]. Linear programming has been applied successfully to automotive energy management problems. For example in the study of Kleimaier *et al.* [38], a convex optimisation technique for the analysis of propulsion capabilities using linear programming was proposed as shown in Figure 9. Pisuet *et al.* [39] designed a stable and robust controller using linear matrix inequalities, to minimise fuel consumption.

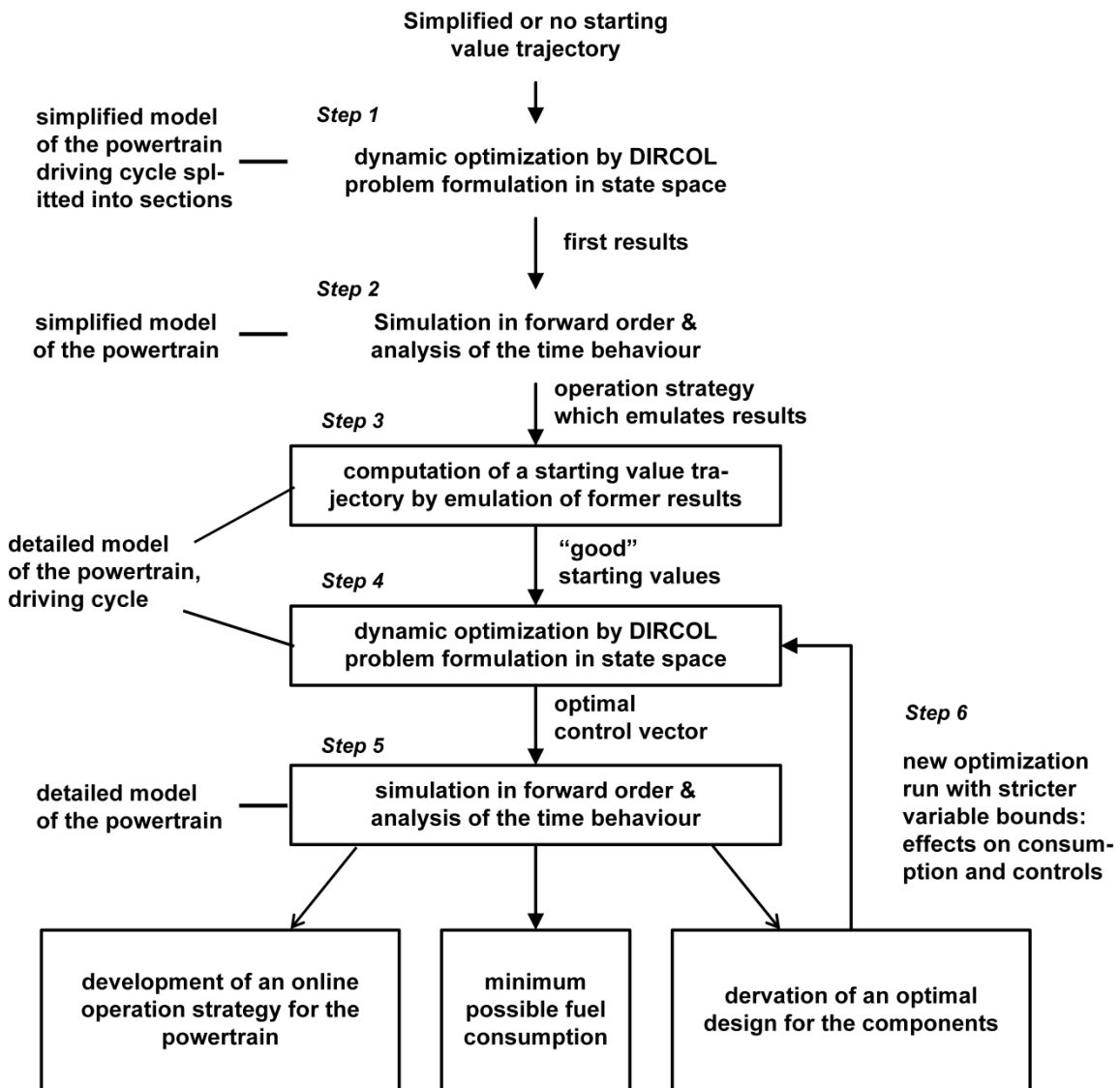

Figure 9: Structure of linear optimisation method (redrawn from [38])

### 5.1.2 Dynamic programming

The dynamic programming technique is a technique originally developed by Richard Bellman, which aims to find optimal control policies using a multi-stage decision process. As defined by Bellman, the principle of optimality can be expressed verbally thus:

*An optimal control policy has the property that no matter what the previous decision (i.e., controls) have been, the remaining decisions must constitute an optimal policy with regard to the state resulting from those previous decisions [40].*

Dynamic programming algorithm is a discrete multi-stage optimisation problem in which a decision based on the optimisation criterion is chosen from a finite number of decision variables at each time step. Bellman's dynamic programming algorithm can be applied using 2 methods: the backward recursive method and the forward method. In the backward recursive method, the optimal sequence of control variables is obtained proceeding backwards from the final state and choosing at each time step the path that minimises the cost-to-go (integral cost from that time step until the final state). By symmetry, most dynamic programming problems solved using the backward recursive method could also be solved using the forward dynamic programming technique. Although both techniques do lead to the same set of optimal control policies for the entire problem, there is a difference in the "by-products" produced by both methods. When solving a problem using the backward dynamic programming technique, the by-products obtained are the optimal values from every state in every stage to the end; whereas in solving a problem using forward dynamic programming, the corresponding by-products would be the optimal values from the initial states(s) in the first stage to every state in the remaining stages.

Dynamic programming has the advantage of being applied to both linear and non-linear systems as well as constrained and unconstrained problems. It also suffers two setbacks: its reliance on prior knowledge of the full driving cycle, and the curse of dimensionality which amplifies the computational burden. Consequently, control results from dynamic programming are only useful as optimal benchmarks for other controllers, or basis for the development and improvement of other sub-optimal controllers. In Shenet. *al.*[41], an effort was made to reduce the computation time of the dynamic programming approach, through the use of a forward search algorithm.

Dynamic programming (DP) features prominently in HEV energy management studies [41-62]. In this section, some notable examples of its application on HEVs are reviewed. Brahma *et. al.* [42], applied dynamic programming to achieve a real-time optimal split between the ICE and electric motor of a series HEV. They suggested that by using the discrete state formulation approach of dynamic programming, computational efficiency can be further improved. Similarly, Lin *et. al.*[46] found that optimal control rules could be extracted from dynamic programming, and used to near-optimally adapt a rule-based controller. The resulting improvement in fuel economy for different levels of heuristic controller modification is detailed in Table 1, for the UDDSHDV cycle.

	Fuel Economy (MPG)
Conventional	10.63
Preliminary Rule-Based	12.56
New Shift Control	13.02
New Power Split Control	13.17
New Recharging Control	13.24
Dynamic Programming	13.63

Table 1: Fuel economy comparison over UDDSHDV cycle (source [46])

In another study by Lin *et. al.* [44], a simple approach for extracting heuristic control rules from dynamic programming (based on the ratio of power request to transmission speed) was formulated. Simulation results from this study showed that, by properly analysing control results from dynamic programming, an improved rule-based control strategy could be developed. In this study, heuristic control rules were extracted from one driving cycle and used to near-optimally control 7 other driving cycles. Obtained simulation results (Table 2) showed a 50 – 70% reduction in performance gap between the optimal controller (DP controller) and the improved rule-based controller. The combination of dynamic programming and rule-based control strategies for real-time charge-sustaining control of HEVs, have also been considered in Lin *et. al.* [44, 46] and Kumet. *al.* [60]. In Kumet. *al.* [60], the control steps are articulated as follows: dynamic programming is first used to obtain a global optimal solution to the formulated energy management problem. Next, battery SOC for the remaining trip distance is estimated using the energy-to-distance ratio (EDR). An adaptive supervisory powertrain controller is applied subsequently, to reduce fuel consumption and emissions based on results from the EDR and catalyst temperature system.

In Perez *et. al.*[63], a finite horizon dynamical optimisation problem is formulated and solved using dynamic programming, with the objective of maintaining battery energy levels within the prescribed range without affecting the battery state of health.

	FE (mi/gal)	NOx (g/mi)	PM (g/mi)	Performance Measure	
				g/mi	Improvement %
Preliminary Rule-Based	15.31	4.43	0.36	671.23	0%
New Rule-Based	14.61	3.02	0.30	582.18	13.27%
DP (Fuel Economy & Emissions)	15.41	2.78	0.26	526.67	21.54%

a. Results over the WVUSUB cycle (Suburban driving)

	FE (mi/gal)	NOx (g/mi)	PM (g/mi)	Performance Measure	
				g/mi	Improvement %
Preliminary Rule-Based	12.84	7.29	0.51	948.83	0%
New Rule-Based	12.72	6.31	0.49	896.00	5.57%
DP (Fuel Economy & Emissions)	12.97	6.17	0.44	847.67	10.66%

b. Results over the WVUNITER driving cycles (Interstate driving)

	FE (mi/gal)	NOx (g/mi)	PM (g/mi)	Performance Measure	
				g/mi	Improvement %
Preliminary Rule-Based	16.18	3.87	0.33	621.22	0%
New Rule-Based	15.09	2.49	0.23	494.12	20.46%
DP (Fuel Economy & Emissions)	16.63	2.04	0.16	403.58	35.03%

c. Results over the WVUCITY driving cycles (City driving)

Table 2: Fuel economy and emissions evaluation for a dynamic programming inspired rule-base controller (source [44])

Gong *et. al.* [64], investigated two variations of the dynamic programming algorithm (conventional dynamic programming and two-scale dynamic programming) on a charge-depleting plug-in HEV. In the two-scale dynamic programming algorithm, the

electric mode of the operation is used first for the known trip distance. The rest of the distance is divided into different segments of known length and for each segment; fuel consumption and SOC level (Figure 10) are calculated. Finally, spatial domain optimisation is performed to find the optimal solution. Results from this study show that compared to the conventional dynamic programming algorithm which is very computationally expensive, a near-optimal fuel economy (3.7% less than optimal fuel economy) could be achieved using the two-scale dynamic programming algorithm. The two-scale dynamic programming algorithm was further used to develop an efficient on board control strategy in another study by Gong *et al.* [48].

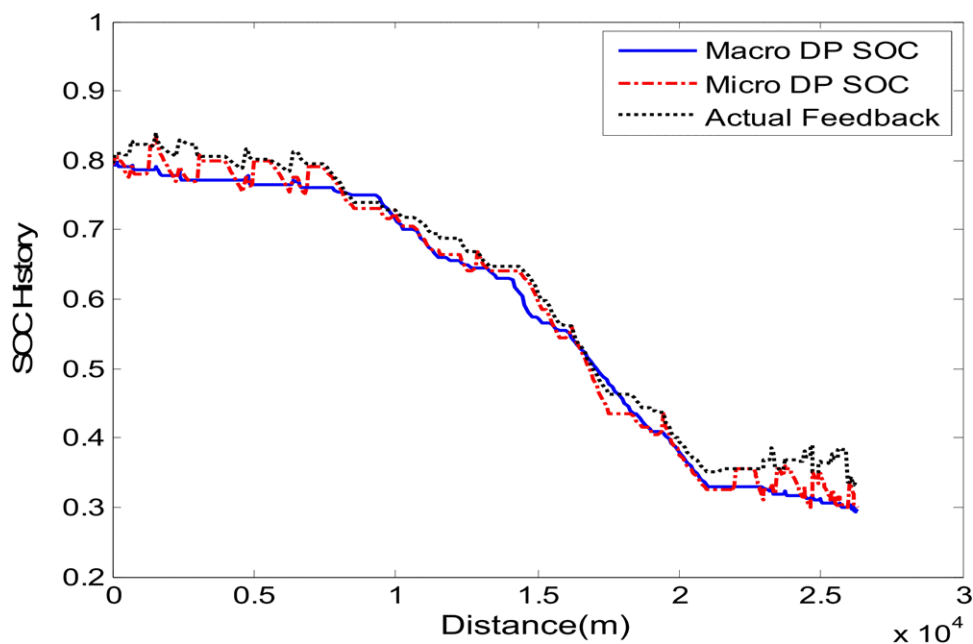

Figure 10: Trip segmentation on road segment (source [64])

### 5.1.3 Stochastic control strategy

Stochastic control is a framework developed to model and solve optimisation problems involving uncertainties. In this strategy, an infinite-horizon stochastic dynamic optimisation problem is formulated. The vehicular power demand is modelled as a random Markov process. Using the Markov driver, future power demand is predicted based on current transition probabilities. The optimal control strategy is then obtained using stochastic dynamic programming (SDP) [65-68]. The obtained control policy is in the form of a stationary full-state feedback, optimised over a family of driving patterns; that can be directly implemented in a vehicle. In contrast to dynamic programming which optimises the control policy over a given driving cycle, stochastic dynamic programming optimises the control policy over a



family of diverse driving patterns. Though relatively new, the concept of stochastic energy management in HEVs has attracted considerable attention worth reviewing. Using stochastic dynamic programming, Liu *et al.*[69] successfully formulated a hybrid power optimal control strategy which uses an engine-in-loop (EIL) system to instantly analyse the impact of transients on engine emissions. In a study by Tate *et al.*[70], two variations of the stochastic control strategy (infinite horizon SDP and shortest path SDP) were developed and implemented on a parallel HEV. As shown in Figure 11 and summarised in Table 3, the shortest path SDP controller was found to yield better results, as it offers better battery state of charge control and fewer parameters to be tuned.

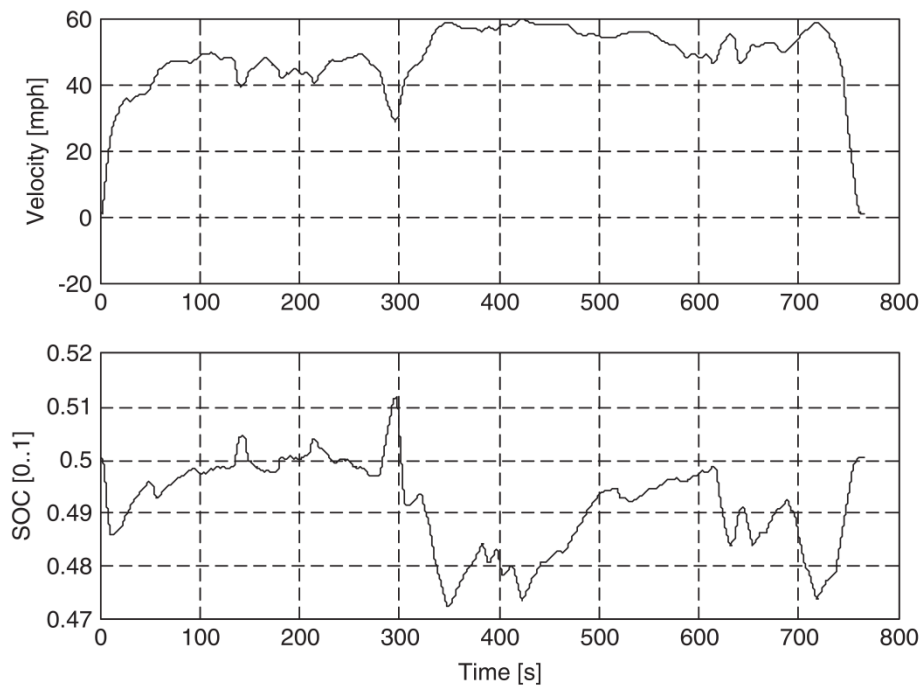

Figure 11: SOC on the HWFET using the SP-SDP controller (Source [70])

Cycle	SP-SDP		SDP		SP-SDP improvement	
	Performance	Final SOC	Performance	Final SOC	Performance (%)	Reduction in Final SOC error (%)
UDDS HDV	833.58	0.4982	850.46	0.5128	2.03	85.94
WVU suburban	627.05	0.5058	654.44	0.5103	4.37	43.7
WVU city	509.46	0.4997	536.82	0.5095	5.37	96.84
FET highway	944.14	0.5004	972.93	0.5214	3.05	98.13

Table 3: Comparison of performance in control laws for the SP-SDP and SDP controller (Source [70])

Using the shortest path SDP method, the optimal trade-off between fuel consumption and tailpipe emissions was investigated on an HEV facilitated with a dual mode EVT [71]. Results from this study showed that even with the much simplified shortest path SDP, 8000 simulation hours was required to obtain an optimal solution to the formulated energy management problem. The shortest path SDP was further developed in a study by Opilaet. *al.*[72] to account for HEV energy management problems involving fuel economy and driveability. Results from this study showed that for the same level of drivability, the SP-SDP-based controllers were 11% more fuel efficient than a baseline controller over the FTP driving cycle (Table 4).

Controller Descriptions	Fuel Economy (Corrected)	Engine Events	Gear Events	Final SOC	Fuel Economy (Uncorrected)
Baseline Controller	1.000	88	93	0.505	0.997
SP-SDP #1- Best Fuel Economy	1.119	88	106	0.504	1.117
SP-SDP #2 Similar Drivetrain Activity	1.114	88	93	0.506	1.110
SP-SDP #3 Similar Fuel Economy	1.010	34	36	0.561	0.977

Table 4: SP-SDP controller performance over the FTP driving cycle

SP-SDP #1 is the controller with the best corrected fuel economy without regard to drivability. SP-SDP #2 has the closest drivability metrics to the baseline controller, and is closely related to SP-SDP #1. SP-SDP #3 is selected by finding a controller with similar fuel economy to the baseline controller and about half the number of drivability events.

Wang et. al.[73] proposed an SDP-extremum seeking algorithm with feedback control as shown in Figure 12. By definition, this approach leverages the global optimality and SOC sustainability characteristics of the SDP controller; and compensates its optimal control errors by introducing a real-time extremum seeking output feedback. The resulting effect is a real-time near-optimal and charge-sustaining performance, as shown in Figure 13.

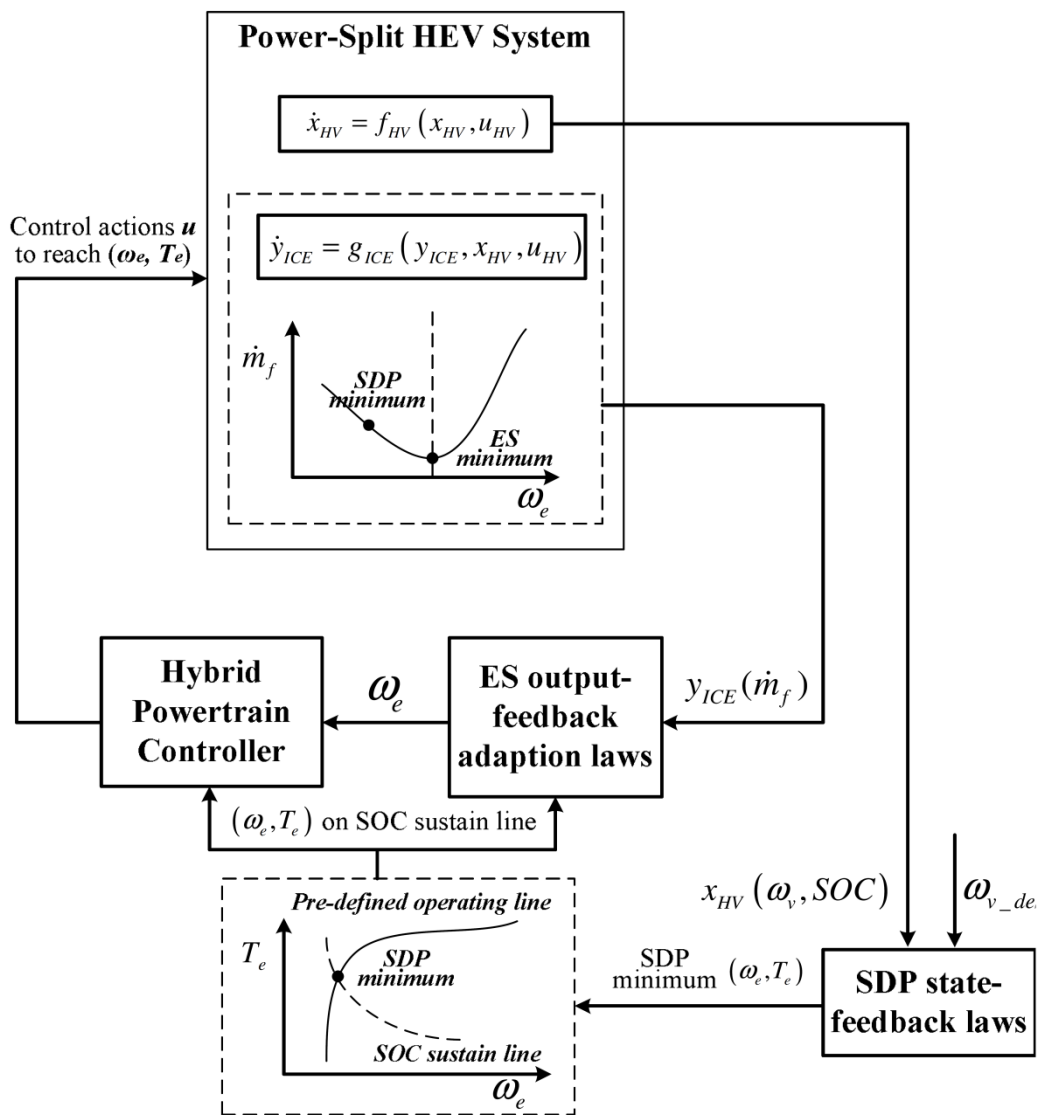
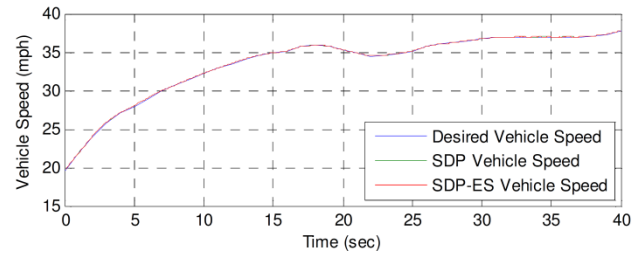
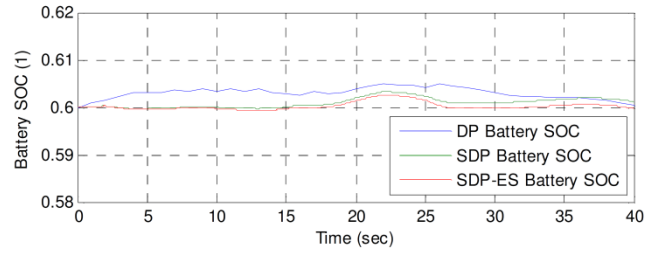

Figure 12: The schematic diagram of the SDP-ES optimization algorithm (source [73])



(a) vehicle speed



(b) battery SOC

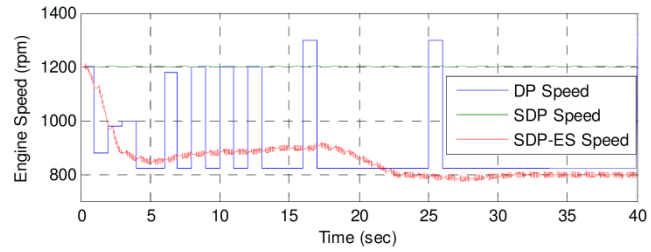

(c) engine speed

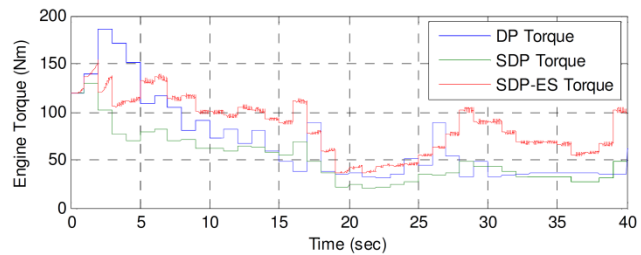

(d) engine torque

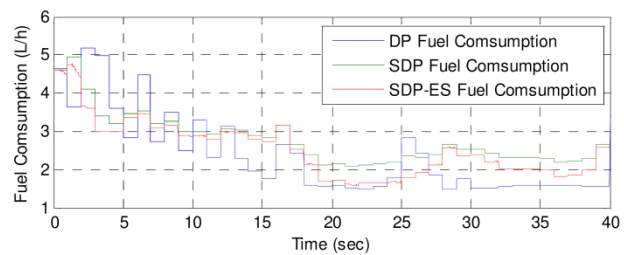

(e) fuel consumption

Figure 13: Comparison between the optimized results by SDP and SDP-ES (source [73])

### 5.1.4 Genetic algorithm

Genetic algorithm (GA) is a heuristic search algorithm for generating solutions to optimisation problems. This branch of artificial intelligence is inspired by Darwin's theory of evolution. In order to procure an optimal solution to a problem, GA begins with a set of preliminary solutions (chromosomes) called population. The solutions from each population are chosen according to their suitability to form new and improved versions. Consequently, the most suitable solutions have a better chance of growth than weaker solutions. The process is continuously repeated until the desired optimisation conditions are satisfied. Genetic algorithm is a robust and feasible global optimisation approach with a wide range of search space, useful for solving complex engineering optimisation problems characterised by non-linear, multimodal, non-convex objective functions.

A number of studies have considered Genetic algorithm for energy management in HEVs [74-82]. Piccolo *et. al.*[83] applied genetic algorithm to an on-road vehicle with the objective of optimising an objective function involving fuel consumption and emissions terms. They comparatively simulated their genetic based approach with a conventional gradient based approach, and found that the genetic optimisation approach achieved a better reduction in CO emissions, while the HC and NO<sub>x</sub> emissions remained roughly the same (Table 5).

	Genetic Based	Gradient Based	Deviation %
CO, (g/km)	4.53	5.18	-12.5
NO <sub>x</sub> (g/km)	0.25	0.25	0
HC, (g/km)	0.45	0.44	+2.2
Fuel consumption (1/100km)	6.9	6.8	+1.4

Table 5: Genetic algorithm results over an urban driving cycle (source [83])

Ippolito *et. al.*[84], combined a fuzzy clustering criterion with genetic algorithm to compensate the performance of the proposed energy controller in dynamic and unpredictable driving conditions. Results from this study as detailed in Table 6 show that the combination of both strategies yield significant reduction in computational effort and improvement in fuel efficiency when compared to the multi-objective optimisation approach.

Wang *et. al.* [85], Poursamad *et. al.*[86] and Yi *et. al.* [87], used genetic algorithm to tune and optimise a robust real-time implementable fuzzy logic based HEV control

strategy. The application of genetic algorithm for multi-objective energy management is considered by Huang *et. al.*[81]. In this study, a multi-objective genetic algorithm (MOGA) is used to solve a optimisation problem for a series HEV. Their results show that genetic algorithm is flexible and effectively handles multi-objective optimisation problems. By comparing the multi-objective genetic algorithm (MOGA) to a single-objective genetic algorithm (SOGA) and a thermostatic algorithm over different driving cycles as shown in Figure 14, the authors conclude that if the performance of fuel economy and emissions are taken into account, the strategy based on multi-objective genetic algorithm is always better than the thermostatic and single-objective genetic algorithm. The MOGA approach is further developed in a study by Desai *et. al.* [88] to also optimise powertrain component sizing. The ICE size, motor and battery sizes, as well as the control strategy parameters were optimised. The results of the trade-off solutions (Table 7) demonstrated significant improvements in vehicle performance over the UDDS driving cycle. In Fang *et. al.*[82], the MOGA approach is used to simultaneously optimise the control system and powertrain parameters. Genetic algorithm (GA) has also been used to solve an HEV control problem involving the optimisation of component sizes and the minimisation of fuel consumption and emissions [74-79, 89]. In Hu *et. al.*[89], the proposed approach is a non-dominated sorting genetic algorithm (NSGA). The NSGA varies from GA only in the way the selection operator works. Crossover and mutation operations remain the same.

In a study by Montazeri-Ghet. *al.*[90], a genetic-fuzzy approach is formulated to find an optimal region for engine operation. First, a hidden Markov model was developed to classify and recognise driving patters from previous driving experiences. Afterwards, predicted driving patterns were utilised for the optimisation of HEV control parameters using a genetic-fuzzy approach. Simulation results from this study show that adaptation to traffic conditions using intelligent genetic-fuzzy approach is very effective in reducing fuel consumption (Figure 15).

Driving Cycle no.	Monitored Parameters	MOS	DB	Dev%
NEDC	HC (g/km)	0.247	0.2485	+0.63%
	CO (g/km)	1.469	1.4642	-0.36%
	NO, (G/km)	0.134	0.1337	-0.59%
	Fuel Consumption (Litres/km*100)	3.593	3.5992	+0.17%
	Final SOC	0.557	0.5584	-0.16%
	CPU Time consumption during the cycle (s) (N=184)	965.86	70.09	-92.74%
FTP	HC (g/km)	0.173	0.1713	-0.75%
	CO (g/km)	0.996	0.8444	-15.2%
	NO, (G/km)	0.151	0.1501	-0.6%
	Fuel Consumption (litres/km*100)	3.963	3.6926	-6.82%
	Final SOC	0.547	0.5219	-4.65%
	CPU Time consumption during the cycle (s) (N=465)	2018.3	287.45	-85.75%
US06	HC (g/km)	0.216	0.217	0.49%
	CO (g/km)	2.048	2.054	0.31%
	NO, (G/km)	0.251	0.247	-1.69%
	Fuel Consumption (Liters/km*100)	5.127	5.165	0.006%
	Final SOC	0.0508	0.5077	0.75%
	CPU Time consumption during the cycle (s) (N=131)	747.75	35.5	-95.23%
HWFET	HC (g/km)	0.163	0.1603	-1.4%
	CO (g/km)	0.913	0.8853	-3.0%
	NO, (G/km)	0.143	0.1381	-3.7%
	Fuel Consumption (Liters/km*100)	3.446	3.142	-0.99%
	Final SOC	0.357	0.5523	-0.86%
	CPU Time consumption during the cycle (s) (N=156)	833.39	52.24	-93.73%

Table 6: Simulation results: MOS (Multi-objective solutions), DB (Data Base), DEV% (Deviation in Percentile) source [84]



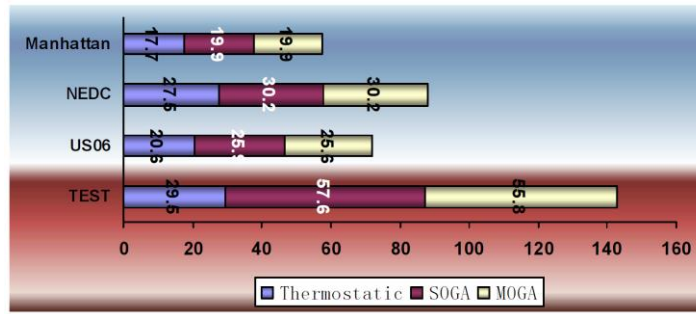

a. Fuel economy performance

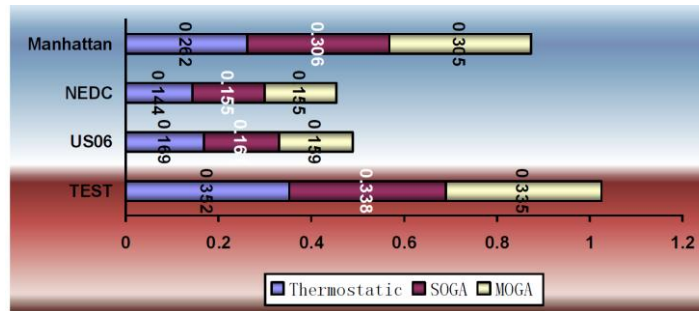

b. HC emissions

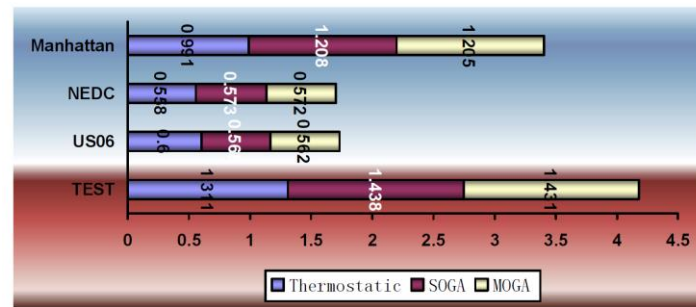

c. CO emissions

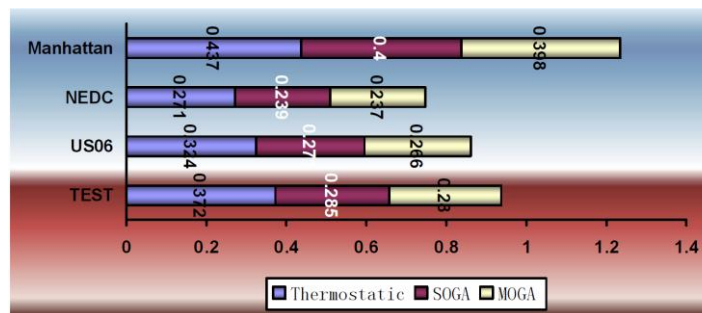

d. NOx emissions

Figure 14: Performance evaluation of the SOGA, MOGA and Thermostatic controller (source [81])

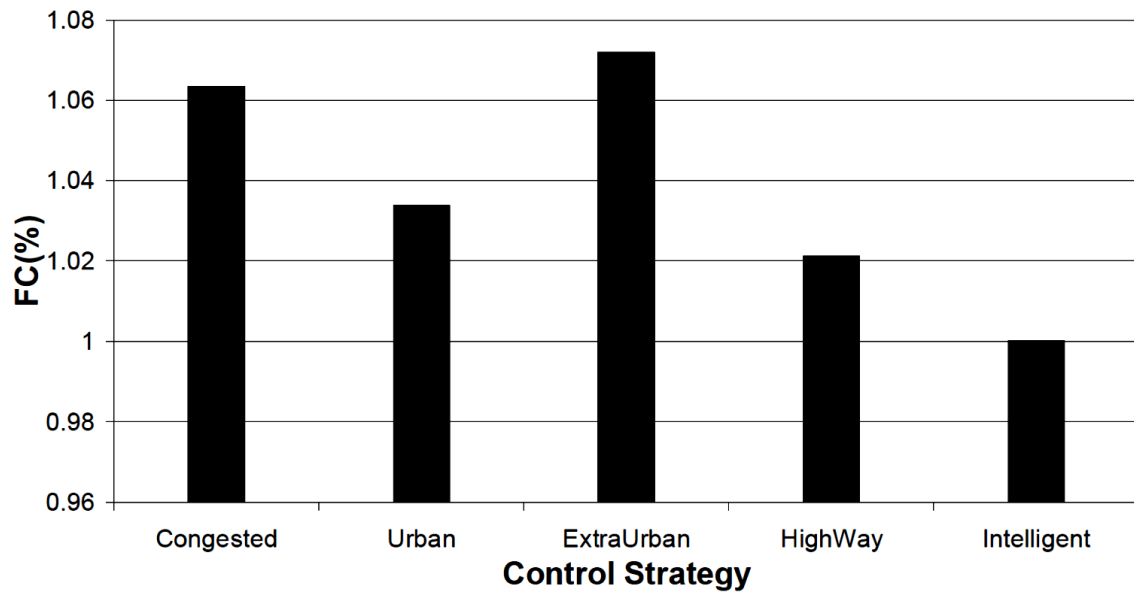

Figure 15: Fuel consumption obtained from simulation HEV over TEH-CAR driving cycle (source [90])

Design Variables							Objectives		Constraint
X1	X2	X3	X4	X5	X6	X7	Fuel Cons. (L/100 km)	Emission (grams/km)	Acceleration t1 (sec)
ICE Power (kW)	Motor Power (kW)	Battery Power (kWh)				(km/h)			
186.3	90.12	54.86	0.5	0.	0.8	6.2	44.45	19.47	24.47
179.9	122.4	56.41	0.4	0.	0.9	5.71	45.33	18.84	24.11
185.6	95.1	54.85	0.5	0.	0.9	5.46	44.8	19.35	23.84
195.4	127.4	54.83	0.4	0.	0.9	3.42	43.51	19.83	23.19
179.3	99.96	53.19	0.4	0.	0.8	5.77	44.8	18.96	24.19
205.7	138.0	52.92	0.5	0.	0.9	2.01	43.15	22.49	22.63
188.4	132.0	53.19	0.6	0.	0.9	4.1	44.38	19.54	23.58
186.3	90.12	54.86	0.5	0.	0.8	6.2	44.45	19.47	24.47
195.3	123.6	55	0.6	0.	0.8	5.59	43.34	21.38	23.19
195.0	128.8	54.26	0.5	0.	0.9	4.4	43.4	20.92	23.22
181.2	122.4	56.64	0.4	0.	0.9	5.72	45.15	18.88	24.02
205.7	138.0	52.92	0.5	0.9	0.9	2.01	43.15	22.49	22.63

Table 7: Multi-objective genetic algorithm parameters over the UDDS driving cycle (source [88])

### 5.1.5 Particle swarm optimization

Particle swarm optimisation (PSO) is a computational method developed by Dr. Eberhart and Dr. Kennedy in 1995 [91, 92]. This technique is inspired by the social behaviour of bird-flocking, which optimises a problem by iteratively trying to improve a candidate solution with regard to a given measure of quality. In PSO, particles move around a search space and are guided by best known positions in the search space, as well as the best known position of the entire swarm. Movement of the swarm particles occur when improved positions are discovered.

PSO is a meta-heuristic approach, and can search very large spaces of candidate solutions. Though non-causal in nature, PSO does not require the optimisation problem to be differentiable and as such is very suitable for optimisation problems with some degree of noise or irregularity. Particle swarm optimisation has successfully been applied in HEVs.

In a study by Huang *et al.*[93], an improved particle swarm optimisation approach was used to optimise a multilevel hierarchical control strategy for a parallel HEV (Figure 16). Results from this study show that compared to a baseline control strategy (PSAT built-in control strategy), the optimal multilevel hierarchical control strategy is able to articulate the engine, electric motor and battery towards operating efficiently in an optimal state. In this way, fuel consumption and emissions are simultaneously minimised (Table 8). In Junhong[94], PSO was also successfully applied to solve an HEV energy management problem involving the simultaneous minimisation of fuel consumption and emissions.

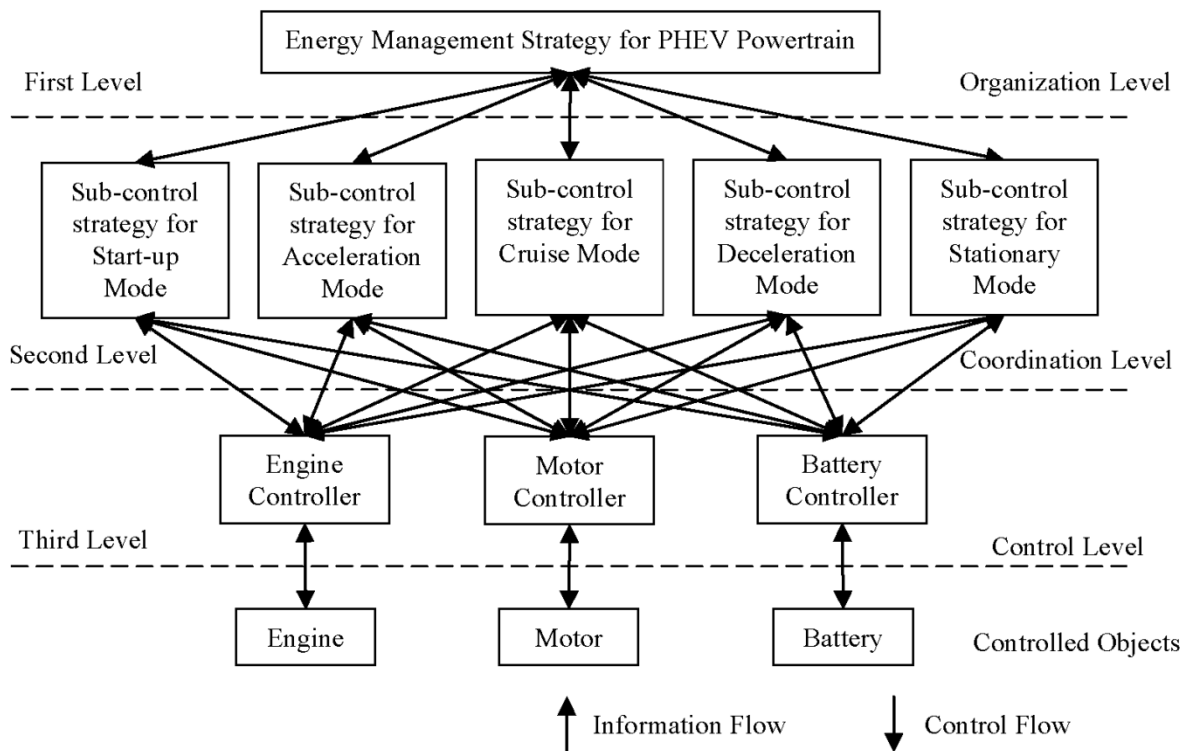

Figure 16: Structure of multilevel hierarchical control system of PHEV powertrain

Control strategy	Fuel Consumption (L/100km)	Final SOC (initial SOC-0.7)
Optimal multilevel hierarchical control strategy	6.0921	0.6929
PSAT Built in control strategy	7.1597	0.7557

Table 8: Comparison of a baseline control strategy (PSAT built-In control strategy), with an optimal multilevel hierarchical control strategy (source [93, 95])

Wang *et. al.*[96] proposed a control strategy to optimise fuel consumption and emissions in HEVs using PSO. Through simulation, the proposed PSO strategy is shown to significantly improved fuel economy in high speed driving cycles (US06), and emissions in middle or low speed driving cycles (NEDC and Manhattan cycle) as detailed in Table 9.

Control Strategy	Fuel Economy (mpg)	HC Emission (g/mi)	CO Emission (g/mi)	NOs Emission (g/mi)
Before Opt	28.8	0.722	3.422	1.003
Direct	35.4902	0.7026	3.5538	0.9757
PSO	44.9723	0.6680	3.4383	0.8892

a. US06 driving cycle

Control Strategy	Fuel Economy (mpg)	HC Emission (g/mi)	CO Emission (g/mi)	NOs Emission (g/mi)
Before Opt	39.9	0.756	3.726	0.959
Direct	30.4926	0.6937	1.7738	0.5324
PSO	38.1694	0.6834	2.3926	0.6984

b. NEDC driving cycle

Control Strategy	Fuel Economy (mpg)	HC Emission (g/mi)	CO Emission (g/mi)	NOs Emission (g/mi)
Before Opt	32.7	2.256	11.497	2.613
Direct	34.8820	0.7056	3.5636	0.9829
PSO	32.5624	0.7304	1.9575	0.7098

c. MANHATTAN driving cycle

Table 9: PSO simulation results over different driving cycles (source [96])

Wuet. *al.*[97] applied PSO to optimise the membership function and rules of a fuzzy logic HEV controller. The resulting strategy was simulated over different driving conditions, and found to yield near-optimal control signals in charge-sustaining operations. In Al-Aawaret. *al.*[98] and Wu *et. al.*[99], PSO is used for sizing electromechanical components for higher efficiency and reduced fuel consumption. In Al-Aawaret. *al.*[98, 100], the design optimisation environment consists mainly of a PSO module and an Electromagnetic-Team Fuzzy Logic (EM-TFL) module. As shown in Figure 17, the PSO optimiser searches the database of the EM-TFL algorithm to obtain the best population. The best population set are then matched to the objective functions. If the degree of match is higher than the present tolerance, the PSO is considered as a successful candidate. The successful candidates of all components are subsequently gathered and a PSO algorithm is used to compute the global optimal sizing for all component combinations. In Wu *et. al.*[99], the component sizing optimisation problem is solved using a multi-objective self-adaptive differential evolution algorithm (MOSADE). The proposed MOSADE (Figure 18) approach adopts an external elitist archive to retain non-dominated solutions that are found during the evolutionary process. To preserve the diversity of Pareto optimal solutions, the MOSADE approach consist of a progressive comparison truncation operator, based on the normalised nearest neighbour distance. Simulation results from both studies, demonstrate the capability of PSO to generate well-distributed Pareto optimal solutions to HEV multi-objective optimisation design problems.

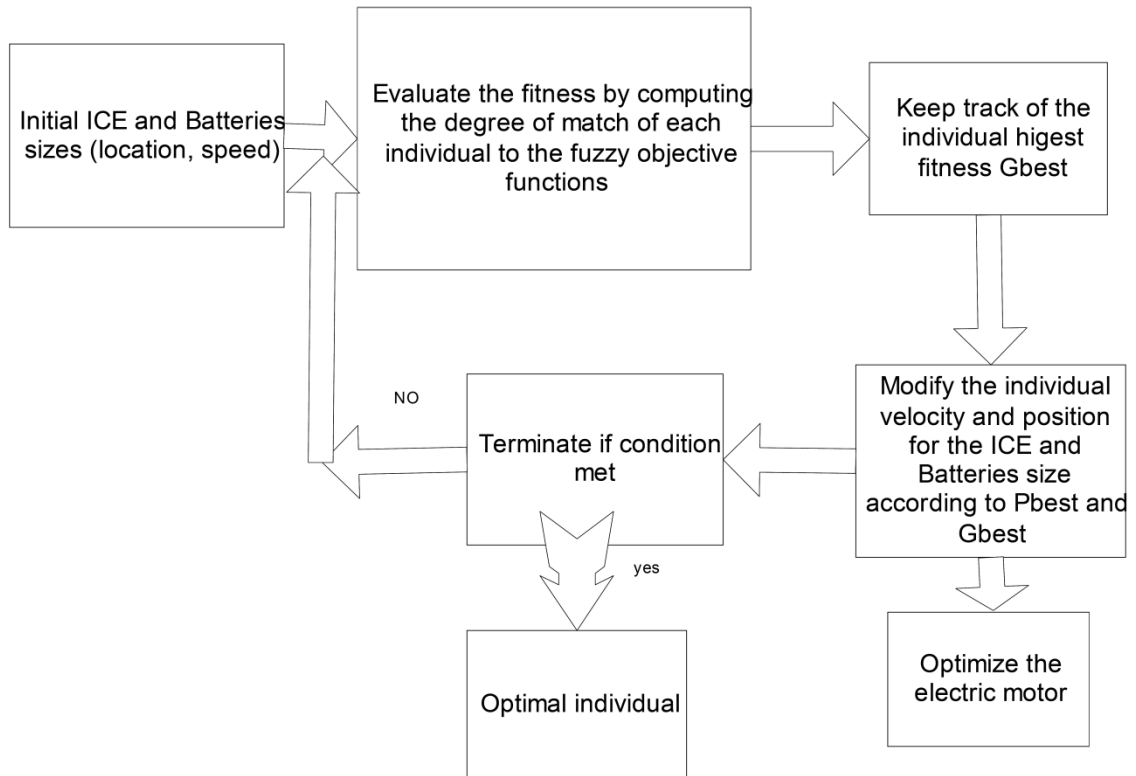

Figure 17: Electromagnetic-Team fuzz logic PSO optimization process for an HEV (source [98])

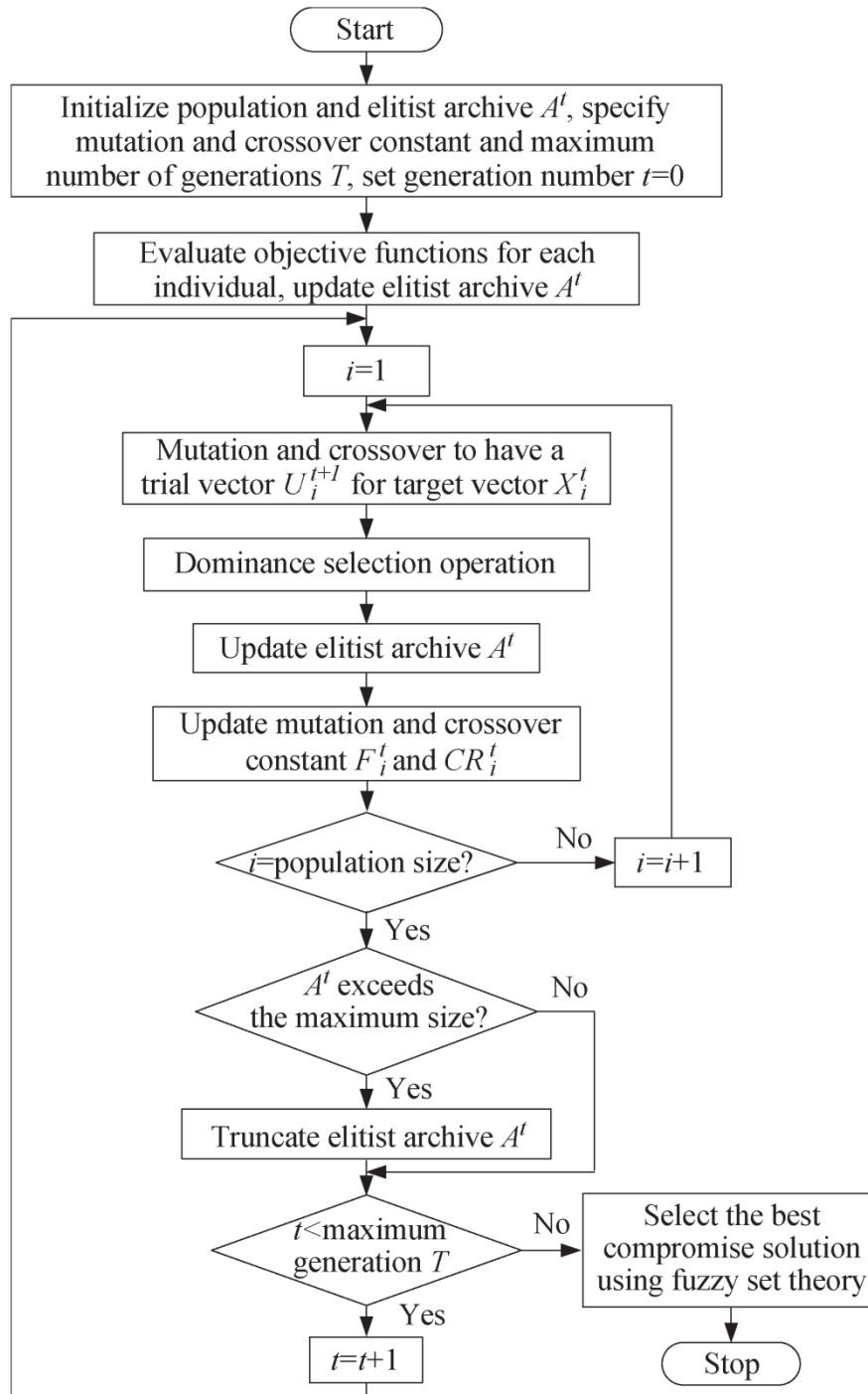

Figure 18: Algorithm flow chart of the MOSADE approach (source [99])

Desai *et. al.*[101], applied PSO to optimise both the powertrain and control strategy for reduced fuel consumption, improved efficiency and reduced emissions. As detailed in Figure 19, simulation results show an improvement in the fuel economy, emissions, and overall drivetrain efficiency. In Varesiet. *al.*[102], PSO is used as shown in Figure 20 to find the optimal degree of hybridisation in a series-parallel



HEV, to optimise vehicle performance, as well as reduce fuel consumption and emissions. By analysing real-time simulation results, the authors conclude that the PSO algorithm is a fast and efficient optimisation technique for component sizing.

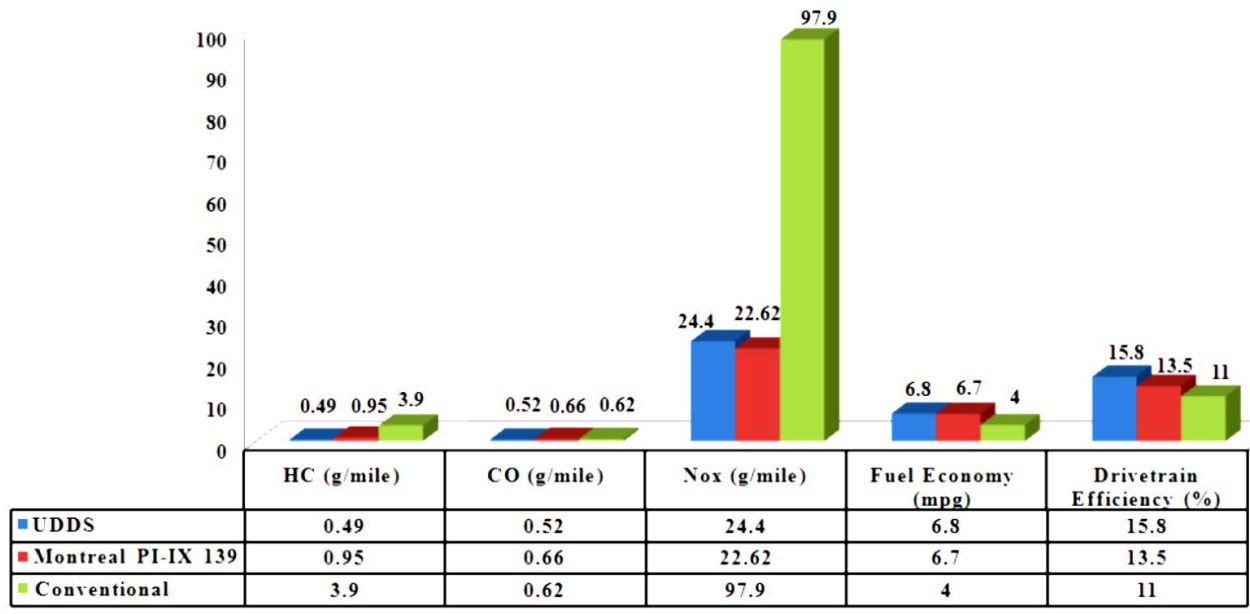

Figure 19: Comparative plot of fuel economy, emissions and drivetrain efficiency for a particle swarm optimisation process (source [101])

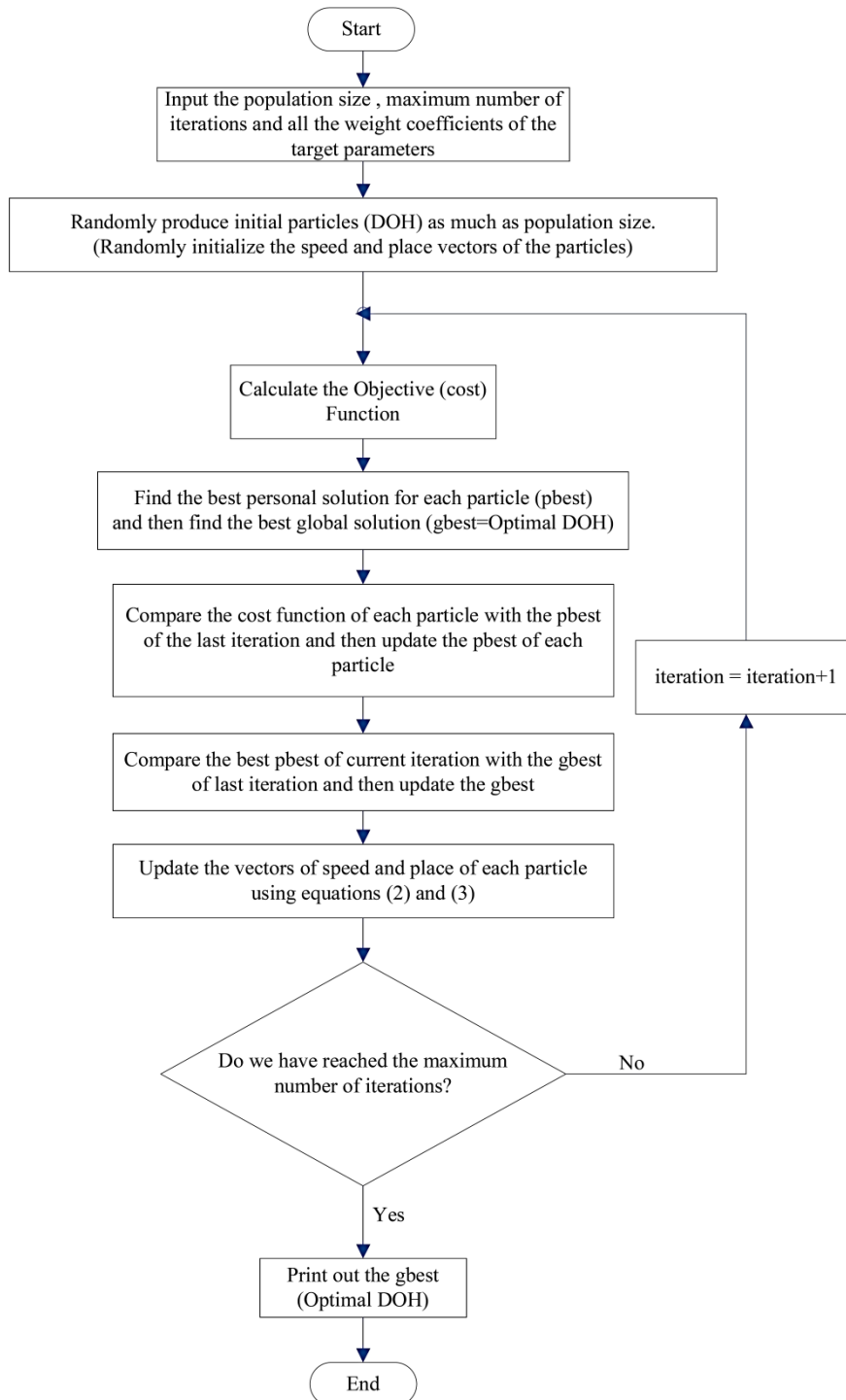

Figure 20: Optimal degree of hybridisation solution process using particle swarm optimisation algorithm (source [102])

## 5.2 HEV online control strategies

In contrast to HEV offline control strategies, HEV online control strategies are causal and can be implemented in real-time. HEV online control strategies can either be formulated in form of heuristic control rules (rule-based control strategies), or as an instantaneous optimisation of a defined objective function (online optimisation based strategies).

### 5.2.1 Rule based control strategy

Rule-based control strategy is the most common way of implementing a real-time supervisory control in an HEV. The control rules are often based on heuristics, engineering intelligence, or mathematical models and are aimed at the objective of enabling the ICE to operate at high efficiency points, as well as enabling energy recuperation via regenerative braking [103-106].

The development of rule-based HEV control methods is generally articulated in two steps: the definition of the relevant rules for the powertrain control, and the calibration of the strategy, which is typically carried out by means of simulations on a vehicle model. Rule-based control methods are generally unable to guarantee the optimality of the solution found, nor satisfy the desired final integral constraint (charge sustainability). To remedy this, the control rules must make sure that the integral constraint (SOC) remains between its prescribed lower and upper bounds. With rule-based control strategies, there is no standard approach to the control rules formation, and no way to determine a priori that the given set of rules is appropriate for the given application. However, there is a possibility that the control rules can be made detailed and complex enough to take care of any special event that may affect the vehicle [26, 107-112].

The main advantage of rule-based HEV control methods lie in their simplicity, which makes them fairly easy to understand and implement on actual vehicles [26, 107-112]. Owing to their low computational demand, natural adaptability to online-applications, good reliability and satisfactory fuel consumption results, rule-based control strategies have monopolised the production vehicle market. Despite widespread utilisation, rule-based HEV control methods, still present some significant challenges. Typically, in a rule-based HEV control strategy, a huge amount of time and investment in qualified work force is required to develop the strategy, owing to the long rules definition and calibration process. This situation is further worsened by the fact that the rules need to be redefined for every new driving

condition and powertrain, thus posing some questions about the robustness of rule-based HEV control strategies [113]. In addition to this, recent research studies show that in comparison to optimisation methods, rule-based HEV control methods produce inferior but satisfactory fuel consumption results [114]. Rule-based controllers could further be subcategorised into deterministic rule-based control strategy [115] and fuzzy rule-based control strategy [106].

### 5.2.1.1 Deterministic rule based control strategy

In the deterministic rule-based control strategy, rules are decided with the aid of a fuel economy or emissions map of the engine in question. Implementation of the rules, are often performed via pre-computed look up tables. Deterministic rule-based control strategy features notably in the study of Kim *et. al.*[116], where the concept of hybrid optimal line was proposed for a parallel HEV, with continuous varying transmission (CVT). Using this concept, optimal values of CVT gear ratio, motor torque and engine throttle were determined successfully and applied in real-time.

One of the most successfully applied deterministic rule-based HEV control strategy is the electric assist control strategy. In this strategy, the ICE works as the sole source of power supply and the electric motor is only used to supply additional power when demanded by the vehicle. Thermostat control strategy is another variation of deterministic rule-based control. In this approach, the electric motor and ICE are used to generate the electrical energy which powers the vehicle. The battery state of charge is always maintained between predefined high and low levels, by simply turning on/off the internal combustion engine. Jalilet. *al.*[105] used the thermostatic control strategy to turn the engine on/off based on the battery state of charge profile. Obtained results were found to be highly sub-optimal, compared to that of a deterministic rule-based control strategy.

In many of the widely employed rule-based control strategies, the following rules apply [117-119]:-

1. Below a certain vehicle power demand, the vehicle works purely as an electric vehicle (EV) and only the electric motor is used to supply the total power demand. This rule is generally set to avoid the engine operating in low engine efficiency points. The applicability of this rule however depends on the size of the electric motor and batteries employed on the HEV.
2. The electric motor is used for power-assist, when the vehicle power request exceeds the maximum engine power.

3. The electric motor charges the battery during regenerative braking.
4. The ICE is used to produce an extra torque to sustain the battery SOC, when it goes below the set minimum value.

### 5.2.1.2 Fuzzy rule based control strategy

Fuzzy rule controllers in general originate from rule-based controllers. However, in a fuzzy rule controller, the linguistic representation of the control inputs is converted into numerical representation with membership function, in the fuzzification and defuzzification process. The underlying logic in the fuzzy rule-based control strategy is a form of multivalued logic derived from fuzzy set theory, to deal with reasoning that is approximate rather than precised. The relative simplicity associated with fuzzy rule controllers allow for tuning and adaptation where necessary, thus enhancing the degree of freedom of control. Its non-linear structure makes it even more useful in complex systems such as advanced powertrain. Fuzzy rule controllers typically accept as inputs, the battery state of charge, desired ICE torque and intended mode and outputs the ICE operating point. In Schoutenet. *al.* [107], Zeng et. *al.* [120] and Khoucha et. *al.* [121], driver command, battery SOC and motor/generator speeds were considered as fuzzy sets for the design of a fuzzy rule-based control strategy. In Liu et. *al.* [122], the fuzzy control framework was extended to include a power notification system, which enables the engine to operate in its high efficiency region.

Typically, the electric motor makes up for the difference between the power demand and the ICE power. Currently, there are several variations to the fuzzy rule-based control in the form of: traditional fuzzy control strategy, adaptive fuzzy control strategy and predictive fuzzy control strategy.

#### 5.2.1.2.1 Traditional fuzzy control strategy

Traditional fuzzy control is typically implemented to optimise fuzzy efficiency, thus enabling the ICE to operate more efficiently. This is achieved by means of load balancing, where the electric motor is used to force the engine towards operating in its most efficient region (low engine speed, high engine torque region), while sustaining the battery state of charge. Schoutenet. *al.* [107] proposed a fuzzy logic controller to optimise fuel consumption in a parallel HEV. The proposed method is based on the efficiency optimisation of the essential parts of the vehicle including the internal combustion engine, electric motor and battery. An efficiency map for a generic compression ignition direct injection (CIDI) engine is used. Taking into

account the battery state of charge, the fuzzy controller is used to track the individual components so that they operate close to the optimal curve, as shown in Figure 21. The entire solution process can be articulated using the following steps: First, the power controller is used to convert the accelerator and brake pedal inputs to driver power command. The driver power command, battery SOC and electric motor speed are then used by a fuzzy logic controller, to compute the optimal generator power and scaling factor for the electric motor, as detailed in Table 10. The driver power command, optimal generator power, and scaling factor are then used to compute the optimal power for the ICE and electric motor.

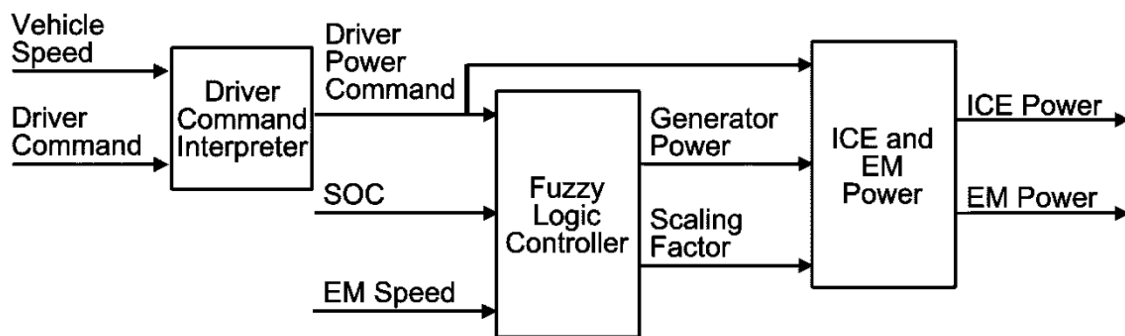

Figure 21: Simplified block diagram of the Fuzzy logic controller (source [107])

---

1	<b>If SOC is too high then <math>P_{gen}</math> is 0 kW</b>
2	<b>If SOC is normal and <math>P_{driver}</math> is normal and <math>\omega_{EM}</math> is optimal then <math>P_{gen}</math> is 10 kW</b>
3	<b>If SOC is normal and <math>\omega_{EM}</math> is not optimal then <math>P_{gen}</math> is 0 kW</b>
4	<b>If SOC is low and <math>P_{driver}</math> is normal and <math>\omega_{EM}</math> is low then <math>P_{gen}</math> is 5 kW</b>
5	<b>If SOC is low and <math>P_{driver}</math> is normal and <math>\omega_{EM}</math> is not low then <math>P_{gen}</math> is 15 kW</b>
6	<b>If SOC is too low then <math>P_{gen}</math> is <math>P_{gen,max}</math></b>
7	<b>If SOC is too low then scale factor is 0</b>
8	<b>If SOC is not too low and <math>P_{driver}</math> is high then <math>P_{gen}</math> is 0 kW</b>
9	<b>If SOC is not too low then scale factor is 1</b>

---

Table 10: Rule base of the Fuzzy logic controller (source [107])

Simulation results show that compared to a default controller on the PSAT (PNGV systems analysis tool kit) simulation model, the fuzzy logic controller achieves on the overall, a 6.8% improvement over an urban driving cycle, and a 9.6% improvement over a highway driving cycle as detailed in Table 11.

Normalised losses	Highway cycle		Urban cycle	
	Default	FLC	Default	FLC
Internal Combustion Engine (ICE)	62.7	59.4	66.5	64.5
Electric Motor EM	3.2	2.2	5.2	3.2
Battery	0.85	0.53	0.6	0.3
Drivetrain	12.3	7.3	12.3	9.4
Vehicle	19.3	19.3	10.8	10.9
Friction braking	0.35	0.35	2.5	2.8
Accessories	1.3	1.3	2.1	2.1
Total	100	90.4	100	93.2

Table 11: Comparison of normalised losses for a default PSAT controller and a Fuzzy logic controller (source [107])

### 5.2.1.2.2 Adaptive fuzzy control strategy

Adaptive fuzzy control strategy is becoming increasingly popular in automotive applications on HEV, because it presents the possibility for the simultaneous optimisation of fuel efficiency and emissions. Fuel efficiency and emissions are often conflicting objectives and as such an optimal solution cannot be achieved to the satisfaction of each individual objective. However, a sub-optimal solution is achievable using the weighted-sum approach, where appropriate weights are tuned over different driving conditions, for fuel efficiency and emissions. The weights assigned are relative, and thus reflect the importance of the individual objectives to which they are assigned (fuel consumption, NO<sub>x</sub>, CO and HC emissions) [123]. Consequently, with adaptive fuzzy controllers it is possible to control individual objectives by changing the value of the weights assigned. An application of adaptive fuzzy logic controllers in solving conflicting objective control problems involving NO<sub>x</sub>, CO and HC emissions, have been reported in literature [86, 123].

### 5.2.1.2.3 Predictive fuzzy control strategy

Predictive fuzzy controller utilises prior information about a planned driving trip. This information is often acquired with the aid of a Global Positioning System (GPS), which provides knowledge about the type of obstacles that the vehicle is bound to encounter e.g. heavy traffic, and steep grade etc. Typical inputs to the predictive controller are vehicle speed, speed state in the look-ahead window and the elevation of the sampled points along a predetermined route.

Based on the available history of vehicle motion, and the speculation of its possible motion in future, the predictive fuzzy controller calculates the optimal ICE torque contribution for each vehicle speed and outputs a normalised signal in the order of -1 to +1, which prescribes whether the battery should be charge or discharged respectively.

Owing to simplicity and robustness, fuzzy controllers have attracted a lot of attention from heuristic control experts within the research and automotive industry. Arsieet. *al.*[124] for example, implemented a fuzzy controller to control the parameters related to driver-vehicle interaction, torque management, and battery recharge. **The proposed driver model uses fuzzy control rules (Table 12), to formulate a realistic representation of the cognitive process of a human driver. Consequently, in a situation where the vehicle speed is greater than the reference speed and the vehicle is already decelerating, the fuzzy driver would not brake hard, but would either keep the throttle closed or brake gently. As shown in Figure 22, simulation results show an excellent agreement between the target and the instantaneous vehicle speed.**

Acc.	A	O	ST	C	MC	MC	HC	HC
	LA	MO	O	ST	C	MC	MC	HC
	ST	HO	MO	O	ST	C	MC	HC
Dec.	LD	HO	MO	MO	O	ST	C	MC
	D	HO	HO	MO	MO	O	ST	C
		HS	MS	S	ST	F	MF	HF
		Slow				Fast		

Membership functions legend			
HS	High Slow	A	Acceleration
MS	Medium Slow	LA	Low Acc.
S	Slow	C	Close
F	Fast	HC	High Close
MF	Medium Fast	MC	Medium Close
HF	High Fast	O	Open
LD	Low Deceleration	MO	Medium Open
D	Deceleration	HO	High Open
ST	Steady		

**Table 12: Rule-based for driver model fuzzy controller (source [124])**



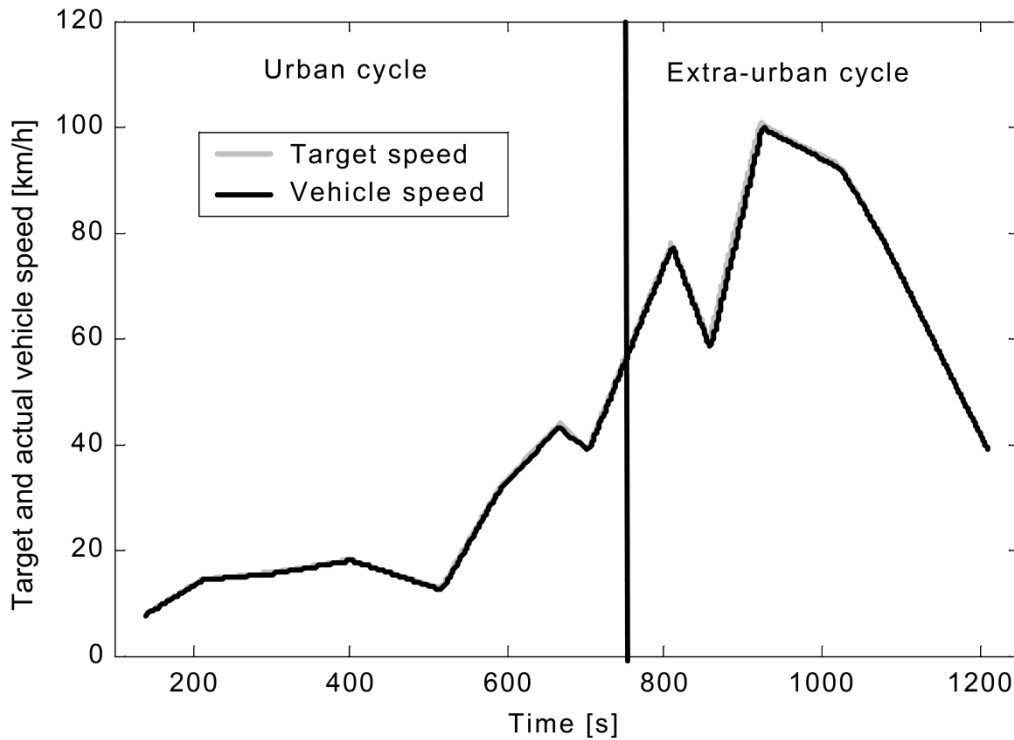

Figure 22: Target and actual vehicle speed for a fuzzy driver model (source [124])

Lee *et. al.*[125] proposed a fuzzy controller that is robust and unaffected by vehicle load variation and road pattern. The proposed fuzzy logic controller is mainly composed of two parts: the driver's intention predictor (DIP) and the power balance controller (PBC), as shown in Figure 23. The difference between the two fuzzy logics is that the DIP generates the torque reference responding to the rapid acceleration or deceleration of the vehicle regardless of the battery's state, and the PBC generates the torque reference responsible for keeping the battery charge balanced.

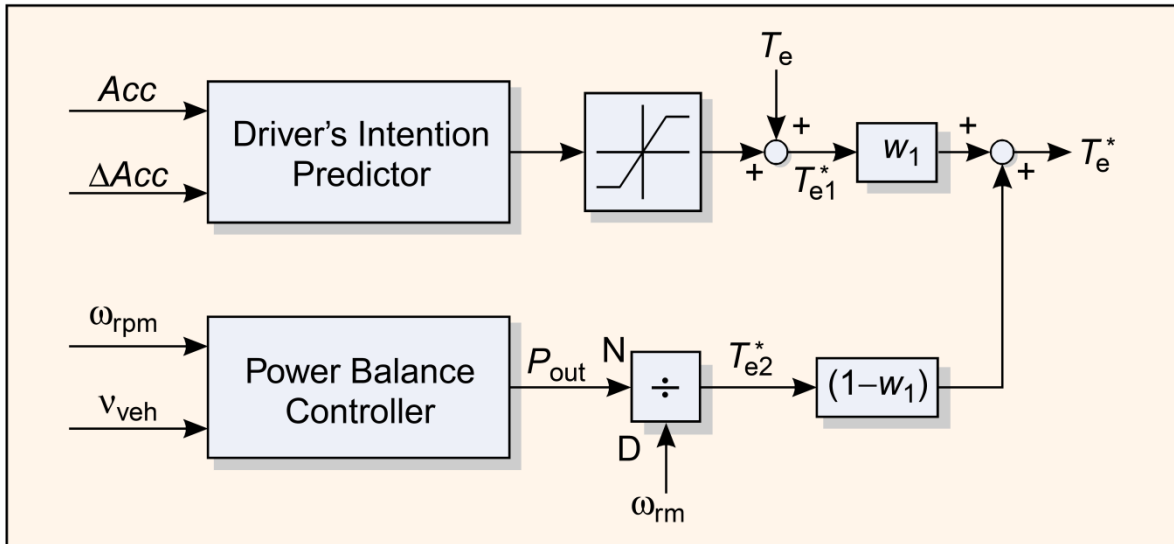

Figure 23: Block diagram of the DIP and PBC fuzzy controller (source [125])

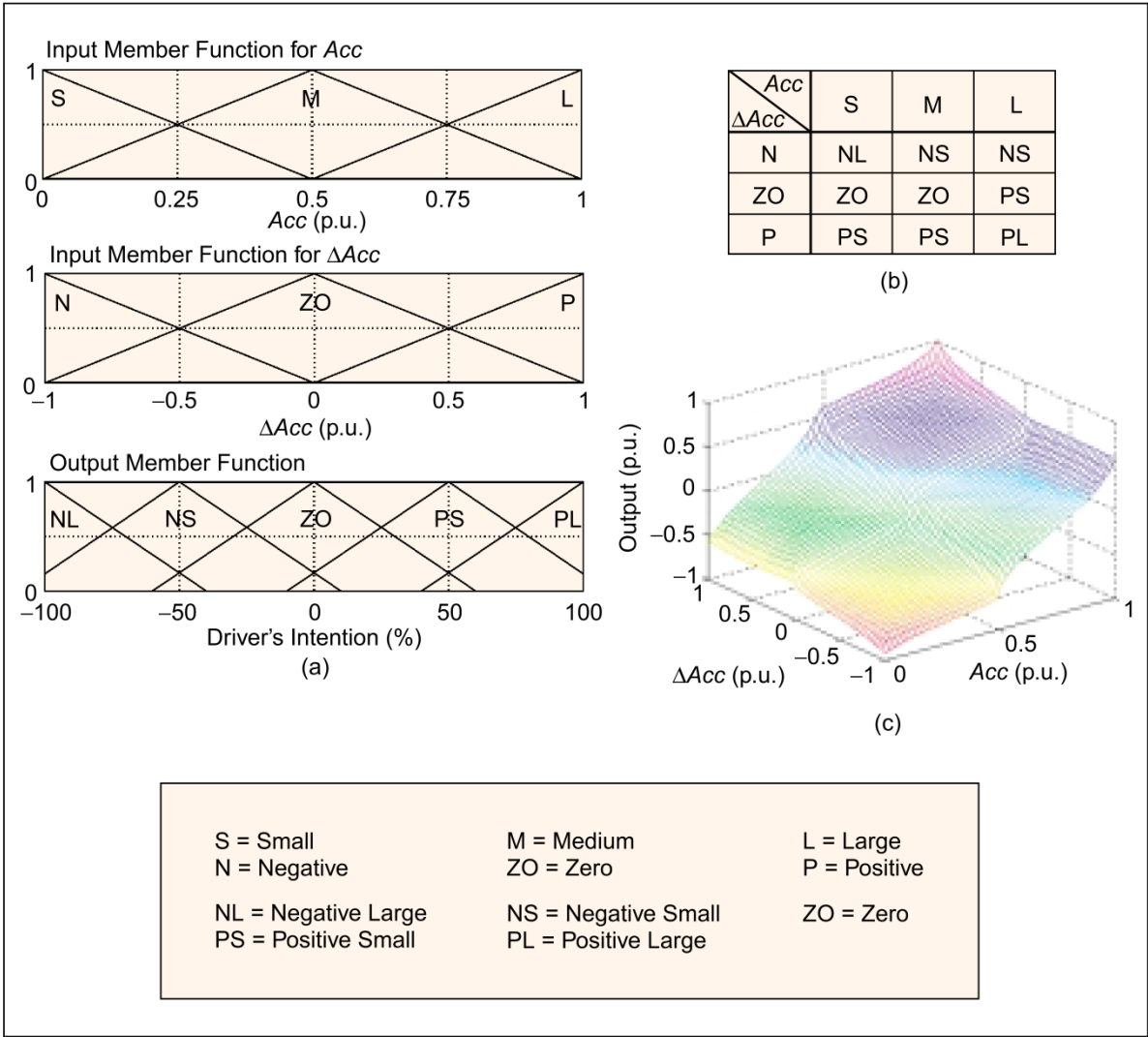

Figure 24: Fuzzy logic based driver's intention predictor (DIP). (a) Input and output membership functions (b) Rule-base (c) Output (source [125])

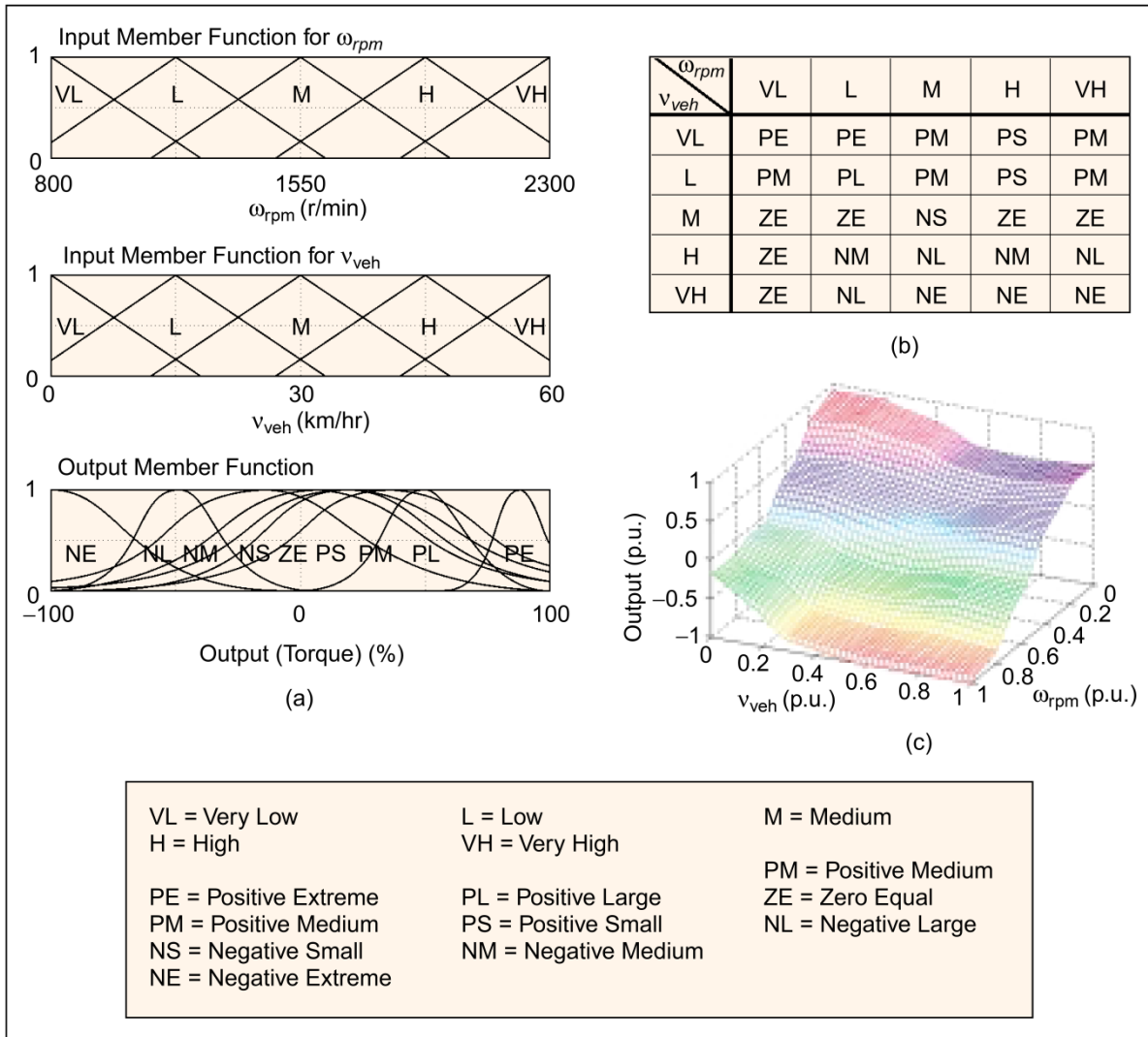

Figure 25: Fuzzy logic based power balance controller (a) Input and output membership functions. (b) Rule base (c) Output (source [125])

Simulation results show that over a 20 days testing period, the proposed controller is able to preserve the battery voltage between its nominal voltage (120% fully charge voltage) without any extra charge (Figure 26).

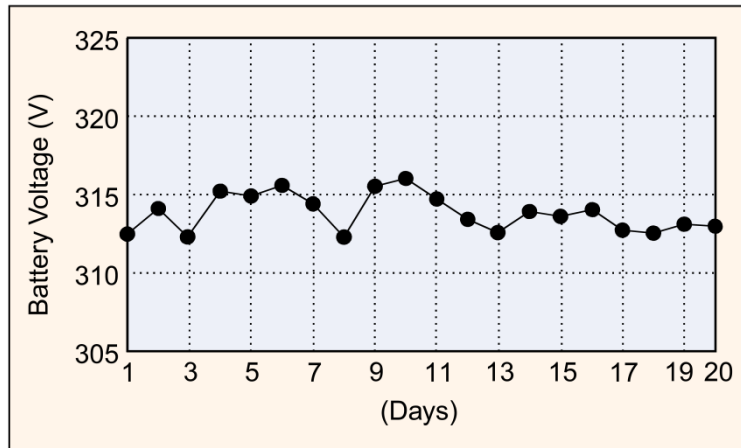

Figure 26: Battery voltage variations for the DIP and PBC fuzzy controller (source [125])

Baumann *et. al.* [108], demonstrated the effectiveness of fuzzy controllers to increase fuel economy and showed that it works well for non-linear, multi-domain and time varying systems. The proposed control scheme forces the majority of operating points to be in the vicinity of the highest point of efficiency. The resulting effect is an increase in average efficiency from 23% to 35.4% over the federal urban driving schedule as shown in Figure 27.

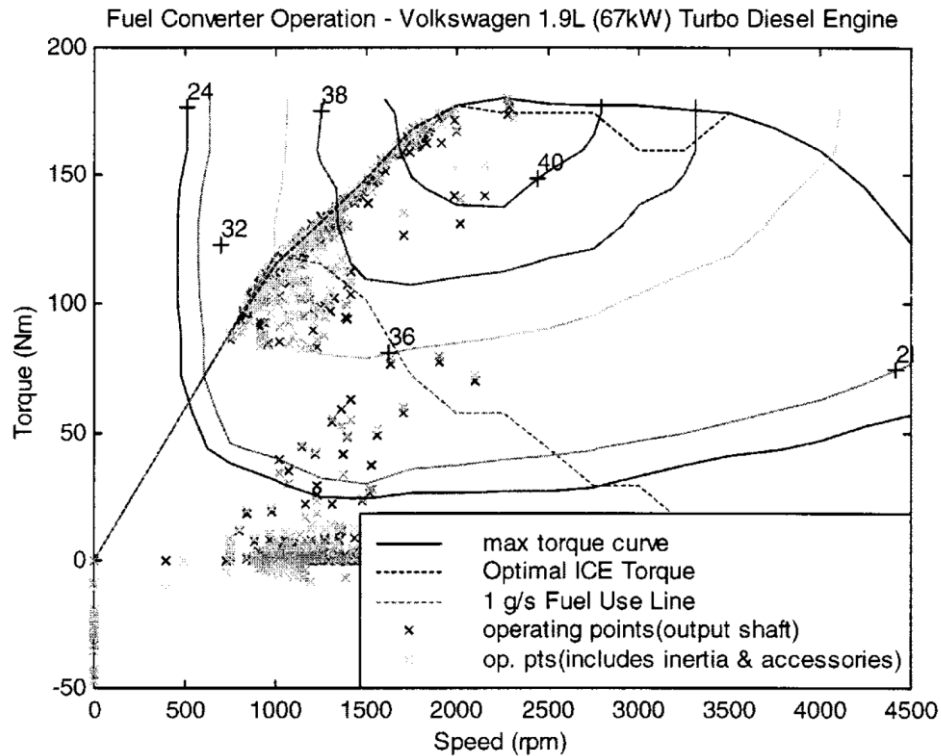

Figure 27: Efficiency map for HEV using efficiency strategy (source [108])

Tao *et al.*[126] designed a *PID-like* fuzzy controller with heuristic functional scaling which is easy to adjust even in the absence of a mathematical model for the vehicle. The proposed controller dubbed “*FPIDF*” (Flexible complexity reduced *PID-like* Fuzzy controller) (Figure 28) was simulated against a normal *PID-like* fuzzy controller and a *PD* controller. Simulation results show that compared to the other controllers, the *FPIDF* controller performs the best with the shortest rise and settling time. Proportional-Integral (*PI*) controllers have also been shown to be effective in the control of non-linear plants [4, 127-129]. In Syed *et al.*[127] for example, a *PI* controller is designed and optimally scheduled using a fuzzy-gain scheduling system, to control engine power and speed in an HEV.

In Jianlong *et al.* [130], an attempt is made to formulate a computationally efficient fuzzy control strategy, using a network structure of 2 inputs and 1 output. In Zhou *et al.* [131], particle swarm optimisation is used to improve the accuracy, adaptability and robustness of a fuzzy control strategy.

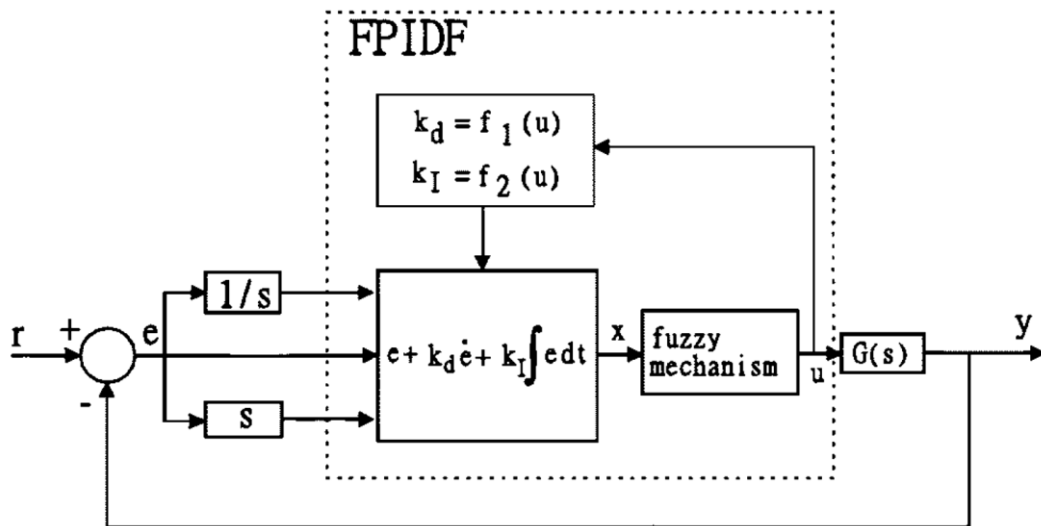

Figure 28: Block diagram of the fuzzy control system with FPIDF (source [126])

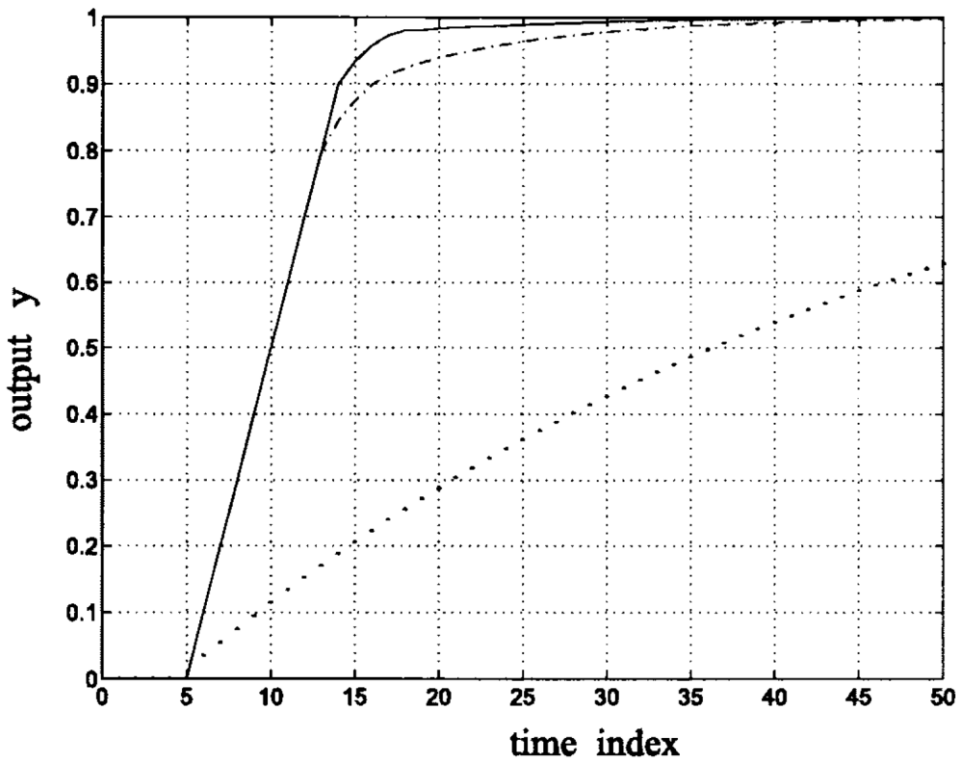

Figure 29: Performances of fuzzy controllers FPIDF (solid line), PIDF (dash-dot line), and PD (dotted line) for delayed plant (source [126])

In Hajimiri *et al.* [132], a predictive fuzzy logic controller which uses inputs such as present elevation, future elevation, present speed and predictive speed is proposed to manage the power flow in a series HEV. Based on the future state of the vehicle, related to traffic and elevation positions, the rules are defined accordingly as detailed in Table 13.

Future State	Increasing elevation	Constant elevation	Decreasing elevation
Increasing traffic flow	Nothing	Normal discharging	High discharging
Constant traffic flow	Normal discharging	Nothing	Normal discharging
Decreasing traffic flow	High charging	Normal discharging	Nothing

Table 13: Fuzzy rule base of a predictive control strategy

The foregoing rules imply that, when the GPS indicates “decreasing elevation” and “increasing traffic flow” for the future state, the output command is “high discharging”. In this case, more battery energy is consumed in slower traffic and higher elevation; while the future state of the vehicle, i.e. decreasing elevation and increasing traffic flow, will compensate the high rate of discharging at present. The comparison results of the predictive fuzzy controller and a power follower algorithm are detailed in Table 14.

	Predictive algorithm	Power follower algorithm
Fuel consumption [Lit/mile]	0.189	0.202
CO [g/mile]	4.293	5.08
HC [g/mile]	0.656	0.676
NOx [g/mile]	0.878	0.894

Table 14: Fuel consumption and emissions of a fuzzy predictive controller and a power follower controller (source [132])

These results show that the predictive fuzzy controller outperforms the power follower algorithm on the basis of fuel consumption reduction and emissions reduction.

In Langariet. *al.*[133], the concept of fuzzy intelligent energy management agent (IEMA) is proposed and implemented for vehicle torque distribution and charge sustenance, on the basis of current vehicle state, vehicle power demand and



available online driving cycle data. Simulation results show that the IEMA is able to manage the torque distribution of a parallel HEV in a charge-sustaining manner.

In Golkaret. *al.*[134], an online adaptive intelligent fuzzy controller (Figure 30) is proposed, and used to optimally control the ICE torque such that conflicting objectives involving fuel consumption and emissions are simultaneously minimised.

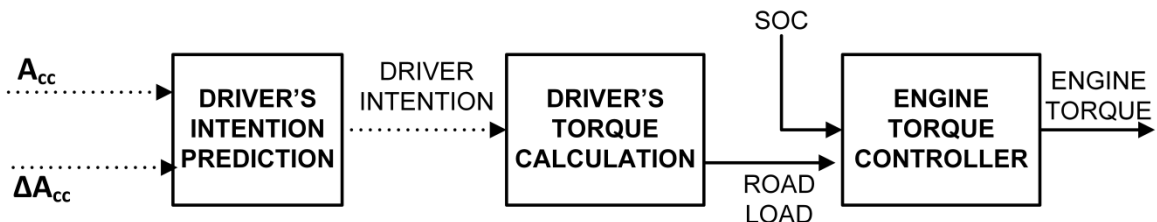

Figure 30: Layout of fuzzy controller with driver intention predictor and driver torque computation (source [134])

Using different variations of the predictive fuzzy control strategy, similar results were observed in the study of Lu *et. al.*[135] (Table 15) and Fu *et. al.*[136].

Drive cycle	Control strategy	NOx Emissions g/km	HC Emissions g/km	CO Emissions g/km	Fuel Economy L/(100km)
NEDC	Electric assist control strategy	0.195	0.344	1.795	7.7
	Fuzzy logic control	0.108	0.295	1.361	5
	Improve (%)	44.62%	14.24%	24.18%	35.06%
UDDS	Electric assist control strategy	0.253	0.323	1.467	7.7
	Fuzzy logic control	0.132	0.269	1.282	4.4
	Improve	47.83%	16.72%	12.61%	42.86%
China	Electric assist control strategy	0.244	0.398	1.869	8.6
	Fuzzy logic control	0.132	0.346	1.62	4.6
	Improve	45.90%	13.07%	13.32%	46.51%

Table 15: Comparison between electric assist control and fuzzy logic control (source [135])

	Fuzzy logic energy management strategy	
	After optimisation	Before optimisation
HC (grams/miles)	0.34	0.421
CO (grams/miles)	1.713	2.071
NOX (grams/miles)	0.159	0.169
Fuel Economy (mpg)	63.6	62.4

Table 16: Simulation results from a fuzzy logic energy management strategy (source [136])

Poursamadet. *al.*[86] proposed an adaptive genetic-fuzzy control strategy to determine how to distribute vehicle power demand between the internal combustion engine and the electric motor of a parallel HEV. First, a fuzzy logic controller is designed, and then the rules are determined and optimised using genetic algorithm. The resulting controller is used to optimise an objective function whose target values are minimised fuel consumption and exhaust emissions (HC, CO, and NOx). Simulation results show that over the TEH-CAR driving cycle, the genetic-fuzzy controller is able to simultaneously achieve reduced fuel consumption, improved vehicle performance and battery charge sustenance (Figure 31).

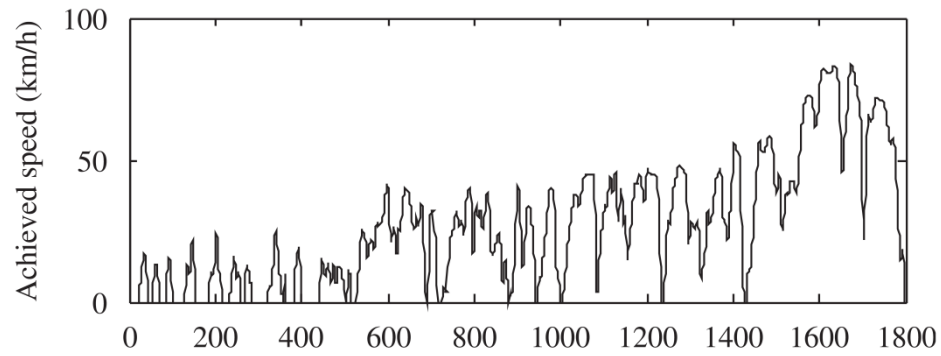

a. Driving cycle

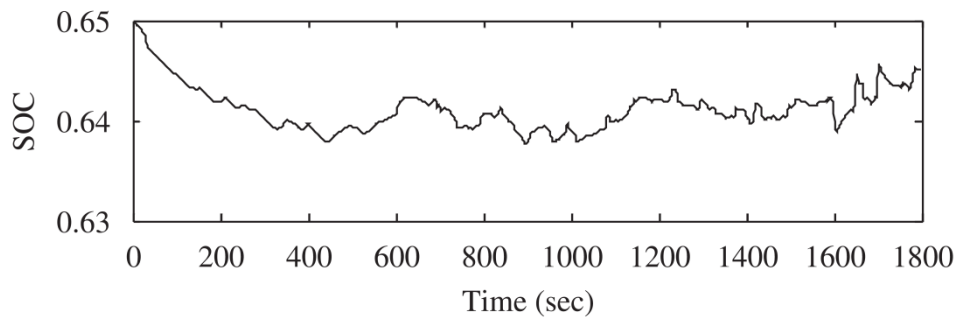

b. SOC history over TEH-CAR driving cycle

Figure 31: Simulation results for the genetic-fuzzy control strategy over the TEC-CAR driving cycle (source [86])

The fuzzy algorithm is also well suited for non-control applications. For example, in Brahma *et. al.* [137], the fuzzy control theory is used to accurately design an HEV modelling tool, with multi-purpose applications.

## 5.2.2 Online optimization based strategies

Online optimisation based strategies reduce global optimisation problems into a succession of local optimisation problems, thus reducing the associated computation effort. This eliminates the need for future driving information, thus making it implemented in real-time. Despite yielding marginally sub-optimal results in comparison to global optimisation strategies, local optimisation strategies have received the greatest research attention in HEV control. ECMS (Equivalent Consumption Minimisation Strategy) [117, 138-141] and PMP (Pontryagin's minimum principle) [142, 143] feature as the most popular of these techniques among researchers. Other online optimization based strategies being researched today include artificial neural network, particle swarm optimisation (PSO) and model predictive control (MPC).

### 5.2.2.1 Pontryagin's minimum principle

Pontryagin's minimum principle (PMP), formulated in 1956 by the Russian mathematician Lev Pontryagin and his students, is a special case of Euler-Lagrange equation of the calculus of variations. The principle stipulates that the optimal solution to the global optimisation problem must satisfy the condition of optimality. PMP is based on the instantaneous minimisation of a Hamiltonian function over a driving cycle [143, 144]. Under the assumption that the trajectory obtained from PMP is unique and satisfies the necessary constraints and boundary conditions, the optimal trajectory obtained by PMP can be considered as a global optimal trajectory [143, 145-150]. In Geering[146] and Serrao *et. al.*[147], the process of formulating a global optimisation problem into a local optimisation problem, and solving it using PMP is discussed.

Kim *et. al.* [150, 151] applied PMP to find the optimal control law for a plug-in HEV. They showed that by setting a correct initial estimate of the co-state, the instantaneous minimisation of the Hamiltonian function over a driving cycle yields a control policy that closely matches results from dynamic programming, when the state boundary conditions are met (Table 17). They also showed that under the assumption that the battery resistance and voltage are independent of SOC, the co-state could be considered a constant, and the resulting controller would still compare very closely in performance to the PMP variation with a variable co-state (Table 17 and Figure 32).

Method	DP	PMP	
		Exact solution ( $p(0) = -301.1$ )	Constant co- state ( $p(0) = -293.4$ )
FE (km/l)	65.716	65.621	65.358

Table 17: Optimal fuel economies for PHEVs under different techniques (source 101)

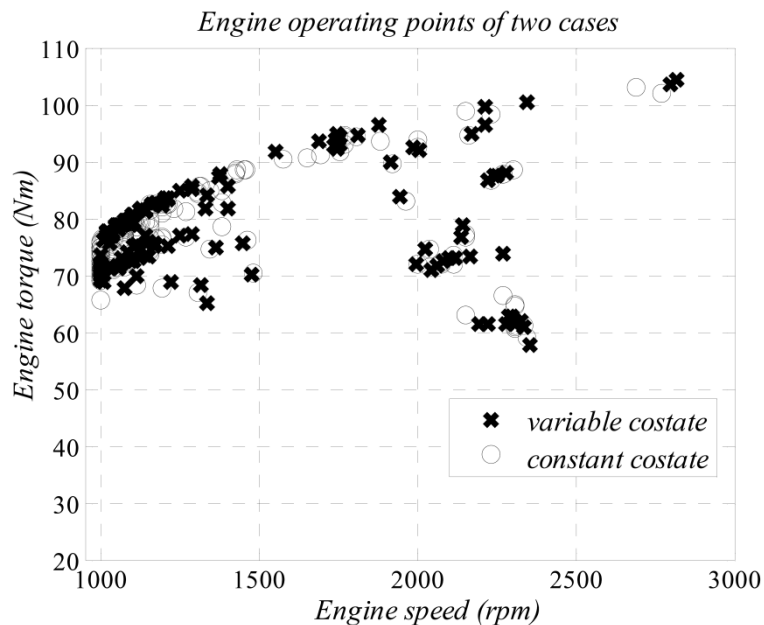

Figure 32: Engine operation points for a PMP controller with constant co-state and variable co-state (source 101)

Stockaret. *al.* [152] proposed a PMP inspired model-based control strategy to minimise CO<sub>2</sub> on a plug-in HEV (Figure 34). By examining the state of energy evolution for different co-state values, it was concluded that the performance of the PMP controller is very sensitive to the estimated co-state value. In the particular example considered (Figure 33), it was found that for a co-state value greater than 10, the model-based PMP control strategy forces the vehicle to deplete the battery, and when the lower SOE (State of Energy) bound is reached, it switches to a charge-sustaining mode. Similarly, when the co-state value is equal to 6, the model-based PMP strategy allows the battery to be gradually depleted during the cycle, reaching the lower SOE bound only at the end of the driving pattern and avoiding any charge-sustaining operations. This operation, which is known as blended mode, allows for the achievement of the minimum vehicle fuel consumption along a prescribed driving cycle. The findings from Stockaret. *al.* [152] suggest that PMP is a shooting method that solves a boundary value optimisation problem. Consequently, the

resulting optimal control strategy is non-causal and cannot be implemented in real-time.

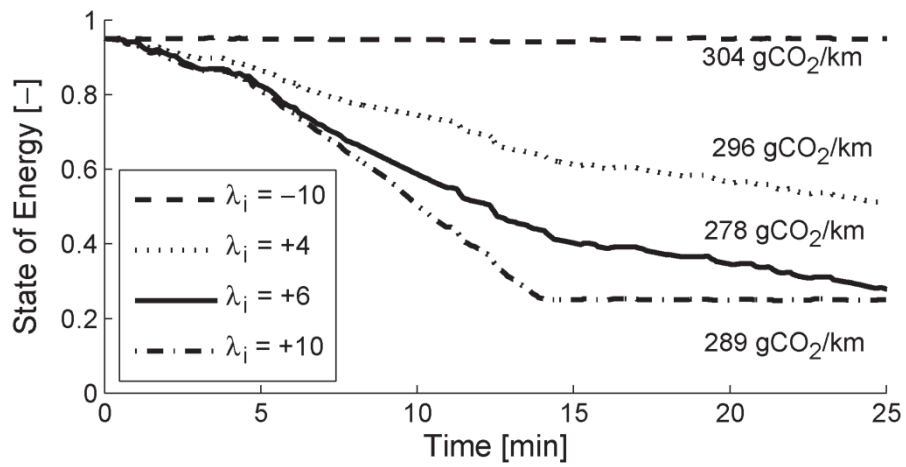

Figure 33: Battery SOE profile during the driving cycle for  $\mu_i = 18$  varying  $\lambda_i$  (cycle Path 3, U.S. scenario) – source [152]

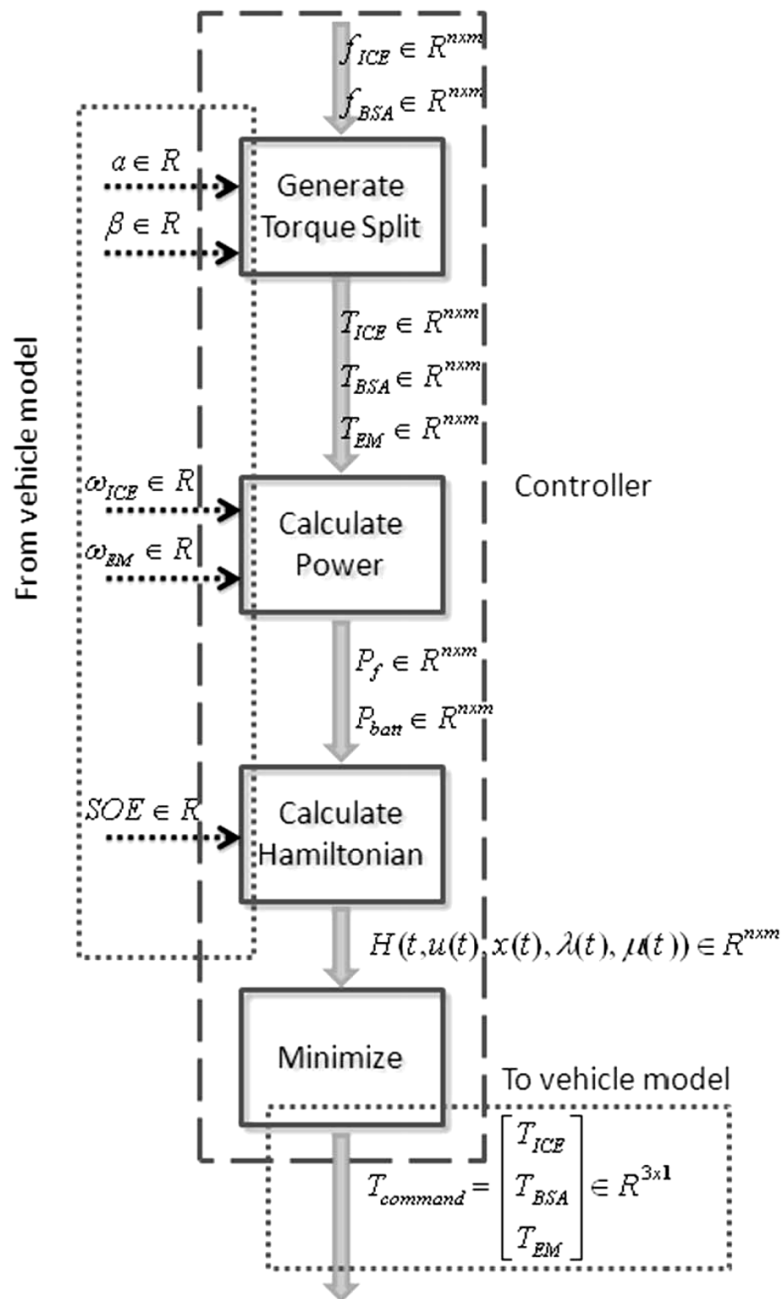

Figure 34: Flow chart describing the model-based PMP control strategy (source [152])

### 5.2.2.2 Equivalent consumption minimization strategy

A more readily implementable local optimisation approach is the Equivalent Consumption Minimisation Strategy (ECMS) [138, 141, 144, 153-160]. ECMS was first developed based on the heuristic concept that the energy used to drive a vehicle over a driving cycle ultimately comes from the engine. As such, the hybrid system merely serves as an energy buffer [138]. This strategy is based on the instantaneous minimisation of a cost index, which is the sum of a number of operation metrics

weighted by equivalence factors. The commonly used metrics in ECMS HEV control are engine fuel cost and battery fuel cost. It does not require prior knowledge of driving pattern and is thus implementable online. Variations to ECMS optimisation control strategy have been reported by a number of studies. Some of such variations include the Adaptive ECMS [153, 161] and Telemetry ECMS [162], which adjust the equivalence factor based on past driving data and future prediction. The downside to these adaptive techniques however, is the need for predictive equipment like GPS which comes at an additional cost.

Paganelliet. al.[154] implemented an ECMS strategy to minimise fuel consumption and pollutant emissions on a sport utility vehicle operating in charge-sustaining mode. To implement the global constraint of charge-sustaining operation, the optimum power split is biased using a non-linear penalty function of the battery state of charge deviation from its target value. Results from this study show that using the ECMS strategy, a charge-sustaining reduction in emissions can be achieved with no additional penalty to fuel economy.

Similar observations were made in Gaoet. al. [163] (Table 18) and Rousseau et. al. [164] (Figure 35). Results from both studies show that even in the absence of driving information, ECMS still yields near-optimal results for fuel consumption minimisation.

	Fuel consumption (l/100 km)		
	IM240	ECE_EUDC_ LOW	MANHATTAN
Thermostat Control Strategy (TCS)	34.7	47.8	63.8
Power Follower Control Strategy (PFC)	36.5	45.7	56.5
Equivalent Fuel Consumption Optimal Control Strategy (EFCOCS)	32.9	42.3	54.7
Global optimisation (DP – Dynamic Programming controller)	30.2	38.5	49.3

Table 18: Comparison between the fuel economy performance of the TCS, PFC, EFCOCS and DP HEV control strategies (source [163])



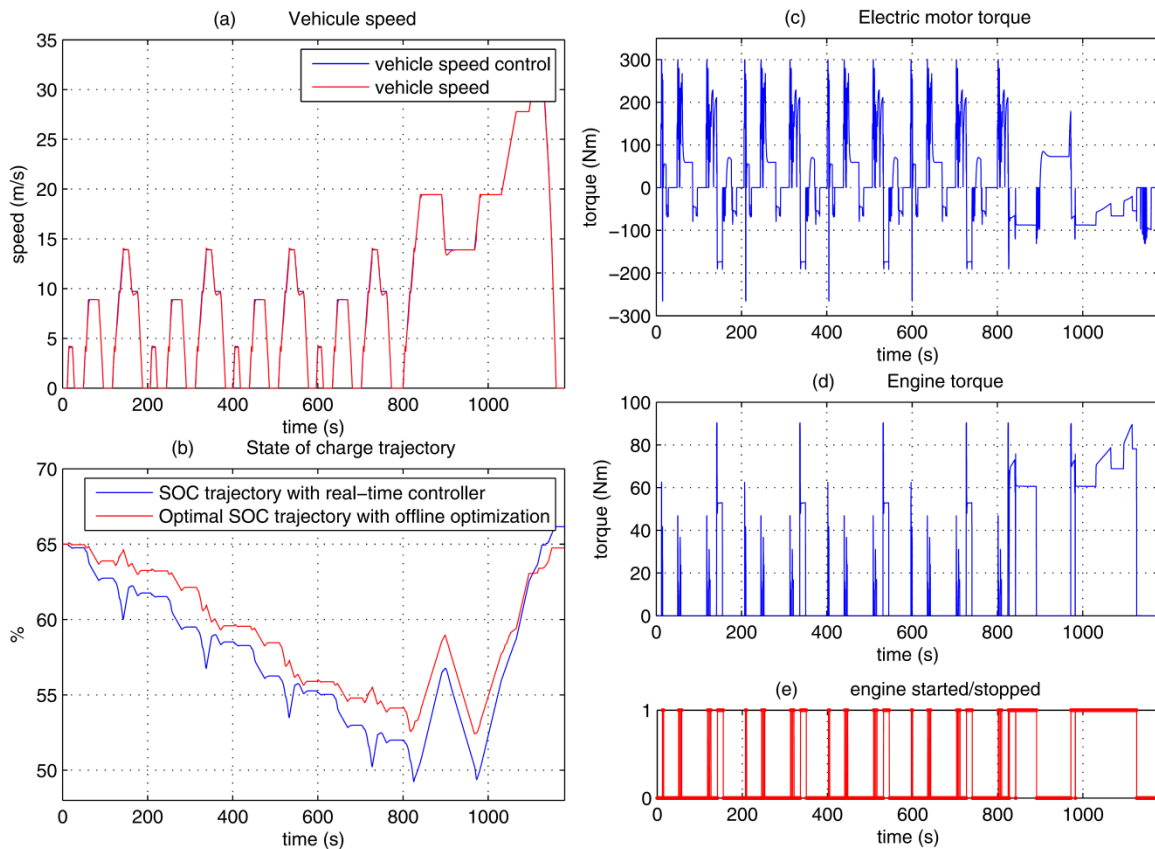

Figure 35: Results obtained with a sub-optimal ECMS strategy (source [164])

In Mursadoet. al.[153], an adaptive equivalent consumption minimisation strategy (A-ECMS), is proposed for the real-time energy management of an HEV (Figure 36). This strategy works by continuously updating the control parameter (equivalence factor) according to road load conditions, such that charge-sustaining, quasi-optimal control signals are obtained. By comparing the results obtained from the A-ECMS controller to those from an optimal controller (based on dynamic programming), the authors concluded that “a very slightly sub-optimal solution can be achieved with a technique much simpler than the one leading to the optimal policy” (Table 19). A similar inference was made in Sciarrettaet. al[141] and Maranoet. al[165]. Mursadoet. al.[153] also analysed the sensitivity of equivalence factors on battery charge sustenance (Figure 37). Results from this analysis show that the control performance of a classical ECMS control strategy is very sensitive to the variation of equivalence factors. In fact as shown in Figure 37, small perturbations of the equivalence factor leads to a non-charge-sustaining operation.

Driving Cycle	Pure Thermal mpg	DP		ECMS opt		A-ECMS	
		mpg	improve	mpg	improve	mpg	improve
FUDS	22.1	25.7	16.4%	25.7	16.3%	25.5	15.5%
FHDS	24.8	26.0	4.9%	25.8	4.1%	25.8	3.9%
ECE	20.8	24.5	18.2%	24.5	18.0%	24.5	17.9%
EUDC	23.3	24.8	6.3%	24.7	6.2%	24.7	6.1%
NEDC	22.2	24.5	10.7%	24.5	10.7%	24.4	10.1%
JP1015	21.0	25.1	20.1%	25.1	19.8%	24.8	18.2%

Table 19: Comparison of fuel economy for a baseline vehicle, dynamic programming controller, ECMS optimal controller and adaptive ECMS controller (source [153])

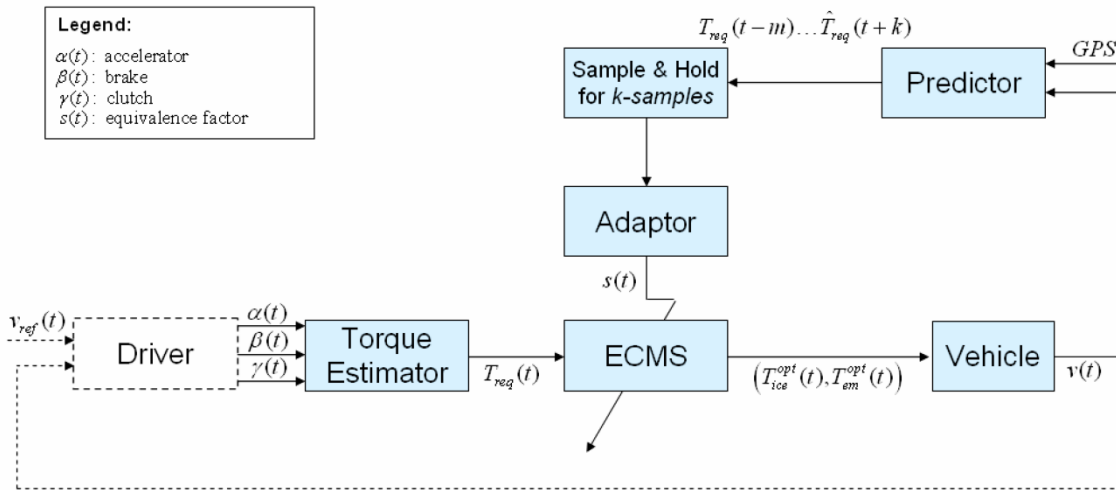

Figure 36: Control block diagram of A-ECMS (source [153])

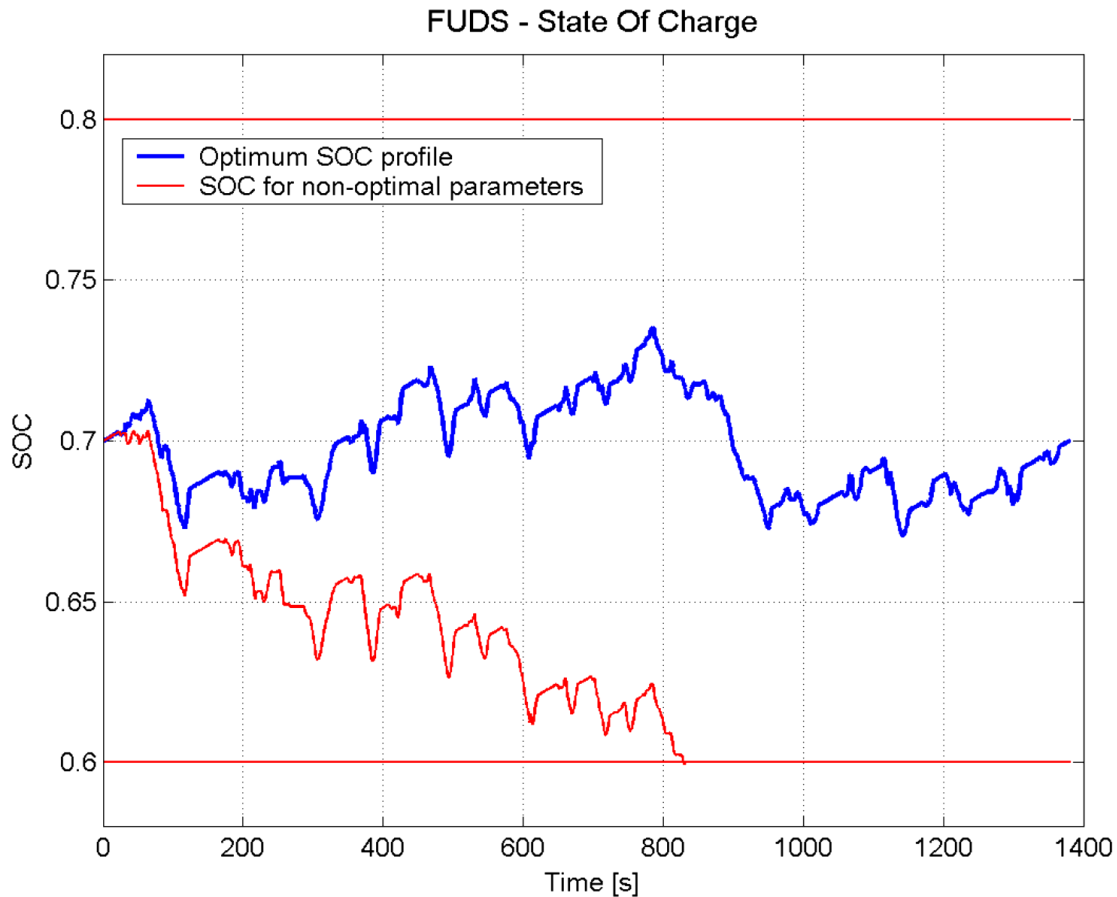

Figure 37: SOC for optimal and non-optimal equivalence factors (source [153])

In Gu *et al.* [160], a Driving Pattern Recognition (DPR) approach to ECMS real-time adaptation is proposed to obtain a better estimation of the equivalence factor under different driving conditions (Figure 38). The proposed control strategy is articulated as follows: first 18 standard driving cycles are analysed. Twenty-one different cycle-characterising quantities, such as average velocity, are extracted. Using the ideas of Principal Component Analysis (PCA) and statistical clustering, driving cycles are classified into 4 classes. While the vehicle is running, a time window of past driving conditions is analysed periodically and recognised as one of the representative driving patterns. Under the assumption that the current driving pattern does not change significantly compared to the past pattern, the equivalence factor is updated. Results obtained in this research show that with the proposed A-ECMS strategy, driving conditions can be successfully recognised, and good control performance can be achieved in various driving conditions while sustaining battery SOC within desired limits. In He *et al.* [166], telemetry ECMS (using predictive speed profiles) for energy management of plug-in HEVs is proposed. Using an optimal window size, the following improvements in cumulative fuel consumption were realized: 14–31% for

the UDDS driving cycle, 1–15% for the HWFET driving cycle, and 1–8% for the US06 driving cycle (depending upon the total length of travel and operating modes).

In Won *et. al.* [155], a multi-objective non-linear ECMS is proposed. First, a multi-objective non-linear optimal torque distribution strategy is formulated and converted into a single objective linear optimisation problem, by defining an equivalent energy consumption rate for fuel flow rate and battery state of charge. A vehicle-mode-based state of charge compensator is then applied to the optimal torque distribution strategy. Simulation results show that by linearising a non-linear optimisation problem, up to 38% reduction in computation time could be achieved over standard driving cycles, with little or no penalty to the optimality of the solution obtained.

In Tulpuleet. al. [167], an ECMS approach is formulated to optimise fuel economy by estimating equivalence factors based on known total trip distance, instead of driving pattern information. The proposed approach estimates equivalence factors based on a battery SOC reference, which varies inversely with increasing trip distance.

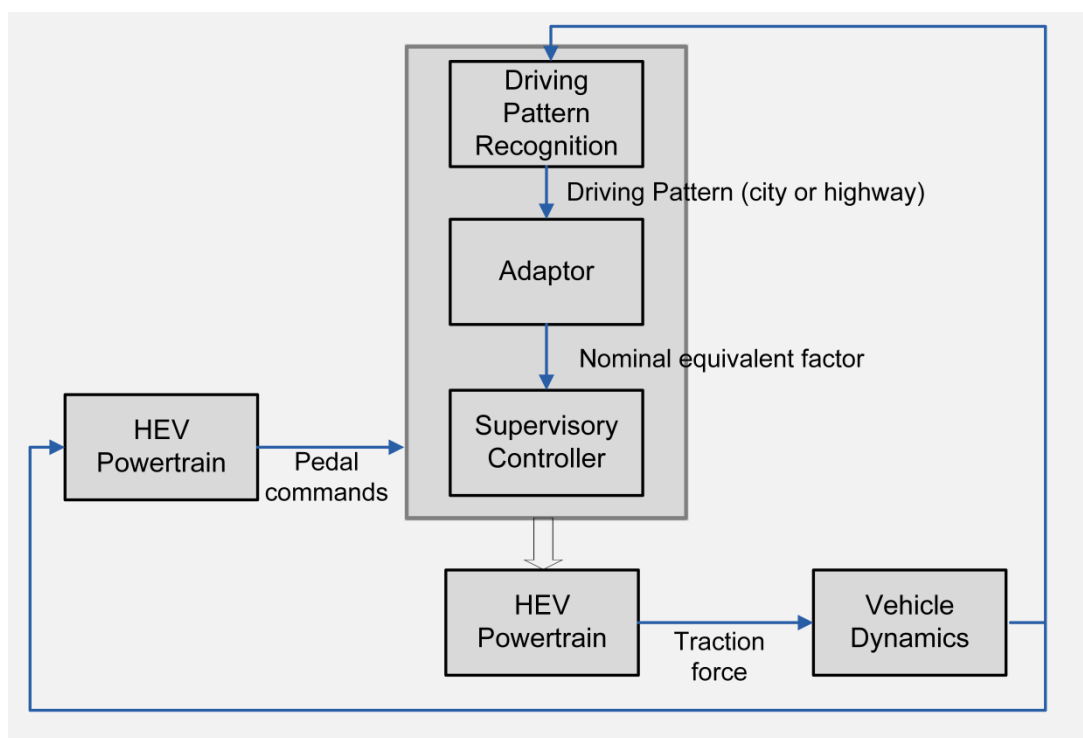

Figure 38: Driving pattern recognition based A-ECMS strategy (source [160])

### 5.2.2.3 Model predictive control strategy

Model predictive control (MPC) makes explicit use of a model of a plant process in order to obtain the control signal, which minimises the objective function. Model

predictive control generally represents the solution of a standard optimal control problem over a finite horizon. It is performed online by using a model to predict the effect of a control on the system output.

It works by instantaneously calculating the optimal control for the prediction horizon, but only applying the first element; then at the next time step, the prediction horizon is displaced towards the future. The working principle of MPC relies heavily on high model accuracy, as well as priori knowledge of reference trajectories which are not directly possible in vehicular applications. However, MPC have been shown by Salman *et. al.* [168] to be an effective real-time predictive optimal control strategy, when used with a navigation system. In this study, a generalised predictive optimal control framework is used to find the conditions under which the predictive strategies will give superior fuel economy compared to instantaneous strategies. Mixed integer linear programming with no assumptions on the control structure is used subsequently to formulate the optimal predictive energy management strategy.

Typically, the information supplied by the navigation system, corresponding to future states is sampled in the look-ahead window along a planned route. Then, the optimal control theory is applied to solve the energy management problem in real-time using a preview of driving pattern and driving route information. In the absence of a navigation system, a static and clustering based analysis method is used to predict future driving conditions from past and present recorded driving data. This method operates on the assumption that the driving condition in future will remain relatively consistent.

MPC control strategy have been shown to yield as much as 31.6% fuel savings compared a rule-based control strategy (Table 20)[169].

Driving cycle	NEDC	UDDS	WVUSUB
Strategies	L/100km	L/100km	L/100km
Rule-based control strategy	5.32	5.32	5.30
Predictive control strategy	3.64	3.82	3.76

Table 20: Fuel consumption results of a rule-based control strategy and a predictive control strategy (source [169])

Few researchers [168, 170-178] have successfully applied MPC to the energy management of HEVs. In Back *et. al.*[43], an MPC energy management strategy is formulated for a parallel HEV. In their computation, they assumed a constant vehicle

speed, and using GPS information, were able to estimate the road grade over the prediction horizon. Dynamic programming was then used to obtain the optimal control sequence which minimises fuel consumption. Simulation results show that by extending the prediction horizon to the entire route, a fuel saving potential as high as 20% could be achieved by the model predictive controller.

Nuijten *et. al.* [179] also successfully applied a similar approach (the receding horizon dynamic programming) on a conventional vehicle with a 42-volts electric power net and an alternator which is able to supplement torque to the driveline as required. Vito *et. al.* [180] also presented a similar approach on a fuel cell hybrid vehicle. In this study, the MPC algorithm uses the linearised model of the fuel cell to predict its dynamic response, thus deciding what battery power is needed in order to satisfy the vehicle power demand, whilst still minimising the objective function. The proposed approach consist of a two level control architecture. The lower level scheme controls the fuel cell acting on the compressor command and on the back pressure valves of the anode and the cathode. The higher control level is devoted to manage the power absorbed by the motor and the one provided by the fuel cell.

In a study by West *et. al.* [181], MPC is applied simultaneously to enhance battery life, vehicle driving range, as well as reduce emissions, fuel consumption and drive train oscillations for HEVs. In Rajagopalan *et. al.* [123], traffic information in the form inform of road speed limits, and topological data from GPS over an entire trip was used alongside a fuzzy logic controller to determine the power split between the internal combustion engine and the electric motor, based on efficiency and emissions. In Sciaretta *et. al.* [141] and Borhan *et. al.* [182], an MPC framework with no need for future driving conditions is proposed for the control of parallel HEVs. In Sciaretta *et. al.* [141], the fuel equivalent of electrical energy is estimated online as a function of current system status, and used to near-optimally adapt the MPC controller. Simulation results over an ECE driving cycle indicate a fuel consumption reduction of around 50% over a typical urban driving scenario. In Borhan *et. al.* [182], the global fuel minimisation problem is converted to a finite horizon optimal control problem with an approximated cost-to-go, using the relationship between the Hamilton-Jacobi-Bellman (HJB) equation and the Pontryagin's minimum principle. A non-linear MPC framework is employed subsequently, to solve the problem in real-time. Simulation results indicate that compared to a rule-based control strategy, the non-linear MPC control strategy offers remarkable improvements in fuel economy over the US06, SC03, JC08 and NYCC driving cycles, with minimum penalty to the final battery state of charge (Table 21).

US06 cycle			
Controller	Initial SOC	Final SOC	Fuel Economy (mpg)
Rule-based	0.7	0.62	45.4
	0.6	0.6	42.8
Non-linear MPC	0.7	0.69	42.49
	0.69	0.69	46.01
SC03 cycle			
Controller	Initial SOC	Final SOC	Fuel Economy (mpg)
Rule-based	0.7	0.68	71.29
	0.68	0.68	69
Non-linear MPC	0.7	0.69	76.66
	0.69	0.69	74.77
JC08 cycle			
Controller	Initial SOC	Final SOC	Fuel Economy (mpg)
Rule-based	0.7	0.67	85.67
	0.67	0.67	81
Non-linear MPC	0.7	0.71	82
	0.71	0.71	83.6
NYCC			
Controller	Initial SOC	Final SOC	Fuel Economy (mpg)
Rule-based	0.7	0.66	68.68
	0.64	0.64	52.6
Non-linear MPC	0.7	0.67	66.47
	0.67	0.67	58.25

Table 21: Comparison between a non-linear MPC strategy and a rule-based strategy over the US06, SC03, JC08 and NYCC driving cycles (source [182])

Ripaccioliet. *al.* [183] proposed a hybrid MPC strategy to co-ordinate powertrains and enforce state and control constraints. At first, the authors develop a hybrid dynamic model using a linear and piecewise affine identification method, and then design an MPC strategy to reduce fuel consumption and emissions. In another study by Ripaccioliet. *al.* [184], a Stochastic Model Predictive Control (SMPC) framework is

developed for the power management of a series HEV. The power demand from the driver is modelled as a Markov chain, estimated on several driving cycles and used to generate scenarios in the SMPC control law. Simulation results show that the SMPC solution governs the engine, motor, and battery operations in a causal, time-invariant, state-feedback way, thus resulting in an improved fuel economy and vehicle performance, compared to deterministic receding horizon control techniques.

In Vogalet. *al.*[185], a predictive MPC model based on driving route prediction is proposed and tuned using inverse reinforcement learning for fuel efficiency optimisation. In a more practical context, the proposed approach considers routes that the driver is likely to take, and then computes an optimal mix of engine and battery power. Using simulation analysis, this approach was shown to increase average vehicle fuel efficiency by 1.22%, without requiring any hardware modification or change in driver behaviour.

In Borhanet. *al.*[186], a complex MPC control strategy articulated in two steps is proposed and applied to a power-split HEV (Figure 39). In the first step, a supervisory MPC is developed and used to calculate the future control sequences that minimise the chosen performance index. The supervisory MPC is made up of a quadratic cost function which characterises the HEV optimal control problem. The formulated problem is solved online using a linear time-varying MPC approach. In the second step, an addition cost function is introduced by dividing the fuel consumption cost into a stage cost and an approximation of the cost-to-go as a function of the battery state of charge. Simulation results show that, compared to a linear time-varying MPC strategy, the proposed two-step non-linear MPC strategy yields significant increase in fuel economy over standard driving cycles.

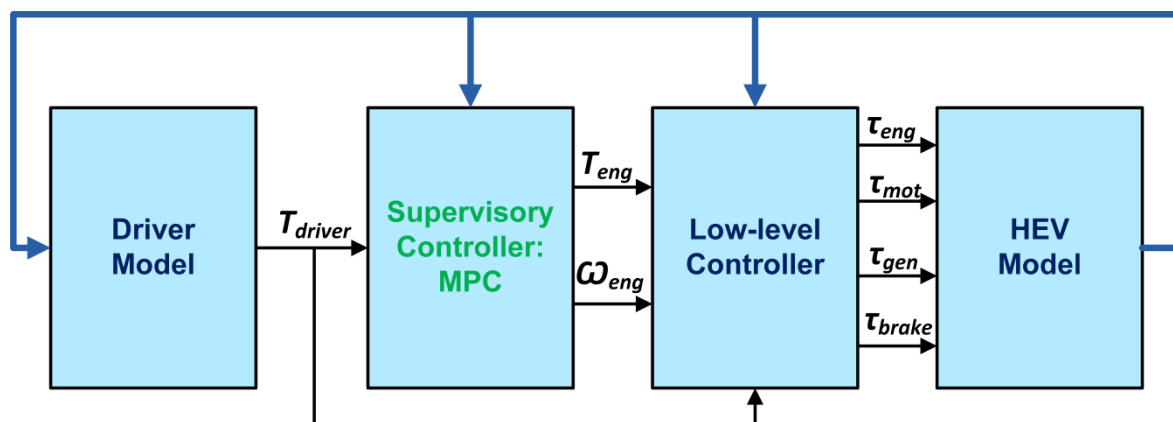

Figure 39: Control block diagram of a two-step MPC strategy (source [186])



Poramapojanaet. al. [177] proposed an MPC-based control strategy (Figure 40) for fuel consumption minimisation and charge sustenance, based on future torque demand predictions (estimated from desired battery SOC and desired vehicle speed). Simulation results show the feasibility of using an MPC controller to improve vehicle performance and minimise fuel consumption.

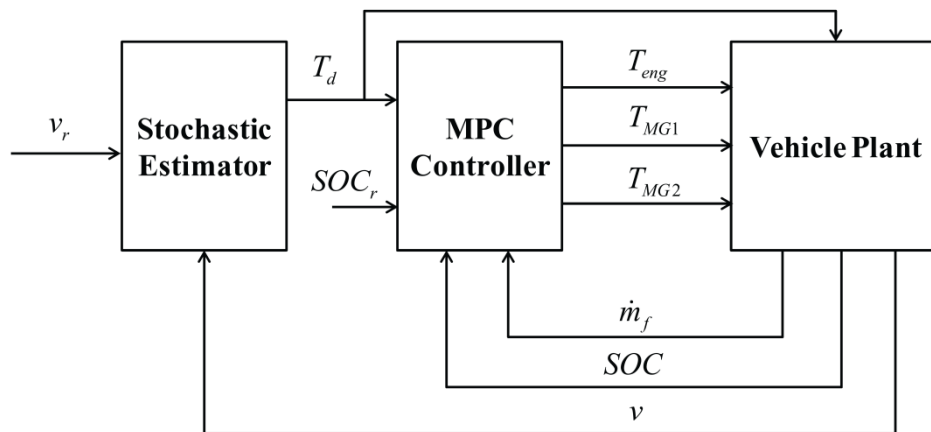

Figure 40: The control architecture of the MPC-based vehicle control system (source [177])

In Sampathnarayananet. al. [173] and Kermaniet. al.[172], MPC is combined with other global optimization strategies to yield a near-optimal HEV control strategy in real-time. In Sampathnarayananet. al. [173], MPC is combined with quadratic programming, to solve an optimal HEV control problem. Simulation results show that a long prediction horizon and high prediction accuracy do not yield better results than a shorter horizon. The results also show that prediction accuracy is only meaningful for long prediction horizons. In Kermaniet. al.[172], a Lagrange formula based MPC global optimisation approach is proposed. The resulting controller is made up of a two stage algorithm. The lower stage deals with solving a receding horizon optimisation problem, while the upper stage deals with prediction error compensation and disturbance rejection.

#### 5.2.2.4 Artificial neural network (ANN)

Artificial neural network (ANN) is a computing system made up of a number of simple highly interconnected processing elements, which process information using their dynamic state response to external inputs. The concept of ANN was originally developed by McCulloch and Pitts in 1943 and further improved with the addition of the first learning rule by Hebb in 1949. Neural networks can be trained to learn a highly non-linear input/output relationship, by adjusting weights to minimise the

error between the actual and predicted output patterns of a training set [187]. This form of supervised learning is facilitated by the back propagation method.

The adaptive structure of neural network makes it suitable for HEV energy management applications. Using neural network, it is possible to learn and replicate the non-linear relationships between inputs and outputs of a well-defined energy management network.

Baumann *et. al.*[188] developed a control strategy that combines artificial neural network and fuzzy logic to implement a load levelling strategy for improved fuel economy and reduced emissions for different drivers and different driving patterns. In Arsieet. *al.*[45], a dynamic model is used to describe the driver-vehicle interaction for a generic transient and to simulate the vehicle driveline, the internal combustion engine (ICE) and the electric motor/generator (EM). In absence of traffic preview information, vehicle load is estimated in real-time through the implementation of a Time Delay Neural Network (TDNN) and used to optimise the supervisory control strategy. Simulation results show a 45% improvement in fuel economy compared to a conventional vehicle with the same thermal engine.

In Mohebbiet. *al.*[106], an adaptive neuro-fuzzy inference system controller is proposed and implemented to maximise fuel economy and minimise emissions in an HEV. The proposed approach is designed based on the torque required for driving and the battery state of charge. The output of the controller is the throttle angle of the internal combustion engine.

In Suzuki *et. al.* [189], the neural network control framework is further improved to account for more multi-objectives including: torque distribution optimisation, fuel efficiency optimisation and electric current consumption minimisation. The entire optimization process is articulated using the flowchart, shown in Figure 41. Controller sampling time, about several minutes, is defined as a parameter. During the sampling time, required vehicle torque demand, engine speed, regenerating current and battery SOC are estimated using neural network. The hybrid controller is then used to iteratively determine the optimal assist torque distribution. Simulation results shown a 7% improvement in fuel economy compared with a heuristic HEV control algorithm.

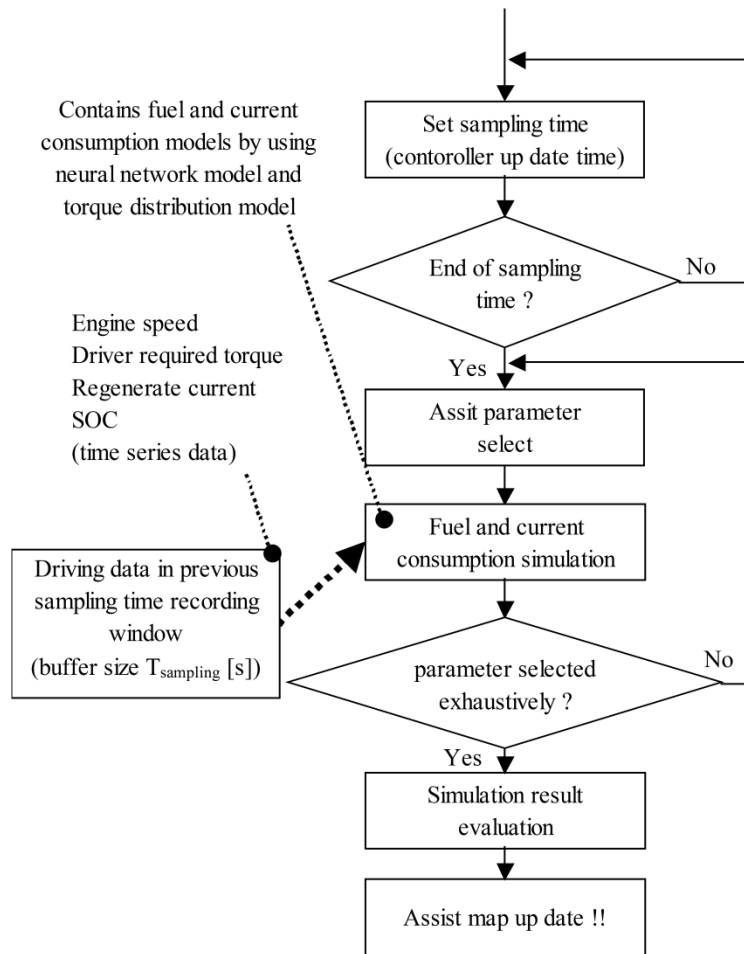

Figure 41: Flow chart of a neuro-fuzzy controller (source [189])

Prokhorov *et. al.* [190] proposed a neural network controller for the Toyota Prius HEV. This approach is based on recurrent neural network using online and offline training including extended Kalman filtering and simultaneous perturbation stochastic approximation. A combination of the online and offline control methods was reported in this study to yield an improved average fuel efficiency of 17% over standard driving cycles. It was also shown to reduce the SOC variance over all the tested driving cycles by at least 25%. In Gong *et. al.* [191] and Boyaliet. *al.* [192] neural network based controllers are developed to consider variation in driving patterns. In Gong *et. al.* [191], a neural network based trip model was developed for a highway trip. The simulation results show that the obtained trip model using neural network can greatly improve the trip modelling accuracy, and thus improve the fuel economy. In Boyaliet. *al.* [192], a neuro-dynamic programming (NDP) method for real-time HEV control is proposed. In this approach, the complex solution structure of dynamic programming optimal control is approximated using artificial learning algorithms for real-time application. Simulation results over two randomly generated urban driving cycles show that although the NDP controller is able to effectively

sustain the battery energy in real-time, it yields highly sub-optimal fuel economy, when compared to the dynamic programming optimal controller (Table 22). In Liu *et. al.* [193], a high accuracy Fuzzy Neural Network (FNN) controller is proposed and optimised using a modified genetic algorithm and an error-compensation approach.

	Fuel consumption	Improvement	$\Delta SOC$
Conventional	10.99 L/100km	-	-
DP Solution	9.39 L/100km	14.5%	0%
NDP Solution	10.53 L/100km	4.12 %	1.7%

a. Randomly generated urban driving cycle 1

	Fuel consumption	Improvement	$\Delta SOC$
Conventional	9.24 L/100km	-	-
DP Solution	8.07 L/100km	12.6%	0%
NDP Solution	8.84 L/100km	4.35 %	1.14%

b. Randomly generated urban driving cycle 2

Table 22: Comparison of simulation results from a dynamic programming controller (DP) and a neuro-dynamic programming controller (NDP) – source [192]

## 6 EXISTING RESEARCH GAPS IN HEV ENERGY MANAGEMENT

As reviewed thus far, vehicle hybridisation poses new challenges in the form of: how to optimally split energy demand in real-time between various competing power sources. In the case of braking, this answer is straightforward because while braking, the focus of the strategy is to maximise energy recovery in the battery by using the motor as much as possible. Simple solutions however, prove inefficient when the vehicle power demand is positive.

The first step in solving energy management problems when the vehicle power demand is positive lies in the formation of an objective function representing the objectives to be minimised (e.g. fuel consumption, emissions). Another aspect of great importance in solving energy management problems lies in the control of the battery state of charge. This control is implemented to constantly keep the battery SOC within safe prescribed boundaries to ensure battery durability, and to ensure appropriate and convenient exploitation of the energy stored in the battery. The

resulting energy management problem is a classical constrained optimisation problem which has been addressed by various studies, as reviewed in section 5.

Despite the vast improvements in fuel consumption and emissions reported by most studies, the following gaps in control strategies still exist:

1. Rule-based control strategies: Rule-based control strategies are by nature sub-optimal, and unable to guarantee the fulfilment of integral constraints such as charge sustenance. They also require vigorous tuning to optimise rules for specific driving scenarios. This affects the robustness of the controller, consequently leading highly sub-optimal online performances. The problem is further worsened in the absence of route preview information.
2. Dynamic programming: Although known to yield global optimal solutions to HEV energy management problems, dynamic programming present non-causal results which are non-implementable in real-time, but can be used to create or benchmark sub-optimal controllers. The possibility of deriving useful real-time control policies from dynamic programming has been widely investigated in literature. Despite the research advances made, some of the resulting sub-optimal control policies have been found to yield selective performances, which are charge-depleting in highway driving scenarios or charge-hoarding in urban driving scenarios.
3. ECMS strategy: The equivalent consumption minimisation strategy is a local optimisation approach based on the heuristic concept that the energy used to drive a vehicle over a driving cycle ultimately comes from the engine, and as such the hybrid system merely serves as an energy buffer [138]. The resulting controller thus impacts the relative advantage of both heuristic controllers and optimal controllers. Consequently, the ECMS has received considerable amount of attention in literature, with several variations in the form of Adaptive ECMS and Telemetry ECMS being proposed. Despite these research advances, the ECMS technique in its present form is still unable to guarantee a charge-sustaining optimisation performance in real-time. In a study Silvertsonnet. *al.*[194] the final battery SOC of sub-optimal ECMS strategies were shown to deviated by as much as 20% over standard driving cycles (Figure 42). This result shows that the equivalence factor of ECMS strategies are highly

sensitive and cycle dependent i.e. the optimal equivalence factor for one driving cycle might lead to a poor performance on another driving cycle.

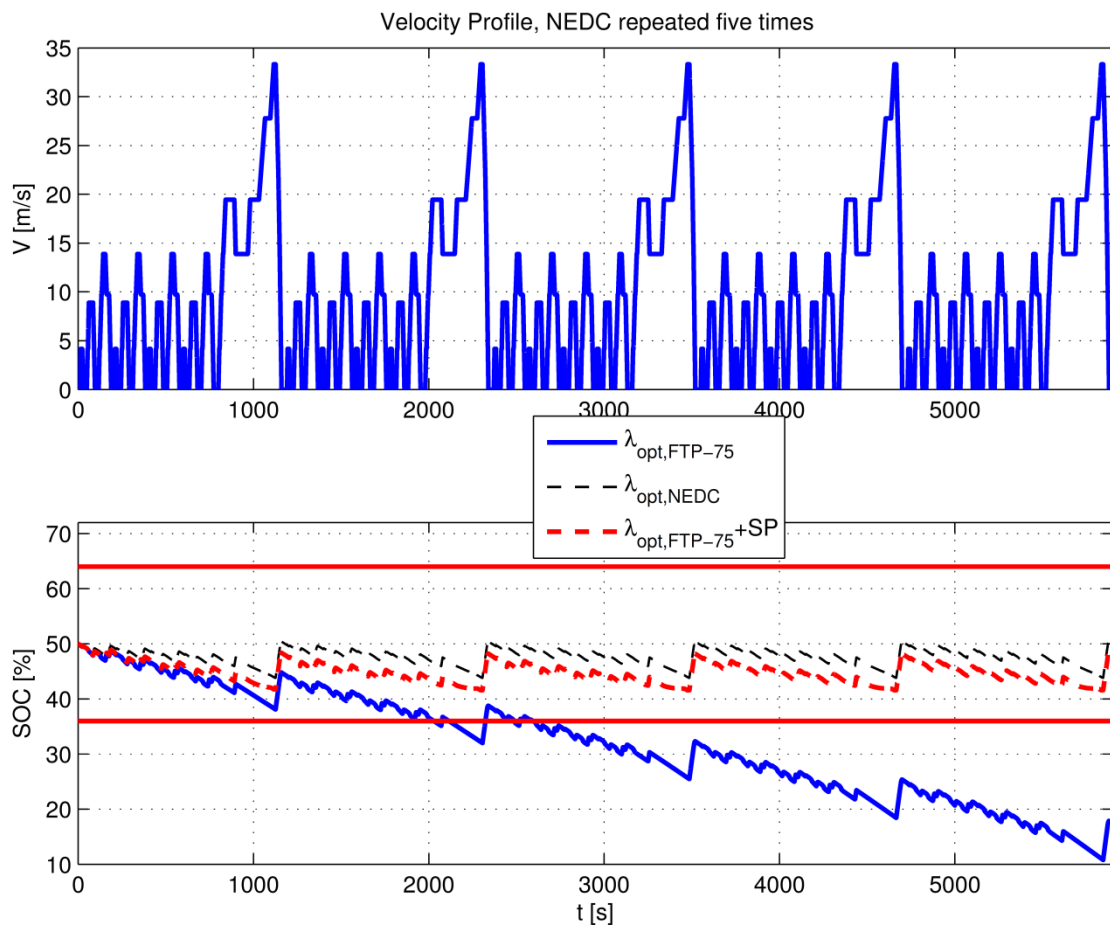

Figure 42: Impact of equivalence factor on battery state of charge (source [194])

4. MPC strategy: Owing to improved vehicular computational capabilities, and the wide availability of partial route preview information, model predictive control (MPC) strategies have gained significant attention, as a viable charge-sustaining energy management approach for HEVs. According to most literatures, future driving information can be predicted and incorporated into MPC strategies in two forms:
  - a. Directly through real-time navigation systems
  - b. Through the clustering based analysis of past recorded driving data.

Although both methods have been successfully implemented in literature, future driving information prediction based on navigation systems, have witnessed a wider appreciation. This is due to the computational burden associated with static and clustering based analysis. In most production vehicles today, the predictive MPC framework is formulated using

heuristics, which decide when the battery should be charged or discharged accordingly. Consequently, the resulting controller contains no form of optimisation and is not defined to account for charge sustenance.

In addition to the foregoing research gaps, the concept of vehicle speed control is relatively new and has only been investigated by a few researchers [195-198]. With the research area only being in its early days, most of the proposed vehicle speed control models are overly simplified and often yield non-realizable fuel-optimal speed trajectories. For example, no study to date has been known to consider engine braking effects in the formulation of fuel-optimal vehicle speed trajectories. By ignoring these real-world effects, the resulting speed trajectory is only of academic interest.

## 7 CONCLUSIONS

Owing to the prospect of improved fuel economy and vehicle performance, HEVs continue to enjoy a wide research attention from academics and industrial researchers alike. With increased government funding and industrial cost optimizations, HEVs are becoming more affordable and accessible than ever.

To meet the energy demands of different HEV configurations, several power management strategies have been proposed in literature. This paper presents a comprehensive review of relevant literatures pertaining to modelling and control of parallel hybrid electric vehicles. HEV control strategies were reviewed at depth on two main tiers: HEV offline control strategies and HEV online control strategies. This detailed appraisal is aimed at highlighting the control structure of the reviewed techniques, their novelty, as well as contributions towards the satisfaction of several optimisation objectives, which includes but are not limited to: reduction of fuel consumption and emissions, charge sustenance, optimisation of braking energy regeneration, and improvement of vehicle drivability.

As part of this treatise, exploitable research gaps pertaining to rule based control strategies, dynamic programming, the equivalent consumption minimization strategy (ECMS) and model predictive control (MPC) strategies were identified. These identified research gaps points towards the direction that current HEV control strategies are still lacking primarily in the aspects of: optimization of braking energy regeneration and charge sustaining sub-optimal control using partial route preview information and no route preview information. Future studies towards mitigating

these research gaps are expected to yield control strategies capable of realising the ultimate charge-sustaining fuel saving potentials of HEVs in real-time.

## 8 REFERENCES

- [1] Brahma A, Guezennec Y, Rizzoni G. Dynamic Optimization of Mechanical/Electrical Power Flow in Parallel Hybrid Electric Vehicles. in: Proceedings of 5th Int Symposium in Advanced Vehicle Control, Ann Arbor, MI. 2000.
- [2] Schouten NJ, Salman MA, Kheir NA. Energy Management Strategies for Parallel Hybrid Vehicles Using Fuzzy Logic. Control Engineering Practice. 2003;vol. 11:171-7.
- [3] Delprat S, Lauber J, Guerra TM. Control of a Parallel Hybrid Powertrain: Optimal Control. IEEE Transactions on Vehicular Technology. 2004;vol. 53:872-81.
- [4] Leduc P, Dubar B. Downsizing of Gasoline Engine: An Efficient Way to Reduce CO2 Emissions. Oil & Gas Science and Technology. 2003;vol. 58:115–27.
- [5] Takaishi T, Numata A, Nakano R, Sakaguchi K. Approach to High Efficiency Diesel and Gas Engines. Mitsubishi Heavy Industries, Ltd Technical Review. 2008;vol. 45.
- [6] Mercier C. Advanced Powertrain Controls. Lecture at IFP School PSA Peugeot Citroën. 2012.
- [7] Mohr S, Wang J, Ellem G, Ward J, Giurco D. Projection of World Fossil Fuels By Country. Fuel. 2015;vol. 141:120-35.
- [8] Sorrell S, Speirs J, Bentley R, Miller R, Thompson E. Shaping the Global Oil Peak: A Review of the Evidence On Field Sizes, Reserve Growth, Decline Rates And Depletion Rates. Energy Conversion and Management. 2012;37:709–24.
- [9] Sorrell S, Speirs J, Bentley R, Brandt A, Miller R. Global Oil Depletion: A Review of the Evidence. Energy Policy. 2010;38:5290–5.
- [10] Sorrell S, Miller R, Bentley R, Speirs J. Oil Futures: A Comparison of Global Supply Forecasts. Energy Policy. 2010;vol. 38:4990–5003.
- [11] Owen N, Inderwildi O, King D. The Status Of Conventional World Oil Reserves- Hype or Cause for Concern? Energy Policy. 2010;38:4743–9.



- [12] Yang Z. Improving the Conversions Between the Various Passenger Vehicle Fuel Economy/Co2 Emission Standards Around the World. The International Council On Clean Transportation, (<http://www.theicct.org/blogs/staff/improving-conversions-between-passenger-vehicle-efficiency-standards>). 03 December 2014.
- [13] Plotkin S. Examining Fuel Economy And Carbon Standards For Light Vehicles. Energy Policy. 2009;vol. 37:3843-53.
- [14] Teratani T, Kuramochi K, Nakao H, Tachibana T, Yagi K, Abou S. Development of Toyota Mild Hybrid System (THS-M) with 42v Powernet. Electric Machines and Drives Conference, IEMDC'03 IEEE International. 2003;vol. 1:3-10.
- [15] Assanis D, Delagrammatikas G, Fellini R, Filipi Z, Liedtke J, Michelena N, et al. Optimization Approach To Hybrid Electric Propulsion System Design. Mechanics of Structures and Machines. 1999;vol. 27:393-421.
- [16] Khan M, C. Kar N. Hybrid Electric Vehicles for Sustainable Transportation: A Canadian Perspective. World Electric Vehicle Journal. 2009;vol. 3.
- [17] Duoba M. Engine Design, Sizing and Operation in Hybrid Electric Vehicles. Argonne National Laboratory, Presentation at University of Wisconsin – Madison, ERC 2011 Symposium. June 8, 2011.
- [18] Technology CfAA. HEV Levels. [http://autocaat.org/Technologies/Hybrid\\_and\\_Battery\\_Electric\\_Vehicles/HEV\\_Levels](http://autocaat.org/Technologies/Hybrid_and_Battery_Electric_Vehicles/HEV_Levels) / 22 May 2016.
- [19] Koichiro M, Yamazaki M, Tokieda J. Development of New-Generation Hybrid System THS II - Drastic Improvement of Power, Performance and Fuel Economy. SAE Technical Paper 2004-01-0064. 2004:182-92.
- [20] Chan CC. The State of the Art of Electric and Hybrid Vehicles. in: Proceedings of the IEEE 902. 2002:247-75.
- [21] Yeo H, Kim H. Hardware-In-The-Loop Simulation of Regenerative Braking for a Hybrid Electric Vehicle. in: Proceedings of the Institution of Mechanical Engineers, Part D: Journal of Automobile Engineering. 2002;vol. 216:855-64.
- [22] Egbue O, Long S. Barriers to Widespread Adoption of Electric Vehicles: An Analysis of Consumer Attitudes and Perceptions. Energy Policy. 2012;vol. 48:717–29.

- [23] Axsen J, Kurani KS. Hybrid, Plug-In Hybrid, or Electric – What Do Car Buyers Want. *Energy Policy*. 2013;vol. 61:532–43.
- [24] Bitsche O, Gutmann G, . Systems for Hybrid Cars. *Journal of Power Sources*. 2004;vol. 127:8-15.
- [25] Chau KT, Wong YS. Overview of Power Management in Hybrid Electric Vehicles. *Energy Conversion and Management*. October, 2002;vol. 43:1953-68.
- [26] Guzzella L, Sciarretta A. *Vehicle Propulsion Systems: Introduction to Modelling and Optimization*. Springer: 9783642094156. Berlin, 2007;2nd Edition.
- [27] Husain I. *Electric and Hybrid Vehicles: Design Fundamentals*. Florida: CRC Press. 2010;2nd edition.
- [28] Çağatay Bayindir K, Gözüküçük M, Teke A. A Comprehensive Overview of Hybrid Electric Vehicle: Powertrain Configurations, Powertrain Control Techniques and Electronic Control Units. *Energy Conversion and Management*. February 2011;52:1305–13.
- [29] Liu J, Peng H, Filipi Z. Modeling And Control Analysis Of Toyota Hybrid System. *Advanced Intelligent Mechatronics Proceedings, 2005 IEEE/ASME International Conference*. 2005:134-9.
- [30] Genta G. *Motor Vehicle Dynamics: Modelling and Simulation*. Series on Advances in Mathematics for Applied Sciences World Scientific Pub Co Inc Singapore. 1997;vol. 43
- [31] Millo F, Rolando L, Andreatta M. Numerical Simulation for Vehicle Powertrain Development. in Book: *Numerical Analysis - Theory and Application*. 2011.
- [32] Vassallo A, Cipolla G, Mallamo F. Transient Correction of Diesel Engine Steady-State Emissions and Fuel Consumption Maps for Vehicle Performance Simulation. *Aachener Kolloquim Fahrzeug und Motorentechnik, Aachen, Germany*. 2007.
- [33] Pettiti M, Pilo L, Millo F. Development of a New Mean Value Model for the Analysis of Turbolag Phenomena in Automotive Diesel Engines. *SAE Technical paper; 2007-01-1301*. 2007:14.
- [34] Keribar R, Ciesla C, Morel T. Engine/Powertrain/Vehicle Modeling Tool Applicable to all Stages of the Design Process. *SAE Technical Paper 2000-01-0934*. 2000.

- [35] Morel T, Keribar R, Leonard A. Virtual Engine/Powertrain/Vehicle Simulation Tool Solves Complex Interacting System Issues. SAE Technical Paper 2003-01-0372. 2003.
- [36] Ehsani M, Gao Y, Gay SE. Modern Electric, Hybrid Electric, and Fuel Cell Vehicles Fundamentals, Theory, and Design. Taylor & Francis Group. 2005.
- [37] Tate E, Boyd S. Finding Ultimate Limits of Performance for Hybrid Electric Vehicles. in: Proceedings of Society of Automotive Engineers 2000 Future Transportation Technology Conference. 2001;vol. No of paper 2000-01-3099.
- [38] Kleimaier A, Schroeder D. Optimization Strategy for Design and Control of a Hybrid Vehicle. in: Proceedings of the 6th International Workshop on Advanced Motion Control, Nagoya, Japan. April 2000:459– 64.
- [39] Pisu P, Silani E, Rizzoni G, Savaresi SM. A LMI-based Supervisory Robust Control for Hybrid Vehicles. in: Proceedings of the American Control Conference, Denver, Colorado, USA. June 2003:4681–6.
- [40] Lewis F, Syrmos V. Optimal Control. Wiley-Interscience. 1995.
- [41] Shen C, Chaoying X. Optimal Power Split in a Hybrid Electric Vehicle Using Improved Dynamic Programming. in: Proceedings of the Asia-Pacific Power and Energy Engineering Conference (APPEEC'10), Chengdu, China. March 2010:1–4.
- [42] Brahma A, Guezennec Y, Rizzoni G. Optimal Energy Management in Series Hybrid Electric Vehicles. in: Proceedings of the American Control Conference. October 2000;vol. 1:60 - 4.
- [43] Back M, Simons M, Kirschaum F, Krebs V. Predictive Control of Drivetrains. in: Proceedings of IFAC 15th Triennial World Congress, Barcelona, Spain. 2002;vol. 35:241–6.
- [44] Lin CC, Peng H, Grizzle JW, Kang JM. Power Management Strategy for a Parallel Hybrid Electric Truck. IEEE Transactions on Control Systems Technology. 2003;vol. 11:839–49.
- [45] Arsie I, Graziosi M, Pianese C, Rizzo G, Sorrentino M. Optimization of Supervisory Control Strategy for Parallel Hybrid Vehicle With Provisional Load Estimate. in: Proceedings of the 7th International Symposium on Advanced Vehicle Control (AVEC), Arnhem, The Netherlands. August 2004:483-8.

- [46] Lin CC, Kang JM, Grizzle JW, Peng H. Energy Management Strategy for a Parallel Hybrid Electric Truck. in: Proceedings of the American Control Conference, Ann Arbor, Mich, USA. June 2001:2878–83.
- [47] O’Keefe MP, Markel T. Dynamic Programming Applied to Investigate Energy Management Strategies for a Plug-In HEV1. in: Proceedings of the 22nd International Battery, Hybrid and Fuel Cell Electric Vehicle Symposium and Exposition (EVS ’06), National Renewable Energy Laboratory, Golden, CO. October 2006:1035–46.
- [48] Gong Q, Li Y, Peng Z-R. Trip-Based Optimal Power Management of Plug-In Hybrid Electric Vehicles. IEEE Transactions on Vehicular Technology. November 2008;vol. 57:3393–401.
- [49] Zhou Z, Mi C, Chen Z, Masrur A, Murphey YL. Power Management of Passive Multi-Source Hybrid Electric Vehicle. in: Proceedings of the IEEE Vehicle Power and Propulsion Conference (VPPC’11), Chicago, Ill, USA. September 2011:1–4.
- [50] Van Keulen T, DeJager B, Steinbuch M. An Adaptive Suboptimal Energy Management Strategy for Hybrid Drive-Trains. in: Proceedings of the 17th International Federation of Automatic Control World Congress (IFAC’08). July 2008;vol. 17:102–7.
- [51] Tulpule P, Stocker S, Marano V, Rizzoni G. Optimality Assessment of Equivalent Consumption Minimization Strategy for PHEV Applications. in: Proceedings of the ASME Dynamic Systems and Control Conference, Hollywood, California, USA. October 2009:265–72.
- [52] Tulpule p, Marano V, Rizzoni G. Energy management for plug-in hybrid electric vehicles using equivalent consumption minimisation strategy. International Journal of Electric and Hybrid Vehicles. 2010;vol. 2:329–50.
- [53] Shams-Zahraei M, Kouzani AZ, Kutter S, Baker B. Integrated Thermal and Energy Management of Plug-in Hybrid Electric Vehicles. Journal of Power Sources. 2012;vol. 216:237-48.
- [54] Ravey A, Roche R, Blunier B, Miraoui A. Combined optimal sizing and energy management of hybrid electric vehicles. in: Proceedings of the IEEE Transportation Electrification Conference and Exposition (ITEC’12), Dearborn, Mich, USA. June 2012:1–6.

- [55] P´erez LV, Bossio GR, Moitre D, Garcia GO. Optimization of Power Management in an Hybrid Electric Vehicle Using Dynamic Programming. *Mathematics and Computers in Simulation*. 2006;vol. 73:244–54.
- [56] Oprean M, Ionescu V, Mocanu N, Beloiu S, Stanciu C. Dynamic Programming Applied to Hybrid Vehicle Control. in: *Proceedings of the International Conference on Electric Drives (ICED’88)*. 1988;vol. 4:D2/10/1–D2//20.
- [57] Ngo DV, Hofman T, Steinbuch M, Serrarens AFA. An Optimal Control-Based Algorithm for Hybrid Electric Vehicle Using Preview Route Information. in: *Proceedings of the American Control Conference (ACC ’10)*, Baltimore, Md, USA. July 2010:5818–23.
- [58] Miaohua H, Houyu Y. Optimal Design of Control Strategy for Series Hybrid Electric Bus. *Journal of Yuhan University of Technology*. 2004;vol. 4.
- [59] Li Y, Kar NC. Advanced Design Approach of Power Split Device of Plug-In Hybrid Electric Vehicles Using Dynamic Programming. in: *Proceedings of the 7th IEEE Vehicle Power and Propulsion Conference (VPPC ’11)*, Chicago, Ill, USA. September 2011:1–6.
- [60] Kum D, Peng H, Bucknor NK. Optimal Catalyst Temperature Management of Plug-In Hybrid Electric Vehicles. in: *Proceedings of the American Control Conference (ACC ’11)*, San Francisco, California, USA. June-July 2011:2732-8.
- [61] Koot M, Kessels A, Jager B, Heemels W, Bosch P, Steinbuch M. Energy Management Strategies for Vehicular Electric Power Systems. *IEEE Transactions on Vehicular Technology*. 2005;vol. 54:771–82.
- [62] Jang JSR, Sun CT, Mizutani E. *Neuro-Fuzzy and Soft Computing: A Computational Approach to Learning and Machine Intelligence*. Prentice Hall, New York, NY, USA. 1997.
- [63] Perez L, Pilotta E. Optimal Power Split in a Hybrid Electric Vehicle Using Diect Transcription of an Optimal Control Problem. *Mathematics and Computers in Simulation*. 2009;vol. 79:1959-70.
- [64] Gong Q, Li Y, Peng ZR. Computationally Efficient Optimal Power Management For Plug-In Hybrid Electric Vehicles Based on Spatial-Domain Two-Scale Dynamic Programming. in: *Proceedings of the IEEE International Conference on Vehicular Electronics and Safety (ICVES ’08)*, Milwaukee. 22-24 September 2008:90–5.

- [65] Lin CC, Peng H, Grizzle JW. A Stochastic Control Strategy for Hybrid Electric Vehicles. in: Proceedings of the American Control Conference (AAC'04), Boston, Mass, USA. June-July 2004:4710–5.
- [66] Moura JS, Fathy HK, Callaway DS, Stein JL. A Stochastic Optimal Control Approach for Power Management in Plug-In Hybrid Electric Vehicles. IEEE Transactions on Control Systems Technology. 2011;vol. 19:545–55.
- [67] Opila DF, Wang X, McGee R, Grizzle JW. Real-time Implementation and Hardware Testing Of A Hybrid Vehicle Energy Management Controller Based on Stochastic Dynamic Programming. Journal of Dynamic Systems, Measurement and Control, Transactions of the ASME. 2013;vol. 135:11.
- [68] Johannesson L, Asbogard M, Egardt B. Assessing The Potential of Predictive Control for Hybrid Vehicle Powertrains Using Stochastic Dynamic Programming. Intelligent Transportation Systems, 2005 Proceedings 2005 IEEE. 13-15 September 2005:366-71.
- [69] Liu J, Hagen J, Peng H, Filipi ZS. Engine-In-The-Loop Study of the Stochastic Dynamic Programming Optimal Control Design for a Hybrid Electric HMMW. International Journal of Heavy Vehicle Systems. 2008;vol. 15:309–26.
- [70] D TE, Grizzle JW, Peng H. Shortest Path Stochastic Control for Hybrid Electric Vehicles. International Journal of Robust and Nonlinear Control. 2008;vol. 18:1409–29.
- [71] Tate ED, Grizzle JW, Peng H. SP-SDP for Fuel Consumption and Tailpipe Emissions Minimization in an EVT Hybrid. IEEE Transactions on Control Systems Technology. 2010;vol. 18:673–87.
- [72] Opila DF, Wang X, McGee R, Gillespie RB, Cook JA, Grizzle JW. An Energy Management Controller to Optimally Trade Off Fuel Economy and Drivability for Hybrid Vehicles. IEEE Transactions on Control Systems Technology. 2012;vol. 20:1490-505.
- [73] Wang Y, Sun Z. SDP-Based Extremum Seeking Energy Management Strategy for a Power-Split Hybrid Electric Vehicle. in: Proceedings of the American Control Conference (ACC'12), Fairmont Queen Elizabeth, Montréal, Canada. June 2012:553–8.

- [74] Wenzhong G, Porandla SK. Design Optimization of a Parallel Hybrid Electric Power Train. in: Proceedings of the IEEE Vehicle Power and Propulsion Conference (VPPC'05), Chicago, Ill, USA. 7-9 September 2005:530–5.
- [75] Montazeri-Gh M, Poursamad A. Optimization of Component Sizes in Parallel Hybrid Electric Vehicles via Genetic Algorithm. in: Proceedings of the ASME International Mechanical Engineering Congress and Exposition, Orlando, Fla, USA. November 2005:225–32.
- [76] Song PG, Guan EY, Zhao L, Liu SP. Hybrid Electric Vehicles With Multi Level Cascaded Converter Using Genetic Algorithm. in: Proceedings of the 1st IEEE Conference on Industrial Electronics and Applications (ICIEA '06), Singapore. 24-26 May 2006:1–6.
- [77] Montazeri-Gh M, Poursamad A. Application of Genetic Algorithm For Simultaneous Optimization of HEV Component Sizing And Control Strategy. International Journal Alternative Propulsion. 2006;vol. 1:63–78.
- [78] Liu X, Wu Y, Duan J. Optimal Sizing of a Series Hybrid Electric Vehicle Using A Hybrid Genetic Algorithm. in: Proceedings of the IEEE International Conference on Automation and Logistics (ICAL'07), Jinan, Chin. 18-21 August 2007:1125–9.
- [79] Zhang B, Chen Z, Mi C, Murphey YL. Multi-Objective Parameter Optimization of a Series Hybrid Electric Vehicle Using Evolutionary Algorithms. in: Proceedings of the IEEE Vehicle Power and Propulsion Conference, Dearborn, Mich, USA. 7-10 September 2009:921–5.
- [80] Huang B, Shi X, Xu Y. Parameter Optimization of Power Control Strategy for Series Hybrid Electric Vehicle. in: Proceedings of the IEEE Congress on Evolutionary Computation (CEC '06), Vancouver, Canada. July 2006:1989–94.
- [81] Huang B, Wang Z, Xu Y. Multi-Objective Genetic Algorithm for Hybrid Electric Vehicle Parameter Optimization. in: Proceedings of the IEEE/RSJ International Conference on Intelligent Robots and Systems (IROS '06). October 2006:5177–82.
- [82] Fang LC, Qin SY. Concurrent Optimization For Parameters of Power Train and Control System of Hybrid Electric Vehicle Based on Multi-Objective Genetic Algorithms. in: Proceedings of the SICE-ICASE International Joint Conference, Busan, Republic of Korea. October 2006:2424–9.

- [83] Piccolo A, Ippolito L, Galdi VZ, Vaccaro A. Optimisation of Energy Flow Management in Hybrid Electric Vehicles via Genetic Algorithms. in: Proceedings of the IEEE/ASME International Conference on Advanced Intelligent Mechatronics, Como, Italy. July 2001;vol. 1:434–9.
- [84] Ippolito L, Loia V, Siano P. Extended Fuzzy C-Means and Genetic Algorithms to Optimize Power Flow Management in Hybrid Electric Vehicles. in: Proceedings of the IEEE Conference on Control Applications, Istanbul, Turkey. June 2003;vol. 1:115–9.
- [85] Wang A, Yang W. Design of Energy Management Strategy in Hybrid Vehicles By Evolutionary Fuzzy System Part I: Fuzzy Logic Controller Development. in: Proceedings of the 6th World Congress on Intelligent Control and Automation (WCICA '06), Dalian, China. June 2006;vol. 2:8324-8.
- [86] Poursamad A, Montazeri M. Design of Genetic-Fuzzy Control Strategy For Parallel Hybrid Electric Vehicles. Control Engineering Practice. 2008;vol. 16:861-73.
- [87] Yi T, Xin Z, Liang Z. Fuzzy-Genetic Control Strategy of Hybrid Electric Vehicle. in: Proceedings of the 2nd International Conference on Intelligent Computing Technology and Automation (ICICTA '09), Zhangjiajie, China. October 2009:720–3.
- [88] Desai C, Williamson SS. Optimal Design of a Parallel Hybrid Electric Vehicle Using Multi-Objective Genetic Algorithms. in: Proceedings of the 5th IEEE Vehicle Power and Propulsion Conference (VPPC '09), Dearborn, Mich, USA. September 2009:871–6.
- [89] Hu X, Wang Z, Liao L, Xiao Z. Application of Multi Objective Evolutionary Algorithm In Hybrid Electric Vehicle Design and Control. Journal of Wuhan University of Technology. 2004;vol. 28:384–7.
- [90] Montazeri-Gh M, Ahmadi A, Asadi A. Driving Condition Recognition for Genetic-Fuzzy HEV Control. in: Proceedings of the 3rd International Workshop on Genetic and Evolving Fuzzy Systems, Witten-Bommerholz, Germany. March 2008:65–70.
- [91] Eberhart RC, Kennedy J. A New Optimizer Using Particle Swarm Theory. in: Proceedings of the 6th International Symposium on MicroMachine and Human Science, Nagoya, Japan. October 1995:39–43.
- [92] Shi Y, Eberhart RC. Parameter Selection in Particle Swarm Optimization. in: Proceedings of the 7th Annual Conference on Evolutionary Programming, San Diego, California, USA. March 1998:591–600.



- [93] Huang M. Optimal Multilevel Hierarchical Control Strategy for Parallel Hybrid Electric Vehicle. in: Proceedings of the IEEE Vehicle Power and Propulsion Conference (VPPC'06), Windsor, UK. 6-8 September 2006:1-4.
- [94] Junhong LXZ. Optimal Energy Management Strategy for a Plug-In Hybrid Electric Vehicle Based On Particle Swarm Arithmetic. Journal Shanghai Auto. 2011;vol. 5:3.
- [95] Huang M, Yu H. Optimal Control Strategy Based On PSO For Powertrain of Parallel Hybrid Electric Vehicle. in: Proceedings of the IEEE International Conference on Vehicular Electronics and Safety (ICVES'06), Beijing, China. 13-15 December 2006:352-5.
- [96] Wang Z, Huang B, Li W, Xu Y. Particle Swarm Optimization for Operational Parameters of Series Hybrid Electric Vehicle. in: Proceedings of the IEEE International Conference on Robotics and Biomimetics (ROBIO '06), Kunming, China. 17-20 December 2006:682-8.
- [97] Wu J, Zhang CH, Cui NX. Fuzzy Energy Management Strategy of Parallel Hybrid Electric Vehicle Based on Particle Swarm Optimization. Control and Decision. 2008;vol. 23:46-50.
- [98] Al-Aawar N, Hijazi TM, Arkadan AA. EM-TFL Identification for Particle Swarm Optimization Of HEV Power Train. in: Proceedings of the IEEE International Electric Machines and Drives Conference (IEMDC'09), Miami, Fla, USA. 3-6 May 2009:109-12.
- [99] Wu L, Wang Y, Yuan X, Chen Z. Multiobjective Optimization of HEV Fuel Economy and Emissions Using the Self-Adaptive Differential Evolution Algorithm. IEEE Transactions on Vehicular Technology. 2011;vol. 60:2458-70.
- [100] Al-Aawar N, Hijazi TM, Arkadan AA. Particle Swarm Optimization of Coupled Electromechanical Systems. IEEE Transactions on Magnetics. 2011;vol. 47:1314-7.
- [101] Desai C, Williamson SS. Particle Swarm Optimization for Efficient Selection of Hybrid Electric Vehicle Design Parameters. in: Proceedings of the 2nd IEEE Energy Conversion Congress and Exposition (ECCE '10), Atlanta, Ga, USA. September 2010:1623-8.
- [102] Varesi K, Radan A. A Novel PSO Based Technique For Optimizing The DOH In Hybrid Electric Vehicles to Improve Both the Fuel Economy and Vehicle Performance and Reduce the Emissions. in: Proceedings of the 2nd Power Electronics, Drive

Systems and Technologies Conference (PEDSTC '11), Tehran, Iran. February 2011:342–9.

[103] Boyali A, Demirci M, Acarman T, Guvenc L, Tur O, Ucarol H, et al. Modeling and Control of a Four Wheel Drive Parallel hybrid Electric Vehicle. in: Proceedings of the 2006 IEEE International Conference on Control Applications, Munich, Germany. October 4-6, 2006.

[104] Bowles P, Peng H, Zhang X. Energy Management in a Parallel Hybrid Electric Vehicle with a Continuously Variable Transmission. in: Proceedings of the American Control Conference, Chicago, Illinois. June 2000 55-9.

[105] Jalil N, Kheir NA, Salman M. A Rule-Based Energy Management Strategy for a Serie Shybrid Vehicle. in: Proceedings of the American Control Conference, Albuquerque, NM, USA. June 1997;vol. 1:689–93.

[106] Mohebbi M, Charkhgard M, Farrokhi M. Optimal Neuro-Fuzzy Control of Parallel Hybrid Electric Vehicles. in: Proceedings of the IEEE Vehicle Power and Propulsion Conference (VPPC'05), Tehran, Iran. 7-9 September 2005:26–30.

[107] Schouten NJ, Salman MA, Kheir NA. Fuzzy Logic Control for Parallel Hybrid Vehicles. IEEE Transaction on Control Systems Technology. May 2002;vol. 10:460 - 8.

[108] Baumann BM, Washington G, Glenn BC, Rizzoni G. Mechatronic Design and Control of Hybrid Electric Vehicles. IEEE/ASME Trans Mechatronics. March 2000;vol. 5:58–72.

[109] Powell BK, Bailey KE, Cikanek SR. Dynamic modeling and control of hybrid electric vehicle powertrain systems. IEEE Control Syst Mag. October 1998;vol. 18:17–33.

[110] Rizoulis D, Burl J, Beard J. Control Strategies for a Series-Parallel Hybrid Electric Vehicle. SAE, Warrendale, PA. 2001;Paper No. 2001-01-1354.

[111] Sharer PB, Rousseau A, Karbowski D, Pagerit S. Plug-in Hybrid Electric Vehicle Control Strategy: Comparison Between EV and Charge-Depleting Options. SAE, Warrendale, PA. 2008;Paper No. 2008-01-0460.

[112] Rousseau A, Pagerit S, Gao D. Plug-in Hybrid Electric Vehicle Control Strategy Parameter Optimization, Anaheim, California. Electric Vehicle Symposium and Exposition 2–5 December 2007.

- [113] Sciarretta A, Guzzella L. Rule-Based and Optimal Control Strategies for Energy Management in Parallel Hybrid Vehicles. 6th International Conference on Engines for Automobile (ICE 2003). 2003.
- [114] Opila DF, Wang X, McGee R, Cook A, Grizzle JW. Fundamental Structural Limitations of an Industrial Energy Management Controller Architecture for Hybrid Vehicles. ASME Dynamic Systems and Control Conference. 2009.
- [115] Shumei C, Wei Z, Likun T. Control Strategy for Double Shaft Parallel Hybrid Electric Vehicle. in: Vehicle Power and Propulsion Conference. 2006;VPPC'06. IEEE:1-4.
- [116] Kim C, NamGoong E, Lee S, Kim T, Kim H. Fuel Economy Optimization for Parallel Hybrid Vehicles With CVT. SAE Technical Paper 1999-01-1148. 1999:9.
- [117] Pisu P, Rizzoni G. A Comparative Study of Supervisory Control Strategies for Hybrid Electric Vehicles. IEEE Trans on Control Systems Technology. 2007;vol. 15:506–18.
- [118] Mohammadian M, Bathaee M. Motion Control for Hybrid Electric Vehicle. Power Electronics and Motion Control Conference IPEMC 2004 The 4th International. 2004:1490-4.
- [119] Phillips AM, Jankovic, M, Bailey KE. Vehicle System Controller Design for a Hybrid Electric Vehicle. Control Applications Proceedings of the IEEE International Conference. 2000:297-302.
- [120] Zeng Q, Huang J. The Design And Simulation of Fuzzy Logic Controller for Parallel Hybrid Electric Vehicles. in: Proceedings of the IEEE International Conference on Automation and Logistics (ICAL '07), Jinan, China. August 2007:908–12.
- [121] Khoucha F, Benbouzid MEH, Kheloui A. An Optimal Fuzzy Logic Power Sharing Strategy for Parallel Hybrid Electric Vehicles. in: Proceedings of the IEEE Vehicle Power and Propulsion Conference (VPPC '10), Lille, France. September 2010:1–5.
- [122] Liu X, Wu Y, Duan J. Power Split Control Strategy for a Series Hybrid Electric Vehicle Using Fuzzy Logic. in: Proceedings of the IEEE International Conference on Automation and Logistics (ICAL'08), Qingdao, China. September 2008:481–6.

- [123] Rajagopalan A, Washington G. Intelligent Control of Hybrid Electric Vehicles Using GPS Information. SAE Technical Paper 2002-01-1936, Future Car Congress. 2002.
- [124] Arsie I, Pianese C, Rizzo G, Santoro M. A Model For The Energy Management in a Parallel Hybrid Vehicle. in: Proceedings of the 3rd International Conference on Control and Diagnostics in Automotive Applications, Sestri Levante, Italy. July 2001:Paper No. 01A3037.
- [125] Lee HD, S KE, K SS, Kim JS. Torque Control Strategy for a Parallel-Hybrid Vehicle Using Fuzzy Logic. IEEE Industry Applications Magazine. 2000;vol. 6:33–8.
- [126] Tao CW, Taur JS. Flexible Complexity Reduced Pidlike Fuzzy Controllers. IEEE Transactions on Systems, Man, and Cybernetics B: Cybernetics. 2000;vol. 30:510-6.
- [127] Syed FU, Kuang ML, Smith M, Okubo S, Ying H. Fuzzy Gain-Scheduling Proportional-Integral Control For Improving Engine Power and Speed Behavior in a Hybrid Electric Vehicle. IEEE Transactions on Vehicular Technology. 2009;vol. 58:69–84.
- [128] Patel AV, Mohan BM. Analytical Structures and Analysis of the Simplest fuzzy PI Controllers. Automatica. 2002;vol. 38:981–93.
- [129] Galichet S, Foulloy L. Fuzzy Controllers: Synthesis and Equivalences. IEEE Transactions on Fuzzy Systems 1995;vol. 3:140-8.
- [130] Jianlong Z, Chengliang Y, Jianwu Z. Use Of Fuzzy Controller for Hybrid Traction Control System in Hybrid Electric Vehicles. in: Proceedings of the IEEE International Conference on Mechatronics and Automation (ICMA '06), Luoyang, China. June 2006:1351–6.
- [131] Zhou M, Zhang H, Wang X. Research on Fuzzy Energy Management Strategy of Parallel Hybrid Electric Vehicle. in: Proceedings of the International Conference on Electronic and Mechanical Engineering and Information Technology (EMEIT '11), Heilongjiang, China. August 2011:967–71.
- [132] Hajimiri MH, Salmasi FR. A Predictive and Battery Protective Control Strategy for Series HEV. Asian Electric Vehicle. December, 2008;vol. 6.

- [133] Langari R, Won JS. Integrated Drive Cycle Analysis for Fuzzy Logic Based Energy Management in Hybrid Vehicles. in: Proceedings of the 12th IEEE International Conference on Fuzzy Systems (FUZZ '03), Missouri. 25-28 May 2003:290–5.
- [134] Golkar MA, Hajizadeh A. Power Management Strategy for Parallel Hybrid Electric Vehicles. in: Proceedings of the Joint International Conference on Sustainable Energy and Environment, Bangkok, Thailand. November 2006:1–6.
- [135] Lu D, Li W, Zhou M. Fuzzy Logic Control Approach To The Energy Management Of Parallel Hybrid Electric Vehicles. in: Proceedings of the IEEE International Conference on Information and Automation( ICIA'12), Shenyang, China. 6-8 June 2012:592–6.
- [136] Zhumu F, Junya X, Aiyun G. Research on Energy Management and Optimization for PHEV. Automation and Logistics (ICAL), 2012 IEEE International Conference. 15-17 August 2012:578-82.
- [137] Brahma A, Glenn B, Guezennec Y, Miller T, Rizzoni G, Washington G. Modeling, Performance Analysis and Control Design of a Hybrid Sport-Utility Vehicle. in: Proceedings of the IEEE International Conference on Control Applications (CCA'99), Kohala Coast, Hawaii, USA. August 1999:448–53.
- [138] Paganelli G, Delprat S, Guerra TM, Rimaux J, Santin JJ. Equivalent Consumption Minimization Strategy for Parallel Hybrid Power Trains. in: Proceedings of the 55th Vehicular Technology Conference, Vancouver, BC, Canada. May 2002;vol. 4:2076–81.
- [139] Kleimaier A, Schröder D. An Approach for the Online Optimized Control of a Hybrid Powertrain. in: Proceedings of 7th International Workshop Advanced on Motion Control. 2002:215–20.
- [140] Rizzoni G, Pisu P, Calo E. Control Strategies for Parallel Hybrid Electric Vehicles. in: Proceedings of IFAC Symposium on Advanced Automotive Control. 2004:508–13.
- [141] Sciarretta A, Back M, Guzzella L. Optimal Control of Parallel Hybrid Electric Vehicles. IEEE Transactions On Control Systems Technology. 2004;vol. 12.
- [142] Delprat S, Guerra TM, Rimaux J. Optimal Control of a Parallel Powertrain: From Global Optimization to Real-time Control Strategy. in: Proceedings of the 55th Vehicular Technology Conference, Berlin, Germany. May 2002:2082–8.

- [143] Kim N, Cha S, Peng H. Optimal Control of Hybrid Electric Vehicles Based on Pontryagin's Minimum Principle. IEEE Transactions on Control Systems Technology. September 2011;vol. 19:1279–87.
- [144] Serrao L, Onori S, Rizzoni G. ECMS as a Realization of Pontryagin's Minimum Principle for HEV Control. in: American Control Conference, IEEE. 2009:3964-9.
- [145] Krotov VF. Global Methods in Optimal Control Theory. Marcel Dekker, Incorporated New York, USA, . 1995:74-121.
- [146] Geering H. Optimal Control with Engineering Applications. Springer, New York, NY, USA. 2007.
- [147] Serrao L, Rizzoni G. Optimal Control of Power Split for a Hybrid Electric Refuse Vehicle. in: Proceedings of the American Control Conference (ACC '08), Washington, DC, USA. June 2008:4498–503.
- [148] Stockar S, Marano V, Rizzoni G, Guzzella L. Optimal Control for Plug-In Hybrid Electric Vehicle Applications. in: Proceedings of the American Control Conference (ACC '10), Baltimore, Md, USA. July 2010:5024–30.
- [149] Chasse A, Sciarretta A. Supervisory Control of Hybrid Powertrains: An Experimental Benchmark of Offline Optimization and Online Energy Management. Control Engineering Practice. 2011;vol. 19:1253-65.
- [150] Kim N, Lee D, Cha SW, Peng H. Optimal Control of a Plug-In Hybrid Electric Vehicle (PHEV) Based on Driving Patterns. in: Proceedings of the 24th International Battery, Hybrid and Fuel Cell Electric Vehicle Symposium, Stavanger, Norway. 2009:1–9.
- [151] Kim N, Rousseau A, Lee D. A Jump Condition of Pmpbased Control for PHEVs. Journal of Power Sources. 2011;vol. 196:10380–6.
- [152] Stockar S, Marano V, Canova M, Rizzoni G, Guzzella L. Energy-Optimal Control of Plug-In Hybrid Electric Vehicles for Real-World Driving Cycles. IEEE Transactions on Vehicular Technology. 2011;vol. 60:2949–62.
- [153] Musardo C, Staccia B, Rizzoni G. A-ECMS: An Adaptive Algorithm for Hybrid Electric Vehicle Energy Management. in: Proceedings of the 44th IEEE Conference on Decision and Control, and the European Control Conference (CDC-ECC'05), Seville, Spain. December 2005:1816–23.

- [154] Paganelli G, Tateno M, Brahma A, Rizzoni G, Guezennec Y. Control Development for a Hybrid-Electric Sport Utility Vehicle: Strategy, Implementation and Field Test Results. in: Proceedings of the American Control Conference, Columbus, Ohio, USA. June-July 2001:5064–9.
- [155] Won JS, Langari R, Ehsani M. An Energy Management and Charge Sustaining Strategy for a Parallel Hybrid Vehicle with CVT. IEEE Transactions on Control Systems Technology. 2005;vol. 13:313–20.
- [156] Pisu P, Rizzoni G. A Supervisory Control Strategy for Series Hybrid Electric Vehicles With Two Energy Storage Systems. in: Proceedings of the IEEE Vehicle Power and Propulsion Conference (VPPC'05), Chicago, Ill, USA. September 2005:65–72.
- [157] Xu I, Cao g, Li J, Yang F, Lu L, Ouyang M. Equivalent Consumption Minimization Strategies of Series Hybrid City Buses. Energy Management. 2010:133–46.
- [158] Salmasi FR. Control Strategies for Hybrid Electric Vehicles: Evolution, Classification, Comparison, and Future Trends. IEEE Transactions on Vehicular Technology. 2007;vol. 56:2393-404.
- [159] Paganelli G, Ercole G, Brahma A, Guezennec Y, Rizzoni G. General Supervisory Control Policy for the Energy Optimization of Charge-Sustaining Hybrid Electric Vehicles. Society Automotive Engineers Review. 2001;vol. 22:511–8.
- [160] Gu B, Rizzoni G. An Adaptive Algorithm for Hybrid Electric Vehicle Energy Management Based on Driving Pattern Recognition. in: Proceedings of the ASME International Mechanical Engineering Congress and Exposition, Chicago, Illinois, USA. 2006:249–58.
- [161] Onori S, L S, Rizzo G. Adaptive Equivalent Consumption Minimization Strategy for HEVs, Cambridge, MA. in: 3rd Annual Dynamic Systems and Control Conference. September 2010.
- [162] Sciarretta A, Guzzella L, Back M. A Real-time Optimal Control Strategy for Parallel Hybrid Vehicles With On-Board Estimation of Control Parameters. in: Proceedings of IFAC Symposium on Advances Automotive Control. Salerno, Italy, 2004:502–7.

- [163] Gao JP, Zhu GMG, Strangas EG, Sun FC. Equivalent Fuel Consumption Optimal Control of a Series Hybrid Electric Vehicle. *Journal of Automobile Engineering*. 2009;vol. 223:1003–18.
- [164] Rousseau G, Sinoquet D, Sciarretta A, Milhau Y. Design Optimization and Optimal Control for Hybrid Vehicles. in: *Proceedings of the International Conference Engineering Optimization*, Riode Janeiro, Brazil. 2008:1–10.
- [165] Marano V, Tulpule P, Stockar S, Rizzoni G. Comparative Study of Different Control Strategies for Plug-In Hybrid Electric Vehicles. in: *Proceedings of the SAE International Conference on Engines and Vehicles*, Naples, Italy. 2009.
- [166] He Y, Chowdhury M, Pisu P, Ma Y. An Energy Optimization Strategy For Power-Split Drivetrain Plug-In Hybrid Electric Vehicles. *Transportation Research Part C: Emerging Technologies*. 2012;vol. 22:29–41.
- [167] Tulpule P, Marano V, Rizzoni G. Effects of Different PHEV Control Strategies on Vehicle Performance. in: *Proceedings of the American Control Conference (ACC '09)*, StLouis, Mo, USA. June 2009:3950– 5.
- [168] Salman M, Chang MF, Chen JS. Predictive Energy Management Strategies for Hybrid Electric Vehicles. in: *Proceedings of the IEEE Vehicle Power and Propulsion Conference (VPPC'05)*, Chicago, Illinois. September 2005:536-40.
- [169] Cui N, Fan J, Zhang C, Wu J. Research on Predictive Control Based Energy Management Strategy for Hybrid Electric Vehicle. in: *Proceedings of the 3rd IEEE International Symposium on Power Electronics for Distributed Generation Systems(PEDG '12)*, Aalborg, Denmark. June 2012:642–6.
- [170] Beck R, Richert B, A. F. Model Predictive Control of a Parallel Hybrid Vehicle Drivetrain. in: *Proceedings of the 44th IEEE Conference on Decision and Control, and the European Control Conference*, Aachen, Germany. December 2005:2670–5.
- [171] Wang Y, Boyd S. Fast Model Predictive Control Using Online Optimization. in: *Proceedings of the International Federation Automatic Control World Congress (IFAC '08)*, Seoul, Korea. July 2008:6974 – 97.
- [172] Kermani S, Delprat S, Guerra TM, Trigui R. Predictive Control For HEV Energy Management: Experimental Results. in: *Proceedings of the 5th IEEE Vehicle Power and Propulsion Conference (VPPC '09)*, Lille, France. September 2009:364–9.



- [173] Sampathnarayanan B, Serrao L, Onori S, Rizzoni G, Yurkovich S. Model Predictive Control as an Energymanagement Strategy for Hybrid Electric Vehicles. in: Proceedings of the ASME Dynamic Systems and Control Conference (DSCC '09). October 2009:1161–8.
- [174] Ichikawa S, Yokoi Y, Doki S, Okuma S, Naitou T, Shiimado T, et al. Novel Energy Management System for Hybrid Electric Vehicles Utilizing Car Navigation Over a Commuting Route. Intelligent Vehicles Symposium, 2004 IEEE. 2004:161-6.
- [175] Yan F, Wang J, Huang K. Hybrid Electric Vehicle Model Predictive Control Torque-Split Strategy Incorporating Engine Transient Characteristics. IEEE Transactionson VehicularTechnology. 2012;vol. 61:2458–67.
- [176] Won JS, Langari R. Intelligent Energy Management Agent for a Parallel Hybrid Vehicle - Part II: Torque Distribution, Charge Sustenance Strategies, and Performance Results. in: Proceeding of the American Control Conference, Denver, Colo, USA. June 2003:935–56.
- [177] Poramapojana P, Chen B. Minimizing HEV Fuel Consumption Using Model Predictive Control. in: Proceedings of the 8th IEEE/ASME International Conference on Mechatronic and Embedded Systems and Applications (MESA '12), Sozhou, China. 8-10 July 2012:148–53.
- [178] Mahapatra S. Model-Based Design for Hybrid Electric Vehicle Systems. Auto Electronics <http://autoelectronicscom/powertrain/hybridelectricvehicles/model-based-design-forhybrid-electric-vehicles-081109/>. 2009.
- [179] Nuijten E, Koot M, Kessels J. Advanced Energy Management Strategies for Vehicle Power Nets. in: Proceedings of EAEC 9th Int Congress: European Automotive Industry. 2003.
- [180] Vito DD, Miotti A, Scattolini R. Power Flow Management With Predictive Capabilities for a Hybrid Fuel Cell Vehicle. in: Proceedings of the 5th IFAC Symposium on Advances in Automotive Control. 2007;vol. 40:9-16.
- [181] West MJ, Bingham CM, Schofield N. Predictive Control for Energy Management in All/More Electric Vehicles With Multiple Energy Storage Units. in: Proceedings of the IEEE International Electric Machines and Drives Conference, M J West, Ed. 1-4 June 2003;vol. 1:222–8.

- [182] Borhan HA, Zhang C, Vahidi A, Phillips AM, Kuang MI, Di Cairano S. Nonlinear Model Predictive Control for Power-Split Hybrid Electric Vehicles. in: Proceedings of the 49th IEEE Conference on Decision and Control (CDC'10), Clemson, SC, USA. December 2010:4890–5.
- [183] Ripaccioli G, Bemporad A, Assadian F, Dextreit C, Cairano SD, Olmanovsky I. Hybrid Modeling, Identification, and Predictive Control: An Application to Hybrid Electric Vehicle Energy Management. Hybrid Systems: Computation and Control, Springer, Berlin, Germany. 2009;vol. 5469 of Lecture Notes in Computer Science:321–35.
- [184] Ripaccioli G, Bernardini D, Di Cairano S, Bemporad A, Kolmanovsky IV. A Stochastic Model Predictive Control Approach for Series Hybrid Electric Vehicle Power Management. in: Proceedings of the International Conference Mechatronics and Automation, Siena, Italy. 2011:4890–5.
- [185] Vogal A, Ramchandran D, Gupta R, Raux A. Improving Hybrid Vehicle Fuel Efficiency Using Inverse Reinforcement Learning. in: Proceedings of 26th AAAI Conference on Artificial Intelligence. 2012:384–90.
- [186] Borhan H, Vahidi A, Phillips AM, Kolmanovsky IV, Kuang MI, Di Cairano S. MPC-Based Energy Management of a Power-Split Hybrid Electric Vehicle. IEEE Transactions on Control Systems Technology. 2012;vol. 20:593–603.
- [187] Hagan MT, Demuth HB, Beale MH. Neural Network Design. PWS Publishing Company, Boston. 1996;1st edition.
- [188] Baumann B, Rizzoni G, Washington G. Intelligent Control of Hybrid Vehicles Using Neural Networks and Fuzzy Logic. SAE Technical Paper no 981061, Society of Automotive Engineers. 1998:11.
- [189] Suzuki M, Yamaguchi S, Araki T, Raksincharoensak P, Yoshizawa M, Nagai M. Fuel Economy Improvement Strategy for Light Duty Hybrid Truck Based on Fuel Consumption Computational Model Using Neural Network. in: Proceedings of the 7th World Congress, International Federation of Automatic Control, Seoul, Korea. July 2008:10719–25
- [190] Prokhorov D. Toyota Prius HEV Neurocontrol. in: Proceedings of the International Joint Conference on Neural Networks (IJCNN'07), Orlando, Florida, USA. August 2007:2129–34.

- [191] Gong Q, Li Y, Peng H. Power Management of Plugin Hybrid Electric Vehicles Using Neural Network Based Trip Modeling. in: Proceedings of the American Control Conference (ACC'09), St Louis, Mo, USA. June 2009:4601–6.
- [192] Boyali A, Guvenc L. Real-time Controller Design for a Parallel Hybrid Electric Vehicle Using Neuro-Dynamic Programming Method. in: Proceedings of the IEEE International Conference on Systems, Man and Cybernetics (SMC '10), Istanbul, Turkey. 10-13 Oct. 2010:4318–24.
- [193] Liu MJ. A Fuzzy Neural Network Control System Based on Improved Learning Algorithms. in: Proceedings of the Chinese Society of Electrical Engineering. 2007;vol. 27:87–92.
- [194] Sivertsson M, Sundstrom C, Eriksson L. Adaptive Control of a Hybrid Powertrain with Map-based ECMS. IFAC World Congress. 2011.
- [195] Manzie C. Relative Fuel Economy Potential of Intelligent, Hybrid and Intelligent–Hybrid Passenger Vehicles. Electric and Hybrid Vehicles. 2010:61-90.
- [196] Adhikari S. Real-time Power Management of Parallel Full Hybrid Electric Vehicle. PhD Thesis. October, 2010.
- [197] Hellstrom E, Aslund J, Nielsen L. Horizon Length and Fuel Equivalents for Fuel-Optimal Look-Ahead Control. 6th IFAC Symposium Advances in Automatic Control. 2010.
- [198] Hellstrom E, Ivarsson M, Aslund J, Nielsen L. Look-ahead Control for Heavy Trucks To Minimize Trip Time and Fuel Consumption. Control Engineering Practice. 2009;vol. 17:245-54.