

*Citation for published version:*

Hernando Gil, I, Li, F, Collin, A & Djokic, SZ 2016, 'Development of Sub-Transmission Network Equivalents and After-Diversity-Demand Values: Case Study of the UK Residential Sector' Paper presented at 18th Mediterranean Electrotechnical Conference (MELECON), 2016, Cyprus, 18/04/16 - 20/04/16, .
<https://doi.org/10.1109/MELCON.2016.7495364>

DOI:

[10.1109/MELCON.2016.7495364](https://doi.org/10.1109/MELCON.2016.7495364)

Publication date:

2016

Document Version

Peer reviewed version

[Link to publication](#)

© 2016 IEEE. Personal use of this material is permitted. Permission from IEEE must be obtained for all other users, including reprinting/ republishing this material for advertising or promotional purposes, creating new collective works for resale or redistribution to servers or lists, or reuse of any copyrighted components of this work in other works.

University of Bath

General rights

Copyright and moral rights for the publications made accessible in the public portal are retained by the authors and/or other copyright owners and it is a condition of accessing publications that users recognise and abide by the legal requirements associated with these rights.

Take down policy

If you believe that this document breaches copyright please contact us providing details, and we will remove access to the work immediately and investigate your claim.

Development of Sub-Transmission Network Equivalents and After-Diversity-Demand Values: Case Study of the UK Residential Sector

Ignacio Hernando-Gil
Furong Li

Dept. of Electronic and Electrical Engineering
University of Bath
Bath, UK
i.hernando.gil@bath.ac.uk
f.li@bath.ac.uk

Adam Collin
Sasa Djokic

School of Engineering
The University of Edinburgh
Edinburgh, UK
a.collin@ed.ac.uk
sasa.djokic@ed.ac.uk

Abstract—This paper, which can be divided into two main interrelated studies, firstly describes the generic modelling of a sub-transmission network model to serve as a UK variant of the original IEEE 14-bus test system. The revised model, based on the actual/realistic power components found both in the UK and in European grids, provides an updated and complete technical description, ready for use in a variety of power system studies, in which the 14-bus test system is one of the most commonly used in the literature. Afterwards, this paper categorises the typical demand characteristics of the residential load sector in the UK, by providing a wider range of reference demand values and loading conditions for the planning and modelling studies of distribution networks, dividing them into four generic residential load subsectors. Different ‘after diversity demand’ values are therefore provided per residential load subsector, classes of customers and seasonal variations of annual power consumption.

Keywords—power system planning; network equivalent; residential demand; load modelling; distribution network.

I. INTRODUCTION

Relatively small test network models (10-20 buses) are often used for the initial planning and testing stages of various researches, as well as for the communication of their final results and outcomes. These test networks, which may or may not be based on real power supply systems, should provide detailed information on all the modelled network components and relevant system operating/loading conditions. Among the test networks available in the existing literature, the IEEE 14-bus network [1, 2] was selected as the initial test network for analysis in the presented paper, as it is one of the most commonly used in a wide variety of power system studies. An internal survey was accordingly carried out on [3] in order to build a reference library, returning over 260 scientific papers and reports where the IEEE 14-bus network is used for power flow, security and power quality analysis, system state estimation, planning purposes, analysis of voltage stability, economic dispatch, optimal location of flexible alternating current transmission system (FACTS) devices, reactive power optimisation and many other studies.

Therefore, based on all the technical specifications and parameters gathered for a wide range of power components operating in UK/EU grids, the generic sub-transmission network proposed in this paper is an UK variant of the original IEEE 14-bus test system, as presented in Fig. 1. Accordingly, the new test network model provides an updated information on all network component values, which is generally more appropriate for the analysis of modern electricity networks with the inclusion of e.g. distributed generation (DG) or demand-side response (DSR) functionalities.

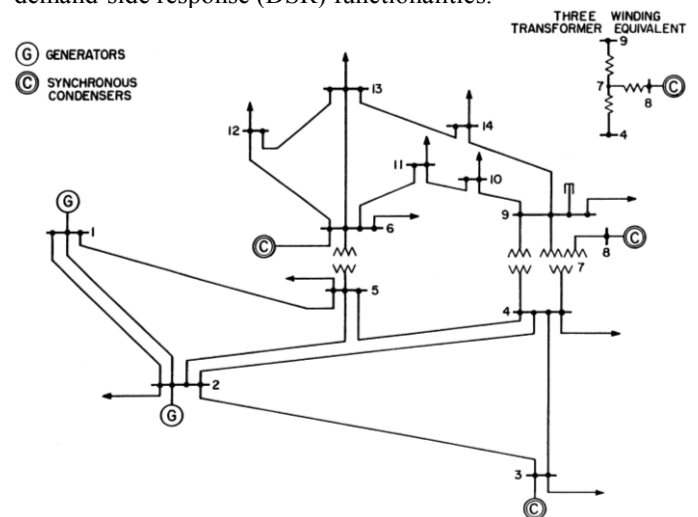

Fig. 1. Original IEEE 14-bus test system [1, 2].

Additionally, this paper also aims to link the bulk demand supplied at the load points of the sub-transmission network by identifying the typical demand characteristics of the residential load sector in the UK. This forms the second part of the paper, providing further demand references and different loading conditions (e.g. max. and min. values) for the modelling and design of generic distribution networks supplying four different residential load subsectors (i.e. from metropolitan to rural areas). These can be used to represent the demand at bulk load points with detailed/aggregate network configurations designated to supply different types of residential customers.

TABLE II. SPECIFICATIONS OF OVERHEAD LINES FOR THE UK SUB-TRANSMISSION NETWORK EQUIVALENT

From Bus	To Bus	Voltage (kV)	Thermal Rating (MVA)	Length (km)	R	X	B	R ₀	X ₀	Type	Cross Section (mm ²)
1	2	132	170.3	28.47	0.01938	0.060075	0.034637	0.042932	0.241087	ACSR ^a	242/39
1	5		125.7	93.8	0.053998	0.213306	0.077423	0.166696	0.62877		152/25
2	3		125.7	82	0.047205	0.186472	0.067683	0.145726	0.549671		152/25
2	4		82.3	67	0.051238	0.153254	0.033721	0.138402	0.433619		85/14
2	5		57.1	65	0.049709	0.148679	0.032715	0.134271	0.420675		42/25
3	4		48	71	0.064301	0.166844	0.034473	0.165488	0.432891		34/6
4	5		91.4	18	0.012754	0.040834	0.009154	0.027727	0.158946		89/52
6	11	33	12	7	0.091582	0.191339	0.002297	0.258699	0.722075		34/6
6	12		12	9.5	0.12429	0.259674	0.003117	0.351092	0.979959		34/6
6	13		22.8	4.2	0.066408	0.130396	0.00043	0.1488	0.591803		89/52
7	8		20.5	5.67	0.089651	0.176035	0.000581	0.20088	0.798934		85/14
9	10		12	2.7	0.032141	0.085922	0.000513	0.078162	0.360353		34/6
9	14		14.3	7.64	0.128604	0.272985	0.000309	0.231299	1.136162		42/25
10	11		12	5.6	0.082068	0.192406	0.000475	0.166419	0.807539		34/6
12	13	12	6.2	0.222427	0.201072	0.000937	0.321514	0.894288	34/6		
13	14	12	10.5	0.169921	0.343964	0.001717	0.357364	1.41428	34/6		

^a ACSR: Aluminium Conductor Steel Reinforced.

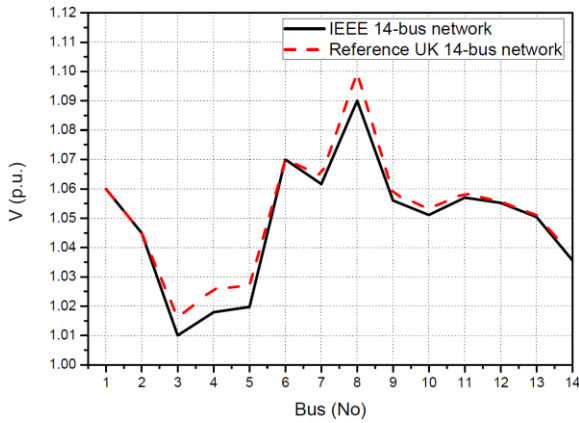

(a) voltage profile comparison

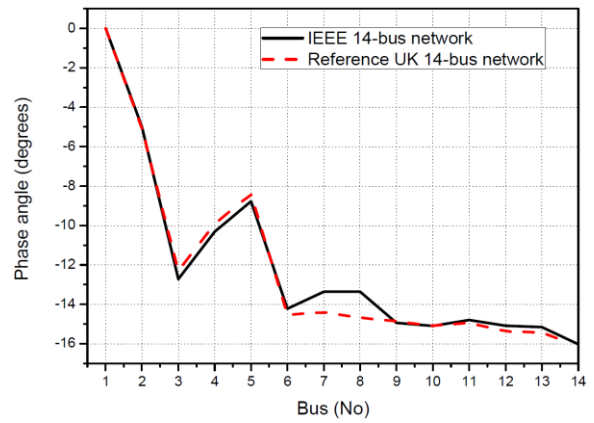

(b) phase angle comparison

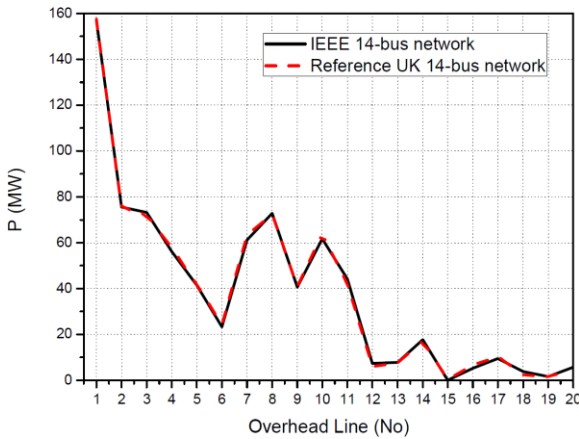

(c) active power flows comparison

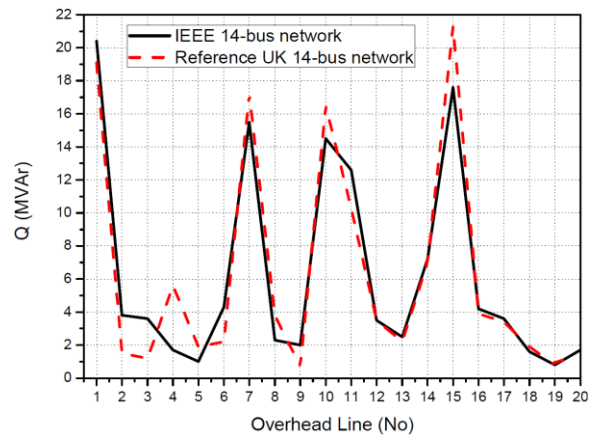

(d) reactive power flows comparison

Fig. 3. Original IEEE 14-bus network and revised UK sub-transmission network representation.

III. RESIDENTIAL LOAD SUB-SECTORS

Power distribution networks differ from each other in both characteristics and configurations, mainly depending on geographic location and type/density of served loads. This will determine important factors such as network strength, fault levels and source impedances, transformer ratings and feeder types/lengths, as well as the level of dedicated public/street lighting. In addition, time of the day and season of the year will have a strong influence on the changes of the electrical characteristics of the supplied load/demand sectors. Therefore, for the purpose of this paper, these variations are taken into account for the correct modelling of domestic loads and their associated power consumption.

Although the purpose of every residential dwelling is identical and, generally, the individual loads used there will be similar, it is possible to divide the residential load sector into four subsectors, based on the location, size and type of dwelling, as studied e.g. in [12]. The level of street/outdoor lighting will also be influenced by the location, while differences will also exist in terms of the size of renewable/distributed generation that is likely to be located in close proximity to the residential areas. Therefore, based on these general characteristics and parameters, the residential load sector can be divided into the four following subsectors: highly-urban, urban, suburban and rural [10, 13].

A. Highly-Urban (HU) Residential Load Subsector

This subsector is represented by flat-type dwellings, usually found in large cities, in multi-storey and high-rise buildings and it is characterised by highly concentrated power demands. Three-phase motors may be used for elevators, pumps and central air-conditioning systems, which are usually not present or low in other residential subsectors. The number of rooms per dwelling is expected to be lower than in other subsectors, and there will be additional interior lighting load for illumination of communal areas. Dedicated public/street lighting is also greater than in other subsectors, due to the presence of parking spaces and higher required lighting levels in metropolitan areas.

B. Urban (U) Residential Load Subsector

This subsector consists of house-type dwellings, ranging from one to few-storey buildings, located in city urban areas and it is characterised by medium to high concentration of power. As the average number of residents and rooms per household is greater than in the highly-urban subsector, higher power demands per household may occur. The public/street lighting in this sector is slightly reduced in comparison with the highly-urban subsector.

C. Sub-Urban (SU) Residential Load Subsector

This subsector is similar to the urban subsector, representing individual house dwellings located in city suburban areas and towns in close proximity to big cities. The load mix is similar to the urban subsector but the contribution from public/street lighting is likely to be further reduced. It is also characterised by medium power density.

D. Rural (Ru) Residential Load Subsector

House-type dwellings in this subsector are one to few-storey buildings, located in more remote areas. Power density is low and some (smaller) three-phase motors may be used for agricultural works. Another notable difference is that no public/street lighting is present. Furthermore, the connection of larger DG is possible in this subsector.

IV. TYPICAL 'AFTER DIVERSITY DEMAND' UK VALUES

To identify the typical demand characteristics of the residential load sector in the UK, the Electricity Association (supplied by Elexon Ltd) provides in [14] a full database with half-hourly electricity daily load profiles for standard UK profile class definitions (e.g. domestic unrestricted and domestic Economy 7), considering different days and seasons of the year. In the UK, the domestic Economy 7 electricity tariff is a type of off-peak energy tariff that allows customers to make use of several appliances (e.g. storage space and water heaters) at times of the day (i.e. night hours) when the overall demand and energy prices are lower. Therefore, the typical load curve for this type of customers is significantly different from the normal unrestricted (i.e. Ordinary) domestic customers. As these typical load profiles are provided for different seasons (spring, summer, autumn and winter), they have been per-unitised from their peak value and are shown in Fig. 4 for both Ordinary and Economy 7 customers.

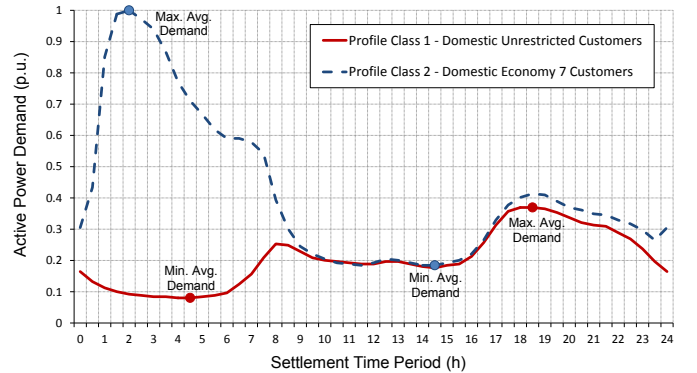

Fig. 4. Typical UK domestic profile classes [14].

This section aims to provide further reference demands and different loading conditions (i.e. the max. and min. points highlighted in Fig. 4) for the analysis, modelling and design of generic distribution networks supplying the four different load subsectors. Apart from the average demand per customer under minimum and maximum loading conditions respectively, this paper will provide correlated values of the 'after diversity demand' (ADD) for both Ordinary and Economy 7 customers, as well as for each season of the year. The demand estimation for the design of power distribution networks is usually based on diversity factors, such as the ADD concept, which can be defined in terms of the min/max demand per customer, as the number of customers connected to the network increases. This is usually derived from the min/max yearly nodal demands on the distribution network, divided by the total number of customers served [15].

A. Methodology for ADD Calculation

The proposed methodology uses actually measured load data provided by a UK distribution network operator (DNO), covering one calendar year of operation (April 2009 to April 2010) at several 'grid supply point' (GSP) 132/33 kV substations. The recordings of active (MW) and reactive (MVar) power demands at different network busbars over the one-year period are then used to calculate the total energy consumption, in MWh, for that particular year. Although the total aggregate demand may include demands from different load sectors (industrial, commercial, residential, mixed, etc.) depending on the location of each network GSP, the idea is to identify the total percentage energy consumption for each season of the year, with respect to the aggregate annual energy consumption. The calculated results are provided in Table III, where as expected, a higher energy demand contribution takes place during winter, 29% of the total, while the summer only contributes with 21% of the annual energy demand.

TABLE III. SEASONAL PERCENTAGE CONTRIBUTIONS TO THE ANNUAL ENERGY DEMAND IN UK NETWORKS

Season/Year	Energy Consumption (MWh)	Load Contribution (%)	Days
Total (1 year)	19,208,960	100	365
Spring	4,333,436	23	91.25
Summer	4,086,898	21	91.25
Autumn	5,178,254	27	91.25
Winter	5,610,372	29	91.25

Sub-national electricity consumption statistics in [16], providing information on the average electricity consumption in different cities, areas, and even neighbourhoods in the UK, have also been processed in order to identify the ratio of Ordinary/Economy 7 customers over the total served electricity meters. Therefore, as the DNO's load measurements previously analysed refer to year 2009, the study focuses on statistics for energy consumption in that particular year [17], where it is possible to extract that around 27% of the total customers have an Economy 7 tariff, so the rest (73%) of customers are billed according to an Ordinary tariff. This information, considering the total number of customers served, has been used to allocate a specific percentage of customers (73%/27%) to their corresponding load profiles in Fig. 4. Also, the information in [17] has been used (Table IV) to select a corresponding 'annual average consumption' per customer electricity meter, depending on location (i.e. HU, U, SU and Ru subsectors).

TABLE IV. ANNUAL AVERAGE DOMESTIC ELECTRICITY CONSUMPTION PER METER IN UK NETWORKS [17]

Load Sub-Sector	Average Ordinary Domestic Consumption (73% of customers)	Average Economy 7 Domestic Consumption (27% of customers)	Total Average Domestic Consumption
	(kWh)		
HU	3,185	4,795	3,500
U	3,594	5,411	3,950
SU	4,140	6,233	4,550
Ru	4,550	6,850	5,000

B. ADD Values for UK Residential Sector

The data provided in Table IV is based on the annual (i.e. 365 days) consumption per electricity meter, from which it is already known what percentage corresponds to each season of the year (e.g. 23% over 91.25 days in Spring), as shown in Table III. However, the timescale for the typical load profiles provided in Fig. 4 for Ordinary/Economy 7 customers is based on 24 hours. Thus, in order to estimate the average energy consumed per domestic customer in only one day (for each yearly season), the data in Table IV has been divided by the corresponding number of days, either for annual (365 days) or seasonal calculations (91.25 days).

For each case (i.e. considering seasons, load subsectors and classes of customers), once the daily average demand per customer is estimated in kWh, that energy amount is used to 'fill' the area under the per-unitised load curves presented in Fig. 4, representing the active power demand over the 24-hour period. By using the Trapezoid method, as in [18], the load curve is divided in different time periods, each with a trapezoidal area representing the energy consumption within that period. In that way, it is possible to convert energy values (kWh) into active power demand, enabling to identify the ADD points (maximum and minimum average conditions in kW) for each case. These points have been put together in Table V, providing a much wider range of residential ADD values than those commonly used in the literature for planning and modelling of power distribution systems. For example, in the UK, load demand figures produced by the Electricity Association data, presented e.g. in [19], show a single value for minimum and maximum average demand of 0.16 kVA and 1.3 kVA respectively, without considering the comprehensive classification of ADD values provided in Table V for different residential load subsectors, class of customers connected, and season of the year.

TABLE V. AFTER DIVERSITY DEMAND (ADD) VALUES PER RESIDENTIAL LOAD SUBSECTOR, CLASS OF CUSTOMER AND SEASON OF THE YEAR

			SPRING (23% of total consumption)	SUMMER (21% of total consumption)	AUTUMN (27% of total consumption)	WINTER (29% of total consumption)	ANNUAL
			ADD (kW)				
HIGHLY URBAN	Ordinary (73% of customers)	max	0.61	0.56	0.72	0.77	0.66
		min	0.13	0.12	0.15	0.16	0.14
	Economy 7 (27% of customers)	max	1.20	1.10	1.42	1.53	1.31
		min	0.22	0.20	0.26	0.28	0.24
URBAN	Ordinary (73% of customers)	max	0.69	0.63	0.81	0.87	0.76
		min	0.15	0.14	0.18	0.19	0.16
	Economy 7 (27% of customers)	max	1.36	1.25	1.60	1.72	1.48
		min	0.25	0.23	0.29	0.32	0.27
SUB URBAN	Ordinary (73% of customers)	max	0.79	0.72	0.93	1.00	0.86
		min	0.17	0.15	0.20	0.22	0.18
	Economy 7 (27% of customers)	max	1.58	1.44	1.85	1.99	1.71
		min	0.29	0.27	0.34	0.37	0.31
RURAL	Ordinary (73% of customers)	max	0.87	0.79	1.02	1.10	0.95
		min	0.19	0.17	0.22	0.24	0.21
	Economy 7 (27% of customers)	max	1.73	1.58	2.03	2.18	1.88
		min	0.32	0.29	0.37	0.40	0.35

Also, Fig. 5 provides a seasonal comparison of the ADD max/min values (in kW) for both Ordinary and Economy 7 customers, divided into the four UK residential subsectors.

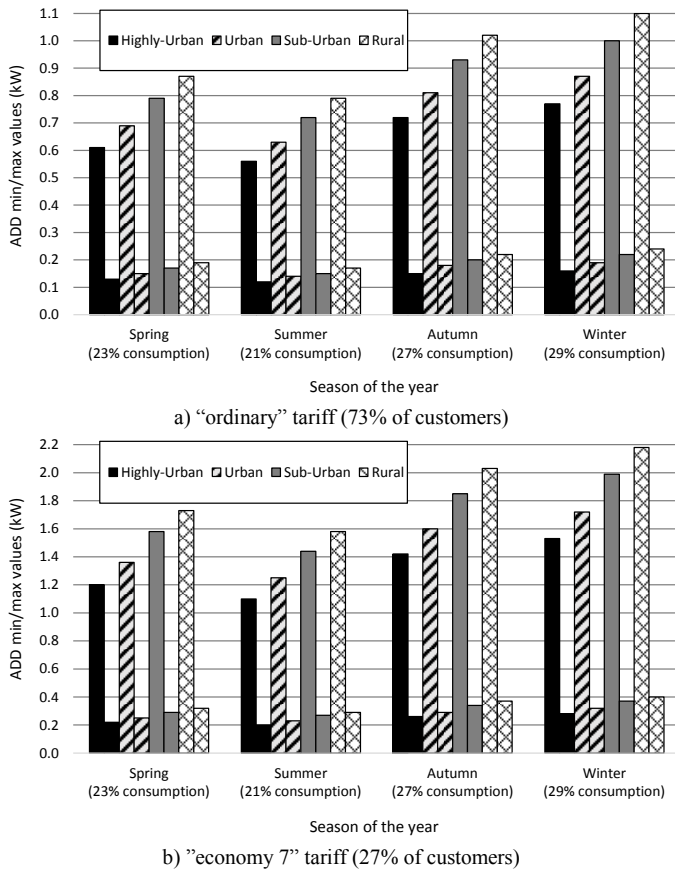

Fig. 5. Seasonal variations in the minimum and maximum ADD values (kW) for both “ordinary” and “economy 7” UK tariffs.

V. CONCLUDING REMARKS

This paper presents the results of two interrelated studies. First, a comprehensive description of a generic sub-transmission network serving as a UK variant of the original IEEE 14-bus test system is presented and analysed. The revised network, based on actual/realistic power components operating in UK/EU grids, provides an updated and complete model, more appropriate and ready for the wide variety of power system studies based on the original IEEE 14-bus test system, which is one of the most commonly used in literature.

Additionally, this paper further identifies the typical demand characteristics of the residential load sector in the UK (which are generally similar to those in the EU), by providing more detailed reference demands and loading conditions (e.g. maximum and minimum values) for the analysis and modelling of distribution networks supplying four generic residential load subsectors, i.e. from highly-urban to rural areas. Accordingly, a wide range of ‘after diversity demand’ values is provided per load subsector, class of customer, and season of the year, which is essential to tackle the current disparity in the data used for distribution network planning and design, as these will have a strong influence on the power delivered at each network load point.

REFERENCES

- [1] L. Freris and A. Sasson, “Investigation of the load-flow problem,” in *Proceedings of the Institution of Electrical Engineers*, vol. 115, no. 10. IET, 1968, pp. 1459–1470.
- [2] University of Washington Department of Electrical Engineering. (2010) Power systems test case archive. [Online]. Available: <http://www.ee.washington.edu/research/pstca/>
- [3] IEEEExplore Database. [Online]. Available: <http://ieeexplore.ieee.org>
- [4] I.-S. Ilie, I. Hernando-Gil, A. Collin, J. Acosta, and S. Djokic, “Reliability performance assessment in smart grids with demand-side management,” in *ISGT Europe, 2011 2nd IEEE PES International Conference and Exhibition on*, 2011, pp. 1–7.
- [5] H. Saadat, Ed., *Power System Analysis*, 3rd ed. McGraw-Hill, 2010.
- [6] J. J. Grainger and W. D. Stevenson, *Power system analysis*. McGraw-Hill New York, 2003, vol. 621.
- [7] Siemens Energy, “Power System Simulator for Engineering,” <http://www.ptius.com/pti/software/psse/index.cfm>, 2012.
- [8] MathWork, SimPowerSystems Toolbox, Matlab/Simulink, [Online]. Available: <http://uk.mathworks.com/products/simpower/>.
- [9] PowerWorld, PowerWorld Simulator Overview, [Online]. Available: <http://www.powerworld.com/products/simulator/overview>
- [10] I. Hernando-Gil, B. Hayes, A. Collin, and S. Djokic, “Distribution network equivalents for reliability analysis (Parts 1&2),” in *ISGT Europe, 2013 4th IEEE/PES International Conference and Exhibition on*, 2013, pp. 1–5.
- [11] I. Hernando-Gil, I. Ilie, and S. Djokic, “Reliability performance of smart grids with demand-side management and distributed generation/storage technologies,” in *ISGT Europe, 2012 3rd IEEE PES International Conference and Exhibition on*, 2012, pp. 1–8.
- [12] J. Ribeiro and F. Lange, “A new aggregation method for determining composite load characteristics,” *Power Apparatus and Systems, IEEE Transactions on*, no. 8, pp. 2869–2875, 1982.
- [13] A. Collin, I. Hernando-Gil, J. Acosta, and S. Djokic, “An 11 kV steady state residential aggregate load model (Parts 1&2),” in *PowerTech, 2011 IEEE Trondheim*, 2011, pp. 1–8.
- [14] UKERC. (1997) Electricity user load profiles by profile class. Electricity Association (supplied by Elexon Ltd). [Online]. Available: <http://data.ukedc.rl.ac.uk/browse/edc/Electricity/LoadProfile/doc/MetaDataLoadProfileClass.html>
- [15] D. McQueen, M. Mcqueen, P. Hyland, and S. Watson, “Simulation of power quality in residential electricity networks,” in *Power Quality*.
- [16] Department of Energy and Climate Change. (2011) Sub-national electricity consumption data, regional and local authority electricity consumption statistics: 2005-2010. [Online]. Available: <https://www.gov.uk/government/collections/sub-national-electricity-consumption-data>
- [17] Department of Energy and Climate Change, “Sub-national electricity consumption statistics for 2009,” DECC, Special feature, December 2010.
- [18] I. Hernando-Gil, “Energy Efficiency Management and Monitoring Services for the Domestic Sector,” Master’s thesis, Heriot Watt University, September 2009.
- [19] S. Ingram, S. Probert, and K. Jackson, “The impact of small scale embedded generation on the operating parameters of distribution networks,” *PB Power, Department of Trade and Industry (DTI)*, 2003.