



Citation for published version:

Le Blond, SP & Aggarwal, RK 2010, Design of adaptive autoreclosure schemes for 132kV network with high penetration of wind: Part 1 - Real time modeling. in 2010 IEEE PES Transmission and Distribution Conference and Exposition: Smart Solutions for a Changing World. IEEE, 2010 IEEE PES Transmission and Distribution Conference and Exposition: Smart Solutions for a Changing World, April 19, 2010 - April 22, 2010, New Orleans, LA, USA United States, 1/04/10. <https://doi.org/10.1109/TDC.2010.5484727>

DOI:

[10.1109/TDC.2010.5484727](https://doi.org/10.1109/TDC.2010.5484727)

Publication date:

2010

Document Version

Early version, also known as pre-print

[Link to publication](#)

University of Bath

General rights

Copyright and moral rights for the publications made accessible in the public portal are retained by the authors and/or other copyright owners and it is a condition of accessing publications that users recognise and abide by the legal requirements associated with these rights.

Take down policy

If you believe that this document breaches copyright please contact us providing details, and we will remove access to the work immediately and investigate your claim.

Design of adaptive autoreclosure schemes for 132kV network with high penetration of wind: Part 1 – Real time modelling

S. P. Le Blond, *Student Member, IEEE*, and R. K. Aggarwal, *Fellow, IEEE*

Abstract-- This paper is the first of a series of publications detailing the development an AI-based adaptive autoreclosing algorithm. In part 1, a detailed model of the Scottish 132kV Network has been constructed on a real time digital simulator. The system model is discussed, including the network topology, line and source modelling and the DFIG-based wind farm model. An initial investigation on penetration of harmonics from local wind farms is conducted using short circuit faults on two transmission lines in the network. This is necessary to ascertain to what extent wind farms may interfere with the adaptive autoreclosing scheme. As well as validating the model, the results suggest that penetration of harmonics is only significant on lines adjacent to the wind farms.

Index Terms--Power system protection, real time systems, power system simulation, power system transients, power transmission lines, reclosing devices

I. NOMENCLATURE

TBP = Transient based protection

OHL = Overhead Transmission Line

SPG = Single Phase to Ground Fault

VSC = Voltage Source Converter

PWM = Pulse Width Modulation

AI = Artificial Intelligence

AA = Adaptive Autoreclose

DFIG = Doubly Fed Induction Generator

Z' = Sub-transient impedance

$P_{s.c.c.}$ = Short Circuit Power

V_{l-l} = Line to line voltage

I_{peak} = Bus three-phase peak current

G = Stationary arc conductance

τ = Arc time constant

g = Time dependant arc conductance

II. INTRODUCTION

Power system protection and control is an area to which the smart grid revolution brings opportunities and challenges in equal measure. In the UK in particular, an integral part of the short to mid term strategy for implementing a low carbon generation mix is a significant increase in wind generation. Latest government targets are 30% renewables in the generation mix by 2020 [1]. Recent advances in generation and power conversion have increased the scalability of wind power. Consequently wind farms will form some of the primary generators, along with many more embedded units connected at distribution level. From a technical perspective, the consequences of this for the UK system are two fold. The network operator must carefully consider the effect of high penetration of intermittent wind on maintaining the system, particularly stability, frequency response, power quality and voltage control. Larger farms may also have an impact on the correct operation of protection and control equipment. Increasing demand and the greater distance between generation and major load centres, will lead to a concomitant decrease in transient stability margins as greater power is pushed through the networks. From a protection standpoint, this demands a shorter critical clearing time, the time in which circuit breakers must operate in order to maintain system stability.

In recent years, the academic community has extensively investigated transient based protection (TBP) [2]. TBP uses the high frequency information, above the power frequency, within the transient fault signature to effect a relay decision. The advantages of such techniques are faster fault clearance times, immunity to electromechanical oscillations, power swings and sub-synchronous resonance associated with reactive power compensation equipment. Since more information is contained in the wideband signal, transient based relays are less vulnerable to mal-operation caused by power system phenomena occurring at any localised frequency. In future, these techniques may be deployed in parallel with conventional power frequency based relays to increase selectivity, security and dependability.

Despite potential advantages, the uptake of TBP among manufacturers is slow. Power systems are safety critical so utilities are naturally reluctant to install novel relays over

S. P. Le Blond and R. K. Aggarwal are with the Centre for Sustainable Power Distribution, Department of Electronic Electrical Engineering at University of Bath, Bath, UK BA2 7AY (email s.p.le.blond@bath.ac.uk)

proven techniques, and thus manufacturers have less incentive to develop and support them. Moreover, a significant technical barrier is the need to consider the unique transient response of each item of primary equipment.

Typically, novel unit-protection, including TBP, is developed using a much simplified power system model, with the component in between two bus bars, terminated in sources behind a subtransient impedance (see Fig. 1). However, when developing TBP, it is also important to model equipment outside the protected zone in order to be confident that it has no adverse effect on its performance.

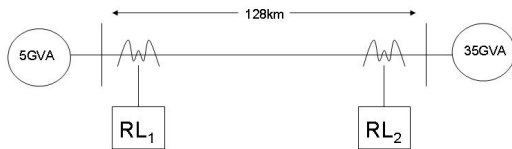

Fig. 1. A typical power system for investigating transient based OHL line relays.

Broadly speaking, the intended use of the test network described here is to develop a more realistic testing ground for TBP. The real world system will be used to evaluate the feasibility of TBP, and the effect of various power system components on TBP, including variable speed wind turbines.

This series of papers is concerned with the development of adaptive autoreclosing (AA) techniques. This is where the transient signature is used to diagnose the extinguishing of the secondary arc and thus the safe reclose times for temporary faults. Furthermore, reclosing is blocked for permanent faults minimising secondary shocks due to failed reclose attempts and leading to increased equipment lifetime. Since the signature associated with a dynamic arc resistance manifests itself at high frequencies this technique must be based on transients. The method developed will be building on those presented in [3]. This model will therefore initially be used to develop and demonstrate a transient based AA relay in real time.

III. REAL TIME DIGITAL SIMULATION

The real time digital simulator (RTDS) is a proprietary product of RTDS Technologies. It uses parallel processing techniques on rack-mounted processors to maintain continuous real time digital simulation of a power system of arbitrary complexity. The computation techniques are based on those developed by H.W. Dommel and used in the well-known EMTP software [3]. The advantage of real time operation means that the power system operates in its own closed loop. The user may interact with the simulation in real time observing the effect of control actions.

The power system is drafted offline in a CAD-based program, 'RSCAD', and then uploaded to the RTDS hardware in real time via RSCAD's runtime module. Here

fault condition(s) can be applied and the long-term power system response can be analysed and observed. If necessary, the user can interact with the simulation in real time via various control actions. These features combine to make a highly realistic simulation of a power system. The simulation time step is typically between 50-60 μ s, meaning that for real time operation, the RTDS must be capable of solving system conditions in under that time *for every successive time step*. RTDS Technologies state frequencies of up to 3kHz can be reproduced with confidence [4].

III. NETWORK MODEL - 132KV PRIMARY SYSTEM

The modelled network forms part of the 132kV network in the Scottish Highlands. Currently, this network is owned and maintained by SHETL, part of the Scottish and Southern group, and operated by National Grid, the UK system operator.

The network comprises of eight 132kV bus bars in a ring topology as shown in Fig. 2. The northern branch of the network runs 90km from Beauly to Keith, supplying the load centres of Inverness, Nairn and Elgin. To the south, a 50 km branch supplies a load at Boat of Garten collecting power on route from the Farr wind farm. Another 50km branch runs from Boat of Garten to Keith via Paul's Hill wind farm, covering an area of approximately 1300km². Although in the UK, 132kV is considered subtransmission, here the network forms the transmission system since there is no higher local voltage network installed.

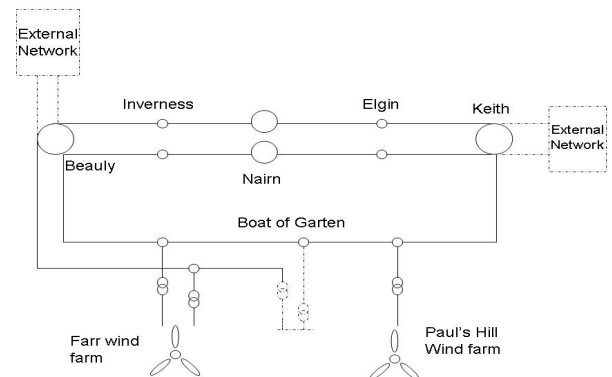

Fig. 2. Section of Scottish system under study, dashed components are omitted from the simulation.

The area is ideally suited for the study since it includes two wind farms, provides an area large enough for extensive real world studies, yet small enough to implement a real time transient model with the processing power available. In addition, an important constraint on travelling wave models is that the travel time must be longer than the simulation time step. In this network all the lines are longer than 15km, (a distance limitation imposed by RTDS's 50 μ s time step) so they may be represented using travelling wave models. Since the entire network is at 132kV, extensive transformer

modelling is not necessary, freeing up valuable processing power.

A) Source Modelling

The grid infeed points at Beauly and Keith are represented using the RTDS source model behind an equivalent subtransient impedance. These are based on the short circuit values for the three-phase peak current at each bus bar, taken from National Grid's seven year statement [5]. The subtransient impedance is calculated using (1) and (2)

$$P_{s.c.c.} = (\sqrt{3}V_{l-l})I_{peak} \quad (1)$$

$$Z' = \frac{P_{s.c.c.}}{I_{peak}^2} \quad (2)$$

The X/R ratio is then taken to be 13.5, an average of the values for 132kV quoted in [6]. This then gives the positive sequence impedance and phase angle that may be entered directly into RSCAD's source component. Strictly speaking, the sources should be represented by a dynamic impedance, where the subtransient reactance becomes the transient value and steady state reactance about 0.5 and 2 seconds post-disturbance respectively. This is beyond the scope of the paper due to limited information and computational power. However, since the phenomenon under consideration is mostly in the fast transient range, under 0.5 seconds, this approximation is reasonable.

B) Line Modelling

132kV overhead lines in this part of the network are predominantly of the double circuit tower type, typical of the UK system. The exception is the line connecting Keith to Boat of Garten, which is a single circuit. The conductor is the *Lynx* type with a single conductor per phase on all lines. The lines are not long enough to require transposition so the RTDS model was set to reflect this. All the line configurations can be found in appendix A.

The RSCAD-line modelling program allows RLC-type data entry. The information associated with each circuit is public domain and can be found in [5]. However, for the greatest accuracy and transient frequency response RSCAD requires physical data associated with the lines, including conductor configuration. The line data for the network can be found in appendix B, and is reproduced with permission of Scottish and Southern Energy.

The RTDS line models are distributed-parameter and frequency dependent, based on travelling wave theory. The line parameters are represented using hyperbolic functions in the frequency domain and then transferred to the time domain using convolution and the inverse Fourier transform. For

simplicity, the assumption is made that the transformation matrix is frequency independent when this is not the case in reality. This does introduce some degree of error at DC and low frequencies, as the transformation frequency is generally chosen to be higher than the power frequency. However, the study is not concerned with sub-synchronous frequencies at this stage so this limitation should not be too onerous. For the double circuit lines a six conductor model is used which is able to determine inter-circuit coupling as well as inter phase coupling. A detailed discussion of travelling wave theory and its application for RTDS models can be found in [4].

C) Loads and Power flow

Loads are assumed to be purely inductive, and are modelled using a passive shunt inductance and a resistance connected at the relevant bus bar. The real and reactive loads were aggregated, based on the data in National Grid's estimated peak power flow for winter 2009 [5]. The true dynamic nature of loads was neglected since they are not critical, either at this voltage level or over the short timescales under investigation.

In RSCAD, initial conditions must be specified for the network sources and the generators within the network. These then settle down to a steady state after the simulation begins real time operation. Initial conditions were based on the peak power flow for winter 2009 published in National Grid's seven year statement [5].

D) Wind Farm Model

The Farr wind farm is located approximately ten miles south of Inverness. It consists of 40 Bonus/Siemens 2.3MW wind turbines, to give a total installed capacity of 92MW. Paul's Hill wind farm lies 23km southwest of Elgin and with 28 x 2.3MW turbines of the same manufacturer and model. The generators in the turbines are of the modern variable-speed DFIG type. The DFIG (doubly fed induction generator) is an induction generator where partial power conversion is handled by back-to-back converter.

The induction generator's rotor is connected to a partial frequency converter via slip rings, which in turn is coupled to the grid through a three-winding transformer. The stator of the generator is connected directly to the grid as shown in Fig 3. The power electronic converter makes up for the shortfall or excess speed difference (and thus the difference in the turbine's mechanical frequency and the grid's electrical frequency) by injecting the appropriate variable current into the rotor. In the over-synchronous case, power flows from the rotor to the converter to the grid, and in the sub-synchronous case it flows in the opposite direction. However, in either case, net power flow is onto the grid via the stator. This mechanism enables the turbine to operate at a wide range of speeds, typically up to +30% and -40% of synchronous speed.

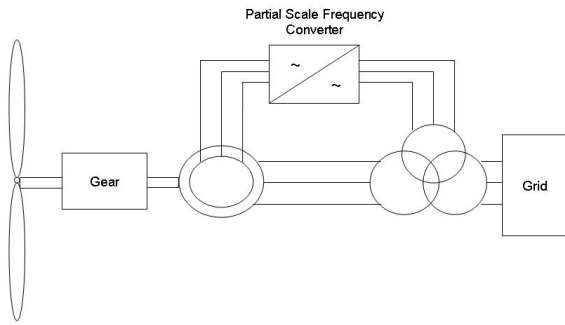

Fig. 3. Basic diagram of DFIG turbine.

The back-to-back converter allows two-way power flow, consisting of a rectifier and an inverter whose thyristors are Pulse Width Modulated. Fast discrete switching of the thyristors, controlled by modulating the width of signal pulse approximates a DC input signal to a sinusoid and vice versa. The basic premise is that power is taken at one AC frequency, converted to DC and then converted back to AC at the required grid frequency. The capacitor across the DC link allows control of the rectifier and inverter to be decoupled. This means more complex control of the thyristors can be introduced to suit the requirements both at the grid side (i.e. reduce power fluctuations and control voltage) and at the generator side (appropriate excitation currents can be established along with the desired rotor speed). It is the fast switching of the semiconductor thyristors that introduces harmonics onto the grid [7].

Unfortunately, transient models of the particular turbine design are not available since they are proprietary to the manufacturer. However, a generic model of a DFIG wind turbine has been developed by RTDS Technologies. A more in-depth explanation of the model can be found in [8]. Briefly, the wind farm includes a mechanical model of the turbine, whose input wind speed, pitch and thus mechanical torque can be adjusted in real time. The switching of the thyristors for both the grid side and the rotor side is decoupled and governed by two separate vector control schemes. This means that on the grid side, frequency can be maintained and real and reactive power can be independently controlled. On the rotor side, maximum energy capture over a wide range of wind speeds is achieved. The model of the partial power converter uses the small time step (below $2\mu\text{s}$) VSC component of the RTDS. An interface transformer converts signals from the small time step module to the main power system time step. This is necessary for the fast switching resolution of the PWM voltage source converters. A discussion of how this is achieved in real time, and the interfacing with the main power system can be found in [9] and [4]. Ideally, the wind farm would be modelled using the full number of turbines but this would require considerable processing power. Therefore, a single turbine model has been scaled up to represent the installed capacity of the entire wind farm. It should be noted that for the harmonic study in section

4, the windfarms were represented by ideal harmonic sources, with the intention to use this model in later publications.

IV. NETWORK MODEL – SECONDARY SYSTEM AND MISCELLANEOUS

A) Transducer Modelling

An important aspect of designing transient based protection schemes is including the transient response of the instrument transducers. The RTDS includes models for a capacitive voltage transformer (CVT) for measuring primary system voltages, and a Current Transformer (CT) for system currents. Modelling the transient response of transformers is necessary since some conditions may initiate ferroresonance and inrush phenomena that may confuse or compromise relay functionality. A detailed discussion and an investigation into the effect of these models will be reported in part two of this paper.

B) Arc Modelling

In adaptive autoreclosing schemes it is necessary to determine whether a fault is transient or permanent. Transient faults exhibit arcing behaviour, with high frequency signatures due to a dynamic resistance. In the design of the scheme it is necessary to simulate the arc and its interaction with the power system, so that the logic may respond appropriately to an arcing fault or a permanent fault.

The arcing behaviour can be described by the primary and secondary stages. The primary arc is in the period before the circuit breakers open and is due to the fault current flowing from the energised phase to ground. The lower current secondary arc is sustained by the mutual coupling between the faulted and healthy phases, and only present when one or more of the phases remain energised. The behaviour of both arcs are governed by time varying conductance, and can be described by (3) the dynamic equation for unconstrained arcs in air.

$$\frac{dg}{dt} = \frac{1}{\tau}(G - g) \quad (3)$$

Where G is the Stationary arc conductance, g is the time dependent arc conductance and τ is the time constant. The secondary arc is more complex because it has a varying arc length, on which the time constant depends, and a number of successive partial re-strikes. Arcing signatures also may be significant as a result of the action of the circuit breakers. Since the RTDS circuit breaker model operates at a current zero crossing it is assumed that no arcing takes place. Arc models and their implementation into the network model will be discussed in detail in part two of this paper [10].

V. HARMONIC PENETRATION STUDY

A suitable starting point for the study is to determine the extent to which harmonics generated by the wind farms penetrate onto the local grid. This is important for adaptive autoreclosing since harmonics may mimic high frequency information associated with the arcing fault, leading to a permanent fault being misdiagnosed as transient. A wind farm must comply to operating constraints imposed by the utility, known collectively as the *grid code*. An important aspect of this is ensuring a certain degree of power quality. The UK grid code demands all generators to be compliant to Engineering Recommendation G5/4 [11], which in turn is based on the international standard IEC61000. This governs the levels of harmonic distortion permissible, up to and including the 50th harmonic. ER G5/4 recommends the following planning levels for Harmonic voltages in systems between 20kV and 145kV [11].

TABLE 1
G 5/4 RECOMMENDATIONS FOR THE FIRST 9 HARMONICS ON SYSTEMS
BETWEEN 20KV AND 145KV

Harmonic Number (h)	Harmonic Voltage %	Harmonic Number (h)	Harmonic Voltage %
2	1	6	0.5
3	2	7	2
4	0.8	8	0.4
5	2	9	1

In practice, wind farms have filters to suppress the level of harmonic distortion and the operational levels should be well below the planned levels. However, as a worst case scenario, harmonic emissions should not exceed those stated in G5/4. The harmonic source component in RSCAD allows up to four harmonics superimposed on the fundamental AC sinusoidal source. The magnitudes of the harmonics are expressed as a percentage of the fundamental. In order to assess the worse case scenario, harmonic emissions equivalent to G5/4 levels were used to represent both wind farms. (The DFIG wind farm model discussed earlier will be used for subsequent investigations). It has been observed with PWM back to back converters, the 5th and 7th harmonics are most significant occurring at 250Hz and 350Hz respectively [12]. The four harmonics were chosen to be the 3rd, 5th, 7th and 9th with respective harmonic voltage levels of 2%, 2%, 2% and 1%, as per G5/4.

A) Simulation Setup

As mentioned before, of particular interest to the authors are transient based adaptive autoreclosing schemes. During a single phase to ground fault, the current and voltage waveforms were measured at the OHL terminating bus bars in front of the breakers, since this is where the transducers will be based in practice.

Short circuit studies were conducted on the Beauly/Farr line, defined as “adjacent” and the Nairn/Elgin line defined as “distant”. These lines were chosen since the former was adjacent to the wind generation, whereas the latter is the most distant. Also the lines are of a similar length, both suitable for phase domain travelling wave models on the RTDS. For each line, an equivalent control case was conducted for comparison. In the control cases the wind farms were represented by sources without harmonics.

For each case, a single phase to ground fault was initiated at the mid point of the line and the corresponding phase circuit breakers subsequently tripped at either end of the line simultaneously. The fault path resistance to ground was assumed to be 2 ohms. Adaptive autoreclosure schemes make use of frequency domain information. There is greater frequency domain information when single pole tripping is used over three phase tripping due to mutual inductive and capacitive coupling between the faulted and healthy phases. Although three-phase tripping is used extensively on the UK system, the circuit breakers were set to trip a single phase for the purposes of this investigation. (However, Adaptive autoreclosing for three phase circuitbreakers may be possible on UK type double circuit lines by using the signature arising from inter-circuit coupling. This technique will be investigated in a subsequent paper).

B) Simulation Results

The time domain graphs all show a partial voltage collapse and large over-currents caused by the single phase to ground fault. The circuit breaker responded between one and three cycles later and causes a total voltage and current collapse. Following the breaker operation the voltage attenuated over a short period as the isolated trapped charge is reflected up and down the line. The frequency spectra were obtained using MATLAB’s inbuilt FFT routine.

It should be noted that the circuit breaker response varies from one to three cycles, due to the breaker logic requiring a coincidence of a voltage zero followed by a current zero. However, since the frequency domain information is of interest, the inconsistent response time of the circuit breaker does not significantly affect the results.

The study showed that there was significant penetration of harmonics onto the adjacent lines. This can be seen in Fig. 4, which shows the frequency spectrum for the healthy phase

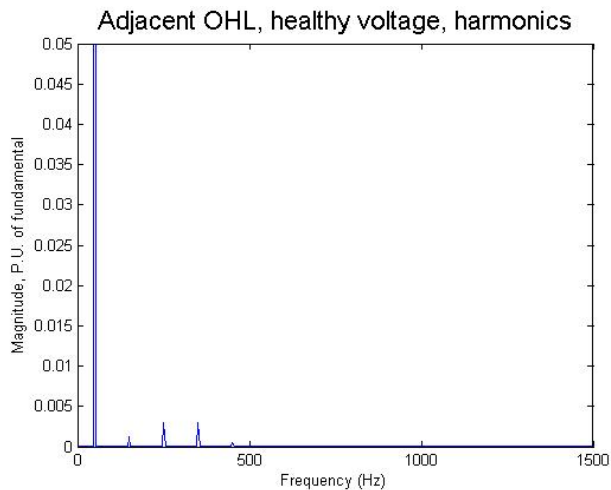

Fig. 4. Voltage frequency spectra, healthy phase, adjacent line with harmonics.

voltage for the sending end bus bar. This can be directly compared to the control case shown in Fig. 5 that did not have harmonic sources at Farr and Paul's Hill wind farms.

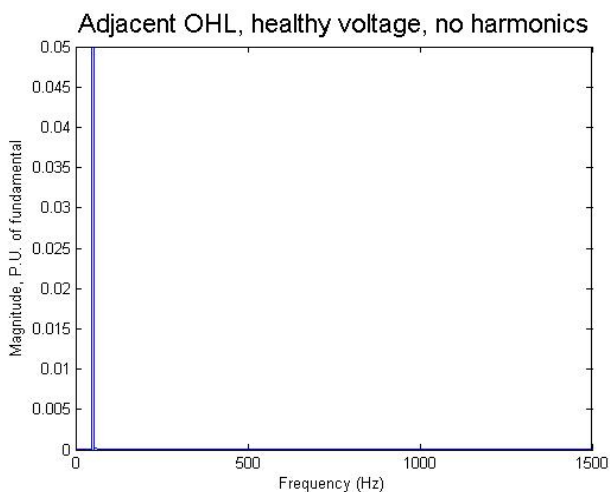

Fig. 5. Voltage frequency spectra, healthy phase, adjacent line without harmonics

In the case of the adjacent line, there is significant generation nearby, and so the transients were suppressed due to the local strength of the grid. This can be seen in Fig. 6 and Fig. 7, which show the voltage time domain for the sending end with harmonics and the control case respectively. The effect of mutual coupling in the healthy phases was particularly suppressed: see Fig. 5, Fig 6 and Fig 7.

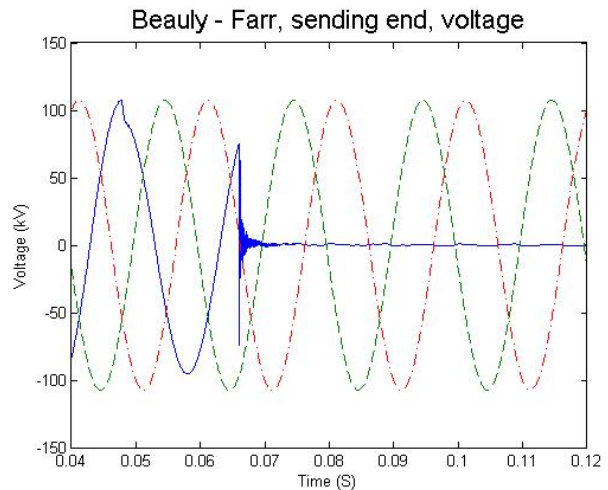

Fig. 6. Time domain voltage, all phases, adjacent line with harmonics.

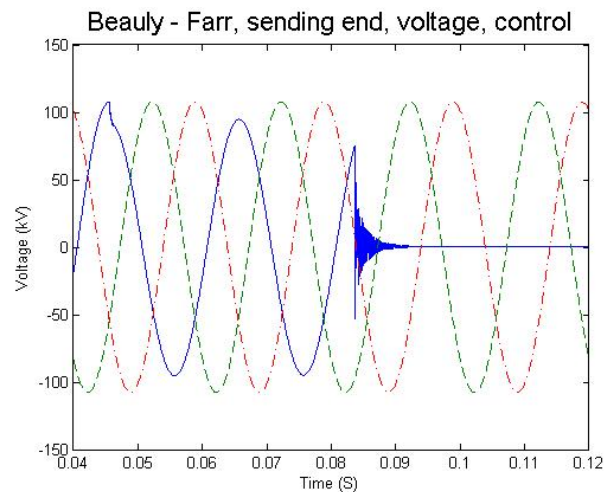

Fig. 7. Time domain of voltage, all phases, adjacent line without harmonics.

In comparison, the distant line has significant mutual coupling between the healthy and faulted phases on the voltage waveforms. This can be observed in Fig. 8, which shows the frequency spectrum for one of the healthy phases *without* harmonic sources.

Due to this pronounced mutual coupling, it cannot be determined to what extent the harmonics penetrate onto the voltage signals at this location on the grid. This is so because the coupling swamps the frequency spectrum on the distant line. The magnitude of the coupling here is even greater than the harmonics on the adjacent line. Comparison can be made between Fig 4 and Fig 8. In other words, if coupling to this extent was present on the adjacent line, the harmonics would not be clearly observed even though this line is electrically nearer the wind farms.

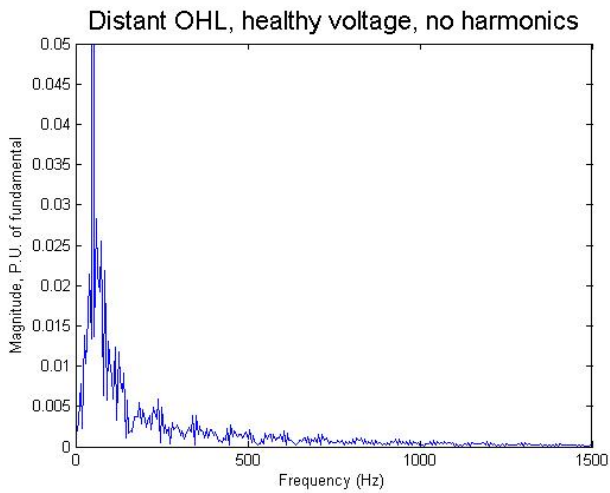

Fig. 8. Voltage frequency spectra, healthy phase, distant line without harmonics

However, the current signals and corresponding spectra of the distant line (Fig. 9 and Fig. 10) suggest that wind farm harmonics do not significantly penetrate this far. This can be concluded when these plots are compared to healthy phase current frequency spectra on the adjacent line with harmonics, shown in Fig. 11. Incidentally, since the absolute current on the healthy phases was much smaller in comparison, there is very significant harmonic component in proportion to the fundamental. The reduced current is due to much less real power transfer on both circuits between Farr and Beaulieu than on those between Elgin and Nairn.

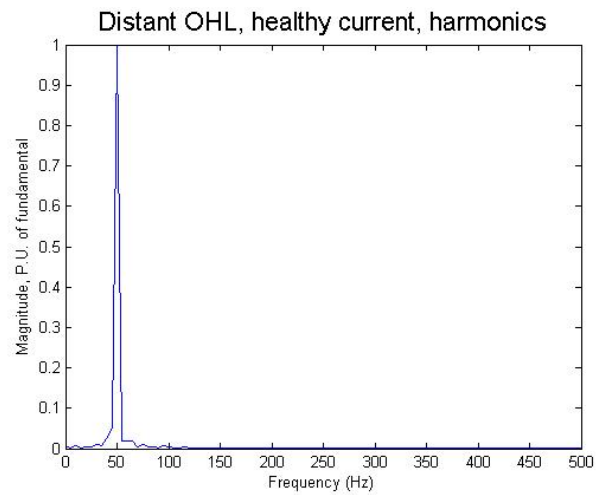

Fig. 10. Current frequency spectra, healthy phase, distant line with harmonics

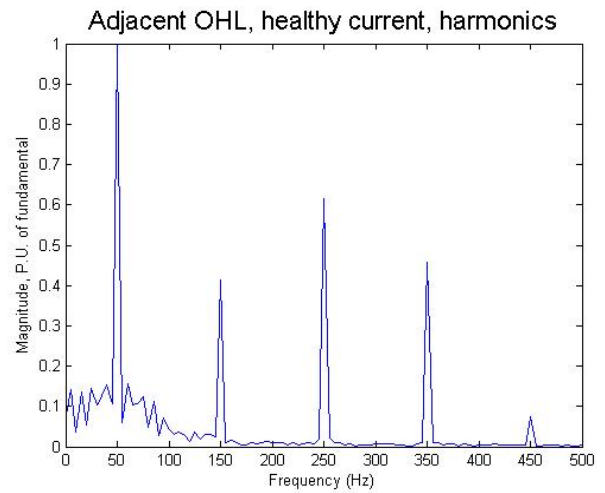

Fig. 11. Current frequency spectra, healthy phase, adjacent line with harmonics

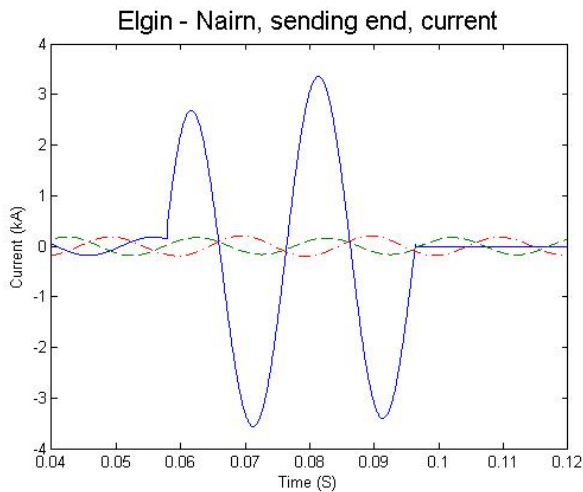

Fig. 9. Time domain of currents, all phases, distant line without harmonics

C) Discussion

Typical AA schemes rely on diagnosing the extinguishing of the secondary arc using a combination of signal processing and AI, such as neural networks or fuzzy logic [3]. The time series information is transferred into the frequency domain, and different bandwidths form the inputs to an AI inference system. The AI is able to discern non-linearity between the input and output data and able to generalize in the presence of unknown fault cases.

The harmonic study shows the power system topology is more important than the presence of harmonics, particularly on the distant line. Since AA schemes using AI can overcome varying primary system parameters, this suggests they will be robust in the presence of wind farm harmonics. However, on nearby lines it would be prudent to include harmonics signatures in the calibration of adaptive aurtoreclosing relays.

For example in the case where neural networks are trained with fault cases [3], including harmonic emissions in training fault data would lead to improved response in the AA relay.

VIII. CONCLUSION

This paper presents a modelled section of 132kV Scottish network, built for developing TBP and in particular adaptive autoreclosing. The section of network was chosen since it represents a real world example with high penetration of wind generation. The power system model has been implemented on the RTDS, demonstrating that it is capable of stable, sustained real time operation. Some preliminary results are presented investigating the penetration of harmonics onto the local grid. The results suggest that in the worst case scenario, in this system, harmonics are only significant on adjacent lines. The study suggests primary system parameters such as real power flow and the local level of generation are more significant in determining the normalised frequency spectra of the current and voltage waveforms, on which AA relays would be based.

IX. APPENDIX A: CONDUCTOR CONSTANTS

Lynx conductor

DC resistance per sub-conductor.....0.156489ohms/km
 Sub-conductor radius:.....0.976cm
 Number of sub-conductors:1

Lynx ground wire

DC resistance.....0.1469 ohms/km
 Radius.....0.976cm

X. APPENDIX B: TOWER CONFIGURATIONS

All measurements are in metres. The horizontal displacement of the second circuit is assumed to be symmetrical about the vertical axis of the tower.

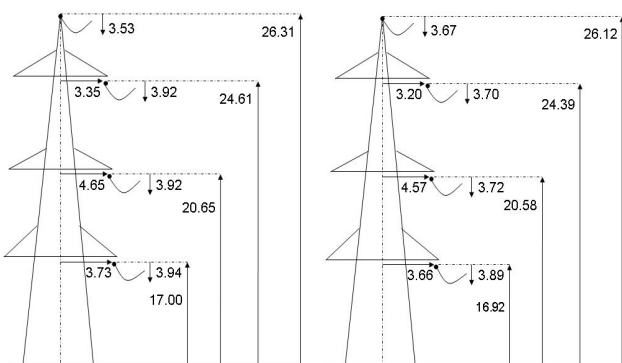

Fig. 12a. Double circuit towers, from left to right: Beaulay to Boat of Garten OHL and Beaulay to Keith via Nairn OHL, geometric configuration, showing horizontal and vertical placement, conductor positioning and conductor sag at mid span.

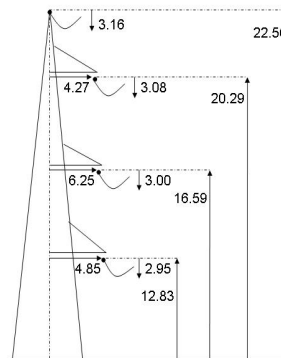

Fig. 12b. Single circuit tower, Boat of Garten to Keith OHL geometric configuration, showing horizontal and vertical placement, conductor positioning and conductor sag at mid span

XI. ACKNOWLEDGEMENTS

The authors would like to thank all the contributors to the Flexnet research consortium. Flexnet is an EPSRC led Supergen consortium: see www.supergen-networks.org.uk. The authors would also like to thank Scottish and Southern Energy, National Grid and RWE npower.

XII. REFERENCES

- [1] BERR: Department for business enterprise and reform. (2008, 10/11/2008). [Online] Available: <http://www.berr.gov.uk/whatwedo/energy/sources/renewables>
- [2] Z. Q. Bo, F. Jiang, Z. Chen, X. Z. Dong, G. Weller, M. A. Redfern "Transient Based Protection for power transmission systems," in *proc 2000 IEEE Power Engineering Society Winter Meeting - Vols 1-4*, pp. 1832-1837
- [3] D. S. Fitton, R. W. Dunn, R. K. Aggarwal, and A. T. Johns, 1996 "Design and implementation of an adaptive single pole autoreclosure technique for transmission lines using artificial neural networks," *IEEE Transactions on Power Delivery*, vol. 11, pp. 748-756
- [4] H. W. Dommel, *Electromagnetic Transients Program Reference Manual (EMTP Theory Book)* Portland Bonneville Power Administration, 1986.
- [5] RTDS Technologies, *Real Time Digital Simulator Power System Users Manual*, Winnipeg, Canada, 2006.
- [6] National Grid plc, (2008 May), National Grid GB Seven Year Statement. National Grid House, Warrick, UK, [Online] Available: http://www.nationalgrid.com/uk/sys_08/
- [7] B. M. Weedy and B. J. Cory, *Electric power systems*, 4th ed., Chichester (West Sussex, England): Wiley, 1998, p.293.
- [8] T. Ackermann, *Wind power in power systems*, Chichester (West Sussex, England); Hoboken (NJ): Wiley, 2005 p.74.
- [9] R. Pena, J.C. Clare, G.M. Asher, "Doubly fed induction generator using back-to-back PWM converters and its application to variable-speed wind-energy generation," *IEEE Proc. 1996 Electric Power Applications*, vol. 143, pp. 231-241,
- [10] T. Maguire and J. Giesbrecht, "Small Time-step (<2 microseconds) VSC Model for the Real Time Digital Simulator," presented at the Int. Conf. on Power Systems Transients, Montreal, Canada, 2005.
- [11] A. T. Johns, R. K. Aggarwal, Y.H. Song, "Improved techniques for modelling fault arcs on faulted EHV transmission systems," *IEE Pro. Generation, Transmission and Distribution*, vol. 141, p. 6, 1994.
- [12] Electricity Association (2001), *Planning levels for harmonic voltage distortion and the connection of non-linear equipment to transmission systems and distribution networks in the United Kingdom*.
- [13] G. Hensman, "Connecting nonlinear loads to public electricity systems - a guide to Engineering Recommendation G5/4," *Power Engineering Journal*, vol. 16, pp. 77-87, 2002.