

Quantized Peak Based Impulsive Noise Blanking in Powerline Communications

Khaled M. Rabie and Emad Alsusa

Microwave and Communication Systems (MACS) Group,
School of Electrical and Electronic Engineering,
The University of Manchester, United Kingdom, M13 9PL,
Email: {khaled.rabie, e.alsusa}@manchester.ac.uk

Abstract—Many IN mitigation techniques have been proposed to mitigate impulsive noise (IN) over powerlines, the most common of which is the blanking technique. The conventional way to implement this technique however requires prior knowledge about the IN characteristics to identify the optimal blanking threshold (OBT). When such knowledge cannot be obtained the performance deteriorates rapidly. To alleviate this, a look-up table (LUT) based algorithm with uniform quantization is deployed to utilize estimates of the peak to average power ratio at the receiver to determine the OBT. In this paper, we investigate the impact of quantization bits on the system performance as well as the performance loss due to the impact of IN on the side information. Two aspects of the achievable performance are considered namely, output signal-to-noise ratio (SNR) and symbol error rate under various IN scenarios. The results reveal that a 5 bit LUT is sufficient to achieve a gain of up to 3dB SNR improvement relative to the conventional blanking method. Furthermore, it will be shown that the loss due to the practical impact of IN on the side information is insignificant.

Index Terms—Impulsive noise, Middleton class-A model, OFDM, peak to average power ratio (PAPR), powerline communications (PLC), uniform quantization.

I. INTRODUCTION

POWERLINE communications (PLC) technology is becoming a more attractive alternative for inhome networking applications. The main advantage of PLC is the fact that it exploits a pre-installed infrastructure of wiring networks. However, reliable communications over such channels require overcoming many challenges including noise, high levels of frequency-dependent attenuation and multipath propagation [1]. Noise over powerline channels is generally categorized into background noise and impulsive noise (IN); the latter is, however, the major factor responsible for degrading the performance of PLC systems [2]. IN has a short duration with random occurrence rate and a high power spectral density (PSD) which is always 10–15dB higher than the PSD of background noise [3]. In order to evaluate the system performance over IN channels, an accurate noise model is required. The most widely accepted analytical model is the Middleton class-A noise model [4], [5] which will be adopted in our investigations.

Many studies have been carried out on the topic of mitigating IN over powerline channels particularly for multicarrier modulation based systems such as orthogonal frequency division multiplexing (OFDM). To reduce the effect of IN, the OFDM demodulator is preceded with a blanker to zero the incoming signal when it exceeds a certain threshold [6], [7]. This method is widely used in practice because of its simplicity and ease of

implementation. Theoretical performance analysis and optimization of blanking was first investigated by Zhidkov in [8], [9] where closed-form expressions for the signal-to-noise ratio (SNR) at the output of the blanker and the optimal blanking threshold (OBT) were derived. These studies rely on the assumption that the IN characteristics, in the form of signal-to-impulsive noise ratio (SINR) and the IN probability of occurrence, can be made available at the receiver in order to optimally blank the IN. This method is referred to here as the conventional optimal blanking (COB) method. Such assumptions constrain the applicability of this method and can be difficult to accomplish in practice. In [10], it is shown that even for small error estimations of the OBT, the COB method can suffer from significant performance degradation. Furthermore, the authors introduced a different criterion for estimating the OBT independently of the IN parameters by using estimates of the transmitted signals' peak to average power ratio (PAPR); this method was referred to as dynamic peak based threshold estimation (DPTE) method. The DPTE technique not only completely eliminates the need for prior knowledge about the characteristics of IN but can also achieve a considerable gain in the output SNR if the signal peaks can be estimated accurately.

The question that arises here is, however, how can the signal peaks be determined for every single OFDM symbol at the receiver. In this paper, we propose and implement a technique to accomplish this by exploiting a look-up table (LUT) based algorithm with uniform quantization. This technique will be referred to as DPTE-LUT method. The OFDM symbol peaks are quantized and the corresponding bits are transmitted to the receiver as side information. Therefore, the contribution of this paper includes proposing a method for exploiting quantized estimates of the signal peak to estimate the OBT. In addition, the impact of the LUT size on the different implementations of DPTE-LUT technique is investigated in terms of the output SNR and symbol error rate (SER) under various IN conditions. The results reveal that the proposed can provide up to 3dB SNR enhancement relative to the COB method. It is also found that as the LUT size increases, the system performance improves, but more side information will be required at the receiver to identify the symbol peaks. Furthermore, it will be shown that the performance degradation caused by the impact of IN on the side information is insignificant making the proposed system practically feasible.

The rest of this paper is organized as follows. In Section II the system model is described. In Section III the proposed technique

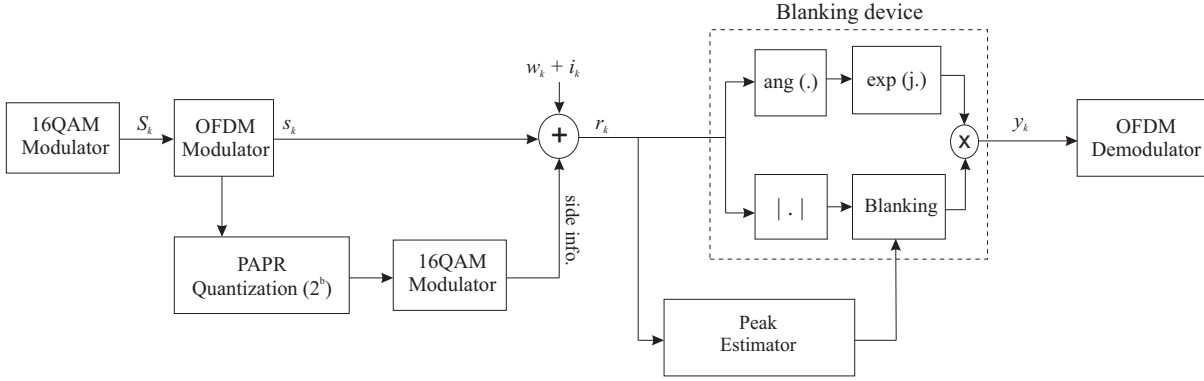

Fig. 1: Block diagram of the proposed DPTE-LUT system

is demonstrated and a detailed discussion on OFDM symbol peak distribution is presented. Simulation results are presented in Section IV. Finally, conclusions are drawn in Section V.

II. SYSTEM MODEL

Fig. 1 shows the basic block diagram of the system under consideration. The information bits are mapped into 16QAM baseband symbols S_k which are then passed through an OFDM modulator to produce a time domain signal

$$s(t) = \frac{1}{\sqrt{N}} \sum_{k=0}^{N-1} S_k e^{\frac{j2\pi kt}{T_s}}, \quad 0 < t < T_s \quad (1)$$

where S_k is the complex constellations of the data symbols, N is number of sub-carriers and T_s is the active symbol interval. The PAPR of the transmitted signal is expressed as

$$\text{PAPR} = \frac{\max |s(t)|^2}{\mathbb{E} [|s(t)|^2]} \quad (2)$$

where $\mathbb{E}[\cdot]$ is the expectation function. It is assumed that the signal power is normalized to unity and hence the PAPR simply indicates the peak value of the signal, i.e. $P = \max |s(t)|$. In this paper we deploy a special case of Middleton class-A noise model in which IN is characterized as a Bernoulli-Gaussian random process [11] and is given by

$$n_k = w_k + i_k \quad (3)$$

where

$$i_k = b_k g_k, \quad k = 0, 1, 2, \dots, N-1 \quad (4)$$

n_k is the total noise component, w_k is the additive white Gaussian noise (AWGN), i_k is the IN, b_k is the Bernoulli process with probability $\Pr(b_k = 1) = p$ and g_k is complex white Gaussian noise with mean zero. The probability density function (PDF) of the total noise n_k can be written as

$$P_{n_k}(n_k) = (1-p)G(n_k, 0, \sigma_w^2) + pG(n_k, 0, \sigma_w^2 + \sigma_i^2) \quad (5)$$

where $G(\cdot)$ is the Gaussian PDF, σ_w^2 and σ_i^2 are the AWGN and IN variances, respectively. Under perfect synchronization condition, the received signal can be expressed as

$$r_k = s_k + w_k + i_k, \quad k = 0, 1, 2, \dots, N-1 \quad (6)$$

$s_k = s(kT_s/N)$; s_k , w_k and i_k are assumed to be mutually independent.

In the COB method, a blanker is applied before the OFDM demodulator and its basic principle is

$$y_k = \begin{cases} r_k, & |r_k| \leq T \\ 0, & |r_k| > T \end{cases} \quad k = 0, 1, \dots, N-1 \quad (7)$$

where T is the blanking threshold, r_k and y_k are the input and output of the blanker, respectively. The blanking threshold must be carefully chosen for optimal performance. In [8], a theoretical expression for the OBT of the COB method was derived as a function of the IN parameters as well as the output SNR. It was shown that these expressions work well when the IN characteristics are accurately known a priori. These expression will be used in this paper to provide a comparative analysis. On the other hand, in the DPTE technique [10], the OBT is obtained independently of IN characteristics. The blanker is applied at the receiver where the peak of each OFDM symbol is determined and adaptive blanking is employed accordingly as illustrated in Fig. 1 where its basic principle is

$$y_k = \begin{cases} r_k, & |r_k| \leq \tilde{P} \\ 0, & |r_k| > \tilde{P} \end{cases} \quad k = 0, 1, \dots, N-1 \quad (8)$$

\tilde{P} is the estimated OFDM symbol peak value which is obtained as presented in the next section.

III. THE PROPOSED METHOD

In this section the proposed method is described. For better realization of this method, it is important to analyze the peaks distribution of the OFDM signal. Therefore, we begin by presenting a bar-chart for the signal peaks distribution in Fig. 2 from which it is noticeable that the vast majority of the symbols have peaks between 2.5 and 3.5. This figure provides useful and insightful information for instance, it can be seen that 99.5% of the symbol peaks, i.e. widow size (WS = 99.5%), are concentrated within the range from 2.1 to 4.3 whereas 99.9% of the peaks lie in the range between 2 and 5. In all our investigations in this paper we consider a WS of 99.9%.

As mentioned earlier, the proposed technique utilizes a LUT, the size of which depends on the required accuracy of the signal peak estimate at the receiver. The symbol peak amplitudes can take on any value on a continuous range following the probabilistic model (9) [12] and therefore must be discretized into a finite number of quantized levels (P_q), where $q = \{1, 2, \dots, N_q\}$,

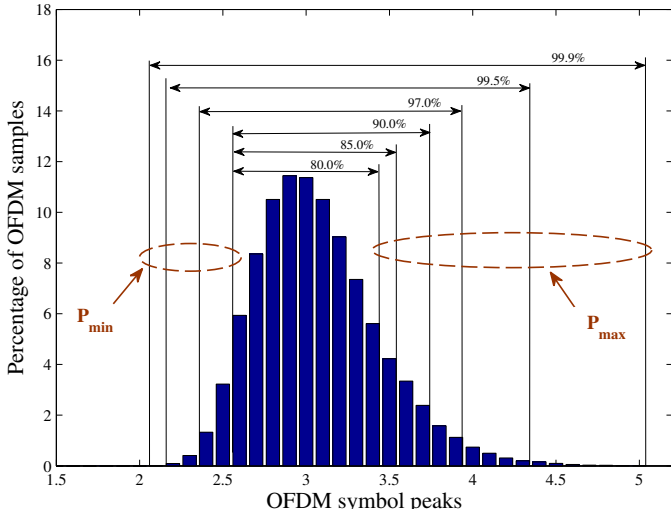

Fig. 2: OFDM symbol peak distribution

ranging from predetermined minimum and maximum values $P_{min} = P_1$ and $P_{max} = P_{N_q}$, respectively, see Fig. 2. N_q depends on the size of the LUT being used ($N_q = 2^b$), where b is the number of bits representing each OFDM symbol peak.

$$CCDF = 1 - \Pr(P \leq P_o) = 1 - (1 - e^{-(P_o)})^N \quad (9)$$

Since the proposed technique exploits uniform quantization the resolution factor (R_F), i.e. the spacing between quantization levels, can be defined as $R_F = (P_{max} - P_{min})/N_q$. The smaller the R_F , the better the precision of the signal peak estimates achieved. It is important to ensure that signal peaks which fall between two quantization levels are assigned to the upper level. This minimizes the possibility that the receiver will not blank the useful signal energy for that specific symbols. However, symbols with peaks larger than P_{max} are mapped into P_{max} and similarly all symbols having peaks below P_{min} will be mapped into P_{min} . The quantized peaks are represented by b bits per OFDM symbol which are transmitted to the receiver as side information. At the receiver, the peak estimator, shown in Fig. 1, will extract the peak value of the associated symbol and adjust the blanking threshold of the of the blanking device accordingly. Fig. 3 shows the exact (P) and quantized (P_q) signal peaks and it is clear that as the LUT size increases, the resolution becomes higher and consequently the quantization error ($e_q = P - P_q$) is minimized. This implies that more accurate estimation of the signal peaks can be obtained at the receiver, hence more accurate blanking threshold is used resulting in more efficient IN suppression.

In this paper three different DPTE scenarios are considered:

- Ideal DPTE: assumes exact signal peaks are determined precisely at the receiver. This establishes the lower bound performance of DPTE method.
- Ideal DPTE-LUT: means that the quantized signal peaks are detected at the receiver error-free, i.e. assuming that the side information is not contaminated with noise.
- Practical DPTE-LUT: this is the case when side information is passed through the PLC channel and experience IN impairments.

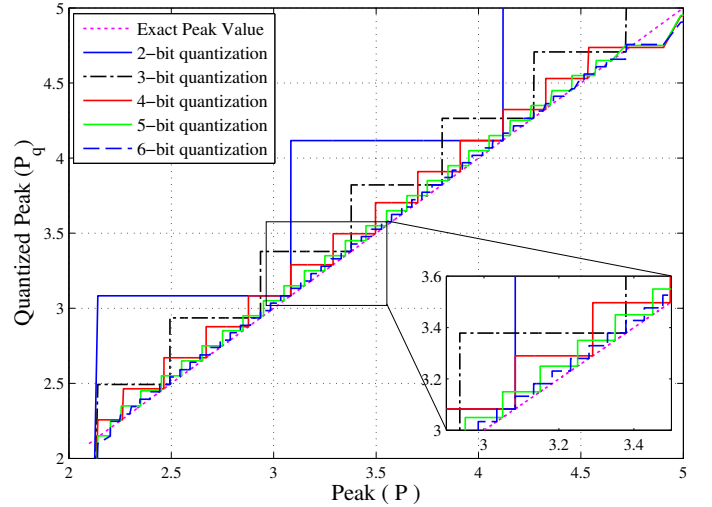

Fig. 3: Uniform quantization of OFDM symbol peaks

IV. SIMULATION RESULTS

In this section we investigate the impact of the LUT size on the two different implementations of the proposed method, the ideal and practical DPTE-LUT techniques, in terms of output SNR and SER under various IN scenarios. Our simulations are based on: OFDM system consisting of $N = 64$ subcarriers with 16QAM modulation, the OFDM signal power is normalized to unity $\sigma_s^2 = (1/2)\mathbb{E}[|s_k|^2] = 1$, $\sigma_w^2 = (1/2)\mathbb{E}[|w_k|^2]$ and $\sigma_i^2 = (1/2)\mathbb{E}[|i_k|^2]$, respectively. The input SNR and SINR are defined by $\text{SNR} = 10\log_{10}(1/\sigma_w^2)$ and $\text{SINR} = 10\log_{10}(1/\sigma_i^2)$. For all the simulation results $\text{SNR} = 40\text{dB}$ and the output SNR is determined by (10). The results for the DPTE-LUT system are obtained for a WS of 99.9% , $P_{min} = 2$ and $P_{max} = 5$, see Fig. 2.

$$\text{SNR}_{DPTE} = \frac{E[|s_k|^2]}{E[|y_k - s_k|^2]} \quad (10)$$

1) *The Ideal DPTE-LUT Technique:* The output SNRs versus SINR for the COB, ideal DPTE and ideal DPTE-LUT techniques are shown in Fig. 4 for LUT sizes $\{b = 2, 3, 4, 5\text{ bits}\}$ and IN probabilities $\{p = 0.001, 0.01, 0.1\}$. The results of the COB method are obtained using equations (5) (26) and (28) derived in [8] under the assumption of perfect IN parameters estimation. As anticipated it can be seen from these results that as the LUT size increases, the performance of the DPTE-LUT scheme becomes closer to that of the ideal DPTE system. It is also evident that for low IN probabilities $\{p = 0.001, 0.01\}$, the proposed technique always outperforms the COB method irrespective of the LUT size. On the other hand, however, for heavily-disturbed IN environment $\{p = 0.1\}$, the importance of LUT size becomes more significant. It is observed that when a LUT size of only 2 bits is used, the proposed scheme slightly under-performs the COB method in the intermediate SINR region ($-5\text{dB} \rightarrow -15\text{dB}$). This clearly states that higher resolution is required when the IN probability of occurrence is relatively high. It is worth pointing out that for all IN scenarios a LUT of size 4 or 5 bits is sufficient to achieve a near-ideal performance. It is also clear that for the ideal DPTE system, a gain of about 3dB and

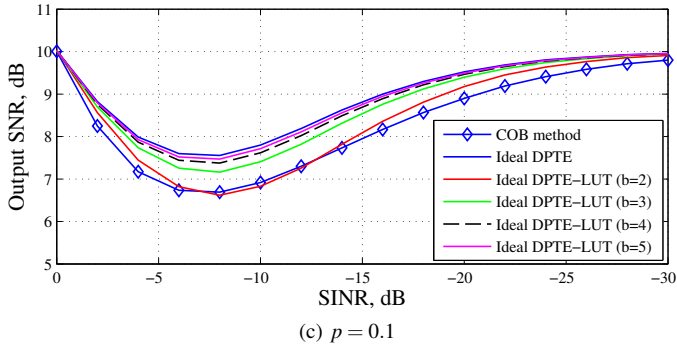
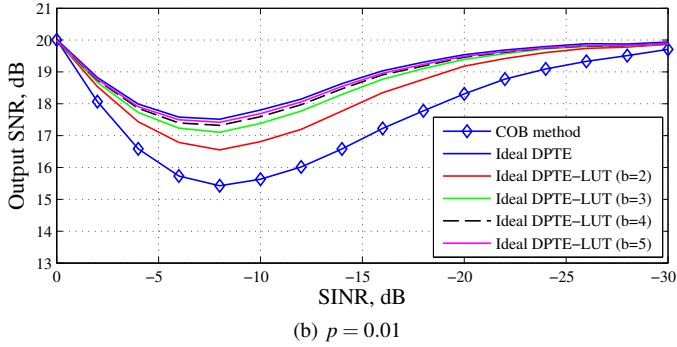
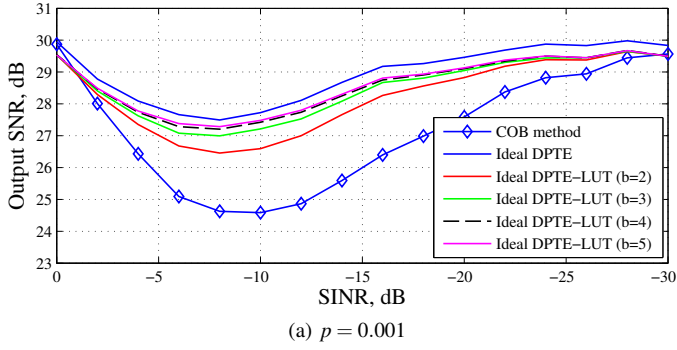

Fig. 4: Output SNR of the COB, ideal DPTE and ideal DPTE-ULT methods versus SINR for various values of p

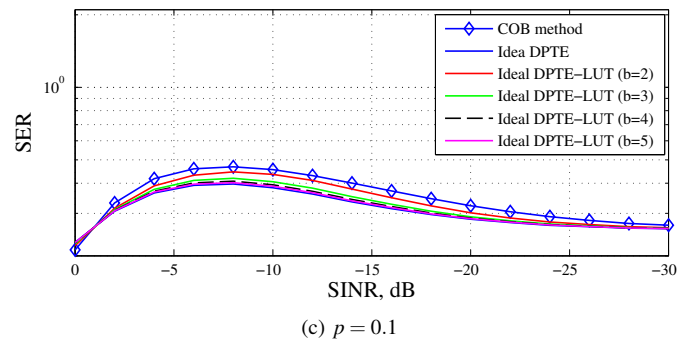
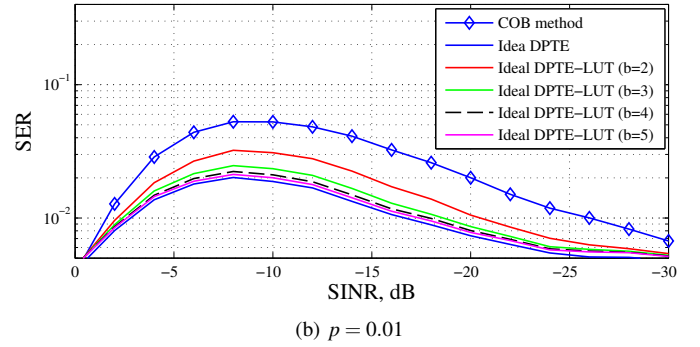
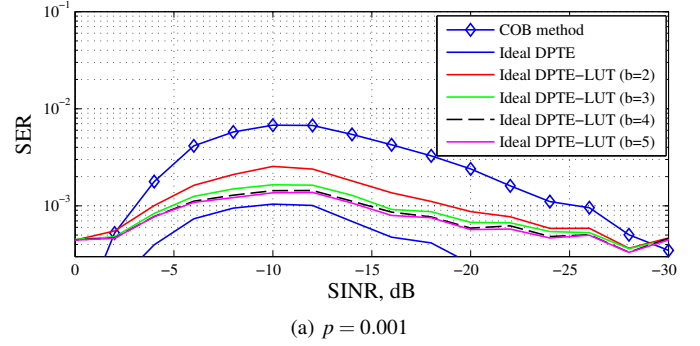

Fig. 5: SER performance of COB, ideal DPTE and ideal DPTE-LUT methods versus SINR for various values of p

1dB can be attained when $p = 0.001$ and 0.1 , respectively. This represents the highest achievable gain and it is obvious that the proposed technique approaches this performance with a LUT of size 4 or 5 bits. Furthermore, the SER performance corresponding to the SNR results in Fig. 4 is presented in Fig. 5 and same trends can be observed.

2) *The Practical DPTE-LUT Technique:* The realization of the proposed scheme requires transmitting the side information associated with each OFDM symbol peak. In practice, however, the PLC channel is contaminated with noise which may lead to receiving some of such information in error. In this subsection we investigate the impact of practical implementation on the proposed system. Our investigations will adopt a 4-bit LUT as such LUT size is found in the previous section to provide sufficiently accurate peak estimation. Fig. 6 compares the output SNR for the ideal DPTE, ideal DPTE-LUT and practical DPTE-LUT techniques in addition to the COB method for various values of p . As expected, it is observed that the performance of the practical DPTE-LUT technique becomes closer to that of the

ideal DPTE case as p becomes smaller. This can be justified as follows: when p is high, the side information is more likely to be detected in error resulting in using the inaccurate blanking threshold and therefore, causing inefficient IN reduction. From these figures it is clearly seen that the loss due to the practical impact of IN on the side information is insignificant. Hence it can be concluded that the proposed technique is promising and can be reliably implemented in practice. Similarly as in the previous section, the SER performance in correspondence to the SNR curves in Fig. 6 is depicted in Fig. 7 and similar observations can be seen. However, it is worthwhile stressing the fact that the robustness of the proposed scheme can be further enhanced by applying powerful coding techniques to make the side information more resistant to IN.

V. CONCLUSION

Signal Blanking can dramatically reduce the effect of IN over powerline channels. In this paper we introduced a technique for estimating the signal peak and utilize it to reduce the effect

(a) $p = 0.001$ (b) $p = 0.01$ (c) $p = 0.1$

Fig. 6: Output SNR of the COB, ideal DPTE, ideal DPTE-LUT and practical DPTE-LUT methods versus SINR for various values of p

(a) $p = 0.001$ (b) $p = 0.01$ (c) $p = 0.1$

Fig. 7: SER performance of the COB, ideal DPTE, ideal DPTE-LUT and practical DPTE-LUT methods versus SINR for various values of p

of IN. This technique deploys a LUT based algorithm with uniform quantization and allows optimal blanking without the need to any IN measurements. Three different DPTE techniques are considered in this paper namely, ideal DPTE, ideal DPTE-LUT and practical DPTE-LUT and the ideal DPTE technique establishes the lower bound performance of this method. It is found that better performance is achieved as the LUT size increases. It was also demonstrated that, in general, a LUT size of 5 bits is sufficient to achieve near-ideal performance. More importantly, it was shown that the loss due the practical impact of IN on the side information is insignificant.

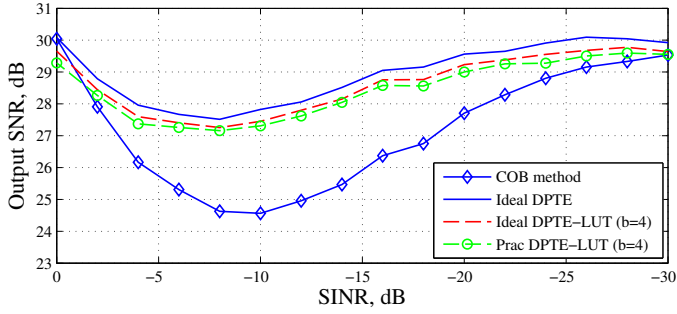
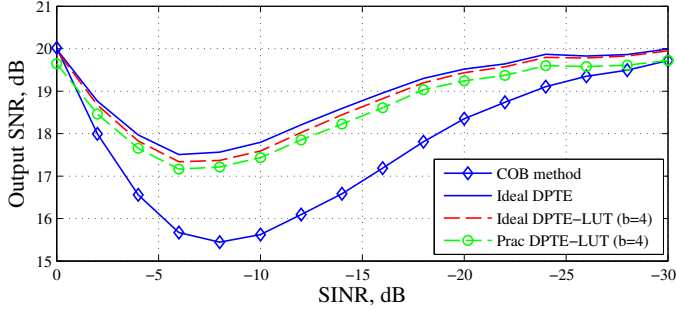
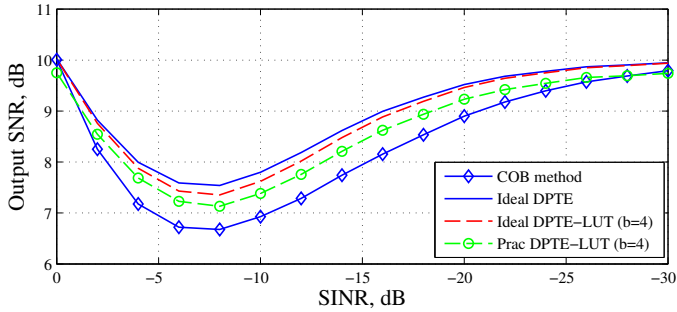
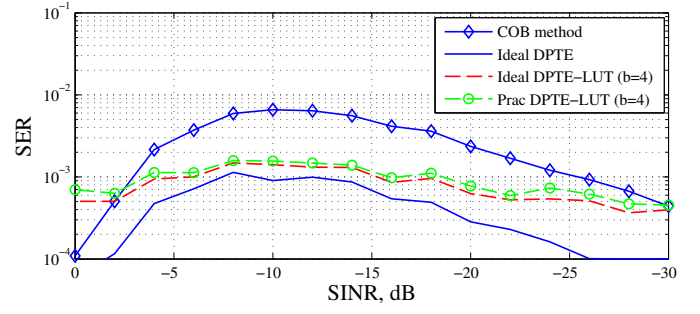
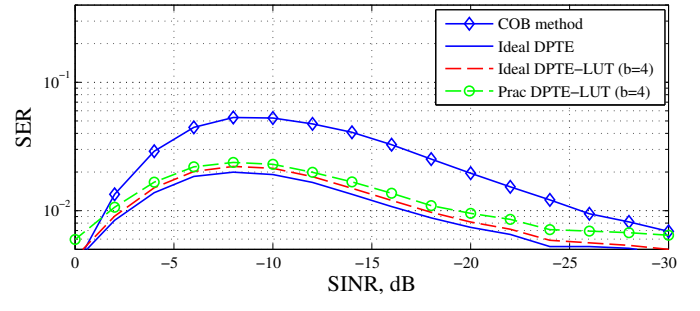
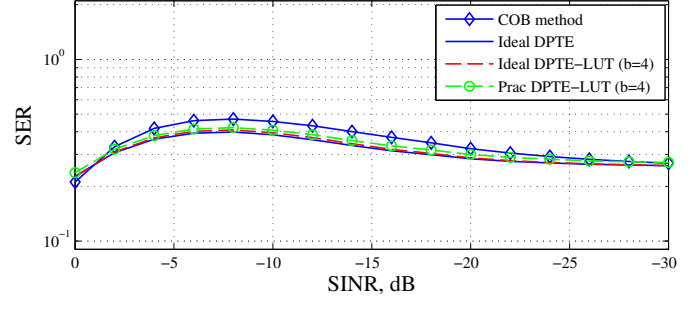
REFERENCES

- [1] M. Zimmermann and K. Dostert, "A multipath model for the powerline channel," *IEEE Trans. Commun.*, vol. 50, no. 4, pp. 553–559, 2002.
- [2] P. Cuntic and A. Bazant, "Analysis of modulation methods for data communications over the low-voltage grid," in *Proc. of the 7th Int. Conference on Telecommunications, 2003. ConTEL 2003*, vol. 2, Jun. 2003, pp. 643–648.
- [3] M. Zimmermann and K. Dostert, "Analysis and modeling of impulsive noise in broad-band powerline communications," *IEEE Trans. Electromagn. Compat.*, vol. 44, pp. 249–258, Feb. 2002.
- [4] D. Middleton, "Statistical-physical models of electromagnetic interference," *IEEE Trans. Electromagn. Compat.*, vol. EMC-19, no. 3, pp. 106–127, Aug. 1977.
- [5] —, "Canonical and quasi-canonical probability models of class-A interference," *IEEE Trans. Electromagn. Compat.*, vol. EMC-25, pp. 76–106, May 1983.
- [6] O. P. H. et al., "Detection and removal of clipping in multicarrier receivers," *European patent application EP1043874*, Oct. 2011.
- [7] N. P. Cowley, A. Payne, and M. Dawkins, "COFDM tuner with impulse noise reduction," *Eur. Patent Application EP1180851*, Feb. 2002.
- [8] S. V. Zhidkov, "On the analysis of OFDM receiver with blanking non-linearity in impulsive noise channels," *IEEE international symposium on intelligent signal processing and communication systems (ISPACS 2004)*, pp. 492–496, Nov. 2004.
- [9] —, "Performance analysis and optimization of OFDM receiver with blanking nonlinearity in impulsive noise environment," *IEEE Trans. Veh. Technol.*, vol. 55, no. 1, pp. 234–242, Jan. 2006.
- [10] E. Alsusa and K. Rabie, "Dynamic peak based threshold estimation method for mitigating impulsive noise in powerline OFDM systems," *to appear in IEEE Trans. Power Del.*
- [11] M. Ghosh, "Analysis of the effect of impulse noise on multicarrier and single carrier QAM systems," *IEEE Trans. Commun.*, vol. 44, no. 2, pp. 145–147, Feb. 1996.
- [12] R. van Nee and R. Prasad, "OFDM for wireless multimedia communications," *Artech House*, 2000.