



**Manchester  
Metropolitan  
University**

---

[Redfern, James](#) (2013) *Development and evaluation of innovative microbiological laboratory practical activities for secondary schools*. Doctoral thesis (PhD), Manchester Metropolitan University.

---

**Downloaded from:** <http://e-space.mmu.ac.uk/48/>

**Usage rights:** Creative Commons: Attribution-Noncommercial-No Derivative Works 4.0

Please cite the published version

<http://e-space.mmu.ac.uk>

DEVELOPMENT AND EVALUATION OF INNOVATIVE  
MICROBIOLOGICAL LABORATORY PRACTICAL  
ACTIVITIES FOR SECONDARY SCHOOLS

JAMES REDFERN

A thesis submitted in partial fulfilment of the  
requirements of the Manchester Metropolitan University  
for the degree of Doctor of Philosophy

School of Healthcare Science  
the Manchester Metropolitan University  
in collaboration with  
the Society for General Microbiology

December 2013

## Declaration

I, James Redfern, declare that this thesis entitled *Development and Evaluation of Innovative Microbiological Practical Activities for Secondary Schools*, and the work presented in this thesis are both my own, and have been generated by me as the result of my own original research. I confirm that:

- This work was done wholly or mainly while in candidature for a research degree at this University;
- Where I have consulted the published work of others, the source is always given. With the exception of such quotations, this thesis is entirely my own work;
- I have acknowledged the all main sources of help;
- Where this thesis is based on work done by myself jointly with others, I have made clear exactly what was done by others and what I have contributed myself;
- Parts of this work have been published as listed on page III.

Signed:

Date:

## Abstract

Microbiology features in the school curriculum being noted in a range of topics, for example, antibiotics, aseptic technique, pathogens and genetic mutation. Support material for the delivery of practical activity is relatively plentiful, but no material could be found in the literature that described their development or evaluation. The aim of this work was to produce a new educational resource for secondary school teachers in support of practical microbiology. The resource would be designed so that it fulfilled particular objectives of the science specifications, and also satisfied teachers' concerns about delivering microbiology in the laboratory.

Preliminary studies comprised a survey of 22 school teaching specifications to identify mentions of microbiology and topics where microbiology could be used to illustrate other scientific concepts. Ninety-five links to microbiology, direct and indirect, were found. In parallel, a survey of 248 secondary school teachers discovered that although practical microbiology was being undertaken, it focused on a small number of activities and was limited by a number of (real and perceived) issues. The relatively recent emphasis on the nature of science (NOS) in the National Curriculum also appears to have been overlooked by teachers, who favour content-driven material. Yet, it is the NOS and inquiry that is more likely to be of transferable value to students and which should be embedded in practical work.

It was decided that a resource focusing on algae would satisfy both the curriculum requirements in terms of scientific content and learning by inquiry (NOS) and teachers' needs in terms of appropriate support and information (both technical and content knowledge). Algae are large, colourful and diverse microorganisms that are safe to use and cheap to purchase. Five laboratory activities not available elsewhere were identified: using a microscope to identify microalgae, phototaxis, bioluminescence, eutrophication and gas cycling. Each exercise was refined so that curriculum/specification links were stated, methods (for teacher, technician and student) clearly described, reliable results were likely and extension work suggested. An identification key of fifteen algal species was developed to support identification of microalgae using a microscope (activity one).

Formative evaluation with three different audiences comprising over 100 individuals guided modifications of the resource. One activity was successfully modified to enable the public to engage with algae in an event named 'The Good, the Bad and the Algae'. Over 2,200 people interacted with this event over a three-day period, with over 80% noting acquisition of scientific or application knowledge of algae.

The resource, published in January 2012 underwent summative evaluation. A survey was distributed to approximately 750 participants and gained a poor (but not unexpected) return rate (7%). About half of teachers were using the resource, and all activities had been used. Comments were positive yet showed similar issues with regards to limitations identified in the survey of practical microbiology in schools. This reinforces the need for continued support from professional microbiologists in order to ensure the field is represented in the classroom.

To the author's knowledge, the process by which this resource was developed and produced is the first, certainly in microbiology, devised with relevance to teaching specifications and teacher's needs, and the first to be systematically trialled and evaluated by the target audience (teachers). It is suggested that this process be a template for the development of learning material in the future.



## Publications arising from this project

### Educational resources

**REDFERN, J.** 2014. *Viruses: a practical resource for post 16 biology teachers*. Reading, UK, Society for General Microbiology. ISBN: 978-0-9536838-4-0

**REDFERN, J.** 2012. *Algae: a practical resource for secondary schools*. Reading, UK, Society for General Microbiology. ISBN: 978-0-9536838-7-1

### Peer-reviewed publications (Appendix 6)

**REDFERN, J., BURDASS, D. & VERRAN, J.** 2013. Practical microbiology in schools: a survey of UK teachers. *Trends in Microbiology*.21:11, 557-559. DOI: 10.1016/j.tim.2013.09.002. (IF 8.434)

**REDFERN, J., BURDASS, D. & VERRAN, J.** 2013. Transforming a school learning exercise into a public engagement event: "The Good, the Bad and The Algae". *Journal of Biological Education*, 47:4, 246-252. DOI: 10.1080/00219266.2013.801872. (IF 0.269)

**REDFERN, J., BURDASS, D. & VERRAN, J.** in press. The development of a new practical activity: Using microorganisms to model gas cycling. *School Science Review*.

**REDFERN, J., BURDASS, D. & VERRAN, J.** in press. Using Soxhlet ethanol extraction to produce and test plant material (essential oils) for their antimicrobial properties. *Journal of Microbiology and Biology Education*.

### Magazine articles (Appendix 7)

**REDFERN, J., BURDASS, D. & VERRAN, J.** 2013. School zone – Bacteriophage practical. *Microbiology Today*. Reading: Society for General Microbiology. 40:1

**VERRAN, J., BURDASS, D. & REDFERN, J.** 2012. The Development and Launch of a school laboratory activity resource about algae. *The Phycologist*. British Phycological Society, Glasgow: 82

**REDFERN, J.** 2011. Call for evaluation volunteers. *Microbiology Today*. Reading: Society for General Microbiology. 38:1

### Online reports

**VERRAN, J. & REDFERN, J.** 2013. 3.1 Some general principles for public engagement events. In: NICHOLSON, D. & WHEATER, P. (eds.) *Public Engagement in the GEES Disciplines* York: The Higher Education Academy. ISBN: 978-1-907207-92-1 [online].

Available:

[http://www.heacademy.ac.uk/assets/documents/disciplines/GEES/GEES\\_6\\_Public\\_engagement\\_guide\\_Nicholson\\_and\\_Wheater.pdf](http://www.heacademy.ac.uk/assets/documents/disciplines/GEES/GEES_6_Public_engagement_guide_Nicholson_and_Wheater.pdf)

## Acknowledgements

My greatest thanks go to all those at Manchester Metropolitan University who made my time on this project enjoyable (and successful), and to the Society for General Microbiology for providing the funding to make it possible.

First and foremost, I would like to give unreserved thanks to my director of studies, Professor Joanna (Jo) Verran. The abilities and attributes Jo has taught me are numerous, far ranging, and I consider myself a stronger researcher and communicator for the time and effort Jo has given in my development over the years. Jo's boundless attention to detail has finally driven me to learn to punctuate prose. I greatly appreciate all her time, ideas and considerable efforts making my Ph.D experience productive, stimulating and most of all, enjoyable.

Considerable thanks are also due to my second supervisor, Dariel Burdass. Dariel's work-ethic and passion for the project have been an inspiration, without which it would not have been possible. The number and variety of opportunities Dariel has provided over the years is considerable and has had an undeniable effect on my development into a keen and passionate science communicator. It has been an honour to work with both Jo and Dariel.

In addition, I would like to acknowledge Professor Peter Gilroy, who's supervision regarding education theory has been second-to-none. Peter's seemingly limitless knowledge on education has enabled me to ensure my work relevant, and provided a guiding light through the considerable literature.

Also I would like to thank Professor Jan Green and all at the Science Learning Centre who have helped me in my work.

Thanks go to all my fellow researchers, technicians, academics and others at MMU (past and present); David Wickens, Sarah Jackson, Dr Gavin Bingly, Dr Angie Dudman, Dr Malcolm Kinninmonth, Dr Paul Benson, Dr Leanne Fischer, Daniel Hudson, Anne Leahy-Gilmartin, Lindsey Smith, and Natalie Callaghan, who have contributed ideas, taught me new techniques and helped make my Ph.D fun and enjoyable. I consider all friends and I am grateful to have worked with them.

Additionally I would like to mention those (past and present) at the Society for General Microbiology, notably Dr Vicki Symington, Yvonne Taylor, Laura Udakis and Ian Atherton for their friendly nature and help over the years.

Ultimately, this project aimed to deliver new learning materials for schools. Thanks is due to all those who enabled this, from proof-reading, ensuring scientific accuracy, delivering surveys to facilitating and taking part in trials.

Last, but by no means least, thanks are due to my family and friends, who, although they may not realise, have all had an impact on my work in one-way or another.

# Table of Contents

<b>Declaration</b>	<b>I</b>
<b>Abstract</b>	<b>II</b>
<b>Publications arising from this project</b>	<b>III</b>
<b>Acknowledgements</b>	<b>IV</b>
<b>List of figures</b>	<b>IX</b>
<b>List of tables</b>	<b>XIV</b>
<b>Acronyms</b>	<b>XVI</b>
<b>Preface</b>	<b>1</b>
<b>Section 1 - Microbiology and the school classroom</b>	<b>2</b>
<b>Chapter 1 - Part 1: Practical science in UK secondary schools</b>	<b>2</b>
1.1 - Science education in secondary schools	3
1.2 – A need for microbiology education in schools	4
1.3 - Microbiology in the National Curriculum for England and other UK teaching specifications	6
1.3.1 - Microbiology in science for students aged 11-14 in England, Wales and Northern Ireland	7
1.3.2 - Microbiology in science for students aged 14-16 in the United Kingdom	10
1.3.2.1 - Review of microbiology in the awarding bodies of the United Kingdom for qualifications taken aged 14 to 18.	10
1.4 -Practical science in schools	18
<b>Chapter 1 - Part 2: Practical microbiology in UK Secondary Schools: a National Survey of Teachers</b>	<b>21</b>
1.5 Practical microbiology in UK secondary schools: a national survey of teachers	22
1.5.1 - Introduction	22
1.5.2 - Methodology	22
1.5.2.1 - Survey design	22
1.5.2.2 - Definition of terms	25
1.5.2.3 - Ethics	26
1.5.2.4 - Participants	28
1.5.2.5 – Instrumentation (question types)	29
1.5.2.6 - Analyses	30
1.5.3 - Results and discussion	31
1.5.3.1 - Practical microbiology in the secondary school classroom	33
1.5.3.2 - Limitations of teaching practical microbiology in the secondary school laboratory	39
1.5.3.2.1 Statistical test: Are teachers who have limitations in practical microbiology using it less?	43
1.5.3.3 – Importance of practical activity and in particular practical microbiology	47
1.5.3.3.1 - Statistical test: Do those who teach practical microbiology in the classroom value it in the teaching of biology/science?	52
1.5.3.4 – Effect of school membership of the Society for General Microbiology on practical microbiology in the classroom	54
1.5.3.4.1 - Statistical test: Is there a link between practical microbiology in the classroom and school membership of the Society for General Microbiology?	54
1.5.3.4.2 - Statistical test: Are school members of the Society for General Microbiology finding fewer limitations in practical microbiology in the classroom?	56
1.5.4 - Additional comments	58
1.5.5 - Conclusion	61
<b>Chapter 1 - Part 3: Project aims and objectives</b>	<b>63</b>
1.6 - Project aim and objective	64

1.6.1 - Aim	64
1.6.2 - Objectives	64
<b>Section 2 - Research in science education</b>	<b>65</b>
<b>Chapter 2 – Science and the classroom</b>	<b>65</b>
2.1 - <i>The Nature of Science (NOS)</i>	66
2.1.1 - What is science?	66
2.1.2 – How is science done?	68
2.1.2.1 - Induction	69
2.1.2.2 - Falsificationism	73
2.1.2.3 - Discussion	77
2.2 – <i>The Nature of Science and the school classroom</i>	79
2.2.1 – Constructivism and the nature of science	83
2.2.1.1 - Misconceptions and common sense	85
2.2.2 - Practical activity and the nature of science	86
2.3- <i>Nature of science, constructivism and microbiology</i>	90
2.4 - <i>Conclusion</i>	96
<b>Chapter 3 – Secondary school science pedagogy</b>	<b>98</b>
3.1 - <i>Introduction</i>	99
3.2 - <i>Science pedagogy and practical activity resources</i>	99
3.3 <i>Pedagogical Content Knowledge (PCK)</i>	100
3.4 – <i>Student learning and educational resources</i>	105
3.4.1 – Thinking styles	106
3.5 - <i>Conclusion</i>	111
<b>Section 3 – ‘Algae a practical resource for secondary schools’</b>	<b>113</b>
<b>Chapter 4 – Developing an educational resource for practical microbiology activity</b>	<b>113</b>
4.1 – <i>Introduction</i>	114
4.2 – <i>‘Algae: a practical resource for secondary schools’ - developing resource content</i>	115
4.2.1 – Introduction	115
4.2.2 – Aims and objectives	122
4.2.3 - Methods	123
4.2.3.1 – Introduction	123
4.2.3.2 – Activity 1 – Identifying microalgae using a microscope	124
4.2.3.3 – Activity 2 – Investigating phototaxis	135
4.2.3.4 – Activity 3 – Demonstrating bioluminescence	143
4.2.3.5 – Activity 4 – Eutrophication	149
4.2.3.6 – Activity 5 – Gas cycling in microorganisms	157
4.2.4 – Design of the resource	163
4.2.5 – Formative evaluation	165
4.2.5.1 - Teacher trial one	165
4.2.5.2 - Teacher trial two	169
4.2.5.3 – Student trial	171
4.2.5.4 – Public trial – ‘The Good, the Bad and the Algae’	173
4.2.5.5 – Results and discussion	175
4.3 <i>Conclusion</i>	180
<b>Chapter 5 – ‘Algae: a practical resource for secondary schools’: summative evaluation</b>	<b>181</b>
5.1 – <i>Introduction</i>	182
5.2 – <i>Dissemination, promotion and use</i>	182
5.3 – <i>Summative evaluation of SGM school members</i>	185
5.3.1 - Introduction	185
5.3.2 - Methodology	185
5.3.2.1 - Survey design	185
5.3.2.2 - Ethics	187
5.3.2.3 - Participants	187
5.3.2.4 – Instrumentation (question types)	188

5.3.2.5 - Analyses	188
5.3.3 – Results and discussion	189
5.3.3.1 General use of the resource in the classroom	190
5.3.3.2 – Use of specific activities	192
5.3.3.3 – Implementation of specific activities in the classroom	195
5.3.3.4 – Additional comments	200
5.3.3.5 – Survey design and implementation	203
5.3.4 – Conclusion	204
<b>Section 4 – School science and public engagement</b>	<b>206</b>
<b>Chapter 6 – Developing a school practical activity into a science communication event</b>	<b>206</b>
6.1 – Case study: transforming a school learning exercise into a public engagement event: ‘The good, the bad and the algae’	207
6.1.1 Introduction	207
6.1.2 - Public engagement event: low throughput, intensive laboratory workshop	209
6.1.3 - Public engagement event: high throughput reduced hands-on activity	212
6.1.4 - Conclusion	217
<b>Section 5</b>	<b>219</b>
<b>Chapter 7 – Conclusion</b>	<b>219</b>
7.1 Conclusions and future work	220
<b>References</b>	<b>224</b>
<b>Appendix 1 – Review of microbiology-related content in science / biology teaching specifications in the United Kingdom</b>	<b>239</b>
<b>Appendix 2 – Summary of thinking styles presented by the model of mental self-government</b>	<b>256</b>
<b>Appendix 3 – Experiments supporting the development of activity 2 – Investigating phototaxis</b>	<b>258</b>
<i>Experiment one: design</i>	259
Aim	259
Method	259
Results	259
<i>Experiment two: source of light</i>	262
Aim	262
Method	262
Results	262
<i>Experiment three: Incubation time</i>	264
Aim	264
Method	264
Results	264
<i>Experiment four: Distance from source of light</i>	266
Aim	266
Method	266
Results	266
<b>Appendix 4 – Experiments supporting the development of activity 4 – Eutrophication</b>	<b>268</b>
<i>Experiment one: Growth rate of Euglena gracilis using different media</i>	269
Aim	269
Method	269
Results	269
<i>Experiment two: Using optical density as an indicator for eutrophic behaviour of Euglena gracilis</i>	273
Aim	273
Method	273
Results	274
<i>Experiment three: calculating the total count of Euglena gracilis in liquid culture</i>	276

Aim	276
Method	276
Results	276
<b>Appendix 5 – Experiments supporting the development of activity 5 – Gas cycling in microorganisms</b>	<b>278</b>
<i>Experiment one: investigating the time required for a heated water bath to produce visible and reproducible results</i>	279
Aim	279
Method	279
Results	279
<b>Appendix 6 – Peer-reviewed publications</b>	<b>281</b>
<b>Appendix 7 – Magazine publications</b>	<b>310</b>

## List of figures

FIGURE 1 - PERCENTAGE FREQUENCY OF MICROBIOLOGY MENTIONS, THEMES, TOPICS AND CONCEPTS IN GCSE, IGCSE, BTEC AND STANDARD GRADE 14-16 QUALIFICATION SPECIFICATIONS (N=15) .....	14
FIGURE 2 - PERCENTAGE FREQUENCY OF MICROBIOLOGY MENTIONS, THEMES, TOPICS AND CONCEPTS IN A LEVEL, HIGHER AND ADVANCED HIGHER 16-18 QUALIFICATION SPECIFICATIONS (N=7).....	17
FIGURE 3 - THE FIRST PAGE OF THE QUESTIONNAIRE PROVIDED TO RESPONDENTS FROM DISTRIBUTORS IN ENGLAND.....	23
FIGURE 4 - THE SECOND AND FINAL PAGE OF THE QUESTIONNAIRE PROVIDED TO RESPONDENTS FROM DISTRIBUTORS IN ENGLAND .....	24
FIGURE 5 - A BAR CHART REPRESENTING THE PERCENTAGE FREQUENCY OF THE 37 ACTIVITIES MENTIONED IN RESPONSE TO THE QUESTION 'DO YOU TEACH PRACTICAL MICROBIOLOGY? IF YES, WHAT TYPE OF ACTIVITIES DO YOU CARRY OUT?'. THE DATA ARE INCLUSIVE OF KEY STAGE 3, KEY STAGE 4 AND POST-16 ANSWERS. ....	34
FIGURE 6 - PERCENTAGE FREQUENCY OF THE NUMBER OF AGREEMENTS WHEN ASKED IF ANY OF THE VARIABLES LISTED LIMITED THEIR TEACHING OF PRACTICAL MICROBIOLOGY .....	40
FIGURE 7 - PERCENTAGE OF RESPONDENTS AGREEING THAT FINANCE WAS A LIMITING FACTOR TO THEIR TEACHING OF PRACTICAL MICROBIOLOGY SEPARATED BY THE LEVEL OF EDUCATION AT WHICH THEY TAUGHT SCIENCE, AND WHETHER OR NOT THAT SCIENCE EDUCATION INCLUDED PRACTICAL MICROBIOLOGY.....	46
FIGURE 8 - PERCENTAGE OF RESPONDENTS WHO DISAGREED THAT THE VARIABLES: CONFIDENCE, EQUIPMENT, TECHNICIAN SUPPORT AND HEALTH AND SAFETY WERE LIMITING FACTORS BROKEN DOWN INTO WHETHER OR NOT THEY TAUGHT PRACTICAL MICROBIOLOGY AS PART OF THE POST-16 BIOLOGY EDUCATION THEY TEACH .....	48
FIGURE 9 - PERCENTAGE FREQUENCY OF RESPONSES GIVEN TO EACH SCALE VALUE, ANSWERING THE QUESTION 'TO WHAT EXTENT DO YOU CONSIDER PRACTICAL SCIENCE ACTIVITY IN SECONDARY SCIENCE EDUCATION TO BE IMPORTANT?' .....	50
FIGURE 10 - PERCENTAGE FREQUENCY OF THE SCALE VALUE SELECTED BY RESPONDENTS ANSWERING THE QUESTION 'TO WHAT EXTENT DO YOU CONSIDER PRACTICAL SCIENCE ACTIVITY IN SECONDARY SCIENCE EDUCATION TO BE IMPORTANT?', SEPARATED BY THOSE WHO HAD IDENTIFIED AS TEACHING SCIENCE/BIOLOGY AT KEY STAGE 3, KEY STAGE 4 AND/OR POST-16 BIOLOGY.....	50
FIGURE 11 - PERCENTAGE FREQUENCY OF RESPONSES GIVEN TO EACH SCALE VALUE, ANSWERING THE QUESTION 'TO WHAT EXTENT DO YOU VALUE PRACTICAL SCIENCE ACTIVITY IN THE TEACHING OF MICROBIOLOGY?' .....	51
FIGURE 12 - PERCENTAGE FREQUENCY OF THE SCALE VALUE SELECTED BY RESPONDENTS ANSWERING THE QUESTION 'TO WHAT EXTENT DO YOU VALUE PRACTICAL SCIENCE ACTIVITY IN THE TEACHING OF MICROBIOLOGY?', SEPARATED BY THOSE WHO HAD IDENTIFIED AS TEACHING SCIENCE/BIOLOGY AT KEY STAGE 3, KEY STAGE 4 AND/OR POST-16 BIOLOGY .....	51

FIGURE 13 - FREQUENCY OF RESPONSES BY THOSE WHO IDENTIFIED THEMSELVES AS TEACHING PRACTICAL MICROBIOLOGY, SPLIT BY WHETHER OR NOT THEY ARE A MEMBER OF THE SOCIETY FOR GENERAL MICROBIOLOGY .....	57
FIGURE 14 - PERCENTAGE OF RESPONDENTS AGREEING THE VARIABLES MENTIONED TO BE LIMITING TO THEIR TEACHING OF PRACTICAL MICROBIOLOGY SEPARATED BASED ON IDENTIFICATION AS A MEMBER OF THE SOCIETY FOR GENERAL MICROBIOLOGY.....	59
FIGURE 15 - ILLUSTRATION SHOWING THE PROCESS OF INDUCTION (FROM OBSERVATION TO THEORY/LAW CONSTRUCTION) AN THE PROCESS OF DEDUCTION (FROM THEORY/LAW TO PREDICTION OR EXPLANATION) .....	71
FIGURE 16 - ILLUSTRATION SHOWING THE PROCESS OF FALSIFICATION. THE PROCESS BEGINS WITH OBSERVATION AND USES THIS INFORMATION TO BUILD A FALSIFIABLE HYPOTHESIS (IF IT IS NOT FALSIFIABLE IT IS NOT CLASSED AS SCIENTIFIC). THE HYPOTHESIS IS TESTED FOR FALSIFIABILITY. IF THE HYPOTHESIS IS FALSIFIED, IT IS DISREGARDED AND A NEW HYPOTHESIS IS DEVELOPED AND TESTED. IF IT SURVIVES THE TESTING, IT IS 'CONFIRMED' AND UNDERGOES FURTHER TESTING.....	75
FIGURE 17 – GRAPHICAL REPRESENTATION OF THE NUMBER OF RESULTS WHEN SEARCHING KEYWORDS 'PCK SCIENCE EDUCATION' IN SEARCH ENGINE GOOGLE SCHOLAR, LIMITING RESULTS TO JOURNAL ARTICLES AND BOOKS ON A YEAR-BY-YEAR BASIS.	101
FIGURE 18 - PAGE 13 OF THE RESOURCE 'ALGAE: A PRACTICAL RESOURCE FOR SECONDARY SCHOOLS'. DETAILING PAGE 1 OF 4 OF THE TEACHER'S GUIDE TO ACTIVITY 1: IDENTIFYING MICROALGAE USING A MICROSCOPE .....	125
FIGURE 19 - PAGE 14 OF THE RESOURCE 'ALGAE: A PRACTICAL RESOURCE FOR SECONDARY SCHOOLS'. DETAILING PAGE 2 OF 4 OF THE TEACHER'S GUIDE TO ACTIVITY 1: IDENTIFYING MICROALGAE USING A MICROSCOPE .....	126
FIGURE 20 - PAGE 15 OF THE RESOURCE 'ALGAE: A PRACTICAL RESOURCE FOR SECONDARY SCHOOLS'. DETAILING PAGE 3 OF 4 OF THE TEACHER'S GUIDE TO ACTIVITY 1: IDENTIFYING MICROALGAE USING A MICROSCOPE .....	127
FIGURE 21 - PAGE 16 OF THE RESOURCE 'ALGAE: A PRACTICAL RESOURCE FOR SECONDARY SCHOOLS'. DETAILING PAGE 4 OF 4 OF THE TEACHER'S GUIDE TO ACTIVITY 1: IDENTIFYING MICROALGAE USING A MICROSCOPE .....	128
FIGURE 22 - PAGE 17 OF THE RESOURCE 'ALGAE: A PRACTICAL RESOURCE FOR SECONDARY SCHOOLS'. DETAILING PAGE 1 OF 1 OF THE TECHNICAL GUIDE TO ACTIVITY 1: IDENTIFYING MICROALGAE USING A MICROSCOPE.....	130
FIGURE 23 - PAGE 19 OF THE RESOURCE 'ALGAE: A PRACTICAL RESOURCE FOR SECONDARY SCHOOLS'. DETAILING PAGE 1 OF 2 OF THE STUDENT'S GUIDE TO ACTIVITY 1: IDENTIFYING MICROALGAE USING A MICROSCOPE.....	131
FIGURE 24 - PAGE 20 OF THE RESOURCE 'ALGAE: A PRACTICAL RESOURCE FOR SECONDARY SCHOOLS'. DETAILING PAGE 2 OF 2 OF THE STUDENT'S GUIDE TO ACTIVITY 1: IDENTIFYING MICROALGAE USING A MICROSCOPE.....	132
FIGURE 25 - ADDITIONAL A3 LEAFLET PROVIDED WITH THE RESOURCE 'ALGAE: A PRACTICAL RESOURCE FOR SECONDARY SCHOOLS'. DETAILING THE MICROALGAE IDENTIFICATION KEY TO ACCOMPANY ACTIVITY 1: IDENTIFYING MICROALGAE USING A MICROSCOPE.....	133



FIGURE 26 - PAGE 27 OF THE RESOURCE 'ALGAE: A PRACTICAL RESOURCE FOR SECONDARY SCHOOLS'. DETAILING PAGE 1 OF 2 OF THE STUDENT'S GUIDE TO ACTIVITY 2: INVESTIGATING PHOTOTAXIS.....	137
FIGURE 27 - PAGE 28 OF THE RESOURCE 'ALGAE: A PRACTICAL RESOURCE FOR SECONDARY SCHOOLS'. DETAILING PAGE 2 OF 2 OF THE STUDENT'S GUIDE TO ACTIVITY 2: INVESTIGATING PHOTOTAXIS.....	138
FIGURE 28 - EXAMPLE OF A TEST TUBE (LEFT) AFTER THE PHOTOTAXIS EXPERIMENT HAS FINISHED AND SLEEVE (RIGHT) IS REMOVED. ....	139
FIGURE 29 – A GUIDE TO ATTACHMENT DENSITY PROVIDED IN THE TEACHER'S GUIDE (PAGE 24) OF THE RESOURCE "ALGAE: A PRACTICAL RESOURCE FOR SECONDARY SCHOOLS' .....	139
FIGURE 30 - ACTION SPECTRUM OF PHOTOSYNTHESIS SHOWS WAVELENGTHS WHERE CHLOROPHYLLS A AND B HAVE ABSORPTION PEAKS, PROVING THAT LIGHT ABSORBED BY THESE PIGMENTS LEADS TO PHOTOSYNTHESIS (WHITMARSH, 1999). ....	141
FIGURE 31 - PAGE 35 OF THE RESOURCE 'ALGAE: A PRACTICAL RESOURCE FOR SECONDARY SCHOOLS'. DETAILING PAGE 1 OF 2 OF THE STUDENT'S GUIDE TO ACTIVITY 3: DEMONSTRATING BIOLUMINESCENCE.....	145
FIGURE 32 - PAGE 36 OF THE RESOURCE 'ALGAE: A PRACTICAL RESOURCE FOR SECONDARY SCHOOLS'. DETAILING PAGE 1 OF 2 OF THE STUDENT'S GUIDE TO ACTIVITY 3: DEMONSTRATING BIOLUMINESCENCE.....	146
FIGURE 33 -A MICROGRAPH OF THE BIOLUMINESCENT CELL <i>Pyrocystis lunula</i> (TAKEN WITH AN X40 OBJECTIVE LENS ON A STANDARD LIGHT MICROSCOPE). (B) A CULTURE OF <i>Pyrocystis lunula</i> BIOLUMINESCING DURING A PERIOD OF MECHANICAL STRESS IN THE EARLY STAGES OF ADAPTION TO A LIGHT/DARK CYCLE (C) A CULTURE OF <i>Pyrocystis lunula</i> BIOLUMINESCING DURING A PERIOD OF MECHANICAL STRESS HAVING WELL ADAPTED TO ITS LIGHT/DARK CYCLE.....	148
FIGURE 34 - PAGE 45 OF THE RESOURCE 'ALGAE: A PRACTICAL RESOURCE FOR SECONDARY SCHOOLS'. DETAILING PAGE 1 OF 4 OF THE STUDENT'S GUIDE TO ACTIVITY 4: EUTROPHICATION.....	151
FIGURE 35 - PAGE 46 OF THE RESOURCE 'ALGAE: A PRACTICAL RESOURCE FOR SECONDARY SCHOOLS'. DETAILING PAGE 2 OF 4 OF THE STUDENT'S GUIDE TO ACTIVITY 4: EUTROPHICATION.....	152
FIGURE 36 - PAGE 47 OF THE RESOURCE 'ALGAE: A PRACTICAL RESOURCE FOR SECONDARY SCHOOLS'. DETAILING PAGE 3 OF 4 OF THE STUDENT'S GUIDE TO ACTIVITY 4: EUTROPHICATION.....	153
FIGURE 37 - PAGE 48 OF THE RESOURCE 'ALGAE: A PRACTICAL RESOURCE FOR SECONDARY SCHOOLS'. DETAILING PAGE 4 OF 4 OF THE STUDENT'S GUIDE TO ACTIVITY 4: EUTROPHICATION.....	154
FIGURE 38 - PAGE 55 OF THE RESOURCE 'ALGAE: A PRACTICAL RESOURCE FOR SECONDARY SCHOOLS'. DETAILING PAGE 1 OF 4 OF THE STUDENT'S GUIDE TO ACTIVITY 5: GAS CYCLING IN MICRO-ORGANISMS.....	158
FIGURE 39 - PAGE 56 OF THE RESOURCE 'ALGAE: A PRACTICAL RESOURCE FOR SECONDARY SCHOOLS'. DETAILING PAGE 2 OF 4 OF THE STUDENT'S GUIDE TO ACTIVITY 5: GAS CYCLING IN MICRO-ORGANISMS.....	159

FIGURE 40 - PAGE 57 OF THE RESOURCE 'ALGAE: A PRACTICAL RESOURCE FOR SECONDARY SCHOOLS'. DETAILING PAGE 3 OF 4 OF THE STUDENT'S GUIDE TO ACTIVITY 5: GAS CYCLING IN MICRO-ORGANISMS.....	160
FIGURE 41 - PAGE 58 OF THE RESOURCE 'ALGAE: A PRACTICAL RESOURCE FOR SECONDARY SCHOOLS'. DETAILING PAGE 4 OF 4 OF THE STUDENT'S GUIDE TO ACTIVITY 5: GAS CYCLING IN MICRO-ORGANISMS.....	161
FIGURE 42 - A1 POSTER INCLUDED WITH THE PUBLICATION 'ALGAE: A PRACTICAL RESOURCE FOR SECONDARY SCHOOLS' .....	164
FIGURE 43 - SCREENSHOT OF THE CCAP HOMEPAGE (WWW.CCAP.AC.UK/ - AS OF OCTOBER 2013) DISPLAYING THE KIT ON SALE TO SUPPORT THE USE OF THE RESOURCE 'ALGAE: A PRACTICAL RESOURCE FOR SECONDARY SCHOOLS' .....	184
FIGURE 44 - DATA COLLECTED FROM QUESTION TWO OF THE SUMMATIVE EVALUATION SURVEY DISPLAYED AS A PERCENTAGE FREQUENCY OF USABLE DATA (N=47). .....	191
FIGURE 45 - BAR CHART SHOWING DATA FROM QUESTION ONE AND QUESTION TWO (IF RESPONDENTS HAD USED THE RESOURCE SPLIT BY TIME SINCE RECEIVING THE RESOURCE). .....	191
FIGURE 46 - DATA COLLECTED FROM QUESTION THREE OF THE SUMMATIVE EVALUATION SURVEY DISPLAYED AS A PERCENTAGE FREQUENCY. IDENTIFICATION, N=18. PHOTOTAXIS, N=18. BIOLUMINESCENCE, N=15. EUTROPHICATION, N=13. GAS CYCLING, N=15. ....	194
FIGURE 47 - COMPARISON OF 'YES' ANSWERS FOR WHEN ASKED IF RESPONDENTS HAD USED ANY ACTIVITY AS A HANDS-ON PRACTICAL ACTIVITY OR A CLASS DEMONSTRATION (QUESTION THREE AND FOUR). ....	194
FIGURE 48 - DATA COLLECTED FROM QUESTION FIVE OF THE SUMMATIVE EVALUATION SURVEY DISPLAYED AS A BOX-AND-WHISKER PLOT. INTRODUCTION MATERIAL, TEACHER'S GUIDE, TECHNICIAN'S GUIDE, STUDENT'S GUIDE AND SUPPLIER INFORMATION N=22. CULTIVATION OF ALGAE AND SUPPORT MATERIAL, N=21. ....	196
FIGURE 49 - DATA COLLECTED FROM QUESTION SIX OF THE SUMMATIVE EVALUATION SURVEY DISPLAYED AS A BOX-AND-WHISKER PLOT. N=19. SCORE ONE WAS 'NOT USER FRIENDLY' AND SCORE FIVE WAS 'VERY USER FRIENDLY'. ....	196
FIGURE 50 - EXAMPLES OF MODELS MADE DURING THE WORKSHOP 'THE GOOD, THE BAD AND THE ALGAE' USING THE MODELLING CLAY PROVIDED .....	211
FIGURE 51 - THE PERSPEX BOX, USED TO ILLUSTRATE HALF A DROP OF WATER, MAGNIFIED X200. HANGING INSIDE ARE PLASTICINE® ALGAE MODELS MADE BY PARTICIPANTS AT THE BIG BANG EVENT .....	215
FIGURE 52 - SLEEVE DESIGNS; (1) SLEEVE DESIGN ONE, (2) SLEEVE DESIGN TWO .....	261
FIGURE 53 - A GUIDE TO ATTACHMENT DENSITY PROVIDED IN THE TEACHER'S GUIDE (PAGE 24) OF THE RESOURCE "ALGAE: A PRACTICAL RESOURCE FOR SECONDARY SCHOOLS' .....	261
FIGURE 54 - AVERAGE ATTACHMENTS RATING OF PHOTOTACTIC ALGAE <i>EUGLENA GRACILIS</i> DEPENDING ON COLOUR AND SHAPE OF THE FIELD OF LIGHT (N=3) .....	261

FIGURE 55 - AVERAGE ATTACHMENTS RATING OF PHOTOTACTIC ALGAE <i>EUGLENA GRACILIS</i> DEPENDING ON SOURCE OF LIGHT (N=6)	263
.....	.....
FIGURE 56 - ATTACHMENT RATING REPRESENTING LEVELS OF PHOTOTACTIC ACTIVITY OF <i>EUGLENA GRACILIS</i> OVER A PERIOD OF 7 DAYS	265
.....	.....
FIGURE 57 – DAILY OPTICAL DENSITY READINGS (N=3) OF <i>EUGLENA GRACILIS</i> IN WATER CONTROLS AND GROWTH SUPPORTING SOLUTIONS UNDER STERILE AND NON-STERILE CONDITIONS.	272
.....	.....
FIGURE 58 – OPTICAL DENSITY MEASUREMENTS (N=3) OF <i>EUGLENA GRACILIS</i> IN SOLUTIONS OF DIFFERENT CONCENTRATIONS OF NUTRIENTS	275
.....	.....
FIGURE 59 – A GRAPH SHOWING THE AVERAGE TOTAL COUNT OF <i>EUGLENA GRACILIS</i> CELLS AT A RANGE OF OPTICAL DENSITY READINGS.	277
.....	.....
FIGURE 60 - OPTICAL DENSITY READINGS (N=3) OF <i>EUGLENA GRACILIS</i> MEASUREMENTS AT 665NM IN THE PRESENCE OF ADDED CARBON DIOXIDE (FOR 4 HOURS A DAY) (FLASK 1) COMPARED TO <i>EUGLENA GRACILIS</i> IN THE PRESENCE OF ATMOSPHERIC LEVEL CARBON DIOXIDE (FLASK 2)	280
.....	.....
FIGURE 61 - OPTICAL DENSITY READINGS (N=3) COMPARISON OF <i>EUGLENA GRACILIS</i> IN THE PRESENCE OF ADDED CARBON DIOXIDE (FOR 2 HOURS A DAY) (FLASK 1) COMPARED TO <i>EUGLENA GRACILIS</i> IN THE PRESENCE OF ATMOSPHERIC LEVEL CARBON DIOXIDE (FLASK 2).	280
.....	.....
FIGURE 62 - SETTING UP THE ACTIVITY. ADD DRIED BAKER’S YEAST AND FERTILIZER TO SOME TAP WATER IN A BUCHNER FLASK.	300
.....	.....
FIGURE 63 - ALGAE AND FERTILIZER ARE ADDED TO TWO BEAKERS OF TAP WATER	301
.....	.....
FIGURE 64 – THE BUCHNER FLASK IS PLACED IN A WATER BATH AND ALGAE PLACED NEAR A LIGHT SOURCE	301
.....	.....
FIGURE 65. - DIAGRAM OF SOXHLET EXTRACTION EQUIPMENT.	307
.....	.....
FIGURE 66. AN EXAMPLE OF ZONES OF INHIBITION PRODUCED FROM EXTRACTED THYME PLANT MATERIAL AFTER 16 HOURS ETHANOL SOXHLET EXTRACTION ON TEST ORGANISMS <i>S. AUREUS</i> (LEFT) AND <i>E. COLI</i> (RIGHT).	308
.....	.....

## List of tables

TABLE 1 – EDUCATION LEVELS IN ENGLAND AND SCOTLAND BASED ON THE NATIONAL QUALIFICATION FRAMEWORK (NQF), THE NATIONAL CURRICULUM IN ENGLAND, WALES AND NORTHERN IRELAND, THE SCOTTISH CREDIT AND QUALIFICATIONS FRAMEWORK (SCQF) AND CURRICULUM FOR EXCELLENCE (CFE) WHICH INCLUDE MICROBIOLOGY AND/OR HAVE POTENTIAL FOR PRACTICAL MICROBIOLOGY IN THE SPECIFICATIONS. ....	27
TABLE 2 – PERCENTAGE FREQUENCY OF THE TOP TEN MICROBIOLOGY ACTIVITIES CARRIED OUT IN THE CLASSROOM, SPLIT BY THE THREE LEVELS OF EDUCATION: KEY STAGE 3 SCIENCE, KEY STAGE 4 SCIENCE AND POST-16 BIOLOGY .....	36
TABLE 3 – PERCENTAGE FREQUENCY OF THE REASONS RESPONDENTS GAVE AS TO WHY THEY DO NOT CARRY OUT PRACTICAL MICROBIOLOGY AS PART OF THEIR SCIENCE/BIOLOGY EDUCATION, SPLIT BASED ON THE LEVELS OF EDUCATION THEY TAUGHT: KEY STAGE 3 SCIENCE, KEY STAGE 4 SCIENCE AND POST-16 BIOLOGY .....	38
TABLE 4 - CHI-SQUARE TEST DATA INCLUDING TEST STATISTIC, DEGREES OF FREEDOM AND P VALUE. THE TEST INVESTIGATED INDEPENDENCE BETWEEN THOSE WHO USE PRACTICAL MICROBIOLOGY IN THEIR SCIENCE/BIOLOGY EDUCATION AND FINDING ONE OR MORE VARIABLES A LIMITING FACTOR IN PRACTICAL MICROBIOLOGY. P VALUES IN ITALICS ARE STATISTICALLY SIGNIFICANT ( $P < 0.05$ ). ....	44
TABLE 5 – INDEPENDENT SAMPLE MANN WHITNEY U TEST DATA, INCLUDING MEAN AND MODE SCALE VALUE, STANDARD DEVIATION AND P VALUE. THE TEST LOOKED AT ANSWERS TO THE QUESTION: TO WHAT EXTENT DO YOU VALUE PRACTICAL SCIENCE ACTIVITY IN THE TEACHING OF MICROBIOLOGY? INVESTIGATING DIFFERENCES IN THOSE WHO USED PRACTICAL MICROBIOLOGY AND THOSE WHO DID NOT USE PRACTICAL MICROBIOLOGY IN THEIR SCIENCE/BIOLOGY TEACHING .....	53
TABLE 6 - CHI-SQUARE TEST DATA INCLUDING TEST STATISTIC, DEGREES OF FREEDOM AND P VALUE. THE TEST INVESTIGATED INDEPENDENCE BETWEEN WHETHER RESPONDENTS WHO TAUGHT PRACTICAL MICROBIOLOGY AND MEMBERSHIP OF THE SOCIETY FOR GENERAL MICROBIOLOGY.....	55
TABLE 7 - CHI-SQUARE TEST DATA INCLUDING TEST STATISTIC, DEGREES OF FREEDOM AND P VALUE. THE TEST INVESTIGATED INDEPENDENCE BETWEEN MEMBERSHIP OF SGM AND FINDING ONE OR MORE VARIABLES A LIMITING FACTOR IN PRACTICAL MICROBIOLOGY EDUCATION .....	57
TABLE 8 - THE NATURE OF SCIENCE OBJECTIVES EXTRACTED FROM EIGHT INTERNATIONAL SCIENCE STANDARDS DOCUMENTS (MCCOMAS AND OLSON, 2002).....	81
TABLE 9 – THINKING STYLES ADAPTED FROM THE ‘THEORY OF MENTAL SELF GOVERNMENT’ (STERNBERG AND ZHANG, 2005), SPLIT DEPENDING ON HOW THEY ALIGN WITH CONSIDERATION OF NOS IN PRACTICAL ACTIVITY IN SCHOOL SCIENCE .....	109
TABLE 10 -EXAMPLES OF LINKS BETWEEN A KEY STAGE 4 (GCSE) SPECIFICATION (AQA, 2010) AND THE RELEVANCE OF ALGAE IN THE CLASSROOM.....	116

TABLE 11 - QUESTIONS PRESENTED TO PARTICIPANTS IN THE SUMMATIVE EVALUATION SURVEY FOR 'ALGAE: A RESOURCE FOR SECONDARY SCHOOLS' .....	186
TABLE 12 – TWO-TAILED INDEPENDENT STUDENTS' T TEST DATA (P VALUES). THE TEST INVESTIGATED DIFFERENCE BETWEEN RATINGS GIVEN TO EACH ELEMENT OF THE RESOURCE IN RELATION TO EACH OTHER. NO DATA WERE SIGNIFICANTLY DIFFERENT (P<0.05).....	197
TABLE 13 - COMMENTS LEFT BY PARTICIPANTS IN RESPONSE TO QUESTION NINE OF THE SUMMATIVE SURVEY QUESTIONNAIRE. RESPONSES ARE SPLIT INTO POSITIVE OR NEGATIVE AND GROUPED INTO THEMES .....	202
TABLE 14 - COMPARISON OF AVERAGE RESULTS (N=3) FROM EXPERIMENT FOUR: DISTANCE FROM SOURCE OF LIGHT. ....	267
TABLE 15 – SOLUTIONS CAPABLE OF ACCELERATING GROWTH, AND WATER CONTROLS, USED TO INVESTIGATE THE GROWTH RATE OF <i>EUGLENA GRACILIS</i> IN STERILE AND NON-STERILE CONDITIONS. ....	271

## Acronyms

<b>Acronym</b>	<b>Full term</b>
<b>ASM</b>	American Society for Microbiology
<b>AQA</b>	Assessment and Qualifications Alliance
<b>ATP</b>	Adenosine triphosphate
<b>ASE</b>	Association for Science Education
<b>BTEC</b>	Business and Technology Education Council
<b>CCEA</b>	Council for the Curriculum, Examinations and Assessment
<b>CIE</b>	Cambridge International Examinations
<b>CCAP</b>	Culture Collection for Algae and Protozoa
<b>CfE</b>	Curriculum for Excellence
<b>CLEAPPS</b>	Consortium of Local Education Authorities for the Provision of Science Services
<b>CPD</b>	Continued professional development
<b>DNA</b>	Deoxyribose nucleic acid
<b>GCE</b>	General certificate of education (A Level)
<b>GCSE</b>	General certificate of secondary education
<b>IAS</b>	Ideas about science
<b>IGCSE</b>	International general certificate of secondary education
<b>NADP</b>	Nicotinamide adenine dinucleotide
<b>NCBE</b>	National Centre for Biotechnology Education
<b>NCCPE</b>	National Coordinating Centre for Public Engagement
<b>NOS</b>	Nature of science
<b>NQF</b>	National Qualifications Framework
<b>NSLC</b>	National Science Learning Centre
<b>OCR</b>	Oxford, Cambridge and RSA Examinations
<b>OD</b>	Optical density
<b>OFQUAL</b>	Office of Qualifications and Examinations Regulation
<b>PCK</b>	Pedagogical content knowledge
<b>PCR</b>	Polymerase chain reaction
<b>PGCE</b>	Postgraduate certificate of education
<b>SAPS</b>	Science and Plants for Schools

---

<b>SCQF</b>	Scottish Credit and Qualifications Framework
<b>SMK</b>	Subject matter knowledge
<b>SQA</b>	Scottish Qualifications Authority
<b>SSERC</b>	Scottish Schools Education Resource Centre
<b>WJEC</b>	Welsh Joint Education Committee

---

## **Preface**

This thesis consists of seven chapters split into five sections.

### Section One – Microbiology and the school classroom

Here, the current state of practical science in schools is considered and practical microbiology in schools is investigated.

- Chapter 1
  - Part 1 – Practical science in UK secondary schools
  - Part 2 - Practical microbiology in UK secondary schools: a national survey of teachers
  - Part 3 – project aims and objectives

### Section Two – Research in science education

This section provides a literature review of school science education and its relation to producing a practical activity resource

- Chapter 2 – Science and the classroom
- Chapter 3 –Secondary school science pedagogy

### Section Three – ‘Algae: a practical resource for secondary schools’

These two chapters detail the development and evaluations of a new practical microbiology activity resource

- Chapter 4 – Developing an educational resource for practical microbiology activity
- Chapter 5 - ‘Algae: a practical resource for secondary schools’: summative evaluation

### Section Four – School science and science communication

This section discusses how a school activity can be successfully translated into a science communication event

- Chapter 6 – Developing an school practical activity into a science communication event

### Section Five

- Chapter 7 – Conclusion



## **Section 1 - Microbiology and the school classroom**

### **Chapter 1 - Part 1: Practical science in UK secondary schools**

## **1.1 - Science education in secondary schools**

As the world recovers from a time of severe financial crisis, governments have shuffled policy agendas towards economic stimulation. “The United Kingdom has always had a proud track record of achievement within science and engineering, and it is on these strengths that the UK should continue to build” (The Royal Society, 2010). In recent years there has been a call for a review of the way STEM (Science, technology, engineering and mathematics) subjects are taught to young students because it is believed that these academic disciplines are essential in keeping the UK a world leader in science-based research (DES, 2006). Thus, to maintain and increase engagement in science through school and beyond, more funding has been made available to various STEM subject initiatives (Science and Technology Committee, 2010). However, there are numerous problems to address before science can be successfully promoted to the young student population, including class size, cost, time, student behaviour (CaSE, 2007b), teacher knowledge and interest, and technical expertise. Support for educators in promoting science to their students is likely to be welcomed.

This support can come from many sources. More than 80 professional societies in the United States alone represent disciplines in the life sciences, providing a significant level of focused support for research, with many of these societies having built into their constitutions a strong emphasis on public and school education (Eastwood, 2000). Conversely, fragmentation of this sort can be detrimental to biological education (Chang, 2011). Biology education resources aimed at schools, produced by learned societies, may become diluted by several attempts to cover similar topics. However, the in-depth knowledge base that each of these societies is likely to hold is a useful starting place for developing school educational materials, because it is likely to be current and relevant.

## **1.2 – A need for microbiology education in schools**

It is well known within the scientific community that research is becoming more and more interdisciplinary (Porter and Rafols, 2009), branching outside of the 'normal' parameters of a particular field to broaden investigations. Microbiology is no exception. The study of microorganisms has aided advancement in areas of biological sciences that might not immediately be associated with microbiology (genetics, cellular physiology and molecular biology for example). Thus, scientists working with microorganisms may not necessarily identify themselves as microbiologists. It is for this reason some scientists within the microbiology community are concerned that the subject may be 'losing its identity' to modern molecular and genetic sciences (Bennett, 1999). In correspondence with an American colleague, the then chairman of the education group of the Society for General Microbiology in the UK had commented that "we have become very concerned about the way that 'microbiology', since the onset of the cloning era has become synonymous with 'molecular biology'" (Pelczar, 1991).

Another concern is the disappearance of certain aspects of microbiology. Some elements of the science such as medical microbiology and biotechnology remain popular, but some more 'classical' microbiology topics are under threat. Mycology, the study of fungi, is described by some as a dying field, with a decrease in structure and scope of mycology research, leading to a lack in trained individuals (Steinbach, 2003). There is also a decline in the number of practicing taxonomists (Ando, 2004, Caine, 2011), presenting problems for the perpetuation of the science, a concern echoed by a review into microbial science research by the Biotechnology and Biological Sciences Research Council (BBSRC) noting an erosion in the number of researchers and students skilled in the core microbial sciences (Dorman, 2006).

Despite the notion of a loss of identity and often being viewed by the public (and therefore potentially school students) as the science of disease (as is often reported in the media), microbiology is a vibrant subject. Microbiology plays a vital role in agriculture, medicine, bioremediation, biotechnology, engineering and other fields (Maloy and Schaechter, 2006), as scientists attempt to confront current global issues, such as enhancing human, plant and animal health, combating food shortages and providing clean, renewable energy sources. Understanding these 'real life' applications enables students to make a connection between their textbooks and real life (Miller, 2011). In turn the scientific community must meet these challenges: progress in microbiology research must advance on many fronts, particularly in providing a future for the subject by capturing the imagination of young students, training them and communicating to them the importance of microbiologists within society (Bassler, 2011).

Microbiology has a century-long tradition of commitment to science education (Handelsman, 2002). Louis Pasteur, widely regarded as one of the founders of microbiology, was a keen educator. Pasteur's pedagogy mirrored his conception of experimental science training (open ended investigations, experimental, active learning), a process in which theory and practice were closely linked (Opinel, 2008). This has remained an essential element in training microbiologists worldwide ever since. However in order to inspire young students to follow Pasteur's footsteps into the field of microbiology, this style of practical teaching is required at all levels of education.

### **1.3 - Microbiology in the National Curriculum for England and other UK teaching specifications**

Numerous documents produced by government bodies or examining/certification organisations dictate and guide science education in UK secondary schools.

In England, Wales and Northern Ireland, the National Curriculum (NC) was split into different age-dependant levels, known as Key Stages. It was Key Stage (KS) 3, (generally taught to school years seven to nine or ages 11 to 13), and KS 4, (generally taught to school years ten and 11, or ages 14 and 15, culminating with examinations for the General Certificate of Secondary Education (GCSE)) that dictated the architecture of science in secondary schools. Science formed a key role in both of these Key Stages, and is classed as core subject by the Education Act 2002, ensuring it was taught to all students in state schools. Those schools operating as academies did not have to follow the broad reach of the NC, but, they were required to teach the same core subjects (including science) as state schools. The Government body OFQUAL, responsible for regulation of qualifications and assessments in England, produced subject criteria based on the NC, which all awarding body specifications must follow in order to be accredited. From these, the various awarding bodies that operate in England constructed their own specifications, detailing what subject knowledge students were required to learn in order to pass the GCSE examination.

There was no NC for education post-GCSE qualifications (16+). However, a similar subject criteria existed for science at A Level. Again, awarding bodies used this as a basis for their specifications, which required accreditation before teaching of that specification could commence.

Additionally, the BTEC qualification offered an alternative to the classic academic qualifications of GCSE and A level. BTEC is an applied qualification, with learning

directly applicable to the workplace. BTEC options in science and biology are available (Edexcel, n.d.).

The implementation of the subject criteria and the overview of OFQUAL ensured that qualifications in the UK are comparable with each other and their international counter-parts (Ofqual, 2012). This ensured students receive a similar level of broad education regardless of the awarding body that the school has chosen to follow. However, there were six awarding bodies in England, Wales and Northern Ireland and one in Scotland, all of which had different science/biology specifications. This means that although students should be receiving the same broad education, the detail of specifics, such as inclusion, breadth and reach of microbiology, may very well have been different.

### **1.3.1 - Microbiology in science for students aged 11-14 in England, Wales and Northern Ireland**

The following information was based on the latest National Curriculum provided to state schools in England at the time of writing (2013). The 'Science programme of study for Key Stage 3', the document produced by the Qualifications and Curriculum Authority (QCA, 2007a) was used to inform on what should be taught as science in school years seven to nine. It includes a series of key concepts and key processes of science. These include understanding scientific thinking, application and implementation of science, cultivating understanding, collaboration, practical and enquiry skills, critical understanding and communication of science.

Many of these concepts and processes could be demonstrated/highlighted when using microorganisms in the classroom. Under its Range and Content section, the document stated four, somewhat vague, areas of science to be taught. One area

had obvious potential for linking microbiology; 'Organisms, behaviour and health', with the document specifically mentioning disease and variation in organisms. Other areas (energy, electricity and forces, and the environment, Earth and the universe) also had potential to use microbiology, for example showing algae or cyanobacteria as primary producers or the effects pollution can have on the ecology of a body of water (eutrophication). However, the document lacked any direct mention of microorganisms.

Similarly, the National Curriculum document for Wales (DfCELLS, 2008) and its Northern Ireland counterpart (CCEA, n.d.) did not make any specific reference to microbiology.

It should be noted that in 2011, the Government announced a major review of the National Curriculum in England (DfE, 2012). A revised edition is expected to come into effect for teaching in 2014. The purpose of the revision is to slim down the National Curriculum to better represent the body of essential knowledge required to be taught, freeing up teaching time and allowing teachers to use their professional judgement in their own curricula development. At time of writing, a draft curriculum has been presented by the Department for Education for consultation (DfE, 2013a). This document does make direct mention to microorganisms. It states the following should be taught:

- The structure of *Euglena* (a microalgae – classed as a microorganism)
- The importance of bacteria in the digestive system
- Photosynthesis
- Chemosynthesis in bacteria

- Anaerobic respiration in organisms including microorganisms and fermentation
- How organisms are affected by and effect the environment

Although it is encouraging that microbiology was directly referenced (compared to the current National Curriculum), along with the notion that teachers will have more time to teach topics they see fit, one issue in particular is obstructive to the teaching of microbiology. The terms 'plant cell' or 'animal cell' was used when discussing the different types of cell structures, implying that these two types of cells encompass all organisms. If students are led to believe that all organisms can fit into one of these two categories, topics taught with microorganisms, in particular prokaryotes (bacteria) may cause confusion. It is also possible that microalgae (for example, *Euglena*, which is directly mentioned in the draft National Curriculum), a single celled photosynthetic microorganism, may be misidentified as plants. This presents an issue for delineating the science of microbiology within the National Curriculum: although it may have been there in essence, the students, and in some cases, teachers (particularly those who have not specialised in biology), may not have been able to identify it as such. This is somewhat contradictory to one of the aims of the National Curriculum, which under the section 'curriculum opportunity', states that students should prepare to specialise in a range of science subjects at Key Stage 4, and be considering these sciences as potential careers. If microbiology is misidentified, or hidden under the oversimplification of organisms, it is likely students will not have the chance to consider the field of microbiology as a career option.



### **1.3.2 - Microbiology in science for students aged 14-16 in the United Kingdom**

The following information is based upon the latest National Curriculum provided to state schools in England. The 'Science programme of study for Key Stage 4', the document produced by the Qualifications and Curriculum Authority (QCA, 2007b) is used to inform on what should be taught as science in school years ten and eleven, ending with the GCSE award. It states that students "should be taught the Knowledge, skills and understanding of how science works through the study of organisms and health, chemical and material behavior, energy, electricity and radiations, and the environment, Earth and universe".

However, the particular topics taught in secondary schools at this stage are dependent on which awarding body the school chooses. Schools in England, Wales and Northern Ireland can choose between six awarding bodies for Science GCSEs (the Scottish system has one examining body, and, although not directly comparable, the Standard grade qualifications are awarded to students aged between 14 and 16).

#### ***1.3.2.1 - Review of microbiology in the awarding bodies of the United Kingdom for qualifications taken aged 14 to 18.***

In order to assess and understand what microbiology is accessible to schools via the topics they are expected to teach, a review of awarding bodies teaching specifications was undertaken. The following review is inclusive of all the awarding bodies operating in the United Kingdom, which award the GCSE, IGCSE, BTEC, standard grade, A Level, Higher or Advanced Higher qualifications. These bodies included AQA, CCWA, CIE, Edexcel, OCR, SQA and WJEC. Specifications reviewed included general science awards and biology awards for GCSE, BTEC IGCSE and standard grades (14-16 qualifications) and biology awards for A Level/GCE, Highers and Advanced Highers (16-18 qualifications). Twenty-two

specifications were included (15 GCSE, IGCSE, BTEC and standard grades and seven A Level/GCE, Highers or Advanced Highers):

- WJEC Linear Science (WJEC, 2012b) and Linear Science B (WJEC, 2012a) GCSE
- OCR Twenty First Century Science Suite Biology A(OCR, 2012a), Science A (OCR, 2012b) and Science Additional A(OCR, 2012c)
- Edexcel GCSE in Science (Edexcel, 2013) and Biology (Edexcel, 2011)
- Edexcel BTEC in Applied Science Level 3 National (Edexcel, 2008)
- CCEA GCSE in Science (CCEA, 2012b) and Biology (CCEA, 2012c)
- CIE Cambridge IGCSE Biology (CIE, 2010)
- AQA GCSE in Science (AQA, 2012b) and Biology (AQA, 2007)
- SQA Standard in Science (SQA, 2000b) and Biology (SQA, 2000a)
- AQA GCE Biology 2410 (AQA, 2007)
- CCEA GCE Biology (CCEA, 2012a)
- Edexcel GCE Biology 9BIO1(Edexcel, 2010)
- OCR GCE Biology H421 (OCR, 2008)
- WJEC GCE Biology (WJEC, 2008)
- SQA Biology Higher (SQA, 2002) and Biology Advanced Higher (SQA, 2006)

A comprehensive table of themes, topics or concepts, either directly or indirectly mentioning a topic related to microbiology was constructed (Appendix 1 – Review

of microbiology-related content in science / biology teaching specifications in the United Kingdom). Due to the nature of the different teaching specifications, microbiology topics have been grouped together into general topic areas (e.g. antibiotics), despite slight variations in the particulars of each specification. A summary of the findings is provided below.

The syllabuses for GCSE, IGCSE, BTEC and standard grades (14-16 qualifications) provided 43 mentions, themes or concepts that could be attributed to, or supported by microbiology. The spectrum of microbiology covered is wide, with mention of all types of microorganisms. The most common themes to appear included the phenomenon of photosynthesis, the role of microorganisms in cycling of carbon and nitrogen and the use of lichen as an environmental indicator of pollution. Seventeen references to microbiology appeared in the majority (over 50%) of the teaching specifications (Figure 1). Here, a range of applications were discussed, including the role of microorganisms in the environment and how microorganisms can affect human populations (particularly with reference to disease). Additionally, understanding the bacterial cell structure featured in just over half of the specifications, an interesting concept given the focus on 'plant or animal' cells in the National Curriculum.

There are 26 additional references to microbiology that featured in fewer than 50% of specifications. However, these are by no means less important concepts, themes or ideas. Important scientific foundations such as how scientists classify organisms, using the five kingdoms or three-domain system, and genetic or morphological features (including the use of identification keys) are noted. Physiological phenomena, such as the structure of fungal, yeast and algal cells and viral particles, understanding that organisms are able to sense and respond to

external stimuli, and that some respire aerobically and/or anaerobically whilst some photosynthesize, are also featured.

Understanding algal cell structure appeared in four of the specifications, whilst the role of microorganisms in digestion appeared in two specifications. Both topics appear specifically in the forthcoming revised National Curriculum.

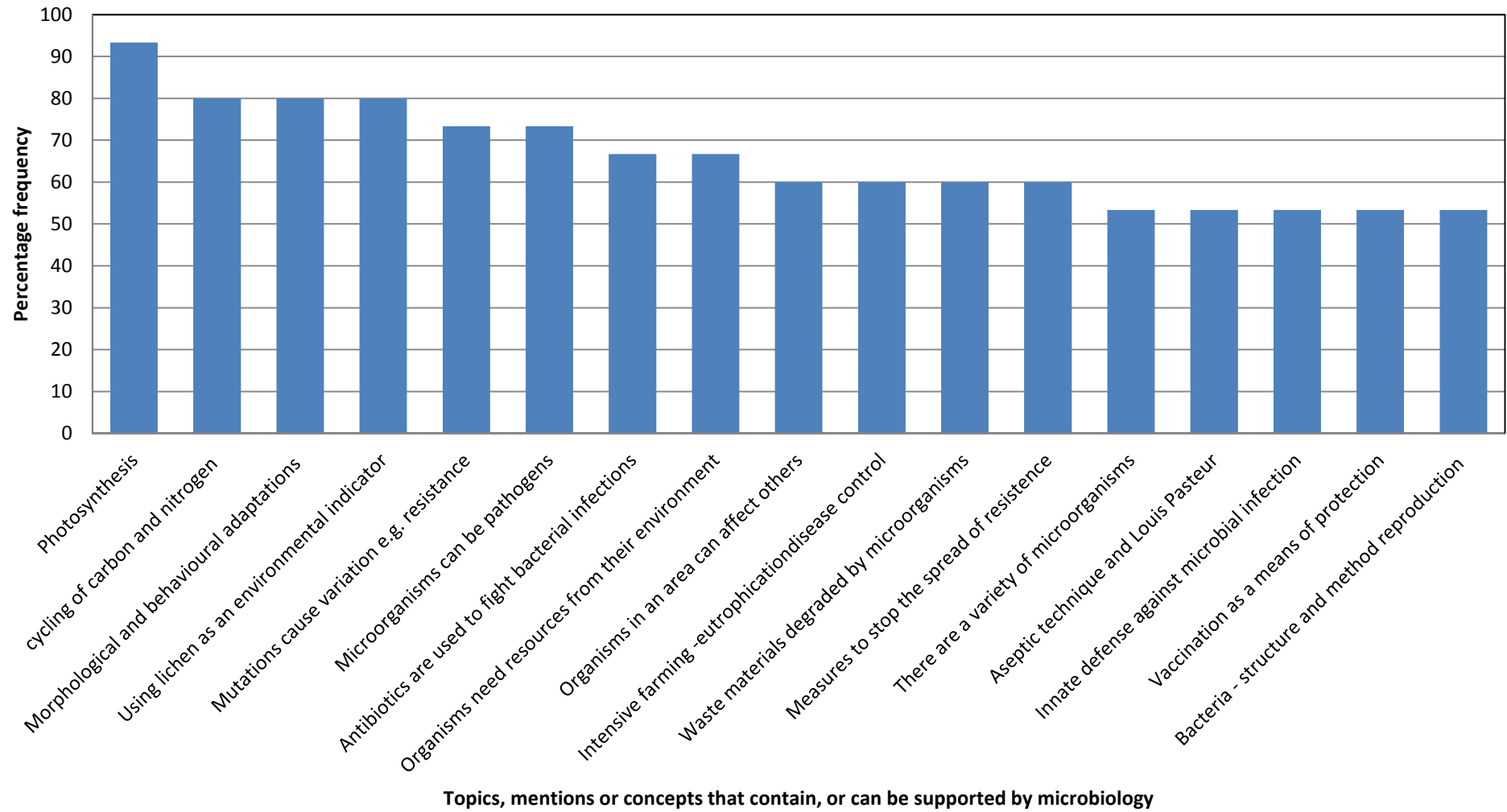

Figure 1 - Percentage frequency of microbiology mentions, themes, topics and concepts in GCSE, IGCSE, BTEC and standard grade 14-16 qualification specifications (n=15)

Only one specification (BTEC Applied Science) made reference to the field of science communication and microbiology, and how it affects the greater scientific community, discussing the MMR vaccine debate. This is an interesting direction for science education in secondary schools, potentially allowing students to understand how science informs decisions that affect their day-to-day life, whilst understanding the potential controversy and ethical debate that science can bring.

The 16-18 qualification specifications noted a different, yet equally important range of microbiology. The seven specifications for A Level, Higher and Advanced Higher provided 52 mentions, themes or concepts that could be attributed to, or supported by microbiology. The topics mentioned in the majority of specifications (Figure 2) share some similarities/crossover from the previous qualification level, with mentions to cycling of carbon and nitrogen, photosynthesis and the concept of energy transfer through the environment. Additionally there is previously unspecified subject content, such as the use of microorganisms in protein manufacture, actions of pathogens within the host cell, antibiotic modes of action and using molecular biology techniques such as PCR to conclude a medical diagnosis. In a change from the 14-16 specifications, the 16-18 specifications state that students should understand the structure of both the prokaryotic and eukaryotic cell, a scientifically accurate representation of how science classifies organisms (compared to previous specifications).

Across the 14-16 specifications, there was an average of 16.67 references to microbiology in each specification, and an average of 27 references to microbiology within each of the 16-18 specifications. As noted above, these vary greatly in content and application. Along with the scientific content, each of the teaching specifications designates certain skills and competencies that students require. A key focus of this was practical activity, for example, the WJEC science

GCSE specification (WJEC, 2012b) states that practical work is essential and should be integral to content of the syllabus. The specification links to learned societies such as the Society of Biology for information and practical activity ideas. As an essentially 'practical' field, microbiology poses a logical starting point for practical science in the secondary school classroom. However, the current state of practical microbiology activity in secondary schools is undocumented.

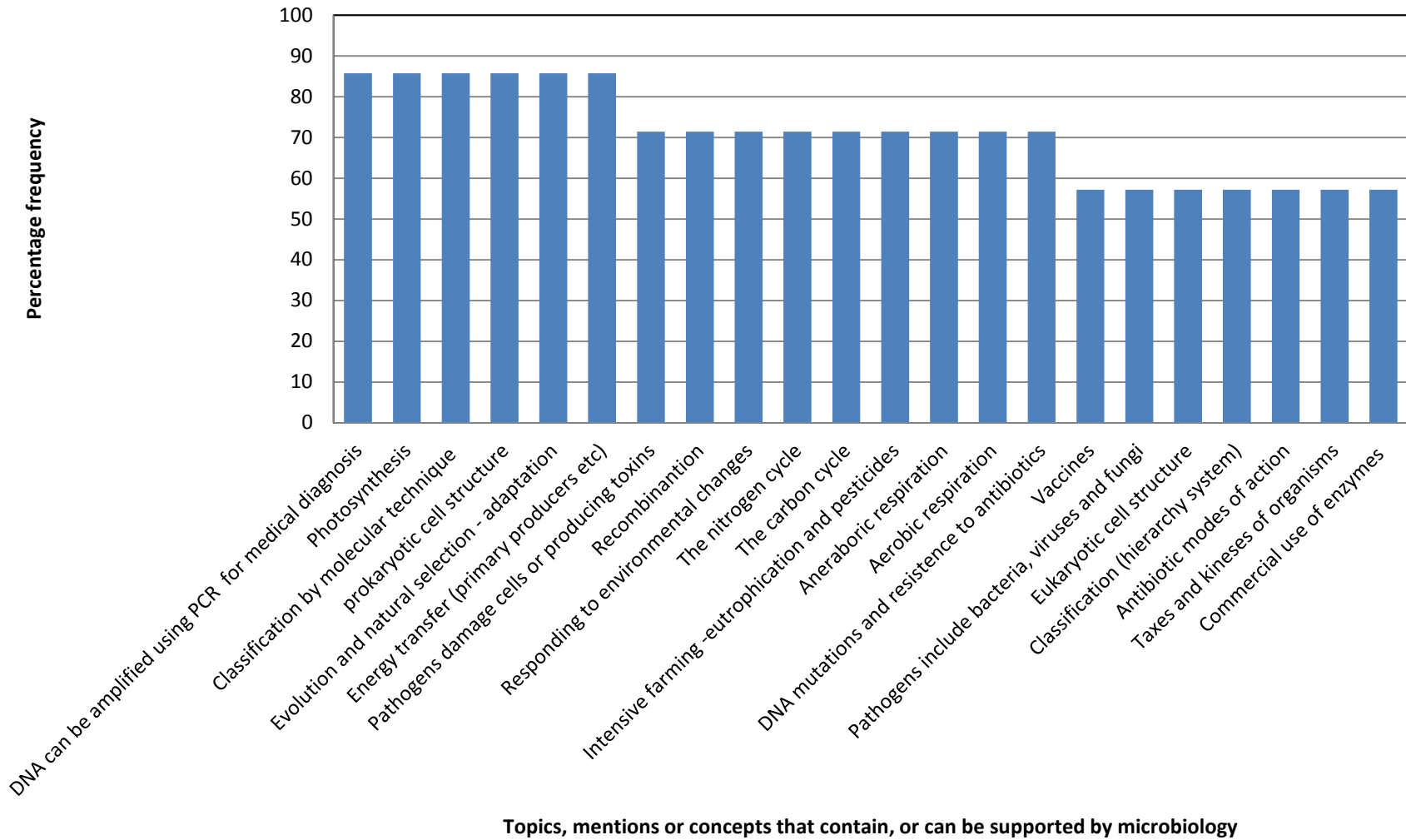

Figure 2 - Percentage frequency of microbiology mentions, themes, topics and concepts in A Level, Higher and Advanced Higher 16-18 qualification specifications (n=7)



## **1.4 -Practical science in schools**

“Tell me and I will forget; show me and I may remember; involve me and I will understand” – Confucius circa 450BC

An essential aspect of science education, in contrast to many other subject areas in schools is its practical element. Practical science in education has been common practice since the mid 1800s (Sunal, 2008), providing an opportunity for students to get hands-on experience, tying together the theory behind science with visual demonstration. Research suggests that development of critical thinking and analytical skills rather than memorization of content is more effective for learning (Gregory, 2011), and that ways of learning that lead to a better understanding can not only help develop learning skills, but will help students operate more effectively in an ever changing world (Harlen, 2010). All of these behaviours are encouraged by practical science. However, practical and investigative work has had a difficult time in the UK curriculum (Sears, 2000) and evidence shows that teachers are reducing the amount of practical activity performed in school classes (CaSE, 2007a). One survey suggested that over 3 out of 4 school practical sessions were at times cancelled (SBS, 2004), with the most common reasons listed as student behaviour issues, class size and lack of appropriate equipment. It is also possible that practical activities in the classroom are not always appropriate; research has suggested that experimental approaches to science can on occasion have little effect on the learning process of students, as they fail to understand the teacher’s intentions behind the practical activity at the student’s educational level (Welz, 2006).

Ofsted stated that in outstanding schools the vast majority of science teachers were subject-specific, and practical work was used particularly effectively (OFSTED, 2008). However, a report from the Royal Society suggests that there is

a serious shortage of science teachers, and for a long time there had been no accurate means of suggesting what number of these teachers are science specialists (The Royal Society, 2007). It has been claimed that a push to increase numbers of physics and chemistry teachers at secondary level would be detrimental to those wanting to teach biology at secondary school level, by reducing the number of spaces available to biology graduates wishing to teach the subject (Lock, 2011). A lack of science specialism in teachers is not just an issue for secondary schools. It has been suggested that the number of science specialist teachers in primary education needs to be tripled to meet the current demand (Garner, 2010).

Despite all the problems teachers may have when attempting to support students in practical activities, practical science is essential. Teachers strongly supported with resources are able to make the curriculum as engaging as possible (Downs, 2010). Research has suggested that for practical activity in the classroom to result in a positive stimulation and motivation towards science, a number of criteria should be met. These include simple and clear instruction, repeatable and reliable activities, minimal sophistication, provocative, surprising and fascinating exercises that clearly demonstrate the point of the activity, having connections to the daily lives of the student and motivating the students to reflect about the problems they are investigating (Welz, 2006). It is therefore easy to conclude that an educational resource which aims to provide practical activities for teachers, designed to be as simple as possible for the teachers and school technicians to deliver, while providing an engaging, stimulating yet interesting platform targeted at students of the correct age/educational level, would be of great value.

After considering all the information discussed in this section, it is logical to next discover what microbiology, particularly in the sense of practical activity, is carried

out in the classroom, and see if this complements the variety of microbiology the NC and teaching specifications of the UK. Currently, there is no research indicating the status of practical microbiology in the classroom, however there is anecdotal evidence to suggest that teachers find it difficult to employ a microbiological topic as a practical activity. The aim of the next section is to undertake this task, identifying what microbiology is presented practically to students, and what teacher's thoughts and feelings were towards having the field of microbiology in their classrooms.

**Chapter 1 - Part 2: Practical microbiology in UK Secondary  
Schools: a National Survey of Teachers**

## **1.5 Practical microbiology in UK secondary schools: a national survey of teachers**

### **1.5.1 - Introduction**

After informal discussion with a number of secondary school science teachers, a questionnaire was developed (Figure 3 and Figure 4) to investigate the following two research questions:

- What is the current state of practical microbiology activity carried out in UK secondary school science laboratories (including post-16 education)?
- What are a teacher's thoughts and concerns about practical microbiology in the secondary school science laboratory (including post-16 education)?

The results from this survey have been published in the peer-reviewed journal *Trends in Microbiology* (Redfern *et al.*, 2013a).

### **1.5.2 - Methodology**

#### **1.5.2.1 - Survey design**

This survey was designed with a mixed methods approach, a research paradigm that has strong support from education researchers (Gorard and Smith, 2006). The mixed methods approach, whilst being a relatively young and potentially confusing research paradigm (Leech and Onwuegbuzie, 2009) allows for a convergence between the two 'conflicting' data types (quantitative and qualitative), providing a stronger, less-biased view, and includes the "collecting, analysing, and interpreting quantitative and qualitative data in a single study" (Tashakkori and Teddlie, 2003). Consequently, there were several kinds of questions and response modes used, creating a semi-structured questionnaire. These included dichotomous questions, multiple-choice questions, rating scales and open-ended questions. Although the

## Practical microbiology in schools survey

Thank you for taking time to complete this questionnaire. The purpose of the questionnaire is to assess the current state of practical microbiology in secondary schools education including A level (or Scottish equivalent). Please note 'Practical Microbiology' should be taken to mean any experimental/practical application that can be considered microbiology (for example the use of bacteria, fungi, algae, protozoa or phage). All responses are anonymous.

- 
- Q1) Does your school currently hold membership of The Society for General Microbiology?  
Yes   
No   
Don't know
  
  - Q2) Do any of the following limit your teaching of practical microbiology?  
Confidence in microbiological technique   
Resources
    - Time
    - Equipment
    - Technician support
    - FinancialReliability/reproducibility of practical activities   
Health and safety considerations   
Other, please specify \_\_\_\_\_
  
  - Q3) What stage of science education do you teach? (Please tick all that apply and continue to the relevant questions)  
Key stage 3  (go to Q4)  
Key stage 4  (go to Q5)  
A-Level (biology)  (Go to Q6)

---

Answer if you teach Key stage 3 science (or Scottish equivalent)

- Q4) Do you teach practical microbiology?  
Yes   
No
  
- If yes, what type of practical activities do you carry out? Please list up to the 5 most important/significant.
  
- If no, why do you not teach practical microbiology?

Questions 5 to 9 overleaf

Figure 3 - The first page of the questionnaire provided to respondents from distributors in England

Answer if you teach Key stage 4 science (or Scottish equivalent)

- Q5) Do you teach practical microbiology?  
Yes   
No
- If yes, what type of practical activities do you carry out? Please list up to the 5 most important/significant.
- If no, why do you not teach practical microbiology?

---

Answer if you teach A Level biology (or Scottish equivalent)

- Q6) Do you teach practical microbiology?  
Yes   
No
- If yes, what type of practical activities do you carry out? Please list up to the 5 most important/significant.
- If no, why do you not teach practical microbiology?

---

Q7) To what extent do you consider practical science activity in secondary science education to be important? (Please circle)

Of no importance 1 2 3 4 5 6 7 Extremely important

Q8) To what extent do you value practical science activity in the teaching of microbiology?

Valueless 1 2 3 4 5 6 7 Valuable

Q9) Do you have any further comments regarding the teaching of microbiology in key stage 3, 4 and A level teaching?

Thank you for taking part in this survey



Figure 4 - The second and final page of the questionnaire provided to respondents from distributors in England

majority of questions produced quantitative data, the incorporation of qualitative questions allowed for a deeper understanding, supporting the numerical data produced.

A pilot questionnaire was supplied to a trial group of teachers (n=6) prior to distribution. The aim of this was to test the questionnaire for ease-of-completion and readability. Following the pilot questionnaire, questions two and three were reversed, and greater distinction was made between questions four, five and six, to ensure respondents understood that these questions were to be answered individually (Figure 3 and Figure 4).

#### **1.5.2.2 - Definition of terms**

The survey was distributed in two countries which operate different levels of education and curricula (England and Scotland). Therefore some of the questions were worded differently, depending on the location of the distributor. (Table 1).

The term 'practical microbiology' should be taken to mean any experimental/practical application that can be considered microbiology (for example the use of bacteria, fungi, algae, protozoa or viruses). This information was provided in an explanatory text at the top of the survey.

'Membership of the Society for General Microbiology (SGM)' is referencing school membership. SGM is a scientific membership society. It is the largest society for Microbiology in Europe. One of the societies aims is to promote microbiology in the school classroom. Membership to this society in particular is being investigated as it holds the largest school-specific membership of any microbiology society in the UK, and is the leading source of free support for microbiology in schools. The



benefits of school membership include copies of all educational resources they produce and discounts on SGM INSET courses.

### **1.5.2.3 - Ethics**

All responses were analysed blind. This was made clear to participants at the start of the questionnaire. The distributors (detailed below) gave respondents the option to withdraw from completing the survey, at any point, for any reason. This study follows the British Educational Research Association ethical guidelines for educational research (BERA, 2011).

**Table 1 – Education levels in England and Scotland based on the National Qualification Framework (NQF), the National Curriculum in England, Wales and Northern Ireland, the Scottish Credit and Qualifications Framework (SCQF) and Curriculum for Excellence (CfE) which include microbiology and/or have potential for practical microbiology in the specifications.**

<b>Level of education in England</b>	<b>Level of education in Scotland</b>	<b>Term used in the survey report</b>
<b>Key Stage 3 science Entry level BTEC awards</b>	Biological systems (CfE level 3/4)	Key Stage 3 science
<b>Key Stage 4 science (GCSE) Applied Science &amp; Land based and environment (Level 1 &amp; 2 BTEC awards)</b>	Standard grade science/biology	Key Stage 4 science
<b>A Level biology Applied Science (Level 3 BTEC award)</b>	Higher biology Advanced higher biology	Post-16 biology

#### 1.5.2.4 - Participants

The target audience for the survey was teachers providing science education to secondary school students in the UK, thus potentially teaching microbiology as part of the National Curriculum at Key Stage 3 (KS3) and Key Stage 4 (KS4) or awarding body specification (post-16) or other age/level-appropriate award. Teachers involved in KS3 and KS4 science education are often required to teach all branches of science, therefore the participants were not restricted to biology specialists. The survey, described subsequently, was distributed through a number of locations:

- Two Science Learning Centres in England (The National and North West centres) to teachers visiting on continued professional development (CPD) courses
- The Scottish School Education Research Centre (SSERC) to teachers visiting on continued professional development (CPD) courses
- Delegates at the Association for Science Education (ASE) conference in Liverpool, 2012, who visited the SGM exhibition stand
- Electronic (email) distribution to the school membership of the SGM

The distributors were informed that only those in a science teaching position in a UK secondary school should participate. All responses were collected by the individual distributors, anonymised where necessary and returned to the author for analysis. Any responses that were not from teaching staff (i.e. technical or support staff or those from outside the UK) were not included in the analysis. Respondents were encouraged to complete a survey at the ASE conference by receiving a complimentary copy of a microbiology education pack. Otherwise there was no incentive for completing the survey. A general mail-out to secondary schools was

ruled out during the planning stages due to the concern of a low turnout and lack of access to a suitable mailing list.

A total of 248 teachers completed the survey. Ninety-one point one per-cent of respondents identified themselves as teaching KS3 science, 89.5% KS4 science and 66.9% post-16 biology. Teachers were asked if their school had a school-level membership to the Society for General Microbiology: 39.1% answered yes, 43.1% answered no, whilst 16.9% did not know.

#### **1.5.2.5 – Instrumentation (question types)**

The survey consisted of a two-page, nine question questionnaire covering four areas of interest. The first gathered basic information (questions 1 and 3) such as what education level they taught and their membership status to the SGM, detailed in the previous section ('Participants' – page 28). The second focused on limitations to the teaching of practical microbiology. This question (question 2) was posed in a tick box format, giving the following options: confidence in microbiological technique, time, equipment, technician support, finance, reliability/reproducibility of practical activities or health and safety considerations. Respondents were then given space to write an additional answer if deemed necessary.

The third area (questions 4 to 6) addressed whether the respondent carried out practical microbiology as part of their teaching. This was covered by three questions, one for each of the levels of education KS3, KS4 and post-16. Respondents were asked to answer each question only if they taught science/biology at that particular level. The first part of each question asked if the respondent taught practical microbiology with a yes or no answer. If the respondent answered yes, they were asked to elaborate on the type of practical

activities they carried out, listing up to the five most important/significant. If the respondent answered no, they were asked to provide a reason as to why not.

The last area of the survey (questions 7 and 8) investigated whether teachers believed that practical activity and in particular practical microbiology were important and valuable in science education. This was assessed by responses in two seven-point-semantic differential scales. Semantic differential scales are often used in one of three contexts; evaluative (e.g. valuable-valueless), potency (e.g. large-small) and activity (e.g. active-passive) (Osgood, 1957). Here they were used in an evaluative context. Question seven asked the respondent to decide, on a scale of one to seven, to what extent they considered practical science activity in secondary science education to be important (with a rating of one being of no importance, and seven being extremely important). Question eight asked to what extent do teachers value practical science activity in the teaching of microbiology (with a rating of one representing valueless and seven representing valuable).

A final question (question 9) allowed respondents to provide any additional comments regarding microbiology in the classroom in a written, open-ended format. These data would be analysed to see if they could offer qualitative support; backing up any themes or suggestions that the quantitative data may have produced.

#### **1.5.2.6 - Analyses**

Overall trends and responses are presented in a mixture of tables and charts. Chi-square analysis for independence was carried out to allow different variables (answers) to be considered together where appropriate. Mean and mode of scores were calculated for questions with semantic differential scale responses, and the Independent Samples Mann-Whitney U test used to analyse data. A significance level of five per-cent ( $P < 0.05$ ) was used on all statistical tests. All statistical

analysis was carried out using the statistical software package IBM® SPSS® Statistics 19.

### **1.5.3 - Results and discussion**

This survey examined the current status of practical microbiology activity in UK secondary schools over the academic year 2011 - 2012. Distributors were followed up throughout the survey period, with no reports of difficulties understanding the questions or following the survey design. The data collection period closed (12 months), with 248 responses from a distribution of approximately 700, giving a response rate of about 35%. The sample size is small compared to the current number of in-service science teachers (about 32,000 (DfE, 2013b)), however this was a small-scale, exploratory investigation into practical microbiology in UK secondary schools. After considering the results, changes to the design and an addition of two questions would have improved feedback.

The sequence of questions approached the topics of what limitations teachers had, followed by whether they taught practical microbiology, and lastly what they thought about practical activity and practical microbiology in particular. Had the questions been ordered to address whether the teachers used practical activity first, followed by what limitations they found and lastly their thoughts, the survey may have felt like a more natural progression with potentially less repetition.

It would have been useful to ask in what country within the UK the respondent taught. Although the survey was distributed in two different countries, one cannot ascertain whether those responding in England only taught in England, and those that responded in Scotland only taught in Scotland. Additionally the ASE conference regularly draws in delegates from England, Wales, Northern Ireland

and Scotland. The online version of the survey was distributed to all SGM members (which may be either English or Scottish schools). This means no inference can be made to differences between the two curricula followed in the UK (the National Curriculum of England, Wales and Northern Ireland, and the Curriculum for Excellence in Scotland). Instead all data were grouped together and analysed as a UK-wide survey.

The science speciality of the respondent is likely to affect their opinions regarding practical microbiology in the classroom. This additional data would have allowed analyses as to whether those that had trained in biology education had different practices, issues and comments from physics or chemistry-trained teachers.

The survey results are presented in five sections:

- Practical microbiology in the secondary school classroom
- Limitations of teaching practical microbiology in the secondary school laboratory
- Importance of practical activity and in particular practical microbiology
- Effect of school membership of the Society for General Microbiology on practical microbiology in the classroom
- Additional comments

### 1.5.3.1 - Practical microbiology in the secondary school classroom

Practical microbiology was used by 65.7% of respondents (teachers). Thirty-seven different activities were mentioned 784 times (Figure 5). Five activities mentioned were not microbiology at all. These included using a microscope to investigate animal cells, plant cells & blood smears, DNA extraction from fruit, and cloning cauliflower. This suggests that there was a broad misconception regarding the identity of microbiology, most likely linking to gaps in the teacher's learning experiences and expertise/pedagogical content knowledge.

The remaining relevant activities addressed a range of principles of microbiology, biology, and science in general. Approximately one third of activities were what can be termed 'classic microbiology' (n=13). These encompass activities that underpin microbiology, such as culturing on agar and aseptic technique, which although essential elements of the science, can be unimaginative and lacking in enthusiasm for delivery and uptake. Some of the more skilled activities, such as antibiotic sensitivity testing, would also fall into this category, due to their traditional and somewhat unambitious nature.

Some more investigative, open-ended, technically skilled and inspiring activities were reported. These included investigating the effects of hand washing on the microflora of the hand, sampling the environment, investigating antimicrobial resistance, using plant extracts as antimicrobial agents, and PCR and DNA gel electrophoresis (using microbial DNA). The evidence for value of 'type' (classic versus open-ended) of practical activity performed in secondary schools is anecdotal (Toplis, 2011), and debated. However, it is noted that open-ended activity is likely to provide students with a realistic, "messy" view of science research (Nott and Wellington, 1996), although the 'unknown answer' nature of



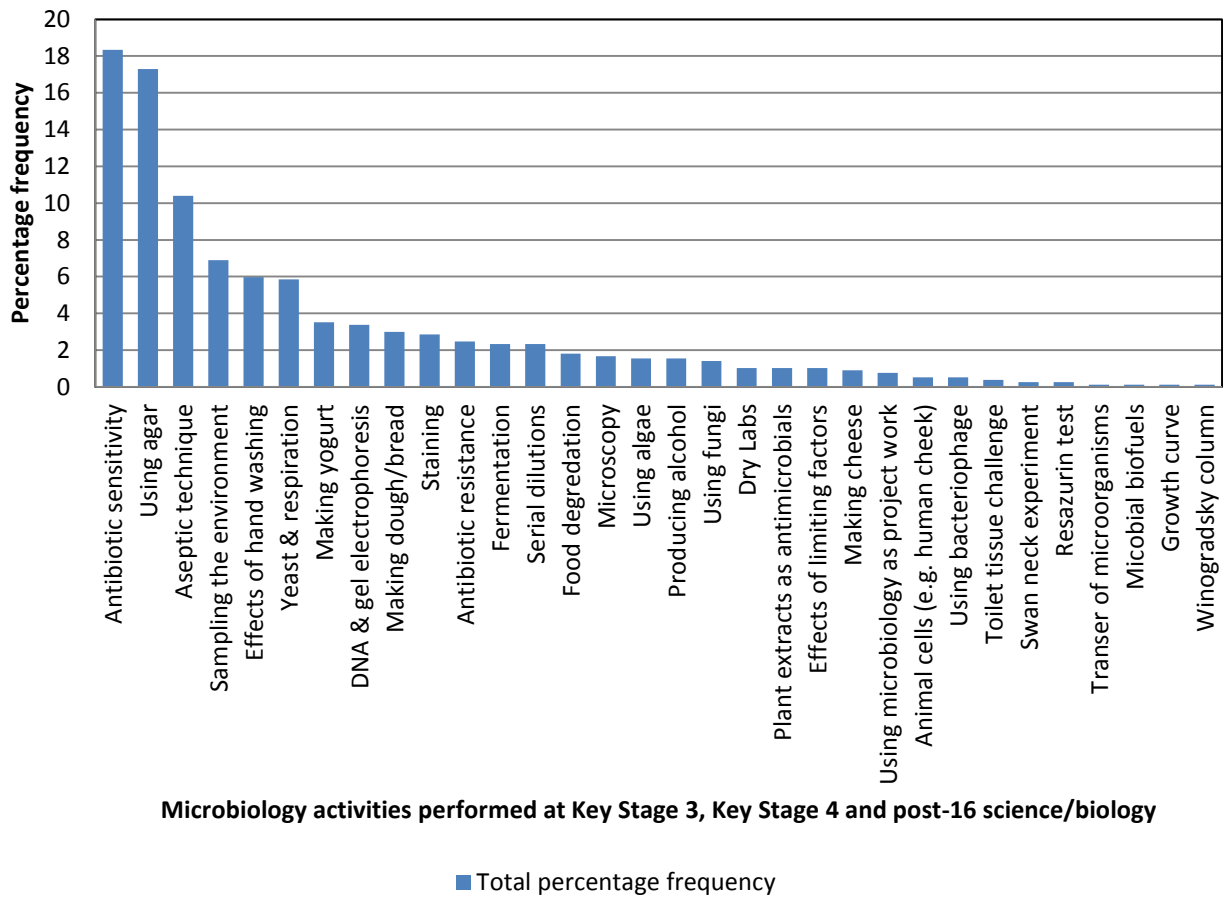

**Figure 5 - A bar chart representing the percentage frequency of the 37 activities mentioned in response to the question 'Do you teach practical microbiology? If yes, what type of activities do you carry out?'. The data are inclusive of Key Stage 3, Key Stage 4 and post-16 answers. N=769.**

such an experiment may make it tricky for a teacher to plan with reference to the National Curriculum or other teaching specifications. The unknown element may also be a fearful concept to a teacher, particularly if they are inexperienced with microbiology.

There were also mentions of dry labs, an activity used to teach microbiology that does not include laboratory equipment or microbial cultures. The use of dry labs in university-level microbiology education has been debated in literature (Baker and Verran, 2004, de Jong *et al.*, 2013), with similarities and observations made to application in secondary schools. They can offer an attractive alternative to 'wet-labs' (experiments performed in a science laboratory), often being cheaper, containing fewer health and safety considerations and being less time-consuming (for example, no incubation period). However, it has been noted that the best choice, in terms of student learning, may be a mix of both approaches (de Jong *et al.*, 2013). Microbiologists may argue it is essentially a practical field, and should be taught as such.

The microbiology activities were split into the corresponding levels of education. The top ten activities were tabulated as a percentage frequency (Table 2). The top eight microbiology activities mentioned in Key Stage 3 science and Key Stage 4 science were the same, although the order was slightly different. At Key Stage 3 science, using agar is mentioned with the highest frequency, with antibiotic sensitivity second, whilst these were reversed in Key Stage 4 sciences. All of the Key Stage 3 and 4 activities could be described as being of a classic nature, with the exception of exploring the effects of hand washing, and sampling the environment, which are investigative and open-ended. The lack of investigative activities may be due to the teachers' belief that the students' needs are best suited to classic microbiology at these early levels of education (particularly Key

**Table 2 – Percentage frequency of the top ten microbiology activities carried out in the classroom, split by the three levels of education: Key Stage 3 science, Key Stage 4 science and post-16 biology**

<b>Key Stage 3 science</b>		<b>Key Stage 4 science</b>		<b>Post-16 biology</b>	
Activity	Frequency of mentions	Activity	Frequency of mentions	Activity	Frequency of mentions
Culturing on agar	17.5%	Antibiotic sensitivity	21.4%	Antibiotic sensitivity	18.6%
Antibiotic sensitivity	12.9%	Culturing on agar	16.9%	Culturing on agar	16.5%
Effects of hand washing	11.25%	Aseptic technique	12.7%	DNA & gel electrophoresis	10.6%
Sampling the environment	10.4%	Sampling the environment	7.8%	Aseptic technique	8.9%
Aseptic technique	8.3%	Yeast & respiration	5.5%	Staining	8.1%
Yeast & respiration	7.5%	Effects of hand washing	5.5%	Serial dilutions	4.7%
Making bread	4.6%	Making yogurt	5.2%	Yeast & respiration	4.2%
Making yogurt	4.6%	Making bread	3.2%	Antibiotic resistance	3.4%
Microscopy	3.6%	Producing alcohol	3.2%	Plant extracts as antimicrobial agents	3.4%
Food degradation	3.3%	Fermentation	2.9%	Limiting factors on bacterial growth	3.4%

Stage 3); however the limitations of teaching practical microbiology (discussed in the next section) are also likely to play a major role, with the classic microbiology being a 'safer' (predictable and understood by the teacher) option in the classroom.

Only three of the post-16 top ten microbiology activities were previously mentioned in Key Stage 3 and 4 sciences, including the same top two, antibiotic sensitivity and using agar. The remaining seven were all investigative, and require a higher level of skill. These include performing a serial dilution, investigating antibiotic resistance, the use of plant extracts as antimicrobial agents, using microbial DNA for polymerase chain reaction (PCR) and investigating limiting effects on the growth of microorganisms. The increase in open-ended activities at this higher level is a positive sign in terms of promotion of the subject. By completing an activity with 'no correct answer', students should gain valuable skills, applicable to the undergraduate science laboratory and beyond.

The majority of activities mentioned used bacteria. However, 10.2% used yeast or fungi, with a small number using algae and bacteriophage making up 1.5% and 0.5% of activities respectively. Interestingly, using fungi or yeast is mentioned at least twice as many times at Key Stage 3 and 4 than at post-16, possibly due to the perceived easier nature of using these microorganisms (for example they are larger and more readily visualised under a microscope). Conversely, bacteriophages are mentioned more under post-16, again likely due to perceived difficulty level in handling. However, algae are mentioned at a consistent level across all three levels of education.

Those respondents that did not carry out practical microbiology activity gave 131 answers across all three levels of education, incorporating 11 different reasons for this choice (Table 3). The reason given with the highest frequency for Key Stage 3

**Table 3 – Percentage frequency of the reasons respondents gave as to why they do not carry out practical microbiology as part of their science/biology education, split based on the levels of education they taught: Key Stage 3 science, Key Stage 4 science and post-16 biology**

<b>Key Stage 3 science</b>		<b>Key Stage 4 science</b>		<b>Post-16 biology</b>	
Reason	Frequency of mentions	Reason	Frequency of mentions	Reason	Frequency of mentions
Lack of equipment	27.1%	Time restrictions	23.3%	Restriction of the syllabus	32.5%
Restriction of the syllabus	20.8%	Lack of confidence and skills	21%	Time restrictions	32.5%
Lack of confidence and skill	16.7%	Lack of equipment	21%	Lack of confidence and skill	12.5%
No resources or ideas	12.5%	Restriction of the syllabus	21%	Lack of equipment	7.5%
Limited or no technical support	8.3%	No resources or ideas	4.7%	Not the teachers specialism	5%
Health and safety concerns	6.25%	Health and safety concerns	4.7%	Financial constraints	5%
Not the teachers specialism	2.1%	Not the teachers specialism	2.3%	Limited or no technical support	2.5%
Not suitable for the level of study	2.1%	Financial constraints	2.3%	Not suitable for the level of study	2.5%
Large class size	2.1%				
Time restrictions	2.1%				

science, Key Stage 4 science and post-16 biology are different: lack of equipment, time restrictions and restriction of the teaching specifications respectively. Interestingly and conversely, the number of restrictions reduces slightly as the level of education rises, with responses spread over ten reasons for Key Stage 3, to eight in Key Stage 4 and post-16. Over 75% of answers given for post-16 restrictions fall into the top three reasons, whilst the two lower levels receive over 75% of their answers in the top four reasons.

### **1.5.3.2 - Limitations of teaching practical microbiology in the secondary school laboratory**

Regardless of whether a teacher used practical microbiology or not, all respondents stated they faced at least one limitation to delivering practical microbiology in the classroom. Equipment was the most frequent indicated limitation (47.6%), followed closely by financial constraint (41.5%) (Figure 6). These two are somewhat linked, as financial constraint may stop the purchasing of equipment required for practical activity. Additionally, the actual cost of consumables may be perceived by teachers to be higher than they are. The need for an autoclave and incubator were two specific common pieces of equipment that teachers assumed were essential for microbiology practical activity. Both of these items of equipment are listed by SCORE (who represent the science community in matters of science education) as a 'benchmark' of the science laboratory in secondary schools (SCORE, 2012), and should be expected when carrying out practical activity. Although, in an ideal world, both of these would be used routinely, they can (safely) be circumvented with cheaper alternatives. A pressure cooker can be used instead of an autoclave. In addition, due to health and safety requirements, all microbial cultures used in schools can only be incubated up to 30°C, thus species most commonly used can be incubated at room temperature (with plates sealed and kept out of reach of students).

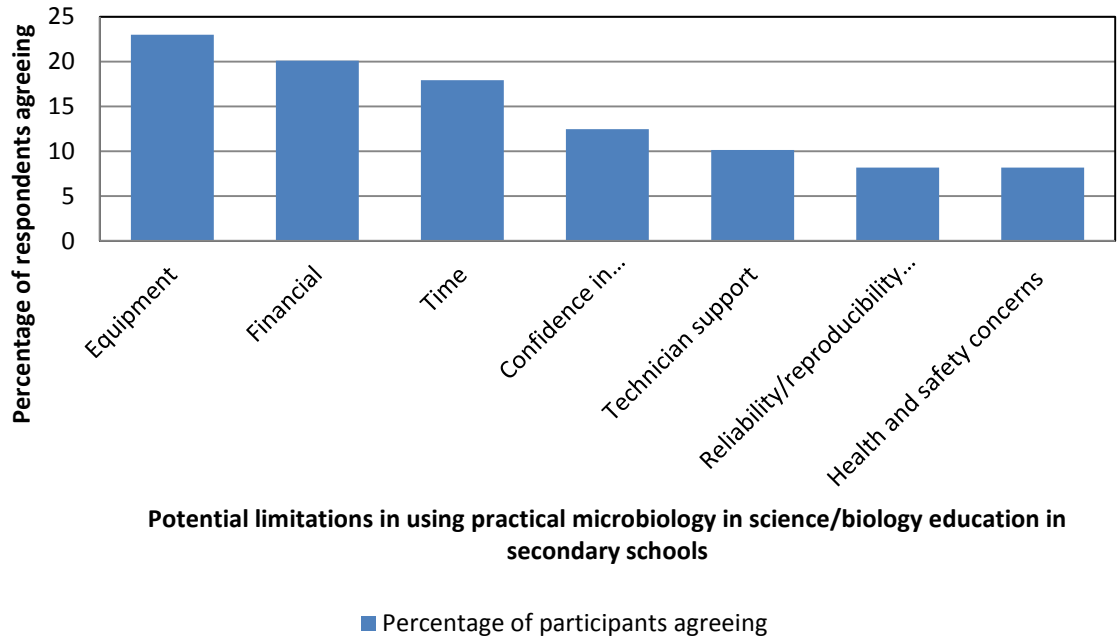

**Figure 6 - Percentage frequency of the number of agreements when asked if any of the variables listed limited their teaching of practical microbiology. N=248.**

A recent survey (SCORE, 2013) on resourcing practical science at secondary level (including post-16 education) provided further evidence that teachers have widespread problems with equipment and finance. The survey (which covers all topics of science) found biology was the poorest resourced science taught in English secondary schools, with 37% (concerning Key Stage 3 and 4) and 44% (concerning post-16) having insufficient quantities of working equipment required to perform effective practical work.

Time has always been a concern in science education. Literature supports the findings that time is an important limitation in practical science. Hargreaves (1994) stated that teachers “experience [time] as a major constraint on what they are able and expected to achieve in their schools. No time, not enough time and need more time are verbal gauntlets that teachers repeatedly throw in the path of enthusiastic innovators”. The remaining limitations (confidence in technique, technical support, reproducibility and health and safety) (Figure 6) can be overcome by provision of well-tested activities supported by reliable suppliers and appropriate documentation. Although it can take time to perform bacteriology activities (due to incubation of cultures), activities using fungi (e.g. watching *Neurospora* hyphal growth on agar under a light microscope (John Schollar, personal communication, July 2010)) and algae (e.g. Identifying different species using a microscope (Redfern, 2012)) provide an instant result, whilst still highlighting essential biological principles such as growth and identification. Confidence in technique can only be acquired with practice: there are many visual resources for teachers on correct microbiology techniques (for example [www.microbiologyonline.org.uk/](http://www.microbiologyonline.org.uk/) and <http://www.hsri.mmu.ac.uk/microbiology/>) to support them through this, in conjunction with training sessions offered to in-service teachers.



Open-ended questions regarding limitations offer an interesting insight. Of those who left a comment, 60% recognised that microbiology was useful, fun, exciting, and educational and had a place in the classroom (supporting the results to the semantic differential scale questions discussed in the next section). However, teachers had reservations about how, what and why they could/should use practical microbiology, writing that they often felt like they faced limitations (both perceived and genuine). Only one comment in the entire survey was overtly negative towards the science, "it's boring". When looking at both quantitative and qualitative data, it seems that health and safety concerns played a major role in the avoidance of practical microbiology. Only two respondents indicated that the issue of health and safety may be over-exaggerated, stating that they thought it was not only safe to work with microbial cultures (as long as some basic rules are adhered to, often highlighted by organisations such as CLEAPPS and the Association for Science Education (ASE)), but also noting that other teachers may use 'health and safety' to cover-up their own insecurities. This attitude is likely to reinforce the negative public-face of microbiology, that is; its association with disease and illness. It is important therefore to ensure that a more balanced view of microbiology is provided in the classroom, enabled by teacher support and by hands-on activities that reveal the broader role of microbiology in society.

Comments also indicated that reproducibility of activities is another key issue. If a teacher has a past experience of a failed experiment, it may be they will not have the time, and/or technical knowledge to identify/explain what went wrong, and they may therefore decide to stick to the more reliable, potentially less ambitious activities. This is a concern for those interested in producing new activities for schools (microbiology and other sciences), as teachers may rely on 'tried and tested' activities year on year. Additionally, if a teacher has a bad experience with a new practical activity, this may prejudice them against future ideas/activities of a

similar nature. It is therefore important that before an activity is presented to the teaching community, it has undergone rigorous testing for reproducibility, making it as infallible as possible, as well as providing trouble-shooting advice in case it does go wrong.

*1.5.3.2.1 Statistical test: Are teachers who have limitations in practical microbiology using it less?*

H<sub>0</sub>: Whether or not microbiology is taught practically is independent of i.e. not associated with, finding any of the listed variables in question two as a limitation to teaching practical microbiology

Statistical analyses, using a chi-square test, were performed on the data from question two, in relation to questions four, five and six, to investigate independence between variables agreed as limiting factors and whether or not the respondents used practical microbiology at the level of education they taught (Key Stage 3, 4 or post-16) (Table 4).

For those teaching science at Key Stage 3, the P values for the limiting factors confidence, time, equipment, technician support, reliability/reproducibility and health and safety were all greater than 0.05. Therefore, the test fails to reject the null hypothesis. However, the test statistic for the variable finance suggested a significant ( $P < 0.05$ ) relationship, therefore rejecting the null hypothesis.

Similarly, for those teaching science at Key Stage 4, the P values for the limiting factors confidence, time, equipment, technician support, reliability/reproducibility and health and safety were all greater than 0.05. Therefore the test fails to reject the null hypothesis. However, the test statistic for the variable finance suggests a significant ( $P < 0.05$ ) relationship, therefore rejecting the null hypothesis.

Table 4 - Chi-Square test data including test statistic, degrees of freedom and P value. The test investigated independence between those who use practical microbiology in their science/biology education and finding one or more variables a limiting factor in practical microbiology. P values in italics are statistically significant ( $P < 0.05$ ).

Level of education respondents taught	Possible limiting variable	Test statistic	Degrees of freedom	P value
<b>Key Stage 3</b>	Confidence	2.081	1	0.149
	Time	1.151	1	0.283
	Equipment	0.211	1	0.646
	Technician support	0.12	1	0.914
	Finance	7.018	1	<i>0.008</i>
	Reliability / reproducibility of practical activities	0.560	1	0.454
	Health and safety	0.001	1	0.970
<b>Key Stage 4</b>	Confidence	2.551	1	0.110
	Time	0.440	1	0.507
	Equipment	2.383	1	0.123
	Technician support	0.461	1	0.497
	Finance	8.082	1	<i>0.004</i>
	Reliability / reproducibility of practical activities	0.283	1	0.595
	Health and safety	0.148	1	0.700
<b>Post-16</b>	Confidence	4.315	1	<i>0.038</i>
	Time	0.002	1	0.967
	Equipment	7.153	1	<i>0.007</i>
	Technician support	5.209	1	<i>0.022</i>
	Finance	1.162	1	0.281
	Reliability / reproducibility of practical activities	0.001	1	0.974
	Health and safety	5.126	1	<i>0.024</i>

Thus, the data are suggesting, with confidence, that there is a relationship between whether or not the respondent used practical microbiology as part of their science education at Key Stage 3 or 4, and whether or not they found finance to be a limiting factor.

If the data are presented differently (Figure 7) it is apparent that it is those teachers who are using practical microbiology as part of their Key Stage 3 or 4 science education who consider finance to be a limiting factor (92.7% and 93.7% respectively), compared to those who do not currently teach practical microbiology at Key Stage 3 or 4 (13.4% and 12.4% respectively).

Research by SCORE (2013) suggests that due to the ever-changing nature of the curriculum, and introduction of controlled assessment (where a school is required to provide a class of students with the same, fully functional equipment decided on by the exam board) schools are finding it difficult to effectively budget for science activity. Nevertheless, results from this survey show they still include it in their teaching. Although some teachers find practical microbiology to be potentially costly, the data shows a willingness to overcome potential barriers to use of practical microbiology – a positive indication of its value in the classroom. Conversely, those who do not use practical microbiology at KS3 and KS4 do not share this limitation, suggesting that there are possible other factors limiting their inclusion of microbiology in the classroom.

For the respondents who identified themselves as teaching post-16 biology, the P values for the limiting factors: time, finance and reliability/reproducibility were all greater than 0.05. Therefore the test fails to reject the null hypothesis. However, the test statistic for the variables: confidence, equipment, technician support and health and safety suggested a significant ( $P < 0.05$ ) relationship, therefore rejecting the null hypothesis for post-16 teachers. Consequently the data are suggesting,

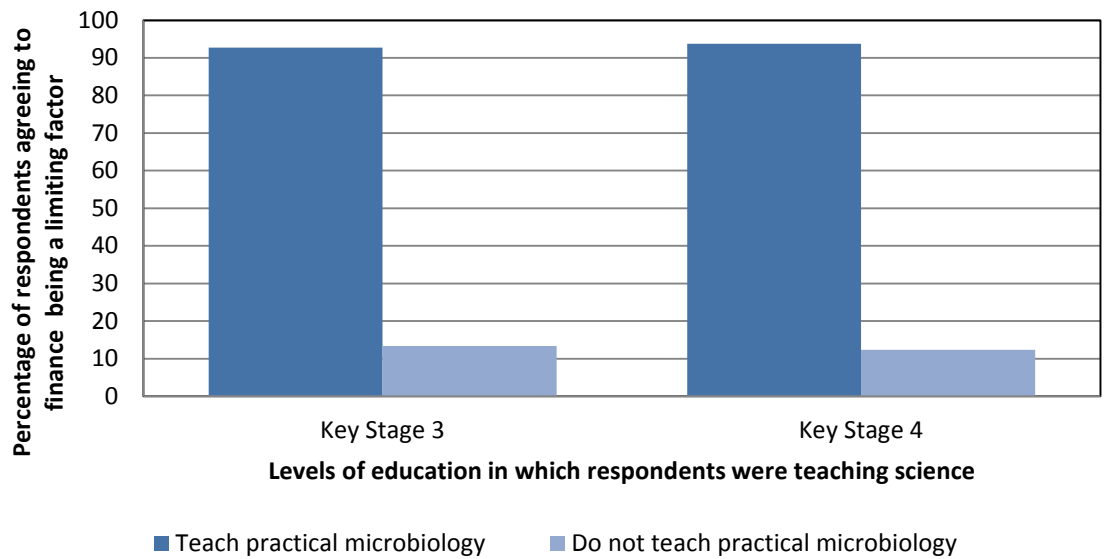

**Figure 7 - Percentage of respondents agreeing that finance was a limiting factor to their teaching of practical microbiology separated by the level of education at which they taught science, and whether or not that science education included practical microbiology. Key Stage 3 N=226, Key Stage 4 N=222.**

with confidence, that there is a relationship between whether or not the respondent taught practical microbiology as part of their post-16 biology teaching and whether or not they found confidence, equipment, technician support and health and safety to be limiting factors to teaching practical microbiology. This would suggest that funding is not as much of an issue at post-16 level, compared to Key Stage 3 and 4, and likely due to a wider range of issues (possibly linked to the higher level of content). However, it should be noted that qualitative data gained throughout this survey suggests that teachers at post-16 do still struggle with financing practical activity.

If the data are presented differently (Figure 8) it is apparent that those teaching practical microbiology as part of post-16 biology find confidence, equipment, technician support and health and safety less of a limitation, compared to those who do not include practical microbiology as part of their post-16 education (a different selection of issues to that of KS3 and KS4 education). Therefore, it may be assumed that these issues were standing in the way of inclusion of practical microbiology at post-16 education. These concerns can be readily alleviated by producing safe and effective microbiological practical activity resources which address each of these points, enabling teachers to overcome these limitations.

### **1.5.3.3 – Importance of practical activity and in particular practical microbiology**

Question seven asked respondents to consider the extent to which they believed practical activity to be important in secondary school science education. The answer was measured on a semantic differential scale, with values ranging one to seven, one representing 'of no importance' and seven representing 'extremely important'. A total of 98% of all respondents answered this question. Respondents only chose values four, five, six and seven, at a frequency of 1.2%, 6%, 13.7%

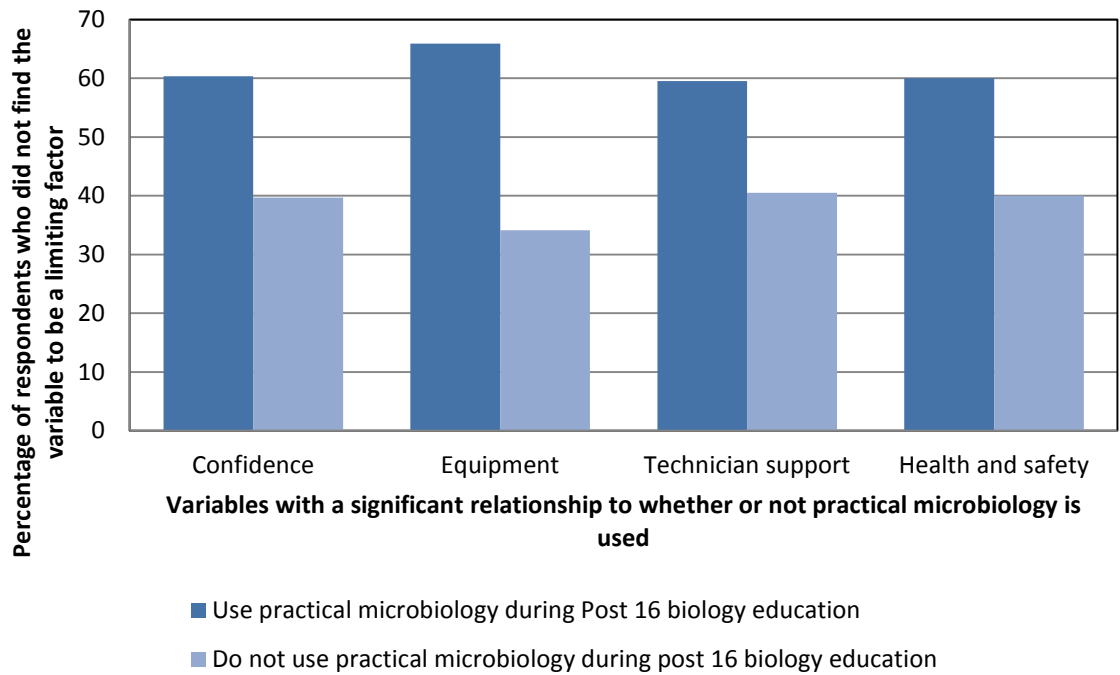

**Figure 8 - Percentage of respondents who disagreed that the variables: confidence, equipment, technician support and health and safety were limiting factors broken down into whether or not they taught practical microbiology as part of the post-16 biology education they teach. Confidence N=184, Equipment N=129, Technical support N=195, Health and safety N=205.**

and 77% respectively. It is clear from looking at the bar chart (Figure 9) that the highest level of agreement is 'extremely important' compared to the lower scores.

The scores were separated into those who responded yes to teaching Key Stage 3, Key Stage 4 and/or post-16 (Figure 10). The pattern of responses (the majority scoring a value of seven, then decreasing in order) is similar at each level of education. This indicates that regardless of education level, teachers believe practical microbiology is very important.

Respondents were also asked 'to what extent do you value practical science activity in the teaching of microbiology?' in question eight of the survey. Answers were again captured on a semantic differential scale, from values one to seven. Value one was labelled 'valueless' and value seven was labelled 'valuable'. The question was answered by 96.8% of respondents. No respondents answered with a value of one or three. The remaining answers, two, four, five, six and seven received an increasing frequency of responses: 0.4%, 2.9%, 13.8%, 15.8%, and 67.1% respectively (Figure 11). This is a similar pattern of responses to the first scale value question shown by Figure 9.

The scores were separated into those who responded yes to teaching Key Stage 3, Key Stage 4 and/or post-16 (Figure 12). The pattern of responses differ from those found when talking generally about science practical activity (Figure 10). Those who identify as teaching post-16 biology had a much higher frequency of answering value 6 (out of 7), instead of the overwhelming choice of value 7 found in all other education levels (when asking about importance of practical activity or value of practical microbiology). This suggests that there may be a small deviation in belief of importance at post-16. Possibly down to necessity and other constraints/limitations.



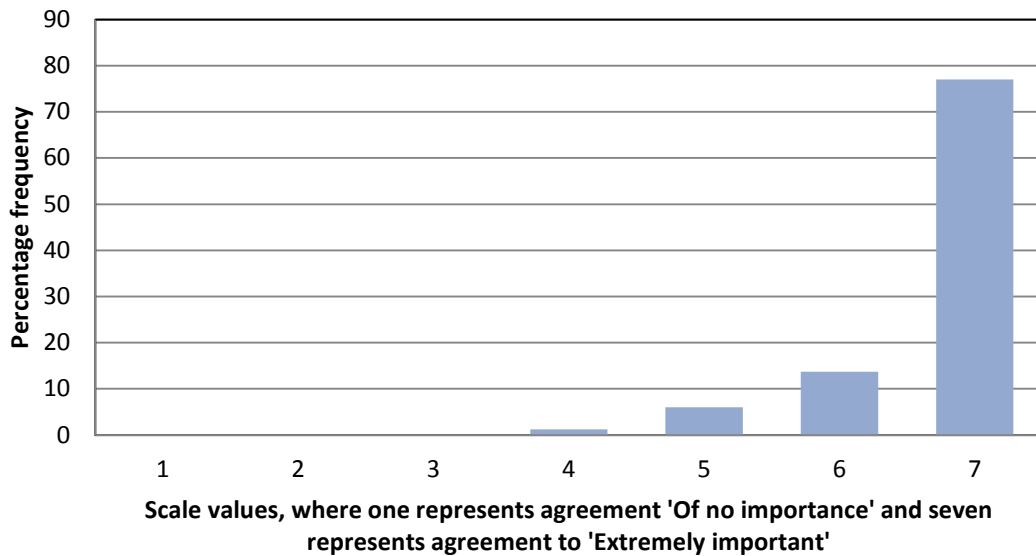

Figure 9 - Percentage frequency of responses given to each scale value, answering the question 'To what extent do you consider practical science activity in secondary science education to be important?'. N=243.

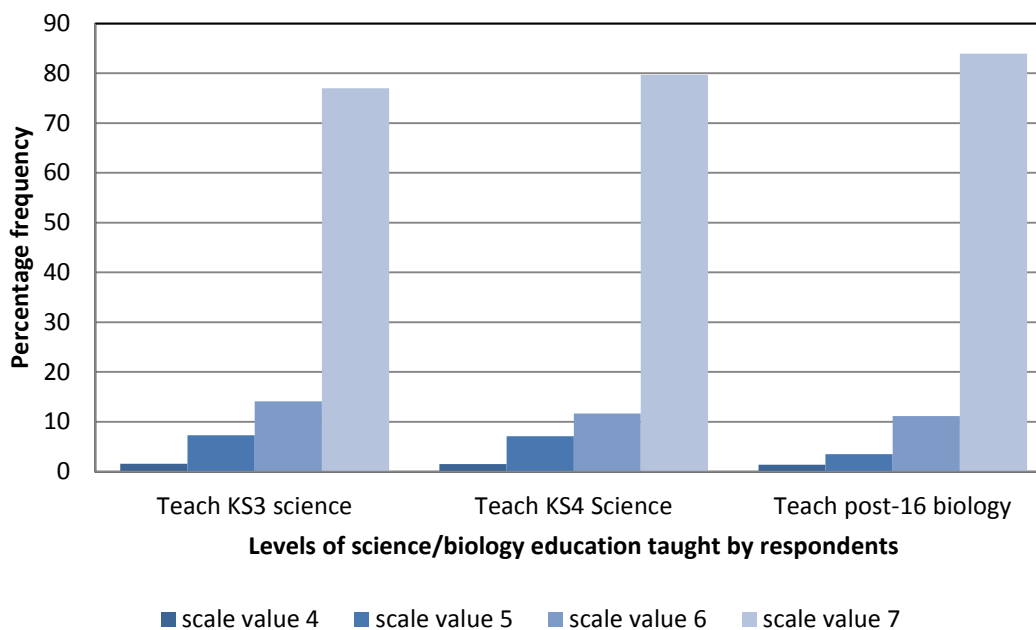

Figure 10 - Percentage frequency of the scale value selected by respondents answering the question 'to what extent do you consider practical science activity in secondary science education to be important?', separated by those who had identified as teaching science/biology at Key Stage 3, Key Stage 4 and/or post-16 biology. KS3 N=191, KS4 N=197, Post-16 N=143.

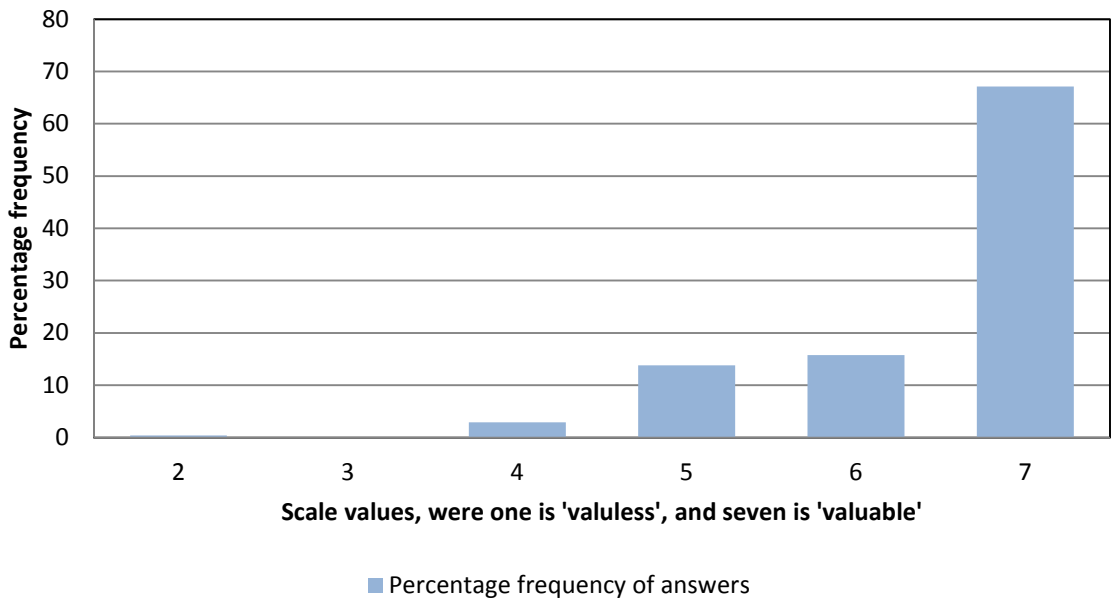

Figure 11 - Percentage frequency of responses given to each scale value, answering the question 'To what extent do you value practical science activity in the teaching of microbiology?'. N=240.

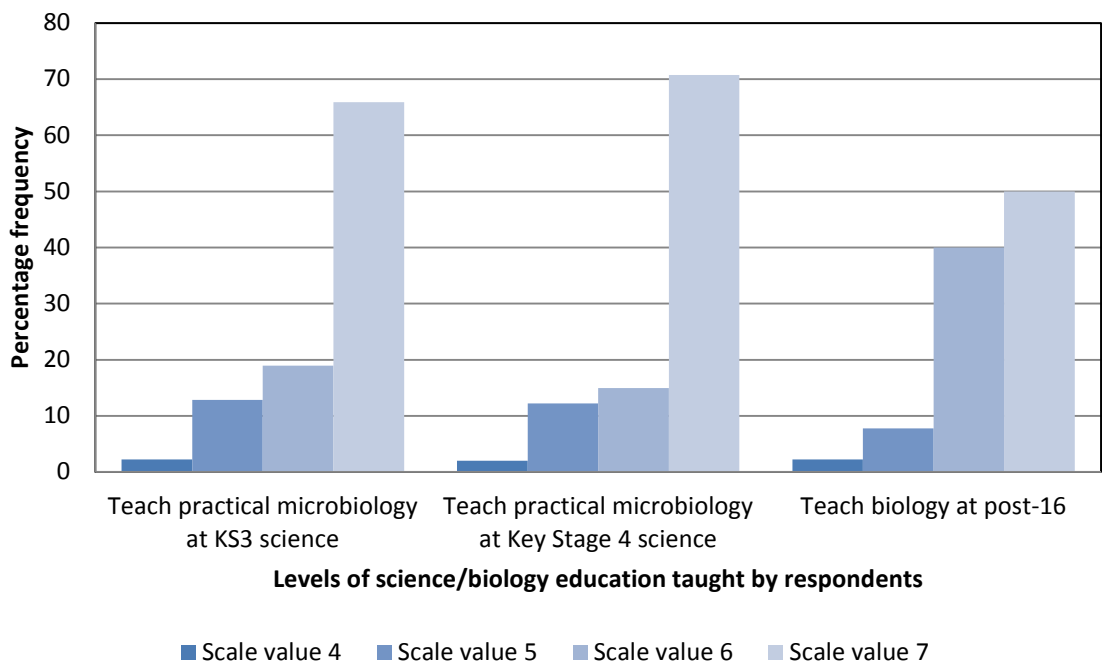

Figure 12 - Percentage frequency of the scale value selected by respondents answering the question 'To what extent do you value practical science activity in the teaching of microbiology?', separated by those who had identified as teaching science/biology at Key Stage 3, Key Stage 4 and/or post-16 biology. KS3 N=132, KS4 N=147, Post-16 N=180.

*1.5.3.3.1 - Statistical test: Do those who teach practical microbiology in the classroom value it in the teaching of biology/science?*

H<sub>0</sub>: There will be no difference in the distribution of values scored by those who use practical microbiology in their teaching and those that do not use practical microbiology in their teaching

Question eight data were reduced to those who used practical microbiology in their education, and those who did not (data from questions four, five and six). Analyses of these data was performed to investigate if there was a difference in respondents answers to question eight (how valuable they found practical science activity in their teaching of microbiology), based on their inclusion of practical microbiology in their classroom. In other words, did their opinion of the importance of practical microbiology inform their decision to include it in their teaching? Independent Sample Mann Whitney U test performed (Table 5).

The P value from Key Stage 3 and Key Stage 4 respondents were greater than 0.05. Therefore the test fails to reject the null hypothesis. However, the P value for the test on post-16 biology respondents suggested a significant difference (P<0.001) and therefore rejects the null hypothesis. Consequently, the data were suggesting, with confidence, a difference in the average score given by those who teach post-16 biology, based on whether or not they used practical microbiology in their classroom. Further investigation of the post-16 mean scores (Table 5) show that those who used practical microbiology value practical microbiology more highly than those who do not.

An in-school experience of a particular science may be the only interaction pupils will have with a discipline, and so, in order to encourage future generations of microbiologists, it is important to win over the support of the post-16 biology teachers, with respect to understanding the value of practical activity in the

Table 5 – Independent Sample Mann Whitney U test data, including mean and mode scale value, standard deviation and P value. The test looked at answers to the question: To what extent do you value practical science activity in the teaching of microbiology? Investigating differences in those who used practical microbiology and those who did not use practical microbiology in their science/biology teaching

Level of education respondents taught	Respondents who use practical microbiology in their teaching			Respondents who do not use practical microbiology in their teaching			P value
	Mean	Mode	Standard deviation	Mean	Mode	Standard deviation	
Key Stage 3	6.68	7	0.68	6.70	7	0.64	0.884
Key Stage 4	6.54	7	0.79	6.30	7	1.09	0.153
Post-16	6.70	7	0.61	6.10	7	0.61	<0.001

science. If a teacher's decision on whether to include practical microbiology is linked to how valuable they believe it is, then (at least in part) practising scientists should work to ensure that teachers understand the potential of microbiology in the classroom.

#### **1.5.3.4 – Effect of school membership of the Society for General Microbiology on practical microbiology in the classroom**

It appears that school membership of an organisation that produces learning materials (such as the Society for General Microbiology) and subject-specific support is of benefit to teachers. Thus, non-members of SGM were more likely than members to find equipment, technician support and reliability/reproducibility a barrier to their use of practical microbiology.

*1.5.3.4.1 - Statistical test: Is there a link between practical microbiology in the classroom and school membership of the Society for General Microbiology?*

H<sub>0</sub>: The use of practical microbiology in science/biology education is independent of, i.e. not associated with, the school holding membership to the Society for General Microbiology

Statistical analyses, using a chi-squared test, were performed on the data from question four, five and six, in relation to question one, to investigate independence between those who taught practical microbiology as part of their science/biology education and whether or not they were a member of the Society for General Microbiology (Table 6).

For those who taught practical microbiology as part of Key Stage 3 and Key Stage 4 science, the P value was greater than 0.05. Therefore, the test fails to reject the null hypothesis. However, there is a statistically significant relationship (P<0.05) between those who taught practical microbiology as part of their post-16 biology education and membership to the Society for General Microbiology.

**Table 6 - Chi-Square test data including test statistic, degrees of freedom and P value. The test investigated independence between whether respondents who taught practical microbiology and membership of the Society for General Microbiology.**

	<b>Test statistic</b>	<b>Degrees of freedom</b>	<b>P value</b>
<b>Key Stage 3</b>	0.230	1	0.632
<b>Key Stage 4</b>	1.059	1	0.304
<b>Post-16</b>	46.262	1	<0.001

If the data are presented differently using a bar chart (Figure 13) it is apparent that there is a considerably higher percentage of those who taught practical microbiology at post-16 that were a member of the Society for General Microbiology than non-members of the Society. It may be assumed that the increased likelihood is down to two cohesive determinations. The efforts displayed by SGM to promote the practical side of microbiology by supporting teachers with a range of resources (including print material, online multimedia and training sessions for PGCE students and in-service teachers) is complemented by the teacher's ability to take the provided material and develop/use it into their classroom.

***1.5.3.4.2 - Statistical test: Are school members of the Society for General Microbiology finding fewer limitations in practical microbiology in the classroom?***

*H<sub>0</sub>: Identification of respondent as a member of the Society for General Microbiology is independent of, i.e. not associated with, finding any of the listed variables in question two as a limitation to teaching practical microbiology*

Statistical analyses, using a chi-square test, of question one and question two data were performed to investigate independence between the variables agreed as limitations and whether the respondent identified as a member of the Society for General Microbiology (SGM) (Table 7).

The P value for the limitations confidence, time, financial and health and safety variables were all greater than 0.05, therefore the test fails to reject the null hypothesis. However, the test statistic for the variables equipment, technician support and reliability/reproducibility of practical activities suggests a significant

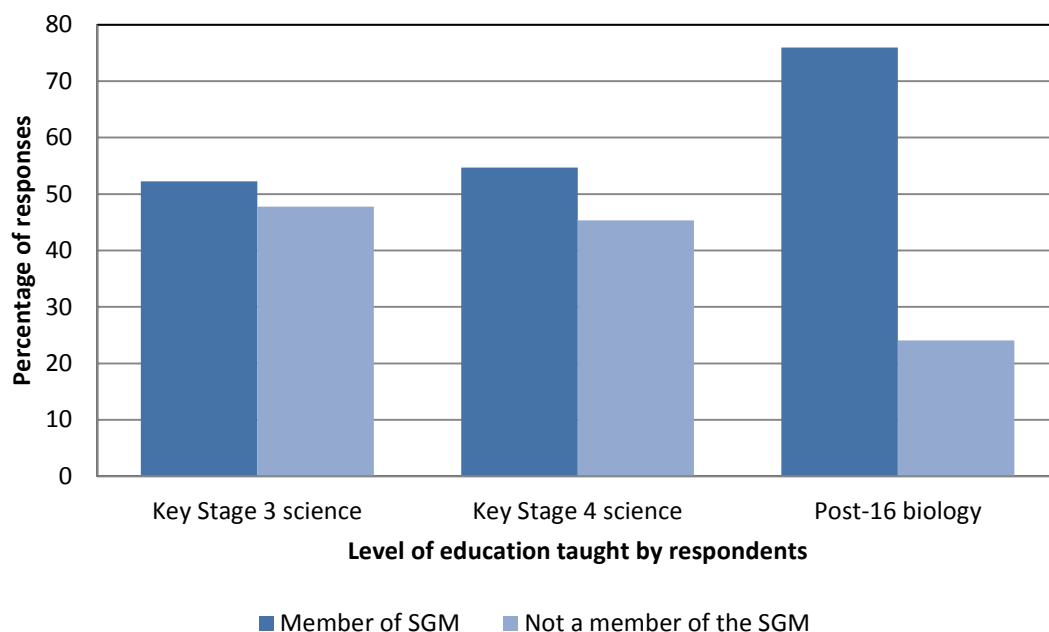

Figure 13 - Frequency of responses by those who identified themselves as teaching practical microbiology, split by whether or not they are a member of the Society for General Microbiology. KS3 N=111, KS4 N=128, Post-16 N=79.

Table 7 - Chi-Square test data including test statistic, degrees of freedom and P value. The test investigated independence between membership of SGM and finding one or more variables a limiting factor in practical microbiology education

Possible limiting variable	Test statistic	Degrees of freedom	P value
Confidence	1.365	1	0.243
Time	1.237	1	0.266
Equipment	17.879	1	<0.001
Technician support	10.095	1	0.001
Finance	3.330	1	0.068
Reliability / reproducibility of practical activities	5.382	1	0.020
Health and safety	1.419	1	0.234



relationship ( $P < 0.05$ ) with membership of SGM. Therefore, there is sufficient evidence to reject the null hypothesis for these three variables. If the data are presented as a bar chart (Figure 14) it is apparent that non-members of the SGM were more likely to find equipment, technician support and reliability/reproducibility of practical activities to be a limitation in their teaching of practical microbiology than members. In other words, teachers understand that confidence, time, financial and health and safety are all minor issues that can be overcome by good planning, whereas equipment, technical support and reliability/reproducibility can cause a more obstructive issue. For example, activities can be altered depending on time limitations, however, if the necessary equipment is missing, the activity may not be feasible.

#### **1.5.4 - Additional comments**

The final question gave respondents a chance to write any further comments regarding the teaching of microbiology at Key Stage 3, Key Stage 4 and post-16 education. Fifty-five respondents chose to answer this question. Although respondents ( $n=45$ ) stated issues related to a teacher's capacity to deliver practical microbiology activity (for example, support from the curriculum, cost and time), it was suggested by some ( $n=25$ ) that they enjoyed the subject as a whole, with a wish for it to be easier to carry out in the classroom.

*“Great fun, covers loads of useful practical skills, interesting, measureable results, covers lots of important biological concepts” (a UK Science teacher discussing microbiology)*

A number of comments ( $n=18$ ) were made regarding limitations of the National Curriculum (NC), focusing on a lack of formal support for microbiology, and the time teachers had in which to deliver its requirements and outcomes.

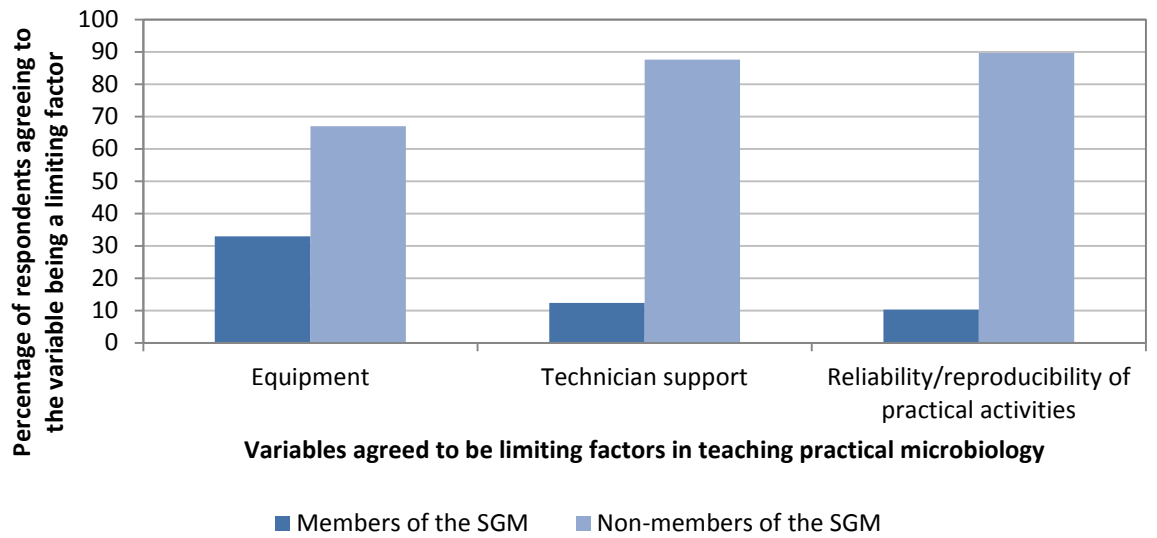

**Figure 14 - Percentage of respondents agreeing the variables mentioned to be limiting to their teaching of practical microbiology separated based on identification as a member of the Society for General Microbiology. Equipment N=118, Technician support N=128, Reliability/reproducibility N=79.**

One respondent suggested “the National Curriculum chokes creativity” and another suggesting that the NC does not allow the time for proper practical activity to be carried out – “Every time any specification is revamped the content goes up and the time for practical work goes down... no real science experiments can be squeezed in anymore”. However, this opinion is ill informed: microbiology is well represented in the National Curriculum and various other teaching specifications (page 6). In addition, microbiology offers a range of opportunities for teachers to utilise microorganisms to demonstrate other phenomena, for example, using algae to demonstrate photosynthesis and the effects of pollutants, or yeast to demonstrate gas cycling (Redfern, 2012).

*“The best biology practicals you can do – they work! (sic)” (a UK Science teacher discussing microbiology)*

Comments also suggest that the confidence teachers have in practical microbiology was an issue. One respondent suggested that a teacher might use health and safety concerns as an excuse if they are not confident enough to carry out practical microbiology. Another respondent simply states “too much scare-mongering!”

*“The society of microbiology provides excellent support for all we try to do here at school (sic)” - a UK Science teacher discussing microbiology*

The 2006 Programme for International Student Assessment study (OECD, 2009) suggests there is a strong and direct correlation between a student’s performance in science, and interaction with student-initiated science, such as science clubs. However, only one respondent stated that they incorporate microbiology into after school science clubs, believing this gives them more time and freedom to follow

activities they would not be able to fit in when following the NC. This is a potentially strong avenue for engaging students with microbiology.

Other comments include cost issues; with a wish that more microbiology could be delivered in a 'kit form', where a school could buy in what is necessary. One respondent stated that they recognise (and likely remember) the fun and investigative nature of practical microbiology at undergraduate level, but unless the equipment and consumables can be purchased as a kit, they remain unachievable in the school classroom. They go on to note "Microbiology is an amazing branch of biology that is all but ignored at the practical level in secondary education".

#### **1.5.5 - Conclusion**

Although the educational benefit of practical microbiology is acknowledged throughout the survey, many teachers found it difficult in making it manageable, relevant and deliverable. This brings to light an interesting question: do teachers truly understand microbiology, and the potential of microbiology as a learning tool?

Microbiology may prove trickier to perform in the school classroom compared to some other sciences due to the limitations that have been discussed (both actual and perceived), but this is no reason to exclude it altogether. All of these limitations raised can be addressed by using trusted, tested practical resources, and following the advice given by professional bodies and organisations that endeavour to aid teachers in improving practical science in the classroom. Results of this survey indicate that teachers hold certain misconceptions about the excessive cost, technical difficulty, reproducibility/reliability and health and safety aspects of performing microbiology in the classroom.

One way to increase the amount of microbiology in the school laboratory is to provide an effective two-way communication between subject 'experts' and teachers. It is important that teachers (especially those who may not be biology/microbiology specialists) understand how to overcome their perceived limitations. Professional scientists, who understand the field in-depth, may be able to offer a solution. Additionally, the involvement of academia would not be a one-way relationship. By getting involved in school practical science; troubleshooting, inspiring new activities, testing new activities, and ensuring relevance whilst encouraging and inspiring young students may increase the number of students who become interested in the field. Hopefully, more students that are interested will result in more microbiologists and researchers in years to come. Thus, microbiologists should be prepared to play a role in the promotion of their subject in order to maintain its health for the future.

Organisations such as the Association for Science Education, specific professional learned society, such as the Society for General Microbiology (who are interested in school microbiology education (SGM, n.d.-a)), and public engagement bodies such as the National Co-ordinating Centre for Public Engagement (NCCPE) can offer a gateway between schools and universities. It has long been recognised that an effective approach to any problem (for example, how best to provide support for science teachers with subject-specific content) takes shape using a collection of ideas and discussion, and science education is no different. With valid advice and arguments from various locations, a constructed unified approach is likely to help deliver the best results (Alberts, 2013). Organisations such as learned societies can moderate the balance of schools and universities, ensuring that schools feed universities with vibrant and interested students, whilst universities inspire schools in such a way that schools are given the support they require to deliver microbiology as effectively as possible.

## **Chapter 1 - Part 3: Project aims and objectives**

## **1.6 - Project aim and objective**

### **1.6.1 - Aim**

To develop laboratory protocols for GCSE/A Level teaching in appealing, current, microbiology areas.

### **1.6.2 - Objectives**

- To assess the current state of microbiology teaching, particularly the practical element, in schools & colleges
- To investigate the microbiology resources currently available to teaching staff in schools & colleges
- To identify gaps in the current GCSE and A level curricula where microbiology can be utilised
- To develop an in-depth practical resource based on topics selected to enable novel, exciting and relevant practical activities to be carried out in UK schools, using microorganisms to illustrate key concepts identified in the curriculum. Topics to be developed include;
  - Algae (Key Stage 3 and Key Stage 4)
  - Bacteriophage (Post-16)
- To evaluate the resources (formative and summative), focusing on their usability and practicality

## **Section 2 - Research in science education**

### **Chapter 2 – Science and the classroom**



## **2.1 - The Nature of Science (NOS)**

The nature of science and how it is delivered to students has been an area of academic interest for some time. As shown in the previous chapter, microbiology in the classroom is underused, is plagued with issues of concern and is biased to a small number of topics and activities. Through development of practical activity resources these issues may be addressed, however, it is important that they are developed with current thinking of science in education in mind. This chapter will explore what is meant by science and how it is used in the classroom.

What science lessons teach children in school has been a topic of great debate. It has been suggested that the aim of science education should be to teach about science, as well as learning scientific knowledge (Osbourne, 2002). Although science education may be perceived as learning facts by rote, the influence of constructivist thinking, discussed later in this chapter, has placed a greater emphasis on understanding the nature of science (NOS) and ideas about science (IAS), attempting to correct any misconceptions a learner may have previously constructed. The terms NOS and IAS are widely used to encompass the philosophy, history and communication of science (Miller, 1983, Osborne *et al.*, 2003a), and are relatively recent yet increasingly more prevalent concepts in school science education.

### **2.1.1 - What is science?**

If we are to suggest that students should be learning about science as well as scientific knowledge, then it is important to consider what science is. Although philosophers of science have been debating this for some time, practical scientists may be somewhat unconcerned by the philosophical nature of this question. However, society often regards scientists as a voice of truth, and can take statements and judgements made by scientists without question. It is known that

scientists occasionally 'get it wrong', and despite possible serious consequences of this (for example, the UK Government advice that mad cow disease was of no concern to human health), people still trust scientists. This was recently evidenced by the Wellcome Trust Monitor Two report (2013) stating that over two-thirds of UK adults had a complete or great deal of trust in university scientists. When considering the level of trust put in scientists, and the requirement for teaching the NOS in the school classroom (DfE, 2013c), it is important that all involved, not just philosophers, ask the question: What is science?

Is science an assortment of facts used to develop theories and laws? This is the way in which some might argue science is portrayed in the school biology classroom (Fischer, 2011). In his book, *Philosophy of Science: A Very Short Introduction*, Okasha (2002) poses the idea that people may assume that science is an attempt to understand, explain and predict the world round us. This view was echoed by The Wellcome Trust Monitor One report (2009). During a survey of UK adults and young people's attitudes towards biomedical research, respondents were asked in an interview what it meant to 'study something scientifically?' Interestingly, there was no single concept or term given by a large proportion of respondents. The most popular answer given by adults and the second most popular answer given by young people: 'looking into a problem in detail' agrees with Okasha's statement about people's assumptions on the point of science. However, Okasha quite rightly points out that this is not a very good explanation. After all, religion, fortune telling, and to some extent history attempts the same objectives (understand, explain and predict); however, few people would consider these 'science'.

The way in which scientific methods are used to reach conclusions and generate scientific knowledge may be another factor in people's acceptance of science. This

seems plausible: it takes the values of scientific knowledge mentioned in the above paragraph, links them with scientific method, and assigns the greater societal respect often observed with scientific knowledge. Arguably, the central pillar of this is the testing of theories through observation and experimentation. Once again the Wellcome Trust Monitor One report (2009) on people's perceptions as to what it means to 'study something scientifically?' supports this. It found that the most popular answer from young people, and the third most popular answer from adults was to 'experiment', with 'to test' being the final contribution to populate the top three answers for adults and young people alike.

### **2.1.2 – How is science done?**

If, as it seems, science knowledge is taken to be proven knowledge, it is wise to take into account just how this proven knowledge is derived. After all, how can one teach a student the nature of science if they are yet to fully understand it? For most scientists, this may seem a trivial point to make. Often a scientist will spend years making observations, researching, asking questions, experimenting and concluding with a theory. This seems a straightforward/logical progression concerning how science is performed, and as previous discussed; various non-scientists are likely to hold a similar view. But, philosophers of science disagree with this assessment.

Many different philosophers have attempted to classify how we do science, which in turn informs how we develop scientific knowledge and what in fact constitutes knowledge. The study of knowledge is known as epistemology. Historically, there have been numerous epistemological views making their mark on the scientific method. Understanding epistemological views on the nature of science is important, not least because it can be the basis of scientific revolutions (paradigm shifts), where the framework from which scientists carry out science is changed.

The concept of a paradigm shift was first presented by Kuhn (1996), a historian of science, who argued that the history of science was dotted with cases of 'scientific revolution' (for example, the change from Ptolemaic to Copernican astronomy, or from Newtonian to Einsteinian physics). Epistemology is currently in its own state of renaissance (Pritchard, 2004). Critical analysis of older theories of the scientific method can be put to pedagogical use (Chalmers, 1982) when considering how science should be delivered. Although these theories, such as inductivism and falsificationism (described in the following sections) may be controversial when considering how people perceive science today, understanding them, especially their issues and problems, will allow future theories to be better understood.

#### ***2.1.2.1 - Induction***

In his popular book *What is this thing called science?* Alan Chalmers presents a critical review of the philosophy of science (Chalmers, 1982). He begins with the process of induction, and the 'naïve inductivist' researcher. He states that many people believe science has no place for personal opinion, and should be totally objective (an opinion that may be described as an idealistic approach to science, leading to the prefix 'naïve'). Scientific knowledge is derived from facts of experience, a direct result of observation. The epistemology that best suits this view is that of empiricism, which argues that knowledge is built on sensory experience. This is often cited as the most common 'method of science' (Nola and Irzik, 2005), so is a good place to begin.

The process begins with observing something (a singular observation) at a particular time and date. This observation is repeated under a variety of conditions and added together to form an account for all events of that type. This collection of observations is then described as a universal statement. The concept is based on inductive reasoning (Figure 15). This allows the scientist to collect a list of singular

statements (from observation) and is used to justify a universal statement. The naïve inductivist must stick to three rules in order to comply with this method.

1. Number of singular observations must be suitably large
2. Observations must be repeated a large number of times under a variety of conditions
3. No observation can conflict with the derived universal law

Once a theory has been developed using these three rules of induction, it is then possible to predict and explain using the derived scientific knowledge. This is deductive reasoning, a separate process from induction. Here, a conclusion (the prediction or explanation) is derived from the scientific knowledge gained from induction (Figure 15). For example, if a scientist had observed a large number of participants reading a thesis on the development of school science activities, and the participants had all thought it a good piece of work, the scientist could conclude, using the process of induction, that all theses on the development of school science activities to be a good piece of work. The scientist is then able to use the process of deduction to predict using this theory, for example:

- (1) All theses on school science activities are good pieces of work
- (2) This is a thesis on school science activities
- (3) This thesis is a good piece of work

In this example, (1) and (2) form the premise of the deductive reasoning, with (3) being the prediction or explanation. As such it is a typical example of a logical argument, the syllogism, where the argument moves from the universal to the particular, where facts are derived from a combination of statements.

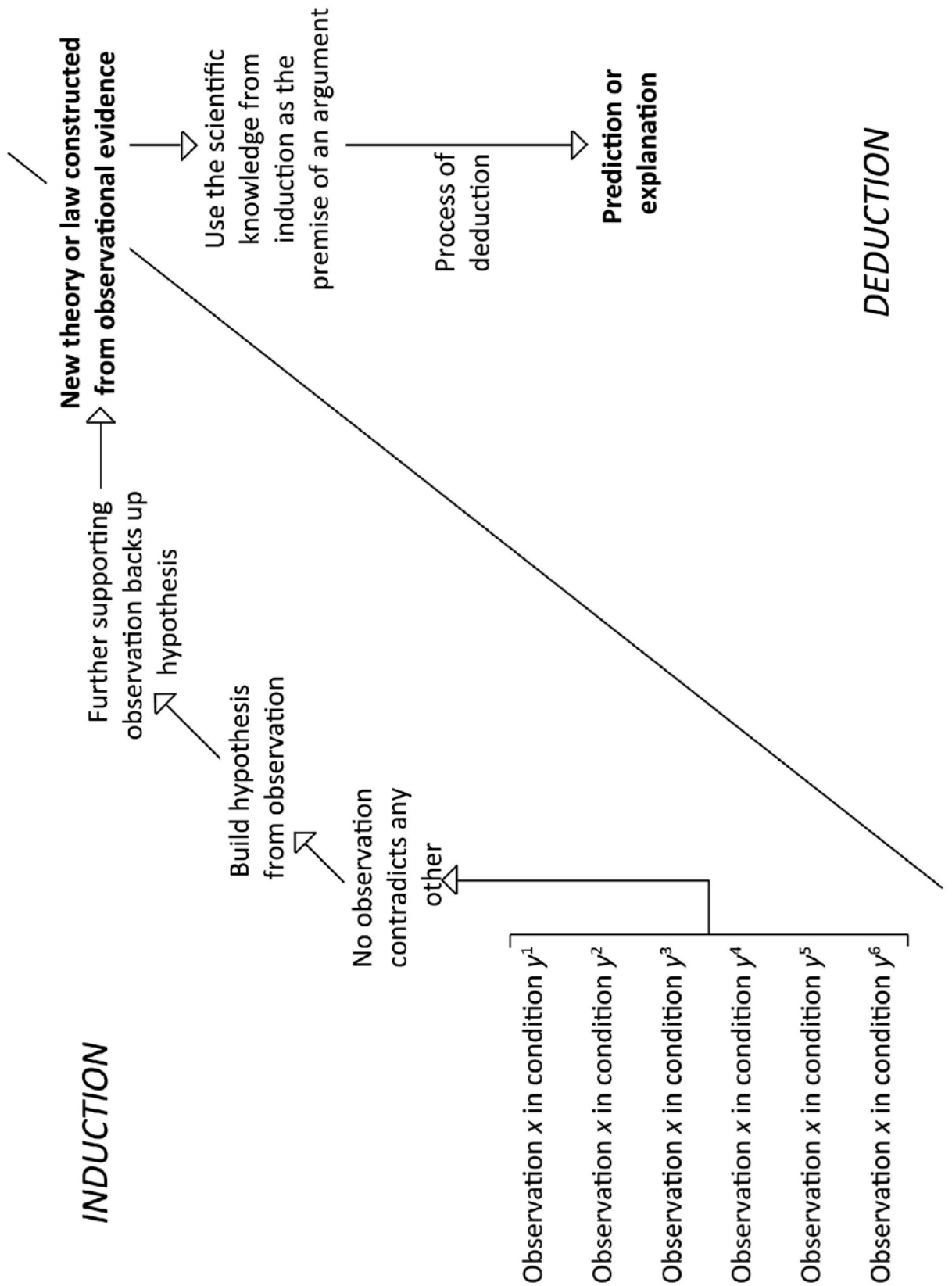

Figure 15 - Illustration showing the process of induction (from observation to theory/law construction) and the process of deduction (from theory/law to prediction or explanation)

Critics have some concerns with this account of science, the focus being how to validate or justify the processes. In response, inductivists have provided two lines of defence; logic and experience.

Using logic, if the premise of an argument is true, for example, 'at  $t$  time and date, bacterial species  $x$  bacteria contain  $y$  gene', and this was observed on a number of times in different conditions, then the hypothesis developed from this would also be true. In this scenario, the universal statement would be 'all bacterial species  $x$  contain  $y$  gene'. Although in this example no contradiction has occurred, that is, all observations of  $x$  bacteria contained  $y$  gene, there is no assurance that the universal statement is not false. There is no logical guarantee that the next species of bacteria  $x$  to be observed will not contain  $y$  gene. Even though the initial inference from inductive reasoning can be legitimate, following the three rules of Inductivism, it may still lead to a false conclusion, regardless of the fact that the premise of the inference was true. This example shows that there is an important distinction between an argument being logically valid and it being true.

Logic can also be problematic when discussing the process of deduction. Regardless of the potential for false scientific knowledge, logically, a deductive conclusion can still be gained. Chalmers provides the following example to explain this:

- (1) Cats have five legs
- (2) I have a cat
- (3) My cat has five legs

This is a very abstract example, however, it serves its purpose. A defence based on using logic is potentially flawed, because, as shown, logical methods might follow the laws of logic (and so be valid), but this does not guarantee their truth.

The defence of experience is founded in the fact that it is possible to show when observation appear true a large number of times, the universal laws and theories derived henceforth can hold up to scrutiny. Examples of this are numerous across the history of science, for example, laws of optics or plenary motion. However, in criticism, Chalmers points to an issue commonly known as Hume's problem of induction. When Hume published this work in the eighteenth century, it created widespread discussion; it was 'philosophical dynamite' (Howson, 2000, p 1). It is not acceptable to state that because the principle of induction has worked in  $x$  scenarios, and has worked under a variety of different conditions and on a high number of times, that the principle of induction will work every time. To argue that the process of induction is to be trusted because it has worked well up until now is to reason in an inductive way (using the very same method of induction to validate the method of induction), so represents a circular argument.

The 'naïve Inductivists' portrayed in Chalmers's book may be extreme cases. However, the arguments he presents show cause for caution. It is possible, using this scientific method, to construct scientific knowledge which is incorrect. He does note that the process has some merits, stating it gives a formal account of the popular held view of science, as well as being objective, and with little or no subjective elements.

#### ***2.1.2.2 - Falsificationism***

Falsificationism is another epistemology of science, attempting to explain the nature of science whilst avoiding the pitfalls of Inductivism. First championed by



the philosopher Karl Popper in 1934 (Popper, 2002), the falsificationist takes a different approach to science, being centred on a falsifiable hypothesis. Popper argued that when developing a hypothesis it should aim to make a prediction that is capable of being tested against experience. If these experiences turn out to prove the hypothesis wrong, then the hypothesis has been falsified, that is, it is not possible for it to fit every encountered experience. Once proven wrong, the scientist is able to construct a new hypothesis for investigation (based on the knowledge of the wrong hypothesis), and undertake tests, once again attempting to falsify it. If the hypothesis turns out to hold up to the testing, it must undergo further, more stringent testing (Figure 16).

If the hypothesis could not be falsified, this should not be taken to mean it is proven. Instead it is 'confirmed'. This is a key consideration of the falsificationist. A hypothesis can conclusively be proven wrong, however it cannot be considered true, regardless of the amount of evidence supporting it. It has been argued that the best advancements for science come from the confirmation of a bold hypothesis. A bold hypothesis should, if surviving falsifiability testing, predict/explain a good amount of information about the subject in question (in comparison to a cautious hypothesis, which would predict/explain little or nothing of relevance). Popper believed this should be an important factor in designing a falsifiable hypothesis.

Popper added that if a theory was not falsifiable, then it should not be called science at all (instead naming it pseudo-science). This is known as the problem of demarcation. Popper believed that falsifiability should be a criterion of demarcation. The psychoanalytic theory of Freud was used by Popper as an example of an unfalsifiable pseudo-science as a way to justify the problem of demarcation (Okasha, 2002). Popper believed that Freud's theory could be used

# FALSIFICATION

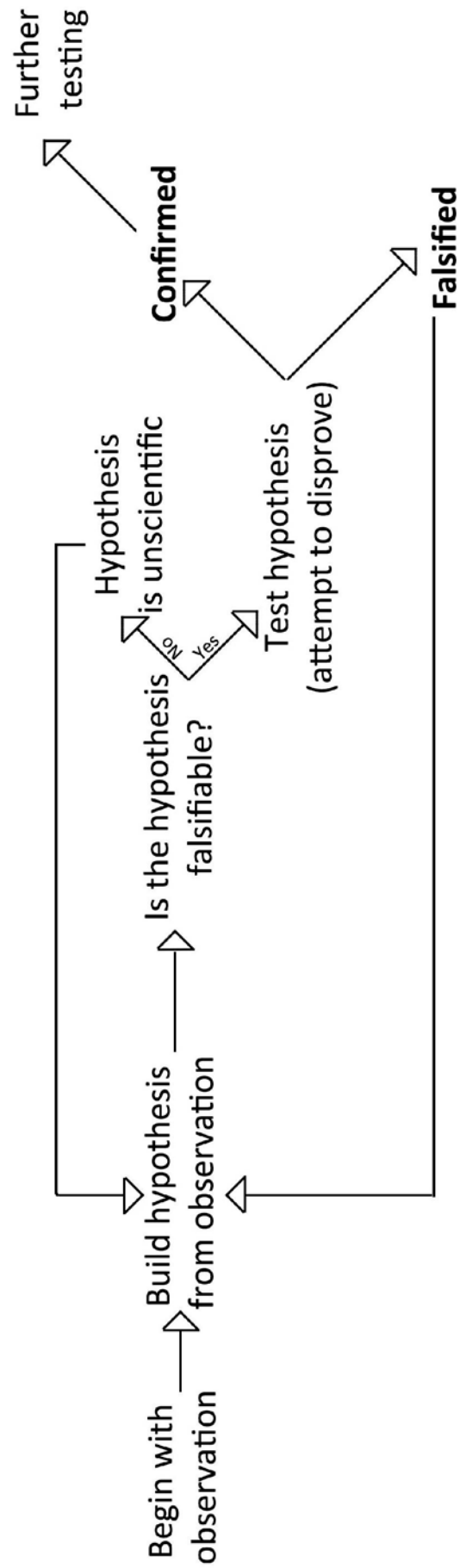

Figure 16 - Illustration showing the process of falsification. The process begins with observation and uses this information to build a falsifiable hypothesis (if it is not falsifiable it is not classed as scientific). The hypothesis is tested for falsifiability. If the hypothesis is falsified, it is disregarded and a new hypothesis is developed and tested. If it survives the testing, it is 'confirmed' and undergoes further testing.

to fit any empirical evidence. Whatever the patient's behaviour, Freud could find an explanation from within his theory (so never having to consider the possibility that the theory itself was incorrect).

Although highlighted as an answer to the issues surrounding Inductivism, Falsificationism is not without its critics. Chalmers (1982) argues that, just like Inductivism, Falsificationism is based on observation, and as previously discussed, observation is based on theory, and theory is fallible.

Popper attempted to argue the position of observation within falsifiability by using the ability to withstand testing. If an observation could survive a test, that is, not be shown false, then it was justifiable to use observation as a starting point. However, this highlights a contradiction in Popper's work. When putting a hypothesis through testing, there comes a point when the scientist must make a decision as to whether the test fails or should be confirmed. This brings a subjective element to the process of scientific knowledge. Interestingly in a later publication, Popper describes how he believes science is without subject (Popper, 1979) (that is, totally objective – a similar view to the Inductivists) counteracting an underlying feature of his falsifiability epistemology.

Additionally, can one be certain that when a theory is falsified, it is actually incorrect? It seems logical to suggest this is the case, after all, if it fails testing, it surely cannot be true. However, testing a hypothesis may include a complex series of theoretical knowledge and equipment. For example, if a scientist observed a new strain of bacteria growing at 30°C, they may hypothesise that the strain of bacteria will only grow at 30°C. The scientist can then test this for falsifiability, attempting to grow it at a temperature of 31°C. If the microorganism grows, then it would prove the original hypothesis as wrong (falsified), and the scientist would have to reconsider their hypothesis. However, the test would

include previous knowledge/theories (such as bacterial culturing), as well as laboratory equipment (for example incubators). It could be that the falsification of the hypothesis is due to an error in previous knowledge/theory or equipment. If, for example, the scientist's incubator was reading the temperature incorrectly, and the incubator was in fact 30°C, and not 31°C as thought, the hypothesis would be wrongly falsified.

Historically, there have been examples of major laws and theories being developed in spite of being falsified. Copernicus's work on the solar system did not come from the process of either induction or falsification. It instead was supported over time, as science progressed scientific advancements, other scientists were able to produce evidence in support of Copernicus's work (Kuhn, 1957). If the theories had been subjected to falsification when they were first proposed, they would have been proven wrong, as the laws of physics as they were then believed were unable to support the theory now universally accepted by the scientific community. Additionally, as this law of physics framework was not correct at the time of Copernicus, the process of induction would not have been possible. It has instead grown out of centuries of hard work: observations, experiments and input from many different scientists.

### *2.1.2.3 - Discussion*

The importance of understanding how science works is agreed to have wide ranging impact on everyday societal decisions (as described earlier). Whilst in essence, the answer to 'what is science?' is still up for debate, the core principles of investigation, evidence, scientific theory and scientific law are not.

Scientific research, and therefore the acquisition of new scientific knowledge are implicitly tied to the epistemology of the time. Inductivism and falsificationism by no means cover the whole gamut of the epistemology of science; however, they have

both been very influential in the development of scientific philosophy. However, as discussed, what people commonly perceive to be the scientific method (inductivism) and other popular attempts at describing science (falsificationism) are plagued with issues. Some of this criticism is unique to each of the methods (for example, the problem of induction), or are shared by both (for example, being grounded on observation). They do however share some core principles: observe, test, hypothesise and predict/explain.

Due to the current discussion around the epistemology of science, it may be reasonable to suggest that it is these core principles that the general population should be aware of. Additionally, they should be mindful that to the best of current thinking, science does not follow any specific process (opposing the ideas people have on science) and that past attempts to describe it as such have been unsuccessful.

It is likely that, for most people, the school classroom has a major effect on shaping how people think about science. Therefore, the current knowledge on the nature of science, combined with how the nature of science interacts with the school science classroom should be given strong consideration to anybody wishing to support science education. The next section will explore this relationship further.

## **2.2 – The Nature of Science and the school classroom**

The philosophical questions addressed in the last section (2.1 - The Nature of Science (NOS), page 66) raise many important issues. How we define the process of science remains, and is likely to continue to be, up for debate. It has been suggested in the past that the nature of science has no sound and precise description (Herron, 1969), which has been reiterated more recently (Driver *et al.*, 1994). However, what is not so controversial is why understanding this is important to society. It has been noted that a lack of understanding about science can prove harmful, particularly where lay-people are engaged with science funding decisions, policy evaluation and interpreting scientific evidence in legal proceedings (McComas *et al.*, 1998).

It has been suggested (Taber, 2012) that for someone to understand the nature of science, they must be able to:

- Appreciate why scientists can disagree with each other, despite both claiming to have scientific evidence in their favour
- Distinguish between controversy where there is no general consensus within the scientific community, and issues that have consensus, but have a minority view against
- Be able to understand why, even with clear, agreed scientific evidence, people may come to different (non-scientific) judgements
- Be able to judge when a claim is scientifically supported

Is it essential for school children to understand all the above points? And if yes, why is it important they do so in the formal setting of a school classroom? During a review of Standards Documents for science education around the world, McComas and Olson (2002) discovered many commonalities referring to the

inclusion of NOS in formal science education (Table 8). These agree with the more general claims Taber (2012) makes, and makes very clear that science is not just a process of experimenting and concluding, but instead has a much wider scope and impact.

For many students, school education may be the first (and potentially only) formal chance they get to construct their own ideas on the NOS. Many researchers agree that the inclusion of the nature of science in the school classroom will enhance an individual, not only creating a scientifically literate person, but also enabling that person to make sound socio-economic, and other society-important judgements (Holbrook and Rannikmae, 2007).

A view has developed that the noticeable decline in students wanting to take up science as a career option is linked to the lack of NOS in the classroom. A review of relevant literature by Osborne et al., (2003b) suggests that in order to ensure students are considering science as a career, NOS must play a central role in their science education. This is by no means a recent concern. One of the earliest complaints about the lack of focus with regard to NOS in science education came from the Central Association of Science and Math Teachers in 1907, who argued for an emphasis on the scientific method and processes of science (Lederman, 1992). Additionally, Thomas Kuhn, an influential scientist from the mid-twentieth century stated that the concept behind science education should be about the history of science in relation to the nature of science. He cites this line of thought as far back as the 1940s. Kuhn believed there was little need for students studying biology to know scientific facts if they did not plan a career as a scientist, and suggests they would be better prepared for other job roles if they could understand the nature of science (Kuhn, 1957). This idea finds support in the recent changes to the National Curriculum (NC) for science, for example, assessment of NOS

Table 8 - The nature of science objectives extracted from eight international science Standards Documents (McComas and Olson, 2002)

---

### **A consensus view of the nature of science objectives extracted from eight international science Standards Documents**

---

- Scientific knowledge while durable, has tentative character
  - Scientific knowledge relies heavily, but not entirely, on observation, experimental evidence, rational arguments, and scepticism
  - There is no one way to do science (therefore, there is no universal step-by-step scientific method)
  - Science is an attempt to explain natural phenomena
  - Laws and theories serve different roles in science, therefore students should note that theories do not become laws even with additional evidence
  - People from all cultures contribute to science
  - New knowledge must be reported clearly and openly
  - Scientists require accurate record keeping, peer review and reproducibility
  - Observations are theory-laden
  - Scientists are creative
  - The history of science reveals both an evolutionary and revolutionary character
  - Science is part of social and cultural traditions
  - Science and technology impact on each other
  - Scientific ideas are affected by their social and historical milieu
-



within GCSE awarding body (see section 1.3 - Microbiology in the National Curriculum for England and other UK teaching specifications). Despite this, a focus in school science on subject knowledge still exists.

The nature of science can be a tricky concept for students (and teachers). In general, secondary school age students can be considered to have a somewhat unsophisticated understanding of key concepts about science (Taber, 2012), and tend to have a rather simplistic notions of the nature of scientific ideas (Driver *et al.*, 1996). The Wellcome Trust Monitor One (The Wellcome Trust, 2009) report found young people commonly believed that doing experiments was the main function of doing science, a possible reflection on the way science is portrayed in schools.

A study by Grosslight *et al.*, (1991) interviewed a mixed-age, mixed-ability group of students about their conceptions of models and their use in science. The study found that students were more likely to think of models as physical copies of reality, just in a smaller scale and different location, something Grosslight defines as 'a naive realist epistemology', compared to a constructed representation that may embody many different theoretical perspectives. It was noted however, that as a student's way of thinking becomes more sophisticated, their knowledge constructs can change. They increasingly include the fact that models are designed for a purpose, in particular, to communicate ideas.

However, the problems surrounding students view on the NOS is possibly down to a number of interlinked issues. It may be that the topic of science itself is particularly difficult to grasp, or that, due to a lack of emphasis on the NOS in the school classroom, students have simply not learned anything of it, and find it difficult to conceptualise. But it may not all be down to the individual student. Maybe somewhat unsurprisingly, research conducted by Abd-El-Khalick in 2002

discovered that a teacher's knowledge about the NOS may be just as weak as that found in school children (as cited in Taber, 2012) , because teachers are unlikely to have been exposed to the NOS as part of their formal training. Initial teacher training is likely to imbed the pedagogical strategies that will remain with the teacher during their career. However, although NOS may be discussed, it is unlikely the construct of science that a pre-service teacher has developed from their own school science education is going to undergo radical change in the relative limited time of teacher training (Abd-El-Khalick and Lederman, 2000). Therefore, material provided to teachers to enhance or promote science education should provide sufficient information and support to allow teachers to develop the material subject knowledge alongside their teachings on the nature of science.

### **2.2.1 – Constructivism and the nature of science**

Despite many attempts, arguments and rationales for including the NOS as a core concept of science education, science teachers, and in particular the curriculum they are bound by, are steeped in the tradition of communicating facts and knowledge of science whilst generally ignoring how the knowledge is constructed (McComas *et al.*, 1998).

There is agreement that knowledge is not simply passed from one person to another. Instead, it is actively built by the learner. It is believed that learners build a personal construction of meaning from the many theories a person may encounter by interacting with physical events in their day to day life (Driver *et al.*, 1994). Learning science from this perspective is thought to require practical activities that challenge prior knowledge, and encourage the formation of new personal theories. This is what is commonly known as the constructivist theory, a widely researched paradigm. It has gathered considerable empirical evidence to support the claim that constructivism has improved teachers' knowledge and understanding of a

child's scientific thinking (its origins and its development) (Osborne, 1996). To put it simply, it represents a theory of science, human learning and teaching all at the same time (Confrey, 1990). It is arguably the current leading paradigm in science education (Cakir, 2008).

Constructivists believe that students need to make sense of what is presented to them by building on the concepts they already hold (Lord, 1997). In an article about constructivism in the classroom, Millar (1989) believed that educators were attempting to propose a relationship between constructivist views and implications for pedagogy, a view he very much disagreed with. Instead, he argued that the particular views of learning are not necessarily linked to specific pedagogical practices. Instead, Matthews (1992) suggests of constructivism:

It is a view on how teaching should proceed, how children should be treated, how classrooms should be organised, how curricula should be developed and implemented, and sometimes even a view about the purpose of schooling

Driver et al., (1994) suggest that a key factor of the constructivist view is that it allows science education to appreciate that scientific knowledge is both symbolic in nature and also socially negotiated. Science itself is not a phenomenon, but instead forms constructs that are built by the scientific community used to interpret nature. This is often achieved by substantial intellectual struggles. As students are unlikely to acquire/build the constructs important to understanding science, scientific ideas, hypothesis construction and validation solely through their own empirical enquiry, learning science will involve being initiated into the 'world' of science and making these ideas and practices meaningful at an individual level. It should be down to the science teacher to mediate this process.

One pedagogical approach based on this teacher-mediation is to provide a student with a physical experience (for example, practical activity) and induce cognitive

conflict, encouraging learners to develop new schemes that are better adapted to experience (Driver *et al.*, 1994). The use of discourse is one route literature suggests achieves this (Erduran, 2012). The teacher can encourage conversation with students, asking thought provoking and reflection questions. However, this can be problematic. It is likely that students may have plural or previous constructions, which may directly conflict with the objective the teacher is trying to achieve.

#### ***2.2.1.1 - Misconceptions and common sense***

Young people will inevitably construct their own ideas of the world based on their interaction with day-to-day life. This is frequently referred to as the 'common sense' view. A classic example of this often cited in literature is the misconception that a constant force is necessary to maintain an object in constant motion (Clement, 1982). This is scientifically false. However, it is not surprising students may hold this misconception considering they are likely to have required pushing a heavy object across a floor, or continuous pedalling of a bicycle in order to move the object or ride the bike. These ideas evolve into 'common sense' over the course of childhood. However, everyday reasoning is often pragmatic, being used to explain interaction with a specific situation (for example pushing a heavy box across a floor), and not scientifically derived. Receiving contradictory information during science education is a relatively common occurrence, and is argued by some as being at the heart of knowledge acquisition in science (Chinn and Brewer, 1993).

Research has shown that change in understanding of this nature requires progressive restructuring of underlying theories within a student's mind (Chinn and Brewer, 1993) – similar to the historical development of science itself. However, some critics have argued that constructivism does not offer much in the way of

teaching theory (Jenkins, 2000). What the constructivists do say is that learning is not achieved by simply providing the student with facts or by extending existing knowledge. Individuals must engage in a process of ‘making sense’ of any contradiction they encounter. This must happen in two respects – social and personal. Students should engage in discourse with others in the scientific community (in the case of school science, this will be addressed within the classroom). Here, conversation will lead to questions about the student’s perceived concept of the phenomenon being discussed. This can take the shape of:

- *Common knowledge* (Guesne, 1985) – a teacher introduces a topic and encourages direct answers to questions they ask, encouraging contributions from the students, and allowing them to discuss their thoughts and theories between each other. This may be supported by a range of tactics (for example, supporting discourse with a practical activity demonstration). Students are asked to discuss their observations, and are mediated by the teacher.
- *Scaffolding* (Bruner, 1986) – Where the teacher (an expert) helps a student (less of an expert), in a way the student would not be able to achieve on their own (Bliss *et al.*, 1996).

### **2.2.2 - Practical activity and the nature of science**

*“School practical work is commonly teacher-directed busy work, poorly planned and with an unclear purpose”* (Griffin, 2002, p 179)

As discussed, there is a shift within the science education framework towards an emphasis on the nature of science. However, this is often interpreted by teachers

as requiring experiences equivalent to or based on the procedures of science. There is a misconception within science education that pedagogic strategy should align with the process of the discipline being studied (Kirschner, 1992). This is of a particular concern when discussing practical activity. Take for example, a teacher who wishes to conduct a hands-on laboratory experiment with a class. This teacher is likely to have retrieved the experiment from one of a number of locations: possibly her own imagination, knowledge passed on from other teachers (institutionalised activities) or an educational resource published by an external organisation. If the teacher were to retrieve the methods she required from one of the latter options, it may very well be counter-productive to constructivist thinking.

*Institutionalised activities* – These types of activities are likely to have been passed down from one teacher to another. They will have undergone years of meticulous fine-tuning in order to be highly predictable and repeatable. Although there are valid reasons for teachers using such experiments, they often conclude with ‘proof’ of a hypothesis, something the student may then take to be a certainty. This is not how science works in the real world, as discussed (see 2.1.2 – How is science done?), the issues of ‘proving’ science is still very much debatable.

*Educational resources* – Research has shown that teachers can be heavily reliant on educational resources and textbooks in order to plan, develop or copy practical activity for the classroom (Appleton, 2002). These practical activity resources (like many elements of science education) may be disconnected from the students’ lives (Hurd, 2002) (little or no obvious real-life relevance), and have an emphasis on teaching science as inquiry (Kirschner, 1992), instead of teaching about inquiry. However, any potential user should consider who that publisher is, and what their aim was regarding the resource. Although an organisation such as a learned society, museum or other scientific organisation may consider educational material

output to be central to their role, this may not be a 'for the greater good' purpose. Such organisations, particularly ones which specialise in a particular field of a science, may have a remit to promote their field, with the hope of increasing awareness or the number of students that follow that particular science to a professional level. This is by no means a bad thing, and often the resources and educational outputs these organisations create are well received by the teaching community. However, they are, by their nature, scientifically-centric organisations, and may, unknowingly, promote 'the rationale of the scientist' (Hurd, 1969) in the classroom. Hurd describes the rationale of the scientist as teaching the nature of science as it is viewed from a scientist, rather than teaching the nature of science with respect to its interaction with non-scientists everyday lives.

This issue has been identified with the overall use of practical activities in the class room: practical activities are all too often used for teaching, affirming or illustrating the substantive structure of science, whereas they are more suited to conveying the pathways of inquiry that scientists use: what they mean by and how they undergo the process of verification (Kirschner, 1992). This dimension should be give strong consideration when designing new practical activities (Millar, 2009).

Thus, when it comes to practical activity in the classroom, students may not be the only participants who require rebuilding of existing misconceptions. It has been noted in the literature that teachers can have an affinity to the term 'experiment', with teachers and students alike often using the term to describe any type of practical activity (Wellington, 1998). This will no doubt lead students to misunderstand the term 'experiment', giving an incorrect view on science. Externally produced educational resources can help here. Using correct terminology in their printed/online literature may encourage teachers to identify and correct their own misconceptions.

Some of the points noted above emphasise the gap between science education research and its practice within the school environment (either at teacher level or that of an external organisation producing educational resources). If, as researchers are suggesting, NOS is an essential part of science education, more needs to be done to encourage teachers to address this with their students using constructivist theory. This may be achieved by providing teachers with the resources for new practical activities (Ratcliffe and Millar, 2009), developed with the concept of NOS in mind, attempting to move away from more tried and tested institutionalised activities. Then, teachers may be more likely to achieve the intended curricula outcomes.



### **2.3- Nature of science, constructivism and microbiology**

Microbiology (as with many life sciences) is experimental in its nature. Questions regarding the techniques required and what type of practical activity is best to teach microbiology (For example Baker and Verran, 2004, Engohang-Ndong and Gerbig, 2013, Marbach-Ad *et al.*, 2009) are debated in literature. However, much of this focuses on the undergraduate teaching laboratory. There is little literature regarding microbiology in the school science laboratory.

Some may argue the subject is well positioned to enhance the powers of constructivism. Microbiology is often plagued by misconceptions (Redfern *et al.*, 2013b), whether this be a student misunderstanding the difference between a bacterial cell and a viral particle, a teacher misunderstanding what the field of microbiology is, or a lay person misunderstanding the use of antibiotics for treatment of a viral infection. One study (Buxeda and Moore, 2009) suggested that considering constructivist learning theory when teaching microbiology would be likely to increase student learning. Another study (Luciano *et al.*, 2009) found that teaching using bacteriophage as a model (supported by constructivist learning theory - active learning, group work and learning about inquiry) were very successful and increased student satisfaction due to the constructivist nature of delivery.

Much emphasis is placed on technical skill in the school microbiology laboratory. In the previously described survey on microbiology in UK secondary schools (Section 1.5) the top three activities; antibiotic testing, using agar and aseptic technique, all require skills often seen as unique and essential to microbiology. This emphasis on skill, precision and 'getting it right' might remove the focus of the nature of science from any hands-on experience. Teaching inquiry as opposed to by inquiry. Some may argue that microbiology requires an autonomous behaviour

with respect to practical activity (for example in using aseptic technique). However, the way in which this autonomous behaviour is achieved, teaching and practise, should be enhanced using constructivist approaches. If students are putting all of their attention into the careful manipulation required of microbiology, they may miss or overlook the aspects of what they are actually doing (the processes of science). The results indicated that teachers and students alike could struggle with practical microbiology activity. This may in some way explain the success of microbiology-focused learned societies educational resources (Editorial, 2012).

Many microbiology resources, for example, a pair of practical activity resources published by the Society for General Microbiology (Burdass *et al.*, 2006, Fry *et al.*, 2008) follow a 'cook-book' approach to practical activity. Activities are presented with a short paragraph explaining their purpose. This paragraph is somewhat vague, scientifically written and the text does not make obvious connections to the nature of science or the 'real world'. The procedure/methods are written as numbered points, in a step-by-step fashion. The text is instructional, and does not explain the process. Each activity does have a small section of 'learning objectives', which highlight different aspects of microbiology which the activity is targeting. Some of these are very specific, for example 'the dangers of re-freezing thawed food' and 'how pectinase is useful in the fruit juice industry' and are not clearly linked to the scientific knowledge content of the National Curriculum. This may be due to the aim of the publication, likely to promote the science of microbiology with a range of different applications. However, there is considerable opportunity to use microbiology to discuss the nature of science, particularly with respect to history and the development of scientific methods, as well as linking scientific inquiry to the real world experiences of students. Therefore, there should be a greater emphasis placed on the relationship between microbiology, its real

world relevance and the nature of science in school microbiology activity resources, which is explored in the remainder of this section.

Historically, microbiology has played a huge role in the development of scientific methods. Ever since 1889 when Roux began teaching *Cours de Microbie technique* at the Institut Pasteur, the role of experimentation in science has been central to microbiology education (Opinel, 2008). Many of the most famous scientific discoveries and advancements have been microbiology-centric, for example,

- The discovery of Penicillin by Alexander Fleming
- The invention of Pasteurization by Louis Pasteur
- The introduction of medical hand washing practice to reduce infections by Ignaz Semmelweis

These three are by no means an exhaustive list of key microbiology inputs, but they are good examples of the different aspects of the nature of science that can be discussed using microbiology. The discovery of Penicillin was a serendipitous observation, highlighting the unpredictable nature of scientific discovery. Louis Pasteur on the other hand invented the process of Pasteurization after a request from the French military to provide a method for food preservation, a good example of the scientific process from pragmatic perspective. The story of Semmelweis identifies a third aspect. When Semmelweis observed that washing hands in between medical inspections of patients significantly reduced infection, his theories on infection transfer were not accepted by the wider community and discredited. At the time (mid nineteenth century), the Hippocratic concept of epidemics (that being disease was caused by an imbalance in the four humors present in the human body: blood, yellow bile, black bile and phlegm) was still very

much the doctrine surrounding disease, and Semmelweis's work only gained widespread appraisal long after his death with the help of many other scientists providing supporting evidence, most notably, Louis Pasteur who evidenced the germ theory some years later (an example of the way a dominant paradigm can suppress an alternative theory). The story of Semmelweis illustrates science as a progressive element in society, developing over time, being shaped by current epistemology (Wyklicky and Skopec, 1983). These examples provide a lasting legacy immediately relevant to everyday life. They also show that microbiology is well prepared for considering the nature of science. Perhaps, more attention should be paid to the history of the field when developing such resources, linking practical activity with the history and development of the science and how it currently plays a role in the day-to-day life of the student.

Recently there has been a call to close the gap between teachers and pedagogical researchers, requiring a change in attitudes of the teaching profession (Goldacre, 2013). Additionally in the UK there is a push for scientific organisations such as learned societies to lobby science education policy (SCORE, 2011) demonstrating the understanding of a unified approach to supporting science education. However, there is no standard in the UK for published educational resources from scientific organisations. This may be due to a number of reasons, particularly the high number of scientific organisations producing such material, and the vast array of subjects they provide. The development and implementation of such guidance, based on research and examples of best practice would surely be of benefit to all concerned.

However, the same cannot be said for other scientific organisations around the world. The American Society for Microbiology (ASM) ([www.asm.org](http://www.asm.org)), the largest microbiology society in the world, follows a strict brief as to what can be included

in their schools outreach programme (ASM, n.d.). This is based on the National Science Education Standards (National Committee on Science Education Standards and Assessment, 1996), and from this, the ASM requires all its output to feature the following detail:

- Activity characteristics, for example:
  - Classroom setting? Requires special equipment? Uses hands-on manipulation? Can be performed individually?
- Core themes addressed, for example:
  - Microorganisms and humans
  - Microorganisms the environment
- Interdisciplinary themes, for example:
  - English
  - Mathematics
  - Chemistry
- Learning objectives
- Science education standards addressed, for example:
  - Experimental design and conduct
  - Science as enquiry
  - Developing a hypothesis

The ASM is not the only American learned society to follow such rigor, the American Physiological Society, the American Association for Anatomists, the Society for Developmental Biology and the Northwest Association for Biomedical

Research all require similar detail, with many undergoing peer review (APS, n.d.). A similar set of standards developed in order to encourage learning materials published by scientific organisations (such as learned societies) in the UK could provide teachers with a new level of confidence that the resources they are using in their classroom are of good standing. Any standards developed could ensure the themes of nature of science are included, as well as scientific knowledge, linking to the goals set by the National Curriculum and the various awarding bodies.

## **2.4 - Conclusion**

How science is portrayed, how science works and what is meant by the term 'nature of science' is very much contested. Many laypeople may conflate to answer these questions with concepts that closely resemble ideologies of past scientific eras. Previous attempts to define science described in this chapter (inductivism and falsificationism) highlight philosophical issues surrounding science. Whilst the philosophical debate may not be of concern to many, it will undoubtedly affect how people interact with science knowledge in the world around them; making decisions based on data and observation, and evaluating evidence to make an informed decision.

The importance of NOS, and its place in school education is no longer debated, and as evidenced by its inclusion and recent emphasis in the National Curriculum and research literature. However, a recent review by Abd-Ed-Khalick (2012) states that despite broad efforts in promoting the education of the NOS, students continue to ascribe to naïve conceptions of NOS, and that teachers continue to structure and conduct science education in a way that is incommensurate with scientific inquiry. Currently, evidence is building to support the epistemology of constructivism (argued as the theory of learning that best suits science education), with relation to teaching the nature of science in the school classroom with the hope that this will correct these issues.

Despite this focus on NOS, scientific knowledge is unlikely to be removed as a major part of scientific education in schools. Microbiology, with its historical input in the nature of science and its vast importance in the world around us is well-positioned to enhance the teaching of both the nature of science and scientific knowledge in the classroom. However, microbiology is somewhat underused/misunderstood in the school classroom (section 1.5).

Currently, one way in which in-service teachers receive new teaching activities is through the heavily relied-on use of educational resources. Many scientific organisations produce such material; however, no standard exists in the UK for such publications. This could lead to some educational resources developed without current research thinking (importance of nature of science) being utilised in the science classroom. Additionally, the inclusion of the nature of science is further hampered by the limited time (rightly or wrongly) practising teachers wish spend interacting with pedagogical theorists (discussed in Chapter 3).

It has been suggested teachers in the UK may hold an anti-pedagogical position when it comes to their teaching strategies. If educational resources were to use current theory in their development, and have NOS concepts embedded in their content (a potentially achievable aim for a practical activity resource) with the balance of scientific knowledge required to align with curricula, then it may enable teachers to effectively demonstrate and teach the nature of science and subject knowledge.



## **Chapter 3 – Secondary school science pedagogy**

### **3.1 - Introduction**

The importance of scientific meta-theory (the theory underpinning science – the nature of science) should be a significant consideration when developing new practical activity resources. However, although these resources may have been developed with the appropriate content, how that is transcribed into active teaching in the classroom is likely to be variable. This chapter will look at the way in which science teachers interact with such education support materials in order to guide the process of developing a learning resource.

### **3.2 - Science pedagogy and practical activity resources**

Pedagogy is considered to be the science and art of education. The research field promotes principles and good practices of teaching, and therefore is a critical concern in science education. A relatively recent (the past three decades) interest in the science of pedagogy has enabled teachers to better inform their practices through research-proven methods. Pedagogical knowledge is routinely taught through pre-service teacher education in the UK (DfE, 2011). However, science education research can be regarded as ‘a fuzzy discipline’ by many involved in the field, as it is notoriously difficult to argue that any particular teaching method is better than any other (Oversby, 2012). Worryingly, there is a view held by many practicing educators that it is best to ignore advances in pedagogical theory because they believe it to be nothing more than researchers “handing out recipes and models to be followed” (Coffield *et al.*, 2004).

The way in which a teacher might employ pedagogical knowledge is likely to be a personal decision, with teachers often reassessing strategies and ideas whilst personalising approaches to individual situations (Staver, 1998). Research

(Lederman *et al.*, 1994) has shown that content knowledge, pedagogical knowledge structures and complexity of subject matter are key factors in ensuring the best delivery of science. All of these should be addressed during the development of learning materials. However, as discussed in the previous chapter, the teaching of science, and in particular, using constructivist theory, should not be linked to any particular pedagogical strategy. It is therefore important that learning materials should not dictate any specific pedagogy, and instead offer support to deliver the material to teachers through other means.

### **3.3 Pedagogical Content Knowledge (PCK)**

As noted previously, the nature of science is fast becoming a central concept in secondary science education; however, subject matter knowledge (SMK) will always be fundamental to any school subject. Nevertheless, the role of subject matter knowledge has been somewhat overlooked in science education research (Berry, 2012) in favour of pedagogical research.

The term 'pedagogical content knowledge' (PCK) has been in use since the late 1980s. Originally coined by Lee Shulman (1986), PCK refers to the way in which a teacher understands specific subject content within the context of teaching and student learning. It should be considered a separate knowledge base to other important science education knowledge such as knowledge on pedagogy (Magnusson *et al.*, 1999). Since its introduction, PCK has been a research focus for in-service and pre-service teachers, with studies highlighting different uses and concerns. PCK has become increasingly prominent in research literature, particularly between 2009 and the present (Figure 17), highlighting its current prominent standing in science education.

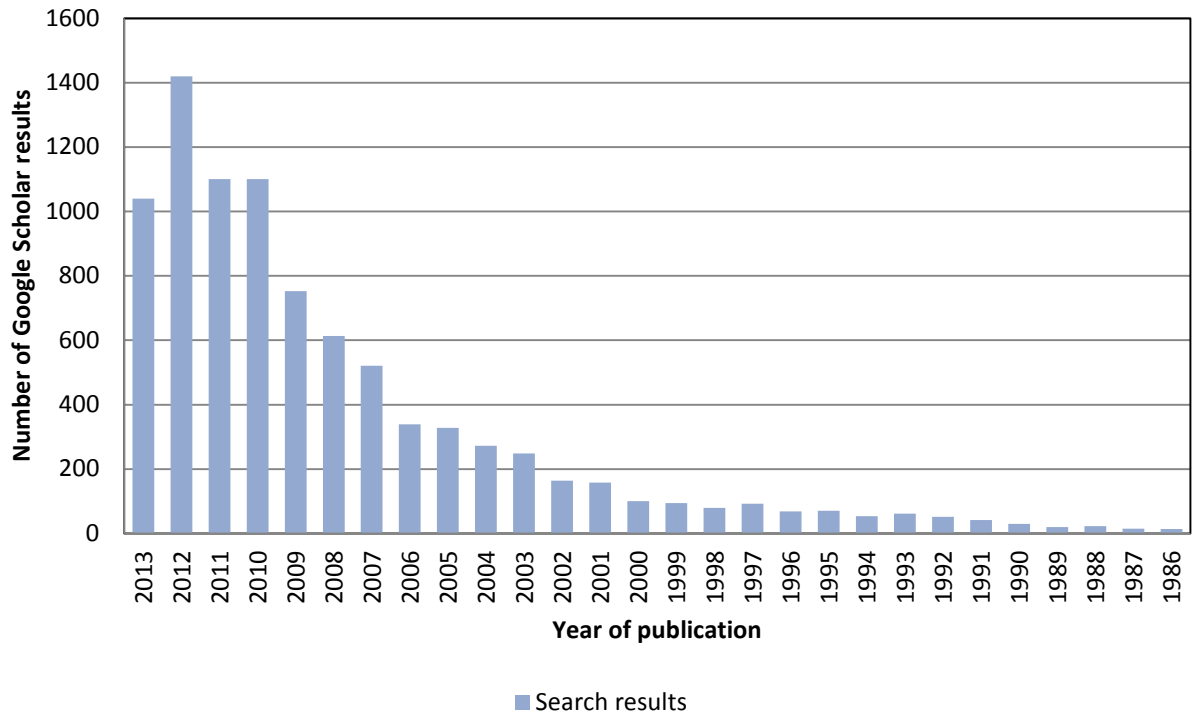

**Figure 17 – Graphical representation of the number of results when searching keywords ‘PCK science education’ in search engine Google Scholar, limiting results to journal articles and books on a year-by-year basis.**

A lack of SMK, and in particular PCK in teachers could prove detrimental to science students. Interestingly, in contrast to the physical sciences, there has been a distinct lack of biology-specific studies focusing on teachers' understanding of science (Kind, 2012). This may be due to a larger proportion of teachers holding biology degrees (DfE, 2013b) than is the case with the other sciences, and therefore research may be less fruitful as one might assume biology graduates would hold fewer issues and misconceptions about their field. However, research also suggests that holding a degree in a particular field does not automatically give the specific subject knowledge required in the classroom (Deng, 2007), and therefore, biology teacher's PCK should not be overlooked.

Appleton (2002) found that pre-service and non-specialist newly qualified teachers would often find ways to compensate for a lack of PCK. This included reverting to tried-and-tested activities (previously described as *institutionalised activities* - page 87) recommended by experienced teachers and relying heavily on printed resources to gain both scientific knowledge and ideas for teaching (Osborne and Simon, 1996). Other teachers relied heavily on copying and worksheet activities (Ratcliffe and Millar, 2009), whilst some focused their teaching on topics they are more content with (Harlen, 1997), avoiding areas where they have limited SMK and PCK and being reluctant to take risks with teaching strategies they were uncomfortable with (Appleton and Kindt, 2002). Additionally, those who may have difficulty understanding the content they are to deliver are more likely to embed misconceptions into the delivery of their lessons (Hashweh, 1987).

Researchers have provided differing ideas on what the construct of PCK should encompass. These have included a teacher's understanding of student misconceptions in science (Carlsen, 1999), understanding of the role of assessment (Tamir, 1988) and the incorporation of technology (Niess, 2005). In a

highly-cited paper, Magnusson et al., (1999) identified five aspects of PCK they believed were essential to any science teacher:

1. Orientation toward teaching science
2. Knowledge of science curriculum
3. Knowledge of students' understanding of science
4. Knowledge of assessment in science
5. Knowledge of subject-specific and topic-specific strategies

The first aspect, orientation, Magnusson believed to be critical, affecting all subsequent aspects. Orientation encompasses the goal the teacher believes they are trying to reach, and can serve “as a basis for judgements about textbooks, classroom objectives, assignments and evaluation of students” (Grossman, 1990). However, a review of the literature revealed that very few studies examine secondary science teaching orientations (Friedrichsen, 2002 as quoted by Friedrichsen and Dana, 2005). A substantive study by Friedrichsen and Dana (2005) on four highly regarded science teachers did find that although subject matter was a goal in a teacher’s orientation, it did not always have a central role. Additionally, the study found that orientations were strongly influenced by personal beliefs about the learners and learning, as well as any previous work experience, professional development and time constraints the teacher may have had or be under. There is limited literature discussing teacher orientation and practical activity in secondary schools. However, one study found that teacher orientation is able to effectively limit or even stop a teacher from carrying out practical activity in the classroom (Kim and Chin, 2011), as they may not feel comfortable with it or find it obstructive to their own teaching goals. Combined with the existing pressures of the classroom, such as lack of administrative support (Zion *et al.*,

2007), if not aided in some way, teacher orientation could provide a significant block to practical activity in the science classroom.

This may be of particular concern for those interested in microbiology in the classroom. As previously discovered (see section Chapter 1 - Part 2: Practical microbiology in UK Secondary Schools: a National Survey of Teachers), some teachers are not comfortable with practical microbiology. Reasons for this are various; however, as pointed out by one respondent to the survey in Chapter 1, some teachers may be using other potential issues as an excuse for not performing practical microbiology due to fear of the subject.

Whether this perceived fear is of the subject matter or of the practical nature of the experiments (for example fearing a lack of reproducibility or health and safety), educational resources may offer support. A well-prepared introduction, including sufficient information regarding the scientific underpinning as well as aspects of the nature of science should be included for every activity. Additional information that could be helpful to a non-microbiologist in order to implement successfully practical microbiology activity in the classroom, for example, specific health and safety information and culturing advice should also be included. This, supporting a teacher's SMK and PCK will hopefully reduce any limiting issues concerning non-specialist biology teachers performing practical microbiology.

Once the teacher is comfortable with the material, it is then down to the teacher to teach the programme to the class of students. The next section will investigate and propose the role of educational resources in achieving this.

### **3.4 – Student learning and educational resources**

Although the development of a learning resource may take into account the concepts mentioned in the preceding sections of this and previous chapter (NOS, SMK & PCK), science cannot simply just be ‘delivered’ to students (Amos and Boohan, 2002).

For many decades the science laboratory has been viewed as a place for students to engage with and construct knowledge by doing science (Tobin, 1990). However, it is now realised that helping individual students to achieve desired outcomes can be a very complex issue (Hofstein and Lunetta, 2004). Tobin (1986) stated that this complexity and the inevitable difficulty of tailoring laboratory activities to diverse students (particularly those with low motivation and skills) could be another reason teachers are put off practical activity altogether. Therefore, some might suggest that it is important when developing practical activity resources to keep knowledge of different styles associated with learning at the forefront; in order to support the teacher, and subsequently, the learner, to achieve the desired outcome.

However this is not as straightforward as it may seem. Taking into account the personal nature of learning styles, it becomes very difficult to construct an educational resource that caters for all. It is essentially down to the professional in the classroom (the teacher) to use any learning material provided in order to fit each student’s requirements.

Research in this area has been significant in recent decades, investigating one of a number of factors affecting the way in which a student may learn in a science classroom, including; effects of environmental, emotional, sociological, physiological and cognitive preferences (Dunn *et al.*, 2002), often grouped together to form the research field known as learning styles.



Learning styles, as the name suggests, denotes the specific ways in which we acquire information. Over the past century over 70 different models have been proposed (Coffield *et al.*, 2004), yet, recently, researchers have begun to question the authenticity of learning styles, proposing an end to the pursuit of understanding them as individual models, and focusing on a more integrative approach to understanding learning (Coffield *et al.*, 2004, Tanner, 2004, Pashler *et al.*, 2008).

Whilst there are numerous approaches to the topic of learning, it is generally agreed that any approach will be different depending on the outcomes required, i.e. no single person has a single approach to learning (Reid, 2005) requiring teachers to be flexible with their approaches (Lyon, 2013). The concept of learning styles has long had great influence on education, with the most popular interpretation being the meshing hypothesis – people learn best when the information is provided to them in a way that matches their preference of learning (Pashler *et al.*, 2008). Examples of this include different ways of presenting material (for example, visually to a visual learner) or consideration of thinking styles (for example, conservative or liberal thinking). The next section provides as a critical review of just one of the learning styles used in the classroom, thinking styles.

### **3.4.1 – Thinking styles**

Thinking styles encompass the way in which people use their abilities to learn (Sternberg, 1999). They are an attempt to explain why students differ in achievement in different scenarios (Sternberg and Zhang, 2005). Many models of thinking styles have been suggested over the last century. A prominent model in the literature is that of the 'Theory of Mental Self Government'. Sternberg (1999), proposed that thinking styles could be categorised in a similar manner to

government organisation. The use of a particular style is decided on by the individual, and may change depending on the situation. He suggested a level of social interaction, noting that they could be cultivated and modified. Sternberg's model was based on 13 thinking styles that were categorised into five dimensions (see Appendix 2, page 256).

How a teacher interacts with learning styles in the classroom is likely to be decided on a case-by-case basis. Understanding their students' thinking styles can better prepare a teacher successfully to present information in order to achieve the desired outcomes. In one article, Zhang (2004) reviewed studies carried out on thinking styles and achievement in the classroom. The literature suggests that there is a link between thinking styles and academic achievement. The thinking styles most likely associated with positive academic achievement were 'executive, conservative, and monarchic styles (styles that denote conformity and rule adherence), as well as the hierarchical style (a student that communicates a sense of order)'. Misinterpreting a student's thinking style, or failing to acknowledge a difference across a classroom could potentially deprive a student of opportunity (Sternberg and Zhang, 2005).

The use of learning styles may affect the way in which a student perceives a practical activity in the school science laboratory (Sternberg and Zhang, 2005). Therefore, when considering how to approach thinking styles with respect to practical activity, it is important to consider NOS. If the practical activity is able to support the concept of NOS, and it is indeed one of the activity outcomes, then encouraging certain thinking styles may be a way to ensure students are better able to grasp the NOS. Some thinking styles could be considered discouraging to understanding the concepts of NOS in practical activity, whilst others may prove helpful in students' understanding (Table 9).

As discussed (Chapter 2), the NOS and constructivist theory require students to challenge their current ideas and theories, ask questions, evaluate data and reconstruct their beliefs about science and the world it symbolises. Four of the thinking styles proposed in the Theory of Mental Self Government (monarchic, local, internal and consecutive) may encourage people against thinking in this way (Table 9).

It is important when considering science via a practical activity to think of the 'bigger picture', what is it you are doing, and how does it fit into the scientific knowledge we already hold? Those who follow a monarchic thinking style tend to only focus on one thing at any given time, whilst those with a local thinking style may understand a string of facts, however, do not necessarily understand how these facts link together or consider their overarching importance. These are in opposition to some of the fundamentals of constructivist thinking which is likely to cause friction alongside current supported teaching concepts. Additionally, by its very nature, constructivist learning requires a certain level of ambiguity, challenging a student's current thoughts, something a student with a conservative thinking style may attempt to avoid.

A commonly cited pedagogical avenue of constructivist teaching in science is that of group work and discussion-based activity. This is important for practical activity, giving students the chance to question each other, think out loud, and build a construct about what activity they might have just undertaken. Students with a local thinking style are unlikely to enjoy this, preferring instead to work independently and not offer their thoughts to a group.

Table 9 – Thinking styles adapted from the ‘Theory of Mental Self Government’ (Sternberg and Zhang, 2005), split depending on how they align with consideration of NOS in practical activity in school science

Helpful to nature of science in practical activity	Not helpful to nature of science in practical activity
<b>Judicial</b> – enjoys evaluating and analysing, judging existing ideas.	<b>Monarchic</b> – likes to focus on one thing at one time
<b>Hierarchic</b> – understands the goals they need to achieve and order them in a hierarchy	<b>Local</b> – Can understand a great amount of facts but little understanding of a superstructure
<b>Anarchic</b> – draws ideas from many different sources and enjoys creativity	<b>Internal</b> – likes working independently of others, does not speak out or offer ideas
<b>Global</b> – likes engaging with large and abstract ideas	<b>Conservative</b> – doesn’t like change and avoids ambiguity
<b>External</b> – enjoys working with others in a group or interacting with others at different stages of progress	
<b>Liberal</b> – Likes challenges and enjoys ambiguity	

However, there are a number of thinking styles that can aid constructivist learning through practical activity. Students that hold an anarchic style are likely to draw on data from more than one source, questioning and considering where they are getting their information. Those with global and external styles are more likely to be comfortable with abstract ideas, viewing the activity within the 'bigger picture' of scientific knowledge, whilst being more likely to work with others and discuss their findings, ideas and theories. Liberal thinkers are more open to a challenge and happy to deal with ambiguity (something that may occur during a science activity) whilst those with a judicial thinking style are happy to evaluate, analyse and judge the information they are presented with in order to challenge their existing ideas.

Despite the potential importance of thinking styles affecting interaction with a practical activity in school science, it is difficult to consider/guide this from an external publication (such as a practical activity resource). Nevertheless, it may not be impossible.

Research has found that there is a significant match between a teacher and their students' learning styles, and in a similar study, research suggested students performed better when their thinking style matched that of their teacher (Sternberg and Zhang, 2005). However, in their review, Sternberg and Zhang suggest that teachers, particularly at a level similar to secondary school, become more executive with their thinking styles (following clear instruction, using activities that follow well-established guidelines), whilst science teachers in particular were found to be more local with their style. This may encourage teachers to revert to using *institutionalised activities* (Chapter 2), discouraging the use of new, exciting and well-designed practical activity in the classroom.

Therefore, if a teacher thinking style can be guided towards a constructivist/NOS supporting style through an educational resource, this may in-turn benefit the

student. Any practical activity resource that is written in such a way to encourage the thinking styles which could potentially aid the demonstration of NOS through practical activity, should be considered when developing any educational resource aimed at teachers. If a teacher can be guided to use an 'encouraging' thinking style, their students may follow with regards to their thoughts and ideas regarding science.

### **3.5 - Conclusion**

Consideration of learning theory when developing an educational resource is a thorny area. Recent reviews suggest there may be more to understanding how a student learns than by support from specific learning styles (alongside with the intrinsic individual nature of learning, and not to mention the sheer number of different, and often opposing models). Considering this, it becomes near impossible to build an educational resource that can at one and the same time effectively cater for all learning styles.

However, that does not mean an educational resource does not need to be developed from an uninformed position on learning. It is instead possible to consider what it is the resource is aiming to achieve (for example imparting nature of science ideas or important microbiology concepts using practical activity), and ensure that a teacher will be able to use the resource effectively to meet those goals. This can be helped by considering PCK, ensuring the resource is built in such a way that a science teacher (who might potentially not have SMK) should be able to pick it up, and have all the information they require to complete the activity successfully with their students. From this viewpoint, an educational resource would be better presented as a teacher's 'tool-kit'. Instead of promoting any particular delivery method, it instead presents all the information required to use

practical microbiology effectively in the classroom to enhance the particular learning outcomes required by the teacher and curriculum, for example, understanding the nature of science and scientific enquiry. This is precisely the approach that underpins the resources that are the focus of this thesis.

## **Section 3 – ‘Algae a practical resource for secondary schools’**

### **Chapter 4 – Developing an educational resource for practical microbiology activity**



## **4.1 – Introduction**

This section will describe the development of a practical activity-based educational resource that will fulfil the aim stated thus far: to develop laboratory protocols for GCSE/A Level teaching in appealing, current, microbiology areas. The development will utilise the research and investigation described in previous chapters to support the resource. This will include:

- Consideration of the current state of microbiology teaching, particularly the practical element, in schools & colleges
- Consideration of microbiology resources currently available to teaching staff in schools & colleges
- Knowledge of gaps in the current GCSE and A level curricula where microbiology can be utilised

The resource will use algae as model microorganisms, and will be aimed at Key Stage 3 and 4 in the England, Wales and Northern Ireland education system (ages 11 to 16). This section is split into two chapters:

- Chapter 4 - Development of resource content: practical activities included in the resource, other components of the resource and trial and evaluation pre-publication
- Chapter 5 - Resource post-publication: dissemination, promotion, use and summative evaluations

The resource was published in January 2012. Any mention herein referring to 'the resource' are referencing this publication.

- Redfern, J. (2012). Algae: a practical resource for secondary schools. Reading, UK, Society for General Microbiology. ISBN: 978-0-9536838-7-1

## **4.2 – ‘Algae: a practical resource for secondary schools’ - developing resource content**

### **4.2.1 – Introduction**

Algae are well placed for use in the secondary school science laboratory. Classified as microorganisms, they are safe to handle, relatively large compared to other microorganisms and visually appealing. According to EU directive 90/679/EEC (EU, 1990), many algal species fall under the ‘group 1 – biological agent’ category, designating them as microorganisms unlikely to cause human disease. The Association for Science Education (ASE) publication ‘Topics in safety’ (ASE, 2001 p. 96) notes that there is little cause for health and safety concern when using algae in the school classroom. Compared to other microorganisms, their size allows them to be viewed easily on low magnification microscopes (such as those often found in secondary school science laboratory) and their cells and colonies are often different shapes, sizes, colours, and they exhibit different types of motility, providing opportunities to intrigue and excite students. Following the review of the National Curriculum described in section 1.3, it is clear algae have many important functions in the world around us. Therefore it is possible to link algae with many aspects of a teaching specification (Table 10). Algae are well suited to use for teaching the four most frequently cited topics in GCSE teaching specifications in the UK secondary school (Chapter 1 part 1.3.2):

1. Photosynthesis
2. Gas cycling (carbon and nitrogen)
3. Adaptation
4. Lichen

Table 10 -Examples of links between a Key Stage 4 (GCSE) specification (AQA, 2010) and the relevance of algae in the classroom

Topic	Link to algae
Interdependence and adaptation	Algae are well adapted to survive in their habitat. Changes in the environment can affect the distribution of algae, these changes can be living (e.g. predation) or non-living (e.g. change in temperature)
Energy and biomass in the food chain	Algae, as primary producers play an essential role in the food chain and the transfer of energy and biomass
Waste materials from plants and animals – the carbon cycle	Carbon dioxide is removed from the environment by algae using the process of photosynthesis. When they respire carbon dioxide is released into the atmosphere. When they are eaten the carbon inside their cells are transferred to other organisms
Why organisms are different	Characteristics of organisms are controlled by genes, found in the nucleus
Evolution	Algae have evolved to allow for the microorganisms to better survive its environment
Cells and simple cell transport	Algae can highlight the concept that all living things are made up of cells, and that microorganisms are often single-celled organisms. Algae contain a nucleus and chlorophyll
Photosynthesis	Algae use light energy to make their own food, and by photosynthesizing have become an essential primary producer
Organisms and their environment	Living organisms such as algae can form communities and relationships with others. These relationships are affected by external influences
Biofuels	Algae have potential to form a valuable biofuel, using the fats stored inside the algal cells
Food production	Algae form the bottom of many food chains and therefore are an important factor when considering food production. They can also be used as a food source for other microorganisms and animals

Algae are eukaryotic and photosynthetic microorganisms. They are diverse in both structure and size. The algae have seven different groups (Hoek, 1995) classically described as so due to their morphology (page five in the resource). The groups do not necessarily share many common features, but, they are all photosynthetic – possessing the ability to harvest light energy (which is a notable feature of the algae). Algae have existed on the planet for millions of years. Some lineages have been estimated to have evolved over a billion years ago (Potin *et al.*, 2002).

Photosynthesis is one of the most important biological processes on earth. During this process, light energy is absorbed by chemical pigments and is converted into chemical energy in the form of ATP (adenosine triphosphate) and NADP (nicotinamide adenine dinucleotide). Photosynthesis can use light in the range of 400 – 700nm (known as photosynthetically active radiation – PAR) (Sze, 1997). The diversity of pigments in this group of microorganisms show that any common ancestor was likely primitive with little or no close proximity to the multitude of algae found on earth today (Rowan, 1989). Until the 1960s when developments in microscopy allowed intracellular investigation, Cyanobacteria, once known as blue-green algae, were considered to be in the same group as algae. Cyanobacteria are in fact prokaryotic, whereas algae are eukaryotic. Cyanobacteria have now been reclassified as bacteria (Stanier, 1977).

Algae habitats are not restricted and are found in abundance all over the planet, commonly residing in locations of moisture. This includes most bodies of water such as marine (the sea), brackish (estuaries) and fresh water (ponds and lakes), as well as on surfaces such as walls, stones (in biofilms) or other algal cells (together known as an epiphyte). They can be symbiotic, most notably forging partnership with fungi to form lichen (Ahmadjian, 1960) and their growth pattern can be used as an indicator of pollution (Rose and Hawksworth, 1981).

Like other microorganisms, algae can be used as a tool to facilitate discussion not directly associated with microbiology. An example of this is evolution by natural selection. Algae have evolved many attributes which make them better suited to their environment. The species *Euglena gracilis* has evolved the ability to relocate by sensing light, enabling the cell to better position itself to carry out the process of photosynthesis. Another example of algal evolution is that of bioluminescence. Some algal species (for example *Pyrocystis lunula*) can emit a blue light in a series of flashes, each flash lasting approximately 100 milliseconds, with a latency of 20 milliseconds, although the intensity, kinetics and duration of the flashes can vary depending on species (Lynch, 1981). The cell can only emit light if the cell membrane is disturbed (Cussatlegras, 2007). The disturbance triggers a series of biochemical reactions, resulting in the entry of hydrogen ions into organelles known as scintillons. Here, oxidation of a specific photoprotein (luciferin) releases energy in the form of blue light (Hastings, 1972). Although the biological purpose of the bioluminescence is still under debate, it is believed it may have evolved as a defensive mechanism. This is known as the 'Burglar alarm theory'. It states that as the light is emitted, due to a disturbance in the water around the cell (likely to be from a predator of the algae), the attention of other predators is drawn from a distance. As the other predators move in closer and attack the predator of the alga, the number of algae lost to predation falls (Abrahams, 1993).

As noted in previous chapters, it is important that students make link between their science education and the world outside the classroom. Algae provide numerous examples of such links. Examples include:

- Potential use as a source of biofuel - Some species can store oil, for example up to 50% of the genus *Nannochloropsis* biomass can be oil (Singh and Gu, 2010)

- Food production – Carrageenan, produced by some algae can be used in food preparations as a gelling agent (Cardozo *et al.*, 2006).
- Pollution monitoring – Some bioluminescent algae, for example *Pyrocystis fusiformis* can be used as a bioassay (a test using a living organism) to test for high pollution levels (Lapota, 2007).
- Manufacturing – Diatoms, a large group of algae, have cell walls that are made of a hard substance called silica. Once the diatom has died, the cell wall can form diatomaceous earth on the sea floor. This has many industrial applications, for example: as a filler in medicines (Cohen, 1994), in toothpaste (Yeh, 1986), pest control (Quarles, 1992), a stabiliser in dynamite (Meyers, 1990) and a component of china clay (Kubo, 1970).

Algal effects on humans and the environment around us are not always positive. A small number of algal species can produce toxins. Under normal circumstances the amount of toxin produced is not high enough to cause any great danger, but, under optimal conditions (such as fertilizer pollution), the population of algae will multiply rapidly and an algal bloom (a large population of algae) may form, increasing the concentration of toxin produced. If toxin production is sufficient it can kill larger organisms, decrease feeding and growth rates, cause food safety issues or adversely affect the quality of the product (Anderson, 1994, BBC, 2011). Additionally, algal blooms can have significant negative effects on the economy of coastal regions (Hudnell, 2010).

Saxitoxin, brevetoxin and domoic acid are toxins that can be produced by algae. They can be responsible for effects such as vomiting, nausea, paralysis, amnesia and a variety of neurological symptoms such as slurred speech. In some cases they can be fatal to humans (BatorÈu, 2005).

As discussed in Chapter 2, concepts central to 'how we do science' are becoming more and more important in school science education. Additional to the scientific topics highlighted in the specifications, algae can also be used to demonstrate key concepts associated with the nature of science. For example, as noted previously, until reclassification in the late 1970s (Stanier *et al.*, 1978), cyanobacteria were believed to be a group of algae. This was based on experimental data and observation determining the presence of chlorophyll and photosynthetic activity. Before this time, cellular structure was unknown, due to insufficient experimental equipment and methods. After the development of high-resolution microscopes, it became apparent that the 'blue-green algae' were in fact prokaryotes, and should therefore be considered bacteria. This suggestion caused controversy between bacteriologists and botanists (Oren, 2004). Now, the notion that cyanobacteria are bacteria and not algae is widely accepted. However the lack of coherent approach from the bacteriologists and botanists has caused confusion due to a dual nomenclature system. As of 2004, only five species have received validated bacteriological nomenclature in the relevant literature (Oren, 2004). The history surrounding the separation of cyanobacteria from the algae can be used to highlight the nature of science. In particular, it shows that science is performed and decisions made based on data and equipment currently available and may change as scientific investigative methods advance. Importantly, it highlights that science should not be considered as an undisputable fact. The controversy caused at the time highlights the importance of discussion in the scientific community, and demonstrates that scientific consensus is not always easily achieved.

Despite the positive attributes that algae possess in relation to the school classroom, the survey of UK science teachers performed and reported previously (section 1.4) shows that teachers are overlooking the potential of algae in the

classroom. Only 1.6% of microbiology activities carried out in schools use algae, compared to the significant majority of activities that utilise bacteria. The survey also noted that a range of obstacles that teachers perceive when using practical microbiology in the classroom (section

1.5.3), particularly equipment, time, cost and expertise. The use of algae does not require expensive equipment such as an autoclave and incubator. They do not require overnight cultivation (as is almost always required using bacteria) and are usually ready to use from a supply. Algae are considerably cheaper to buy and require less skill and manipulation compared to bacteriology-based activities. Additionally, it should be emphasised to teachers that practical activity using algae can be investigative, relating well to the world around us and provide the opportunity to discuss nature of science topics such as the purpose of science, observation, hypotheses, evidence and how these relate to the wider world.



#### 4.2.2 – Aims and objectives

##### Aim:

- Develop an educational resource to encourage and promote practical microbiology in the school classroom.

##### Objectives

- Use previous knowledge on curriculum content and current thinking in science education research to choose appropriate topics using algae.
- Develop a collection of practical activities that target different aspects of the curriculum and presents a range of required skills whilst illustrating the nature of science
- Develop additional support content to be included in the resource

### 4.2.3 - Methods

#### 4.2.3.1 – Introduction

The review of the National Curriculum and awarding body specifications used in the United Kingdom highlighted topics that may be demonstrated using algae (for example as described in Table 10, page 116). This information was combined with properties of algae as microorganisms (briefly discussed in the above section 4.2.1). Subsequently, five themes were selected that would be translated into practical activity suitable for teaching in the Key Stage 3 and 4 science laboratory. Other educational resources focusing on or using algae were reviewed to ensure that any activities developed are not unnecessarily repeated.

The five themes are:

- Identification
- Phototaxis
- Bioluminescence
- Eutrophication
- Biofuels/gas cycling

In the final resource, each activity comprised three separate guides addressing different users: teacher, technician and student. The resource included a general introduction to algae, as well as activity-specific background information. Additionally, information on cultivation, suppliers and further educational resources were included. The five student methods are described in this section. However, only the first activity is presented in its full format (as supplied in the resource) as an example of the product delivered to the end users. Subsequently, key aspects of the development of each activity are presented.

#### *4.2.3.2 – Activity 1 – Identifying microalgae using a microscope*

The first theme, 'identification' was developed into an activity with the aim to identify one of fifteen species of microalgae using a light microscope and an identification key (developed for and provided in the resource). It was anticipated that the activity would enable teachers to focus on algae as microorganisms, demonstrating their diversity, whilst developing the students' observational, technical and classification skills. Using identification keys in biology is mentioned in seven teaching specifications in the UK (appendix 1, page 239).

##### *4.2.3.2.1 – The activity*

The introduction to the activity (page 12 of the resource) provided basic information regarding algae in the ecosystem. It briefly covered topics including global importance, particularly with reference to oxygen production, how and where they grow, diversity (size, colour and shape) and how they can be affected by their environment.

The Teacher's guide (Figure 18 to Figure 21) provided a teacher-centric introduction. It included the aim and objectives of the exercises, and provides additional background information. A list of themes or topics that are found in the National Curriculum or awarding body specifications that can be supported by the activity was included. Furthermore, notes on the method and results were presented to enable successful delivery of the activity, such as tips on culture maintenance, conditions (temperature, light etc), activity running time required and any potential specific health and safety issues. Extension activities were suggested.

## Practical 1 – Teacher's guide

### Introduction to the practical

The aim of this practical is to get students to appreciate the diversity of microalgae in the environment. Samples can be taken from an unpolluted environmental source such as a pond or alternatively mixed algal cultures can be purchased from a recommended schools' supplier. These samples can be studied using a microscope and observations recorded. The key can be used to identify any microalgae present in the sample.

### Educational links

Interdependence and adaptation, environmental changes, biomass and food chains, cell morphology, photosynthesis, organisms and the environment, developing observational skills and following instructions.

### Notes on the method

- This practical is best conducted in the warmer months as algae are then more likely to be growing in the natural environment.
- Collecting the samples – the students can either collect the samples themselves or they can be pre-collected by a technician/teacher. Sample sites can either be areas of undisturbed water (such as a pond or garden ornaments), particularly if there is obvious algal growth (green), or a sample can be scraped from a wall where green growth is occurring (an algal biofilm) and dispersed into a small volume of tap water. Samples should not be collected from polluted areas.
- Samples can also be purchased from suppliers. This may be beneficial if your school is in an area where there is little open water or if the practical is being conducted during the winter months. For more information, please see the **Supplier information** section of this resource (p. 60).
- Only 1 drop of sample per microscope slide is required.

### Notes on the results

- Although the identification key has been designed to encompass many of the more common species of microalgae, not all species of microalgae will be identifiable using the key. Many species of cyanobacteria can resemble algae; however, as they are classified as bacteria they have not been included on the identification key.

Figure 18 - Page 13 of the resource 'Algae: a practical resource for secondary schools'. Detailing page 1 of 4 of the Teacher's guide to Activity 1: Identifying microalgae using a microscope

- A diagram of a typical algal cell is included in the associated PowerPoint® presentation and on p. 20.
- The ideal location for algal growth is an undisturbed pool of water with plenty of sunlight. Under these optimum conditions for growth you are likely to find a wider variety of different algae.
- When considering the environment the samples came from, it is important to remember that algae are photosynthetic, and so access to sunlight is key to their habitat. However, many algae are mixotrophic (able to get energy from numerous sources) and are able to take in nutrients from the environment around them, so polluted water is likely to enhance algal growth. However, it can also enhance the growth of cyanobacteria, which can be toxic, and so should be avoided if possible.

#### Extension work

- Get students to take photographs of the site from where they collected their sample.
- Mark the sample locations and corresponding results on a map of the local area for a geographical representation of results.
- The eutrophication practical included in this resource would be a very useful follow-up to provide students with deeper understanding of the concept of algal growth and habitat.

For tips on how to use a microscope effectively, check out the online guide at [www.microbiologyonline.org.uk/teachers/microscopes](http://www.microbiologyonline.org.uk/teachers/microscopes)



Figure 19 - Page 14 of the resource 'Algae: a practical resource for secondary schools'. Detailing page 2 of 4 of the Teacher's guide to Activity 1: Identifying microalgae using a microscope

## Guide to algae included on the identification key to the practical

***Spirogyra*** – A filamentous, green alga. Each oblong cell contains between 1 and 16 ribbon-like chloroplasts that are wound into a spiral inside the cell. Often found entangled with *Zygenema* and *Mougeotia*.

***Zygenema*** – A filamentous, green alga. Each cell contains two star-like (stellate) chloroplasts. Often found entangled with *Spirogyra* and *Mougeotia*.

***Mougeotia*** – A filamentous, green alga. Usually one (sometimes two) flat, ribbon-like chloroplast per cell. The ribbon-like structure can rotate inside the cell to maximize exposure to light. This means that, under a microscope, the cell may look as if the chloroplast fills it at certain locations along the filament. Often found entangled with *Spirogyra* and *Zygenema*.

***Microspora*** – A filamentous, green alga. Cells are often swollen. The end cells of the filaments often have two protrusions, creating an 'H' shape.

***Chaetophora*** – A highly branched, filamentous, green alga, each branch tapering to a blunted end. Each cell contains a single plate-like chloroplast. Very few species have been reported.

**Diatom** – A very common type of alga. Mostly unicellular, but may be colonial. The colour of the chloroplast is yellow-brown due to accessory pigments. The cell wall is made of silica.

***Chlorococcum*** – A unicellular, green alga that may either be spherical or slightly oblong in shape. Cells may be on their own or in non-uniform clumps. The single chloroplast often does not fill the entire cell.

***Pyrocystis*** – This group of algae is usually found in tropical marine environments. The only species likely to be found around the coast of Britain, in our more temperate waters, is *Pyrocystis lunula*. *P. lunula* is unicellular and curved (lunate) in shape. The chloroplast is centred in the cell and is often brown. Produces bioluminescence in a circadian rhythm.

***Cryptomonad*** – Motile, unicellular, oval alga commonly found in freshwater. Typically, each cell has two flagella, which may not be visible under a light microscope. Cells vary in colour from brown, red to blueish-green, depending on the accessory pigments present.

***Euglena*** – A motile, unicellular, green alga that is cylindrical with a rounded anterior and tapered posterior. Each cell has two flagella, which may not be visible under a light microscope. This alga has a distinctive red eyespot at the anterior end of the cell, which it uses to sense light and move accordingly.

Figure 20 - Page 15 of the resource 'Algae: a practical resource for secondary schools'. Detailing page 3 of 4 of the Teacher's guide to Activity 1: Identifying microalgae using a microscope

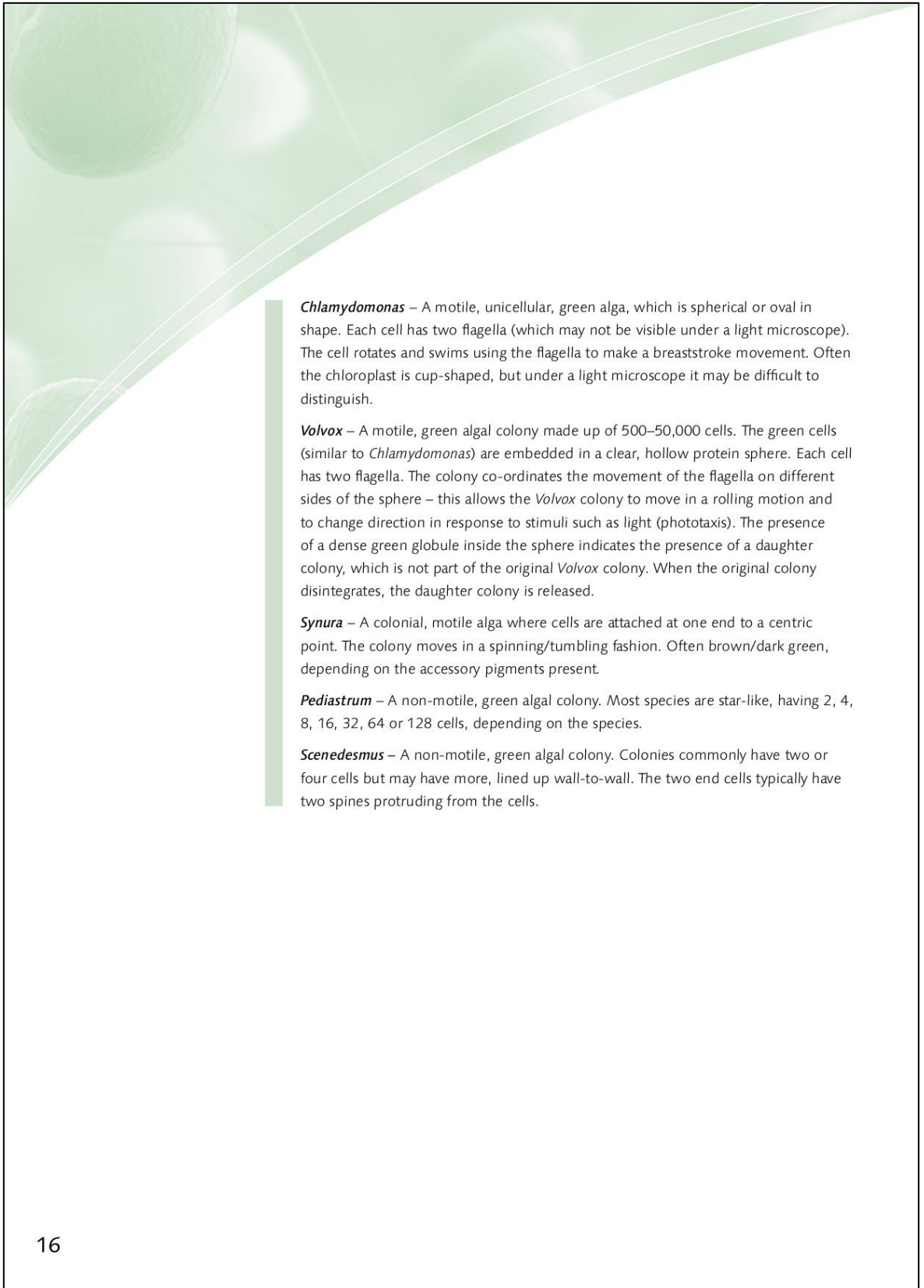

***Chlamydomonas*** – A motile, unicellular, green alga, which is spherical or oval in shape. Each cell has two flagella (which may not be visible under a light microscope). The cell rotates and swims using the flagella to make a breaststroke movement. Often the chloroplast is cup-shaped, but under a light microscope it may be difficult to distinguish.

***Volvox*** – A motile, green algal colony made up of 500–50,000 cells. The green cells (similar to *Chlamydomonas*) are embedded in a clear, hollow protein sphere. Each cell has two flagella. The colony co-ordinates the movement of the flagella on different sides of the sphere – this allows the *Volvox* colony to move in a rolling motion and to change direction in response to stimuli such as light (phototaxis). The presence of a dense green globule inside the sphere indicates the presence of a daughter colony, which is not part of the original *Volvox* colony. When the original colony disintegrates, the daughter colony is released.

***Synura*** – A colonial, motile alga where cells are attached at one end to a centric point. The colony moves in a spinning/tumbling fashion. Often brown/dark green, depending on the accessory pigments present.

***Pediastrum*** – A non-motile, green algal colony. Most species are star-like, having 2, 4, 8, 16, 32, 64 or 128 cells, depending on the species.

***Scenedesmus*** – A non-motile, green algal colony. Colonies commonly have two or four cells but may have more, lined up wall-to-wall. The two end cells typically have two spines protruding from the cells.

Figure 21 - Page 16 of the resource 'Algae: a practical resource for secondary schools'. Detailing page 4 of 4 of the Teacher's guide to Activity 1: Identifying microalgae using a microscope

The technical guide (Figure 22) provided all the information required to deliver the activity. This included a list of all the materials required (per person or per group of students), notes on preparation time, specific health and safety considerations, as well as notes on setting up and finishing the practical (for example disposal of microbial cultures in a disinfectant solution).

The Student's guide (Figure 23 and Figure 24) presented the aim, methods and guidance on results in appropriate language. The aim of activity one is 'to demonstrate the diversity of microalgae in the environment'

The method was split into two parts. Examining your sample deals with observing the samples of algae provided by the teacher. Recording your results informs on what observations should be noted by the student and used to correctly identify the algae using the identification key provided (Figure 25). It is noted in the Teacher's guide that the algae can either be collected first-hand, for example in a school pond, or purchased from a schools supplier.

#### 4.2.3.2.2 – Development

The identification key was developed specifically for use in this activity. It provides students with experience investigating cellular and colony morphology to identify microorganisms using a microscope. Identification keys allow biologists to identify an organism by answering a series of questions usually based on morphology. Application of identification keys in science is often varied and tailored for a specific use (Payne, 1980) and so no standard exists. Single access keys are the most traditional biological identification key (Hagedorn, 2010), allowing the user to answer a question with a choice of answers, leading to another question and so on, until the identification is reached. Single access keys can be visual, often with minimal words and can contain images.



## Practical 1 – Technical guide

### Materials

- Microscope (1 per group)
- Microscope slide (1 per person)
- Microscope slide cover slips (1 per person)
- Dropper
- Beaker of disinfectant (discard pot)
- Small bottles for collection of samples
- Environmental sample likely to contain microalgae, either collected by students or to be provided:
  - Green pond water
  - Scraping from a wall with a green biofilm growing on it, dispersed in tap water

### Preparation time

Limited preparation time required as no pre-purchased cultures or culture maintenance is required. If the samples are to be prepared by the school, the collection of the samples may take some time, for example travelling to different sample sites. See the [Teacher's guide](#) (p. 13) for suggested sample sites.

If the samples used are going to be purchased from a supplier, please see the [Supplier information](#) section of this resource (p. 60).

### Health and safety considerations

Please refer to the [Health and safety considerations](#) section of this resource (p. 61) for general health and safety information.

### Set up

Observation is recommended at x10 and x40 if required, but not any higher. A beaker of disinfectant should be placed within easy reach of each microscope for disposal of used microscope slides and droppers.

### End of the practical

All used microscope slides should be discarded into the beaker of disinfectant and autoclaved at the end of the activity. Any remaining environmental samples should be sterilized using an autoclave or pressure cooker before discarding. Benches should be decontaminated at the end of the practical session. Once slides have been cleaned they are reusable.

Please see the [Health and safety considerations](#) section of this resource (p. 61) for more information.

Figure 22 - Page 17 of the resource 'Algae: a practical resource for secondary schools'. Detailing page 1 of 1 of the Technical guide to Activity 1: Identifying microalgae using a microscope

## Practical 1 – Student's guide

### Identifying microalgae using a microscope

#### Aim

To demonstrate the diversity of microalgae in the environment.

#### Method

Collect your sample and note its name/origin.

##### (1) Examining your sample

- (a) Draw up a small amount of algal culture with the pipette/dropper. Place a single drop onto a microscope slide, then carefully place a cover slip over the top of the drop. Do not press down on the cover slip. Place the pipette into the discard pot containing disinfectant.

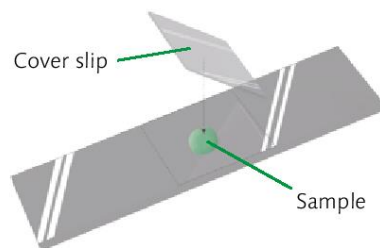

- (b) Place the slide under the microscope on a x10 objective lens, moving the stage of the microscope so your sample is under the lens. If unsure, ask your teacher.
- (c) Focus the microscope so that you can see the algae. You may need to keep focusing the microscope, using fine focus, especially if the algae are moving.

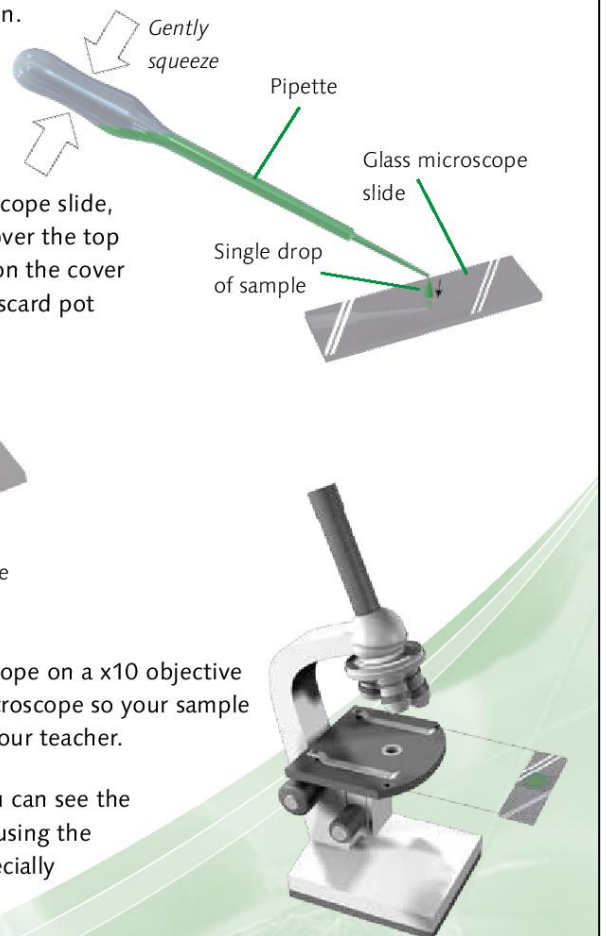

Figure 23 - Page 19 of the resource 'Algae: a practical resource for secondary schools'. Detailing page 1 of 2 of the Student's guide to Activity 1: Identifying microalgae using a microscope

(2) Recording your observations

- (a) Once you have found an algal cell, note its features, such as colour, flagellum, number of chloroplasts, etc.
- (b) Record your results in a table as shown below.

Sample number	Diagram	Features	Name
1	Draw diagram	Green, swims, long	<i>Euglena</i>

- (c) Use these features to identify the algae in your sample using the microalgae identification key. Once you have finished identifying your algae, place the slide into the discard pot containing disinfectant.

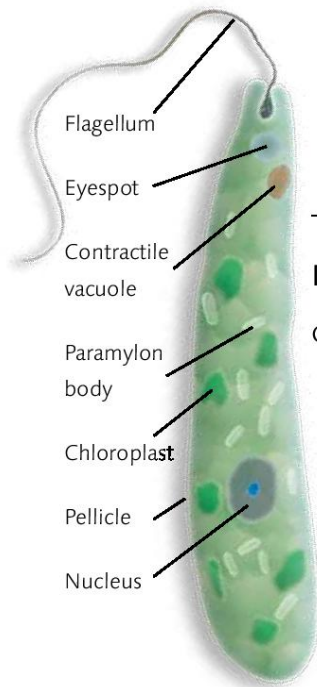

**Results**

Observe the algae/alga in your sample

- Note as many features as possible – colour, shape, movement/behaviour, flagella, unicellular, colonial.
- Draw a diagram of an algal cell that you have found, labelling it as fully as you can.
- Using the identification key provided, try to identify the microalga/algae in your sample.
- Record the name of your algal species on a class results table and draw a frequency chart to show the number of each type.
- Were there many different species in your culture? If so, what were they?
- Can you explain your observations? Consider the environment you sampled. What effects might the environment or environmental conditions have on the population of algae?

Figure 24 - Page 20 of the resource 'Algae: a practical resource for secondary schools'. Detailing page 2 of 2 of the Student's guide to Activity 1: Identifying microalgae using a microscope

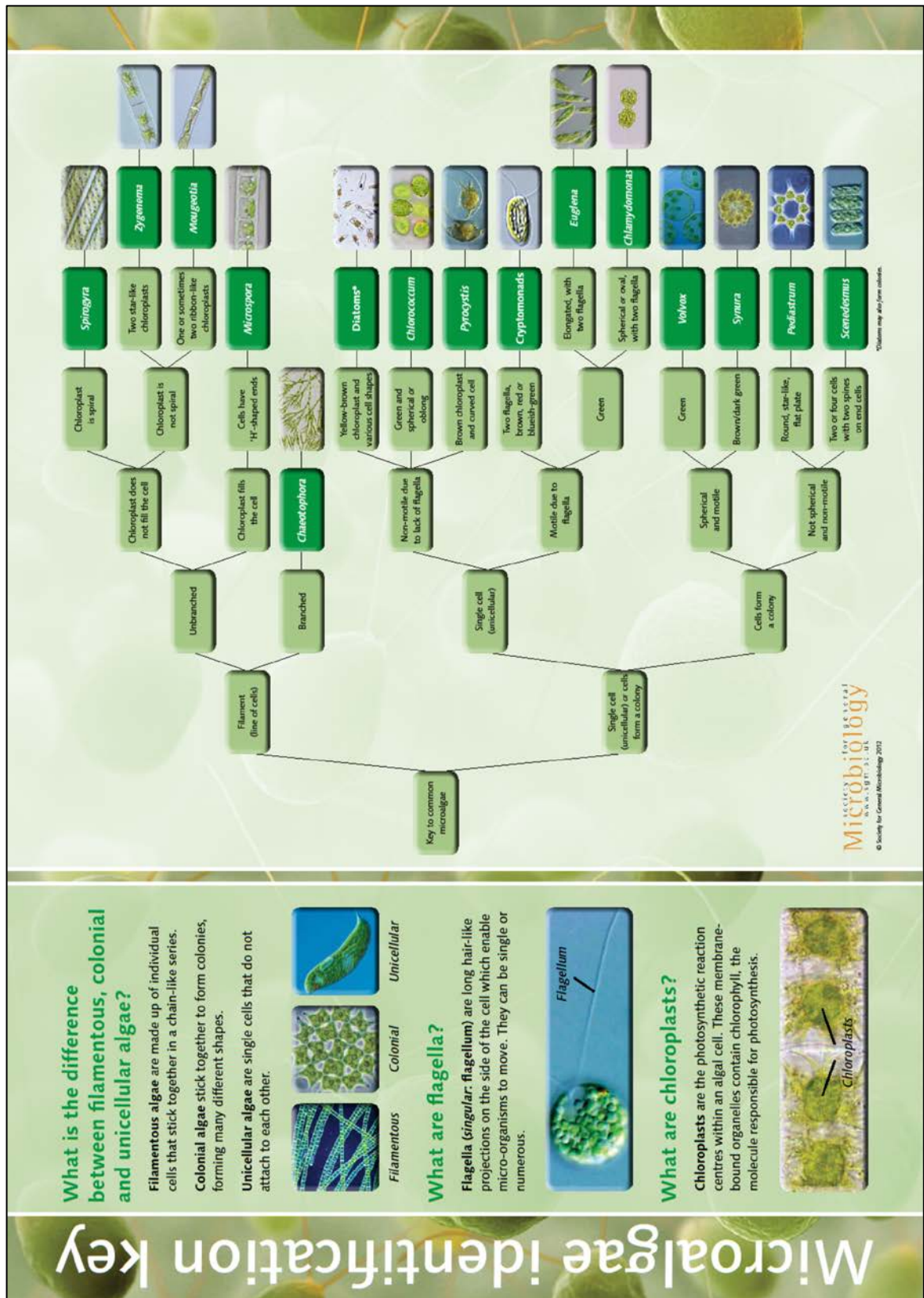

Figure 25 - Additional A3 leaflet provided with the resource 'Algae: a practical resource for secondary schools'. Detailing the Microalgae identification key to accompany Activity 1: Identifying microalgae using a microscope



Existing identification keys that include algal species were examined for style and choice of language (Folin, n.d., Hiebert, n.d.). Selection of algal species for incorporation into the identification key was made using a range of factors:

- The species would have to be easily accessible; therefore, they are all (with the exception of *Pyrocystis* sp.) fresh water algae, being found in ponds or other local bodies of water. However, not all educators may be able to source algae from the environment (or may not want to); they may not live near water, or they may wish to carry out the activity in the winter, when dense populations of algae are less likely (due to a reduction in sunlight/photosynthetic activity). Additionally, cyanobacteria, some of which can be toxic, commonly bloom (grow in large numbers) in fresh water (Paerl *et al.*, 2001), adding a potential health and safety issue. Therefore, all species selected were available to schools to purchase from a recognised schools supplier, for example, the Culture Collection for Algae and Protozoa ([www.ccap.ac.uk](http://www.ccap.ac.uk)) or Sciento ([www.sciento.co.uk](http://www.sciento.co.uk)), with contact information provided.
- Some species were added for specific reasons. *Euglena* and *Pyrocystis* are used elsewhere in the resource, and *Scenedesmus* is used by the Science and Plants for Schools (SAPS) photosynthesis activity (Eldridge, 2004), which is commonly believed to be the most widely used algae-based activity in schools. Also, considerations of morphological diversity, colour and motility were made (from unicellular, colonial or filamentous cells, to spherical, oblong, star or random assortments of shapes). The 15 species selected were *Spirogyra* species, *Zygenema* sp., *Mougeotia* sp., *Microspora* sp., *Chaeotophora* sp., Diatoms, *Chlorococcum* sp., *Pyrocystis*

sp., *Cryptomonads*, *Euglena* sp., *Chloamyomonas* sp., *Volvox* sp., *Synura* sp., *Pediastrum* sp. and *Scenedesmus* sp.

An identification key appropriate for use in a school classroom was developed using differentiating visual factors of the fifteen algal species selected. The key begins with basic identifying questions such as cell shape, followed by shape and motility, and finally colour and specific unique features, such as spiralling chloroplasts or round, star-like flat plates. Scientific terminology was kept to a minimum. Some scientific terms (such as unicellular, colonial, filamentous, flagellum and chloroplast) that are beyond the Key Stage 3 and Key Stage 4 levels were retained due to their importance in the key. Explanations of these terms is provided on the key. During the process of formative evaluation, changes and developments were made to the identification key; these are detailed in section 4.2.5 – Formative evaluation.

#### ***4.2.3.3 – Activity 2 – Investigating phototaxis***

The second theme to be addressed, 'phototaxis' tackled some fundamental aspects of the National Curriculum and teaching specifications. All species of algae carry out photosynthesis and some have evolved certain traits to allow the process to be optimised. Phototaxis is the directed movement in relation to light. The process allows the organism to relocate to a more useful position for photosynthetic activity. The activity emphasised the need for observation in scientific inquiry, and demonstrated how subjective experimental data can be when based on a personal decision (i.e. not objective). As discussed in chapter 2, this is a controversial method of data collection due to difference of perception that may be made by the participating students. Yet, this is an important topic when discussing the nature of science as data is not always purely objective.

#### 4.2.3.3.1 – The activity

The Student's guide (Figure 26 and Figure 27) states the aim of the activity. The aim is to investigate how the algal species *Euglena gracilis* moves in relation to light.

The activity is split into two sections. The first section, setting up the experiment required the construction of a cardboard test tube sleeve and preparation of the experimental apparatus (Figure 26). After inoculation and the appropriate time (guided by information in the Teacher's guide) has elapsed, the second section describes how to assess the observations and record the results (Figure 27). The level of algal attachment will depend on the colour of the plastic window (Figure 28). The intensity of green should be measured of a scale between zero and five (Figure 29).

## Practical 2 – Student's guide

### Investigating phototaxis

#### Aim

To investigate how *Euglena* cells move around their environment.

#### Method

##### (1) Session 1 – Setting up the practical

- Take a piece of black paper/card large enough to make a sleeve around a test tube. Cut five 1 x 1 cm square holes (windows) into the paper/card. Ensure the holes are in a vertical line.
- Stick a different coloured square of plastic film (filter) (1.5 x 1.5 cm) over each of the windows using adhesive tape. Use yellow, clear (colourless), green, red and blue filters.
- Wrap the paper/card around the test tube and secure in place with tape. Do not stick the paper/card to the tube as you will have to remove it later.
- Cover the bottom of the tube with foil as light should only enter the tube through the colour windows.
- Fill the tube with *Euglena gracilis* culture. What does the culture look like? What colour is it?
- Cover the top of the tube with foil. The only light entering the tube should come through the coloured windows.
- Place the tube in a rack and leave with the windows facing a light source.

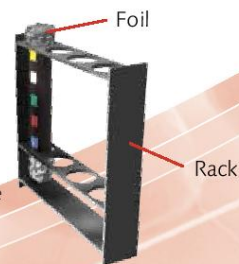
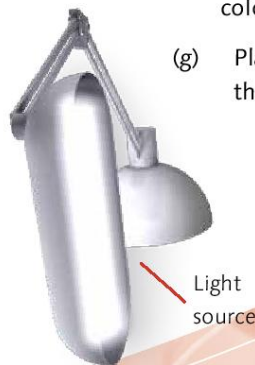
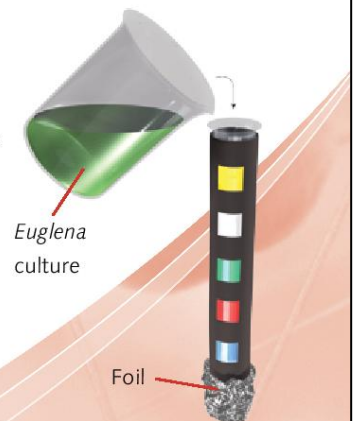
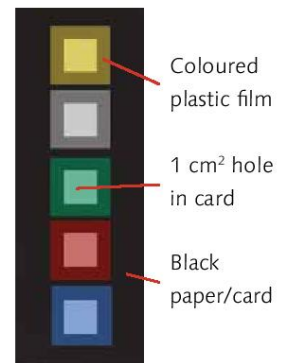

Figure 26 - Page 27 of the resource 'Algae: a practical resource for secondary schools'. Detailing page 1 of 2 of the Student's guide to Activity 2: Investigating phototaxis





(2) Session 2 – Assessing phototaxis

- (a) Gently remove your tube from the rack and carefully remove the paper sleeve and foil. It is important that you do not disturb the contents of the tube.
  - (b) Replace the tube in the rack to ensure it does not fall over.
  - (c) Results should be observed and recorded quickly as the algae may start to detach.
- 

### Results

- Look at the algal growth on the sides of the test tube. In some cases, you should be able to see squares of growth
  - Rank growth on each of the coloured windows from 1 to 5; 5 should represent the most growth on the glass, and 1 should represent the least. If no growth is present in the square, then rate it as 0.
  - Write down key observations about your practical.
    - Is the culture the same colour as at the start of the practical?
    - Which windows have more algal growth?
  - Why do the different colours affect the growth rate of *Euglena*?
  - Collect your data together into a class table.
    - Create an average growth reading for each colour.
    - Put these averages into a chart.
    - Do any particular colours have a significant effect on growth?
- 

Figure 27 - Page 28 of the resource 'Algae: a practical resource for secondary schools'. Detailing page 2 of 2 of the Student's guide to Activity 2: Investigating phototaxis

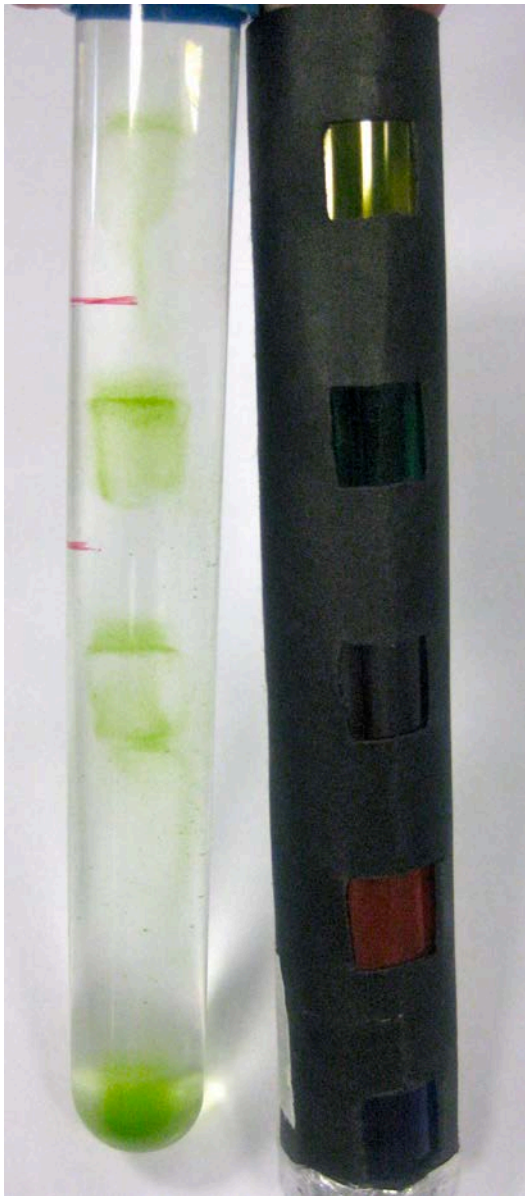

Figure 28 - Example of a test tube (left) after the phototaxis experiment has finished and sleeve (right) is removed.

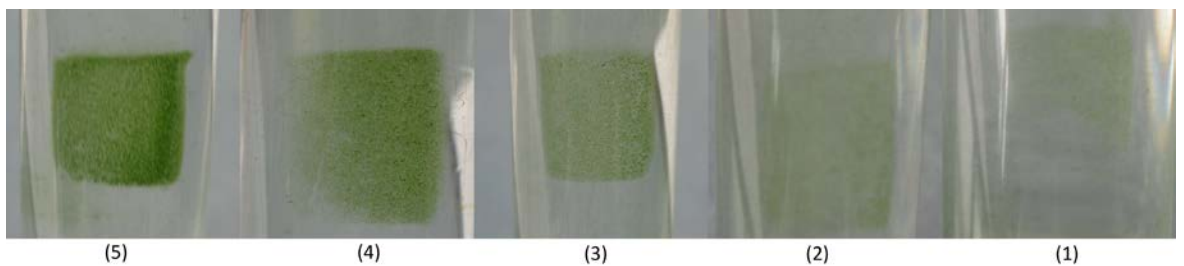

Figure 29 – A guide to attachment density provided in the Teacher’s guide (page 24) of the resource “Algae: a practical resource for secondary schools’

#### 4.2.3.3.2 – Development

A range of variables was investigated in order to identify optimum experimental conditions. The first variable was sleeve design. Two different sleeves were investigated (experiment described in Appendix 3, page 258); each would focus light onto different parts of the test tube. Tube type one (chosen for the activity) placed all five coloured windows (clear, blue, yellow, green and red) in a vertical line, whereas tube type two had one coloured window per tube, requiring five tubes to test all five different coloured windows. Although both sleeves provided results (described in Appendix 3), sleeve one was selected for the activity because it provided more distinct results between the coloured windows in one sample, which in turn would likely be easier to interpret and explain in the classroom. Additionally it required less materials and less preparation time (creating one sleeve per experiment as opposed to five).

The crux of the experiment is to see whether a change in light (colour), and therefore irradiation wavelength, has an effect on phototaxis. The order of attachment, from most dense attachment to no attachment is as follows: clear, blue, green, yellow and red. This result presents two elements that may be of educational interest. First, the clear window provided the best results, as might be expected, due to the window not selecting any particular wavelengths of light. Secondly, the red window allowed little or no attachment. If the action spectrum of photosynthesis at various wavelengths (Figure 30) is consulted, it shows that the wavelength of blue light (450-495nm) can allow for a high level of photosynthesis. Photosynthesis decreases at the wavelength of green light, 495-570nm as it does at the wavelength of yellow light, 570-590nm (a relatively narrow boundary). These patterns of the photosynthetic rate mirror the results of these experiments, with one exception, red light (620-750nm).

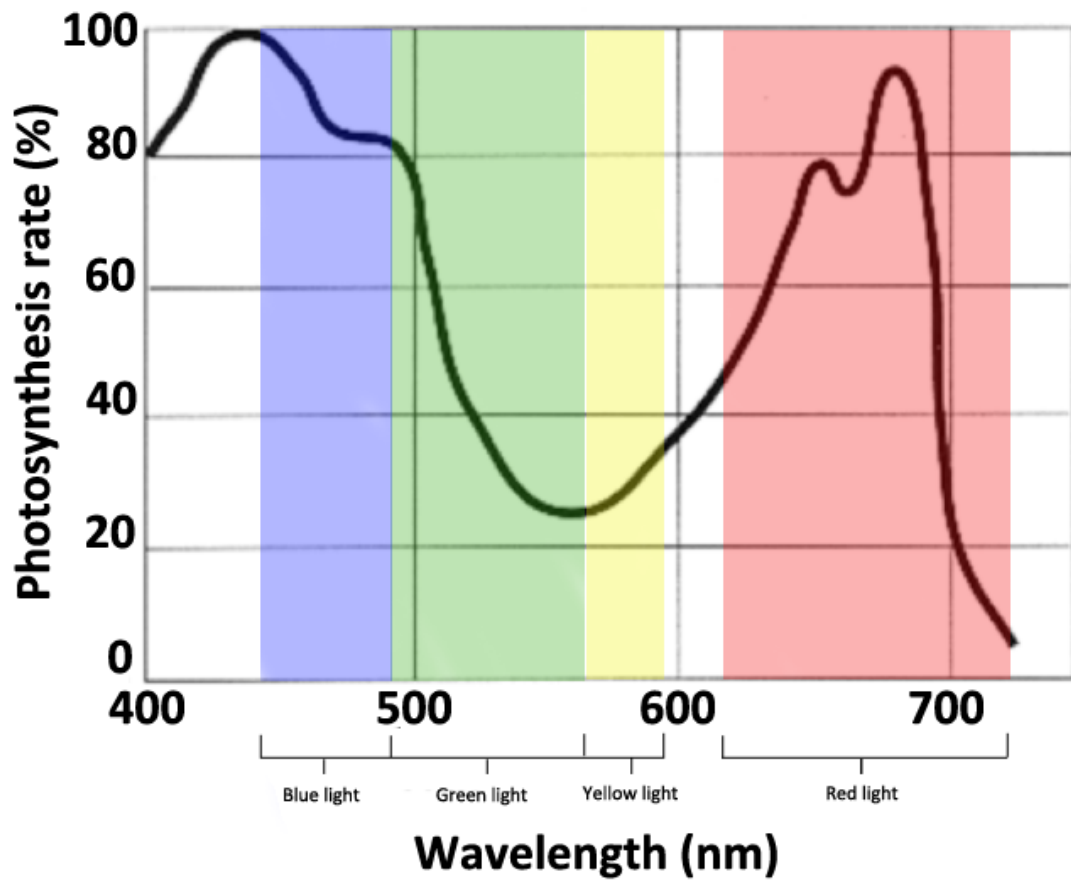

Figure 30 - Action spectrum of photosynthesis shows wavelengths where chlorophylls a and b have absorption peaks, proving that light absorbed by these pigments leads to photosynthesis (Whitmarsh, 1999).

This result is counterintuitive as it may be assumed that phototactic movement and attachment would be high when considering the potential for photosynthesis. This is thought to be because the molecule responsible for activating phototaxis (photoactive adenylyl cyclase) in *Euglena* is triggered by blue light, which is at the opposite end of the visible spectrum (Iseki, 2002, Ntefidou, 2003). A teacher can use this result to get students to ‘think outside the box’.

Additional considerations, such as the source of light, the time required for incubation and distance from the light source were investigated to ensure repeatability.

The tubes left in natural light provided weaker attachment than those left near a fluorescent lamp (described in Appendix 3). This may be because the culture placed near the lamp had longer exposure to light because the lamp was on for the duration of the experiment. The cultures left near the window only experienced ‘day light’ hours, with an inconsistent exposure due to changing weather patterns. Thus, the use of a lamp is preferable for use in the practical activity.

School science classes are timetabled across a teaching week/fortnight (one session per week for example). Therefore, it is important for the teaching and technical staff to be aware how long the tubes can be left for before the attached algae (biofilm) deteriorates. Exposure of between one and seven days after setting up the experiment gave reliable, repeatable results (described in Appendix 3).

Finally the cultures should be placed between 5 and 25cm from a fluorescent lamp to provide reliable and repeatable results of the activity (described in Appendix 3, page 258).

#### ***4.2.3.4 – Activity 3 – Demonstrating bioluminescence***

As previously considered, modelling is becoming common in the modern science classroom (Duschl *et al.*, 2007). It has been suggested that computational models provide a good example of demonstrating circadian rhythm in biology education (Svoboda and Passmore, 2013). Circadian rhythm features across the living world, from humans to trees, from birds to microorganisms (including cyanobacteria, algae, fungi and bacteria) (Bell-Pedersen *et al.*, 2005). However, to the author's knowledge, no practical activity currently undertaken in schools utilises the cyclic nature of microbial physiology to demonstrate the topic of circadian rhythm, despite the subject being taught at GCSE throughout the United Kingdom (Appendix 1).

Thus, the third theme to be addressed, 'bioluminescence' provided a demonstration of a unique physiological adaptation that allows certain species of algae to glow in the dark. The activity is best used as a demonstration due to the effort required to culture high quantities and the limited time bioluminescence can be witnessed. The activity highlights how organisms can adapt/evolve to survive their environment, whilst emphasising the importance of the circadian rhythm, because bioluminescence is only being visible during the night (the algae will not emit light during the day – even if moved into a dark room). Thus, the rhythm of the algae needs to be modified to enable bioluminescence to be shown during normal teaching hours. This activity supports National Curriculum and teaching specification topics such as; Independence and adaptation, environmental changes, why organisms are different, evolution and organisms and their environment. It provides visually interesting results and can be used to stimulate discussion on various intellectual levels such as impact of bioluminescence on nearby organisms (predators) to the cellular processes leading to the emission of light.

#### 4.2.3.4.1 – The activity

The Student's guide (Figure 31 and Figure 32) states the aim of the activity: investigate how the algal species *Euglena gracilis* moves in relation to light.

The activity is split into two sections. Section one is setting up the activity. Three test tubes containing *Pyrocystis lunula* should be placed into different light cycles/conditions:

- Continuous light
- Continuous dark
- Eight-hour dark/sixteen-hour light cycle (the darkened period should be during normal working hours, for example, 9am to 5pm)

Section two is observing results (investigating bioluminescence).

#### 4.2.3.4.2 – Development

The protocol was tested a number of times to ensure repeatability. However, the results of this experiment, 'does the microorganism emit light?' and if so 'how strong is the light?' are very difficult to quantify. Similarly to the phototaxis activity, the results are open to personal interpretation (subjective). This will offer the students some stimulus for discussion when considering scientific experimentation, particularly with respect to repeatability and accuracy of experimental data.

Whilst writing the protocol for the activity, it was noted that cultivation of *Pyrocystis lunula* was not as easy as other microorganisms. The species required water supplemented with sea salts, and a specific growth medium (L1 Marine growth media; CCAP) because it is a marine organism.

## Practical 3 – Student's guide

### Demonstrating bioluminescence

#### Aim

To investigate the effect of circadian rhythm on algae that glow in the dark (bioluminescence).

#### Method

##### (1) Session 1 – Setting up the practical

- (a) Label each tube: Tube 1, Tube 2 and Tube 3.
- (b) Fill each of the test tubes (1–3) with 10 ml of bioluminescent algal culture (*Pyrocystis lunula*).
- (c) Place a lid on top of each test tube.

- (i) Tube 1 should be kept illuminated. The light should remain on for the duration of the practical.

- (ii) Tube 2 should be placed in complete darkness. This can be achieved by wrapping the test tube in foil.

- (iii) Tube 3 should be exposed to an 8 h dark/16 h light cycle. For example, place the tube into darkness at 9am, and remove and put into light at 5pm.

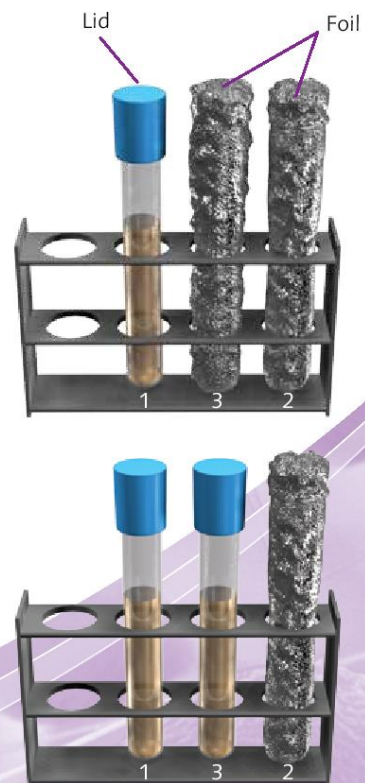



Figure 31 - Page 35 of the resource 'Algae: a practical resource for secondary schools'. Detailing page 1 of 2 of the Student's guide to Activity 3: Demonstrating bioluminescence





(2) **Session 2 – Collecting results**

Repeat the following instructions (a–c) each time you collect your results.

- Observe each tube separately.
- Take the tube into a dark room. For Tube 2 that has been kept in the dark, you will need to remove the foil to observe the results.
- Gently rock the tube from side to side. As the liquid inside the tube moves around the algae might emit light and glow. This is bioluminescence.

---

**Results**

- Which tubes show bioluminescence? How long does it take before bioluminescence is observed?
- Why do you need to place the algae in the dark during regular daylight hours and give them light during the night?
- Why do you think the algae bioluminesce when the tube is agitated?

---

36

Figure 32 - Page 36 of the resource 'Algae: a practical resource for secondary schools'. Detailing page 1 of 2 of the Student's guide to Activity 3: Demonstrating bioluminescence

Additionally, the microorganism is relatively slow growing (taking up to a month for a culture of sufficient size to perform the activity), which may be a hindrance in the school setting. Following discussion and trials with teachers (described in section 4.2.5 – Formative evaluation) it was decided that it would be costly, time consuming and potentially technically difficult for a school to perform an entire investigation using *Pyrocystis lunula* with minimal benefit in results/data analysis, and therefore a demonstration activity would be more appropriate. Thus, photographs and video footage were captured to be supplied along with the existing support material via a CD that would be included with the resource.

It proved difficult to capture the bioluminescence with photography. A 'point and click' digital camera did not have sufficient sensitivity to allow the light from the bioluminescence to be captured. A Canon 400D SLR with a Canon EF-S 60mm f/2.8 Macro USM lens was used (Figure 33).

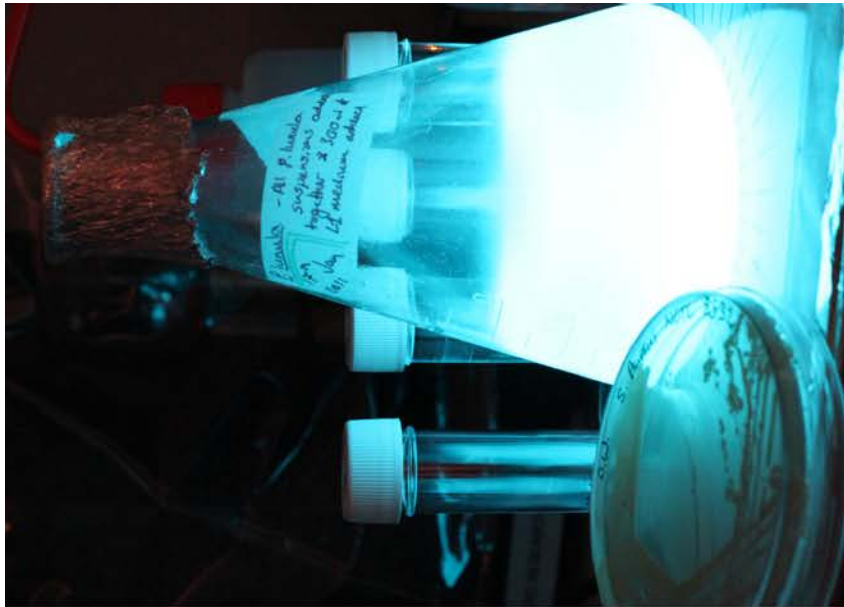

(C)



(B)

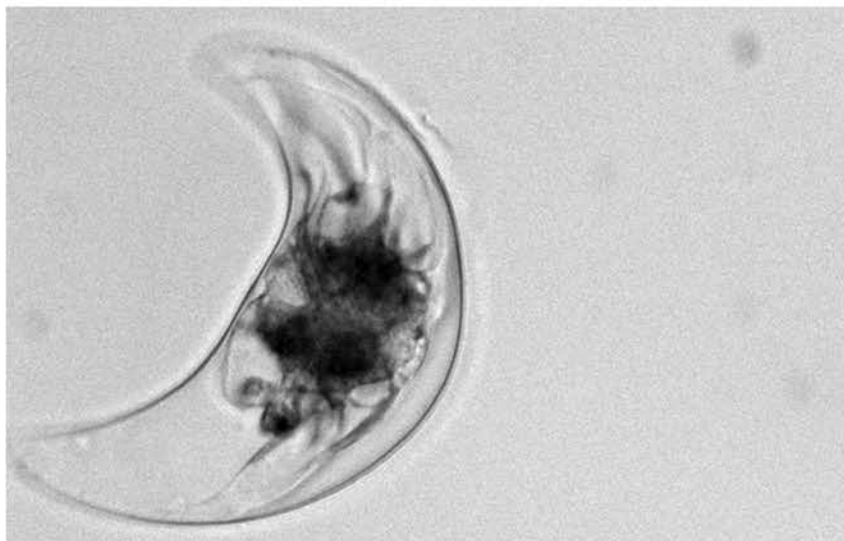

(A)

Figure 33 -A micrograph of the bioluminescent cell *Pyrocystis lunula* (taken with an x40 objective lens on a standard light microscope). (B) A culture of *Pyrocystis lunula* bioluminescing during a period of mechanical stress in the early stages of adaption to a light/dark cycle (C) A culture of *Pyrocystis lunula* bioluminescing during a period of mechanical stress having well adapted to its light/dark cycle

#### ***4.2.3.5 – Activity 4 – Eutrophication***

It has long been known that although algae are photosynthetic primary producers, they can exhibit mixotrophic behaviours (a mixotroph is as an organism that is able to use different sources of energy, for example, light and macronutrients). Sustained growth of algae can be achieved from the energy provided by photosynthesis. Algal growth can be further enhanced by the presence of added nutrients (Funchess, 1947). Thus, growth of unwanted 'pond scum' or an increased covering on fish tank surfaces by algae are illustrations of eutrophication, a process which accelerates the growth of algae, usually due to an increase of the macronutrients nitrogen, phosphorous and carbon in the environment (Smith, 2006).

The phenomenon is also apparent on a larger scale. Eutrophication occurs around the globe, can cause negative effects on local industry and tourism, and is considered a major threat to marine ecosystems (Andersen *et al.*, 2006). Human activity, such as intensive farming and use of pesticides can increase the amount of macronutrients finding their way to water systems, which in turn can encourage eutrophication.

The topic of eutrophication is well established in school teaching specifications. As well as specific mentions with regard to intensive farming and the issue of eutrophication, topics such as cycling of carbon and nitrogen, organisms in an environment affecting others, and the use of waste materials by microorganisms are also noted (Chapter 1 - Figure 1). Nevertheless, the results of the survey of practical microbiology carried out in UK secondary schools (section

1.5.3) suggest that there were no specific laboratory activities that demonstrate eutrophication. The following activity was developed to show the process of

eutrophication using algae (*Euglena gracilis*) with added macronutrients (plant fertiliser).

#### 4.2.3.5.1 – The activity

The Student's guide (Figure 34 to Figure 37) stated the aim of the activity: to investigate the effects of fertilizers on the growth of algae.

The first stage of the activity is to set up the investigation and collect benchmark data. Two conical flasks of algae and distilled water should be inoculated and left to culture over a period of time (decided by the teacher). One flask should have added nutrients (the experimental condition). Colourimeter readings should be taken at equal intervals to determine any difference in cell concentration/growth. The second stage is recording results

#### 4.2.3.5.2 – Development

The success of the activity depends on the fertilizer promoting the growth of the algal culture compared with a distilled water control.

In order to identify an acceptable nutrient source, two store purchased plant foods, with different concentrations of macronutrients (fertilizer 1 – N-P-K value of 0.2-0.2-0.2, fertilizer 2 – N-P-K value of 5-5-5) were tested against algal growth medium (Biobred algal medium – macronutrient contents unknown) to see which would best promote algal growth (Appendix 4, page 268). The store purchased plant food with the highest concentration of macronutrients (fertilizer 2) gave a higher growth of *Euglena gracilis*. The growth medium did enhance the growth of the algae above the water controls, but it did not attain those levels achieved by the store-purchased plant food/fertilizers.

## Practical 4 – Student's guide

### Eutrophication

#### Aim

To investigate the effects of fertilizers on the growth of algae.

#### Method

##### (1) Setting up the practical

- Take two conical flasks. Label one Flask 1 – Distilled Water Only, and the other Flask 2 – Distilled Water and Fertilizer.
- Using a measuring cylinder, fill each conical flask with 250 ml of distilled water.
- Place the appropriate amount (designated by your teacher) of fertilizer into the conical flask labelled Flask 2.
- Collect two samples of 25 ml of algae culture (*Euglena gracilis*) from your teacher. Add 25 ml of algae culture to each conical flask.

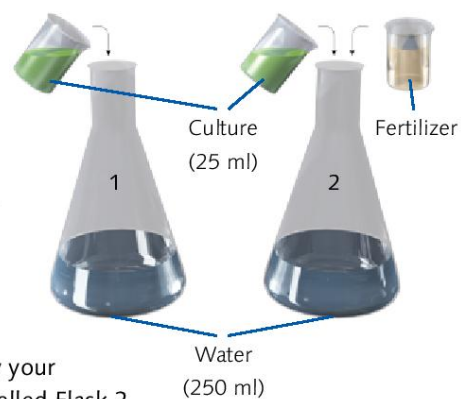

##### (2) Calibration of colorimeter and first reading

###### Control 1 and Flask 1

###### *Calibration of colorimeter*

Use Control 1 cuvette provided by the teacher to calibrate the colorimeter for Flask 1 (at wavelength 665 nm).

DO NOT EMPTY the Control 1 cuvette – return it to your teacher.

Figure 34 - Page 45 of the resource 'Algae: a practical resource for secondary schools'. Detailing page 1 of 4 of the Student's guide to Activity 4: Eutrophication

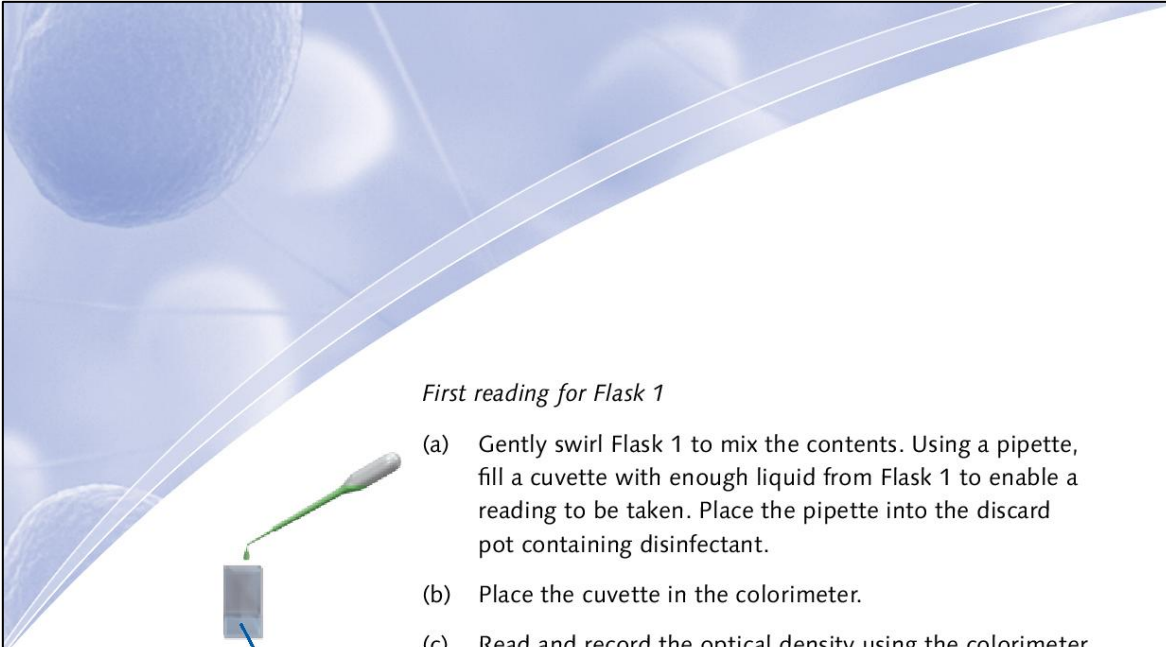

*First reading for Flask 1*

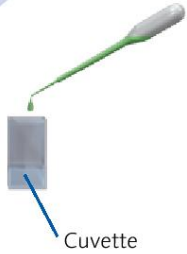

(a) Gently swirl Flask 1 to mix the contents. Using a pipette, fill a cuvette with enough liquid from Flask 1 to enable a reading to be taken. Place the pipette into the discard pot containing disinfectant.

(b) Place the cuvette in the colorimeter.

(c) Read and record the optical density using the colorimeter.

(d) Empty the cuvette back into Flask 1.

**Control 2 and Flask 2**

*Calibration of colorimeter*

Use Control 2 cuvette provided by the teacher to calibrate the colorimeter for Flask 2 (at wavelength 665 nm).

DO NOT EMPTY the Control 2 cuvette – return it to your teacher.

*First reading for Flask 2*



(a) Gently swirl Flask 2 to mix the contents. Using a pipette, fill a cuvette with enough liquid from Flask 2 to enable a reading to be taken. Place the pipette into the discard pot containing disinfectant.

(b) Place the cuvette in the colorimeter.

(c) Read and record the optical density using the colorimeter.

(d) Empty the cuvette back into Flask 2.

Place both Flask 1 and Flask 2 near a light source.  
DO NOT COVER.

46

Figure 35 - Page 46 of the resource 'Algae: a practical resource for secondary schools'. Detailing page 2 of 4 of the Student's guide to Activity 4: Eutrophication



(3) Subsequent readings

**Control 1 and Flask 1**

*Calibration of colorimeter*

Use Control 1 cuvette provided by the teacher to calibrate the colorimeter for Flask 1 (at wavelength 665 nm).

DO NOT EMPTY the Control 1 cuvette – return it to your teacher.

*Subsequent readings for Flask 1*

- (a) Gently swirl Flask 1 to mix the contents. Using a pipette, fill a cuvette with enough liquid from Flask 1 to enable a reading to be taken. Place the pipette into the discard pot containing disinfectant.
- (b) Place the cuvette in the colorimeter.
- (c) Read and record the optical density using the colorimeter.
- (d) Empty the cuvette back into Flask 1.

**Control 2 and Flask 2**

*Calibration of colorimeter*

Use Control 2 cuvette provided by the teacher to calibrate the colorimeter for Flask 2 (at wavelength 665 nm).

DO NOT EMPTY the Control 2 cuvette – return it to your teacher.

*Subsequent readings for Flask 2*

- (a) Gently swirl Flask 2 to mix the contents. Using a pipette, fill a cuvette with enough liquid from Flask 2 to enable a reading to be taken. Place the pipette into the discard pot containing disinfectant.
- (b) Place the cuvette in the colorimeter.

Figure 36 - Page 47 of the resource 'Algae: a practical resource for secondary schools'. Detailing page 3 of 4 of the Student's guide to Activity 4: Eutrophication

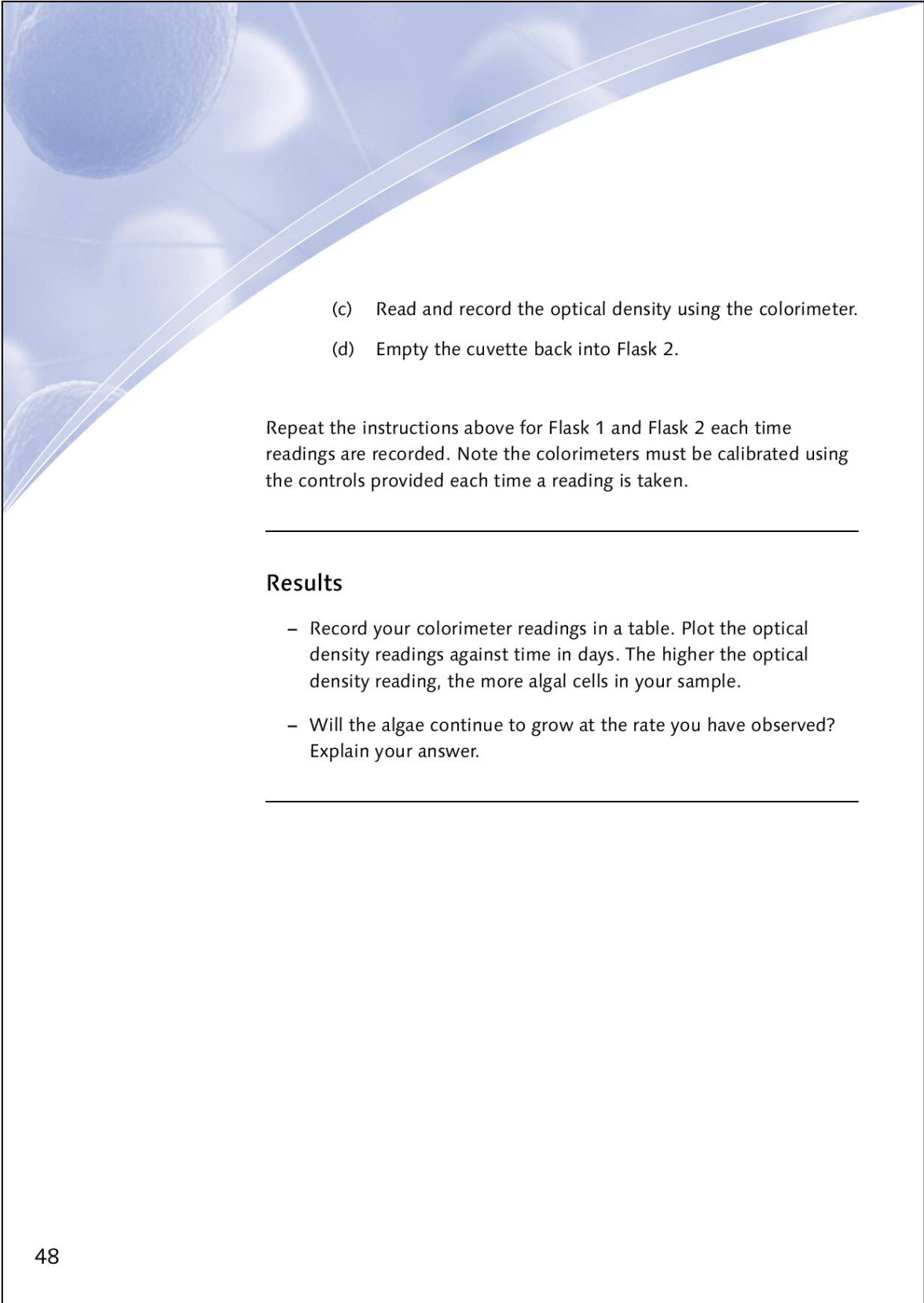

- 
- (c) Read and record the optical density using the colorimeter.
  - (d) Empty the cuvette back into Flask 2.

Repeat the instructions above for Flask 1 and Flask 2 each time readings are recorded. Note the colorimeters must be calibrated using the controls provided each time a reading is taken.

---

### Results

- Record your colorimeter readings in a table. Plot the optical density readings against time in days. The higher the optical density reading, the more algal cells in your sample.
  - Will the algae continue to grow at the rate you have observed? Explain your answer.
- 

Figure 37 - Page 48 of the resource 'Algae: a practical resource for secondary schools'. Detailing page 4 of 4 of the Student's guide to Activity 4: Eutrophication

No significant difference was recorded between growth obtained using sterilized and non-sterilized plant foods. Readily available store-purchased plant food, cheaper and easier to acquire than manufactured algal medium, can be used to illustrate eutrophication and as an example of a real life scenario (e.g. intensive farming). Thus unsterilized plant food was recommended in the Teacher's guide.

Once the growth was optimised, attention was turned to measurement of growth. Currently, there is a push for an increased use of data loggers in the school classroom due to the educational benefits they provide (Boniec. *et al.*, 2011) and they were specifically referenced in the Key Stage 3 National Curriculum (QCA, 2007a). Eutrophic bodies of water are routinely monitored using pH readings (Pelizar, 2002), although this is more commonly used to monitor eutrophic behaviour of cyanobacteria (for example *Spirulina platensis*) and this could provide a potential application for data logging. However, preliminary investigation into the use of pH as an indicator for the school activity showed rapid and immediate rise from pH7.7 to pH9. Although this is positive (in that the change is measureable), the rapid change would potentially make it difficult for a class of students to measure the change. Therefore, the use of pH as an indicator for the activity was not followed up.

Optical density (OD) was investigated as a useable measurement (described in Appendix 4). The wavelength used, 665 nm, is often cited in literature for use with algal cultures because it is optimal for reading pigments chlorophyll *a* and *b* (Jenway, *n.d.*). OD readings increased over time, and differentiated between the experimental condition (added plant food) and the control (no added plant food).

However, although OD, routinely used in scientific research, can be an indicator of turbidity, which is often used synonymously with microbial culture growth, the concept is not central to any Key Stage 3 or Key Stage 4 teaching specification in

the UK. Thus the data alone from the experiment (OD readings) may have little relevance to school students at this early stage in their scientific education. To allow students to translate their data into something more relatable and in-context, a growth curve for *Euglena gracilis* relating optical density to total cell count (described in Appendix 4) was constructed. The curve (provided in the resource – page 40) shows the data trend line, allowing students to estimate the total number of cells from their optical density readings. This addition to the activity incorporates mathematics in science, which features in all teaching specifications for Key Stage 3 and 4. Examples of mathematics in science (AQA, 2012a) that are supported by this activity include:

- Substituting numerical values into simple formulae and equations,
- Translate information between graphical and numeric form,
- Extract and interpret information from charts, graphs and tables

One issue encountered was contamination of the blank controls, due to the presence of plant fertilizer and the requirement to keep the blank measures for upwards of four weeks. This altered the OD reading as the water became turbid. To limit this, it was suggested in the Technical guide (page 43 of the resource) that when not required, the blank measures should be frozen, being thawed out prior to future use.

The resultant activity covered a range of different curriculum goals, from specific science content (e.g. eutrophication) to skill and theory (e.g. experimentation and evidence) to data interpretation and analysis.

#### 4.2.3.6 – Activity 5 – Gas cycling in microorganisms

The investigation explores whether one microorganism (*Saccharomyces cerevisiae* - Baker's yeast, a microorganism used in the production of bread) could be used to promote the growth of another microorganism (*Euglena gracilis* – a species of alga). The activity enabled demonstration of production of carbon dioxide from aerobic respiration of the yeast, being delivered to a culture of algae for use in photosynthesis.

##### 4.2.3.6.1 – The activity

The Student's guide (Figure 38 to Figure 41) provided the aim of the activity: to demonstrate how the growth of one microorganism can benefit the growth of another. A control condition and an experimental condition (additional carbon dioxide produced from respiring yeast cells) are left for a length of time determined by the teacher (with guidance provided in the resource). Optical density is used to measure difference in growth.

##### 4.2.3.6.2 – Development

Originally, the fifth activity intended to demonstrate the use of algae as a biofuel. Students would culture algae in order to attain sufficient biomass, allowing separation of cells from culture medium, followed by release of the oil stored inside the cell, and use of the resultant extract to demonstrate a source of energy, for example as an 'algal candle' (Fischer, 2009). However, preliminary investigation showed that the methods required were too complex to perform in a school laboratory because significant volumes (likely upwards of 40 litres) of algae would be required to achieve sufficient biomass.

## Practical 5 – Student's guide

### Gas cycling in micro-organisms

#### Aim

To demonstrate how the growth of one micro-organism can benefit the growth of another.

#### Method

##### (1) Setting up the practical

- Place 2 g (approximately 1 teaspoon) of dried Baker's yeast (*Saccharomyces cerevisiae*) and 4 g sugar (approximately 2 teaspoons) into a 500 ml Buchner flask.
- Fill the Buchner flask with 300 ml of warm water from a tap and place a rubber bung on top of the flask.
- Attach the rubber piping to the glass nozzle protruding from the Buchner flask.
- Label two beakers Beaker 1 (control) and Beaker 2.
- Fill Beaker 1 and Beaker 2 with equal volumes of tap water.
- Add equal amounts of fertilizer to Beaker 1 and Beaker 2 (Ask your teacher for the mass of fertilizer to be added.) The fertilizer will help the algae to grow.

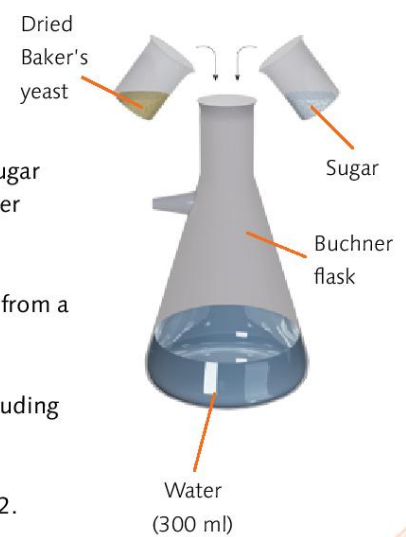

Figure 38 - Page 55 of the resource 'Algae: a practical resource for secondary schools'. Detailing page 1 of 4 of the Student's guide to Activity 5: gas cycling in micro-organisms

#### *Calibration of colorimeter*

Use the liquid in Beaker 1 (control) to calibrate the colorimeter at wavelength 665 nm.

Gently swirl Beaker 1 (control) to mix the contents. Using a pipette, fill a cuvette with enough liquid from Beaker 1 to enable a reading to be taken. Place the pipette into the discard pot containing disinfectant.

DO NOT EMPTY the Control 1 cuvette – give it to your teacher to store, as you will need this sample to calibrate the colorimeter each time you take a reading.

Add approximately 25 ml of algae to Beaker 1 and Beaker 2.

#### *First reading for Beaker 1*

- (i) Gently swirl Beaker 1 to mix contents. Using a pipette, fill a cuvette with enough liquid from Beaker 1 to enable a reading to be taken. Place the pipette into the discard pot containing disinfectant.
- (ii) Place the cuvette in the colorimeter.
- (iii) Read and record the optical density using the colorimeter.
- (iv) Empty the cuvette back into Beaker 1.

#### *First reading for Beaker 2*

- (i) Gently swirl Beaker 2 to mix contents. Using a pipette, fill a cuvette with enough liquid from Beaker 2 to enable a reading to be taken. Place the pipette into the discard pot containing disinfectant.
- (ii) Place the cuvette in the colorimeter.
- (iii) Read and record the optical density using the colorimeter.
- (iv) Empty the cuvette back into Beaker 2.

Figure 39 - Page 56 of the resource 'Algae: a practical resource for secondary schools'. Detailing page 2 of 4 of the Student's guide to Activity 5: gas cycling in micro-organisms

Place the Buchner flask into a warm water bath set to approximately 30 °C.

Place the carbon dioxide diffuser into Beaker 2 and secure in place (see illustration below).

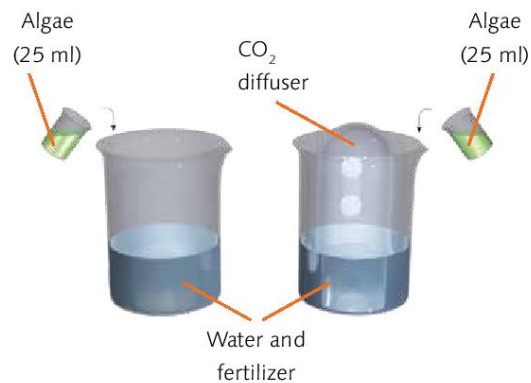

The other end of the rubber piping from the Buchner flask should then be attached to the carbon dioxide diffuser.

Place both Beakers 1 and 2 near a light source. Both beakers should be an equal distance from the light, to ensure a more reliable result.

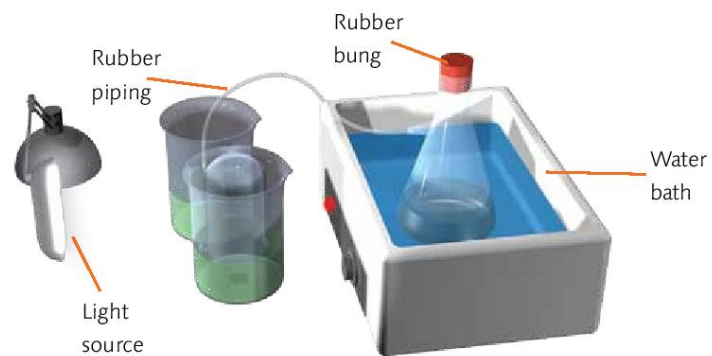

Figure 40 - Page 57 of the resource 'Algae: a practical resource for secondary schools'. Detailing page 3 of 4 of the Student's guide to Activity 5: gas cycling in micro-organisms

## (2) Subsequent readings

*Note:* each time results are taken the colorimeter needs to be calibrated.

### *Calibration of colorimeter*

Collect the Control 1 cuvette from your teacher.

Use the Control 1 cuvette to calibrate the colorimeter (at wavelength 665 nm).

DO NOT EMPTY the Control 1 cuvette – return it to your teacher.

### *Recording your results*

Repeat *First reading* steps 1(i)–(iv) for Beaker 1 and Beaker 2 each time results are taken.

---

## Results

- Compare your first and subsequent readings. Have they changed? What does this indicate?
  - Is there a difference between the results of the beaker containing the carbon dioxide diffuser compared to the one without? If so, why do you think this is?
  - How quickly did you see bubbles in the Buchner flask?
- 

Figure 41 - Page 58 of the resource 'Algae: a practical resource for secondary schools'. Detailing page 4 of 4 of the Student's guide to Activity 5: gas cycling in micro-organisms



Despite the increased growth obtained from addition of nutrients (fertilizers and growth media – discussed in section 4.2.3.5), the limiting factor was probably carbon dioxide (Smith, 2011). Although intervention through addition of carbon dioxide (carbon dioxide diffuser linked to a pressurised carbon dioxide canister) still failed to achieve the level of algal biomass required to construct an algal candle, it did yield a higher optical density compared to a control (no added carbon dioxide).

Subsequently, what has developed is a practical investigation that demonstrates gas cycling with the use of two different types of microorganisms, which, to the knowledge of the author, is not readily available to teachers. The activity has direct links to the real world, for example, removal of a waste product from one organism by another. Scottish Bioenergy has developed a process by which they can use two existent waste products to grow algal biomass. The process enhances percolation of flue gas carbon dioxide through a culture alga, whilst the alga is taking up nitrogen and metal ions from distillery wastewater (ScottishBioenergy, 2007).

Although they do not follow the original plan, demonstrating biofuels, activities focusing on this topic were in development at the same time as this activity and are now available for schools (Bunn, 2011). Additionally to publication in the resource, this activity (along with its development) has been accepted for publication in a peer-reviewed journal: *School Science Review* (Redfern *et al.*, in press).

#### 4.2.4 – Design of the resource

In addition to scientific/activity content, other considerations were necessary prior to the use of the resource in the classroom.

Student protocols were written in appropriate language and underwent formative evaluation by teachers to ensure suitability (section 4.3). Additional supporting information (such as background information, links to curriculum and exam board specification, teacher notes, technical notes, health and safety information, supplier information, images and a glossary of terms) was assembled. The author managed the design and the remaining aspects of the resource whilst liaising with a number of external people in order to produce content.

An illustration brief was written for each activity. The illustrations were to highlight key/important stages in each activity. A 3D coloured image was requested (opposed to a black line drawing often seen in educational resources) as it was felt they would provide a clearer illustration. A professional illustrator was commissioned to prepare all the illustrations (Jamie Symonds).

An A1 poster titled 'Fascinating facts about algae' was designed using facts included in the resource (Figure 42).

Draft copies of the text were edited and sent to proof readers. Following this, the resource, in its draft format, was reviewed by an algae specialist (Gary Caldwell, University of Newcastle) to check for scientific accuracy. Finally, the resource was laid out by a graphics designer (Ian Atherton – Society for General Microbiology).

Before 'Algae: a practical resource for secondary schools' went to print, a range of formative evaluations was carried out, and where necessary, changes were made.

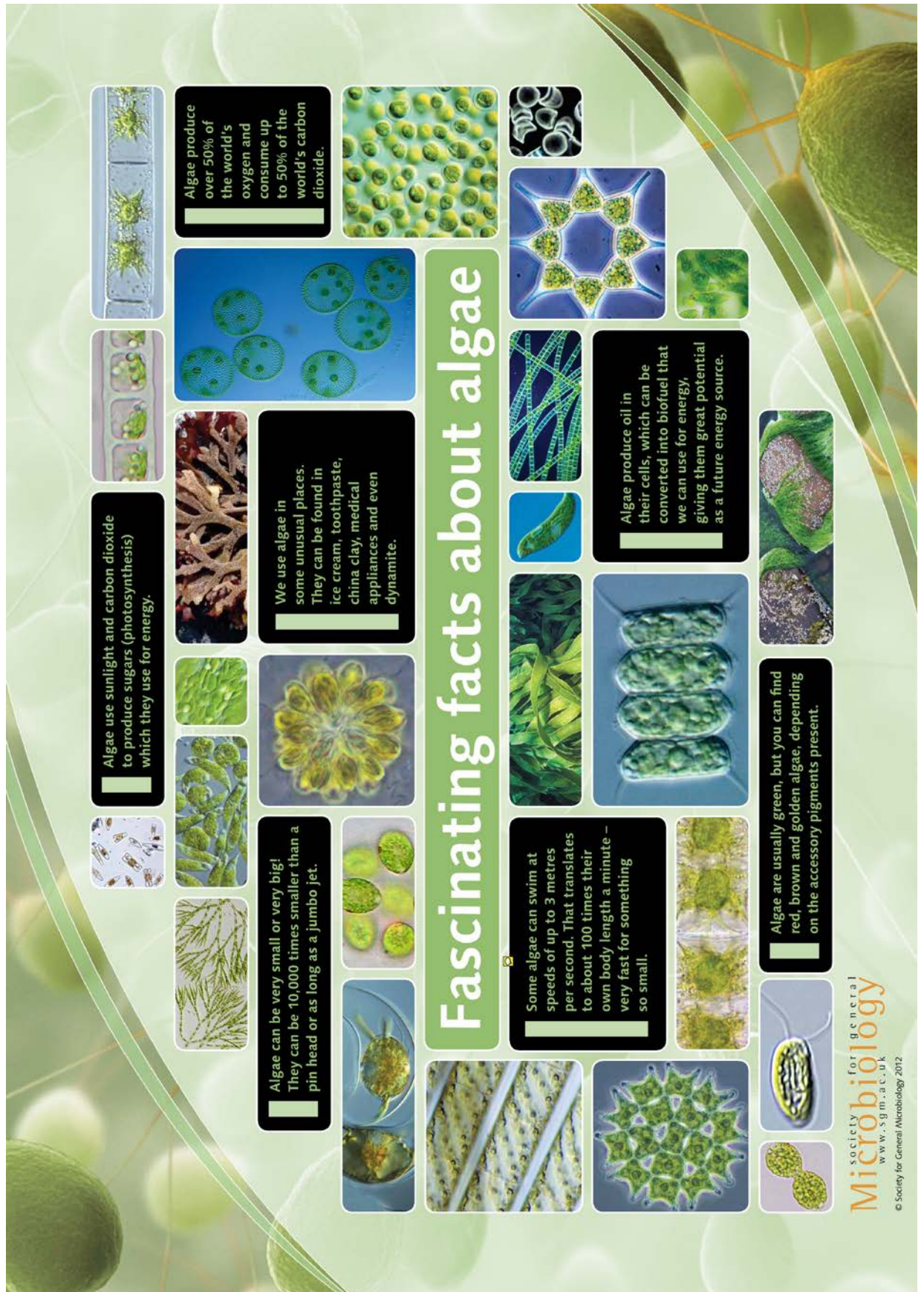

Figure 42 - A1 poster included with the publication 'Algae: a practical resource for secondary schools'

#### **4.2.5 – Formative evaluation**

The development of the practical activities and the resource as a whole was supported by a number of trials carried out with different audiences in order to gather feedback. This type of evaluation, known as formative evaluation, is designed to help the progress and design of an unfinished product (Flagg, 1990). Thus, use of the resource in the classroom is not addressed. Instead findings are used to ensure that the resource is fit-for-purpose. The trials undertaken included students, teachers and members of the public. Particular attention was paid to input gathered from teachers. Student and public feedback was considered as a test of usability of methods and presentation. There is little information on formative evaluation strategies for educational material in the literature.

##### ***4.2.5.1 - Teacher trial one***

Teacher trial one allowed for thorough analysis of the resource by a group of science teachers. The trial, held at Manchester Metropolitan University in the microbiology teaching laboratory, took place during the secondary school summer term (July) of 2011.

Participants were recruited through a magazine article written for the Society for General Microbiology (SGM) quarterly magazine, *Microbiology Today* (which all school members of the SGM receive) (Redfern, 2011). The opportunity was also advertised on the social micro-blogging website Twitter, and through a direct mailing to all SGM school members in the northwest of England (close to the trial location). The trial was to take place over two days, and so overnight accommodation and reimbursement for travel expenses were provided by the Society for General Microbiology. In recognition of participation in the trial, the teachers' names and schools were listed in the credits of the resource. The trial aimed to recruit no more than ten teachers, and was successful in recruiting six.

#### 4.2.5.1.1 – The trial

Upon arrival, each participant was provided with a full colour printed draft copy of the resource. The format of the trial was as follows:

##### 1. Day one

- a. Participants introduced to the trial. The purpose of the trial – to ensure the resource is useable and classroom-ready from the perspective of a science teacher– was explained.
- b. Interaction with the trial was explained. Teachers were asked to carry out the resource activities<sup>1</sup>. Whilst doing so, they were asked to consider how they would implement this in the classroom. They were encouraged to write all their comments/suggestions on their draft copies of the resource, to include comments/suggestions on any aspect of the resource, from design, presentation, scientific content, educational content and usability. Participants were encouraged to be as critical as they felt necessary.
- c. During the evening, participants were asked to read the introduction and support material, again, commenting (both positive and negative) in order to provide feedback.

##### 2. Day two

- a. Remaining resource activities were performed, continuing to critique where necessary.
- b. Following lunch (provided), an informal discussion on the resource was encouraged.

---

<sup>1</sup> For activities that normally run over a number of weeks, participants were presented with samples of the experiment taken at weekly intervals (prepared in advance of the trial). Participants were asked to set up the activity, but use the prepared samples to collect data.

#### 4.2.5.1.2 – Results

After collecting the evaluated draft resources, as well as consideration of information received from informal discussion, themes from the data were collated.

Feedback included:

- Design – Participants were positive about the overall design of the resource. They agreed it was both aesthetically pleasing and easy to follow and understand. Additionally praised was the use of spiral binding, which as a simple, yet useful addition to any laboratory resource, allowing the booklet to stay open on a bench top.
- Support material – Introductory material was agreed by all to be clear, relevant and usable, providing information required to perform the activities. Participants did highlight a number of elements they believed were missing, and if included, would strengthen the resource:
  - Technical information on the cultivation of algae
  - Supplier information
  - The inclusion of editable student protocols (for example as Word<sup>®</sup> documents) on the accompanying CD to enable teachers to further personalise the activity to the requirements of their particular students
- Activity content – Overall participants agreed that the activities included in the resource were of a high, usable standard. Some language required alterations, to bring it in line with scientific language currently used in schools, for example, using the word ‘method’ instead of ‘protocol’, and ‘plotting a graph’ instead of ‘drawing a graph’. Some teachers did suggest that they may find some activities difficult to perform in their own

laboratories due to a lack of equipment (for example a colourimeter), an issue that supports trends noted in the survey of UK secondary school teachers discussed in Chapter 1.

Further specific feedback included:

- Activity one, identifying microalgae using a microscope, was a particular favourite with the participants. They noted how interesting and inspiring it was to see living, colourful, motile microorganisms under the microscope as opposed to standard classroom microscopy activities, such as investigating onion cells. It was felt that this would be popular with students. However, opinions were divided as to whether images should be included on the accompanying identification key. Some believed that including the images would encourage students to cheat, whilst others believed that excluding them would be a disadvantageous to both the teacher and students, particularly if the teacher had no prior knowledge of the algae species.
- Activity two was agreed to be interesting and of good standard. Particular mention was given to the 'unusual behaviour' of the phototactic microorganism. Participants believed this would stimulate curiosity with students.
- Activity three, demonstrating bioluminescence, was generally agreed to be the experiment least likely to be performed in the classroom. It was noted that the inclusion of additional support materials for this activity (images and videos) were likely to be very useful as they could aid a quick demonstration exercise as opposed to a practical laboratory activity.
- Activity four and five, eutrophication and gas cycling were considered to be useful investigative activities. One participant liked them specifically



because they gave a visual and data-driven result, with great potential for expansion and project work.

#### *4.2.5.2 - Teacher trial two*

Teacher trial two allowed for another round of analysis by a group of science teachers. The trial, held at the National Science Learning Centre (NSLC), University of York, took place during the secondary school summer term (July) of 2011. Time at this trial was limited compared to the in-depth trial held at MMU. Two one-hour sessions over two consecutive days provided eleven newly qualified science teachers and two teacher-educators time to evaluate the resource. Participants chose to attend the workshop as part of a larger course on practical science in the classroom organised by the NSLC. The sessions were advertised as an opportunity for teachers to have an impact on the construction of a new microbiology activity resource.

##### 4.2.5.2.1 – The trial

Similar to teacher trial one (section 4.2.5.1), participants were provided with copies of the draft resource for writing on. The format of the trial was as follows:

#### 1. Day one

- a. Participants introduced to the trial. The purpose of the trial – to ensure the resource is useable and classroom-ready from perspective of teachers – was explained.
- b. Interaction with the trial was explained. Teachers would be asked to carry out selected activities from the resource<sup>2</sup>, (using a microscope to identify microalgae and phototaxis). Participants were given pre-

---

<sup>2</sup> Due to time restrictions not all activities were able to be carried out



prepared visual examples of the remaining activities. During the trial, teachers were asked to consider how they would implement the activities in the classroom. They were encouraged to write all their comments/suggestions on their draft copies of the resource. This should include comments/suggestions on any aspect of the resource, from design, presentation, scientific content, educational content and usability. Participants were encouraged to be critical where necessary.

- c. During the evening (between the two sessions), participants were asked to read the introduction and support material, again, commenting (both positive and negative) in order to provide feedback.

## 2. Day two

- a. Remaining resource activities were performed, continuing to comment where necessary in the draft copies

### 4.2.5.2.2 – Results

Evaluative feedback collected was similar to that received in trial one. In particular participants praised the standard of the language, it being useable for both teachers and students alike, and they also complimented the supporting information. However, it was noted by three of the participants that the glossary of terms contained some ‘confusing’ words in its explanations, which should be removed, as they may be off-putting to students.

Participants found the activities interesting and exciting. The ‘information strip’ (explanatory information on the basic scientific terms within the key) had been on the right hand-side. It was noted that this should be relocated to the left hand-side,

a natural position on the page. Additionally, participants noted that the student methods were bullet pointed, whereas numbered points may help students follow the method. Both of these points were addressed so that the information strip has relocated and the bullet points have become numbered points for the final print.

#### *4.2.5.3 – Student trial*

The student trial took place one day a week over a four-week period during an undergraduate microbiology laboratory class. Three of the five activities were performed (identifying microalgae using a microscope, investigating phototaxis and eutrophication). Eighteen participants took part. The trial was used to assess if students were able to follow the Student's guide in order to effectively carry out the activities.

Additionally, a pre- and post-trial questionnaire was provided to participants. The questionnaire assessed basic scientific knowledge of algae. Results were collected anonymously. The questionnaire included a mix of qualitative and quantitative questions. These were:

- What are algae? (What are their general properties?)
- What are cyanobacteria? (What are their general properties?)
- In which of the following phenomena do algae have a role? (Tick as many boxes as you wish)
  - Global warming; food colouring; symbiosis; pollution control; element cycling; as a fish food source; composting; deterioration of cultural heritage; O<sub>2</sub> production; used to produce oil; biofilms; carbon sink; manufacture dynamite; photosynthesis; alcohol brewing; agar

production; as a human food source; ice cream production; as a plant food source and as an animal food source.

- Would you classify the following as algae? (Tick as many as you wish)
  - Lichen; Seaweed; Protozoa; Copepods; Diatoms; Dinoflagellates; Mycorrhiza; Amoeba; Cyanobacteria

#### 4.2.5.3.1 – The trial

Participants were given the Student's guides for each of the three activities to be performed. The pre-trial questionnaire was completed before any introduction to algae. Upon completion, participants were given a brief introduction to algae using the material that would form the introductory support material for the resource. Additionally, information on the project and how the trial would support the resource was provided. Participants were asked to be as critical of the Student's guides as they felt necessary, paying particular attention to how easy it was to read and follow. They were asked to write all comments directly onto the Student's guides, which were collected at the end of the trial for evaluation.

The three activities were carried out over four weeks. Upon completion of the trial, the post-trial questionnaire was distributed and results were collected. Participants were given a unique number linked to their name, which was marked on their questionnaire by a third party to ensure the pre- and post-questionnaire answers could be matched for analysis.

#### 4.2.5.3.2 – Results

##### *Student's guide evaluation*

A number of grammatical inaccuracies were identified in the instructions. Some participants noted that they found the spectrophotometer (a key piece of

equipment in two of the resource activities) difficult to use (this was witnessed by the researcher observing the trial).

#### *Pre- and post-trial questionnaire*

H1: “carrying out the activities and receiving basic background on the microorganism algae from the draft resource ‘Algae: a practical resource for secondary schools’ will result in an increase in students’ knowledge on algae”.

H0: “There will be no change in students’ knowledge on algae due to the use of background information and participating in practical activities from ‘Algae: a practical resource for secondary schools’”

Each completed questionnaire was marked with a score, receiving one mark per correct answer. A one tailed T Test was carried out to determine if the difference in the number of correct answers given pre- and post-trial suggested an increase in scientific knowledge. The results show a significant difference between the percentage of correct answers pre- (mean=32.593, standard deviation=12.139) and post- (mean=66.173, standard deviation=12.896) trial. Therefore, the null hypothesis is rejected in favour of supporting the research hypothesis.

#### ***4.2.5.4 – Public trial – ‘The Good, the Bad and the Algae’***

Whilst the resource was undergoing formative evaluation, an opportunity arose to be involved with Manchester Metropolitan University’s ‘Science spectacular’ for National Science and Engineering Week 2011. A science communication event was devised out of activity one, identifying microalgae using a microscope. The event was delivered three times in one-hour sessions over the course of one day. Due to the success of this science communication event, the activity, under the name ‘The Good, the Bad and the Algae’ underwent further development. The

science communication output and impact of this trial and its further development is described in Chapter 6. This section will only describe the information relating to evaluating the activity as part of the resource.

#### 4.2.5.4.1 – The trial

Participants registered themselves for the event using an online booking system organized by the University. No personal or demographic data were collected. There were 20 places per workshop (a total of 60), which are open to people of any age. Each workshop was fully booked. Once the participants arrived at the laboratory they were provided with a copy of the identification key, and a PowerPoint<sup>®</sup> introduction to the algae using the material provided in the resource.

Nine unknown species of algae were presented to the participants. They were given a demonstration on using a microscope. They followed the identification key<sup>3</sup> and attempted to correctly identify the microalgae they were observing. The demonstrators, paying close attention to any questions asked in relation to the task, made observations on the use of the key in note form.

#### 4.2.5.4.2 – Results

Feedback on the event was positive. A number of participants said how much they enjoyed carrying out the activity. The participants were able to follow the method effectively, and to utilise the identification key to successful outcomes. Despite this, a number of inaccuracies were uncovered in the identification key. An observation made by many participants was that the inclusion of a description of scientific terms on the key would be worthwhile.

---

<sup>3</sup> The trial with the public took place prior to the teacher trials and the identification key was still in the early stages of development. The version presented to the public did not contain the information bar.

#### *4.2.5.5 – Results and discussion*

Currently, there is no agreed standard for evaluation of independently published science school laboratory support material. This may be due to the fragmented nature of educational resource production (coming from a number of different authors/organisations). As discussed previously, this fragmentation and lack of standards may be detrimental to the community of publishers. It was therefore decided that formative evaluation would utilize a range of audience types.

The process of formative evaluation was very flexible and was completed over an 11-month period between (February to December 2011). Each of the trials provided feedback from the typical end-users (teachers, students, non-biologists). The resource, developed to provide support the teacher in delivering microbiology in the classroom, does not inform on particular learning theory or pedagogy (as discussed in chapter 3, this should be decided on an individual basis by the teacher). For this reason, effect on student learning was not considered and particular focus was paid to input received from teachers. The chronology of the trials were; student trial (February), public trial (March); teacher trial one (July); teacher trial two (July).

The first trial, using students as participants aimed to assess the student guides that had been constructed for the resource. It was decided this should be the first stage of evaluation as, ultimately, it may be seen as the most critical element of a schools educational resource. All background material provided derived from what would become the supporting introductory material. The statistically significant difference ( $P < 0.05$ ) in correct answers pre- and post-trial on basic scientific knowledge of algae suggests that the material may support scientific learning, even though increase in learning was not an aim of the formative evaluation. Students were able to complete all activities as planned, with little confusion or

questioning. This suggests the methods were usable. However, some issues were highlighted.

The phototaxis activity failed. Although students were able to follow the method correctly, the activity failed to provide the expected results. This entailed more experimental work in the development of the phototactic activity, for example, investigating sleeve design, source of light, incubation time and distance from light source (described in part 4.2.3.3). Interestingly, results from the pre- and post-trial questionnaire suggest that students were commonly unable to differentiate between algae and cyanobacteria. The students who were trialling this activity were assumed to have a greater scientific knowledge than those whom would ultimately be exposed to the resource activities. It was therefore anticipated that if trial participants struggled with this important concept of classification, then the end-users may be similarly confused. This led to additional resource content clearly stating the difference between algae and cyanobacteria, which had not originally been part of the support material (page 6, paragraph 6 of the resource). Additionally, it was noted during the trial that some participants had trouble using a colorimeter. The student method was expanded to provide more information on using the equipment.

Following the student trial was the science communication event 'The Good, the Bad and the Algae'. The aim of this event was two-fold. Predominantly, the aim was to assess the usability of the identification key in activity one, identifying microalgae using a microscope. Additionally, the event hoped to raise awareness of algae as a microorganism, and provide a fun and interesting hands-on experience for the general public.

The feedback gained from observation and discussion on the activity with the participants lead to a number of minor changes, specifically inaccuracies in

language. At this early stage of production, the identification key had not undergone its final design workup, and did not contain the information bar present on the left hand side of the key that was included in the final copy of the resource. Participants of the public trial requested information regarding some of the scientific terminology used, e.g. filamentous, colonial or unicellular structures, flagella and chloroplasts. Following the trial, an information bar was added to the right-hand side of the page. This would be the version presented to participants in both teacher trial one and two.

Teacher trial one, delivered at Manchester Metropolitan University, was a comprehensive evaluation by active GCSE science teachers (n=6). Following thorough activity testing, assessing all aspects of the resource (supporting material, guides, images etc) a number of issues were raised. The second teacher trial, delivered at the National Science Learning Centre, University of York, was carried out within two-weeks of the first teacher trial. This, although delivered in a shorter time-frame, still allowed teachers to assess activities (either hands-on or with presentation of examples), and, similarly, asked participants to evaluate supporting material from the point-of-view of a teacher wishing to use the resource in the classroom. By the time these trials were taking place (a number of months since the student and public trial) the resource had undergone design and formatting into what would be its final design/format. Following evaluation of information received from teachers, the following changes/additions were made:

- Additional information included (suppliers, culturing and maintaining algae).
- The inclusion of images of each species of algae on the identification key. Although arguments for both sides were considered valid (that being the inclusion of images may lead to students cheating, but removing them may disadvantage teachers and students alike), it was decided the images



would be included. To further support this, a guide to algae included on the identification key was added to the teacher guide (page 15 and 16 of the resource). This provides a brief description of the organism, as well as any notable facts (for example, organism is motile). A suggestion was made in the teacher guide that if it was felt that the images would be of hindrance to the delivery of the activity, they could be covered up using Post-It™ notes or similar.

- Explicit information in the introductory text with reference to classification of algae as a microorganism was included. Some participants in teacher trial two were confused about the difference between algae and plants. This is an interesting insight into the misconceptions teachers may hold about microbiology.
- All Student guides were restructured with numbered points instead of bullet points.

Additionally, some teachers believed the explanations for the glossary of terms were too complex, and that the scientific language could put-off or confuse students. It was decided that the glossary would be checked to simplify where possible, but scientific terminology was not removed. It has been noted in literature that the use of proper scientific terminology, although it can be major barrier in science education, is an essential element which teachers can often overlook (Wellington and Osborne, 2001) and which should not be ignored.

Another consensus across teacher trial one was that inclusion of the student guides as PDF documents, as well as supporting PowerPoint® presentations is of great value. However, participants requested the guides as .doc files (Microsoft Word® format), so that they would be able to tailor the guides for their teaching. The participants emphasised if the resource was to be used across Key Stage 3

and 4 then it would need to be adaptable, and providing editable guides would help with this. However, the decision was taken by the publisher not to allow the inclusion of editable documents due to issues with copyright.

After results and evaluations of all previous trials had been taken into account, a revised draft was produced. The final formative input came from a subject expert (Gary Caldwell, University of Newcastle). Comments were very positive. However, the addition of a section to the introductory material on 'Can algae be harmful?' was suggested because the resource focused primarily on the positive attributes of the organism, with no mention of negatives, for example, possible toxin production. This section (page 10 of the resource) was added to the final copy.

### **4.3 Conclusion**

The development of the resource focused on two elements:

1. Design of activities
2. Formative evaluation of activities and the resource as a whole

The activities developed for inclusion in the resource cross a range of curricula areas (within the broader subject of biology and science – not just microbiology). The five activities presented (microscopy and identification, phototaxis, bioluminescence, eutrophication and gas cycling) all have individual teaching specification targets. They present a range of ways to ‘do science’ (investigating and identifying, demonstrating biological phenomena and collecting data), encouraging a range of data collection types (qualitative and quantitative) and use algae, a group of microorganisms which has significant relevance to the world outside the laboratory. The information provided alongside the practical activities should provide support for teachers’ PCK and SMK. This is a key concern considering the resource will be aimed at Key Stage 3 and 4, where non-biology specialists are likely to be teaching. The rigor of the activities was supported by a number of formative evaluations.

Formative evaluation had considerable impact on the final copy. Through interaction with a range of different audiences, many issues not previously picked up by the author or editors were raised and addressed. These changes will improve the publication, enhancing support for teachers wishing to deliver practical microbiology in the classroom without the requirement of (perceived) expensive equipment/consumables or the more technical use of bacteria or fungi.

**Chapter 5 – ‘Algae: a practical resource for secondary schools’: summative evaluation**

## **5.1 – Introduction**

Following the development and formative evaluation of 'Algae: a practical resource for secondary school' (chapter 4: referred to as 'the resource' - Redfern, 2012), it was published by the Society for General Microbiology on January 1<sup>st</sup> 2012.

The resource included a 76-page spiral bound book, five copies of the microalgae identification key (Figure 25), one copy of a poster titled 'Fascinating facts about algae' (Figure 42) and a CD-ROM containing additional support material<sup>4</sup>. An initial print run of 1000 copies was made.

The resource was launched at the Association for Science Education conference in Liverpool, January 2012 (<http://www.ase.org.uk/conferences/>). This chapter describes dissemination, promotion (section 5.2), and a summative evaluation encompassing a survey of teachers who received the resource (section 5.3).

## **5.2 – Dissemination, promotion and use**

The bulk of the copies (750) were distributed to UK schools as a SGM school-member benefit. When a school renewed membership of the SGM through 2012, it received one free copy of the resource. Additionally, approximately 150 copies were issued free of charge to PGCE students undertaking microbiology training sessions supported by the SGM at universities across the country. The remaining copies (n≈100) were distributed at various science/education events such as the Association for Science Education conference and the Big Bang Science Fair, or to ordinary members of the SGM whom requested a copy. By October 2013, all 1000 copies have been distributed.

---

<sup>4</sup> Images, videos and PowerPoint® presentations for each activity

To promote to the target audience (teachers) the resource was advertised on the SGM education website ([www.microbiologyonline.org.uk](http://www.microbiologyonline.org.uk)). The Culture Collection for Algae and Protozoa (CCAP), the most diverse algal culture collection in the world (SAMS, n.d.), agreed to advertise the resource on their website alongside an advertisement for an algal species kit, which the culture collection had created specifically to support the resource (Figure 43). The kit contains the algal cultures *Pyrocystis lunula* and *Euglena gracilis* as well as stock solutions of growth media. The kit is priced at a discounted rate of £29 plus VAT (compared to purchasing the contents individually at a price of £160) and is available exclusively to UK schools. Between March 2012 and May 2013, the CCAP received 29 orders for the schools kit (Christine Campbell, personal communication, 17/07/2013). The CCAP have also included a new ‘Bioluminescent Algae info sheet’ on their website, due to increased demand from schools (<http://www.ccap.ac.uk/cultures/bioluminescentalgae.htm>). The algal supplier Sciento also began stocking the bioluminescent algae used in the resource (Robert McNuff, personal communication, 08/10/2013). Thus, suppliers provided direct and indirect evidence of resource use.

Since the launch, the resource has been used at a number of science communication events and professional development workshops for UK secondary school teachers. Workshops have included ‘Cutting edge science in the classroom’ at the Northwest Science Learning Centre (20 teachers, November 2012), incorporating a number of the activities into PGCE science teacher training (80 trainee teachers, MMU – June 2013) and ‘Biology practicals that work – hands-on drop in session’ (*sic.*) at the ASE conference 2013 (approximately 60 teachers/technicians). At each workshop the activities were noted to be fun, useful and relevant to science education (teachers and teacher educators).



[order cultures > go](#)

direct link to our ordering service



**sgm resource for secondary schools in the uk : algal culture kit for schools**

To accompany the experiments CCAP have designed a kit comprising a leaflet with culturing advice and samples of:

- *Pyrocystis lunula* CCAP 1131/1
- *Euglena gracilis* CCAP 1224/5Z

Stock solutions for 1 litre of:

- L1 marine medium
- 3N BBM+V freshwater medium

Note that we can only supply to UK schools  
Please order at least 3 weeks before required, as the cultures will need a couple of weeks to grow once you receive them. See our **Bioluminescent Algae Info sheet** for details on growing and using *Pyrocystis*

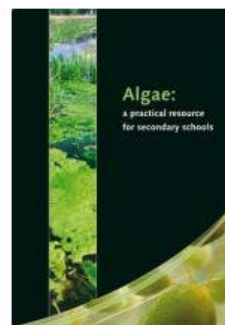

**Purchase from CCAP for £29 plus VAT (incl P&P)  
Contact CCAP directly to order or for more information**

**Society for General Microbiology**

Figure 43 - Screenshot of the CCAP homepage ([www.ccap.ac.uk/](http://www.ccap.ac.uk/) - as of October 2013) displaying the kit on sale to support the use of the resource 'Algae: a practical resource for secondary schools'

## **5.3 – Summative evaluation of SGM school members**

### **5.3.1 - Introduction**

Summative evaluation was carried out following the dissemination and promotion activities using a survey. The survey investigated SGM schools members' use of the resource. The timeframe to begin data collection was eighteen months after publication, because the resource would have been available for a complete academic year. Data collection began in June 2013 and ceased in July 2013. A questionnaire was developed (Table 11) which aimed to investigate the following research questions:

- Are teachers using the resource in the classroom?
- Which aspects of the resource, if any, are being used?
- How are teachers using the resource to support teaching in the classroom?

### **5.3.2 - Methodology**

#### ***5.3.2.1 - Survey design***

This survey was designed with a mixed methods approach, a research paradigm that had been used previously in this project (section 1.5, page 22). Similar to the practical microbiology survey detailed in Chapter 1, the combination of quantitative and qualitative data will support stronger, less-biased conclusions. Consequently, several kinds of questions and response modes were used, creating a semi-structured questionnaire. These included dichotomous questions, multiple-choice questions, rating scales and open-ended questions. Although the majority of questions yielded quantitative data, the incorporation of qualitative questions allowed more in-depth investigation, supporting the numerical data produced.



Table 11 - Questions presented to participants in the summative evaluation survey for 'Algae: a resource for secondary schools'.

Question number	Question text	Response type
1	How long have you had the pack?	<ul style="list-style-type: none"> <li>• Open-ended comment</li> </ul>
2	Have you used any part of the resource 'Algae: a practical resource for secondary schools' in your teaching? If no, please specify why and go to question 9 on the survey.	<ul style="list-style-type: none"> <li>• Dichotomous answer: <ul style="list-style-type: none"> <li>○ Yes</li> <li>○ No</li> </ul> </li> <li>• Open-ended comment</li> </ul>
3	Did you use any of the following as a practical activity? If yes, please state which school year in the comments section.	<ul style="list-style-type: none"> <li>• Dichotomous answer (for each practical activity): <ul style="list-style-type: none"> <li>○ Yes</li> <li>○ No</li> </ul> </li> <li>• Open-ended comment</li> </ul>
4	Did you use any of the following as a class demonstration? If yes, please state which school year the students were in the comments section below	<ul style="list-style-type: none"> <li>• Dichotomous answer (for each practical activity): <ul style="list-style-type: none"> <li>○ Yes</li> <li>○ No</li> </ul> </li> <li>• Open-ended comment</li> </ul>
5	How useful did you find the following sections of the resource? Answers as a scale of 1 to 7: Not at all useful 1 - 7 Extremely useful <ul style="list-style-type: none"> <li>• Introduction, Teachers guide, Technical guide, Student's guide, Supplier information, Cultivation of algae, Printed support material</li> </ul>	<ul style="list-style-type: none"> <li>1. Scale answer (for each variable) <ul style="list-style-type: none"> <li>○ Scale values 1 to 7</li> </ul> </li> </ul>
6	How useable was the resource? Answer as a scale of 1 to 5: Not use friendly 1 – 5 Very user friendly	<ul style="list-style-type: none"> <li>• Scale answer</li> <li>• Scale values 1 to 5</li> </ul>
7	Were you able to use the resource to support the National Curriculum for Science or other teaching specification? Please state in the comments box which curricula you follow	<ul style="list-style-type: none"> <li>• Dichotomous answer: <ul style="list-style-type: none"> <li>○ Yes</li> <li>○ No</li> </ul> </li> <li>• Open-ended comment</li> </ul>
8	Were you able to use the resource to illustrate concepts across the field of biology and science as a whole (as opposed to just microbiology)? If yes, please provide examples in the comments box	<ul style="list-style-type: none"> <li>• Dichotomous answer: <ul style="list-style-type: none"> <li>○ Yes</li> <li>○ No</li> </ul> </li> <li>• Open-ended comment</li> </ul>
9	Any further comments: How could this resource be improved? Any specific positive attributes? Please comment on any aspect of the resource you wish. If you have not used any part of the resource, please can you explain why? If you agree to being contacted further for evaluation, please leave your email address here.	<ul style="list-style-type: none"> <li>• Open-ended comment</li> </ul>

A pilot questionnaire was supplied to a number of professional educators (n=4) prior to distribution. The aim of this was to test the questionnaire for ease-of-completion and readability. Following this, no alterations were made to the survey design.

#### *5.3.2.2 - Ethics*

All responses were analysed blind (this had been made clear to participants at the start of the questionnaire). The delivery method (detailed subsequently) gave respondents the option to withdraw from completing the survey, at any point, for any reason. This study follows the British Educational Research Association ethical guidelines for educational research (BERA, 2011).

#### *5.3.2.3 - Participants*

The target audience for the survey was teachers who had received the resource as part of their membership package to the Society for General Microbiology (n= approximately<sup>5</sup> 750). Unlike the microbiology in schools survey (Section 1.5), this survey was delivered wholly electronically (no paper questionnaires) using the online survey tool Survey Monkey® (<https://www.surveymonkey.com/>).

The participants were informed that the survey should be completed by someone in a science teaching position. A reminder was sent at the beginning of July 2013. No compensation or incentive was offered for completing the survey.

Fifty-two teachers completed the survey, of whom five participants stated that they had not received the resource, so their data were removed from analysis.

---

<sup>5</sup> The survey was delivered by the Society for General Microbiology and no record of the exact number of potential participants was made. However, the survey was distributed to all school members, of which there was approximately 750 at the time.

#### ***5.3.2.4 – Instrumentation (question types)***

The survey comprised a nine-question questionnaire covering four areas of interest.

1. Amount of time the respondent had owned the resource for (question one – open-ended comment).
2. Whether teachers are using the resource in the classroom (questions one and two) and if this relates to the amount of time they have had it.
3. Which components of the resource are being used (questions three and four) and the method by which they are delivered (practical activity or class demonstration).
4. How the respondents are using the resource (question five and six, collecting data on usability; questions seven and eight, collecting data on support of curricula teaching and illustration of non-microbiology topics).

A final question allowed free text response regarding any additional comments (with a focus on possible improvements and any positive attributes the resource holds).

#### ***5.3.2.5 - Analyses***

Overall trends and responses are presented in a mixture of tables and charts. Chi-square analysis for independence was carried out to allow different variables (answers) to be considered together where appropriate. Mean scores were calculated for questions with semantic differential scale responses. A significance level of five per-cent ( $P < 0.05$ ) was used on all statistical tests. All statistical analysis was carried out using the statistical software package IBM® SPSS® Statistics 19.

### 5.3.3 – Results and discussion

The survey examined the Society for General Microbiology school members for their use of the practical activity resource 'Algae: a practical resource for secondary schools'. All school members, likely to be qualified teachers, at the time of survey should have received the resource. The length of time between resource publication and this survey (18 months) means it was possible for teachers to have had the resource for at least one academic year.

Twelve-point-three per-cent of respondents were unsure when they had received the resource, whilst 14.9% had received it recently (0-6 months), 55.3% had owned it for 7-12 months and 8.5% had received their copy in excess of a year ago (12-24 months).

The data collection period (two months) closed with 52 responses from a distribution of approximately 750, giving an estimated response rate of 7%. This is a low response rate, a common issue when surveying in-service teachers (personal communication, Jan Green, January 2011).

The use of semantic differential scale instrumentation in a survey is a valid method for evaluation (chapter 1, part 1.5). The semantic differential questions in this survey (questions five and six) were originally planned to be on a scale of one to seven. It has been noted in literature that respondents tend not to agree with extreme scale values (that being the very first and last values). Therefore, if using a five-point scale, it is possible that respondents are limited to only three response options. The use of a ten-point scale can invite a level of detail and precision when providing an answer, which can be inappropriate with a scale questionnaire instrument (Cohen, 2011). Seven-point scales have been described as the best option in terms of reliability and ability for respondents to discriminate between values on the scale (Schwartz *et al.*, 1991). Question five was presented as

intended, with a seven-point scale. However, during transcription into Survey Monkey® (prior to distribution) question six was assigned a five-point scale.

#### *5.3.3.1 General use of the resource in the classroom*

The majority of respondents had received the resource between 7 and 12 months earlier (55.3%), whilst 14.9% had received it recently (0-6 months). Only 8.5% of respondents had received the resource over a year ago, even though it might have been assumed that the majority of SGM school members would have received the resource at launch (18 months earlier).

Of the 47 participants, when asked if they had used the resource in their teaching (question two), 48.9% said yes, whilst 46.8% said no. Four-point-two per-cent did not answer (Figure 44). Those who responded no were asked to leave an open-ended comment to explain this (n= 21). The most frequently cited reason for not using the resource was time (n=7). One respondent stated: "I haven't even taken it out of its wrapping. Lack of time and inclination". A similar number (n=6) highlighted curricula/teaching specification constraint as a limitation to using the resource. Finance was the only other reason provided with a low number of respondents (n=2) being concerned by this. Additionally, a number of responses (n=6) did not provide any specific reason as to why they had not used the resource, for example one respondent commented "to be honest I had forgotten about it".

If the data from question one is considered alongside responses to question two (Figure 45), it suggests that those who have had the resource for 6-12 months are more likely than not to use it.

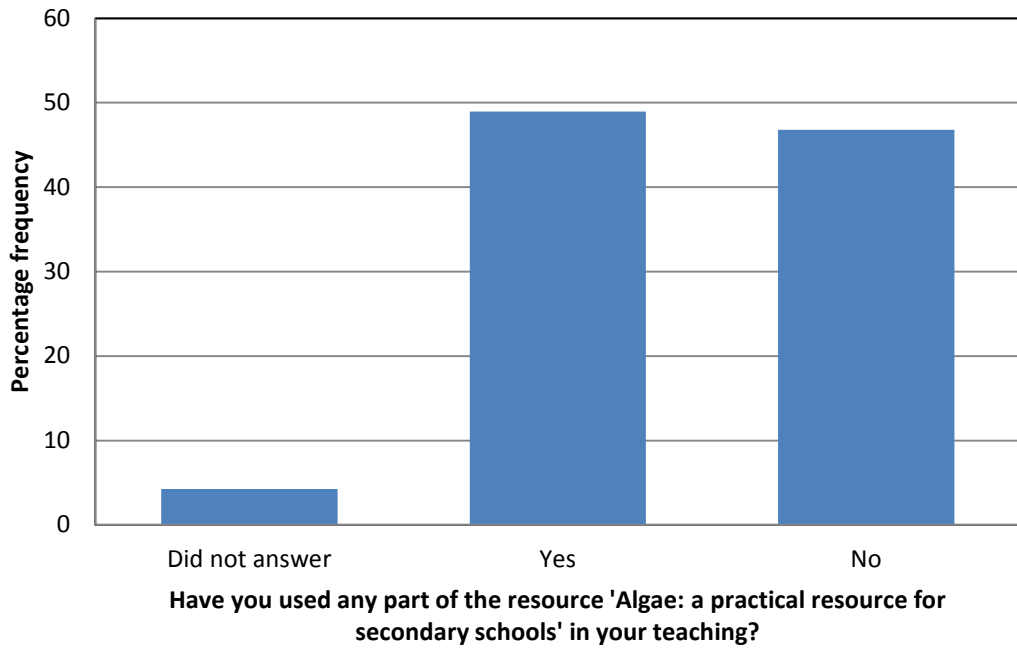

Figure 44 - Data collected from question two of the summative evaluation survey displayed as a percentage frequency of usable data (n=47).

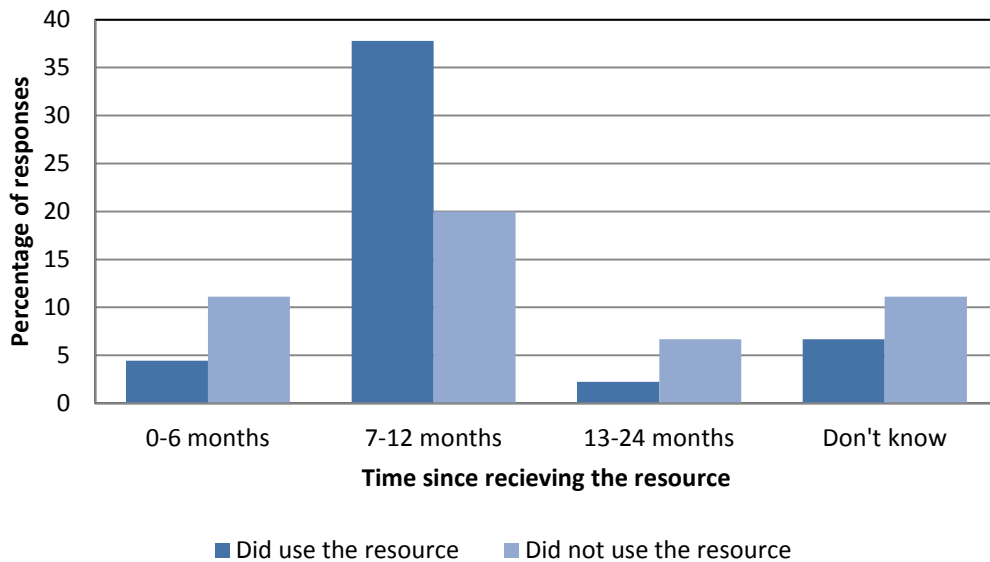

Figure 45 – Bar chart showing data from question one and question two (if respondents had used the resource split by time since receiving the resource). n=45.

If a teacher has had the resource for less or more time than this (or they were unsure when they received it) they were more likely not to use it. This is likely to be due to the time required by a teacher to investigate the value of a new resource and plan it into the scheme of work (potentially waiting until the next academic year to integrate it). It suggests that the time of year new resources are made available should be considered by publishers, with time to implement activities into schemes of work, yet ensuring the resource is fresh in their mind. A reminder could be sent at the appropriate time to encourage teachers to consider using the resource whilst preparing schemes of work for the upcoming year.

#### *5.3.3.2 – Use of specific activities*

All activities were being used in the secondary school science classroom (Figure 46). Activity one was most used followed by two, four, three and five. Activities one and two (identification using a microscope and phototaxis) had higher percentages of participants using the activity than not. Whilst more participants did not use three, four or five (bioluminescence, eutrophication and gas cycling) compared to those who did.

Although no information was sought as to why teachers may or may not have used a particular activity, a number of suggestions can be offered. It may be that activity one and two may be perceived to be easier to implement in the classroom, or may be more relevant to teaching specifications. Conversely, it may also be possible that these two activities seem more popular due to the order they are presented in the book. However, whilst activities three and five had relatively low use (20% and 13% respectively), activity four had a moderate amount of users (46.15%). This suggests teachers were reading the resource and choosing specific activities (activities one, two and four were most popular throughout formative evaluation).

If participants had responded yes to question three, they were asked to leave a comment on what year group the activity was delivered to. The data (n=6) suggests that the activities were being used for higher school years with direct reference made to post-16 education (n=4) and 14-16 education (n=3). One reference was made to using activity one to support 11-14 education. Additionally, reference was made to developing the activities for use in other year groups. These comments, although limited in number, were positive. They showed that the activities were being used across the original targets of Key Stage 3 and 4. Additionally, the use of activities in post-16 education suggests the suitability of the resource to be wider reaching than intended.

Although the resource was designed to help teachers deliver hands-on practical activities to students, it is possible that these activities could instead be used as demonstrations. If data from question three is considered alongside data from question four, ('did you use the following as a class demonstration?') it is apparent that class demonstrations were less popular (Figure 47). These data supports the notion that the resource was being used as originally intended, as practical activities. It is positive to see that all activities have been attempted by teachers (in particular the more tricky/difficult activities three and five).

In response to question four (have they used an activity as a demonstration), respondents were asked to leave a comment regarding the school year they had demonstrated the activity to. Only four responses were provided (with only two comments stating the school year). These were post 16 and 14-16 education. Similar to responses from question 3, one answer stated the respondent was planning to use the activities in the near future and another respondent states that the activities were not relevant to the curriculum.



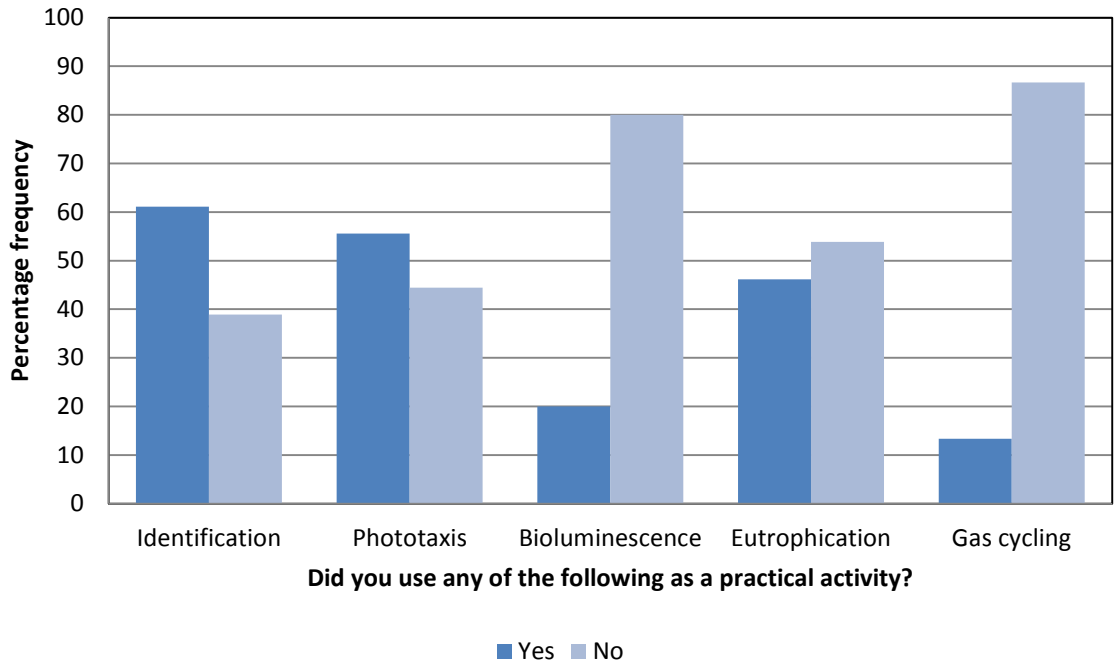

Figure 46 - Data collected from question three of the summative evaluation survey displayed as a percentage frequency. Identification, n=18. Phototaxis, n=18. Bioluminescence, n=15. Eutrophication, n=13. Gas cycling, n=15.

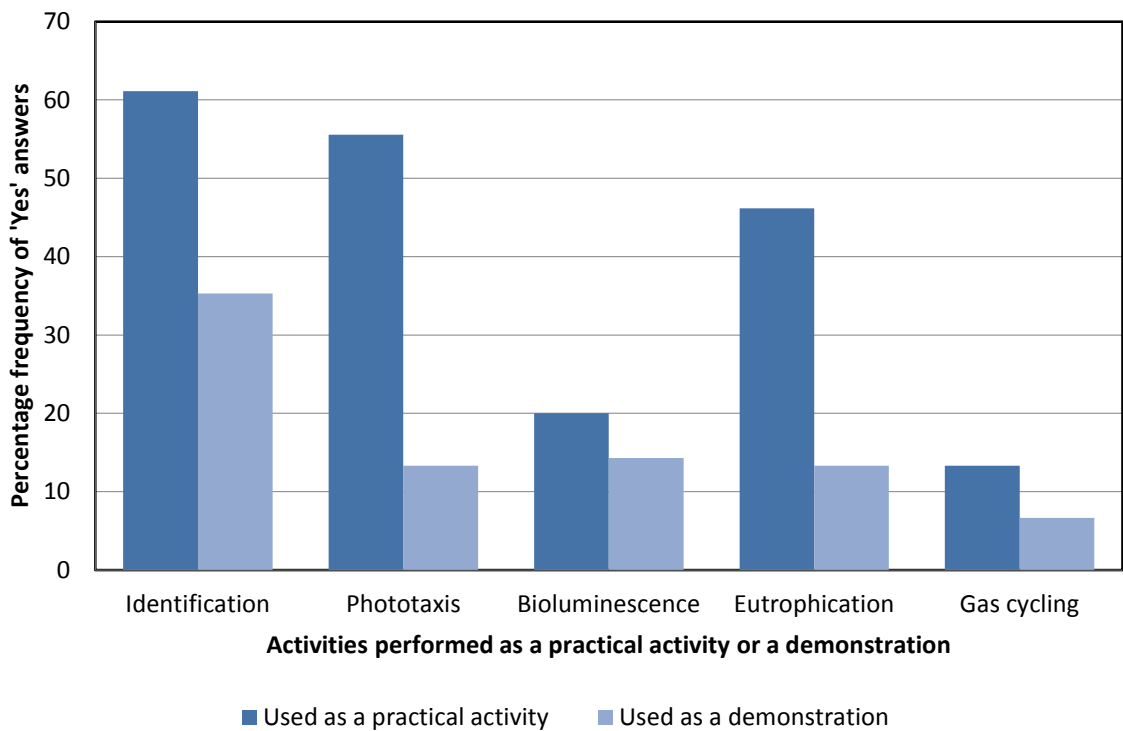

Figure 47 - Comparison of 'Yes' answers for when asked if respondents had used any activity as a hands-on practical activity or a class demonstration (question three and four). Identification, practical activity n=18, demonstration n=17. Phototaxis, practical activity n=18, demonstration n=15. Bioluminescence, practical activity n=15, demonstration n=14. Eutrophication, practical activity n=13, demonstration n=15. Gas cycling, practical activity n=15, demonstration n=15.

### *5.3.3.3 – Implementation of specific activities in the classroom*

Questions five to eight investigated how teachers were interacting with the resource. Respondents rated all aspects of the resource highly (Figure 48). As the box and whisker plot demonstrates the majority of respondents gave marks of between five and seven (on a seven-point scale). All averages are similar with no significant difference between them (Table 12), falling between 5.3 and 5.8 (from a range of one to seven), suggesting respondents valued them equally. However, the 'Student's guide' and 'Supplier information' scores had lower median values suggesting the data points had a greater spread across the scale. The Supplier information and cultivation of algae interquartile ranges are larger than others, suggesting that although the data are still in the upper portion of the scale, they are less consistent.

This data indicates that sections included during development due to potential benefit to teachers (introductory material, Teacher's guides, Technician's guides, Student's guides and the additional printed support material) were successful in supporting practical microbiology activity in the classroom. Additionally, two sections added following formative evaluation (supplier information and cultivation of algae) were equally as useful to teachers. The lack of any low-scoring sections is an indication that subsequent resources of this type should not seek to remove any of this information.

Participants were also asked to rate the usability of the resource as a whole (question six - Figure 49). Scores ranged from two to five (scale ran from one to five – not user friendly to very user friendly). The median value (5) suggests half of respondents answered the question with the highest possible value. The interquartile range lays between values four and five, demonstrating that the majority of responses (>75%) fell above value four, with an average score of 4.3.

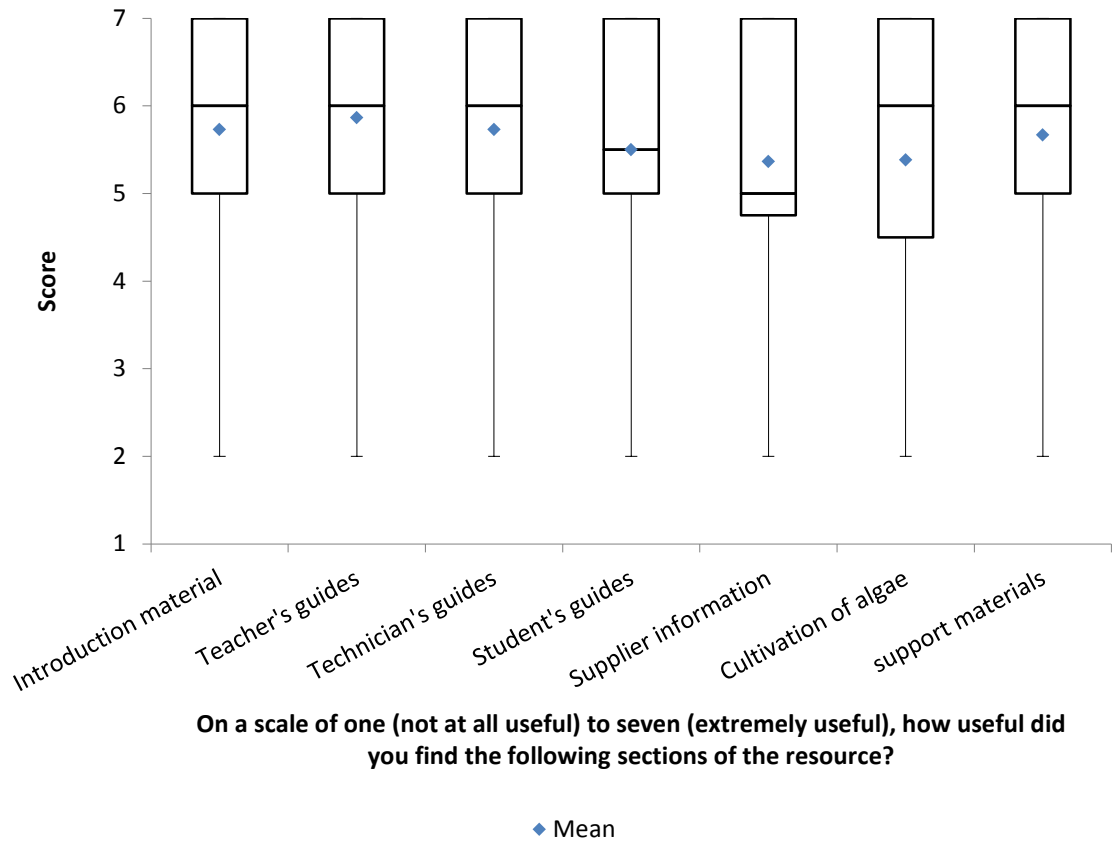

Figure 48 - Data collected from question five of the summative evaluation survey displayed as a box-and-whisker plot. Introduction material, Teacher's guide, Technician's guide, Student's guide and Supplier information n=22. Cultivation of algae and support material, n=21.

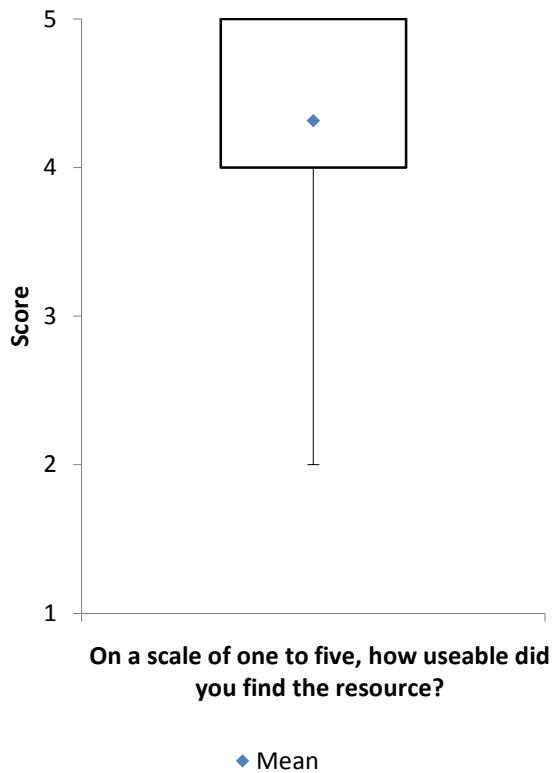

Figure 49 - Data collected from question six of the summative evaluation survey displayed as a box-and-whisker plot. n=19. Score one was 'not user friendly' and score five was 'very user friendly'.

Table 12 – Two-tailed independent Students’ T test data (P values). The test investigated difference between ratings given to each element of the resource in relation to each other. No data were significantly different (P<0.05).

	Introduction material	Teacher's guides	Technician's guides	Student's guides	Supplier information	Cultivation of algae	Support materials
Introduction material		0.760109696	1	0.609031879	0.423350426	0.451220403	0.896820121
Teacher's guides			0.765059552	0.419964871	0.278160571	0.301025761	0.677261644
Technician's guides				0.616742168	0.432956368	0.460810929	0.898913565
Student's guides					0.764622174	0.79627187	0.723138335
Supplier information						0.970597557	0.527805485
Cultivation of algae							0.556759375
Support materials							

This data, suggesting the resource to be 'very user friendly', having benefited from formative evaluation undertaken in preparing the resource (Chapter 4).

These data from question seven (n=20) suggest that 90% of respondents were able to use the resource to support the National Curriculum, whilst 10% felt they were unable to do so. Of those who answered positively, 17 provided comments concerning which curriculum or teaching specification they use. The specifications were wide ranging across post-16 and 14-16 education/qualifications supporting both the National Curriculum for England, Wales and Northern Ireland, and the Scottish Curriculum for Excellence. This included:

- AQA Biology GCSE
- AQA Biology A Level
- Edexcel Biology GCSE
- Edexcel Biology A Level
- OCR Biology GCSE
- OCR Biology A Level
- WJEC (no information on specific level)
- Scottish Intermediates
- Scottish Highers (Biology)
- BTEC microbiological techniques
- Biology IGCSE
- International Baccalaureate

These data (question seven) provided an interesting dilemma. Respondents were able to support a large range of the different teaching specifications used in science education in the UK, which can be used as evidence that the resource has successfully achieved one of its aims, to be open to many different curriculum topics as possible.

Despite two-thirds of respondents (n=18) using the resource to illustrate concepts across the field of biology and science in general, only ten provided examples.

They are:

- Taxis
- Eutrophication
- Response to light
- Nutrient cycling
- Taxonomy
- Photosynthesis
- examine organisms/cell biology/microscopy
- used in investigative projects
- Toxicology/pollutants
- Respiration
- Counting using a microscope

These data provide further evidence that the resource was able to support school science teaching. Importantly, it highlights that the activities were able to support

teachers' practical science offerings with activities that are not typically associated with microbiology.

#### ***5.3.3.4 – Additional comments***

*"I would welcome more of these type of experiments, if any exist in the pipeline; we have used it considerably both in the classroom and in science clubs. Instructions are excellent with good layout on each page, making it very reader-friendly. Above all, the pracs work very well, every time"* (sic.)– A teacher commenting on the resource in response to question nine

Twenty participants provided additional responses (question nine), sixteen with positive feedback and seven with negative feedback (Table 13).

The positive comments pertained to a range of areas. Particularly of note was the academic range the resource was able to support. Alongside Key Stage 3 and 4 (the intended target), the resource had supported post-16 science non-formal science education, for example science clubs, exhibitions and as demonstrations on open days.

The negative focused on limitations to using the resource (for example, time, class size, space, technical support and curriculum links), a recurring theme throughout this survey. Of the respondents who did not use the resource (question two), three limitations were given (teacher time, curriculum restriction and finance). Lack of support for curriculum was also given as a limitation in questions three and four. These data support the limitations identified in the survey of microbiology in schools (Redfern *et al.*, 2013a).

These limitations had been considered during development to help alleviate these pressures. The resource contains activities that can be performed over a range of time (twenty minutes to many weeks). The microorganisms used are cheap

(potentially free if sampling the environment) and easily accessible. Additionally (Chapter 4), the algae, the activities and the resource as a whole have numerous connections to curricula and teaching specifications used throughout the United Kingdom (Table 10, page 116). Alongside this, activity-specific links to curriculum topics are in each of the corresponding Teacher's guides as well as supporting material/background information to support teachers' PCK, an issue which is known to limit teachers using new/unfamiliar practical science activity (Appleton and Kindt, 2002).

Additionally, many of the activities can describe/demonstrate non-microbiology topics (i.e. other aspects of biology or science in general) and can support teaching the nature of science through explanation of scientific method and discussion of introductory material. This could allow a teacher to fulfil more than one objective with any particular activity (saving time by covering more than one topic at once). However, some teachers may not be able to directly link the concepts being illustrated in the resource to the curriculum, particularly if they are not biology specialists and lack the PCK required to link the content with their classroom aims. However, as these links are highlighted in the resource, it can only be assumed that teachers have not given the resource significant attention, and therefore assume the content is not applicable to them. If this is true, it provides a difficult issue for resource developers, as, without a face-to-face explanation, how is it possible to ensure that a teacher understands the curriculum/resource content links? One possibility is to add an overview page at the start of a resource. Therefore, if a teacher were to only read a limited number of pages, they would be made aware of the potential the resource holds.



Table 13 - Comments left by participants in response to question nine of the summative survey questionnaire. Responses are split into positive or negative and grouped into themes

Positive themes	Negative themes
<b>Instructions/methods were clearly presented (n=3)</b>	Time as a limiting factor (n=3)
<b>Although not currently used, plans in place to use in the coming academic year (n=3)</b>	large class size as a limiting factor (n=2)
<b>General praise for the resource (n=2)</b>	Space as a limiting factor (n=1)
<b>Could be used to support classroom teaching (n=2)</b>	Technical support as a limiting factor (n=1)
<b>Could be used to support science clubs, exhibitions and school open days (n=2)</b>	Curriculum relevance as a limiting factor (n=1)
<b>Activities have been adapted to make them more challenging for high achieving students (n=1)</b>	Difficulty in getting activities to work (n=1)
<b>Activities could be incorporated within budget restrictions (n=1)</b>	
<b>Topics covered are interesting and relevant (n=1)</b>	
<b>Activities run effectively and are repeatable</b>	

On a positive note, four respondents did suggest that although they had yet to include the activities in their teaching, they planned to do so in the coming academic year. Interestingly, one respondent states they have been able to adapt the resource to their particular requirements. *"... I altered the practical in that they had to devise the experimental procedures themselves, to make it more challenging. Overall, this was a superb kit. Thank you for it!"*. This supports the feedback during formative evaluation that the resource should provide editable material to help teachers alter the material. Although this was not made available, it does not appear to have been a hindrance to this respondent. Though this would have been a benefit to teachers, the activities were designed to be well tested and reproducible. Inclusion of editable methods would remove the assurances of the resource and may result in an unintended outcome, potentially causing distrust with this or similar resources, discouraging teaching from moving away from institutionalised activities. For this reason, any further development of practical activity resources should not include editable documents.

#### ***5.3.3.5 – Survey design and implementation***

Following the survey, it was noted that it might have been useful to ask what specific science subject the teacher was trained in. The science speciality of the respondent is likely to affect their opinions regarding practical microbiology in the classroom. This additional data would have allowed analyses as to whether those that had trained in biology education had different practices, issues and comments from physics or chemistry-trained teachers and potentially investigated the resource in relation to supporting PCK.

Additionally of interest would be if the resource was able to support teaching the nature of science. Unfortunately, this was not considered for this summative evaluation, as the aim was to only identify how the resource has been used since

publication. Use of an educational resource such as this and its relationship with NOS teaching would be of great benefit to knowledge and the thin literature in the area. For example, assessing students understanding of NOS (Lombrozo *et al.*, 2008) against participation of new investigative practical activities (taught using NOS themes) compared to institutionalised activities (page 87 – taught without NOS).

#### **5.3.4 – Conclusion**

To conclude, the survey has provided an insightful set of data with respect to the performance and use of the resource post-launch. Although the survey was short, and emailed directly to teachers, it received a low response rate (as typically expected with this audience). Although working with a third party (Society for General Microbiology) enabled the survey to reach the intended target audience (which it would not have done without their help), the inability of the researcher to monitor the response rate (which could have been improved by use of follow-up requests) was a problem.

The repetition of ill-informed negative comments exemplifies the problem of perceived limitations. Prominent discussion of curriculum links earlier in the resource may be one way to address this issue. It is worthy of note that limitations were not specifically relating to this resource, but to the wider use of educational resources (particularly practical activity) in the science classroom.

Despite discussion of these limitations, the resource has been successful in achieving its aim (to encourage and promote practical microbiology in the school classroom). It was able to deliver practical microbiology:

- Directly (informing on topics obviously associated with the activities – such as using a microscope to identify microorganisms)
- Indirectly (using the activities as a vehicle to discuss atypical microbiology topics – such as toxicology/pollution)
- To a range of ages, in formal and informal settings
- Whilst supporting almost every biology teaching specification (taught in secondary schools) in the United Kingdom.

All activities were being used, predominantly as hands-on practical activities (opposed to class demonstrations). Teachers found all sections in the resource (e.g. individual guides, cultivation and supplier information) to be highly useful. This lends support to the value of the formative evaluation strategy carried out prior to launch, as much of the development behind these sections benefited from formative input and to the carefully considered curricula and teacher needs.

## **Section 4 – School science and public engagement**

### **Chapter 6 – Developing a school practical activity into a science communication event**

## **6.1 – Case study: transforming a school learning exercise into a public engagement event: ‘The good, the bad and the algae’**

This chapter details the development of a schools-based activity to a successful public engagement event. The event focuses on practical ‘activity one: identifying microalgae using a microscope’, from the resource ‘Algae: a practical resource for secondary school’, This was concurrent with the development of the resource and provided part of the formative evaluation (Chapter 4), and continued after publication. The development process described here has been published in the peer-reviewed journal ‘*Journal of Biological Education*’ (Redfern *et al.*, 2013b).

### **6.1.1 Introduction**

Developing a new and effective hands-on science engagement activity can be challenging with respect to choosing which topics and scientific principles to highlight, but a trawl through the school curriculum can trigger ideas. As with any subject, it might be argued that the profile and development of a particular scientific field relies heavily on the initial inspiration and continued engagement of young students (Rosen *et al.*, 2010). Microbiology poses particular problems in this context, due to perceived health and safety issues. Even in schools, teachers and technicians may be reluctant to deliver practical classes due to unfamiliarity with procedures, and anxiety regarding contamination.

Often, preparation and delivery time is limited; equipment is basic (in comparison with that of a university), and teachers are delivering activities alone, or with limited technical support (SBS, 2004) to a class of students. It is also difficult to keep students, particularly high school students, motivated through a science class (Martin *et al.*, 2000, Rennie *et al.*, 2001). Research suggests that situational interest (a type of short term motivation) in a classroom environment is achievable by incorporating three key experiences, novelty, choice and social involvement

(Palmer, 2009), with novelty being the most powerful in terms of generating interest arousal. For example situational interest can be successfully generated to school students in a out-of-class environment such as a museum (Bonderup Dohn, 2011, Zoldosova and Prokop, 2006). The removal of classroom science limitations (such as time, equipment or expertise) means that when delivering science in an informal setting such as science fairs, science communicators can utilise novelty, choice and social interaction to enhance their engagement with participants. It has also been suggested that in terms of teaching scientific knowledge, practical activity in the classroom should provide a simplified version of science, making it easier to understand (Reiss, 2012), and be seen as a *communication*, not a discovery exercise (Millar, 2004). Some of these experiences are founding principles on which scientific public engagement activities are built, encouraging social involvement whilst enabling learning (Bell *et al.*, 2009) more overtly than the more formal classroom setting. However, public engagement allows science to be presented in different ways to the conventional school science laboratory. There is clearly commonality between the demands and rationales underpinning school-based practical classes and public engagement activities, but there is little literature on the topic. Therefore, effective and stimulating exercises delivered in schools ought to be a good source of inspiration for development into science public engagement events for different audiences.

Within the field of microbiology, many innovative and engaging school activities have already been developed despite the constraints of the school curriculum specifications – some examples include photosynthetic jelly balls (Eldridge, 2004), building a microbial fuel cells (NCBE, 2012) and ‘microbes ate my homework – microbes and cellulose’ (Fry *et al.*, 2008). In addition, many exciting public engagement activities that do not require expensive equipment such as microscopes have been delivered. Examples include the importance of

handwashing using florescent dye and UV light (Burdass, 2010) 'how the mushroom got its spots' (Assinder, 2011) and the linking of vampire and zombie literature with microbiological concepts of disease and epidemiology (Verran, 2010, Verran, 2012, Groves, 2011).

### **6.1.2 - Public engagement event: low throughput, intensive laboratory workshop**

The practical activity was developed into a public engagement event for the National Science and Engineering Week (NSEW) 2011 by the team who had developed the original school activities. It was presented at a family fun day at Manchester Metropolitan University (MMU), where the Faculty of Science and Engineering hosted a series of activities promoting science and engineering to family audiences. The activity was given the catchy title 'The Good, The Bad and The Algae', to highlight the importance of algae compared with other better known groups of microorganisms. The workshop was hosted in the microbiology-teaching laboratory within the university, and ran three times during the day. Each session required three or four demonstrators to ensure that health and safety regulations were adhered to, and that learning opportunities were available for all participants. A maximum of 20 people per session was specified, and each session lasted one hour. The aims of the session were:

- Raise awareness of the importance of algae.
- Encourage hands-on laboratory examination (in a fun and informal manner), as well as providing an introduction to light microscopy, which can prove challenging (Drace *et al.*, 2012).
- Provide formative evaluation for resource development.



The session began with an illustrated five-minute introduction on the importance of algae, focusing on their uses and relevance to everyday life (in a question and answer format), and a demonstration on how to use a light microscope. Nine 'unknown' algae cultures were provided for the audience to identify using a working version of the identification key. Ten microscopes were available. Additionally, 'model magic' (Crayola™, Bedford UK), white air-drying modelling clay, was provided for participants to make a model of their favourite alga to take home in a Petri dish for painting (Figure 50). The activity therefore incorporated the three elements of 'situational interest' noted previously; novelty, choice and social involvement.

Each session was fully attended by an audience of predominantly families (with children of early school age up to grandparents). The atmosphere was friendly and interactive: questions were encouraged. Many participants, children and adults, commented on the size of the algae, not realising how small and attractive they were. The importance of algae to the planet, for example, producing over 50% of the world's oxygen, was also a surprise: many adults assuming they were 'just green pond scum'. To encourage continued engagement a photo competition was launched. Entitled 'Manchester's best algal biofilm' (a biofilm is a community of algal cells that grow from a moist surface). Entries were uploaded to a dedicated Flickr™ photo-sharing group. Details of the competition were printed on algae-themed postcards. The winning photograph received a Giant Microbe™ (Giantmicrobes Inc, Delaware, USA) alga soft toy. Participants at the event were asked to write on a Post-It™ note one new fact or one point of interest. These were then posted near the exit door, and collated for feedback, and where appropriate 'fascinating facts' and comments being noted for incorporation into the teaching resource.



Figure 50 - Examples of models made during the workshop 'The Good, the Bad and the Algae' using the modelling clay provided

There were several aspects of the event that people enjoyed. Being in a University laboratory, listening to (brief) formal presentations, wearing a white laboratory coat and using high quality microscopes provided a sense of 'real science'. The majority of family groups were unwilling to leave the laboratory until they had identified all nine of the unknown species. The modelling activity was successful – but not essential (because of the popularity of the microscopes) with almost all children leaving the session with a model. In addition, the use of the identification key enabled some improvements/developments to be made to the school resource, with some of the dichotomous choices moved to allow for an easier flow. Language (specifically scientific terminology) was also simplified. Images of each alga were inserted into the key (next to the name at the end of each identification) to support self-assessment of success.

The day was tiring for the demonstrators involved, but deemed successful. Having the sessions in a working laboratory provided a great opportunity for those participating, but extra care had to be taken to ensure safe operation. A low bench was available for wheelchair-bound participants. Some children were so small that for health and safety reasons they were unable to wear a university lab coat (these were standard adult sizes, posing a trip hazard to small children). Children's lab coats will be purchased for future events.

### **6.1.3 - Public engagement event: high throughput reduced hands-on activity**

The Big Bang Science Fair is the largest science fair in the UK, focusing on science and engineering. It runs annually and is attended by upwards of 56,000 visitors over a three-day period (The Big Bang, 2012). The audience is primarily groups of schools students (for two of the three days) and families (for one day). The floor plan provides each exhibitor with an allocated space, which students can

visit at any time, with interaction not being time-constrained. The fair is split into zones, keeping similar subjects together. 'The Good, the Bad and the Algae' was modified to best engage this high-throughput audience, and was delivered by the Society for General Microbiology, the largest learned microbiology society in Europe (SGM, n.d.-b), located in the Body Zone', along with the majority of life sciences exhibitors.

The move from a controlled laboratory setting to a 'drop-in' activity provided new challenges, although the intended aims were similar to those of the MMU event. Based on previous Big Bang experiences, it was highly likely that large groups of students (from the same school) would take part in the activity at the same time. Previously, the activity had been run as a workshop, with a defined audience size. Here, students were free to approach the activity as and when they wished, thus, there was no time to 'close' the activity to reset. The smaller space (4x4m) available at the festival, compared to the original laboratory setting (21x9m) limited the amount of 'working' space available. Microscopes with an attached LCD screen (Celestron LCD Digital Microscope 44345) allowed for large numbers of students to see the algal cultures at the same time. The number of algal cultures was reduced from nine to six. Students (and adults) were typically drawn to the microscopes, and were excited to see motile microorganisms on display. Students were encouraged to use the microscopes carefully, under direct supervision of the demonstrator (they were not allowed to handle the glass microscope slides). Since the interaction time per visitor was less than in the laboratory workshop setting, the dialogue between student and demonstrator was inevitably more focused, beginning with simple questions such as 'Do you know what algae are?' Emphasis was placed on getting 'cool facts' across to students, in particular the applications of algae in the 'real world'.

It was obvious that all participants were fascinated with the (small) size and (high) number of microorganisms present in samples, but this was difficult to conceptualise and explain. In science, and particularly microbiology scale is easier understand if comparisons are made to something larger (Nature Reviews Microbiology, , 2011), encouraging the engagement of audience imagination, an essential element to successful science communication (Bray *et al.*, 2011). Colleagues at the British Phycological Society 2012 winter meeting (Jane Lewis, personal communication, January 2012) had suggested the following scale-up activity. Thus, a perspex box (60cm x 60cm x 120cm) was constructed, representing a 200 times scale up from half a drop of water (10 $\mu$ l). Visitors made Plasticine® (Flair Leisure Products Plc., Surrey UK) models of their favourite alga (having already viewed some under the microscope) using a 2cm<sup>2</sup> template. The models were suspended in the box using fishing wire (Figure 51), to highlight how many algae could fit into a drop of water. Visitors were told on average there were around 200 algae in every half drop of water in an average summer pond (Jane Lewis, personal communication, January 2012). A second addition was the introduction of 3D anaglyphs (courtesy of Chris Carter, British Phycological Society member). These were images of different algae projected on to a 42 inch LCD which, when viewed using 3D red cyan glasses, could be seen in 3D. These images provided a useful attractant to the stand drawing participants in.

In order to gauge attendance and engagement, visitors received a 'The Good, The Bad and The Algae' sticker. The number of the stickers given out was recorded. Over the three days of the event, more than 2,200 people participated. The total number of Plasticine® models was 840, and 303 post-it notes were collected.

Defining and testing an outcome for science learning in an informal setting has always been difficult (Bell *et al.*, 2009) and it has been particularly noted that good



Figure 51 - The perspex box, used to illustrate half a drop of water, magnified x200. Hanging inside are Plasticine® algae models made by participants at the Big Bang event

evaluation should provide an insight into the impact of the activities on young students (DCSF, 2009). It was noted on the day by the demonstration team that participants found the activity intriguing and exciting, with a general theme of amazement when they were able to visualise the algae under the microscope. So as not to interfere with activities, post-it notes (written by participants, predominantly students, after completion of the activity) were again utilised to record key observations. These were analysed post-event and consequently divided into four categories:

- 'scientific' (factual), e.g. 'today ive learnt that algae is not a plant but a microorganism' (*sic.*) or 'algae is living and can move'
- 'application', e.g. 'its in ice cream and tooth paste'(*sic.*)
- 'visual' – e.g. 'the colour of algae is green'
- 'other' - e.g. 'algae names are hard to pronounce' and 'I think algae is excellent' (*sic.*).

Verbal feedback during the event was positive, particularly from school teachers, parents and organisers of other events running parallel at the Big Bang. Of particular note was accessibility of the activity for all, with varying levels of skill being required, from low-difficulty (manual - making the models) to more challenging (manipulative and intellectual - using the microscopes and completing identification of a microorganism).

Of the 303 Post-It™ notes collected 51.2% were of a scientific nature whilst 31% referenced an application. A smaller proportion of 14.8% was categorised as 'other' whilst only 3% noted a visual impact. Thus it might be inferred that some scientific impact or application had been noted by over 80% of the participants. Verbal feedback on the day supported the notion that learning was taking place.

Retention of the information post-event was not considered. No mechanism was in place to carry this out, but it has been shown that an activity with a 'wow' factor (like the motile, algal species) contributes towards making an event memorable (Palmer, 2009). The Society for General Microbiology is now using the entire event package as a mobile activity for other science festivals.

#### **6.1.4 - Conclusion**

The focus of the events were primarily directed towards topic content and development of ideas on how to best present to the targeted audience. Evaluation methodologies were not considered during development, although several formative evaluations were carried out using students, teachers and the general public, thus, the activities lacked a full summative evaluation. Therefore, it is not possible to comment on the impact the activities may have had, but the aim was to bring an element of microbiology to the wider public audience, and inspire the participants to consider the use of algae as an example of a microorganism, and their importance, aims which the demonstration team agreed had been achieved, evidenced by participant interaction and verbal feedback. It has been suggested (Bell *et al.*, 2009) that feelings of excitement, delight, awe and surprise can be used to monitor success of a delivery via participant pleasure, and that emotional responses such as these may hold a long lasting value, though this evidence is somewhat anecdotal (Royal Society, 2004, Smith, 1012). The event was successful in this respect, with the majority of participants exhibiting these types of emotional responses. Although it is always a good idea to provide a full and rounded summative evaluation, many of the measures commonly used to do this in a public engagement activity such as questionnaires, interviews and focus groups (Bowater and Yeoman, 2013) are not practicable in the settings in which the activities were delivered (i.e. in a time-restricted workshop and in a science



fair) .The Post-It™ notes allowed the organisers to gauge key messages regarding the participant's enjoyment and learning.

The success of both iterations of 'The Good The Bad and The Algae', demonstrates that it is possible to transform a simple school activity into an exciting and effective public engagement activity. School practical classes and public engagement activities both require a specific learning-based outcome; and both should be interactive, interesting, stimulating and open-ended (Millar, 2004) for the participant. The work described in this chapter shows that by removing the limitations of a science laboratory, a school science activity can be opened up, developed into an engaging interactive event. Equipment (such as LCD microscopes) and techniques (use of 3D images on a television monitor or investigating scale using Plasticine® models) not typically found in the classroom can be used to encourage situational interest. There is considerable potential for those interested in developing an activity for public engagement to seek inspiration from successful practices in the school science laboratory.

## **Section 5**

## **Chapter 7 – Conclusion**

## **7.1 Conclusions and future work**

This work described in this thesis successfully achieved the aim to develop, produce and evaluate an educational resource containing novel activities using microorganisms. The need for such resources is recognised by organizations such as ASE, CLEAPPs, NCBE, learned societies, examining bodies and peer-reviewed journals (such as School Science Review), evidenced by their plentiful efforts to support practical science education (for example NCBE, 2012, ASE, 2001, Redfern *et al.*, in press). Currently, literature on how learned societies deliver this support is absent; although anecdotal evidence suggests a lack a coherent approach, potentially limited reach (targeted at society members, negating the wider teaching community) and follow the 'rationale of a scientist' (Hurd, 1969) (owing to their scientifically-centric nature) (Chapter 2). A survey of learned societies by an umbrella organisation such as the Society of Biology addressing how they develop and deliver such resources to teachers would be of benefit to the literature.

A survey of UK science teachers (n=248) investigated the current state of practical microbiology in secondary schools (Chapter 1 – Part 2). It suggests that teachers find time, equipment, finance, health and safety and relevance to the curriculum to be barriers to microbiology activity, despite the considerable contribution of microbiology to the National Curriculum and other UK teaching specifications that were identified through this work (Chapter 1 – Part 1). The review of pedagogic literature presented in Chapter 2 suggests science education should move away from content-based science and focus more on the nature of science (for example, learning by inquiry, evaluating methods, understanding evidence and scientific debate). Despite the requirements of the NOS, the work carried out in this thesis has noted a tendency to focus on specific subject knowledge. Although the ability

for microbiology to support NOS themes is discussed in Chapter 2, further work is required to evidence this.

In response to this, a new practical activity resource was developed (Chapter 4). The resource contains five well-tested activities, covering a range of curricula links and types of inquiry. Formative evaluation was undertaken using three different audiences with over 100 participants in four trials. Feedback from this formative evaluation was essential in preparing the resource to be fit-for-purpose and revealed an exciting and adaptable extension in the form of a science communication event (Chapter 6 and Redfern *et al.*, 2013b).

After publication (January 2012) a summative evaluation was undertaken which revealed the resource was being used as intended and emphasises the value of the formative evaluation. Despite links to science curricula being highlighted in each of the teacher guides, lack of curriculum support for the activities was given as a barrier.

Currently, no standard exists for developing a new resource of this type. It is suggested that the processes undertaken in this work be used as a template for the development of future resources. This should comprise of:

- An investigation of the topic with reference to its current status in school science and its links to curricula content/level.
- The content should enable the audience (a teacher) to deliver the activities as they see fit (using their own pedagogical knowledge) and should not dictate pedagogic strategies.
- Information in the resource should support a teacher's pedagogic content knowledge to ensure the teacher is comfortable delivering the activity. This is of particular benefit to teachers who are not subject specialists.

- Themes linking the resource to teaching specifications and the nature of science should be clearly described early in the resource.
- Dedicated guides for the intended audiences (teachers, technicians and students) should be included.
- To ensure that activities remain reliable/repeatable as intended, printed material should not be modified by the teacher.
- Where possible, the resource should be constructed in 'kit format' with teachers being able to source all relevant consumables/cultures from a single location.
- Formative evaluation should be performed using a range of different audiences. Focus should be given to comments made by teachers. Student learning should not be the focus of evaluation. Outcomes of formative evaluation should be considered alongside relevant literature and changes made where necessary.
- A publication and dissemination strategy should be identified. Where possible, dissemination should not be restricted to membership of an organisation. If cross-discipline themes have been identified, this should be highlighted.
- After publication, a summative evaluation should be carried out. This should assess the use of the resource after a given time (between 6 and 12 months post-publication – Chapter 5). Additionally, reminders should be given at specified times of the year (to enable inclusion in planning).

In addition to the work described in this thesis, a second practical activity resource has been developed. 'Viruses: a resource for post-16 teachers' is aimed at post-16

biology education in the UK. It focuses on the use of phage and molecular biology to convey topics of infection, disinfection and diagnosis. The resource was developed using the same strategy; assessing curricula requirements and undertaking formative evaluation. The development was facilitated by the prior knowledge gained from the algae resource. The virus resource has a dedicated table at page three whereby links to the curricula and nature of science are detailed. A focus has been given to further enhancing teacher PCK by including more detailed descriptions of the science, strengthened by various case studies of how the content links to the real world (for example small pox as a successful vaccination scheme). At the time of writing, the resource has undergone formative evaluation and is currently undergoing preparation for publication in spring 2014.

It would be of benefit to the teaching community if organizations such as learned societies who wish to promote their subjects in schools agreed a strategy for educational resources in order to maximise value and impact. Additionally, this will enhance the relationship between learned societies (and therefore professional scientists) and teachers (Redfern *et al.*, 2013a).

Hopefully, an increase in the number of well-tested educational support materials for teachers with regards to microbiology will result in more microbiologists and researchers in years to come. Thus, professional microbiologists should be prepared to play a greater role in the promotion and delivery of their subject in schools to ensure its health for the future.

## References

Education Act 2002 (c.32) England: HMSO.

Abd-El-Khalick, F. (2012) 'Teaching With and About Nature of Science, and Science Teacher Knowledge Domains.' *Science & Education*, 2012/08/04, pp. 1-21.

Abd-El-Khalick, F. and Lederman, N. G. (2000) 'Improving science teachers' conceptions of nature of science: a critical review of the literature.' *International Journal of Science Education*, 22(7), 2000/07/01, pp. 665-701.

Abrahams, M. V. (1993) 'Bioluminescence in Dinoflagellates: A Test of the Burgular Alarm Hypothesis.' *Ecology*, 74(1) pp. 258-260.

Ahmadjian, V. (1960) 'The Lichen Association.' *The Bryologist*, 63(4) pp. 250-254.

Alberts, B. (2013) 'Prioritizing Science Education.' *Science*, 340(6130), April 19, 2013, p. 249.

Amos, S. and Boohan, R. (2002) 'Introduction.' In Amos, S. and Boohan, R. (eds.) *Teaching Science in Secondary Schools: Perspective on Practice*. London: Routledge, pp. 3-22.

Andersen, J. H., Schlter, L. and Ürtebjerg, G. (2006) 'Coastal eutrophication: recent developments in definitions and implications for monitoring strategies.' *Journal of Plankton Research*, 28(7), July 2006, pp. 621-628.

Anderson, D. (1994) 'Red tides.' *Scientific American*, 271(2) pp. 62-68.

Ando, K. (2004). Global Taxonomy Initiative (GTI) and Taxonomy. *WFCC Newsletter*, 38, 50-53.

Appleton, K. (2002) 'Science Activities That Work: Perceptions of Primary School Teachers.' *Research in Science Education*, 32(3), 2002/09/01, pp. 393-410.

Appleton, K. and Kindt, I. (2002) 'Beginning Elementary Teachers' Development as Teachers of Science.' *Journal of Science Teacher Education*, 13(1), 2002/02/01, pp. 43-61.

APS. (n.d.) *Submitting a Resource to the Archive : Partner organisations*. American Physiological Society. [Online] [Accessed on 04/10/2013]  
<http://www.apsarchive.org/partners.cfm>

AQA. (2007) *GCE Biology (2410) 2009 onwards*. Manchester: Assessment and Qualification Alliance.

AQA (2010) *GCSE Sciences - subject content book. Draft specifications*. AQA.

AQA. (2012a) *GCSE Science A 4405*. Manchester: AQA.

AQA. (2012b) *GCSE Biology specification*. Manchester.

ASE (2001) *Topics in Safety*. 3rd ed., Cambridge: ASE.

ASM. (n.d.) *Submit an activity*. ASM. [Online] [Accessed on 30/07/13]  
<http://www.asm.org/index.php/educators/k-12-classroom-activities/23-education/k-12-teachers/8218-submit-an-activity>

- Assinder. (2011). How the mushroom got its spots and other stories. *Microbiology Today*, 38, 38.
- Baker, N. and Verran, J. (2004) 'Science and society - The future of microbiology laboratory classes - wet, dry or in combination?' *Nature Reviews Microbiology*, 2(4), Apr, pp. 338-342.
- Bassler, B. (2011) 'Letter to the editor.' *Journal of microbiology & biology education*, 12(1), May 2011, p. 2.
- BatorÈu, M. C. C. (2005) 'Risk of human exposure to paralytic toxins of algal origin.' *Environmental Toxicology and Pharmacology*, 19(3) pp. 401-406.
- BBC. (2011) *France: Wild boars dead amid algae on Brittany coast*. BBC. [Online] [Accessed on 17/08/2011] <http://www.bbc.co.uk/news/world-europe-14324094>
- Bell-Pedersen, D., Cassone, V. M., Earnest, D. J., Golden, S. S., Hardin, P. E., Thomas, T. L. and Zoran, M. J. (2005) 'Circadian rhythms from multiple oscillators: lessons from diverse organisms.' *Nat Rev Genet*, 6(7) pp. 544-556.
- Bell, P., Lewenstein, B., Shouse, A. W. and Feder, M. A. (2009) *Learning Science in Informal Environments: People, Places, and Pursuits*. The National Academies Press.
- Bennett (1999) "'The Branches into Which Bacteriology Is Now Ramifying" Revisited.' *Yale Journal of Biology and Medicine*, 72(5) pp. 303-311.
- BERA. (2011). Ethical guidelines for educational research. London: British Educational Research Association.
- Berry, A. (2012) 'Pedagogical content knowledge (PCK): a summary review of PCK in the context of science education research.' In Oversby, J. (ed.) *ASE Guide to Research in Science Education*. Hatfield: ASE, pp. 29-43.
- Bliss, J., Askew, M. and Macrae, S. (1996) 'Effective Teaching and Learning: scaffolding revisited.' *Oxford Review of Education*, 22(1), 1996/03/01, pp. 37-61.
- Bonderup Dohn, N. (2011) 'Situational interest of high school students who visit an aquarium.' *Science Education*, 95(2) pp. 337-357.
- Boniec., M. L., Gras-Velázquez., À. and Joyce., A. (2011). Impact of data loggers on science teaching and learning. In Joyce, A. (Ed.). Brussels: European Schoolnet
- Bowater, L. and Yeoman, K. (2013) *Science communication A practical guide for scientists*. West Sussex: Wiley-Blackwell.
- Bray, B., France, B. and Gilbert, J. K. (2011) 'Identifying the Essential Elements of Effective Science Communication: What do the experts say?' *International Journal of Science Education, Part B*, 2(1), 2012/03/01, pp. 23-41.
- Bruner, J. S. (1986) *Actual Minds, Possible Worlds*. Harvard University Press.
- Bunn, T. (2011) *Practical Biofuel Activities for School Engagement and Outreach*. Swindon: BBSRC.



- Burdass. (2010). SGM shines brightly at the Big Bang *Microbiology Today*, 37, 3.
- Burdass, D., Grainger, J. and Hurst, J. (2006) *Basic Practical Microbiology*. Reading: Society for General Microbiology.
- Buxeda, R. J. and Moore, D. A. (2009) 'Expanding a Learner-Centered Environment Using Group Reports and Constructivist Portfolios.' *Journal of Microbiology & Biology Education*, 2
- Caine, J. (2011) 'Taxonomy in trouble.' *The Biologist*, 58(3), September 2011, pp. 16-17.
- Cakir, M. (2008) 'Constructivist Approaches to Learning in Science and Their Implications for Science Pedagogy: A Literature.' *International Journal of Environmental & Science Education*, 3(3)
- Cardozo, K. H. M., Guaratini, T., Barros, M. P., Falcão, V. R., Tonon, A. P., Lopes, N. P., Campos, S., Torres, M. A., Souza, A. O., Colepicolo, P. and Pinto, E. (2006) 'Metabolites from algae with economical impact.' *Comparative Biochemistry and Physiology Part C: Toxicology & Pharmacology*, 146(1-2) pp. 60-78.
- Carlsen, W. S. (1999) 'Domains of teacher knowledge.' In Gess-Newsome, J. and Lederman, N. G. (eds.) *Examining pedagogical content knowledge the constructs and its implications for science education* Dordrecht: Kluwer Academic Publishers,
- CaSE. (2007a) *Opinion Forum on Secondary Science Education: Accompanying Document*. London: Campaign for Science and Engineering.
- CaSE. (2007b) *Secondary Science Education*. London: CaSE.
- CCEA. (2012a) *CCEA GCE Specification in Biology*. Belfast: CCEA.
- CCEA. (2012b) *CCEA GCSE Specification in Science (Single Award)*. Belfast: CCEA.
- CCEA. (2012c) *CCEA GCSE Specification in Biology*. 3rd ed. Belfast: CCEA.
- (n.d.) *Science Statutory Requirements*. Cmnd. CCEA (CCEA Report).
- Chalmers, A. F. (1982) *What is this thing called science?: an assessment of the nature and status of science and its methods*. University of Queensland Press.
- Chang, A. (2011) 'A Retrospective Look at 20 Years of ASM Education Programs (1990-2010) and a Prospective Look at the Next 20 Years (2011--2030).' *Journal of microbiology & biology education*, 12(1), May 2011, pp. 8-12.
- Chinn, C. A. and Brewer, W. F. (1993) 'The Role of Anomalous Data in Knowledge Acquisition: A Theoretical Framework and Implications for Science Instruction.' *Review of Educational Research*, 63(1) pp. 1-49.
- CIE. (2010) *CIE Cambridge IGCSE Biology Specification*. Cambridge: University of Cambridge International Examinations.
- Clement, J. (1982) 'Students preconceptions in introductory mechanics.' *American Journal of physics*, 50(1) pp. 66-71.

Coffield, F., Moseley, D., Hall, E. and Ecclestone, K. (2004) *Should we be using Learning Styles? What research has to say to practice*. London: Learning and Skills Research Centre.

Cohen (2011) *Research Methods in Education*. 7th ed., Oxon: Routledge.

Cohen, B. (1994). Dental or medical alginate impression material. In patent, U. S. (Ed.) (Vol. 5,417,750). United States Essential Dental Systems, Inc.,.

Confrey, J. (1990) 'Chapter 8: What Constructivism Implies for Teaching.' *Journal for Research in Mathematics Education. Monograph*, 4(ArticleType: research-article / Issue Title: Constructivist Views on the Teaching and Learning of Mathematics / Full publication date: 1990 / Copyright –© 1990 National Council of Teachers of Mathematics) pp. 107-210.

Cussatlegras, A.-S. (2007) 'Variability in the bioluminescence response of the dinoflagellate *Pyrocystis lunula*.' *Journal of Experimental Marine Biology and Ecology*, 343(1) pp. 74-81.

DCSF (2009) *Does it work? Better evaluation: Better STEM*. Department for Children Schools and Families.

de Jong, T., Linn, M. C. and Zacharia, Z. C. (2013) 'Physical and Virtual Laboratories in Science and Engineering Education.' *Science*, 340(6130), April 19, 2013, pp. 305-308.

Deng, Z. (2007) 'Knowing the subject matter of a secondary school science subject.' *Journal of Curriculum Studies*, 39(5) pp. 503-535.

Dept for Education and Skills. (2006) *STEM Programme Report*. Cmnd. London: Department for Education and Skills (DES Report).

Department for Children, E., Lifelong Learning and Skills. (2008) *Science in the National Curriculum for Wales* Cmnd. Cardiff: (DfCELLS Report).

Department for Education. (2011) *Teachers' Standards 2012 Onwards*. Cmnd. London: DfE, (DfE Report).

DfE. (2012) *Review of the National Curriculum in England FAQs*. London: [Online] [Accessed <https://www.education.gov.uk/schools/teachingandlearning/curriculum/nationalcurriculum2014/nationalcurriculum/a00201091/faqs-review-of-the-national-curriculum-in-england#faq2>]

Department for Education. (2013a) *School workforce in England: November 2012*. Cmnd. London: DfE (DfE Report).

Department for Education. (2013b) *National Curriculum Consultation Framework*. Cmnd. London: DfE (DfE Report).

Department for Education. (2013c) *Science programme of study for Key Stage 4*. Cmnd. London: (DfE Report).

Dorman. (2006) *Review of Microbial Science Research*. BBSRC.

Downs (2010) 'Biology and Education.' *Society of Biology*,

- Drace, K., Couch, B. and Keeling, P. J. (2012) 'Increasing Student Understanding of Microscope Optics by Building and Testing the Limits of Simple, Hand-Made Model Microscopes.' *Journal of Microbiology and Biology Education*, 13(1)
- Driver, R., Leach, J., Millar, R. and Scott, P. (1996) *Young people's images of science*. London: Open University Press.
- Driver, R., Asoko, H., Leach, J., Scott, P. and Mortimer, E. (1994) 'Constructing Scientific Knowledge in the Classroom.' *Educational Researcher*, 23(7), October 1, 1994, pp. 5-12.
- Dunn, R., Beaudry, J. and Klavas, A. (2002) 'Survey of Research on Learning Styles.' *California Journal of Science Education*, 2(2)
- Duschl, R. A., Schweingruber, H. A. and Shouse, A. W. (2007) *Taking Science to School: Learning and Teaching Science in Grades K-8*. The National Academies Press.
- Eastwood, K. (2000) 'Microbiology in schools: the key to public education?' *Microbiology Australia*, 21(3), July 2000, p. 4.
- Edexcel. (2008) *BTEC Edexcel Level 3 BTEC Nationals in Applied Science*. Mansfield: Edexcel.
- Edexcel. (2010) *GCE Biology Specification*. Pearson.
- Edexcel. (2011) *Edexcel GCSE Biology Accredited Specification*. Mansfield: Edexcel.
- Edexcel. (2013) *Edexcel GCSE Sciences Accredited Specification*. Harlow: Edexcel.
- Edexcel. (n.d.) *BTEC getting started - Learners and parents* Pearson Education Ltd. [Online] [Accessed on 10/06/2013] <http://www.edexcel.com/btec/New-to-btec/learners-parents/Pages/default.aspx>
- Editorial (2011) 'Microbiology by numbers.' *Nat Rev Micro*, 9(9) pp. 628-628.
- Editorial (2012) 'The next generation.' *Nat Rev Micro*, 10(3) pp. 157-157.
- Eldridge (2004) 'A novel approach to photosynthesis practicals.' *School Science Review*, 85(312) p. 9.
- Engohang-Ndong, J. and Gerbig, D. G. (2013) 'Making the Basic Microbiology Laboratory an Exciting and Engaging Experience.' *Journal of Microbiology & biology education*, 14(1) pp. 125 - 126.
- Erduran, S. (2012) 'The role of dialogue and argumentation.' In Oversby, J. (ed.) *ASE Guide to Research in Science Education*. Hatfield: The Association for Science Education, pp. 106 -116.
- EU. (1990). 90/679/EEC - Protection of workers from risks related to exposure to biological agents at work. In Official Journal of the European Communities (Ed.), L 374/1.
- Fischer, C. (2011) 'changing the Science Education Paradigm: From teaching Facts to Engaging the Intellect.' *Yale Journal of Biology and Medicine*, 84(3) pp. 247-251.
- Fischer, M. (2009) *Algae Biofuel*. YouTube. [Online] [Accessed <http://www.youtube.com/user/mfischer1000#p/u/3/h7EavnFqDfU>

Flagg (1990) *Formative Evaluation for Educational Technologies*. London: Lawrence Erlbaum Associates.

Folin. (n.d.) *Hay infusion identification key*. [Online] [Accessed <http://filebox.vt.edu/users/ifollin/Electronic%20Portfolio/PhotosandStudentWork.htm>]

Friedrichsen, P. and Dana, T. M. (2005) 'Substantive-level theory of highly regarded secondary biology teachers' science teaching orientations.' *Journal of Research in Science Teaching*, 42(2) pp. 218-244.

Fry, Grainger, Hurst, Grainger, Tranter, Wymer and Burdass (2008) *Practical Microbiology for Secondary Schools*. Reading: SGM.

Funchess. (1947) *Experiments on pond fertilization*. Auburn, Alabama: Alabama Polytechnic Institute.

Garner, R. (2010) 'Triple science and maths teachers, says report.' *The Independent*.

Department for Education. (2013) *Building evidence into education*. Cmnd. London: DFE (Goldacre, B. Report).

Gorard, S. and Smith, E. (2006) 'Combining Numbers with Narratives.' *Evaluation & Research in Education*, 19(2), 2006/05/15, pp. 59-62.

Gregory, E. (2011) 'Redesigning introductory biology: A proposal.' *Journal of microbiology & biology education*, 12(1), May 2011, pp. 13-17.

Griffin, J. (2002) 'Look! No Hands! .' In Sandra Amos and Richard Boohan (eds.) *Teaching Science in Secondary Schools*. London: RoutledgeFalmer,

Grosslight, L., Unger, C., Jay, E. and Smith, C. L. (1991) 'Understanding models and their use in science: Conceptions of middle and high school students and experts.' *Journal of Research in Science Teaching*, 28(9) pp. 799-822.

Grossman, P. L. (1990) *The Making of a Teacher: Teacher Knowledge and Teacher Education*. Teachers College Press, Teachers College, Columbia University.

Groves, J. (2011) 'Monster Mash proves highly infectious.' *Times Higher Education Supplement*. 27th October 2011. pp. 22-23

Guesne, E. (1985) 'Light.' In Rosalind Driver, Edith Guesne and Tiberghien, A. (eds.) *Children's Ideas in Science*. Milton Keynes: Open University Press, pp. 10 - 32.

Hagedorn. (2010) *Types of identification keys*. Paris. Nimis:

Handelsman, J. (2002, April 2002). Microbiology as a change agent in science education. *ASM News*, 68.

Hargreaves, A. (1994) *Changing Teachers, Changing Times: Teachers' Work and Culture in the Postmodern Age*. Continuum.

Harlen, W. (1997) 'Primary teachers' understanding in science and its impact in the classroom.' *Research in Science Education*, 27(3), 1997/09/01, pp. 323-337.

- Harlen, W. (2010) *Principles and big ideas of science education*. Association for Science Education.
- Hashweh, M. Z. (1987) 'Effects of subject-matter knowledge in the teaching of biology and physics.' *Teaching and Teacher Education*, 3(2) pp. 109-120.
- Hastings, F. a. (1972) 'Bioluminescence: Mechanism and Mode of Control of Scintillon Activity.' *Proceedings of the National Academy of Sciences of the United States of America*, 69(3) pp. 690-693.
- Herron, M. D. (1969) 'Nature of science: Panacea or Pandora's box.' *Journal of Research in Science Teaching*, 6(1) pp. 105-107.
- Hiebert. (n.d.) *Algae Dichotomous Key -- GK12 Fellow*. [Online] [Accessed on 17/08/2011] <http://www.seapyramid.net/rt/writing-a-dichotomous-key/>
- Hoek, V. D. (1995) *Algae - An introduction to phycology*. Cambridge: Cambridge University Press.
- Hofstein, A. and Lunetta, V. N. (2004) 'The laboratory in science education: Foundations for the twenty-first century.' *Science Education*, 88(1) pp. 28-54.
- Holbrook, J. and Rannikmae, M. (2007) 'The Nature of Science Education for Enhancing Scientific Literacy.' *International Journal of Science Education*, 29(11), 2007/09/03, pp. 1347-1362.
- Howson, C. (2000) *Hume's Problem : Induction and the Justification of Belief: Induction and the Justification of Belief*. Clarendon Press.
- Hudnell, H. K. (2010) 'The state of U.S. freshwater harmful algal blooms assessments, policy and legislation.' *Toxicon*, 55(5) pp. 1024-1034.
- Hurd, P. D. (1969) *New directions in teaching secondary school science*. Rand McNally.
- Hurd, P. D. (2002) 'Modernizing science education.' *Journal of Research in Science Teaching*, 39(1) pp. 3-9.
- Iseki, M. (2002) 'A blue-light-activated adenylyl cyclase mediates photoavoidance in *Euglena gracilis*.' *Nature*, 415(6875) pp. 1047-1051.
- Jenkins, E. W. (2000) 'Constructivism in School Science Education: Powerful Model or the Most Dangerous Intellectual Tendency?' *Science & Education*, 9(6), 2000/11/01, pp. 599-610.
- Jenway. (n.d.). Spectrophotometry of chlorophylls a and b: Bibby Scientific.
- Kim, M. and Chin, C. (2011) 'Pre-service teachers' views on practical work with inquiry orientation in textbook-oriented science classrooms.' *International Journal of Environmental and Science Education*, 6(1) pp. 23-37.
- Kind (2012) 'Science teachers' knowledge of science.' In Oversby, J. (ed.) *ASE Guide to Research in Science Education*. Hatfield: Association for Science Education, pp. 58 - 68.
- Kirschner, P. (1992) 'Epistemology, practical work and Academic skills in science education.' *Science & Education*, 1(3), 1992/09/01, pp. 273-299.

- Kubo, K. (1970). Manufacturing aqueous slurry of hydrous calcium silicate and products thereof. In United States Patent Office (Ed.), *Google Patents* (Vol. US3501324 A). United States: Osaka Packing.
- Kuhn, T. S. (1957) *The Copernican Revolution: Planetary Astronomy in the Development of Western Thought*. Harvard University Press.
- Kuhn, T. S. (1996) *The Structure of Scientific Revolutions*. University of Chicago Press.
- Lapota, D. (2007) 'The use of bioluminescent dinoflagellates as an environmental risk assessment tool.' *Marine Pollution Bulletin*, 54(12) pp. 1857-1867.
- Lederman, N. G. (1992) 'Students' and teachers' conceptions of the nature of science: A review of the research.' *Journal of Research in Science Teaching*, 29(4) pp. 331-359.
- Lederman, N. G., Gess-Newsome, J. and Latz, M. S. (1994) 'The nature and development of preservice science teachers' conceptions of subject matter and pedagogy.' *Journal of Research in Science Teaching*, 31(2) pp. 129-146.
- Leech, N. and Onwuegbuzie, A. (2009) 'A typology of mixed methods research designs.' *Quality & Quantity*, 43(2), 2009/03/01, pp. 265-275.
- Lock, R. (2011) 'The Future of Biology Teachers.' *The Biologist*, 58(3) pp. 38-40.
- Lombrozo, T., Thanukos, A. and Weisberg, M. (2008) 'The Importance of Understanding the Nature of Science for Accepting Evolution.' *Evolution: Education and Outreach*, 1(3), 2008/07/01, pp. 290-298.
- Lord, T. (1997) 'A comparison between traditional and constructivist teaching in college biology.' *Innovative Higher Education*, 21(3), 1997/03/01, pp. 197-216.
- Luciano, C. S., Young, M. W. and Patterson, R. R. (2009) *Bacteriophage: A Model System for Active Learning*. Vol. 3.
- Lynch, R. V. (1981) *Patterns of Bioluminescence in the Oceans*. Washington D.C.: Naval Research Laboratory.
- Lyon, E. G. (2013) 'What about language while equitably assessing science?: Case studies of preservice teachers' evolving expertise.' *Teaching and Teacher Education*, 32(0) pp. 1-11.
- Magnusson, S., Krajcik, J. S. and Boriko, H. (1999) *Nature, sources, and development of pedagogical content knowledge for science teaching*. dordrecht: Kluwer Academic Publishers.
- Maloy, S. and Schaechter, M. (2006) 'The era of microbiology: a Golden Phoenix.' *International Microbiology*, 9(1), Mar, pp. 1-7.
- Marbach-Ad, G., McGinnis, J. R., Dai, A. H., Pease, R., Schalk, K. A. and Benson, S. (2009) 'Promoting Science for All by Way of Student Interest in a Transformative Undergraduate Microbiology Laboratory for Nonmajors.' *Journal of Microbiology & Biology Education*, 10

- Martin, Mullis, Gonzalez, Gregory, Smith, Chrostowski, Garden and O'Connor (2000) *TIMMS 1999 International Science Report*. International Study Center Lynch School of Education Boston College.
- Matthews, M. (1992) 'Constructivism and empiricism: An incomplete divorce.' *Research in Science Education*, 22(1), 1992/12/01, pp. 299-307.
- McComas, W. and Olson, J. (2002) 'The Nature of Science in International Science Education Standards Documents.' In McComas, W. (ed.) *The Nature of Science in Science Education*. Vol. 5. Springer Netherlands, pp. 41-52.
- McComas, W., Almazroa, H. and Clough, M. (1998) 'The Nature of Science in Science Education: An Introduction.' *Science & Education*, 7(6), 1998/11/01, pp. 511-532.
- Meyers, S. (1990) 'Industrial explosives - a brief history of their development and use.' *Journal of Hazardous Materials*, 23(2) pp. 183-201.
- Millar. (2004) 'The role of practical work in the teaching and learning of science'. In *High School Science Laboratories: Role and Vision*. National Academy of Sciences, Washington, DC: The University of York,
- Millar, R. (1989) 'Constructive criticisms.' *International Journal of Science Education*, 11(5) pp. 587-596.
- Millar, R. (2009) *Analysing practical activities to assess and improve effectiveness: The Practical Activity Analysis Inventory (PAAI)* York: University of York.
- Miller, A. (2011) 'The Use of Current Events as Assessment Tools.' *Journal of microbiology & biology education*, 12(1), May 2011, pp. 59-60.
- Miller, J. (1983) 'Scientific Literacy: A Conceptual and Empirical Review.' *Daedalus*, 112(2) pp. 29-48.
- National Committee on Science Education Standards and Assessment (1996) *National Science Education Standards*. National Academies Press.
- NCBE. (2012) *Microbial fuel cell*. Reading: NCBE. [Online] [Accessed on 10/07/12] <http://www.ncbe.reading.ac.uk/NCBE/MATERIALS/METABOLISM/fuelcell.html>
- Niess (2005) 'Preparing teachers to teach science and mathematics with technology: Developing a technology pedagogical content knowledge.' *Teaching and Teacher Education*, 21(5) pp. 509-523.
- Nola, R. and Irzik, G. (2005) 'Naive Inductivism as a Methodology in Science.' In *Philosophy, Science, Education and Culture*. Vol. 28. Springer Netherlands, pp. 207-230.
- Nott, M. and Wellington, J. (1996) 'When the black box springs open: practical work in schools and the nature of science.' *International Journal of Science Education*, 18(7), 1996/10/01, pp. 807-818.
- Ntefidou, M. (2003) 'Photoactivated Adenylyl Cyclase Controls Phototaxis in the Flagellate *Euglena gracilis*.' *Plant Physiology*, 133(4), December 1, 2003, pp. 1517-1521.
- OCR. (2008) *AS/A Level GCE Biology specification*. OCR.

- OCR. (2012a) *GCSE Science A Accredited Specification*. Coventry: OCR.
- OCR. (2012b) *GCSE Biology A Accredited Specification* Coventry: OCR.
- OCR. (2012c) *GCSE Science A Additional Accredited Specification*. Coventry: OCR.
- OECD. (2009) *Top of the Class High Performers in science in PISA 2006*.
- Ofqual. (2012) *Welcome*. Coventry: Ofqual.
- OFSTED. (2008) *Identifying good practice: a survey of post-16 science in colleges and schools*. London: OFSTED.
- Okasha, S. (2002) *Philosophy of Science: A Very Short Introduction*. OUP Oxford.
- Opinel, A. (2008) 'Teaching microbiology at the Institut Pasteur: the application of a pedagogical principle (1889-1939).' *Research in Microbiology*, 159(1), Jan-Feb, pp. 36-39.
- Oren, A. (2004) 'A proposal for further integration of the cyanobacteria under the Bacteriological Code.' *International Journal of Systematic and Evolutionary Microbiology*, 54(5), September 1, 2004, pp. 1895-1902.
- Osborne, J. and Simon, S. (1996) 'Primary Science: Past and Future Directions.' *Studies in Science Education*, 27(1), 1996/01/01, pp. 99-147.
- Osborne, J., Simon, S. and Collins, S. (2003) 'Attitudes towards science: A review of the literature and its implications.' *International Journal of Science Education*, 25(9), 2003/09/01, pp. 1049-1079.
- Osborne, J., Collins, S., Ratcliffe, M., Millar, R. and Duschl, R. (2003) 'What "ideas-about-science" should be taught in school science? A Delphi study of the expert community.' *Journal of Research in Science Teaching*, 40(7) pp. 692-720.
- Osborne, J. F. (1996) 'Beyond constructivism.' *Science Education*, 80(1) pp. 53-82.
- Osbourne (2002) In Amos, S. and Boohan, R. (eds.) *Teaching Science in Secondary Schools: Perspective on Practice*. London: Routledge, pp. 227-237.
- Osgood, C. (1957) *The measurement of meaning*. Illinois: University of Illinois Press.
- Oversby, J. (2012) 'Introduction.' In *ASE Guide to Research in Science Education*. Hatfield: The Association for Science Education, pp. ix -xi.
- Paerl, H. W., Fulton, R. S., Moisaner, P. H. and Dyble, J. (2001) 'Harmful Freshwater Algal Blooms, With an Emphasis on Cyanobacteria.' *TheScientificWorldJOURNAL*, 1 pp. 76-113.
- Palmer, D. H. (2009) 'Student interest generated during an inquiry skills lesson.' *Journal of Research in Science Teaching*, 46(2) pp. 147-165.
- Pashler, H., McDaniel, M., Rohrer, D. and Bjork, R. (2008) 'Learning styles concepts and evidence.' *Psychological science in the public interest*, 9(3) pp. 105-119.
- Payne (1980) 'Identification keys and diagnostic tables: a review.' *Journal of the Royal Statistical Society*, 143(3) pp. 253-292.



- Pelczar, M. J. (1991) 'Microbiology education in the United States: the issue of balance.' *World Journal of Microbiology and Biotechnology*, 7(5) pp. 517-521.
- Pelizar, L. (2002) 'Spirulina platensis growth estimation by pH determination at different cultivations conditions.' *Electronic Journal of Biotechnology*, 5(3)
- Popper, K. R. (1979) *Objective Knowledge: An Evolutionary Approach*. Oxford University Press.
- Popper, K. R. A. (2002) *Karl Popper: The Logic of Scientific Discovery*. Routledge Classics.
- Porter, A. and Rafols, I. (2009) 'Is science becoming more interdisciplinary? Measuring and mapping six research fields over time.' *Scientometrics*, 81(3) pp. 719-745.
- Potin, P., Bouarab, K., Sala, J.-P., Pohnert, G. and Kloareg, B. (2002) 'Biotic interactions of marine algae.' *Current Opinion in Plant Biology*, 5(4) pp. 308-317.
- Pritchard, D. (2004) 'Some Recent Work in Epistemology.' *The Philosophical Quarterly*, 54(217) pp. 604-613.
- QCA. (2007a) *Science programme of study for key stage 3 and attainment targets*. London: Qualifications and Curriculum Authority.
- QCA. (2007b) *Science programme of study for key stage 4*. London: Qualifications and Curriculum Authority.
- Quarles, W. (1992) 'Diatomaceous earth for pest control.' *Monitoring the Field of Pest Management*, XIV(5/6)
- Ratcliffe, M. and Millar, R. (2009) 'Teaching for understanding of science in context: Evidence from the pilot trials of the Twenty First Century Science courses.' *Journal of Research in Science Teaching*, 46(8) pp. 945-959.
- Redfern, J. (2011). Call for evaluation volunteers. *Microbiology Today*, 38, 43.
- Redfern, J. (2012) *Algae: a practical resource for secondary schools*. Reading, UK: Society for General Microbiology.
- Redfern, J., Burdass, D. and Verran, J. (2013) 'Practical microbiology in schools: a survey of UK teachers.' *Trends in Microbiology*, 21(11) pp. 557-559.
- Redfern, J., Burdass, D. and Verran, J. (in press-a) 'The development of a new practical activity: Using microorganisms to model gas cycling.' *School Science Review*,
- Redfern, J., Burdass, D. and Verran, J. (in press-b) 'Transforming a school learning exercise into a public engagement event: "The Good, the Bad and The Algae".' *Journal of Biological Education*, pp. 1-7.
- Reid, G. (2005) *Learning Styles and Inclusion*. SAGE Publications.
- Reiss, M. (2012) 'Learning out of the classroom.' In Oversby, J. (ed.) *ASE guide to research in science education*. Hatfield: The Association for Science Education,

- Rennie, L. J., Goodrum, D. and Hackling, M. (2001) 'Science Teaching and Learning in Australian Schools: Results of a National Study.' *Research in Science Education*, 31(4) pp. 455-498.
- Rose, C. I. and Hawksworth, D. L. (1981) 'Lichen recolonization in London's cleaner air.' *Nature*, 289 pp. 289 - 292.
- Rosen, L., Brody, D., Zucker, D., Manor, O., Meier, M., Rosen, B., Lev, E. and Engelhard, D. (2010) 'Spreading the handwashing message: An alternative to traditional media campaigns.' *American Journal of Infection Control*, 38(7, Sp. Iss. SI), Sep, pp. 562-564.
- Rowan, K. S. (1989) *Photosynthetic pigments of algae*. Cambridge: Cambridge University Press.
- Royal Society. (2004) *Taking a lead role A good practice guide for all those involved in role model schemes aiming to inspire young people about science, engineering and technology*. London: The Royal Society.
- SAMS. (n.d.) *Culture Collection of Algae and Protozoa*. Oban: SAMS. [Online] [Accessed on 13/10/2013] <http://www.sams.ac.uk/ccap>
- SBS. (2004) 'SBS Survey of Secondary School Science Teachers.' [Accessed sciencecampaign.org.uk/documents/2004/SBS0401.pdf]
- Schwerz, N., KNÄUPER, B., HIPPLER, H.-J., NOELLE-NEUMANN, E. and CLARK, L. (1991) 'RATING SCALES NUMERIC VALUES MAY CHANGE THE MEANING OF SCALE LABELS.' *Public Opinion Quarterly*, 55(4), December 21, 1991, pp. 570-582.
- (2010) *Science and Technology Committee - Sixth Report, The impact of spending cuts on science and scientific research*. Cmnd. (Science and Technology Committee Report).
- SCORE. (2011). Memorandum of Understanding between the SCORE member organisations. London: SCORE.
- SCORE. (2012) *Secondary school benchmark equipment and consumables*. London: SCORE.
- SCORE. (2013) *Resourcing practical science at secondary level*. London: SCORE.
- ScottishBioenergy. (2007) *Scottish Bioenergy manufactures carbon capture and water decontamination systems which have bioenergy and protein byproducts*. Scottish Bioenergy.
- Sears (2000) *Issues in science teaching*. Routledge Falmer.
- SGM. (n.d.-a) *SGM: About SGM : Introduction*. [Online] [Accessed <http://www.sgm.ac.uk/about/>]
- SGM. (n.d.-b) *Education policy*. Reading: The Society for General Microbiology. [Online] [Accessed on 12/05/13] <http://www.sgm.ac.uk/en/policy/policy-education.cfm>
- SHULMAN, L. S. (1986) 'Those Who Understand: Knowledge Growth in Teaching.' *Educational Researcher*, 15(2), February 1, 1986, pp. 4-14.
- Singh, J. and Gu, S. (2010) 'Commercialization potential of microalgae for biofuels production.' *Renewable and Sustainable Energy Reviews*, 14(9) pp. 2596-2610.

- Smith (2006) 'Eutrophication of freshwater and marine ecosystems.' *Limnology and Oceanography*, 51(1) pp. 351-355.
- Smith, A. (2011). Carbon dioxide is limiting growth of Algae culture to high density. In Redfern, J. (Ed.) (At Univesity of Cambridge ed.). Cambridge.
- Smith, C. (1012) 'High school students' emotional responses to science reading and academic reading engagement: relationships to science achievement '. In *Literacy Research Association*. San Diego, CA:
- SQA. (2000a) *Standard Grade Arrangements for Biology*. Glasgow: SQA.
- SQA. (2000b) *Standard Grade Arrangements in Science*. Glasgow: SQA.
- SQA. (2002) *SQA Biology Higher Specifiction*. Glasgow.
- SQA. (2006) *SQA Biology Advanced Higher*. Glasgow: SQA.
- Stanier, R. (1977) 'The position of cyanobacteria in the world of phototrophs.' *Carlsberg Research Communications*, 42(2) pp. 77-98.
- Stanier, R. Y., Sistrom, W. R., Hansen, T. A., Whitton, B. A., Castenholz, R. W., Pfennig, N., Gorlenko, V. N., Kondratieva, E. N., Eimhjellen, K. E., Whittenbury, R., Gherna, R. L. and Truper, H. G. (1978) 'Proposal to Place the Nomenclature of the Cyanobacteria (Blue-Green Algae) Under the Rules of the International Code of Nomenclature of Bacteria.' *International Journal of Systematic Bacteriology*, 28(2), April 1, 1978, pp. 335-336.
- Staver, J. R. (1998) 'Constructivism: Sound theory for explicating the practice of science and science teaching.' *Journal of Research in Science Teaching*, 35(5) pp. 501-520.
- Steinbach, W. J. (2003) 'Status of medical mycology education.' *Medical Mycology*, 41(6), Dec, pp. 457-467.
- Sternberg, R. J. (1999) *Thinking Styles*. Cambridge University Press.
- Sternberg, R. J. and Zhang, L.-f. (2005) 'Styles of Thinking as a Basis of Differentiated Instruction.' *Theory Into Practice*, 44(3), Summer2005, pp. 245-253.
- Sunal (2008) *The impact of the laboratory & technology on learning and teaching science K-16*. Information Age Publishing.
- Svoboda, J. and Passmore, C. (2013) 'The Strategies of Modeling in Biology Education.' *Science & Education*, 22(1), 2013/01/01, pp. 119-142.
- Symington, V. (2010) *Marvellous Microbes: The Pasteurs*.
- Symington, V. (2011). SGM goes with a bang. *Microbiology Today*, 38.
- Sze, P. (1997) *A biology of algae*. 3rd ed.: McGrew-Hill.
- Taber, K. (2012) 'Teaching and learning about the nature of science.' In Oversby, J. (ed.) *ASE Guide to Research in Science Education*. Hatfield: The Association for Science Education,

- Tamir, P. (1988) 'Subject matter and related pedagogical knowledge in teacher education.' *Teaching and Teacher Education*, 4(2) pp. 99-110.
- Tanner (2004) 'Approaches to Biology Teaching and Learning: Learning Styles and the Problem of Instructional Selection, Engaging All Students in Science Courses.' *Cell Biology Education*, 3(4), Winter 2004, pp. 197-201.
- Tashakkori, A. and Teddlie, C. (2003) *Handbook of Mixed Methods in Social & Behavioral Research*. First ed., London: SAGE.
- The Big Bang. (2012) *About The Big Bang Fair*. [Online] [Accessed [http://www.thebigbangfair.co.uk/about\\_us.cfm](http://www.thebigbangfair.co.uk/about_us.cfm)]
- The Royal Society. (2007) 'State of the Nation report' *The UK's science and mathematics teaching workforce*.
- The Royal Society. (2010) *The Scientific Century: securing our future prosperity*. London: The Royal Society.
- The Wellcome Trust. (2009) *Wellcome Trust Monitor Report Wave 1 - Tracking public views on medical research*. London: The Wellcome Trust.
- The Wellcome Trust. (2013) *Wellcome Trust Monitor Report Wave 2 - Tracking public views on science, research and science education*. London: The Wellcome Trust.
- Tobin, K. (1986) 'Student task involvement and achievement in process-oriented science activities.' *Science Education*, 70(1) pp. 61-72.
- Tobin, K. (1990) 'Research on Science Laboratory Activities: In Pursuit of Better Questions and Answers to Improve Learning.' *School Science and Mathematics*, 90(5) pp. 403-418.
- Toplis, R. (2011) 'The role and value of practical work.' In Oversby, J. (ed.) *ASE guide to research in science education*. ASE,
- Verran, J. (2010). The Microbiology of Vampires. *Microbiology Today*, 37, 2.
- Verran, J. (2012). Public Engagement Grant: Monsters, Maths....and Microbiology. *Microbiologist*, 13, 2.
- Waltz, E. (2013) 'Algal biofuels questioned.' *Nat Biotech*, 31(1) pp. 12-12.
- Wellington, J. (1998) *Practical Work in School Science: Which Way Now?*, London: Routledge.
- Wellington, J. J. and Osborne, J. (2001) *Language and literacy in science education*. Open University Press.
- Welz (2006) *Teaching science in Europe*. Science on stage Deutschland e.V.
- Whitmarsh, J. (1999) *Concepts in Photobiology: Photosynthesis and Photomorphogenesis*. Narosa Publishers.
- WJEC. (2008) *GCE Biology specification*. Cardiff: WJEC.
- WJEC. (2012a) *GCSE Sciences - Linear Specification*. WJEC.

WJEC. (2012b) *GCSE Science B - Linear Specification*. WJEC.

Wyklicky, H. and Skopec, M. (1983) 'Ignaz Philipp Semmelweis, the Prophet of Bacteriology.' *Infection Control*, 4(5) pp. 367-370.

Yeh, H.-C. (1986). Stain removal toothpaste. In Patent, U. S. (Ed.) (Vol. 4,612,191). United States: Block Drug Co., Inc.,.

Zhang, L.-F. (2004) 'Revisiting the Predictive Power of Thinking Styles for Academic Performance.' *The Journal of Psychology*, 138(4), 2004/01/01, pp. 351-370.

Zion, M., Cohen, S. and Amir, R. (2007) 'The Spectrum of Dynamic Inquiry Teaching Practices.' *Research in Science Education*, 37(4), 2007/10/01, pp. 423-447.

Zoldosova, K. and Prokop, P. (2006) 'Education in the Field Influences Children's Ideas and Interest toward Science.' *Journal of Science Education and Technology*, 15(3-4), 2006/10/01, pp. 304-313.

**Appendix 1 – Review of microbiology-related content in science / biology teaching specifications in the United Kingdom**

Awarding body specifications for Science/Biology education to students aged 14-15															
England, Wales and Northern Ireland													Scotland		
Microbiology topics (either specific or potential)	AQA GCSE Science 4405	AQA GCSE Biology 4401	CCEA GCSE Science (single award)	CCEA GCSE Biology	Edexcel GCSE Science	Edexcel GCSE Biology	OCR Twenty First Century Science A	OCR Twenty First Century Science Additional A	OCR Twenty First Century Science Suite - Biology	WJEC Linear Science	WJEC Linear Science B	CIE IGCSE Biology	Edexcel BTEC Applied Science Level 3 National	SQA Standard in Science	SQA Standard in Biology
There are a variety of microorganisms (fungi, bacteria, algae, viruses)			✓	✓	✓	✓	✓			✓	✓	✓			
Classification - three domain							✓		✓	✓		✓			
Classification - five kingdoms			✓	✓	✓	✓									
Construct and/or use an identification key			✓	✓	✓	✓						✓	✓		✓
Organisms have morphological and behavioural adaptations to survive in the environment	✓	✓	✓	✓		✓	✓	✓	✓	✓		✓		✓	✓
Organisms in an area can affect other organisms nearby			✓	✓	✓	✓	✓		✓	✓	✓	✓			
Organisms need resources from their environment e.g. water, light and are impacted by other environmental factors such as temperature	✓	✓		✓			✓		✓	✓		✓	✓	✓	✓

Awarding body specifications for Science/Biology education to students aged 14-15															
England, Wales and Northern Ireland													Scotland		
Microbiology topics (either specific or potential)	AQA GCSE Science 4405	AQA GCSE Biology 4401	CCEA GCSE Science (single award)	CCEA GCSE Biology	Edexcel GCSE Science	Edexcel GCSE Biology	OCR Twenty First Century Science A	OCR Twenty First Century Science Additional A	OCR Twenty First Century Science Suite - Biology	WJEC Linear Science	WJEC Linear Science B	CIE IGCSE Biology	Edexcel BTEC Applied Science Level 3 National	SQA Standard in Science	SQA Standard in Biology
Use of fertilizers (eutrophication) and pesticides (disease control) in intensive farming		✓		✓		✓			✓	✓	✓	✓		✓	✓
Disease in animals (e.g. TB in cattle)										✓					
Using lichen as an environmental indicator			✓	✓	✓	✓	✓	✓	✓	✓	✓	✓	✓		✓
Photosynthesis and factors affecting it, for example CO <sub>2</sub> as a limiting factor	✓	✓	✓	✓	✓	✓	✓	✓	✓	✓	✓	✓	✓	✓	
Waste materials from organisms is degraded by microorganisms	✓	✓		✓			✓			✓	✓	✓		✓	✓
Some microorganisms (e.g. yeast) produce carbon dioxide through aerobic respiration		✓		✓				✓	✓	✓					✓
Microorganisms play a part in the cycling of carbon and nitrogen			✓	✓	✓	✓	✓	✓	✓	✓	✓	✓	✓		✓



Awarding body specifications for Science/Biology education to students aged 14-15															
England, Wales and Northern Ireland													Scotland		
Microbiology topics (either specific or potential)	AQA GCSE Science 4405	AQA GCSE Biology 4401	CCEA GCSE Science (single award)	CCEA GCSE Biology	Edexcel GCSE Science	Edexcel GCSE Biology	OCR Twenty First Century Science A	OCR Twenty First Century Science Additional A	OCR Twenty First Century Science Suite - Biology	WJEC Linear Science	WJEC Linear Science B	CIE IGCSE Biology	Edexcel BTEC Applied Science Level 3 National	SQA Standard in Science	SQA Standard in Biology
Genetic profiling can be used to determine difference between organisms										✓	✓				
Genetic mutations and evolution cause variation, for example, antibiotic resistance or can lead to pandemic/epidemic spread of disease	✓	✓	✓	✓	✓	✓	✓		✓	✓	✓				✓
Organisms can sense and respond to external stimuli e.g. light			✓		✓			✓	✓	✓					
Knowledge of microscopy - light, electron and/or laser						✓				✓			✓		
Bacteria - structure and method reproduction		✓		✓		✓	✓		✓	✓		✓	✓		
Algae - structure		✓								✓			✓		✓
Fungi/yeast - structure		✓							✓	✓		✓	✓		✓

Awarding body specifications for Science/Biology education to students aged 14-15															
England, Wales and Northern Ireland													Scotland		
Microbiology topics (either specific or potential)	AQA GCSE Science 4405	AQA GCSE Biology 4401	CCEA GCSE Science (single award)	CCEA GCSE Biology	Edexcel GCSE Science	Edexcel GCSE Biology	OCR Twenty First Century Science A	OCR Twenty First Century Science Additional A	OCR Twenty First Century Science Suite - Biology	WJEC Linear Science	WJEC Linear Science B	CIE IGCSE Biology	Edexcel BTEC Applied Science Level 3 National	SQA Standard in Science	SQA Standard in Biology
Viruses - structure, replication and destructive nature										✓		✓	✓		
Viruses do not fit the classic 'cell theory'						✓				✓					
Microorganisms are involved in digestion of food				✓						✓					
Microorganisms that cause disease are known as pathogens and can be spread by various means	✓	✓	✓	✓	✓	✓	✓		✓	✓		✓			✓
Vaccination as a means of protection	✓	✓	✓	✓		✓	✓		✓	✓					
Antibiotics are used to fight bacterial infections	✓	✓	✓	✓	✓		✓		✓	✓		✓			✓
Antibiotics don't work against viruses	✓				✓		✓		✓	✓		✓			

Awarding body specifications for Science/Biology education to students aged 14-15															
	England, Wales and Northern Ireland													Scotland	
	AQA GCSE Science 4405	AQA GCSE Biology 4401	CCEA GCSE Science (single award)	CCEA GCSE Biology	Edexcel GCSE Science	Edexcel GCSE Biology	OCR Twenty First Century Science A	OCR Twenty First Century Science Additional A	OCR Twenty First Century Science Suite - Biology	WJEC Linear Science	WJEC Linear Science B	CIE IGCSE Biology	Edexcel BTEC Applied Science Level 3 National	SQA Standard in Science	SQA Standard in Biology
Microbiology topics (either specific or potential)															
Aseptic technique and the teaching of Louis Pasteur	✓	✓	✓	✓		✓				✓			✓		✓
Food items need to be preserved against bacterial infection, e.g. pasteurisation of milk										✓					
Microorganisms are cultured in industry for human application, e.g. <i>Fusarium</i> producing mycoprotein and bacteria being used to produce yogurt						✓		✓	✓			✓			✓
Pros and cons about genetically modified organisms						✓					✓				✓
Sewage can be treated using microorganisms										✓					✓
Be able to calculate the population on microorganisms given secondary data	✓						✓		✓						

Awarding body specifications for Science/Biology education to students aged 14-15															
England, Wales and Northern Ireland													Scotland		
Microbiology topics (either specific or potential)	AQA GCSE Science 4405	AQA GCSE Biology 4401	CCEA GCSE Science (single award)	CCEA GCSE Biology	Edexcel GCSE Science	Edexcel GCSE Biology	OCR Twenty First Century Science A	OCR Twenty First Century Science Additional A	OCR Twenty First Century Science Suite - Biology	WJEC Linear Science	WJEC Linear Science B	CIE IGCSE Biology	Edexcel BTEC Applied Science Level 3 National	SQA Standard in Science	SQA Standard in Biology
The human body can defend itself against microbial infection, e.g. white blood cells or lysozymes	✓	✓	✓	✓	✓	✓	✓		✓						
Biofuels are important for future energy supply (e.g. algae)		✓	✓		✓	✓	✓		✓						
Know about the use of probiotics						✓									
Circadian rhythm in organisms						✓									✓
Viruses can cause cancer				✓											
STIs can be prevented using protective measures e.g. practicing safe sex			✓												

Awarding body specifications for Science/Biology education to students aged 14-15															
England, Wales and Northern Ireland													Scotland		
Microbiology topics (either specific or potential)	AQA GCSE Science 4405	AQA GCSE Biology 4401	CCEA GCSE Science (single award)	CCEA GCSE Biology	Edexcel GCSE Science	Edexcel GCSE Biology	OCR Twenty First Century Science A	OCR Twenty First Century Science Additional A	OCR Twenty First Century Science Suite - Biology	WJEC Linear Science	WJEC Linear Science B	CIE IGCSE Biology	Edexcel BTEC Applied Science Level 3 National	SQA Standard in Science	SQA Standard in Biology
Understand sigmoid population growth (lag, exponential & stationary phases)												✓			
Societies perception of science e.g. MMR vaccine debate													✓		
Control measures have been put in place to stop the spread of resistant microorganisms such as MRSA	✓	✓	✓	✓	✓	✓	✓		✓	✓					

Awarding body specifications for biology education to students aged 16-18							
England, Wales and Northern Ireland					Scotland		
	AQA GCE Biology 2410	CCEA GCE Biology	Edexcel GCE Biology	OCR GCE Biology	WJEC GCE Biology	SQA Higher in Biology	SQA Advanced Higher in Biology
Microbiology topics (either specific or potential)							
Pathogens cause disease, and can include bacteria, viruses and fungi	✓		✓	✓		✓	
Pathogens can infect via various interfaces e.g. digestive and gas-exchange systems	✓		✓			✓	
Pathogens cause disease of the host by damaging cells or producing toxins	✓	✓	✓	✓		✓	
Principles of microscopy: light, electron (TEM and SEM)	✓	✓		✓			
Cholera - toxin production, effect and treatments.	✓						
Effect of influenza (antigenic variability) and other pathogens on immunity	✓			✓			

Awarding body specifications for biology education to students aged 16-18							
England, Wales and Northern Ireland					Scotland		
	AQA GCE Biology 2410	CCEA GCE Biology	Edexcel GCE Biology	OCR GCE Biology	WJEC GCE Biology	SQA Higher in Biology	SQA Advanced Higher in Biology
Microbiology topics (either specific or potential)							
Living organisms vary and adapt depending on genetic and environmental factors	✓	✓	✓	✓	✓	✓	
Describe the ultrastructure of prokaryotic cells	✓	✓	✓	✓	✓		✓
Describe the ultrastructure of eukaryotic cells		✓		✓	✓		✓
DNA in eukaryotes is found in a different form to DNA in prokaryotes	✓				✓		✓
Classification consisting of a hierarchy system	✓	✓		✓	✓		
Understand the five kingdom classification system		✓		✓	✓		
Classification is now based on a range of evidence including DNA, proteins and behaviour	✓	✓	✓	✓	✓		✓

Awarding body specifications for biology education to students aged 16-18							
England, Wales and Northern Ireland					Scotland		
Microbiology topics (either specific or potential)	AQA GCE Biology 2410	CCEA GCE Biology	Edexcel GCE Biology	OCR GCE Biology	WJEC GCE Biology	SQA Higher in Biology	SQA Advanced Higher in Biology
Antibiotics are used to treat bacterial infection. Modes of action include preventing the formation of bacterial cell walls, resulting in osmotic lysis. Difference between bacteriostatic and bactericidal	✓		✓	✓			✓
DNA is the genetic material of bacteria.	✓	✓		✓			
Mutations in bacterial DNA can result in developing resistance to antibiotics	✓		✓	✓	✓	✓	
Resistance can be transferred to future generations by vertical gene transmission	✓						



Awarding body specifications for biology education to students aged 16-18							
England, Wales and Northern Ireland					Scotland		
	AQA GCE Biology 2410	CCEA GCE Biology	Edexcel GCE Biology	OCR GCE Biology	WJEC GCE Biology	SQA Higher in Biology	SQA Advanced Higher in Biology
Microbiology topics (either specific or potential)							
Photosynthesis	✓	✓	✓	✓		✓	✓
Aerobic respiration	✓	✓		✓	✓	✓	
Anaerobic respiration	✓	✓		✓	✓	✓	
Energy transfer (primary producers, decomposers etc.)	✓	✓	✓	✓	✓		✓
Intensive farming - use of fertilizers (eutrophication) and pesticides	✓	✓		✓	✓		✓
The role of microorganisms in the carbon cycle	✓	✓	✓		✓		✓
The role of microorganisms in the nitrogen cycle	✓	✓		✓	✓		✓
Organisms increase their chance of survival by responding to changes in their environment	✓	✓		✓	✓		✓

Awarding body specifications for biology education to students aged 16-18							
England, Wales and Northern Ireland					Scotland		
	AQA GCE Biology 2410	CCEA GCE Biology	Edexcel GCE Biology	OCR GCE Biology	WJEC GCE Biology	SQA Higher in Biology	SQA Advanced Higher in Biology
Microbiology topics (either specific or potential)							
Taxes and kinesis as simple responses to keep an organism in a favourable environment	✓	✓	✓		✓		
Fragments of DNA can be produced using PCR and can be used in medical diagnosis and be separated by gel electrophoresis	✓	✓	✓	✓	✓		✓
The use of recombinant DNA to produce transformed organisms can benefit humans (including gene therapy)	✓	✓		✓	✓		✓
Enzymes produced by microorganisms can be used commercially		✓		✓	✓		✓
Understand the structure of bacteriophage (phages) or 'viruses'		✓	✓		✓		

Awarding body specifications for biology education to students aged 16-18							
England, Wales and Northern Ireland					Scotland		
Microbiology topics (either specific or potential)	AQA GCE Biology 2410	CCEA GCE Biology	Edexcel GCE Biology	OCR GCE Biology	WJEC GCE Biology	SQA Higher in Biology	SQA Advanced Higher in Biology
Understand the structure of HIV		✓					
Viruses replicate within a host cell, thereby destroying them		✓					
Describe features of prokaryotes		✓					
Describe features of fungi		✓					
Describe features of protoctista		✓					
Natural barriers to infection - skin, acid, tears and mucus		✓	✓	✓			
Understand the phases of growth (lag, log, stationary and decline)		✓					✓
Process of cell division by budding yeast				✓			✓

Awarding body specifications for biology education to students aged 16-18							
England, Wales and Northern Ireland					Scotland		
	AQA GCE Biology 2410	CCEA GCE Biology	Edexcel GCE Biology	OCR GCE Biology	WJEC GCE Biology	SQA Higher in Biology	SQA Advanced Higher in Biology
Microbiology topics (either specific or potential)							
Describe the causes and means of transmission of diseases such as malaria, AIDS/HIV and TB			✓	✓			
Microorganisms may be a source of new medicines			✓	✓			✓
Describe how to investigate the antimicrobial properties of plants			✓				
Effect of temperature on rate of enzyme activity in microorganisms			✓				✓
Describe how understanding nosocomial infections have led to a change in practice relating to antibiotic use and hospital prevention and control procedures			✓				

Awarding body specifications for biology education to students aged 16-18							
England, Wales and Northern Ireland					Scotland		
	AQA GCE Biology 2410	CCEA GCE Biology	Edexcel GCE Biology	OCR GCE Biology	WJEC GCE Biology	SQA Higher in Biology	SQA Advanced Higher in Biology
Microbiology topics (either specific or potential)							
Counting microorganisms to monitor population growth and viable count. Performing serial dilutions, plating and counting colonies.					✓		
Jacob-Monod hypothesis of gene action in bacteria (lac operon)						✓	
Gene therapy							✓
Symbiotic relationships							✓
Parasitism							✓
Commensalism							✓

Awarding body specifications for biology education to students aged 16-18							
England, Wales and Northern Ireland					Scotland		
Microbiology topics (either specific or potential)	AQA GCE Biology 2410	CCEA GCE Biology	Edexcel GCE Biology	OCR GCE Biology	WJEC GCE Biology	SQA Higher in Biology	SQA Advanced Higher in Biology
Vaccines provide protection for individuals and populations	✓	✓	✓	✓			
Resistance can be transferred from one species to another when DNA is transferred during conjugation (horizontal gene transfer).	✓						
Understand conditions required to culture microorganisms in the laboratory					✓		✓

## **Appendix 2 – Summary of thinking styles presented by the model of mental self-government**

<b>Dimension</b>	<b>Thinking style</b>	<b>Key characteristics</b>
<b>Function</b>	Legislative	One prefers to work on tasks that require creative strategies; one prefers to choose one's own activities.
	Executive	One prefers to work on tasks with clear instructions and structures; one prefers to implement tasks with established guidelines.
	Judicial	One prefers to work on tasks that allow for one's evaluation; one prefers to evaluate and judge the performance of other people.
<b>Form</b>	Hierarchical	One prefers to distribute attention to several tasks that are prioritized according to one's valuing of the tasks.
	Monarchic	One prefers to work on tasks that allow complete focus on one thing at a time.
	Oligarchic	One prefers to work on multiple tasks in the service of multiple objectives, without setting priorities.
	Anarchic	One prefers to work on tasks that would allow flexibility as to what, where, when, and how one works.
<b>Level</b>	Global	One prefers to pay more attention to the overall picture of an issue and to abstract ideas.
	Local	One prefers to work on tasks that require working with concrete details.
<b>Scope</b>	Internal	One prefers to work on tasks that allow one to work as an independent unit.
	External	One prefers to work on tasks that allow for collaborative ventures with other people.
<b>Leaning</b>	Liberal	One prefers to work on tasks that involve novelty and ambiguity.
	Conservative	One prefers to work on tasks that allow one to adhere to the existing rules and procedures in performing tasks



## **Appendix 3 – Experiments supporting the development of activity 2 – Investigating phototaxis**

## **Experiment one: design**

### **Aim**

Investigate different cardboard sleeve designs for use in activity 2 – investigating phototaxis, in order to achieve an easy, reproducible investigation.

### **Method**

Two sleeves were made of black card. 'Sleeve one' was cut to 13x7cm with 5-1x1cm squares cut out in a vertical line (Figure 52) down the centre of the sleeve. Five pieces of 1.5x1.5cm coloured acetate were attached using adhesive tape. The sleeve was secured around the body of a test tube. 'Sleeve two' was cut to 7x5cm and wrapped around a plastic universal tube (25ml container with screw top), leaving a 1cm vertical gap. A strip of coloured acetate was secured in place in the gap between the black card with adhesive tape (Figure 52). Five universals (one per colour) were prepared. The top and bottom of the tubes were covered in foil.

Each sleeve design was tested three times; three test tubes for sleeve one and fifteen universals for sleeve two (three of each colour). All tubes were filled with the phototactic algal species *Euglena gracilis* and left at a distance of 15cm from a florescent lamp for 96 hours. After this time the sleeves from each tube were removed with care and results recorded.

### **Results**

The level of algal attachment at each area of coloured light was ranked on an arbitrary scale of one to five (Figure 53). If no attachment was visible, a rating of zero was recorded. The two sleeve designs provided different phototactic results

for each colour (Figure 54). The attachment ratings for sleeve one showed a staggered phototactic response, i.e. for each colour, attachment varied. The clear window gave the strongest attachment, with the blue window also providing a strong response. Green and yellow gave a weaker response (rating at an average of 2.333 and 2 respectively). The red window gave no evidence of inducing phototaxis.

Sleeve two provided less variation (each colour gave a similar level of attachment) in attachment levels between coloured windows. Similar to sleeve one, the clear window gave the strongest response. The blue window gave a similar level of phototactic response. Yellow and green light induced a stronger phototactic response than their sleeve one counterparts. Red light gave no evidence of inducing phototaxis. From this, it was decided that sleeve design one would be used for the activity.

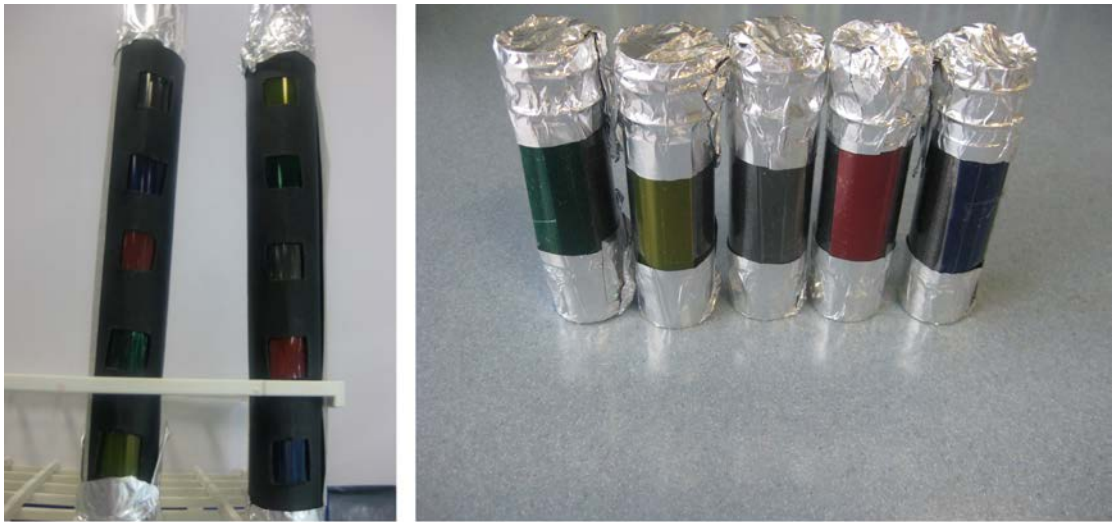

(1)

(2)

Figure 52 - Sleeve designs; (1) Sleeve design one, (2) Sleeve design two

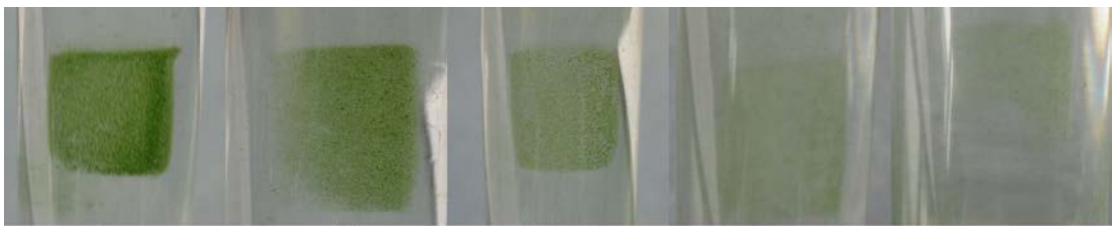

(5)

(4)

(3)

(2)

(1)

Figure 53 - A guide to attachment density provided in the Teacher's guide (page 24) of the resource "Algae: a practical resource for secondary schools"

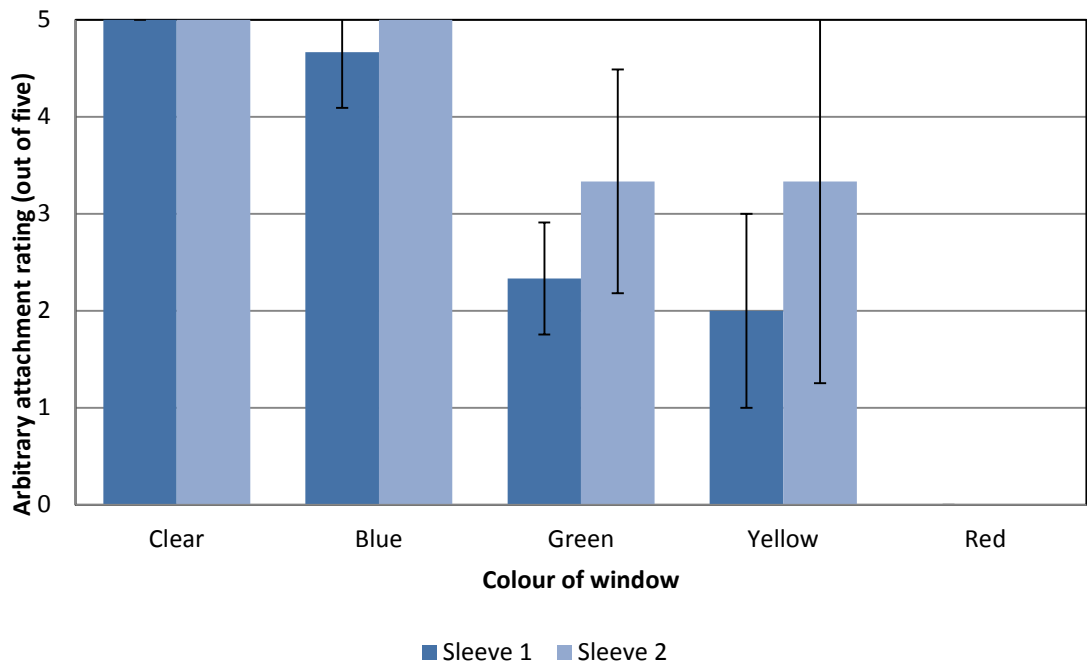

Figure 54 - Average attachments rating of phototactic algae *Euglena gracilis* depending on colour and shape of the field of light (n=3)

## **Experiment two: source of light**

### **Aim**

Investigate two different sources of light (natural light and artificial light) as triggers for phototactic behaviour in order to achieve an easy, reproducible activity.

### **Method**

Using sleeve design one (experiment one: sleeve design) tubes (n=3) filled with *Euglena gracilis* were placed in two different locations: a north-facing window and 15cm from a fluorescent lamp. The experiment was repeated once. After seven days, tubes were removed from their light source, unwrapped and results recorded.

### **Results**

Levels of phototaxis followed a similar trend to those found in the sleeve design experiment (experiment one: sleeve design). The attachment rating was assigned using the same method found in the sleeve design experiment (Figure 53). The tubes left under the fluorescent lamp gave the most defined results (Figure 55). Every window (except red, which received a rating of zero for both light sources) using the fluorescent lamp scored higher attachment ratings. Therefore, it was decided that a fluorescent lamp would be suggested for use with the activity.

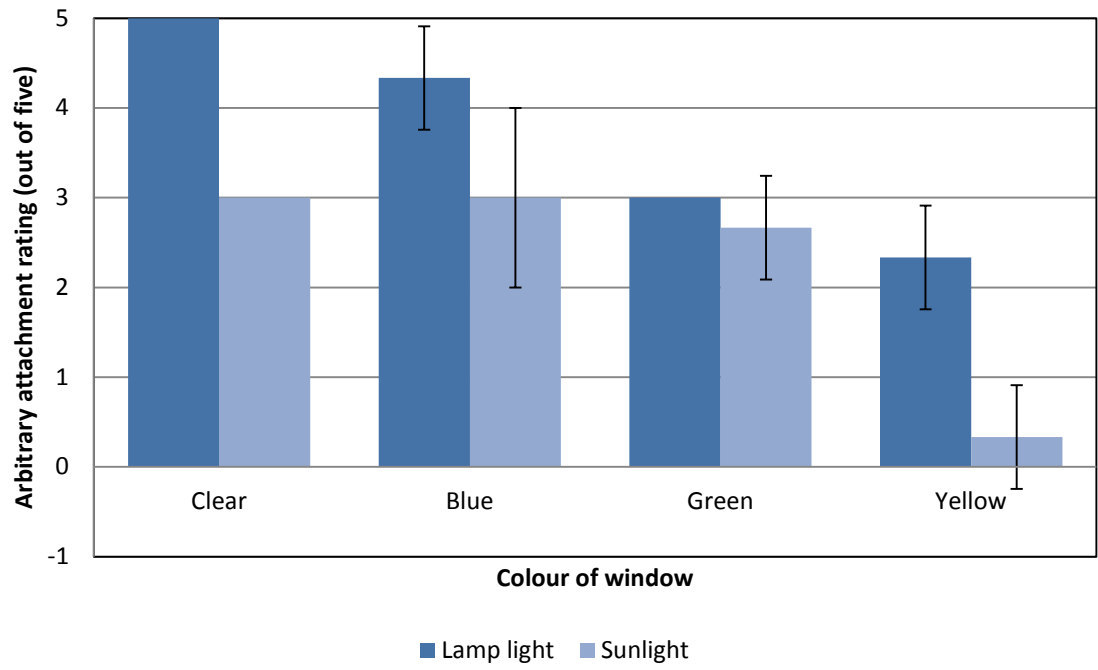

Figure 55 - Average attachments rating of phototactic algae *Euglena gracilis* depending on source of light (n=6)

## **Experiment three: Incubation time**

### **Aim**

Investigate attachment levels of *Euglena gracilis* in activity two: Investigating phototaxis, based on the amount of time the sample is left under a light source.

### **Method**

Using sleeve design one (experiment one: sleeve design), five tubes filled with 20ml culture of *Euglena gracilis* were placed 15cm from a fluorescent lamp. The lamp remained turned on for the duration of the experiment. A tube was removed and results recorded at 24, 48, 72, 96 and 168 hours. The experiment was repeated twice.

### **Results**

The attachment rating was assigned using the same method found in the sleeve design experiment (Figure 53). Results show that irrespective of time (over a 7-day period) phototactic behaviour of *Euglena gracilis* was visible and consistent. The expected trend of attachment based on colour of light remained consistent at any given the length of time (Figure 56). Therefore, the Teacher's guide notes that the experiment can run between one and seven days.

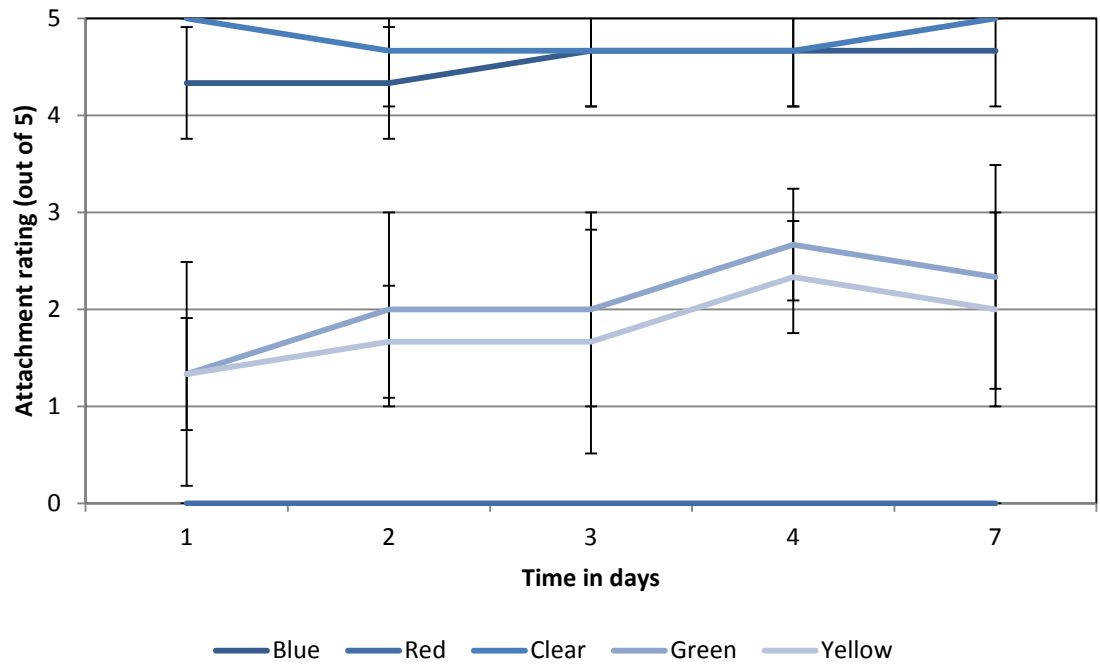

Figure 56 - Attachment rating representing levels of phototactic activity of *Euglena gracilis* over a period of 7 days



## **Experiment four: Distance from source of light**

### **Aim**

Investigate if a range of distances from a fluorescent lamp makes a noticeable change to the reliability of results when demonstrating phototaxis.

### **Method**

Using sleeve design one (experiment one: sleeve design), two tubes filled with 20ml culture of *Euglena gracilis* were placed 5, 15 and 25cm from a fluorescent lamp. The tubes were left undisturbed for 96 hours. After this time, the tubes were removed and results recorded (Table 14).

### **Results**

Phototaxis occurred irrespective of distance tested from the fluorescent bulb with the expected trend of attachment found previously in experiments one, two and three.

Table 14 - Comparison of average results (n=3) from experiment four: distance from source of light.

Window Colour Distance from light	Clear	Blue	Green	Yellow	Red
5cm	5	4.3	2.6	2.6	0
15cm	5	4.3	2	1.6	0
25cm	5	4.6	2.3	1.6	0

## **Appendix 4 – Experiments supporting the development of activity 4 – Eutrophication**

## **Experiment one: Growth rate of *Euglena gracilis* using different media**

### **Aim**

Compare the growth of *Euglena gracilis* in distilled water with one of three nutrient solutions capable of accelerating growth due to their macronutrient composition in sterile and non-sterile conditions.

### **Method**

Three different solutions and two controls (Table 15) were investigated. The three solutions were prepared according to their individual instructions (mixing sterile water with the solution to make up a working concentration). The suspensions were placed in 250ml beakers and left under a fluorescent lamp (which remained on for the duration of the investigation) at a distance of 8 cm. Five ml of *Euglena gracilis* was added to each of the beakers. Beakers containing sterile solutions had foil covering their opening and were opened under aseptic conditions. The beakers with non-sterile solutions were left uncovered. Using their respective 'blank measure' cuvettes, spectrophotometer (calibrated at 665nm – Jenway 6350) readings were recorded daily over an 18-day period.

### **Results**

The optical density readings (Figure 57) show a distinct difference in the use of culture media on the growth of *Euglena gracilis* compared to the water controls. Tap water (solution 1) and distilled water (solution 6) provide the two lowest levels of growth. The algal growth medium 'Biobred' gave a small increase in optical density compared with distilled water. The Miracle-Gro plant food (solutions 2 and 3) increased optical density. The B&Q plant food (solutions 4 and 5) provided the

highest optical density readings. There was no significant ( $p>0.05$ ) difference between the solutions sterilized before inoculation and those left unsterile. Therefore, the resource will recommend store-purchased plant food (at the recommended working concentration) for use with activity four.

**Table 15 – Solutions capable of accelerating growth, and water controls, used to investigate the growth rate of *Euglena gracilis* in sterile and non-sterile conditions.**

<b>Solution name</b>	<b>Solution constituents and condition</b>
One	Tap water (not sterile)
Two	<p>'Fertilizer 1' – not sterile</p> <p>Fertilizer 1 - Miracle-Gro, pour &amp; feed – ready to use liquid plant food (The Scotts Company, Surry, UK). N-P-K value: 0.02-0.02-0.02.</p>
Three	'Fertilizer 1' – sterilized
Four	<p>'Fertilizer 2' – not sterile</p> <p>Fertilizer 2 - B&amp;Q Multipurpose plant food concentrate, mixed to concentration suggested on the label (4.4ml to 1L of tap water). N-P-K value: 5-5-5</p>
Five	'Fertilizer 2' – sterilized
Six	Distilled water (sterilized)
Seven	'Biobred' algae medium (sterile) – Supplied by Sciento, Manchester. Macronutrient composition unknown.

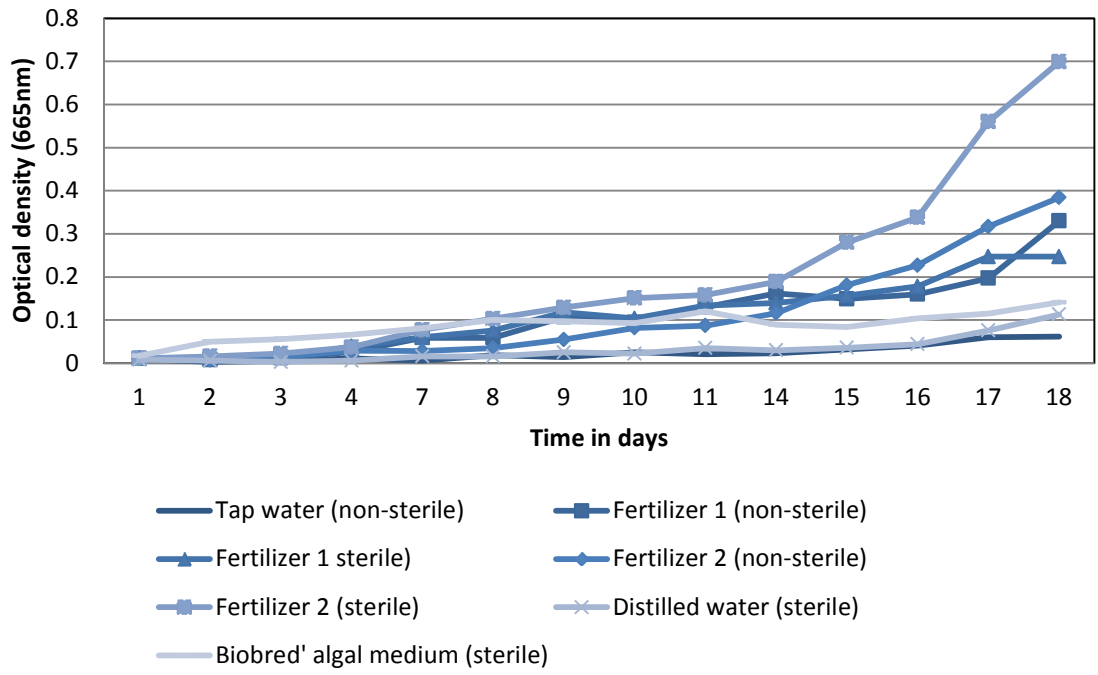

Figure 57 – Daily optical density readings (n=3) of *Euglena gracilis* in water controls and growth supporting solutions under sterile and non-sterile conditions.

## **Experiment two: Using optical density as an indicator for eutrophic behaviour of *Euglena gracilis***

### **Aim**

Investigate if using optical density readings (using a spectrophotometer) as a measure of eutrophic behaviour of *Euglena gracilis* provides results suitable for reproduction in a school classroom.

### **Method**

Four different experimental conditions were tested. These were:

1. Distilled water
2. Distilled water with B&Q liquid plant food (recommended concentration)
3. Distilled water with B&Q liquid plant food (double concentration)
4. Distilled water with B&Q liquid plant food (triple concentration)

The solutions were made up into 250ml volumes in flasks and not sterilized. One ml of each solution was placed in cuvettes to be kept as blank measures for colourimeter readings for the duration of the investigation. These were stored at minus 20°C to prevent growth of any bacterial/fungal contaminants. Five ml of *Euglena gracilis* culture was added to each treatment. After calibration with the appropriate blank measure, optical density measurements were taken at a wavelength of 665nm. Measurements were taken three times a week (Monday, Wednesday and Friday) for four weeks. Flasks were left near a fluorescent lamp for the duration of the investigation.



## Results

Optical density (OD) of *Euglena gracilis* in water was significantly lower ( $p < 0.05$ ) than the other three conditions (Figure 58). The solution containing triple the concentration of plant food recommended by the supplier gave a significantly higher ( $p < 0.05$ ) OD (0.801) after 28 days, compared to all other conditions. Therefore, it was decided optical density would be used as the measurement for activity four: eutrophication.

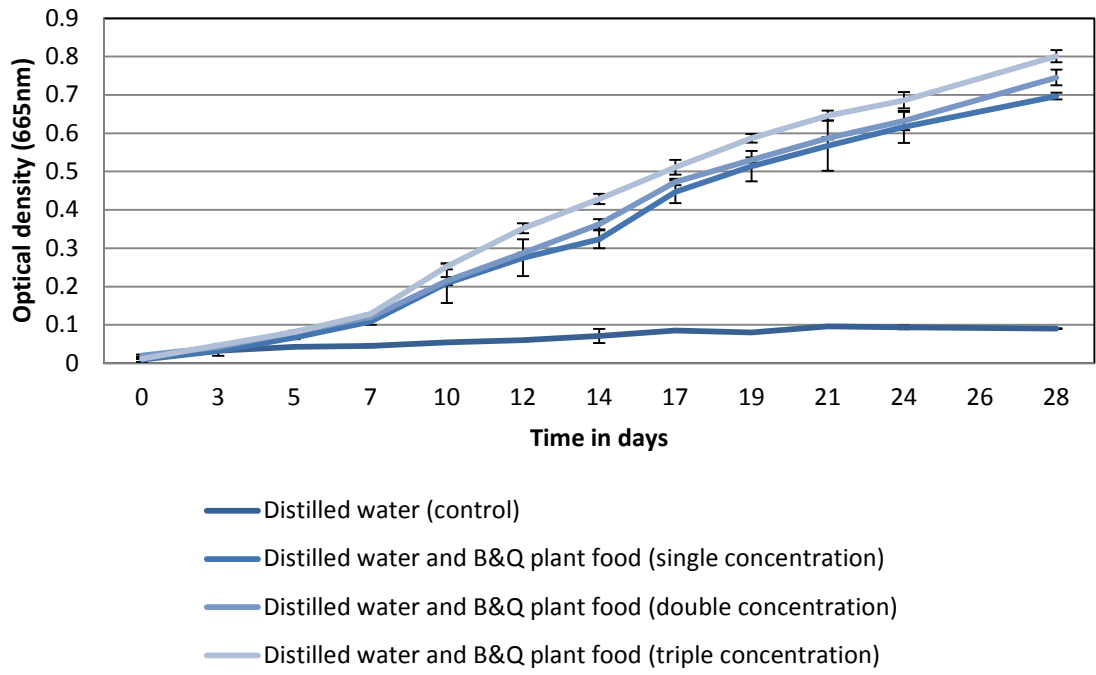

Figure 58 – Optical density measurements (n=3) of *Euglena gracilis* in solutions of different concentrations of nutrients

## **Experiment three: calculating the total count of *Euglena gracilis* in liquid culture**

### **Aim**

Create a calibration curve estimating the total count of *Euglena gracilis* cells based on optical density readings

### **Method**

The investigation as described in the Student's guide (Figure 34 to Figure 37) for practical activity 4, eutrophication, should be carried out. Following completion of the activity, the *Euglena gracilis*, which had been cultured using plant fertilizer was retained. Samples were taken and optical density (OD) recorded at a wavelength of 665nm. Some samples were diluted with distilled water to provide a range of OD readings.

Each sample was then investigated by light microscopy and a haemocytometer. Using a light microscope with a x40 lens, three images (at random locations) were captured. The number of cells was counted and calculated to a total number per ml.

### **Results**

A total of 57 data points were recoded. The optical density range was between 0.028 and 0.88. Using this data, a graph was constructed (Figure 59) to show the correlation between optical density and total count of *Euglena gracilis*. The graph and trend line equation have been included in the resource.

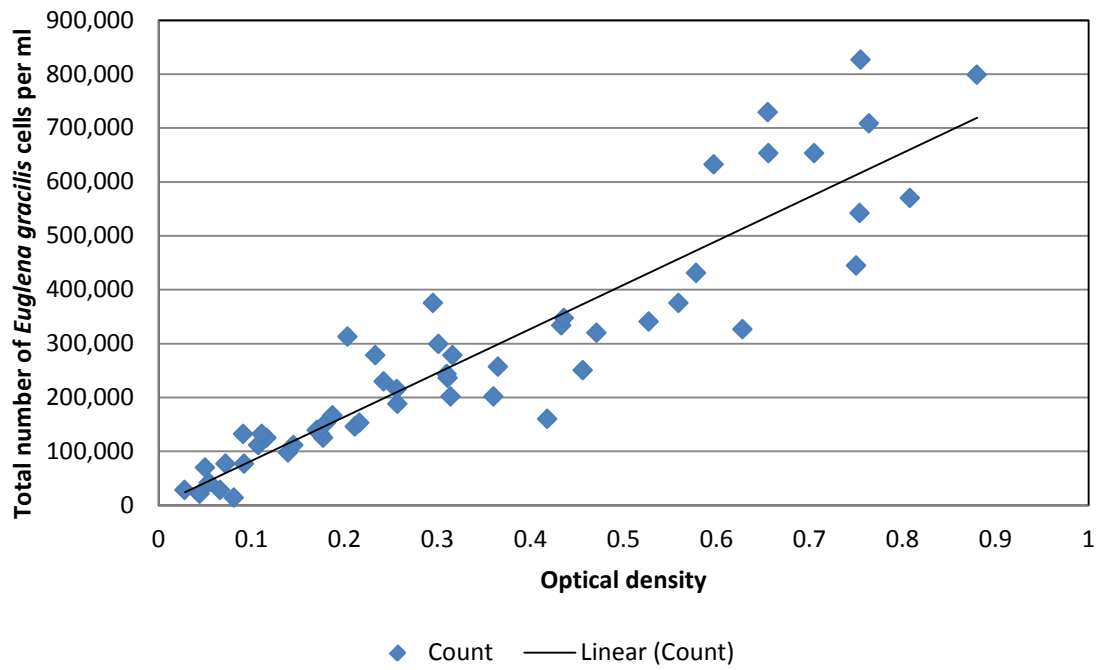

Figure 59 – A graph showing the average total count of *Euglena gracilis* cells at a range of optical density readings

**Appendix 5 – Experiments supporting the development of  
activity 5 – Gas cycling in microorganisms**

## **Experiment one: investigating the time required for a heated water bath to produce visible and reproducible results**

### **Aim**

To investigate the growth of algae by using carbon dioxide produced by Baker's yeast (*Saccharomyces cerevisiae*).

### **Method**

Two grams of Baker's yeast (*Saccharomyces cerevisiae*) and four grams of granulated sugar were placed in a 500ml Buchner flask. Following the addition of 300ml of warm (32°C) tap water, a rubber bung secured the flask. A rubber tube was placed from the outlet to a carbon dioxide diffuser (AquaGro – TMC Ltd.).

Two-hundred millilitres of a solution containing distilled water and store-purchased fertilizer (B&Q plant food) was placed into two beakers, labelled 'Beaker 1' and 'Beaker 2'. A sample of the solution was kept for use as a blank measure for optical density measurements. *Euglena gracilis* (200ml) was added to each beaker. An optical density reading for each beaker was recorded. The Buchner flask was placed in a water bath set at 27°C and the carbon dioxide diffuser secured in 'Beaker 1'. The water bath was heated for four hours a day over a 5-day period. The optical density of each beaker was measured each day (n=3). The experiment was then repeated, changing the time the water bath was heated for from four hours to two hours a day. Optical density readings were collected.

### **Results**

The addition of carbon dioxide from yeast resulted in an increased growth rate of *Euglena gracilis* (Figure 60 and Figure 61) irrelevant of change in duration of heating water. The OD measurements show the flask with added carbon dioxide produces higher levels of biomass.

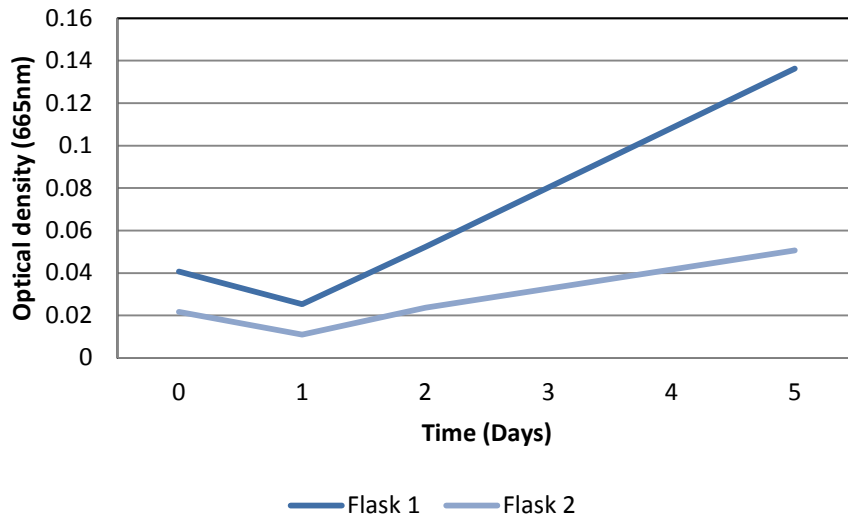

Figure 60 - Optical density readings (n=3) of *Euglena gracilis* measurements at 665nm in the presence of added carbon dioxide (for 4 hours a day) (Flask 1) compared to *Euglena gracilis* in the presence of atmospheric level carbon dioxide (flask 2)

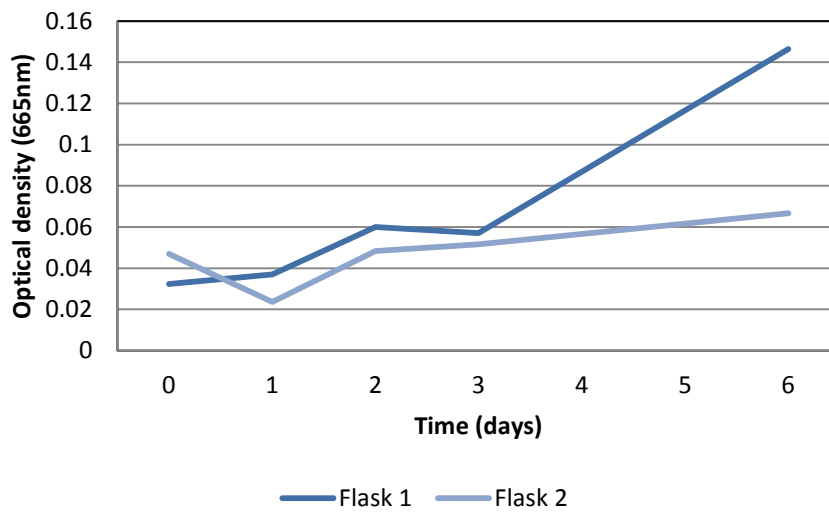

Figure 61 - Optical density readings (n=3) comparison of *Euglena gracilis* in the presence of added carbon dioxide (for 2 hours a day) (Flask 1) compared to *Euglena gracilis* in the presence of atmospheric level carbon dioxide (flask 2)

## **Appendix 6 – Peer-reviewed publications**



## Practical microbiology in schools: a survey of UK teachers

James Redfern<sup>1</sup>, Dariel Burdass<sup>2</sup>, and Joanna Verran<sup>1</sup>

<sup>1</sup>School of Healthcare Science, Manchester Metropolitan University, Manchester, UK

<sup>2</sup>Society for General Microbiology, London, UK

**A survey of secondary school teachers investigated practical microbiology in the classroom. The results were heartening (practical microbiology was common), but concerns were expressed regarding equipment, time, cost, and expertise. Microbiologists should engage more with school education to support teachers and maintain the health of microbiology for future generations.**

Microbiology has a century-long tradition of commitment to science education [1], relying heavily on practical activity in its teaching. Since the introduction of the National Curriculum in the UK in 1988, the content of microbiology in schools has undergone some changes and additions. For example, the Education Act 1996 highlighted the need for education on HIV/AIDS and sexually transmitted infection, with a more recent push to include PCR. Despite this, practical activity in schools is in decline for a variety of reasons (cost, time, curriculum issues, class size) [2]. Some have even suggested that microbiology as a subject is undergoing a change in direction, from the 'classical' techniques to a more molecular focus, and is potentially losing its identity as an individual science [3,4].

A recent report [5] found that among the activities that encouraged or discouraged students from school science, the opportunity to conduct experiments, a chance to learn subjects relevant to the real world, and an aid in future study/career options were positive motivators. An increase in young students interested in any subject will hopefully result in increased numbers of researchers and other professionals in years to come. Thus, microbiologists of today should play a role in the promotion of their subject to maintain its health for the future [6].

There is little evidence available that reveals the extent to which practical microbiology is being performed in schools, and the issues, if any, that prevent teachers from delivering practical microbiology. Thus, a questionnaire-based survey was circulated to over 700 teachers (teaching ages 11–18 years) in the UK. Some 248 responses were received. Responses were gathered from continuing professional development events for science teachers (such as at the national Science Learning Centre) ( $n = 152$ ) and from school membership to the Society for General Microbiology

(SGM) ( $n = 96$ ). Of the respondents, 82% taught students aged 14–16 years, 77% taught 11–14-year-olds, and 42% taught only students older than 16 years. The sample was not restricted to any particular science specialism, and was likely to mainly comprise motivated teachers owing to the data collection routes. The survey focused on three areas:

- Are teachers carrying out practical microbiology activities in schools?
- What are the perceived limitations in delivering practical microbiology?
- To what extent is practical activity valued in teaching microbiology?

It was hoped that results would indicate how practicing microbiologists could help to ensure that microbiology in schools remained relevant, stimulating, and indeed present at all. The majority of respondents (77%) considered science practical activity in the classroom extremely valuable and 67% of respondents found practical activity valuable in the teaching of microbiology. Practical microbiology was utilised by 65.7% of teachers. The respondents provided a total count of 769 activities (averaging approximately three activities per respondent) covering a variety of different topics ( $n = 37$ ) ranging in subject and skill level. Five activities mentioned were not microbiology (investigating animal cells, plant cells, blood smears, DNA extraction from fruit, and cloning cauliflower). The relevant activities addressed a range of principles of microbiology, biology, and science in general (Figure 1). Many of the activities satisfy requirements in the National Curriculum [7], such as 'understanding how science works' (the nature of science) in terms of data collection, evidence, theory, and explanation, as well as the more obvious connection to practical and enquiry skills. In addition, a review of the teaching specifications presented by awarding bodies in the UK (data not presented) highlights topics such as photosynthesis, carbon and nitrogen cycling, adaptation, mutation and variation, microorganisms as pathogens, the use of antibiotics, and other topics that can be mapped onto relevant laboratory activities. However, the survey suggests that teachers heavily favour a small number of activities (Figure 1) over others. This may be for a number of reasons. For example, it has been reported that teachers stick to activities that work year on year [8] owing to fear of a new activity failing, or they may simply misjudge the potential of a new activity to match curriculum goals.

All respondents stated that they faced at least one obstacle to delivering practical microbiology in the classroom

Corresponding author: Verran, J. (j.verran@mmu.ac.uk).  
Keywords: microbiology; education.



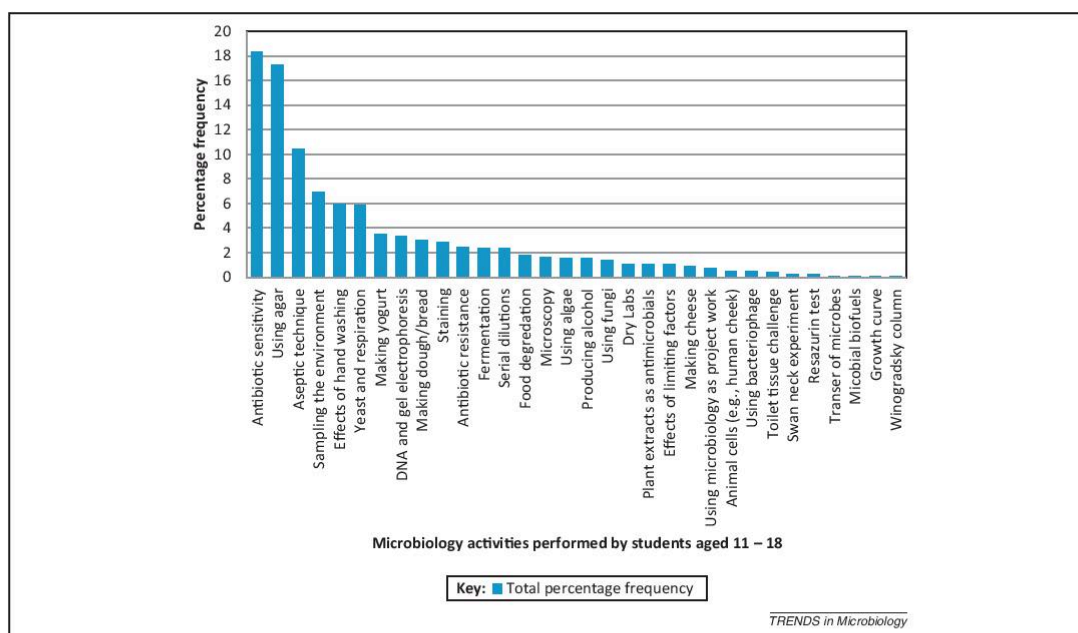

Figure 1. Total count of all 37 activities mentioned in response to the question 'Do you teach practical microbiology? If yes, what type of activities do you carry out?' displayed as percentage frequency.

(Figure 2). Equipment was the most frequently cited limitation (47.6%), followed closely by financial constraints (41.5%). An autoclave and an incubator were considered essential for practical microbiology activity. Both of these items are classed as 'benchmarks' by the science community representing education (SCORE) in the UK [9] owing to their fundamental nature in laboratory experimentation. Nevertheless, alternatives can be found (pressure cooker and room-temperature incubation). A recent survey on resourcing practical science at secondary level provides further evidence that teachers have widespread problems with equipment and finance [10]. It found that biology is the poorest resourced science taught in secondary schools in England; in particular, insufficient quantities of working equipment are available to perform effective practical work.

Data from our survey suggest significant differences between those teaching science/biology for the age groups 11–14 ( $n = 191$ ), 14–16 ( $n = 202$ ), and 16+ years ( $n = 144$ ). Although teachers of the former two age groups found finance to be a limitation, they continue to deliver practical microbiology. Teachers not carrying out these activities did not consider finance to be a limitation. Those teaching students aged 16+ years did not suggest finance as a limitation, but instead highlighted a number of other issues, which included confidence in technique, equipment, technical support, and health and safety concerns. Thus, the support that teachers require depends on the age range they teach. At higher levels of education, some financial outlay is deemed essential for effective laboratory teaching.

The activities carried out for the 16+-year group were of a higher skill level compared to those for the 11–16-year group, for example, using plant extracts to investigate antimicrobial action and PCR. For the latter group, activities were predominantly 'classic' in nature, requiring a lower level of skill. Examples of this include culturing on agar and practicing aseptic technique. These findings suggest that there is recognition that more expertise is required for higher-level delivery.

The Society for General Microbiology is one of the largest learned societies promoting microbiology. It provides significant support to teachers in microbiology education via a school membership scheme, and is regarded as a leading provider of educational resources [11]. The survey investigated whether school membership affected delivery of practical microbiology. The data suggest that those who were not SGM members were significantly more likely ( $P < 0.05$ ) to find equipment, technician support, and reliability/reproducibility a barrier to their use of microbiology compared to SGM members. This finding clearly demonstrates the value of appropriate professional support for the delivery of microbiology in schools.

Overall, although the educational benefit of practical microbiology was acknowledged throughout the survey, many teachers encounter difficulties with delivery and in identifying the relevance of laboratory activities to the curriculum. Results from the survey indicate that teachers hold certain misconceptions about excessive cost, technical difficulty, reproducibility/reliability, and health and safety aspects of performing microbiology in the classroom. All of these limitations could be addressed using



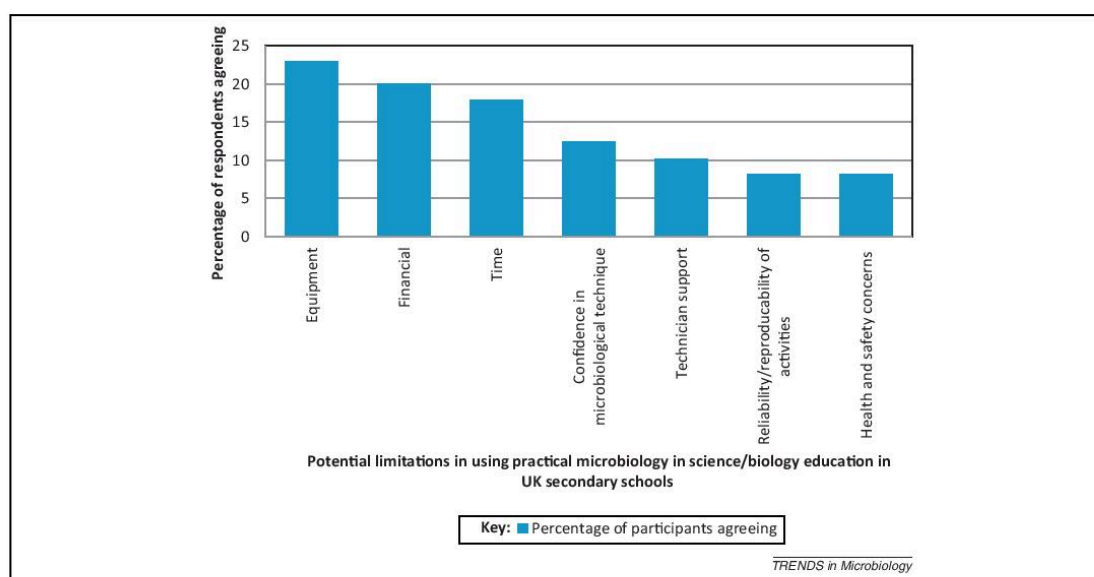

Figure 2. Percentage frequency of the number of agreements when asked if any of the variables listed limited their teaching of practical microbiology.

trusted and tested practical resources. Currently, activities provided by learned societies and other organisations are almost implicitly deemed usable, reliable, and trustworthy owing to the professional standing of the originator. However, if such organisations were to follow a more research-based procedure to develop, trial, and test activities focused towards curriculum goals, then a more robust framework could be provided.

In a 'free text' section of the survey, teachers noted that students enjoyed the subject of microbiology as a whole, but that 'the National Curriculum (NC) chokes creativity' (one comment); another teacher suggested that the NC does not provide the time for practical microbiology, possibly restricting student interaction with the science. However, microbiology is well represented in the NC and teaching specifications [12]. In addition, microbiology offers a range of opportunities for teachers to utilise microorganisms to demonstrate other phenomena, such as using algae to demonstrate photosynthesis and the effects of pollutants, or yeast to demonstrate gas cycling [13]. Thus, this preliminary survey has highlighted areas for future investigation, particularly with regard to obstacles surrounding practical microbiology and school science.

There are two audiences keen to increase their encounters with practical microbiology: teachers and students. One way to address this need is to provide effective two-way communication between subject 'experts' and teachers. It is important that teachers, especially those who may not be biology/microbiology specialists, are encouraged to utilise microbiology in the laboratory. Professional practicing scientists who understand the subject should be able to provide this support. The reward for such efforts could be significant. By getting involved in the development of low-cost, reliable, and inspirational practical school activities that illustrate concepts required by the NC, troubleshooting

when problems are encountered, and ensuring relevance and impact to the world at large, these professional scientists can help in increasing the number of students who become interested in the field. Microbiologists who take part in initiatives developed via organisations and learned societies will strengthen the link between school students, teachers, and academia. Hopefully, this will result in more microbiologists and researchers in years to come. Thus, professional microbiologists should be prepared to play a greater role in the promotion and delivery of their subject in schools to ensure its health for the future.

#### References

- Handelsman, J. (2002) Microbiology as a change agent in science education. *ASM News* 68, 163–167
- CaSE (2007) *Secondary Science Education*, CaSE
- Pelczar, M.J. (1991) Microbiology education in the United States: the issue of balance. *World J. Microbiol. Biotechnol.* 7, 517–521
- Bennett, J.W. and Karr, J. (1999) 'The branches into which bacteriology is now ramifying' revisited. *Yale J. Biol. Med.* 72, 303–311
- The Wellcome Trust (2013) *Tracking Public Views on Science, Research and Science Education*, Wellcome Trust Monitor Report Wave 2, The Wellcome Trust
- Bassler, B. (2011) Letter to the editor. *J. Microbiol. Biol. Educ.* 12, 2
- QCA (2007) *Science Programme of Study for Key Stage 4*, Qualifications and Curriculum Authority
- Appleton, K. (2002) Science activities that work: perceptions of primary school teachers. *Res. Sci. Educ.* 32, 393–410
- SCORE (2012) *Secondary School Benchmark Equipment and Consumables*, SCORE
- SCORE (2013) *Resourcing Practical Science at Secondary Level*, SCORE
- Editorial (2012) The next generation. *Nat. Rev. Microbiol.* 10, 157
- AQA (2012) *GCSE Biology Specification 4401*, AQA
- Redfern, J. (2012) *Algae: A Practical Resource for Secondary Schools*, Society for General Microbiology

0966-842X/\$ – see front matter © 2013 Elsevier Ltd. All rights reserved.  
<http://dx.doi.org/10.1016/j.tim.2013.09.002> Trends in Microbiology, November 2013, Vol. 21, No. 11

## Case study

# Transforming a school learning exercise into a public engagement event: 'The Good, the Bad and The Algae'

James Redfern<sup>a</sup>, Darrel Burdass<sup>b</sup> and Joanna Verran<sup>a</sup>

<sup>a</sup>School of Healthcare Science, Manchester Metropolitan University, UK; <sup>b</sup>Society for General Microbiology, Reading, UK

School science laboratory classes and hands-on public engagement activities share many common aims and objectives in terms of science learning and literacy. This article describes the development and evaluation of a microbiology public engagement activity, 'The Good, the Bad and the Algae', from a school laboratory activity. The school activity was developed as part of an educational resource which aimed to promote practical microbiology in the classroom. The public engagement activity was devised locally for National Science and Engineering Week 2011 and was subsequently adapted for a national science and engineering fair (The Big Bang 2012). The aim of the session was to raise awareness of the importance of algae and to encourage hands-on laboratory examination in a fun and informal manner. Evaluation of the first event, delivered in a workshop format, helped shape the educational resource before publication. The second event was modified to enable delivery to a larger audience. Both events were successful in terms of enjoyment and engagement. Over 2200 people participated in the Big Bang activity over three days, with evaluation indicating 80% of participants had increased awareness/knowledge of algae after the event. The success of both iterations of the activity demonstrates that it is possible to transform a simple school activity into an exciting and effective public engagement activity.

**Keywords:** microbiology education; public engagement; learning activities

### Introduction

Developing a new and effective hands-on science engagement activity can be challenging with respect to choosing which topics and scientific principles to highlight, but a trawl through the school curriculum can trigger ideas. As with any subject, it might be argued that the profile and development of a particular scientific field relies heavily on the initial inspiration and continued engagement of young students (Rowen et al. 2010). Microbiology poses particular problems in this context, due to perceived health and safety issues. Even in schools, teachers and technicians may be reluctant to deliver practical classes, due to unfamiliarity with procedures and anxiety regarding contamination. However, there is little cause for con-

cern. The Control of Substances Hazardous to Health regulations control activities carried out in the school science laboratory, and all activities must undergo a risk assessment. Support material (ASB 2001) suggests that as long as good laboratory practice is followed and aseptic technique is properly employed, along with knowledge of the micro-organism being handled (including methods of disinfection and disposal), practical microbiology should not be disregarded due to the notion of a health and safety risk.

The small size of micro-organisms (bacteria, fungi, protozoa and algae) necessitates the use of microscopes (viruses cannot be seen under the light microscope). Even simple microscopes can be relatively expensive,

Corresponding author: Joanna Verran, Manchester Metropolitan University School of Healthcare Science, Manchester, UK. Email: J.Verran@mmu.ac.uk

and their quality will impact on the calibre and beauty of the images obtained, probably due to low resolution. In addition, the culture of micro-organisms typically requires more than 18 hours of incubation; thus a second visit to the laboratory – or an alternative means of disseminating results – is essential.

School-level science teachers have to overcome these obstacles when teaching microbiology. Often, preparation and delivery time is limited, equipment is basic (in comparison with that of a university) and teachers are delivering activities alone, or with limited technical support (SBS 2004), to a class of students. It is also difficult to keep students – particularly high school students – motivated throughout a science class (Martin et al. 2000; Rennie, Goodrum, and Hacking 2001). Research suggests that situational interest (a type of short-term motivation) in a classroom environment is achievable by incorporating three key experiences – novelty, choice and social involvement (Palmer 2009) – with novelty being the most powerful in terms of generating interest arousal. For example, situational interest can be successfully generated in school students in an out-of-class environment such as a museum (Benderup Dolin 2011; Zeldosova and Prokop 2006). The removal of classroom science limitations (such as time, equipment or expertise) means that when delivering science in an informal setting such as a science fair, science communicators can utilize novelty, choice and social interaction to enhance their engagement with participants. It has also been suggested that in terms of teaching scientific knowledge, practical activity in the classroom should provide a simplified version of science, making it easier to understand (Raisz 2012), and be seen as a *discovery exercise* rather than a *discovery exercise* (Miller 2004). Some of these experiences use founding principles on which scientific public engagement activities are built, encouraging social involvement whilst enabling learning (Bell et al. 2009) more overtly than the more formal classroom setting. However, public engagement allows science to be presented in different ways to the conventional school science laboratory. There is clearly commonality between the demands and rationales underpinning school-based practical classes and public engagement activities, but there is little literature on the topic. Therefore, effective and stimulating exercises delivered in schools ought to be a good source of inspiration for development into science public engagement events for different audiences.

Within the field of microbiology, many innovative and engaging school activities have already been developed despite the constraints of the school curriculum specifications – some examples include photosynthetic jelly balls (Hidridge 2004), building microbial fuel cells (NCRH 2012) and 'Microbes Are My Homework – Microbes and Cellulose' (Fry et al. 2008). In addition, many exciting public engagement activities that do not require expensive equipment

such as microscopes have been delivered. Examples include illustrating the importance of handwashing using fluorescent dye and UV light (Burdan 2010), 'How the Mushroom Got its Spore' (Asimier 2011) and the linking of vampire and zombie literature with microbiological concepts of disease and epidemiology (Groves 2011; Verma 2010, 2012).

This article will describe the development of a microbiology science communication activity, 'The Good, the Bad and the Algae', from a school learning activity. This, in turn, had been developed as a means of encouraging the use of microorganisms in schools, using algae as a vehicle to illustrate a range of concepts noted in the GCSE subject criteria for biology (Ofqual 2009).

### School laboratory activity

'Algae: a practical resource for secondary schools' (Redfern 2012) is a 76-page, full-colour educational resource pack that focuses on the use of algae (microorganisms) in the school laboratory. The pack contains comprehensive instructions for the delivery of five practical activities targeted at Key Stage 3 and 4 students (ages 11 to 16). The five exercises were developed with reference to the GCSE curriculum, enabling a range of key skills and concepts (classification, microscopy, photosynthesis, effects of pollution, evolution, adaptation and bioluminescence and gas cycling) to be addressed using algae rather than plants or other organisms, and were trialled with a number of target audiences (including teachers – both experienced and newly qualified – and students).

The first of the five activities is entitled 'Identifying microalgae using a microscope'. The aim of this exercise is to introduce algae as a diverse group that are classified as microorganisms, to describe and enable the effective use of a (school) light microscope and to learn to use an identification key. Biologists use identification keys to visually classify an organism. The user selects from a number of contrasting statements relating to a single characteristic. This is repeated over a number of stages until identification is derived (Payne 1988). Printed A3 copies of the identification key are included in the algal resource (Figure 1).

The key encompasses fifteen species of microalgae, which present a range of colours, shapes and mode of movement. Students are given 'unknown' species of algae to observe and are asked to use the key to identify the unknown cultures. Algae are relatively large (compared to other microorganisms) and therefore easy to locate under a microscope, which enhances audience satisfaction. Different species of algae often look strikingly different from one another, forming aggregates of unusual shapes and structures (mass, balls, strings etc.), in a range of colour (although predominantly green). Once found



**Figure 1.** The identification key supplied with the educational resource 'Algae: a resource for secondary schools', which formed the basis for the public engagement activity 'The Good, the Bad, and the Algae'

under the microscope, their appearance provides ample 'wow' factor. Additionally, algae are safe to handle (ASR 2001), cheap and easy to obtain or purchase. There are no safety issues regarding disposal and decontamination.

Algae have a significant impact in the world around us. Being primary producers (at the start of the food chain) and photosynthetic (with oxygen production powered by sunlight), they are essential in the upkeep of the majority of life on earth. They are used in the production of toothpaste (Yeh 1986), ice cream and other foods (Cardoso et al. 2008), health and beauty products (El-Nokaly 1997), biofuels (Singh and Gu 2010) and in some less obvious applications such as dynamite (Meyer 1990). The first activity in the resource enables discussion regarding the impact of algae on day-to-day life. Alongside hands-on scientific skills, specifically microscopy and using an identification key, it allows students to conceptualise what they are doing with reference to their own experiences. They are then more likely to construct their scientific concepts in dialogue with peer investigation (Miller and Driver 1987): understanding these 'real-life' connections allows learners to relate what is in their textbooks to the world around them (Miller 2011).

The algae learning resource was developed as part of a research project in a higher education setting;

therefore, current research literature was used to shape the resource. Progress was disseminated at scientific conferences and advice was sought from key researchers in the field. At the British Psychological Society (<http://www.bps.org.uk>) winter meeting in 2012, contacts were made and contributions given by other delegates, enabling enhancement of the resource, which would subsequently impact on the public engagement activity. The resource was published and launched at the Association for Science Education (<http://www.ase.org.uk/>) conference in January 2012.

### Public engagement event: low-throughput, intensive laboratory workshop

The practical activity was developed into a public engagement event for the National Science and Engineering Week (NSEW) 2011 by the team who had developed the original school activities. It was presented at a family fun day at Manchester Metropolitan University (MMU), where the Faculty of Science and Engineering hosted a series of activities promoting science and engineering to family audiences. The activity was given the catchy title 'The Good, The Bad and the Algae', to highlight the importance of algae compared with other, better known groups of

microorganisms. The workshop was hosted in the microbiology teaching laboratory within the university, and ran three times during the day. Each session required three or four demonstrators to ensure that health and safety regulations were adhered to and that learning opportunities were available for all participants. A maximum of twenty people per session was specified, and each session lasted one hour. The aim of the session was to raise awareness of the importance of algae and to encourage hands-on laboratory examination in a fun and informal manner. The session began with an illustrated five-minute introduction on the importance of algae, focusing on their use and relevance to everyday life (in a question-and-answer format), and a demonstration on how to use a light microscope. The audience were provided with nine 'unknown' algae cultures to identify using a working version of the identification key, and ten microscopes were available. Additionally, 'model magic' (Crayola™, Bedford UK) – white air-drying modelling clay – was provided for participants to make a model of their favourite alga to take home in a Petri dish for painting (Figure 2). The activity therefore incorporated the three elements of 'situational interest' noted previously: novelty, choice and social involvement. There was no stated learning outcome for the workshop, but the aim was to increase awareness of algae, the science laboratory and the university, as well as providing an introduction to light microscopy, which can prove challenging (Duce, Couch, and Keeling 2012).

Each session was fully attended by an audience of predominantly families (with children of early school age up to grandparents). The atmosphere was friendly and interactive, and questions were encouraged. Many participants – children and adults – commented on the size of the algae, having not previously realised how small and attractive they were. The importance of algae to the planet – for example, the fact they produce over 50% of the world's oxygen – was also a surprise: many adults

had assumed that algae was just green pond scum'. To encourage continued engagement, a photo competition was launched, entitled 'Manchester's best algal biofilm' (a biofilm is a community of algal cells that grow from a moist surface). Entries were uploaded to a dedicated Flickr™ photo-sharing group. Details of the competition were printed on algae-themed postcards. The winning photograph received a Giant Microbe™ (Giantmicrobe Inc, Delaware, USA) alga soft toy. Participants at the event were asked to write one new fact or one point of interest on a sticky note. These were then posted near the exit door and collated for feedback; where appropriate, 'fascinating facts' and comments were noted for incorporation into the teaching resource.

There were several aspects of the event that people enjoyed. Being in a university laboratory, listening to (brief) formal presentations, wearing a white laboratory coat and using high-quality microscopes provided a sense of 'real science'. The majority of family groups were unwilling to leave the laboratory until they had identified all nine of the unknown species. The modelling activity was successful but not essential (because of the popularity of the microscopes), with almost all children leaving the session with a model. In addition, the use of the identification key enabled some improvements/developments to be made to the school resource, with some of the dichotomous choices moved to allow for an easier flow. Language (specifically scientific terminology) was also simplified. Images of each alga were inserted into the key (next to the name at the end of each identification) to support self-assessment of success.

The day was tiring for the demonstrators involved, but was deemed successful. Having the sessions in a working laboratory provided a great opportunity for those participating, but extra care had to be taken to ensure safe operation. A low bench was available for wheelchair-bound participants. Some children were so small that for health and safety reasons, they were unable to wear a university lab coat (these were provided in standard adult sizes, posing a trip hazard to small children). Children's lab coats will be purchased for future events.

### Public engagement event: high-throughput, reduced hands-on activity

The Big Bang Science Fair is the largest science fair in the UK, focusing on science and engineering. It runs annually and is attended by upwards of 56,000 visitors over a three-day period (The Big Bang, 2012). The audience primarily consists of groups of school students (for two of the three days) and families (for one day). The floor plan provides each exhibitor with an allocated space which students can



**Figure 2.** Examples of models made during the workshop using the modelling clay provided

visit at any time, with interaction not being time-constrained. The fair is split into zones, keeping similar subjects together. 'The Good, the Bad and the Algae' was modified to best engage this high-throughput audience and was delivered by the Society for General Microbiology, the largest learned microbiology society in Europe (SGM n.d.), located in the Body Zone, along with the majority of life sciences exhibition.

The move from a controlled laboratory setting to a 'drop-in' activity provided new challenges, although the intended aims were similar to those of the MMU event. Based on previous Big Bang experiences, it was highly likely that large groups of students (from the same school) would take part in the activity at the same time. Previously, the activity had been run as a workshop, with a defined audience size. Here, students were free to approach the activity as and when they wished; thus, there was no time to 'close' the activity in order to rest. The smaller space (4m x 4m) available at the festival compared to the original laboratory setting (21m x 9m) limited the amount of 'working' space available. Microscopes with an attached LCD screen (Coleman LCD Digital Microscope 44345) allowed for large numbers of students to see the algal cultures at the same time. The number of algal cultures was reduced from nine to six. Students (and adults) were typically drawn to the microscopes, and were excited to see mobile microorganisms on display. Students were encouraged to use the microscopes carefully, under direct supervision of the demonstrator (they were not allowed to handle the glass microscope slides). Since the interaction time per visitor was less than in the laboratory workshop setting, the dialogue between student and demonstrator was inevitably more focused, beginning with simple questions such as 'Do you know what algae are?' Emphasis was placed on getting 'cool facts' across to students, in particular applications of algae in the 'real world'.

It was obvious that all participants were fascinated with the (small) size and (high) number of microorganisms present in samples, but this was difficult to conceptualise and explain. In science, and particularly in microbiology, scale is easier understood if comparisons are made to something larger (Nature Reviews Microbiology 2011), encouraging the engagement of audience imagination, an essential element in successful science communication (Bray, France, and Gilbert 2011). Colleagues at the British Psychological Society 2012 winter meeting (June Lewis, personal communication, January 2012) had suggested the following scale-up activity. A perspex box (60cm x 60cm x 120cm) was constructed, representing a 200x scale-up from half a drop of water (10 $\mu$ l). Visitors made Plasticine<sup>®</sup> (Flair Leisure Products Plc, Surrey UK) models of their favourite algae (having already viewed some under the microscope) using a 2cm<sup>3</sup>

template. The models were suspended in the box using fishing wire (Figure 3), to highlight how many algae could fit into a drop of water. Visitors were told there were on average around 200 algae in every half drop of water in an average summer pond (June Lewis, personal communication, January 2012).

A second addition was the introduction of 3D maggyphs (courtesy of Chris Carter, British Psychological Society member). These were images of different algae projected on to a 42-inch LCD which, when viewed using 3D red cyan glasses, could be seen in 3D. These images provided a useful attraction to the stand, drawing participants in.

In order to gauge attendance and engagement, visitors received a 'The Good, The Bad and the Algae' sticker. The number of stickers given out was recorded. Over the three days of the event, more than 2200 people participated. The total number of Plasticine<sup>®</sup> models was 840, and 303 sticky notes were collected.

Defining and using an outcome for science learning in an informal setting has always been difficult (Bell et al. 2009), and it has been particularly noted that good evaluation should provide an insight into activities' impact on young students (DCSF 2009). It was noted by the demonstration team on the day that participants found the activity intriguing and exciting, with a general theme of amusement when they were able to visualise the algae under the microscope. So as not to interfere with activities, sticky notes (written by participants, predominantly students, after completion of the activity) were again utilised to record key observations. These were analysed post-event and consequently divided into four categories:

- 'scientific' (factual), such as 'today we learn that algae is not a plant but a microorganism' (etc) or 'algae is living and can move';

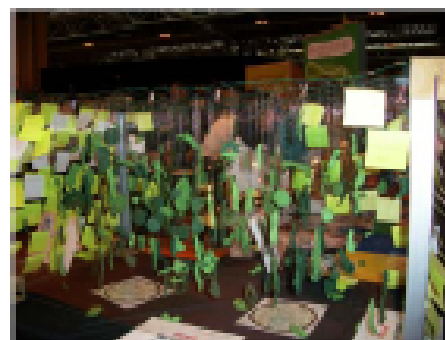

**Figure 3.** The perspex box, which was used to illustrate half a drop of water, magnified x200. Hanging inside are Plasticine<sup>®</sup> algae models made by participants at the event



- 'application', such as 'in ice cream and tooth paste'(sic);
- 'visual', such as 'the colour of algae is green';
- 'other', such as 'algae names are hard to pronounce' and 'I think algae is excellent' (sic).

Verbal feedback during the event was positive, particularly from schoolteachers, parents and organisers of other events running parallel at the Big Bang. Of particular note was the accessibility of the activity for all, with varying levels of skill being required, from low-difficulty (manual; making the models) to more challenging tasks (manipulative and intellectual; using the microscopes and comparing identification of a micro-organism).

Of the 303 sticky notes collected, 51.2% were of a scientific nature while 31% referenced an application. A smaller proportion of 14.8% was categorised as 'other', while only 3% noted a visual impact. Thus it might be inferred that some scientific impact or application had been noted by over 80% of the participants. Verbal feedback on the day supported the notion that learning was taking place. Retention of the information post-event was not considered – no mechanism was in place to carry this out – but it has been shown that an activity with a 'wow' factor (like the model, algal species) contributes towards making an event memorable (Palmer, 2009). The Society for General Microbiology is now using the entire event package as a mobile activity for other science festivals.

## Conclusion

The focus of the event was primarily directed towards topic content and development of ideas on how to best present to the targeted audience. Evaluation methodologies were not considered during development, although several formative evaluations were carried out using students, teachers and the general public; thus, the activities lacked a full summative evaluation. It is therefore not possible to comment on the impact the activities may have had, but the aim was to bring an element of microbiology to the wider public audience and inspire the participants to consider the use of algae as an example of a micro-organism and their importance – aims which the demonstration team agreed had been achieved, as evidenced by participant interaction and verbal feedback. It has been suggested (Bell et al. 2009) that feelings of excitement, delight, awe and surprise can be used to monitor success of a delivery via participant pleasure and that emotional responses such as these may hold long-lasting value, although this evidence is somewhat anecdotal (Royal Society 2004; Smith 2012). The event was successful in this respect, with the majority of participants exhibiting these types of emotional responses. Although it is always a good idea to provide a full and rounded

summative evaluation, many of the measures commonly used to do this in a public engagement activity, such as questionnaires, interviews and focus groups (Bosworth and Vassian 2013), are not practicable in the settings in which the activities were delivered (that is, in a time-restricted workshop and in a science fair). The sticky notes allowed the organisers to gauge key messages regarding the participants' enjoyment and learning.

The success of both iterations of 'The Good, The Bad and the Algae' demonstrates that it is possible to transform a simple school activity into an exciting and effective public engagement activity. School practical classes and public engagement activities both require a specific learning-based outcome, and both should be interactive, interesting, stimulating and open-ended (Miller 2004) for the participant. The work described in this paper shows that by removing the limitations of a science laboratory, a school science activity can be opened up and developed into an engaging interactive event. Equipment (such as LCD microscopes) and techniques (use of 3D images on a television monitor or investigating scale using Rusticus® models) not typically found in the classroom can be used to encourage situational interest. There is considerable potential for those interested in developing an activity for public engagement to seek inspiration from successful practices in the school science laboratory.

## Acknowledgements

Thanks are due to the Society for General Microbiology for funding this work and providing permission for inclusion of figures. Thanks are also due to Vicki Syrington for organising and delivering the Big Bang event on behalf of the Society for General Microbiology.

## References

- AOB. 2001. *Topic Co-Supply*. Cambridge: AOB.
- Asanley, S. 2011. How the Madrasans got in. *Spice and Other Stories: Microbiology Today* 20: 33.
- Bell, P., S. Lomascolo, A. W. Steiner, and M. A. Fisher. 2009. *Learning Science in Informal Environments: People, places, and practices*. Washington, DC: The National Academies Press.
- Bondrup, D. 2011. "Emotional Interest of High School Students who Visit an Aquarium." *Science Education* 95 (2): 227–27.
- Bourcier, L., and K. Yoncas. 2012. *Science Communication: A Practical Guide for Scientists*. Chichester: Wiley-Blackwell.
- Bray, R., S. France, and J. K. Gilbert. 2011. "Identifying the Essential Elements of Effective Science Communication: What do the experts say?" *International Journal of Science Education*, 33 (1): 22–31.
- Burke, D. 2010. *SBM Shows Brightly at the Big Bang*. *Microbiology Today* 19: 1.
- Carlson, K. M. M., T. Shandini, M. P. Burns, V. R. Filson, A. P. Torres, M. P. Lopez, and S. Pizzo. 2008. "Metabolites from Algae with Neurological Impact." *Combinatorial Biochemistry and Physiology: Part C: Toxicology & Pharmacology* 146 (3–4): 10–18. doi: 10.1002/cpt.2008.08.027.

- DCSP. 2008. *How to Help? Help Evaluation: How to Help*. York: Department for Children, Schools and Families.
- Driver, K., B. Gresh, and P. J. Keeling. 2002. "Increasing Student Understanding of Microscope Optics by Building and Testing the Limits of Simple, Hand-Made Model Microscopes." *Journal of Microbiology and Biology Education* 13 (2).
- El-Pakdy, M. 1993. United States Patent No. 5,288,831. U.S.P. Office.
- Hirshige, D. 2004. *A Novel Approach to Photographic Processes*. *Micro Science Review* 9 (202) 9.
- Huy, P., J. Grayson, J. Hark, J. Truett, P. Wynne, and D. Barkin. 2008. *Practical Microbiology for Secondary Schools*. Reading, UK: SSM.
- Green, J. 2003. *Monoclonal Antibodies: Highly Infectious. These Higher Education Supplement*, October 23, 20-3.
- Marin, M., I. Mulla, S. Gensler, K. Gregory, T. Smith, S. Christensen, ... K. O'Connor. 2008. *TEMM2 1999 International Science Report*. Boston, MA: International Study Center Lynch School of Education, Boston College.
- Meyer, S. 1990. "Industrial Exploitation - a Brief History of Their Development and Use." *Journal of Microscopy* 123 (2): 93-101.
- Miley, R. 2004. "The Role of Practical Work in the Teaching and Learning of Science." Paper presented at the High School Science Laboratories Study and Vision, National Academy of Sciences, Washington, DC.
- Miley, R., and K. Driver. 1992. *Report processes: Studies on Science Education* 14(1): 33-43.
- Miley, A. 2011. "The Use of Current Events as Assessment Tools." *Journal of Microbiology & Biology Education* 22 (1): 69-70.
- Nature Reviews Microbiology. 2011. "Microbiology by Numbers." [DOI:10.1038/nrm2684]. *Nature Reviews Microbiology* 9 (5): 438.
- PCR20. 2012. *Microbial Fuel Cell*. <http://www.che.washington.edu/PCR20/MATERIALS/MATERIALS/index.html>.
- Cligal. 2009. *CCSE Subject Guide for Biology*. Coventry, UK: Cligal.
- Palmer, D. H. 2008. "Student Interest Generated During an Inquiry-Based Lesson." *Journal of Research in Science Teaching* 46 (2): 147-65.
- Pigg, R. 1980. "Identification Keys and Diagnostic Tables: A Review." *Journal of the Royal Statistical Society* 143 (2): 283-92.
- Reidies, J. 2002. *Algebra: A Practical Resource for Secondary Schools*. Reading, UK: Society for General Microbiology.
- Rice, M. 2012. Learning out of the Classroom. In *ASB Guide to Research in Science Education*, ed. J. Crowley, 93-98. Hatfield, UK: The Association for Science Education.
- Reidy, L. J., D. Goodson, and M. Hocking. 2001. "Science Teaching and Learning in Australian Schools: Results of a National Study." *Research in Science Education* 31 (2): 489-98.
- Reidy, L., D. Reidy, D. Zacher, C. Murray, M. Miles, B. Reedy, and D. Ringland. 2010. "Spreading the Microbiology Message: An Alternative to Traditional Media Campaigns." *American Journal of Science* 108 (7): 340-4.
- Science Royal. 2008. *Taking a Lead Role: A Good Practice Guide for all those Involved in Self-Motivated Learning in Inquiry-Based Science, Engineering and Technology*. London: The Royal Society.
- SSS. 2008. *The Society of Secondary School Science Teachers*. [www.sst.org.uk/documents/SSS45200803.pdf](http://www.sst.org.uk/documents/SSS45200803.pdf).
- SSM. n.d. SSM About SSM Introduction. <http://www.ssm.ac.uk/about/>.
- Stagh, J., and S. Gu. 2010. "Commercialisation Potential of Microalgae for Biofuels Production." *Renewable and Sustainable Energy Reviews* 14 (9): 2389-93.
- Smith, C. 2011. "High School Students' Emotional Responses to Science Reading and Academic Reading Engagement Relationships in Science Achievement." Paper presented at the Library Research Association, San Diego, CA, 20 November.
- The Big Bang. 2012. About The Big Bang Site. [http://www.thebigbang.org.uk/about/about\\_page.htm](http://www.thebigbang.org.uk/about/about_page.htm).
- Vernon, J. 2010. "The Microbiology of Vampires." *Microbiology Today* 20 (2).
- Vernon, J. 2012. Public Engagement Grants: Microbes, maths... and microbiology. *Microbiology* 13 (2).
- Yeh, H.-C. 1991. United States Patent No. 4,811,991. US Patent.
- Zakarias, K., and P. Bakken. 2008. "Education in the Field Influences Children's Views and Interest Towards Science." *Journal of Science Education and Technology* 18 (2-4): 324-33.

## **The development of a new practical activity: Using microorganisms to model gas cycling**

**James Redfern<sup>1</sup>, Dariel Burdass<sup>2</sup> and Joanna Verran<sup>1</sup>**

<sup>1</sup> Manchester Metropolitan University, <sup>2</sup> Society for General Microbiology

\*\*Joanna Verran is the corresponding author for this publication (J.Verran@mmu.ac.uk)

### **Brief description**

This article describes a simple practical activity that illustrates gas cycling. Algae produce oxygen which is used by yeast, and yeast produce carbon dioxide which is used by algae.

### **Abstract**

For many in the school science classroom, the term 'microbiology' has become synonymous with 'bacteriology'. By overlooking other microbes, teachers may miss out on powerful practical tools. This article describes the development of an activity that uses algae and yeast to demonstrate gas cycling and presents full instructions to enable the exercise to be delivered in a classroom.

### **Introduction**

Microbiology relies heavily on practical activity for demonstration of key principles. For many in the school science classroom, the term 'microbiology' has become synonymous with 'bacteriology', with images of petri dishes, autoclaves and infection springing to mind. However, other microbes, in particular algae, offer interesting means for delivering a range of concepts to students. Use of algae in the classroom reduces health and safety concerns (ASE, 2001), and as microorganisms, they are comparatively large in size, have microscopically visible

colours and shapes, and are easy to acquire and maintain at relatively low cost. In addition to providing simple vehicles to demonstrate photosynthesis, phototaxis and bioluminescence, they also offer potential for use as biofuel (a source of energy derived from carbon fixation) (Waltz, 2013).

Nevertheless there are relatively few activities that are widely available, for example, immobilising algae in hydrogen carbonate (Eldridge, 2004), promoted by Plants and Science for Schools (SAPS). Recently, the Society for General Microbiology (SGM) has published a resource demonstrating the use of algae in the high school laboratory (Redfern, 2012). This article focuses one of the activities, namely, making a practical 'model' to demonstrate gas production and cycling.

#### Development of the activity

The original activity intended to enable students to culture algae in order to attain sufficient biomass that would allow separation of cells from culture medium. This was, followed by release of the oil stored inside the cell, and use of the resultant extract to demonstrate a source of energy, for example as an 'algae candle'. However, the methods required to extract biofuel seemed to be too complex to perform in a school laboratory because significant volumes (likely upwards of 40 litres) of algae would be required. One problem encountered when attempting to obtain sufficient biomass was that the level of carbon dioxide present in the laboratory atmosphere was not sufficient (i.e. carbon dioxide was the limiting factor). Inspiration arrived following a demonstration of yeast respiration (producing carbon dioxide) at the Big Bang science fair (Symington, 2011). Participants captured the gas (CO<sub>2</sub>) produced by yeast cultures in a latex balloon. After a designated time (usually about 20 minutes) the circumference of the balloon, was measured, and plotted against time on a graph. This activity is

available as a free download within the resource 'Marvellous Microbes: The Pasteurs' (Symington, 2010).

This observation led to the development of an investigation to explore whether one microorganism (*Saccharomyces cerevisiae* - Baker's yeast a microorganism used in the production of bread) could be used to promote the growth of another microorganism (*Euglena gracilis* – a species of alga). Although the activity had moved away from the original concept of 'biofuels', it now enabled demonstration of production of carbon dioxide from aerobic respiration of the yeast, being delivered to a culture of algae for use in photosynthesis. As part of the development strategy, the activity was successfully trialled with students and teacher as described below.

### The activity

The activity is written as a 'student guide'. Additional information required by the teacher can be found in the subsequent 'Notes' section. The activity could be used to demonstrate the following topics found within the Key Stages 3 and 4 of the National Curriculum (of England, Wales and Northern Ireland):

Energy and biomass in the food chain,

The carbon cycle,

Photosynthesis,

Organisms and their environment,

Environmental changes,

Symbiotic relationships,

Microbes in industry, among others.

### Aim

To demonstrate how the growth of one microorganism can benefit the growth of another

### Materials

- Dried Baker's yeast (available at most supermarkets)
- Containers for algal cultures – preferably glass beakers. Must be permeable to light.
- Sugar
- Buchner flask
- Rubber bung
- Rubber piping
- Carbon dioxide diffuser\*
- Fertilizer – common plant food will do
- Algae – 2 x 25 ml per model (*Euglena gracilis*)
- Cuvettes
- Pipettes
- Beaker of disinfectant (discard pot containing Virkon® or something similar)
- Colorimeter
- Water bath

\* *The carbon dioxide diffuser should be small enough to fit inside the container. Diffusers can be purchased from pet shops, which sell equipment for aquatic plants (cost usually less than £10). They work by providing a high surface area from which the carbon dioxide can diffuse into the water.*

## Method

### Stage 1 Setting up the investigation (see figure 1)

[Fig 1 near here]

1. Place 2 g (approximately 1 heaped teaspoon) of dried Baker's yeast (*Saccharomyces cerevisiae*) and 4 g sugar (approximately 2 teaspoons) into a 500 ml Buchner flask.
2. Fill the Buchner flask with 300 ml of warm tap water, 32°C to 38°C, and place a rubber bung on top of the flask (note: the exact temperature is not critical, we found it suitable to mix equal quantities from our hot and cold tap water supply).
3. Attach the rubber piping to the glass nozzle protruding from the Buchner flask.
4. Label two beakers 'Beaker 1' (control) and 'Beaker 2'.
5. Fill 'Beaker 1' and 'Beaker 2' with equal volumes of tap water (at room temperature).
6. Add equal amounts of fertilizer to 'Beaker 1' and 'Beaker 2' (the mass of the fertiliser should be determined by following the supplier instructions on the container). The fertilizer will help the algae to grow.

### Calibration of colorimeter

Use the liquid in 'Beaker 1' (control) to calibrate the colorimeter at wavelength 665 nm.

Gently swirl 'Beaker 1' (control) to mix the contents. Using a pipette, fill a cuvette with enough liquid from 'Beaker 1' to enable a reading to be taken. Place the pipette into the discard pot containing disinfectant.

DO NOT EMPTY the Control 1 cuvette – give it to your teacher to store, as you will need this sample to calibrate the colorimeter each time you take a reading.

Add approximately 25 ml of algae to 'Beaker 1' and 'Beaker 2'.

#### First reading of 'Beaker 1'

1. Calibrate the colorimeter
2. Gently swirl 'Beaker 1' to mix contents. Using a pipette, fill a cuvette with enough liquid from 'Beaker 1' to enable a reading to be taken. Place the pipette into the discard pot containing disinfectant.
3. Place the cuvette in the colorimeter.
4. Read and record the optical density using the colorimeter.
5. Empty the cuvette back into 'Beaker 1'.
6. Repeat for 'Beaker 2' instead of 'Beaker 1'

Place the Buchner flask into a warm water bath set to approximately 30 °C.

Place the carbon dioxide diffuser into 'Beaker 2' and secure in place (see Figure 2)

[Fig 2 near here].

The other end of the rubber piping from the Buchner flask should then be attached to the carbon dioxide diffuser.



Place both Beakers 1 and 2 near a light source. Both beakers should be an equal distance from the light, to ensure a more reliable result (See Figure 3) [Fig 3 near here].

### Subsequent readings

You will need to take further readings throughout this investigation, calibrating the colourimeter every time.

### Results

- Plot your results on a graph
- Compare your first and subsequent readings. Have they changed? What could this indicate?
- Is there a difference between the beakers containing the carbon dioxide diffuser to the one without? If so, why do you think this is?

### Notes

- The amount of fertilizer used should conform to the suggested amounts on the label of the container (e.g. 0.5 ml of fertilizer per 100 ml of water). This should provide enough nutrients to promote algal growth. If the quantities are small and difficult for students to pipette, round the quantity up to the nearest ml.
- The sugar is the food source for the yeast. Normal granulated sugar is suitable.
- The rubber piping should be attached firmly at both ends. It must be airtight. Make sure you are familiar with the carbon dioxide diffuser before you start this activity.

- The control beaker will not have the additional carbon dioxide produced from the yeast. The variable is therefore the additional carbon dioxide diffused from the yeast into the water containing the algal culture.
- The light source should be either a fluorescent lamp, which can be left on for 24 hours, or a north-facing window in sunny weather (for consistency, a lamp is recommended).
- The investigation should run for at least a week. The difference in colour should be visible by this time. However, you can use your judgement to wait until a distinct visible difference is present.
- Algae can be purchased at low cost from Sciento ([www.sciento.co.uk](http://www.sciento.co.uk)).
- This activity has lots of potential for extension or use as a project. Investigations could look use different species of algae, different fertilizers, different amounts of yeast, or other methods of increasing the amount of carbon dioxide available, such as carbon dioxide tablets.

\*The text and illustrations for this activity are copyrighted by the Society for General Microbiology, and are reproduced here with permission.

### References

ASE. (2001). *Topics in Safety* (3rd ed.). Cambridge: ASE.

Eldridge. (2004). A novel approach to photosynthesis practicals. *School Science Review*, 85(312), 9.

Redfern, J. (2012). *Algae: a practical resource for secondary schools*. Reading, UK: Society for General Microbiology.

Symington, V. (2010). Marvellous Microbes: The Pasteurs. In The Society for General Microbiology (Ed.),

[http://www.microbiologyonline.org.uk/media/transfer/doc/mm1\\_yeast\\_all\\_in\\_on\\_e.pdf](http://www.microbiologyonline.org.uk/media/transfer/doc/mm1_yeast_all_in_on_e.pdf).

Symington, V. (2011). SGM goes with a bang. *Microbiology Today*, 38.

Waltz, E. (2013). Algal biofuels questioned. [10.1038/nbt0113-12a]. *Nat Biotech*, 31(1), 12-12.

## Figures



Figure 62 - Setting up the activity. Add dried Baker's Yeast and fertilizer to some tap water in a Buchner flask.

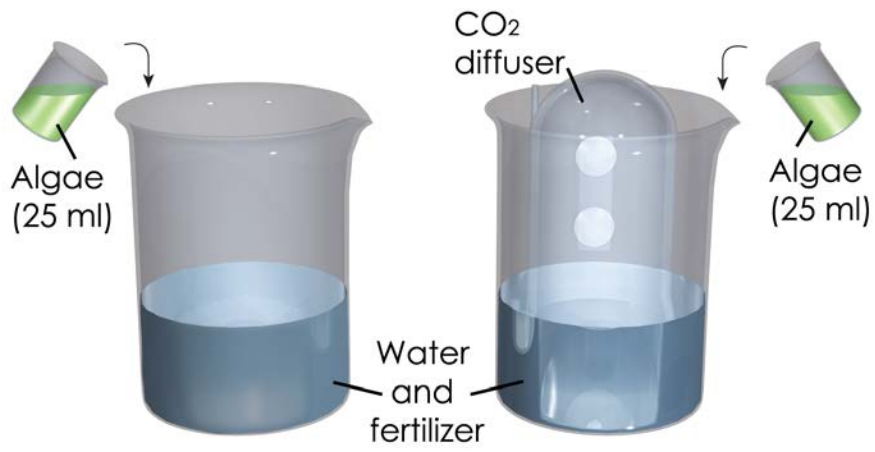

Figure 63 - Algae and fertilizer are added to two beakers of tap water

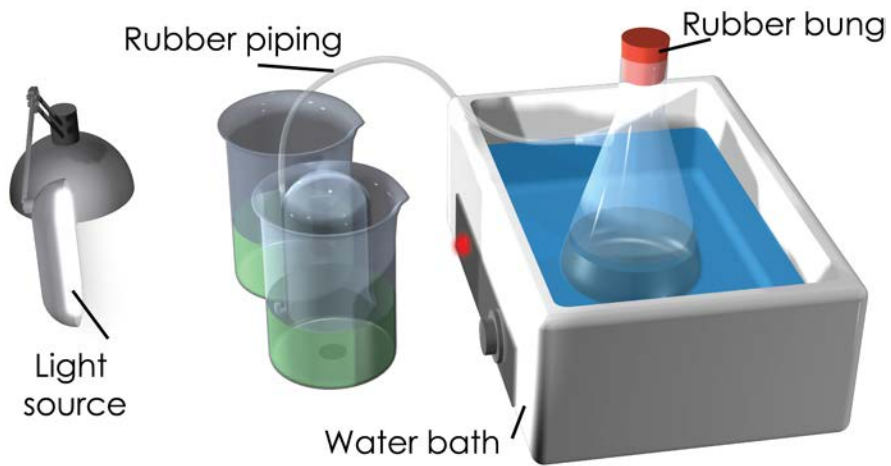

Figure 64 – The Buchner flask is placed in a water bath and algae placed near a light source

Redfern et al., in press. Using Soxhlet ethanol to produce and test plant material (essential oils) for their antimicrobial properties. *Journal of Microbiology and Biology Education*. Accepted manuscript

**'Using Soxhlet ethanol extraction to produce and test plant material (essential oils) for their antimicrobial properties'**

James Redfern<sup>1</sup> BSc

Malcolm Kinninmonth<sup>1</sup> PhD

Daniel Burdass<sup>2</sup> BSc

Joanna Verran<sup>1</sup> PhD

<sup>1</sup>School of Health Care Science, Manchester Metropolitan University, UK

<sup>2</sup>Society for General Microbiology, Reading, UK

**Abstract and key words**

As the issue of antimicrobial resistance continues to grow, there is a renewed interest in deriving antimicrobial products from natural compounds, particularly extracts from plant materials. This paper describes how essential oil can be extracted from the common herb, thyme (*Thymus vulgaris*) in the classroom. Subsequently, the extract can be tested for its antimicrobial activity. A number of variables are suggested.

Essential oils; antimicrobials; plant extracts; practical activity

## **Introduction**

Investigating the effects of antimicrobial products on microorganisms is a common procedure carried out in many microbiology laboratory courses, often using antibiotics or disinfectants against common bacterial species. As the issue of antimicrobial resistance continues to grow, there is a renewed interest in deriving antimicrobial products from natural compounds, particularly extracts from plant material [8]. This article describes a procedure for retrieving the antimicrobial compounds (essential oils) from the plant thyme (*Thymus vulgaris*) and testing it against a variety of microorganisms both Gram negative and Gram positive for antimicrobial effect [4]. The aim of this activity is to investigate the antimicrobial effects of plant material after extracting compounds using the relatively simple Soxhlet method [6]. This article presents information ensuring the existing extraction method is achievable in the teaching laboratory, while allowing students hands-on investigative experience. As well as supporting scientific thinking, laboratory skill and competency, this activity allows students to partake in an investigation with cross-discipline approaches to the very relevant and current healthcare issue of antimicrobials.

## **Procedure**

### *Performing the Soxhlet method of ethanol extraction*

Allowing the students to carry out this section of the investigation provides an added layer to what would be a standard microbiology assay. It takes the students from 'start' to 'finish' in terms of extracting and testing their own antimicrobial compounds. Students should set up and perform the extraction to allow first-hand experience of extraction methods.

Redfern et al., in press. Using Soxhlet ethanol to produce and test plant material (essential oils) for their antimicrobial properties. *Journal of Microbiology and Biology Education*. Accepted manuscript

Plant material can be fresh (for example, a plant leaf) or dried. It needs to be crushed, using a pestle and mortar, to provide a greater surface area.. The plant material should be sufficient to fill the porous cellulose thimble (in our experiments we use an average of 14g of thyme in a 25 x 80mm thimble).

All equipment should be provided for students to assemble. Allowing students to build the extraction apparatus may give them a greater appreciation for the process of extraction, as opposed to testing an antimicrobial compound out of a purchased bottle. The students should begin by building a rig using stands and clamps to support the extraction apparatus. Following this, the solvent (250ml of ethanol) is added to a round bottom flask, which is attached to a Soxhlet extractor and condenser (Figure 65) on an isomantle. The crushed plant material is loaded into the thimble, which is placed inside the Soxhlet extractor. The side arm is lagged with glass wool. The solvent is heated using the isomantle and will begin to evaporate, moving through the apparatus to the condenser. The condensate then drips into the reservoir containing the thimble. Once the level of solvent reaches the siphon it pours back into the flask and the cycle begins again. The process should run for a total of 16 hours. Once the student has set up the extraction it can be left to run without direct supervision. It is not advised to leave the equipment completely alone due to the mix of running water and an electrical appliance, so a technician or other lab user should be made aware. The equipment can be turned on and off when overnight running is not permitted, and the time split over a number of days. For good practice, a control should be added. This could be the use of plant material that has no known antimicrobial effect (for example a carrier oil such as sunflower oil) at the testing stage.

Redfern et al., in press. Using Soxhlet ethanol to produce and test plant material (essential oils) for their antimicrobial properties. *Journal of Microbiology and Biology Education*. Accepted manuscript

Once the process has finished, the ethanol should be evaporated using a rotary evaporator, leaving a small yield of extracted plant material (about 2 - 3ml) in the glass bottom flask.

### *Testing the extract for antimicrobial effect*

Antimicrobial properties of the plant extract should be performed using the agar disc diffusion technique using antibiotic assay discs [1]. It is suggested students test against a Gram-positive microorganism (e.g. *Staphylococcus aureus*) and a Gram-negative microorganism (e.g. *Escherichia coli*). Plates should be incubated at 37°C for 24 – 48 hours. The activity can be modified to meet your curricula requirements. Examples of this can be found in Appendix 1.

### **Safety issues**

The Soxhlet extraction process heats the solvent (ethanol) to boiling temperature (>78°C). The evaporated ethanol is contained within the apparatus by the condenser unit; however the apparatus should be placed under a fume hood in case of escape. Due to the continuous running of water and heat source, it is not advisable to leave the apparatus unattended overnight. Personal protective equipment, including gloves, should be used when handling the plant extract, as it may be an irritant to skin [7].

### **Conclusion**

If an antimicrobial compound has been successfully extracted a clear zone (no growth) around the test substance is observed. This is known as the 'zone of inhibition' (Zoi). Comparisons can be made between different test organisms [3], plant extracts, and other variables (described below). In our lab, average Zoi for



Redfern et al., in press. Using Soxhlet ethanol to produce and test plant material (essential oils) for their antimicrobial properties. *Journal of Microbiology and Biology Education*. Accepted manuscript  
the essential oil extracted from dried thyme is 9mm diameter when tested against *E. coli* and 16mm diameter when tested against *S. aureus* (Figure 66).

## References

1. **Burdass, D. J. Grainger, and J. Hurst.** 2006. Basic practical microbiology. Society for General Microbiology, Reading.
2. **Cavanagh, H. M. A., and J. M. Wilkinson.** 2002. Biological activities of lavender essential oil. *Phytotherapy Res.* **16**(4):301-308.
3. **Haitham, Q.** 2009. Antibacterial activity in vitro of *Thymus capitatus* from Jordan. *Pak. J. Pharm. Sci.* **22**(3):247-251
4. **Hammer, K. A., C. F. Carson, and T. V. Riley.** 1999. Antimicrobial activity of essential oils and other plant extracts. *J. Appl. Microbiol.* **86**(6):985-990.
5. **Hawthorne, S. B., M. S. Krieger, and D. J. Miller.** 1988. Analysis of flavor and fragrance compounds using supercritical fluid extraction coupled with gas chromatography. *Analytical Chem.* **60**(5):472-477.
6. **Luque de Castro, M. D., and L. E. García-Ayuso.** 1998. Soxhlet extraction of solid materials: an outdated technique with a promising innovative future. *Analytica Chimica Acta.* **369**(1-2):1-10.
7. **Metcalfe, J.** 1993. Culpper guides: herbs and aromatherapy. Bloomsbury Books, London.
8. **Thormar, H.** 2011. Front matter, p. i-xvii. *In* H. Thormar, Lipids and essential oils as antimicrobial agents. John Wiley & Sons, Ltd., Chicester.

Redfern et al., in press. Using Soxhlet ethanol to produce and test plant material (essential oils) for their antimicrobial properties. *Journal of Microbiology and Biology Education*. Accepted manuscript

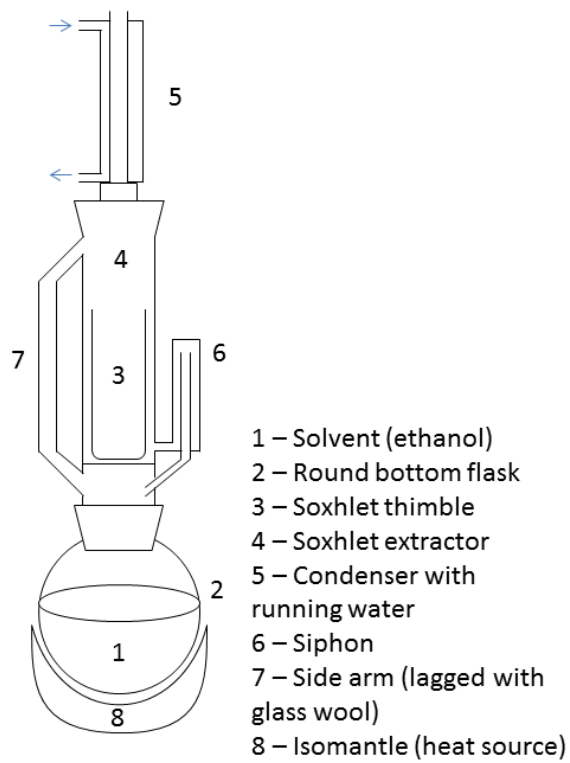

Figure 65. - Diagram of Soxhlet extraction equipment.

Redfern et al., in press. Using Soxhlet ethanol to produce and test plant material (essential oils) for their antimicrobial properties. *Journal of Microbiology and Biology Education*. Accepted manuscript

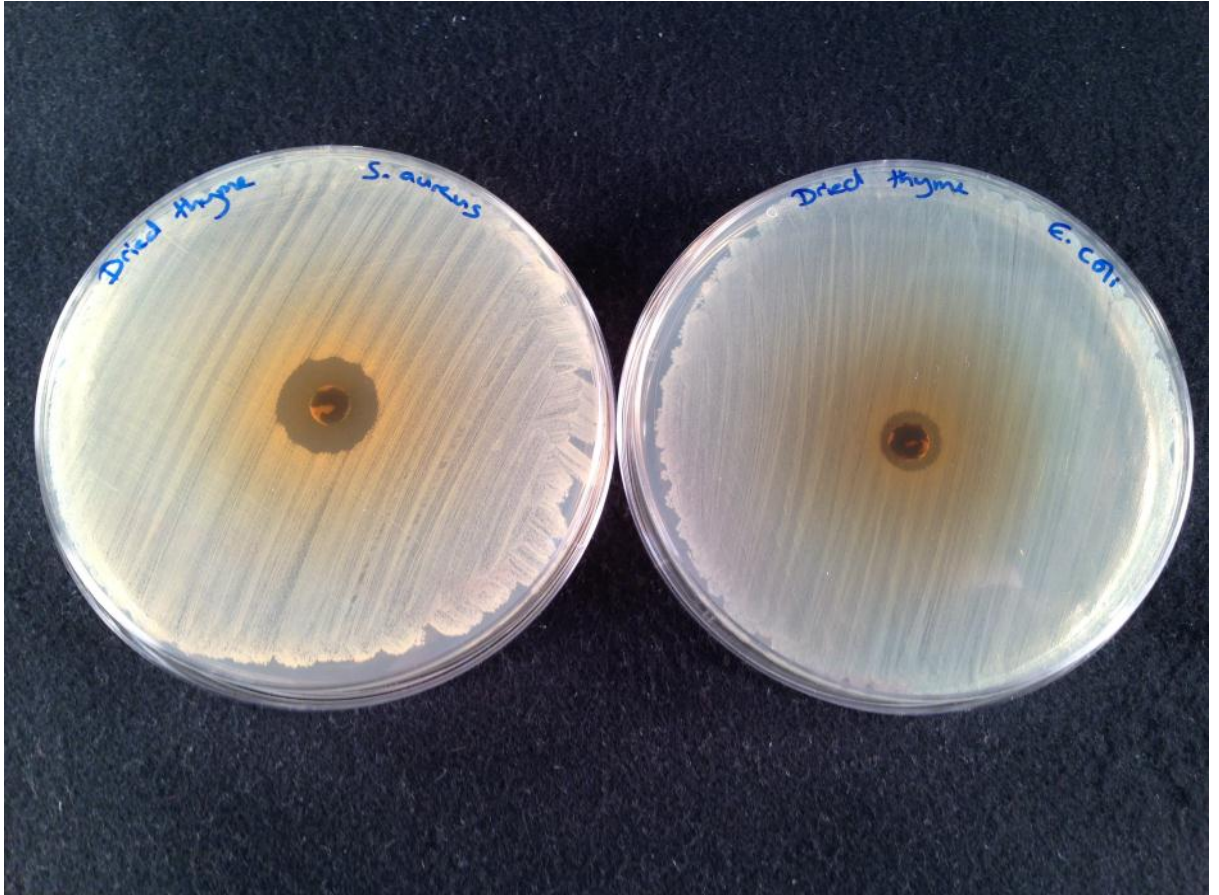

Figure 66. An example of zones of inhibition produced from extracted thyme plant material after 16 hours ethanol Soxhlet extraction on test organisms *S. aureus* (left) and *E. coli* (right).

Redfern et al., in press. Using Soxhlet ethanol to produce and test plant material (essential oils) for their antimicrobial properties. *Journal of Microbiology and Biology Education*. Accepted manuscript

## **Appendix 1**

The activity can be modified to meet your curricula requirements. It can range from a standard extraction of one plant and testing for antimicrobial activity, to a larger investigative project that can look at a range of variables. If enough plant materials are tested against microorganisms then this would provide substantial data for students to complete a comprehensive analysis for efficacy of antimicrobial compounds. Variables include:

- Comparisons between fresh and dried herbs. Dried thyme is easier to handle because it does not leak any liquid, is cheaper and can be stored for future use. Fresh thyme provided a greater yield.
- Comparison between crushed and non-crushed herbs.
- Comparison of antimicrobial effect between direct and vapor contact [2].
- Comparison between different plants known to have antimicrobial actions e.g. eucalyptus, peppermint and lavender.
- Testing the student's own extract against an essential oil purchased from a supplier (for example an oil tincture used for aromatherapy). Dilutions of the commercially available oil (in a carrier oil such as grapeseed oil) can be tested against Soxhlet extract as an assay.
- Gas chromatography can also be used to identify what molecules are present in the extract [5].

## **Appendix 7 – Magazine publications**

## The Development and Launch of a school laboratory activity resource about algae

Despite the clear need for hands-on practical science in schools, there is a notable decrease in these activities. Microbiology in particular suffers from perceived hazards of handling microorganisms, and difficulties in culturing and visualising. Nevertheless, microbiology figures large in the school science curriculum, so attempts should be made to provide useful, interesting and relatively simple exercises that staff and technicians can prepare and lead with confidence. The Society for General Microbiology (SGM) ([www.sgm.ac.uk](http://www.sgm.ac.uk)) provides a range of educational resources for schools, but has not disseminated any practical activities for some years, primarily due to the difficulties of development without ready access to a laboratory. At Manchester Metropolitan University (MMU), we had worked previously with SGM on a range of educational materials, so we devised a 3 year project that would result in the development of new laboratory-based activities for schools. In order to do this, a full-time postgraduate student, James Redfern, was recruited to the task.

Algae provide an excellent microbiological tool for illustrating a range of phenomena that are noted in the school science curriculum at stage 3 and 4 (aged 11-16 including GCSE). Algae are relatively large microorganisms, thus easy to see; attractive, morphologically diverse, thus interesting to look at; cheap and relatively easy to acquire, culture and maintain, and safe to handle. They can also replace plants as examples of photosynthetic organisms, thus increasing access to microbiology in the school environment! James began his project by scrutinising both the National Curriculum and the science specifications, identifying principles or concepts that could be illustrated by algae. These were: using a key/microscope for identification, phototaxis, bioluminescence, eutrophication and biofuels.

James then scoured all available material to identify whether any successful activities were already available: these would then be referenced in the final resource. We also had to identify a couple of 'experts' in the algal world, preferably those who were already involved with education and public engagement activities, who

would advise on the accuracy and relevance of content of our final resource. Many thanks to Gary Caldwell at Newcastle! Starting from scratch, James learnt about algae, and wrote the background material to the resource. In the final 5 exercises, instead of biofuels (which has a burgeoning interest via Research Councils, and thence a range of educational support), he developed a system for cycling gas, whereby carbon dioxide produced by yeast was used to increase biomass in algae and in turn the yeast used the oxygen produced by the yeast as a by-product of photosynthesis. Laboratory activities were trialled with a range of audiences: undergraduate students, the general public ('The good, the bad and the algae' session was held at MMU during National Science and Engineering Week 2011) and two groups of teachers, who subsequently tried out the activities with their students. Their feedback informed on the design, clarity and content of the resource.

The final resource was launched in January 2012 at the BPS meeting, and at the ASE (Association of Science Education) conference, attended by hundreds of teachers. The pack, *Algae: a practical resource for secondary schools*, contains a 72-page full colour book, accompanied by 5 copies of a poster guiding students through the principles of identification using a key, one copy of an attractive poster outlining 'fascinating facts about algae', a CD containing video clip of bioluminescent algae, PowerPoint presentations introducing the activities, and pdfs of the laboratory exercises. The book provides background information about algae, and describes the practical activities for teachers, students and school technicians. Information on suppliers, culture and handling and health and safety are also provided. The resource was provided to all of SGM's 750 school members, and we will contact them in 12 months time to find out what they thought of it.

We are really pleased with our resource, and welcome any feedback. However, James cannot rest on his laurels – we are now focusing our attention on bacteriophage, to illustrate principles of virology to level A level students!

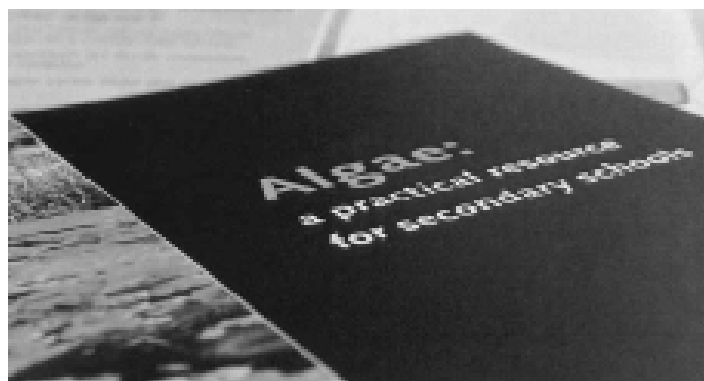

ISBN number: 978-0-9536838-7-1.  
Published by: The Society for General Microbiology.

To purchase, go to [http://www.sgm.ac.uk/education\\_careers/EdBook.cfm](http://www.sgm.ac.uk/education_careers/EdBook.cfm)

Joanna Verran, James Redfern,  
School of Healthcare Science,  
Manchester Metropolitan University  
Daniel Burdass, Society for  
General Microbiology

# SCHOOLZONE

## Bacteriophage practical

Aspects of virology feature in many A Level specifications but practical virology is virtually absent in school because of difficulties in handling the micro-organisms (both perceived and real). Bacteriophages (a virus that only infects bacteria) are relatively easy to handle and can be used to illustrate many concepts of virology, such as counting infectious virus particles.

A **PLAQUE ASSAY** is a technique for detecting viruses. The underlying principle offered here is a serial dilution (gradually diluting a suspension of bacterial viruses and testing for infectivity). The outcome should be an agar plate covered with 'plaques' (holes in a field of constant bacterial growth), where the virus has infected and killed the host bacterium.

The school-friendly method detailed here offers a step-by-step guide to carrying out a plaque assay using T4 bacteriophage and its host, *Escherichia coli*.

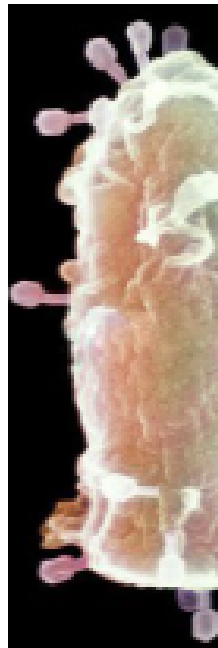

T4 bacteriophages infecting an *E. coli* cell. *Janzen Berger / Science Photo Library*

### AIM

To calculate the number of viable phage in a suspension.

### METHOD

*Note: Aseptic technique should be used throughout this experiment*

#### Stage 1 – Preparing your dilution series of T4 bacteriophage and testing it for infectivity

Each group of students requires 10 nutrient agar plates and 10 bottles each containing 9 ml sterile water.

1. Label one agar plate '10<sup>-1</sup>' and the next one '10<sup>-2</sup>' and so on until '10<sup>-10</sup>'.
2. Label the sterile water bottles '10<sup>-1</sup>', '10<sup>-2</sup>' and so on until '10<sup>-10</sup>'.
3. Transfer 1 ml of bacteriophage suspension into the sterile water bottle labelled '10<sup>-1</sup>' and mix well.
4. Using a sterile pipette (not the one used previously), transfer 1 ml out of the '10<sup>-1</sup>' bottle and place it into the '10<sup>-2</sup>' bottle. Replace the lid and mix well.
5. Continue this process (transferring 1 ml from one dilution to the next) until you have made the '10<sup>-10</sup>' dilution.

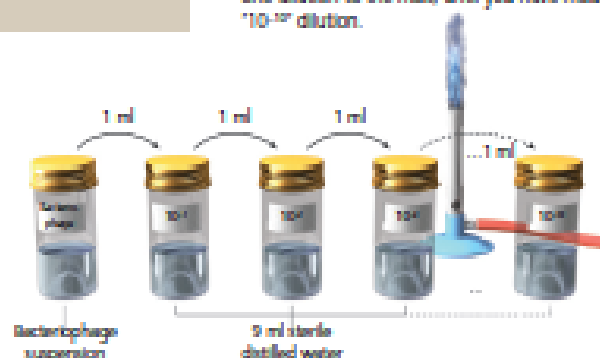

### Stage 2 – Inoculating cultures of bacteria with T4 bacteriophage dilutions

The following steps (1–6) must be completed for each dilution

1. Collect your '10<sup>-1</sup>' agar plate and the bacteriophage dilution bottle labelled '10<sup>-1</sup>'.
2. Collect 3 ml of molten soft agar from a water bath (set at 50°C). When opening the soft agar, ensure you are working aseptically (near a Bunsen burner).
3. Using a sterile pipette, transfer 0.2 ml (200 µl) of your phage dilution into the soft agar bottle.
4. Using a sterile pipette, transfer 0.2 ml (200 µl) of *E. coli* culture into the soft agar bottle.

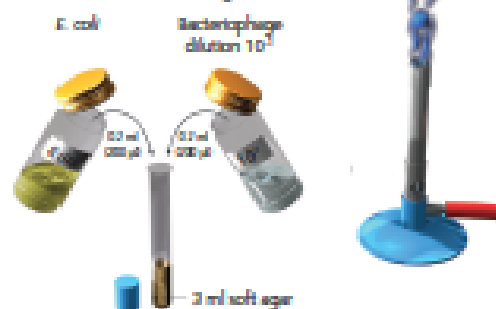

5. Carefully rotate the bottle between two fingers in an upright position, to mix the solution (do not shake).
6. Carefully pour the inoculated soft agar onto your '10<sup>-1</sup>' agar plate. Replace the lid of the Petri dish and carefully rotate the plate in a circular motion so the soft agar is evenly spread over the underlying agar. Leave the plate for approximately 10 minutes for the soft agar to set (at room temperature).



Once all agar plates have been inoculated with soft agar and the agar has set, invert the plates and incubate them at 30°C for 24 hours.

### RESULTS

The bacteria grow as a lawn (a field of confluent growth) across the agar. Small circular gaps in the lawn of bacteria are known as plaques. Here, bacteria have been killed by the bacteriophage so are unable to grow.

Count the number of plaques at a dilution where there are between 20 and 200 plaques present. This will allow calculation of number of plaque-forming units (PFU) per ml of original suspension using the formula:

$$\text{PFU/ml} = \frac{\text{(number of PFUs)}}{\text{(dilution} \times 0.2)}$$

1. Enter the number of PFUs into the top line of the equation.
2. Enter the dilution you chose for your average PFU where the equation says 'dilution'. For example, if you chose 10<sup>-2</sup>, enter 0.001, or if you chose 10<sup>-7</sup>, enter 0.0000001.

### NOTES

- Soft agar is half-strength nutrient agar. It must be sterilised and be molten (kept at 50°C) for students to use.
- The bacteriophage must be able to infect the bacterium you use. They are highly specific.

JAMES REDFERN, Manchester Metropolitan University