

# Open Research Online

---

The Open University's repository of research publications and other research outputs

## Factors affecting conventional and molecular detection of *Bacillus anthracis* in the environment and the stability of *B. anthracis* identification plasmids PX01 and PX02 *in vitro*

### Thesis

How to cite:

Bowen, Jane Elizabeth (2000). Factors affecting conventional and molecular detection of *Bacillus anthracis* in the environment and the stability of *B. anthracis* identification plasmids PX01 and PX02 *in vitro*. PhD thesis Open University.

For guidance on citations see [FAQs](#).

© 2000 The Author

Version: Version of Record

---

Copyright and Moral Rights for the articles on this site are retained by the individual authors and/or other copyright owners. For more information on Open Research Online's data [policy](#) on reuse of materials please consult the policies page.

---

[oro.open.ac.uk](http://oro.open.ac.uk)

**FACTORS AFFECTING CONVENTIONAL AND MOLECULAR  
DETECTION OF *BACILLUS ANTHRACIS* IN THE ENVIRONMENT  
AND THE STABILITY OF *B. ANTHRACIS* IDENTIFICATION  
PLASMIDS PX01 AND PX02 *IN VITRO***

**JANE ELIZABETH BOWEN**

**A thesis submitted in partial fulfilment of the requirements of the  
Open University for the degree of Doctor of Philosophy**

**August 1999**

**Centre for Applied Microbiology and Research**

**AUTHOR'S No: P92689Q2**

**DATE OF AWARD: 6 JANUARY 2000**

## ACKNOWLEDGEMENTS

I would like to acknowledge and thank my supervisors Dr Peter C. B. Turnbull and Dr Ian Henderson for their guidance. I would also like to thank Dr Conrad Quinn for his assistance with the plasmid stability work and Dr Mary Matheson and Dr Tony Fooks for their help during the writing of this thesis.

I would like to thank Mr Paul Poulton, Institute of Arable Crop Research, Rothamstead for the generous provision of a range of soils for testing during this study and Mr André Charlett, from the PHLS Statistics Unit, Colindale for his help with the statistical analysis of the data.

## ABSTRACT

Conventional and molecular methods for the improved detection of *B. anthracis* in environmental material were studied. A system was developed which combines a selective enrichment broth with two-phase concentration using polyethylene glycol and potassium phosphate to form the two immiscible phases.

The enrichment broth alone, based on polymyxin B sulphate, lysozyme, EDTA and thallos acetate, which comprise PLET agar (PLETA), allowed the selective recovery of *B. anthracis* from a mixture of *B. anthracis* and closely related *B. cereus*. When soil was added to the broth, however, *B. anthracis* was rapidly overgrown by other naturally occurring *Bacillus* species. Recovery of *B. anthracis* was improved by using semi-solid PLET broth or by adding chelating agents or the monobactam antibiotic aztreonam to the broth. The combination of chemicals required for optimal recovery of *B. anthracis* varied according to the composition of the soil. Use of the two-phase concentration system showed that in soil *B. anthracis* spores are generally attached to soil particles and need to be separated before they can be concentrated. Separation was achieved by pre-soaking the soil in water.

The sensitivity of standard PLETA is approximately 5 - 50 spores per gram of soil depending on the sample composition. The system finally recommended for the most reliable and sensitive detection of spores in soil achieved an average 25 fold greater sensitivity than PLETA.

Further enrichment of the *B. anthracis* concentrate obtained using the optimised enrichment method allowed the PCR detection of *B. anthracis* DNA. The sensitivity of the PCR was affected by the composition of the soil. In the absence of

inhibition the PCR detection limit was approximately 10 - 100 spores per gram.

A multiplex PCR was developed which targets DNA from pX01, pX02 and the *B. anthracis* chromosome. The PCR allowed the rapid identification of colonies suspected of being *B. anthracis*. In addition to being essential for the definitive identification of *B. anthracis*, the ability to determine the presence of virulence plasmids in *B. anthracis* has reduced the need to use animals for virulence tests.

Attenuated pX01<sup>+</sup>/pX02<sup>-</sup> or pX01<sup>-</sup>/pX02<sup>-</sup> strains of *B. anthracis* are occasionally found in the environment. Naturally occurring pX01<sup>-</sup>/pX02<sup>+</sup> derivatives have not been isolated. No other plasmid DNA has been identified in *B. anthracis*. To examine the nature of the stability of pX01 and pX02 in *B. anthracis*, the effect of selective pressure for non-indigenous plasmid DNA that had been introduced into *B. anthracis* was studied. A plasmid based on the minimal replicon of pAMβ1 (pAEX-5E, 5.8.kb) was found to be stable in pX01<sup>-</sup>/pX02<sup>-</sup> and pX01<sup>-</sup>/pX02<sup>+</sup> derivatives of *B. anthracis* for more than 100 generations of growth. In the pX01<sup>+</sup>/pX02<sup>+</sup> and pX01<sup>+</sup>/pX02<sup>-</sup> derivatives of *B. anthracis*, pAEX-5E was expelled within 105 culture generations. Loss of pAEX-5E was most rapid in the pX01<sup>+</sup>/pX02<sup>-</sup> derivative. Plasmids pX01 and pX02 both remained stable under selection pressure for pAEX-5E, and in the pX01<sup>+</sup>/pX02<sup>-</sup> derivative retention of pX01 led to a reduction in growth rate. This indicates that, in the absence of pX02, *B. anthracis* will endure a significant metabolic compromise in order to retain pX01.

This study has provided extensive new information about the selective recovery of *B. anthracis* in environmental material and novel data about the stability of identity plasmids pX01 and pX02 under selective pressure for non-indigenous plasmid DNA.

**PUBLICATIONS AND COMMUNICATIONS  
RELATING TO THIS THESIS**

Selective Systems for the Detection of *Bacillus anthracis* in Environmental Specimens (1996).

**J. E. Bowen, I. Henderson and P. C. B. Turnbull**

Proceedings of the International Workshop on Anthrax, Winchester, England, 19 - 21 September 1995. pp 40 - 42. Edited by P. C. B. Turnbull. Salisbury Medical Bulletin. Number 87, Special Supplement.

Development of a Selective Enrichment System for *Bacillus anthracis* in Environmental Samples (1997).

**J. E. Bowen and P. C. B. Turnbull**

Poster presentation at the PHLS Annual Scientific Conference, University of Warwick Conference Park, 8 - 10 September 1997.

The Native Virulence Plasmids Affect the Segregational Stability of a Theta-Replicating Shuttle Vector in *B. anthracis* var. New Hampshire (1998).

**J. E. Bowen**

Oral presentation. Third International Conference on Anthrax, University of Plymouth 7 - 10 September 1998.

The Native Virulence Plasmids Affect the Segregational Stability of a Theta-Replicating Shuttle Vector in *B. anthracis* var. New Hampshire (1999).

**J. E. Bowen and C. P. Quinn**

Proceedings of the Third International Conference on Anthrax, University of Plymouth 7 - 10 September 1998 (in press).

The Segregational Stability of a Theta Replicating Shuttle Vector in *B. anthracis* var. New Hampshire is Modulated by the Native Virulence Plasmids.

**J. E. Bowen, P. C. B. Turnbull and C. P. Quinn**

Poster presentation at The Second International Workshop on the Molecular Biology of *Bacillus cereus*, *Bacillus anthracis* and *Bacillus thuringiensis*. Taos, New Mexico, USA, 11 - 13 August 1999.

## **DECLARATION OF ORIGINALITY**

I declare that the work presented in this thesis is all my own work, except where otherwise indicated, and has not been submitted elsewhere for a research degree.



## LIST OF CONTENTS

	PAGE NUMBER
Title	i
Acknowledgements	ii
Abstract	iii
Publications and Communications	v
Declaration of Originality	vii
List of Contents	viii
List of Figures	xxvi
List of Tables	xxxii
List of Abbreviations	xxxvi

## CONTENTS

	PAGE NUMBER
1.0 INTRODUCTION	
1.1 The disease	1
1.1.2 The historical relevance of <i>B. anthracis</i>	1
1.1.3 Current relevance of <i>B. anthracis</i>	3
1.2 Incidence of anthrax	5
1.2.1 Transmission of spores of <i>B. anthracis</i> in the environment	5
1.2.2 Persistence of spores of <i>B. anthracis</i> in the environment	9
1.3 Susceptibility to anthrax	11

1.4	<b>Pathogenesis of anthrax</b>	13
1.4.1	Forms of anthrax	13
1.4.2	Symptoms of anthrax	14
1.4.3	Development of the disease	14
1.4.4	Treatment of anthrax	17
1.4.5	Control of anthrax by vaccination	17
1.5	<b>Classification of <i>B. anthracis</i></b>	18
1.5.1	The genus <i>Bacillus</i>	18
1.5.2	The ' <i>B. cereus</i> group'	20
1.6	<b>Isolation and identification of <i>Bacillus</i> species</b>	25
1.6.1	Identification of <i>B. anthracis</i>	25
1.7	<b>The detection of <i>B. anthracis</i></b>	31
1.7.1	Detection of <i>B. anthracis</i> in animal carcasses	31
1.7.2	The detection of <i>B. anthracis</i> in environmental samples	32
1.8	<b>Molecular methods for the detection of <i>B. anthracis</i> in the environment</b>	33
1.8.1	The detection of <i>B. anthracis</i> DNA using the PCR	35
1.8.2	Methods for the extraction of bacterial DNA from soil	35
1.8.2.	The effect of humic and phenolic compounds in soil on the PCR	36
1		
1.9	<b>The stability of plasmids pX01 and pX02 in <i>B. anthracis</i></b>	38
1.10	<b>Objectives of this study</b>	42

## 2.0 MATERIALS AND METHODS

2.1	<b>Bacterial strains and plasmids</b>	43
2.2	<b>Bacterial culture</b>	43
2.2.1	Growth of <i>Bacillus</i> species	43
2.2.2	Preparation of spores	43
2.2.3	Preparation of vegetative bacilli	46
2.3	<b>Bacterial counts</b>	46
2.4	<b>Processing of soil samples for the detection of <i>B. anthracis</i></b>	47
2.4.1	Processing other samples for the detection of <i>B. anthracis</i>	48
2.4.2	Examination of cultures for the presence of a poly-D-glutamic acid capsule (M'Fadyean Reaction)	48
2.5	<b>Preparation of agars for the selective growth of <i>B. anthracis</i></b>	49
2.6	<b>Germination of spores of <i>B. anthracis</i> and <i>B. cereus</i></b>	49
2.6.1	The effect of sodium acetate on spores of <i>B. anthracis</i> and <i>B. cereus</i>	49
2.6.2	The effect of amino acid germinants on spores of <i>B. anthracis</i> and <i>B. cereus</i>	49

2.7	<b>Determination of the minimum inhibitory concentration (MIC) of amoxicillin and clavulanic acid required to inhibit growth of <i>B. anthracis</i> and <i>B. cereus</i>.</b>	50
2.8	<b>Two-phase concentration of <i>B. anthracis</i> spores</b>	50
2.9	<b>The Polymerase Chain Reaction (PCR)</b>	51
2.9.1	Horizontal agarose gel electrophoresis	52
2.10	<b>Extraction and purification of <i>B. anthracis</i> DNA directly from soil</b>	53
2.10.1	NMRI method for the extraction of <i>B. anthracis</i> DNA from spores in soil using GlassMAX (Gibco BRL)	53
2.10.1.1	Removal of inhibitory substances from soil using GlassMax	54
2.10.2	Separation of DNA from contaminating humic material by agarose gel electrophoresis	54
2.10.3	Detection of <i>B. anthracis</i> in soil using a non-selective enrichment method followed by the PCR	55
2.10.3.1	Phenol chloroform extraction of DNA	56
2.11	<b>Curing <i>B. anthracis</i> of plasmids pX01 and pX02</b>	57
2.11.1	Curing <i>B. anthracis</i> of pX01	57
2.11.2	Curing <i>B. anthracis</i> of pX02	57

2.12	<b>Determination of the genotype of isolates of <i>B. anthracis</i> using phenotypic characteristics</b>	57
2.12.1	Determination of the plasmid content of isolates of <i>B. anthracis</i> by growth in the presence of bicarbonate ions and CO <sub>2</sub>	58
2.13	<b>Transformation of <i>B. anthracis</i> by electroporation</b>	59
2.14	<b>Transformation of <i>E. coli</i> GM2163 with plasmid DNA</b>	60
2.14.1	Preparation of competent <i>E. coli</i> cells	60
2.14.2	Transformation of <i>E. coli</i>	60
2.14.3	Plasmid rescue of pAEX-5E and pAEX-5E/K from <i>B. anthracis</i>	61
2.14.4	Restriction digest analysis of plasmid DNA	62
2.15	<b>Determination of bacterial growth rate</b>	62
2.16	<b>Determination of the stability of plasmids in <i>B. anthracis</i></b>	63
2.16.1	Stability in the absence of antibiotic selection	63
2.16.2	Stability in the presence of antibiotic selection	63
2.16.3	Determination of the stability of pX01 and pX02 in <i>B. anthracis</i> under selection pressure for pAEX-5E	64
2.17	<b>Southern blot analysis of derivatives of <i>B. anthracis</i> using pAEX-5E DNA as a probe</b>	64
2.17.1	Extraction of total genomic DNA from <i>B. anthracis</i>	64
2.17.2	Removal of RNA from the nucleic acid sample	66

2.17.3	Restriction digestion of total genomic DNA from <i>B. anthracis</i>	66
2.17.4	Transfer of <i>B. anthracis</i> DNA to a nylon membrane by Southern (capillary) blotting	67
2.17.5	Generation of the pAEX-5E DNA probe	68
2.17.6	Fluorescein labelling of the pAEX-5E DNA probe	68
2.17.7	Hybridization of the probe to the digested <i>B. anthracis</i> DNA	70

### 3.0 EVALUATION OF SELECTIVE AGARS AND BROTHS FOR THE DETECTION OF *BACILLUS ANTHRACIS* IN ENVIRONMENTAL MATERIAL

3.1	<b>Introduction</b>	72
3.1.1	The current system used at CAMR for the detection of <i>B. anthracis</i> in environmental material	73
3.1.2	The requirement for a selective enrichment system for the detection of <i>B. anthracis</i> in environmental samples	74
3.2	<b>Aim of the work described in this chapter</b>	75
3.3	<b>Evaluation of the growth of <i>B. anthracis</i> on different selective agars</b>	76
3.3.1	<b>Introduction</b>	76
3.3.1.1	The culture of <i>Bacillus</i> species on agar	76
3.3.1.2	Selective agars for members of the ' <i>B. cereus</i> group'	76
3.3.1.3	Selective agars for <i>B. anthracis</i>	77
3.3.2	<b>Aim</b>	80
3.3.3	<b>Materials and Methods</b>	80
3.3.4	<b>Results</b>	82
3.3.4.1	Comparison of the growth of <i>B. anthracis</i> and <i>B. cereus</i> on PEA	83
3.3.5	<b>Conclusions</b>	83

3.4	<b>Optimisation of the growth of <i>B. anthracis</i> on PLETA</b>	84
3.4.1	<b>Introduction</b>	84
3.4.2	<b>Aim</b>	87
3.4.3	<b>Materials and Methods</b>	87
3.4.3.1	Comparison of the use of different basal media in PLETA	87
3.4.3.2	The effect of the individual components of PLETA on the selective growth of <i>B. anthracis</i>	88
3.4.4	<b>Results</b>	88
3.4.4.1	The use of different basal media in PLETA	88
3.4.4.2	The effect of the individual components of PLETA on the selective growth of <i>B. anthracis</i>	89
3.4.5	<b>Conclusions</b>	90
3.5	<b>The use of the selective germination of spores in an enrichment system for <i>B. anthracis</i></b>	91
3.5.1	<b>Introduction</b>	91
3.5.2	<b>Aim</b>	91
3.5.3	<b>Materials and Methods</b>	92
3.5.4	<b>Results</b>	93
3.5.4.1	Comparison of the growth of <i>B. anthracis</i> and <i>B. cereus</i> in the presence of sodium acetate	93
3.5.4.2	Comparison of the effect of different compounds on the germination of spores of <i>B. anthracis</i> and <i>B. cereus</i>	93
3.5.5	<b>Conclusions</b>	96



3.6	<b>The development of a selective enrichment broth for <i>B. anthracis</i></b>	97
3.6.1	<b>Introduction</b>	97
3.6.2	<b>Aim</b>	97
3.6.3	<b>Materials and Methods</b>	97
3.6.3.1	Comparison of the growth of <i>B. anthracis</i> and <i>B. cereus</i> in BHIB	97
3.6.3.2	The detection of <i>B. anthracis</i> and other <i>Bacillus</i> species in blood	98
3.6.3.3	Comparison of the growth of <i>B. anthracis</i> and <i>B. cereus</i> in broth containing the selective agents described in Table 3.1	98
3.6.4	<b>Results</b>	99
3.6.4.1	The detection of <i>B. anthracis</i> in soil after enrichment in blood	100
3.6.4.2	The recovery of <i>B. anthracis</i> in broths containing the selective agents described in Table 3.1	100
3.6.5	<b>Conclusions</b>	101
3.7	<b>Optimisation of the recovery of <i>B. anthracis</i> in PLETB</b>	103
3.7.1	<b>Aim</b>	103
3.7.2	<b>Materials and Methods</b>	103
3.7.3	<b>Results</b>	104
3.7.3.1	Optimisation of the growth of <i>B. anthracis</i> in PLETB	104
3.7.3.2	Comparison of growth of spores and vegetative cells of <i>B. anthracis</i> in PLETB	106
3.7.3.3	The effect of pH on the growth of <i>B. anthracis</i> in PLETB	106
3.7.3.4	The effect of temperature on the growth of <i>B. anthracis</i> in PLETB	110
3.7.4	<b>Conclusions</b>	110

3.8	<b>The substitution of thallium ions with potassium ions and the evaluation of different chelating agents in PLETB</b>	112
3.8.1	Introduction	112
3.8.2	Aim	113
3.8.3	Materials and Methods	113
3.8.4	Results	113
3.8.5	Conclusions	115
3.9	<b>The recovery of different strains of <i>B. anthracis</i> and <i>B. cereus</i> in PLETB</b>	117
3.9.1	Introduction	117
3.9.2	Aim	117
3.9.3	Materials and Methods	117
3.9.4	Results	117
3.9.5	Conclusions	118
3.10	<b>The use of antibiotics in the development of a selective enrichment system for <i>B. anthracis</i></b>	119
3.10.1	<b>Introduction</b>	119
3.10.1.1	The mode of action of cephalosporins and aztreonam	121
3.10.1.2	The effect of clavulanic acid on $\beta$ -lactamase producing bacteria	122
3.10.2	<b>Aim</b>	123
3.10.3	<b>Materials and Methods</b>	123
3.10.4	<b>Results</b>	124
3.10.4.1	Determination of the MIC of cefuroxime and cefotaxime for growth of <i>B. anthracis</i> ASC 80 and <i>B. cereus</i> F4433/73	124

3.10.4.2	Comparison of the growth of <i>B. anthracis</i> and <i>B. cereus</i> in the presence of amoxicillin and clavulanic acid	124
3.10.4.3	The effect of aztreonam on the growth of <i>B. anthracis</i> and <i>B. cereus</i>	125
3.10.4.4	The effect of aztreonam on the growth of <i>B. anthracis</i> in PLETB	127
3.10.5	<b>Conclusions</b>	129
3.11	<b>The effect of soil on the selective recovery of <i>B. anthracis</i> in PLETB</b>	130
3.11.1	<b>Introduction</b>	130
3.11.1.1	The composition of soil	130
3.11.2	<b>Aim</b>	130
3.11.3	<b>Materials and Methods</b>	131
3.11.4	<b>Results</b>	133
3.11.4.1	The effect of adding different types of soil on the selective recovery of <i>B. anthracis</i> from a mixture of <i>B. anthracis</i> ASC 80 and <i>B. cereus</i> F4433/73 in PLETB	136
3.11.4.2	The effect of humic acids (HA) on the selective growth of <i>B. anthracis</i> in PLETB	137
3.11.4.3	The effect of mineral ions on the selective growth of <i>B. anthracis</i> in PLETB	138
3.11.4.4	The effect of chelating agents on the selective growth of <i>B. anthracis</i> in PLETB containing mineral ions	139
3.11.5	<b>Conclusions</b>	141

<b>3.12</b>	<b>Comparison of direct culture on PLETA with PLETB enrichment on the recovery of <i>B. anthracis</i></b>	<b>143</b>
3.12.1	Aims	143
3.12.2	Materials and Methods	143
3.12.3	Results	143
3.12.4	Conclusions	144
<b>3.13</b>	<b>The effect of the addition of agar to PLETB on the selective recovery of <i>B. anthracis</i></b>	<b>145</b>
3.13.1	Introduction	145
3.13.2	Aim	146
3.13.3	Materials and Methods	146
3.13.4	Results	146
3.13.5	Conclusions	148
<b>3.14</b>	<b>Discussion</b>	<b>150</b>

## 4.0 THE CONCENTRATION AND SUBSEQUENT DETECTION OF *BACILLUS ANTHRACIS* SPORES IN ENVIRONMENTAL MATERIAL

4.1	<b>Introduction</b>	156
4.1.1	Aqueous two-phase separation systems	156
4.1.2	The concentration of spores of <i>Bacillus</i> species using two-phase systems	157
4.1.3	Other methods for the separation of spores from soil particles	158
4.2	<b>The aim of this chapter</b>	159
4.3	<b>Materials and Methods</b>	159
4.3.1	Soils used in this study	159
4.3.2	Seeding soils with spores of <i>B. anthracis</i>	159
4.3.3	Evaluation of the two-phase separation method of Sacks and Alderton (1961)	160
4.3.4	Optimisation of the centrifuge speed and concentration of $K_2PO_4$ buffer	161
4.3.5	Separation of spores from soil particles using cation exchange	161
4.3.6	The effect of soaking soil on the recovery of spores of <i>B. anthracis</i>	162
4.3.7	The addition of broth to the two-phase concentration system	162
4.3.8	Comparison of the two-phase concentration system to enrichment culture	163
4.3.9	Evaluation of the two-phase concentration system using a range of soil types and strains of <i>B. anthracis</i>	163
4.3.10	Scale up of the two-phase concentration with enrichment system	164

4.4	<b>Results</b>	164
4.4.1	Two-phase concentration of <i>B. anthracis</i> spores	164
4.4.2	Optimisation of the centrifugation speed and $KPO_4$ buffer concentration used in the two-phase concentration system	165
4.4.3	Evaluation of the two-phase concentration system using naturally contaminated soils	167
4.4.4	A comparison of two-phase concentration using soil seeded with <i>B. anthracis</i> immediately before or one week before the experiment	170
4.4.5	The separation of <i>B. anthracis</i> spores from soil particles prior to two-phase concentration	170
4.4.6	Combination of two-phase separation with enrichment	175
4.4.7	Optimisation of the two-phase concentration with enrichment system	175
4.4.7.	Combination of soaking and two-phase concentration with enrichment	175
1		
4.4.7.	Optimisation of the concentration of $KPO_4$ buffer	175
2		
4.4.8	Comparison of two-phase concentration with enrichment to the use of selective broth culture for the detection of <i>B. anthracis</i> in soil	179
4.4.9	Evaluation of the optimised two-phase concentration with enrichment system using a range of soil types, and different strains of <i>B. anthracis</i>	179
4.4.10	Comparison of the two-phase concentration system with culture in PLETB for the detection of low numbers of spores of <i>B. anthracis</i> in soil	185
4.5	<b>Discussion</b>	186

**5.0 EVALUATION OF METHODS FOR THE PCR DETECTION OF  
*BACILLUS ANTHRACIS* DNA**

<b>5.1</b>	<b>Introduction</b>	<b>190</b>
5.1.1	The PCR	190
5.1.2	Application of the PCR for the detection of <i>B. anthracis</i> DNA	190
5.1.3	Evaluation and specificity of available primers for the PCR detection of DNA from <i>B. anthracis</i>	192
5.1.4	Detection of a chromosomal DNA sequence from <i>B. anthracis</i> using the PCR	195
5.1.5	The extraction of DNA from spores and vegetative cells of <i>B. anthracis</i>	197
5.1.6	The PCR detection of <i>B. anthracis</i> DNA in clinical and environmental material	197
<b>5.2</b>	<b>The aim of this chapter</b>	<b>198</b>
<b>5.3</b>	<b>Materials and Methods</b>	<b>199</b>
5.3.1	The extraction of template DNA directly from colonies of <i>B. anthracis</i>	199
5.3.2	Design of S-layer primers	199
5.3.3	Evaluation of the S-layer primers in the PCR	202
5.3.4	The specificity of S-layer primers	203
5.3.5	The detection of <i>B. anthracis</i> DNA in environmental material	203

5.3.6	The effect of humic material on the PCR detection of <i>B. anthracis</i> DNA	203
5.3.7	The PCR detection of <i>B. anthracis</i> spores concentrated using the two-phase separation method	204
5.4	<b>Results</b>	205
5.4.1	The detection of <i>B. anthracis</i> DNA using the PCR	205
5.4.2	The PCR detection of <i>B. anthracis</i> DNA directly from colonies	205
5.4.3	Evaluation of the use of S-layer primers	206
5.4.4	The specificity of S-layer primers for <i>B. anthracis</i>	210
5.4.5	The detection of <i>B. anthracis</i> DNA in environmental material	212
5.4.6	The detection of <i>B. anthracis</i> DNA in environmental material following non-selective enrichment	214
5.4.7	The effect of humic acids and soil on the PCR detection of <i>B. anthracis</i> DNA	217
5.4.8	The PCR detection of DNA from <i>B. anthracis</i> spores concentrated using the two-phase separation method	219
5.5	<b>Discussion</b>	220



**6.0 THE STABILITY OF PX01 AND PX02 IN *BACILLUS ANTHRACIS* IN THE PRESENCE OF NON-INDIGENOUS PLASMID DNA**

6.1	<b>Introduction</b>	224
6.2	<b>Aims of this chapter</b>	229
6.3	<b>Materials and Methods</b>	229
6.3.1	The stability of <i>E. coli/Bacillus</i> shuttle vectors in pX01/pX02 <i>B. anthracis</i> UM23C1-1	229
6.3.1.	The construction of <i>E. coli/Bacillus</i> shuttle vectors	229
1		
6.3.1.	Determination of the segregational stabilities of small shuttle plasmids 2 in <i>B. anthracis</i> strain UM23C1-1 in the absence of antibiotic selection	230
6.3.2	The stability of pAEX-5E over 100 generations of growth in derivatives of <i>B. anthracis</i> ASC 69, in the absence of antibiotic selection pressure	231
6.3.2.	Construction of plasmid pAEX-5E	231
1		
6.3.2.	The stability of pAEX-5E in derivatives of <i>B. anthracis</i> ASC 69 in the 2 absence of antibiotic selection pressure	233
6.3.2.	The effect of chain length on the segregational stability of pAEX-5E in 3 <i>B. anthracis</i> ASC 69 in the absence of antibiotic selection pressure	234
6.3.2.	The structural stability of pAEX-5E in <i>B. anthracis</i> in the absence of 4 antibiotic selection pressure	234

6.3.4	The stability of pX01 and pX02 under antibiotic selection pressure for pAEX-5E	235
6.3.5	The structural stability of pAEX-5E under antibiotic selection pressure	235
6.4	<b>Results</b>	237
6.4.1	The stability of small shuttle plasmids in <i>B. anthracis</i> UM23C1-1 in the absence of antibiotic selection pressure	237
6.4.2	The stability of pAEX-5E in derivatives of <i>B. anthracis</i> ASC 69 in the absence of antibiotic selection pressure	239
6.4.3	The effect of chain length on the segregational stability of pAEX-5E in <i>B. anthracis</i> ASC 69 in the absence of antibiotic selection pressure	241
6.4.4	The structural stability of pAEX-5E DNA in <i>B. anthracis</i> in the absence of antibiotic selection pressure	244
6.4.5	The stability of pX01 and pX02 under antibiotic selection pressure for pAEX-5E	244
6.4.6	The structural stability of pAEX-5E	246
6.5	<b>Discussion</b>	247
7.0	<b>GENERAL DISCUSSION</b>	258
8.0	<b>REFERENCES</b>	271
	<b>Appendix I</b>	332
	<b>Appendix II</b>	338

## LIST OF FIGURES

FIGURE NUMBER		PAGE NUMBER
<b>Introduction</b>		
1.1	The global incidence of anthrax in livestock in 1994 (from Hugh-Jones, 1996)	6
1.2	Notifications of cases of human and livestock anthrax in the UK 1900 - 1998	7
1.3	Diagrammatic representation of the model for the translocation of anthrax toxin into the host cell cytosol (Petosa <i>et al.</i> 1997)	16
1.4	Schematic diagram showing the procedure for the identification of colonies suspected to be <i>B. anthracis</i>	28
1.5	Schematic diagram showing the procedure for the identification of atypical colonies suspected to be <i>B. anthracis</i>	29
<b>Materials and Methods</b>		
2.1	Assembly of capillary transfer system	67
2.2	Diagrammatic representation of the fluorescein labelling and detection of DNA probes using the ECL random prime labelling and detection system	69
<b>Chapter 3</b>		
3.1	The effect of L-alanine, adenosine and inosine on spores of <i>B. anthracis</i> ASC 80	95
3.2	The proportional growth of <i>B. anthracis</i> in NB containing 0.1 - 1.0% PEA from a mixture of <i>B. anthracis</i> ASC 80 and <i>B. cereus</i> F4433/73	102

3.3	a) The effect of EDTA on the recovery of <i>B. anthracis</i> from a mixture of <i>B. anthracis</i> ASC 80 and <i>B. cereus</i> F4433/73 in BHIB	105
	b) The effect of EDTA on the recovery of <i>B. anthracis</i> from a mixture of <i>B. anthracis</i> ASC 80 and <i>B. cereus</i> F4433/73 in BHIB (TA = 40 mg/l)	
3.4	The effect of increasing the lysozyme and TA concentration of the selective recovery of <i>B. anthracis</i> from a mixture of <i>B. anthracis</i> ASC 80 and <i>B. cereus</i> F4433/73 in BHIB containing polymyxin B sulphate (30 000 units/l) and EDTA (300 mg/l)	106
3.5	a) The effect of the addition of TA to broth 0 - 5 h after inoculation on the recovery of <i>B. anthracis</i> from a mixture of <i>B. anthracis</i> ASC 80 and <i>B. cereus</i> F4433/73	108
	b) The effect of the addition of EDTA to broth 0 - 5 h after inoculation on the recovery of <i>B. anthracis</i> from a mixture of <i>B. anthracis</i> ASC 80 and <i>B. cereus</i> F4433/73	
3.6	Comparison of the growth of <i>B. anthracis</i> ASC 80 and <i>B. cereus</i> F4433/73 in PLETB at different incubation temperatures	111
3.7	The effect of aztreonam on the recovery of <i>B. anthracis</i> from a mixture of <i>B. anthracis</i> ASC 80 and <i>B. cereus</i> F4433/73 in BHIB	126
3.8	The recovery of <i>B. anthracis</i> ASC 80 in PLETB containing non-sterile soil	134
3.9	a) The effect of increased EDTA concentration on the recovery of <i>B. anthracis</i> ASC 80 in PLETB containing 3% (W/V) soil (ASS 91/90)	135
	b) The effect of increased TA concentration on the recovery of <i>B. anthracis</i> ASC 80 in PLETB containing 3% (W/V) soil (ASS 91/90) EDTA = 600 mg/l	

## Chapter 4

4.1	Concentration of spores of <i>B. anthracis</i> ASC 245 using a two phase system in the presence and absence of environmental material	166
-----	---	-----

4.2	Concentration of spores of <i>B. anthracis</i> ASC 245 using a two-phase system with different molarities of potassium phosphate buffer	168
4.3	Concentration of spores of <i>B. anthracis</i> from naturally contaminated soil (ASS 91/2, ASS 93/288)	169
4.4	Comparison of the concentration of spores of <i>B. anthracis</i> ASC 245 in pre-seeded and freshly seeded soil	171
4.5	The effect of Chelex on the two-phase concentration of spores of <i>B. anthracis</i> ASC 245 pre-seeded into GTS soil	172
4.6	Two-phase concentration with enrichment for the recovery of <i>B. anthracis</i> from soil (ASS 91/2)	175
4.7	The effect of the addition of Chelex on the recovery of <i>B. anthracis</i> in soil ASS 91/2 using two phase concentration with enrichment	177
4.8	Comparison of two-phase concentration with enrichment to the use of broth culture alone for the selective recovery of <i>B. anthracis</i> in soil (ASS 91/90)	180
4.9	The recovery of <i>B. anthracis</i> from soil using two-phase concentration 0 - 28 days after the soil was seeded with <i>B. anthracis</i> spores	182
 <b>Chapter 5</b>		
5.1	Nucleotide and deduced amino acid sequence of the <i>cap</i> region of pX02 (Makino <i>et al.</i> , 1989) showing the positions of oligonucleotides 1234 and 1301 (Turnbull <i>et al.</i> , 1992; Hutson <i>et al.</i> , 1993)	194
5.2	Nucleotide and deduced amino acid sequence of the PA gene and 5' and 3' flanking sequences (Welkos <i>et al.</i> , 1988) showing the position of oligonucleotide primers 975 and 976 (Hutson <i>et al.</i> , 1993) and PA5 and PA8 (Beyer <i>et al.</i> 1996)	196
5.3	Nucleotide and deduced amino acid sequence of the region encompassing the <i>sap</i> gene (Etienne-Toumelin <i>et al.</i> , 1995) showing the position of S-layer oligonucleotide primers	200

5.4	Possible binding site of lower primer 1 to the S-layer DNA sequence of <i>B. stearothermophilus</i>	202
5.5	Determination of the plasmid content of derivatives of <i>B. anthracis</i> ASC 69 using the duplex colony PCR	207
5.6	Evaluation of the effectiveness of S-layer primers using <i>B. anthracis</i> ASC 245 DNA as template material	208
5.7	Determination of the plasmid content of derivatives of <i>B. anthracis</i> ASC 69 using the multiplex PCR with S-layer primers	209
5.8	Comparison of the specificity of S-layer primer set 2 against different <i>Bacillus</i> species using annealing temperatures of 55 °C and 65 °C	211
5.9	Evaluation of the PCR detection of <i>B. anthracis</i> DNA after non-selective enrichment and phenol chloroform DNA extraction using the method of Beyer <i>et al.</i> , 1995, 1996	216
5.10	The effect of adding soil (ASS 149/93) on the PCR amplification of <i>B. anthracis</i> ASC 80 DNA	218

## Chapter 6

6.1	The mechanisms by which rolling circle replication (from Jannière <i>et al.</i> , 1993) and theta replication are conducted	228
6.2	A diagrammatic representation of the pAEX-5E and pAEX-5E/K constructs, indicating the orientations of the kanamycin cassette	232
6.3	The stability of small shuttle plasmids in <i>B. anthracis</i> UM23C1-1 over 100 generations of growth in LB	238
6.4	The stability of pAEX-5E (measured by antibiotic resistance) in derivatives of <i>B. anthracis</i> ASC 69 over 100 generations of growth in LB	240
6.5a	<i>Hind</i> III digested genomic DNA extracted from derivatives of <i>B. anthracis</i> ASC 69 which have been grown for 100 generations under antibiotic selection pressure for pAEX-5E	248

6.5b	Southern blot analysis of <i>Hind</i> III digested genomic DNA extracted from derivatives of <i>B. anthracis</i> ASC 69 after 100 generations of growth in the presence of antibiotic selection for pAEX-5E, probed with pAEX-5E DNA	249
6.6a	<i>Hind</i> III digested genomic DNA from derivatives of <i>B. anthracis</i> ASC 69 prior to the introduction of pAEX-5E DNA	250
6.6b	Southern blot analysis of <i>Hind</i> III digested genomic DNA extracted from derivatives of <i>B. anthracis</i> ASC 69 prior to the introduction of pAEX-5E, probed with pAEX-5E DNA	251
6.7	Comparison of the stability of pAEX-5E in the pX01 <sup>+</sup> /pX02 <sup>-</sup> derivative of <i>B. anthracis</i> ASC 69 with and without growth (100 generations) under selection pressure for pAEX-5E	252

## General Discussion

7.1	Protocol for the selective recovery of <i>B. anthracis</i> from soil samples	261
7.2	Protocol for the PCR detection of <i>B. anthracis</i> after two-phase concentration and enrichment	262

## LIST OF TABLES

TABLE NUMBER		PAGE NUMBER
<b>Chapter 1</b>		
1.1	Examples of the longevity of spores of <i>B. anthracis</i> in the environment	10
1.2	Susceptibility of different animal species to anthrax	12
1.3	Characteristics used for the differential identification of <i>B. anthracis</i> , <i>B. cereus</i> , <i>B. thuringiensis</i> and <i>B. megaterium</i>	26
1.4	Suggested methods for the molecular detection of microorganisms from soil	37
1.5	The inhibition effect of humic substances on the PCR	38
<b>Chapter 2</b>		
2.1	Bacterial species and strains used in this study	44
2.2	Plasmids used in this study	45
2.3	Characteristics of isolates of <i>B. anthracis</i> grown on bicarbonate agar under candle extinction and in the presence of 20% CO <sub>2</sub>	58
<b>Chapter 3</b>		
3.1	Selective agars recommended for the growth of <i>B. anthracis</i> from environmental samples	78
3.2	Soils used in this study	81
3.3	Comparison of the growth of <i>B. anthracis</i> on different selective agars	82
3.4	Comparison of the growth of strains of <i>B. anthracis</i> and <i>B. cereus</i> on PEA	83
3.5	Comparison of different basal media for the selective growth of <i>B. anthracis</i> on PLETA	89
3.6	The effect of the different chemical components of PLETA on the growth of <i>B. anthracis</i> in soil	90



3.7	Reports on the induction of germination of spores of <i>B. anthracis</i> and <i>B. cereus</i>	92
3.8	Comparison of growth of spores of <i>B. anthracis</i> ASC 80 and <i>B. cereus</i> F4433/73 in LB containing different concentrations of sodium acetate	94
3.9	The effect of different germinants on spores of <i>B. anthracis</i> ASC 80	94
3.10	Comparison of the germination of spores of <i>B. anthracis</i> ASC 80 and <i>B. cereus</i> F4433/73 in various germination inducing compounds	96
3.11	Comparison of the growth of <i>B. anthracis</i> ASC 80 and <i>B. cereus</i> F4433/73 in BHIB	99
3.12	Identification of <i>B. anthracis</i> in blood by M'Fadyean reaction and culture on PLETA	100
3.13	Comparison of the growth of spores and vegetative cells of <i>B. anthracis</i> and <i>B. cereus</i> in PLETB	109
3.14	The effect of pH on the growth of <i>B. anthracis</i> ASC 80 in PLETB	109
3.15	The effect of TA and KA the growth of <i>B. anthracis</i> from a mixture of <i>B. anthracis</i> ASC 80 and <i>B. cereus</i> F4433/73 in BHIB	114
3.16	The effect of EGTA, EDDA or EDTA on the growth of <i>B. anthracis</i> from a mixture of <i>B. anthracis</i> ASC 80 and <i>B. cereus</i> F4433/73 in PLETB	114
3.17	Growth of <i>B. anthracis</i> from a mixture of <i>B. anthracis</i> ASC 80 and <i>B. cereus</i> F4433/73 when other chelating agents are substituted for EDTA in PLETB	115
3.18	The growth of different combinations of strains of <i>B. anthracis</i> and <i>B. cereus</i> in PLETB	118
3.19	The susceptibility of <i>B. anthracis</i> to different antimicrobial agents	120
3.20	Minimum inhibitory concentrations of cefuroxime and cefotaxime on <i>B. anthracis</i> ASC 80 and <i>B. cereus</i> F4433/73	124
3.21	The effect of amoxycillin and clavulanic acid on the growth of <i>B. anthracis</i> ASC 80 and <i>B. cereus</i> F4433/73	125

3.22	The growth of different strains of <i>B. anthracis</i> and <i>B. cereus</i> in BHIB containing 600 µg/ml aztreonam	127
3.23	The effect of aztreonam on the growth of <i>B. anthracis</i> from a mixture of different strains of <i>B. anthracis</i> and <i>B. cereus</i> in BHIB and PLETB	128
3.24	Approximate composition of known terrestrial matter in the lithosphere (from Brock, 1966)	131
3.25	Soils used in this study	132
3.26	The recovery of <i>B. anthracis</i> from different combinations of strains of <i>B. anthracis</i> and <i>B. cereus</i> in PLETB containing 3% soil (ASS 91/90) and subcultured onto PLETA	133
3.27	The recovery of <i>B. anthracis</i> ASC 80 from a mixture of <i>B. anthracis</i> ASC 80 and <i>B. cereus</i> F4433/73 in PLETB containing sand, peat, charcoal or soil	136
3.28	The effect of different soils with (1) a high mineral content and (2) a high organic content on the selective growth of <i>B. anthracis</i> from a mixture of <i>B. anthracis</i> ASC 80 and <i>B. cereus</i> F4433/73 in PLETB	137
3.29	The effect of HA on the selective recovery of <i>B. anthracis</i> from a mixture of <i>B. anthracis</i> ASC 80 and <i>B. cereus</i> F4433/73 in PLETB	138
3.30	The effect of various salts on the selective recovery of <i>B. anthracis</i> from a mixture of <i>B. anthracis</i> ASC 80 and <i>B. cereus</i> F4433/73 in PLETB	139
3.31	The recovery of <i>B. anthracis</i> from a mixture of <i>B. anthracis</i> ASC 80 and <i>B. cereus</i> F4433/73 in PLETB containing 2.5 mM CaCl <sub>2</sub> and EDTA or EGTA	140
3.32	The effect of the addition of iron chelating agents to PLETB containing FeCl <sub>2</sub> on the selective growth of <i>B. anthracis</i> from a mixture of <i>B. anthracis</i> ASC 80 and <i>B. cereus</i> F4433/73	141
3.33	The effect of the addition of Chelex to PLETB containing 0.5 mM CuSO <sub>4</sub> on the selective growth of <i>B. anthracis</i> ASC 80	140

3.34	Comparison of the recovery of <i>B. anthracis</i> from naturally contaminated soil (ASS 91/85) with and without broth enrichment	144
3.35	Comparison of the growth of <i>B. anthracis</i> in semi-solid PLETB to growth in PLETB	147
3.36	Comparison of the growth of low numbers of <i>B. anthracis</i> in 50 ml volumes of semi-solid PLETB to growth in PLETB	148
3.37	The effect of the addition of different environmental samples to 50 ml volumes of semi-solid PLETB on the selective recovery of <i>B. anthracis</i>	149
 <b>Chapter 4</b>		
4.1	Range of soils used for two-phase concentration experiments	160
4.2	Comparison of the recovery of spores of <i>B. anthracis</i> ASC 245 from the two-phase system after centrifugation at different speeds	167
4.3	The effect of Triton-X100 and sodium deoxycholate on the selective recovery of <i>B. anthracis</i> spores in the two-phase system	172
4.4	The effect of soaking soil on the recovery of spores of <i>B. anthracis</i>	174
4.5	Effect of the concentration of $KPO_4$ buffer concentration on the recovery of <i>B. anthracis</i> spores in the two-phase separation with enrichment system	178
4.6	Concentration of spores incubated with soil for 0,4, 8 and 28 days using two-phase concentration	181
4.7	Two-phase concentration with enrichment of soil samples > 28 days after seeding with <i>B. anthracis</i> spores	183
4.8	Scale up of two-phase concentration with enrichment using 5 g soil samples using soil seeded > 28 days previously	184
4.9	Comparison of the recovery of spores of <i>B. anthracis</i> using the scaled up two-phase concentration system with culture in PLETB	185
4.10	Detection of <i>B. anthracis</i> from soil naturally contaminated with low numbers of <i>B. anthracis</i> spores	186

## Chapter 5

- |     |  |     |
|-----|--|-----|
| 5.1 | Summary of published methods describing the detection of <i>B. anthracis</i> DNA using the PCR   | 191 |
| 5.2 | S-layer sequences screened for potential binding sites of primers designed for detection of part of the S-layer gene sequence from <i>B. anthracis</i> | 201 |
| 5.3 | Specificity of S-layer primers against a range of <i>Bacillus</i> species  | 212 |
| 5.4 | Specificity of S-layer primer set 2 when tested against a range of <i>Bacillus</i> species   | 213 |
| 5.5 | The recovery of <i>B. anthracis</i> during non-selective enrichment, followed by the PCR detection of <i>B. anthracis</i> DNA                          | 215 |
| 5.6 | Inhibition of the PCR by humic acid solution   | 217 |
| 5.7 | The PCR detection of <i>B. anthracis</i> DNA from spores concentrated by two-phase separation with enrichment  | 219 |

## Chapter 6

- |     |   |     |
|-----|---|-----|
| 6.1 | The doubling time of derivatives of <i>B. anthracis</i> UM23C1-1 containing pAEX-1- <i>pag</i> pAEX-4- <i>pag</i> or pAEX-5- <i>pag</i> grown in LB | 237 |
| 6.2 | The doubling time of derivatives of <i>B. anthracis</i> ASC 69 containing plasmid pAEX-5E grown in LB in the absence of antibiotic selection        | 239 |
| 6.3 | A comparison of length of chains formed by derivatives of <i>B. anthracis</i> ASC 69 containing pAEX-5E grown in LB for 100 generations             | 242 |
| 6.4 | The mean chain length of the pX01 <sup>+</sup> /pX01 <sup>-</sup> derivative of ASC 69 over 100 generations of growth in LB                         | 243 |
| 6.5 | The doubling time of derivatives of <i>B. anthracis</i> ASC 69 in LB under antibiotic selection pressure for pAEX-5E                                | 244 |
| 6.6 | The stability of pX01 and pX02 over 100 generations of growth under selective pressure for pAEX-5E  | 245 |

## LIST OF ABBREVIATIONS

ASS	Anthrax Section Sample (CAMR)
ASC	Anthrax Section Culture (CAMR)
BA	Blood Agar
BHI (B/A)	Brain Heart Infusion (Broth or Agar)
CAMR	Centre for Applied Microbiology and Research
cfu	Colony Forming Units
CTAB	Cetyltrimethylammonium bromide
DNA	Deoxyribonucleic acid
EB	Elution Buffer
EDDA	Ethylenediamidine - N - N' - diacetic acid
EDTA	Ethylenediaminetetraacetic acid
EF	Oedema Factor
EGTA	Ethylene glycol - bis ( $\beta$ - aminoethyl ether) N, N, N' N' tetraacetic acid
EtBr	Ethidium bromide
GTS	Garden Top Soil
HA	Humic acid
HI (A/B)	Heart Infusion (Agar or Broth)
HLA	Haematin and Lysozyme Agar
KA	Potassium Acetate
KPO <sub>4</sub> Buffer	Potassium Phosphate Buffer
L (A/B)	Luria (Agar or Broth)
LBG	LB + Glucose
LF	Lethal Factor
MCL	Mean Chain Length
MHB	Muller Hinton Broth
MIC	Minimum Inhibitory Concentration

MO	Minus Origin
NA	Nutrient Agar
NAM	N-acetylmuramic acid
NAG	N-acetylglucosamine
NCTC	National Collection of Type Cultures
NMRI	Naval Medical Research Institute, Bethesda, MA
PA	Protective Antigen
<i>pag</i>	DNA sequence coding for PA
PBP	Penicillin Binding Protein
PCR	Polymerase Chain Reaction
PEA	Phenylethyl alcohol
PEG	Polyethylene Glycol
PI (A)	Propamidine Isethionate (Agar)
PLET (A/B)	Polymyxin B sulphate, Lysozyme, EDTA and Thallous Acetate (Agar or Broth)
RCR	Rolling Circle Replication
RNA	Ribonucleic acid
RT	Room Temperature
SDW	Sterile Deionised Water
TA	Thallous acetate
TAE	Tris-Acetate EDTA buffer
TBE	Tris-Borate EDTA buffer
TCB (A)	Trimethoprim Colistin Blood (Agar)
$t_d$	Doubling time
TE	Tris-EDTA buffer
TSB	Tryptone Soya Broth
TSB	Transport Storage Buffer

# 1. INTRODUCTION

## 1.1 The disease

*Bacillus anthracis* is a Gram-positive endospore forming bacillus and is the causative agent of anthrax. Anthrax is primarily a disease of herbivorous mammals, although all mammals are susceptible to varying degrees (Turnbull and Kramer, 1995). Humans can become infected by exposure to *B. anthracis* through contact with contaminated animals, animal products or environmental material (Carman *et al.*, 1985). Rare cases of anthrax in birds and reptiles have been reported (Turnbull, 1990).

### 1.1.2 The historical relevance of *B. anthracis*

*Bacillus anthracis* was used in many of the pioneering microbiological studies which took place in the eighteenth and nineteenth centuries. In 1769, in France, Fournier described anthrax as a disease that affected both animals and humans (Whitford, 1979). Between 1838 and 1860 several workers observed bacilli in the blood of animals which had died of anthrax, but the link between bacilli and the disease was not made until the 1870 's (Klemm and Klemm, 1959). In 1876, in Germany, Robert Koch published a paper describing the life cycle of *B. anthracis* in relation to the epidemiology of anthrax (Farrar, 1995). This included the first description of the bacterial spore (Keynan and Sandler, 1983).

The name anthrax is derived from the Greek word anθraks which originally referred to 'live coals', or pustular or vesicular forms of dermatitis (Pfisterer, 1996). The association of anthrax with humans may have started between 10 000 and 12 000 years ago, with the earliest domestication of animals. A more likely origin, however, is

6000 to 7000 years ago in Mesopotamia, with the beginnings of agricultural civilization (Klemm and Klemm, 1959). Throughout history, descriptions of diseases of both humans and animals which may have been anthrax have been made (Klemm and Klemm, 1959), and by the Middle Ages, anthrax was a common disease of humans and livestock (Farrar, 1995). In 1613 a major epidemic, attributed to anthrax, occurred in southern Europe, which killed approximately 60 000 people. This was referred to as the "black bain" (Farrar and Reboli, 1991). Animal diseases with similar symptoms to anthrax include botulism; blackleg in sheep, or blackquarter in cattle, caused by *Clostridium chauvoei*; toxicosis, for example caused by a snake bite; the tick borne parasitic disease babesiosis; lightning strikes; malnutrition and bloat (Lindeque, 1991; Sainsbury, 1986).

With the advent of industrialisation and the move towards factory processing, pulmonary anthrax became a serious health threat to people working with animal products contaminated with spores of *B. anthracis* (Friedlander, 1998). In 1879 in Bradford, England, Bell connected *B. anthracis* with woolsorter's disease, which was the name given to pulmonary anthrax at that time (Hambleton *et al.*, 1985). Woolsorter's disease had previously been attributed to a form of 'blood poisoning' (Tigertt, 1980). In 1918 a report was published by the Government Departmental Committee appointed to evaluate the precautions required for the prevention of infection from anthrax in the processing of contaminated animal products. They reported that between 1899 and 1912, 12% (40/315) of cases of human anthrax in the UK were fatal (Anon, 1918). During this period treatment for cutaneous anthrax involved destruction or removal of the external lesion by the use of arsenic or sulphur containing preparations (Stein, 1948) or by cauterization or excision (Knudson, 1986).



Local application of antimicrobial ointment or localised injection with anti-anthrax serum were also used, but found to be ineffective. At the beginning of the twentieth century the use of anti-anthrax serum reduced the mortality from pulmonary anthrax in the UK from 48% to 4% (Stein, 1963; Mitchell, 1911; cited in Knudson, 1986).

Serum therapy is still used today in China (Dong, 1990) and Russia (Cherkasskiy, 1996). Other treatments used included bacteriophage therapy in the 1930's, which was ineffective, and radiological treatment in the 1940's (Dubourg and Ouary, 1932; Riebling, 1948; cited in Knudson, 1986). The first successful treatment of cutaneous anthrax with penicillin was carried out in 1944. This led to sterilisation of the lesion within 24 h (Murphy *et al.*, 1944; cited in Knudson, 1986).

The first livestock vaccine effective against anthrax was produced in 1880 in London by Greenfield, by the attenuation of *B. anthracis* by continuous liquid culture. Lack of funding and strict regulations imposed on the use of animals in his experiments prevented him from expanding his work (Tigertt, 1980). In 1881 Pasteur produced a vaccine by continuous culture of *B. anthracis* at 43 °C - 47 °C (Keynan and Sandler, 1983). Pasteur was able to conduct high profile large-scale trials in sheep to demonstrate the efficacy of his vaccine (Turnbull, 1991). In the mid-nineteenth century anthrax was killing up to 30% of livestock in Europe, and the work of Pasteur led to the introduction of widespread animal vaccination.

### 1.1.3 Current relevance of *B. anthracis*

Today, the number of cases of human and animal anthrax worldwide are in decline (Hugh-Jones, 1998). This can be attributed to improved understanding of the disease, leading to more effective precautionary measures, and, in industrialised countries, to

the implementation of vaccination programmes.

In animals, large unexpected outbreaks of anthrax can occur, for example in 1945 in Iran one million from a total of 15 million sheep died of anthrax (Kohout, 1964, cited in Titball *et al.*, 1991) and in 1987 approximately 4000 hippopotami from an estimated population of 18 000 to 20 000 died of anthrax in a 300 km<sup>2</sup> area in the Luangwa Valley National Park, Zambia. The trigger for this epizootic remains unknown (Turnbull *et al.*, 1991). Anthrax may also affect the survival of susceptible animal species, for example in the Etosha National Park, Namibia, between 1966 and 1974 more than 50% of the recorded animal deaths were caused by anthrax (Ebedes, 1976, cited in Turnbull *et al.*, 1986). In the Lake Manyara National Park, Tanzania, 92% (1364 of 1476) of the impala population were killed in an outbreak of anthrax (Lindeque, 1991).

Occasionally large outbreaks of human anthrax occur, for example between 1978 and 1980, following the disruption of animal vaccination programmes and medical services due to the civil war in Zimbabwe, 9711 cases of human anthrax were reported with 151 deaths (Farrar, 1995). Another significant outbreak of anthrax in a human population occurred in 1979 in Sverdlosk, Russia, when accidental leakage of anthrax spores from a military laboratory caused up to one thousand cases of anthrax, a proportion of which were fatal (Meselson *et al.*, 1994).

Over the past decade *B. anthracis* has assumed greater strategic importance, due to its potential use as an agent of bioterrorism (Atlas, 1998; Turnbull, 1999). This has led to renewed programmes of research into the molecular biology of *B. anthracis*, the development of more effective vaccines against anthrax and methods for the improved detection and identification of *B. anthracis* in the environment.

## **1.2 Incidence of anthrax**

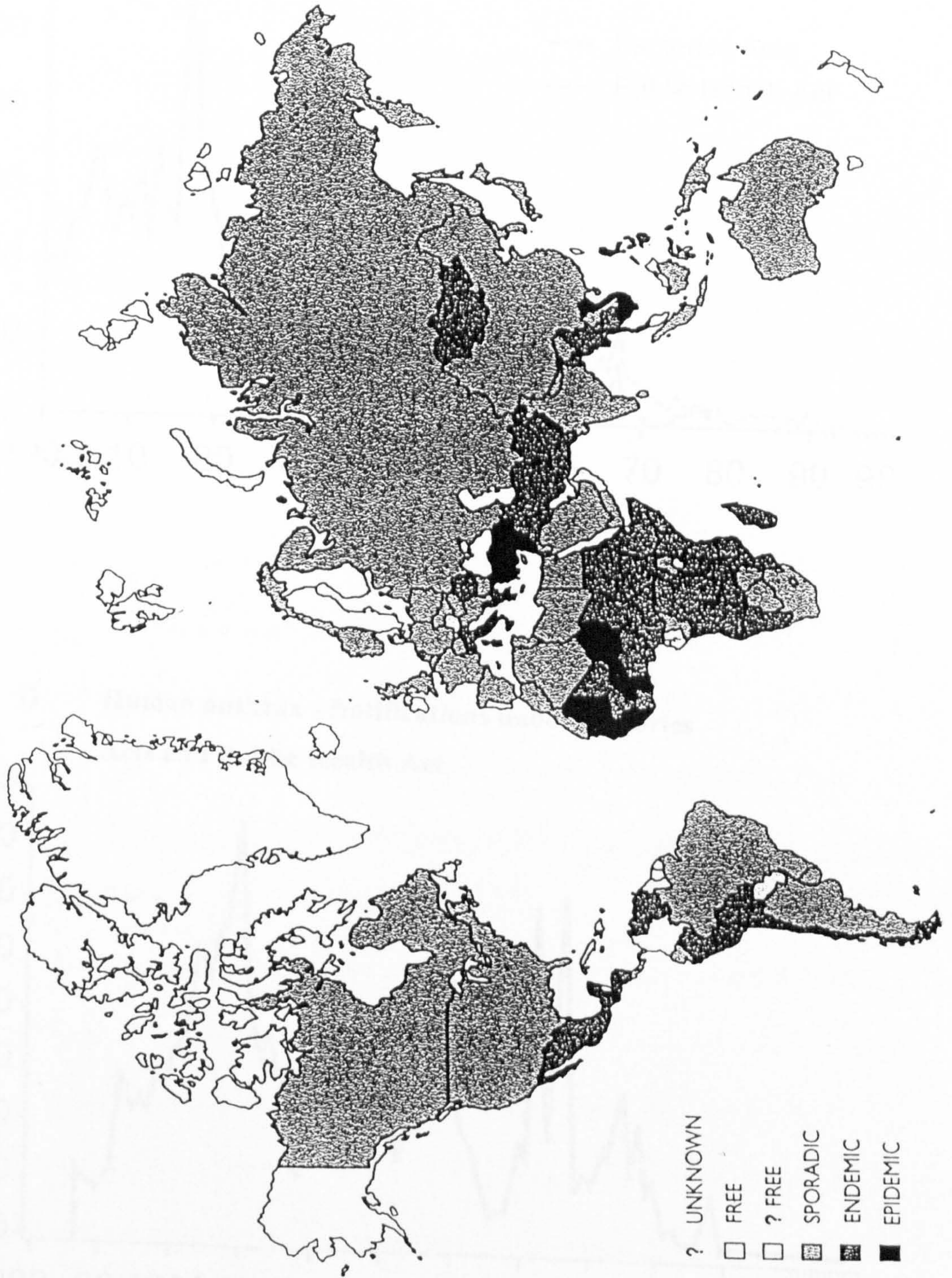
Anthrax is enzootic in a region encompassing areas of tropical Africa, the Middle East and South East Asia. The levels of reporting of the disease remain variable from country to country and may be limited to the number of human cases; the number of animal cases can be estimated by multiplying this by 10 (Hugh-Jones, 1998). The incidence of livestock anthrax in different world regions is shown in Figure 1.1. The incidence of human and animal anthrax in the UK are shown in Figure 1.2.

The decline in the number of cases of anthrax in the UK can be attributed to the British Anthrax Prevention Act of 1919 which introduced legislation aimed at preventing the importation of contaminated animal products from anthrax endemic areas. Unexpected cases of anthrax may still occur, for example in 1996 in London a man survived pulmonary anthrax. The source of the infection remains unknown (Breathnach *et al.*, 1996).

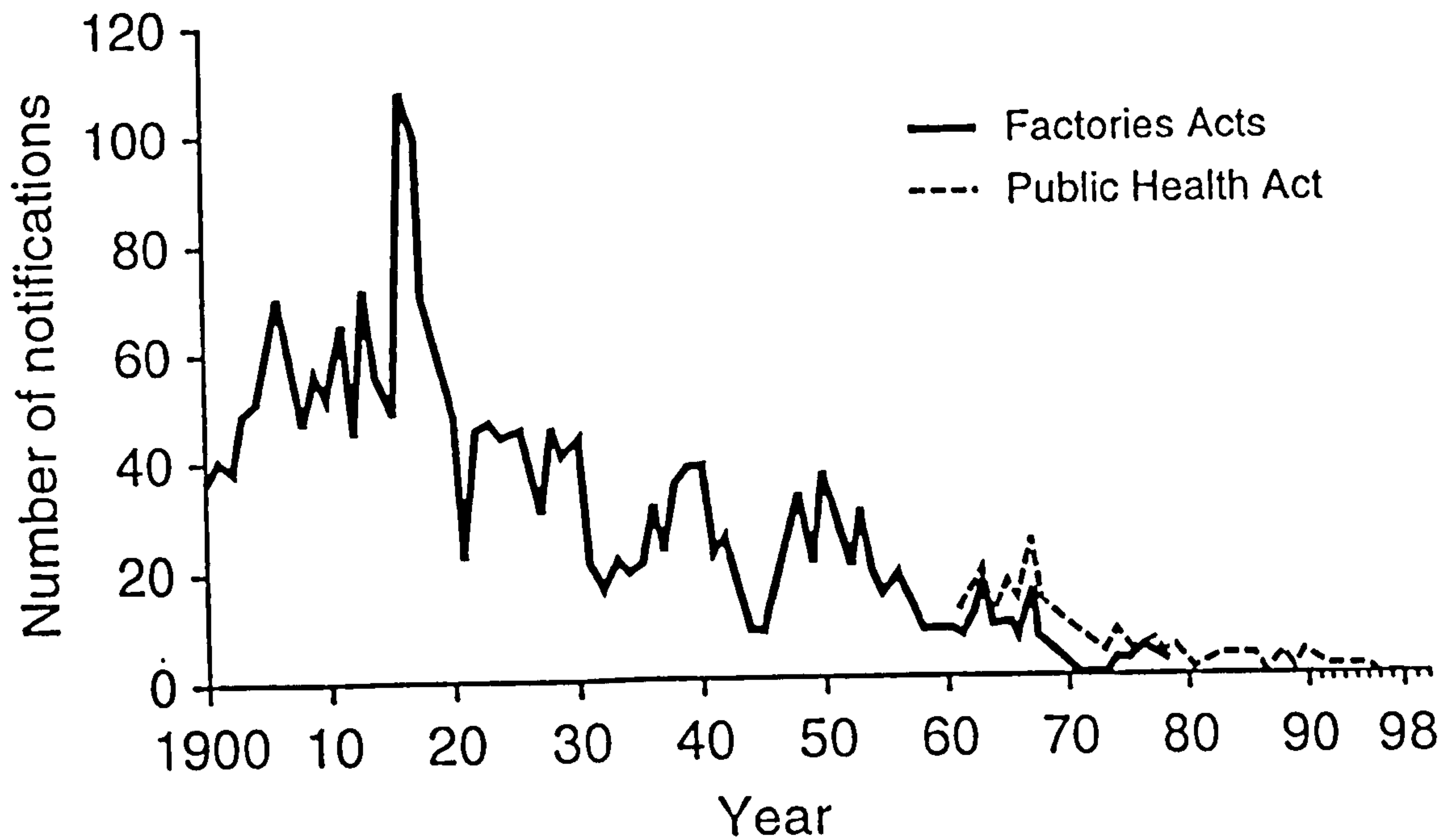
### **1.2.1 Transmission of spores of *B. anthracis* in the environment**

When an animal dies of anthrax, blood loaded with vegetative bacilli are shed from its nose, mouth and anus. A proportion of the bacilli sporulate and remain in the environment as a potential source of further infection (Quinn and Turnbull, 1998). If the animal is part of a domestic herd or flock, and the carcass is disposed of carefully, contamination is likely to remain only at the site of death. Spores may, however, be spread by ploughing or digging a contaminated area (Turnbull *et al.*, 1996) or by disturbance caused by heavy rain (Dragon and Rennie, 1995). Pasteur hypothesised that spores may also be spread by earthworms (Mock, 1995). To limit the spread of *B. anthracis* spores, careful disposal of infected carcasses, preferably without opening

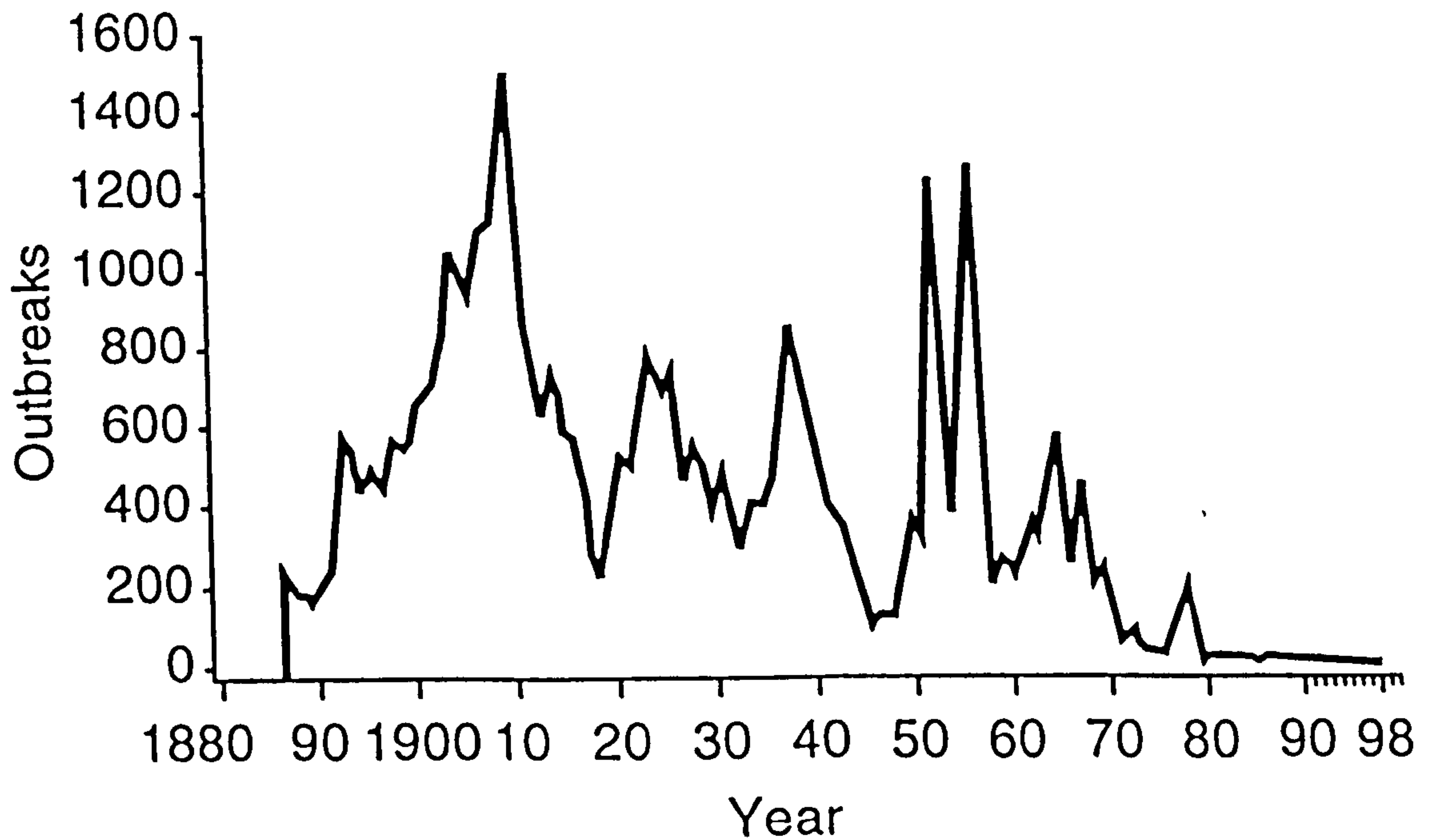
Figure 1.1 The global incidence of anthrax in livestock in 1994 (from Hugh-Jones, 1996)



**Figure 1.2** Notifications of human and livestock anthrax in the UK 1900 - 1998



**1) Human anthrax - Notifications under Factories Acts and Public Health Act**



**2) Reported cases of animal anthrax in Britain (From MAFF CVO reports)**

and by burning, to prevent further spore contamination of the surrounding area, should be employed wherever possible (Turnbull *et al.*, 1993). If death from anthrax occurs in a wild animal, in an area where anthrax is enzootic, spores may be spread to the surrounding area in the fur, feathers or faeces of predating carnivores (de Vos and Bryden, 1996) or can be disseminated by flies (Titball *et al.*, 1991; Turell and Knudson, 1987). Dismantling of a carcass can occur with great rapidity. A carcass of a 100 kg wildebeest which has died from anthrax can be stripped by griffon vultures in 30 min (Lindeque, 1991). This may reduce spore contamination, as vegetative bacilli are ingested and destroyed by gastric juices before they sporulate.

The likelihood of spores being spread by aerosolisation is probably low. In the Etosha National Park, Namibia, air samples were taken from areas surrounding sites where spores of *B. anthracis* were present at levels of up to  $10^6$  per gram of soil. Results showed a maximum of 160 spores were collected in 7500 l of air, sampled 6 m downwind from a site containing approximately  $10^5$  spores of *B. anthracis* per g of soil, after soil disturbance and when the wind speeds were the highest recorded (Turnbull *et al.*, 1998).

Spread of spores of *B. anthracis* can also occur when contaminated animal products such as hides, hairs, bones and skins are transported to factories for processing. If decontamination is not carried out effectively, spores may become incorporated in the finished product. For example during the First World War 149 cases of anthrax and 22 deaths were reported in US troops who had been shaving with brushes made from *B. anthracis* contaminated bristles which had been imported from Siberia and China (Whitford, 1979).

### 1.2.2 Persistence of spores of *B. anthracis* in the environment

Sporulation is affected by the ambient temperature, humidity, availability of moisture, amount of sunlight, background bacterial flora, the pH of the soil, and the presence of divalent cations, carbon and nitrogen compounds (Lindeque, 1991; Lindeque and Turnbull, 1994). Lindeque (1991) studied the effect of soil type on sporulation of *B. anthracis* at the Etosha National Park, Namibia. She found that of five soils studied, sandy soils with low pH values and the lowest total aerobic and anaerobic spore count were the most conducive to sporulation. In contrast, sporulation has been linked to alkaline soil types (Siala and Grey, 1974). In India, outbreaks of anthrax have been associated with calcareous soil with a high pH. In regions containing acidic soil anthrax does not persist (Hugh-Jones, 1998). Dragon and Rennie (1995) suggested that high calcium levels in the soil may extend the viability of spores by providing a reservoir of calcium to supplement that present in the spore wall. Between 1945 and 1947 in the USA the majority of veterinarians reported that anthrax outbreaks occurred on heavy gumbo (clay) soils. Occasional outbreaks on sandy soils occurred in areas adjacent to low lying ponds or water holes, which were the probable source of infection (Stein, 1948).

Sterne (1959) hypothesised that spores of *B. anthracis* remained viable in the environment for between three months and three years. This seems feasible when the amount of environmental contamination with *B. anthracis* is compared to the number of cases of anthrax reported (Hugh-Jones, 1998). In some cases *B. anthracis* has persisted for longer periods. Examples of the longevity of spores of *B. anthracis* in the environment are shown in Table 1.1.

**Table 1.1 Examples of the longevity of spores of *B. anthracis* in the environment**

Description of sample	Area	Length of time spore have persisted	Reference
Soil	Etosha NP, Namibia	82 months *	Lindeque <i>et al.</i> , 1996
Soil	Gruinard Island UK	40 years	Manchee <i>et al.</i> , 1994
Soil (burial site of bull)	Landkey, Devon UK	50 years	Turnbull <i>et al.</i> , 1996
Rockwool lagging	Roof space of Kings Cross Station, UK,	110 years	Quinn and Turnbull, 1998
Bones	Parfuri in the Kruger NP, South Africa	200 years	de Vos, 1990

NP = National Park. \* A slow decline in spore numbers was observed, attributed to both spore death and dispersion.

Spores of other *Bacillus* species have been reported to survive in the environment for much longer, for example viable *Bacillus* spores were reported to have been recovered from lake sediment estimated to be between 566 and 1000 years old (Slepacky and Leadbetter, 1983).

In the laboratory, spores prepared by Pasteur in 1888 were still viable after 68 years (Jacotet and Virat, 1954, cited by Sneath 1962) and spores in soil were found to remain viable for 60 years (Wilson and Russell, 1964).



### 1.3 Susceptibility to anthrax

Susceptibility to anthrax is greatest in herbivores; omnivores and carnivores are much more resistant. Susceptibility also varies greatly depending on the route of infection (Beall *et al.*, 1966). A summary of some of the available information on the susceptibility of various animals to anthrax is shown in Table 1.2.

A higher number of *B. anthracis* spores are required to cause infection by ingestion, as a lesion in the alimentary canal is required for infection to occur, and spores may pass without germination through the digestive tract (Barnes, 1947).

Human resistance to anthrax is extrapolated from results of animal studies. Meselson *et al.* (1994) estimated the inhalation LD<sub>50</sub> for humans to be  $8 \times 10^3 - 1 \times 10^4$  spores. There is evidence of asymptomatic carriage of spores of *B. anthracis* in humans. Carr and Rew (1957) isolated *B. anthracis* from seven nasal swabs and seven pharyngeal washings from 101 mill workers at a goat hair processing factory. Despite this apparent carriage of the organism, anthrax infections remained sporadic amongst the workers and their outside contacts. Dahlgren (1960) estimated that workers at a goat hair processing factory were inhaling 600 - 1300 spores per day without incidences of anthrax. This may be attributed to a build up of resistance to anthrax spores over time. In other instances people who, as far as it has been possible to determine, have had a minimal exposure to anthrax, for example by passing a factory, or handling one contaminated animal product have been known to contract the disease (Watson and Kier, 1994). Gray (1963) suggested that malnutrition, particularly lysine deficiency, may increase susceptibility to anthrax (Knudson, 1986).

**Table 1.2 Susceptibility of different animal species to anthrax**

Animal species	Route of infection	LD <sub>50</sub> values	Reference
Mouse (outbred)	parenteral injection	5.0	Welkos <i>et al.</i> , 1986
Mouse	inhalation	1.4 x 10 <sup>5</sup>	Druett <i>et al.</i> , 1953
Guinea pig	parenteral injection	5.0 x 10 <sup>1</sup>	Welkos <i>et al.</i> , 1986
Guinea pig	inhalation	1.6 x 10 <sup>5</sup> - 8.6 x 10 <sup>6</sup>	Welkos <i>et al.</i> , 1986
Sheep	ingestion	2.0 x 10 <sup>5</sup>	Watson and Kier, 1994
Sheep	inhalation	3.5 x 10 <sup>4</sup> *	Fildes, 1943, cited in Turnbull <i>et al.</i> , 1998
Chimpanzee	inhalation	5.0 x 10 <sup>4</sup> spores	Albrink and Goodlow, 1959
Rhesus monkey †	parenteral injection	3.0 x 10 <sup>4</sup>	Watson and Kier, 1994
Rhesus monkey	inhalation	5 x 10 <sup>4</sup> - 7.6 x 10 <sup>5</sup>	Watson and Kier, 1994
Pig	parenteral injection	1.0 x 10 <sup>9</sup>	Watson and Kier, 1994
Pig	inhalation	2.7 x 10 <sup>7</sup>	Watson and Kier, 1994

\* minimal infectious dose; † the preferred non-human primate animal model.

## 1.4 Pathogenesis of anthrax

### 1.4.1 Forms of anthrax

Anthrax in humans can be classified as industrial anthrax, caused by exposure to contaminated animal products during processing, and non-industrial anthrax, which occurs when anthrax is contracted directly from an infected animal (Quinn and Turnbull, 1998).

*B. anthracis* can enter the body of the host by three routes: through the lung epithelium via the macrophages; through a lesion in the alimentary canal; or through an abrasion on the skin, causing pulmonary, intestinal and cutaneous anthrax respectively (Quinn and Turnbull, 1998). When treatment is not administered, pulmonary and intestinal anthrax are usually fatal (Turnbull *et al.*, 1998a). Cutaneous anthrax accounts for 95 - 99% of all human cases (Friedlander, 1998) and responds rapidly to treatment with antibiotics. Untreated cases, however, can progress to septicaemia and renal failure and may be fatal in up to 20% of cases (Anon, 1918).

A rare complication of any of the three forms of anthrax is anthrax meningitis, which may follow any of the 3 forms of anthrax. Signs of anthrax meningitis include inflammation of the meninges and blood in the cerebral spinal fluid followed by loss of consciousness and death (Lalitha *et al.*, 1996).

In animals, the route of infection in the majority of cases of anthrax is thought to be intestinal, caused by the ingestion of spores which enter a lesion in the alimentary canal caused by eating tough or spiky plant material (Lindeque, 1991). Cutaneous anthrax in animals is not well documented, but probably occurs through insect bites, or when spores enter abrasions on the skin (Quinn and Turnbull, 1998).

### 1.4.2 Symptoms of anthrax

In humans, cutaneous anthrax is characterised by the development of a small skin abrasion into a pustule and the formation of a ring of vesicles around an area of necrosis, with a severe oedema. The area of necrosis is known as the 'characteristic eschar'. Unless a secondary infection occurs, little pain is associated with the lesion. The incubation period for cutaneous anthrax is generally 2 - 4 days, although it can range from 9 hours to 12 days (Shylakhov, 1996; Doganay, 1996; Pfisterer, 1996).

Pulmonary anthrax is difficult to diagnose with non-specific influenza like symptoms occurring, which persist for 1 - 2 days. Symptoms of intestinal anthrax may include fever, nausea, vomiting and production of bloody diarrhoea (Knudson, 1986). The incubation period for pulmonary or intestinal anthrax is 1 - 7 days (Friedlander, 1998).

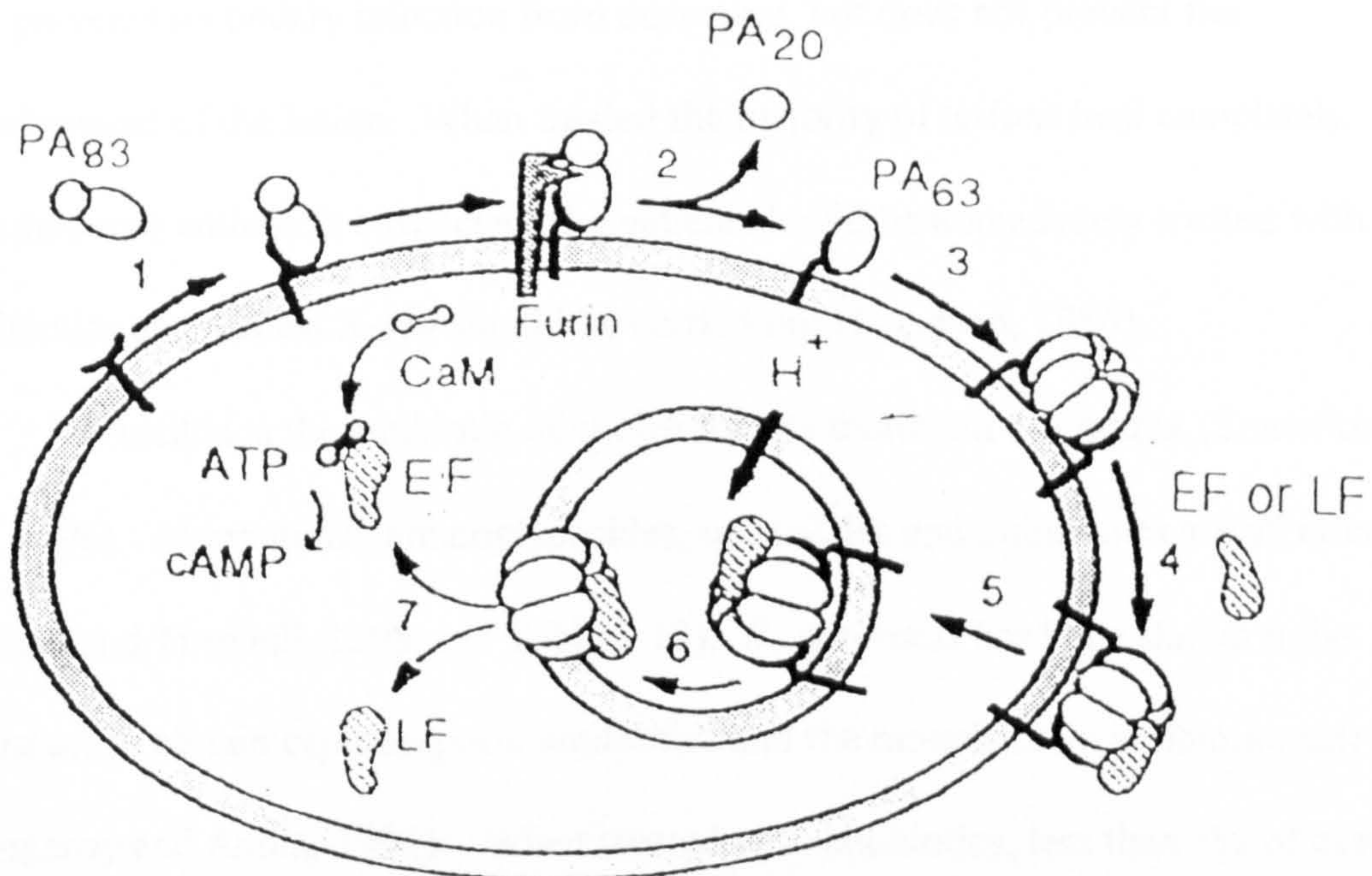
In animals, the symptoms of pulmonary or intestinal anthrax are generally evident only shortly before death (Quinn and Turnbull, 1998). The animal may appear feverish or disorientated or exhibit respiratory difficulties for up to two days. In some cases the animal may recover (West, 1986; Redmond *et al.*, 1996). In herbivores the peracute form of the disease is most common, in which animals die without exhibiting symptoms.

### 1.4.3 Development of the disease

Cutaneous anthrax in humans is usually self-limiting, and remains localised at the site of infection. In cases of pulmonary or intestinal anthrax *B. anthracis* spores enter the blood stream of the host and pass undetected by the host immune system to the lymphatic system and spleen. Germination and subsequent rapid vegetative cell

multiplication and toxin production occurs in the lymph nodes (Lincoln *et al.*, 1961). Vegetative bacilli produce a  $\gamma$ -linked poly-D-glutamic acid capsule which is thought to protect the bacilli from phagocytosis by the macrophages (Ezzell, 1998). When numbers reach a certain level, bacilli and toxin burst into the blood stream, causing toxæmia, bacteraemia and rapid death of the animal host (Quinn and Turnbull, 1998). Anthrax toxin was first identified by Smith, Keppie and Stanley in 1955. It consists of three proteins, protective antigen (PA, 83 kDa), which is the essential immunogen in anthrax vaccines, oedema factor (EF, 89 kDa) which is a calmodulin dependent adenyl cyclase which converts ATP to cAMP (Wang *et al.*, 1996) and lethal factor (LF, 90 kDa) which is a calcium and zinc dependent metalloenzyme endopeptidase (Hammond and Hanna, 1998). The toxin is organised into AB receptor domains (Pugsley, 1996). LF or EF (B domains) bind to the A domain (PA), leading to the production of lethal toxin or oedema toxin respectively (Figure 1.3). PA receptors are found on the surface of all types of cells, but PA generally binds to macrophages. The combination of PA and EF suppresses polymorphonuclear leucocyte activity and inhibits phagocytosis of bacilli (O'Brien, 1985). LF has recently been shown to rapidly kill macrophages and to cleave the N-terminus of mitogen-activated protein kinase kinase 1 and 2 (MAPKK) which subsequently inhibits the MAPK signal transduction pathway. Protein kinases are activated by cAMP and modulate the activity of various proteins in different cells by phosphorylation. In mice, MAPKK has been shown to be required for spindle formation in the nucleus of the host cell prior to meiosis (Duesbury *et al.*, 1998).

**Figure 1.3** Diagrammatic representation of the model for the translocation of anthrax toxin into the host cell cytosol (Petosa *et al.*, 1997)



(1) PA binds to a cell membrane receptor and is cleaved by a furin-like calcium-dependent heat labile cell surface protease (Ezzell and Abshire, 1992) into a 20 kDa and a 63 kDa subunit (2). Seven membrane bound 63 kDa PA subunits aggregate to form a membrane-inserting heptameric ring structure (3). A tubular channel consisting of 2  $\beta$ -pleated sheets from each subunit is formed, through which LF or EF (4) is translocated across the cell membrane in a pH dependent membrane insertion mechanism (5) (Milne *et al.*, 1994; Petosa *et al.*, 1997). The heptameric ring subsequently undergoes receptor mediated endocytosis (6). Acidification of the endosome leads to the translocation of LF and EF into the cytosol (7). EF is a calmodulin (CaM) dependent adenylyl cyclase (Wang *et al.*, 1996), which converts ATP to cAMP. Increased adenylyl cyclase activity and increased levels of cAMP leads to an efflux of  $\text{Na}^+$  ions and water into the surrounding cells causing the characteristic oedema.

#### **1.4.4 Treatment of anthrax**

In humans, antibiotic treatment of cutaneous anthrax limits the spread of the disease, and prevents secondary infection from occurring, but does not prevent the development of the lesion. When treated the majority of lesions heal completely. If pulmonary anthrax is suspected, the patient should be immediately treated with antibiotics and a chest X-ray should be carried out (Knudson, 1986).

Penicillin is the antibiotic of choice for the treatment of anthrax (Sumerkan *et al.*, 1996). Alternatively aminoglycosides, macrolides and quinolones are all effective (Quinn and Turnbull, 1998; see Table 3.19). *B. anthracis* has been shown to be resistant to certain cephalosporin antibiotics and the monobactam antibiotic, aztreonam (Dogonay and Aydin, 1991). When treated with antibiotics, less than 1% of cases of anthrax are fatal.

In animals, the rapidity of death from anthrax generally prevents treatment being administered. If further cases are suspected, however, prophylactic antibiotic treatment or vaccination can be carried out.

#### **1.4.5 Control of anthrax by vaccination**

Most animal vaccines are based on that produced by Sterne (1937) in which live avirulent, capsule negative (pX01<sup>+</sup>/pX02<sup>-</sup>) spores of *B. anthracis* are administered to the animal. Animal vaccination is a very effective measure of controlling anthrax. For example in the 1930's in Russia, approximately 100 000 reindeer were contracting anthrax each year. In the 1940's the animals were vaccinated, the chain of infection broken and the outbreak was halted (Cherkasskiy, 1998). In 1997 in Australia, vaccination was successful in controlling an outbreak of 234 cases of anthrax in cattle.

The operation, however, involved the vaccination of almost 80 000 head of cattle and was very expensive, costing the Australian Government 750 000 US dollars (Turner, 1998).

A live spore vaccine is widely used in Russia and China for immunisation of humans. This is administered by scarification or subcutaneous injection (Shylakhov and Rubenstein, 1994; Turnbull *et al.*, 1993). Such vaccines are not licensed for use in the UK or US, due to the possible risk of side effects.

The UK human licensed vaccine is an alum precipitated cell free culture filtrate of the Sterne 34F<sub>2</sub> strain grown in conditions to maximise PA production (Hambleton *et al.*, 1985; Turnbull, 1991; Quinn and Turnbull, 1998). The protective efficacy of this vaccine in humans is not known, as an accurate correlate of protection has not been identified (McBride *et al.*, 1997). The American human vaccine is an anaerobically produced cell-free filtrate of a pX01<sup>+</sup>/pX02<sup>-</sup> bovine isolate V770 which yields high levels of PA and low levels of LF and EF (Turnbull, 1991).

## **1.5 Classification of *B. anthracis***

### **1.5.1 The genus *Bacillus***

*Bacillus* species are aerobic or facultatively anaerobic rod-shaped endospore forming bacilli which are Gram-positive or Gram-variable; some species are only visibly Gram-positive as young cultures. The vegetative bacilli are round or square ended and occur singly or in chains. The bacilli range in size from 0.5 x 1.2 µm to 2.5 x 10 µm and the majority of species are motile with peritrichous flagella. A single centrally or terminally situated cylindrical, spherical, kidney shaped or ellipsoidal endospore is formed per cell. *Bacillus* species have adapted to grow at temperatures



ranging from -4.5 °C to 75 °C and between pH 2.0 and pH 10.0 (Turnbull and Kramer, 1991). Combined with the ability to form spores, this has allowed *Bacillus* species to colonise most habitats in the biosphere.

Classification of bacteria can be conducted using techniques ranging from the observation of cultural, morphological, physiological and biochemical properties, to immunological methods and the analysis of cell components such as proteins, fatty acids, lipids and genomic RNA and DNA (Logan, 1994).

The classification of *Bacillus* species has been hampered by the wide diversity which occurs within and between *Bacillus* species. The mol % G + C in prokaryotes ranges from 25 - 75% and theoretically when the mol % G + C varies by more than 30% there is little similarity between organisms. The theoretical mol % G + C variation within a genus is approximately 10 - 12% (Priest, 1993). The mol % G + C within the genus *Bacillus*, however, ranges from 32 - 69%. Similar degrees of variation are found within *Bacillus* species, for example the mol % G + C of different strains of *B. circulans* ranges from 31 - 61% (Logan, 1994). Approximately 5% variation in mol % G + C has been observed between repeat analyses conducted using the same strain.

In 1993, 65 validly described *Bacillus* species had been identified (Priest, 1993) and classification of the genus is being constantly revised. In 1946 Smith *et al.* devised a classification system for *Bacillus* species according to the morphology of spores, which was revised in 1952 and 1973 (Smith *et al.*, 1952; Gordon *et al.*, 1973). This system classified *Bacillus* species into three groups: Group 1 *Bacillus* species which produce ellipsoidal or cylindrical spores that are centrally or terminally positioned and do not distend the sporangium; Group 2

*Bacillus* species which produce ellipsoidal spores that distend the sporangium; and Group 3 species which produce spherical spores. Group 1 is further divided into two sub groups; subgroup A which comprises species with cells wider than 1  $\mu\text{m}$  that contain protoplasmic globules; and subgroup B which comprises species with cells less than 1  $\mu\text{m}$  wide that lack protoplasmic globules. The species of interest in this study belong to subgroup A and are *B. anthracis*, *B. cereus*, *B. thuringiensis* and *B. mycoides*, which may be referred to as the '*B. cereus* group', and *B. megaterium*.

More recent classifications have separated *Bacillus* species into between three and six groups. For example Priest *et al.* (1988) tested 118 morphological, biochemical and growth characteristics of 368 *Bacillus* species. Computer analysis divided *Bacillus* species into six major clusters. This showed that strains of *B. cereus*, *B. thuringiensis* and *B. mycoides* were at least 87% similar and belonged to the same cluster. *B. megaterium*, however, was found to be more closely related to *B. firmus*, *B. licheniformis* and *B. subtilis*. Comparable results were found in two other extensive numerical classifications of *Bacillus* species (Priest *et al.*, 1981; Logan and Berkeley, 1981).

### 1.5.2 The '*B. cereus* group'

Debate continues about whether members of the '*B. cereus* group' are in fact true species, or sub species of *B. cereus*. Smith *et al.* (1946) classified *B. anthracis*, *B. thuringiensis*, and *B. mycoides* as varieties of *B. cereus*, but retained their separate species status.

The analysis of phenotypic characteristics of *Bacillus* species has been used to differentiate between members of the '*B. cereus* group'. Simple tests which can be

used to differentiate between members of the '*B. cereus* group' are described in Section 1.6.1 (p 25).

Carlson *et al.* (1994) compared *B. cereus* and *B. thuringiensis* using pulse field gel electrophoresis and multi locus enzyme electrophoresis. Results showed no identifiable differences between 24 strains of *B. cereus* and 12 strains of *B. thuringiensis*. Lawrence *et al.* (1991) reported that when grown on a complex medium three strains of *B. anthracis* and three strains of *B. cereus* produced almost identical profiles using gas chromatography whole cell fatty acid analysis. When cultures were grown on synthetic RM medium (Ristroph and Ivins, 1983), which stimulates *B. anthracis* to produce toxin, *B. anthracis* and *B. cereus* could however be distinguished from each other. These results exemplify the close relationship between *B. anthracis*, *B. cereus* and *B. thuringiensis*. Fox *et al.* (1993) reported that spores and vegetative cell cultures of *B. anthracis* could be distinguished from those of *B. cereus* using carbohydrate profiles produced by gas chromatography mass spectrometry.

Studies of the genotypes of members of the '*B. cereus*' group have yielded similar results. Somerville and Jones (1972) reported DNA homology of 50 - 100% between the '*B. cereus* group' species. Kaneko *et al.* (1978) reported 70 - 100% homology between nine isolates of *B. anthracis*, *B. cereus* and *B. thuringiensis*. Homology of 70% has been suggested as the minimum which should occur within a species. The mol % G + C values of *B. anthracis*, *B. cereus*, *B. thuringiensis* and *B. mycoides* have been reported to be 33.2% 35.7%, 33.8% and 34.2% respectively (Claus and Fritze, 1989), a variation of 2.5%. This is comparable to the G + C mol % variation within a species rather than between species. Nakamura (1994) compared

the genetic relationship between *B. cereus* and serovars of *B. thuringiensis*. Within the serovars of *B. thuringiensis* the DNA relatedness was 80 - 100%, and between serovars 60 - 70%. Between *B. cereus* and *B. thuringiensis* relatedness was 65 - 70%. This indicated that there was no more difference between *B. cereus* and *B. thuringiensis* than between strains of *B. thuringiensis*.

Sequence analysis of ribosomal RNA can provide information about the relatedness of bacterial species. Certain regions are highly conserved, and may provide information about the evolutionary relatedness between species, whereas other regions contain greater sequence alterations. Study of the variable regions allows the comparison of more closely related bacterial species (Logan, 1994). Ash *et al.* (1991, 1992) reported that the 16S rRNA sequences of *B. anthracis* and *B. cereus* were identical and that only two differences exist between the 23S rRNA sequences of *B. cereus* and *B. thuringiensis*. Barry *et al.* (1991) hypothesised that the intergenic spacer regions (ISR) are likely to be under less selective pressure than DNA sequences which code for functional genes, and may therefore show more variation between isolates. Borque *et al.* (1995) compared the 144 bp ISR between the 16S and 23S rRNA of *B. thuringiensis* with that of *B. anthracis* and *B. cereus*. Although only one strain of *B. anthracis* and two strains of *B. cereus* were compared with 24 strains of *B. thuringiensis*, they found the same minor differences in the ISR among all strains tested, which were insufficient to allow the design of species specific probes. Te Giffel *et al.* (1997) compared the variable (V<sub>1</sub>) region of 16S rRNA of *B. cereus*, *B. thuringiensis* and *B. mycoides*. They reported that the V<sub>1</sub> regions of *B. cereus* and *B. mycoides* were identical, and differed from that of *B. thuringiensis* by three bases. Several isolates previously identified as *B. cereus* could be reclassified as

*B. thuringiensis* using DNA probes based on the V<sub>1</sub> region. Again these results highlight the close relationship between members of the '*B. cereus* group'.

Strains of *B. anthracis* have been shown to be almost completely homogeneous. The first paper which identified differences between isolates of *B. anthracis* was that of Henderson *et al.* (1994) who examined DNA from isolates of the '*B. cereus* group' using restriction digest analysis and PCR fingerprinting. Only minor differences were observed between isolates of *B. anthracis* in PCR fingerprints using 1 of 11 different primers tested. PCR fingerprints of *B. cereus*, *B. thuringiensis* and *B. mycooides* exhibited significant strain to strain variation. Use of the 20 bp insertion sequence, IS231, originally identified in *B. thuringiensis* (Manillion *et al.*, 1985), also allowed differentiation between *B. anthracis*, *B. cereus* and *B. thuringiensis*, but again showed only minor variation between isolates of *B. anthracis* (Henderson *et al.*, 1995). These results showed that strains of *B. anthracis* are more homogeneous than strains of *B. cereus* or *B. thuringiensis*. Priest *et al.* (1994) used ribotyping in which chromosomal DNA is digested with restriction enzymes and probed with the prokaryotic 16S rRNA gene, to characterise 43 strains of *B. thuringiensis*, and eight reference strains of *B. anthracis*, *B. cereus* and *B. mycooides*. Cluster analysis of the results showed that the four strains of *B. anthracis* were assigned to a single group, whereas strains of *B. cereus* were dispersed throughout the dendrogram. The strains of *B. thuringiensis* could be divided into 19 *Hind*III ribotypes. This diversity was greater than that observed in the other *Bacillus* species on which the analysis has been performed. These results also exemplify the homology between strains of *B. anthracis* and heterogeneity between strains of *B. cereus* and *B. thuringiensis*.

Recently developed molecular methods such as amplified fragment length polymorphism analysis (AFLP; Keim *et al.*, 1997) and variable-number tandem repeat analysis (VNTR, Jackson *et al.*, 1997) have been applied to the development of a strain differentiation system for *B. anthracis*. Keim *et al.* (1997) suggested that *B. anthracis* was one of the most molecularly monomorphic bacteria known. Using AFLP analysis to examine approximately 6.3% of the *Bacillus* genome for length mutations they found at least 97% homology between 79 isolates of *B. anthracis*, in contrast to 40% homology between 1 strain of *B. cereus* and two strains of *B. thuringiensis*. Although only 3 strains of *B. cereus* and *B. thuringiensis* were tested, these results also revealed strains of *B. anthracis* to be almost identical, whereas strains of *B. cereus* and *B. thuringiensis* showed greater variation.

In favour of the retention of *B. anthracis*, *B. cereus*, *B. thuringiensis* and *B. mycoides* as separate species is the obligate pathogenicity of *B. anthracis* in mammals and the pathogenicity of *B. thuringiensis* in a broad range of insect species (Claus and Berkeley, 1986). Genes responsible for this pathogenicity, however, are present on plasmids. Plasmids pX01 and pX02 in *B. anthracis* which harbour genes encoding the toxin and capsule production respectively (see Section 1.8.1) are thought to be unique to *B. anthracis* and are highly conserved between isolates. Plasmids encoding the  $\delta$ -endotoxin production in *B. thuringiensis*, however, vary between strains, and up to 12 plasmids may be present per cell (Turnbull *et al.*, 1990). These  $\delta$ -endotoxin producing plasmids are transferrable between strains of *B. thuringiensis* and *B. cereus* (Gonzalez *et al.*, 1982). Such genetic exchange causes the distinction between '*B. cereus* group' species to become less clear.

## 1.6 Isolation and identification of *Bacillus* species

The identification of a rod shaped bacterial isolate as a member of the genus *Bacillus* can be done by aerobic culture on sporulation agar (Claus and Fritze, 1989), and examination of the resulting culture for the presence of spores. Identification of an isolate to species level, however, is time consuming and requires detailed morphological and biochemical examination. This is complicated by the degree of relatedness between species and the constant updates in classification. Systems such as API (bioMérieux, Basingstoke) and Biolog (Biolog Inc., Hayward, California) provide a standardised format for testing the response of isolates to different biochemical reactions, and may provide a rapid method for the classification of *Bacillus* species (Logan *et al.*, 1984; Logan *et al.*, 1985; Baillie *et al.*, 1995; Cogne *et al.*, 1996). These tests, however, are reliant on the accuracy of the information provided in their identification databases, which needs to be updated regularly (Cogne *et al.*, 1996).

### 1.6.1 Identification of *B. anthracis*

*Bacillus* species can be distinguished from *Clostridial* species, to which they are most closely related (Priest, 1993) by their ability to grow aerobically and to produce catalase (Turnbull and Kramer, 1995). Members of the '*B. cereus* group' can be identified by observing the morphological characteristics of colonies grown for 24 h on blood agar. Colonies which are green-grey to white in colour, have a 'ground glass' appearance and are between 2 and 10 mm in diameter, are likely to belong to this group. *B. cereus* and *B. thuringiensis* are generally haemolytic on blood agar, whereas *B. anthracis* is generally non-haemolytic. Colonies which fit the above description should be suspected of being *B. anthracis*. *B. mycoides* is also haemolytic and can be

distinguished from other members of the group by its rhizoid growth habit. Although *B. megaterium* is not part of the '*B. cereus* group' it is more likely to be confused with *B. anthracis* due to its similar colony morphology. The characteristics which can generally be used to distinguish colonies of *B. anthracis* from *B. cereus*, *B. thuringiensis* and *B. megaterium* are listed in Table 1.3.

**Table 1.3** Characteristics used for the differential identification of *B. anthracis*, *B. cereus*, *B. thuringiensis* and *B. megaterium*

Characteristic	<i>Bacillus anthracis</i>	<i>Bacillus cereus</i>	<i>Bacillus thuringiensis</i>	<i>Bacillus megaterium</i>
haemolysis	-	+	+	weak
motility	-	+	+	+
lysis by $\gamma$ bacteriophage	+	-	-	-
sensitivity to penicillin	+	-	-	+
parasporal body formation	-	-	+	-
M'Fadyean reaction	+	-	-	weak
capsule production	+	-	-	weak
production of PA LF and EF	+	-	-	-
virulence in mice	+	-	-	-
presence of pX01 and pX02	+	-	-	-

These characteristics, however, are not definitive. Occasionally, penicillin resistant *B. anthracis* has been isolated from clinical samples (Green and Jamieson, 1958; Bradaric and Punda-Polic, 1992; Lalitha and Thomas, 1997) and certain isolates of

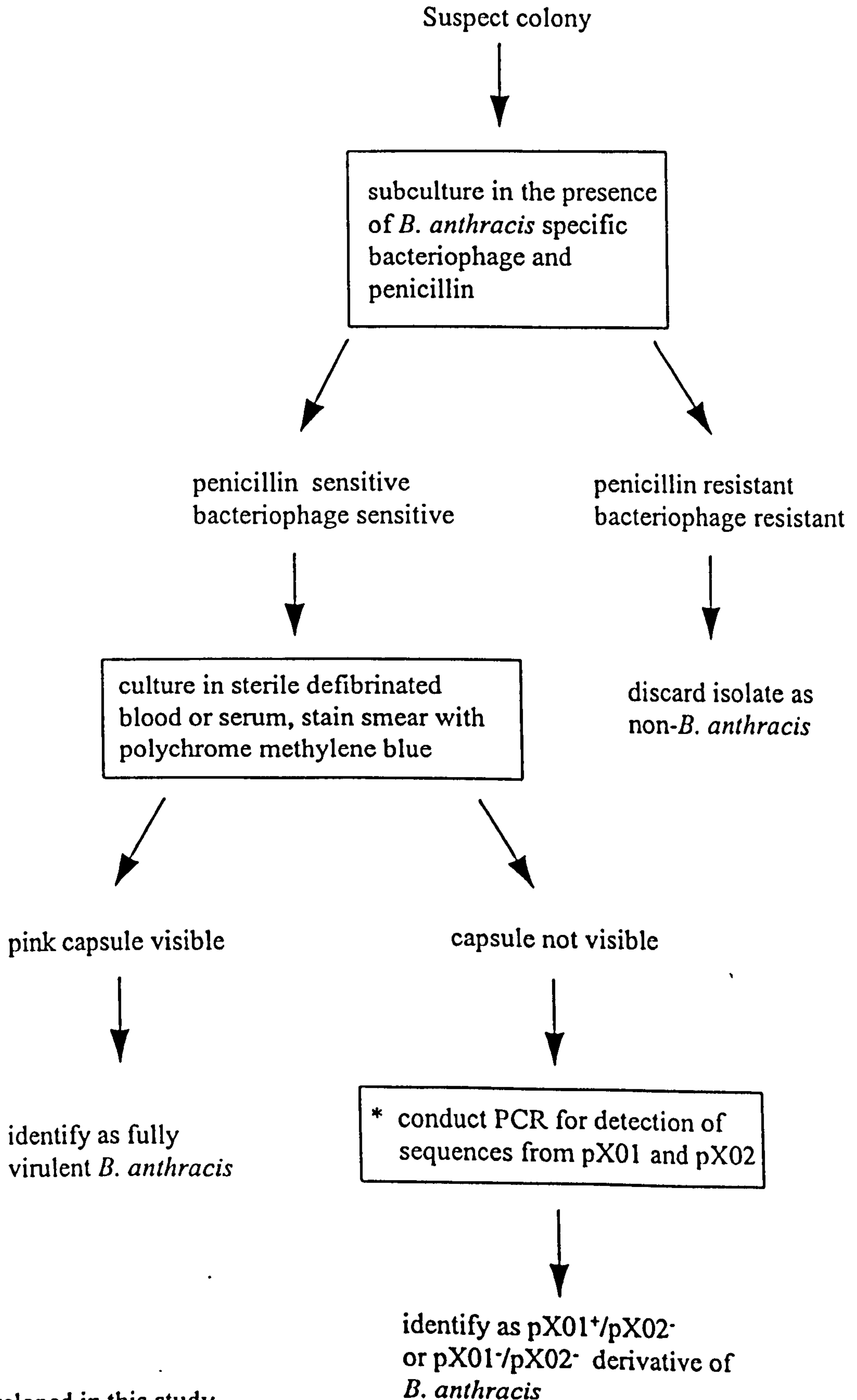


*B. anthracis* have been found to be resistant to anthrax specific bacteriophage (Redmond *et al.*, 1996a). Colonies suspected of being *B. anthracis* should be subcultured and tested for sensitivity to penicillin and *B. anthracis* specific bacteriophage. Any colonies which are sensitive to both penicillin and bacteriophage should be grown statically for 5 h - 8 h at 37 °C in 2 ml volumes of sterile defibrinated horse blood or serum. A thin blood smear of the resulting bacterial growth should be made, stained with polychrome methylene blue and examined microscopically for the presence of chains of square ended bacilli (1.0 - 1.5 µm - 5.0 - 8.0 µm) surrounded by a characteristic pink capsule (M' Fadyean, 1903). The presence of such a capsule, together with clear bacteriophage and penicillin susceptibility is diagnostic. A schematic diagram for the identification of colonies suspected of being *B. anthracis* is shown in Figure 1.4.

Atypical isolates can be identified using the additional tests described in Figure 1.5. Three *Bacillus* species other than *B. anthracis* will produce a polypeptide capsule when grown in blood, although growth is poor and capsules are rarely seen. *B. megaterium* produces a capsule similar to that of *B. anthracis*. It can be distinguished from *B. anthracis* by its resistance to *B. anthracis* specific bacteriophage and by using the tests described in Table 1.3. *B. subtilis* and *B. licheniformis* produce smaller capsules but can be easily distinguished from *B. anthracis* by their colony morphology so are unlikely to be picked for culture in blood.

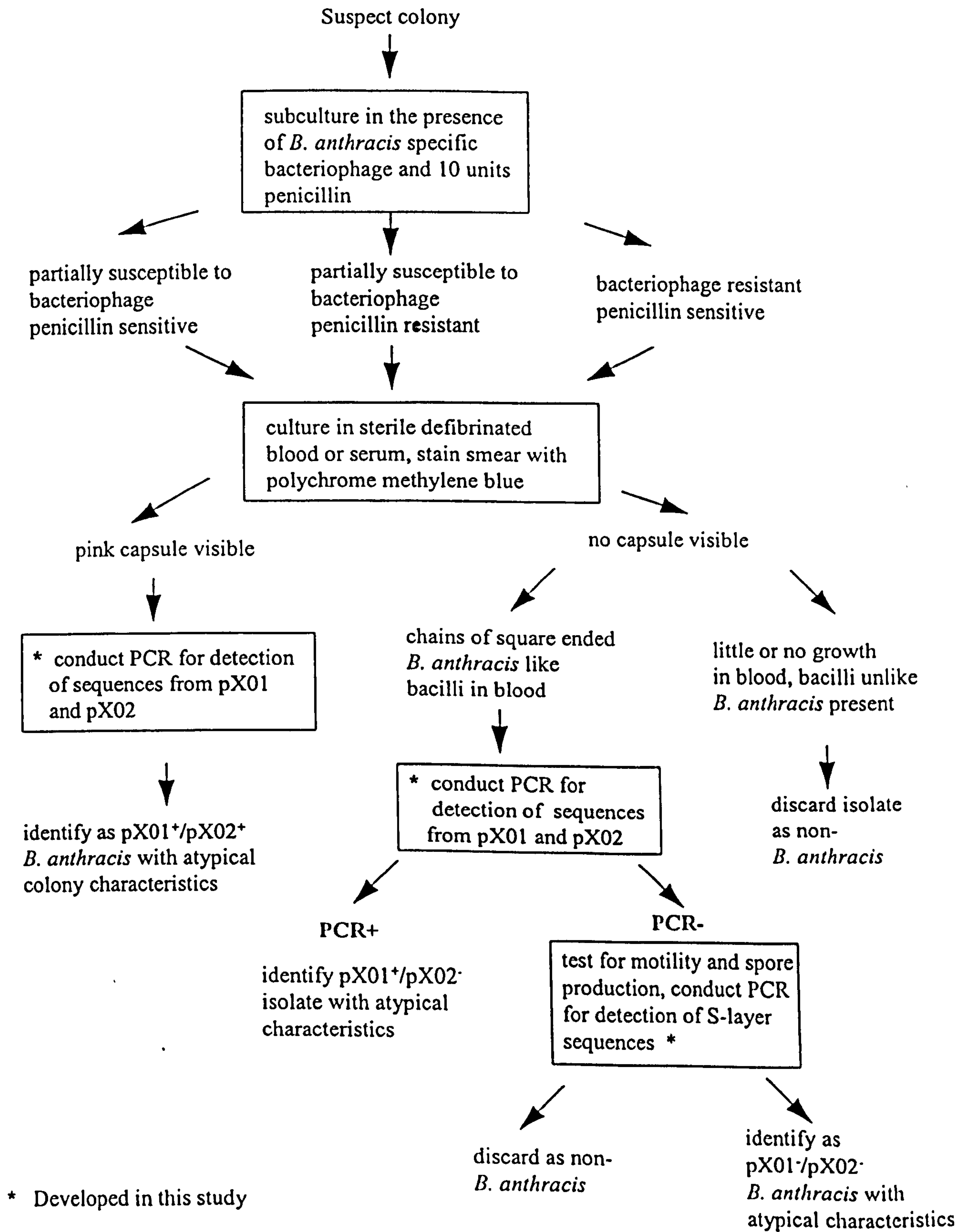
Non-capsulating bacilli which appear morphologically similar to *B. anthracis*, are susceptible to the bacteriophage and penicillin and grow well in blood as square

Figure 1.4 Schematic diagram showing the procedure for the identification of colonies suspected to be *B. anthracis*



\* Developed in this study

**Figure 1.5 Schematic diagram showing the procedure for the identification of atypical colonies suspected to be *B. anthracis***



ended chains of bacilli may be capsule negative strains of *B. anthracis* and should be tested for the presence of pX01 and pX02 using the PCR. The use of the PCR as a diagnostic tool has, in the majority of cases, eliminated the requirement for animal tests for the identification of *B. anthracis* and has also eliminated the requirement to test suspect colonies for the ability to produce toxin. Anthrax toxin is produced *in vitro* when *B. anthracis* is grown in the presence of bicarbonate ions or CO<sub>2</sub> (Meynell and Meynell, 1964). The presence of anthrax toxin components can be determined by growth of a suspect colony in RM medium (Ristroph and Ivins, 1983), followed by an antibody capture ELISA on the culture filtrate to detect PA (Turnbull *et al.*, 1992). PA can also be detected using a rapid hand-held immunochromatographic antigen capture assay (Burans *et al.*, 1996). This test, however, is not commercially available. More established tests, such as agar diffusion (Thorne and Belton, 1957; Angelety and Wright, 1971) can be used where the equipment required to perform ELISA is not available, and are useful as backup tests for use in conjunction with ELISA.

The development of serological tests for the identification of spores of *B. anthracis* has been hampered by cross-reactivity with spores from other *Bacillus* species. Such cross-reactivity was observed by Phillips and Martin who published a series of papers describing the differentiation of spores of *B. anthracis* and *B. cereus* (Phillips and Martin, 1982, 1982a, 1983, 1988; Phillips *et al.*, 1983). An immunochromatographic assay developed for the detection of spores of *B. anthracis* has also been shown to cross-react with spores from other *Bacillus* species (Long and O'Brien, 1998).

## **1.7 The detection of *B. anthracis***

### **1.7.1 Detection of *B. anthracis* in animal carcasses**

Diagnosis of anthrax in a recently dead animal can be done by microscopic examination of a blood smear stained with polychrome methylene blue. Rod shaped bacilli with the characteristic pink capsule may be present at levels of up to  $10^8$ /ml of blood (Turnbull and Kramer, 1991; Ivins *et al.*, 1996). In some animal species, the number of bacilli in the blood is much lower, for example in pigs, confirmation of the cause of death by direct examination of a blood smear may not be possible (Redmond *et al.*, 1996). In the Kruger National Park, South Africa, bacterial counts from terminal blood smears were highest in animals which are very susceptible to anthrax and lower in animals less susceptible to anthrax (de Vos and Bryden, 1995). Culture of a blood sample on agar, or, if the carcass has been opened, samples from the spleen or lymph nodes (Turnbull and Kramer, 1995) should also yield typical colonies of *B. anthracis*. Diagnosis can also be made by detecting PA in the blood or serum of the dead animal using the hand held immunochromatographic assay (Burans *et al.*, 1996), or by the ELISA (Turnbull *et al.*, 1986a). Once a carcass is no longer freshly dead, the putrefaction process leads to a decrease in vegetative cell numbers inside the carcass. Remaining vegetative bacilli are less likely to be identified due to the degeneration of capsular material which alters its affinity for polychrome methylene blue stain (Sterne, 1959; Lindeque and Turnbull, 1994). After 24 h, diagnosis by polychrome methylene blue staining of a blood smear becomes unreliable (Turnbull *et al.*, 1993). In such cases identification of *B. anthracis* should be conducted using culture on agar (Turnbull and Kramer, 1995). Inside a carcass *B. anthracis* is destroyed within 48 - 72 hours (Turnbull *et al.*, 1993).

### 1.7.2 The detection of *B. anthracis* in environmental samples

The detection of microorganisms in environmental material can be done by direct culture on agar (Roszak and Colwell, 1987), direct microscopic examination of the soil (Pickup, 1991), and immunological detection, using polyclonal sera or monoclonal antibodies raised against the target microorganism (Pickup, 1991). Growth on agar is often unsatisfactory for the identification of the total bacterial population present in a sample, as only a small portion of the microorganisms present (0.01 - 12.5%) are culturable (Pickup, 1991) and the most commonly used incubation temperatures (30 - 37 °C) are much higher than those in the natural environment. For the detection of *B. anthracis* in environmental material, however, culture on agar at 37 °C, the body temperature of the animal host, should promote growth.

Direct microscopic examination of samples using fluorescent antibodies specific to cells and spores has been used to identify *B. subtilis* and *B. circulans* in soil. No cross-reactivity was observed between the sera raised against the two species, but antisera raised against *B. circulans* cross-reacted with *B. alvei* (Hill and Gray, 1967). Such a method is not suitable for the detection of *B. anthracis* due to the immunological cross-reaction observed between closely related *Bacillus* species (Phillips and Martin, 1988) and the subsequent unavailability of a specific anti-*B. anthracis* antibody. The lack of specific antigens also prevents the use of methods such as immunomagnetic separation (Safarik *et al.*, 1995).

Travers *et al.* (1987) described a method for the selective detection of *B. thuringiensis* in soil containing a background flora of up to  $10^9$  bacteria per gram. The method involved the selective inhibition of germination of *B. thuringiensis* spores using sodium acetate. Under the conditions used, the majority of undesired spore

forming bacilli germinated, and could be killed by heating the sample at 80 °C for 3 min. Surviving spores of *B. thuringiensis* were subsequently cultured on agar. The use of such a differential germination technique may allow the selective recovery of *B. anthracis* from a mixture of other closely related *Bacillus* species.

The detection of spores of *B. anthracis* in soil is hampered by the presence of other *Bacillus* species which are generally more numerous than *B. anthracis*, and will outgrow *B. anthracis* in culture. For this reason a selective culture system is required for the detection of *B. anthracis* in environmental material. In the 1960's PLET agar (PLETA) was developed which is composed of polymyxin B sulphate, lysozyme, EDTA and thallos acetate in a heart infusion agar base (Knisely, 1966). Knisely reported that on PLETA, *B. anthracis* grew whilst most other *Bacillus* species were suppressed. This remains the selective agar of choice in many laboratories, including those at CAMR (see Section 3.1).

A potential problem associated with the detection of microorganisms in soil is the spatial distribution of the microorganisms. This makes it difficult to obtain a representative sample of a bacterial population, and variations in results may occur due to different sampling techniques. Also microorganisms may form strong associations with particulate matter (Stotzky, 1985) which may prevent them from being sampled or recovered.

### **1.8. Molecular methods for the detection of *B. anthracis* in the environment**

Molecular methods for the detection of microorganisms in the environment include the use of nucleic acid probes to identify specific DNA sequences (Olsen and Tsai, 1993) and the PCR (Mullis, 1990). The use of nucleic acid probes involves the binding of a

short sequence of DNA to a complementary sequence in the target DNA. Detection of the bound probe is taken as evidence that the target DNA sequence is present. The sensitivity of such probes has been estimated to be approximately  $10^2 - 10^3$  copies per gram of environmental material (Pickup, 1991).

The use of the PCR also involves the binding of short DNA sequences to the complementary sequence in the target DNA. The target DNA sequence is then amplified in a reaction using DNA polymerase. This amplification of the target DNA makes the PCR more sensitive than nucleic acid probes. Theoretically, one copy of a gene sequence can be detected. The PCR can provide a specific and sensitive method for the detection of the DNA from microorganisms in the environment. It is especially useful for the detection of organisms which are difficult, time consuming, or impossible to culture (Leff *et al.*, 1995). The PCR has been adapted for detection of various bacterial species from aquatic environments, sewage (Picard *et al.*, 1992) and clinical samples (Ramamurthy *et al.*, 1993).

When using nucleic acid probes or the PCR it is not possible to determine whether the DNA detected originated from a living or dead organism. When it is necessary to determine whether a sample contains viable bacteria, an enrichment stage combined with PCR detection could be used (Cooray *et al.*, 1994). Alternatively the PCR can be conducted using only separated intact bacterial cells, to eliminate the possibility of detecting free nucleic acid in a sample (Olsen and Tsai, 1993).

The sensitivity of direct plate culture, direct fluorescent antibody staining (DFA) and the PCR for the detection of *Legionella* species in environmental water and effluent samples was compared (Palmer *et al.*, 1993). The PCR appeared to be the most sensitive method (less than  $10^3$  colony forming units per ml of sample were



detected). Direct culture was the least sensitive technique and although DFA produced the highest number of positive results, there was concern, that cross-reactivity may have occurred between closely related species resulting in false positives. All of these techniques, however, rely heavily on the sampling strategy adopted for their efficiency (Pickup, 1991; Turnbull, 1996).

### 1.8.1 The detection of *B. anthracis* DNA using the PCR

DNA sequences have been published for PA (*pag*, Welkos *et al.*, 1988); LF (*lef*, Bragg and Robertson, 1989); EF (*cya*, Robertson *et al.*, 1988); and their *trans*-acting transcriptional activator (*atxA*, Uchida *et al.*, 1993; Dai *et al.*, 1995) from pX01. Sequences from pX02 (*capA*, *capB* and *capC*, Makino *et al.*, 1989) and their *trans*-acting transcriptional activator (*acpA*, Vietri *et al.*, 1995) have also been published.

The PCR detection of such specific gene sequences from pX01 and pX02 allows the rapid identification of isolates of *B. anthracis* (see Section 5.1). For the PCR detection of pX01/pX02 derivatives of *B. anthracis*, it is necessary to detect a sequence of DNA specific to the *B. anthracis* chromosome. The only published DNA sequence from the *B. anthracis* chromosome is that of the S-layer (Etienne-Toumelin *et al.*, 1995). The homology between *B. anthracis* and other members of the '*B. cereus* group' makes the specificity of any such sequence difficult to determine (see Section 5.1.4).

### 1.8.2 Methods for the extraction of bacterial DNA from soil

For the PCR detection of microorganisms in soil, the template DNA needs to be extracted from cells. Two approaches have been applied; direct lysis of cells *in situ*, in

which both extracellular and intracellular DNA is recovered (Ogram *et al.*, 1987; Steffan *et al.*, 1988; Tsai and Olsen, 1991) and indirect lysis in which microorganisms are separated from soil before lysis. Indirect lysis may allow some concentration of the required organism (Steffan and Atlas, 1988; Jacobsen and Rasmussen, 1992) and could prevent the detection of free nucleic acids from non-living organisms (Olsen and Tsai, 1993). A selection of methods published describing the extraction of DNA and the detection of microorganisms in environmental samples are shown in Table 1.4. As well as problems related to soil itself (see below) one of the difficulties encountered when extracting DNA from *Bacillus* species is the recovery of DNA from spores (Carl *et al.*, 1992; Rief *et al.*, 1994; Johns *et al.*, 1994). Methods which have been suggested for the extraction of DNA from spores of *B. anthracis* include physical disruption of the spore coat by bead-beating and germination of spores using appropriate amino acids, followed by DNA extraction (see Section 5.1).

#### **1.8.2.1 The effect of humic and phenolic compounds in soil on the PCR**

Another problem associated with the extraction of DNA from soil for use in the PCR is that humic and phenolic compounds, which are co-purified from soil with DNA, have been found to inhibit DNA polymerase (Abbaszadegan, 1993) and have been implicated in mispriming during the PCR (Steffan and Atlas, 1988). Clay and organic matter can also bind to DNA and inhibit the DNA polymerase by altering the ion concentration in the PCR (Aardema *et al.*, 1983). The composition of humic substances in the soil is variable and is affected by all aspects of the soil environment (Muller-Wegener, 1988). Humic substances can be divided into humic acids (HA), which precipitate in acidic solution, fulvic acids which precipitate in alkaline solution

**Table 1.4 Suggested methods for the molecular detection of microorganisms from soil**

AUTHOR	METHOD	TIME TAKEN	SAMPLE SIZE	SENSITIVITY (g)	TARGET (SEEDED IN SOIL)	COMMENTS
Steffan and Atlas (1988)	Cell extraction, CsCl centrifugation, PCR	5 days	100 g	10 <sup>6</sup> with PCR 10 <sup>4</sup> without PCR	<i>Pseudomonas cepacia</i> AC110	15-20 copies of target per cell
Tsai & Olsen (1992)	Direct lysis, freeze thaw, Sephadex to remove HA, PCR	7 hours	1 g	7.0 x 10 <sup>1</sup>	16S rRNA fragment <i>E. coli</i>	-
Picard <i>et al.</i> (1992)	Direct lysis sonication, heat, freeze thaw, PCR	1 day	0.1 g	10 <sup>3</sup>	<i>Agrobacterium tumefaciens</i>	Using plasmid DNA
Tebbe & Vahjen (1993)	Direct lysis, PCR	1.5 days	5 g	10 <sup>1</sup>	<i>Hansenula polymorpha</i>	8 copies of target per cell
Smalla <i>et al.</i> (1993)	Direct lysis, freeze thaw, bead beating, PCR	1 day	5 g	10 <sup>3</sup>	<i>Pseudomonas fluorescens</i>	-
Cresswell <i>et al.</i> (1991)	Direct lysis, beadbeating, phenol /chloroform, DNA hybridization	2 days	10 g	10 <sup>3</sup> spores	<i>Streptomyces violaceolatus</i>	Using plasmid DNA (multi copy number)
Dijkmas <i>et al.</i> (1993)	Alkaline lysis, Sephadex to remove HA, PCR	1 hour	0.5 g	6 x 10 <sup>3</sup>	<i>B. subtilis</i> vegetative cells	Effective for plasmid DNA only
Straub <i>et al.</i> (1995)	Centrifugation, Sephadex or Chelex to remove HA, PCR	1 day	10 g	200 pfu	Enterovirus	Using semi-nested PCR
Degrange & Barden (1995)	Direct lysis, PCR	1 day	0.6 g (3 x 200 mg)	10 <sup>2</sup>	<i>Nitrobacter hamburgensis</i>	-
Hotzel <i>et al.</i> (1996)	Lysis, filter, phenol chloroform, PCR	24 hours	1 ml	5 x 10 <sup>2</sup> gel, 5 x 10 <sup>1</sup> hybridization	<i>Mycobacterium bovis</i>	-

and humin, which cannot be precipitated (Abbaszadegan *et al.*, 1993) and phenolic compounds. The co-purification of HA with DNA from soil was first recorded by Torsvik (1979). The HA content of soil has been estimated to vary from 16 - 80  $\mu\text{g/ml}$  (Jacobsen, 1995). Methods suggested for the removal of HA from DNA include the addition of ion affinity resins such as Chelex or Sephadex to bind with the humic material (Abbaszadegan *et al.*, 1993), or the addition of water soluble polyvinylpyrrolodine (PVP) or insoluble polyvinylpolypyrrolodine (PVPP), which form hydrogen bonds with phenolic compounds and can subsequently be removed (Young *et al.*, 1993). The concentrations of HA reported to inhibit the PCR are shown in Table 1.5. In all cases the inhibitory concentration of HA was lower than the concentration of HA present in DNA purified from soil.

**Table 1.5 The inhibition effect of humic substances on the PCR**

Author and year	Inhibitory HA concentration/ml
Abbaszadegan <i>et al.</i> , 1993	1 $\mu\text{g}$ 10 $\mu\text{g}$
Tebbe and Vahjen, 1993	0.08 $\mu\text{g}$ 0.16 $\mu\text{g}$ 0.64 $\mu\text{g}$
Jacobsen, 1995	64 ng 8.3 $\mu\text{g}$

Despite these disadvantages, the PCR detection of *B. anthracis* DNA directly in environmental material would be advantageous as it would decrease the time taken to

identify *B. anthracis*. It would also eliminate the requirement for Category 3 laboratory facilities for culture of *B. anthracis* and would allow the identification of *B. anthracis* by operators unfamiliar with its morphology. It would also increase the likelihood of detecting *B. anthracis* which has an atypical colony morphology, or does not grow well on the selective agar used for the detection of *B. anthracis* in environmental material (see thesis aims).

### **1.9 The stability of pX01 and pX02 in *B. anthracis***

Unlike strains of *B. cereus* which harbour a range of extrachromosomal elements (Bernhard *et al.*, 1978; Lereclus *et al.*, 1982; Reddy *et al.*, 1987) and *B. thuringiensis* which comprises hundreds of strains containing different plasmids (Aronson *et al.*, 1986; Ebehardt, 1989) *B. anthracis* appears to maintain only plasmids pX01 (Mikesell *et al.*, 1983) and pX02 (Green *et al.*, 1985, Uchida *et al.*, 1985). This could be a consequence of the life cycle of *B. anthracis*, as an obligate pathogen, which minimises the opportunity for genetic transfer in the environment. Alternatively it may reflect an ability of *B. anthracis* to specifically exclude non-indigenous plasmid DNA. The ability of organisms to destroy foreign DNA by the production of endonucleases has been reported (Olson and Tsai, 1993). The function of the majority of DNA present on plasmids usually remains unknown (Beringer and Hirsch, 1984), similarly the function of the majority of the DNA on pX01 and pX02 is not known (Leppla, 1991).

Although plasmids are not required for growth of the host bacterium they commonly carry genes for important functions (Beringer and Hirsch, 1984). The reason why *B. anthracis* retains its virulence genes on such large plasmids which are not essential for growth is not known (Leppla, 1991). It has been suggested that an advantage of

maintaining such genes on plasmids may be that some gene products can be amplified more rapidly when they are encoded on plasmids (Eberhardt, 1989).

Plasmids pX01 and pX02 from Sterne (pX01<sup>+</sup>/pX02<sup>-</sup>) and Pasteur (pX01<sup>-</sup>/pX02<sup>+</sup>) strains of *B. anthracis* have recently been sequenced (Okinaka *et al.*, 1998). Results showed that the mol % G + C content of pX01 and pX02 was 32.5% and 32.9% respectively. This is comparable to the mol % G + C of the *B. anthracis* chromosome which is 33.2%. Plasmid pX01 was found to contain 152 open reading frames, and homology with 42 genes deposited in the GenBank database was observed. The function of the remaining 50% of the DNA could not be determined. No clear origin of replication was observed for pX01, and sequencing results indicated that the plasmid may contain two separate origins of replication. Replication genes *repE*, *repS* and *repB* were identified in pX02 (Okinaka *et al.*, 1998). These genes were originally identified in the pAM $\beta$ I plasmid from *Enterococcus faecalis* (Braund and Ehrlich, 1998), plasmid pST1 from *Streptococcus thermophilus* (Solaiman and Somkuti, 1998) and the streptococcal plasmid pMV158 (Acebo *et al.*, 1998) respectively.

Plasmids have been shown to reduce the growth rate of the host, so when in competition with strains lacking plasmids, plasmid containing strains may be out-competed (Eberhardt, 1989). In the environment, however, this lack of competitive ability is unlikely to affect *B. anthracis*, as no growth outside the animal host is thought to take place. A similar lack of competitive ability has been observed in strains of *B. thuringiensis* which cause invasive disease in insects and grow poorly, or not at all in the environment (Eberhardt, 1989).

In the environment, bacteria are generally observed to contain either small

plasmids which are maintained with a high copy number (20 - 200 copies per cell) or large plasmids which are maintained at a low copy number (1-2 copies per cell; Williams and Thomas, 1992; Olsen and Tsai, 1993). Plasmids which have a long association with their bacterial host, such as pX01 and pX02, are almost always inherited with high fidelity, at a low copy number, which reduces the metabolic burden on the bacterial cell. Low copy number plasmids are usually stably maintained by cell division and accompanied by active plasmid partitioning. This is controlled by *par* genes, which ensure that plasmid copies are passed to daughter cells when bacteria replicate (Williams and Thomas, 1992).

Many reports have been made of 'anthrax-like' bacilli being isolated from environmental samples. For example in the 1966 Bergeys Manual, 6 additional species were described with names such as *Bacillus anthracis similis* (Turnbull, 1999). Many similar isolates may have simply been discarded as non-anthrax due to their inability to meet the full identification criteria. An investigation of such organisms demonstrated that they may have originated from virulent strains of *B. anthracis* (Turnbull *et al.*, 1992a). Such derivatives were often isolated from samples in which microorganisms were likely to have been 'stressed', for example tannery effluent, which may contain traces of harsh chemical, or from treated sewage effluent. This could be analogous to the stress placed on *B. anthracis* in the laboratory in order to 'cure' isolates of pX01 and pX02. *B. anthracis* can be cured of pX01 and pX02 by continual passage at 43 °C, or by culture in the presence of novobiocin (Green *et al.*, 1985; Leppla, 1991). Traditionally culture at elevated temperatures has been used to cure *B. anthracis* of pX01 and novobiocin used to cure *B. anthracis* of pX02, although there is no reason why these methods should cure one

plasmid in preference to the other. The mechanism by which pX01 or pX02 may be lost in the environment is not understood (Turnbull *et al.*, 1992a). Strains lacking pX01 are essentially avirulent and strains lacking pX02 are at least  $10^5$  times less virulent than the wild type strain (Ivins *et al.*, 1986).

An understanding of the stability of plasmids pX01 and pX02 in *B. anthracis* is necessary to provide further information about the likelihood of isolating of pX01<sup>-</sup> or pX02<sup>-</sup> derivatives of *B. anthracis* in environmental samples. This may provide information about the possibility of genetic exchange occurring in *B. anthracis* in the environment.

### 1.10 Objectives of this study

The aims of this study were as follows:-

- To evaluate the available methods for the selective detection of *B. anthracis* in environmental material and to develop a liquid selective enrichment system which would allow the consistent sensitive and specific detection of *B. anthracis* in a range of environmental samples.
- To develop a protocol for the introduction of the PCR into the routine procedure used for the detection of *B. anthracis* in environmental material.
- To provide information about the stability of plasmids pX01 and pX02 in *B. anthracis*, on which present detection systems are dependent.



## 2.0 MATERIALS AND METHODS

Published methods used are described in this chapter. Modifications and methods developed during this study are detailed in the relevant results chapter.

### 2.1 Bacterial strains and plasmids

All bacterial strains and plasmids used in this study are presented in Table 2.1 and Table 2.2.

Manipulations with *B. anthracis* were conducted in a Class III safety cabinet. Other *Bacillus* species and *Escherichia coli* were used on the bench.

### 2.2 Bacterial culture

#### 2.2.1 Growth of *Bacillus* species

*Bacillus anthracis* was grown aerobically at 37 °C on blood agar (BA, see Appendix I) L-agar (LA, see Appendix I) or LA supplemented with the appropriate antibiotic (see Appendix I). Other *Bacillus* species were grown aerobically at 37 °C on BA. Broth cultures were grown in brain heart infusion broth (BHIB), heart infusion broth (HIB) or L-broth (LB) at 37 °C statically or with shaking (220 - 230 rpm). *Escherichia coli* was grown on LA or in LB containing 200 µg/ml erythromycin, or 50 µg/ml kanamycin where appropriate.

#### 2.2.2 Preparation of spores

*Bacillus* species were cultured overnight at 37 °C on BA. Cells (1 µl) were resuspended in 100 µl of PBS (see Appendix I) and grown on thin sporulation agar

**Table 2.1. Bacterial species and strains used in this study**

<i>B. anthracis</i> Isolate	Other designation	History	Reference
ASC 1	Sterne, 34F <sub>2</sub>	Vaccine strain, pX01 <sup>+</sup> /pX01 <sup>-</sup>	Sterne, 1937
ASC 2	-	Gruinard Island, 1950's	-
ASC 6 <sup>†</sup>	Vollum	Cow, UK, pre-1939	Smith <i>et al.</i> 1964
ASC 27	-	Cow, UK, 1978	Mansley 1978
ASC 65	-	Cow Brazil, atypical morphology, 1982	Bowen and Turnbull 1992
ASC 68	Ames	Cow, US, highly virulent, 1980	-
ASC 69	New Hampshire	Human outbreak, 1957	Plotkin 1960
ASC 80	-	Tannery dump site, UK, 1988	-
ASC 187	-	Cow, sewage farm, UK, 1990	-
ASC 189	-	Human, Zimbabwe 1982	Davies 1982
ASC 192	-	Soil, UK, 1991	Turnbull <i>et al.</i> 1996
ASC 245	Sterne, 34F <sub>2</sub>	pX01 <sup>+</sup> pX02 <sup>-</sup> , UK human vaccine,	Sterne 1937,(Weybridge 1950's)
ASC 319	-	Cattle, Ardgay Scotland, 1993	-
ASC 404	-	Soil, Etosha National Park, Namibia, 1995	
UM23C1-1	-	pX01 <sup>+</sup> pX02 <sup>-</sup> . Sterne derivative Ura <sup>-</sup> St <sup>r</sup>	C. B. Thorne, Amherst, MA
Species	Strain	Source	
<i>B. cereus</i>	F4433/73, F4748/76, F4618/75, F1983/77 T1, F4562/75 T1 F1586/79, F4165/75, F564/49, F147B/78, F2146/82, F484/83 F431/83, F4667/82, F2875/77, F2532/77, F4810/72 B039, B040, B074,	Food Hygiene Laboratory, CPHL Colindale UK	
<i>B. thuringiensis</i>	F2113A/78 ST7, F2107/78 ST4AB <i>solte</i> , F2115A/78 ST7, F2106/78 F1373/89, F1343/89, F2113/78 ST6	Food Hygiene Laboratory, CPHL Colindale UK	
	<i>var kurstaki</i> HD 102, <i>var israelensis</i> <i>var aizawai</i> HD 130, HD 137, HD 228,	H.T Dulmage US Dept of Agriculture, Brownsville, Texas	
<i>B. megaterium</i>	F2326/89, F5831/84, F2947/A/89, NCTC 06094	Food Hygiene Laboratory, CPHL Colindale UK	
<i>B. mycoides</i>	NCTC 06890	National Collection of Type Cultures, London, UK	
<i>Bacillus sp.</i>	WW1 †, WW2 †, WW3 †, WW4 †. 23.2.95 *, ST3AB *, 12.13 *, 4060 * 4430, 2106, 2141/74, F6619, 2054/76	Environmental isolates, CAMR † phage sensitive; * identified as <i>B. thuringiensis</i>	
<i>B. stearothermophilus</i>	2701/88, 2702/88, 2703/88, 530/89	Food Hygiene Laboratory, CPHL Colindale UK	
<i>Escherichia coli</i>	GM2163 <i>dam13 ::Tn 9 <i>dcm-6 hsd R2 mcrA, mcrB1</i></i>	M. G. Marinus, University of Massachusetts, Amherst, MA	

† = Type strain

ASC = Anthrax Section Culture; Ura<sup>-</sup> = auxotrophic for uracil; St<sup>r</sup> = streptomycin resistant;  
CPHL = Central Public Health Laboratories

Table 2.2 Plasmids used in this study

Plasmid	Size	Replicon and markers ( <i>E. coli</i> )	Replicon and markers ( <i>Bacillus</i> )	Characteristics	Reference
pAEX-1- <i>pag</i>	8.2 kb	pUC9, Amp <sup>r</sup>	pC194, Cm <sup>r</sup>	RCR, <i>orfA</i> and <i>orfD</i> deleted; <i>palA</i> minus origin, complete <i>pag</i> gene with promoter and transcriptional terminator sequences	Quinn <i>et al.</i> , 1991 Quinn and Shone, 1994
pAEX-4- <i>pag</i>	8.8 kb	pUC9, Amp <sup>r</sup>	pUB110, Neo <sup>r</sup> Kan <sup>r</sup>	RCR, <i>palU</i> minus origin; complete <i>pag</i> gene with promoter and transcriptional terminator sequences	Quinn and Shone, 1994
pAEX-5- <i>pag</i>	8.4 kb	pUC9, Em <sup>r</sup>	pAMβ1, Em <sup>r</sup>	derived from pAEX-5E, complete <i>pag</i> gene with promoter and transcriptional terminator sequences	Quinn and Shone, 1994
pAEX-5E	5.8 kb	pUC9, Em <sup>r</sup>	pAMβ1, Em <sup>r</sup>	theta replication minimal replicon, contains <i>pag</i> promoter signal sequence and transcriptional terminator sequences; <i>pag</i> structural gene absent	Quinn and Shone, 1994
pAEX-5E/K (+) pAEX-5E/K (-)	7.0 kb	pUC9, Em <sup>r</sup>	pAMβ1, Em <sup>r</sup> Kan <sup>r</sup>	derived from pAEX-5E, Tn903 kanamycin resistance cassette inserted in both orientations. (+) = <i>aph</i> promoter convergent on pAMβ1 RepE promoter; (-) = <i>aph</i> promoter divergent to pAMβ1 RepE promoter	This study

r = resistant; Amp = ampicillin; Em = erythromycin; Cm = chloramphenicol; Neo = neomycin; Kan = Kanamycin; RCR = rolling circle replication;

*orf* = open reading frame; *palA* = palindromic sequence A, not functional in *Bacillus* species; *palU* = palindromic sequence U, functional in *Bacillus* species;

*pag* = gene encoding protective antigen, *aph* = gene encoding kanamycin resistance.

plates (see Appendix I) for 48 h at 37 °C, or until sporulation had occurred. Growth was examined using phase contrast microscopy to determine how many of the bacilli had sporulated. When at least 95% sporulation had occurred, spores were harvested in 10 ml of sterile deionised water (SDW), washed twice in SDW by centrifugation at 3000 x g for 10 min at 4 - 8 °C and resuspended in 5 - 10 ml SDW. Unheated (U) and heated (H, 62.5 °C for 10 min) samples were counted as described in Section 2.3. An identical count from U and H samples indicated that a negligible number of vegetative cells were present.

### **2.2.3 Preparation of vegetative bacilli**

Spores were heat shocked (62.5 °C for 10 min) to trigger germination and 1 µl inoculated into 10 ml of BHIB. This was incubated at 37 °C with shaking (220 - 230 rpm) for 2 h. An aliquot (1 ml) was transferred to 50 ml of BHIB and incubated at 37 °C for 5 h. Cultures were held on ice and harvested by centrifugation at 3000 x g for 15 min at 4 °C, washed twice in 10 ml of ice cold PBS, and resuspended in a 1 - 2 ml of ice cold PBS. Vegetative cell cultures were held on ice and counts were done on U and H samples. No growth on the heated samples indicated that no spores were present.

### **2.3 Bacterial counts**

Bacterial counts were done using a modification of the method described by Miles and Misra in 1938 (ICMSF, 1978). Ten-fold serial dilutions of bacterial culture were made in SDW or PBS. From each dilution three 20 µl drops were cultured overnight at 37 °C on BA. The number of colonies was counted from the first dilution giving

approximately 20 individual colonies per drop. The average number of colonies per 20 µl drop, and the number of bacteria per ml of the original sample was calculated.

#### **2.4 Processing soil samples for the detection of *B. anthracis***

Soil (50 - 100 g) was placed in a sterile container and approximately 1 - 2 times the volume of SDW added, depending on the dryness of the soil, to produce a suspension which consists of approximately equal amounts of soil and water. The sample was then mixed to produce a homogeneous soil suspension. When heavy clay samples were being processed, a blender was used to disperse the clods of clay. Approximately 10 ml of the sample was transferred to a 25 ml universal container, and 1 ml added to 9 ml of SDW in a universal container to produce a 1 in 10 dilution of the soil. A second 1 in 10 dilution was made, so that the final dilution was 1 in 100. The dilutions were heat shocked by incubating the tubes at 62.5 °C for 15 min in a water bath.

When the samples have cooled, 200 µl from each dilution was spread onto pre-dried BA and PLETA. Plates were incubated at 37 °C for 18 - 24 h. After this time plates were examined for the presence of colonies which resemble *B. anthracis* (see Section 1.6, p 25). The PLETA plates were incubated for a further 24 h and re-examined.

Any suspect colonies were sub-cultured onto a BA plate which has been divided into six triangular segments, so that cultures will grow towards the centre of the plate.

A 10 µl drop of *B. anthracis* specific bacteriophage was added to the centre of the streak lines for each culture, and a disc containing 10 units of penicillin was placed in the middle of the plate. Plates were incubated at 37 °C for 24 h. Any cultures sensitive to both bacteriophage and penicillin were tested for the presence of the pink capsule characteristic of *B. anthracis* by growth in blood and staining with

polychrome methylene blue (M'Fadyean reaction; see Section 2.4.2). Cultures which were both bacteriophage and penicillin resistant were discarded as non-*B. anthracis* (see Figure 1.4; p28). Cultures which showed partial resistance to bacteriophage and penicillin were subjected to the further tests which are described in Figure 1.5 (p 29).

#### **2.4.1 Processing other samples for the detection of *B. anthracis***

Sludge and water samples were processed as described above without the initial dilution of the sample in SDW. Smaller samples, for example hair or bristle were resuspended in a minimum volume of SDW before sampling. Samples of plaster or bone were broken up if necessary using a hammer before sampling, or were soaked prior to making the dilutions to allow the SDW to penetrate the sample.

#### **2.4.2 Examination of cultures for the presence of a poly-D-glutamic acid capsule (M'Fadyean Reaction)**

A loopful of cells (1  $\mu$ l) from a colony cultured overnight at 37 °C on agar was inoculated into 2 ml of sterile defibrinated horse blood or horse serum (TCS Biologicals Ltd, Bucks, UK) and incubated at 37 °C for 5 - 8 h. After this time a thin blood smear was made on a microscope slide, allowed to air-dry, and fixed by immersion in 100% ethanol for 1 min. The slide was air dried, and approximately 10  $\mu$ l of polychrome methylene blue stain (BDH Chemicals, Dorset, UK) was spread carefully over the blood smear. After 1 - 2 min the slide was washed in SDW, blotted and the smear examined using oil immersion microscopy for the presence of chains of blue square ended rod shaped bacteria surrounded by the characteristic pink capsule (M'Fadyean, 1903).

## **2.5 Preparation of agars for the selective growth of *B. anthracis***

Haematin and lysozyme agar (Pearce and Powell, 1951), propamidine isethionate agar (Morris, 1956) phenylethanol agar (Yu and Washington, 1981) trimethoprim colistin blood agar (Oppenheim and Koornhof, 1980) and PLETA (Knisely, 1966) were prepared according to the methods recommended by the authors (see Appendix I).

## **2.6 Germination of spores of *B. anthracis* and *B. cereus***

### **2.6.1 The effect of sodium acetate on spores of *B. anthracis* and *B. cereus***

The effect of sodium acetate on the germination of *B. anthracis* and *B. cereus* was determined according to the method of Travers *et al.* (1987). LB (50 ml) containing sodium acetate (0.25 M - 1.0 M) was seeded with  $1 \times 10^4$  spores of *B. anthracis* ASC 80 and  $1 \times 10^4$  spores of *B. cereus* F4433/73 and grown at 37 °C with shaking (220 - 230 rpm) for 4 h. Samples were heated at 80 °C for 3 min as described by Travers *et al.* (1987). Counts were done on unheated (U) and heated (H) samples as described in Section 2.3. The amount of growth and the proportion of *B. anthracis* and *B. cereus* spores which had germinated was recorded.

### **2.6.2 The effect of amino acid germinants on spores of *B. anthracis* and *B. cereus***

The effect of germinants on spores of *B. anthracis* and *B. cereus* was determined using the method of Titball *et al.* (1987). The germination compounds tested were combinations of L-alanine, inosine, adenosine and guanosine, ranging in concentration from 1 mM to 200 mM in SDW. Spores of *B. anthracis* ASC 80 and *B. cereus* F4433/73 were added to separate 1 ml volumes of germinants in eppendorfs

to a final volume of  $5.0 \times 10^6$  -  $1.0 \times 10^7$  spores /ml and the suspension incubated at room temperature (RT; 20 - 25 °C). At 5 min intervals aliquots were removed and the number of organisms of *B. anthracis* or *B. cereus* was counted using the method described in Section 2.3. Identical aliquots were removed at the same time, heated to 62.5 °C for 15 min and the number of viable bacilli subsequently counted in the same manner. The proportion of spores which had germinated was determined.

### **2.7 Determination of the minimum inhibitory concentration (MIC) of amoxicillin and clavulanic acid required to inhibit growth of *B. anthracis* and *B. cereus***

This was done using a modification of the method recommended by the National Committee for Clinical Laboratory Standards, Pennsylvania, USA (Hindler *et al.*, 1994). Muller-Hinton broth (MHB, 50 µl) was added to each well of a 96-well microtitre plate. Amoxicillin or clavulanic acid (50 µl of 2.048 mg/ml solution in MHB) was added to the first well, then diluted down the plate, to give successive 1:1 serial dilutions. An 18 h culture of the appropriate *Bacillus* species, grown in MHB at 37 °C with shaking (220 - 230 rpm), was diluted 1 in 500, and 50 µl added to each well. The microtitre plate was incubated overnight at 37 °C. The MIC of amoxicillin and clavulanic acid required to inhibit growth was defined as the highest dilution at which no growth occurred, as judged by eye.

### **2.8 Two-phase concentration of *B. anthracis* spores**

The two-phase system used was that of Sacks and Alderton (1961). Potassium phosphate buffer (2.91 ml of a 3.0 M solution pH 7.0), polyethylene glycol 8000 (2.01



ml of a 50% w/v solution in SDW) and 3.7 ml SDW were mixed in a 15 ml centrifuge tube and seeded with spores of *B. anthracis* alone, or spores and soil. The solution was vortexed for 30 s and a 100 µl sample taken. The tube was centrifuged in a swing out rotor for 2 min at 3000 x g. The solution formed 2 layers, and 100 µl was taken from the top layer. The remainder of the top layer was removed, the sample vortexed, and 100 µl taken from the lower layer. The 100 µl samples were spread on BA or PLETA and incubated at 37 °C overnight. The number of colonies of *B. anthracis* was subsequently recorded.

## 2.9 The Polymerase Chain Reaction (PCR)

The PCR (Mullis, 1990) was performed using purified *B. anthracis* DNA or DNA extracted directly from bacterial colonies. When colony PCR was carried out, a loopful of cells (1 µl) was resuspended in 25 µl of SDW and heated to 95 °C for 10 min, then cooled to 4 °C. For each PCR reaction, 2.5 µl or 5 µl of this suspension was used as template material. PCR was done in 25 µl or 50 µl reaction volumes containing 200 µM each of dATP, dCTP, dTTP and dGTP, 1.5 mM MgCl<sub>2</sub>, 0.2 µM or 1.0 µM of each primer and 2.5 units of Taq DNA polymerase (Bioline Ltd, UK) in PCR buffer (16 mM (NH<sub>4</sub>)<sub>2</sub>SO<sub>4</sub>, 67 mM Tris-HCl, 0.01 % (v/v) Tween). Primers (produced by the Structural Sciences department at CAMR) were used to detect sequences of the PA, capsule and S-layer genes. As a positive control, approximately 50 ng of pure genomic DNA (Henderson *et al.*, 1994) was used. Negative control reactions were performed omitting the template material.

The PCR was carried out in a Perkin Elmer 9600 thermocycler using the following cycle:-

95 °C for 5 min	95 °C for 30 s	} x 30	72 °C for 5 min, cool to 4 °C
	55 °C for 30 s		
	72 °C for 30 s		

Samples were analysed by agarose gel electrophoresis

### 2.9.1 Horizontal agarose gel electrophoresis

Horizontal agarose gel electrophoresis was done according to the method of Sambrook *et al.* (1989). A 1% (w/v) agarose gel in TBE buffer (0.045 M Tris - borate, 0.001 M EDTA) was melted in a microwave. The agarose was cooled to 50 °C, then poured to a depth of 5 mm into a gel tray, which was taped at each end and contained 1 or 2 gel combs. Once the agarose had set, the tape was removed and the gel placed in a tank (GNA-100 Gel Apparatus, Pharmacia, Herts, UK or BRL H5 Horizontal System, Bethesda Research Laboratories, Maryland, USA) containing sufficient TBE buffer to cover the gel and the combs were removed. Tracking dye (50% glycerol, 0.02% bromophenol blue, 0.02% xylene cyanol) was added to the DNA to be analysed (10% (v/v) and 10 µl loaded into each well of the gel. To determine the size of the PCR products, 1-kb ladder (Gibco BRL, Paisley, UK, or MBI Fermentas, Tyne and Wear, UK) was run in the wells at either end of the gel. The gel was run at 90 V for 1 h. Gels were stained in a solution of 1 µg/ml ethidium bromide (EtBr) for 10 min. Alternatively 0.5 µg/ml of EtBr was added to the agarose before pouring the gel. For extraction of the DNA bands from agarose gels (see Section 2.10.2) a 1% Nusieve ultrapure low melting point agarose gel (FMC BioProducts,

Maine, USA) containing 0.5 µg/ml EtBr was made using TAE (0.04 M Tris acetate, 0.001 M EDTA) buffer. After electrophoresis at 80 V for 2 h in TAE, gels were visualised under a 256 nm ultraviolet light (Model UUT, Interactive Biotechnology Ltd, UK).

Photographs of the gels were taken using a Direct Screen Polaroid Instant mounted camera with a DS 0.85 or DS 0.7 hood and Type 667 Polaroid film or using an Appligene gel imager (software version 2.03) and printed using a Seikosha VP 1500 II printer.

## **2.10 Extraction and purification of *B. anthracis* DNA directly from soil**

### **2.10.1 NMRI method for the extraction of *B. anthracis* DNA from spores in soil using GlassMAX (Gibco BRL)**

TEP (1 ml of 10 mM Tris-HCl, pH8.0, 1 mM EDTA, 1% polyvinylpolypyrrolidone) was added to 0.2 g of soil ASS 92/90 seeded with  $1 \times 10^6$  spores of *B. anthracis* ASC 245 in a 1.5 ml tube. The sample was vortexed for 10 s and incubated at RT for 30 min with occasional vortexing. The sample was centrifuged at 13 000 x g for 2 min, and the supernatant removed. The pellet was resuspended in 1 ml SDW, centrifuged (13 000 x g for 2 min) and the supernatant discarded. Lysostaphin lysis buffer (300 µl of 50 mM Tris-HCl pH 7.5, 5 mM EDTA, 100 mM NaCl; 10 units/ml lysostaphin) was added to the soil pellet. The soil was vortexed and incubated at RT for 30 min at 37 °C. Chelex 100 was added to a final concentration of 5% and the sample incubated for 30 min at 56 °C. The sample was boiled for 8 min, and the supernatant removed for purification using GlassMAX spin cartridges.

### **2 10.1.1 Removal of inhibitory substances from soil using GlassMAX**

Extracted soil supernatant (40 µl) was added to 180 µl of Binding Solution (sodium iodide) and added to a GlassMAX cartridge. The cartridge was placed into a collection tube and centrifuged (13 000 x g for 20 s) and the collection tube emptied. Cold Wash Buffer (400 µl) was added to the spin cartridge and centrifuged (13 000 x g for 20 s). The collection tube was emptied and the cartridge centrifuged (13 000 x g for 1 min). The cartridge was transferred to a sample recovery tube and 40 µl of TE buffer, preheated to 65 °C, added. The DNA was eluted by centrifugation (13 000 x g for 20 s). The eluted DNA was used as template material in the PCR (see Section 2.9).

### **2.10.2 Separation of DNA from contaminating humic material by agarose gel electrophoresis**

DNA was extracted from soil samples using the method of Porteous and Armstrong (1993). Sterile and non sterile soil (20 mg) seeded with vegetative cells of *B. anthracis* ASC 245 ( $5 \times 10^7$ ) was added to 400 µl of extraction buffer (200 mM Tris-HCl pH 7.5, 250 mM NaCl, 25 mM EDTA and 0.5 % w/v SDS), vortexed for 1 min and incubated at RT for 60 min. The sample was then vortexed for 1 min and centrifuged at 13 000 x g for 5 min. Isopropanol (200 µl) was added to the sample and incubated at RT for 5 min followed by centrifugation at 13 000 x g for 5 min. The supernatant was removed, the pellet air dried and resuspended in 200 µl SDW. DNA was separated from contaminating humic material by agarose gel electrophoresis of a 15 µl sample (see Section 2.9.1) in ultra pure low melting point agarose. When the DNA was sufficiently separated from contaminating material the DNA band was

visualised by minimal exposure to 256 nm ultraviolet light and excised from the gel using a sterile cut off tip. The agarose was frozen, heated to 95 °C for 10 min and 5 µl used as a template for the PCR (see Section 2.9).

### **2.10.3 Detection of *B. anthracis* DNA in soil using a non-selective enrichment method followed by the PCR**

This was done using the method of Beyer *et al.* (1995, 1996). Soil ( 50 g) was seeded with  $10^4$  -  $10^6$  spores of *B. anthracis* and mixed with 100 ml of SDW and 30 g of glass beads (5 mm in diameter). The initial concentration of *B. anthracis* was determined by removal of a sample and growth for 48 h at 37 °C on PLETA. The seeded soil samples were incubated overnight at room temperature with shaking (140 - 150 rpm) then sieved successively through 1.0 mm and 0.25 mm sieves, and centrifuged at 5000 x g at 4 °C for 25 min. The pellet was resuspended in 50 ml of tryptone soya broth (TSB) and incubated overnight at 37 °C with shaking (140 - 150 rpm). Samples were taken and cultured on PLETA. Fresh TSB (10 ml) was inoculated with 100 µl of the overnight culture, incubated for 6 h at 37 °C and a sample cultured on PLETA. To kill the bacterial growth hydrogen peroxide was added to a final concentration of 3 % (v/v) and the broth incubated for 1 h at 37 °C. The sample was centrifuged at 3000 x g at 4 °C for 20 min, the supernatant discarded and the pellet resuspended in 10 ml Tris-NaCl buffer (0.05 M Tris-HCl pH 7.2, 0.15 M NaCl). The sample was washed twice by centrifugation (3000 x g for 20 min at 4 °C) and resuspended in 10 ml Tris-NaCl buffer. A 1 ml sample was grown overnight at 37 °C on BA to ensure that no viable cells were present. The remainder of the sample was frozen overnight. The sample was thawed, centrifuged at 3000 x g

for 20 min at 4 °C and the pellet resuspended in 0.5 ml TE buffer (10 mM Tris-HCl pH 8.0, 1 mM EDTA). Mutanolysin (15 µl, 5000 units/ml in SDW) and 2.5 mg lysozyme were added and incubated at 37 °C for 1 h. Proteinase K and SDS were added to a final concentration of 200 µg/ml and 1% (w/v) respectively and the sample incubated at 50 °C for 30 min. NaCl (3.0 M) and 25% (w/v) SDS were added to give a final volume of 1 M NaCl and 1% (w/v) SDS in 3 ml of TE buffer. This was refrigerated for 60 min, centrifuged at 13 000 x g at 4 °C for 15 min and the supernatant transferred to a fresh tube for phenol chloroform extraction of the DNA.

#### **2.10.3.1 Phenol chloroform extraction of DNA**

TE buffer saturated phenol (3 ml) was added to an equal volume of the sample in a 15 ml centrifuge tube and mixed by inversion. Chloroform (3 ml) was added and the sample mixed by inversion then centrifuged at 3000 x g at 4 °C for 20 min. The aqueous supernatant containing the DNA was removed to a fresh tube and a further 3 ml of chloroform added. The upper aqueous layer was removed and incubated for 15 - 45 min at 37 °C with 20 µl RNase solution (500 µg/ml). Ice cold ethanol was slowly added to a final volume of 11.5 ml. Insufficient DNA was present for spooling, so samples were stored at -20 °C overnight, to precipitate the DNA and centrifuged at 3000 x g for 20 min at 4 °C. The ethanol was removed and the pellet air dried and resuspended in 100 µl TE buffer. The PCR was performed using the sample as template material in the presence and absence of 1 µl of T4 gene protein (1 µg/µl; Boehringer Mannheim Ltd, Germany).

## **2.11 Curing *B. anthracis* of plasmids pX01 and pX02**

### **2.11.1 Curing *B. anthracis* of pX01**

*B. anthracis* ASC 69 was cultured overnight on LA, then one colony inoculated into 50 ml of prewarmed LB and grown for 10 days at 43 °C, with shaking (220 - 230 rpm) and daily subcultures (10 µl) into 50 ml volumes of fresh LB. After 10 days a sample was taken, diluted in LB and grown on LA overnight at 37 °C to obtain individual colonies. Colonies were screened for loss of pX01 using the phenotypic methods described in Section 2.12 and using the PCR (see Section 2.9).

### **2.11.2 Curing *B. anthracis* of pX02**

*B. anthracis* ASC 69 was grown in LB containing 1 µg/ml novobiocin for 10 days at 37 °C with shaking (220 - 230 rpm) and daily 10 µl subcultures into fresh LB. After 10 days a sample was diluted in LB, spread on LA and incubated at 37 °C overnight. Colonies were tested for loss of pX02 using the methods described in Section 2.12 and using the PCR (see Section 2.9).

## **2.12 Determination of the genotype of isolates of *B. anthracis* using phenotypic characteristics**

To determine whether colonies of *B. anthracis* were able to produce capsular material, and hence contained pX02, colonies were grown in blood and stained with polychrome methylene blue as described in Section 2.4.2 (p 48).

**2.12.1 Determination of the plasmid content of isolates of *B. anthracis* by growth in the presence of bicarbonate ions and CO<sub>2</sub>**

The presence of pX01 and pX02 in partially cured and fully cured derivatives of *B. anthracis* was determined phenotypically by culture of colonies for 24 h at 37 °C on bicarbonate agar (see Appendix I) under candle extinction (CE, approximately 5% CO<sub>2</sub>) and in the presence of 20% (v/v) CO<sub>2</sub> in air. The plasmid content of different isolates of *B. anthracis* was determined using the criteria described in Table 2.3.

**Table 2.3 Characteristics of isolates of *B. anthracis* grown on bicarbonate agar under CE and in the presence of 20% CO<sub>2</sub>**

Plasmid content of <i>B. anthracis</i>	Appearance on bicarbonate agar	
	Under CE	Under 20% (v/v) CO <sub>2</sub>
pX01 <sup>+</sup> /pX02 <sup>+</sup>	mucoïd	mucoïd
pX01 <sup>+</sup> /pX02 <sup>-</sup>	dry	dry
pX01 <sup>-</sup> /pX02 <sup>+</sup>	dry	mucoïd
pX01 <sup>-</sup> /pX02 <sup>-</sup>	dry	dry

Any dry colonies from a population of mucoïd cells were examined microscopically for the production of capsular material by making a smear of growth from a colony on a microscope slide and staining as described in Section 2.4.2. The presence or absence of pX01 was determined using the PCR (see Section 2.9).

The ability of an isolate to produce protective antigen (PA), was also determined using a hand held immunochromatographic antigen capture assay,



according to the method of Burans *et al.* 1996. A colony was grown for 24 h at 37 °C with shaking (220 - 230 rpm) in 2 ml of RM medium (Ristroph and Ivins 1983, see Appendix I). The test strip was dipped into the culture and incubated at room temperature for 15 min. The presence of PA was determined by the observation of a visible red band on the strip. In the absence of PA only the control band was visible. The supply of these strips was, however, limited, and for the majority of the work it was necessary to depend on the PCR.

### **2.13 Transformation of *B. anthracis* by electroporation**

Electroporation was done using the method of Quinn and Dancer (1990).

*B. anthracis* was grown in 50 ml of LBG medium (LB + 0.1% w/v glucose; see Appendix I) at 37 °C with shaking (220 - 230 rpm) to an  $A_{600}$  of 0.15 - 0.35, measured using an LKB Ultraspec III spectrophotometer (Pharmacia, Herts, UK). The cells were harvested by centrifugation (3000 x *g* at 4 °C for 10 min), washed twice in 20 ml of ice cold electroporation buffer (EB, 10% sucrose, 15% glycerol, 2 mM phosphate buffer pH 8.4), and resuspended in EB to a final volume of 800 µl. Plasmid DNA pAEX-5E or pAEX-5E/K (10 µl of a 0.5 µg/ml solution; see Table 2.2) was added to 400 µl of cells, incubated on ice for 10 min and then electroporated at 2.5 kV, 200 Ohms and 2.5 µF capacitance, using a Bio-Rad Gene Pulser (Bio-Rad Laboratories Ltd, California, USA). LBG medium (1 ml) was added and the samples were incubated with shaking at 37 °C for 90 min. Samples (400 µl) were spread onto LA containing 5 µg/ml erythromycin (EM<sub>5</sub>). The plates were left at room temperature for 2 h, then incubated at 37 °C overnight. Colonies were picked in duplicate onto LA and LA + EM<sub>5</sub>, and incubated at 37 °C overnight. As a negative control, samples were

processed in the same manner without the addition of DNA to the cells of *B. anthracis*.

## **2.14 Transformation of *E. coli* GM2163 with plasmid DNA**

### **2.14.1 Preparation of competent *E. coli* cells**

Competent cells were made according to the method of Chung *et al.* (1989). *E. coli* GM2163 cells were grown in 100 ml LB at 37 °C for 3 h with shaking to an  $A_{600}$  of 0.6. Cells were harvested by centrifugation at 1000 x *g* for 10 min at 4 °C, resuspended in 10 ml of transfer storage buffer (TSB; see Appendix I) and incubated on ice for 10 min. The cells were aliquotted into 300 µl volumes, quick frozen on dry ice with ethanol and stored at -70 °C.

### **2.14.2 Transformation of *E. coli***

Transformation was done using the method of Chung *et al.* (1989). Competent cells were thawed on ice and 100 µl mixed with 5 - 20 µl (10 - 100 ng) of plasmid DNA and left on ice for 20 min. TSB + 0.1% glucose (TSBG, 900 µl; see Appendix I) was then added and the cultures incubated at 37 °C for 60 - 90 min. The cell suspension (200 µl) was spread on LA containing 200 µg/ml erythromycin (EM<sub>200</sub>) and incubated for 24 h at 37 °C. Transformants were cultured overnight on fresh LA + EM<sub>200</sub> then grown overnight in 1.5 ml of LB + EM<sub>200</sub>. DNA was extracted using the Krystal Plasmid DNA extraction kit as described in Section 2.14.3. The resulting plasmid DNA was used for restriction digest analysis.

### **2.14.3 Plasmid rescue of pAEX-5E and pAEX-5E/K from *B. anthracis***

Plasmid DNA was extracted from pX01<sup>+</sup>/pX02<sup>+</sup>, pX01<sup>+</sup>/pX02<sup>-</sup> and pX01<sup>-</sup>/pX02<sup>+</sup> derivatives of *B. anthracis* using the Krystal Plasmid DNA extraction kit (Stratech, UK Ltd) which is based on an alkaline lysis extraction procedure. Colonies of *B. anthracis* were grown for 5 h in 25 ml volumes of LB, containing antibiotic where appropriate, until mid-log phase. Cultures were then centrifuged at 3000 x g for 10 min and the pellet resuspended in a minimum volume of LB and transferred to a 1.5 ml tube. This was centrifuged at 13 000 x g for 30 s at room temperature (RT) and the supernatant removed. The pellet was resuspended in 150 µl of resuspension buffer (Solution 1). Lysis buffer (Solution 2, 150 µl) was added and mixed by gentle inversion of the tube. Neutralization solution (Solution 3, 150 µl) was added and the tube gently inverted 10 times. The lysate was centrifuged at 13 000 x g for 5 min at RT. The binding resin was shaken thoroughly, and 200 µl added to a spin column. The supernatant containing the plasmid DNA was added to the spin column which was placed in a collection tube and mixed. The column was centrifuged at 13 000 x g for 30 s, and the effluent removed from the bottom of the collection tube. Wash buffer (500 µl) was added to the resin, mixed and the column centrifuged at 13 000 x g for 30 s. The effluent from the bottom of the collection tube was again discarded and the spin column tapped to remove the resin from the walls. To remove final traces of wash buffer the column was centrifuged for a further 30 s. The resin was dried at 37 °C for 5 min and the spin column was transferred to a fresh tube. To elute the DNA, elution buffer (50 µl) was added, and the column tapped to ensure that all of the resin was covered with buffer. The column was again centrifuged at 13 000 x g for 30 s

and the DNA eluted into the tube. The presence of plasmid DNA was determined by running 10  $\mu$ l of the eluted plasmid DNA on an 0.8 % (w/v) agarose gel in TBE buffer (see Section 2.9.1).

#### 2.14.4 Restriction digest analysis of plasmid DNA

Restriction digest analysis of the plasmid DNA was done using *Hind*III, *Nhe*I and *Bam*HI enzymes according to the enzyme manufacturer's instructions (NBL, Gene Sciences Ltd, UK). For each digest 6  $\mu$ l ( $\approx$  1  $\mu$ g) of plasmid DNA, 2.5  $\mu$ l of 10 x buffer, 16  $\mu$ l of SDW and 1 unit of enzyme, were mixed and incubated at 37 °C for 3 h. Digests were analysed on a 1% agarose gel (see Section 2.9.1).

#### 2.15 Determination of bacterial growth rate

To calculate the length of time required for each derivative of *B. anthracis* to grow for 100 generations, the growth rate of *B. anthracis* was determined. A loopful (1  $\mu$ l) of growth from an overnight culture on LA was grown in 50 ml of LB, with or without antibiotic at 37 °C with shaking (220 - 230 rpm). Samples (1 ml) were taken at 15 - 30 min intervals and the  $A_{600}$  measured using a LKB Ultraspec III spectrophotometer (Pharmacia, Herts, UK). A graph was plotted of natural log ( $\ln$ ) of the  $A_{600}$  absorbency against time and the gradient of the curve ( $g$ ) calculated at the mid-log phase of growth. The doubling time ( $t_d$ ) was determined by the calculation of  $\ln_2$  (0.693) divided by  $g$ . All growth rate experiments were repeated in triplicate.

## **2.16 Determination of stability of plasmids in *B. anthracis***

### **2.16.1 In the absence of antibiotic selection**

To determine the stability of small shuttle plasmids in *B. anthracis*, cultures containing the plasmids were grown for 100 generations, and the presence of the plasmid determined at intervals by screening colonies from the culture for antibiotic resistance. Cultures were grown overnight on LA containing the appropriate antibiotic, then a single colony inoculated into 50 ml of prewarmed LB to give a  $A_{600}$  of approximately 0.05. This was incubated at 37 °C with shaking (220 - 230 rpm). When the culture reached mid-log phase ( $A_{600} \approx 0.5$ ), approximately 1 or 2 ml was transferred to fresh LB to give an  $A_{600}$  of 0.05. When the cultures needed to be left overnight, they were serially diluted in LB, and incubated for 14 h at 37 °C. After this time the dilution of the culture with the  $A_{600}$  closest to 0.5 was used to continue the experiment. Samples were taken at appropriate intervals, serially diluted in LB to 1 in 1000 and 1 in 10000, and cultured overnight on LA with the aim of obtaining individual colonies. To determine the number of colonies which remained antibiotic resistant, colonies (200 from each sample) were picked in duplicate onto fresh LA and LA containing antibiotic. Plates were incubated at 37 °C overnight and the percentage of colonies which had retained resistance to antibiotic was recorded.

### **2.16.2 In the presence of antibiotic selection**

When cultures were grown for 100 generations in the presence of antibiotic, the presence of plasmid DNA was determined at the end of the 100 generations of growth by plasmid rescue. Cultures were grown for 100 generations as described above at 37 °C in LB + antibiotic. After 100 generations of growth, a sample was diluted in LB

and cultured on LA + antibiotic. Presence of pAEX-5E was determined by extraction of plasmid DNA, and amplification in *E. coli* followed by restriction digest analysis (see Sections 2.13 and 2.14).

### **2.16.3 Determination of the stability of pX01 and pX02 in *B. anthracis* under selection pressure for pAEX-5E**

Cultures were grown for 100 generations at 37 °C with shaking (220 - 230 rpm) in the presence of antibiotic selection pressure for pAEX-5E. Where the pX01 and pX02 content could be determined by phenotypic methods (in the pX01<sup>+</sup>/pX02<sup>+</sup> and pX01<sup>-</sup>/pX02<sup>+</sup> derivatives; see Section 2.12.1) samples of growth of *B. anthracis* were taken at intervals over the 100 generations and colonies tested for the presence of pX01 and pX02 by culture on bicarbonate agar under CE and in the presence of 20% CO<sub>2</sub> and observation of the colony morphology. In the pX01<sup>+</sup>/pX02<sup>-</sup> derivative, the presence of pX01 was determined by growth for 100 generations, followed by testing 100 colonies for the presence of part of the *pag* gene using the PCR (see Section 2.9).

## **2.17 Southern blot analysis of derivatives of *B. anthracis* using pAEX-5E DNA as a probe**

### **2.17.1 Extraction of total genomic DNA from *B. anthracis***

Total genomic DNA was extracted from *B. anthracis* using the method of Jackson *et al.* (1997). Cultures of *B. anthracis* were grown overnight on LA and a single colony inoculated into 10 ml of LB or LB + erythromycin and cultured at 37 °C with shaking (220 - 230 rpm) for 2 h. A proportion of this culture (2 - 10 ml, depending on the growth rate of the derivative of *B. anthracis*) was subcultured into 100 ml LB or

LB + erythromycin and cultured at 37 °C for 5 h. Further growth of cultures was likely to lead to sporulation of *B. anthracis*, and consequent spore contamination of *B. anthracis* DNA. The cultures were harvested by centrifugation at 3000 x g for 20 min, and the resulting pellet resuspended in 8.5 ml of TE buffer and frozen at -20 °C overnight. The bacterial suspension was thawed by heating to 65 °C in a water bath, then fast frozen by immersion in dry ice with ethanol. This freeze-thaw procedure was repeated twice. SDS (450 µl of a 10% w/v solution) and proteinase K (45 µl of a 20 mg/ml solution) were added, and the cells incubated at 42 °C for 1 h. NaCl (1.5 ml of a 5 M solution) was added and mixed thoroughly. A cetyltrimethylammonium bromide (CTAB)-NaCl solution (10% w/v CTAB, 0.7 M NaCl; 1.4 ml) was added and the solution mixed thoroughly by inversion, and incubated at 65 °C for 10 min. An approximately equal volume of chloroform-isoamyl alcohol (24:1 v/v) was added and the sample mixed gently by inversion for 10 min. The solution was centrifuged at 3 000 x g at RT for 5 min and the upper aqueous layer carefully removed to a fresh tube. An equal volume of chloroform-isoamyl alcohol was added, the sample mixed by gentle inversion for 10 min, centrifuged (3 000 x g for 5 min) and the upper phase removed to a fresh tube. To extract the nucleic acid, 0.6 volumes of isoamyl alcohol (RT) were added and the tube inverted gently until strings of nucleic acid were visible. The nucleic acid was collected by centrifugation (800 x g for 2 min) and resuspended in 70% ethanol to remove any residual CTAB. The sample was centrifuged (800 x g for 2 min), the ethanol removed and the pellets dried at RT for 1 h. The pellet was resuspended in 1 ml of TE buffer.

### **2.17.2 Removal of RNA from the nucleic acid sample**

DNase free RNase (Boehringer Mannheim Ltd, Germany) was added to the nucleic acid in TE buffer to a final concentration of 20 µg/ml and incubated at 42 °C for 1 h. An equal volume of TE buffered phenol chloroform was added and samples mixed by inversion for 5 min. The sample was centrifuged (3 000 x g for 5 min) and the upper layer removed to a fresh tube. An equal volume of chloroform isoamyl alcohol was added, the sample mixed by inversion for 5 min and centrifuged (3 000 x g for 5 min). The aqueous upper layer was removed and the DNA precipitated by the addition of 1/10 volume of 5 M ammonium acetate (pH 5.5) and 2.5 volumes of ice cold 95% ethanol. The tubes were inverted to precipitate the DNA then centrifuged (3 000 x g for 10 min). The pellet was air dried for 30 min and resuspended in 200 - 500 µl of SDW. The yield of the DNA was estimated by agarose gel electrophoresis of dilutions of the sample in the presence of a molecular weight marker of known concentration (MBI Fermentas, UK). DNA was stored at 4 - 8 °C.

### **2.17.3 Restriction digestion of total genomic DNA from *B. anthracis***

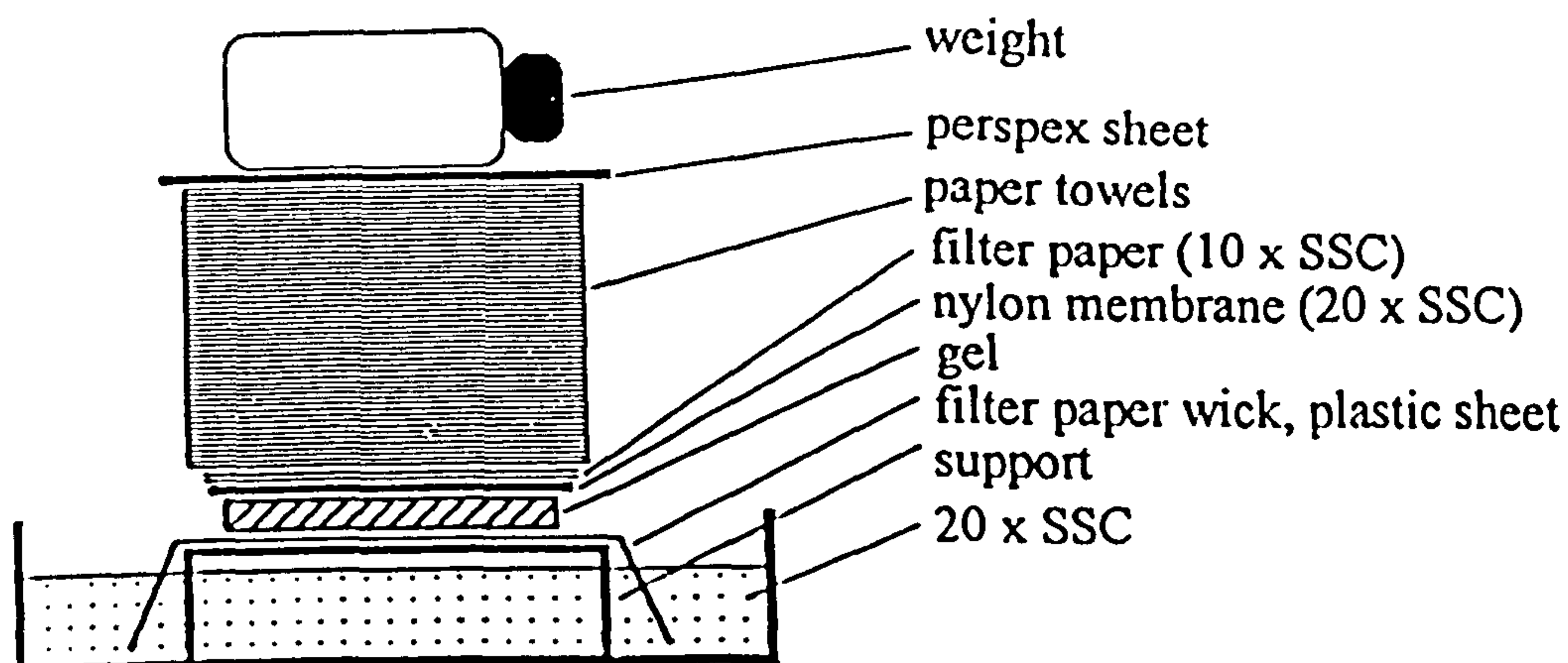
*B. anthracis* DNA (1 µg) was digested using 70 units of *Hind*III or *Eco*RI restriction enzyme in the appropriate buffer, according to the manufacturer's instructions (NBL Gene Science Ltd, UK). Digests were incubated at 37 °C overnight, then run on a 1% agarose gel, visualised under ultraviolet light, and photographed using the Appligene gel imager (see Section 2.9.1)



#### 2.17.4 Transfer of *B. anthracis* DNA to a nylon membrane by Southern (capillary) blotting

To prepare the DNA for transfer to a nylon membrane, the gel was depurinated by incubation for 2 x 10 min in 250 mM HCl, with gentle agitation, then denatured for 25 min in a solution containing 1.5 M NaCl and 0.5 M NaOH. The gel was neutralised in 1.5 M NaCl, 0.5 M Tris-HCl, pH 7.5 for 25 min. Capillary transfer was set up as shown in Figure 2.1.

Figure 2.1 Assembly of the capillary transfer system



The gel was placed on a sheet of plastic with a hole cut in it slightly smaller than the gel, resting on blotting paper. The nylon membrane soaked in 20 X SSC (3.0 M NaCl, 0.3 M Na<sub>3</sub> citrate) was carefully layered on top of the gel and any air bubbles removed. Four sheets of blotting paper cut to the size of the gel and soaked in 10 x SSC were layered on top of the membrane, followed by a layer of paper towel

approximately 10 cm in thickness and a 500 g weight. The DNA was allowed to transfer to the nylon membrane for 16 h. The blot was then dismantled and the DNA fixed to the membrane by exposure to a 302 nm ultraviolet light for 4 min. The blot was wrapped in clingfilm and stored in a sealed box at RT (22 - 25 °C).

#### **2.17.5 Generation of the pAEX-5E DNA probe**

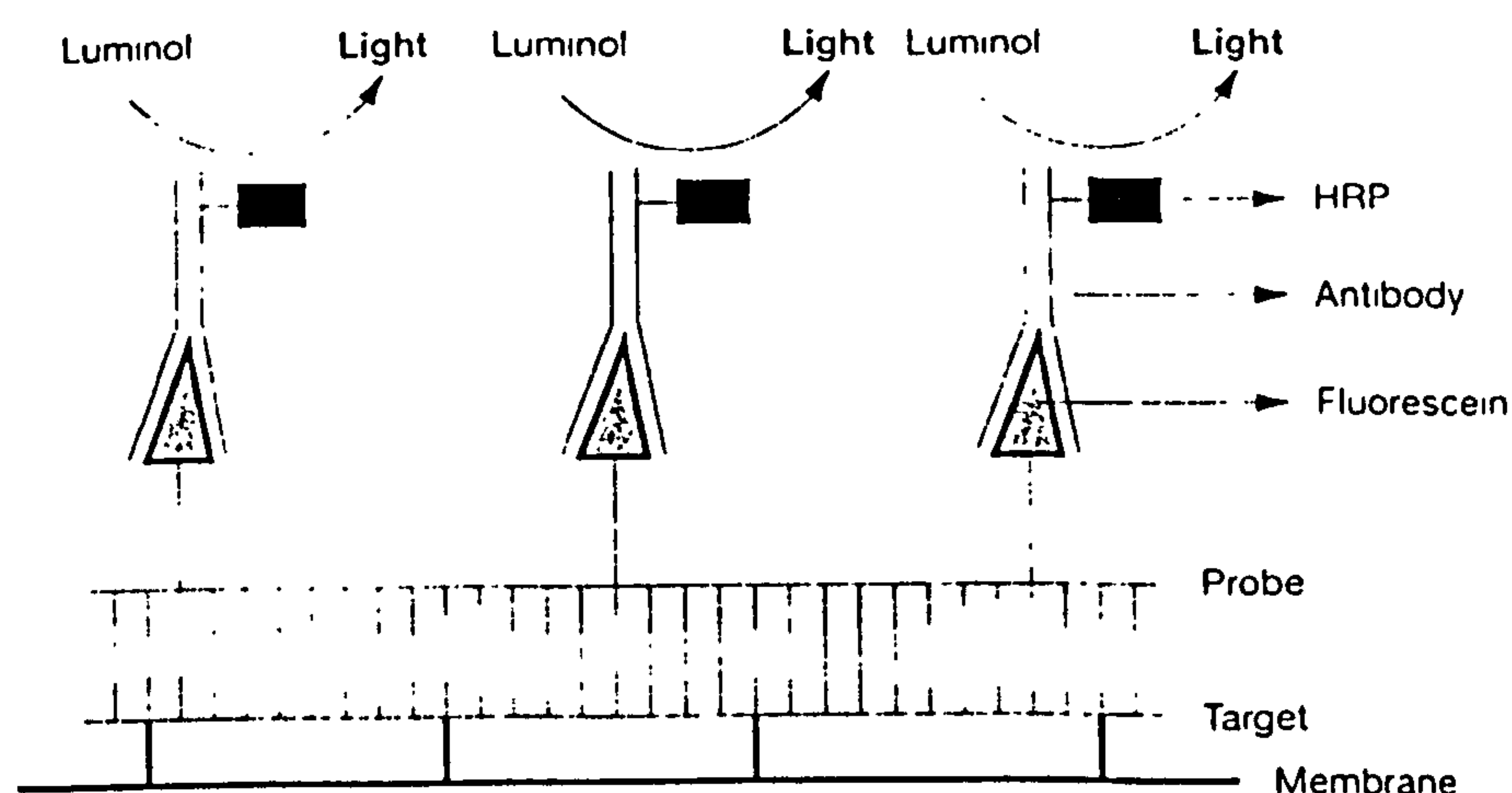
To remove DNA sequences which show homology to those on plasmid pX01, pAEX-5E DNA was double digested with *EcoRI* and *XbaI* enzymes as described in Section 2.14.4. The resulting DNA was run on a 1% agarose gel and the 5.1 Kb fragment of pAEX-5E excised from the gel and the DNA purified using the QIAquick DNA extraction kit (Qiagen Ltd, West Sussex, UK) according to the manufacturer's instructions. The gel slice was incubated for 10 min at 50 °C in 3 x the gel volume of buffer QG, to dissolve the agarose. The DNA solution was then loaded into a spin column and bound to the column matrix by centrifugation at 13 000 x g for 1 min. The DNA was washed by the addition of 750 µl PE buffer to the spin column and centrifuged at 13 000 x g for 1 min. The eluted PE buffer was removed and the column centrifuged for a further 1 min. The DNA was eluted in 30 µl of EB (10 mM Tris-HCl). The concentration of the DNA was determined by running 5 µl of the purified DNA on a 1% agarose gel alongside marker DNA of known concentration.

#### **2.17.6 Fluorescein labelling of the pAEX-5E DNA probe**

The pAEX-5E DNA was labelled using the ECL random prime labelling and detection system, version II (Amersham Life Sciences, Bucks, UK). This technique involves the random incorporation of fluorescein II - dUTP into the probe, partially replacing

dTTP. The resulting probe can subsequently be detected by conjugation with anti-fluorescein labelled horse radish peroxidase conjugate (HRP) and detected using ECL reagents (Figure 2.2).

**Figure 2.2 Diagrammatic representation of the fluorescein labelling and detection of DNA probes using the ECL random prime labelling and detection system**



The probe was labelled according to the manufacturer's instructions. DNA (pAEX-5E; 50 ng) was diluted to a final volume of 20  $\mu$ l in SDW, denatured by boiling for 5 min and chilled on ice. The nucleotide mix (10  $\mu$ l of fluorescein II dUTP, dATP, dCTP, dGTP and dTTP in Tris-HCl buffer pH 7.8, with 2-mercaptoethanol and  $MgCl_2$ ), 5  $\mu$ l random nonamer primers in aqueous solution, 5 units of Klenow fragment polymerase and 14  $\mu$ l SDW were added to the DNA, the solution mixed gently and incubated at 37  $^{\circ}C$  for 1 h. The reaction was terminated by the addition of EDTA to a final concentration of 20 mM (5  $\mu$ l of 200 mM EDTA, pH 8.0). The yield

of the probe was determined to be 400 ng (in 50  $\mu$ l) by dilution of the probe and comparison to dilutions of control fluorescein labelled DNA, using the information provided in the manufacturer's instructions. The probe was stored at - 20 °C in the dark.

#### **2.17.7 Hybridization of the probe to the digested *B. anthracis* DNA**

The probe was hybridized to the *B. anthracis* DNA according to the protocol described in the ECL random prime labelling instruction manual. The blot was incubated with gentle agitation for 30 min in 20 ml hybridization buffer (see Appendix I) preheated to 60 °C. Probe (pAEX-5E; 2.5 ng/ml) was added to the hybridization buffer and the blot incubated at 60 °C overnight. The blot was washed for 15 min in 200 ml 1 x SSC with 0.1% (w/v) SDS at 60 °C, followed by 15 min in 200 ml 0.5 x SSC with 0.1% SDS (w/v). The blot was placed in a clean container and rinsed in 200 ml buffer A (100 mM Tris-HCl, 600 mM NaCl pH 7.5) for 1 min, then washed in 20 ml of a 20 fold dilution of liquid block (supplied) in buffer A for 30 min at RT. The anti-fluorescein-HRP conjugate was diluted 1/1000 in 10 ml of freshly prepared 0.5% (w/v) bovine serum albumin fraction V in buffer A. The blot was incubated in the conjugate solution for 30 min. Unbound conjugate was removed by washing the blot for 3 x 10 min in 200 ml 0.1% (w/v) Tween 20 in buffer A. The signal from the hybridized probe was detected using the ECL detection system as described in the manufacturer's instruction. Equal volumes (5 ml) of Solution A and Solution B were mixed and added to the blot for 1 min. The blot was placed on a piece of filter paper in a film cassette, secured by clingfilm. In the dark room, a sheet of autoradiography film (Hyperfilm ECL, Amersham Life Sciences, Bucks, UK) was

placed on top of the blot and left for 30 s - 5 min. The film was subsequently developed by incubation in autoradiography film developing and fixing solutions, then rinsed in SDW and air dried.

### 3.0 EVALUATION OF SELECTIVE AGARS AND BROTHS FOR THE DETECTION OF *BACILLUS ANTHRACIS* IN ENVIRONMENTAL MATERIAL

#### 3.1 INTRODUCTION

The persistence of *B. anthracis* spores in the environment (see Section 1.2.2) has led to the potential for *B. anthracis* contamination to remain at sites where animals have died of anthrax, or where *B. anthracis* contaminated animal products have been processed. Such sites include animal burial sites, knackers yards, hide, hair and bone processing factories and tanneries. The introduction of the 1919 regulations to prevent the importation of *B. anthracis* contaminated animal products (Anon, 1918) has made it unlikely that *B. anthracis* is present in factories which have been operational in the last 50 years (Turnbull, 1996).

When the use of land which may be contaminated with *B. anthracis* is altered, or when plans for redevelopment are made, there is a potential risk to public health if spores of *B. anthracis* are disturbed. For this reason, in the course of site development, samples are taken from areas where contamination is most likely to be found and tested for the presence of *B. anthracis*. Should *B. anthracis* be found, the appropriate measures can be taken to reduce the risk to public health (Watson and Kier, 1994; Turnbull, 1996).

The majority of samples tested for the presence of *B. anthracis* are soil: other samples include plaster, sewage, water, hair and bone.

### 3.1.1 The current system used at CAMR for the detection of *B. anthracis* in environmental material

The method used at CAMR for the detection of *B. anthracis* in environmental material is described in Section 2.4 (p 47). Briefly, the sample is resuspended in an equal volume of SDW and ten fold serial dilutions in SDW are made. The dilutions are heat shocked (62.5 °C for 15 min) to kill any unwanted vegetative bacteria and to encourage any spores which have remained dormant for long periods of time to germinate. Dilutions are then cultured on blood agar (BA) and selective PLETA (Knisely, 1966). At lower dilutions, reduced competition for nutrients allows *B. anthracis*, which grows more slowly than competing *Bacillus* species, to produce visible colonies. The detection limit for *B. anthracis* on PLETA varies according to the type of soil being sampled and the sampling strategy adopted. Manchee *et al.* (1994) estimated a detection limit of three spores per gram of soil. Turnbull (1996) reported a detection limit of five spores per gram of soil, unless the sample was very heavily contaminated with other *Bacillus* species, when the detection limit may increase to approximately 50 spores per gram. Due to the heterogeneous nature of the soil, or the low numbers of spores of *B. anthracis* present, spores may be found individually, or in only one dilution of a sample. This makes the level of contamination difficult to estimate. Using pure cultures, a similar number of colonies of *B. anthracis* will grow on both BA and PLETA, indicating that PLETA is not generally inhibitory to the growth of *B. anthracis* (Turnbull, 1998). When a mixture of *Bacillus* species are cultured on BA, *B. anthracis* is invariably outgrown by other *Bacillus* species. On PLETA, however, *B. anthracis* forms readily detectable colonies and the majority of other *Bacillus* species are suppressed. PLETA is therefore used as the 'gold standard'

by which to measure the performance of other selective agars.

A disadvantage of using selective agar is that only a very small portion of a sample is cultured, for example after the sample has been resuspended in SDW, diluted and spread on agar only approximately 0.2 g from 100 g of soil is actually tested.

*B. anthracis* must therefore be present in sufficiently high numbers to be detected in such a sample. Spores present in very low numbers, or unevenly distributed may remain undetected.

### **3.1.2 The requirement for a selective enrichment system for the detection of *B. anthracis* in environmental samples**

To try and increase the likelihood of detecting a required bacterial species, a selective enrichment system may be used in which samples are grown in an enrichment broth before culture on agar. The aim of a selective enrichment system is to modify the conditions in the microbial ecosystem to allow rapid multiplication of the desired bacterial species, whilst suppressing or eliminating growth of unwanted competing species (Iveson, 1973). Selective enrichment may be achieved by altering the temperature, pH, aeration, rate of agitation, illumination or osmotic pressure of the broth system (Brock, 1966) or by the addition of a toxic chemical such as a dye or an antibiotic (Wyatt *et al.*, 1992). One of the drawbacks with the use of inhibitory chemicals is that, in addition to suppressing the growth rate of competing bacteria, they may also reduce the growth rate of the target organism (Wyatt *et al.*, 1992). Growth of damaged cells, or certain strains of the required species may also be inhibited.

To increase recovery of the required organism, after growth in an enrichment



broth, samples are generally cultured on selective agar. To improve the recovery of a desired species in the presence of selective agents, a non-selective pre-enrichment broth is often recommended to allow recovery of bacteria before growth under selective pressure (Van Doorne *et al.*, 1981).

A selective enrichment system which would allow *B. anthracis* to grow to a level at which it could be easily and consistently detected, whilst suppressing overgrowth of other *Bacillus* species, would improve the sensitivity of the detection of *B. anthracis* in environmental samples. To date, very little work has been published describing the development of such an enrichment broth for the selective detection of *B. anthracis*.

### **3.2. Aim of the work described in this chapter**

The aim of the work described in this chapter was to conduct a comparative systematic study to evaluate the effectiveness of the agents described by other workers for the selective growth of *B. anthracis* in environmental material, and to develop a selective enrichment broth which would allow the consistent detection of low numbers of *B. anthracis* spores in environmental samples.

This Chapter has been sub-divided into 10 sections (Section 3.3 - Section 3.13).

### **3.3 THE EVALUATION OF THE GROWTH OF *B. ANTHRACIS* ON DIFFERENT SELECTIVE AGARS**

#### **3.3.1 Introduction**

##### **3.1.1.1 The culture of *Bacillus* species on agar**

Most *Bacillus* species will grow well on nutrient agar (NA) or BA (Turnbull *et al.*, 1990). In soil, the majority of *Bacillus* species exist in spore form and can therefore be selected for by heating to a temperature which will kill vegetative cells, without affecting the viability of spores, followed by culture on agar. Generally heat treatment is carried out at temperatures between 60 °C - 80 °C for 10 min - 1 h (Carman *et al.*, 1985; Turnbull and Kramer, 1991). An alternative to heat is killing vegetative organisms with ethanol (Claus and Berkeley, 1986).

##### **3.3.1.2 Selective agars for members of the '*B. cereus* group'**

*Bacillus cereus* may be responsible for 5 - 10% of cases of food poisoning (Notermans, 1993), thus a number of agars have been developed for the selective culture of *B. cereus* from food and clinical samples. For the detection of high numbers of *B. cereus* in food ( $> 10^6$  cfu/g) non-selective BA is used (Holbrook and Anderson, 1980). Where *B. cereus* exists in lower numbers or in the presence of other organisms, a selective medium is required. The main selective agent used is polymyxin B sulphate which inhibits the growth of Gram-negative organisms. To identify *B. cereus* from other bacterial species, egg yolk emulsion is added which leads to the formation of an area of lysis and precipitation around lecithinase producing colonies of *B. cereus*. The addition of mannitol and an indicator of mannitol utilization such as bromothymol blue

allows colonies of *B. cereus* to be identified by their inability to catabolize mannitol.

The most commonly used selective agars are MYP agar (mannitol, egg yolk and phenol red; Mossel *et al.*, 1967) and PEMBA (polymyxin B sulphate, pyruvate, egg yolk, mannitol and bromothymol blue agar; Holbrook and Anderson, 1980).

*B. thuringiensis* will grow equally well on these agars, forming very similar colonies to those of *B. cereus* (Holbrook and Anderson, 1980). To distinguish between colonies of *B. cereus* and *B. thuringiensis*, they need to be tested for the presence of parasporal bodies (Brousseau *et al.*, 1993). The use of such agars would not encourage the selective growth of *B. anthracis* as it would invariably be outgrown by *B. cereus* which is commonly found in the majority of environmental samples tested for the presence of *B. anthracis*.

### 3.3.1.3. Selective agars for *B. anthracis*

A number of agars have been recommended over the years for the selective growth of *B. anthracis* in environmental material. The formulations of these are summarised in Table 3.1. Pearce and Powell (1951) based their selective agar on haematin and lysozyme, as *B. anthracis* was reported to be resistant to both chemicals. They found that on this agar *B. anthracis* grew, whilst up to 95% of other *Bacillus* species were suppressed.

Morris (1955) reported that propamidine isethionate agar (PIA) inhibited the growth of *B. mycoides*, *B. subtilis* and *B. licheniformis*, but that *B. cereus* and *B. anthracis* both grew well. Some strains of *B. anthracis*, however, were also inhibited, and the detection limit was 50 spores per gram of soil. Propamidine

**Table 3.1 Selective agars recommended for the growth of *B. anthracis* from environmental samples**

Agar	Selective agents	Author and year
Haematin and lysozyme	40 mg/l haematin, 77 mg/l lysozyme in peptone agar pH 7.4	Pearce and Powell, 1951
PI	0.01% propamidine isethionate, 20 units/ml polymyxin B sulphate in peptone agar pH 7.6	Morris, 1955
PLET	30 000 units/l polymyxin B sulphate, 40 mg/l lysozyme, 300 mg/l EDTA, 40 mg/l thallos acetate in heart infusion agar, pH 7.3	Knisely, 1966
TCB	175 µg/ml trimethoprim, 75 µg/ml colistin, 5% horse blood in Oxoid DST agar base	Oppenheim and Koornhof, 1980

isethionate (PI) was originally synthesised as an antiprotozoal agent and was found to be antibacterial against Gram-positive cocci (Elson, 1945). Elson also reported, however, that 0.005% PI in heart infusion agar inhibited the growth of *B. anthracis*.

TCB agar (TCBA) was developed with the aim of producing a selective medium which is easier to prepare than PLETA. Trimethoprim inhibits folic acid synthesis by inhibiting dihydrofolate reductase (Hindler *et al.*, 1994). Doganay and Aydin (1991) reported that 27 strains of *B. anthracis* were sensitive to 1.6 - 3.2 µg/ml of trimethoprim when it was combined with 8 - 16 µg/ml of sulfamethoxazole. Schmidt *et al.* (1977) used trimethoprim to compare biosynthetic pathways for the production of ribothymidine in Gram-positive and Gram-negative bacteria. They reported that, when grown on a minimal medium, *B. brevis*, *B. circulans*, *B. licheniformis*, *B. macerans* and *B. megaterium* were inhibited by the

presence of 10 µg/ml - 100 µg/ml trimethoprim.

Colistin, or polymyxin E, inhibits Gram-negative bacteria by binding to and altering the permeability of the cell membrane, followed by inhibition of DNA synthesis. Trimethoprim and colistin work in synergy to provide increased antimicrobial action against Gram-negative organisms; colistin disrupts the cell membrane, allowing trimethoprim to inhibit enzyme activity in the cell cytoplasm (Rosenblatt and Stewart, 1974). Oppenheim and Koornhof (1980) reported that TCBA allowed growth of *B. anthracis* whilst suppressing growth of *B. cereus*, *B. megaterium*, *B. subtilis* and *B. polymyxa*.

Knisely (1966) reported that on PLETA, *B. anthracis* grew whilst most other *Bacillus* species were suppressed. Some strains of *B. anthracis*, however, were also inhibited. The mode of action of the chemicals which comprise PLETA is described in Section 3.4.1 (p 84). Today, PLETA is made using the original formulation recommended by Knisely, with the exception that the lysozyme concentration is reduced to allow for the greater activity of modern lysozyme. McGetrick *et al.* (1982) compared the growth of *B. anthracis*, *B. cereus* and *B. thuringiensis* on PLETA and TCBA. They found that 12/12 strains of *B. anthracis* grew well on both media. On PLETA, 35/46 strains of *B. cereus* were suppressed compared to 1/46 strains on TCBA. PLETA also inhibited the growth of 8/8 strains of *B. thuringiensis*. On TCBA all 8 strains of *B. thuringiensis* grew. Turnbull *et al.*, (1986) compared the growth of *B. anthracis* and *B. cereus* on PLETA and TCBA in the Etosha National Park, Namibia. They found that in the laboratory TCBA was slightly preferable to PLETA, due to the faster incubation period (24 h, compared to 48 h) and the rapid dismissal of haemolytic colonies as non-*B. anthracis*. In the field, however, TCBA and

PLETA did not perform as well as BA. These tests led to the lysozyme concentration in PLETA being reduced. Prior to this modification Turnbull *et al.* (1986) reported that only 5 of 12 spore preparations and 9 of 12 of vegetative cell preparations grew on PLETA.

Yu and Washington (1981) reported that *B. anthracis* could be distinguished from *B. cereus* by growth on agar containing 0.3% phenolethanol. They reported that *B. anthracis* will grow on PEA whilst *B. cereus* is inhibited. Knisely (1965), however, reported that *B. cereus* and *B. mycoides* grew on PEA, whilst *B. anthracis* was inhibited. More recent textbooks also state that *B. anthracis* is sensitive to phenolethanol, whereas *B. cereus* is resistant (Collins and Lyne, 1995; Koneman *et al.*, 1992). Phenolethanol damages the cytoplasmic membrane of *Bacillus* species, which in *B. cereus* causes leakage of intracellular potassium ions. This alteration in the permeability of the cytoplasmic membrane subsequently affects DNA synthesis (Silva, 1976).

### **3.3.2 Aim**

The aim of the experiments described in this section was to compare the growth of *B. anthracis* on the agars described in Table 3.1

### **3.3.3 Materials and Methods**

Agars were made up according to the author's instructions (see Appendix I). A dilution of *B. anthracis* in soil was cultured on each agar using a modification of the method described in Section 2.4 (p 47). Soil ASS 91/2 (Table 3.2), chosen as a representative UK soil which contains spores of *B. anthracis*, was resuspended in

**Table 3.2 Soils used in this study**

ASS no	Place of origin	Description of the soil and site	No. of <i>B. anthracis</i> spores/g †
91/2	Landkey, Devon, UK	Heavy clay soil, from a field containing the burial site of a bull	$1 \times 10^3$
91/4			0
91/85			$< 1 \times 10^3$
91/88			$< 1 \times 10^3$
91/89			$< 5 \times 10^2$
91/90			0
93/288	Etosha National Park, Namibia	Sandy soil underneath an elephant carcass	$1 \times 10^6$
92/90	Wessex Water	Sewage processing plant (high organic content)	$1 \times 10^5$ *

\* seeded with spores of *B. anthracis* ASC 80 (1  $\mu$ l of a  $10^8$  /ml spore was added to 1 g of soil diluted in 10 ml of SDW); † As determined by serial dilution and culture on PLETA

an equal volume of SDW, and diluted 1 in 10 in SDW. The soil solution was heat shocked at 62.5 °C for 15 min and 200  $\mu$ l spread onto each agar. Plates were incubated at 37 °C overnight. Any of the resulting colonies suspected of being *B. anthracis* were subcultured onto BA and tested for their susceptibility to *B. anthracis* specific bacteriophage and penicillin as described in Section 2.4 (p 47). The number of colonies of *B. anthracis* and the growth of other bacterial species, as a percentage cover of the plate, as judged by eye was recorded.

To determine whether culture on PEA may provide a method for the selective growth of *B. anthracis*, spores (1  $\mu$ l from a  $10^9$  / ml spore suspension) of four strains

of *B. anthracis* and five strains of *B. cereus* were cultured on PEA and incubated overnight at 37 °C. The resulting growth was recorded.

### 3.3.4 RESULTS

When dilutions of soil ASS 91/2 were cultured on different selective agars, colonies of *B. anthracis* were detected on HLA, PIA, TCBA and PLETA (Table 3.3).

**Table 3.3 Comparison of the growth of *B. anthracis* on different selective agars**

Each value is the mean of duplicate experiments. Inoculum: ASS 91/2 soil.

Agar	% cover of other bacterial species *	No. of colonies of <i>B. anthracis</i>
Haematin and lysozyme (HLA)	80	30
Propamidine isethionate (PIA)	80	10
TCBA	70	2
PLETA	20	80
BA	95	0

\* An estimation of the amount of the petri dish covered in bacterial growth, as judged by eye.

No colonies of *B. anthracis* were observed on BA. On HLA, PIA and TCBA other bacterial species, and those identified as being *B. cereus*, *B. mycoides* and *B. thuringiensis* all grew equally well or better than *B. anthracis*. The highest number of colonies of *B. anthracis* and the most reduced background growth of other soil bacterial species was observed on PLETA.



### 3.3.4.1 Comparison of the growth of *B. anthracis* and *B. cereus* on PEA

Different strains of both *B. anthracis* and *B. cereus* grew on PEA, although the growth of *B. anthracis* was slightly slower (Table 3.4).

**Table 3.4 Comparison of the growth of strains of *B. anthracis* and *B. cereus* on PEA**

<i>B. anthracis</i> strain (ASC No.)	Growth on PEA *	<i>B. cereus</i> strain	Growth on PEA *
27	++	F1983/77	+++
65	++	F4562/75	+++
80	++	F4748/76	+++
192	++	F4618/75	+++
-	-	BO39	+++

Results shown are from representative experiments; \* Growth was measured on a scale of 1 - 4; + < 25% cover; ++ 25 - 50% cover; +++ 50 - 75% cover; ++++ > 75% cover.

### 3.3.5 CONCLUSIONS

These results showed that optimal recovery of *B. anthracis* and suppression of growth of other bacterial species occurred on PLETA. All strains of *B. anthracis* and *B. cereus* were found to grow on PEA. From these results, further experiments were conducted using the chemicals which comprise PLETA. In agreement with these results, Parry *et al.* (1983) also concluded that the chemicals in PLETA were the most promising for the development of a selective enrichment system for *B. anthracis*, and reported that *B. anthracis* and *B. cereus* appeared to grow equally well on PEA.

### 3.4. OPTIMISATION OF THE GROWTH OF *B. ANTHRACIS* ON PLETA

#### 3.4.1 Introduction

The reasons why the chemicals that are used in PLETA were chosen have been long forgotten (Knisely 1992, personal communication) and the mode of action which allows the selective growth of *B. anthracis* is not known.

Polymyxin B sulphate inhibits the growth of Gram-negative organisms by binding to the membrane of the cell and displacing phospholipids and lipopolysaccharide aggregates. This increases the permeability of the cell membrane and subsequently causes inhibition of biosynthetic pathways (Storm *et al.*, 1977). Lysozyme dissolves the 1 - 4  $\alpha$  glycosidic bonds between N-acetylmuramic acid (NAM) and N-acetylglycosamine (NAG) which form the peptidoglycan in the bacterial cell wall. Susceptibility to lysozyme varies between *Bacillus* species and *B. anthracis* is resistant. This resistance has been attributed to the presence of unsubstituted amino groups on the glucosamine and muramic acid residues (Zipperle *et al.*, 1984). Cell walls from lysozyme resistant strains of *B. cereus* and *B. thuringiensis* have also been shown to contain a high percentage of unsubstituted amino sugars (Zipperle *et al.*, 1984). When glucosamine residues are acetylated with acetic anhydride cell walls become sensitive to lysozyme (Kleppe *et al.*, 1981).

Lysozyme has also been shown to act on the septa between cells of *B. anthracis*, and growth in the presence of lysozyme leads to a decrease in the average number of cells per chain (Westmacott and Perkins, 1979). Modification of the peptidoglycan in cell walls by lysozyme has also been shown to promote the activation of autolysins, which in *Bacillus* species are used for cleavage of the septum

and removal of old material from the growing bacterial cell wall (Archibald *et al.*, 1993). Candeli *et al.* (1978) attempted to correlate the mol % G + C of *Bacillus* species to sensitivity to lysozyme. They reported that *Bacillus* species with an average mol % G + C of  $33.65\% \pm 0.59$ , which includes the members of the '*B. cereus* group' were resistant to lysozyme, whereas species with an average mol % G + C of  $44.2\% \pm 1.76$ , which includes *B. licheniformis* and *B. subtilis* were lysozyme sensitive.

EDTA is a chelating agent which binds preferentially to  $Mg^{2+}$  and  $Ca^{2+}$  ions that are present in cell membranes. EDTA has been shown to remove cation bridges from the outer membrane of the peptidoglycan complex of the cell wall. This allows the subsequent entry of other chemical inhibitors, for example, in Gram-negative organisms, the action of lysozyme is enhanced by the presence of EDTA (Repaske, 1958; Gray and Wilkinson, 1965; Hamilton Miller, 1966; Pellegrini *et al.*, 1992). Gray and Wilkinson (1965) reported that the pre-treatment of Gram-negative organisms with EDTA or polymyxin B sulphate rendered them sensitive to lysozyme. These observations were published at the time when PLETA was being formulated, and may explain why these chemicals were used together.

Thallos acetate (TA) is one of the few salts of rare earth metals which has an antimicrobial effect on both Gram-positive and Gram-negative bacteria. It was originally used as a fungicide, and is still used as a rodenticide in developing countries. Thallium (Tl) which is slightly more toxic to mammals than mercury (Zitko, 1975) is analogous to potassium (K), with which it shares the same charge, and a similar ionic radius ( $1.40\text{\AA}$ , compared to  $1.33\text{\AA}$ ). This allows  $Tl^+$  to use  $K^+$  transport systems (Gutknecht, 1983).

In mammalian cells Tl has been shown to alter a number of K dependent processes. Possible toxic mechanisms include ligand formation with protein sulfhydryl groups; inhibition of cellular respiration; interaction with riboflavin and riboflavin based cofactors; and disruption of calcium homeostasis (Mulkey and Oehme, 1993). In bacteria it is also likely that Tl is taken up in the same manner as K. Norris *et al.* (1976) proposed that Tl was taken up by *Escherichia coli* by spontaneous binding to the electronegative cell surface, followed by incorporation into the cell using an ion transport system, probably concerned with K uptake. Skul'skii *et al.* (1982) suggested that Tl<sup>+</sup> readily penetrates bacterial membranes, allowing it to be used in the study of the mechanism of K<sup>+</sup> transport in bacteria. The toxicity of Tl in bacteria has been attributed to its preferential binding to ligands compared to K<sup>+</sup> (Hughes and Poole, 1989).

Cases of Tl poisoning in mammals can be treated by Prussian blue (a chelating agent) or with activated charcoal, both of which interrupt the enterohepatic cycling of Tl (Mulkey and Oehme, 1993). Alternatively, potassium chloride can be used to facilitate the mobilization of tissue bound Tl (Rasmussen, 1981).

TA is also a component of GTC (gentamycin, thallos, carbonate) medium suggested for the isolation of Group D *Streptococci*. Donnelly and Hartman (1978), who formulated this medium, reported that the mechanism of action of TA was not known.

Knisely (1966) specified that only Difco Heart Infusion Agar (HIA) was suitable for use as the basal medium in PLETA. HIA is composed of an infusion from beef hearts, tryptose and sodium chloride, and is recommended for the culture of fastidious microorganisms, including pathogenic bacteria, such as *Pneumococci* and

*Meningococci*. Tryptose is composed of short chain peptides from milk and is used in HIA in preference to peptone as it is reported to be better for the cultivation of pathogenic bacteria. Peptone is a commercially available hydrolysate of casein. An alternative basal media which could be tested in PLETA is brain heart infusion agar (BHIA, Oxoid) which contains a more nutrient rich formulation of calf brain and beef heart infusion solids, peptone, glucose, sodium chloride and disodium phosphate. BHIA is also recommended for the cultivation of fastidious organisms. L-broth (LB) and NB are less nutrient rich and are recommended for cultivation of organisms less exacting in their nutritional requirements and were used in this study for comparison.

### **3.4.2 Aim**

The aim of the work described in this section was to optimise the growth of *B. anthracis* on PLETA

### **3.4.3 Materials and Methods**

#### **3.4.3.1 Comparison of the use of different basal media in PLETA**

PLETA was made using HIA, as recommended by Knisely as the basal medium, and also using BHIA, LA and NA as the basal media at the concentrations recommended by the manufacturers (see Appendix I). Agar was spread with a dilution of soil ASS 93/288 (see Table 3.2) using the method described in Section 3.3.3 (p 80). The total amount of growth and the number of colonies of *B. anthracis* was recorded.

### **3.4.3.2 The effect of the individual components of PLETA on the selective growth of *B. anthracis***

Agar was made up containing HIA or BHIA (25 g/l) as the basal medium and EDTA and TA were added individually and together at the concentrations recommended by Knisely (1966). The plates were spread with a dilution of soil ASS 92/90 (see Table 3.2) as described in Section 3.3.3. The total amount of growth, and the number of colonies of *B. anthracis* was recorded.

## **3.4.4 RESULTS**

### **3.4.4.1 The use of different basal media in PLETA**

No significant difference was observed between the number of colonies of *B. anthracis* which grew on PLETA with 25 g/l or 37 g/l of HIA, BHIA or LA as the basal medium (using the Student's t-test; see Appendix II; Table 3.5). In the presence of 25 g/l of nutrient, however, the number of non-*B. anthracis* colonies was significantly lower than in plates containing 3.7 g/l of nutrient in the basal medium ( $p < 0.001$  using a Student's t-test). These results indicated that a nutrient rich basal medium is required for optimal growth of *B. anthracis* on PLETA, and that the precise composition of the medium is less important than the overall level of nutrients present. As expected no growth of *B. anthracis* occurred on NA.

**Table 3.5. Comparison of different basal media for the selective growth of *B. anthracis* on PLETA**

Soil used = ASS 93/288

Basal medium	No. colonies of <i>B. anthracis</i>				mean	No. colonies of other <i>Bacillus</i> species				mean
HIA 25 g/l†*	29	25	35	36	32	0	0	1	2	1
HIA 37 g/l	32	9	33	28	26	27	3	50	3	8
BHIA 25 g/l	33	26	20	25	26	4	9	3	7	5
BHIA 37 g/l*	23	18	25	16	24	7	2	15	6	8
LA 25 g/l *	0	15	1	-	5	21	6	1	-	9
LA 37 g/l	0	31	15	1	12	17	12	10	3	18
NA 13 g/l *	0	0	0	0	0	0	0	0	0	0
NA 25 g/l	0	0	0	0	0	2	0	0	0	2

† Knisely's formulation of PLETA; \* Manufacturer's recommended concentration of basal medium; - = not done

#### 3.4.4.2 The effect of the individual components of PLETA on the selective growth of *B. anthracis*

The incorporation of EDTA and TA in combination led to the greatest recovery of *B. anthracis* on agar (Table 3.6). No significant difference was observed between the number of colonies of *B. anthracis* which grew on PLETA containing HIA as the basal medium compared to BHIA (using the Student's t-test). The percentage cover of other *Bacillus* species, however, was higher when BHIA was used as the basal medium compared to HIA ( $p < 0.05$  using the Student's t-test). The amount of

**Table 3.6 The effect of the different chemical components of PLETA on the growth of *B. anthracis* in soil.**

Soil used = ASS 91/90

Addition to agar	HIA (25 g/l)		BHIA (25 g/l)	
	Number of colonies <i>B. anthracis</i>	% cover other bacterial species	Number of colonies <i>B. anthracis</i>	% cover other bacterial species
0	0	100	1	100
EDTA (300 mg/l)	0	10	5	90
TA (40 mg/l)	15	30	8	100
EDTA and TA	21	30	11	95
PLET *	14	5	17	20

Results shown are from representative experiments

\* Made using the formulation described by Knisely (1966)

growth of other bacterial species was greatly reduced on PLETA compared to on HIA or BHIA alone.

### 3.4.5 CONCLUSIONS

The results of these experiments showed that for optimal growth of *B. anthracis* on agar both EDTA and TA need to be present. The use of HIA as the basal medium is preferable to the use of BHIA as it leads to reduced background growth of other bacterial species.



### **3.5 THE USE OF THE SELECTIVE GERMINATION OF SPORES IN AN ENRICHMENT SYSTEM FOR *B. ANTHRACIS***

#### **3.5.1 Introduction**

The results of previous studies into the germination of spores of *B. anthracis* and *B. cereus* indicate that differences in germination requirements of *B. anthracis* and *B. cereus* may exist. For example Hills (1949a) reported that *B. cereus* would germinate in L-alanine alone, whereas *B. anthracis* required L-alanine combined with tyrosine and adenosine. The results of some of these studies are summarised in Table 3.7. They are, however, not directly comparable, as the experiments used different strains of *Bacillus* species and were conducted under different conditions.

The selective germination of spores of *Bacillus* species other than *B. anthracis*, followed by heat killing and culture of the remaining spores could provide a method of inducing the selective growth of *B. anthracis* from a mixture of other *Bacillus* species. A study of the germination requirements of *B. anthracis* and *B. cereus* could reveal a combination of germinants which would allow the selective isolation of *B. anthracis*. Alternatively, Travers *et al.* (1987) recommended sodium acetate for the selective recovery of *B. thuringiensis* from soil. This may be of use for the selective recovery of *B. anthracis* from a mixture of '*B. cereus* group' species.

#### **3.5.2 Aim**

The aim of the work described in this section was to determine whether selective germination would allow the selective recovery of *B. anthracis* from a mixture of *B. anthracis* and *B. cereus* spores.

**Table 3.7 Reports on the induction of germination of spores of *B. anthracis* and *B. cereus***

Author	Compounds required to induce germination	
	<i>B. anthracis</i>	<i>B. cereus</i>
Hills (1949)	adenosine	ND
Hills (1949a)	L-alanine, tyrosine and adenosine	L-alanine
Powell and Hunter (1955)	inosine, adenosine, tyrosine and L-alanine	as <i>B. anthracis</i>
Lawrence (1955)	ND	L-alanine, adenosine, inosine, guanosine, xanthosine
Murty and Halvorson (1957)	ND	L-alanine and adenosine
Powell (1957)	inosine, adenosine, L-alanine, tyrosine	as <i>B. anthracis</i>
Foerster and Foster (1966)	ND	L-alanine and inosine
Warren and Gould (1966)	ND	L-alanine and inosine
Titball <i>et al.</i> (1987)	L-alanine + OCDS	ND
Senesi <i>et al.</i> (1991)	ND	L-alanine and adenosine

ND = Not done; OCDS = O-carbamyl-D-serine.

### 3.5.3 Materials and Methods

The effect of sodium acetate on the germination and growth of spores of *B. anthracis* ASC 80 and *B. cereus* F4433/73 was determined using the method of Travers *et al.*

(1987) described in Section 2.6.1 (p 49). The effect of L-alanine, inosine, adenosine and guanosine on the germination of spores of *B. anthracis* and *B. cereus* was determined using the method of Titball *et al.* (1987) described in Section 2.6.2. The concentrations of the germinants used were chosen by referring to the papers cited in Table 3.7. Loss of heat resistance was taken as an indication that spores had started to germinate (Fernelius, 1960).

### **3.5.4 RESULTS**

#### **3.5.4.1 Comparison of the growth of *B. anthracis* and *B. cereus* in the presence of sodium acetate**

After 4 h incubation in LB + sodium acetate, *B. anthracis* ASC 80 was greatly outgrown by *B. cereus* F4433/73 (Table 3.8). In samples that had been heated (to kill vegetative cells) spores of *B. cereus* also outnumbered those of *B. anthracis*. The growth of *B. anthracis* and *B. cereus* decreased with increasing sodium acetate concentration. For this reason, concentrations of sodium acetate greater than 0.5 M were not tested.

#### **3.5.4.2 Comparison of the effect of different compounds on the germination of spores of *B. anthracis* and *B. cereus***

The results of a typical germination experiment are shown in Figure 3.1. Germination occurred rapidly, within the first 5 min of incubation and was represented by a 2-log drop in the viable count of *B. anthracis* after heat shocking. Optimal germination of *B. anthracis* occurred in the presence of L-alanine and either inosine and adenosine (Table 3.9). None of the compounds tested induced germination individually.

**Table 3.8 Comparison of the growth of *B. anthracis* ASC 80 and *B. cereus***

**F4433/73 in LB containing different concentrations of sodium acetate.**

Sodium acetate concentration (M)	Unheated (CFU/ml)		Heated (CFU/ml)	
	<i>B. anthracis</i>	<i>B. cereus</i>	<i>B. anthracis</i>	<i>B. cereus</i>
0	Not detected	> 10 <sup>8</sup>	Not detected	3.5 x 10 <sup>2</sup>
0.125	Not detected	>10 <sup>6</sup>	2.0 x 10 <sup>1</sup>	1.5 x 10 <sup>2</sup>
0.25	Not detected	1.1 x 10 <sup>7</sup>	3.0 x 10 <sup>1</sup>	1.5 x 10 <sup>2</sup>
0.5	4.5 x 10 <sup>4</sup>	1.8 x 10 <sup>5</sup>	2.0 x 10 <sup>1</sup>	2.0 x 10 <sup>2</sup>

**Table 3.9 The effect of different germinants on spores of *B. anthracis* ASC 80**

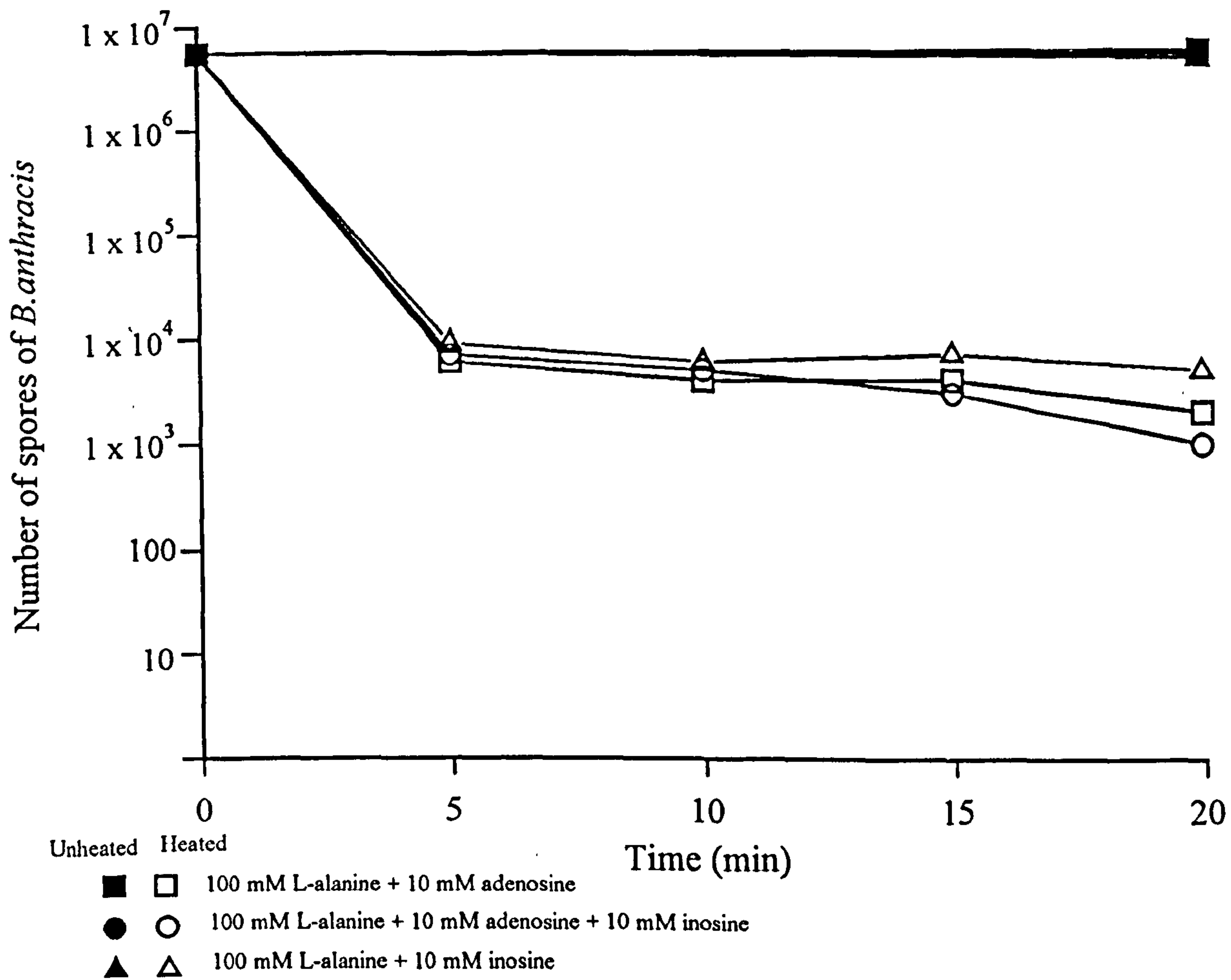
Combination of Germinants	Effect on <i>B. anthracis</i> ASC 80 spores
100 mM L-alanine, 10 mM inosine, 10 mM adenosine	+
100 mM L-alanine, 10 mM adenosine	+
100 mM L-alanine, 10 mM inosine	+
10 mM L-alanine, 10 mM inosine	+
10 mM L-alanine, 1 mM inosine	+
10 mM L-alanine, 0.1 mM inosine	+
10 mM L-alanine, 0.1 mM adenosine	+
20 mM adenosine	-
1 mM inosine	-
10 mM L- alanine	-
SDW	-

+ germination occurred; - no germination occurred; Germination was represented by a

2 log drop in the heated count of *B. anthracis* (see Fig. 3.1)

**Figure 3.1**

The effect of L-alanine, adenosine and inosine on spores of *B. anthracis* ASC 80



Spores ( $5.5 \times 10^6$ ) were added to 1 ml volumes of different germination compounds in 1.5 ml tubes. At 5 min intervals a sample was removed from each tube, heated to 62.5 °C for 10 min and the number of remaining spores counted. After 20 min unheated (total) and heated (spore only) counts were done.

When parallel experiments were carried out using spores of *B. anthracis* ASC 80 and *B. cereus* F4433/73 (Table 3.10) results showed that differences in the germination requirements of spores of *B. anthracis* and *B. cereus* were not readily identified.

**Table 3.10 Comparison of the germination of spores of *B. anthracis* ASC 80 and *B. cereus* F4433/73 in various germination inducing compounds**

Germination compound	Effect on spores	
	<i>B. anthracis</i>	<i>B. cereus</i>
100 mM L-alanine 10 mM inosine	+	+
10 mM L-alanine, 1 mM inosine	+	+
10 mM L-alanine	-	-
10 mM l-alanine, 10 mM guanosine	-	-
20 mM adenosine	-	-
2 mM inosine	-	-
1 mM inosine	-	-

+ = germination occurred; - = no germination occurred

### 3.5.5 CONCLUSIONS

These results showed that the use of commonly available germination compounds did not lead to the selective germination of spores of *B. anthracis* ASC 80 or *B. cereus* F4433/73. From these results it appeared that the possibility of identifying a compound which would allow the selective germination of *B. anthracis* or *B. cereus* was unlikely, hence further experiments of a similar nature were not conducted.

## **3.6 THE DEVELOPMENT OF A SELECTIVE ENRICHMENT BROTH FOR *B. ANTHRACIS***

### **3.6.1 Introduction**

'Ad hoc' attempts at developing a selective enrichment system for *B. anthracis* have been unsuccessful. Turnbull *et al.* (1986) use trimethoprim, colistin and fresh zebra blood in BHIB as a selective broth. This was ineffective due to the overgrowth of other *Bacillus* species. Carman *et al.* (1985) noted that *B. anthracis* grew well in blood and most other soil organisms were suppressed. They subsequently used fresh blood as a selective medium for *B. anthracis*. This was, however, no more effective than culture on PLETA. Further work describing the development of a selective enrichment broth for *B. anthracis* has, to date, not been published.

### **3.6.2 Aim**

The aim of the work described in this section was to develop an enrichment broth for the selective growth of *B. anthracis* from a mixture of *B. anthracis* and *B. cereus*, using the agents recommended for the selective growth of *B. anthracis* on agar described in Table 3.1 (p 78).

### **3.6.3 Materials and Methods**

#### **3.6.3.1 Comparison of the growth of *B. anthracis* and *B. cereus* in BHIB**

BHIB (10 ml) was inoculated with 1-10  $\mu$ l of a spore suspension containing  $1 \times 10^9$  spores of *B. anthracis*/ml, and 1-10  $\mu$ l of a spore suspension containing  $1 \times 10^9$  spores of *B. cereus* F4433/73/ml, to give an initial concentration of approximately

$1 \times 10^5$  -  $1 \times 10^6$  spores of each of *B. anthracis* and *B. cereus* per ml of broth. BHIB was incubated at 37 °C. Samples were taken at appropriate intervals and the number of colonies of *B. anthracis* and *B. cereus* was counted using the method described in Section 2.3 (p 46).

### **3.6.3.2 The detection of *B. anthracis* and other *Bacillus* species in blood**

Soil ASS 91/2 (0.3 g: see Table 3.2) was added to 2 ml of sterile defibrinated horse blood and incubated for 6 h at 37 °C. Samples (1 µl) were taken at 2 h intervals, stained and examined microscopically using the method described in Section 2.4.2 (p 48). Samples (1 µl) were also cultured for 48 h at 37 °C on PLETA.

### **3.6.3.3 Comparison of the growth of *B. anthracis* and *B. cereus* in broth containing the selective agents described in Table 3.1**

Selective broths (10 ml) were made up containing haematin, propamidine isethionate (PI), trimethoprim and phenolethanol (PEA). Haematin was dissolved in SDW and added to BHIB to final concentrations of 50 - 500 µg/ml. PI was dissolved in nutrient broth (NB) and added to BHIB to final concentrations of 40 - 240 µg/ml.

Trimethoprim was dissolved in DMSO to a concentration of 40 mg/ml and added to BHIB to give final concentrations of 50 - 500 µg/ml. PEA was added directly to NB to give final concentrations ranging from 0.1 - 1.0%. Broths were seeded with 1 µl of a  $1 \times 10^8$  spore/ml suspension of *B. anthracis* ASC 80 and 1 µl of a  $1 \times 10^8$  spores/ml of *B. cereus* F4433/73 and were incubated at 37 °C overnight. A sample (1 µl) was then removed and cultured overnight at 37 °C on BA. The amount of growth was



measured on a scale of 1 - 4 and the proportion of growth which was *B. anthracis* was recorded.

### 3.6.4 RESULTS

When *B. anthracis* and *B. cereus* were cultured in BHIB, *B. anthracis* was rapidly outgrown by *B. cereus* by approximately 3 - 10 fold (Table 3.11). Similar results were observed when *B. anthracis* and *B. cereus* were grown in LB in the presence of sodium acetate (Table 3.8; p 94).

**Table 3.11 Comparison of the growth of *B. anthracis* ASC 80 and *B. cereus* F4433/73 in BHIB**

	Number of hours after inoculation				
	0	2	4	6	24
<i>B. anthracis</i>	$1.0 \times 10^6$	$1.5 \times 10^6$	ND	ND	$5.0 \times 10^7$
<i>B. cereus</i>	$1.5 \times 10^6$	$1.4 \times 10^7$	$1.5 \times 10^7$	$2.5 \times 10^8$	$1.7 \times 10^8$
<i>B. anthracis</i>	$1.5 \times 10^5$	-	-	$1.0 \times 10^7$	$5.0 \times 10^8$
<i>B. cereus</i>	$2.0 \times 10^5$	-	-	$2.0 \times 10^7$	$2.5 \times 10^9$
<i>B. anthracis</i>	$2.0 \times 10^5$	-	-	ND	ND
<i>B. cereus</i>	$3.0 \times 10^5$	-	-	$3.5 \times 10^8$	$6.0 \times 10^8$

Results shown are from 3 representative experiments

ND not detected; - not done.

### 3.6.4.1 The detection of *B. anthracis* in soil after enrichment in blood

Capsulated *B. anthracis* was detected microscopically after 6 h incubation in blood.

*B. anthracis* was not detected, however, when an equivalent sample was cultured on PLETA (Table 3.12).

**Table 3.12 Identification of *B. anthracis* in blood by M'Fadyean reaction and culture on PLETA**

Number of hours incubation	Detection of <i>B. anthracis</i>	
	microscopic examination	culture on PLETA
0	-	-
2	-	-
4	-	-
6	+	-

+ *B. anthracis* detected; - *B. anthracis* not detected.

### 3.6.4.2 The recovery of *B. anthracis* in broths containing the selective agents described in Table 3.1

When *B. anthracis* ASC 80 and *B. cereus* F4433/73 were grown in the presence of PI, trimethoprim or haematin, 95 - 100% of the resulting growth was *B. cereus* (results not shown). In NB containing 0.5 - 1.0% PEA, however, the proportion of growth of *B. anthracis* and *B. cereus* was more equal. Results remained variable and

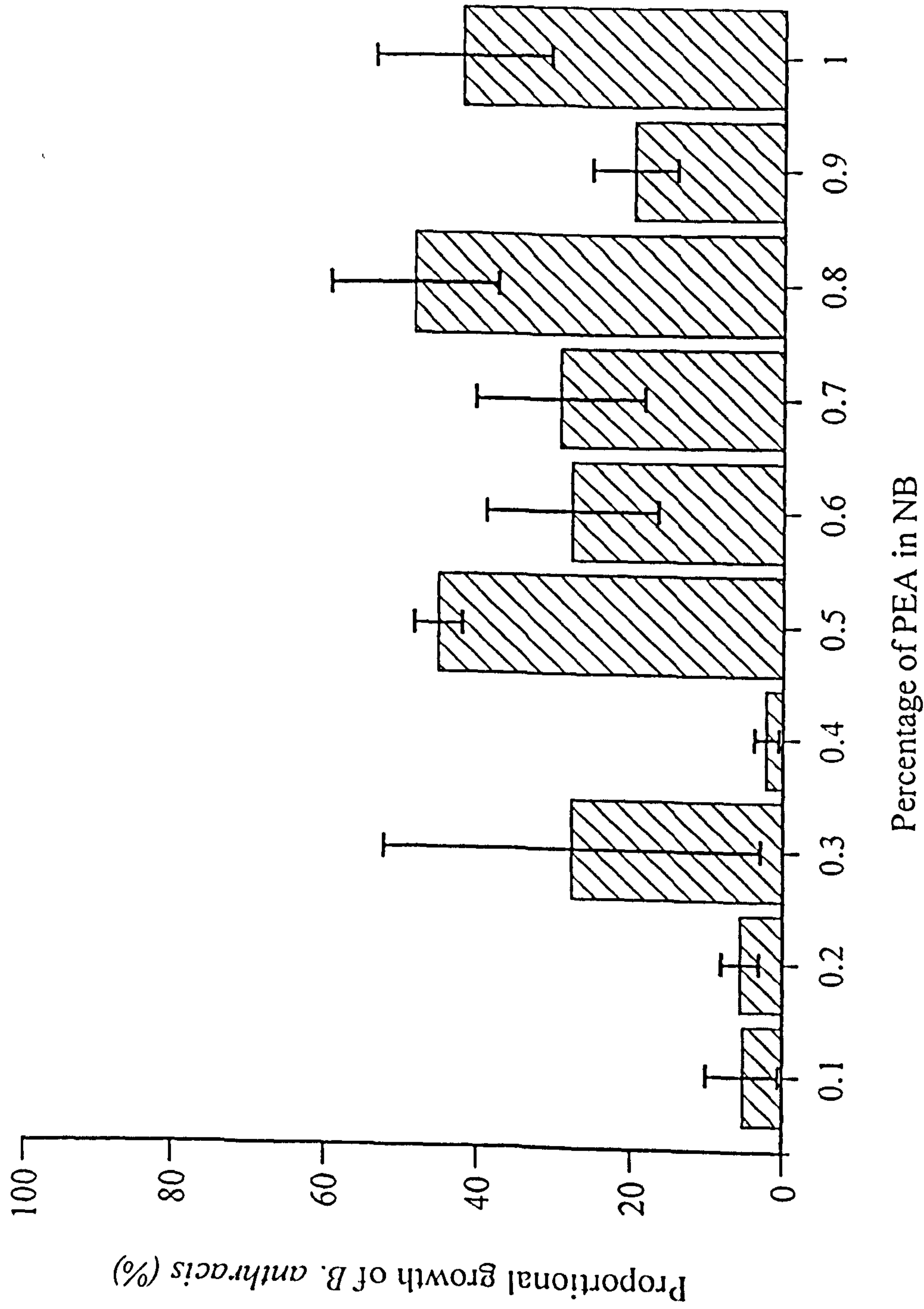
generally the growth of *B. cereus* was greater than that of *B. anthracis* (Fig. 3.2). No obvious relationship was observed between concentration of PEA and selective recovery of *B. anthracis*.

When the mixture of *B. anthracis* and *B. cereus* spores were cultured in BHIB containing the chemicals which comprise PLETA, 50 - 95% of the resulting growth was *B. anthracis* (data not shown).

### 3.6.5 CONCLUSIONS

The overgrowth of *B. anthracis* by *B. cereus* in BHIB showed why a selective enrichment system for *B. anthracis* is required. The use of blood as a pre-enrichment medium allowed the microscopic identification of *B. anthracis* by observation of the characteristic pink capsule. When cultured on PLETA after pre-enrichment in blood, however, recovery of *B. anthracis* was lower than by direct culture on agar. The results of this study confirm those of Carman *et al.* (1985) indicating that blood is unsuitable for use as a selective medium for the detection of *B. anthracis* without also using microscopic examination. The chemicals recommended for use in the selective agars described in Table 3.1, with the exception of those contained in PLETA, did not allow the selective recovery of *B. anthracis* in broth culture. These results are consistent with those observed using selective agars containing the same compounds (see Table 3.3). From these results, further experiments were carried out using broth containing the chemicals which comprise PLETA.

Figure 3.2 The proportional growth of *B. anthracis* in NB containing 0.1-1.0% PEA from a mixture of *B. anthracis* ASC 80 and *B. cereus* F4433/73



PEA was added to NB (10 ml) which was seeded with spores of *B. anthracis* ASC 80 and *B. cereus* F4433/73 to give a final concentration of  $10^4$  spores/ml of each. Broths were incubated at  $37^\circ\text{C}$  overnight. Samples (1  $\mu\text{l}$ ) were taken and cultured overnight on BA. The proportion of the resulting growth which was *B. anthracis* was recorded. Results are the mean of 4 experiments. Error bars represent the standard error of the mean

## 3.7 OPTIMISATION OF THE RECOVERY OF *B. ANTHRACIS* IN PLETB

### 3.7.1 Aim

The aim of the work presented in this section was to optimise the recovery of *B. anthracis* in PLETB from a mixture of *B. anthracis* and *B. cereus*.

### 3.7.2 Materials and Methods

PLETB was made up in universal bottles containing either HIB and BHIB as the basal medium. Broths (10 ml) were inoculated with 1 µl of a suspension of spores of *B. anthracis* ASC 80 containing  $10^8$  spores/ml and an 1 µl of a suspension of spores of *B. cereus* F4433/73 containing  $10^8$  spores/ml to give an initial concentration of  $10^4$  spores of *B. anthracis* and  $10^4$  spores of *B. cereus* per ml of broth. Broths were incubated statically at 37 °C overnight. The upper 9.5 ml of broth was removed and 1 µl of the growth adhering to the bottom of the bottle subcultured onto BA which was incubated at 37 °C overnight. The total resulting growth was recorded on a scale of 1 - 4, and the growth of each species was recorded as a percentage of this total. To determine the effect of lysozyme, EDTA and TA on the selective growth of *B. anthracis* in broth, increasing concentrations of each chemical were added to BHIB which was seeded with *B. anthracis* and *B. cereus* and sampled as described above.

To determine whether EDTA or TA affected the germination of spores of *B. anthracis* and *B. cereus*, EDTA or TA were added 1, 2 and 5 h after the broth had been inoculated and incubated at 37 °C.

To compare the growth of spores and vegetative cells of *B. anthracis* and *B. cereus* in PLETB, vegetative cells of different strains of *B. anthracis* and *B. cereus*

were inoculated into PLETB, at the same density as spores of *B. anthracis* and *B. cereus*. PLETB was incubated and sampled as described above.

To optimise the recovery of *B. anthracis* from a mixture of spores of *B. anthracis* ASC 80 and *B. cereus* F4433/73 in PLETB, the pH and incubation temperature of PLETB was varied. The pH was adjusted to cover a range from pH 6.8 to pH 8.0, and PLETB was incubated overnight at temperatures of 28 °C to 43 °C. PLETB was seeded, cultured and the resulting growth sampled as described above.

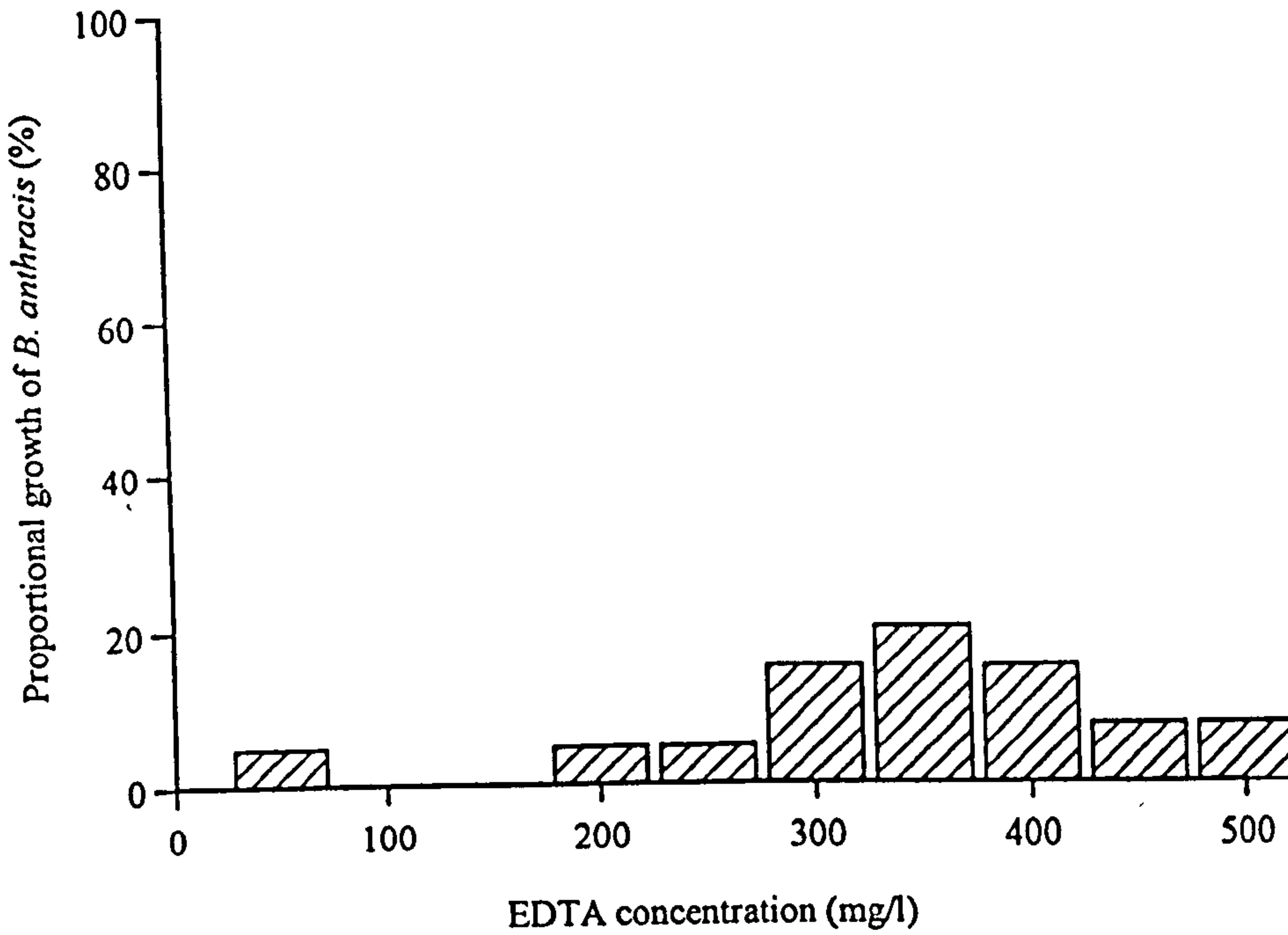
### 3.7.3 RESULTS

#### 3.7.3.1 Optimisation of the growth of *B. anthracis* in PLETB

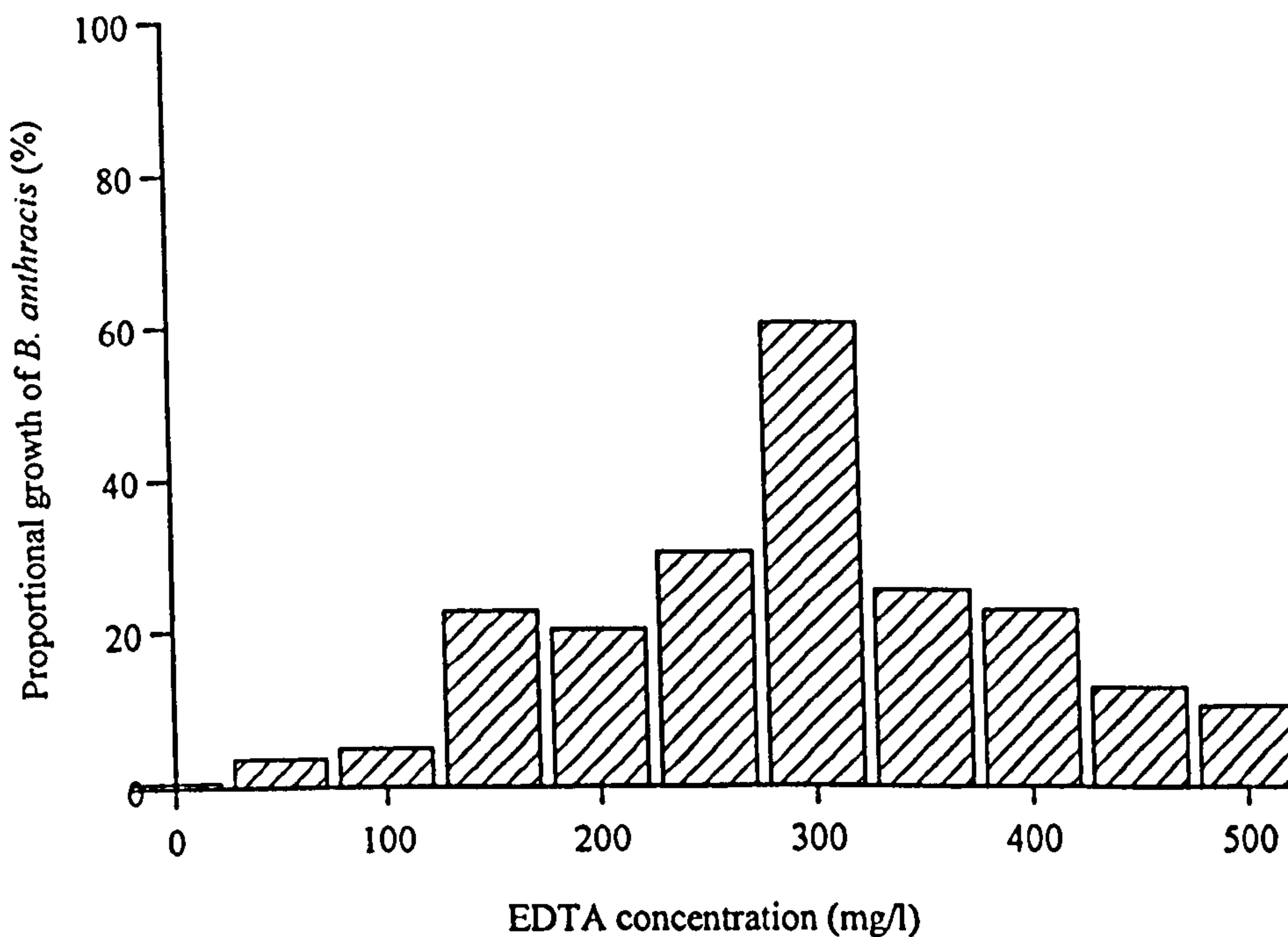
When BHIB was used as the basal medium for PLETB, sufficient growth of *B. anthracis* occurred after 24 h incubation at 37 °C, compared to 48 h which was required when HIB was used (results not shown). When EDTA was added to BHIB, an increase in the proportion of *B. anthracis* was observed compared with *B. cereus* at a concentration of 300 mg/l (Fig. 3.3; upper graph). At EDTA concentrations of greater than 350 mg/l, a reduction in the total amount of growth of *B. anthracis* and *B. cereus* was observed.

The addition of TA alone to BHIB resulted in growth consisting of 95 - 100% *B. cereus* (Fig 3.3; lower graph). When 40 mg/l TA, as recommended by Knisely (1966), was added to BHIB, the optimal growth of *B. anthracis* occurred when 300 mg/l EDTA was added to the broth (Fig 3.3; lower graph). The EDTA concentration was subsequently left constant at 300 mg/l and the effect of different concentrations of lysozyme and TA on the recovery of *B. anthracis* was determined (Fig. 3.4). Some variation in the growth of *B. anthracis* and *B. cereus* were observed

**Figure 3.3** The effect of EDTA on the recovery of *B. anthracis* from a mixture of *B. anthracis* ASC 80 and *B. cereus* F4433/73 in BHIB

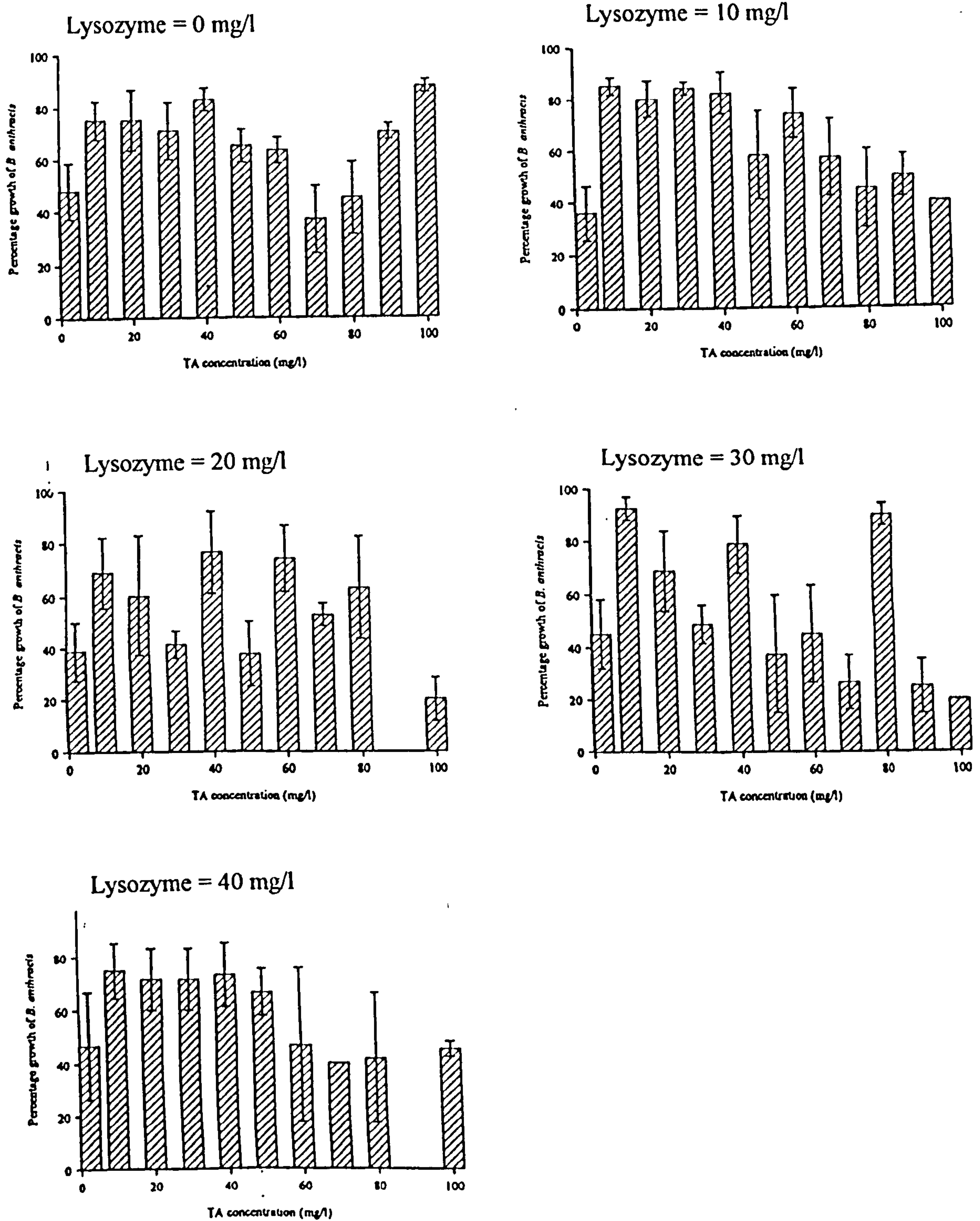


The effect of EDTA on the recovery of *B. anthracis* from a mixture of *B. anthracis* ASC 80 and *B. cereus* F4433/73 in BHIB (TA = 40 mg/l)



EDTA (50-100 mg/l) was added to BHIB (top graph) or BHIB containing 40 mg/l TA (lower graph). The broths were seeded with  $10^4$  spores/ml of *B. anthracis* ASC 80 and *B. cereus* F4433/73 and incubated overnight at 37 °C. Samples (1  $\mu$ l) were taken and cultured overnight on BA. The percentage of *B. anthracis* colonies was recorded. Results are from representative experiments

**Figure 3.4** The effect of increasing the lysozyme and TA concentration on the selective recovery of *B. anthracis* from a mixture of *B. anthracis* ASC 80 and *B. cereus* F4433/73 in BHIB containing polymyxin B sulphate (30 000 units/l) and EDTA (300 mg/l)



Lysozyme (500 000 - 2 000 000 units/l) and TA (10 - 100 mg/l) was added to BHIB containing polymyxin B sulphate (30 000 units/l) and EDTA (300 mg/l). The broths were inoculated with  $10^4$  spores/ml of *B. anthracis* ASC 80 and *B. cereus* F4433/73 and incubated at 37 °C overnight. Samples (1  $\mu$ l) were taken and cultured on BA at 37 °C overnight. The percentage of colonies of *B. anthracis* was recorded. Experiments were conducted in triplicate. Error bars represent the standard error of the mean.



between triplicate experiments. At TA concentrations ranging from 10 - 40 mg/l, 45% - 95% of the resulting growth was *B. anthracis*. In the absence of TA, the proportion of *B. anthracis* was approximately 25% lower than in the presence of 10 mg/l TA. As the lysozyme concentration was increased to cover a range similar to that recommended by Knisely (1966) a reduction in the average overall growth in the broth from 66% to 58% was observed. A concentration of 5 - 10 mg/l (250 000 - 500 000 units/l) lysozyme was found to be optimal.

When EDTA was present before inoculation of the broth with spores, and TA was added after broth had been incubated at 37 °C for 1 - 5 h, 15% - 85% of the resulting growth was *B. anthracis* (Fig. 3.5; upper graph). When TA was added before inoculation and EDTA added after a time interval, no selective growth of *B. anthracis* occurred (Fig. 3.5; lower graph). Recovery of *B. anthracis* was therefore dependent on the presence of EDTA in the broth.

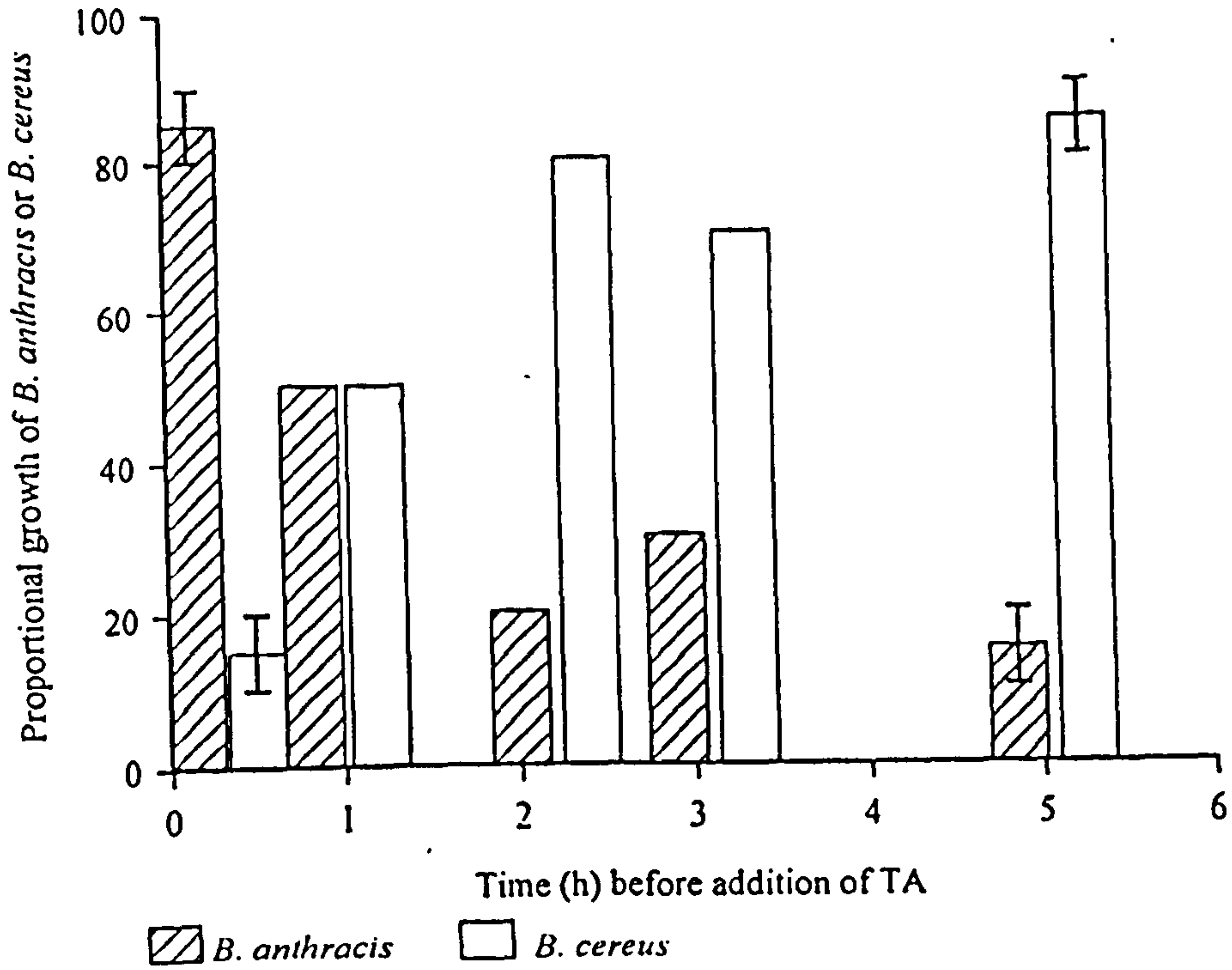
### **3.7.3.2 Comparison of growth of spores and vegetative cells of *B. anthracis* in PLETB**

When PLETB was inoculated with a suspension of vegetative cells of *B. anthracis* and *B. cereus* instead of spores 70 - 100% of the resulting growth comprised *B. anthracis* (Table 3.13).

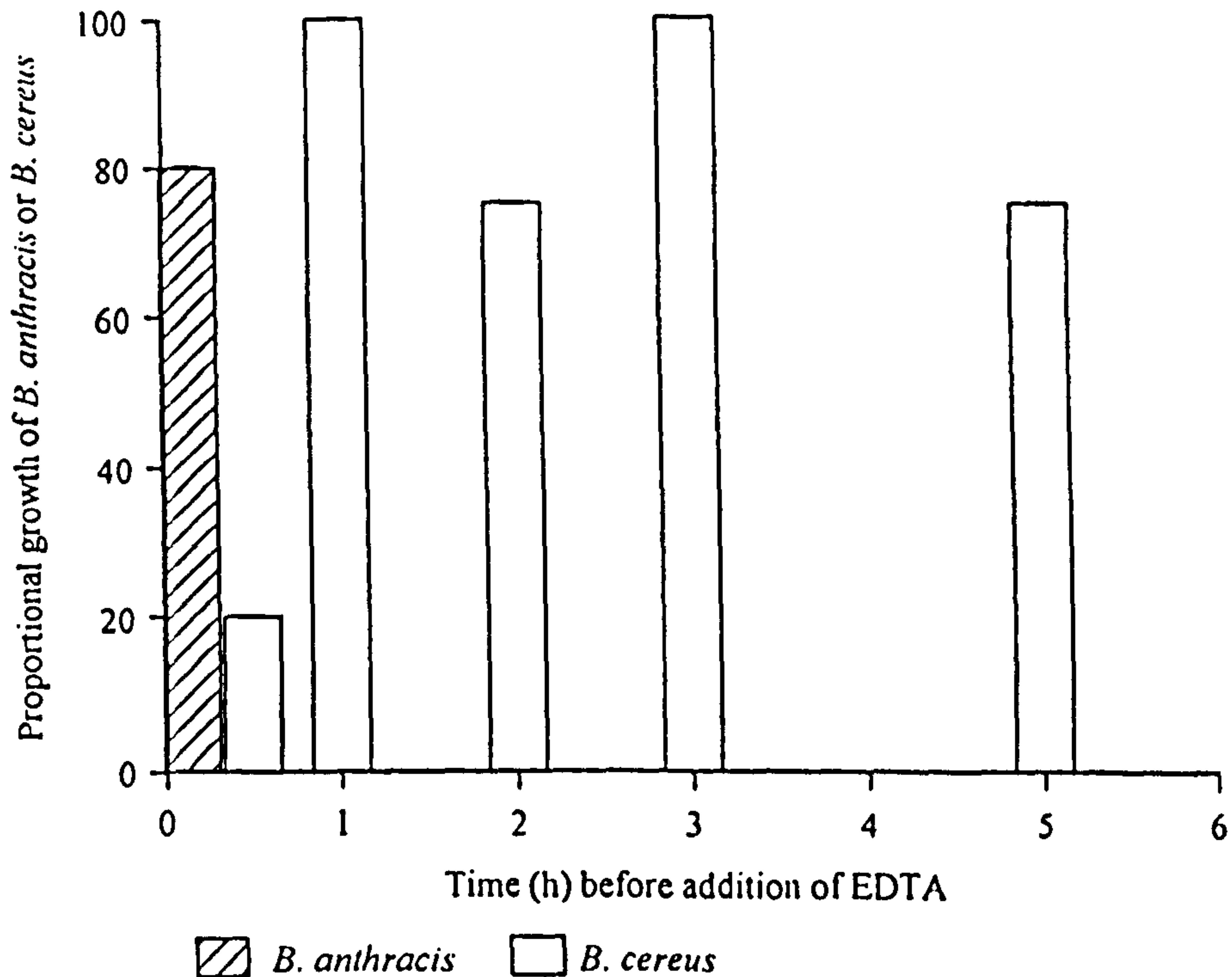
### **3.7.3.3 The effect of pH on the growth of *B. anthracis* in PLETB.**

Optimal recovery of *B. anthracis* was obtained when the initial pH of PLETB was between pH 7.4 and pH 8.0 (Table 3.14).

Figure 3.5 The effect of the addition of TA to broth 0-5 h after inoculation on the recovery of *B. anthracis* from a mixture of *B. anthracis* ASC 80 and *B. cereus* F4433/73



The effect of the addition of EDTA to broth 0-5 h after inoculation on the recovery of *B. anthracis* from a mixture of *B. anthracis* ASC 80 and *B. cereus* F4433/73



EDTA (300 mg/l; top graph) and TA (40 mg/l; lower graph) was added to BHIB containing polymyxin B sulphate (30 000 units/l) lysozyme (500 000 units/l) and either TA (40 mg/l; top graph) or EDTA (300 mg/l, lower graph) 0-5 h after the broths were inoculated with  $10^4$  spores/ml of *B. anthracis* ASC 80 and *B. cereus* F4433/73 and incubated at 37 °C. Incubation of the broths was continued overnight. Samples (1  $\mu$ l) were taken and cultured on BA at 37 °C overnight. The percentage of colonies of *B. anthracis* was recorded. Experiments were conducted in duplicate. Error bars represent the standard error of the mean.

**Table 3.13 Comparison of the growth of spores and vegetative cells of *B. anthracis* and *B. cereus* in PLETB**

Combination of strains used		Proportional growth of <i>B. anthracis</i> (%)	
<i>B. anthracis</i>	<i>B. cereus</i>	Inoculum: spores	Inoculum: vegetative cells
ASC 80	F4433/73	70	85
ASC 192	F4433/73	90	70
ASC 192	F4748/76	100	80
ASC 192	NCTC 09680 *	70	100

Results are from a representative experiment; \* *B. mycoides*

**Table 3.14 The effect of pH on the growth of *B. anthracis* ASC 80 in PLETB.**

pH of PLETB	Growth of <i>B. anthracis</i> (%)
6.8	5.0
7.0	60
7.2	65
7.4 *	95
7.6	95
7.8	95
8.0	95

Results are from representative experiments; \* the unadjusted pH of PLETB

#### **3.7.3.4 The effect of temperature on the growth of *B. anthracis* in PLETB**

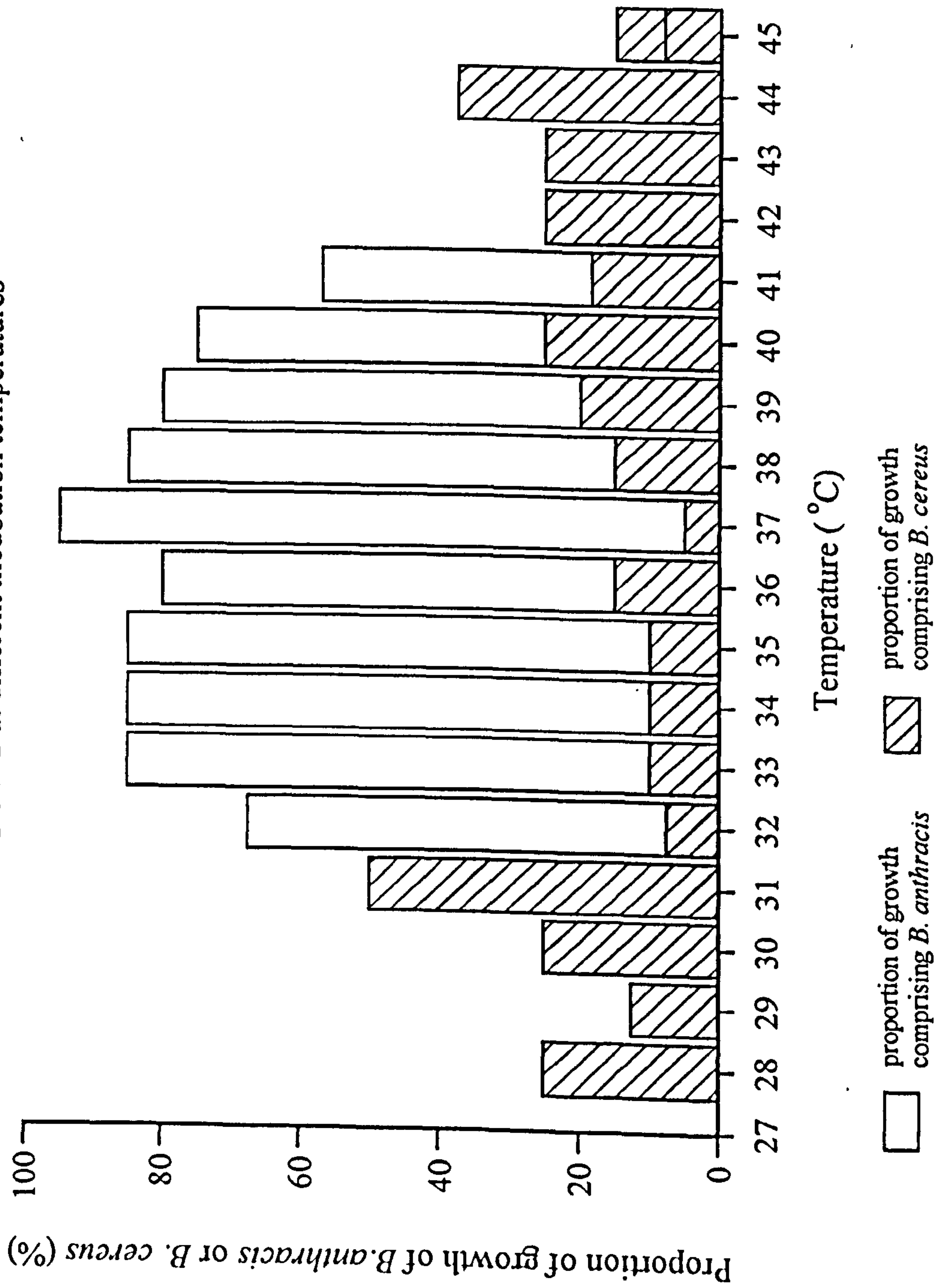
Maximum growth of *B. anthracis* was observed between 33 °C and 38 °C (Fig. 3.6).

Below 31 °C and above 40 °C the total amount of growth of *B. anthracis* and *B. cereus* and the selective growth of *B. anthracis* were reduced.

#### **3.7.4 CONCLUSIONS**

The results of the experiments described in this section showed that the concentrations of the chemicals used in PLETA, allowing for the increased activity of modern lysozyme, were also optimal for the selective detection of *B. anthracis* from a mixture of *B. anthracis* and *B. cereus* in broth. The use of more nutrient rich BHIB as the basal medium, however, was an improvement on using HIB due to the more rapid growth of *B. anthracis* observed in BHIB. The addition of EDTA or TA at intervals after inoculation of the broth showed that EDTA was essential for the selective recovery of *B. anthracis*. EDTA and TA in combination, however, led to increased recovery of *B. anthracis*. Results also showed that adjusting the pH of PLETB, or the incubation temperature did not improve the selective recovery of *B. anthracis*. Sterne (1959) also reported that *B. anthracis* grew at temperatures between 12 - 44 °C, and grew optimally between 35 - 37 °C. Optimal growth at 37 °C is consistent with growth of *B. anthracis* in its natural mammalian host. PLETB was also found to be equally effective for the selective recovery of spores and vegetative cells of *B. anthracis*, indicating that the selective action of PLETB was not linked to spore germination. From these results, the formulation of PLETB used for further experiments was 30 000 units/l polymyxin B sulphate, 250 000 units/l lysozyme, 300 mg/l EDTA and 40 mg/l TA in BHIB.

**Figure 3.6** Comparison of the growth of *B. anthracis* ASC 80 and *B. cereus* F4433/73 in PLETB at different incubation temperatures



PLETB (10 ml) containing polymyxin B sulphate (30 000 units/l) lysozyme (250 000 units/l) EDTA (300 mg/l) and TA (40 mg/l) was seeded with spores of *B. anthracis* ASC 80 and *B. cereus* F4433/73 to an initial concentration of  $10^4$  spores of each /ml. The broths were incubated overnight at 28 - 45 °C. A sample (1 µl) were taken and cultured overnight on BA. The proportion of the resulting growth which was *B. anthracis* and was recorded. Results are from representative experiments

### 3.8 THE SUBSTITUTION OF THALLIUM IONS WITH POTASSIUM IONS, AND THE EVALUATION OF DIFFERENT CHELATING AGENTS IN PLETB.

#### 3.8.1 Introduction

One of the disadvantages of using PLETA is the toxicity of TA, and the generation of Tl containing waste. In clinical studies it has been found that Tl and potassium (K) can share the same ion transport system (Kashket, 1979) and have similar ionic radii (see Section 3.4.1; p 85). Potassium counteracts the toxic action of Tl poisoning in mammals, and promotes renal excretion of the metal (Berman, 1980). Norris *et al.* (1976) studied the toxicity and accumulation of Tl in *B. megaterium*, *Escherichia coli* and *Saccharomyces cerevisiae*. They reported that increasing the potassium content of the medium alleviated inhibition caused by thallium sulphate. The substitution of potassium acetate (KA) for TA in PLETB could decrease the toxicity of the medium, and reduce the production of Tl containing waste products. It could also provide information about the mechanism by which TA improves the growth of *B. anthracis* in PLETB.

Chelating agents will generally bind to a range of metal ions. Different chelating agents do, however, have varying affinities for metal ions. EDTA, for example preferentially binds to  $Mg^{2+}$  and  $Ca^{2+}$  ions but will also form complexes with  $Cu^{2+}$  and  $Fe^{3+}$ . EGTA has been shown to complex preferentially with  $Ca^{2+}$  ions, and EDDA and 1,10-phenanthroline have a high affinity for ferrous ions. Chelex 100 is a chelating ion exchange resin which has a preference for  $Cu^{2+}$ ,  $Pb^{2+}$ ,  $Fe^{3+}$  and  $Al^{3+}$  (Biorad Technical Bulletin). The substitution of other chelating agents for the EDTA

in PLETB could improve the selective growth of *B. anthracis*, or may provide information regarding the mechanism by which selective enrichment of *B. anthracis* in PLETB occurs.

### 3.8.2 Aim

The aim of the work described in this section was to determine whether the selective action of PLETB could be improved using KA instead of TA or by using different chelating agents.

### 3.8.3 Materials and Methods

A solution of KA (0.1 M) was added to BHIB to give a  $K^+$  concentration that was equimolar to that of  $Tl^+$  used in PLETB. The other components of PLETB were added, and the broths seeded with the mixture of spores of *B. anthracis* ASC 80 and *B. cereus* F4433/73. Broths were cultured and sampled as described in section 3.7.2

PLETB was made up substituting 300 mg/l EGTA or EDDA for EDTA and seeded with the mixture of spores as described in section 3.7.2. A range of concentrations of 10 mM 1, 10-phenanthroline and Chelex were added to the broth. These were chosen from those used in other protocols (Oram and Reiter, 1968).

### 3.8.4 RESULTS

Selective growth of *B. anthracis* occurred in the presence of KA, however greater selective recovery of *B. anthracis* was observed when TA was used ( $p < 0.002$ , using the Student's t-test; Table 3.15). Selective recovery of *B. anthracis* was also found to occur in the presence of EDTA alone.

The only chelating agent which led to the selective recovery of *B. anthracis* was EDTA. (Table 3.16, Table 3.17).

**Table 3.15** Effect of TA and KA on the growth of *B. anthracis* from a mixture of *B. anthracis* ASC 80 and *B. cereus* F4433/73 in BHIB

Addition to BHIB *	% recovery of <i>B. anthracis</i> †	Number of repeats
0	0 ± 0.2	8
EDTA	60 ± 1.3	4
P,L,EDTA	70 ± 3.4	6
P,L, EDTA, KA	75 ± 3.3	13
P, L, EDTA, TA	90 ± 4.0	11

\* P = polymyxin B sulphate (30 000 units/l); L = lysozyme (250 000 units/l) ; EDTA (300 mg/l); KA = potassium acetate (40 mg/l); TA = thallos acetate (40 mg/l);

† Growth of *B. anthracis* ± the standard error of the mean

**Table 3.16** The effect of EGTA, EDDA or EDTA on the growth of *B. anthracis* from a mixture of *B. anthracis* ASC 80 and *B. cereus* F4433/73 in PLETB

Addition to PLETB (300 mg/l)	Ions chelated	Percentage growth of <i>B. anthracis</i>
EDTA	Mg <sup>2+</sup> , Ca <sup>2+</sup>	80
EGTA	Ca <sup>2+</sup>	0
EDDA	Fe <sup>2+</sup> , Fe <sup>3+</sup>	0

Results are from a representative experiment



**Table 3.17** Growth of *B. anthracis* from a mixture of *B. anthracis* ASC 80 and *B. cereus* F4433/73 when other chelating agents are substituted for EDTA in PLETB

EGTA mg/l	% growth of <i>B. anthracis</i>	Chelex (%)	% growth of <i>B. anthracis</i>	1, 10-phenanthroline	% growth of <i>B. anthracis</i>
300	0	0.5	1	10 µM	0
400	1	1	1	5 mM	0
500	5	2	1	1.0 mM	0
600	10	3	1	-	-
700	10	4	-	-	-
800	10	5	1	-	-
900	1	-	-	-	-
1000	1	-	-	-	-
1100	0	-	-	-	-
1200	0	-	-	-	-
+C *	95	+C *	60	+C *	70

Broths contained polymyxin B sulphate (30 000 units/l) lysozyme (250 000 units/l) and TA (40 mg/l); Results are from a representative experiment;

\* + C = control, 300 mg/l EDTA in PLETB; - = not done

### 3.8.5 CONCLUSIONS

The results of these experiments showed that although selective recovery of *B. anthracis* was observed in broth containing KA instead of TA, the use of TA led to greater recovery of *B. anthracis*. Results also showed that it is likely to be the

specific chelating activity of EDTA which allows the selective detection of *B. anthracis* in PLETB. From these results no further alterations of the chemical composition of PLETB were made.

### **3.9 THE RECOVERY OF DIFFERENT STRAINS OF *B. ANTHRACIS* AND *B. CEREUS* IN PLETB.**

#### **3.9.1 Introduction**

The results of the previous sections showed that PLETB containing the concentrations of chemicals recommended by Knisely (1966) allowed optimal recovery of *B. anthracis* from a mixture of *B. anthracis* ASC 80 and *B. cereus* F4433/73. To determine whether the growth of *B. anthracis* in PLETB varies with the combination of strains of *B. anthracis* and *B. cereus* tested, it was necessary to examine the recovery of *B. anthracis* from mixtures containing different strains of *B. anthracis* and *B. cereus* in PLETB.

#### **3.9.2 Aim**

The aim of the work described in this section was to evaluate the recovery of a range of different strains of *B. anthracis* and *B. cereus* in PLETB.

#### **3.9.3 Materials and Methods**

Combinations of spores from different strains of *B. anthracis* and *B. cereus* were inoculated into PLETB which was incubated and the resulting growth sampled as described in Section 3.7.2 (p 103).

#### **3.9.4 RESULTS**

The recovery of different strains of *B. anthracis* in PLETB varied from 30% - 95%. Growth of *B. anthracis*, however, remained readily detectable (Table 3.18).

**Table 3.18 The recovery of combinations of strains of *B. anthracis* and *B. cereus* in PLETB**

Mean of duplicate experiments

Strains of <i>B. cereus</i>	Percentage recovery of <i>B. anthracis</i>				
	ASC 27	ASC 80	ASC 187	ASC 189	ASC 192
F4433/73	30	70	70	45	55
F4562/75	65	55	85	70	95
F4748/76	80	65	95	75	30
F4618/75	90	90	65	100	95
B039	85	90	95	80	90

No particular trend in growth was observed, although mixing with *B. cereus* strains F4618/75 and B039 did allow greater recovery of all strains of *B. anthracis* tested.

### 3.9.5 CONCLUSIONS

These results showed that PLETB allows the selective recovery of a range of different strains of *B. anthracis* when mixed with different strains of *B. cereus*. None of the strains of *B. cereus* tested prevented the selective recovery of *B. anthracis* in PLETB. *B. cereus* strain F4433/73, used for the majority of experiments in this study, was found to produce slightly lower recovery of *B. anthracis* than the other strains tested.

### 3.10 THE USE OF ANTIBIOTICS IN THE DEVELOPMENT OF A SELECTIVE ENRICHMENT SYSTEM FOR *B. ANTHRACIS*

#### 3.10.1 Introduction

*B. anthracis* can be distinguished from other members of the '*B. cereus* group' by its sensitivity to penicillin. Unlike *B. cereus*, *B. anthracis* generally does not produce a broad spectrum  $\beta$ -lactamase. Lightfoot *et al.* (1990) detected  $\beta$ -lactamase in two of 70 strains of *B. anthracis* and found that  $\beta$ -lactamase could be induced in a further three strains. Finding an antibiotic to which *B. anthracis* is resistant, and other '*B. cereus* group' species are sensitive would aid the development of a selective enrichment system for *B. anthracis*. Until recently, the clinical significance of *Bacillus* species had not been recognised (Wong and Dolan, 1992) hence, relatively little information is available about the antibiotic susceptibilities of different *Bacillus* species.

In 1990, Lightfoot *et al.* also tested the antimicrobial susceptibilities of 70 isolates of *B. anthracis* to nine antimicrobial agents. Their results showed that 69 of 70 isolates were resistant to cefuroxime, a second generation cephalosporin antibiotic. Doganay and Aydin (1991) tested the antimicrobial susceptibilities of 22 isolates of *B. anthracis* to 27 antimicrobial agents. They found that *B. anthracis* was resistant to certain second and third generation cephalosporin antibiotics, and to the closely related monobactam antibiotic aztreonam. The results of these studies are summarised in Table 3.19.

**Table 3. 19 The susceptibility of *B. anthracis* to different antimicrobial agents.**

From the results of Lightfoot *et al.* (1990) and Doganay and Aydin (1991).

Antibiotic	Classification	MIC (90%) $\mu\text{g/ml}$	Mode of action
penicillin benzyl penicillin	penicillinase sensitive penicillins	0.125 0.015	inactivation of penicillin binding proteins in cell wall peptidoglycan synthesis  inhibition of peptidoglycan assembly enzymes, to shift the equilibrium of cell wall synthesis in favour of autolysin production
ampicillin amoxycillin amoxycillin and clavulanic acid	penicillinase resistant penicillins $\beta$ -lactamase inhibitor	0.03 0.125 0.015	
pipercillin mezlocillin	acylaminopenicillins	0.5 0.06	
cefazolon cephalothim cephradine	first generation cephalosporins	0.015 S S	
cefuroxime	second generation cephalosporin	64	
cefotaxime ceftizoxime ceftriaxone ceftazidime cefoperazone	third generation cephalosporins	32 32 32 128 4	
aztreonam	monobactam	128	
erythromycin	macrolide	1.0	Inhibition of protein synthesis, binds to 50S ribosome, possibly inhibits transpeptidisation
clindamycin chloramphenicol	- -	1.0 1.0	
tetracycline	tetracycline	0.125	Inhibition of protein synthesis, binds to 30S RNA subunit inhibits attachment of aminoacyl tRNA to acceptor site in mRNA complex
trimethoprim/sulfa methoxazole	diaminopyrimidine/ sulfonamide	3.2/16	inhibition of foile acid synthesis by inhibition of dihydrofolate reductase
gentamycin streptomycin amikacin notilmicin tobramycin vancomycin	aminoglycosides	0.25 1.0 0.06 0.125 1.0 1.0	Inhibition of protein synthesis by binding to p10 protein in 30S RNA complex causing mis-reading of codons
ofloxacin ciprofloxacin	quinolones	0.06 0.06	inhibition of DNA synthesis

S = sensitive

### **3.10.1.1 The mode of action of cephalosporins and aztreonam.**

Cephalosporins are structurally similar to penicillins, but have a 6-member dihydrothiazine ring joined to the  $\beta$ -lactamase ring instead of a 5-member thiazolidine ring. This makes them more resistant to hydrolysis by  $\beta$ -lactamases. Second and third generation cephalosporins act by inhibiting the final stages of cell wall synthesis, leading to disruption of the cell wall. These antibiotics cross the cell wall and bind to penicillin binding proteins (PBPs; transpeptidases, carboxypeptidases and endopeptidases). This inhibits peptidoglycan synthesis (Hindler *et al.*, 1994) by preventing the cleavage of the peptide bond between the two terminal D-alanine residues of one pentapeptide side chain of *N*-acetylmuramic acid (NAM) and the subsequent cross-linking between the penultimate D-alanine and the free amino group on the third amino acid on the neighbouring NAM pentapeptide chain. In Gram-positive organisms this cross-link is a short peptide or amino acid. PBPs are unique for each bacterial species and have different roles in the construction of the cell wall (Gustafarro and Steckelberg, 1991). This variation in PBPs leads to differences in susceptibility to cephalosporin antibiotics. First generation cephalosporins are generally active against Gram-positive organisms and second and third generation cephalosporins are usually active against Gram-negative organisms (Hindler *et al.*, 1994). Cephalosporins have also been shown to play a role in the activation of cell wall autolysins.

Aztreonam is the only commercially available monobactam antibiotic. It is structurally similar to the cephalosporins, but has a methyl group and a sulphide group in place of the dihydrothiazine ring. Aztreonam remains stable in the presence

of  $\beta$ -lactamases and has been reported to act mainly against Gram-negative bacteria. The mechanism of action of aztreonam has been proposed to be similar to that of the first generation cephalosporins.

The mode of action of the cephalosporins and aztreonam is such that different antibiotics have varying effects on the cell wall of different bacterial species. The resistance of *B. anthracis* to certain cephalosporins and aztreonam indicates that due to differences in the cell wall structure of different *Bacillus* species, these classes of antibiotic are most likely to allow the selective growth of *B. anthracis*. Antibiotics which target DNA, RNA and protein synthesis are likely to be ineffective, as *B. anthracis* has been reported to be sensitive to antibiotics from these groups (see Table 3.19).

#### **3.10.1.2 The effect of clavulanic acid on $\beta$ -lactamase producing bacteria**

Clavulanic acid is a metabolite of *Streptomyces clavulgaris* which prevents  $\beta$ -lactamases produced by Gram-positive and Gram-negative bacteria from inactivating antibiotics. Clavulanic acid mimics the antibiotic substrate, causing the  $\beta$ -lactamases to bind to the clavulanic acid rather than to the antibiotic (Comber *et al.* 1980; Reading, 1982). Clavulanic acid can therefore provide a selective advantage to bacteria which do not produce  $\beta$ -lactamase. Doganay and Aydin (1991) reported that *B. anthracis* was sensitive to amoxycillin in the presence of clavulanic acid. A direct comparison of the sensitivity of *B. anthracis* and *B. cereus* to amoxycillin and clavulanic acid may reveal differences in their susceptibility that could favour *B. anthracis*.



### 3.10.2 Aim

The aim of the experiments described in this section was to determine whether the use of antibiotics to which *B. anthracis* is resistant would allow the selective recovery of *B. anthracis* from a mixture of *B. anthracis* and *B. cereus*.

### 3.10.3 Materials and Methods

Solutions of cefuroxime (Zinacef; 10 mg/ml), cefotaxime (Claforan; 5 mg/ml) and aztreonam (10 mg/ml) were made up in SDW and added to BHIB to give final antibiotic concentrations of 10 - 400 µg/ml. The minimum inhibitory concentration (MIC) of cefuroxime and cefotaxime required to inhibit growth of *B. anthracis* ASC 80 and *B. cereus* F4433/73 was determined by the addition of different concentration of antibiotic to broths. Broths were seeded with spores of *B. anthracis* ASC 80 and *B. cereus* F4433/73 incubated and the subsequent growth recorded as described in Section 3.7.2 (p 103). The MIC of amoxycillin and clavulanic acid for *B. anthracis* ASC 80 and F4433/73 was determined using the standard method described in Section 2.7 (p 50).

To screen a number of strains of different *Bacillus* species for resistance to aztreonam, 1 µl of cells of different strains of *Bacillus* species which had been cultured overnight at 37 °C on BA were added to 10 ml volumes of BHIB containing 600 µg/ml aztreonam (chosen from the results of the above experiments). After overnight incubation at 37 °C, strains were identified as sensitive or resistant to aztreonam by examination for the presence or absence of growth in the broth.

To determine whether the addition of aztreonam to PLETB would improve the selective growth of *B. anthracis*, 400 µg/ml of aztreonam was added to BHIB and

PLETB. Combinations of strains of *B. anthracis* and *B. cereus* were seeded into broths which were incubated and sampled as described in Section 3.7.2.

### 3.10.4 RESULTS

#### 3.10.4.1 Determination of the MIC of cefuroxime and cefotaxime for *B. anthracis* ASC 80 and *B. cereus* F4433/73

The MIC of both cefuroxime and cefotaxime required to inhibit the growth of *B. anthracis* ASC 80 was significantly lower than that required to inhibit *B. cereus* F4433/73 (Table 3.20).

**Table 3.20** Minimum inhibitory concentrations of cefuroxime and cefotaxime on *B. anthracis* ASC 80 and *B. cereus* F4433/73

Antibiotic	<i>B. anthracis</i> ASC 80 MIC (µg/ml)	<i>B. cereus</i> F4433/73 MIC (µg/ml)
Cefuroxime	35	> 100
Cefotaxime	15	> 20

#### 3.10.4.2 Comparison of the growth of *B. anthracis* and *B. cereus* in the presence of amoxicillin and clavulanic acid

*B. cereus* F4433/73 was found to be more resistant to amoxycillin and clavulanic acid than *B. anthracis* ASC 80 (Table 3.21).

**Table 3.21 The effect of amoxycillin and clavulanic acid on the growth of *B. anthracis* ASC 80 and *B. cereus* F4433/73**

Results show the range from duplicate experiments

Antibiotic	MIC of <i>B. anthracis</i> ASC 80 (µg/ml)	MIC of <i>B. cereus</i> F4433/73 (µg/ml)
Amoxycillin	0.25 - 0.5	16 - 32
Clavulanic acid	0.5 - 2.0	4.0 - 16

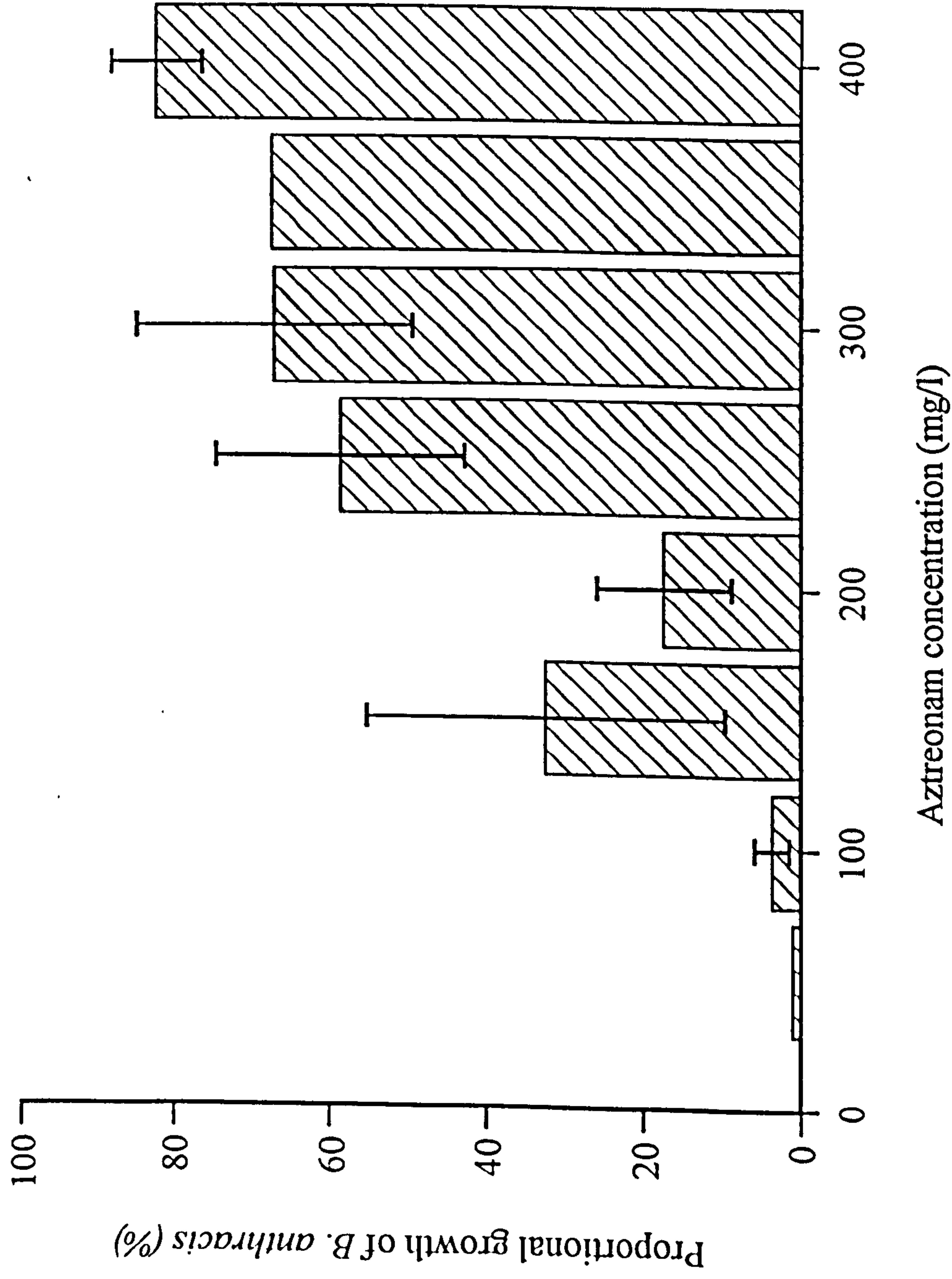
### 3.10.4.3 The effect of aztreonam on the growth of *B. anthracis* and *B. cereus*

As the aztreonam concentration in the broth was increased, the recovery of *B. anthracis* ASC 80 was greater than that of *B. cereus* F4433/73. In the presence of 400 µg/ml aztreonam, *B. anthracis* comprised approximately 95% of the culture (Fig. 3.7). The aztreonam concentration could be increased to 600 µg/ml, however no further increase in the selective recovery of *B. anthracis* was observed.

When different combinations of strains of *B. anthracis* and *B. cereus* were tested for their sensitivity to 600 µg/ml aztreonam, as expected, all strains of *B. anthracis* were resistant to aztreonam, however 7 of 9 strains of *B. cereus* tested were also resistant (Table 3.22).

Further screening experiments revealed that 19/24 strains of *B. cereus*, 2/4 strains of *B. thuringiensis*, 2/3 strains of *B. licheniformis*, and 1/5 strains of *B. subtilis* were resistant to aztreonam. Comparable results were obtained whether 600 µg/ml or 400 µg/ml aztreonam was used. Further experiments were carried out using 400 µg/ml of aztreonam in BHIB.

**Figure 3.7** The effect of aztreonam on the recovery of *B. anthracis* from a mixture of *B. anthracis* ASC 80 and *B. cereus* F4433/73 in BHIB



BHIB (10 ml) containing aztreonam (50 - 400 mg/l) was seeded with spores of *B. anthracis* ASC 80 and *B. cereus* F4433/73 to give a final concentration of  $10^4$  spores/ml of each. The broths were incubated at 37 °C overnight. Samples (1 µl) were taken and cultured overnight on BA. The proportion of the resulting growth which was *B. anthracis* and was recorded. Results are the mean of 4 experiments. Error bars represent the standard error of the mean.

**Table 3.22** The growth of different strains of *B. anthracis* and *B. cereus* in BHIB containing 600 µg/ml aztreonam

All combinations of strains of *B. anthracis* and *B. cereus* in each row were tested

<i>B. cereus</i> strain	<i>B. anthracis</i> strain (ASC)	Proportional recovery of <i>B. anthracis</i> (%)
B039, F1983/77, F4618/75, F4562/75, F4748/76,	27, 80, 187, 189, 192	all < 10
F564/49, NCTC 09680 †	27, 187, 192	all < 5
F4433/73	27, 80, 187, 189, 192	35, 65, 90, 100, 60 *
F147B/78	27, 187, 192	95, 100, 100 *

\* Figures represent the percentage growth of each strain of *B. anthracis* respectively

† *B. mycooides*

#### 3.10.4.4 The effect of aztreonam on the growth of *B. anthracis* in PLETB

The addition of aztreonam to PLETB did not improve the recovery of *B. anthracis* from a mixture of *B. anthracis* and *B. cereus* ( $p < 0.001$  using a Student's t-test; Table 3.23).

**Table 3.23** The effect of aztreonam on the growth of *B. anthracis* from a mixture of different strains of *B. anthracis* and *B. cereus* in BHIB and PLETB

Each figure represents the mean of 3 or 5 individual experiments conducted using the different strains of *B. anthracis* indicated

<i>B. cereus</i> strain	Percentage growth of <i>B. anthracis</i>		
	BHIB + aztreonam	PLETB	PLETB + aztreonam
F4433/73 *	50	60	85
B039 *	0	70	40
F4562/75 *	0	60	30
F4748/76 *	0	25	65
F1983/77 *	0	75	70
F4618/75 *	0	65	25
F546/49 †	0	95	10
F147B/78 †	75	55	95
NCTC 09680 †‡	0	65	20

\* *B. anthracis* strains used: ASC 27, ASC 80, ASC 187, ASC 189 and ASC 192.

† *B. anthracis* strains used: ASC 27, ASC 187 and ASC 192; ‡ *B. mycooides*

In some experiments using PLETB, better growth of *B. anthracis* was observed in the absence of aztreonam. The recovery of *B. anthracis* in PLETB was lower in this experiment than in the experiment described in Table 3.18 (p 118), demonstrating that the recovery of *B. anthracis* is variable between comparable experiments.

### 3.10.5 CONCLUSIONS

The results from this section showed that although *B. anthracis* was resistant to cefuroxime, cefotaxime and aztreonam, *B. cereus* showed greater resistance to these antibiotics. Aztreonam may be of limited use for the selective growth of *B. anthracis* from a mix of certain, aztreonam sensitive, *Bacillus* species, but would not be suitable for routine use, or for inclusion in PLETB.

Values for the MIC of amoxicillin and clavulanic acid for *B. anthracis* and *B. cereus* indicated that these substances would not improve the selective recovery of *B. anthracis*.

## 3.11 THE EFFECT OF SOIL ON THE SELECTIVE RECOVERY OF

### *B. ANTHRACIS* IN PLETB.

#### 3.11.1 Introduction

##### 3.11.1.1 The composition of soil

Soil consists of mineral matter (40 - 60%), dissolved organic and inorganic material (20 - 50%), air (10 - 20%) and approximately 5% organic matter, which includes humic material (see Section 1.8.2.1; FitzPatrick, 1983; White, 1987). The major mineral particles in soil are sand, silt and clay. Sandy and silty soils consist mainly of silicates which generally form tetrahedral structures with atoms of oxygen ( $\text{SiO}_4^{4-}$ ). Cations such as  $\text{Al}^{3+}$ ,  $\text{Fe}^{3+}$ ,  $\text{Fe}^{2+}$ ,  $\text{Ca}^{2+}$ ,  $\text{Mg}^{2+}$ ,  $\text{K}^+$  and  $\text{Na}^+$  bind to the oxygen atoms. The majority of the clay fraction of a soil is aluminosilicate, which forms layers with mineral cations, most commonly  $\text{K}^+$ ,  $\text{Ca}^{2+}$  and  $\text{Mg}^{2+}$ . The main salt in clay soil is  $\text{CaCO}_3$ . Other common salts are oxides of manganese, iron and aluminium. The approximate composition of terrestrial matter in the lithosphere is tabulated in Table 3.24.

#### 3.11.2 Aim

The aim of the experiments described in this section was to determine whether the addition of soil to PLETB affected the selective recovery of *B. anthracis*.



**Table 3.24** Approximate composition of known terrestrial matter in the lithosphere (From Brock, 1966)

Element	Percentage composition	Element	Percentage composition
oxygen	46	calcium	3.6
silicon	28	sodium	2.8
aluminium	8.1	potassium	2.6
iron	5.1	carbon, chlorine, phosphorous, sulphur, hydrogen manganese, nitrogen,	< 0.15
magnesium	2.1		

### 3.11.3 Materials and Methods

The soil and plaster samples used in this section are described in Table 3.25.

Soils were sterilised by sealing in an autoclave bag and autoclaving at 121 °C for 15 min, cooling, and autoclaving for a second time.

The following compounds were added to 10 ml volumes of PLETB which were seeded with spores of *B. anthracis* ASC 27, 80, 187 or 192 and *B. cereus* F4433/73, F1983/77, F4562/75 or BO39, incubated and sampled as described in Section 3.7 2 (p 103): Sterile and non-sterile soil samples (0.3 g) as described in Table 3.25; sand (0.3 g), charcoal (0.3 g); a 3% solution of humic acids (Sigma Chemicals, UK) in SDW to give a final concentration of 0.01% -0.15%. Increasing volumes (50 - 250 µl) of 100 mM solutions of metal salts containing ions common in soil (see Table 3.30) and dilutions of EDTA, EGTA, EDDA (100 - 100 µg/ml)

**Table 3.25 Soils used in this study**

Soil ASS No	Source of sample	Description	Characteristics
91/82	Pontypridd	Soil from a bone processing plant	sand > organic content
92/90	Wessex Water	top soil	organic ≥ mineral content
N/A	Commercially available compost	Peat	organic > mineral content
N/A	Redlynch, near Salisbury	Garden top soil (GTS)	organic ≈ mineral content
92/322	St Pancras loft space	Plaster and horse hair	calcium carbonate
149/93	Atherstone borehole Peterborough	Soil taken from a depth of 0.5 - 1.0 M	High mineral content (≈ 50% chalk)

1, 10- phenanthroline (0.0001 - 0.0005%) and Chelex (0.2 - 1.0%) were also added individually and in combination with metal salts to PLETB. Broths were seeded and sampled as described in Section 3.7.2 (p 103).

To try and improve the selective recovery of *B. anthracis*, after growth in PLETB containing soil, the EDTA and TA concentrations in PLETB were increased to 600 mg/l and 80 mg/l respectively. Samples (1 µl) were also subcultured onto PLETA instead of BA and incubated at 37 °C for 48 h.

### 3.11.4 RESULTS

The presence of non-sterile soil in PLETB significantly reduced the selective recovery of *B. anthracis* (Fig. 3.8). Comparable results were obtained when sterile soil was used (results not shown). Increasing the EDTA concentration to 600 mg/l and the TA content to 80 mg/l led to a slight increase in recovery of *B. anthracis*, however, in non-sterile soil, other soil *Bacillus* species greatly outnumbered *B. anthracis* (Fig 3.9). Further increases in the EDTA and TA concentration in the broth reduced the recovery of *B. anthracis*.

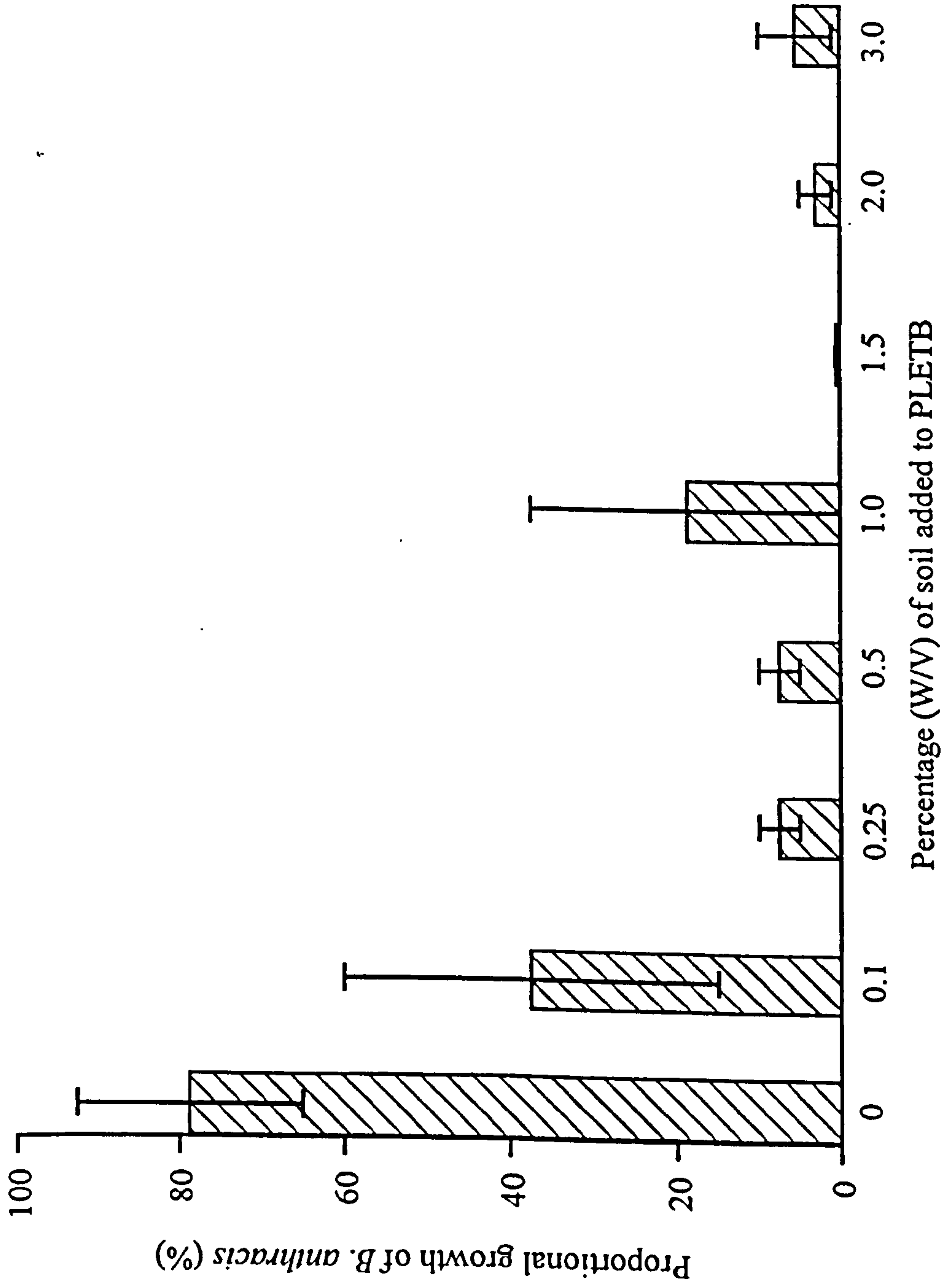
Subsequent culture of the growth in PLETB onto PLETA, rather than BA (used previously) resulted in 90% - 100% recovery of *B. anthracis*. When different combinations of strains of *B. anthracis* and *B. cereus* were tested, however, the recovery of *B. anthracis* varied depending on the strain used (Table 3.26).

**Table 3.26. The recovery of *B. anthracis* from different combinations of strains of *B. anthracis* and *B. cereus* in PLETB containing 3% soil (ASS 91/90) and subcultured onto PLETA**

Each value is the mean of triplicate experiments. EDTA = 600 µg/ml, TA concentration = 40 µg/ml

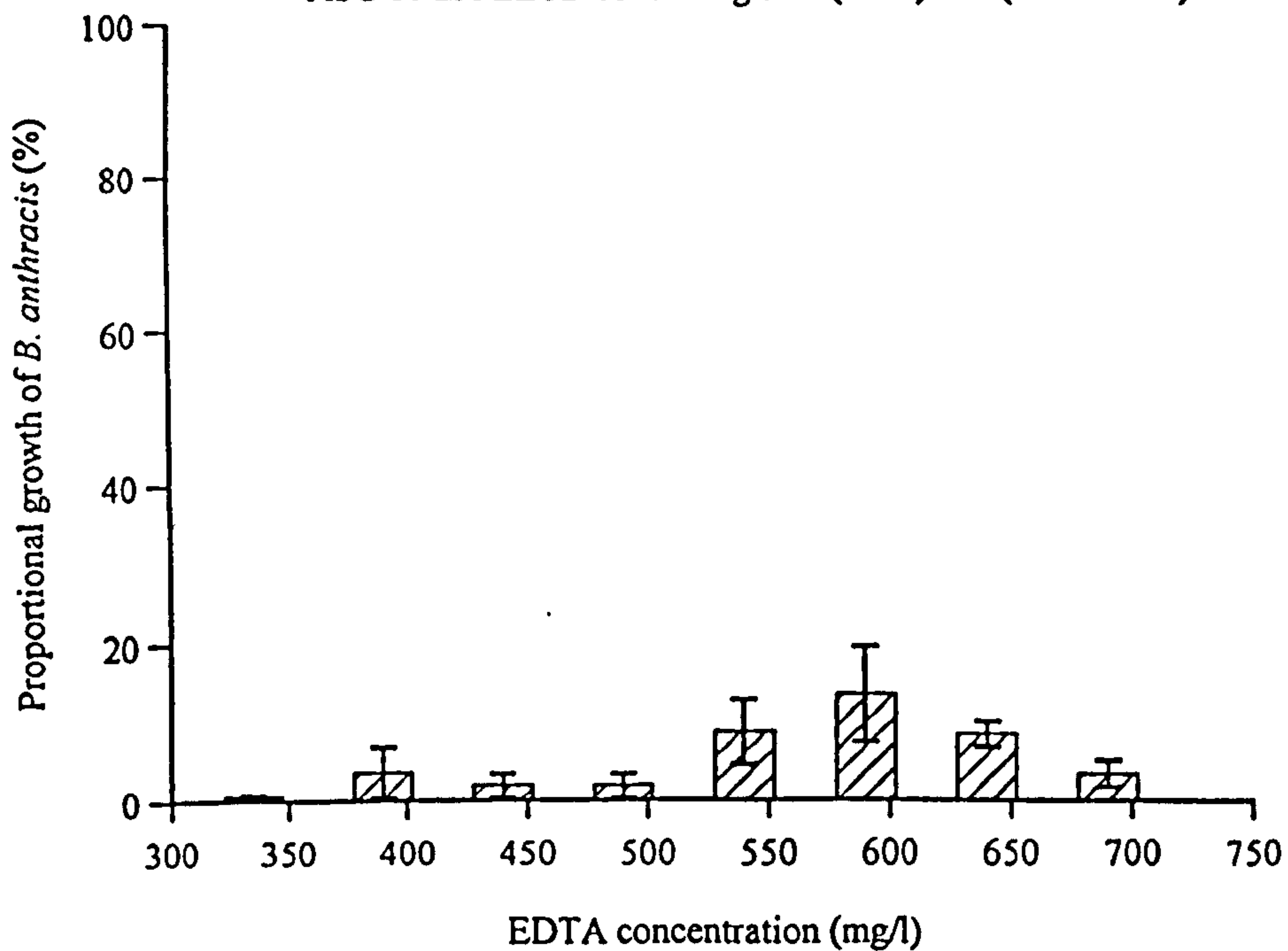
Strains of <i>B. cereus</i>	Proportion of growth of <i>B. anthracis</i>		
	ASC 27	ASC 187	ASC 192
F1983/77	0	50	85
F4562/75	0	40	65
B039	0	95	100

**Figure 3.8** The recovery of *B. anthracis* ASC 80 in PLETB containing non-sterile soil (ASS 91/90)

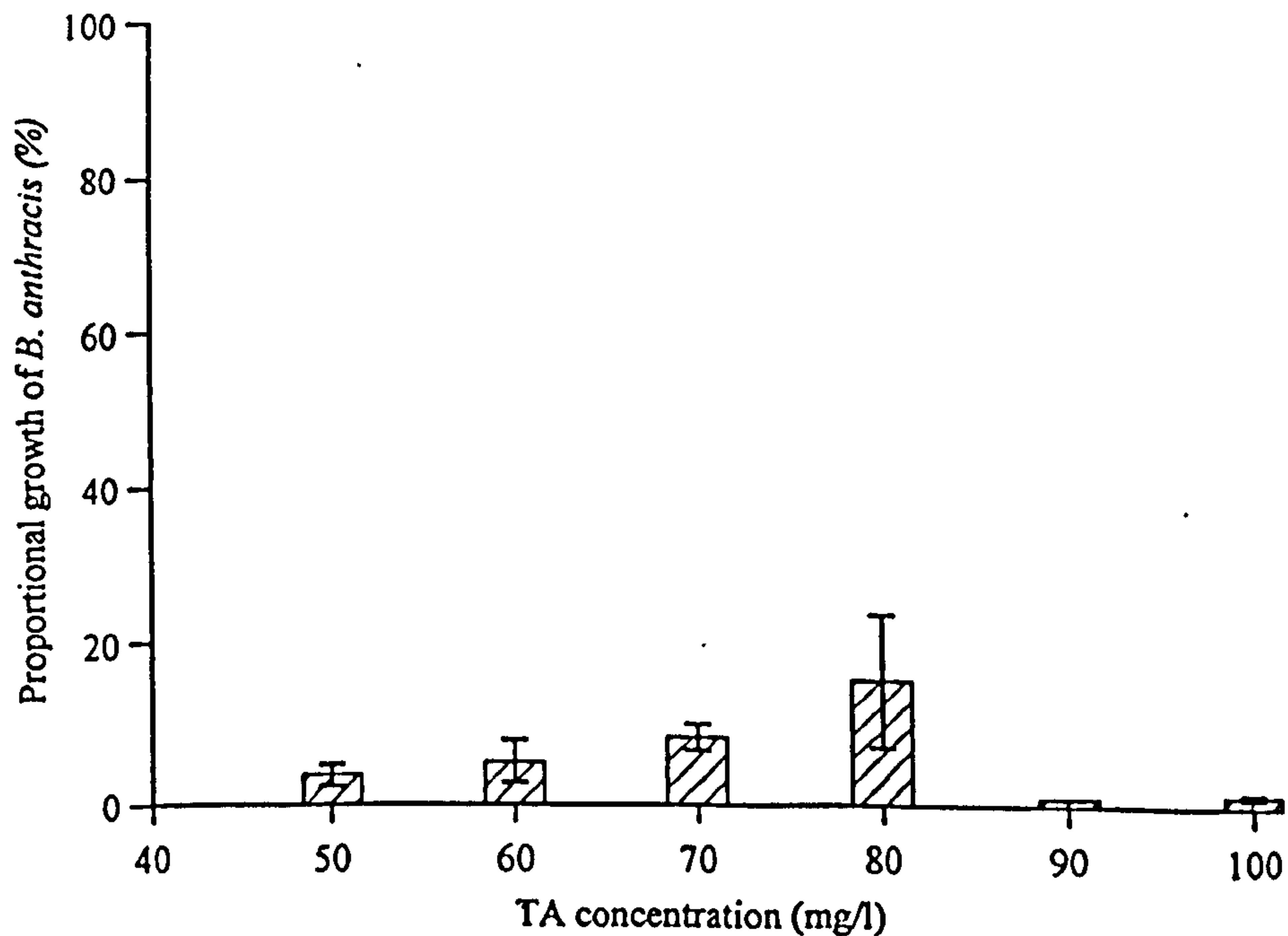


Soil (0.1 - 3%) was added to PLETB (10 ml) containing polymyxin B sulphate (30 000 units/l) lysozyme (250 000 units/l) EDTA (300 mg/l) and TA (40 mg/l) which was seeded with spores of *B. anthracis* ASC 80 and *B. cereus* F443/73 to an initial concentration of  $10^4$  spores of each/ml. The broths were incubated overnight at 37 °C. A sample (1 µl) were taken and cultured overnight on BA. The proportion of the resulting growth which was *B. anthracis* and was recorded. Experiments were carried out in triplicate. Error bars represent the standard error of the mean

Figure 3.9 The effect of increased EDTA concentration on the recovery of *B. anthracis* ASC 80 in PLETB containing 3 % (W/V) soil (ASS 91/90)



The effect of increased TA concentration on the recovery of *B. anthracis* ASC 80 in PLETB containing 3 % (W/V) soil (ASS 91/90) EDTA = 600 mg/l



EDTA (350 - 750 mg/l; top graph) and TA (50 - 100 mg/l; lower graph) was added to BHIB containing polymyxin B sulphate (30 000 units/l) lysozyme (500 000 units/l) and either TA (40 mg/l; top graph) or EDTA (300 mg/l, lower graph). The broths were inoculated with  $10^4$  spores/ml of *B. anthracis* ASC 80 and *B. cereus* F4433/73 and incubated at 37 °C. Samples (1  $\mu$ l) were taken and cultured on BA at 37 °C overnight. The percentage of colonies of *B. anthracis* was recorded. Experiments were conducted in duplicate. Error bars represent the standard error of the mean.

*B. anthracis* strain ASC 27 was not detected on PLETA after growth in PLETB containing soil. No unusual phenotypic or genotypic characteristics have been attributed to this strain which could explain this difference.

**3.11.4.1 The effect of adding different types of soil on the selective recovery of *B. anthracis* from a mixture of *B. anthracis* ASC 80 and *B. cereus* F4433/73 in PLETB**

When sand, peat or charcoal was added to PLETB, selective recovery of *B. anthracis* occurred. In the presence of chalk containing soil (ASS 93/149), however, no selective recovery of *B. anthracis* occurred (Table 3.27). Testing the pH of the broths indicated that alteration of the pH was unlikely to have affected the selective recovery of *B. anthracis*.

**Table 3.27 The recovery of *B. anthracis* from a mixture of *B. anthracis* ASC 80 and *B. cereus* F4433/73 in PLETB containing sand, peat, charcoal or soil**

Addition to PLETB	Recovery of <i>B. anthracis</i> (%)	pH before growth in broth	pH after growth in broth
Sand	80	-	-
Peat	70	7	6
Charcoal	80	-	-
Chalk soil (ASS 149/93)	0	7	6
No addition	75	7	7

Results are from representative experiments; - not done

Further experiments showed that 0.25% chalk soil in PLETB was sufficient to inhibit the selective recovery of *B. anthracis* (Table 3.28).

**Table 3.28** The effect of soils with (1) a high mineral content and (2) a high organic content on the selective growth of *B. anthracis* from a mixture of *B. anthracis* ASC 80 and *B. cereus* F4433/73 in PLETB

Percentage of soil added to PLETB	Percentage growth of <i>B. anthracis</i> ASC 80	
	(1) Chalk soil (ASS 149/93)	(2) Peat
0	90	90
0.25	50	80
0.5	40	95
1.0	30	95
1.5	15	90
3.0	0	70

Results are from a representative experiment.

#### 3.11.4.2 The effect of humic acids (HA) on the selective growth of *B. anthracis* in PLETB

As the amount of HA added to PLETB was increased, reduced recovery of *B. anthracis* was observed. At 0.1% HA (1 mg/ml) no selective recovery of *B. anthracis* occurred (Table 3.29).

**Table 3.29** The effect of HA on the selective recovery of *B. anthracis* from a mixture of *B. anthracis* ASC 80 and *B. cereus* F4433/73 in PLETB

Each value is the mean of duplicate experiments

% Humic acid solution in PLETB	% recovery of <i>B. anthracis</i>
0	80
0.01*	70
0.025	50
0.05	30
0.1	0
0.15	0

\* In soil the approximate humic acid concentration is 16 - 80 µg/ml (< 0.001%).

#### **3.11.4.3** The effect of mineral ions on the selective recovery of *B. anthracis* in PLETB

No *B. anthracis* was recovered from PLETB containing 0.5 mM FeCl<sub>2</sub>, MnCl<sub>2</sub>, CuSO<sub>4</sub>, or ZnCl<sub>2</sub>. Both 1.5 mM CaCl<sub>2</sub> and 1.5 mM NaCl reduced the recovery of *B. anthracis* significantly. Growth was not inhibited by the presence of 2.5 mM MgCl<sub>2</sub>, KCl, CsCl or NH<sub>4</sub>Cl. (Table 3.30).



**Table 3.30** The effect of various salts on the selective recovery of *B. anthracis* from a mixture of *B. anthracis* ASC 80 and *B. cereus* F4433/73 in PLETB

Results are from a representative experiment

Concentration	Percentage recovery of <i>B. anthracis</i> ASC 80					
	0	0.5 mM	1 mM	1.5 mM	2.0 mM	2.5 mM
MgCl <sub>2</sub> , KCl, CsCl or NH <sub>4</sub> Cl	90	90	90	90	90	90
NaCl	80	100	100	12.5	12.5	12.5
CaCl <sub>2</sub>	95	90	60	1	1	0
MnCl <sub>2</sub> , ZnCl <sub>2</sub> , CuSO <sub>4</sub> , or FeCl <sub>2</sub>	80	5	0	0	0	0

#### 3.11.4.4 The effect chelating agents on the selective recovery of *B. anthracis* in PLETB containing mineral ions

The inhibitory effect of CaCl<sub>2</sub> could be at least partly reversed by the addition EDTA or EGTA ( which chelate Ca<sup>2+</sup> ions) to PLETB (Table 3.31). Similarly, the inhibitory effect of FeCl<sub>2</sub> could be reversed using Chelex, 1,10-phenanthroline, or EDDA which chelate Fe<sup>2+</sup> ions (Table 3.32). The inhibition of the selective recovery of *B. anthracis* caused by excess CuSO<sub>4</sub> could also be prevented by the addition of Chelex which chelates Cu<sup>2+</sup> ions (Table 3.33). For each chelating agent a concentration which provided optimal recovery of *B. anthracis* was observed. Above this concentration, no increase in the selective recovery of *B. anthracis* was observed. For example more than 300 µg/ml of EGTA, or 3.0% Chelex did not increase the recovery of *B. anthracis*. Increasing the EDDA concentration above 400 µg/ml reduced

the selective recovery of *B. anthracis* for both concentrations of FeCl<sub>2</sub> tested.

**Table 3.31** The recovery of *B. anthracis* from a mixture of *B. anthracis* ASC 80 and *B. cereus* F4433/73 in PLETB with 2.5 mM CaCl<sub>2</sub> and EDTA or EGTA

EDTA concentration μg/ml	Percentage recovery of <i>B. anthracis</i> ASC 80	EGTA concentration μg/ml	Percentage recovery of <i>B. anthracis</i> ASC 80
300	10	100	0
500	70	200	1
600	80	300	60
700	90	400	60
ND	-	600	60
ND	-	700	60
ND	-	800	65
No CaCl <sub>2</sub>	95	No chelating agent	0

ND not done; Results are from a representative experiment

**Table 3.33** The effect of the addition of Chelex to PLETB containing 0.5 mM CuSO<sub>4</sub> on the selective growth of *B. anthracis* ASC 80

Percentage Chelex	Percentage of growth of <i>B. anthracis</i> ASC 80
0	15
0.2	30
0.5	70
1.0	55
No CuSO <sub>4</sub>	90

Results are from a representative experiment

**Table 3.32** The effect of the addition of iron chelating agents to PLETB containing FeCl<sub>2</sub> on the selective growth of *B. anthracis* from a mixture of *B. anthracis* ASC 80 and *B. cereus* F4433/73

Addition to PLETB	Percentage growth of <i>B. anthracis</i> ASC 80	
	0.25 mM FeCl <sub>2</sub>	0.5 mM FeCl <sub>2</sub>
<b>Chelex (%)</b>		
1.0	60	50
2.0	70	70
3.0	90	70
4.0	80	70
5.0	80	70
<b>EDDA µg/ml</b>		
100	70	0
200	60	50
400	80	60
500	20	40
1000	10	ND
<b>1-10 phenanthroline (%)</b>		
0.0001	ND	0
0.0002	ND	0
0.0003	ND	70
0.0004	ND	60
0.0005	ND	70
+ C (no FeCl <sub>2</sub> )	90	100
No chelating agent	50	40

ND = Not Done; Results are from a representative experiment

### 3.11.5 CONCLUSIONS

The addition of both sterile and non-sterile soil to PLETB reduced the selective

enrichment of *B. anthracis*. In non-sterile soil the recovery of *B. anthracis* was further reduced due to the overgrowth of other *Bacillus* species in the soil. The recovery of *B. anthracis* could be improved by subsequent culture of the growth in PLETB onto PLETA rather than BA. In the presence of soil, however, *B. anthracis* strain ASC 27 was not recovered. The reason for this was not clear.

The recovery of *B. anthracis* in PLETB was not affected by the presence of peat, sand and charcoal. The addition of chalk containing soil to PLETB, however reduced the recovery of *B. anthracis*. Peat, sand and charcoal all contain low levels of mineral ions, whereas the chalk containing soil has a high mineral content. This indicated that it was most likely to be the mineral ion content of the soil which was preventing the selective growth of *B. anthracis*. The concentration of humic acids required to inhibit the recovery of *B. anthracis* (0.1%) was much higher than that likely to be encountered in soil (0.001%; Jacobson, 1995).

The hypothesis that it was the mineral ion content of the soil which inhibited the selective recovery of *B. anthracis* was supported by the inhibition of the selective growth of *B. anthracis* by the addition of mineral ions to PLETB. The actual concentrations of  $\text{Ca}^{2+}$ ,  $\text{Fe}^{2+}$  and  $\text{Na}^{2+}$  present in soil are much higher than those found to be inhibitory to the growth of *B. anthracis* in this study (see Table 3.24; p 131).

The inhibitory effect of mineral ions on the selective growth of *B. anthracis* in PLETB could be at least partially reversed by the addition of the appropriate chelating agent. The addition of a cocktail of chelating agents may improve the selective growth of *B. anthracis* from a specific soil, however, a different combination of chelating agents would be required for each soil type tested. This approach would therefore not be practical for routine use on a wide range of soil samples.

## **3.12 COMPARISON OF DIRECT CULTURE ON PLETA WITH PLETB ENRICHMENT ON THE RECOVERY OF *B. ANTHRACIS***

### **3.12.1 Aim**

The aim of the work described in this section was to compare direct culture on PLETA with growth in PLETB and subsequent culture on PLETA for the detection of *B. anthracis* from soil containing low numbers of spores of *B. anthracis*.

### **3.12.2 Materials and Methods**

A sample (100 µl) of a 1 in 10 dilution of naturally contaminated soil ASS 91/85 (see Table 3.2) was cultured on PLETA. A 100 µl sample was also inoculated into 10 ml volumes of BHIB and PLETB which were incubated overnight at 37 °C, then a 10 µl sample was cultured on PLETA. The number of colonies of *B. anthracis* observed on each of the PLETA plates was recorded.

### **3.12.3 RESULTS**

*B. anthracis* was detected when a sample of the soil solution was cultured directly on PLETA, but was not detected when equal volumes of the soil solution were cultured in PLETB prior to culture on PLETA (Table 3.34). After culture in broth was carried out 80 - 100% of the PLETA was covered with growth of other bacterial species.

This was attributed to the more rapid growth rate of other *Bacillus* species in the soil.

**Table 3.34 Comparison of the recovery of *B. anthracis* from naturally contaminated soil (ASS 91/85) with and without broth enrichment**

Enrichment medium	Number of colonies of <i>B. anthracis</i> on PLETA*	
	Initial sample	After enrichment culture
No enrichment	4	N/A
BHIB	7	0 †
PLETB	9	0 †

\* In 100 µl cultured on PLETA; N/A not applicable

† 90 - 100% cover of other *Bacillus* species

### 3.12.4 CONCLUSIONS

These results showed that when *B. anthracis* is present in low numbers, direct culture of a dilution of the soil on PLETA is preferable to selective enrichment in PLETB.

### **3.13 THE EFFECT OF THE ADDITION OF AGAR TO PLETB ON THE SELECTIVE RECOVERY OF *B. ANTHRACIS***

#### **3.13.1 Introduction**

The advantage of using a semi-solid medium for the growth of bacterial species was first described in the late nineteenth century. The improved bacterial growth was attributed to the diffusion of inhibitory metabolic products within the medium, and the ability of motile bacteria to travel through the medium to areas with a fresh supply of nutrients (Hitchins, 1921).

Lignieres (1919, cited in Spray 1936) and Hitchins (1921) reported that the addition of 0.25% and 0.1% agar improved growth of anaerobic bacteria in broth. Hitchins concluded that the improved growth was due to the physical composition of the medium, in which particles of agar resisted the penetration of oxygen. He also suggested the use of semi-solid media for the culture of bacteria requiring a partial oxygen tension, and noted its physical similarity to tissues and their fluids. Spray (1936) used semi-solid media for the isolation and identification of 328 strains of anaerobic spore forming bacilli, without the requirement for traditional anaerobic culture methods.

Technical information provided by Difco states that the addition of 0.1% agar to broth has been reported to yield an oxygen tension similar to that in brain tissue. This allows good growth of anaerobes uniformly throughout the medium, and growth of aerobes in the upper part of the medium.

The addition of agar to PLETB may improve the selective growth of *B. anthracis* from a mixture of other *Bacillus* species. Conditions in the semi-solid

agar may be closer to those found in mammalian tissue, which is the natural environment for the growth of *B. anthracis*.

### 3.13.2 Aim

The aim of the work presented in this section was to determine whether the addition of agar to PLETB improved the selective recovery of *B. anthracis*.

### 3.13.3 Materials and Methods

10 ml or 50 ml volumes of BHIB were made up containing 0.1 - 0.9% agar. The chemicals which comprise PLETB were added to the broth. When more than 0.4% agar was used, the medium was inoculated with spores of *B. anthracis* in liquid phase at 50 °C and mixed well. Broths were incubated at 37 °C overnight. Samples (10 µl) were taken from the upper 25% of the agar which appeared to harbour most growth, and subcultured on PLETA.

Broths were inoculated with dilutions of soils ASS 93/188, 91/2 and 91/90 and 92/90 and plaster sample ASS 92/322 (see Table 3.2, p 81 and Table 3.25 ,p 132). PLETB without agar was used for comparison.

### 3.13.4 RESULTS

The addition of 0.3 - 1.0% agar to PLETB resulted in the recovery of *B. anthracis* where no detection occurred in PLETB alone (Table 3.35, Table 3.36).



**Table 3.35 Comparison of the growth of *B. anthracis* in semi-solid PLETB to growth in PLETB**

% agar in PLETB	Percentage of growth of <i>B. anthracis</i>		
	Inoculum ≈ 100 colonies *	Inoculum ≈ 70 colonies †	Inoculum ≈ 2 colonies ‡
0	0	0	0
0.1	0	0	ND
0.2	0	0	ND
0.3	100	5	ND
0.4	100	70	100
0.5	100	100	50
0.6	100	100	0
0.7	100	100	0
0.8	50	100	0
0.9	100	100	ND
1.0	100	ND	ND

\* ASS 93/188 soil; † ASS 91/2 soil; ‡ ASS 91/90 soil; ND = not done

The addition of 0.4 - 0.6% agar to PLETB improved the detection of low numbers of *B. anthracis* in these environmental samples, equivalent to the detection of 1 spore of *B. anthracis* on PLETA (Table 3.36). Screening a wide range of soil and plaster samples was carried out. This revealed, however, that certain other rapidly growing *Bacillus* species common in environmental samples were able to grow through the medium and prevented the detection of *B. anthracis* (Table 3.37). These were identified as other Group 1 *Bacillus* species, but not members of the '*B. cereus* group',

**Table 3.36 Comparison of the growth of low numbers of *B. anthracis* in 50 ml volumes of semi-solid PLETB to growth in PLETB**

% agar in PLETB	Percentage growth of <i>B. anthracis</i>				
	Number of colonies of <i>B. anthracis</i> inoculated into PLETB				
	≈ 30 *	≈ 50 *	≈ 50 *	≈ 1 †	≈ 1 †
0	0	0	0	0	0
0.4	0	100	0	0	0
0.6	0	100	100	100	100
0.8	0	0	100	0	0

\* Soil = ASS 91/2; † Soil = ASS 93/188

### 3.13.5 CONCLUSIONS

The addition of 0.6% agar to PLETB improved the selective growth of *B. anthracis* in certain environmental samples in comparison with growth of *B. anthracis* in PLETB. Semi-solid agar also allowed the recovery of *B. anthracis* from samples where only one colony of *B. anthracis* was observed when an equal amount of the soil dilution was cultured on PLETA. The unpredictable overgrowth by certain other *Bacillus* species present in a variety of environmental samples, however, would prevent this method from being applied to the routine detection of *B. anthracis* in environmental samples.

**Table 3.37** The effect of adding different environmental samples to 50 ml volumes of semi-solid PLETB on the selective recovery of *B. anthracis*

Addition to medium	0.4 % agar		0.6% agar	
	<i>B. anthracis</i>	% cover ‡	<i>B. anthracis</i>	% cover ‡
Plaster ASS 92/322 *	0	80	0	80
Plaster ASS 92/322 †	0	100	0	100
Soil ASS 92/90	0	100	0	100

Results are from a representative experiment; \* 0.2 g plaster † 1.5 g plaster

‡ Other *Bacillus* species

### 3.14 DISCUSSION

The results of this study confirmed that of the chemicals recommended for the selective growth of *B. anthracis*, described in Table 3.1, those used in PLETA are the most effective for the selective recovery of *B. anthracis* from a mixture of spores of *B. anthracis* and *B. cereus* in both selective agars and broths. The substitution of potassium ions for thallium ions in PLETB, and the use of different chelating agents instead of EDTA were tested, but were not found to improve the selective recovery of *B. anthracis*.

The recovery of *B. anthracis* following the selective germination of other *Bacillus* species was also found to be ineffective, as no difference in the germination requirements of *B. anthracis* and *B. cereus* were identified. This approach was not pursued.

A search for other chemicals which may improve the selective recovery of *B. anthracis* was not conducted. This was due to the absence of a clear rationale for the choice of chemicals used in PLETA, which provides no guidance for the identification of further chemical compounds to test. Also, systematic studies of antibiotics and dyes for use in a selective agar for *B. anthracis* conducted at the Institute of Environmental and Animal Hygiene at the University of Hohenheim, Stuttgart, did not produce a new media formulation (Böhm, personal communication, 1993). The outstanding performance of PLETA, in comparison with the other selective agars tested, made the likelihood of developing a novel media formulation which is an improvement on PLETA remote.

Alteration of the basal medium used in PLETA revealed that HIA, as recommended by Knisely (1966) provided optimal recovery of *B. anthracis*, and

reduced the amount of growth of other *Bacillus* species. It was found that it was a combination of the concentration and the specific composition of the nutrients present in PLETA which led to increased recovery of *B. anthracis* and reduced growth of other *Bacillus* species. In PLETB, however, the more nutrient rich BHIB led to increased growth and recovery of *B. anthracis* from a mixture of *B. anthracis* and *B. cereus*.

The requirement for EDTA to be present for the selective recovery of *B. anthracis* in PLETB provides some information about the mechanism by which selective growth of *B. anthracis* may occur. The results of this study indicate that it is the ability of EDTA to chelate  $Mg^{2+}$  ions, which are required to maintain the integrity of the cell wall permeability barriers (Haque and Russell, 1966; Webb, 1968) which results in the selective growth of *B. anthracis*. The substitution of EGTA which preferentially chelates  $Ca^{2+}$  ions and EDDA which chelates  $Fe^{2+}$  and  $Fe^{3+}$  ions did not result in the selective growth of *B. anthracis*.

The effect of EDTA on the cell wall of Gram-negative bacteria has been well documented (Lieve, 1974; Hancock, 1984; Vaara, 1992). EDTA is bactericidal to many Gram-negative bacteria (Haque and Russell, 1976) and pre-treatment with EDTA has been observed to render Gram-negative cell walls more susceptible to lysozyme (Repaske, 1958) and to antibiotics such as penicillin and chloramphenicol (Weister *et al.*, 1968).

Haque and Russell (1976) suggested that EDTA forms chelate compounds with  $Mg^{2+}$ ,  $Ca^{2+}$  or  $Zn^{2+}$  ions which are non-covalently bound to the lipopolysaccharide (LPS) which protrudes from the outer membrane layer of the Gram-negative cell wall. This brings about disaggregation of the LPS and protein- LPS portions of the cell wall

which may subsequently allow antimicrobial agents such as lysozyme to reach their target site. Haque and Russell reported that of 8 strains of Gram-negative organism tested, the two with the most  $Mg^{2+}$ ,  $Ca^{2+}$  and lipid in the cell envelope showed the greatest sensitivity to chelating agents, and also the greatest resistance to  $\beta$ -lactam antibiotics ampicillin and cephaloridine. This indicated that the cation and lipid structure of the Gram-negative bacterial membrane was linked to bacterial cell wall permeability. Haque and Russell (1976) also reported that when *Pseudomonas aeruginosa* was grown in a  $Mg^{2+}$  depleted medium, cell envelopes produced with a lower  $Mg^{2+}$  content were found to be resistant to EDTA and polymyxin. Experiments have also shown that the effect of outer membrane disorganisation and permeability caused by EDTA in broth can be prevented by adding  $Mg^{2+}$  or  $Ca^{2+}$  ions to the medium (Hamilton-Miller, 1966; Weister *et al.*, 1968). Gram-positive bacteria are generally less susceptible to the effect of EDTA due to the thick peptidoglycan layer which comprises the cell wall. Webb (1968) reported that  $Mg^{2+}$  or  $Ca^{2+}$  are necessary to maintain the integrity of the Gram-positive cell wall permeability barrier and that  $Mg^{2+}$  and  $Ca^{2+}$  are accumulated in *B. megaterium* and *B. subtilis*. Archibald *et al.* (1993) suggested that teichoic acids which form part of the Gram-positive cell wall are involved in ion exchange and control of the access of ions, particularly  $Mg^{2+}$ . Lambert *et al.* (1975) examined the role of teichoic acid in the binding of  $Mg^{2+}$ . They showed that when *B. subtilis* was grown under  $Mg^{2+}$  limiting conditions, the cell walls produced more  $Mg^{2+}$  binding teichoic acid, thus increasing the  $Mg^{2+}$  binding capacity of the cell. They also showed that  $Ca^{2+}$  competed with  $Mg^{2+}$  for ion binding sites, but that  $Mg^{2+}$  is bound preferentially. Monovalent cations such as  $Na^+$  and  $K^+$  were also found to bind, but both  $Mg^{2+}$  and  $Ca^{2+}$  were bound in preference (10 mM  $Ca^{2+}$  had the

same effect on the cell wall as 50 mM Na<sup>+</sup>). In this study some selective recovery of *B. anthracis* was observed in the presence of EDTA alone, however, recovery was enhanced in the presence of both EDTA and TA. These results indicate that variations in the cell wall composition of *B. anthracis* and *B. cereus* may lead to differences in susceptibilities to EDTA. It is possible that *B. cereus* is able to adapt more rapidly to growth in the Mg<sup>2+</sup> limited condition caused by the addition of EDTA to PLETB, leading to increased production of Mg<sup>2+</sup> binding teichoic acids. This may subsequently lead to greater disaggregation of the cell wall caused by EDTA, and binding of Tl<sup>+</sup> ions from the medium to the cell wall, which exert a toxic effect on cells of *B. cereus*.

Although PLETB allowed the selective recovery of different strains of *B. anthracis* from a mixture of *B. anthracis* and *B. cereus*, the addition of soil to PLETB reduced this selective recovery of *B. anthracis*. The addition of mineral ions, common in soil, to PLETB in the absence of soil showed that it was likely to be the excess mineral ions present in the soil which inhibited the recovery of *B. anthracis* in PLETB. Experiments revealed that Ca<sup>2+</sup>, Fe<sup>2+</sup>, Mn<sup>2+</sup>, Zn<sup>2+</sup> and Cu<sup>2+</sup> all inhibited the growth of *B. anthracis* in PLETB. The addition of Mg<sup>2+</sup> did not inhibit the recovery of *B. anthracis*. This indicated that the equilibrium between the free Mg<sup>2+</sup> ions in the broth and the Mg<sup>2+</sup> ions in the cell wall favoured the growth of *B. anthracis*.

Clay minerals have been shown to reduce the bioavailability of toxic metals, so may decrease the quantity of active Tl in the PLETB. For example, clay has been shown to increase the survival of *B. cereus* in lake water contaminated with 50 ppm nickel (Beveridge and Doyle, 1989). The addition of the appropriate chelating agent, to bind with the excess mineral ions introduced into the broth reduced the inhibition of the selective growth of *B. anthracis* caused by the mineral ions. This approach,

however was not practical for use in combination with different soil types, due to the variations in mineral ion composition of the soils tested.

The selective recovery of *B. anthracis* in PLETB could be improved by culture on PLETA after growth in PLETB, rather than culture on BA. Examining the growth of different strains of *B. anthracis* in PLETB in the presence of soil showed that *B. anthracis* ASC 27 could not readily be recovered. This could not be attributed to any unusual phenotypic or genotypic characteristics of this strain.

In the presence of soil the reduction in the selective recovery of *B. anthracis* in PLETB compared to the selective recovery of *B. anthracis* on PLETA could be attributed to the surface area of the agar leading to the separation of the *B. anthracis* spores and soil particles. Also on agar the direct competition between *B. anthracis* and *B. cereus* which occurs in PLETB is reduced. The use of semi-solid agar led to improved recovery of *B. anthracis* in environmental samples. This was attributed to the physical conditions in the medium resembling the characteristics of human tissue. When the use of semi-solid agar was tested on a range of samples, however, the results showed that *Bacillus* species other than those which comprise the '*B. cereus* group' outgrew *B. anthracis*.

To determine whether the use of antibiotics in an enrichment broth may lead to the selective recovery of *B. anthracis*, the recovery of *B. anthracis* from a mixture of *B. anthracis* and *B. cereus* in the presence of antibiotics to which *B. anthracis* has been reported to show resistance (Lightfoot *et al.*, 1990; Doganay and Aydin, 1991) was tested. These antibiotics act by inhibiting cell wall synthesis. The precise mechanism of action of these antibiotics on *Bacillus* species, however, has not been reported. The MIC's of cefuroxime and cefotaxime required to inhibit the growth of



*B. anthracis* determined in this study were comparable to those reported by Lightfoot *et al.* (1990) and Doganay and Aydin (1991). *B. cereus* however was found to be resistant to higher concentrations of cefuroxime and cefotaxime than *B. anthracis*. *B. anthracis* was shown to be resistant to 600 µg/ml aztreonam, however the majority of strains of *B. cereus* tested (19 of 24) were equally resistant to aztreonam. The reasons for the variation in resistance to aztreonam shown by different strains of *B. cereus* is beyond the scope of this study, but may be related to the different serotypes of *B. cereus*.

Culture in the presence of amoxicillin and clavulanic acid, which inhibit β-lactamase activity did not reduce the growth of *B. cereus* so therefore did not increase the recovery of *B. anthracis*. These results indicated that β-lactamase production is not especially important in the ability of *B. cereus* to outgrow *B. anthracis*.

Overall, the results of this chapter indicate that the use of semi-solid PLETB or PLETB in combination with chelating agents or aztreonam may improve the detection of *B. anthracis* in environmental material, in comparison to culture on PLETA alone. The wide variations in types of soil and sample which require testing, however, prevented the development of a system which would be generally applicable for the routine detection of *B. anthracis* in environmental samples.

From these results the most logical approach for further experiments was the separation or concentration of spores from soil prior to selective growth, rather than the enrichment of spores of *B. anthracis* directly in soil.

## 4.0 THE CONCENTRATION AND SUBSEQUENT DETECTION OF *BACILLUS ANTHRACIS* SPORES IN ENVIRONMENTAL MATERIAL

### 4.1 INTRODUCTION

When cultured in PLETB, the selective recovery of *B. anthracis* in soil is inhibited by mineral ions present in the soil (see Chapter 3). The physical separation of spores from soil particles, and the concentration of spores in environmental material, is an approach which could improve the selective recovery of *B. anthracis* as an alternative to using a chemical based enrichment broth.

The separation of spores from environmental material could also facilitate the detection of *B. anthracis* in soil using the PCR, which is generally inhibited by the mineral ions and humic material present in the soil (Aardema *et al.*, 1983; Steffan and Atlas, 1988; Wilson, 1997; see Section 1.8.1).

#### 4.1.1 Aqueous two-phase separation systems

Aqueous two-phase systems were originally developed to concentrate and separate cells and cell organelles from tissue (Albertsson, 1958). Two chemicals are used which at certain molarities form immiscible layers. A partition coefficient is established between the two phases. This results in the distribution of particles between the upper and lower layers and the interphase between them, according to their molecular weight, hydrophobicity or surface area. Alteration of the concentration of chemicals in the system allows the separation of different types of particle to be controlled.

#### 4.1.2 The concentration of spores of *Bacillus* species using two-phase systems

Sacks and Alderton (1961) investigated the behaviour of spores of *Bacillus* species in aqueous two-phase systems with the aim of producing clean bacterial spore preparations for use in biochemical studies. They found that in an aqueous two-phase system consisting of potassium phosphate buffer (KPO<sub>4</sub>; pH 7.0) and polyethylene glycol (PEG), spores of *B. cereus*, *B. megaterium*, *B. subtilis* and *B. coagulans* were concentrated in the upper, PEG rich, layer of the system. Vegetative cells and complex natural materials such as soil or faeces, were concentrated in the interphase and lower layer of the system.

Blomquist *et al.* (1984) and Ström and Blomquist (1986) used a two-phase system consisting of dextran and PEG with sulfonyl PEG to examine the partitioning behaviour of fungal propagules. The method was developed for use as an alternative to plate count techniques for the selective sampling and isolation of airborne fungal spores. The inhalation of high concentrations of such spores has been linked to allergies of the respiratory system. They found that spores of different species of *Penicillium* and *Aspergillus* could be selectively separated from each other by altering the composition of the two-phase system. Ström *et al.* (1987) used the same system to separate microorganisms from organic dust particles before microscopic examination. They found that 60 - 90% of the microorganisms showed an affinity with the upper PEG rich layer of the system. Vegetative cells of *B. subtilis*, however were located in the lower layer. These results indicate that the successful development of such an aqueous two-phase system may improve the selective recovery of spores of *B. anthracis* from environmental samples such as soil.

### 4.1.3 Methods for the separation of spores from soil particles

A potential problem which may occur when using a system for the concentration of spores in soil is the adhesion of spores to soil particles. The adhesion between bacteria and soil particles is difficult to study because of the complexity and heterogeneity of soil ecosystems (Stenstrom, 1989). Edwards and Bremner (1965) described a cation exchange method for dispersing mineral colloids in soil by replacing polyvalent cations with monovalent cations, using Dowex 1, an ion exchange resin analogous to Chelex. Bacteria are believed to be adsorbed to soil particles by bonds similar to those between the mineral colloids in soil. Chelex has been shown to separate microorganisms from soil particles by breaking down soil aggregates and disrupting the bonds between microorganisms and soil particles. Chelex has been used to separate *Streptomyces* spores and *Salmonella* species from soil (Herron and Wellington, 1990; Turpin *et al.*, 1993).

Other reagents which have been recommended for the separation of microorganisms from soil include sodium deoxycholate and Triton X-100. Sodium deoxycholate is a non-ionic detergent that can be used to disrupt polymers which bind cells to soil particles (Macdonald, 1986). Triton X-100 is used in methods developed at the Naval Medical Research Institute, Bethesda, Maryland.

An alternative method which may allow the separation of spores from soil particles is germination and outgrowth of the spores. This would alter the physical bonds between the spores and soil particles and may allow vegetative cells to become separate from the soil.

## **4.2 The aim of this chapter**

The aim of the work presented in this chapter was to develop a two-phase system for the concentration of spores of *B. anthracis* in soil.

## **4.3 Materials and Methods**

### **4.3.1 Soils used in this study**

Soil naturally contaminated with spores of *B. anthracis* from the Etosha National Park Namibia (ASS 93/288), and Landkey, Devon (ASS 91/2, 91/85, 91/88 and 91/89) were used (see Table 3.2; p 81). Artificially seeded soils GTS, ASS 149/93, peat and plaster ASS 92/322 were also used (see Table 3.25; p 132).

Soils with a wide range of clay and organic contents were provided by Mr Paul Poulton, Institute of Arable Crop Research, Rothampstead. The approximate clay, organic content and pH of these soils are presented in Table 4.1. To try and retain the moisture content of the soils, before seeding with spores of *B. anthracis*, soils were stored out of doors in terracotta pots, dug into the ground.

### **4.3.2 Seeding of soils with spores of *B. anthracis***

Soils were sterilised by placing in plastic autoclave bags and heating to 90 °C in a drying oven for 1 week. The sterility of each soil was checked by culture on BA. For initial experiments sterile soil (30 g) was seeded with 1 ml of SDW containing  $1 \times 10^4$  spores of *B. anthracis* ASC 245. Seeded soils were stored in air tight sample pots at room temperature. For experiments using the bank of different soil samples described in Table 4.1, non-sterile soil (10 g) was seeded with 1 ml of SDW containing  $1 \times 10^4$  spores of *B. anthracis* ASC 6, ASC 80, ASC 69, ASC 192 or ASC 245 (see Table

2.1; p 44). Soils were stored at room temperature in glass bottles plugged with cotton wool stoppers.

**Table 4.1 Range of soils used for two-phase concentration experiments**

Soil	% Clay	% Organic Carbon	pH
Woburn Organic Manuring Plot 8	8	0.6	6.5
Woburn Ley-Arable Plot 19	12	0.65	7.1
Woburn Ley-Arable Plot 24	12	1.3	6.9
Broadbalk Plot 031	20	1.0	7.4
Broadbalk Plot 221	20	2.5	7.3
Parkland (grass)	25	3.5	6.5
Ver (grass)	25	6.0	5.5
Agdell	30	1.5	7.4
Broadmead IV (Eastern corner)	40	3.0	8.3

Data provided by Mr P. Poulton

#### **4.3.3 Evaluation of the two-phase separation method of Sacks and Alderton (1961)**

The two-phase separation method used by Sacks and Alderton (1961) was carried out as described in Section 2.8 (p 50). Briefly, the  $KPO_4$  buffer (2.91 ml, 3.0 M) and PEG solution (2.0 ml, 50% in SDW) were added to SDW (3.7 ml) in a 15 ml plastic centrifuge tube and seeded with spores of *B. anthracis* ASC 245 to a final concentration of approximately  $5 \times 10^2$  spores/ml. For further experiments, sterile soil

or plaster (0.5 g) was added in addition to the spores, or 0.5 g of soil previously seeded with *B. anthracis* spores was added. The system was mixed by vortexing and a sample (100 µl) taken. The tubes were then centrifuged to separate the two layers and further samples were taken from the upper and lower phases. Samples were cultured overnight at 37 °C on BA when sterile soil seeded with *B. anthracis* was used, or for 48 h on PLETA when non-sterile soil was used. The number of colonies of *B. anthracis* detected on the agar was recorded.

#### **4.3.4 Optimisation of the centrifuge speed and concentration of $KPO_4$ buffer**

Different concentrations of  $KPO_4$  buffer (1.5 M - 3.0 M) were used to make the two-phase system. Similar experiments were conducted using 3.0 M  $KPO_4$  buffer and centrifugation speeds of 3000 x g to 500 x g, in 500 x g intervals. Tubes were seeded with spores of *B. anthracis* ASC 245 and sampled as described above.

#### **4.3.5 Separation of spores from soil particles using cation exchange**

Samples for which two-phase concentration was unsuccessful were examined using cation exchange methods. Sterile soil samples GTS, ASS 49/149, peat and ASS 91/82 (see Table 3.25) pre-seeded with *B. anthracis* spores were added to SDW containing Chelex (0 - 20%), 0.1% sodium deoxycholate or 0.5 - 5.0% Triton X-100 and mixed at 4 - 8 °C on a roller mixer for 60 - 90 min. Samples were taken before and after incubation.  $KPO_4$  buffer and PEG were subsequently added and two-phase concentration was conducted as described above. Samples were cultured overnight at 37 °C on BA and the number of colonies of *B. anthracis* detected on agar was recorded.

#### **4.3.6 The effect of soaking soil on the recovery of spores of *B. anthracis***

Soil (0.5 g) was added to 3.7 ml of SDW and mixed at 4 - 8 °C for 90 min. Samples (100 µl) were taken before and after incubation and cultured on agar. After incubation, a second sample was taken and heated (62.5 °C for 15 min) before culture on agar. As a control, spores were incubated in the absence of soil with glass beads (0.4 mm diameter, which is the size of medium sized sand particles) which were added to represent the soil particles. Also soil samples were held at 4 - 8 °C without mixing. Spore solutions were sampled as described above.

#### **4.3.7 The addition of broth to the two-phase concentration system**

BHIB or PLETB was substituted for the SDW added to the two-phase concentration system. After mixing, instead of centrifugation, samples were allowed to form layers by static incubation at 37 °C for 5 - 7 h. Samples were subsequently taken from the top, interphase and bottom of the tube and cultured on PLETA for 48 h at 37 °C. Prior to the addition of broth to the system, no particles were visible in the interphase, hence in previous experiments the interphase was not sampled. The resulting growth of *B. anthracis* on agar was recorded.

To determine whether incubation with Chelex in combination two-phase concentration with PLETB would improve the concentration of spores of *B. anthracis*, the methods were combined. Soil (0.5 g) seeded with spores of *B. anthracis* was added to SDW containing 0, 5, 10 and 20% Chelex and mixed for 60 - 90 min at 4 - 8 °C. Samples were taken before and after this period. PLETB (4 x concentrated to allow for the dilution factor), PEG and 3.0 M  $KPO_4$  were then added to the solution. For comparison, dry soil, diluted just before the addition of PEG and



KPO<sub>4</sub> was used. Broths were incubated at 37 °C for 6 h, and samples taken from the interphase and lower phase and cultured on PLETA for 48 h at 37 °C. To determine whether the concentration of KPO<sub>4</sub> buffer affected the separation of *B. anthracis* in the presence of PLETB, different concentrations of buffer (2.5 M - 3.0 M) were tested in the two-phase system (in the absence of Chelex) using naturally contaminated soil and soil pre-seeded with spores of *B. anthracis* ASC 245. To further increase the recovery of *B. anthracis*, samples from the interphase (1 ml) were concentrated by centrifugation (13 000 x g for 2 min). The pellet was resuspended in 100 µl SDW and cultured on BA or PLETA and the number of colonies of *B. anthracis* recorded.

#### **4.3.8 Comparison of the two-phase concentration system to enrichment culture**

The optimised two-phase concentration system developed in this study was compared to enrichment broth culture, using naturally contaminated soil ASS 91/2. Soil was added to BHIB, PLETB and PLETB containing 5% or 10% Chelex (added to chelate excess ions present in the soil) and incubated at 37 °C for 7 h. Two-phase separation with enrichment was carried out using an identical soil sample, as described above.

#### **4.3.9 Evaluation of the two-phase concentration system using a range of soil types and strains of *B. anthracis***

To determine whether spores inoculated into soil formed attachments to soil particles over time, soils (10 g; see Table 4.1; p 160) were seeded with 1 ml of SDW containing  $1 \times 10^4$  spores of *B. anthracis* and two-phase separation without enrichment was carried out after 0, 2, 4, 8 and 28 days. Two-phase separation with enrichment was carried out 28 days after soils were seeded with *B. anthracis* spores.

#### 4.3.10 Scale up of the two-phase concentration with enrichment system

The two-phase concentration system was scaled up to use 5 g soil samples, by mixing soil seeded with *B. anthracis* spores (0.5 g) with unseeded soil of the same type (4.5 g). Soil was placed in a 50 ml plastic centrifuge tube, SDW (9 ml) added and the solution mixed at 4 - 8 °C for 90 min. Samples were taken before and after mixing. PLETB (9 ml of 4 x concentrated) PEG solution (10 ml) and 14.7 ml of 2.75 M  $KPO_4$  buffer was added. The tubes were mixed by inversion and incubated at 37 °C for 6 h. Liquid from the interphase (6 ml) was diluted in 6 ml of SDW to reduce the viscosity of the liquid and concentrated by centrifugation (3000 x g for 2 min). The pellet was resuspended in 100 µl of SDW and cultured on PLETA.

To compare the scaled up two-phase enrichment system to culture in PLETB, two 5 g samples of soils WLA 19, WOM 8, BB031 and BB221 seeded with ASC 80 spores were used. One tube from each soil type was processed as described above. To the other tube 9 ml of SDW was added to the soil and a sample taken. 9 ml of 2 x PLETB and 24.5 ml of 1 x PLETB, (to give a final concentration in the broth of 1 x PLETB) was subsequently added. Samples were incubated at 37 °C for 7 h and a sample of the resulting growth (10 µl) cultured on PLETA. Soil samples in which *B. anthracis* could not consistently be detected by direct culture on PLETA (see Table 3.2, p 81) were tested in the same manner.

## 4.4 RESULTS

### 4.4.1 Two-phase concentration of *B. anthracis* spores

Initial experiments were conducted to determine whether the two-phase system described by Sacks and Alderton (1961) would allow the concentration of

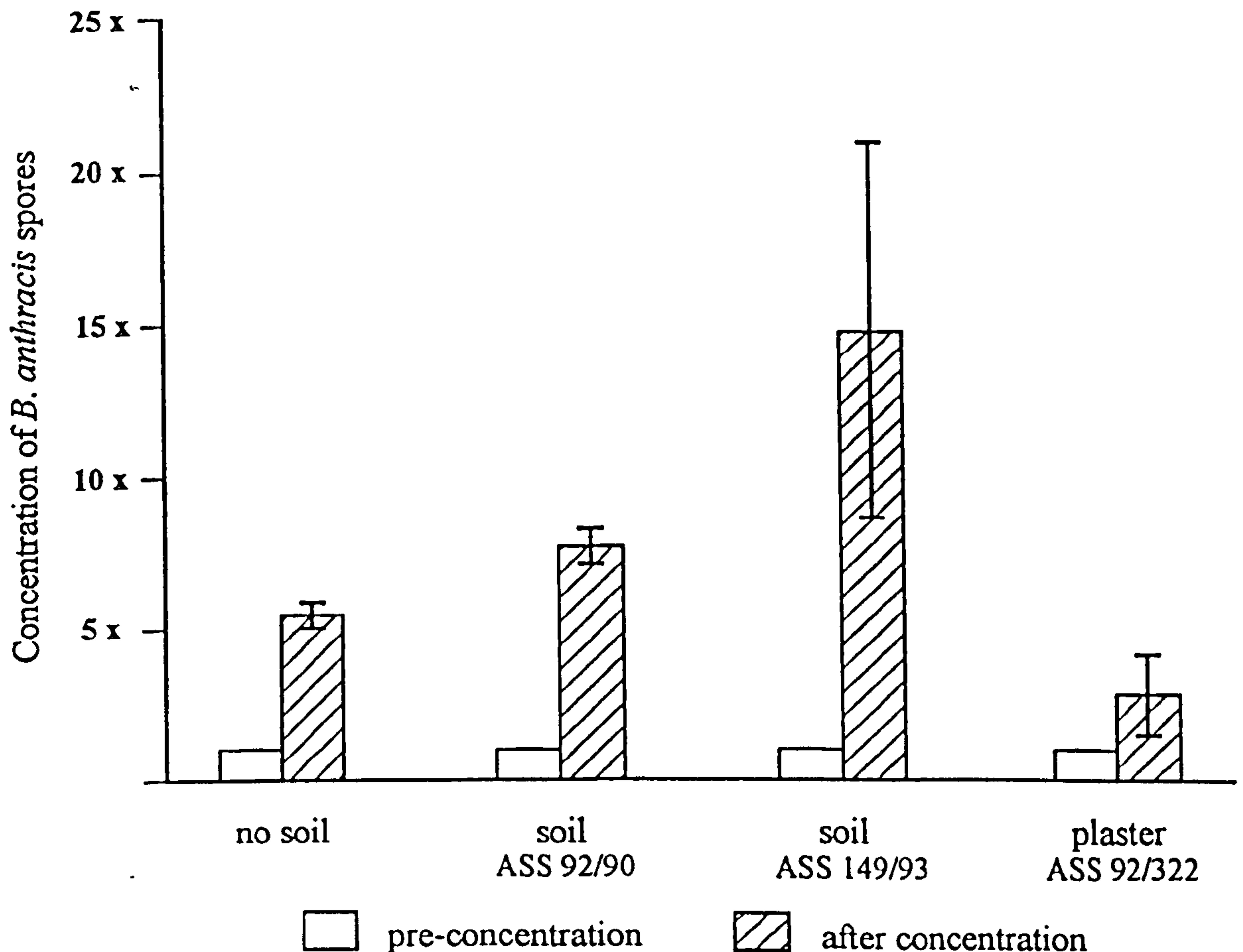
*B. anthracis* spores. A five-fold concentration of *B. anthracis* spores was observed in the upper layer of the two-phase system (Fig 4.1). When sterile soil or plaster was added, the concentration of spores in the upper layer ranged from approximately 3-15 fold (Fig 4.1). The majority of soil or plaster particles collected in the bottom of the tube. The method had the advantages of being rapid, and using chemicals which are readily available in general purpose laboratories. The method recommended by Ström and Blomquist (1986, see p 157) was also evaluated but found to be less practical for routine use, as it is more time consuming, requiring four sequential two-phase separations.

#### **4.4.2 Optimisation of the centrifugation speed and $KPO_4$ buffer concentration used in the two-phase concentration system**

Reduction of the speed at which the samples were centrifuged did not increase the number of spores recovered in the upper layer of the two-phase concentration system (Table 4.2). The concentration of spores in the upper phase was not great, however results allowed the comparison of the effect of centrifugation speed. From the results it appeared unlikely that increasing the centrifuge speed would result in improved recovery of *B. anthracis*. Also 3000 x g was the maximum speed recommended for the rotor used. Decreasing the molarity of the  $KPO_4$  buffer increased the time taken for the two layers to form and gradually reduced the concentration of spores in the upper layer (Fig. 4.2). When 1.5 M  $KPO_4$  was used, the two immiscible layers were not formed. Increasing the  $KPO_4$  concentration above 3.0 M led to solubility problems. Further experiments were conducted using 3.0 M  $KPO_4$  buffer and a centrifugation speed of 3000 x g.

**Figure 4.1**

Concentration of spores of *B. anthracis* ASC 245 using a two-phase system in the presence and absence of environmental material



2.9 ml 3.0 M potassium phosphate buffer (pH 7.0), 2.0 ml PEG (50 % in SDW) and 3.7 ml SDW were mixed in a 15 ml centrifuge tube. Spores of *B. anthracis* ASC 245 ( $10^2$ ) or spores and 0.5 g sterile soil of plaster were added, the solution mixed and a sample (100  $\mu$ l) taken. After centrifugation in a swing out rotor at 3000 x g for 2 min a further sample was taken from the upper layer of the system. Samples were cultured overnight at 37 °C on BA and the number of colonies of *B. anthracis* recorded. The concentration factor was calculated by dividing the total number of spores detected after concentration by the total number of spores detected before concentration. Experiments were conducted in triplicate. Error bars represent the standard error of the mean. Pre-concentration samples were assigned a concentration factor of x 1.

**Table 4.2 Comparison of the recovery of spores of *B. anthracis* ASC 245 from the two-phase system after centrifugation at different speeds**

Centrifugation speed (g)	Number of colonies of <i>B. anthracis</i>	
	Upper phase (%)	Lower phase (%)
3000	17 (55)	14 (45)
2500	16 (41)	23 (59)
2000	11 (44)	14 (56)
1500	9 (21)	34 (79)
1000	10 (29)	24 (71)
500	15 (41)	22 (59)

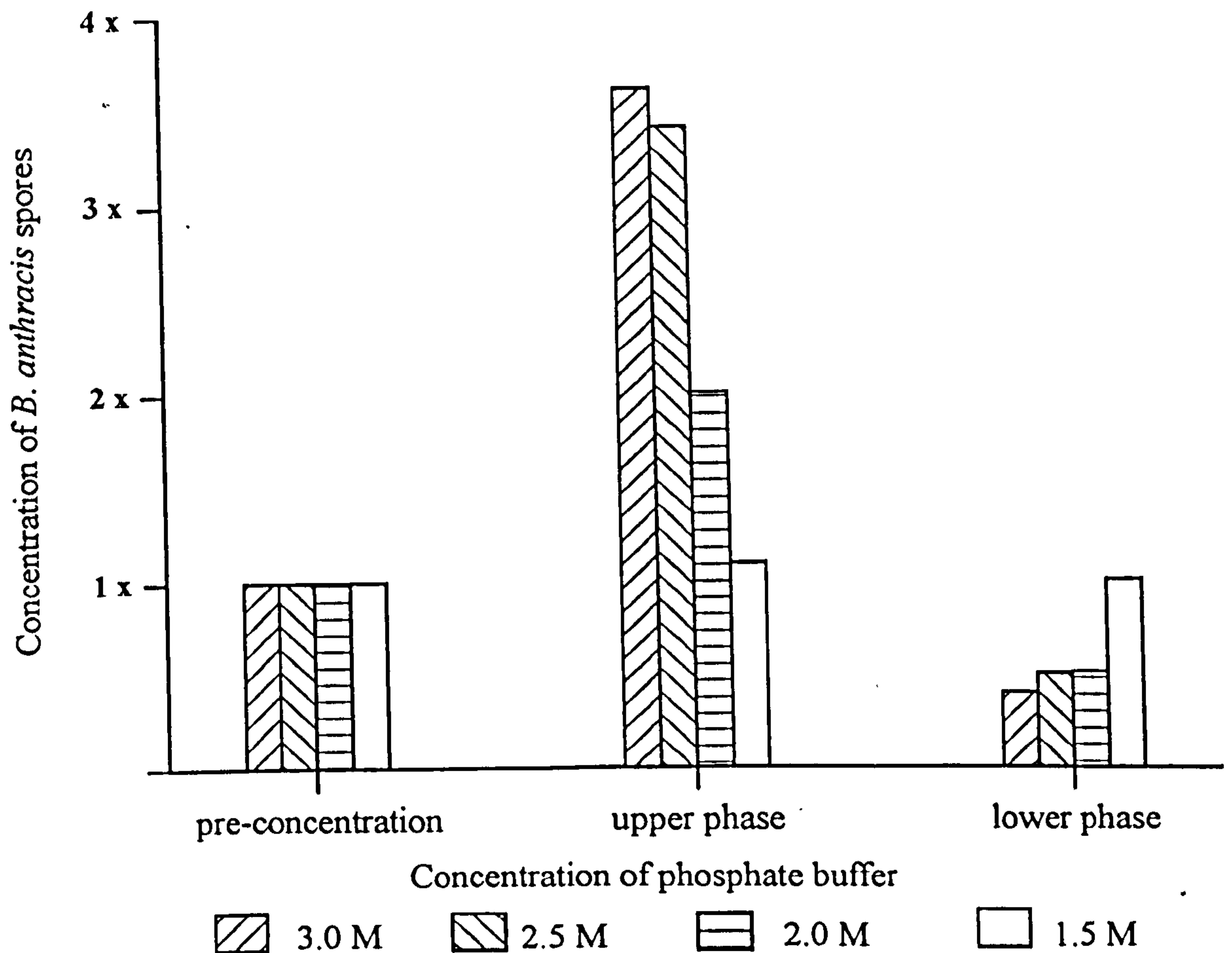
Results are from a representative experiment

#### **4.4.3 Evaluation of the two-phase concentration system using naturally contaminated soils**

*B. anthracis* spores were concentrated in the upper layer of the system when soil ASS 93/288 was used. Using soil ASS 91/2 fewer spores were detected and the majority of these were concentrated in the lower layer (Fig 4.3). Visual examination of soil ASS 93/288 showed that the soil was free running and consisted of coarse and medium sand sized particles (0.2 - 0.6 mm in diameter). Soil ASS 91/2 however formed cohesive lumps which were difficult to disperse, and could be seen to consist predominantly of clay or silt particles. The results indicated that the composition of the soil affects the concentration of spores in the two-phase system. Edwards and Bremner (1965) reported that when using cation exchange, soil with a high clay

**Figure 4.2**

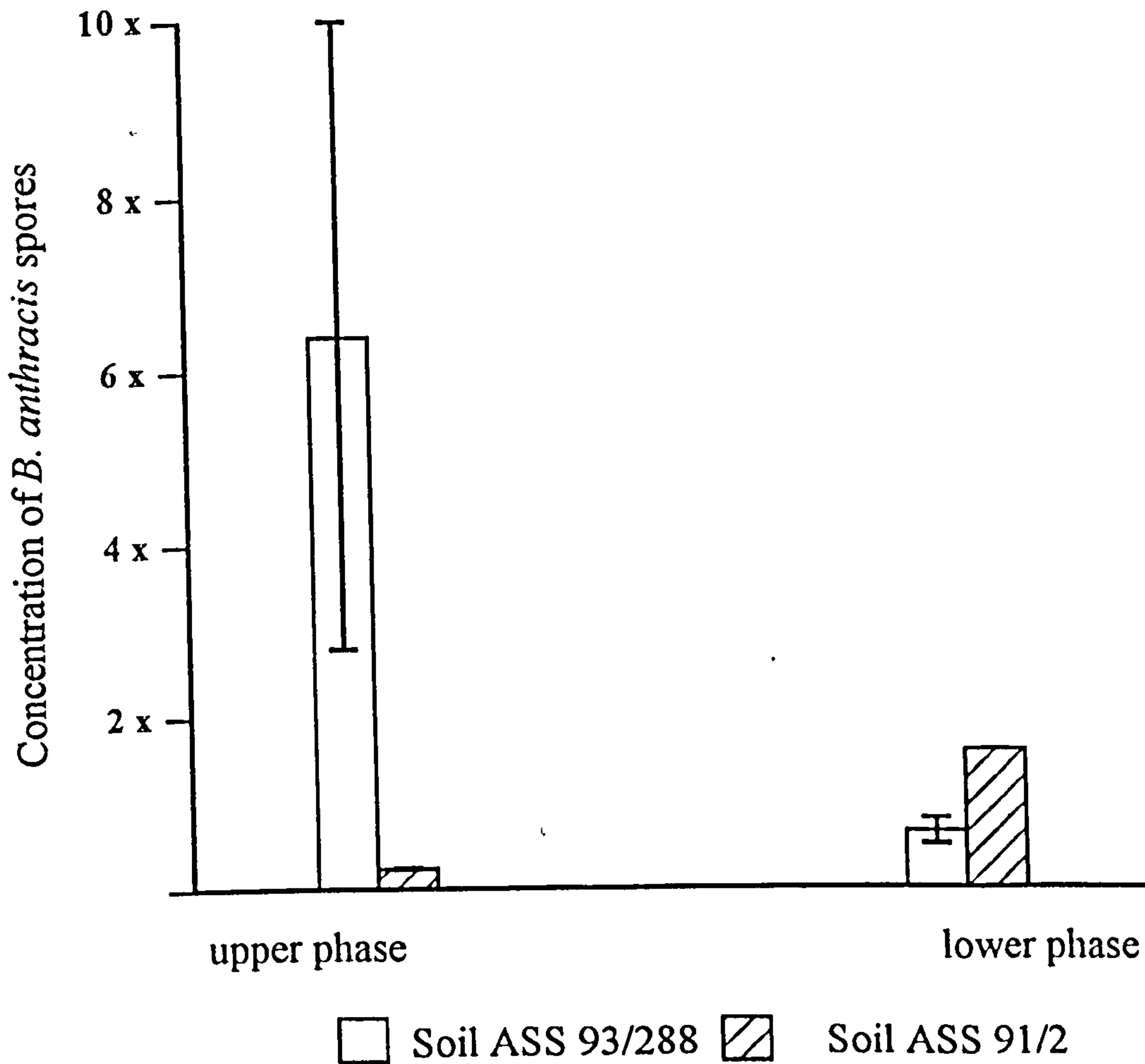
Concentration of spores of *B. anthracis* ASC 245 using a two-phase system with different molarities of potassium phosphate buffer



Potassium phosphate buffer (2.91 ml of 3.0 M, 2.5 M, 2.0 M and 1.5 M solutions; pH 7.0), were added to 2.0 ml PEG (50 % in SDW) and 3.7 ml SDW and seeded with spores of *B. anthracis* ASC 245 ( $10^2$ ). Samples (100  $\mu$ l) were taken after mixing, and from the upper and lower phases of the system after centrifugation (3000 x g for 2 min). Samples were cultured overnight at 37 °C on BA and the number of colonies of *B. anthracis* recorded. The concentration factor was calculated by dividing the total number of spores detected after concentration by the total number of spores detected before concentration. Pre-concentration samples were assigned a concentration factor of x 1.

**Figure 4.3**

Concentration of spores of *B. anthracis* from naturally contaminated soil (ASS 91/2, ASS 93/288)



Soil (0.5 g) was added to 2.9 ml 3.0 M potassium phosphate buffer (pH 7.0), 2.0 ml PEG (50 % in SDW) and 3.7 ml SDW. Samples were taken after mixing, and from the upper and lower phases of the system after centrifugation (3000 x g for 2 min). Samples were cultured on PLETA at 37 °C for 48 h and the number of colonies of *B. anthracis* recorded. The concentration factor was calculated by dividing the total number of spores detected after concentration by the total number of spores detected before concentration. Experiments were conducted in duplicate. Error bars represent the standard error of the mean. Pre-concentration values of x 1 are not shown.

content was the hardest to disperse. From this information it was hypothesised that in the clay soil, spores were more likely to bind to soil particles, and subsequently remain with the soil in the lower layer of the two-phase system.

#### **4.4.4 A comparison of two-phase concentration using soil seeded with *B. anthracis* immediately before or one week before the experiment**

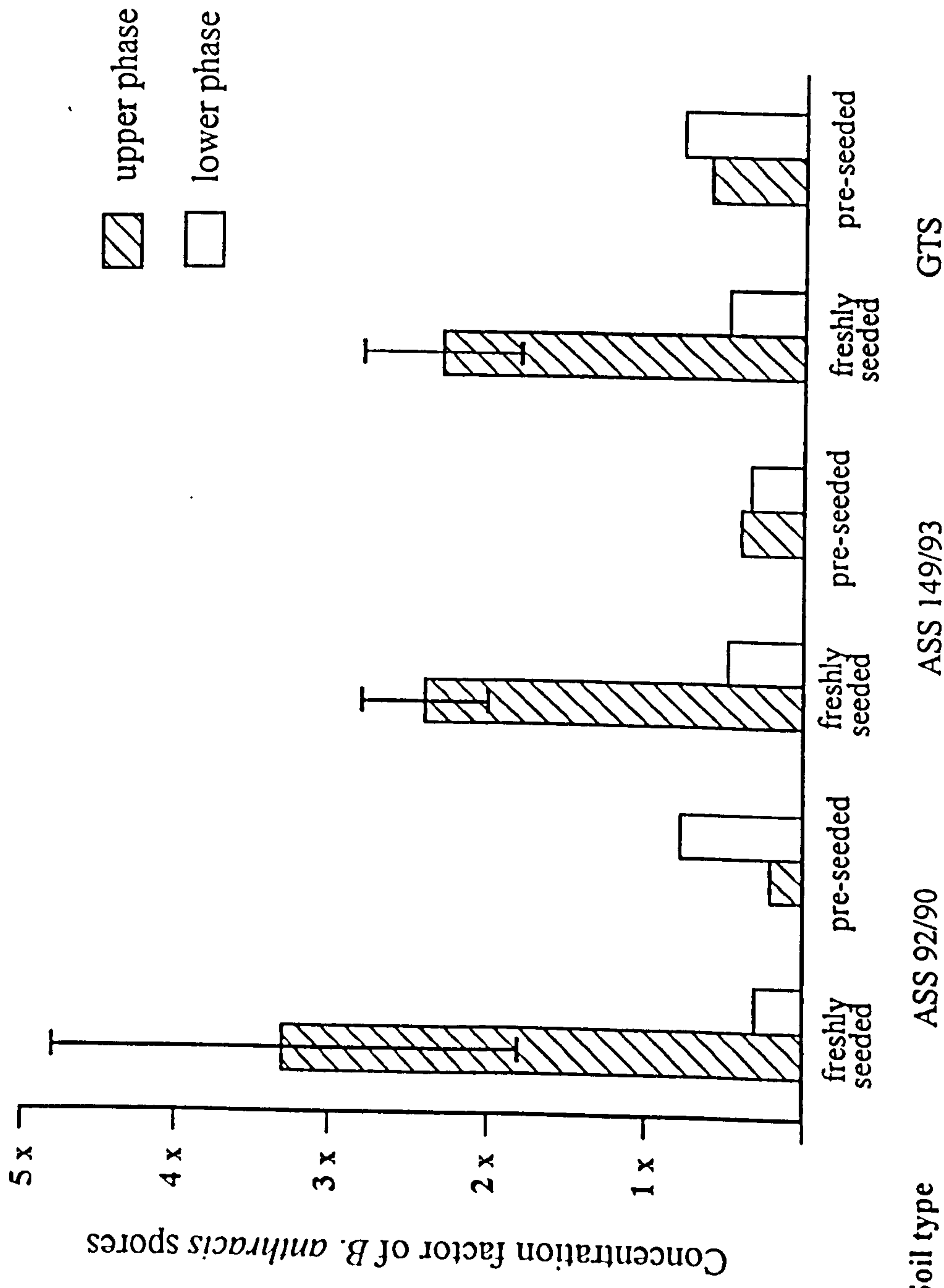
To determine whether spores of *B. anthracis* were attached to soil particles, two-phase concentration was carried out using freshly seeded and pre-seeded soil. When soil was seeded with spores of *B. anthracis* a week before the experiment, the spores were not concentrated in the two-phase system, whereas when spores were freshly added to the soil, concentration in the upper layer occurred (Fig. 4.4). This indicated that when spores were introduced into soil a week before the experiment they had become attached to soil particles. It is therefore unlikely that a two phase system would allow the concentration of spores from naturally contaminated samples in which spores had formed attachments with soil particles, without prior separation of spores from the soil.

#### **4.4.5 The separation of *B. anthracis* spores from soil particles prior to two-phase concentration**

Incubation of soil in a solution of SDW containing 0.1% sodium deoxycholate (as recommended by Macdonald, 1986) or 0.5 - 1% Triton X-100 (used by NMRI) did not increase the spore concentration in the upper phase of the system in comparison to mixing in SDW only (Table 4.3). When soil solution containing 0.1% - 5.0% Triton X-100 was cultured on PLETA, the number of colonies of *B. anthracis* that



Figure 4.4 Comparison of the concentration of spores of *B. anthracis* ASC 245 in pre-seeded and freshly seeded soil



Two-phase concentration was carried out using sterile soil which had been seeded with spores of *B. anthracis* ( $10^3$  spores/g) and incubated at room temperature for 1 week, and with soil freshly seeded with spores of *B. anthracis* ASC 245. 2.9 ml 3.0 M potassium phosphate buffer (pH 7.0), 2.0 ml PEG (50 % in SDW) and 3.7 ml SDW were mixed in a 15 ml centrifuge tube with 0.5 g soil. Samples (100  $\mu$ l) were taken prior to centrifugation (3000 x g for 2 min) and subsequently from the upper and lower phases. Samples were cultured overnight at 37 °C on BA and the number of colonies of *B. anthracis* recorded. The concentration factor was calculated by dividing the total number of spores detected after concentration by the total number of spores detected before concentration. Experiments were conducted in duplicate. Error bars represent the standard error of the mean. Pre-concentration samples were assigned a concentration factor of x 1.

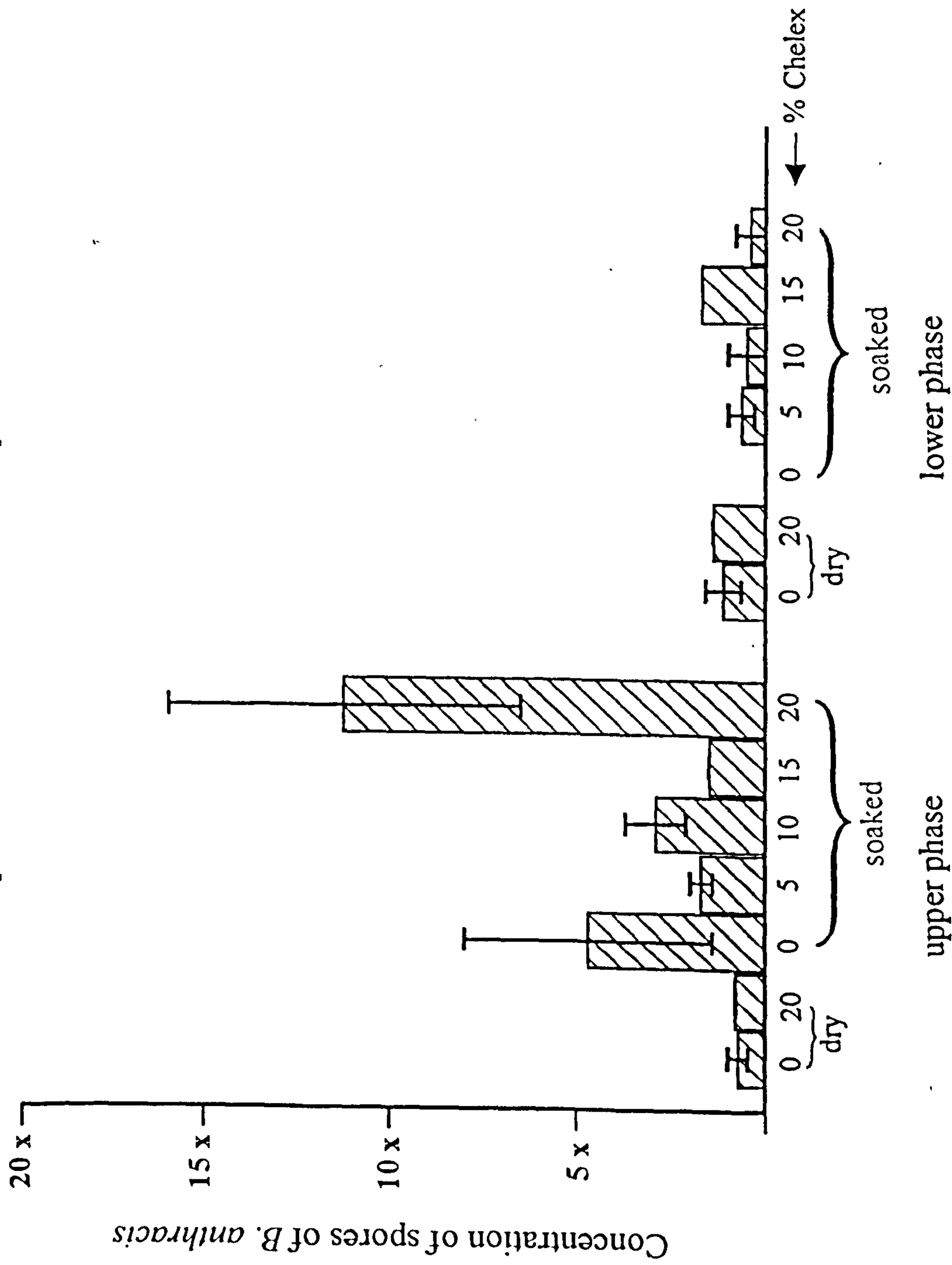
**Table 4.3 The effect of Triton X-100 and sodium deoxycholate on the selective recovery of *B. anthracis* spores in the two-phase system**

Addition to soil solution	Concentration factor	
	Expt 1	Expt 2
No addition	2.9	3.8
0.5% Triton X-100	0.45	0.86
1.0% Triton X-100	0.66	0.61
5.0% Triton X-100	1.19	2.2
0.1% Na deoxycholate	0.3	0.2

The concentration factor was calculated by dividing the total number of spores detected after concentration by the total number of spores detected before concentration

were recovered was lower than that observed when a dilution of soil solution in water was cultured on PLETA. This indicated that the addition of 0.1% - 5.0% Triton X-100 was reducing the recovery of *B. anthracis* spores on PLETA. The use of sodium deoxycholate and Triton X-100 was therefore not pursued. Chelex was found to improve the recovery of spores in the upper phase of the system. Although some variation was found between experiments, when 20% Chelex was used, almost total recovery of the spores present in the system was achieved (Fig. 4.5). For comparison, identical experiments were conducted using soil which was not mixed with SDW prior to the addition of the two-phase concentration reagents. Mixing soil in SDW alone also led to an increase in the number of spores detected on agar, although the increase was not as great as that observed in the presence of Chelex. This was

**Figure 4.5** The effect of Chelex on the two-phase concentration of spores of *B. anthracis* ASC 245 pre-seeded into GTS soil



Soil (0.5g) was incubated in 3.7 ml SDW containing 0 - 20 % Chelex on a roller mixer at 4 °C. For comparison, dry soil and dry soil with 20% Chelex was processed in the same manner, without the initial incubation in SDW. After 1 h, 2.9 ml potassium phosphate buffer (3.0 M, pH 7.0) and 2.0 ml PEG (50 % in SDW) were added. Samples (100 µl) were taken before and after centrifugation (3000 x g for 2 min) from the upper and lower phases. Samples were cultured overnight on BA at 37 °C and the number of colonies of *B. anthracis* recorded. The concentration factor was calculated by dividing the total number of spores detected after concentration by the total number of spores detected before concentration. Experiments were conducted in duplicate. Error bars represent the standard error of the mean. Pre-concentration samples were assigned a concentration factor of x 1.

attributed to the breaking down of soil particles, allowing a more even distribution of spores throughout the sample. To determine whether chemical factors in the soil could be affecting the recovery of spores of *B. anthracis*, soils containing spores were soaked in water statically or with mixing, and samples taken before and after mixing. A further sample was taken after mixing and heated (62.5 °C for 15 min) before culture on agar. One of 6 soils tested (GTS) showed a decrease in concentration of spores after heating (Table 4.4; line 4).

**Table 4.4** The effect of soaking soil on the recovery of spores of *B. anthracis*

Sample	Soil incubated with mixing		Soil incubated statically	
	After soaking	After heating	After soaking	After heating
1) Peat	2.3	1.1	1.0	1.0
2) ASS 91/82	1.7	1.6	1.8	1.5
3) ASS 93/149	0.8	1.8	0.9	0.8
4) GTS	1.6	0.6	1.1	0.7
5) ASS 91/2	1.5	1.5	2.0	2.0
6) ASS 93/288	0.8	1.2	0.8	1.5
7) glass beads	0.9	1.0	ND	ND

Results shown are from representative experiments; 1 - 4 = seeded soils; 5 - 6 = Naturally contaminated soils. Each value represents the concentration factor. This was calculated by dividing the total number of spores detected after concentration by the total number of spores detected before concentration; ND = not done

This reduction in the recovery of spores could be due to certain compounds present in the soil causing spores to germinate and subsequently be killed by heating. When naturally contaminated soil was used, no reduction in the recovery of spores of *B. anthracis* was observed (Table 4.4; lines 5 and 6). . The addition of glass beads instead of soil did not lead to a reduction in spore count ( Table 4.4; line 7).

#### **4.4.6 Combination of two-phase separation with enrichment.**

The incorporation of broth into the two-phase system led to the concentration of *B. anthracis* from naturally contaminated soil ASS 91/2 (Fig. 4.6). *B. anthracis* was found to be concentrated in the interphase of the system, rather than the upper phase, and concentration increased slightly with incubation time. The addition of broth to the system may have either altered the ionic composition of the system, improving the recovery of spores from soil particles or led to a limited germination and growth phase of *B. anthracis*. The addition of PLETB was found to produce a greater concentration of *B. anthracis* than BHIB (Fig. 4.6).

#### **4.4.7 Optimisation of the two-phase concentration with enrichment system**

##### **4.4.7.1 Combination of soaking and two-phase concentration with enrichment**

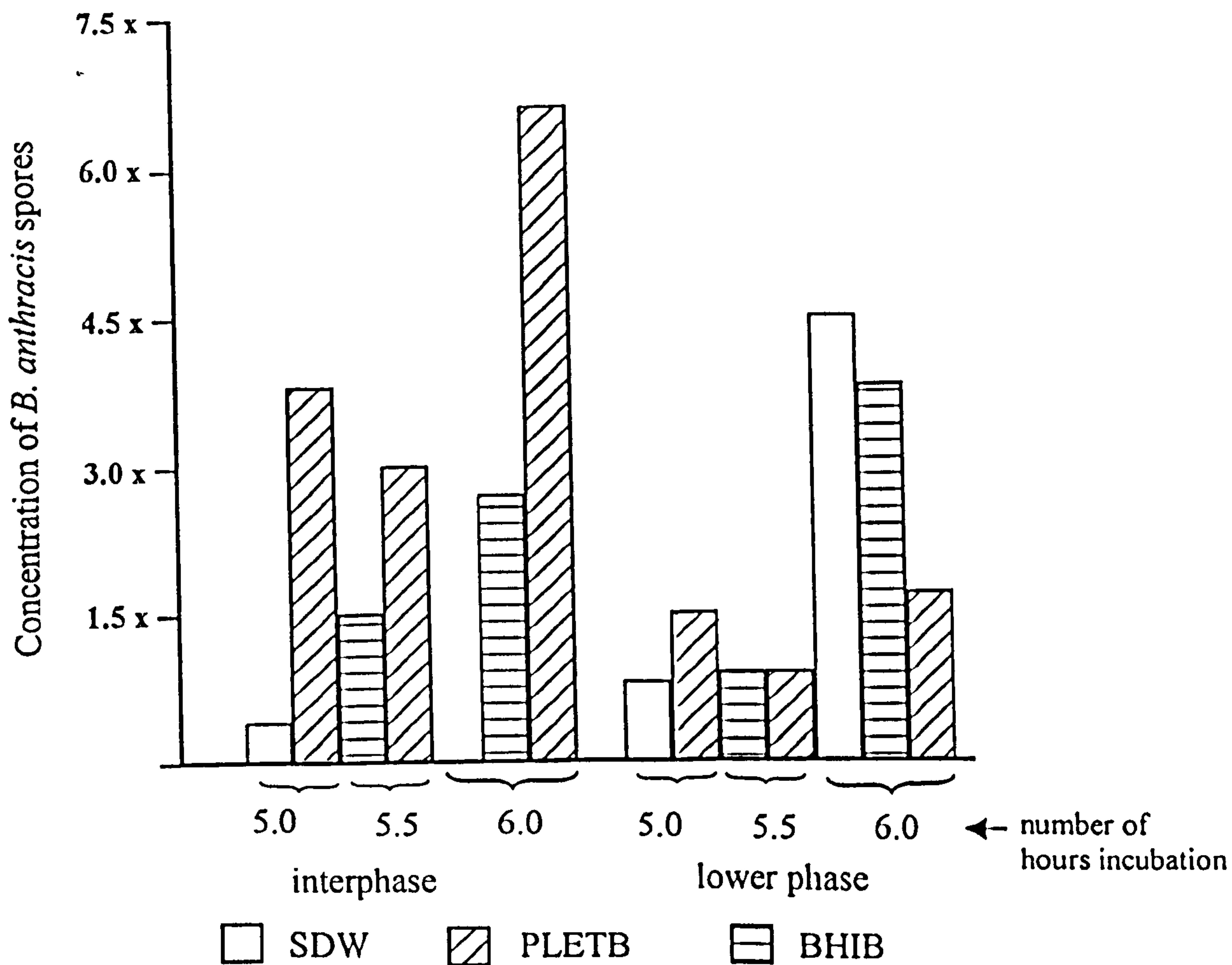
When combined with enrichment, Chelex reduced the recovery of *B. anthracis* (Fig. 4.7). This may have been due to the Chelex complexing with cations in the broth, and altering the ionic composition of the system.

##### **4.4.7.2. Optimisation of the concentration of $KPO_4$ buffer**

Reduction of the concentration of  $KPO_4$  buffer to 2.6 M - 2.75 M was an

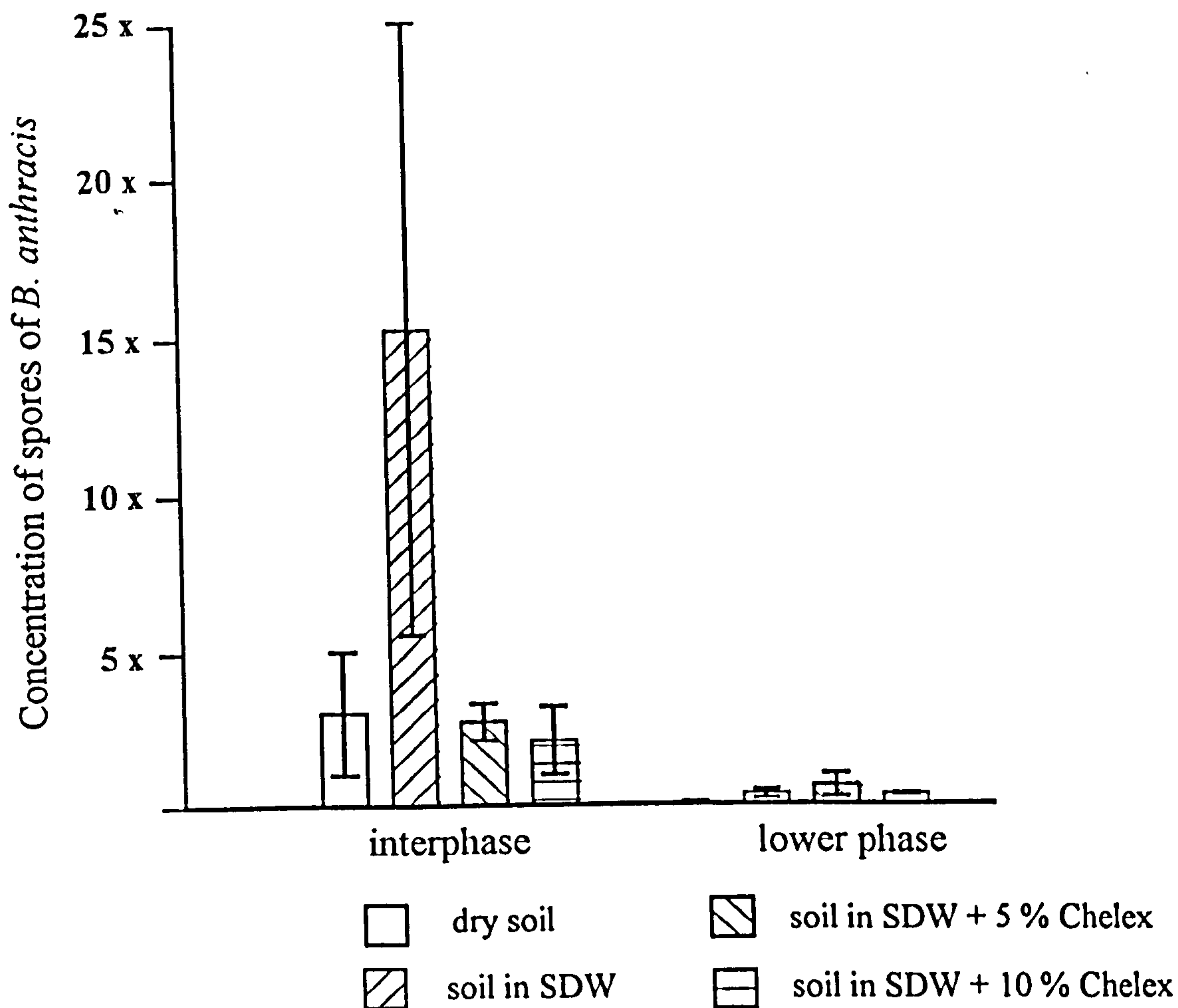
**Figure 4.6**

The recovery of *B. anthracis* from soil (ASS 91/2) using a two-phase concentration system with enrichment



3.7 ml SDW, BHIB or PLETB, 2.9 ml 3.0 M potassium phosphate buffer (pH 7.0) and 2.0 ml PEG (50 % in SDW) were added to 0.5g soil. After mixing, a sample was taken and the mixture incubated at 37 °C for 5 h, 5.5 h or 6 h. Samples (100 µl) were taken from the interphase and lower phases of the system and cultured for 48 h on PLETA at 37 °C, and the number of colonies of *B. anthracis* recorded. The concentration factor was calculated by dividing the total number of spores detected after concentration by the total number of spores detected before concentration. Pre-concentration values of x 1 are not shown. Results are from a representative experiment.

**Figure 4.7** The effect of the addition of Chelex on the recovery of *B. anthracis* in soil ASS 91/2 using two-phase concentration with enrichment



Soil (0.5 g) was incubated for 1 h at 4 °C in SDW in the presence of 0, 5 % and 10 % Chelex. PLETB (60 000 units/l polymyxin B sulphate, 500 000 units/l lysozyme, 600 mg/l EDTA and 80 mg/l TA in 4 x concentrated BHIB) 2.9 ml 3.0 M potassium phosphate buffer (pH 7.0) and 2.0 ml PEG (50 % in SDW) were added. For comparison, dry soil was added to the two-phase system without soaking. After mixing, broths were incubated at 37 °C for 6 h. Samples (100 µl) were taken from the interphase and lower phase, cultured on PLETA for 48 h at 37 °C and the number of colonies of *B. anthracis* recorded. The concentration factor was calculated by dividing the total number of spores detected after concentration by the total number of spores detected before concentration. Experiments were conducted in duplicate. Error bars represent the standard error of the mean. Pre-concentration values of x 1 are not shown

improvement on using 3.0 M  $KPO_4$  buffer. No clear trend in the recovery of *B. anthracis* with different concentrations of buffer was observed. For further experiments 2.75 M  $KPO_4$  buffer was used (Table 4.5).

**Table 4.5 Effect of  $KPO_4$  buffer concentration on the recovery of *B. anthracis* spores in the two-phase separation with enrichment system**

<b><math>KPO_4</math> concentration (M)</b>	<b>Concentration factor of spores</b>		
	<b>Seeded sterile GTS soil (ASC 245)</b>	<b>ASS 91/2 * (high clay content)</b>	<b>ASS 93/288 * (high sand content)</b>
2.60	7.8	20.9	25.4
2.65	7.0	40.0	13.5
2.70	8.7	20.7	8.5
2.75	9.4	65.0	14.0
3.0	5.8	9.4	ND

Results shown are from a representative experiment; \* Naturally contaminated soils; The concentration factor was calculated by dividing the total number of spores detected after concentration by the total number of spores detected before concentration; ND = not done

The concentration  $KPO_4$  of buffer was not reduced below 2.5 M as the addition of 2.0 M  $KPO_4$  buffer was shown to reduce concentration of spores (see Fig. 4.2; p 168).



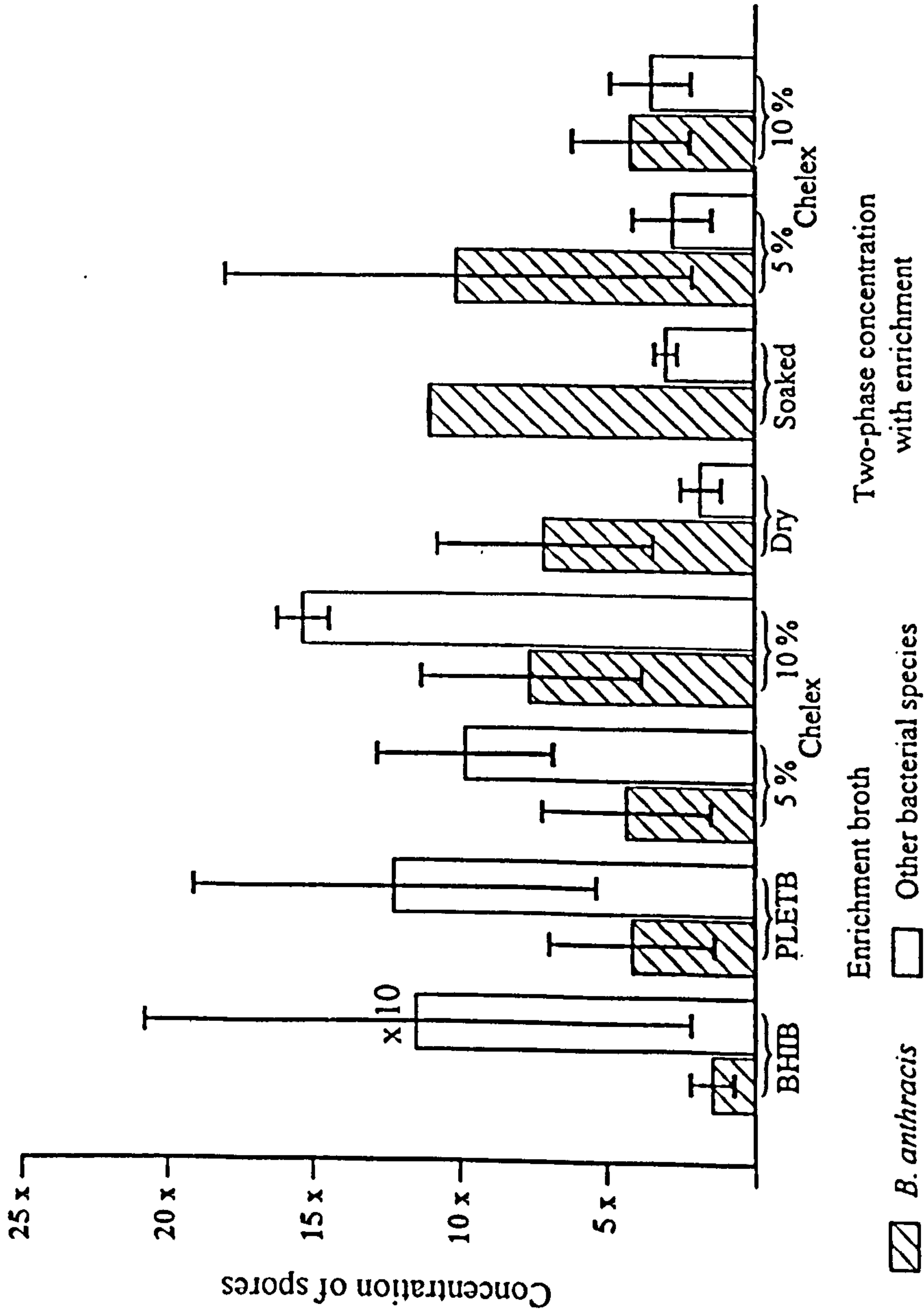
#### **4.4.8 Comparison of two-phase concentration with enrichment to the use of selective broth culture alone for the detection of *B. anthracis* in soil**

The detection of *B. anthracis* was greatest, and background flora of other *Bacillus* species most reduced using the two-phase concentration system (Fig. 4.8). In BHIB alone, *B. anthracis* was significantly outgrown by other *Bacillus* species. In PLETB, a 2 - 8 fold concentration of *B. anthracis* was observed, but other *Bacillus* species were concentrated 5 - 15 fold. The addition of Chelex to PLETB led to a slight increase in the recovery of *B. anthracis*, however recovery of other *Bacillus* species remained much greater. Using two-phase concentration with enrichment, *B. anthracis* was concentrated 5 - 20 fold whilst other *Bacillus* species were concentrated a maximum of 5 fold. These results showed that the use of two-phase concentration with enrichment improved the recovery of *B. anthracis* in comparison to growth in BHIB or PLETB and, more importantly, reduced the recovery of other *Bacillus* species.

#### **4.4.9 Evaluation of the optimised two-phase concentration with enrichment system using a range of soil types, and different strains of *B. anthracis***

A range of different soils (see Table 4.1; p 160) were seeded with 5 different strains of *B. anthracis* and two-phase concentration carried out 0, 2, 4, 8 and 28 days after samples were seeded. The number of spores recovered from the upper phase of the system was found to decrease with time (Table 4.6, Fig. 4.9). After more than 28 days, two-phase separation with enrichment was carried out. This led to a 1 - 14 fold increase in the concentration of *B. anthracis* (Table 4.7).

**Figure 4.8** Comparison of two-phase concentration with enrichment to the use of broth culture alone for the selective recovery of *B. anthracis* in soil (ASS 91/90)



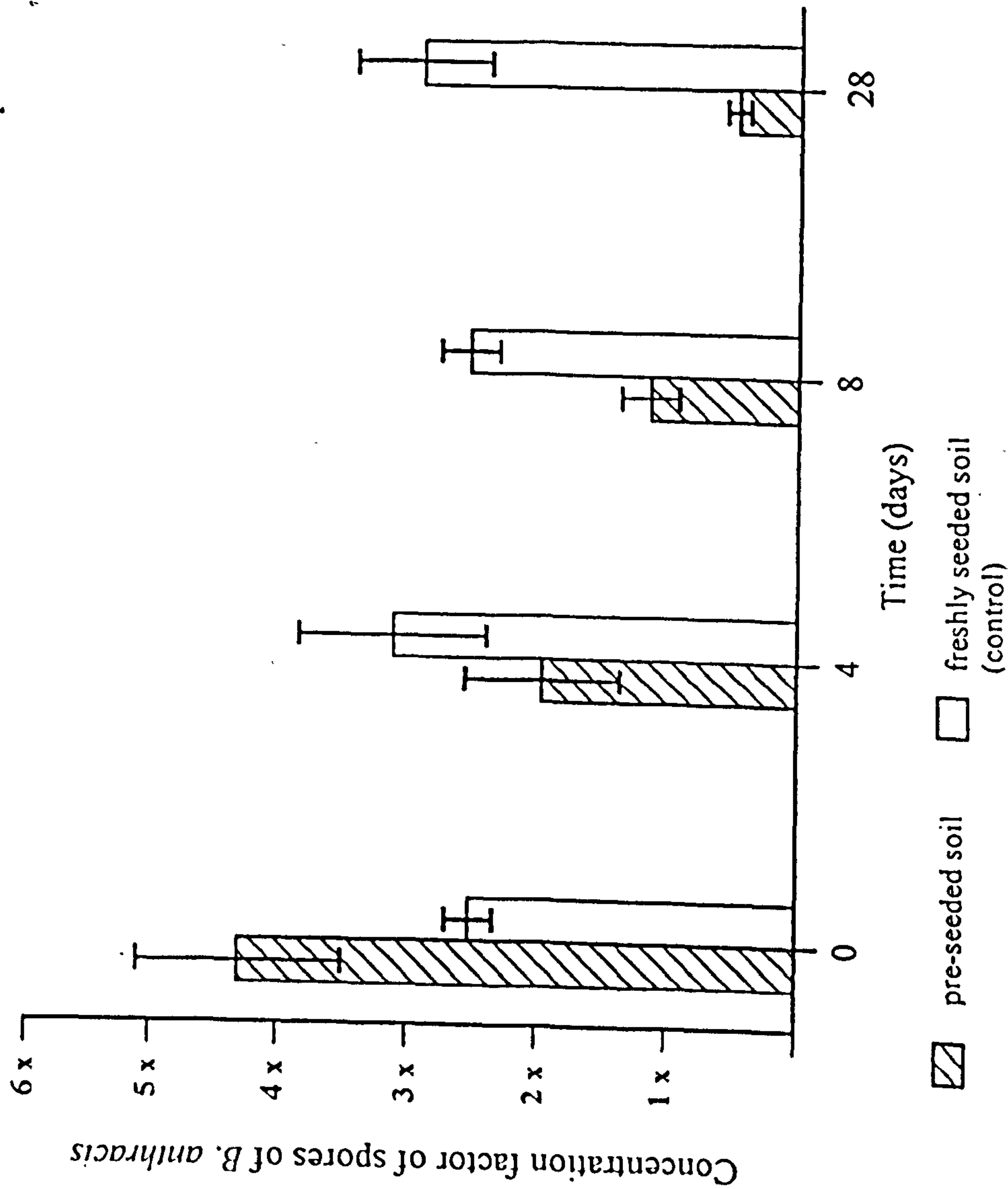
For enrichment broth culture, soil (0.5 g) was added to 8.5 ml of BHIB, PLETB (BHIB + 30 000 units/l polymyxin B sulphate, 250 000 units/l lysozyme, 300 mg/l EDTA and 40 mg/l TA), or PLETB containing 5% or 10% Chelex (added for comparison) and incubated at 37 °C for 8 h. Samples (100 µl) were taken before and after incubation. For two-phase concentration, soil (0.5 g) was added to 1.8 ml SDW or SDW containing 5% or 10% Chelex and mixed for 1 h at 4 °C and a sample taken (100 µl) 1.8 ml of PLETB (4 x concentrated BHIB + 60 000 units/l polymyxin B sulphate, 500 000 units/l lysozyme, 600 mg/l EDTA and 80 mg/l TA), 2.9 ml 2.75 M potassium phosphate buffer (pH 7.0) and 2.0 ml PEG (50% in SDW) were added and incubated at 37 °C for 7 h. After incubation 1 ml was taken from the interphase, centrifuged at 13 000 x g for 2 min and resuspended in 100 µl SDW. All samples were cultured on PLETA for 48 h at 37 °C, and the number of colonies of *B. anthracis* recorded. The concentration factor was calculated by dividing the total number of spores detected after concentration by the total number of spores detected before concentration. Experiments were conducted in triplicate. Error bars represent the standard error of the mean. Pre-enrichment samples were assigned a concentration factor of x 1.

Table 4.6. Concentration of spores incubated with soil for 0, 4, 8 and 28 days using two-phase concentration

Strain	Concentration factor of spores																																												
	ASC 245						AMES						VOLLUM						LANDKEY						ASC 80																				
	2.4	6.0	2.7	3.5	2.9	2.3	1.5	2.3	2.1	2.4	1.8	2.1	2.2	2.5	3.2	2.0	3.0	2.4	2.5	4.7	2.4	6.0	2.7	3.5	2.9	2.3	1.5	2.3	2.1	2.4	1.8	2.1	2.2	2.5	3.2	2.0	3.0	2.4	2.5	4.7					
+c*	0	4	8	28	0	4	8	28	0	4	8	28	0	4	8	28	0	4	8	28	0	4	8	28	0	4	8	28	0	4	8	28	0	4	8	28	0	4	8	28	0	4	8	28	
WLA 19	2.1	2.3	1.1	0.3	2.0	2.9	1.4	0.3	1.1	0.1	0.2	0	1.8	0.5	0.04	0.2	1.3	0.8	0.3	0.6	4.4	1.4	3.0	0.4	4.1	0.7	1.8	0.8	3.0	0.4	4.4	1.4	3.0	0.4	4.1	0.7	1.8	0.8	3.0	0.4	4.4	1.4	3.0	0.4	
WLA 24	31.5	3.4	0.8	0.7	4.3	3.4	4.4	0	0.9	0.1	4.5	0.5	3.1	0.9	0.9	0.4	0.8	4.1	0.7	1.8	0.8	3.0	0.4	4.1	0.7	1.8	0.8	3.0	0.4	4.1	0.7	1.8	0.8	3.0	0.4	4.1	0.7	1.8	0.8	3.0	0.4	4.1	0.7	1.8	0.8
WOM 8	2.5	2.7	2.1	0	1.4	2.4	1.0	0	0.9	0.2	0.2	0.1	4.3	0.4	0.1	0.8	4.1	0.7	1.8	0.8	3.0	0.4	4.1	0.7	1.8	0.8	3.0	0.4	4.1	0.7	1.8	0.8	3.0	0.4	4.1	0.7	1.8	0.8	3.0	0.4	4.1	0.7	1.8	0.8	
BMEAD	3.0	5.5	1.5	0	3.2	2.0	0.3	0.3	2.5	0.2	0	0.2	1.4	1.3	0.1	0.2	8.0	1.2	1.3	0.5	8.0	1.2	1.3	0.5	8.0	1.2	1.3	0.5	8.0	1.2	1.3	0.5	8.0	1.2	1.3	0.5	8.0	1.2	1.3	0.5	8.0	1.2	1.3	0.5	
BB 031	3.6	11.0	0.7	0	7.0	1.6	0.7	0.3	1.3	0.2	0.2	0.04	2.8	0.8	0	0.5	0.8	0.8	0.6	0.3	0.8	0.6	0.3	0.8	0.6	0.3	0.8	0.6	0.3	0.8	0.6	0.3	0.8	0.6	0.3	0.8	0.6	0.3	0.8	0.6	0.3	0.8	0.6	0.3	
BB 221	1.2	1.0	1.7	1.4	12.0	4.4	1.7	1.3	6.0	NF	0.4	0.5	16.8	2.5	1.2	1.3	5.5	4.0	1.5	0.9	5.5	4.0	1.5	0.9	5.5	4.0	1.5	0.9	5.5	4.0	1.5	0.9	5.5	4.0	1.5	0.9	5.5	4.0	1.5	0.9	5.5	4.0	1.5	0.9	
P.LAND	2.0	3.0	0.8	0.4	1.9	1.4	1.0	0.4	0.4	0.8	0.2	0.6	5.0	1.4	0.5	0.5	3.2	0.7	3.0	0.6	3.2	0.7	3.0	0.6	3.2	0.7	3.0	0.6	3.2	0.7	3.0	0.6	3.2	0.7	3.0	0.6	3.2	0.7	3.0	0.6	3.2	0.7	3.0	0.6	
AGDELL	8.0	3.0	1.1	0.2	3.4	3.7	0.7	0.3	0.1	0.2	0	0	1.7	0.5	0.2	0.3	2.2	0.6	0.5	0.2	2.2	0.6	0.5	0.2	2.2	0.6	0.5	0.2	2.2	0.6	0.5	0.2	2.2	0.6	0.5	0.2	2.2	0.6	0.5	0.2	2.2	0.6	0.5	0.2	
VER	3.4	2.4	2.5	1.2	3.0	1.8	2.5	0.4	0.7	0.3	0.1	0.2	8.2	3.8	1.5	1.6	10.0	3.1	2.1	0.9	10.0	3.1	2.1	0.9	10.0	3.1	2.1	0.9	10.0	3.1	2.1	0.9	10.0	3.1	2.1	0.9	10.0	3.1	2.1	0.9	10.0	3.1	2.1	0.9	

NF = *B. anthracis* not found in the initial sample; \* spores added freshly to soil just before each experiment

Figure 4.9 The recovery of *B. anthracis* from soil using two-phase concentration 0-28 days after the soil was seeded with *B. anthracis* spores



Two-phase concentration was carried out 0, 4, 8, and 28 days after soil was seeded with spores of *B. anthracis*. Soil (0.5 g) was added to 3.7 ml SDW, 2.9 ml 3.0 M potassium phosphate buffer (pH 7.0) and 2.0 ml PEG (50 % in SDW). The solution was mixed and a sample (100 µl) taken. After centrifugation (3 000 x g for 2 min) a sample (100 µl) was taken from the upper phase. Samples were cultured on PLETA for 48 h at 37 °C, and the number of colonies of *B. anthracis* recorded. The concentration factor was calculated by dividing the total number of spores detected after concentration by the total number of spores detected before concentration. Experiments were conducted using 9 different types of soil and 5 strains of *B. anthracis* at each time point. Each point represents the mean of all 9 different soils, seeded with all 5 strains of *B. anthracis*. Error bars represent the standard error of the mean. Pre-concentration values of x 1 are not shown

**Table 4.7 Two-phase separation with enrichment of soil samples > 28 days after seeding with *B. anthracis* spores**

<i>B. anthracis</i>	Average concentration factor				
	ASC 245	ASC 80	ASC 68	ASC 6	ASC 192
No. of repeats	4	2	2	3	2
WOM8	4.4	3.9	4.4	3.1	6.7
WLA 19	6.0	2.7	6.3	5.5	4.8
WLA 24	3.1	4.1	3.5	6.0	5.4
BB031	4.9	2.8	2.3	6.4	14.3
BB221	8.2	1.0	6.4	2.3	7.7
Parkland	6.7	3.6	5.5	4.1	4.9
Ver	4.6	3.7	5.9	3.0	7.5
Agdell	5.2	5.9	2.3	8.8	2.7
Broadmead	3.2	0.9	1.7	1.9	14.3

Concentration factor = number of spores detected after concentration divided by the number of spores detected before concentration

The highest concentration of *B. anthracis* was observed when ASC 192 spores, originally isolated in soil from Landkey, Devon were used (Table 4.7). No relationship was observed between the amount of clay or organic matter in the soil, and the concentration of spores.

When the enrichment method was scaled up to use 5 g soil samples, up to 136 fold concentration of *B. anthracis* was observed (Table 4.8).

**Table 4.8 Scale up of two-phase concentration with enrichment using 5 g soil samples using soil seeded > 28 days previously**

	Average concentration factor				
<i>B. anthracis</i>	ASC 245	ASC 80	ASC 69	ASC 6	ASC 192
No. of repeats	2	1	1	2	3
WOM <sup>8</sup>	36.4	136	NF	5.0	16.3
WLA19	16.5	117	NF	10.8	14.9
WLA24	19.5	16.5	8.5	21.8	10.7
BB 031	73.5	84.6	25.5	10.0	7.5
BB 221	5.7	21.9	17.0	5.4	14.2
Parkland	49.5	0	8.5	10.4	8.9
Ver	79.8	4.7	12.8	14.1	12.3
Agdell	70.0	18.8	42.5	5.3	5.0
Broadmead	18.6	1.6	NF	3.8	5.2

The concentration factor was calculated by dividing the total number of spores after concentration by the total number of spores before concentration. NF = *B. anthracis* not detected before concentration

Again no clear relationship was observed between the soil type and the concentration of spores of *B. anthracis*. Concentration was least successful, however, in Broadmead soil, which has the highest clay content (Table 4.8).

**4.4.10 Comparison of the two-phase concentration system with culture in PLETB for the detection of low numbers of *B. anthracis* in soil**

Soil samples containing low numbers of spores of *B. anthracis* were divided into two. Half was processed using two-phase concentration with enrichment and half cultured in PLETB. Two-phase concentration with enrichment improved the detection of *B. anthracis* in soil when compared to culture on PLETA (Table 4.9; columns 1 and 2). In PLETB, no increase in the recovery of *B. anthracis* was observed (Table 4.9; columns 3 and 4). When naturally contaminated soil was used, *B. anthracis* was consistently detected in one sample from which it could not be detected at all using PLETA (Table 4.10).

**Table 4.9 Comparison of the recovery of spores of *B. anthracis* using the two-phase system and culture in PLETB**

Soil (seeded with ASC 80 spores)	Two-phase concentration		PLETB culture	
	No of colonies of <i>B. anthracis</i> on PLETA		No of colonies of <i>B. anthracis</i> on PLETA	
	(1) Pre- enrichment	(2) After enrichment	(3) Pre- enrichment	(4) After enrichment
WOM 8	0	29	2	0
BB 031	1	18	2	1
BB 221	3	14	1	0
WLA 19	2	50	1	0

Results are from a representative experiment

**Table 4.10** Detection of *B. anthracis* from soil naturally contaminated with low numbers of *B. anthracis* spores

Landkey soil	No of colonies of <i>B. anthracis</i> on PLETA	
	Before enrichment	After two- phase enrichment
ASS 91/2	0 1 52	3 47 348
ASS 91/85	0 0 0	1 6 2
ASS 91/88 *	0	0
ASS 91/89 *	0	0

\* Each soil sample was tested 3 times. Identical results were obtained in all 3 experiments

These results also show that *B. anthracis* is unevenly distributed in sample ASS 91/2. Where *B. anthracis* was not detected, it was not possible to determine whether it was absent from the sample used, or simply not detected on PLETA. This demonstrates the problems with soil sampling, as discussed in Chapter 3. These results indicate that the use of two-phase concentration can improve the detection of *B. anthracis* in environmental material in comparison with direct culture on PLETA.

#### 4.5 DISCUSSION

This study demonstrated that the use of a two-phase concentration with enrichment system enhanced the detection of *B. anthracis* in soil compared with direct culture on PLETA or culture in PLETB. An advantage of the two-phase system is that it



increases the amount of soil sampled from 0.2 g to 5 g, thus increasing the likelihood of sampling *B. anthracis*.

For each experiment a sample was taken before enrichment, to determine the concentration of *B. anthracis* in the soil. The difference in recovery observed when freshly seeded and pre-seeded soil samples were used was therefore attributed to the adhesion of spores to particles in the soil, and not to a reduction in the spore count in the soil. Using freshly seeded soil to develop a detection system for *B. anthracis* in environmental samples is therefore not ideal, as in naturally contaminated soil spores of *B. anthracis* may be more firmly attached to soil particles. Thus seeded soils used in experimental procedures may behave differently to soil naturally contaminated with spores of *B. anthracis*.

The adhesion between microorganisms and soil particles is affected by the surface charge, texture, 'wettability' and diversity of the soil particles, as well as the surface characteristics and activity of microorganisms (Stenstrom, 1989). The main interactions between microorganisms and soil are ionic bonds, and the entrapment of microorganisms inside soil particles and by 'gummy' polymers (Macdonald 1986; Hopkins *et al.*, 1991). Ramsay (1984) compared the adhesion of the indigenous soil population to that of bacteria seeded into the soil. She found that by sonication 97% and by shaking 72% of bacteria seeded into soil could be recovered. Only 63% and 19.5% of indigenous soil bacteria could be recovered using the same methods. Edwards and Bremner (1965) reported that 2 h incubation at 4 °C in the presence of Dowex 1 (analogous to Chelex) led to maximum dispersion of soil particles. Edwards and Bremner (1965) reported that soils high in both clay and organic matter were the most difficult to disperse. Similarly Hopkins *et al.* (1991) reported that peat soil was

most difficult to disperse, followed by clay loam, then sandy loam. In the present study, the concentration of *B. anthracis* spores was slightly lower in the soil which has the highest concentration of clay. No clear relationship between the clay or organic content of the soil and the recovery of spores of *B. anthracis* was observed. In the present study similar results were observed for the separation of *B. anthracis* spores from soil particles using Chelex.

Sodium deoxycholate, suggested by Macdonald (1986) to improve separation of cells from soil particles, and Triton X-100 used at NMRI, were not found to enhance recovery of spores from soil particles. In agreement with these results Turpin *et al.* (1993) reported that sodium deoxycholate did not improve the separation of *Salmonellas* from soil. The incubation of soil samples in SDW alone also served to break down soil aggregates, as observed by the more homogeneous nature of the sample after incubation and the slight increase in the recovery of *B. anthracis*.

The substitution of PLETB for SDW in the two phase system led to an increase in the concentration of spores of *B. anthracis*. It was not clear whether this was due to a limited growth phase occurring in the broth, or whether the ionic composition of the broth was more favourable to the localization of spores at the interphase, perhaps due to the viscosity of the broth causing a change in the relative buoyant density of the spores. Heating experiments revealed that at the interphase *B. anthracis* was present in spore form.

The recovery of *B. anthracis* artificially seeded into soil was highest using strain ASC 192, which was originally isolated from soil from Landkey, Devon. The concentration of spores was generally found to be greatest in soils taken from naturally contaminated areas. In one of the artificially seeded soils tested a drop in spore count

was observed when the soil was soaked for 90 min in SDW. This could indicate that in certain soils compounds may exist which have a bactericidal effect on spores or vegetative cells of *B. anthracis*. In such soils *B. anthracis* would presumably be unlikely to persist. In naturally contaminated soils, incubation in SDW did not reduce the recovery of spores of *B. anthracis*.

A link between persistence of *B. anthracis* and soil types has been proposed. Stein (1948) reported that *B. anthracis* was generally associated with heavy 'Gumbo' (clay) soils, and Dragon and Rennie (1995) reported a correlation between detection of *B. anthracis* and the calcium content of the soil. In the course of this study, samples of soil and water from Gruinard Island that have been stored in the laboratory since 1986 were examined. Surprisingly, no *B. anthracis* could be detected in the samples which were shown to contain *B. anthracis* at the time of storage. The soil from Gruinard Island consists predominantly of peat, and has a low mineral content. *B. anthracis* may therefore be unlikely to persist in such a soil. Similarly when other soils seeded with *B. anthracis* during this work were examined 6 months after seeding a drop in the recovery of *B. anthracis* in the samples was observed.

Overall, the method described in this chapter allowed the separation and concentration of low levels of spores of *B. anthracis* from a range of soils with greater sensitivity than that achieved by enrichment in PLETB or direct plating on PLETA. The method is simple and can be completed in one day, with less than one hour spent on sample processing, followed by 48 h for incubation of plates. To confirm the value of this method, a study using a wider range of samples needs to be conducted. The isolation of spores from the majority of soil particles using this system may facilitate the PCR detection of *B. anthracis* from soil. (see Chapter 5).

## 5.0 EVALUATION OF METHODS FOR THE PCR DETECTION OF *BACILLUS ANTHRACIS* DNA

### 5.1 INTRODUCTION

#### 5.1.1 The PCR

The PCR (Mullis, 1990) is a simple method for amplifying fragments of DNA to levels at which they can easily be detected. The principles of the PCR are well established (Steffan and Atlas, 1991; Arnheim and Ehrlich, 1992).

#### 5.1.2 Application of the PCR for the detection of *B. anthracis* DNA

The PCR has been used for the detection of virulence factor genes on *B. anthracis* plasmids pX01 and pX02 (see Table 5.1) and may be used for the rapid differentiation of colonies of *B. anthracis* from those of other closely related *Bacillus* species. A further potential use of the PCR is for the direct detection of *B. anthracis* DNA in environmental samples.

One of the first reports of the application of the PCR to identify *B. anthracis* DNA was by Turnbull *et al.* (1992a) who used the PCR in combination with phenotypic examination to determine the identity of "anthrax-like" environmental isolates. Carl *et al.* (1992), Reif *et al.* (1994) and Johns *et al.* (1994) developed methods for the PCR detection of *B. anthracis* DNA directly from spores. Carl *et al.* (1992) used the PCR combined with Southern blot or dot blot analysis of the PCR product. They reported a detection limit of  $10^5$  spores of *B. anthracis* per PCR reaction. Boiling spores in SDW for 15 min, to release DNA from spores, did not increase this sensitivity. Germination of spores in nutrient broth containing

Table 5.1 Summary of published methods describing the detection of *B. anthracis* DNA using the PCR

Author	Target DNA sequence *	Initial template material	DNA extraction method	Sensitivity	Time taken
Turnbull <i>et al.</i> 1992	<i>pag. lef. capA. capB. capC</i>	broth culture	lysis, phenol chloroform	N/A	2 - 3 d
Carl <i>et al.</i> 1992	<i>cya</i>	spores in SDW	germination, boiling, freeze thaw, lysis	2 x 10 <sup>4</sup> spores 2 spores by nested PCR	5 h
Makino <i>et al.</i> 1993	<i>capA</i>	mouse blood and spleen	boiling and centrifugation or lysis and phenol chloroform	10 <sup>3</sup> spores	9 h
Reif <i>et al.</i> 1994	<i>capC. cya</i>	spores in SDW	germination, bead beating	1 spore	5 h
Johns <i>et al.</i> 1994	<i>capB</i>	spores in SDW	germination, bead beating	< 10 spores	5 h
Beyer <i>et al.</i> 1996	<i>pag. capB. capC</i>	soil seeded with spores	enrichment, lysis, phenol chloroform	< 10 spores / 100 g soil, nested PCR	5 d
Sjostedt <i>et al.</i> 1996	<i>cap. lef</i>	soil seeded with vegetative cells	lysis, phenol chloroform	3.0 x 10 <sup>4</sup> - 3.0 x 10 <sup>7</sup> bacilli / g soil	1 d
Sjostedt <i>et al.</i> 1997	<i>capBC, capCA, lef</i>	soil seeded with spores	freeze thaw, lysis, phenol chloroform	10 <sup>3</sup> - 10 <sup>4</sup> / sample, 10 <sup>6</sup> spores / g soil, nested PCR	1 d

\* *pag. lef* and *cya* are from gene sequences encoding PA, LF and EF proteins respectively; *capA. capB. capC* code for the *B. anthracis* poly-D-glutamic acid capsule

O-carbamyl- D- serine (OCDS), a racemase inhibitor which prevents the conversion of L-alanine to the germination inhibitor D-alanine, increased the sensitivity to  $2 \times 10^4$  spores per reaction by disrupting the spore coat and allowing greater access to the *B. anthracis* DNA. Using the product from the first reaction as template material a nested PCR increased the sensitivity to the equivalent of 2 spores per PCR (Carl *et al.*, 1992).

Reif *et al.* (1994) used the PCR followed by a quantitative dual probe hybridization assay and reported the detection of  $10^2$  spores per PCR. This greater sensitivity, in comparison to the sensitivity of  $2 \times 10^4$  spores per reaction reported by Carl *et al.* (1992) was attributed to extracellular *B. anthracis* DNA adhering to the surface of spores. Germination of spores in L- alanine and OCDS prior to the PCR increased the sensitivity to 1 spore per reaction. Johns *et al.* (1994) reported a detection limit of 10 spores per reaction by germination using L-alanine and OCDS.

The use of a mini bead-beater (Biospec) to mechanically disrupt the *B. anthracis* spore coat was investigated by Johns *et al.* (1994) and Reif *et al.* (1994). This allowed the detection of *B. anthracis* DNA with equal sensitivity to that obtained using germination.

The above methods were conducted using pure suspensions of spores in SDW and were not tested for the detection of *B. anthracis* DNA in environmental material.

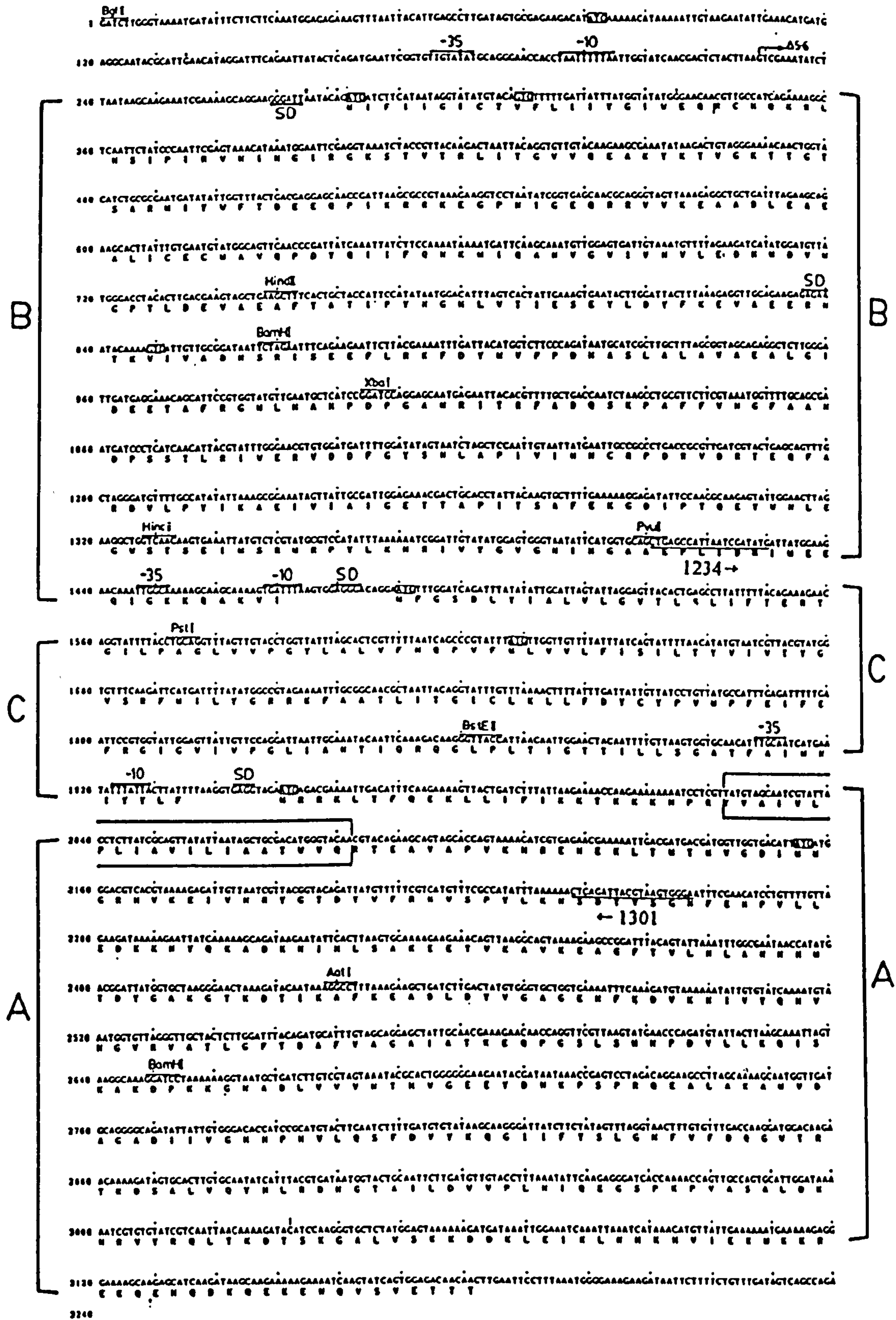
### **5.1.3 Evaluation and specificity of available primers for the PCR detection of DNA from *B. anthracis***

Hutson *et al.* (1993) designed a series of oligonucleotides for use as probes for the specific detection of *B. anthracis* DNA from pX01 and pX02, and for use as PCR

primers. The specificity of the oligonucleotide probes was tested against 52 strains of *B. anthracis* and 233 strains of other *Bacillus* species using a slot blot method followed by a non-radioactive detection system. Under high stringency conditions, the probes were found to be specific for *B. anthracis*, and no cross-reactivity was observed with any of the other *Bacillus* species tested. Under less stringent conditions, which were not specified, occasional cross-reactions with other *Bacillus* species occurred. Hutson *et al.* concluded that oligonucleotide probes specific to gene sequences from PA and CapB would be suitable for the specific detection of *B. anthracis* DNA, and for the determination of the plasmid content of isolates of *B. anthracis*. Turnbull *et al.* (1992) used the CapB oligonucleotide probe (oligonucleotide 1234) with oligonucleotide 1301 (Fig. 5.1) for the PCR detection of *B. anthracis* DNA. Using these primers they reported the specific detection of gene sequences from pX02 in 17 capsule producing strains of *B. anthracis*.

The primers designed by Carl *et al.* (1992) to amplify a 1247 bp and a 208 bp region of the *cya* gene were tested for specificity by homology searches through GenBank. Johns *et al.* (1994) designed primers to amplify a 536 bp fragment of *cya* and a 350 bp fragment from *capC* and tested their specificity against 1 strain of *B. subtilis*, 1 strain of *B. cereus*, 6 strains of *Clostridia* species and 10 strains of Gram-negative bacteria. No cross reactions were observed. Reif *et al.* designed primers to amplify a 622 bp fragment from *capC*, and reported no cross-reactions when the primers were tested against 1 strain of each species in the '*B. cereus* group', 1 strain each of *B. megaterium*, *B. licheniformis*, *B. globigii* and *B. subtilis* and 8 strains of Gram-negative bacteria.

Figure 5.1 Nucleotide and deduced amino acid sequence of the *cap* region of pX02 (Makino *et al.*, 1989) showing the positions of oligonucleotides 1234 and 1301 (Turnbull *et al.*, 1992; Hutson *et al.*, 1993)



A, B and C indicate the open reading frames of CapA, CapB and CapC products respectively; Small boxes represent possible translation initiation codons; Possible promoter sequences are shown as -35 and -10; SD = possible Shine-Dalgarno sequence; Large box represent hydrophobic amino acid sequences; Oligonucleotide 1234, Position 1411 - 1430, 5' - 3' sequence CTG AGC CAT TAA TCG ATA TG; Oligonucleotide 1301, Position 2257 - 2238, 5' - 3' sequence TCC CAC TTA CGT AAT CTG AG; product size = 846 bp.



Beyer *et al.* (1996) designed PA primers using the DNASTAR computer programme and tested the specificity of the primers with 20 strains of *B. anthracis*, 6 strains of *B. cereus*, 2 strains each of *B. thuringiensis*, *B. mycoides*, *B. megaterium* and *B. subtilis* and 7 strains of other bacterial species (Fig. 5.2). Again no cross-reactions were observed.

#### 5.1.4 Detection of a chromosomal DNA sequence from *B. anthracis* using the PCR

DNA sequences which code for the *B. anthracis* toxin and capsule proteins and their *trans*-acting activators have been published (see Section 1.8.1; p 35). Currently the only chromosomal DNA sequence from *B. anthracis* which has been published is from the S-layer (Etienne-Toumelin *et al.*, 1995). The S-layer is a single homogenous protein or glycoprotein which has been found to be associated with the cell wall of over 185 bacterial species, including at least 19 *Bacillus* species (Luckerich and Beverage, 1989). Two S-layer proteins of *B. anthracis* have been described, EA1 (95 kDa, Fauchaus *et al.*, 1995) and a 94 kDa protein encoded by the *sap* gene (Etienne-Toumelin *et al.*, 1995).

The use of primers specific to such a chromosomal DNA sequence of *B. anthracis*, in combination with primers specific to sequences from pX01 and pX02, would allow the positive identification of pX01/pX02 derivatives of *B. anthracis* using the PCR. For use under such circumstances, chromosome specific primers are needed which do not cross-react with closely related members of the '*B. cereus* group'.



### **5.1.5 The extraction of DNA from spores and vegetative cells of *B. anthracis***

One of the problems associated with the PCR detection of *Bacillus* species is the difficulty involved in extracting DNA from spores and vegetative cells. The majority of protocols for DNA extraction from *Bacillus* species require extensive cell lysis and phenol chloroform extraction, and take 2 -3 days (Henderson *et al.* 1994). Brousseau *et al.* (1993) described a simple boiling method for the direct extraction of DNA from colonies of *B. thuringiensis* suitable for use as template material in the PCR. This method has the potential to significantly reduce the time taken to screen colonies for the presence of pX01 and pX02.

### **5.1.6 The PCR detection of *B. anthracis* DNA in clinical and environmental material**

The use of the PCR for the detection of *B. anthracis* in environmental samples such as soil may be hampered by the presence of mineral ions and humic material which have been shown to inhibit the PCR (see Section 1.8.2.1; p 36). Makino *et al.* (1993) used the PCR to detect approximately  $10^3$  vegetative bacilli in mouse blood and spleen 8 h after spores of *B. anthracis* were administered to the animals. In this instance, however, bacilli could have been identified more rapidly by microscopic examination of a polychrome methylene blue stained blood smear taken from the animal (M'Fadyean, 1903).

Beyer *et al.* (1995, 1996) reported the PCR detection of less than 10 spores of *B. anthracis* in 100 g samples of soil taken from old tannery sites. This was achieved by non-selective enrichment, hydrogen peroxide inactivation, cell lysis, phenol chloroform extraction of the DNA and nested PCR in the presence of bacteriophage

T4 gene protein. The T4 gene protein is a single stranded DNA stabiliser which was added to prevent target DNA binding to soil particles. No information was provided about the abundance of competing bacterial flora in the soil samples during the non-selective enrichment stages. A potential problem with this method could be that the spores were added separately to the soil, hence, they may behave differently to spores naturally present in the environmental material (see Chapter 4).

Sjostedt *et al.* (1996, 1997) evaluated a number of published methods recommended for the detection of *B. anthracis* seeded into soil. They reported that the methods, including that of Beyer *et al.* (1995), did not produce the expected results and that success varied greatly with the type of soil used in the experiments. Sjostedt *et al.* (1997) eventually developed a method for the PCR detection of *B. anthracis* DNA involving direct lysis of bacteria in soil and phenol chloroform extraction of DNA and a nested PCR method, using degenerate primers for the initial PCR. For the PCR to be successful a minimum number of  $1.0 \times 10^6$  spores or  $3.0 \times 10^4 - 3.0 \times 10^7$  vegetative bacilli were required to be present per gram of soil.

## 5.2 The aim of this chapter

The aim of the work presented in this chapter was to incorporate the PCR into the methodology used in the routine identification of colonies which are suspected to be *B. anthracis* isolated from environmental material. The second objective of this work was to compare the use of the PCR for the detection of *B. anthracis* DNA in environmental material to conventional culture procedures in terms of sensitivity and reproducibility of the methodology.

### 5.3 Materials and Methods

The PCR was conducted using the method described in Section 2.9 (p 51). Initial experiments were conducted using oligonucleotide primers 1234 and 1301 (see Fig. 5.1) and primers 975 and 976 (Hutson *et al.*, 1993; see Fig. 5.2). Pure genomic DNA was used as template material (Henderson *et al.*, 1994) and the thermocycling conditions were those recommended by Turnbull *et al.* (1992a).

#### 5.3.1 The extraction of template DNA directly from colonies of *B. anthracis*

The use of template material prepared directly from colonies was evaluated in the PCR. The growth from the edge of a fresh colony of *B. anthracis* was resuspended in 25 µl of SDW, heated to 95 °C for 10 min, then cooled to 4 °C and briefly centrifuged. The resulting supernatant (5 µl) was used as template material in a 50 µl PCR. This method was used to prepare template material from selected strains of *B. anthracis* and tested using the PA and capsule primers as described in Section 2.9. To further simplify the methodology for the routine use of the multiplex PCR, "Ready-to Go" PCR beads (Pharmacia) were substituted for the individual components of the PCR.

#### 5.3.2 Design of S-layer primers

Three pairs of primers were designed from the *sap* gene of *B. anthracis* using the DNASTAR computer programme (Fig. 5.3). Primers were designed to function at the annealing temperatures and magnesium concentration used in the multiplex PCR reaction. To check the specificity for *B. anthracis* the sequences of the primers were compared with other S-layer sequences available in the GenBank database (Table 5.2). A possible complementary region was identified between lower primer 1 and

**Figure 5.3 Nucleotide and deduced amino acid sequence of the region encompassing the *sap* gene (Etienne-Toumelin *et al.*, 1995) showing the positions of S-layer oligonucleotide primers**

```

1 AAGCTTGTAACTTATTTCTATAAAAAAGAAAGTTTGGAGATAAGATGTTATGTTTTAAAAATCCTAACATTAATATAAAGGAATGTTGGTATTTAAGGTT
HindIII
101 TTATTAGTAAATGATAAGAAAAAGGTATGGTAATTTTTGAAAAATCTAACGCTAAGAAAAATGTCGAATTCCAGAAAAATAAGTTGTGGATTAATGTCG
201 TAATATCTCTATAGTTAGATGTTGTAATGGAAACCTTTTTCTGTTATAGTTGTAATAGTTATAAAATGTAATTCGACGCCCTTTT
301 TCTGCTGTTTTAAAAATTTCTGATTTTATAATTCATCTTTTTAAATGGAAGTCGAAAAACGATCGTTTAGAATTTGTAAAAATTCACCTTTTTTGTGAA
401 TTTAATGTTTTAAAAATTCGATAAAAAAGGGTGTATGATTTCTTTATGATTCTATAATACGGGATATTCTATTATTCTGTATGTCGAACTTTAAACCATTT
/1 H A K T N
501 TATACTACTAGTTTCGAAAAAATAGAACATCTATTAAAAATATTA TGGAACTAGTATTACATTCCTAAGGAGGAAATATATAAAAAATGGCAAAGACTAA
/6 S Y K K V I A G T M T A A M V A G V V S P V A A A G K T F P D V P
601 CTCTTACAAAAAGTAATCGCTGGTACAA TGCAGCAGCAATGGTAGCAGGTTGTTTTCTCCAGTAGCAGCAGCAGGTAACAATTCCAGACGTTCTCT
/39 A D H W G I D S I N Y L V E K G A V K G N D K G H F E P G K E L T R ①
701 GCTGATCACTGGGGAATGATTCTATTAAGTACTTAGTAAAGGAGGCGGCTTAAAGGTAACGCAAAAGGAAATGTCGAGCCTCGAAAAAGAAATTAAC
/73 A E A A T H A Q I L N L P I D K D A K P S F A D S Q G Q W Y T P
801 GTCCAGAAGCAGCTACAAATGAGTGGCTCAAACTTAACTTACCAATCGATAAAGATGCTAAACCATCTTTCCGCTGACTCTCAAGGCCAATGGTACTCTC
/106 F I A A V E K A G V I K G T G N G F E P N G K I D R V S H A S L L ③
901 ATTCAATCGCAGCTGTACAAAAAGCTGGCGTTATTAAGGTACAGGAAACGGCTTTGAGCCAAACGGAAAAATCGACGGGTTTCTATGGCATCTCTTCTT
/139 V E A Y K L D T K V N G T P A T K F K D L E T L N W G K E K A N I L ⑤
1001 GTAGAAGCTTACAAATAGATACTAAAGTAAACGGTACTCCAGCAACTAAATTCAAAGATTAGAAACATTAACCTGGGTAAGAAAAAGCTAACTAATCT
HindIII
/173 V E L G I S V G T G D Q W E P K K T V T K A E A A Q F I A K T D K
1101 TAGTTGAATTAGGAATCTCTGTTGGTACTGCTGATCAATGGCAGCCTAAGAAAACTGTAACAAAGCAGAAGCTGCTCAATTCATTGCTAAGACTGACAA
/206 Q F G T E A A K V E S A K A V T T Q K V E V K F S K A V E K L T K
1201 GCAGTTGGTACAGCAAGCAAGGTGAAATCTGCAAAAGCTGTTTACAACCTCAAAAAGTAGAAGTAAATTCAGCAAAAGCTGTTGAAAAATTAACATAA
/239 E D I K V T N K A N N D K V L V K E V T L S E D K K S A T V E L Y S
1301 CAAGATATCAAAAGTAACTAACAAAGCTAACCAAGATAAACTACTAGTTAAAGAGGTAACCTTTATCAGAAAGATAAAAAATCTGCTACAGTTGAATTATATA
EcoRV
/273 N L A A K Q T Y T V D V N K V G K T E V A V G S L E A K T I E M A ④
1401 GTAACCTAGCAGCTAAACAACTTACACTGTAGATGTAACAAAGCTGGTAAAAACAGAAGTACCTGTAGGTTCTTTAGAAAGCAAAAACAATCGAAATGGC
/306 D Q T V V A D E P T A L Q F T V K D E N G T E A G V V S P E G I E F Y ②
1501 TGACCAAAACAGTTGTAGCTGATGAGCCAACACGCAATTCACAGTTAAAGATGAAAACGCTACTGAAVTGTTTCAACGAGGGTATTGAATTTCTA ⑥
/339 T P A A G T A K I N A K G E I T L A K G T S T T V K A V Y K K D G K V Y
1601 ACGCCAGCTGCAGAAAAAATTAATGCAAAAAGGTGAAATCACTTTAGCAAAAAGGTAAGTAACTGTTAAAGCTGTTTATAAAAAAGACGGTAAAGTAG
/373 A E S K E V K V S A E G A A V A S I S N W T V A E Q N K A D P T S
1701 TAGCTGAAAGTAAAGAAGTAAAAAGTCTGCTGAAAGGCTGCACTGACTGCAATCTCTAACTGGACAGTTGCGAGAACAAAAATAAGCTGACTTTACTTC
/406 K D F K Q N N K V Y E G D N A Y V Q V E L K D Q F N A V T T G K V
1801 TAAAGATTTCAACAAAAACAATAAAGTTTACGAAAGCGCAGCAGCTTACCTTCAAGTAGAATTGAAAGATCAATTTAACCCAGTAACTGCAAAAGTT
/439 E Y E S L N T E V A V V D K A T G K V T V L S A G K A P V K V T V K
1901 GAATATGAGTGTAAACACAGAAAGTGTCTGTACTAGATAAAGTAACTGTAAGTAACTGATTATCTGCAGGAAAGCACAGTAAAGTAACTGTA
/473 D S K G K E L V S K T V E I E A F A Q K A M K E I K L E K T N V A
2001 AAGATTCAAAAGGTAAGAACTTGTTCAAAAACAGTTGAAATTCGCTCAAAAAGCAATGAAAGAAATTAATTAAGAAAAACTAAGCTT
HindIII
/506 L S T K D V T D L K V K A P V L D Q Y G K E F T A P V T V K V L D
2101 GCTTTCTACAAAAGATGTAACAGATTTAAAGTAAAAAGCTCCAGTACTAGATCAATACGGTAAAGAGTTTACAGCTCCTGTAACAGTCAAAGTACTTGAT
/539 K D G K E L K E O K L E A K Y V N K E L V L N A A G Q E A G N Y T V
2201 AAAGATGGTAAAGAATTAAGAACAATAAAGGTAAGCTAATATGTTAACAAGAATTAGTCTGAAATGCAGCAGGTCAAGAAGCTGTAATTATACAG
/573 V L T A K S G E K E A K A T L A L E L K A P G A F S K F E V R G L
2301 TTGTATTAAGTCAAAAATCTGGTGAATAAGCAAGCAAAAGCTACATTAGCTCTAGAAATTAAGCTCCAGTGCAATTCTCTAAATTTCAAGTTGCTGGTTT
/603 E K E L D K Y V T E E N Q K N A M T V S V L P V D A N G L V L K G
2401 AGAAAAAGAATTAGATAAATATGTTACTGAGGAAAACCAAAAGAAATGCAATGCACTGTTTCACTGTTTCTTCTGATAGATGCAAAATGATTAGTATTAAGGTT
/639 A E A A E L K V T T T N K E G K E V D A T D A Q V T V Q N N S V I T
2501 GCAGAAGCAGCTGAACTAAAAGTAAACAACAACAAGGTAAGGTAAGTAAAGGTAAGCAACTGATGCACAAGTACTGTACAAAATAACAGTGAATTA
/673 V G Q G A K A G E T Y K V T V V L D G K L I T T H S F K V V D T A
2601 CTGTTGGTCAAGGTGCAAAAGCTGGTAAAATTAAGGTAAGGTTGACTAGATGGTAAATTAATCACAACCTCATTCAATTCAAAGTTGTTGATACAGC
/706 P T A K G L A V E P T S T S L K E V A P N A D L K A A L L N I L S
2701 ACCAACTGCTAAAAGGATTAGCAGTAGAATTTACAAGCAGCTCTCTTAAAGAAGTACCTCCAAAATGCTGATTTAAAAGCTGCACCTTTTAAATATCTTATCT
/739 V D G V P A T T A K A A T V S N V E F V S A D T N V V A E N G T V G A
2801 GTTGTGCTGACTGGACTACAGCAAAAGCAAGCAAGTCTTCTAATGTAGAAATTTGTTTCTGCTGACAAAATGTTGTAGCTGAAAAATGCTACAGTTGGTG
/773 K G A T S I Y V K N L T V V K D G K E O K V E P F D K A V Q V A V S
2901 CAAAAGGTGCAACATCTATCTATGTA AAAAAGCTGACAGTGTAAAAAGATGCAAAAAGCAAAAAGTAGAATTTGATAAAAGCTGTACAAGTCCAGTTTC
/806 I K E A K P A T K
3001 TATTAAGAAGCAAAACCTGCAACAAAATAATTA AAAATCATTTAATAAATGATTAAAGGGCCTATCAGAAAATAGACAAAAGTCTATGAGTATCATA
3101 GCTTTTATTTTGCTCTTATTTCATATACATTTGAAATGAAAAGGAGTAGCCTTATTGAGAAACAAATCAAAAAGCCTTTCAAAAATAGAAATACCT
3201 CATTGATATGTAATTTTGTAATTAACACCTTTTTTGTAAAAAACAATCCGAAAAGGAAATAAAATGTCGAAATGTAATAATTTTACTCGAATG
3301 TAGTCTGAAAAATGTATTTATGTA AAAAATATTAGTGCATCAAGTCGAAAATATGTCGTATAATTCGAATTTGATATCGATATGAAAAATATACGAAG
3401 CCGACTGACAGTGGTTTATAGAAAATGGTTTGTTCATTTCTATATTTAAGTATTATCGAT

```

Putative ribosome binding sites, promoter sequences and 4 short internal repeats are underlined. Arrows indicate palindromic sequences; ① Oligonucleotide upper 1, Position 57 - 82, 5' - 3' sequence GGT ACG AGG TGT TGT TTC TCC AGT AG; ② Oligonucleotide lower 1, Position 897 - 919, 5' - 3' sequence GGT CAG CCA TTT CGA TTG TTT TTT; product size = 837 bp. ③ Oligonucleotide upper 2, Position 391 - 413 5' - 3' sequence CGC GTT TCT ATG GCA TCT CTT CT; ④ Oligonucleotide lower 2, Position 1008 - 1029 5' - 3' sequence TTC TGC AGC TGG CGT TAC AAA T; product size = 639 bp. ⑤ Oligonucleotide upper 3, Position 391 - 414 5' - 3' sequence CGC GTT TCT ATG GCA TCT CTT CTT; ⑥ Oligonucleotide lower 3, Position 890 - 914 5' - 3' sequence GCC ATT TCG ATT GTT TTT GCT TCT A ; product size = 524 bp

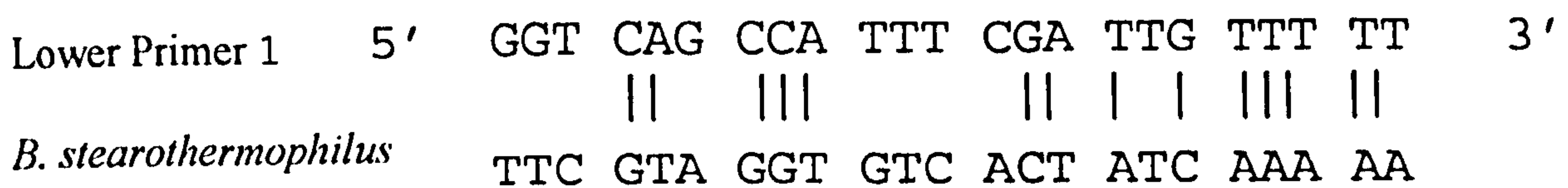
**Table 5.2 S-layer sequences screened for potential binding sites of primers designed for detection of part of the S-layer gene sequence from *B. anthracis***

S-layer open reading frames (orf) screened	Binding sites identified
<i>Aeromonas hydrophila</i>	-
<i>Acetogenium kivui</i>	-
<i>Bacillus brevis</i> partial orf	-
<i>Bacillus circulans</i>	-
<i>Bacillus stearothermophilus</i>	+
<i>Bacillus thuringiensis</i>	-
<i>Haloferax volcanii</i>	-
<i>Lactobacillus acidophilus</i>	-
<i>Lactobacillus brevis</i>	-
<i>Methanosarcina mazei</i>	-

the S-layer sequence of *B. stearothermophilus* (Fig. 5.4). *B. stearothermophilus* is a thermophilic *Bacillus* species which usually grows at temperatures above 50 °C (Priest, 1993). For this reason it is unlikely to be isolated under the same culture conditions as *B. anthracis*, hence the design of the primer was not altered.

**Figure 5.4 Possible binding site of lower primer 1 to the S-layer DNA sequence of *B. stearothermophilus***

Lines represent bases predicted to bind to the S-layer DNA sequence of *B. stearothermophilus*.



### 5.3.3 Evaluation of the S-layer primers in the PCR

The PCR was conducted using template DNA prepared directly from colonies of *B. anthracis* ASC 245. The 3 sets of S-layer primers were tested under the conditions used for the PA and capsule primers. The 3 sets of primers were further tested using 7 strains of *B. anthracis* (ASC 1, 2, 32, 65, 69, 319 and 404).

The 3 sets of primers were subsequently tested using DNA from colonies of *B. anthracis* as template material in a multiplex PCR in combination with the PA and capsule primers. To separate the similarly sized PCR products generated by the PA primers and S-layer primer set 2, PCR products were run through a 2% (w/v) agarose gel for 2 - 3 h, rather than a 1% (w/v) agarose gel for 1 h.



#### **5.3.4 The specificity of S-layer primers**

Initial experiments were done using DNA extracted directly from colonies as template material for the PCR. The 3 sets of S-layer primers were tested using species chosen from those available in the Anthrax Section *Bacillus* species collection. The specificity of primer set 2 was further tested using the PCR on a wider range of *Bacillus* species under the conditions used in the multiplex PCR.

To try and improve the specificity of primer set 2, the annealing temperature used in the PCR reaction was increased, from 55 °C to 60 °C and 65 °C and the PCR repeated using the strains of *Bacillus* species with which cross- reaction was observed. The multiplex PCR was subsequently carried out as described above, using an annealing temperature of 65 °C.

#### **5.3.5 The detection of *B. anthracis* DNA in environmental material**

The methods tested for the PCR detection of *B. anthracis* DNA in soil are described in section 2.10 (p 53). To compare PCR methods to direct culture, samples of supernatants and pellets were taken throughout the course of the DNA extraction protocols and cultured on BA or PLETA. The soils used were soil GTS (see Table 3.25; p 132), ASS 91/2, 91/4 and ASS 93/288 (see Table 3.2; p 81) and WLA 19 (see Table 4.1; p 160). For some experiments 0.5 g of ASS 93/288 soil was combined with 50 g of WLA 19 soil. Insufficient quantities of soil ASS 93/288 were available for testing without combination with other soils.

#### **5.3.6 The effect of humic material on the PCR detection of *B. anthracis* DNA**

To determine the concentration of humic acids required to inhibit the PCR using

primers specific to *B. anthracis*, a 3% humic acid solution (Sigma Chemical Co, UK) was added to the PCR at final concentrations of 0.02 - 20 µg/ml. The PCR was conducted under the conditions described in Section 2.9 (p 51), using PA primers and approximately 50 ng of pure DNA as template material. To determine the inhibitory effect of soil on the PCR, ten fold dilutions of soil from Landkey, Devon (ASS 91/4) and ASS 149/93 were substituted for 10 µl of the SDW in a 100 µl PCR.

### **5.3.7 The PCR detection of *B. anthracis* spores concentrated using the two-phase separation method**

Two-phase separation with enrichment was used to concentrate spores and separate them from the majority of inhibitory material present in soil as described in Section 4.3.10 (p 164). In an attempt to link two-phase separation with the PCR, the spore concentrate from the interphase was further enriched by overnight incubation at 37 °C in an equal volume of sterile horse serum. Sterile horse serum was used as growth of *B. anthracis* in serum is similar to growth in blood, and in both blood and serum *B. anthracis* produces capsular material. Serum is less inhibitory to the PCR than blood. After overnight incubation, the sample could be seen to consist of bacterial growth covering a layer of fine soil particles. The bacterial growth was carefully removed using a fine tipped pipette, placed in a fresh tube, washed twice in 100 µl of SDW and resuspended in 25 µl of SDW. A thin smear of the bacterial suspension was air dried onto a microscope slide, fixed and stained with polychrome methylene blue (as described in Section 2.4.2; p 48). The slide was examined microscopically for the presence of chains of bacilli displaying the characteristic pink capsule, which identified them as cells of *B. anthracis* (M'Fadyean, 1903). A sample

of the bacterial suspension was also cultured on PLETA. The PCR was carried out by heating the bacterial growth to 95 °C for 10 min, cooling to 4 °C and using 2.5 µl as template material to complete a 25 µl PCR.

## 5.4 RESULTS

### 5.4.1 The detection of *B. anthracis* DNA using the PCR

Capsule primers 1234 and 1301 (Fig. 5.1) were tested in the PCR system. A MgCl<sub>2</sub> concentration of 1.5 mM and an annealing temperature of 55 °C were found to give optimal PCR results (results not shown). PA primers 975 and 976 (Hutson *et al.*, 1993; Fig. 5.2) and primers PA5 and PA8 (Beyer *et al.*, 1996; Fig. 5.2) were compared. Primers 975 and 976 were found to give less consistent results than primers PA5 and PA8. Although the specificity of PA5 and PA8 was not tested against such a wide range of *Bacillus* species as those tested by Hutson *et al.* (1993), they were preferable to the use of primers 975 and 976 (results not shown). The optimal magnesium concentration for primers PA5 and PA8 was 1.5 mM, and the optimum annealing temperature 55 °C. These primers were therefore suitable for use in a combination with the capsule primers (1234 and 1301).

### 5.4.2 The PCR detection of *B. anthracis* DNA directly from colonies

Using template DNA prepared directly from colonies of *B. anthracis* and primers PA5, PA8, 1234 and 1301 the correct sized PCR products were consistently produced. Subsequently, a PCR reaction was performed in which both PA and capsule primers were used. DNA fragments from both *pag* and *capC* were amplified together. The duplex PCR was successfully used to identify the plasmid content of pX01<sup>+</sup>/pX02<sup>+</sup>,

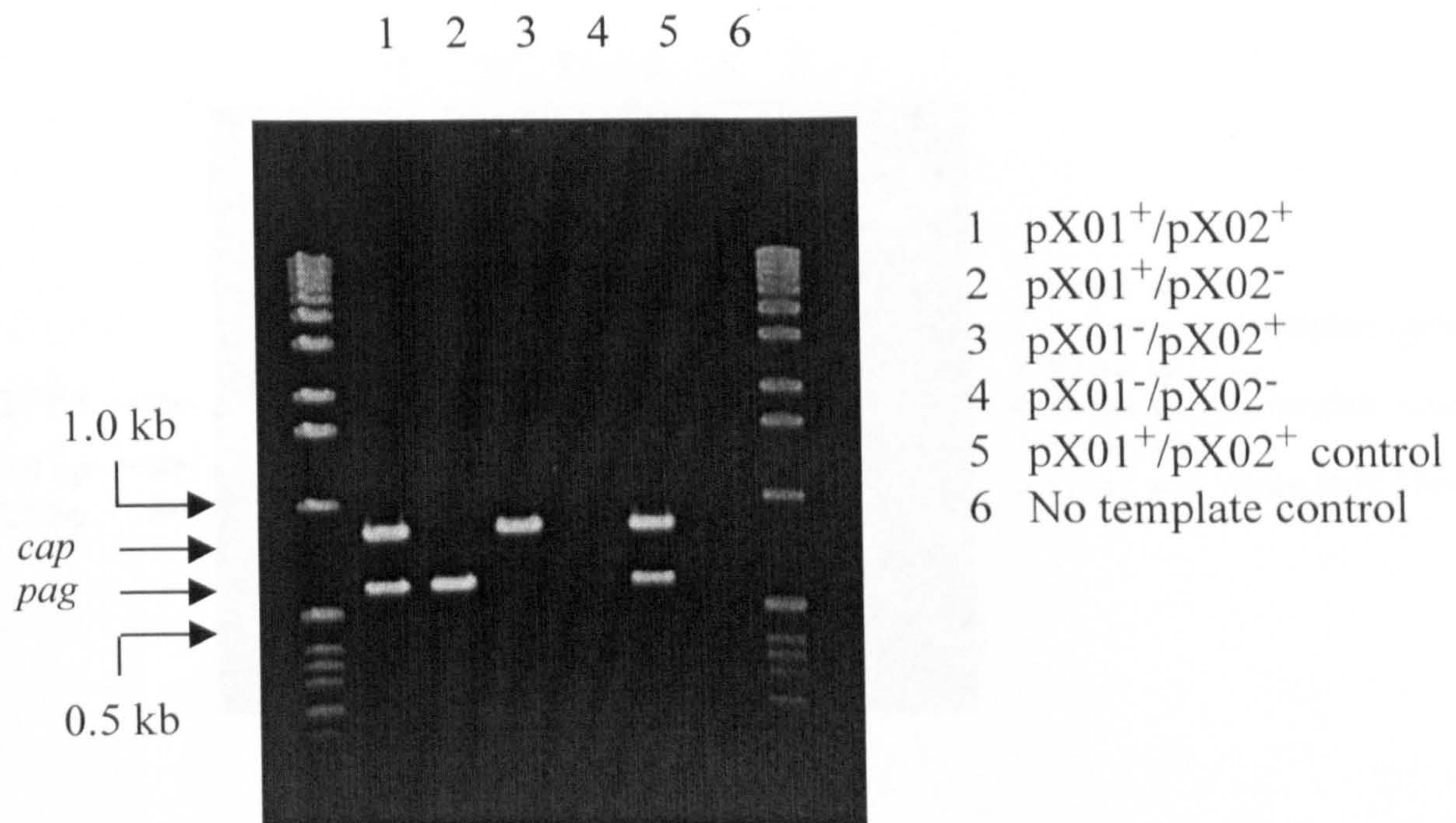
pX01<sup>+</sup>/pX02<sup>-</sup>, pX01<sup>-</sup>/pX02<sup>+</sup> and pX01<sup>-</sup>/pX02<sup>-</sup> derivatives of *B. anthracis* (Fig. 5.5).

The use of “Ready-to Go” PCR beads allowed the duplex PCR to be adopted in addition to phenotypic tests for the identification of bacterial isolates sent to the Anthrax Section at CAMR. The PCR was also used to confirm the plasmid content of isolates of *B. anthracis* required for various research projects. All primers were found to remain stable at -20 °C for over 12 months.

#### 5.4.3 Evaluation of the use of S-layer primers

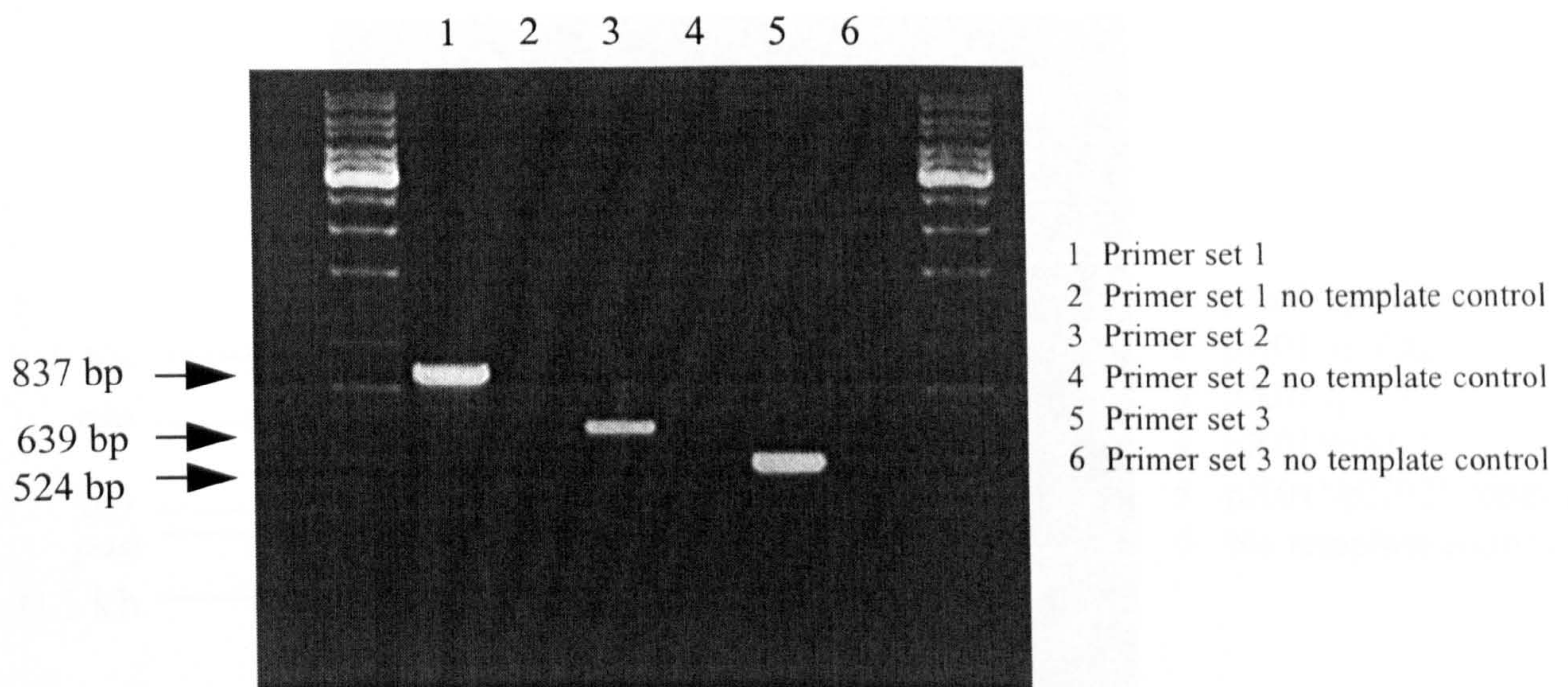
When tested using pure genomic DNA (ASC 245) as template material all 3 sets of S-layer primers produced products of the expected size (Fig. 5.6). All 3 primer sets also successfully amplified DNA from *B. anthracis* strains ASC 1, 2, 32, 65, 69, 319 and 404 (results not shown). These strains included a penicillin resistant isolate (ASC 32, Turnbull *et al.*, 1989) and an isolate which produces atypical smooth grey-green colonies (ASC 65; Henderson *et al.*, 1994). Although all 3 primer pairs were effective, primer set 2 produced the most consistently strong PCR products. When S-layer primers were tested with the PA and capsule primers, primer set 2 again gave the most consistent results, but had the slight disadvantage of producing a DNA fragment close in size to that of the *pag* PCR product. Multiplex PCR was subsequently carried out on pX01<sup>+</sup>/pX02<sup>+</sup>, pX01<sup>+</sup>/pX02<sup>-</sup>, pX01<sup>-</sup>/pX02<sup>+</sup> and pX01<sup>-</sup>/pX02<sup>-</sup> derivatives of *B. anthracis* (Fig. 5.7). This allowed the positive identification of the fully cured derivative of *B. anthracis* ASC 69.

**Figure 5.5** Determination of the plasmid content of derivatives of *B. anthracis* ASC 69 using the duplex colony PCR



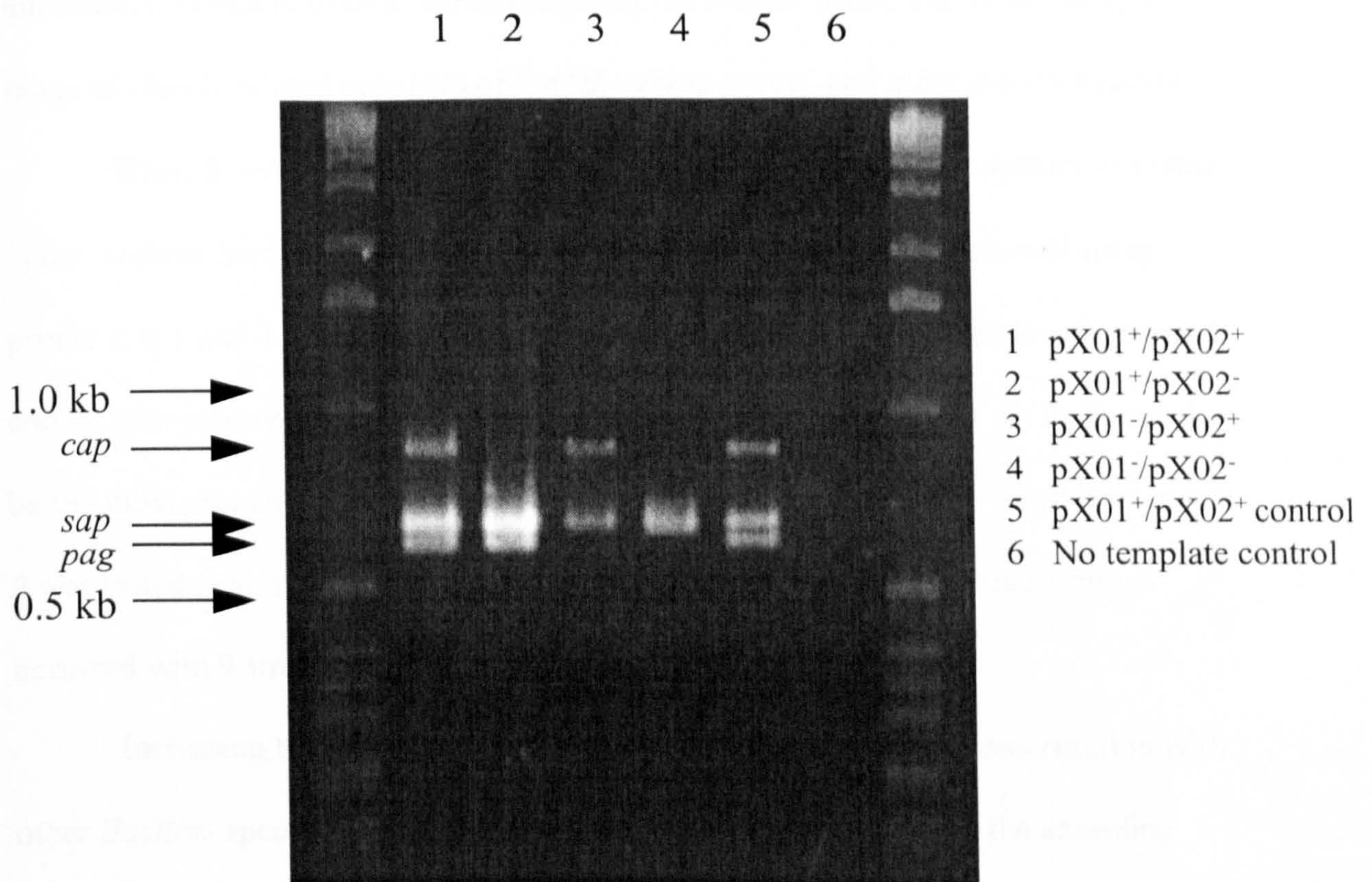
PCR was carried out using PA primers PA5 and PA8 and capsule primers 1234 and 1301 (Fig. 5.1 and Fig. 5.2). DNA extracted directly from colonies was used as template material. The annealing temperature was 55 °C. Samples were run on a 1% agarose gel in TBE buffer for 1 h at 80 V.

**Figure 5.6 Evaluation of the effectiveness of S-layer primers using *B. anthracis* ASC 245 DNA as template material**



Primers were used at a final concentration of 0.2  $\mu\text{M}$  per reaction, and with a  $\text{Mg}^{2+}$  concentration of 1.5 mM. The PCR was conducted using an annealing temperature of 55 °C PCR products were run on a 1% agarose gel for 1 h at 80 V

**Figure 5.7** Determination of the plasmid content of derivatives of *B. anthracis* ASC 69 using the multiplex PCR with S-layer primers



The PCR was conducted using PA primers PA5 and PA8, capsule primers 1234 and 1301 and S-layer primer set 2 (Fig. 5.1, Fig. 5.2 and Fig. 5.3). DNA extracted directly from colonies was used as template material. The annealing temperature was 55 °C. Samples were run on a 2% agarose gel in TBE buffer for 3 h at 80 V.

#### 5.4.4 The specificity of S-layer primers for *B. anthracis*

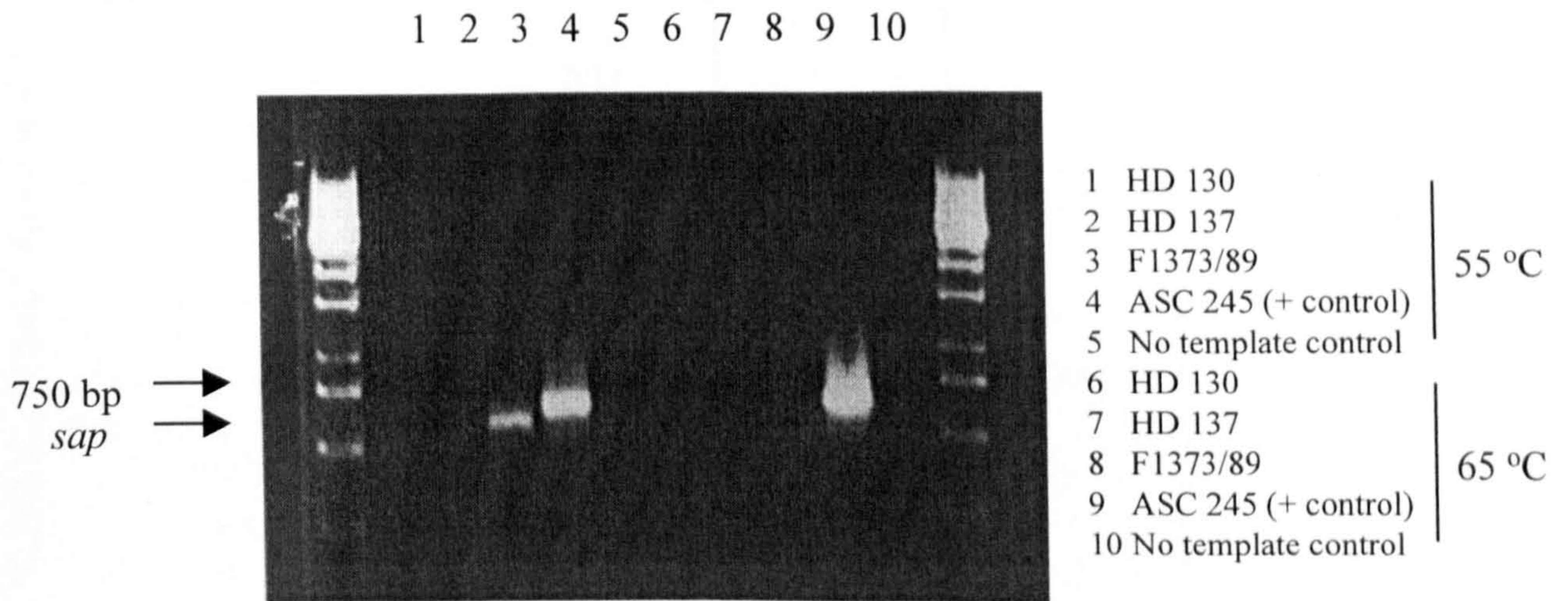
The only *Bacillus* species for which a cross reaction was predicted using the *B. anthracis* S-layer primers designed in this study when compared to the S-layer sequences available in GenBank was that of *B. stearothersophilus* (see Fig. 5.4). The considerable variation between strains of *B. cereus* and the lack of sequence information available from *B. cereus* required the S-layer primers to be tested against a range of closely related members of the '*B. cereus* group' and other *Bacillus* species.

When S-layer primers were tested against a range of *Bacillus* species available in the Anthrax Section *Bacillus* species collection, cross-reactions occurred using primer sets 1 and 3 (Table 5.3). The predicted cross-reaction between lower primer 1 and *B. stearothersophilus* did not occur. From these results, primer set 2 appeared to be the most promising for the specific identification of *B. anthracis*. When primer set 2 was tested against a wider range of *Bacillus* species, however, cross-reactions occurred with 9 strains of other *Bacillus* species (Table 5.4).

Increasing the annealing temperature to 60 °C reduced the cross-reaction with other *Bacillus* species, but faint bands remained present. Increasing the annealing temperature to 65 °C eliminated all cross-reaction with other *Bacillus* species tested allowing the specific identification of *B. anthracis* (Fig. 5.8). When the multiplex PCR was conducted using an annealing temperature of 65 °C PA and capsule primers did not produce the correct sized PCR products, and hence the use of an increased annealing temperature could not be applied to the multiplex PCR (results not shown).



**Figure 5.8** Comparison of the specificity of S-layer primer set 2 against different *Bacillus* species using annealing temperatures of 55 °C and 65 °C



The PCR was conducted in duplicate using S-layer primer set 2 and annealing temperatures of 55 °C and 65 °C respectively. DNA extracted directly from colonies was used as template material. PCR products were run on a 1% agarose gel for 1 h at 80 V

**Table 5.3 Specificity of S-layer primers against a range of *Bacillus* species**

<i>Bacillus</i> species *	Results of PCR reaction		
	Primer Set 1	Primer Set 2	Primer Set 3
<i>B. cereus</i> F4433/73 F2532/77 F4810/72	+ - -	- - -	+ + -
<i>B. stearothermophilus</i> 2701/88 2702/88 2703/88 530/89	ND ND - -	- - - -	- - - -
<i>B. thuringiensis</i> HD137 23.2.95	+ +	- -	- -
<b>Other <i>Bacillus</i> species</b> WW3 4430 2106 2141/74 F6619 2054/76	+ - - - - -	- - - - - -	- - - - - -
Number of cross-reactions	4/13	0/15	3/15

ND = Not Done; \* see Table 2.1

#### 5.4.5 The detection of *B. anthracis* DNA in environmental material

The PCR detection of *B. anthracis* using the method developed by NMRI was tested.

This involved lysis in TEP buffer (Tris-HCl, EDTA and polyvinylpolypyrrolidone) and

lysostaphin, and the use of GlassMax spin cartridges to remove inhibitory humic

**Table 5.4 Specificity of S-layer primer set 2 when tested against a range of *Bacillus* species**

<i>Bacillus</i> species and strain *	Results of PCR
<i>B. cereus</i> F4165/75 Type 1, F2875/77, F1586/79 Type D, F2146/82, F431/83, BO39, BO40, BO74 F4667/82, F484/83	- +
<i>B. thuringiensis</i> <i>israelensis</i> , F2106/78, F2107/78 ST4AB SOTTE F2113/78 ST6, F2115A/78 ST7 ST3AB, 12.13, 4060 F2113A/78 ST7, F1373/89 HD102, HD130 HD137, HD228	- +
<b>Other <i>Bacillus</i> species</b> WW1, WW2, WW3, WW4	-
<i>Bacillus megaterium</i> F2336/89 F5381/84, F2947/A/89, NCTC 06094	+ -

\* see Table 1.2.

compounds (see Section 2.10.1; p 53). When culture of the soil solution was carried out at each stage, *B. anthracis* was readily detected in the supernatants which were not used for further processing, as well as in the sample which was processed. Using primers PA5 and PA8 the PCR, however, did not yield a product (results not shown). This showed that this method was not suitable for the PCR detection of *B. anthracis* in soil samples in situations where culture of samples could be conducted.

The PCR detection of DNA from *B. anthracis* using the method recommended by Porteus and Armstrong (1993; see Section 2.10.2, p 54) was tested. This involved cell

lysis and running samples on a low melting point agarose gel to separate them from contaminating environmental material and excision of the separated DNA from the agarose. This method resulted in the detection of *B. anthracis* DNA when the soil sample was seeded with  $1 \times 10^6$  spores of *B. anthracis* (results not shown). This method was not pursued, however, due to the high detection limit and the potential for cross-contamination of samples during the electrophoresis stage of the protocol.

#### **5.4.6 The detection of *B. anthracis* DNA in environmental material following non-selective enrichment**

The method described by Beyer *et al.* (1995, 1996; Section 2.10.3; p 55) was tested. This involved non selective enrichment, and phenol chloroform extraction of the DNA. Using this method *B. anthracis* was rapidly outgrown by other *Bacillus* species during the non-selective enrichment stage. (Table 5.5). When DNA extraction followed by a single round of PCR was carried out, *B. anthracis* DNA was detected from soil WLA 19, seeded with  $1.6 \times 10^6$  spores/ ml of ASC 80, when T4 gene protein ( $10 \mu\text{g/ml}$ ) was added to the PCR. In the absence of the T4 gene protein the PCR was unsuccessful. When soil ASS 93/288 was combined with soil WLA 19 sufficient humic material remained present, as determined by observation of the colour of the DNA extract, to inhibit the PCR (Fig. 5.9). No PCR product was observed when the DNA preparation was diluted to 1 in 1000 which indicated that in the absence of inhibition by humic material, insufficient *B. anthracis* DNA was present for detection. The limit of detection using this method was found to be  $10^4 - 10^6$  spores per gram of soil. Beyer *et al.* reported that the use of nested PCR increased the sensitivity of the PCR by  $10^4$ . Nested PCR should have therefore been unnecessary when the soil was

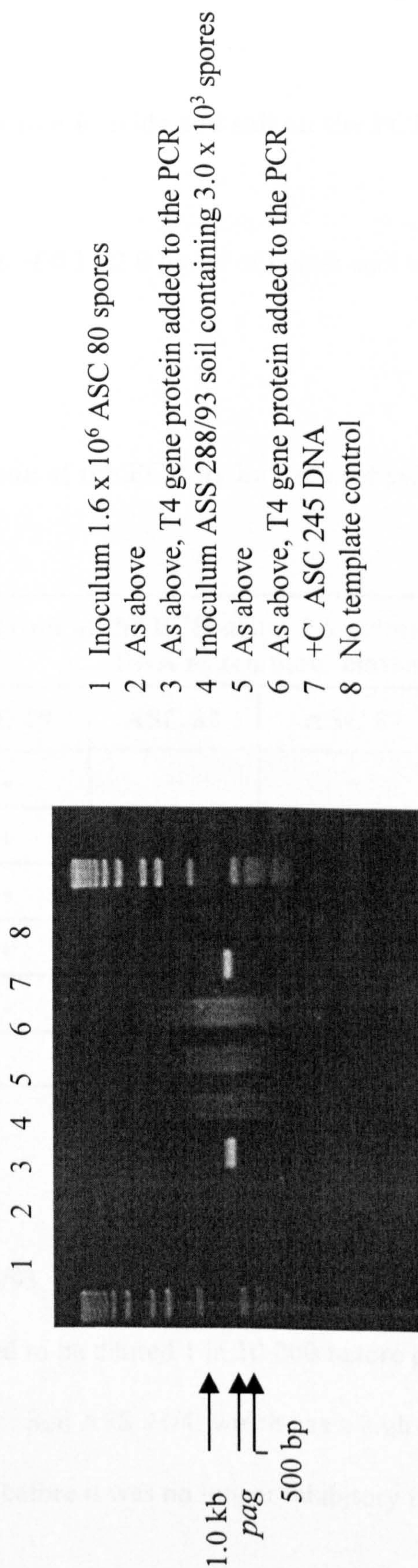
**Table 5.5 The recovery of *B. anthracis* during non-selective enrichment, followed by the PCR detection of *B. anthracis* DNA**

Soil used	Number of colonies of <i>B. anthracis</i> /ml detected on PLETA					
	ASS 91/2		WLA 19		ASS 91/2	
Addition to soil	ASC 80 spores	ASS 93/288 soil *	ASC 80 spores	ASS 93/288 soil *	ASC 80 spores	ASS 93/288 soil *
Initial inoculum	1.1 x 10 <sup>6</sup>	1.2 x 10 <sup>4</sup>	1.6 x 10 <sup>6</sup>	3.0 x 10 <sup>3</sup>	2.4 x 10 <sup>5</sup>	4.5 x 10 <sup>6</sup>
o/n in TSB	2.0 x 10 <sup>8</sup>	not detected	1.5 x 10 <sup>6</sup>	1.2 x 10 <sup>5</sup>	1.2 x 10 <sup>7</sup>	2.7 x 10 <sup>6</sup>
6 h in TSB	1.5 x 10 <sup>5</sup>	not detected	not detected	not detected	5.4 x 10 <sup>5</sup>	not detected
Result of PCR †	+	-	+ ¶	-	-	-

Soil (50g) was inoculated with spores of *B. anthracis* ASC 80, or naturally contaminated soil ASS 93/288. SDW (100 ml) was added and the non-selective enrichment system recommended by Beyer *et al.* (1995, 1996) was conducted. Samples were taken over the course of the non-selective enrichment and cultured on PLETA. PCR was carried out using PA5 and PA8 primers under the conditions described previously. All PCR's were conducted in the presence and absence of 10 µg/ml T4 gene protein.

\* Containing 1.0 x 10<sup>6</sup> spores of *B. anthracis*/g; o/n = overnight; TSB = tryptone soya broth; ¶ = In the presence of T4 gene protein

**Figure 5.9 Evaluation of the PCR detection of *B. anthracis* DNA after non-selective enrichment and phenol chloroform DNA extraction using the method of Beyer *et al.*, 1995, 1996**



Soil WLA 19 was inoculated with ASC 80 spores or with ASS 288/93 soil, naturally contaminated with spores of *B. anthracis* (See Table 5.5). The PCR was conducted using primers PA5 and PA8 (Fig. 5.2) and an annealing temperature of 55 °C. T4 gene protein (10 µg/ml) was added to identical PCRs. Samples were run on a 1% agarose gel for 1 h at 80 V

seeded with as at least  $10^4$  spores of *B. anthracis* per gram of soil.

#### 5.4.7 The effect of humic acids and soil on the PCR detection of *B. anthracis* DNA.

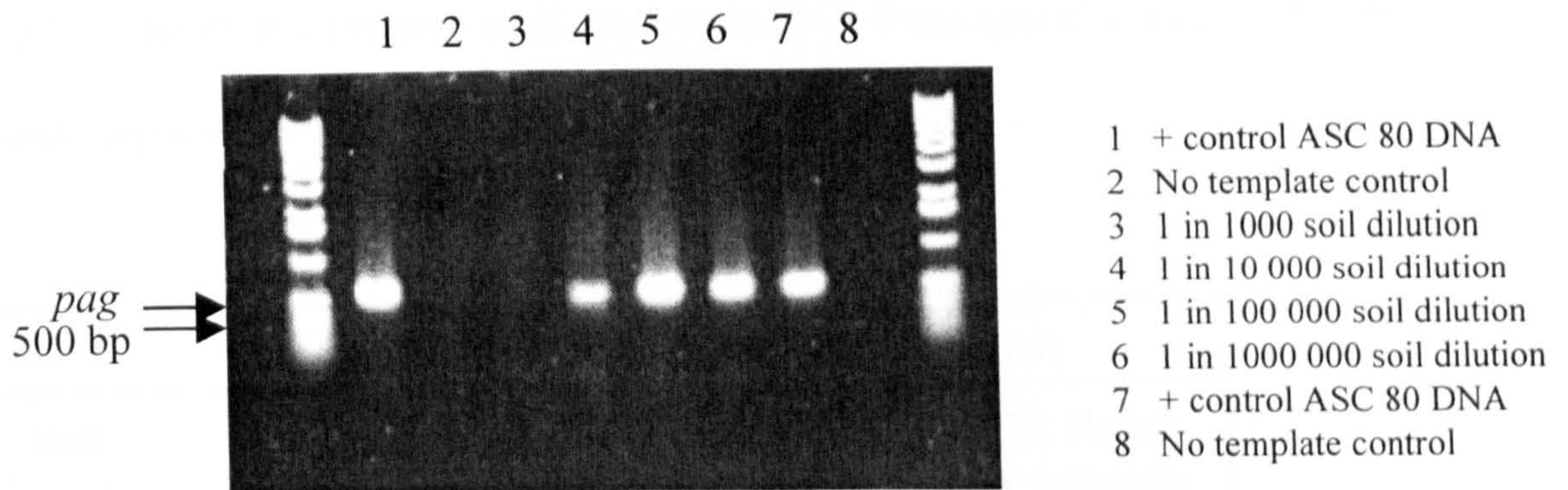
A final concentration of 0.2 - 2.0  $\mu\text{g/ml}$  of humic acid was sufficient to inhibit the PCR reaction (Table 5.6).

**Table 5.6 Inhibition of the PCR by humic acid solution**

Humic acid conc. ( $\mu\text{g/ml}$ )	Result of the PCR using PA primers and pure DNA as template material			
	ASC 79	ASC 82	ASC 87	ASC 162
0	+	+	+	+
0.02	+	+	+	+
0.2	+	-	+	+
2.0	+	-	-	-
10.0	-	-	-	-
20.0	-	-	-	-

When soil ASS 149/93, which has a high chalk content, was seeded with *B. anthracis* DNA the soil needed to be diluted 1 in 10 000 before positive PCR amplification occurred (Fig 5.10). Soil ASS 91/4, which has a high clay content, also needed to be diluted 1 in 10 000 before it was no longer inhibitory to the PCR (results not shown).

**Figure 5.10** The effect of adding soil (ASS 149/93) on the PCR amplification of *B. anthracis* ASC 80 DNA



The PCR was conducted using primers PA5 and PA8 (Fig. 5.2) in the presence of 10% w/v dilutions of soil ASS 149/93. 50 ng of purified DNA was used as template material. PCR products were run on a 1% agarose gel for 45 min.



**5.4.8 The PCR detection of DNA from *B. anthracis* spores concentrated using the two-phase separation method**

Using two-phase separation with enrichment linked to the PCR, described in Section 5.3.7 (p 204), capsulated *B. anthracis* could be identified microscopically in all 9 of the samples tested after overnight enrichment in serum. The PCR detection of *B. anthracis* DNA was achieved in 7 out of 9 samples (Table 5.7).

**Table 5.7 The PCR detection of *B. anthracis* DNA from spores concentrated by two-phase separation with enrichment**

Soil	No. of <i>B. anthracis</i> colonies *	After enrichment	
		Identification by microscopic examination	PCR Result (PA primers)
ASS 91/2	0	+	+
WLA 19	7	+	+
WLA 24	1	+	-
WOM 8	9	+	-
BBO31	13	+	+
BB221	15	+	+
AGDELL	25	+	+
VER	3	+	+
PARKLAND	16	+	+

\* Detected by culture on PLETA prior to two-phase concentration

When a sample of growth equivalent to that from which *B. anthracis* could be

identified by microscopic examination was cultured on PLETA, *B. anthracis* was not detected. This was attributed to the overgrowth of other bacterial species present in the serum which could be readily dismissed as non-*B. anthracis* due to their inability to produce the characteristic pink capsule when examined microscopically. Using soil sample ASS 91/2, *B. anthracis* was detected by microscopic examination and by the PCR, but was not detected by culture on PLETA, indicating that for certain soil types when combined with enrichment the PCR was comparable in sensitivity to culture on PLETA.

## 5.5 DISCUSSION

The use of the PCR to confirm the identity of pX01<sup>+</sup>/pX01<sup>+</sup>, pX01<sup>+</sup>/pX01<sup>-</sup>, pX01<sup>-</sup>/pX01<sup>+</sup> and pX01<sup>-</sup>/pX01<sup>-</sup> derivatives of *B. anthracis* was achieved by conducting a multiplex PCR, in which more than one target DNA sequence was amplified simultaneously, directly on bacterial colonies suspected to be *B. anthracis*. Results could be obtained within 4 h of examination of the colony, which is more rapid than overnight sub-culture in the presence of penicillin and anthrax specific bacteriophage, or culture in blood and microscopic examination of bacterial growth for the presence of the characteristic pink capsule indicating the presence of pX02 (M'Fadyean reaction). The PCR also provided an alternative to ELISA or gel diffusion for determination of the presence of pX01 in an isolate of *B. anthracis*.

The use of a multiplex PCR to determine the plasmid content of isolates of *B. anthracis* has been reported by Rammissse *et al.* (1996). In their study, however, pure genomic DNA isolated from *B. anthracis* using the method of Henderson *et al.* (1994), which takes 2 - 3 days was used as template material, rather than template

DNA extracted directly from colonies. Thus this method was not suitable for the rapid identification of colonies suspected to be *B. anthracis*.

The use of S-layer primers as an internal control in the multiplex PCR allowed the identification of pX01<sup>+</sup> / pX01<sup>+</sup> and pX01<sup>-</sup> or pX02<sup>-</sup> derivatives of *B. anthracis*. S-layer primers could not be used for the specific detection of pX01<sup>-</sup> / pX01<sup>-</sup> derivatives of *B. anthracis* within the multiplex PCR, due to the potential for cross-reaction with other *Bacillus* species. A single PCR using the S-layer primers and a higher annealing temperature alleviated the cross-reaction observed with DNA from other *Bacillus* species tested, and may allow the specific identification of *B. anthracis* from a range of *Bacillus* species. Such a method should, however, be applied with caution, as the potential for cross-reaction with other *Bacillus* species remains. The use of S-layer primers for the identification of pX01<sup>+</sup> / pX01<sup>-</sup> derivatives of *B. anthracis* may be used in conjunction with phenotypic observation and testing the susceptibility of colonies to penicillin and *B. anthracis* specific bacteriophage. The further screening of a considerable number of isolates of closely related *Bacillus* species to ensure that no unexpected cross-reactions occur was beyond the scope of this study, as the PCR would not be relied on alone for the identification of isolated *Bacillus* species.

When the non-selective enrichment method recommended by Beyer *et al.* (1995, 1996) was tested, the detection limit of *B. anthracis* was found to range from 10<sup>4</sup> - 10<sup>6</sup> spores per gram of soil. This method may be of use for the detection of *B. anthracis* from samples from tannery sites, which are likely to contain harsh chemicals, and subsequently a reduced bacterial flora. However when using soils containing a background flora consisting of a wide range of *Bacillus* species this

method is not as sensitive. Other explanations for the lack of success of this method during the present study could be the presence of higher concentrations of chemical compounds such as humic acids in the soils tested which are co-purified with the DNA and are inhibitory to the PCR (Wilson, 1997).

Sjostedt *et al.* (1997) evaluated the use of a non-selective enrichment system for the PCR detection of *B. anthracis* and reported results similar to those presented in this study. They added 100 mg of soil containing  $10^6$  spores of *B. anthracis* to 1 ml of heart infusion broth and incubated the broth at 37 °C. Samples (1 µl) were taken after 0, 4, 7 and 24 h and used as template material for the PCR. Their results showed that despite the dilution of the soil, and the high numbers of *B. anthracis* present (up to  $1.0 \times 10^8$  cfu/ml) PCR amplification was not possible. Amplification was achieved when the same experiment was performed using silica quartz which does not contain mineral ions or humic compounds, instead of soil. Sjostedt *et al.* (1997) also reported that specific nested PCR did not improve the sensitivity of detection of *B. anthracis* DNA, compared to using a single PCR. The addition of T4 gene protein was also not found to improve the PCR detection of *B. anthracis* under these conditions.

A final concentration of 0.2 - 2.0 µg/ml of humic acid was sufficient to inhibit the PCR reaction (Table 5.6). This figure was within the range of 0.064 - 8.3 µg/ml determined by other workers (See Section 1.8.3; p 39). This shows that the PCR primers and reaction conditions used in this study are of comparable sensitivity to those obtained in previous studies.

The sensitivity of the PCR for the detection of *B. anthracis* has been reported to be 1 spore or 1 plasmid copy per reaction (See Table 5.1; p 191). In a 100 µl PCR,

this is equivalent to a minimum of 10 organisms per ml of template material (Wilson, 1997). When soil is diluted 1 in 100 to 1 in 10 000 to prevent inhibition of the PCR by components of the soil, the sample would need to contain at least  $10^3 - 10^5$  spores per ml for *B. anthracis* DNA to be theoretically detectable using the PCR. The detection limit of PLETA is approximately 5 spores per ml of sample. To produce a system of comparable sensitivity to PLETA for the PCR detection of viable *B. anthracis* a concentration or selective enrichment step would be required prior to the PCR. Thus where available culture remains preferable to the use of the PCR.

When the two-phase concentration method developed in this study was linked to the PCR, a PCR product was identified from 7 of 9 samples. One of the samples was naturally contaminated with *B. anthracis*, and in the other 8 soils spores had been allowed to bind to soil particles before being used in the experiment. The failure of PCR amplification of DNA from the two samples may have been due to carry over of humic material or mineral ions from the soil as a result of insufficient washing of the bacterial growth prior to the PCR. The use of the proposed two-phase concentration method linked to the PCR may improve the detection of *B. anthracis* in environmental material containing low numbers of spores. Further work is, however, required to optimise and standardise this protocol, and to evaluate its use for the detection of *B. anthracis* in a range of environmental samples.

The results of this chapter have provided methodology for using the PCR as a confirmatory tool for the rapid identification of colonies suspected to be *B. anthracis*. Attempts at detecting *B. anthracis* DNA directly from soil showed that the PCR methods currently available are not suitable for the detection of low levels (less than 10 spores per gram) of *B. anthracis* in soil without an enrichment stage.

## 6.0 THE STABILITY OF PX01 AND PX02 IN *BACILLUS ANTHRACIS* IN THE PRESENCE OF NON-INDIGENOUS PLASMID DNA

### 6.1 INTRODUCTION

When pX01<sup>+</sup>/pX02<sup>-</sup> or pX01<sup>-</sup>/pX02<sup>-</sup> derivatives of *B. anthracis* are isolated from environmental samples, it is not known whether this indicates that fully virulent *B. anthracis* is present at the same site but has not been detected. Between 1987 and 1995, Turnbull *et al.* (1996a) isolated fully virulent (pX01<sup>+</sup>/pX02<sup>+</sup>) *B. anthracis* from eight sites and pX01<sup>+</sup>/pX02<sup>-</sup> strains from four sites. A further six sites yielded a mixture of pX01<sup>+</sup>/pX02<sup>+</sup> and pX01<sup>+</sup>/pX02<sup>-</sup> isolates. Turnbull *et al.* (1992a) hypothesised that pX01<sup>+</sup>/pX02<sup>-</sup> environmental isolates may occur when the organisms have been subjected to 'stressful' or harsh environmental conditions, for example in sewage effluent, or in waste from tannery sites.

Fellows (1996) surveyed 31 human and animal isolates and laboratory strains of *B. anthracis*. She reported that 22 of the isolates were pX01<sup>+</sup>/pX02<sup>+</sup>, and exhibited all the characteristics of fully virulent *B. anthracis*. One isolate, from a wildebeest in South Africa, was found to contain a plasmid the size of pX01, but PCR testing of the plasmid DNA failed to identify gene sequences specific to PA, LF or EF. The strain was, however, found to produce PA. This indicated that the genes encoding toxin production had integrated into the chromosome. Six isolates were identified which were pX01<sup>+</sup>/pX02<sup>-</sup>. Two of these isolates, obtained from the Center for Disease Control (CDC), Atlanta, USA, originally isolated from goats in Pakistan, did not express PA when tested by immunoassay, although the PCR confirmed the presence of gene sequences from PA, LF and EF. This could indicate

that these isolates have altered PA regulatory functions. Two pX01<sup>-</sup>/pX02<sup>-</sup> strains were characterised. One of these originated from an unknown source in Argentina. Although the strain was pX01<sup>-</sup>/pX02<sup>-</sup>, toxin and capsule genes were identified by the PCR, indicating that plasmid DNA may have integrated into the chromosome. No plasmid DNA other than that of pX01 and pX02 was identified in any of the isolates. These results exemplify the variations which occur between isolates of *B. anthracis*, but do not indicate whether such alterations are likely to have occurred in the environment or during subsequent manipulation or possible cross-contamination of samples.

The only record of natural isolation of pX01<sup>-</sup>/pX02<sup>+</sup> derivatives of *B. anthracis* was by Liang *et al.* (1996) who reported the identification of four such derivatives in vomit and faeces from human anthrax patients in China. In their laboratory tests pX02 was identified using the PCR and DNA hybridization. The isolates, however, did not produce capsules, indicating that they were unlikely to be true pX01<sup>-</sup>/pX02<sup>+</sup> derivatives of *B. anthracis*. The method used to test for capsule production was not stated.

Attenuation of *B. anthracis* by serial culture was first reported by Greenfield and Pasteur for the production of anthrax vaccines (Tigertt, 1980; Turnbull, 1991). This has since been linked to the loss of pX01 or pX02. In the laboratory, *B. anthracis* can be cured of pX01 by culture at 43 °C and of pX02 by culture in the presence of novobiocin, which inhibits DNA synthesis (Lambert and O' Grady, 1992). Colonies which have lost pX02 spontaneously can be identified by culture on bicarbonate agar in 20% CO<sub>2</sub> for several days. Any colonies which have lost their mucoid appearance can be tested for loss of pX02 (Welkos and Marrero, 1996).

Although protocols for the curing of *B. anthracis* of plasmid DNA appear fairly simple, the efficiency of the methods may not be very high. For example in this study culture over a 10 day period had to be repeated several times before the required derivatives of *B. anthracis* were identified.

The study of the stability of plasmids pX01 and pX02 in *B. anthracis* under 'stressful' growth conditions will provide information which may be related to the likelihood of *B. anthracis* losing pX01 or pX02 in the environment. One method for increasing the metabolic burden on cells of *B. anthracis* is growth in the presence of non-indigenous plasmid DNA. Such plasmid DNA can be introduced into *B. anthracis* by electroporation (Quinn and Dancer, 1990).

Small non-mobilisable shuttle vectors have been developed which can replicate in both *Escherichia coli* and *Bacillus* species. Introducing such plasmid DNA into *B. anthracis* and monitoring the stability of pX01 and pX02 in *B. anthracis* in their presence will provide information on the likelihood of *B. anthracis* losing pX01 or pX02 under 'stressful' conditions. Shuttle plasmids are based on naturally occurring plasmids from various bacterial species. Each plasmid contains the minimum replicon of the parent plasmid, the minimal replicon for *E. coli* and an antibiotic resistance marker which allows the plasmid to be manipulated.

The stability of such plasmids in *Bacillus* species in the absence of antibiotic selection pressure is dependent on specific characteristics of the plasmid such as the mode of replication (Jannièrè *et al.*, 1993); size (Bron, 1990; Jannièrè *et al.*, 1993) and the presence of specific genes, such as partition (*par*) genes, which ensure that each daughter cell inherits a copy of the plasmid (Williams and Thomas, 1992), and



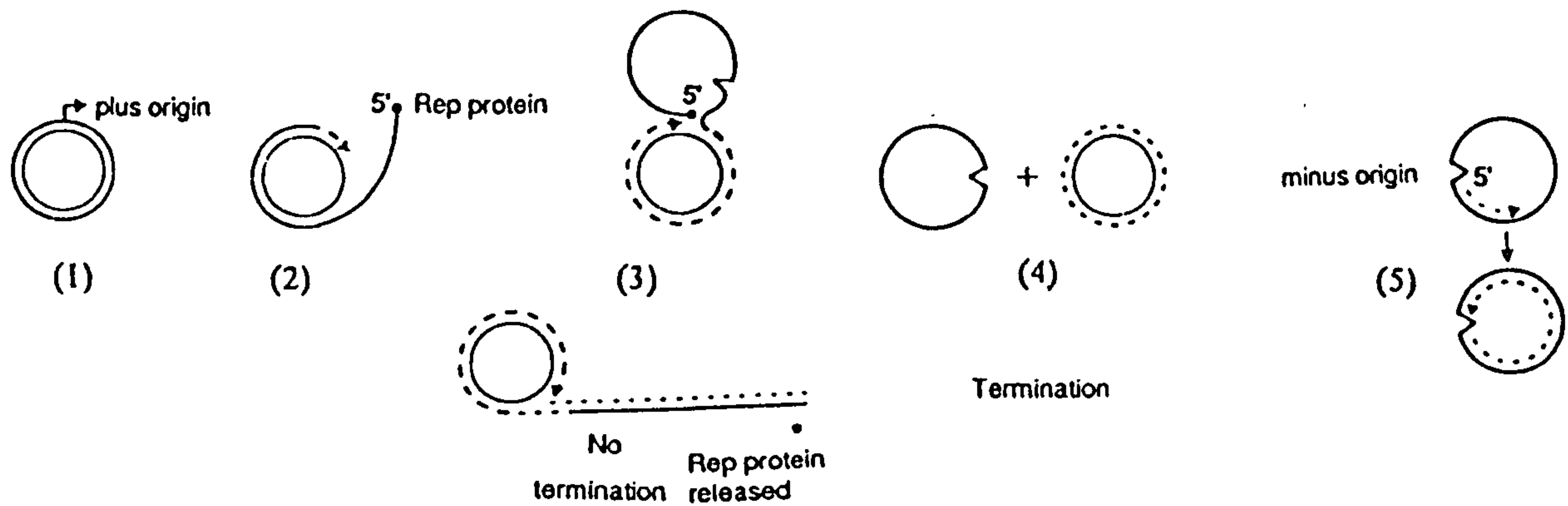
resolvase genes (*res*) which interact with the replication mechanism of the plasmid, leading to increased stability (Jannièrè *et al.*, 1993). The stability of plasmid DNA also depends on the influence of other plasmid DNA present in the host bacterium (Olsen and Tsai, 1993), in particular the homology between the replication regions of the plasmids (Baum and Gilbert, 1991; Gamel and Piot, 1992).

Another factor which affects plasmid stability is the Minus Origin (MO) which is the point from which lagging strand DNA synthesis occurs. For example the *pal A* type MO present in pC194 (Gruss *et al.*, 1987) is non-functional in *B. subtilis* (Bron *et al.*, 1988). The *pal U* type MO in pUB110, however, is functional in *B. subtilis* (Bron *et al.*, 1988). Non-function of the MO reduces the effectiveness of lagging strand DNA synthesis, increasing the proportion of single stranded DNA intermediates present. This can lead to incorrect recombination events, and a decrease in plasmid stability (Ebishu *et al.*, 1995).

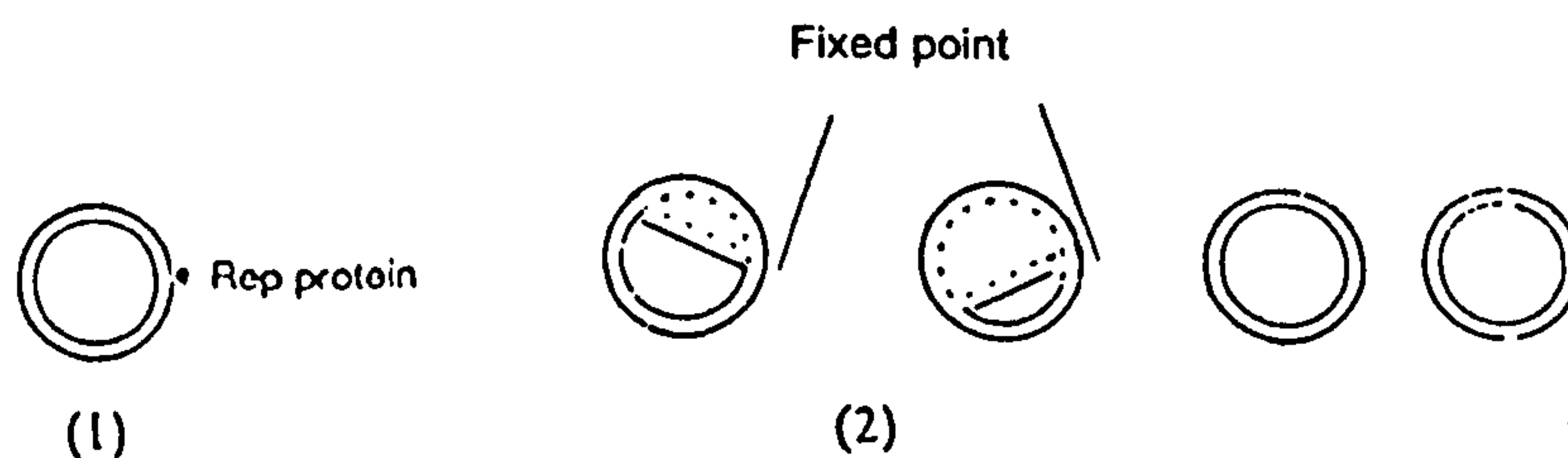
A plasmid which remains present in more than 80% of cells after 100 generations of growth in the absence of antibiotic selection pressure is considered to be very stable (Devine *et al.*, 1989). Similarly a plasmid which is lost at a rate of greater than 5% per generation is considered to be very unstable.

Plasmids which originate from Gram-positive bacteria have been shown to replicate by two mechanisms; rolling circle replication (RCR, Gros *et al.*, 1987) and theta ( $\theta$ ) replication which is named after the shape of the replication intermediates formed, which resemble the Greek letter  $\theta$ , (Swinfield *et al.*, 1990). The mechanisms for RCR and  $\theta$  replication are shown in Figure 6.1.

**Figure 6.1** The mechanisms by which rolling circle replication (from Jannière *et al.*, 1993) and  $\theta$  replication are conducted



(1) The leading (+) DNA strand is nicked at the plus origin by the replication protein (Rep) which attaches to the 5' end of the DNA strand. (2) The leading strand is extended from the 3' OH nick to form a new (+) strand. (3) If termination of (+) strand synthesis is not initiated, high molecular weight (HMW) linear concatemers are formed. (4) Following termination of (+) strand synthesis a new double stranded (ds) plasmid is released and a single stranded replication intermediate is formed. (5) A new lagging strand is synthesised from the minus origin (MO) and a second ds plasmid is produced.



(1) Theta replication is initiated by a DNA polymerase I (Bruand *et al.*, 1993) from a fixed point close to the 3' end of the plasmid encoded Rep protein. It is unidirectional and occurs in the same direction as transcription of the Rep protein. (2) The plasmid DNA unwinds and new DNA is synthesised at the fork where the two strands are separated.

Theta replication does not generate single stranded DNA intermediates or HMW DNA concatemers, and allows the copy number of the plasmid to be controlled, using a resolution function. Theta replication has been reported to provide plasmids with increased stability, in comparison to RCR (Jannièrè *et al.*, 1990). The large size of plasmids pX01 and pX02 indicates that they are likely to replicate using  $\theta$ -replication.

## **6.2 Aims of this chapter**

The aim of the work described in this chapter was to study the stability of pX01 and pX02 in *B. anthracis* in the presence of a metabolic burden, caused by non-indigenous plasmid DNA. This will provide information relevant to the incidence of pX01<sup>-</sup> or pX02<sup>-</sup> derivatives of *B. anthracis* in the environment. Additionally, the stability of such plasmid DNA in the absence of selection pressure was studied in order to provide information which may be of use in predicting the likelihood of genetic exchange involving *B. anthracis* occurring in the environment.

## **6.3 Materials and Methods**

### **6.3.1 The stability of *E. coli*/*Bacillus* shuttle vectors in pX01<sup>-</sup>/pX02<sup>-</sup>**

#### ***B. anthracis* UM23C1-1**

##### **6.3.1.1 The construction of *E. coli*/*Bacillus* shuttle vectors**

The shuttle plasmids used were ACGM (Advisory Committee for Genetic Manipulation) compliant, non-mobilisable shuttle vectors, based on different plasmid replicons. The three shuttle vectors used for initial experiments were originally constructed for evaluation for the production of PA (Quinn and Shone, 1994). All

three plasmids contained the complete *pag* gene with promoter, signal and transcriptional terminator sequences. Characteristics of the plasmids are shown in Table 2.2 (p 45).

Plasmids pAEX-1-*pag* and pAEX-4-*pag* are based on the minimal replicons from pC194 and pUB110 respectively which were originally isolated from *Staphylococcus aureus*, and replicate using RCR. Plasmid pAEX-5-*pag* is based on the pAM $\beta$ 1 minimal replicon, originally isolated from *Enterococcus faecalis* and replicates using  $\theta$ -replication. The characteristics of *B. anthracis* strain UM23C1-1, a derivative of the Sterne strain are detailed in Table 2.1 (p 44).

### **6.3.1.2 Determination of the segregational stabilities of small shuttle plasmids in *B. anthracis* strain UM23C1-1 in the absence of antibiotic selection**

To determine how long it would take for derivatives of *B. anthracis* UM23C1-1 containing pAEX-1-*pag*, pAEX-4-*pag* or pAEX-5-*pag* to grow for 100 generations in L-broth (LB) the doubling time ( $t_d$ ) of each construct was determined using  $A_{600}$  absorbancy readings as described in section 2.15 (p 62).

*B. anthracis* UM23C1-1 containing each plasmid was grown for 100 generations in LB in the absence of antibiotic selection as described in Section 2.16. Briefly, each derivative of *B. anthracis* was grown in LB with subculture into fresh medium each time the growth reached mid-log phase, as determined by  $A_{600}$  readings. Where it was necessary to leave cultures growing overnight, a series of 10 fold dilutions into fresh LB were made, and the dilution containing growth closest to mid-log phase ( $A_{600} \approx 0.5$ ) was used to continue the experiment. Samples were taken at appropriate intervals, diluted and cultured overnight on LA. The stability of each

plasmid was monitored using loss of antibiotic resistance as a marker of plasmid loss. Colonies (200 from each sample) were picked in duplicate onto LA and LA + antibiotic, and the percentage of colonies retaining antibiotic resistance was recorded.

### **6.3.2 The stability of pAEX-5E over 100 generations of growth in derivatives of *B. anthracis* ASC 69, in the absence of antibiotic selection pressure**

#### **6.3.2.1 Construction of plasmid pAEX-5E**

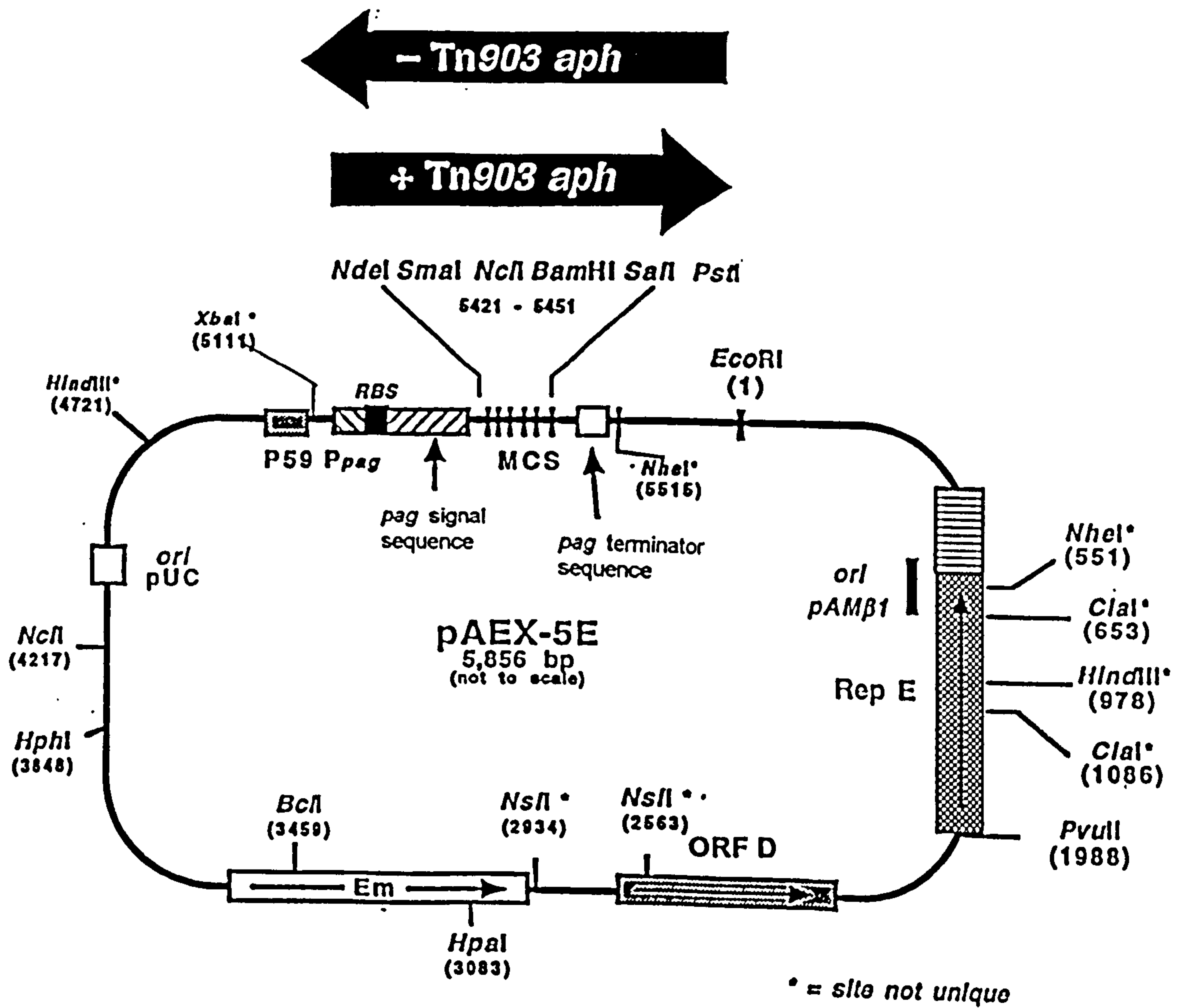
Plasmid pAEX-5E is based on pAEX-5-*pag* but does not contain the *pag* structural gene. The *pag* promoter, signal and transcriptional terminator sequences remain present (Fig. 6.2). The *pag* structural gene was removed as the sequence homology with *pag* on pX01 may affect the interaction between pX01 and pAEX-5-*pag*.

Plasmid pAEX-5E contains the 2.59 kb minimal replicon from pAM $\beta$ 1 (Swinfield *et al.*, 1990) and is analogous to vector pMTL500E (Janni $\acute{e}$ re *et al.*, 1990; Swinfield *et al.*, 1991). The main differences between pAEX-5E and pMTL500E being the orientation of the replicon, the absence of the ampicillin resistance cassette and the non-mobilisable origin of replication from pUC9 (Vieira and Messing, 1982).

Plasmid pAEX-5E does not contain the resolvase gene of pAM $\beta$ 1 which controls the plasmid copy number and has been reported to increase segregational stability of the pAM $\beta$ 1 replicon in *B. subtilis* (Swinfield *et al.*, 1991; Janni $\acute{e}$ re *et al.*, 1993).

To study the stability of pAEX-5E in the presence of erythromycin selection pressure, a second antibiotic marker was introduced into pAEX-5E, to ensure that antibiotic resistance after growth in erythromycin was not due to induced chromosomal resistance. The Tn903 *aph* gene (kanamycin resistance) was

**Figure 6.2** A diagrammatic representation of the pAEX-5E and pAEX-5E/K constructs, indicating the orientations of the kanamycin cassette



introduced into the polylinker region of pAEX-5E in both orientations (see Fig. 6.2) and transformed into the pX01<sup>+</sup>/pX02<sup>+</sup> and pX01<sup>-</sup>/pX02<sup>-</sup> derivatives of *B. anthracis* ASC 69 (see below). In the pAEX-5E/K (+) construct where the *aph* gene promoter and the pAM $\beta$ 1 replication functions, open reading frame D (ORFD) and *repE*, are convergent, the plasmid was not as segregationally stable as in the (-) construct, in which the *aph* gene promoter and *rep* functions were running in the same direction. This would imply that the *aph* gene promoter interferes with the functions of ORFD and *repE*. The pAEX-5E/K plasmid containing the (-) construct was used in this study.

The isolate of *B. anthracis* chosen for use in these experiments was ASC 69. This was originally isolated in 1958 from an outbreak of pulmonary anthrax in Manchester, New Hampshire (USA), in which 4 people died (Plotkin *et al.*, 1960). *B. anthracis* ASC 69 was cured of pX01 by culture for 10 days at 43 °C and of pX02 by culture in the presence of novobiocin as described in Section 2.11 (p 57). Plasmid pAEX-5E was introduced into pX01<sup>+</sup>/pX02<sup>+</sup>, pX01<sup>+</sup>/pX02<sup>-</sup>, pX01<sup>-</sup>/pX02<sup>+</sup> and pX01<sup>-</sup>/pX02<sup>-</sup> derivatives of *B. anthracis* by electroporation as described in Section 2.13 (p 59).

### **6.3.2.2 The stability of pAEX-5E in derivatives of *B. anthracis* ASC 69 in the absence of antibiotic selection pressure**

The doubling time ( $t_d$ ) of each derivative of *B. anthracis* was calculated from growth curves constructed based on  $A_{600}$  absorbancy readings as described in Section 2.15 (p 62). Using these  $t_d$ 's the different derivatives of *B. anthracis* were grown for 100 generations in LB in the absence of antibiotic at 37 °C. The stability of pAEX-5E

was determined by using erythromycin resistance as a marker of the presence of the plasmid as described in Section 2.16 (p 63). All growth experiments were conducted at least in triplicate.

### **6.3.2.3 The effect of chain length on the segregational stability of pAEX-5E in *B. anthracis* ASC 69 in the absence of antibiotic selection pressure**

When *B. anthracis* is grown *in vitro* long chains of cells are formed. When a sample of growth from broth is cultured on agar each chain of cells will form an individual colony. When the stability of a plasmid is being monitored, a single antibiotic resistance colony would be formed whether a single cell or the whole chain of cells contained the plasmid. Thus chain length may mask the actual rate of plasmid loss in *B. anthracis*. To determine whether chain length affected the stability of pAEX-5E, cultures were grown for 100 generations in LB (in the absence of antibiotic).

Samples (1  $\mu$ l) were taken at appropriate intervals, air dried onto microscope slides, stained with polychrome methylene blue and examined microscopically. The number of cells in 50 chains of *B. anthracis* from each sample was counted. The mean chain length (MCL,  $\pm$  the standard error of the mean) was determined for each sample.

### **6.3.2.4 The structural stability of pAEX-5E in *B. anthracis* in the absence of antibiotic selection pressure**

To determine whether pAEX-5E remained structurally stable where it was retained for over 100 generations of growth in the absence of antibiotic selection pressure, plasmid rescue was conducted as described in Section 2.14.3 (p 61). Briefly, the pX01/pX02<sup>+</sup> derivative of *B. anthracis* ASC 69 was grown for 100 generations in



the absence of antibiotic selection pressure, a sample was taken and cultured on LA. Colonies (5) were sub-cultured in LB, and plasmid DNA extracted using Krystal Plasmid DNA Extraction Kit. The plasmid DNA was subsequently transformed into *E. coli* GM2163 (*dcm<sup>-</sup>dam<sup>-</sup>*) as described in Section 2.14.2. The plasmid DNA was amplified by culture in *E. coli*, extracted and restriction digest analysis carried out as described in Section 2.14.4 (p 62).

#### **6.3.4 The stability of pX01 and pX02 under antibiotic selection pressure for pAEX-5E**

To determine the effect of antibiotic selection pressure for pAEX-5E on the stability of pX01 and pX02, cultures were grown for 100 generations in LB containing 5 µg/ml erythromycin. Growth curves and  $t_d$  values were calculated using  $A_{600}$  absorbancy measurements as described in Section 2.15 (p 62). To screen for the presence of pX01 and pX02 in the pX01<sup>+</sup>/pX02<sup>+</sup> and pX01<sup>-</sup>/pX02<sup>+</sup> derivatives of *B. anthracis*, samples were taken and colonies cultured on bicarbonate agar under candle extinction (~5% CO<sub>2</sub>) or in the presence of 20% CO<sub>2</sub> (Green *et al.*, 1985) as described in Section 2.12.1 (p 58). Comparison of the appearance of colonies under these conditions allowed their pX01 and pX02 content to be determined (see Table 2.3; p 58). Capsulation of colonies of *B. anthracis* on agar has been observed to increase with incubation time, and a minimum number of bacilli are required to be present before capsular material can be observed (Meynell and Meynell, 1964). To ensure that capsular material was not remaining undetected, all colonies which appeared dry when cultured in the presence of 20% CO<sub>2</sub> were observed microscopically for the presence of capsular material (Welkos, 1991).

When the pX01<sup>+</sup>/pX02<sup>-</sup> derivative of *B. anthracis* was tested, a sample was taken after 100 generations of growth and 100 colonies tested for the presence of pX01 using the PCR (p 51). The presence of *pag* was taken to indicate the presence of pX01.

### 6.3.5 The structural stability of pAEX-5E under antibiotic selection pressure

To ensure that during the 100 generations of growth under selection pressure for pAEX-5E, erythromycin resistance remained pAEX-5E mediated, rather than due to the induction of a chromosomally encoded antibiotic resistance gene, *B. anthracis* (pX01<sup>+</sup>/pX02<sup>+</sup>) containing pAEX-5E/K was grown for 100 generations in LB containing erythromycin. After this time a sample was taken, and colonies (200) grown on LA containing kanamycin.

To determine whether pAEX-5E and pAEX-5E/K had remained structurally stable after 100 generations of growth in *B. anthracis* under antibiotic selection pressure, plasmid rescue into *E. coli* and restriction digest analysis were carried out as described in Sections 2.14.3 and 2.14.4 (p 61).

To ascertain whether pAEX-5E had integrated into the *B. anthracis* genome after 100 generations of growth under selection pressure for pAEX-5E, Southern blot analysis of genomic DNA from *B. anthracis* was conducted as described in Section 2.17 (p 64). Digested genomic DNA was probed with pAEX-5E DNA from which the *pag* promoter and terminator sequences had been removed (See Fig 6.2) as described in Section 2.17.5 (p 68).

As an additional test to determine whether pAEX-5E had integrated into the *B. anthracis* chromosome, the pX01<sup>+</sup>/pX02<sup>-</sup> derivative was grown for 100

generations in the presence of erythromycin. Antibiotic selection was subsequently removed, and the stability of pAEX-5E monitored by screening colonies for erythromycin resistance over time as described in Section 2.16.1 (p 63).

## 6.4 RESULTS

### 6.4.1 The stability of small shuttle plasmids in *B. anthracis* UM23C1-1 in the absence of antibiotic selection pressure

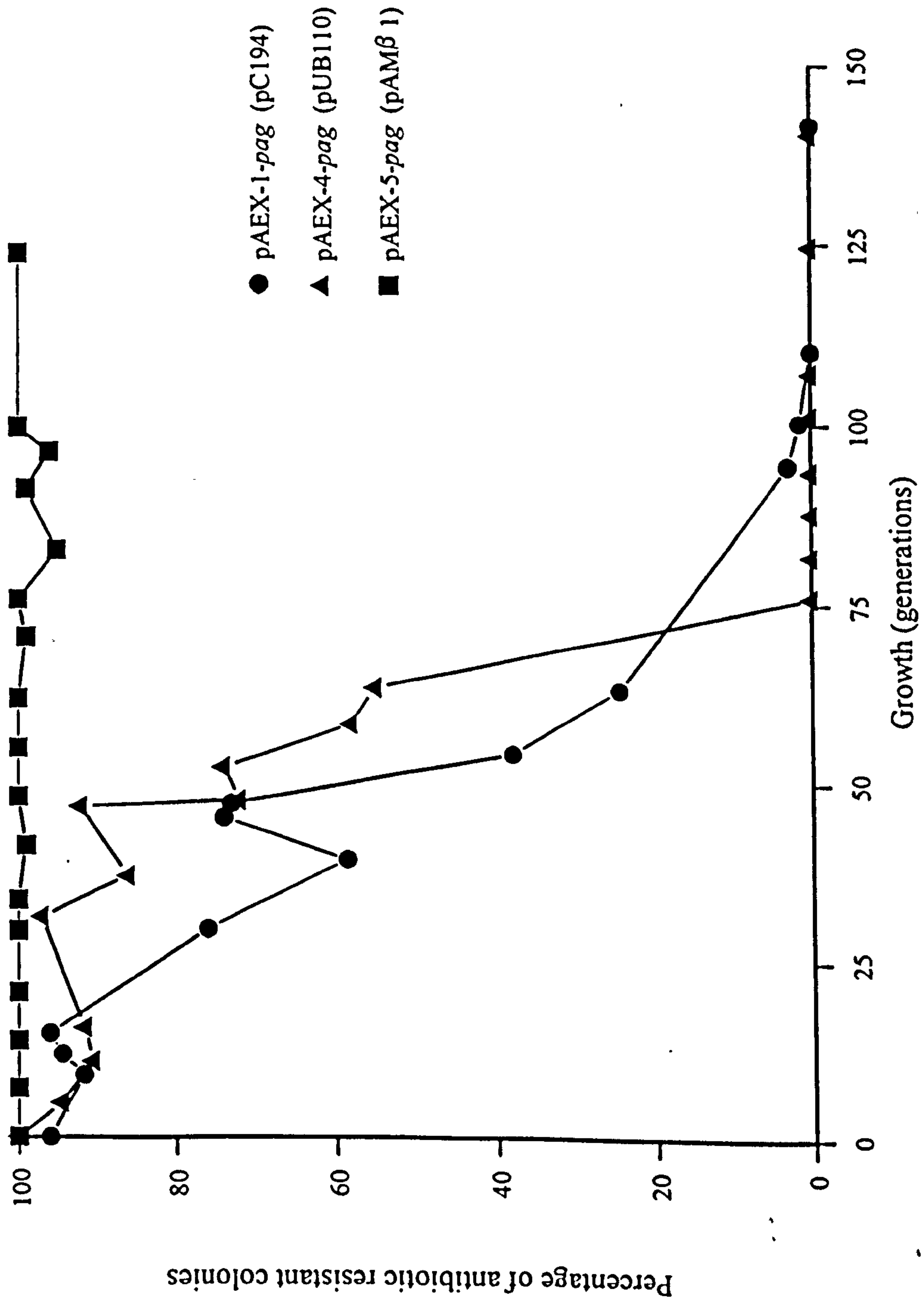
The  $t_d$  for each derivative of *B. anthracis* UM23C1-1 is shown in Table 6.1.

**Table 6.1** The doubling time of derivatives of *B. anthracis* UM23C1-1 containing pAEX-1-*pag*, pAEX-4-*pag* or pAEX-5-*pag* grown in LB

Plasmid contained in <i>B. anthracis</i>	Doubling time ( $t_d$ ) min
pAEX-1- <i>pag</i>	30.1
pAEX-4- <i>pag</i>	30.8
pAEX-5- <i>pag</i>	34.8

When each derivative of *B. anthracis* UM23C1-1 was cultured for 100 generations in LB in the absence of antibiotic selection pressure, the plasmids based on the minimal replicons from pC194 and pUB110 were lost from *B. anthracis* UM23C1-1 after 110 and 75 generations of growth respectively (Fig. 6.3). The plasmid based on the pAM $\beta$ 1 minimal replicon (pAEX-5-*pag*) however, remained 100% stable for more than 100 generations. These results showed that such a  $\theta$ -replicating plasmid

**Figure 6.3** The stability of small shuttle plasmids in *B. anthracis* UM23C1-1 over 100 generations of growth in LB



*B. anthracis* was grown for 100 generations (calculated from  $t_d$  values) in LB. Samples were taken at appropriate intervals and grown on LA. 200 colonies from each sample were cultured on LA + antibiotic, and the percentage of antibiotic resistant colonies calculated. Two experiments were conducted and samples taken at different points. The results of both experiments were combined.

would be suitable for use in further experiments.

#### 6.4.2 The stability of pAEX-5E in derivatives of *B. anthracis* ASC 69 in the absence of antibiotic selection pressure

The  $t_d$  of derivatives of *B. anthracis* ASC 69 containing pAEX-5E are shown in Table 6.2.

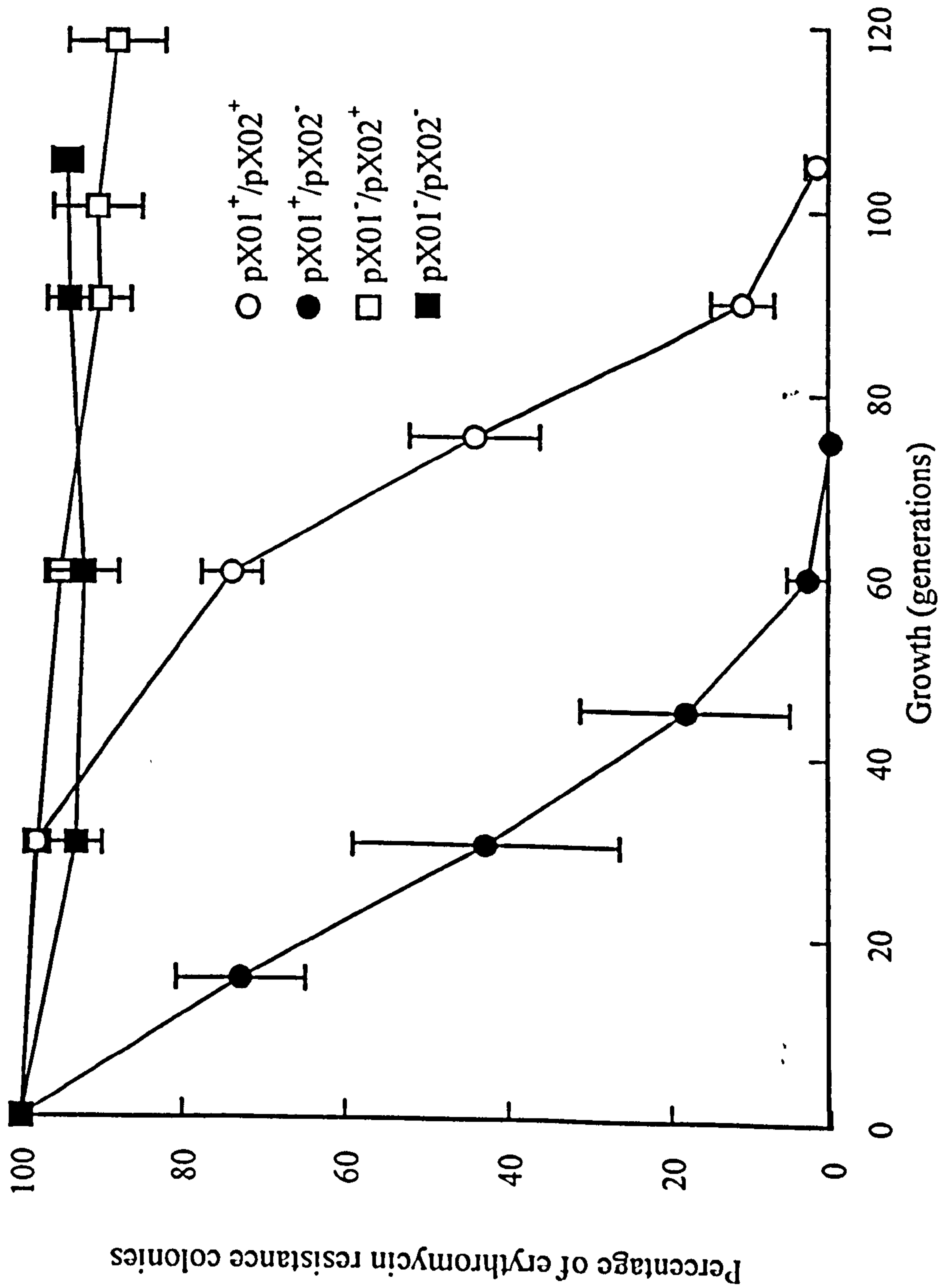
**Table 6.2** The doubling time of derivatives of *B. anthracis* ASC 69 containing plasmid pAEX-5E grown in LB in the absence of antibiotic selection

Derivative of ASC 69	$t_d \pm \text{SEM}^*$ (min)
pX01 <sup>+</sup> /pX02 <sup>+</sup>	46.0 $\pm$ 2.9
pX01 <sup>+</sup> /pX02 <sup>-</sup>	58.2 $\pm$ 3.0 †
pX01 <sup>-</sup> /pX02 <sup>+</sup>	40.5 $\pm$ 4.7
pX01 <sup>-</sup> /pX02 <sup>-</sup>	43.2 $\pm$ 1.2

\* SEM = standard error of the mean; † Prior to transformation with pAEX-5E the  $t_d$  of the pX01<sup>+</sup>/pX02<sup>-</sup> derivative was 41.9  $\pm$  3.4 min

The stability of pAEX-5E in the different derivatives of *B. anthracis* when grown in LB is shown in Fig. 6.4. Plasmid pAEX-5E was found to remain stable in the pX01<sup>-</sup>/pX02<sup>-</sup> and pX01<sup>-</sup>/pX02<sup>+</sup> derivatives of *B. anthracis* for more than 100 generations of growth. In the pX01<sup>+</sup>/pX02<sup>-</sup> derivative, pAEX-5E was expelled within 63 culture generations and in pX01<sup>+</sup>/pX02<sup>+</sup> isolate pAEX-5E was expelled

Figure 6.4 The stability of pAEX-5E (measured by antibiotic resistance) in derivatives of *B. anthracis* ASC 69 over 100 generations of growth in LB.



Derivatives of *B. anthracis* were grown for 100 generations (calculated from  $t_d$  values) in LB. Samples were taken at appropriate intervals and grown on LA. 200 colonies from each sample were cultured on LA + 5µg/ml erythromycin and the percentage of antibiotic resistant colonies calculated. Experiments were conducted in triplicate. Error bars represent the standard error of the mean (SEM)

within 105 generations of growth. These results show that the presence of pX01 causes the expulsion of pAEX-5E from *B. anthracis*, which could indicate that pAEX-5E and pX01 are incompatible. The expulsion of pX01 was slower in the original isolate of ASC 69 which also contains pX02 (pX01<sup>+</sup>/pX02<sup>+</sup>).

#### **6.4.3 The effect of chain length on the segregational stability of pAEX-5E in *B. anthracis* ASC 69 in the absence of antibiotic selection pressure**

The mean chain lengths of derivatives of *B. anthracis* in LB are shown in Tables 6.3 and 6.4. In the pX02<sup>+</sup> derivatives, the mean chain length was almost double that observed in the pX02<sup>-</sup> derivatives of *B. anthracis* ( $P < 0.0001$  using a two sample t-test; see Tables 6.3). There was some indication that in the pX01<sup>+</sup> derivatives, the mean chain length increased as pAEX-5E was expelled (for the pX01<sup>+</sup>/pX02<sup>-</sup> derivative  $p < 0.0014$ , Table 6.4). No increase in chain length over time was observed in the pX01<sup>-</sup> derivatives. The similar mean chain lengths observed in the pX01<sup>+</sup>/pX02<sup>-</sup> and pX01<sup>-</sup>/pX02<sup>-</sup> derivatives ( $17.0 \pm 1.6$  and  $15.9 \pm 1.9$  respectively) compared to their different pAEX-5E retention profiles (see Fig. 6.4) supported the interpretation that it is the presence of pX01 which affects the stability of pAEX-5E in the absence of antibiotic selection, rather than a difference in chain length in the two derivatives.

In the pX01<sup>+</sup>/pX02<sup>+</sup> isolate, loss of pAEX-5E was slower and chain lengths were longer than in the pX01<sup>+</sup>/pX02<sup>-</sup> derivative. Even when the increased chain length was taken into account, pAEX-5E was still found to have been retained for longer in the pX01<sup>+</sup>/pX02<sup>+</sup> isolate of *B. anthracis* ASC 69.

**Table 6.3** A comparison of the length of chains formed by derivatives of *B. anthracis* ASC 69 containing pAEX-5E grown in LB for 100 generations (for the pX01<sup>+</sup>/pX02<sup>-</sup> information see Table 6.4)

No. of generations *	Mean number of cells per chain (50 chains)					
	pX01 <sup>+</sup> /pX02 <sup>+</sup>		pX01 <sup>-</sup> /pX02 <sup>+</sup>		pX01 <sup>-</sup> /pX02 <sup>-</sup>	
	Expt. 1	Expt. 2	Expt. 1	Expt. 2	Expt. 1	Expt. 2
1	26.0	17.3	32.7	6.6	7.2	24.7
	19.9	14.0	35.0	9.5	9.1	21.4
32	19.4	17.7	30.2	36.8	11.1	15.6
	28.7	29.9	33.7	30.5	12.5	33.8
64	13.7	49.5	73.8†	17.7	5.1	23.1
	16.2	28.4	15.0	24.7	9.2	19.2
96	34.7	42.9	78.1†	12.1	17.9	ND
	31.2	44.1	ND	15.0	12.2	ND
128	ND	24.0	ND	21.6	14.9	ND
	ND	54.1	ND	34.2	18.1	ND
160	ND	42.0	ND	ND	ND	ND
MCL ± SEM	29.0 ± 2.8		29.8 ± 4.8		15.9 ± 1.9	

\* The number of generations was calculated using an average  $t_d$  of 45 min;

MCL = mean chain length (the average number of cells per chain over the culture period); SEM = standard error of the mean; ND = not done; † Excluding these figures the alternative mean would be 25.0.



**Table 6.4 The mean chain length of the pX01<sup>+</sup>/pX02<sup>-</sup> derivative of ASC 69 over 100 generations of growth in LB**

No of * generations	Chain length † (determined from 50 chains)		
	1	2	3
Expt. no			
1	16.4	7.0	6.0
	14.9	13.2	15.5
25	9.5	9.2	12.9
	20.4	12.1	15.2
50	29.7	21.9	20.0
	25.7	17.2	29.0
74	18.2	ND	26.2
MCL	17.0 ± 1.6		

\* Calculated using a  $t_d$  of 58 min; † Chain length was compared to the stability of pAEX-5E. At points above the thick single line at least 50% of colonies contained pAEX-5E, below the line less than 50% of colonies contained pAEX-5E;  
MCL = mean chain length (the average number of cells per chain over the culture period) ± the standard error of the mean; ND = not done

These results indicate that chain length is unlikely to be a factor affecting the stability of pAEX-5E in the absence of antibiotic selection pressure for pAEX-5E.

#### 6.4.4 The structural stability of pAEX-5E DNA in *B. anthracis* in the absence of antibiotic selection pressure

In the absence of antibiotic selection pressure for pAEX-5E, plasmid rescue to *E. coli* followed by restriction digest analysis showed that pAEX-5E had remained structurally stable over 100 generations of growth the pX01<sup>+</sup>/pX02<sup>+</sup> derivative of ASC 69 (results not shown).

#### 6.4.5 The stability of pX01 and pX02 under antibiotic selection pressure for pAEX-5E

The  $t_d$  for the different derivatives of *B. anthracis* ASC 69 when grown in the presence of 5 µg/ml erythromycin are shown in Table 6.5.

**Table 6.5** The doubling times of derivatives of *B. anthracis* ASC 69 in LB under antibiotic selection pressure for pAEX-5E

Derivative of ASC 69	Mean generation time ± SEM *
pX01 <sup>+</sup> /pX02 <sup>+</sup>	47.3 ± 1.1
pX01 <sup>+</sup> /pX02 <sup>-</sup>	75.3 ± 1.4
pX01 <sup>-</sup> /pX02 <sup>+</sup>	43.2 ± 1.2

\* SEM = standard error of the mean

When derivatives of *B. anthracis* ASC 69 were grown for 100 generations under

antibiotic selection for pAEX-5E, the results of duplicate experiments showed that pX01 and pX02 remained stable (Table 6.6).

**Table 6.6 The stability of pX01 and pX02 over 100 generations of growth under selection pressure for pAEX-5E**

Derivative of ASC 69	Expt no.	% Loss		No. of colonies screened
		pX01	pX02	
pX01 <sup>+</sup> /pX02 <sup>+</sup>	1	0.09 *	0.02	5330
	2	0.05	0	3752
pX01 <sup>+</sup> /pX02 <sup>-</sup>	1	0	-	100 ‡
	2	0	-	100 ‡
pX01 <sup>-</sup> /pX02 <sup>+</sup>	1	-	0 †	5221
	2	-	0	4118

\* In the first sample taken, after 6 generations of growth, 4.3% of colonies lost pX01 (49 out of 1118). Including this figure, loss of pX01 would be 1.0%;

† 0.78% (41/5330) of colonies appeared dry when grown under 20 % CO<sub>2</sub>,

however capsular material was evident when colonies were examined

microscopically; ‡ screened using the PCR.

In the pX01<sup>+</sup>/pX02<sup>+</sup> derivative 0.02% of colonies were observed to have lost pX02 and 0.07% of colonies lost pX01. At one sample point, 4.3% of colonies were observed to have lost pX02. This loss was attributed to a dislodgement event (Williams and Thomas, 1992). No comparable losses were observed in any other sample taken during the experiments. These results indicated that when under

metabolic pressure, *B. anthracis* still retains pX01 and pX02. The increase in generation time which was observed in the pX01<sup>+</sup>/pX02<sup>-</sup> derivative of *B. anthracis* (Table 6.5) may be linked to the proposed incompatibility of pAEX-5E and pX01, shown by the more rapid expulsion of pAEX-5E in the pX01<sup>+</sup>/pX02<sup>-</sup> derivative in the absence of antibiotic selection pressure for pAEX-5E (Fig. 6.4; p 240). The  $t_d$  of 58.2 min observed in the absence of antibiotic selection (Table 6.2; p 239) may represent the growth rate of a mixed population of cells some of which contain pAEX-5E, and some of which that have lost pAEX-5E. The presence of pX02 in the pX01<sup>+</sup>/pX02<sup>+</sup> isolate of ASC 69 appeared to prevent the reduction in growth rate observed in the derivative containing pX01 and pAEX-5E only, and reduced the metabolic stress incurred in the presence of pX01 alone.

#### 6.4.6 The structural stability of pAEX-5E

The pX01<sup>+</sup>/pX02<sup>+</sup> derivative of ASC 69 containing pAEX-5E/K was grown for 100 generations under erythromycin selection pressure and colonies (200) picked onto agar containing kanamycin. All colonies tested were resistant to kanamycin. This indicated that pAEX-5E/K had remained functional over the 100 generations of growth. Plasmid rescue experiments showed that 10 of 10 colonies tested from the pX01<sup>+</sup>/pX02<sup>+</sup> derivative contained pAEX-5E/K and 5 of 5 colonies tested from the pX01<sup>+</sup>/pX02<sup>-</sup> derivative contained pAEX-5E. This showed that the appropriate plasmid had remained functional and structurally stable over the 100 generations of growth.

Southern blot analysis was conducted under medium stringency conditions (hybridization temperature of 60 °C followed by washes in 1.0 x and 0.5 x SSC).

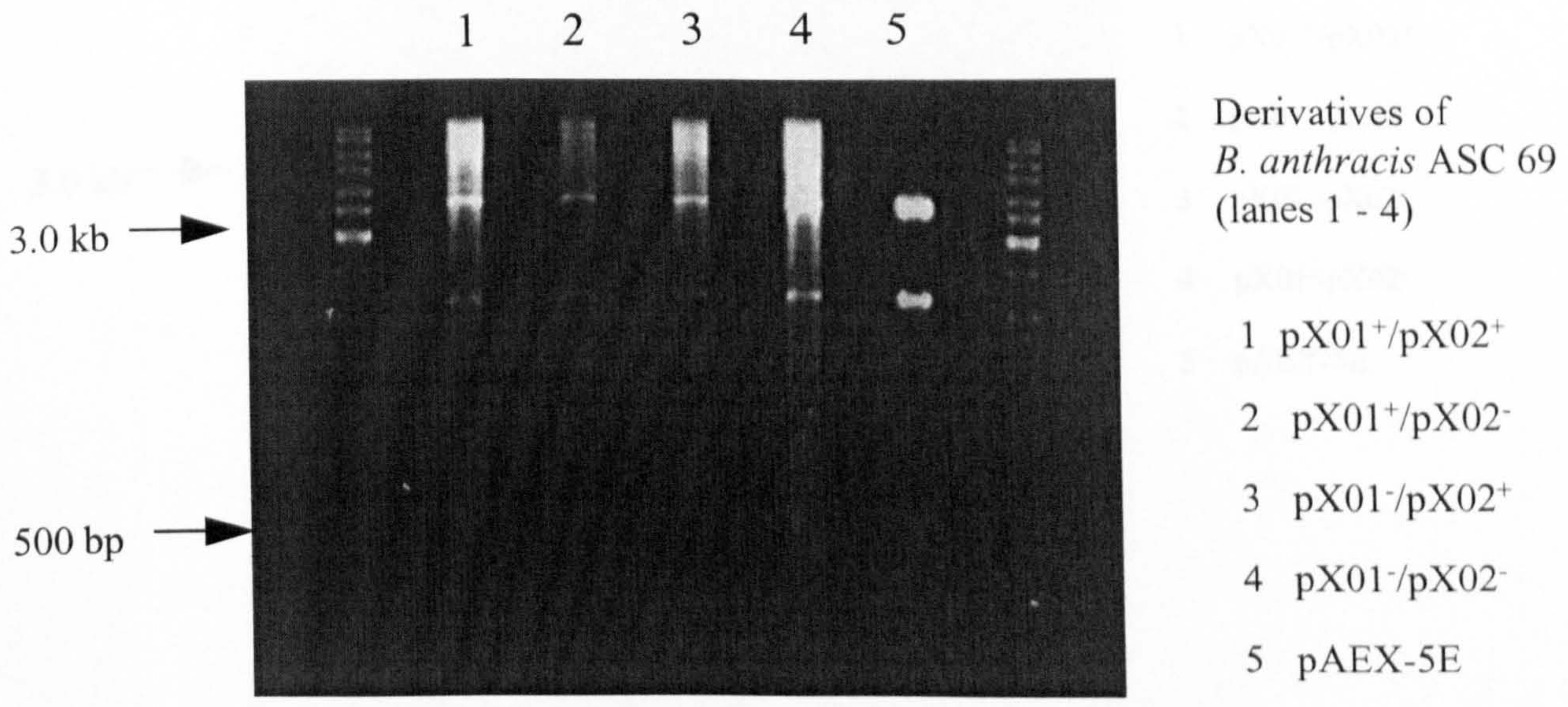
Plasmid pAEX-5E DNA was shown to have remained structurally stable in derivatives of *B. anthracis* ASC 69 and had not integrated into the *B. anthracis* genome (Fig. 6.5 a + b and Fig. 6.6 a + b). *Hind*III digested pAEX-5E DNA produces two DNA fragments of 3743 bp and 2113 bp (see Fig. 6.2; p 232). Both DNA fragments were visible as discrete bands in all 4 derivatives of *B. anthracis* which had been cultured for 100 generations in the presence of erythromycin. The pAEX-5E probe used in this study contained the entire pAM $\beta$ 1 replication region. No difference was observed between the pX01<sup>+</sup> and pX01<sup>-</sup> derivatives of *B. anthracis*, indicating that there is little sequence homology between the pAM $\beta$ 1 the pX01 replication regions.

When the pX01<sup>+</sup>/pX02<sup>-</sup> derivative of *B. anthracis* was grown for 100 generations in the presence of antibiotic selection pressure for pAEX-5E and then grown in the absence of selection pressure, pAEX-5E was expelled from the culture within 40 generations. This plasmid loss was comparable to that observed when the pX01<sup>+</sup>/pX02<sup>-</sup> derivative was grown in the absence of antibiotic from the onset (Fig. 6.7). This is further evidence that pAEX-5E had not integrated into the chromosome.

## 6.5 DISCUSSION

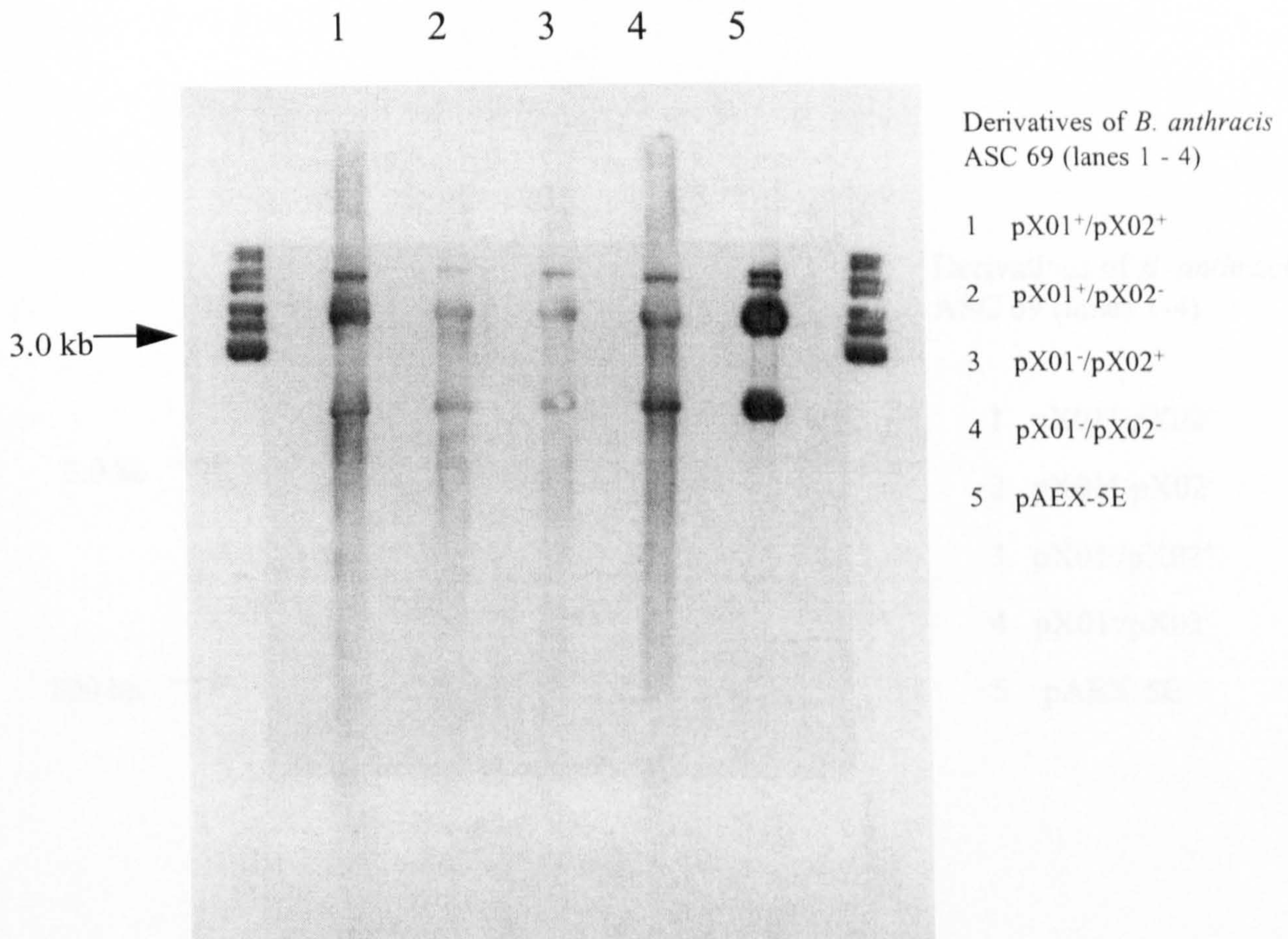
The stability of plasmids pAEX-1-*pag* and pAEX-4-*pag* (which are based on the minimal replicons from pC194 and pUB110 respectively and use RCR) in *B. anthracis* UM23C1-1 as determined in this study were comparable with the results from published studies on the stability of similar plasmids in other *Bacillus* species. Plasmid pC194 has been reported as being both stable and unstable in *B. subtilis*

**Figure 6.5.a** *Hind*III digested genomic DNA from derivatives of *B. anthracis* ASC 69 which have been grown for 100 generations under antibiotic selection pressure for pAEX-5E



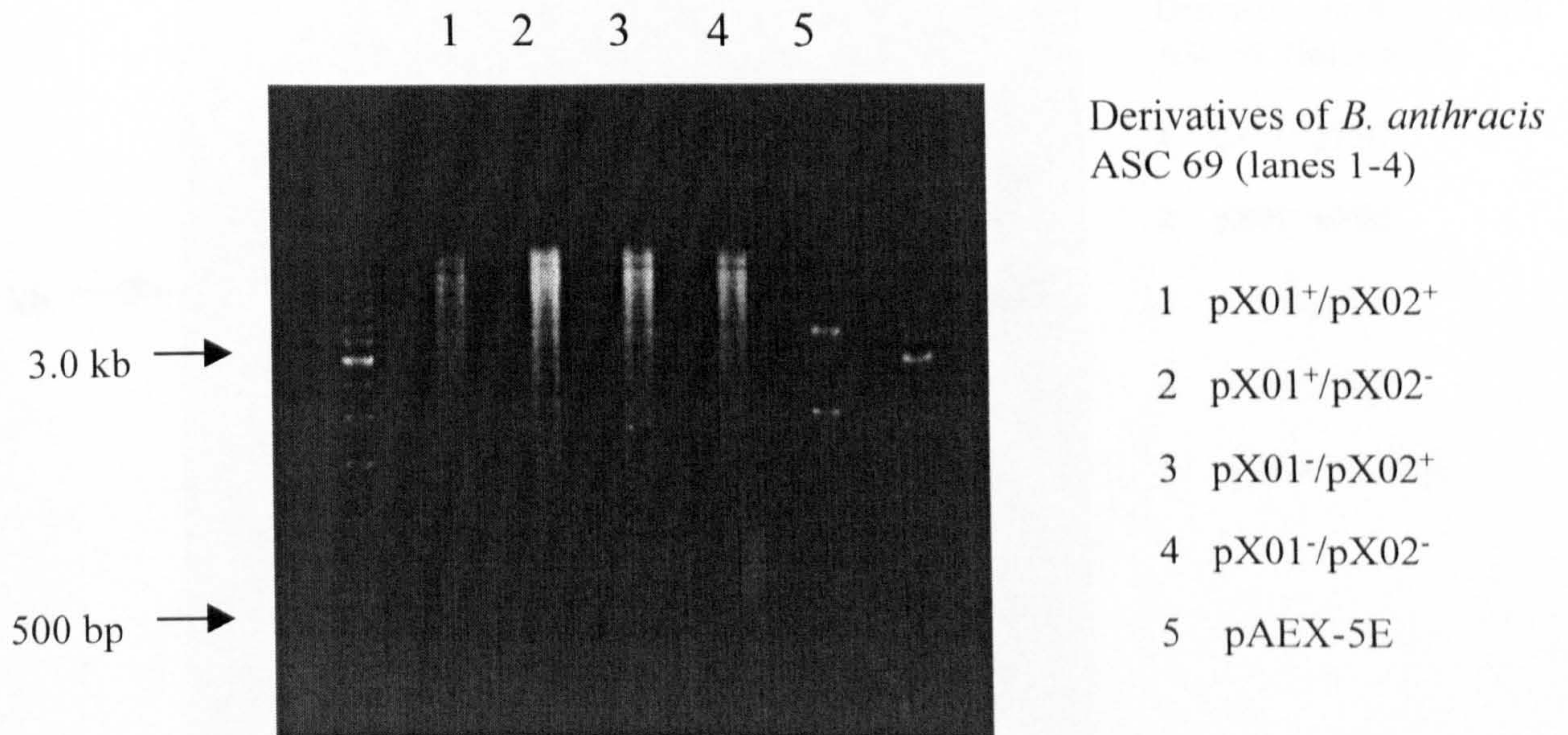
Total genomic DNA (1 µg) was digested overnight at 37 °C using *Hind*III restriction enzyme, according to the manufacturer's instructions. DNA was run on a 1% agarose gel for 4 h at 80 V. The digests were also the same in each derivative of *B. anthracis* when DNA was digested with *Eco*RI

**Figure 6.5 b** Southern blot analysis of *Hind*III digested genomic DNA extracted from derivatives of *B. anthracis* ASC 69 after 100 generations of growth in the presence of antibiotic selection pressure for pAEX-5E, probed with pAEX-5E DNA



Digested DNA was transferred to a nylon membrane by capillary action and fixed under ultraviolet light. The pAEX-5E probe was hybridized to the DNA overnight at 60 °C followed by washes in 1 x SSC and 0.5 x SSC. The probing pattern was also the same in each derivatives of *B. anthracis* when DNA was digested with *Eco*RI

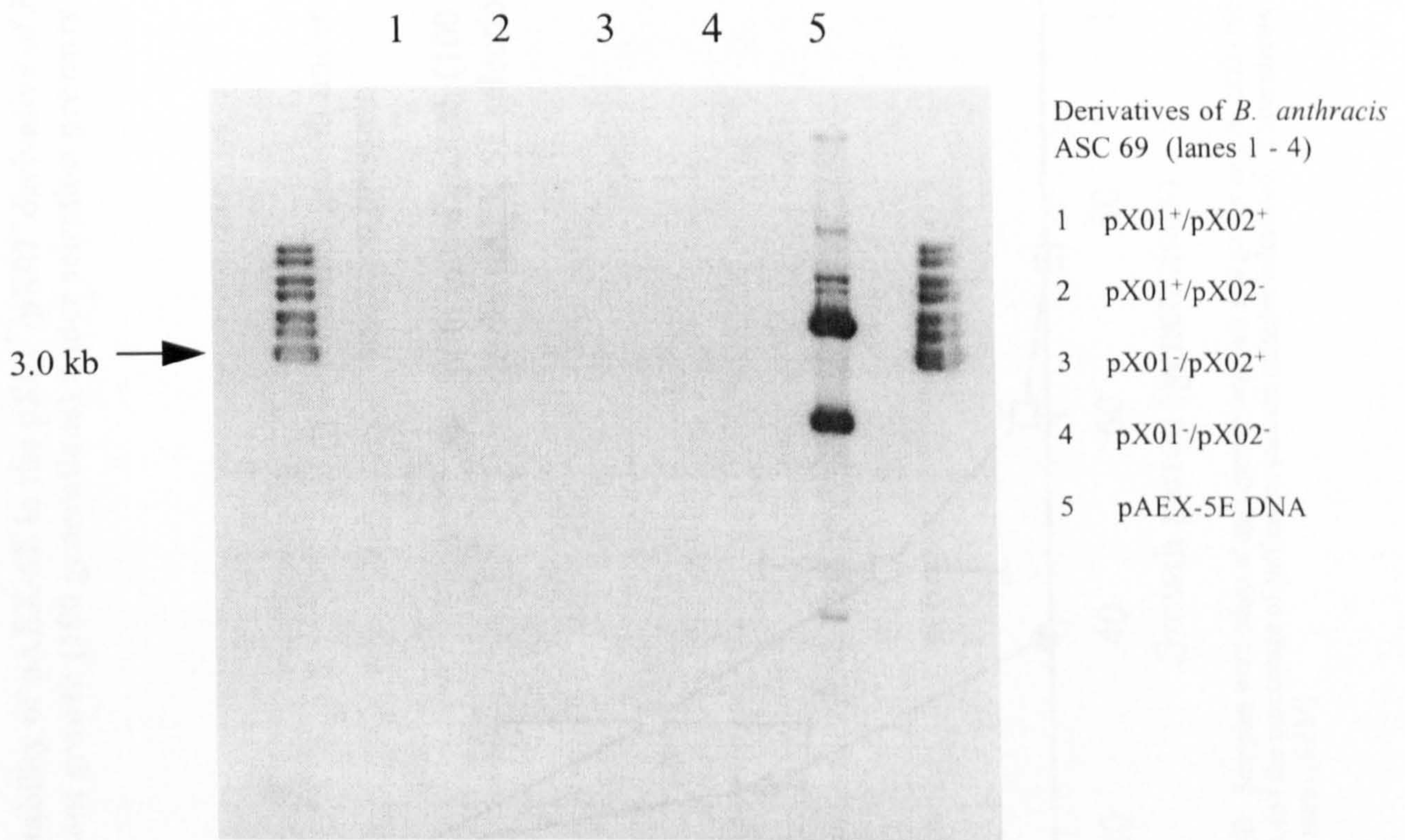
**Figure 6.6 a** *Hind*III digested genomic DNA from derivatives of *B. anthracis* ASC 69 DNA prior to the introduction of pAEX-5E DNA



Total genomic DNA (1  $\mu$ g) was digested overnight at 37 °C using *Hind*III restriction enzyme according to the manufacturer's instructions. DNA was run on a 1% agarose gel for 4 h at 80V

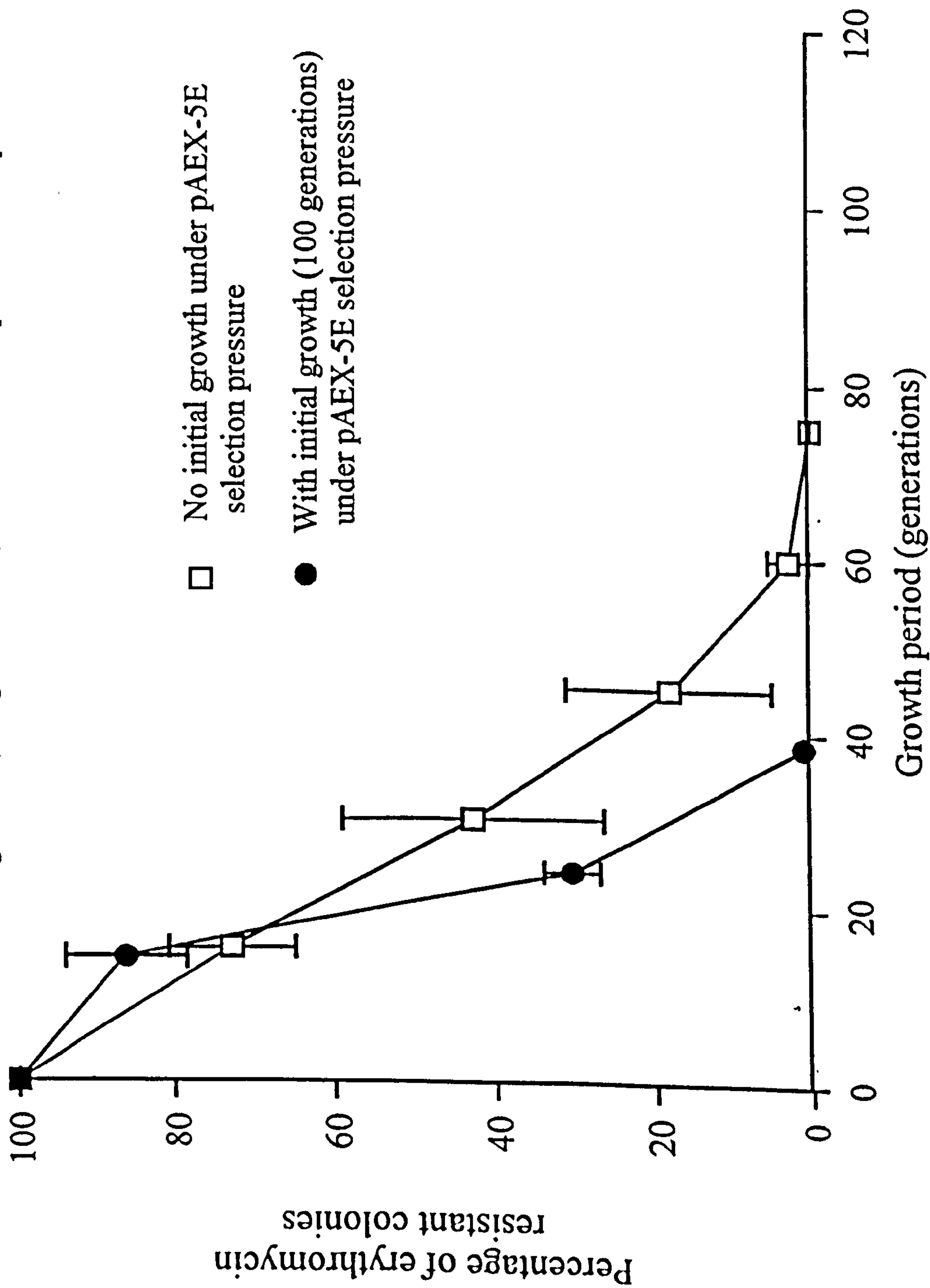


**Figure 6.6 b** Southern blot analysis of *Hind*III digested genomic DNA extracted from derivatives of *B. anthracis* ASC 69 prior to the introduction of pAEX-5E, probed with pAEX-5E DNA



Digested DNA was transferred to a nylon membrane by capillary action and fixed under ultraviolet light. The pAEX-5E probe was hybridized to the DNA overnight at 60 °C, followed by washes in 1 x SSC and 0.5 x SSC

Figure 6.7 Comparison of the stability of pAEX-5E in the pX01<sup>+</sup>/pX02<sup>+</sup> derivative of *B. anthracis* ASC 69 with and without growth (100 generations) under selection pressure for pAEX-5E



Cultures were grown for 100 generations in LB. Samples were taken at appropriate intervals and grown on LA. 200 colonies from each sample were grown on L-agar + 5µg/ml erythromycin and the percentage of antibiotic resistant colonies calculated. Experiments were conducted in duplicate. Error bars represent the standard error of the mean (SEM)

in the absence of antibiotic selection (Devine, 1989; Bron *et al.*, 1988). Plasmid pUB110 has been reported to be stable for 80 generations in *B. subtilis* in the absence of selection pressure (McKenzie *et al.*, 1986; Leonhardt, 1990). In contrast the minimal replicon from pUB110 has been reported to be unstable in *B. subtilis* (Bron, 1990). Barnard and Friedlander (1999) studied the stability of plasmids in *B. anthracis* as part of a study of the production of recombinant PA *in vivo*. They found that pUB110 containing the PA gene, which is similar to pAEX-4-*pag* used in this study was stable for 17 generations of growth in LB in a pX01<sup>+</sup>/pX02<sup>-</sup> derivative of *B. anthracis* in the absence of antibiotic selection. The incorporation of a multiple cloning site in the construct was found to decrease plasmid stability.

The stability of pX01 and pX02 under metabolic stress caused by the presence of non-indigenous plasmid DNA indicated that pX01 and pX02 are not easily lost from vegetative cells of *B. anthracis*. The reduction in the growth rate observed in the pX01<sup>+</sup>/pX02<sup>-</sup> derivative in the presence of pAEX-5E showed that *B. anthracis* will invest significant metabolic energy in retaining pX01. This may partially explain why pX01<sup>+</sup>/pX02<sup>+</sup> derivatives of *B. anthracis* have not been isolated from environmental samples. Fouet and Mock (1996) stated that pX01 is the predominant plasmid which controls expression from both pX01 and pX02. Uchida *et al.* (1997) demonstrated that the *trans*-acting regulatory element of the toxin genes (*atxA*) exerts an effect on capsule expression from pX02. They proposed that there was a degree of 'cross talk' between pX01 and pX02. This is the first example of gene expression from one plasmid affecting another plasmid (Fouet and Mock,

1996). Two lines of evidence from this study indicate that the presence of pX02 affects the metabolism of *B. anthracis*. These are the slower expulsion of pAEX-5E in the absence of antibiotic selection in the pX01<sup>+</sup>/pX02<sup>+</sup> derivative of *B. anthracis* compared to the pX01<sup>+</sup>/pX02<sup>-</sup> derivative, and the lack of a reduction in growth rate in the pX01<sup>+</sup>/pX02<sup>+</sup> derivative of *B. anthracis* grown under selection pressure for pAEX-5E. At least some of the metabolic control elements governing the maintenance of pX01 and pX02 may be located on pX02. These results also support the concept that there is a degree of 'cross talk' from pX02 to pX01. *In vivo* pX01 encodes factors which are necessary for the growth of *B. anthracis* (Fouet *et al.*, 1996). In this study it was observed that the pX01<sup>-</sup>/pX02<sup>+</sup> derivative of *B. anthracis* ASC 69 took longer (24 h at 37 °C) to grow and produce capsular material when cultured in blood than the pX01<sup>+</sup>/pX02<sup>+</sup> derivative (5 - 8 h at 37 °C).

In the absence of antibiotic selection pressure, the loss of pAEX-5E in derivatives of *B. anthracis* containing pX01 may indicate that pAEX-5E is incompatible with pX01. This could be due to homology between the *pag* signal, promoter and terminator sequence, on pAEX-5E and pX01 which can lead to plasmid incompatibility. In *B. thuringiensis* plasmid incompatibility has been attributed to sequence homology between the replication regions of two plasmids (Baum and Gilbert, 1991; Gamel and Piot, 1992). In the present study, however, Southern blot analysis of derivatives of *B. anthracis*, using pAEX-5E DNA as the probe from which the *pag* signal, promoter and terminator sequences had been removed did not reveal any homology with pX01. Southern blot analysis using probes specific to pX01 and pX02 is necessary before further conclusions can be drawn about the replication regions of pX01. Examining the stability of plasmids

based on the pAM $\beta$ 1 minimal replicon in which *pag* sequences are absent in *B. anthracis* would provide further information about the nature of the compatibility of pX01 and pAEX-5E.

The stability of a pAM $\beta$ 1 derived vector in *B. anthracis* was studied by Fouet *et al.* (1994) who published a paper describing the identification of a DNA topoisomerase like gene sequence on pX01. In their study they reported that the stability of pX01 was usually reduced in the pX01<sup>+</sup>/pX02<sup>-</sup> *B. anthracis* isolate 7702 under antibiotic selection pressure for vector pAT28. This plasmid contained a topoisomerase fragment from pAM $\beta$ 1 which was associated with plasmid stability in pAM $\beta$ 1. The incompatibility of pAT28 with pX01 was attributed to the sequence similarity. Other experiments, however, showed that in the absence of selection pressure, pAT28 was lost from 66% of pX01<sup>+</sup>/pX02<sup>-</sup> colonies of *B. anthracis*, but maintained in 95% of colonies containing pX01. All strains had lost pAT28 after 48 h. These results are in contrast to the results observed in the present study. These differences could be due to the differences in the vectors used, differences in the isolates of *B. anthracis* used or could be due to the more systematic nature of the study conducted in this thesis.

One of the possibilities not examined during this study was that pX01 or pX02 may have integrated into the *B. anthracis* chromosome during growth under selective pressure for pAEX-5E. This is unlikely to be the case in the pX01<sup>+</sup>/pX02<sup>+</sup> isolate of *B. anthracis* as under selective pressure for pAEX-5E a small percentage of colonies were observed to have lost pX01 or pX02 over the course of the experiment.

The results described in this chapter indicate that the retention of pX01 is a

priority for *B. anthracis*, and that *B. anthracis* will endure a significant metabolic compromise in order to retain pX01. This may explain why pX01<sup>+</sup>/pX02<sup>+</sup> derivatives of *B. anthracis* are not detected in the environment, whereas pX01<sup>+</sup>/pX02<sup>-</sup> derivatives occasionally are. In the environment it is possible that pX01 or pX02 may be lost during sporulation or germination. This would be hard to study as although immunofluorescence methods for observing the germination of a single spore have been described (Ezzell and Abshire, 1996) methods for monitoring the sporulation and subsequent germination of spores followed by determination of the presence of pX01 and pX02 have not been developed. The *B. thuringiensis* plasmid pHT1030 has been shown to have a resolvase independent stability system, which confers stability during sporulation and germination as well as during cell growth. This system utilizes a 15 kDa protein which has no homology with other proteins for which sequence information is available in the DNA data banks (Jannièrè *et al.*, 1993). It would be interesting to determine whether a similar protein is present on plasmids pX01 and pX02. This information may become available when sequence analysis of pX01 and pX02 DNA is complete (Okinaka *et al.*, 1998).

The expulsion of pAEX-5E from the pX01 containing derivatives of *B. anthracis* in the absence of selection pressure indicates that pX01<sup>+</sup>/pX02<sup>+</sup> and pX01<sup>+</sup>/pX02<sup>-</sup> derivatives of *B. anthracis* are able to exclude non-indigenous plasmid DNA. This may be the reason why no plasmid DNA other than that from pX01 and pX02 has been extracted from isolates of *B. anthracis* (Fellows, 1996). Another aspect which may provide information about the transfer of genetic material occurring in the environment is the likelihood of genetic exchange occurring between *Bacillus* species in the laboratory. Heemskerk and Thorne (1990) examined

mechanisms for genetic exchange between *B. thuringiensis* and *B. anthracis*. They reported that plasmid transfer from *B. thuringiensis* to *B. anthracis* was unaffected by the addition of DNase to mating mixtures, and that no plasmid transfer would occur when the donor DNA was present as a cell free filtrate. These results eliminated the possibility that plasmid transfer was occurring by transformation or transduction. The requirement for cell to cell contact showed that a conjugation-like process was taking place. For conjugation to occur, dense cultures of donor and recipient bacteria are required ( $10^8$ /ml). This indicates that it is unlikely that genetic exchange by transformation, transduction or conjugation will occur in *B. anthracis* in the environment (Beringer and Hirsch, 1984).

## 7.0 GENERAL DISCUSSION

Initial experiments conducted during this study confirmed that of the agars that have been recommended for the selective growth of *B. anthracis*, PLETA allowed optimal recovery of *B. anthracis* and reduced growth of other *Bacillus* species. The agents which comprise PLETA were also the most promising for use in an enrichment broth.

The selective enrichment broth developed during the course of this study was partially successful; recovery of *B. anthracis* was dependent on the type of soil sample and the strain of *B. anthracis* used. The recovery of *B. anthracis* from soil using PLETB could be improved by adding chelating agents, or by using semi-solid PLETB or culture in BHIB containing aztreonam.

A major problem encountered was the rapid overgrowth of the selective culture by other *Bacillus* species. This prevented the development of a broth based on the PLET chemicals that was consistently preferable to direct culture on PLETA, and may explain why so few publications on this subject exist. Reports of overgrowth of *B. anthracis* by other *Bacillus* species (Turnbull *et al.*, 1986) and the potential of PLETA for development into a selective system for growth of *B. anthracis* (Parry *et al.*, 1983) were confirmed during this study.

The difficulty encountered in the selective recovery of *B. anthracis* could be at least partly due to its life cycle. As an obligate pathogen *B. anthracis* is adapted to grow *in vivo*, in the absence of competition from other *Bacillus* species. Spores of *B. anthracis* are not generally thought to germinate and grow outside of the animal host in the absence of nutrient rich conditions. This is in contrast to closely related *B. cereus* which is widespread in the environment, indicating that it may be able to



grow in a wide range of conditions and in competition with other bacterial species. It is therefore logical that *B. anthracis* will be unable to compete with *B. cereus* in an enrichment broth.

The two-phase separation method, recommended by Sacks and Alderton (1961), allowed the concentration of spores of *B. anthracis* from soil samples in which spores had not formed attachments to soil particles. The binding of spores to soil particles is an important factor which must be taken into account when developing a selective enrichment system for *B. anthracis* in soil. If soil and spores are added separately in an experimental system, results may not be representative of soil naturally contaminated with *B. anthracis*. The results of this study have shown that spores should be seeded into soil, and left for at least a week to allow *B. anthracis* spores to adhere to soil particles before use in an experimental detection system.

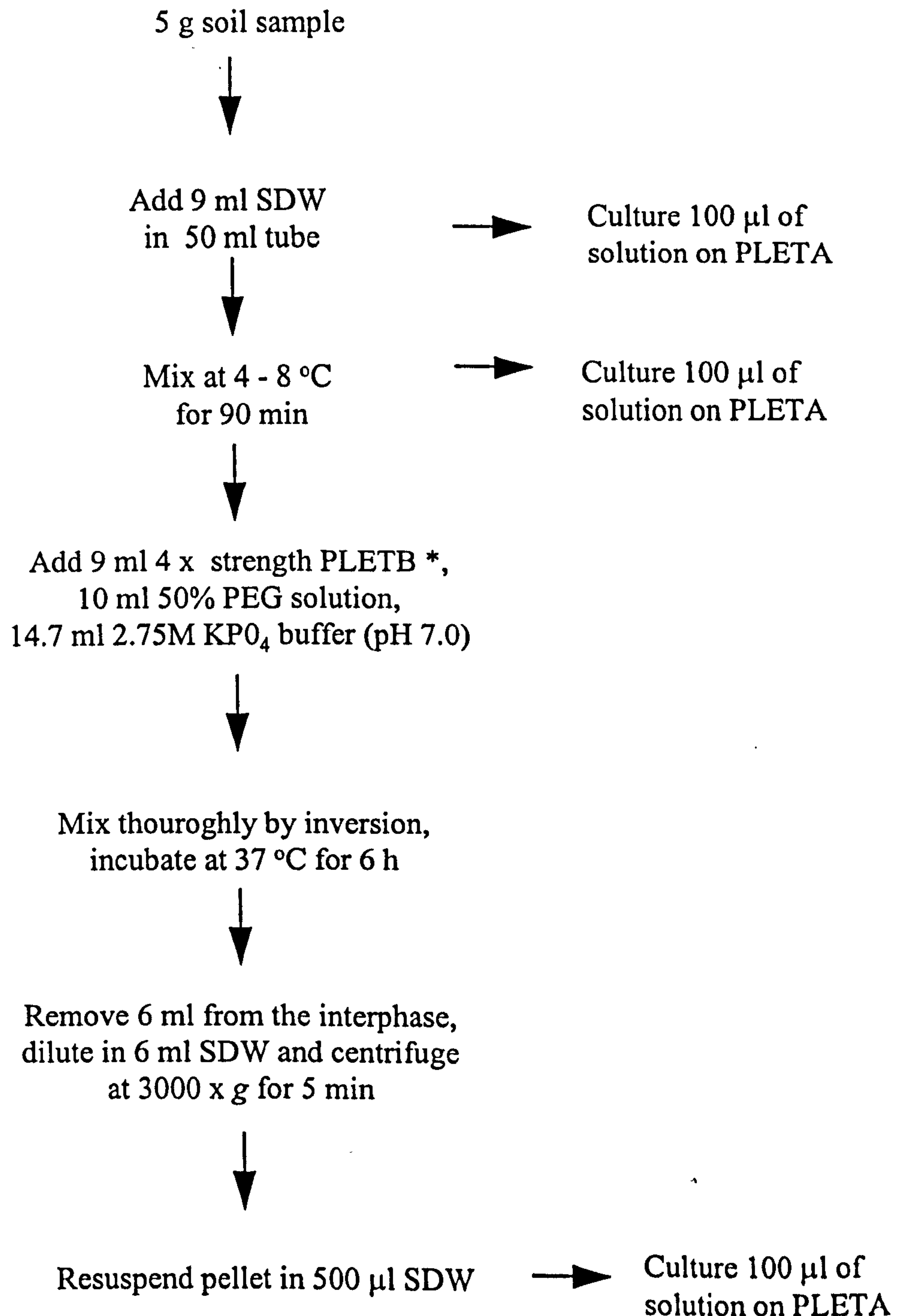
Results obtained during this study also showed that when *B. anthracis* spores are artificially seeded into soil they may be unlikely to persist. When soil samples which were seeded with approximately  $10^3$  spores of *B. anthracis* per gram were re-examined after 6 months of storage, the levels of *B. anthracis* detected in the soils had dropped to less than 10 spores per gram of soil. Spores could not be consistently detected on PLETA or using the enrichment system developed during this study. Soil suspensions from Gruinard Island from which *B. anthracis* was isolated in 1984 were also tested. *B. anthracis* could not be detected in these samples. This was unlikely to be due to spores adhering to soil particles and becoming inaccessible as the soils were in solution. This could be a result of the effect of laboratory storage, or could support the theory that *B. anthracis* will not survive in certain types of soil. This is consistent with the low levels of *B. anthracis* found in environmental samples.

The two-phase system combined with the enrichment broth developed in this study improved the recovery of *B. anthracis* compared with direct culture on PLETA. It provides a relatively simple and inexpensive method for the recovery of spores of *B. anthracis* from a 5 g sample of soil. This system increases the probability of detecting very low numbers of *B. anthracis* in soil, as approximately 25 times the amount of soil is sampled compared to that cultured on PLETA. Further enrichment of the sample in which the spores had been concentrated allowed the PCR detection of *B. anthracis* DNA to be carried out. The protocols developed during this study are summarised in Figures 7.1 and 7.2.

One of the important features of the approach taken towards the improved detection of *B. anthracis* in environmental samples during this study was that both selective culture methods and molecular methods for the PCR detection of *B. anthracis* DNA were evaluated and compared. Many studies focus on either molecular methods or culture methods, but do not combine the two. Molecular methods alone are used where the objectives of the work are the rapid detection of *B. anthracis* in samples where it is likely to be present in high numbers, for example for forensic investigations or for use in the field where the results need to be obtained within a few hours, and culture methods are inappropriate. Alternatively in areas where anthrax is endemic, for example in parts of Africa, culture techniques are used for the diagnosis and detection of *B. anthracis*, and the equipment for molecular biology is generally not available.

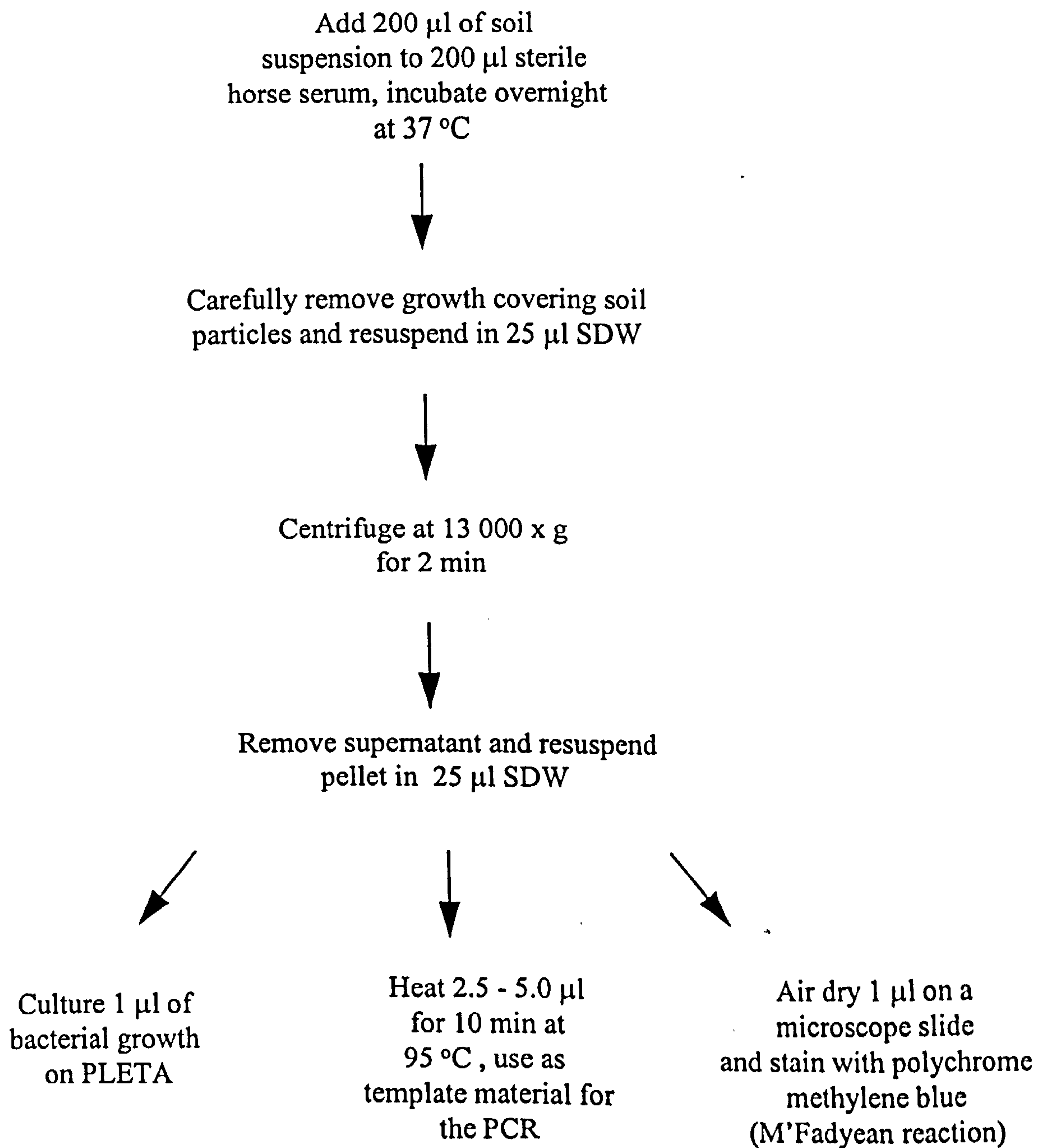
The combination of two-phase concentration, followed by microscopic examination and the PCR may reduce the time taken to identify *B. anthracis* in an environmental sample by 24 - 48 h in comparison with culture on PLETA and

**Figure 7.1 Protocol for the selective recovery of *B. anthracis* from soil samples**



\* 4 x strength BHIB containing 60 000 units/l polymyxin B sulphate, 500 000 units/l lysozyme 600 mg/l EDTA and 80 mg/l TA

**Figure 7.2 Protocol for the PCR detection of *B. anthracis* after two-phase concentration and enrichment**



subculture on BA. At CAMR where the majority of samples which are routinely sent for examination come from site surveys, a reduction of the time taken to process each sample is of benefit in terms of increasing the productivity of the operator and improving the service offered to the customer. For a minority of samples which are sent, in which the threat of contamination with anthrax spores has been used as a form of bioterrorism, the speed with which *B. anthracis* can be identified may be critical to the outcome and seriousness with which any such threats are taken.

One of the limitations of reliance on the PCR for the detection of *B. anthracis* in environmental material is that other than the presence or absence of the organism in the sample, no further phenotypic information about the isolate can be obtained. It is also not possible to determine whether the DNA originated from a dead or living organism. This may be of particular importance in relation to the antibiotic susceptibility of a strain, which is essential information if humans or animals are believed to have been exposed to an infectious dose. In the present study the colony PCR protocol was developed to combine the advantages of rapid detection of the presence of virulence plasmids in a strain of *B. anthracis* with the ability to conduct further tests on the isolate of *B. anthracis*. Detection of the virulence genes by the PCR reduces the requirement for using ELISA techniques and, most importantly, reduces the need to perform animal tests to determine the presence of virulence factors.

A good example of a case where the use of culture methods, such as the determination of susceptibility to penicillin and *B. anthracis* specific bacteriophage in conjunction with the use of the PCR would have clarified results is the work described by Yamada *et al.* (1999). They designed primers specific to *B. anthracis*, *B. cereus*,

*B. thuringiensis* and *B. mycooides* by identifying variable regions of the housekeeping *gyrB* gene from type strains of *B. anthracis*, *B. cereus*, *B. thuringiensis* and *B. mycooides*. When the specificity of these primers was evaluated against a range of different serotypes of *B. cereus*, however, one strain was identified as *B. thuringiensis* and 4 strains as *B. anthracis*. When the primers were tested on a wider range of *B. cereus* strains, 1 of 50 strains from food, and 6 of 20 isolates from the environment were identified as *B. anthracis*. Also 8 of 10 strains of *B. thuringiensis* were identified as *B. cereus*. No explanation of these observations were given, but it appears that the PCR primers used were not species specific. The results of Yamada *et al.* show that when inappropriate primers are used, the PCR alone is unsuitable for the identification of strains of *B. anthracis*.

To allow the specific identification of pX01<sup>+</sup>/pX02<sup>+</sup> isolates of *B. anthracis*, S-layer primers specific to the *B. anthracis* chromosome were developed in this study for use in combination with the PA and capsule primers. At the annealing temperature used for the multiplex PCR (55 °C), however, the S-layer primers were found to cross-react and produce a PCR product when other *Bacillus* species were used as template material. Conducting a second PCR using the S-layer primers at a higher annealing temperature (65 °C) was shown to allow the specific identification of pX01<sup>+</sup>/pX02<sup>+</sup> *B. anthracis*. This test, however, should be used in combination with subculture in the presence of penicillin and *B. anthracis* specific bacteriophage to ensure that the phenotypic characteristics are those of *B. anthracis* for complete reliability.

To expand the use of the PCR to include an internal control which would confirm that PCR amplification had taken place in a sample in which no *B. anthracis* specific amplification product was obtained, primers specific for a housekeeping gene

such as that from the 16S or 23S RNA genes (Wilson *et al.* 1990) could be included in the PCR. This would ensure that false negatives did not occur due to inhibitory substances in the sample preventing PCR amplification. If primers for such a housekeeping gene sequence were included in the multiplex PCR, pX01/pX02 derivatives of *B. anthracis* would produce two DNA fragments on PCR amplification, whereas other members of the '*B. cereus* group' would produce a single band.

Another approach to the development of internal controls for the multiplex PCR detection of *B. anthracis* DNA was described by Brightwell *et al.* (1998). A modified target DNA was constructed that was added to all PCR reactions and co-amplified using the primers specific to the *B. anthracis* target DNA. Due to deletions or insertions in the control target DNA the amplification products could be distinguished from genuine *B. anthracis* DNA by their size. This method allowed the effective PCR detection of *B. anthracis* DNA, without false negative results being obtained due to the inhibition of PCR amplification.

The results obtained in the present study on the direct detection of *B. anthracis* DNA in soil showed that, where the facilities are available, culture remains the most sensitive method for the detection of *B. anthracis* in environmental samples. During the time taken to conduct this study, the emphasis on using the PCR for the detection of *B. anthracis* in environmental material has shifted. Experience has now shown that the direct detection of *B. anthracis* DNA in environmental material is more difficult than anticipated due to difficulties involved with extracting DNA from spores and removing inhibitory humic material from the samples, and because of the wide variation between samples. Problems have also occurred due to cross-reaction of primers designed to be specific for *B. anthracis* with other *Bacillus* species. Böhm

*et al.* (1998) used PCR primers designed to amplify gene sequences from *B. anthracis* which had no homology with available DNA sequences present in the DNA data banks and were originally thought to be specific to *B. anthracis*. These primers were subsequently found to cross-react with other *Bacillus* species, hence were not suitable for the specific detection of *B. anthracis*. Patra *et al.* (1998) recently reported that the chromosomal sequence Ba813 that was originally thought to be specific to *B. anthracis* was also present in a number of non-*B. anthracis* environmental isolates. On comparing PCR and culture methods Long and O'Brien (1998) stated that, although significant effort had been put into the direct detection of *B. anthracis* DNA in soil, selective culture still remained the most sensitive detection method. Patra *et al.* (1998) have also adopted the selective culture of colonies on agar followed by multiplex PCR for detection and identification of *B. anthracis*. These results are in agreement with the conclusions made in the present study, and show that the use of selective culture methods have not yet been superseded by molecular techniques.

Kuske *et al.* (1998) evaluated the available methods for the PCR detection of *B. globigii* spores in soil with the aim of developing a rapid in-the-field assay for the detection of microorganisms introduced into the environment. They reported that the only successful method for extracting DNA from *B. globigii* spores was using a bead beater, and suggested that other reports of the extraction of DNA from spores without the use of a bead beater may actually reflect the extracellular DNA present in the sample. Kuske *et al.* (1998) reported that the detection limit of DNA from soil was affected by the purity of the DNA, the amount of template and background DNA present, and the physical condition of the DNA. The detection limit for *B. globigii* spores in soil was found to range from  $2.5 \times 10^3$  spores per gram for a New Mexico



soil which comprised 78% sand and less than 1% organic matter to  $2.5 \times 10^5$  spores per gram for soil containing a high level of organic matter. When the amount of the sample used for PCR amplification was taken into account, the detection of the DNA from  $2.5 \times 10^3$  spores in the New Mexico soil could be interpreted as the detection of 14 copies of target DNA per PCR reaction. This is equivalent to the sensitivity of their PCR in the absence of environmental material ( $2.5 \times 10^3$  spores per ml or 25 spores per PCR). The limit of detection of  $2.5 \times 10^5$  spores per gram in soil containing a high level of organic matter was comparable to the detection limit of approximately  $1.0 \times 10^6$  spores per gram of soil determined in this study. These results also confirm that where the facilities are available, direct culture of a sample on agar remains significantly better than direct detection of *B. anthracis* DNA using the PCR.

The colony PCR developed in the present study was found to be robust and reliable for the identification of virulence plasmids in different strains of *B. anthracis*. Steps were not taken to optimise the sensitivity of the PCR conducted in this study, for example by using a 'hot start' PCR, or by using a brand of DNA polymerase shown to improve the sensitivity of the PCR. This was primarily to prevent problems associated with cross contamination of samples, which may be observed when a more sensitive PCR is conducted (Wilson, 1997).

The stability of pX01 and pX02 in the presence of non-indigenous plasmid DNA was studied, to gain information which may be related to the stability of pX01 and pX02 in the environment. The effect of a  $\theta$ -replicating plasmid (pAEX-5E) on pX01 and pX02, individually and in combination, in vegetative cells of *B. anthracis* was studied. When pX01 alone was present, the growth rate of *B. anthracis* was reduced, and pAEX-5E was expelled. When under selective pressure to retain

pAEX-5E, *B. anthracis* appeared to endure a further reduction in growth rate in order to retain pX01. In the pX01<sup>+</sup>/pX02<sup>+</sup> strain this effect was ameliorated by the presence of pX02. This indicated that under certain conditions pX02 may have some beneficial effect on the metabolism of *B. anthracis*. The ability of *B. anthracis* to retain pX01 under adverse conditions may in part explain the lack of pX01<sup>+</sup>/pX02<sup>+</sup> derivatives of *B. anthracis* isolated from environmental samples.

The stability of plasmid pAEX-5-*pag*, from which pAEX-5E was derived, in pX01<sup>+</sup>/pX02<sup>-</sup> *B. anthracis* indicates that pAEX-5-*pag* is a potential candidate for the production of recombinant PA in *B. anthracis*. Barnard and Friedlander (1999) studied the stability of plasmids in *B. anthracis* as part of a study of the production of recombinant PA *in vivo*. Strains which were the most stable in LB were found to produce the most PA, and were also the most effective when used as a vaccine to protect guinea pigs against challenge with *B. anthracis* spores. The results obtained in the present study showed that pAEX-5-*pag*, which contains the PA gene and the minimal replicon from pAMβ1, was stable in the absence of selection pressure for 100 generations in LB.

The results of this project go some way to fill the gap in the literature on the development of a selective enrichment system for *B. anthracis* in environmental material which has existed since Knisely published his work on PLETA in 1966.

The development of a robust colony PCR for the identification of virulence factors from *B. anthracis* has also been of great benefit in the laboratory.

Overall, the results presented in this thesis provide a broad base of novel information about methods for the improved growth and detection of *B. anthracis* in environmental samples, on which future enrichment and molecular studies

could be based.

## 7.1 FUTURE WORK

During this study it was necessary to obtain the right balance between conducting systematic studies with the aim of improving the selective detection of *B. anthracis* in environmental material, and conducting more in-depth studies, to obtain further information about the mechanisms by which selective agents may act. As a result almost all the approaches used in this study are suitable for further study. Further work could be conducted in any of the following areas:-

- Evaluation of the proposed method for the detection of *B. anthracis* in soil samples (see Figure 7.1) by parallel processing of a range of samples using culture on PLETA and two-phase concentration with enrichment.
- Optimisation of the methodology for the PCR detection of *B. anthracis* DNA from spore concentrate as described in Figure 7.2.
- Incorporation of an internal control into the multiplex PCR protocol to ensure that false negative PCR results are not obtained due to the inhibition of PCR amplification in a sample.

- Investigation of the use of plasmid pAEX-5-*pag* as a potential candidate for the production of recombinant PA.

## REFERENCES

Aardema, B. W., Lorenz, M. G. and Krumbein, W. E. (1983). Protection of sediment-adsorbed transforming DNA against enzymatic inactivation. *Appl. Environ. Microbiol.* 46: 417 - 420.

Abbaszadegan, M., Huber, M. S., Gerba, C. P. and Pepper, I. L. (1993).

Detection of enteroviruses in groundwater with the polymerase chain reaction.

*Appl. Environ. Microbiol.* 59: 1318 - 1324.

Acebo, P., Hernandez-Arriaga, A. M., Kramer, M. G., Espinosa, M. and

del-Solar, G. (1998). Identification of a new gene in the streptococcal plasmid

pLS1: the *rnaI* gene. *Plasmid* 40: 214 - 224.

Albertsson, P. (1958). Particle fractionation in liquid two phase systems. The composition of some phase systems and the behaviour of some model particles in their applications to the isolation of cell walls from microorganisms. *Biochem. Biophys. Acta.* 27: 378 - 395.

Albrink, W. S. and Goodlow, R. J. (1959). Experimental inhalation anthrax in the chimpanzee. *Am. J. Pathol.* 35: 1055 - 1065.

Angeley, L. H. and Wright, G. G. (1971). Agar diffusion method for the differentiation of *Bacillus anthracis*. *Appl. Microbiol.* **21**: 157 - 159.

Anon. (1918). Report of the Departmental Committee appointed to inquire as to precautions for preventing danger of infection from anthrax in the manipulation of wool, goat hair and camel hair. Vol 3, *Summary of Evidence and Appendices*. HMSO, London.

Archibald, A. R., Hancock, I. C. and Harwood, C. R. (1993). Cell wall structure, synthesis and turnover. *In Bacillus subtilis and other Gram-positive Bacteria. Biochemistry, Physiology and Molecular Genetics* pp 381 - 410. Eds. A. L. Sonenshein, J. A., Hoch and R. Losick. ASM, Washington, DC.

Arnheim, N. and Ehrlich, H. (1992). Polymerase chain reaction strategy. *Annu. Review Biochem.* **61**: 131 - 156.

Aronson, A. I., Beckman, W. and Dunn, P. (1986). *Bacillus thuringiensis* and related insect pathogens. *Microbiol. Reviews* **50**: 1 - 24.

Ash, C. J., Farrow, A. E., Forsch, M., Stackenbrandt, E. and Collins, M. D. (1991). Comparative analysis of *Bacillus anthracis* and *Bacillus cereus* and related species on the basis of reverse transcriptase sequencing of 16S rRNA. *Int. J. Syst. Bacteriol.* **41**: 343 - 346.

**Ash, C. J. and Collins, M. D. (1992).** Comparative analysis of 23S ribosomal RNA gene sequences of *Bacillus anthracis* and emetic *Bacillus cereus* determined by PCR-direct sequencing. *FEMS Microbiol. Lett.* 73: 75 - 80.

**Atlas, R. M. (1998).** The medical threat of biological weapons. *Crit. Reviews Microbiol.* 24: 157 - 168.

**Bailey, N. T. J. (1985).** Statistical Methods in Biology. Second Edition. Hodders and Stoughton Educational, The Chaucer Press Ltd, UK.

**Baillie, L. W., Jones, M. N., Turnbull, P. C. B. and Manchee, R. J. (1995).** Evaluation of the Biolog system for the identification of *Bacillus anthracis*. *Lett. Appl. Microbiol.* 20: 209 - 211.

**Barnard, J. P. and Friedlander, A. M. (1999).** Vaccination against anthrax with attenuated recombinant strains of *Bacillus anthracis* that produce protective antigen. *Infect. Immun.* 67: 562 - 567.

**Barnes, J. M. (1947).** The development of anthrax following the administration of spores by inhalation. *Br. J. Exp. Pathol.* 28: 385 - 393.

**Barry, T., Colleran, G., Glennon, M., Dunican, L. K. and Gannon, F. (1991).** The 16S/23S ribosomal spacer region as a target for DNA probes to identify eubacteria. *PCR Methods Appl.* 1: 51 - 56.

**Baum, J. A. and Gilbert, M. P. (1991).** Characterization and comparative sequence analysis of replication origins from three large *Bacillus thuringiensis* plasmids. *J. Bacteriol.* 173: 5280 - 5289.

**Beall, F. A., Dalldorf, F. G. (1966).** The pathogenesis of the lethal effect of anthrax toxin in the rat. *J. Infect. Dis.* 116: 377 - 389.

**Beringer, J. E. and Hirsch, P. R. (1984).** Genetic adaptation to the environment. The role of plasmids in microbial ecology. *Curr. Perspect. in Microbial Ecology* Proceedings of the Third International Symposium on Microbial Ecology, 7 - 12 August, 1983. pp 63 - 69. Eds. M. J. Klug and C. A. Reddy.

**Berman, E. (1980).** Thallium. In *Toxic metals and their analysis.* pp 201 - 208. Heyden International Topics in Science. Ed. L. C. Thomas. Heyden and Sons Ltd.

**Bernhard, K., Schrempf, H. and Goebel, W. (1978).** Bacteriocin and antibiotic resistance plasmids in *Bacillus cereus* and *Bacillus subtilis*. *J. Bacteriol.* 133: 897 - 903.

**Beveridge, T. J. and Doyle, R. J. (1989).** Metal ions and bacteria. John Wiley and Sons, New York.



**Beyer, W., Glöckner, P., Otto, J. and Böhm, R. (1995).** A nested PCR method for the detection of *Bacillus anthracis* in environmental samples collected from former tannery sites. *Microbiol. Res.* 150: 179 - 186.

**Beyer, W., Glöckner, P., Otto, J. and Böhm R. (1996).** A nested PCR and DNA amplification fingerprinting method for detection and identification of *Bacillus anthracis* in soil samples from former tanneries. In *Proceedings of the Second International Workshop on Anthrax, Winchester, England, September 19-21, 1995.* pp 47 - 49. Ed. P. C. B. Turnbull. Salisbury Medical Bulletin Special Supplement No. 87.

**Bio-Rad Technical Bulletin 2020. (1986).** Chelex 100 chelating ion exchange resin for analysis, removal or recovery of Trace Metals. Bio-Rad Laboratories Ltd. USA.

**Blomquist, G. K., Ström, G. B. and Söderström, B. (1984).** Separation of fungal propagules by partitioning in aqueous polymer two-phase systems. *Appl. Environ. Microbiol.* 47: 1316 - 1318.

**Böhm, R., Pocivalsek, S. and Beyer, W. (1998).** PCR-ELISA for detection of *Bacillus anthracis* in environmental samples. *Third International Conference on Anthrax.* Plymouth, UK 7 - 10 September 1998. Abstract book p11.

- Bourque, S.N., Valero, J. R., Lavoie, M.,C. and Levesque, R. C. (1995).** Comparative analysis of the 16S to 23S ribosomal intergenic spacer sequences of *Bacillus thuringiensis* strains and subspecies and of closely related species. *Appl. Environ. Microbiol.* **61**: 1623 - 1626.
- Bowen, J. E. and Turnbull, P. C. B. (1992).** The fate of *Bacillus anthracis* in unpasteurised and pasteurised milk. *Lett. Appl. Microbiol.* **15**: 224 - 227.
- Bradaric, N. and Punda-Polic, V. (1992).** Cutaneous anthrax due to penicillin resistant *Bacillus anthracis* transmitted by an insect bite. *Lancet* **340**: 88 - 89.
- Bragg, T. S. and Robertson, D. L. (1989).** Nucleotide sequence and analysis of the lethal factor gene (*lef*) from *Bacillus anthracis*. *Gene* **81**: 45 - 54.
- Breathnach, A. S., Turnbull, P. C. B., Eykyn, S. J. and Twort, C. H. C. (1996).** A labourer with a spot on his chest. *Lancet* **347**: 96.
- Brightwell, G., Pearce, M. and Leslie, D. (1998).** Development of internal controls for PCR detection of *Bacillus anthracis*. *Mol. Cell. Probes.* **12**: 367 - 377.
- Brock, T. D. (1966).** Principles of Microbial Ecology. Prentice-Hall Inc. New Jersey.

**Bron, S.** (1990). Plasmids. In *Molecular Biology Methods for Bacillus*, pp. 75-125. Eds. C. R. Harwood and S. M. Cutting: John Wiley and Sons Ltd.

**Bron, S., Luxen, E. and Swart, P.** (1988). Instability of recombinant pUB110 plasmids in *Bacillus subtilis*: Plasmid-encoded stability function and effects of DNA inserts. *Plasmid* 19: 231 - 241.

**Brousseau, R., Saint-Onge, A., Prefontaine, G., Masson, L. and Cabana, J.** (1993). Arbitrary primer PCR, a powerful method to identify *Bacillus thuringiensis* serovars and strains. *Appl. Environ. Microbiol.* 49: 1482 - 1487.

**Bruand, C. and Ehrlich, S. D.** (1998). Transcription-driven DNA replication of plasmid pAM $\beta$ 1 in *Bacillus subtilis*. *Mol. Microbiol.* 30: 135 - 145.

**Bruand, C., Ehrlich, S. D. and Janniere, L.** (1991). Unidirectional theta replication of the structurally stable *Enterococcus faecalis* plasmid pAM $\beta$ 1. *EMBO J.* 10: 2171 - 2177.

**Bruand, C., Le Chatelier, E., Ehrlich, S. D. and Janni re, L.** (1993). A fourth class of theta replicating plasmids: the pAM $\beta$ 1 family from Gram-positive bacteria. *Proc. Natl. Acad. Sci.* 90: 11668 - 11672.

**Burans, J., Kehler, A., O'Brien, T., Hagar, J., Plummer, A. and Morgan, C.** (1996). Rapid method for the diagnosis of *Bacillus anthracis* infection in clinical samples using a hand-held assay. In *Proceedings of the Second International Workshop on Anthrax, Winchester, England, September 19-21, 1995*. pp 36 - 37. Ed. P. C. B. Turnbull. Salisbury Medical Bulletin Special Supplement No. 87.

**Candeli, A., Mastrandrea, V., Cenci, G. and De-Bartolomeo, A.** (1978). Sensitivity to lytic agents and DNA base composition of several aerobic spore-bearing bacilli. *Zbl. Bakteriolog. Naturwiss.* 133: 250 - 260.

**Carl, M., Hawkins, R., Coulson, N., Lowe, J., Robertson, D. L., Nelson, W. M., Titball, R. W. and Woody, J. N.** (1992). Detection of spores of *Bacillus anthracis* using the polymerase chain reaction. *J. Infect. Dis.* 165: 1145 - 1148.

**Carlson, C. R., Caugant, D. A. and Kolsto, A-B.** (1994). Genotypic diversity among *Bacillus cereus* and *Bacillus thuringiensis* strains. *Appl. Environ. Microbiol.* 60: 1719 - 1725.

**Carman, J. A., Hambleton, P. and Melling, J.** (1985). *Bacillus anthracis*, Isolation and identification of micro-organisms of medical and veterinary importance. *Society for Applied Bacteriology Technical Series 21*, pp 207 - 214. Eds. C. H. Collins and G. M. Grange. Academic Press, London.

**Carr, E. A. and Rew, R. R. (1957).** Recovery of *Bacillus anthracis* from the nose and throat of apparently healthy workers. *J. Gen. Microbiol.* 100: 169 - 171.

**Cherkasskiy, B. (1996).** Anthrax in Russia. In *Proceedings of the Second International Workshop on Anthrax, Winchester, England, September 19-21, 1995.* pp 6 - 7. Ed. P. C. B. Turnbull. Salisbury Medical Bulletin Special Supplement No. 87.

**Cherkasskiy, B. (1998).** A National Register of Historic and Contemporary Anthrax Foci. *Third International Conference on Anthrax.* Plymouth, UK. 7 - 10 September 1998. Abstract book p 2.

**Chung, C. T., Niemla, S. L. and Miller, R. H. (1989).** One step preparation of competent *Escherichia coli*: transfer and storage of bacterial cells in the same solution. *Proc. Natl. Acad. Sci. USA* 86: 2172 - 2175.

**Claus, D and Berkeley, R. C. W. (1986).** Genus *Bacillus* Cohn 1982. In *Bergeys Manual of Systematic Bacteriology Vol 2.* pp 1105 - 1139. Ed. P.H.A. Sneath. Bergey's Manual Trust, Williams and Wilkins, Baltimore.

**Claus, D. and Fritze, D. (1989).** Taxonomy of *Bacillus*. In *Bacillus, Biotechnology Handbooks.* pp 5 - 26. Ed. C. R. Harwood. Plenum Press, New York and London.

Cogne, R., Stares, N. E., Jones, M. N., Bowen, J. E., Turnbull, P. C. B. and Boeufgras, J-M. (1996). Identification of *Bacillus anthracis* using the API 50CHB system. In *Proceedings of the Second International Workshop on Anthrax, Winchester, England, September 19-21, 1995*. pp 34 - 35. Ed. P. C. B. Turnbull. Salisbury Medical Bulletin Special Supplement No. 87.

Collins, C. H. and Lyne P.M. (1995). Microbiological Methods. pp 391 - 393. Butterworth-Heinmann Ltd. Oxford.

Comber, K. R., Horton, R., Layte, S. J., White, A. R. and Sutherland, R. (1980). Augmentin: antibacterial activity in vitro and in vivo. In *Augmentin, clavulanate-potentiated amoxicillin*. pp19 - 38. Proceedings of the First Symposium, 3 rd and 4 th July, 1980. Eds. G. N. Rollinson and A. Watson. Excerpta Medica, Amsterdam-Oxford-Princeton.

Cooray, K. J., Nishibori, T., Xiong, H., Matsuyama, T., Fujita, M. and Mitsuyama, M. (1994). Detection of multiple virulence associated genes of *L. monocytogenes* by PCR in artificially contaminated milk samples. *Appl. Environ. Microbiol.* 60: 3028 - 3036

Cresswell, N., Saunders, V. A. and Wellington, E. M. H. (1991). Detection and quantification of *Streptomyces violaceolatus* plasmid DNA in soil. *Lett. Appl. Microbiol.* 13: 193 - 197.

Dahlgren, C. M., Buchanan, L. M., Decker H. M., Freed, S. W., Phillips, C. R. and Brachman, P. S. (1960). *Bacillus anthracis* in goat hair processing mills *Am. J. Hyg.* 72: 6 - 23.

Dai, Z., Sirard, J-C., Mock, M. and Koehler, T.M. (1995). The *atxA* gene product activates transcription of the anthrax toxin genes and is essential for virulence. *Mol. Microbiol.* 16: 1171 -1181.

Davies, J. C. A. (1982). A major epidemic of anthrax in Zimbabwe. I. *Cent. Afr. J. Med.* 28: 291 - 298.

Degrange, V. and Barden, R. (1995). Detection and counting of nitrobacter populations in the soil by PCR. *Appl. Environ. Microbiol.* 61: 2093 - 2098.

Devine, K. M., Hogan, S. T., Higgins, D. G. and McConnell, D. J. (1989). Replication and segregational stability of *Bacillus* plasmid pBAA1. *J. Bacteriol.* 171: 1166 - 1172.

De Vos, V. (1990). The Ecology of Anthrax in the Kruger National Park, South Africa. In *Proceedings of the International Workshop on Anthrax, Winchester, England, April 11-13, 1989.* pp 19 - 23. Ed. P. C. B. Turnbull. Salisbury Medical Bulletin Special Supplement No. 68.

**De Vos, V. and Bryden, H. B. (1995).** The epidemiology of a major anthrax outbreak in the Kruger National Park. *Second International Workshop on Anthrax, 19-21 September 1995, Winchester, England.* Abstract book pp 25-26.

**De Vos, V. and Bryden, H. B. (1996).** Anthrax in the Kruger National Park: temporal and spatial patterns of disease occurrence. In *Proceedings of the Second International Workshop on Anthrax, Winchester, England, September 19-21, 1995.* pp 26 - 30. Ed. P. C. B. Turnbull. Salisbury Medical Bulletin Special Supplement No. 87.

**Difco Manual.** Dehydrated Culture Media and Reagents for Microbiology. p 160. Tenth edition. Difco Laboratories. Detroit Michigan.

**Dijkmans, R., Jagers, A., Kreps, S., Collard, J-M. and Mergeay, M. (1993).** Rapid method for purification of soil DNA for hybridization and PCR analysis. *Microb. Releases. 2:* 29 - 34.

**Doganay, M. (1996).** Incubation period. In *Proceedings of the Second International Workshop on Anthrax, Winchester, England, September 19-21, 1995.* p 139. Ed. P. C. B. Turnbull. Salisbury Medical Bulletin Special Supplement No. 87.

**Doganay, M. and Aydin, N. (1991).** Antimicrobial susceptibility of *Bacillus anthracis*. *Scand. J. Infect. Dis. 23:* 333 - 335.



**Donnelly, L. S. and Hartman, P. A. (1978).** Gentamicin-based medium for the isolation of group D *Streptococci* and application of the medium to water analysis. *Appl. Environ. Microbiol.* **35**: 576 - 581.

**Dong, S. L. (1990).** Progress in the control and research of anthrax in China. In *Proceedings of the International Workshop on Anthrax, Winchester, England, April 11-13, 1989.* pp 104 - 105. Ed. P. C. B. Turnbull. Salisbury Medical Bulletin Special Supplement No. 68.

**Dragon, D. C., Rennie, R. P. (1995).** The ecology of anthrax spores: tough but not invincible. *Can. Vet. J.* **36** : 295 - 301.

**Druett, H. A., Henderson, D. W., Packman, L., and Peacock, S. (1953).** Studies on respiratory infection. I. The influence of particle size on respiratory infection with anthrax spores. *J. Hyg.* **51**: 359 - 371.

**Dubourg, G. and Ouary, D. G. (1932).** A case of anthrax in the neck cured by bacteriophage. *J. Med. de Bordeaux* **109**: 120 - 121 (cited in Knudson, 1986).

**Duesbury, N. S., Webb, C. P., Leppla, S. H., Gordon, V. M., Klimpel, K. R., Copeland, T. D., Ahn, N. G., Oskarsson, M. K., Fukasawa, K., Paull, K. D. and Vande Woude, G. F. (1998).** Proteolytic inactivation of MAP-kinase-kinase by anthrax lethal factor. *Science* **280**: 734 - 737.

**Ebedes, H. (1976).** Anthrax epizootics in Etosha National Park. *Madoqua* **10**: 99 - 118. (cited in Turnbull *et al.*, 1998).

**Ebehardt, W. G. (1989).** Why do bacterial plasmids carry some genes and not others? *Plasmid* **21**: 167 - 174.

**Ebishu, S., Murahashi, Y., Takagi, H., Kadowaki, K., Yamaguchi, K., Yamagata, M. H. and Udaka, S. (1995).** Nucleotide sequence and replication properties of the *Bacillus borstelensis* Cryptic plasmid pHT926. *Appl. Environ. Microbiol.* **61**: 3154 - 3157.

**Edwards, A. P. and Bremner, J. M. (1965).** Dispersion of mineral colloids in soils using cation exchange resins. *Nature* **205**: 208 - 209.

**Elson, W. O. (1945).** The antibacterial and fungistatic properties of propamidine. *J. Infect. Dis.* **76**: 193 - 197.

**Etienne-Toumelin, I., Sirard, J-C., Duflot, E., Mock, M. and Fouet, A. (1995).**

Characterization of the *Bacillus anthracis* S-layer: cloning and sequencing of the structural gene. *J. Bacteriol.* **177**: 614 - 620.

**Ezzell, J. W. (1998).** The capsule of *B. anthracis*: a review. *Third International Conference on Anthrax*. Plymouth, UK. 7 - 10 September 1998. Abstract book p15.

**Ezzell, J. W. and Abshire, T. G. (1992).** Serum protease cleavage of *Bacillus anthracis* protective antigen. *J. Gen. Microbiol.* 138: 543 - 549.

**Ezzell, J. W. and Abshire, T. G. (1996).** Encapsulation of *Bacillus anthracis* spores and spore identification. In *Proceedings of the Second International Workshop on Anthrax, Winchester, England, September 19-21, 1995*. p42.

Ed. P. C. B. Turnbull. Salisbury Medical Bulletin Special Supplement No. 87.

**Farchaus, J. W., Ribot, W. J., Downs., M. B. and Ezzell, J. W. (1995).** Purification and characterization of the major surface array protein from the avirulent *Bacillus anthracis* Delta Sterne-1. *J. Bacteriol.* 177: 2481 - 2489.

**Farrar, W. E. and Reboli. A. C. (1991)** The genus *Bacillus* - Medical. In *The Prokaryotes*, 2nd edition. Ed. A. Ballows. Harder and Schleifer, UK.

**Farrar, W. E. (1995).** Anthrax: from Mesopotamia to molecular biology.

*Pharos* 58: 35 - 38

**Fellows, P. F. (1996).** A Survey of worldwide strains of *Bacillus anthracis*. In *Proceedings of the Second International Workshop on Anthrax, Winchester, England, September 19-21, 1995*. pp 31 -33. Ed. P. C. B. Turnbull. Salisbury Medical Bulletin Special Supplement No. 87.

**Fernelius, A. L. (1960).** Comparison of two heat-shock methods and a phenol treatment method for determining germination rates of spores of *Bacillus anthracis*. *J. Bacteriol.* 79: 755 - 756.

**Fildes, P. (1943).** Defensive aspects of biological warfare. Unpublished Ministry of Supply report: BDP Report No 19. (cited in Turnbull *et al.*, 1998).

**FitzPatrick, E. A. (1983).** Soils, their Formation, Classification and Distribution, Longman Group Ltd, England.

**Foerster, H. F. and Foster, J. W. (1966).** Response of *Bacillus* spores to combinations of germinative compounds. *J. Bacteriol.* 91: 1168 - 1177.

**Fouet, A., Sirard, J-C. and Mock, M. (1994).** *Bacillus anthracis* pX01 virulence plasmid encodes a type 1 DNA topoisomerase. *Mol. Microbiol.* 11: 471 - 479.

Fouet, A. and Mock, M. (1996). Differential influence of the two *Bacillus anthracis* plasmids on regulation of virulence gene expression. *Infect. Immun.* 64: 4928 - 4932.

Fouet, A., Sirard, J-C. and Mock, M. (1996). Virulence gene determinants. In *Proceedings of the Second International Workshop on Anthrax, Winchester, England, September 19-21, 1995*. pp 84 - 85. Ed. P. C. B. Turnbull. Salisbury Medical Bulletin Special Supplement No. 87.

Fox, A., Black, G. E., Fox, K. and Rostovtseva, S. (1993). Determination of carbohydrate profiles of *Bacillus anthracis* and *Bacillus cereus* including identification of o-methyl methylpentoses by using gas chromatography-mass spectrometry. *J. Clin. Microbiol.* 31: 887 - 894.

Friedlander, A. M. (1998). Clinical aspects, diagnosis and treatment of anthrax. *Third International Conference on Anthrax*. Plymouth, UK. 7 - 10 September 1998. Abstract book p 31.

Gamel, P. H. and Piot, J-C. (1992). Characterization and properties of a novel plasmid vector for *Bacillus thuringiensis* displaying compatibility with host plasmids. *Gene* 120: 17 - 26.

te Giffel, M. C., Beumer, R. R., Klijn, N., Wagandrop, A. and Rombouts, F. M. (1997). Discrimination between *Bacillus cereus* and *Bacillus thuringiensis* using specific DNA probes based on variable regions of 16S rRNA. *FEMS Microbiol. Letters* 146: 47 - 51.

Gonzalez, J. M. Jr., Brown, B. J. and Carlton, B. C. (1982). Transfer of *Bacillus thuringiensis* plasmids coding for  $\delta$ -endotoxin genes among strains of *Bacillus thuringiensis* and *Bacillus cereus*. *Proc. Natl. Acad. Sci. USA*. 79: 6951 - 6955.

Gordon, R. E., Haynes, W. C. and Pang, C. H. N. (1973). The genus *Bacillus*. *U. S. Department of Agriculture Agricultural Handbook no 427*. U. S. Department of Agriculture, Washington, D.C.

Gray, I. (1963). Lysine deficiency and host resistance to anthrax. *J. Exp. Med.* 117: 497 - 508. (cited in Knudson, 1986).

Gray, G. W. and Wilkinson, S. G. (1965). The action of ethylenediaminetetraacetic acid on *Pseudomonas aeruginosa*. *J. Appl. Bacteriol.* 28: 153 - 164.

Green, D. M. and Jamieson, W. M. (1958). Anthrax and bone-meal fertilizer. *Lancet* 2: 153 - 154.

- Green, B. D., Battisti, L., Koehler, T. M., Thorne, C. B. and Ivins, B. E.** (1985). Demonstration of a capsule plasmid in *Bacillus anthracis*. *Infect. Immun.* 49: 291-297.
- Gros, M. F., te Riele, H. and Ehrlich, S. D.** (1987). Rolling circle replication of single stranded DNA plasmid pC194. *EMBO J.* 6: 3863 - 3869.
- Gruss, A. D., Ross, H. F. and Novik, R. P.** (1987). Functional analysis of a palindromic sequence required for normal replication of several staphylococcal plasmids. *Proc. Natl. Acad. Sci.* 84: 2165 - 2169.
- Gustafarro, C. A. and Steckelberg, J. M.** (1991). Cephalosporin antimicrobial agents and related compounds. *Mayo Clin. Proc.* 66: 1064 -1073.
- Gutknecht, J.** (1983). Cadmium and thallos ions permeabilities through lipid bilayers membranes. *Biochem. Biophys. Acta* 753: 185 - 188.
- Hambleton, P., Carman, J. A. and Melling, J.** (1985). Anthrax: the disease in relation to vaccines. *Vaccine* 2: 125 - 132.
- Hamilton-Miller, J. M. T.** (1966). Damaging effects of ethylenediaminetetraacetate and penicillins on permeability barriers in Gram-negative bacteria. *Biochem. J.* 100: 675 - 682.

**Hammond, S. E. and Hanna P. C. (1998).** Lethal factor active site mutations affect catalytic activity in vitro. *Infect. Immun.* 66: 2374 - 2378.

**Hancock, P. E. W. and Wong, P. G. W. (1984).** Compounds which increase the permeability of the *Pseudomonas aeruginosa* outer membrane. *Antimicrob. Agents. Chemother.* 26: 48 - 52.

**Haque, H. and Russell, A. D. (1976).** Cell envelopes of Gram-negative bacteria: composition, response to chelating agents and susceptibility of whole cells to antibacterial agents. *J. Appl. Bacteriol.* 40: 89 - 99.

**Heemskerk, D. D. and Thorne, C. B. (1990).** Genetic exchange and transposon mutagenesis in *Bacillus anthracis*. In *Proceedings of the International Workshop on Anthrax, Winchester, England, April 11-13, 1989.* pp 63 - 67. Ed. P. C. B. Turnbull. Salisbury Medical Bulletin Special Supplement No. 68.

**Henderson, I., Duggleby, C. J. and Turnbull, P. C. B. (1994).** Differentiation of *Bacillus anthracis* from other *Bacillus cereus* group bacteria with the PCR. *Int. J. Syst. Bacteriol.* 44: 99 - 105.

**Henderson, I., Yu, D. and Turnbull, P. C. B. (1995).** Differentiation of *Bacillus anthracis* and other '*Bacillus cereus* group' bacteria using IS231-derived sequences. *FEMS Microbiol. Lett.* 128: 113 - 118.



Herron, P. R. and Wellington, E. M. H. (1990). New method for extraction of *Streptomyces* spores from soil and application to the study of lysogeny in sterile amended and non-sterile soil. *Appl. Environ. Microbiol.* 56: 1406 - 1412.

Hill, I. R. and Gray, T. R. G. (1967). Application of the fluorescent-antibody technique to an ecological study on bacteria in soil. *J. Bacteriol.* 93: 1888 - 1896.

Hills, G. M. (1949). Chemical factors in the germination of spore-bearing aerobes. The effect of yeast extract on the germination of *Bacillus anthracis* and its replacement by adenosine. *Biochem. J.* 45: 353 - 362.

Hills, G. M. (1949a). Chemical factors in the germination of spore-bearing aerobes. The effect of amino acids on the germination of *Bacillus anthracis* with some observations on the relation of optical form to biological activity *Biochem. J.* 45: 363 - 370.

Hindler, J. A., Howard, B. J. and Keiser, J. F. (1994). Antimicrobial agents and Antimicrobial Susceptibility Testing. p145 - 198. In *Clinical and Pathogenic Microbiology*. Ed. B. J. Howard. Mosby Inc. St Louis.

Hitchens, A.P. (1921). Advantages of culture mediums containing small percentages of agar. *J. Infect. Dis.* 29: 390 - 407.

**Holbrook, R. and Anderson, J. M. (1980).** An improved selective medium for the isolation and enumeration of *Bacillus cereus* in foods. *Can. J. Microbiol.* **263:** 753 - 759.

**Hopkins, D. W., Macnaughton, S. J. and O'Donnell, A. G. (1991).** A dispersion and differential centrifugation technique for representatively sampling microorganisms from soil. *Soil Biol. Biochem.* **23:** 217 - 225.

**Horinouchi, S. and Weisblum, B. (1982).** Nucleotide sequence and functional map of pC194, a plasmid that specifies inducible chloramphenicol resistance. *J. Bacteriol.* **150:** 815 - 825.

**Hotzel, H., Sachse, K. and Prutzner, H. (1996).** Rapid detection of mycoplasma bovis in milk samples and nasal swabs using the polymerase chain reaction. *J. Appl. Bacteriol.* **80:** 505 - 510.

**Hughes, M. N. and Poole, R. K. (1989).** Metal microbe interactions. In *Metal Microbe Interactions*. p1 - 17 Eds. R. K Poole and G. M. Gadd. Special publications of the Society for General Microbiology. Vol. 26. IRL Press at Oxford University Press.

Hugh-Jones, M. E. (1996). World situation 1993/1994. In *Proceedings of the Second International Workshop on Anthrax, Winchester, England, September 19-21, 1995*. pp 1 - 2. Ed. P. C. B. Turnbull. Salisbury Medical Bulletin Special Supplement No. 87.

Hugh Jones, M. E. (1998). 1996 Global anthrax report. *Third International Conference on Anthrax*. Plymouth, UK. 7 - 10 September 1998. Abstract book p 1.

Hutson, R. A., Duggleby, C. J., Lowe, J. R., Manchee, R. J. and Turnbull, P. C. B. (1993). The development and assessment of DNA and oligonucleotide probes for the specific detection of *Bacillus anthracis*. *J. Appl. Bacteriol.* **75**: 463 - 472.

ICMSF (1978). *Microorganisms in foods*, Vol. 1. *Their significance and Methods of Enumeration*, 2nd edtn. pp119 - 120. University of Toronto Press. Toronto, Canada.

Iveson, J. B. (1973). Current procedures for the isolation of *Salmonella*, *Arizona*, *Edwardsiella* and *Shigella* from faeces. *J. Hyg. Camb.* **71**: 349 - 361.

Ivins, B. E., Ezzell, J. W., Jemski, J., Hedlung, K. W., Ristroph, J. D., and Leppla, S. H. (1986). Immunisation studies with attenuated strains of *Bacillus anthracis*. *Infect. Immun.* **52**: 454 - 458.

Ivins, B. E., Fellows, P. F., Pitt, M. L. M., Estep, J. E., Welkos, S. L.,  
Worsham, P. L. and Friedlander, A. M. (1996). Efficacy of a standard human  
anthrax vaccine against *Bacillus anthracis* aerosol spore challenge in rhesus  
monkeys. In *Proceedings of the Second International Workshop on Anthrax,  
Winchester, England, September 19-21, 1995*. pp 125 - 126. Ed. P. C. B.  
Turnbull. Salisbury Medical Bulletin Special Supplement No. 87.

Jacketot, H. and Virat, B. (1954). La longévité des spores de *B. anthracis*  
(premier vaccin de Pasteur). *Ann. Inst. Pasteur*. 87: 215- 217. (cited in Sneath,  
1962)

Jackson, P. J., Walthers, E. A., Kalif, A. S., Richmond, K. L., Adair, D. M.,  
Hill, K. K., Kuske, C. R., Anderson, G. L., Wilson, K., H., Hugh-Jones, M.  
H. and Keim, P. (1997). Characterization of the variable-number tandem  
repeats in *vrrA* from different *Bacillus anthracis* isolates. *Appl. Environ.  
Microbiol.* 63:  
1400 - 1405.

Jacobsen, C. S. and Rasmussen, O. E. (1992). Development and application of  
a new method to extract bacterial DNA from soil based on separation of bacteria  
from soil with cation-exchange resin. *Appl. Environ. Microbiol.* 58: 2458 - 2462.

Jacobsen, C. S. (1995). Microscale detection of specific bacterial DNA in soil with a magnetic capture hybridization and PCR amplification assay. *Appl. Environ. Microbiol.* 61: 3347 - 3352.

Jannièrè, L., Braund, C. and Erlich, S. D. (1990). Structurally stable *Bacillus subtilis* cloning vectors. *Gene* 87: 53 - 61.

Jannièrè, L., Gruss, A., and Ehrlich, S. D. (1993). Plasmids. In '*Bacillus subtilis and other Gram-positive bacteria*'. pp625 - 664. Eds. A. L. Sonenshein, J. A. Hoch and Losick, L. ASM Washington. DC.

Johns, M. L., Harrington, R. W., Titball, R. W. and Leslie D. L. (1994). Improved methods for the detection of *Bacillus anthracis* spores by the PCR. *Lett. Appl. Microbiol.* 18: 236 - 238.

Kaneko, T. Nozaki, R. Arzawa, K. (1978). Deoxyribonucleic acid relatedness between *Bacillus anthracis*, *Bacillus cereus* and *Bacillus thuringiensis*. *Microbial. Immunol.* 22: 639 - 641.

Kashket, E. R. (1979). Active transport of thallos ions by *Streptococcus lactis*. *J. Biolol. Chem.* 254: 8129 - 8131.

**Keim, P., Kalif, A., Schupp., Hill, K., Travis, S. E., Richmond, K., Adair, D. M., Hugh-Jones, M., Kuske, C. R. and Jackson, P. (1997).** Molecular evolution and diversity in *Bacillus anthracis* as detected by amplified fragment length polymorphism markers. *J. Bacteriol.* 179: 818 - 824.

**Keynan, A., and Sandler, N. (1983).** Spore Research in Historical Perspective. In *The Bacterial Spore*. Volume 2. pp72 - 87 Eds. A. Hirst and G. W. Gould. Academic Press Inc. London

**Klemm D. M. and Klemm, W. R. (1959).** A history of anthrax. *J. A. V. M. A.* 135: 458 - 462.

**Kleppe, G., Vasstrand, E. and Jensen, H. B. (1981).** The specificity requirements of bacteriophage T4 lysozyme. Involvement of N -acetamido groups. *Eur. J. Biochem.* 119: 589 - 593.

**Knisely, R. F. (1965).** Differential media for the identification of *Bacillus anthracis*. *J. Bacteriol.* 90: 1778 - 1783.

**Knisely, R. F. (1966).** Selective medium for *Bacillus anthracis*. *J. Bacteriol.* 92: 784 - 786.

**Knudson, G. B. (1986).** Treatment of anthrax in man. History and Current Concepts. *Military medicine* 151: 71 - 77.

**Kohout, E., Sehat, A. and Ashraf, M. (1964).** Anthrax. A continuous problem in South West Iran. *American Journal of Medical Science*. 247: 565. (cited in Titball *et al.*, 1991).

**Koneman, E. W., Allen, S. D., Janda, W. M., Schreckenberger, P. C. and Winn Jr, W. C. (1992).** Colour Atlas and Textbook of Diagnostic Microbiology. 4 th edition. pp 468 - 479. J. B. Lippincott Company, Philadelphia.

**Kuske, C. R., Banton, K. L., Adorada, D. L., Stark, P. C., Hill, K. H. and Jackson, P. J. (1998).** Small-scale DNA sample preparation method for field PCR detection of microbial cells and spores in soil. *Appl. Environ. Microbiol.* 64: 2363 - 2472.

**Lalitha, M. K., Mathai, D., Thomas, K., Kumar, A. and Ganesh, A. (1996).** Anthrax, a continuing problem in southern India. In *Proceedings of the Second International Workshop on Anthrax, Winchester, England, September 19-21, 1995*. pp 14 - 15. Ed. P. C. B. Turnbull. Salisbury Medical Bulletin Special Supplement No. 87.

**Lalitha, M. K. and Thomas, M. K. (1997).** Penicillin resistance in *Bacillus anthracis*. *Lancet* 349: 1522.

**Lambert, P. A., Hancock, I. C. and Baddiley, J. (1975).** The interaction of magnesium ions with teichoic acid. *Biochem. J.* 149: 519 - 524.

**Lambert, H. P. and O'Grady, F. (1992).** Antibiotic and Chemotherapy. Sixth Edition. The Bath Press Inc. UK.

**Lawrence, N. L. (1955).** The cleavage of adenosine by spores of *Bacillus cereus*. *J. Bacteriol.* 70: 577 - 582.

**Lawrence, D., Heitefuss, S. and Seifert, S. H. (1991).** Differentiation of *Bacillus anthracis* from *Bacillus cereus* by gas chromatography whole cell fatty acid analysis. *J. Clin. Microbiol.* 29: 1508 - 1512.

**Leff, L. G., Dana, J. R., McMrthur, J. V. and Schimkets, L. J. (1995).** Comparison of methods of DNA extraction from stream sediments. *Appl Environ Microbiol* 61: 1141 - 1143.

**Leonhardt, H. (1990).** Replication of a low copy number mutation within the pUB110 replicon and its effect on plasmid stability in *Bacillus subtilis*. *Gene* 94: 121 - 124.

**Leppla, S. H. (1991).** The anthrax toxin complex. In *Sourcebook of Bacterial Protein Toxins*, pp. 277-302. Eds. J. E. Alouf and J. H. Freer: New York Academic Press Inc.



**Lereclus, D., Lecadet, M-M., Ribier, J. and Dedonder, R. (1982).** Molecular relationships among plasmids of *Bacillus thuringiensis*: conserved sequences through 11 crystalliferous strains. *Mol. Gen. Genet.* 186: 391 - 398.

**Lieve, L. (1974).** The barrier function of the Gram-negative envelope. *Ann. N. Y. Acad. Sci.* 235: 109 - 127.

**Lignières, (1919).** *Compt. Rend. Soc. de Biol.* 82: p1091. (cited in Spray, 1936).

**Liang, X., Ma, F., Yu, D. and Lin, T. (1996).** Plasmid and protein profiles of *Bacillus anthracis* strains isolated in China. In *Proceedings of the Second International Workshop on Anthrax, Winchester, England, September 19-21, 1995.* pp 43-45. Ed. P. C. B. Turnbull. Salisbury Medical Bull Special Supplement No. 87.

**Lightfoot, N. F. Scott, R. J. D. and Turnbull, P. C. B. (1990).** Antimicrobial susceptibility of *Bacillus anthracis* In *Proceedings of the International Workshop on Anthrax, Winchester, England, April 11-13, 1989.* pp 95 - 98. Ed. P. C. B. Turnbull. Salisbury Medical Bulletin Special Supplement No. 68.

**Lincoln, R. E., Rhian, M. A., Klein, F and Fernelius A. (1961).** Pathogenesis as related to physiological state of anthrax spore and cell. Pathogenesis of anthrax: working hypothesis. In *Spores II* Ed. H.O. Halverson. pp 255-275. Burgess Publishing Co, Minneapolis.

**Lindeque, P. M. (1991).** Factors affecting the incidence of anthrax in the Etosha National Park, Namibia. PhD thesis. Council for National Academic Awards, London.

**Lindeque, P. M. and Turnbull, P. C. B. (1994).** Ecology and epidemiology of anthrax in the Etosha National Park, Namibia. *Onderstepoort J. Vet Res.* **61**: 71 - 83.

**Lindeque, P. M., Brain, C. and Turnbull, P. C. B. (1996).** A review of anthrax in the Etosha National Park. In *Proceedings of the Second International Workshop on Anthrax, Winchester, England, September 19-21, 1995.* pp 264 - 267. Ed. P. C. B. Turnbull. Salisbury Medical Bulletin Special Supplement No. 87.

**Logan, N. A., Capel, B. J., Melling, J. and Berkeley, R. W. (1984).** Identification of *Bacillus* strains using the API system. *J. Gen. Microbiol.* **130**: 1871 - 1882.

**Logan, N. A., Carman, J. A., Melling, K. and Berkeley, R. C. W. (1985).**

Identification of *Bacillus anthracis* by API tests. *J. Med. Microbiol.* 20: 75 - 85.

**Logan, N. A. (1994).** The Gram-positive rods. In *Bacterial Systematics*. pp 165 - 182. Blackwell Scientific Publications, Oxford.

**Logan, N. A. and Berkeley, R. C. W. (1981).** Classification and identification of members of the genus *Bacillus*. In *The Aerobic Endospore forming Bacteria*. pp 105 - 140. Eds R.C. W. Berkeley and M. Goodfellow. Academic press London.

**Long, G. W and O'Brien, T. (1998).** Antibody based systems for the detection of *Bacillus anthracis* in environmental samples. *Third International Conference on Anthrax*. Plymouth, UK. 7 - 10 September 1998. Abstract book p 7.

**Luckevich, M. D. and Beveridge, T. J. (1989).** Characterization of a dynamic S-layer on *Bacillus thuringiensis*. *J. Bacteriol.* 171: 6656 - 6667.

**McBride, B. W., Mogg, A., Telfer, J. L., Lever, M. S., Miller, J., Turnbull, P. C. B. and Baillie, L. (1998).** Protective efficacy of a recombinant protective antigen against *Bacillus anthracis* challenge and assessment of immunological markers. *Vaccine* 16: 810 - 817.

**M' Fadyean J. (1903).** A peculiar staining reaction of the blood of animals dead of anthrax. *J. Comp. Pathol.* 16: 35 - 40.

**McKenzie, T., Hoshino, T., Tanaka, T. and Sueoka, N. (1986).** The nucleotide sequence of pUB110: Some salient features in relation to replication and its regulation. *Plasmid* 15: 93 - 103.

**McGetrick, A. M. T., Turnbull, P. C. B., Oppenheim, B. A. and Koornhof, H. J. (1982).** Selective media for *Bacillus anthracis*. *Proceedings of the Second annual congress of the South African Society for Microbiology*, 15 - 17 September, Pretoria.

**Macdonald, R. M. (1986).** Sampling soil microfloras: Dispersion of soil by ion exchange and extraction of specific microorganisms from suspension by elutriation. *Soil Biol. Biochem.* 18: 399 - 406.

**Mahillion, J., Seurinck, J., Van Rompuy, L., Delcour, J. and Zabeau, M. (1985).** Nucleotide sequence and structural organisation of an insertion sequence element (IS231) from *Bacillus thuringiensis* strain *berliner* 1715. *EMBO J.* 4: 3895 - 3899.

**Makino, S.I., Uchida, I., Terakado, N., Sasakawa, C. and Yoshikawa, M. (1989).** Molecular characterization and protein analysis of the cap region, which is essential for encapsulation in *Bacillus anthracis*. *J Bacteriol.* 171: 722 - 730.

**Makino, S. I., Iinuma-Okada, Y., Maruyama, T., Ezaki, T., Sasakawa, C. and Yoshikawa, M. (1993).** Direct detection of *Bacillus anthracis* DNA in animals by polymerase chain reaction. *J. Clin. Microbiol.* **31**: 547 - 551.

**Manchee, R. J., Broster, M. G. Stagg, A. J. and Hibbs, S. E. (1994).** Formaldehyde solution effectively inactivates spores of *Bacillus anthracis* on the Scottish Island of Gruinard. *Appl. Environ. Microbiol.* **60**: 4167 - 4171.

**Mansley, L. M. (1978).** An outbreak of anthrax in the West Midlands. *State Vet. J.* **33**: 72 - 75.

**Meselson, M., Guillemin, J., Hugh-Jones, M., Langmuir, A., Popova, I., Shelokov, A. and Yampolskaya, O. (1994).** The Sverdlovsk anthrax outbreak of 1979. *Science* **266**: 1202 - 1208.

**Meynell, E. and Meynell, G. G. (1964).** The role of serum and carbon dioxide in capsule formation by *Bacillus anthracis*. *J. Gen. Microbiol.* **34**: 153 - 164.

**Mikesell, P., Ivins, B. E., Ristroph, J. D. and Dreier, T. M. (1983).** Evidence for plasmid mediated toxin production in *Bacillus anthracis*. *Infect. Immun.* **39**: 371-376.

Milne, J. C., Furlong, D., Hanna, P. C., Wall, J. S. and Collier, R. J. (1994). Anthrax protective antigen forms oligomers during intoxication of mammalian cells. *J. Biol. Chem.* 269: 20607 - 20612.

Mitchell, W. (1911). Anthrax and Fatalism. *Brit. Med. J.* 1: 751 - 752. (cited in Knudson, 1986).

Mock, M. (1995). Plenary paper, Anthrax before and in the 100 years since the death of Louis Pasteur, and where to now? *Second International Workshop on Anthrax, 19-21 September 1995, Winchester England.*

Morris, E. J. (1955). A selective medium for *Bacillus anthracis*. *J. Gen. Microbiol.* 13: 456 - 460.

Mossel, D. A. A., Koopman, M. J. and Jongerius, E. (1967). Enumeration of *Bacillus cereus* in foods. *Appl. Microbiol.* 15: 650 - 653.

Mulkey, J. P. and Oehme, F. W. (1979). A review of thallium toxicity. *Vet. Hum. Toxicol.* 35: 445 - 453.

Muller-Wegener, U. (1988). Interaction of humic substances with biota. In *Humic substances and their role in the Environment.* pp 179-192. Eds. F. H. Frimmel and R. F. Christman. John Wiley and Sons Ltd.

**Mullis, K. B. (1990).** The unusual origin of the polymerase chain reaction.

*Scientific American* April pp 36 - 43.

**Murphy, T. D., LaBocchetta, A. C., Lockwood, J. S. (1944).** Treatment of human anthrax with penicillin: report of 3 cases. *J.A.M.A.* 126: 948 - 950. (cited in Knudson, 1986).

**Murty, K. G. G. and Halvorson, H. O. (1957).** Effect of enzyme inhibitors on the germination and respiration of and growth from *Bacillus cereus* var. *terminalis* spores. *J. Bacteriol.* 73: 230 - 234.

**Nakamura, L. K. (1994).** DNA relatedness among *Bacillus thuringiensis* serovars. *Int. J. Syst. Bacteriol.* 44: 125 - 129.

**Norris, P., Man, W. K., Hughes, M. N. and Kelly, D. P. (1976).** Toxicity and accumulation of thallium in bacteria and yeasts. *Arch. Microbiol.* 110: 279 - 286.

**Notermans, S. H. W. (1993).** Emerging public health problems with *Bacillus cereus*. *The Society for Applied Bacteriology, 62 nd Annual Meeting and Summer Conference.* University of Nottingham 13 - 16 July, 1993. Colloquium 2: Aspects of *Bacillus* and *Closteridium* in the environment as pathogens.

**O'Brien, J., Friedlander, A., Dreier, T., Ezzell, J. and Leppla, S. H. (1985).** Effects of anthrax toxin components on human neutrophils, *Infect. Immun.* **47**: 306 - 310.

**Ogram, A. V., Saylor, G. S., and Barkay, T. (1987).** The extraction and purification of microbial DNA from sediments. *J. Microbiol. Methods* **7**: 57 - 60.

**Okinaka, R., Cloud, K., Hampton, O., Hoffmaster, A., Hill, K., Keim, P., Koehler, T., Lamke, G., Kumano, S., Manter, D., Martinez, Y., Ricke, D., Svensson, R. and Jackson, P. (1998).** Sequence assembly and analysis of pX01 and pX02. *Third International Conference on Anthrax*. Plymouth, UK. 7 - 10 September 1998. Abstract book p 18.

**Olsen, B. H. and Tsai, Y-L. (1993).** Molecular approaches to Environmental Management. *Environmental Microbiology*. pp 239 - 263. Ed. R. Mitchell. Wiley-Liss, Inc. New York.

**Oppenheim, B. A., and Koornhof, H. J. (1980).** A selective medium for anthrax. *Proceedings of the congress of the South African Society of Pathologists*. 7 - 9 July Johannesburg.

**Oram, J. D. and Reiter, B. (1968).** Inhibition of bacteria by lactoferrin and other iron-chelating agents. *Biochem. Biophys. Acta* **170**: 351 - 365.



**Palmer, C. J., Tsai, Y-L., Paszko-kolva, C., Mayer, C. and Sangermano.**

(1993). Detection of *Legionella* species in sewage and ocean water by polymerase chain reaction, direct immunofluorescent-antibody and plate culture methods. *Appl. Environ. Microbiol.* 3618 - 3624.

**Parry, J. M., Turnbull, P. C. B. and Gibson, J. R. (1983).** *A Colour Atlas of*

*Bacillus species.* Wolfe Medical Atlases - 19. Wolfe Medical Publications Ltd. London.

**Patra, G., Sylvestre, P., Ramnissse, V., Therasse, J. and Guesdon, J. L.**

(1996). Isolation of a specific chromosomal DNA sequence of *B. anthracis* and its possible use in diagnosis. *FEMS Immunol. Med. Microbiol.* 15: 223 - 231.

**Patra, G., Vaissaire, J., Weber-Levy, M., Le Doujet, C. and Mock, M. (1998).**

Molecular characterisation of *Bacillus* strains involved in outbreaks of anthrax in France in 1997. *J. Clin. Microbiol.* 36: 3412 - 3414.

**Pearce, T. W. and Powell, E. O. (1951).** A selective medium for *Bacillus*

*anthracis.* *J. Gen. Microbiol.* 5: 387 - 390.

**Pellegrini, A., Thomas, U., von Fellenberg, R. and Wild, P. (1992).**

Bactericidal activities of lysozyme and aprotinin against Gram-negative and Gram-positive bacteria related to their basic character. *J. Appl. Bacteriol.* 72: 180 - 187.

**Petosa, C., Collier, R. J., Klimper, K. R., Leppla, S. H., Liddington, R. C.** (1997). Crystal structure of the anthrax toxin protective antigen. *Nature* **385**: 833 - 838.

**Pfisterer, R. M.** (1996). History, setting the record straight. In *Proceedings of the Second International Workshop on Anthrax, Winchester, England, September 19-21, 1995*. p 139. Ed. P. C. B. Turnbull. Salisbury Medical Bulletin Special Supplement No. 87.

**Phillips, A. P. and Martin, K. L.** (1982). Quantitative immunofluorescence studies of the serology of *Bacillus anthracis* spores. *Appl. Environ. Microbiol.* **46**: 1430 - 1432.

**Phillips, A. P. and Martin, K. L.** (1982a). Assessment of immunofluorescence measurements of individual bacteria in direct and indirect assays for *Bacillus anthracis* and *Bacillus cereus* spores. *J. Appl. Bacteriol.* **53**: 223 - 231.

**Phillips, A. P. and Martin K. L.** (1983). Comparison of direct and indirect immunoradiometric assays (IRMA) for *Bacillus anthracis* spores immobilised on multispot microscope slides. *J. Appl. Bacteriol.* **55**: 315 - 324.

**Phillips, A. P. and Martin, K. L.** (1988). Investigation of spore surface antigens in the genus *Bacillus* by the use of polyclonal antibodies in immunofluorescence. *J. Appl. Bacteriol.* **64**: 47 - 55.

Phillips, A. P., Martin, K. L. and Broster, M. G. (1983). Differentiation between spores of *Bacillus anthracis* and *Bacillus cereus* by a quantitative immunofluorescence technique. *J. Clin. Microbiol.* 17: 41 - 47.

Picard, C., Ponsonnet, C., Paget, E., Nesme, X. and Simonet, P. (1992). Detection and enumeration of bacteria in soil by direct DNA extraction and polymerase chain reaction. *Appl. Environ. Microbiol.* 58: 2717 - 2722.

Pickup, R. W. (1991). Development of molecular methods for the detection of specific bacteria in the environment. *J. Gen. Microbiol.* 137: 1009 - 1019.

Plotkin, S. A., Brachman, P. S., Utell, M., Bumford, F. H. and Atchison, M. M. (1960). An epidemic of inhalation anthrax, the first in the Twentieth Century. I. Clinical Features. *Amer. J. Medicine* 29: 992 - 1001.

Porteus, L. A. and Armstrong J. L. (1993). A simple mini method for extraction of DNA directly from soil for use with PCR amplification. *Curr. Microbiol.* 27: 115 - 118.

Powell, J. F. (1957). Biochemical changes occurring during spore germination in *Bacillus* species. *J. Appl. Bacteriol.* 20: 349 - 358.

**Powell, J. F. and Hunter J. R. (1955).** Spore germination in the genus *Bacillus*: the modification of germination requirements as a result of pre-heating. *J. Gen. Microbiol.* 13: 59 - 67.

**Priest, F. G. (1993).** Systematics and Ecology of *Bacillus* species. In *Bacillus subtilis and other Gram-positive bacteria: Biochemistry, Physiology and Molecular Genetics*. pp 3 - 16. Eds. A. L. Sonenshein, J. A. Hoch and R. Losick. ASM, Washington D. C.

**Priest, F. G., Goodfellow, M. and Todd C. (1981).** The genus *Bacillus*: a numerical analysis, in *The Aerobic endospore-forming Bacteria: Classification and Identification*. pp 91 - 103. Eds. R. C. W. Berkeley and M Goodfellow. London Academic Press.

**Priest, F. G., Goodfellow, M. and Todd, C. (1988).** A Numerical Classification of the Genus *Bacillus*. *J. Gen. Microbiol.* 134: 1847 - 1882.

**Priest, F. G., Kaji, D. A., Rosato, Y. B., and Canhos, V. P. (1994).** Characterization of *Bacillus thuringiensis* and related bacteria by ribosomal RNA gene restriction fragment length polymorphisms. *Microbiology* 140: 1015 - 1022.

**Pugsley, A. P. (1996).** Bacterial toxins deliver the goods. *Proc. Natl. Acad. Sci. USA.* 93: 8155 - 8156.

Quinn, C. P. and Dancer, B. N. (1990). Transformation of vegetative cells of *Bacillus anthracis* with plasmid DNA. *J. Gen. Microbiol.* 136: 1211 - 1215.

Quinn, C. P. and Shone, C. C. (1994). Shuttle plasmids for expression of anthrax toxin in *Bacillus*. In *Bacterial Protein toxins Zbl Bakt Suppl* 24, pp 154-155. Ed.G Freer: Gustav Fischer. Stuttgart.

Quinn, C. P. and Turnbull, P. C. B. (1998). Anthrax. In: *Topley and Wilson's Microbiology and Microbial Infections*, 9 th ed, Vol 3. pp779 - 818. Eds. L. Collier, A. Ballows, M. Sussman and W. J. Hausler. Arnold, London.

Quinn, C. P., Singh, Y., Klimpel, K. R. and Leppla, S. H. (1991). Functional mapping of anthrax toxin lethal factor by in-frame insertion mutagenesis. *J. Biol. Chem.* 266: 20124 - 20130.

Ramamurthy, T., Pal, A., Bag, P. K., Bhattacharya, S. K., Nair, G. B., Kurozono, H., Yamasaki, Y., Shirai, H., Takeda, T., Uesaka, Y., Horigome, K. and Takeda, Y. (1993). Detection of cholera toxin gene in stool specimens by polymerase chain reaction comparison with bead enzyme-linked immunosorbent assay and culture methods for laboratory diagnosis of cholera. *J. Clin. Microbiol.* 31: 3068 - 3070.

- Rammise, V., Patra, G., Garrigue, H., Guedson, J-L. and Mock, M. (1996). Identification and characterization of *Bacillus anthracis* by multiplex PCR analysis of sequences on plasmids pX01 and pX02 and chromosomal DNA. *FEMS Microbiol. Lett.* 145: 9 - 16.
- Ramsay, A. J. (1984). Extraction of bacteria from soil: efficiency of shaking or ultrasonication as indicated by direct counts and autoradiography. *Soil Bio. Biochem.* 16: 475 - 481.
- Rasmussen, O. V. (1981). Thallium poisoning: An aspect of human cruelty. *Lancet* May 23: 1164.
- Reddy, A., Battisti, L. and Thorne, C. B. (1987). Identification of self-transmittable plasmids in four *Bacillus thuringiensis* subspecies. *J. Bacteriol.* 169: 5263 - 5270.
- Reading, C. (1982). The biochemistry and mode of action of augmentin. *In* *Augmentin, clavulanate-potentiated amoxycillin*. pp 5 - 21. Proceedings of an International Symposium, 17th July, 1981. Eds. D. A. Leigh and O. P. Robinson. Excerpta Medica, Amsterdam-Oxford-Princeton
- Riebling, M. (1948). Roentgen treatment of external infections due to *Bacillus anthracis*. *Radiology* 51: 333 - 340. (cited in Knudson, 1986).

**Ristroph, J. D. and Ivins, B. E. (1983).** Elaboration of *Bacillus anthracis* antigens in a new, defined culture medium. *Infect. Immun.* 39: 483 - 486.

**Redmond, C., Hall, G. A., Green, M. and Turnbull, P. C. B. (1996).** Bacteriology, Serology and Pathology of experimental Anthrax in pigs. In *Proceedings of the Second International Workshop on Anthrax, Winchester, England, September 19-21, 1995.* pp 79 - 82. Ed. P. C. B. Turnbull. Salisbury Medical Bulletin Special Supplement No. 87.

**Redmond, C., Henderson, I., Turnbull, P.C.B. and Bowen J. (1996a).** Phage from different strains of *Bacillus anthracis*. In *Proceedings of the Second International Workshop on Anthrax, Winchester, England, September 19-21, 1995.* pp 60 - 63. Ed. P. C. B. Turnbull. Salisbury Medical Bulletin Special Supplement No. 87.

**Reif, T. C., Johns, M., Pillai, S. D. and Carl, M. (1994).** Identification of capsule-forming *Bacillus anthracis* spores with the PCR and a novel dual-probe hybridization format. *Appl. Environ. Microbiol.* 60: 1622 - 1625.

**Repaske, R. (1958).** Lysis of Gram-negative bacteria by lysozyme. *Biochem. Biophys. Acta* 22: 189 - 190.

- Robertson, D. L., Tippetts, M. T. and Leppla, S. H. (1988). Nucleotide sequence of the *Bacillus anthracis* edema factor gene (*cya*): a calmodulin-dependent adenylate cyclase. *Gene* 73: 363 - 371.
- Rosenblatt, J. E. and Stewart, P. R. (1974). Combined activity of sulfamethoxazole, trimethoprim and polymyxin B against Gram-negative bacilli. *Antimicrob. Agents and Chemother.* 6: 84 - 92.
- Rozak, D. B. and Colwell, R. R. (1987). Survival strategies of bacteria in the Natural Environment. *Microbiol. Reviews* 51: 365 - 379.
- Ruhfel, R. E., Robillard, N. J. and Thorne, C. B. (1984). Interspecies transduction of plasmids among *Bacillus anthracis*, *B. cereus* and *B. thuringiensis*. *J. Bacteriol.* 157: 708 - 711.
- Sacks, L. E. and Alderton, G. (1961). Behaviour of bacterial spores in aqueous polymer two-phase systems. *J. Bacteriol.* 82: 331 - 341.
- Safarik, I., Saforikova, M. and Forsythe, S. J. (1995). The application of magnetic separation in Applied Microbiology. *J. Appl. Bacteriol.* 78: 575 - 585.
- Sainsbury, D. (1986). Animal Health. Health, Disease and Welfare of Farm Livestock. Collins Professional and Technical Books.



**Sambrook, J., Fritsch, E. F. and Maniatis, T. (1989).** *Molecular Cloning: a Laboratory Manual*, 2nd edn. Cold Spring Harbor, NY: Cold Spring Harbor Laboratory.

**Schmidt, W., Arnold, H. H. and Kersten, H. (1977).** Tetrahydrofolate-dependent biosynthesis of ribothymidine in transfer ribonucleic acids of Gram-positive bacteria. *J. Bacteriol.* **129**: 15 - 21.

**Senesi, S., Cercignani, G., Freer, G., Batoni, G., Barnini, S. and Ota, F. (1991).** Structural and stereospecific requirements for the nucleoside-triggered germination of *Bacillus cereus* spores. *J. Gen. Microbiol.* **137**: 399 - 404.

**Shlyakhov, E. N. and Rubinstein, E. (1994).** Human live anthrax vaccine in the former USSR. *Vaccine.* **12**: 727 - 730.

**Shylakhov, E. (1996).** Incubation period. In *Proceedings of the Second International Workshop on Anthrax, Winchester, England, September 19-21, 1995.* p 139. Ed. P. C. B. Turnbull. Salisbury Medical Bulletin Special Supplement No. 87.

**Siala A. and Gray, G. (1974).** Growth of *Bacillus subtilis* and spore germination in soil observed by a fluorescent-antibody technique. *J. Gen. Microbiol.* **81**: 191 - 198.

**Silva, M. T., Sousa, J. C. F., Macedo, M. A. E., Polnoia, J. and Parente, A. M. (1976).** Effects of phenyl alcohol on *Bacillus* and *Streptococcus*. *J. Bacteriol.* 127: 1359 - 1369.

**Sjostedt, A., Errikkson, U., Rammisse, V. and Garrigue, H. (1996).** Detection of the vegetative form of *Bacillus anthracis* in soil by PCR. In *Proceedings of the Second International Workshop on Anthrax, Winchester, England, September 19-21, 1995.* p 50. Ed. P. C. B. Turnbull. Salisbury Medical Bulletin Special Supplement 87.

**Sjostedt, A., Errikkson, U., Rammisse, V. And Garrigue, H. (1997).** Detection of *Bacillus anthracis* spores in soil by PCR. *FEMS Microbiol. Ecol.* 23: 159 - 168.

**Skul'skii, I. A., Glazunova, V. V., Riabova, I. D. and Gonerva, G. A. (1977).** Selective permeability of bacterial membranes for monovalent thallium ions. *Biokhimiia* 42: 1637 - 1641 (in Russian).

**Slepecky, R. A. and Leadbetter, E. R. (1983).** On the prevalence and roles of spore forming bacteria and their spores in nature. *In The Bacterial Spore Volume* 2. p 89 Eds. A. Hurst and G. W. Gould. Academic Press Inc, London.

**Smalla, K., Cresswell, N., Mendonca-Hagler, L. C., Wolters, A. and Van Elsas, J. D. (1993).** Rapid extraction protocol from soil for polymerase chain reaction mediated amplification. *J. Appl. Bacteriol.* 74: 78 - 85.

**Smith, N. R., Gordon, R. E. and Clark, F. E. (1946).** Aerobic Mesophilic Sporeforming Bacteria, Miscellaneous Publication No. 559. U. S. Department of Agriculture, Washington D. C.

**Smith, N. R., Gordon, R. E. and Clark, F. E. (1952).** Aerobic spore forming bacteria. Agriculture monograph No 16. United States Department of Agriculture.

**Smith, H., Keppie, J., and Stanley, J. T. (1955).** The chemical basis of virulence of *Bacillus anthracis* V. The specific toxin produced by *B. anthracis* in vivo. *Br. J. Exp. Pathol.* 36: 460 - 472.

**Smith, N. E., Gordon, R. E. and Sneath, P. H. A. (1964).** Type cultures and proposed neotype cultures of some species in the genus *Bacillus*. *J. Gen. Microbiol.* 34: 269 - 272.

**Sneath, P. H. A. (1962).** Longevity of micro-organisms. *Nature* 195: 643 - 646.

**Solaiman, D. K. and Somkuti, G. A. (1998).** Characterization of a novel *Streptococcus thermophilus* rolling-circle plasmid used for vector construction. *Appl. Microbiol. Biotechnol.* **50**: 174 - 180.

**Somerville, H. J. and Jones, M. L. (1972).** DNA competition studies within the *Bacillus cereus* group of bacilli. *J. Gen. Microbiol.* **73**: 257 - 265.

**Spray, R. S. (1936).** Semisolid media for cultivation and identification of the sporulating anaerobes. *J. Bacteriol.* **32**: 135 - 155.

**Stein, C. D. (1948).** Incidence of anthrax in livestock during 1945, 1946 and 1947 with special reference to control measures in the various states. *Vet. Med.* Nov 463 - 469.

**Stein, C. D. (1963).** Anthrax. *In Diseases transmitted from Animal to Man.* pp 82 -125 Eds. T. G. Hull, C. C. Thomas. Springfield, Illinois. (cited in Knudson, 1986).

**Steffan, R. J. and Atlas, R. M. (1988).** DNA amplification to enhance detection of genetically engineered bacteria in environmental samples. *Appl. Environ. Microbiol.* **54**: 2185 - 2191.

**Steffan, R. J., and Atlas, R. M. (1991).** Polymerase chain reaction: applications in environmental microbiology. *Ann. Rev. Microbiol.* **45**: 137 - 161.

Steffan, R. J., Goksoyr, J., Bej, A. K. and Atlas R. M. (1988). Recovery of DNA from soils and sediments. *Appl. Environ. Microbiol.* 54: 2908 - 2915.

Stenstrom, T. A. (1989). Bacterial hydrophobicity, an overall parameter for the measurement of adhesion potential to soil particles. *Appl. Environ. Microbiol.* 55: 142 - 147.

Sterne, M. (1937). The effects of different carbon dioxide concentrations on the growth of virulent anthrax strains. Pathogenicity and immunity tests on guinea-pigs and sheep with anthrax variants derived from virulent strains. *Onderstepoort J. Vet. Sci.* 9: 49 - 67.

Sterne, M. (1959). Anthrax, In *Infectious Diseases of Animals . Diseases due to bacteria*. Vol 1. pp 16-52. Eds. A. W Stableforth and I. A. Galloway. Butterworths, London.

Storm, D. R., Rosenthal, K. S. and Swanson, P. E. (1977). Polymyxin and related peptide antibiotics. *Ann. Rev. Biochem.* 46: 723 - 763.

Stotzky, G. (1985). Influence of soil mineral colloids on metabolic processes, growth adhesion, and ecology of microbes and viruses. pp 305 - 428. In *Interactions of Soil Minerals with Natural Organics and Microbes*. Soil Science Society of America, Madison, USA.

**Straub, T. M., Pepper, I. L. and Gerba, C. P. (1995).** Comparison of PCR and cell culture for detection of enteroviruses in sludge-amended field soils and determination of their transport. *Appl. Environ. Microbiol.* **61**: 2066 - 2068.

**Ström, G., Palmgren, U. and Blomquist, G. (1987).** Separation of organic dust from microorganism suspensions by partitioning in aqueous polymer two-phase systems. *Appl. Environ. Microbiol.* **53**: 860 - 863.

**Ström, G. B. and Blomquist, G. K (1986).** Selective partitioning of conidia of some *Penicillium* and *Aspergillus* species in aqueous two-phase systems. *Appl. Environ. Microbiol.* **52**: 723 - 726.

**Sumerkan, B., Aygen, B., Doganay, M. and Sehman, S. (1996).** Antimicrobial susceptibility of *Bacillus anthracis* against macrolides. In *Proceedings of the Second International Workshop on Anthrax, Winchester, England, September 19-21, 1995.* p 138. Ed. P. C. B. Turnbull. Salisbury Medical Bulletin Special Supplement No. 87.

**Swinfield, T-J., Oultram, J. D., Thompson, D. E., Brehm, J. K. and Minton, N. P. (1990).** Physical characterization of the replication region of the *Sterptococcus faecalis* plasmid pAM $\beta$ 1. *Gene* **87**: 79 - 90.

**Swinfield, T-J., Janniere, L., Erlich, S. D. and Minton N. P. (1991).**

Characterization of a region of the *Enterococcus faecalis* plasmid pAM $\beta$ 1 which enhances the segregational stability of pAM $\beta$ 1-derived cloning vectors in *Bacillus subtilis*. *Plasmid* 26: 209 - 221.

**Tebbe, C. C. and Vahjen, W. (1993).** Interference of humic acids and DNA extracted directly from soil in detection and transformation of recombinant DNA from bacteria and yeast. *Appl. Environ. Microbiol.* 59: 2657 - 2665.

**Thorne, C. B. and Belton, F. C. (1957).** An agar diffusion method for titrating *Bacillus anthracis* immunizing antigen and its application to a study of antigen production. *J. Gen. Microbiol.* 17: 505 - 517.

**Tigertt, W. D. (1980).** Anthrax. William Smith Greenfield, MD., FRCP., Professor Superintendent, The Brown Animal Sanatory Institution (1878-81). Concerning the priority due to him for the production of the first vaccine against anthrax. *J. Hyg. Camb.* 85: 415 - 420.

**Titball, R. W., and Manchee, R. J. (1987).** Factors affecting the germination of spores of *Bacillus anthracis*. *J. Appl. Bacteriol.* 62: 269 - 273.

Titball, R. W., Turnbull, P. C. B. and Hutson, R. A. (1991). The monitoring and detection of *Bacillus anthracis* in the environment. *J. Appl Bacteriol. Symposium Supplement 70*: 9S - 18S.

Torsvig, V. L. (1979). Isolation of bacterial DNA from soil. *Soil Biol. Biochem.* 12: 15 - 21.

Travers, R. S., Martin, P. A. W. and Reichelderfer, C. F. (1987). Selective process for efficient isolation of soil *Bacillus* spp. *Appl. Environ. Microbiol.* 53: 1263 - 1266

Tsai, Y-L. and Olsen, B. H. (1991). Rapid method for direct extraction of DNA from soil and sediments. *Appl. Environ. Microbiol.* 57: 1070 - 1074.

Tsai, Y-L. and Olsen, B. H. (1992). Rapid method for separation of bacterial DNA from humic substances in sediments for polymerase chain reaction. *Appl. Environ. Microbiol.* 58: 2292 - 2295.

Turnbull, P. C. B. (1990). Anthrax. In *Topley and Wilson's Principles of Bacteriology, Virology and Immunity*, 8th edtn. pp 365 - 379. Eds. G. R. Smith, C. S. F. Easman. Edward Arnold, London.

Turnbull, P. C.B. (1991). Anthrax vaccines: past, present and future. *Vaccine* 9: 533 - 539.



Turnbull, P. C. B. (1996). Guidance on environments known to be or suspected of being contaminated with anthrax spores. *Land Contamination and Reclamation* 4: 37 - 45.

Turnbull, P. C. B. (1999). Definitive identification of *Bacillus anthracis* - a review. *Proceedings of the Third International Conference on Anthrax*. Plymouth, UK. 7 - 10 September 1998 (in press).

Turnbull, P. C. B. and Kramer, J. M. (1991). *Bacillus* p 296 -303. In *Manual of Clinical Microbiology*. 5 th editn. Eds. A. Balows, J. W. J. Hausler, K. L. Herrmann, H. D. Isenberg and H. J. Shadomy, H. ASM, Washington, D. C.

Turnbull, P. C. B. and Kramer, J. M. (1995). *Bacillus* In *Manual of Clinical Microbiology* 6 th Edition pp 349-356. Ed. P. R. Murray. Washington, DC: ASM Press.

Turnbull, P. Kramer, J. and Melling, J. (1990). *Bacillus*. In *Topley and Wilson's Principles of Bacteriology, Virology and Immunity*. pp 189 - 210. 8 th editn. Eds. G. R. Smith, C. S. F. Easman. Arnold, London.

Turnbull, P. C. B., Hofmeyr, J. M. McGetrick, A. M. T. and Oppenheim, B. A. (1986). Isolation of *Bacillus anthracis*, the agent of anthrax in the Etosha National Park. A comparison of various media and methods. *Madoqua* 14: 321 - 331.

**Turnbull, P. C. B., Broster, M. G., Carman, J. A., Mancchee, R. J. and Melling, J. (1986a).** Development of antibodies to protective antigen and lethal factor components of anthrax toxin in humans and guinea pigs and their relevance to protective immunity. *Infect. Immun.* 52: 356 - 363.

**Turnbull, P. C. B., Bell, R. H. V., Saigawa, K., Munyenyembe, F. E. C., Mulenga, C. K. and Makala, L. H. C. (1991).** Anthrax in wildlife in the Luangwa Valley, Zambia. *Vet. Record* Apr 27 399 - 404.

**Turnbull, P. C. B., Doganay, M., Lindeque, P. M., Aygen, B. and McLaughlin, J. (1992).** Serology and anthrax in humans, livestock and Etosha National Park Wildlife. *Epidemiol. Infect.* 108: 299 - 313.

**Turnbull, P. C. B., Hutson, R. A., Ward, M. J., Jones, M. N., Quinn, C. P., Finnie, N. J., Duggleby, C. J., Kramer, J. M. and Melling, J. (1992a).** *Bacillus anthracis* but not always anthrax. *J. Appl. Bacteriol.* 72: 21 - 28.

**Turnbull, P. C. B., Böhm, R., Chizyuka, H. G. B., Fujikura, T., Hugh-Jones, M. H. and Melling, J. (1993).** Guidelines for the surveillance and control of anthrax in humans and animals. World Health Organization, Geneva (unpublished document: WHO/Zoon./93.170).

**Turnbull, P., Bowen, J. and Mann, J. (1996).** Stubborn contamination with anthrax spores. *Environmental Health* 104: 171 - 173.

**Turnbull, P. C. B., Bowen, J. E., Gillgan, J. S. and Barrett, N. J. (1996a).** Incidence of anthrax, and environmental detection of *Bacillus anthracis* in the U.K. In *Proceedings of the Second International Workshop on Anthrax, Winchester, England, September 19-21, 1995.* pp 5 - 6. Ed. P. C. B. Turnbull. Salisbury Medical Bulletin Special Supplement No. 87.

**Turnbull, P. C. B., Lindeque, P. M., Le Roux, J., Bennett, A. M. and Parks, S. R. (1998).** Airborne movement of anthrax spores from carcass sites in the Etosha National Park, Namibia. *J. Appl. Microbiol.* 84: 667 -676.

**Turnbull, P. C. B., Böhm, R., Cosivi, O., Doganay, M., Hugh-Jones, M. H. Joshi, D.D., Lalitha, M., K. and De Vos, V. (1998a).** Guidelines for the surveillance and control of anthrax in humans and animals. Third Edition. World Health Organization, Geneva (unpublished document: WHO/EMC/ZDI/98.6.)

**Turner, A. J., Galvin, J. W., Rubria, R. J., Condron, R. J. and Bradley, T. (1998).** Experiences with vaccination in controlling an outbreak of anthrax and epidemiological observations. *Third International Conference on Anthrax.* Plymouth UK 7 - 10 September 1998. Abstract book p 28.

**Turell, M. J., and Knudson, G. B. (1987).** Mechanical transmission of *Bacillus anthracis* by stable flies (*Stomoxys calcitrans*) and mosquitoes (*Aedes aegypti* and *Aedes taeniorhynchus*). *Infect. Immun.* 55: 1859 - 1861.

**Turpin, P. E., Maycroft, K. A., Rowlands, C. L. and Wellington, E. M. H.**  
(1993). Cation-exchange based extraction method for the detection of  
Salmonellas in soil. *J. Appl. Bacteriol.* **74**: 181 - 190.

**Uchida, I., Sekizaki, T., Hashimoto, K. and Terakado, N.** (1985).  
Association of the encapsulation of *Bacillus anthracis* with a 60 megadalton  
plasmid. *J. Gen. Microbiol.* **131**: 363 - 367.

**Uchida, I., Hornung, J. M., Thorne, C. B., Klimpel, K. R. and Leppla, S. H.**  
(1993). Cloning and characterization of a gene whose product is a *trans*-activator  
of anthrax toxin synthesis. *J. Bacteriol.* **175**: 5329 - 5338.

**Uchida, I., Makino, S., Sekizaki, T. and Terakado, N.** (1997). Cross-talk to  
the genes for *Bacillus anthracis* capsule synthesis by *atxA*, the gene encoding the  
*trans*-activator of anthrax toxin synthesis. *Mol. Microbiol* **23**: 1229 - 1240.

**Vaara, M.** (1992). Agents that increase the permeability of the outer membrane.  
*Micribiol. Review.* **56**: 395 - 411.

**Van Doorne, H., Baird, R. M., Hendriksz, D. T., Van der Kreek, D. M. and  
Pauwels, H. P.** (1981). Liquid modification of Baird-Parker's medium for the  
selective enrichment of *Staphylococcus aureus*. *Antonie van Leeuwenhoek* **47**:  
267 - 278.

**Vieira, J. and Messing, J. (1982).** The pUC plasmids, and M13mp7- derived system for insertion mutagenesis and sequencing with synthetic universal primers. *Gene* 19: 259 - 268.

**Vietri, N. J., Marrero, R., Hoover, T.A. and Welkos, S. L. (1995).** Identification and characterization of a *trans*-activator involved in the regulation of encapsulation by *Bacillus anthracis*. *Gene*. 152: 1 - 9.

**Wang, X-M., Mock, M., Ruyschaert, J-M. and Cabiliaux, V. (1996).** Secondary structure of anthrax lethal toxin proteins and their interaction with large unilamellar vesicles: A fourier-transform infrared spectroscopy approach. *Biochemistry* 35: 14939 - 14946.

**Warren, S. C. and Gould, G. W. (1968).** *Bacillus cereus* germination absolute requirement for an amino acid. *Biochem. Biophys. Acta* 170: 341 - 350.

**Watson, A. and Keir, D. (1994).** Information on which to base assessments of risk from environments contaminated with anthrax spores. *Epidemiol. Infect.* 113: 479 - 490.

**Webb, M. (1968).** The influence of certain trace metals on bacterial growth and magnesium utilization. *J. Gen. Microbiol.* 51: 325 - 335.

Weiser, R., Asscher, A. W. and Wimpenny, J. (1968). *In vitro* reversal of antibiotic resistance by Ethylenediamine Tetra-acetic acid. *Nature* 219: 1365 - 1366.

Welkos, S. L. (1991). Plasmid associated virulence factors of non-toxigenic (pX01<sup>-</sup>) *Bacillus anthracis*. *Microb. Path.* 10: 183 - 198.

Welkos, S. L., Keener, T. J. and Gibbs, P. H. (1986). Differences in susceptibility of inbred mice to *Bacillus anthracis*. *Infect. Immun.* 51: 795 - 800.

Welkos, S. L., Lowe, J. R., Eden-McCutchan, F., Vodkin, M., Leppla, S, H. and Schmidt, J.J. (1988). Sequence and analysis of the DNA encoding protective antigen of *Bacillus anthracis*. *Gene* 69: 287 - 300.

Welkos, S. L. and Marrero, R. (1996). Pathogenesis and host resistance to infection: A model system and analysis of capsule synthesis and regulation by *Bacillus anthracis*. In *Microbial Genome Methods*, pp. 209-246. Ed. K. W. Adolph. Boca Raton. CRC Press.

West, G. (1986). Anthrax. In *Blacks Veterinary Dictionary*, 16th Edition.

Westmacott, D. and Perkins, H. R. (1979). Effects of lysozyme of *Bacillus cereus* 569: rupture of chains of bacteria and enhancement of sensitivity to autolysins. *J. Gen. Microbiol.* 115: 1 - 11.

**White, R. E. (1987).** Introduction to the Principles and Practice of Soil Science. Second Edition. Blackwell Scientific Publications, Oxford.

**Whitford, H. W. (1979).** Anthrax In: *CRC Handbook series in zoonoses. Section A. Bacterial, Rickettsial and mycotic diseases.* pp 31 - 66. Eds. H. Stoenner and M. Torten. CRC Press Inc.

**Williams, D. R. and Thomas, C. M. (1992).** Active partitioning of bacterial plasmids. *J. Gen. Microbiol.* 138: 1 - 16.

**Wilson, I. G. (1997).** Inhibition and facilitation of nucleic acid amplification. *Appl. Environ. Microbiol.* 63: 3741 - 3751.

**Wilson, J. B. and Russell, K. E. (1964).** Isolation of *Bacillus anthracis* from soil stored for 60 years. *J. Bacteriol.* 87: 237 - 238.

**Wilson, K. H., Blitchington, R. B., Greene, R. C. (1990).** Amplification of bacterial 16S ribosomal DNA with polymerase chain reaction. *J. Clin. Microbiol.* 28: 1942 - 1946.

**Wong, M. T., Dolan, M. J. (1992).** Significant infections due to *Bacillus* species following abrasions associated with motor vehicle-related trauma. *Clin. Infect. Dis.* 15: 855 - 857.

Wyatt, G. M., Lee, H. A. and Morgan, M. R. A. (1992). Traditional culture methods for bacteria. In *Immunoassays for food poisoning bacteria and bacterial toxins*. pp23 - 24. Chapman and Hall, London.

Yamada, S., Ohashi, E., Agata, N. and Venkateswarwn, K. (1999). Cloning and nucleotide sequence analysis of *gyrB* of *Bacillus cereus*, *B. thuringiensis*, *B. mycooides* and *B. anthracis* and their application to the detection of *B. cereus* in rice. *Appl. Environ. Microbiol.* 65: 1483 - 1490.

Young, C. C., Burghoff, R. L., Keim, L. G., Minak-Bernerero, V., Lute, J. R., and Hilton, S. M. (1993). Polyvinylpyrrolidone-agarose gel electrophoresis purification of polymerase chain reaction-amplifiable DNA from soils. *Appl. Environ. Microbiol.* 59: 1972 - 1974.

Yu, P. K. W. and Washington, J. A. (1981). Identification of aerobic and facultatively anaerobic bacteria. In *Laboratory procedures in Clinical Microbiology*. pp 133 - 148. Ed. J. A. Washington. Springer-Verlag New York.

Zitko, V. (1975). Toxicity and pollution potential of thallium. *Sci. Total. Environ.* 4: 185 -192.



**Zipperle, G. F., Ezzell, J. W. Jr., and Doyle, R. J. (1984). Glucosamine substitution and muramidase susceptibility in *Bacillus anthracis*. *Can. J. Microbiol.* 30: 553 - 559.**

## APPENDIX I

### Blood agar plates (BA)

Blood agar base number 2 (Difco, Michigan, USA) + 7% horse blood (TCS Biologicals Ltd, Bucks, UK),

### L-Broth (LB)

10 g tryptone  
5 g yeast extract  
10 g NaCl

The above ingredients were added to SDW, which was made up to 1 l and the pH adjusted to pH 7.4. The broth was autoclaved at 121 °C for 15 min.

### L-agar (LA)

LB was made up as described above supplemented with 1.5% agar. Stock solutions of antibiotics were made in ethanol and added to LB or LA (cooled to 50 °C) at the following concentrations:-

Antibiotic	Concentration	
	in <i>B. anthracis</i>	in <i>E. coli</i>
Chloramphenicol	20 µg/ml	200 µg/ml
Erythromycin	5 µg/ml	-
Neomycin	10 µg/ml	-
Kanamycin	5 µg/ml	50 µg/ml

### **Phosphate buffered saline (PBS)**

8 g/l NaCl

0.2 g/l KCl

1.15g/l Na<sub>2</sub>HPO<sub>4</sub>

0.2 g/l KH<sub>2</sub>PO<sub>4</sub>

The above ingredients were added to SDW and the pH adjusted to pH7.4. The solution was autoclaved at 121 °C for 15 min.

### **Sporulation agar plates**

3 g tryptone

6 g bacteriological peptone

3 g yeast extract

0.15 g Lab Lemco powder

0.0001% MnCl<sub>2</sub>.4H<sub>2</sub>O

25 g agar

The above ingredients were added to SDW to a total volume of 1 l and autoclaved at 121 °C for 15 min. 10 ml volumes were poured into petri dishes.

### **Haematin and lysozyme agar (Pearce and Powell, 1951)**

2% peptone

0.5% NaCl

2% agar

The above ingredients were added to SDW and the pH adjusted to pH7.4. The agar was autoclaved at 121 °C for 15 min.

The following solutions were made up:-

8 mg of haematin dissolved in 20 ml 0.01M NaOH

1 mg (50 000 units) lysozyme in 13 ml 0.01M acetic acid

The agar was cooled to 50°C and 10 ml of the haematin solution and 10 ml of the lysozyme solution was added to 80 ml of agar.

#### **Propamidine isethionate agar (Morris, 1956)**

Nutrient agar was made up according to the manufacturer's instructions (13 g powder in 1 l of SDW) and autoclaved at 121 °C for 15 min. The agar was cooled to 50 °C and 0.2% dibromopropamidine added to a final concentration of 0.01%.

#### **Phenolethanol agar (Yu and Washington, 1981)**

Nutrient agar was made up according to the manufacturer's instructions (13 g powder in 1 l of SDW) and autoclaved at 121 °C for 15 min. The agar was cooled to 50 °C and 0.1 - 1.0% phenolethanol added to the agar.

#### **TCB agar (Oppenheim and Koornhof, 1980)**

Agar (1.9 g) was dissolved in 95 ml SDW and autoclaved at 121 °C for 15 min.

Trimethoprim (17.5 mg dissolved in 500 µl DMSO), 3 000 units of polymyxin B sulphate and 5 ml of sterile defibrinated horse blood was added.

### **PLETA, Knisely (1966)**

Heart infusion broth (Difco) containing 1.5% agar was made up according to the manufacturer's instruction (40 g powder added to 1 l of SDW) and autoclaved at 121 °C for 15 min. Stock solutions of polymyxin B sulphate and lysozyme were made in SDW and filter sterilised. Stock solutions of EDTA and thallos acetate (TA) were made up and sterilised by autoclaving at 121 °C for 15 min. The agar was cooled to 50 °C and the above ingredients added to the following concentrations:-

30 000 units/l polymyxin B sulphate  
5 mg (250 000 units)/l lysozyme  
300 mg/l EDTA  
40 mg/l TA.

### **Bicarbonate agar**

Nutrient agar was made up according to the manufacturer's instructions (13 g powder in 1 l of SDW) and autoclaved at 121 °C for 15 min. The agar was cooled to 50 °C and 0.7% sodium hydrogen carbonate (BDH 10247) was added.

### **RM medium (Ristroph and Ivins, 1983)**

35 mg/l	L-tryptophan	2920 mg/l	NaCl
65 mg/l	L-glycine	3700 mg/l	KCl
144 mg/l	L-tyrosine	2100 µg/l	adenine sulphate
230 mg/l	L-lysine-HCl	1400 µg/l	uracil
173 mg/l	L-valine	1 mg/l	thiamine HCl
230 mg/l	L-leucine	25 mg/l	L-cysteine
170 mg/l	L-iso-leucine	460 mg/l	KH <sub>2</sub> PO <sub>4</sub>

120 mg/l	L-threonine	9060 mg/l	tris buffer
73 mg/l	L-methionine	5000 mg/l	glucose
184 mg/l	L-aspartic acid	7400 µg/l	CaCl <sub>2</sub> .2H <sub>2</sub> O
612 mg/l	L-glutamic acid sodium salt	9800 µg/l	MgSO <sub>4</sub> .7H <sub>2</sub> O
43 mg/l	L-proline	1 mg/l	MnCl <sub>2</sub> .4H <sub>2</sub> O
55 mg/l	L-histidine HCl	8000 mg/l	NaHCO <sub>3</sub>
125 mg/l	L-phenylalanine	235 mg/l	L-serine

The above ingredients were added to Milli Q water to a total volume of 1 litre, and sterilised by filtration.

#### **LBG medium**

10 g tryptone  
5 g yeast extract  
10 g NaCl  
1 g glucose

The above ingredients were added to SDW, which was made up to 1 l and the pH adjusted to pH 7.0. The broth was autoclaved at 121 °C for 15 min.

#### **TSB medium**

LB was made up at double strength and the pH adjusted to pH 6.1. The following ingredients were added

10% PEG 3350  
10 mM MgCl<sub>2</sub>  
10 mM MgSO<sub>4</sub>

The solution was made up to 95% of the total volume and autoclaved at 121 °C for 15 min. When the solution had cooled DMSO was added to a final volume of 5%.

### **TSBG medium**

TSB medium was made up as described above with the addition of 20 mM glucose to the broth before autoclaving.

### **Hybridization buffer**

5 x SSC

0.1% (w/v) SDS

5% (w/v) dextran sulphate

20 fold dilution of liquid block (supplied with the kit)

The above reagents were combined and heated gently with stirring to dissolve the dextran sulphate. The hybridization buffer was stored at -20 °C.

## APPENDIX II

### Statistical Methods used in this study

Where only one variable factor was involved in an experiment, the difference between the results from two groups was calculated by using the following formula

$$d = \frac{\bar{x}_1 - \bar{x}_2}{\sqrt{\frac{\bar{x}_1}{n_1} + \frac{\bar{x}_2}{n_2}}}$$

- Where
- d = the difference between samples (unit standard deviation)
  - $\bar{x}_1$  = the mean of the observations in sample 1
  - $n_1$  = the number of observations in sample 1
  - $\bar{x}_2$  = the mean of the observations in sample 2
  - $n_2$  = the number of observations in sample 2

for this test to be effective then  $\bar{x}_1 n_1 > 30$  and  $\bar{x}_2 n_2 > 30$ . To determine whether the difference is significant d is compared to the following values:-

P =	0.10	0.05	0.02	0.01	0.002	0.001
	1.645	1.96	2.326	2.576	3.090	3.291

Where  $d < 1.96$  there is no significant difference between the samples tested.

Where more than one variable factor was involved any difference between the results of paired experiments was identified using the following formula:-



$$\bar{x} = \frac{1}{n} \sum x \quad s^2 = \frac{1}{n-1} \left\{ \sum x^2 - \frac{1}{n} (\sum x)^2 \right\} \quad t = \frac{\bar{x} - \mu}{s/\sqrt{n}} =$$

where  $s^2$  = the variance  
 $\mu$  = 0 (the hypothetical difference between the two means)

and the number of degrees of freedom =  $n - 1$

the significance of the  $t$  - value was determined by referral to the 'Student's'  $t$ -distribution table shown below (from Bailey, 1985)

'STUDENTS'  $t$ -DISTRIBUTION

Degrees of freedom	Value of P					
	0.10	0.05	0.02	0.01	0.002	0.001
1	6.314	12.71	31.82	63.66	318.3	636.6
2	2.920	4.303	6.965	9.925	22.33	31.60
3	2.353	3.182	4.541	5.841	10.21	12.92
4	2.132	2.776	3.747	4.604	7.173	8.610
5	2.015	2.571	3.365	4.032	5.893	6.869
6	1.943	2.447	3.143	3.707	5.208	5.959
7	1.895	2.365	2.998	3.499	4.785	5.408
8	1.860	2.306	2.896	3.355	4.501	5.041
9	1.833	2.262	2.821	3.250	4.297	4.781
10	1.812	2.228	2.764	3.169	4.144	4.587
11	1.796	2.201	2.718	3.106	4.025	4.437
12	1.782	2.179	2.681	3.055	3.930	4.318
13	1.771	2.160	2.650	3.012	3.852	4.221
14	1.761	2.145	2.624	2.977	3.787	4.140
15	1.753	2.131	2.602	2.947	3.733	4.073
16	1.746	2.120	2.583	2.921	3.686	4.015
17	1.740	2.110	2.567	2.898	3.646	3.965
18	1.734	2.101	2.552	2.878	3.610	3.922
19	1.729	2.093	2.539	2.861	3.579	3.883
20	1.725	2.086	2.528	2.845	3.552	3.850
21	1.721	2.080	2.518	2.831	3.527	3.819
22	1.717	2.074	2.508	2.819	3.505	3.792
23	1.714	2.069	2.500	2.807	3.485	3.767
24	1.711	2.064	2.492	2.797	3.467	3.745
25	1.708	2.060	2.485	2.787	3.450	3.725
26	1.706	2.056	2.479	2.779	3.435	3.707
27	1.703	2.052	2.473	2.771	3.421	3.690
28	1.701	2.048	2.467	2.763	3.408	3.674
29	1.699	2.045	2.462	2.756	3.396	3.659
30	1.697	2.042	2.457	2.750	3.385	3.646

The table gives the percentage points most frequently required for significance tests and confidence limits based on 'Student's'  $t$ -distribution. Thus the probability of observing a value of  $t$ , with 10 degrees of freedom, greater in absolute value than 3.169 (i.e.  $< -3.169$  or  $> +3.169$ ) is exactly 0.01 or 1 per cent.

When  $t < \text{the } p = 0.05\% \text{ value}$ , then the null hypothesis (that there was no significant difference between the two samples) was accepted. When  $t > \text{the } p = 0.05\% \text{ value}$ , the null hypothesis was rejected.