

O. TRETIAK**PECULIARITIES OF DESIGNING OF SUSPENSIONS FOR STATORS OF HIGH POWER TURBOGENERATORS**

The analysis of existing designs of the stator fastening of Turbogenerators of various design versions is carried out. It is shown that the application of a spring suspension is the integral part of the design of Turbogenerators rated 100 MW and higher. The detailed calculation of the complex stressed state of the stators suspension of Turbogenerators manufactured at SE "PLANT "ELECTROTYAZHMASH" rated 200 MW and 250 MW with hydrogen and hydrogen-water cooling is submitted in the scientific work, taking into account the uneven thermal distribution along the horizontal axis of the aggregate for some number of electrical-sheet steels. The various types of the stator deformation caused by a number of forces are considered. It is proposed to carry out the calculation of mechanical stresses by iterative execution of mechanical and thermal calculations coordinated with electrical stresses. As limiting conditions for taking into account of forces caused by temperature changes, the limiting conditions of the first kind were considered. At that, in the mechanical calculation, it is necessary to take into account the design peculiarities for each row of springs, taking into consideration the correction for temperature. The key factor is the difference between the calculated vibrations for a stand separately core and its installation in to the casing with suspension, depending up on the modulus of elasticity of the stacked up laminated core for electrical-sheet steels 3413, 3414 GOST21427.1-83, M270-50A. The possibility of changing of steel 38X2H2BA to steel 34CrNiMo6 and steel 40NiCrMo7 is shown, provided that the GOST8479-70 complies with the same strength group.

Keywords: turbogenerator, spring suspension, limiting conditions, active steel, the stator casing.

O. В. ТРЕТЯК**ОСОБЛИВОСТІ ПРОЕКТУВАННЯ ПІДВІСОК СТАТОРІВ ТУРБОГЕНЕРАТОРІВ ВЕЛИКИХ ПОТУЖНОСТЕЙ**

Виконано аналіз існуючих конструкцій кріплення статора турбогенераторів різних виконань. Проведено детальний розрахунок складнонапруженого стану підвіски статора турбогенератора з урахуванням нерівномірності теплового розподілу уздовж горизонтальної осі агрегату для ряду електротехнічних сталей. Запропоновано виконувати розрахунок механічної напруги шляхом ітераційного виконання механічного та теплового розрахунку, узгоджених з електричним. Вказана можливість заміни сталі 38X2H2BA на 34CrNiMo6 та 40NiCrMo7 за умови відповідності ГОСТ 8479-70 для тієї ж групи міцності.

Ключові слова: турбогенератор, пружинна підвіска, граничні умови, активна сталь, корпус статора.

A. В. ТРЕТЬЯК**ОСОБЕННОСТИ ПРОЕКТИРОВАНИЯ ПОДВЕСОК СТАТОРОВ ТУРБОГЕНЕРАТОРОВ БОЛЬШОЙ МОЩНОСТИ**

Выполнен анализ существующих конструкций крепления статора турбогенераторов различных исполнений. Проведен детальный расчет сложнонапряженного состояния подвески статора турбогенератора с учетом неравномерности теплового распределения вдоль горизонтальной оси агрегата для ряда электротехнических сталей. Предложено выполнять расчет механических напряжений путем итерационного выполнения механического и теплового расчета, согласованных с электрическим. Указана возможность замены стали 38X2H2BA на 34CrNiMo6 и 40NiCrMo7 при условии соответствия ГОСТ 8479-70 для той же группы прочности.

Ключевые слова: турбогенератор, пружинная подвеска, граничные условия, активная сталь, корпус статора.

Introduction

Carried out analysis of the technical condition of the Turbogenerators equipment of Ukraine indicates that the majority of Turbogenerators have worked out their service life. Turbogenerators and Hydrogenerators designs are outdated and their technical condition no longer meets the modern requirements for efficiency, reliability and maneuverability. At the present time due to the urgent need to bring the equipment indices to the European standards, in connection with the future integration of the United Power System (UPS) of Ukraine with the European Power System (EPS), there is an urgent need to modernize existing and create new highly economic Turbogenerators.

Due to the above mentioned reason, the creation of new highly efficient types of Turbogenerators and Hydrogenerators put in to practice a set of measures on modernizing of existing equipment in order to

bring the Turbogenerators to modern requirements while increasing their power and overload capacity are extremely modern and important tasks.

Turbogenerator design is developed in such a way that there are active and design elements. In order to provide reliable operation of the active elements of Turbogenerators there are design namely housing parts, suspension and bearing elements, pressing down fastening elements of "active steel" and e. t. c.

Calculations and peculiarities of modeling the electrical parameters of Turbogenerators are considered in the scientific works of Milykh V. I. [1], Shevchenko V. V. [2] and others. Along with this the problems of constructive parts are not considered in detail since they are not so obvious and their solution sometimes requires a profound change in the entire design. The solution of these problems is presented in the scientific works of Minko A. N. [3], Kobzar K. A. [4].

© O. Tretiak, 2018

In connection with the qualitative leap of computer technology at this stage of technical development it becomes possible to revise the existing methods of calculation and design to create qualitatively new designs that have high reliability and optimal mass-dimensional indices.

Purpose of Work

Carry out the analysis of the ways in order to improve existing designs of the stator suspensions of Turbogenerators. Propose the calculating method of the stator suspension which takes into account the uneven thermal loads at determining of the mechanical characteristics.

Design Peculiarities of the Stator Fastening of Two-Poles Turbogenerator

The pioneers of the generator engineering, Rabinovich V. M., Spivak B. V., Chigirinsky A. A. submitted a strict definition of the stator suspension of the Turbogenerator. In order to isolate the baseplate and foundation of the Turbogenerator from the vibrations of the stator core under the influence of the magnetic attraction of the poles of the rotating rotor, the flexible fastening of the active iron in the stator casing is usually performed using plates tangentially arranged at several points along the circumference and along the length of the Turbogenerator. The plates forming flat springs are arranged symmetrically to the axis of the machine along the two forming element of the cores and attached to it and to the baseplate in turn at several points.

Application of the designs with put into practice of additional flexible elements, as a rule, is the most suitable for Turbogenerators rated over 100 MW.

Let's consider the design of two-poles Turbogenerator manufactured by EM WEG Group (USA) (see. Fig. 1) [5].

The system of prisms, which held with the help of the pressing down flanges the stacked up core in monolithic state, is included in to the core fastening units.

At that, it is necessary to take in to consideration that pressing forces in the core in the process of its operation does not remain constant and changing in wide range depending upon the load mode and the generator cooling mode. In addition, the load mode can also cause additional heating due to flow of stray currents in the short-circuited contours of the prism groups, which are short-circuited by pressing down flanges. Overloaded mechanically, the prisms are stretched, and then, after cooling, the nuts on them are weakened. However, given design version has significant disadvantage: welds do not perceive fatigue loads and application of this design is not possible for Turbogenerators rated over 100 MW. In this connection, it is necessary to use additional damping elements with a suspension construction.

Determination of the forces caused by the action of electric currents is given in scientific work [2]

The forces applied to the stator teeth are not evenly distributed to every tooth at any instant in time; they are applied with different magnitudes at different teeth, depending upon the relative rotor- and stator-tooth location. This results in force waves over the stator circumference. The mode shape of these magnetic force waves is a result of the difference between the number of rotor and stator slots.

Under the applied magnetic forces the stator core is set into vibration in the same manner that a ring of steel would respond if struck. Depending upon the modal pattern and frequencies of the exciting force, as described above, the stator would vibrate in one or more of its flexural modes m of vibration, as shown in Fig. 2. Each of the mode shapes has its associated natural frequency. The core may be somewhat influenced by the stator frame in actuality, but in analysis the frame is usually neglected, both due to complexity and because the effect on higher frequency modes is minimal [6].

Using mathematical modeling methods, it has been proved that the damage to the tightening prism of the stator core of Turbogenerator is due to the process of fatigue failure in a multi-cycle loading by axially directed vibrational electric-magnetic forces that arise in the end zones and act on the end packages of the stator core.

Variants of Suspensions

The classic school of Turbogenerators includes two types of suspensions namely the internal and external ones.

One of the most bright and reliable representatives of Turbogenerators with the internal suspension are Turbogenerators rated 200 MW and 300 MW of TGV series manufactured by SE "PLANT "ELECTROTYAZHMASH". The design of the stator casing of the electric machine is presented in scientific work [7] and in Fig. 3 shown a serial sample and a longitudinal section with the designation of the main elements.

The representatives of the external suspension are Turbogenerators rated 550 MW manufactured by SE "PLANT "ELECTROTYAZHMASH" [8].

The calculation diagram with the basic loads acting on to the support elements of the suspension is shown in Fig. 4. Where with the help of figures 1, 2, 3 the support studs are indicated, and 4 is the basic body of the spring, with the help of arrows forces action directions are indicated. T_1, T_2, T_3, T_4 is calculation temperature of the suspension elements.

The margins to cut and crushing shall be considered as admissible stresses. Together with that at suspension designing it is necessary to take in to consideration the temperature distribution along the stator length and also maximum forces action.

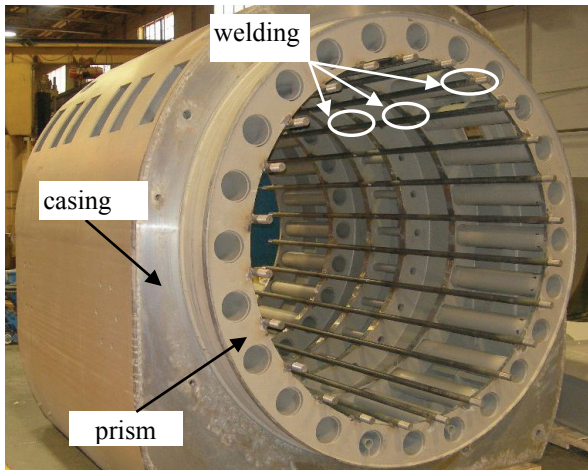

Fig. 1 – Stator Casing of EM WEG Group

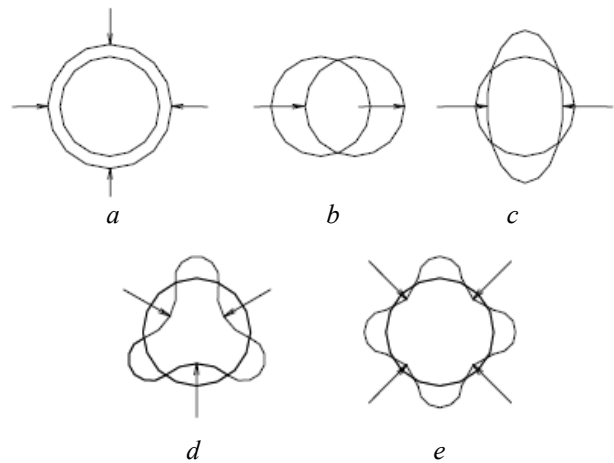

Fig. 2 – Variants of the Stator Deformation. Mode shapes: $a - m = 0$; $b - m = 1$; $c - m = 2$; $d - m = 3$; $e - m = 4$

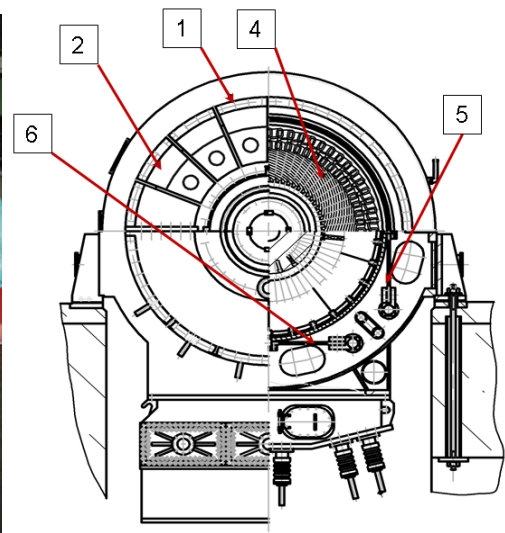
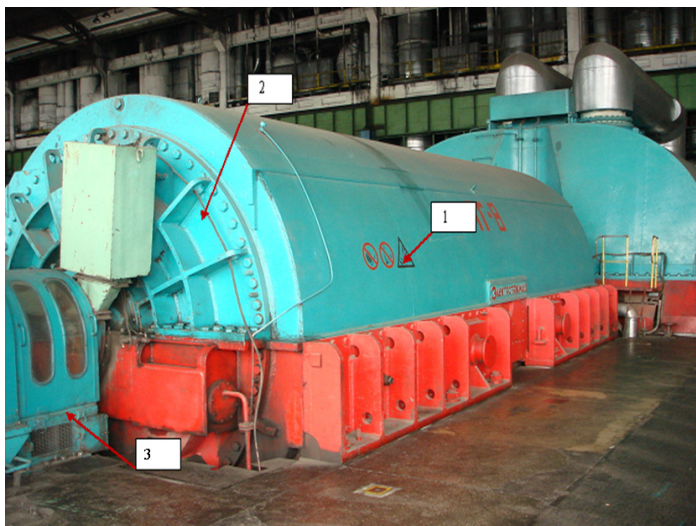

Fig. 3 – Turbogenerator type TGV-300: *a* – at the foundation of operating TPP; *b* – cross section; 1 – the stator casing; 2 – the external shield; 3 – the brush-holders device; 4 – the stator («active steel and bars»); 5 – vertical row of springs; 6 – horizontal row of springs

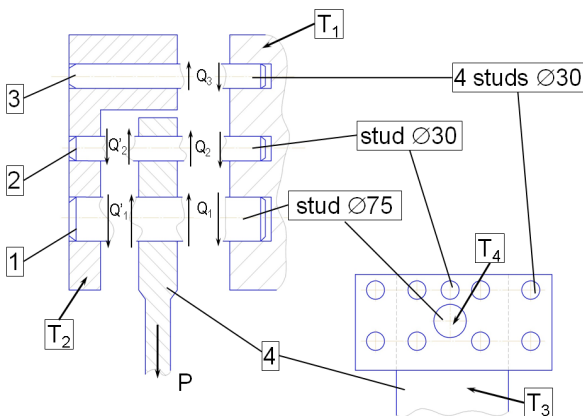

Fig. 4 – Calculation diagram of the suspension

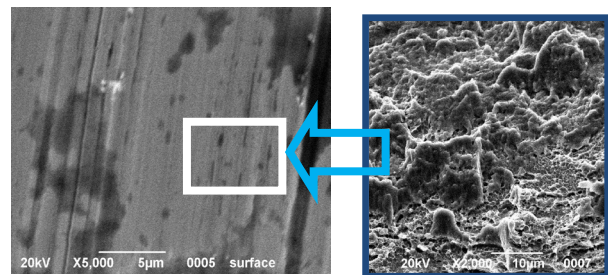

Fig. 5 – Structure of steel 40NiCrMo7: *a* – x 2000; *b* – x 5000

The stator core, casing and springs operate as one unit. And the change in one of the design elements leads to a change in the vibration of the entire construction. Thus, the heterogeneity of temperatures along the stator core length shall have an effect on the state of the suspension unit. Along with this, according to the operational experience, the temperature difference between the core and the stator casing can be 60 degrees.

For Turbogenerator series TGV-250 with hydrogen-water cooling the temperature of «the stator active steel» is 36 °C from the slip rings end, 39°C is in the middle of the machine and 41 °C is from the turbine end. Gas temperature in the radial channel is in range from 25 °C up to 47 °C. The hottest point, as per gas in the stator comprises 47 °C and arranged in the second section in the point of back. The gas temperature increases from the tooth to the back per ~10 °C. Thus, for each row of springs, it is necessary to determine

the mechanical stresses taking into account the change in their thermal state, applying limiting conditions of the first kind for the thermal problem [9].

In Table 1 the basic parameters of the spring suspensions of Turbogenerators TGV series manufactured by SE "PLANT "ELECTROTYAZHMASH".

Force onto vertical spring at rated mode shall be calculated as per the formulae:

$$P_n = \frac{G}{z_v} + \frac{M_n \cos \varphi}{z} \frac{1}{R},$$

where $\cos \varphi$ – is power factor;

G – the stator mass;

z_v – quantity of vertical springs.

At short-circuit mode this force shall be determined as follows:

$$P_{sh} = \frac{G}{z_v} + P_{\max} \frac{M_{sh} \cos \varphi}{z} \frac{1}{R}.$$

Table 1 – Stator core suspensions of Turbogenerators TGV-300 and TGV-250

Options	TGV-300		TGV-250
	Springs quantity	20	16
μz , kg·cm	$2,62 \cdot 10^8$	$2,23 \cdot 10^8$	$2,82 \cdot 10^8$
Impact force on a spring, kg·cm	$1,075 \cdot 10^5$	$1,13 \cdot 10^5$	$1,89 \cdot 10^5$
Natural frequency of torsional vibrations of the core, Hz	70	66	79
Critical force for stability	$1,9 \cdot 10^5$	$1,9 \cdot 10^5$	$3,3 \cdot 10^5$
Stresses in studs $\varnothing 60$:			
– from cut, kgf/cm ²	3291	3464	5794
– from crushing (spring-pin), kgf/cm ²	6400	6726	10500
Stresses of crushing between a pin $\varnothing 60$ and a support (strap), kgf/cm ²	2937	3087	5250
Limiting frequencies of the support $\varnothing 140$:			
– average, Hz	369	387	648
– bending, Hz	1340	1367	2286
– total, Hz	1440	1570	2627

In modern spring designs of Turbogenerators steel 38X2H2BA is applied. The decision to change steel 38X2H2BA to 34CrNiMo6 and 40NiCrMo7 is taken at the basis of correspondence to GOST8479-70 of those steels as per all the points without exclusions. In Fig. 5 macrostructure 40NiCrMo7 at different magnifications is submitted.

The Stator Core – "active steel"

For the stator core of Turbogenerator TGV-325-2U3 TPP "AKSU" electrical-sheet steel Grade M270-50A manufactured by firm Thyssen Krupp Stahl, German was applied for the first time. At dieing of the segments the teeth are arranged along the rolling. The segments steel has the following values of the elasticity modulus:

- along rolled steel – 185000 N/mm²;
- across rolled steel – 200000 N/mm².

Evaluation of expected vibration level of the stator core of Turbogenerator TGV-325 was carried out

based at the following consideration in Turbogenerator TGV-250-2PT3 (NPP "Kaiga", India) for the stator core steel 3413, 3414 GOST21427.1-83, having the following values of the elasticity modulus (as per the data of the tests carried out at SE "PLANT "ELECTROTYAZHMASH") is used:

- along rolled steel – 135000...137000 N/mm²;
- across rolled steel – 245000...265000 N/mm².

As per the results of the generator tests at the Plant stand the core vibration comprised of 55 μ m at 3000 rpm, that corresponds to own frequency of the core vibration $f_c = 157$ Hz (see Fig. 6 and Fig. 7).

Got experimental value of double amplitude of vibration corresponds to calculation one at the elasticity modulus:

$$F_{calc} = 116600 \text{ H/mm}^2.$$

Thus, the ratio of the calculation elasticity modulus to the actual one is recommended to use:

$$\frac{F_{calc}}{F_f} = \frac{116600}{137000} = 0,85.$$

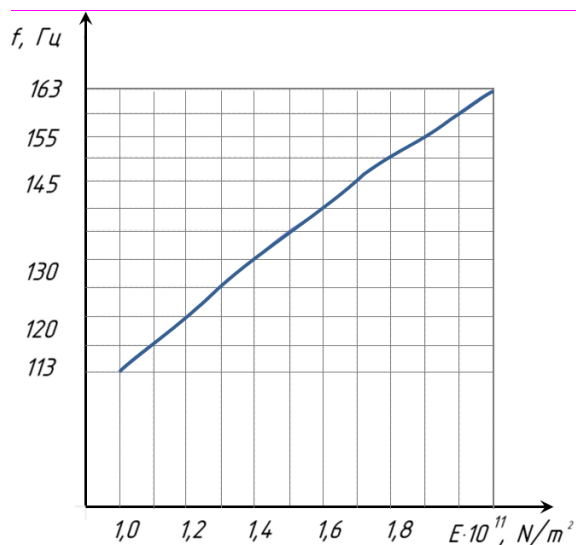

Fig. 6 – Dependence of frequency of self-bending oscillations from the core elasticity modulus

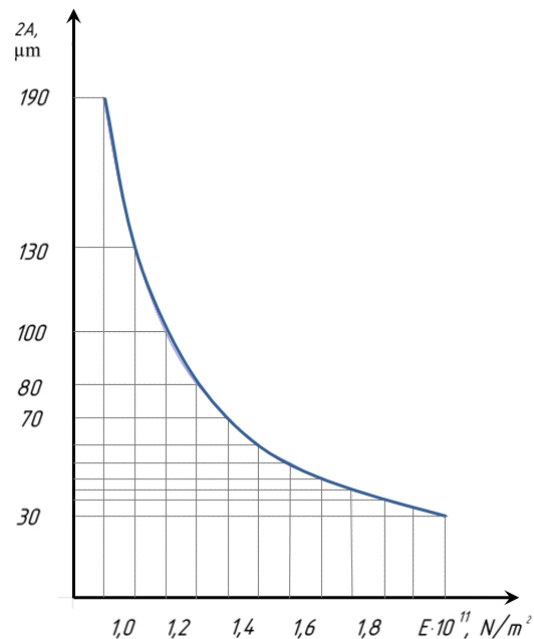

Fig. 7 – Dependence of double amplitude of vibration from the elasticity modulus of the core

In such a case for steel M270-50A calculation values of the elasticity modulus across the rolling steel shall comprise:

$$E = 0,85 \cdot 200000 = 170000 \text{ N/mm}^2.$$

Then the expected vibration level of the stator core of Turbogenerator TGV-325-2U3 shall comprise $2 A_f = 45 \text{ } \mu\text{m}$, $f_0 = 147 \text{ Hz}$. The order of given values was confirmed by the results of in-situ tests of Turbogenerator at the Plant stand.

At Fig. 8 the dependence of double amplitude of vibration from the elasticity modulus of the stacked up laminated core is submitted.

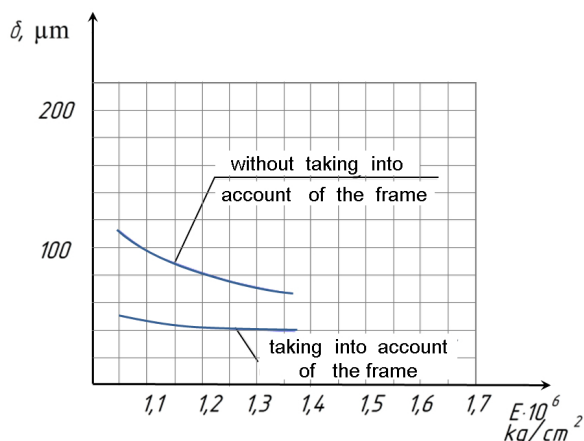

Fig. 8 – Dependence from double amplitude of vibration from the elasticity modulus of the stacked up core

The key factor is the difference between the calculated vibrations for a stand-alone core and its installation in to the casing with the suspension. The values are obtained by calculation in three-dimensional setting.

Conclusions

The design of the stator core suspension components of Turbogenerator includes the mandatory sequential carrying out of the following calculations: electrical, mechanical and thermal. At that, the results of the mechanical calculation shall be sequentially correlated depending on the arrangement of the springs in space, taking into account proposed calculation diagram.

These methods lead to the model accuracy increasing and the work result was the determination of the specified stresses in the suspension units of the stator suspensions of Turbogenerators series TGV-200, TGV-300 and TGV-250 manufactured by SE "PLANT "ELECTROTIAZHMAH". The possibility of the design operation at all modes without exception and limitation according to the requirements of GOST-533-2000 is shown.

The decision on the application of steels conforming to EN standards can be taken only if complete list of GOST requirements is met.

References

1. Милых В. И. Организация численно-полевых расчетов электромагнитных процессов в турбогенераторе при его несимметричной нагрузке. *Вісник НТУ «ХПІ». Серія: «Електричні машини та електромеханічне перетворення енергії»*. 2016. № 11(1183). С. 3–10. ISSN 2409-9295.
2. Шевченко В. В. Определение сил, действующих в сердечнике статора турбогенератора. *Електроенергетика и електромеханіка: сб. науч.-техн. тр. Міжнарод. науч. конф. Воронеж: НОУ ВПО "Міжнарод. ін-т комп'ютер. технологій"*, 2015. С. 52–56.
3. Мінко О. М. *Функціональний взаємозв'язок масогабаритних показників конструкційних частин турбогенератора з електромагнітними навантаженнями* : автореф. дис. ...

- канд. техн. наук : 05.09.01 / Мінко Олександр Миколайович; НТУ "ХПІ". Харків, 2015. 26 с.
4. Кобзар К. О. *Методи і засоби створення та комплексної повузлової модернізації турбогенераторів потужністю 150-300 МВт* : автореф. дис. ... канд. техн. наук : 05.09.01 / Кобзар Константин Александрович, НАНУ Инст-т Электродинамики. Київ, 2015. 22 с.
 5. Site [Electronic resource]. Access mode: <https://www.weg.net/institutional/ES/en/news/products-and-solutions/zest-weg-group-helps-farmers-to-reduce-their-electricity-cost>. The title of the screen. Дата обращения 02.02.2018.
 6. Finley W. R., Hodowanec M. M., Holter W. G. An Analytical Approach to Solving Motor Vibration Problems. *Copyright material IEEE*, Paper No. PCIC-99-20, Norwood. 1999. 16 p.
 7. *Статор електричної машини* : патент 66717 : Україна. МПК НО2К 1/16. / В. Ф. Пенської, А. Ю. Жуков, О. М. Мінко, К. О. Кобзар; заявник і патентовласник ДП завод «Електроважмаш». № u201109022 ; заявл. 19.07.2011 ; опубл. 10.01.2012, Бюл. №1. 8 с. : іл.
 8. Третяк О. В., Сенецький О. В., Шуть О. Ю., Доценко В. М., П'ятницька С. С. Складнонапружений стан деталей генераторів великої потужності. *Вестник двигателестроения*. 2016. № 2. С. 108–114.
 9. Борисенко А. И., Костиков О. Н., Яковлев А. И. *Охлаждение промышленных электрических машин*. Москва: Энергоатомиздат, 1983. 297 с.
- termining of Forces Acting in the Stator Core of Turbogenerator]", *Elektroenergetika i elektromekhanika: sb. nauch.-tekhn. tr. Mezhdunar. nauch. konf.* [Electric energy and electrical mechanic: Collection of scientific and technical works. International scientific conference], NOU VPO "Mezhdunar. in-t komp'yut. tekhnologiy", Voronezh, pp. 52–56.
3. Minko, O. M. (2015), *Funktsional'nyy vzayemozvyazok masohabarytnykh pokaznykh konstruksiynykh chastyn turboheneratora z elektromahnitnyy navantazhenyamy* [Functional interconnection of mass-dimensional indices of design parts of Turbogenerator with electrical-magnetic loads], NTU "KHPI", Kharkiv, 26 p.
 4. Kobzar, K. O. (2015), *Metody i zasoby stvorenniya ta kompleksnoyi povuzlovoyi modernizatsiyi turbohenerativ potuzhnisty 150-300 MVt* [Methods and Means of Designing and Comprehensive Unit Integrated Modernization of Turbogenerators Rated 150-300 MW], Kiev, 22 p.
 5. WEG (2018), *WEG Iberia Industrial S.L.U.* website, available at: www.weg.net (accessed 2 February 2018).
 6. Finley, W. R., Hodowanec, M. M. and Holter, W. G. (1999), "An Analytical Approach to Solving Motor Vibration Problems", *Copyright material IEEE*, Paper No. PCIC-99-20, Norwood, 16 p.
 7. Pens'koy, V. F., Zhukov, A. YU., Minko, O. M. and Kobzar, K. O. (2012), "Stator elektrychnoyi mashyny", patent 66717, Ukrayina. МПК NO2K 1/16, заявник і патентовласник DP zavod "Elektrovazhmash", № u201109022 ; заявл. 19.07.2011 ; опубл. 10.01.2012, Byul. № 1. 8 p.
 8. Tretyak, O. V., Senets'kyy, O. V., Shut, O. YU., Dotsenko, V. M. and P'yatnyts'ka, YE. S. (2016), "Skladnonapuzhenyy stan detaley henerativ velykoyi potuzhnosti [Complex Stressed State of High Power Generators Parts]", *Vestnyk dvyhatelestroyeniya* [Bulletin of Motor Engineering], № 2, pp. 108–114.
 9. Borisenko, A. I., Kostikov, O. N. and Yakovlev, A. I. (1983), *Okhlazhdeniye promyshlennykh elektricheskikh mashin* [Cooling of Industrial Electric Machines], Jenergoatomizdat [Energoatomizdat], Moscow, Russian.

Received 08.02.2018

References (transliterated)

1. Milykh, V. I. (2016), "Organizatsiya chislenno-polevykh raschetov elektromagnitnykh protsessov v turbogeneratore pri yego nesimmetrichnoy nagruzke [Organization of Numerical-Field Calculations of Electrical-Magnetic Processes in Turbogenerator at its asymmetric load]", *Visnik NTU "KHPI". Seriya: "Yeletrichni mashini ta yeletromekhanichne peretvorenniya yenergiy"* [Bulletin STU "KHPI". Series: "Electrical Machines and Electrical-Mechanical Energy Conversion"], No.11 (1183), pp. 3–10, ISSN 2409-9295.
2. Shevchenko, V. V. (2015), "Opredeleniye sil, deystviyushchikh v serdechnike statora turbogeneratora [De-

Відомості про авторів / Сведения об авторах / About the Authors

Третяк Олексій Володимирович (Третяк Алексей Владимирович, Tretiak Olexsii) – кандидат технічних наук, заступник завідувача відділом з механічних розрахунків, ДП «ЗАВОД «ЕЛЕКТРОВАЖМАШ»; старший викладач, Національний аерокосмічний університет ім. М. Є. Жуковського, «ХАІ», м. Харків, Україна; e-mail: alex3tretjak@ukr.net, ORCID 0000-0003-4945-5500.