

A FEATURE APPROACH TO THE PHONOLOGY  
OF PHUKET, A SOUTHERN THAI DIALECT

Thesis submitted for the degree of  
Master of Philosophy of the University  
of London

by

SOMCHIT PIYATHAM

Department of Phonetics and Linguistics,  
School of Oriental and African Studies

May, 1970.



ProQuest Number: 10731282

All rights reserved

INFORMATION TO ALL USERS

The quality of this reproduction is dependent upon the quality of the copy submitted.

In the unlikely event that the author did not send a complete manuscript and there are missing pages, these will be noted. Also, if material had to be removed, a note will indicate the deletion.



ProQuest 10731282

Published by ProQuest LLC (2017). Copyright of the Dissertation is held by the Author.

All rights reserved.

This work is protected against unauthorized copying under Title 17, United States Code  
Microform Edition © ProQuest LLC.

ProQuest LLC.  
789 East Eisenhower Parkway  
P.O. Box 1346  
Ann Arbor, MI 48106 – 1346

ABSTRACT

This thesis presents a phonological study of Phuket, a southern Thai dialect, approached from the point of view of Jakobsonian distinctive features.

Chapter 1, introduction, gives information about the geographical and linguistic background of the Phuket dialect, the scope and aim of the thesis and the arrangement of the data.

Part 1 which contains Chapters 2, 3 and 4 gives the phonetic interpretation of the phonemic transcription, a description of pitch patterns, and suggests a feature analysis of the phonemes, and examines the acoustic correlates of such features.

Part 2 which contains Chapters 5 and 6, proposes phonological rules to deal with problems of distribution, and deals with the treatment of tones and their phonological features, according to W. S-Y Wang's theory.

ACKNOWLEDGEMENTS.

I would like to thank the British Council, who have provided grants for me during these two years of studying in this country.

Many thanks also to Mr. A.W. Stone, the Chief Technician of the School, who has been very helpful in all the experimental work done in this thesis, and in the preparation of all the illustrations.

Thanks to Mr. Peter J. Bee and Dr. N.V. Smith, who have been so kind in giving their spare time for discussion with me.

Above all my deepest gratitude and thanks go to Professor Eugénie J.A. Henderson, and to God Almighty, whose understanding, patience, help, and encouragement have inspired me to bring this thesis into existence.

## TABLE OF CONTENTS

	page
Title	1
Abstract	2
Acknowledgements	3
Table of Contents	4-5
Chapter 1	: Introduction 6-11
	Geographical and
	Linguistic Background 7-9
	Aim of The Thesis 9
	Scope of The Thesis 10
	Arrangement of Data 10-11
Part 1 Chapter 2	: Phonetic Interpretation
	of The Phonemic Transcription 12-23
	Consonants 12-18
	Vowels 18-23
Chapter 3	: Phonetic Description of
	The Pitch Patterns 24-29
	Illustrations 30-40
Chapter 4	: Acoustic Correlates of
	The Phonemes Features 41-49
	Vocalic vs. Nonvocalic 42
	Consonantal vs. Nonconsonantal 42-44
	Voiced vs. Nonvoiced 44
	Interrupted vs. Noninterrupted 44-45
	(Continuant)

	page
Tense vs Nontense (Lax)	45-46
Grave vs. Nongrave(Acute)	46-47
Flat vs. Nonflat(Plain)	47-48
Diffuse vs. Nondiffuse	48
Compact vs. Noncompact	48-49
Illustrations	50-64
Part 2 Chapter 5 : Phonological Rules	65-72
Chapter 6 : Treatment of Tones	73-87
Appendix : Notes on The Frøkjøer-Jensen Pitchmeter, The Mingograph, and The Sound Spectrograph	88-90
Bibliography	91-92

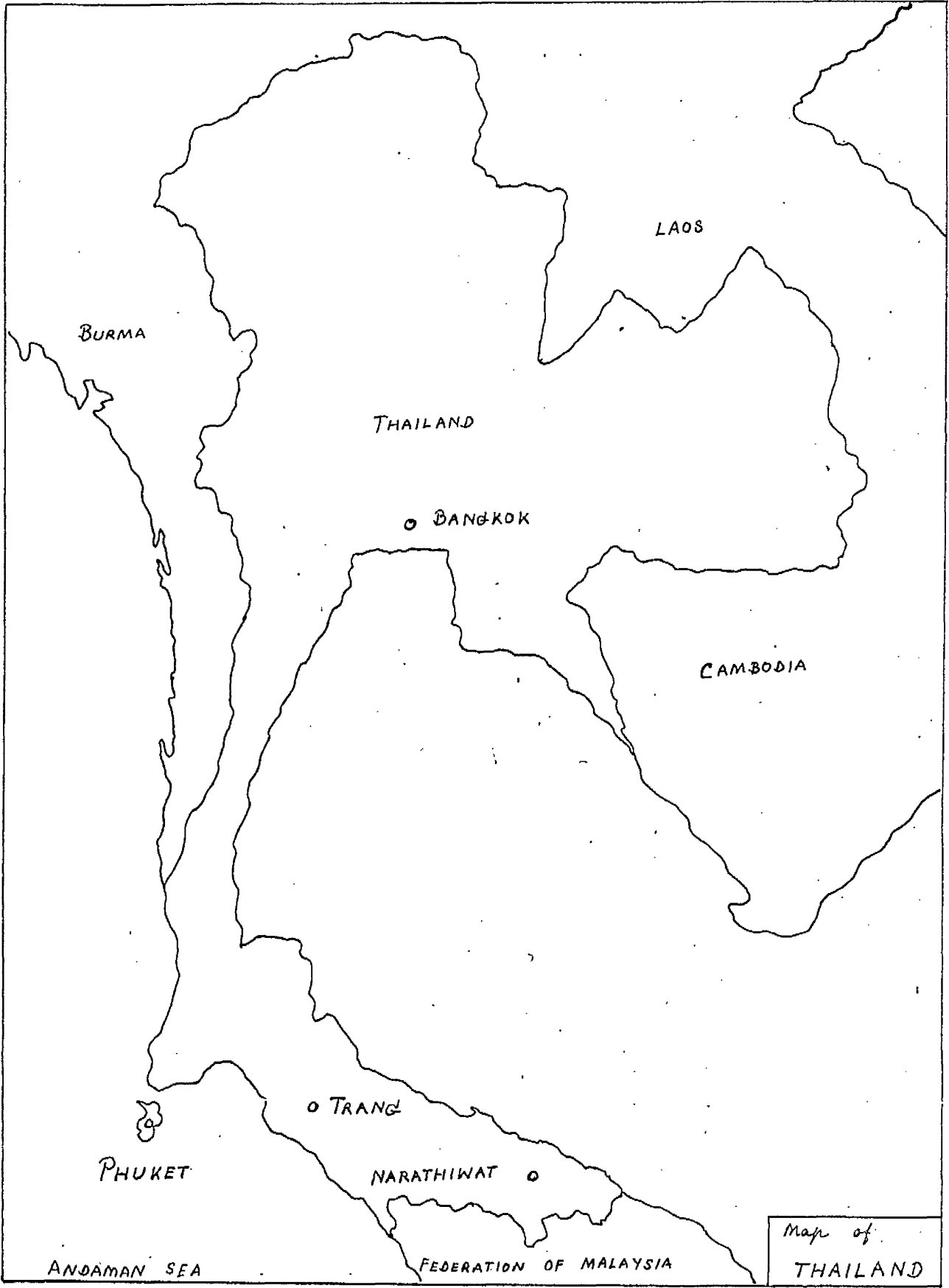

BURMA

LAOS

THAILAND

○ BANGKOK

CAMBODIA

PHUKET

○ TRANG

NARATHIWAT ○

ANDAMAN SEA

FEDERATION OF MALAYSIA

Map of  
THAILAND

## CHAPTER 1

### INTRODUCTION

This thesis is a phonological study of Phuket, a Southern Thai dialect.\*<sup>1</sup> This chapter presents a brief account of the geographical and linguistic background, the scope and aim of the thesis, and the arrangement of the data.

#### Geographical and Linguistic Background.

##### a) Geographical Setting.

Phuket is a province which is an island of 21.3 kilometers wide by 48.7 kilometers long. It is situated in the Andaman sea near the South West coast of Thailand (see map on the facing page). Surrounding Phuket are about 26 small islands, some of which have inhabitants who speak another language entirely different from the Phuket dialect or other dialects of Thai.

Because of the fact that Phuket can provide a good harbour, and natural resources, e.g., tin, rubber, sea-food, etc., the main occupations of the inhabitants are trading, mining, agriculture and fishing. For the last

---

\*1. For more details about dialects of Thai see J.M. Brown, From Ancient Thai to Modern Dialects, Social Science Association Press of Thailand, Bangkok, 1965.



two hundred years Phuket has been trading with Penang, a town in the Federation of Malaysia. Phuket trading is mostly in the hands of Chinese immigrants.

b) Linguistic Setting.

Apart from the native Thai speakers, the next biggest linguistic group, especially in central Phuket, are the Chinese. They speak Hokkian, Cantonese etc. Thus, the people who live in central Phuket have to communicate in the Phuket dialect as well as in Hokkian and Cantonese. Although the Phuket-speaking Thais include some Chinese words in their speech and likewise the Chinese include some Phuket words, this thesis is concerned only with the Phuket dialect excluding Chinese words.

b.1) Linguistic Background.

As I have used myself as an informant, it is necessary to give some information relevant to my linguistic background.

My grand-father was a Chinese, who came from China. He spoke Hokkian dialect. My grand-mother was half-Thai, half-Chinese. My father was brought up in a family that used Phuket and Hokkian dialects as a means of communication. My mother is a Thai, who used Phuket dialect with a limited vocabulary of Hokkian dialect.

During my childhood, because of my father's career, our family moved to Narathiwat, a Southern province next to the Malaysian border. Very often our cousins from Phuket

came to visit us and stayed with us for quite a long time. We lived there for about eight years, then the family moved to Trang, another Southern province next to Phuket across the sea (see map on ~~the back~~ <sup>6</sup>page). Every summer we went to Phuket and stayed there at least a month. And sometimes our cousins from Phuket came to visit us in Trang. I lived with my parents for eight more years before going to Bangkok. During all these years, the Phuket dialect was the language used at home, and my school friends in Trang considered my speech to be "foreign" in both vocabulary and accent.

After my secondary education, I left my parents for eleven years. I still went back to visit and stay with them at least a month every summer until I came to England.

My pronunciation may be considered to be educated Phuket pronunciation. Some Phuket speakers including some of my cousins use f and khw in free variation. I only do so very rarely. Nowadays most educated native speakers of Phuket dialect tend to keep the distinction between f and khw.

#### Aim of the thesis

The aim of this thesis is to present a phonological analysis of Phuket in terms of Roman Jakobson's theory of distinctive features as set out in Preliminaries to Speech Analysis.<sup>\*2</sup> This has involved some study of the acoustical

---

\*2. R. Jakobson, C. Gunnar M. Fant, and M. Halle, Preliminaries to Speech Analysis, Massachusetts Institute of Technology Press, Cambridge, Mass., 1963.

properties of consonants, vowels and tones.

### Scope of the Thesis.

Because of the limitation of time the thesis is a study of phonology at the word level only. The description given is applicable to Phuket words uttered in isolation, except that the realisation of tones in two word sequences has been noted.

As the starting point of the study, a "classical" phonemic analysis in articulatory terms has been made. The phonemes thus established have then been analysed as bundles of distinctive features on the Jakobson model, and an attempt has been made to discover the acoustic correlates of these features. "Redundancies" and unevenness of distribution of the phonemes have been handled by rules.

Selected items from the laboratory work undertaken are included to illustrate the statements made. No attempt at a detailed series of acoustical measurements is included. It is hoped, however, that comparison of selected illustrations will support the tentative statements made.

### Arrangement of data.

The Mingograms and Sonagrams shown in Chapters 3 and 4 were made in the laboratory of the Department of Phonetics and Linguistics, School of Oriental and African Studies, with the help of the chief technician of the School, under Professor Eugénie J.A. Henderson's supervision.

In all, 192 words uttered by me were examined by various means in the laboratory, some with a Frø~~o~~kjoer-Jensen pitch meter and oscilloscope, some with a kymograph, others with the Kay Electric Sound Spectrograph. The aim was to obtain recordings of the fundamental frequencies of the pitch patterns (tones) and acoustic information about the consonant and vowel sounds.

As a check upon my own pronunciation, I received from home a tape-recording of a conversation between 4 Phuket speakers. My own pronunciation has, however, been the basis for all the statements made.

## Chapter 2

### Phonetic Interpretation of the Phonemic Transcription

The consonant phonemes of Phuket are transcribed as follows:--

p ph b , t th d , k kh ʔ

c ch , s , f , h

m , n , ŋ

l , r , j , w

The notes below are intended as a guide, in articulatory terms, to the commonest realizations of these phonemes.

In syllable-initial position p represents a voiceless unaspirated bilabial plosive eg.

^ pa: 'forest'

In syllable-final position it represents a voiceless unexploded bilabial stop with simultaneous glottal closure.\*I

- ka:p 'fragment(as of coconut husk)'

ph represents a voiceless aspirated bilabial plosive eg.

~ pha: 'to bring along'

b represents a voiced bilabial plosive eg.

^ ba: 'shoulder'

\*I for discussion about syllable-final stops in Siamese in general see Eugénie J. A. Henderson, 'Marginalia to Siamese Phonetic Studies', In Honour of Daniel Jones, London, Longmans, Green and Co. Ltd. 1964, 415-424

In syllable-initial position t represents a voiceless unaspirated alveolar plosive eg.

^ta: 'eyes'

In syllable-final position it represents a voiceless unexploded alveolar stop with simultaneous glottal closure eg.

-ka:t 'to entreat by prayer'

th represents a voiceless aspirated alveolar plosive eg.

^tha: 'to paint'

d represents a voiced post-alveolar plosive eg.

^da: 'to scold'

Kinesthetically, the articulation of d appears to be slightly further back than that of t and th, in the post-alveolar area.

In syllable-initial position k represents a voiceless unaspirated velar plosive eg.

^ka: 'crow'

In syllable-final position it represents a voiceless unexploded velar stop with simultaneous glottal closure eg.

^kak 'to imprison'

kh represents a voiceless aspirated velar plosive eg.

^kha: 'in between'

In both syllable-initial and syllable-final positions ʔ represents a glottal stop eg.

^ʔa: 'father's younger brother or sister'

-ka:ʔ 'to estimate'

ç represents a voiceless unaspirated palato-alveolar

affricate [tʃ] eg.

^ ca: 'chief'

ch represents a voiceless aspirated palato-alveolar affricate [tʃh] eg.

^ cha: 'to be stiff'

f represents a voiceless labio-dental fricative eg.

^ fa: 'wall'

This sound has a secondary articulation of velarization, which is particularly noticeable when it precedes front vowels.\*2 eg.

^ fin 'opium'

^ fe:t 'twin'

s represents a voiceless alveolar fricative eg.

^ sa: 'to sense'

h represents a glottal fricative eg.

^ ha: 'to seek'

This sound is frequently slightly nasalized.

In syllable-initial and syllable-final positions m represents a voiced bilabial nasal eg.

^ ma: 'to come'

^ kam 'to hold in one hand'

In syllable-initial and syllable-final positions n represents a voiced post-alveolar nasal eg.

^ na: 'rice-paddy field'

---

\*2 for discussion about the labio-dental fricative in Siamese in general see footnote I, Chapter 2

^kan 'to score or make incisions'

In syllable-initial and syllable-final positions ŋ represents a voiced velar nasal eg.

~ŋa: 'ivory'

^koŋ 'crooked'

l represents a post-alveolar lateral eg.

~la: 'donkey'

This sound is usually voiced, but sometimes voiceless in the clusters phl, and khł.

r represents, in most contexts, a post-alveolar frictionless continuant [ɹ] eg.

~ra: 'mould'

Occasionally in an emphatic style of speech one or two taps may be heard. This sound is usually voiced, but sometimes voiceless in the clusters phr, and chr.

At the beginning of a syllable w represents a labio-velar semi-vowel eg.

~wa: 'a unit of measurement'

This sound is usually voiced, but sometimes voiceless in the cluster khw. For interpretation at the end of a syllable, see following section on vowels.

At the beginning of a syllable j represents a palatal semi-vowel eg.

~ja: 'medicine'

For interpretation at the end of a syllable, see following section on vowels.



Table 1 below summarizes the consonants found in syllable-initial position, and assigns to them a phonetic label in articulatory terms:-

Place of Articulation Manner of Articulation	Bi-Labial	Labio-dental	Alveolar	Post-alveolar	Palato-alveolar	Palatal	Velar	Glottal
Voicless Unaspirated Plosives	p		t				k	ʔ
Voicless Aspirated Plosives	ph		th				kh	
Voiced Plosives	b			d				
Voicless Unaspirated Affricate					c			
Voicless Aspirated Affricate					ch			
Voicless Fricatives		f	s					h
Nasals	m			n			ŋ	
Lateral				l				
Frictionless Continuant				r				
Semi-vowel	w					j	(w)	

### Initial Clusters

Certain sequences of phonemes occur in syllable-initial position, as set out below.

pl represents a voiceless bilabial plosive followed by a voiced post-alveolar lateral eg.

^ pla: 'fish'

phl represents a voiceless bilabial plosive followed by a voiceless post-alveolar lateral [ pl̥ ] eg.

~ phla:n 'meanwhile'

ml represents a bilabial nasal followed by a voiced post-alveolar lateral eg.

` mlaj 'bangle'

kl represents a voiceless velar plosive followed by a voiced post-alveolar lateral eg.

- kla: 'young rice-plant'

khl represents a voiceless velar plosive followed by a voiceless post-alveolar lateral [ kl̥ ] eg.

~ khla:n 'to crawl'

pr represents a voiceless bilabial plosive followed by a voiced post-alveolar frictionless continuant eg.

- pra:ʔ 'to sprinkle'

phr represents a voiceless bilabial plosive followed by a voiceless post-alveolar fricative [ pr̥ ] eg.

/ phra:ʔ 'monk'

kr represents a voiceless velar plosive followed by a voiced post-alveolar frictionless continuant eg.

-kra:ʔ 'one kind of turtle'

khr represents a voiceless velar plosive followed by a voiceless post-alveolar fricative [kʰr] eg.

^ khra:ʔ 'nearly bursting (stomach)'

kw represents a voiceless velar plosive followed by a voiced labio-velar semi-vowel eg.

-kwa:t 'to sweep'

khw represents a voiceless velar plosive followed by a voiceless labio-velar semi-vowel [kʰw] eg.

\ khwa: 'right hand side'

### Vowels

The vowel phonemes of Phuket are transcribed as follows

<u>i</u>	<u>i:</u>	<u>e:</u>	<u>ɛ</u>	<u>ɛ:</u>
<u>u</u>	<u>u:</u>	<u>ɤ</u>	<u>ɤ:</u>	<u>a</u> <u>a:</u>
<u>ʊ</u>	<u>ʊ:</u>	<u>o:</u>	<u>ɔ</u>	<u>ɔ:</u>

The notes below are intended as a guide, in articulatory terms, to the commonest realizations of these phonemes.

i represents a Close Front Unrounded short vowel eg.

^ kin 'to eat'

i: represents a Close Front Unrounded long vowel eg.

^ pi:n 'to climb'

- ni: 'debt.'

In some styles of speech, i: in syllables of the structure CV varies freely with ej

e: represents a Mid Front Unrounded long vowel eg.

^ ke:m 'limit'

˘ le: 'sea'

By Mid I I mean this vowel is in between the Half-Close and Half-Open vowel positions.

ɛ represents an Open Front Unrounded short vowel eg.

˘ kɛp 'to collect.'

ɛ: represents an Open Front Unrounded long vowel eg.

˘ kɛ:n 'core , heartwood'

— kɛ: 'to repair'

ʊ represents a Close Back Unrounded short vowel eg.

— lʊk 'deep (water)'

u: represents a Close Back Unrounded long vowel eg.

˘ pu:n 'gun'

— su: 'to buy'

In some styles of speech, u: in syllables of the structure CV varies freely with ɜw

ɜ represents a Mid Back Unrounded short vowel eg.

˘ ŋɜn 'silver'

ɜ: represents a Mid Back Unrounded long vowel eg.

˘ kɜ:n 'over limit.'

— kɜ: 'to be abashed'

ɑ represents an Open/Unrounded short vowel, phonemically classified as 'back', but phonetically realized as further front and more central than the RP English [ɑ:] in 'father' eg.

˘ kan 'to prevent'

ɑ: represents an Open Back Unrounded long vowel, phone-

mically classified as 'back', but phonetically realized as further front than the R P English [ɑ:] in 'father' eg.

^ka:n 'work'

-tha: 'to wait for'

u represents a Close Back Rounded short vowel eg.

^kun 'a kind of plant'

u: represents a Close Back Rounded long vowel eg.

^pu:n 'lime, plaster'

-phu: 'male(animal)'

In some styles of speech, u: in open syllables varies freely with ow

o: represents a Mid <sup>Back</sup>/Rounded long vowel eg.

^ko:n 'to shave'

\ ho: 'to give a long undulating cheer'

ɔ represents an Open Back Rounded short vowel eg.

^kron 'to snore'

ɔ: represents an Open Back Rounded long vowel eg.

^ko:n 'before'

-khɔ: 'a moveable part of bones'

The vowels are set out below in tabular form :-

	Front		Back			
			Unrounded		Rounded	
Close	i	i:	u	u:	u	u:
Mid		e:	ɤ	ɤ:		o:
Open	ɛ	ɛ:	a	a:	ɔ	ɔ:

## Diphthongs

Phuket has, in addition to the pure vowels described above, a number of diphthongs which are interpreted phonemically as consisting of one of the vowel phonemes already described, followed by either the phonemes w or the phoneme j as set out below :-

### Closing Diphthongs

i:w    e:w    ɛ:w    aw    a:w    ow    yw  
u:j    o:j    ɔ:j    uj    ʏ:j    aj    a:j    ej

i:w , e:w , ɛ:w represent diphthongs starting with Close, Mid and Open Front, Unrounded, long vowels respectively, which move towards the Close Back Rounded vowel position eg.

i:w    as in    \ li:w    'to throw away'  
e:w    as in    / ʔe:w    'waist'  
ɛ:w    as in    / ce:w    'to row a boat'

aw , a:w represent diphthongs starting with short and long Open Back Unrounded vowels respectively, which move towards a Close Back Rounded vowel position eg.

aw    as in    \ saw    'column'  
a:w    as in    \ sa:w    'young woman'

ow represents a diphthong which starts with a Back Rounded vowel sound closer and more centralized than o: , and moves towards a closer Back Rounded vowel position.

ow as in sow 'you'

yw represents a diphthong which starts with a Back Unrounded vowel sound closer and more centralized than y, and moves towards a closer Back Unrounded vowel position [yu] .

yw as in lyw 'to be carried as a rumour.'

u:j , o:j , ɔ:j represent diphthongs beginning with Close Mid and Open Back Rounded long vowels respectively, which move towards a Close Front Unrounded vowel position.

u:j as in lu:j 'to walk through'

o:j as in ko:j 'to sweep away'

ɔ:j as in ko:j 'little finger'

uj , ɜ:j , aj , a:j represent diphthongs starting with Close, Mid and Open Back, Unrounded short and long vowels respectively, which move towards a Close Front Unrounded vowel position .

uj as in mu:j 'hand'

ɜ:j as in ly:j 'beyond distance'

aj as in saj 'crystal as water'

a:j as in sa:j 'line'

ej represents a diphthong which starts with a Front Unrounded vowel sound closer and more centralized than e: and moves towards a closer Front Unrounded vowel position.

ej as in pej 'year'

There are in addition three centering diphthongs,

transcribed ie , ue , ue which from the phonological point of view are regarded as monophonemic . The commonest realizations of these three phonemes are set out below :-

ie , ue , ue represent diphthongs beginning with Close Front Unrounded , Close Back Unrounded and Rounded vowels respectively, which move towards the position of a central vowel, represented by [e] eg.

<u>ie</u>	as in	\ <u>sien</u>	'sound'
		\ <u>sie</u>	'out of order'
<u>ue</u>	as in	/ <u>duen</u>	'moon' <i>of</i>
		/ <u>duə</u>	'a kind/plant'
<u>ue</u>	as in	~ <u>khuəm</u>	'heart of coconut'
		— <u>khue</u>	'to fry'



CHAPTER 3PHONETIC DESCRIPTION OF THE PITCH PATTERNS

Every stressed syllable in the Phuket dialect is pronounced with one of eight pitch patterns.\*<sup>1</sup> The occurrence of some of these patterns is subject to restrictions of either the initial or final consonants or of the length of vowels.

This chapter contains a brief phonetic description of the pitch patterns in perceptual terms, supported by mingograms showing fundamental frequency curves as recorded on a Frøkjøer-Jensen Pitch meter. Since the pitch patterns of syllable uttered in isolation differ in some respects, principally as regards duration, from patterns occurring in the chain of speech, an attempt is made to describe and illustrate all patterns in two contexts: a) in isolation, i.e. before a pause, and b) before a following syllable. Tables showing the correlations of initial and final consonants, vowel length, and the pitch patterns are appended.

---

\*1. In this thesis, I have used the term 'pitch pattern' for the phonetic description of utterances, and have reserved the term 'tone' for phonological description.

Phonetic description of the pitch patterns.

In the Mingograms the line P shows the readings from the Frøkjøer-Jensen Pitchmeter, the lower edges of the striations indicating fundamental frequency. Frequency readings at 225 c/s, 180 c/s, and 140 c/s, obtained from a calibrated scale, are shown to facilitate the comparison of the relative frequencies of the patterns as uttered by one speaker (myself). The line Osc. presents a duplex oscillogram of the relevant utterance. The lower line is the time marker, set at 50 c/s.

High level as in suk 'to be ripe' (see Fig.3.1a),  
suk kha:w 'being fully ripe' (see Fig.3.1b).

In isolation, this pitch pattern is heard as a short high level pitch,<sup>\*2</sup> which is about the same as the starting pitch of the High Fall pitch pattern (sej v.) .

In non-final position duration is shorter than in isolation.

High Fall as in sej, 'colour' (see Fig. 3.2a),  
 and sej kha:w 'white colour' (see Fig. 3.2b).

In isolation, this pitch pattern starts with a sustained high pitch followed by a sharp fall to a low pitch.

---

\*2. 'high' 'mid' and 'low' are, of course, relative not absolute terms. In my pronunciation what I have termed 'high' pitch seemed regularly to correspond to fundamental frequencies in the neighbourhood of 225 c/s, 'mid' pitch to fundamental frequencies in the neighbourhood of 180 c/s, and 'low' to fundamental frequencies in the neighbourhood of 140 c/s.

When syllables with this pattern precede other syllables, the duration of the initial high pitch is much shortened, so that all one hears is a sharp fall in pitch.

The starting pitch of this pattern is about the same as that of the High Level.

Mid Fall as in  $\sim$ tha:, 'to paint' (see Fig. 3.3a), and  $\sim$ tha: `sej 'to paint the colour' (see Fig. 3.3b).

In isolation, this pitch pattern starts from a mid pitch and gradually falls to a slightly lower pitch. The starting pitch of this pattern is regularly higher than that of the Rise Fall pattern, but lower than that of the High Fall.

Before a following syllable, the duration is considerably shorter, and the fall in pitch steeper and more rapid, reaching a very low pitch.

Low Level as in  $\sim$ fa: 'sky' (see Fig. 3.4a), and  $\sim$ fa: `kha:w 'white sky' (see Fig. 3.4b).

In isolation this pattern is heard as a level pitch, slightly lower than the Lower Mid Level ( $\frac{f}{\#}$ .v.). In non-final position, the pattern is shorter and the pitch falls slightly.

Rise Fall as in  $\wedge$ paj, 'to go' (see Fig. 3.5a), and  $\wedge$ paj `khaw 'go to the mountain' (see Fig. 3.5b).

In isolation, this pitch pattern starts from low to mid pitch, gradually rising to a higher mid pitch,

and then falling sharply to a pitch lower than its starting pitch.

In non-final position, only the final sharp fall is heard, and this reaches a lower pitch than that of the pattern in isolation.

Higher Mid Level as in ˈsɔ:ɹ 'elbow' (see Fig. 3.6a), and ˈsɔ:ɹ ˈlɛ:m 'bony elbow' (see Fig. 3.6b).

In isolation, this pattern is perceived as a sustained fairly high pitch, but regularly slightly lower than the High Level. There is sometimes a slight fall in pitch towards the end of the utterance.

In non-final position the pattern is much shortened.

Lower Mid Level as in -pa:ɹ 'mouth' (see Fig. 3.7a), and -pa:ɹ ˈkhiəw 'green mouth' (see Fig. 3.7b).

In isolation, this pattern is perceived as a sustained mid level pitch, slightly lower than the Higher Mid Level. In non-final position it is sometimes heard as a short sharp fall from a mid pitch to a low one.

Low Rise as in ˌphi: 'older sibling' (see Fig. 3.8a), and ˌphi: ˈsa:w 'elder sister' (see Fig. 3.8b)

In isolation, this pattern starts from a low mid pitch and falls fairly rapidly to a low pitch, then rising to a pitch a little higher than its starting point. In quick speech and in non-final position it is perceived as

low rise. Occasionally in non-final position a low level pitch without perceptible following rise may be heard.

### Restrictions of the pitch patterns:-

#### Initial Consonants.

The High Level, High Fall, Mid Fall, Low Level, and Higher Mid Level pitch patterns occur with the following initial consonants only: ph, m, th, n, kh, ŋ, ch, s, f, h, j, w, l, r.

The Rise Fall, and Lower Mid Level pitch patterns occur with the following initial consonants:

p, b, t, d, k, c, ʔ

The Low Rise pitch pattern occurs with initial consonants of every kind.

#### Final Consonants.

The High Level pitch pattern occurs with final p, t, k only.

The Mid Fall, High Fall, and Rise Fall pitch patterns occur with final m, n, ŋ, j, w, and with final vowels, but never with final stops.

The Lower Mid Level, Higher Mid Level, Low Level, and Low Rise pitch patterns occur with final consonants of every kind.

#### Vowels

The High Level pitch pattern occurs with short vowels only, whereas the Lower Mid Level and the Higher

Mid Level pitch patterns occur with long vowels and the centering diphthongs only. The High Level pitch pattern does not occur in open syllables i.e. in syllables ending in a vowel or diphthong.

The High Fall, Mid Fall, Rise Fall, Low Level, and Low Rise pitch patterns occur with both short and long vowels, and in both open syllables and in syllables closed by nasals or semivowels. The Low Level and Low Rise pitch patterns may also occur with syllables closed by stops.

## High level

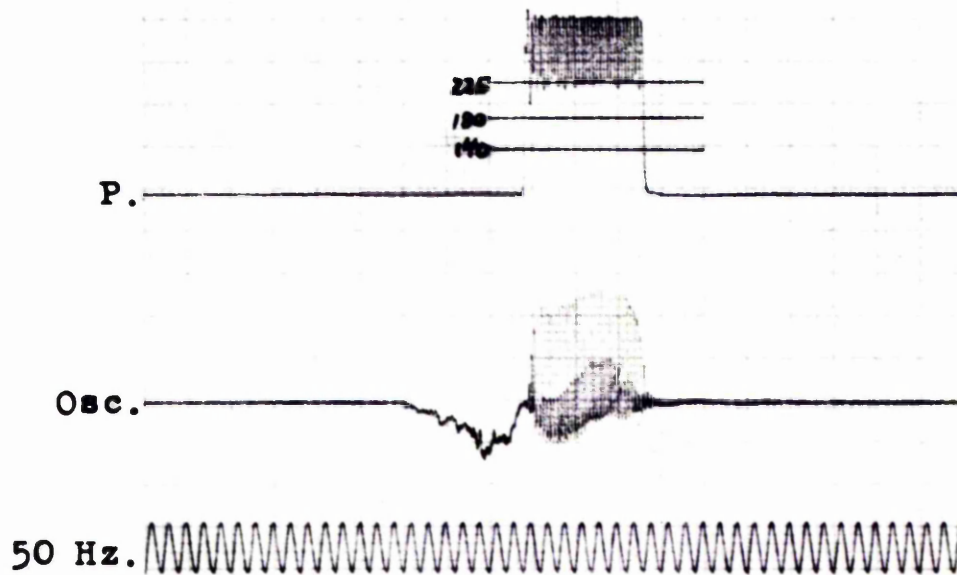

Fig.3.1a.

suk [to be ripe]

## High level-High fall

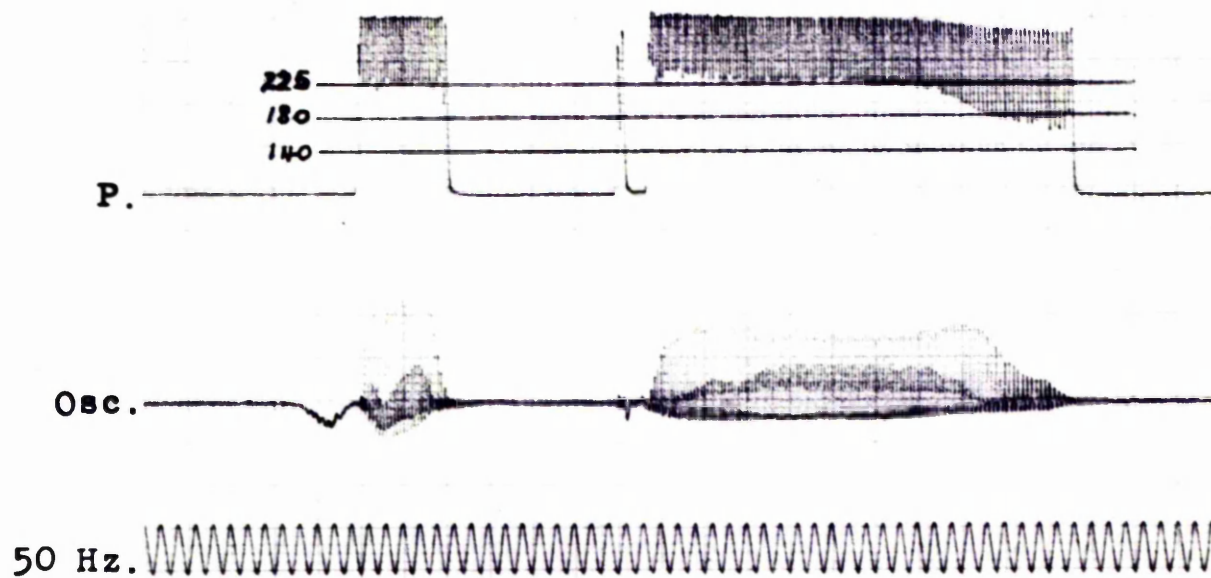

Fig.3.1b.

suk kha:w [being fully ripe]

## High fall

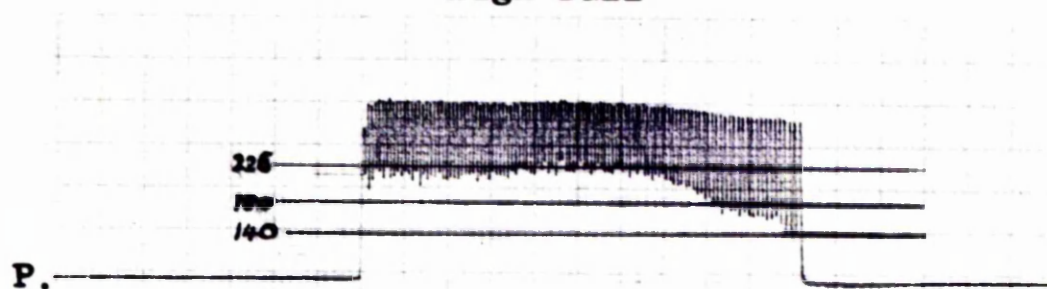
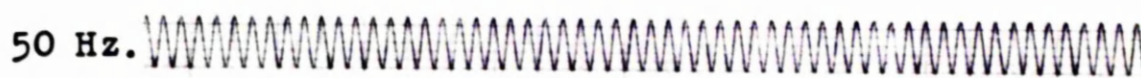

Fig.3.2a.



sej [colour]

## High fall-High fall

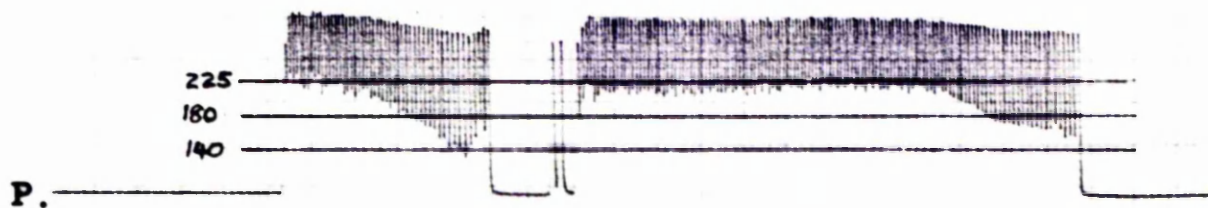
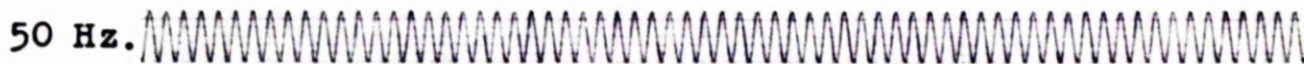

Fig.3.2b.



sej kha:w [white colour]



## Mid fall

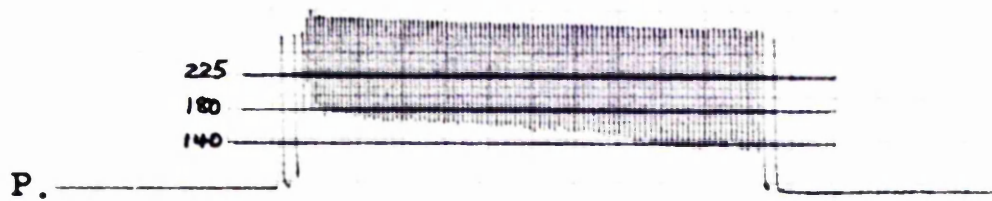

Fig.3.3a.



ˌtha: [to paint]

## Mid fall-High fall

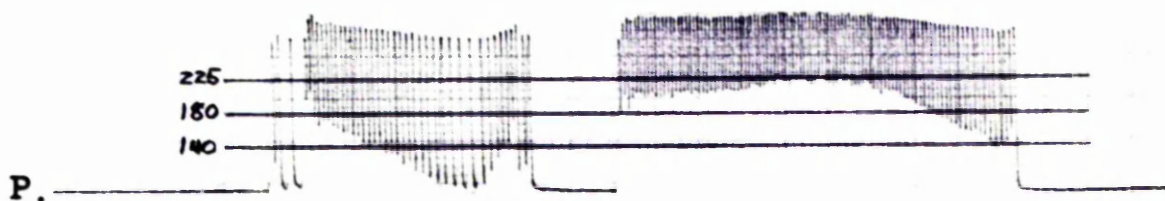

Fig.3.3b.



ˌtha: sej [to paint the colour]

## Low level

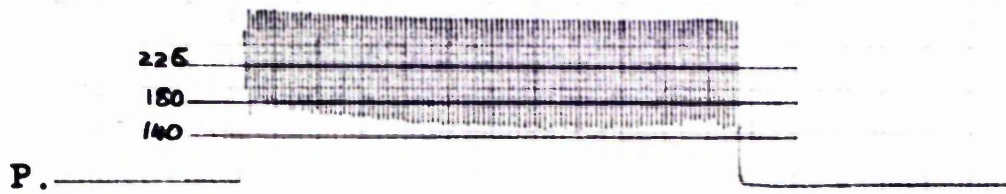
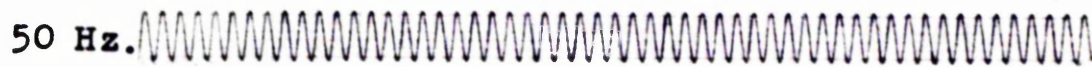

Fig.3.4a.



\_fa: [sky]

## Low level-High fall



Fig.3.4b.

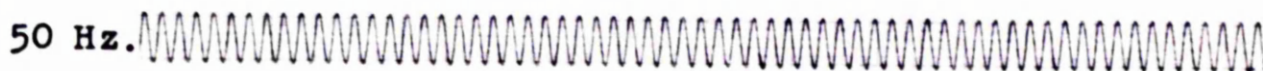
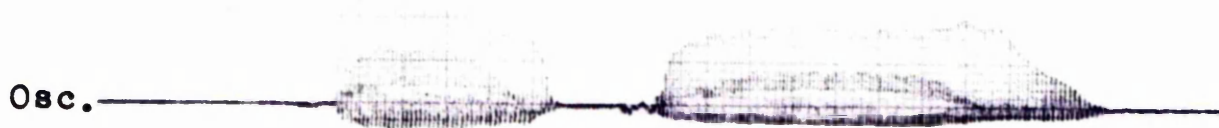

\_fa: kha:w [white sky]

## Rise fall

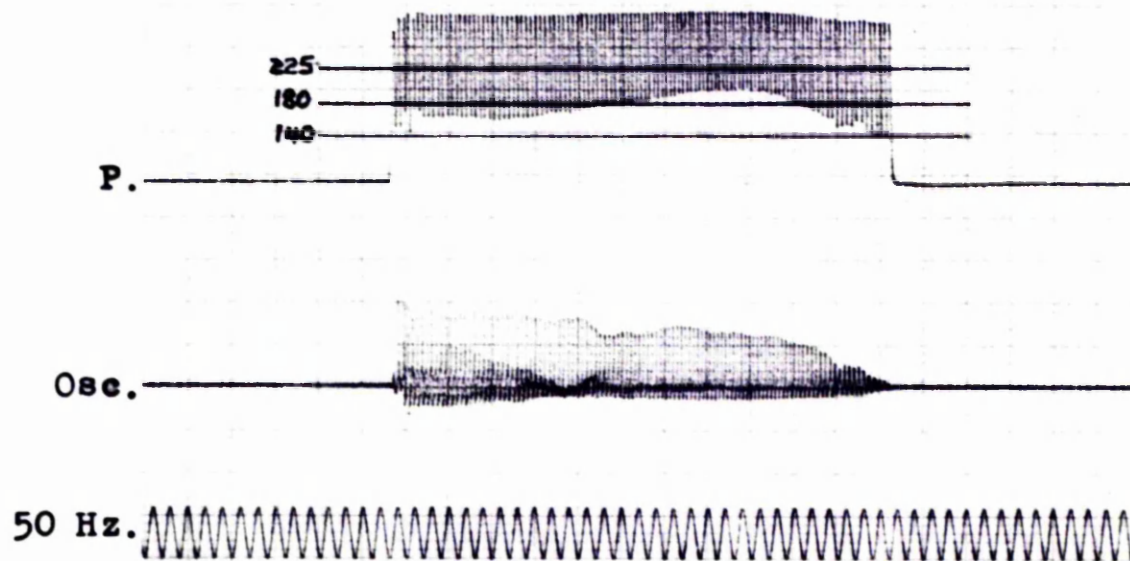

Fig.3.5a.

paj [to go]

## Rise fall-High fall

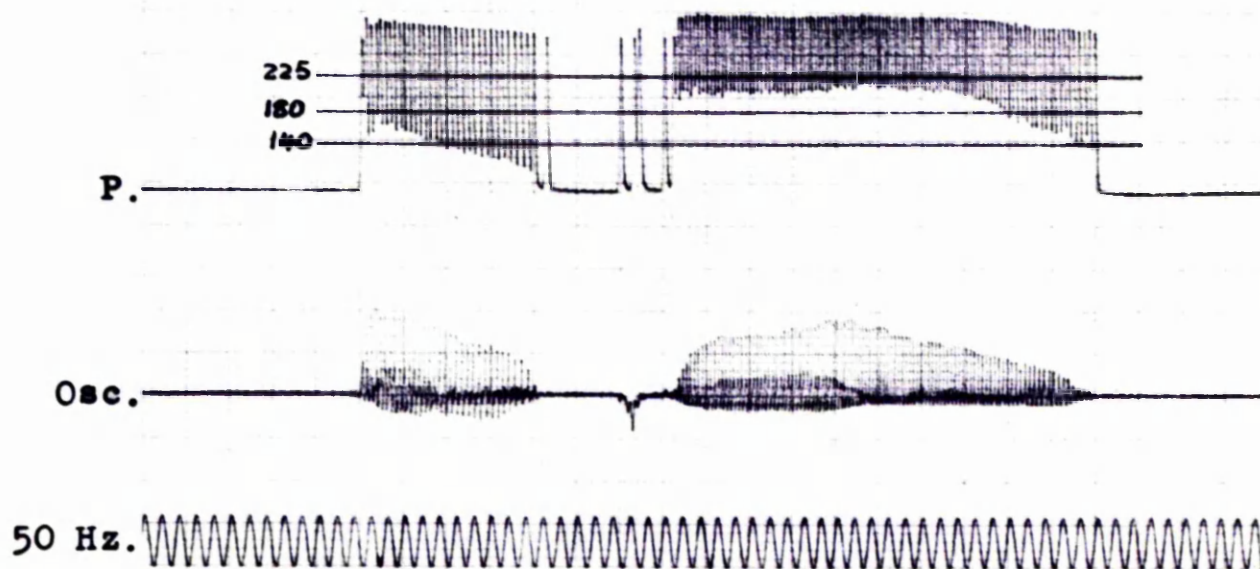

Fig.3.5b.

paj khaw [go to the mountain]

## Higher Mid level

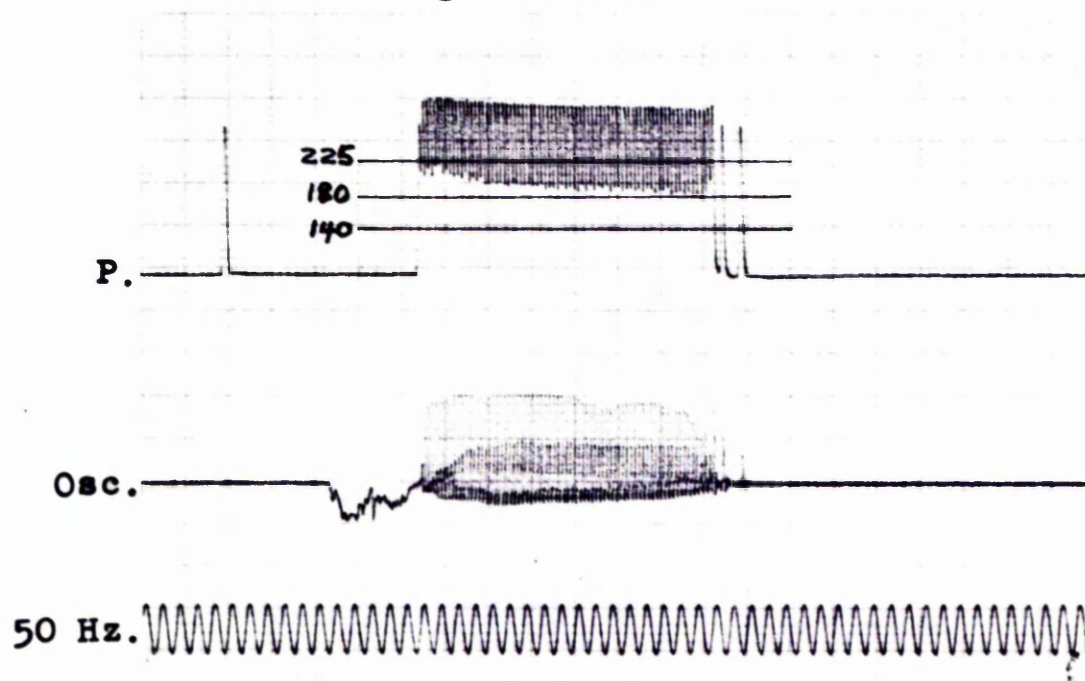

Fig.3.6a.

-sɔ:2 [elbow]

## Higher Mid level-High fall

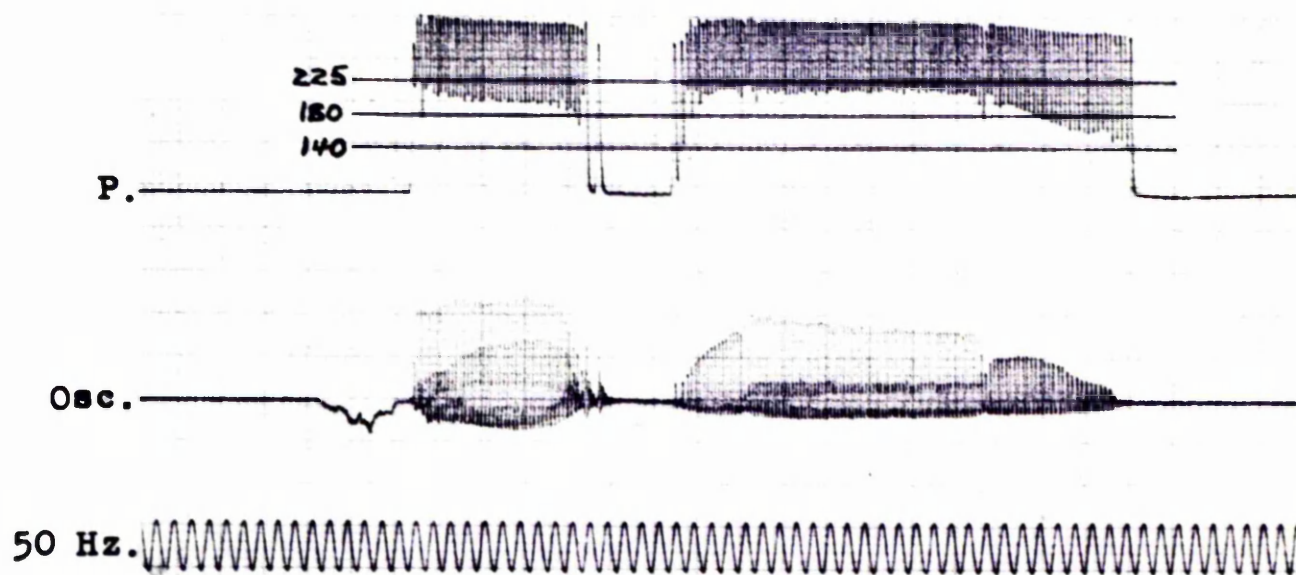

Fig.3.6b.

-sɔ:2 lɛ:m [bony elbow]

## Lower Mid level

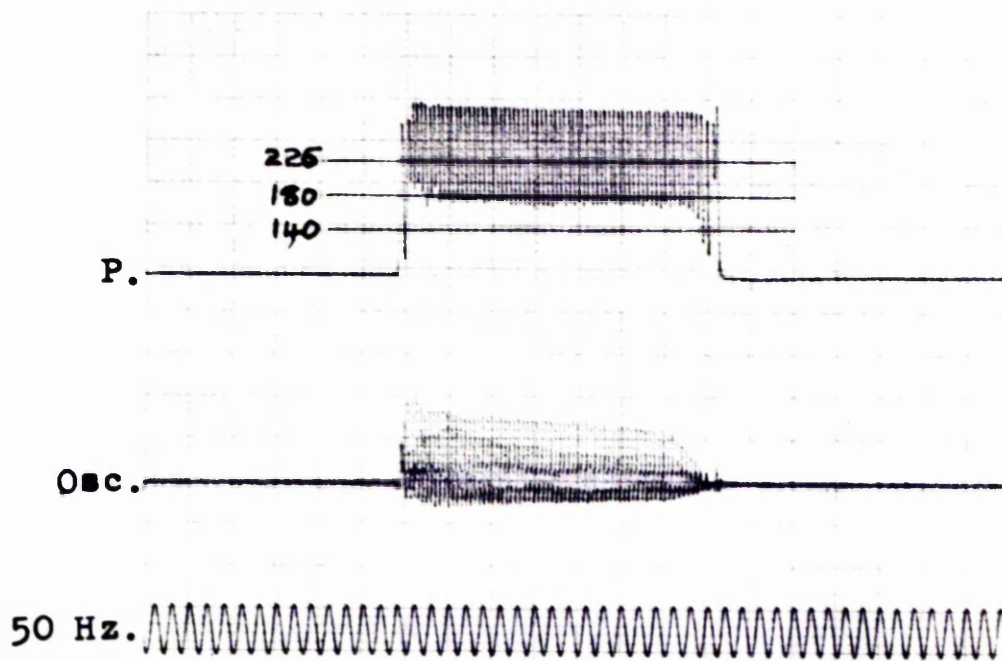

Fig.3.7a.

-pa:2 [mouth]

## Lower Mid level-High fall

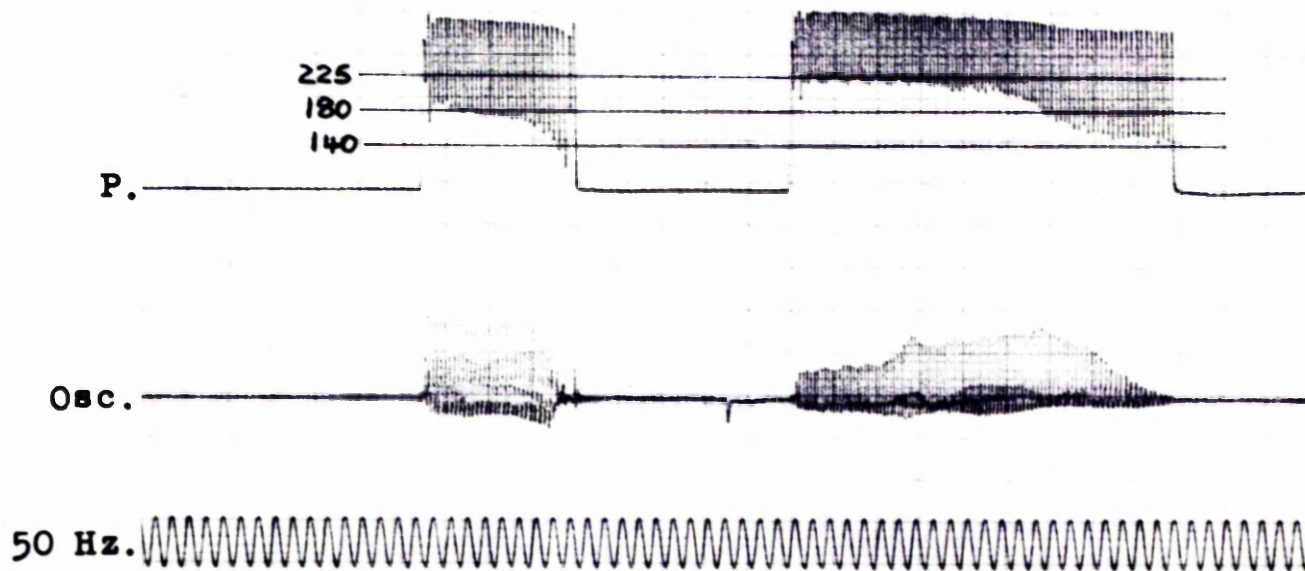

Fig.3.7b.

-pa:2 khiew [green mouth]

## Low rise

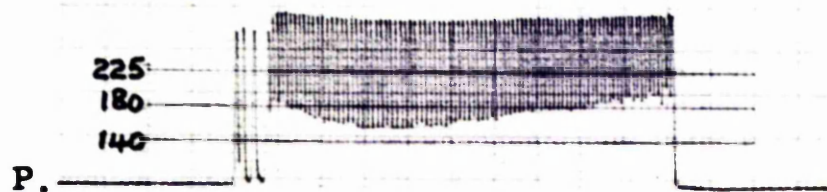

Fig.3.8a.



phi: [older sibling]

## Low rise-High fall

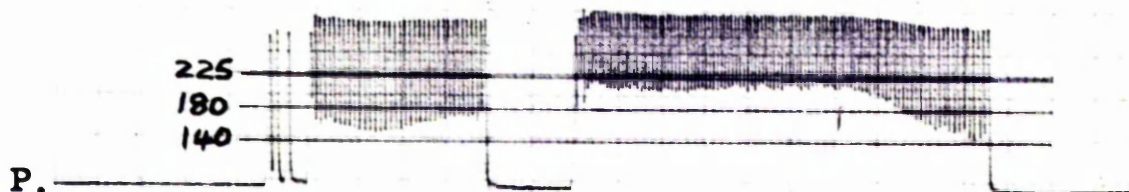
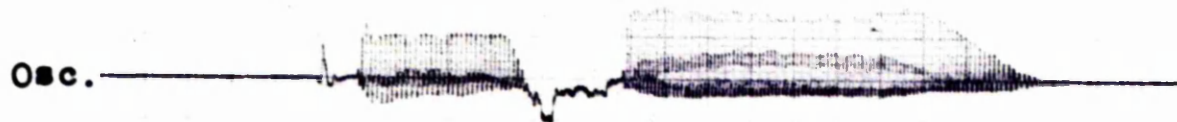

Fig.3.8b.



phi: sa:w [elder sister]

Table 3.1 Correlation of Initial Consonants and Pitch Patterns

Pitch Patterns Initial Consonants	High	High	Mid	Low	Rise	Higher	Lower	Low
	Level	Fall	Fall	Level	Fall	Mid level	Mid level	Rise
p					^ pa:		-pa:	/ pat
ph	phat	pha:	~ pha:	- phat		-pha:p		/ pha:p
b					^ ba:		-ba:p	/ bat
m	mat	ma:	~ ma:	-ma:		-ma:n		/ ma:p
pl					^ pla:		-pla:p	/ plak
pr					^ pra:y		-pra:p	/ prok
phl	phlat	phla:n	~ phla:y	-phlat		-phlo:		/ phla:t
phr		phraj	~ phra:n	-phra:				/ phra:p
ml	mlak	mlaj						/ mlua:p
t					^ ta:		-ta:p	/ tat
th	thak	thaj	~ tha:	-tha:		-tha:		/ tha:p
d					^ da:		-da:p	/ dat
n	nat	na:	~ na:	-na:		-na:		/ na:p
k					^ ka:		-ka:p	/ kat
kh	khak	kha:	~ kha:	-kha:		-kha:		/ kha:
y	yok	ya:j	~ ya:	-ya:y		-yo:y		/ ya:p
kl					^ kla:y		-kla:p	/ klat
kr					^ kraj		-kra:p	/ krot
kw					^ kwa:y		-kwa:t	/ kwak
khl	khlok	khlay	~ khla:n	-khlo:y		-khla:t		/ khla:t
chr			~ khraj	-khra:y				/ khra:p
khw	khwit	khwa:	~ khwa:n	-khwa:n		-khwa:m		/ khwa:p
e					^ ea:		-ea:t	/ eat
eh	ehat	ehan	~ cha:n	-cha:		-chi:y		/ cha:p
s	sat	sa:	~ sa:	-sa:m		-sa:y		/ sa:p
f	fat	fa:	~ fan	-fat		-fa:		/ fa:t
p					^ pa:		-pa:p	/ pat
h	hat	ha:	~ ha: 0	-hut 0		-ha:y		/ huop 0
j	jat	ja:	~ ja:	-ja:m		-ja:		/ ja:p
w	wat	wa:	~ wa:	-we:y		-wa:y		/ wa:t
l	lap	la:	~ la:	-la:n		-lo:m		/ lo:p
r	rit	ria:n	~ ra:	-ra:n		-ra:p		/ ra:p

0 = Onomatopoeic words

Table 3.2 Correlation of Final Consonants and Pitch Patterns

Initial Consonants	Final Consonants				Pitch Patterns			
	p t k	m n ŋ j w	p t k	m n ŋ j w	p t k	m n ŋ j w	p t k	m n ŋ j w
	High Level	Mid Fall	High Fall	Rise Fall	Lower Mid level	Higher Mid level	Low level	Low Rise
p				˩pan	-pa:ʔ			˩pɔk
ph	phit	˩pha:j	phɔŋ			-pha:ʔ	-phɔ:n	˩phɔ:ʔ
b				˩baŋ	-ba:ŋ			˩bɔk
m	mit	˩man	mun			-man	-mat	˩ma:ʔ
pl				˩plɔŋ	-plɔ:ŋ			˩plɔt
pr				˩prɔŋ	-prɔ:w			˩prɔk
phl	phlak	˩phla:ŋ	phla:n				-phla:ŋ	˩phla:t
phr		˩phrɔm	phraŋ				-phra:w	˩phra:ʔ
ml	mlak		mla:j					˩mluɔp
t				˩ta:ŋ	-tɔ:t			˩tɔt
th	thɔk	˩tham	thɔm			-tham	˩tha:j	˩tha:ʔ
d				˩daŋ	-da:ŋ			˩dɔk
n	nat	˩nam	nam			-na:ʔ	-na:ŋ	˩na:ŋ
k				˩kan	-ka:n			˩kɔt
kh	khut	˩khum	khaj			-kha:w	-khɔ:n	˩kha:m
ɣ	ɣɔk	˩ɣɔŋ	ɣa:j			-ɣɔ:ʔ	-ɣa:ŋ	˩ɣa:j
kl				˩klɔm	-klɔ:w			˩klak
kr				˩krɔŋ	-krɔ:p			˩krɔp 0
kw				˩kwa:ŋ	-kwa:t			˩kwak
khl	khlok 0	˩khlo:ŋ	khlay			-khla:t	-khlo:ŋ	˩khlo:ŋ
khr		˩khra:w					-khro:k	˩khro:m
khw	khwit	˩khwa:j	khwa:ŋ			-khwa:m	-khwak	˩khwa:ʔ
e				˩eaj	-eai:t			˩eɔk
eh	ehat	˩eha:j	eha:w			-eha:t	-ehɔk	˩ehɔ:p
s	suk	˩sa:w	sa:j			-sa:j	-sak	˩sa:ʔ
f	fat	˩fa:ŋ	fan			-fa:t	-fat	˩fa:t
ʔ				˩pa:w	-pa:ŋ			˩pɔt
h	hat	˩ha: 0	hɔm			-ha:p	-hut 0	˩huɔp 0
j	˩jat	˩jam	ja:m			-ja:ŋ	-ja:m	˩ja:ʔ
w	wak	˩wa:ŋ	wa:n			-wa:n	-wit	˩wa:w
l	lak	˩la:j	la:ŋ			-lɔ:n	-lak	˩la:w
r	rit	˩ra:w	riɔn			-ra:ʔ	-rɔk	˩ra:ʔ

0 = Onomatopoeic Words



Table 3.3. Correlation of Vocalic Finals and Pitch Patterns.

Pitch Patterns Vocalic Finals	High Level	High Fall	Mid Fall	Rise Fall	Low Level	Higher Mid Level	Lower Mid Level	Low Rise
i:					✓	✓	✓	✓
e:			✓	✓		✓		
ɛ:		✓	✓	✓	✓	✓	✓	✓
u:					✓		✓	✓
ɤ:		✓ 0	✓	✓	✓		✓	✓
a:		✓	✓	✓	✓	✓	✓	✓
u:					✓	✓	✓	✓
o:		✓	✓	✓		✓		
ɔ:		✓	✓	✓	✓	✓	✓	✓
iə		✓	✓	✓		✓	✓	✓
we		✓	✓	✓	✓	✓	✓	✓
ue		✓	✓	✓	✓	✓	✓	✓

0 = Onomatopoeic words.

CHAPTER 4ACOUSTIC CORRELATES OF THE PHONEMESFEATURES.

In this chapter an attempt is made to state the phonology of Phuket syllables in terms based upon Jakobson, Fant, and Halle's theory of distinctive features as set out in Preliminaries to Speech Analysis \*1 . In order to handle the vowel phonemes, however, it has been found necessary to split the Compact/Diffuse opposition into two: Compact vs. Non-compact, and Diffuse vs. Non-diffuse \*2. The phonemes listed in Chapter 2 are treated as bundles of simultaneous features, and an attempt has been made to state the acoustic correlates of such features.

The feature oppositions proposed for the phonology of Phuket are the following:-

1. Vocalic vs. Non-vocalic
2. Consonantal vs. Non-consonantal
3. Voiced vs. Non-voiced
4. Interrupted vs. Non-interrupted (Continuant)
5. Tense vs. Non-tense (Lax)
6. Grave vs. Non-grave (Acute)

---

\*1. See footnote 2 Chapter 1.

\*2. Morris Halle, The Sound Pattern of Russian, Mouton, The Hague, 1959.

7. Flat vs. Non-flat (Plain)
8. Diffuse vs. Non-diffuse
9. Compact vs. Non-compact

The matrix on page 63 shows the distribution on the features assigned to the phonemes. The feature distribution is shown in tree form on page 64.

### 1. Vocalic vs. Non-vocalic

Broad-band spectrograms of phonemes having the feature + vocalic show the well-defined formant structure characteristic of this feature, see Figs. 4.1, 4.2, and 4.3 for ɪiɪ, ɛeɛ, and æææ on which  $F_1$ ,  $F_2$ ,  $F_3$ , and sometimes  $F_4$  are clearly visible.

On the whole the lower formants have greater intensity than the higher formants; and the higher formant frequencies of the Front vowels are more readily distinguishable than those of the Back vowels.

Phonemes with the feature 'non-vocalic', on the contrary, show less well-defined formant structure. For example compare the nasals: m, n, ŋ in Figs. 4.4, 4.5, and 4.6, which are non-vocalic, with the following vowels.

### 2. Consonantal vs. Non-consonantal

Consonantal phonemes have characteristically lower total energy than non-consonantal sounds. Compare Figs. 4.7, and 4.8 in which the sections of the spectrogram corresponding to the consonantal segments b and d show less

acoustic energy than the following non-consonantal vocalic segments.

Among the phonemes which are non-vocalic and consonantal are stops, fricatives, affricates and nasals.

The Liquids l, r which are regarded as being both vocalic and consonantal should in theory show this by having a formant structure more apparent than that of non-vocalic sounds on the one hand (= vocalic), and by lower total energy and sharp shift<sup>\*3</sup> of formants at the phoneme boundaries (= consonantal) as contrasted with vocalic sounds, on the other. Both these features can be observed clearly for l in Fig.4.9. Formant structure is also apparent for r in Fig.4.10, and there is lower total energy than for the following non-consonantal sound.

The Glides ɹ, h, j, and w are non-vocalic in that they do not have such a well defined formant structure as the vowels. h is non-consonantal in that it 'lacks the boundary interval discontinuities'<sup>\*4</sup> since its 'formant pattern approximates that of the following vowel'.<sup>\*4</sup> It also shows the characteristic damping of  $F_1$ <sup>\*4</sup>, see Fig.4.11 on p. 55. j, and w being 'connected smoothly to the following vowel'<sup>\*4</sup> may also be regarded as non-consonantal, although

---

\*3. Gunnar Fant, 'Analysis and synthesis of speech processes', Manual of Phonetics, in B. Malmberg ed., Amsterdam, 1968, 173-277.

\*4. Gunnar Fant, Acoustic Theory of Speech Production, Mouton, The Hague, 1960, p.216.

their formant pattern does not approximate to that of the following vowel, see Figs. 4.12, and 4.13 on page 56

z is non-consonantal in that it has relatively high total energy dispersed over a wide range of the spectrum, i.e. it has 'no significant zeros'<sup>\*5</sup> in its spectrum. The sharp short spike on the spectrogram, bears witness to the 'transient onset of the source',<sup>\*5</sup> and is clearly a non-vocalic feature see Fig.4.14.

### 3. Voiced vs. Non-voiced

The phonemes that are voiced show voice bars in the low frequency regions below 400 c/s see Figs. 4.7, and 4.8 in which b, and d are voiced and compare with Figs. 4.15, and 4.16 in which p and k are non-voiced.

### 4. Interrupted vs. Non-interrupted (Continuant)

The stops and affricates are interrupted, whereas the fricatives are non-interrupted.

In the broad-band spectrograms, the stops and the affricates display their interrupted character and abrupt onset in the form of spikes preceded by stop gaps or voiced stop gaps if the segments are voiced, see Figs. 4.17 and 4.18 in which t and c are interrupted.

---

<sup>5</sup>  
\* See p.19 footnote 2, Chapter 1.

The fricatives are characterized by having no spikes, which testifies to their more gradual onset, accompanied by high frequency noise areas, see Figs. 4.19 and 4.20 in which s and f are non-interrupted.

### 5. Tense vs. Non-tense (Lax)

Previous treatment of the aspirated/unaspirated opposition has regarded aspirated segments as tense, \*6 unaspirated as lax when pronounced without glottal constriction.\*7 This appears to derive from the behaviour of aspirated stops in English, where these are associated with stress. Usage in Thai is different, and kin-aesthetic impression is that unaspirated stops are articulated with greater energy, and sometimes with accompanying glottal closure, whereas aspirated stops are more laxly articulated. It is noted that Chomsky and Halle allow that unaspirated voiceless stops pronounced with glottal constriction must be regarded as '+tense'. \*7 It would have been possible to treat this as a checked/unchecked opposition, based upon higher vs. lower energy, and upon rapid vs. slower decay 'within a longer interval'. \*8 A single opposition, labelled tense/lax has been preferred, however, since it is of wider

---

\*6. M. Halle, G.W. Hughes, and J.-P.A. Radley, 'Acoustic Properties of Stop Consonants', J.A.S.A., Vol.29, no.1, 1957, 107-116.

\*7. Noam Chomsky and Morris Halle, The Sound Pattern of English, Harper & Row, New York, 1968, p.327-8.

\*8. Roman Jakobson and Morris Halle, Fundamentals of Language, Mouton, The Hague, 1956, p.31.

application. This has necessitated some redefinition of the correlates of tenseness and laxness. There is no problem with vowels, '+ tense' vowels are always of longer duration. But for consonants, it is necessary to include some of the checked/unchecked characteristics, i.e. more rapid decay in '+ tense', slower decay in '- tense' segments. See Figs. 4.17 and 4.18 in which t and c are tense, and Figs. 4.21, 4.22 in which th and ch are non-tense.

It will further be noted that the contrast between b and d on the one hand and m and n on the other has been dealt with under the tense/non-tense opposition also, i.e. b and d are regarded as '+ tense' as compared with m and n. If this is accepted there is no need at the phonological level to introduce the features nasal/non-nasal.\*<sup>9</sup>

## 6. Grave vs. Non-grave (Acute)

Back vowels, both Unrounded and Rounded are grave. In the broad-band spectrograms, grave vowels are characterized by an  $F_2$  relatively close to  $F_1$  with a very low  $F_1$ . This means that energy towards the lower end of the spectrum predominates. Front vowels, which are non-grave, display an  $F_1$  far apart from  $F_2$ , with a relatively high  $F_2$ .  $F_2$  is close to  $F_3$  which is maximally high.\*<sup>10</sup> See Figs.4.23,

---

\*9. Such features would, however, presumably require to be introduced at the level of realizational rules if the study were to be proceeded further from phonological contrast to phonetic realization.

\*10. See footnote 3, Chapter 4.

4.24, and 4.25 in which 2u2, 2o2, 2ɔ2 are grave, and Figs. 4.1, 4.2, 4.3 in which 2i2, 2e2, 2ɛ2 are non-grave.

The labial and velar consonants are grave. They should therefore in theory have a concentration of energy in the formants at the lower end of the spectrum. See Figs. 4.15, and 4.16 for p and k. It is possible to see that p fulfils the theoretical requirements of gravity, but less certain with k, where there is a fair spread of energy over the spectrum. There does however appear to be greater intensity of energy towards the lower end. The alveolars and palatals are non-grave, and should therefore have a greater concentration of energy in the upper part of the spectrum. See Figs. 4.17 and 4.18 for t and c. Once again, it is easier to justify this classification for c than for t, which appears to have a fairly even spread of energy over the spectrum as a whole. It is, however, at least true that for t there is no concentration of energy at the lower end. See also comments upon the feature interpretation of these phonemes under the section Compact vs. Non-compact.

#### 7. Flat vs. Non-flat (Plain)

The Back Rounded vowels are flat. They have a very weak  $F_3$ , and their second formants are very close to their first formants. The Back Unrounded vowels which are non-flat, have a relatively stronger  $F_3$ , and their  $F_1$  and  $F_2$



are further apart than those of the Rounded ones. See Figs. 4.23, 4.24, 4.25 in which ɪu, ɪo, ɪɔ, are flat, and Figs. 4.26, 4.27, 4.28 in which ɪu, ɪɔ, ɪa are non-flat.

### 8. Diffuse vs. Non-diffuse

Close vowels, which have non-central formant regions predominating, are diffuse. Mid vowels, whose formants are concentrated more towards the centre of the spectrum than those of diffuse vowels, but are more peripheral than those of compact vowels, are characterized as being both non-diffuse and non-compact. See Figs. 4.1, 4.26, 4.23 in which ɪi, ɪu, ɪu are diffuse, and Figs. 4.2, 4.27, 4.24 in which ɪe, ɪɔ, ɪo are non-diffuse and non-compact.

### 9. Compact vs. Non-compact

Open vowels, r, palatal and velar consonants are compact, whereas Close, and Mid vowels, l, labial and alveolar consonants are non-compact.

In the broad-band spectrograms, Open vowels have a relatively high  $F_1$  and a relatively low  $F_2$ , in other words their formants are located in the central regions of the spectrum. In the non-compact vowels energy is less concentrated in the central area. In the case of the non-flat Mid vowels, energy is dispersed towards the upper and lower parts of the spectrum, as compared with the non-flat open vowels. See Figs. 4.3, 4.28, 4.25 in which

2ɛ2, 2a2, 2ɔ2 are compact, and Figs. 4.1, 4.26, 4.23 in which 2i2, 2u2, 2u2 are non-compact.

In r, which is compact, energy is more concentrated in the central region than for l, which is non-compact. See Figs. 4.9 for l and 4.10 for r.

In this thesis, the Phuket stops are analysed as a square pattern, following that proposed for Czech in 'Preliminaries to Speech Analysis'<sup>\*11</sup>, viz.:-

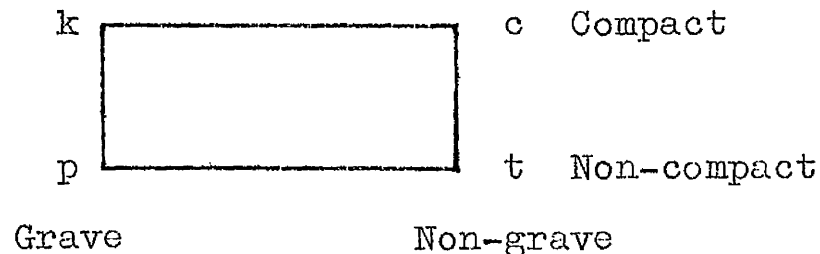

It is difficult to reconcile this, however, with the findings of spectrograms made. See Fig. 4.15, 4.16, 4.17/<sup>4.18</sup> from which one might be tempted to regard t and k as compact, and p and c, in which energy is concentrated at the bottom and top of the spectrum respectively, as non-compact. See also earlier comments upon the feature analysis of these phonemes in the section Grave vs. Non-grave.

---

\*11. See p.33 footnote 2<sup>o</sup>, Chapter 1.

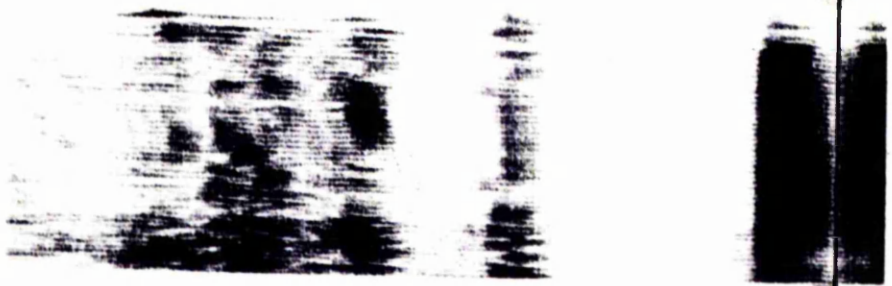

fig. 4.1 212



fig. 4.2 2e2

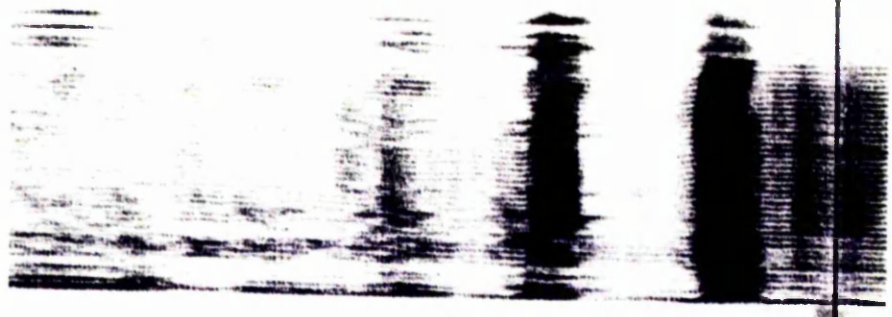

fig. 4.3 2e2



fig. 4.5 \na: [rice-paddy field]

fig. 4.4 \ma: [to come]

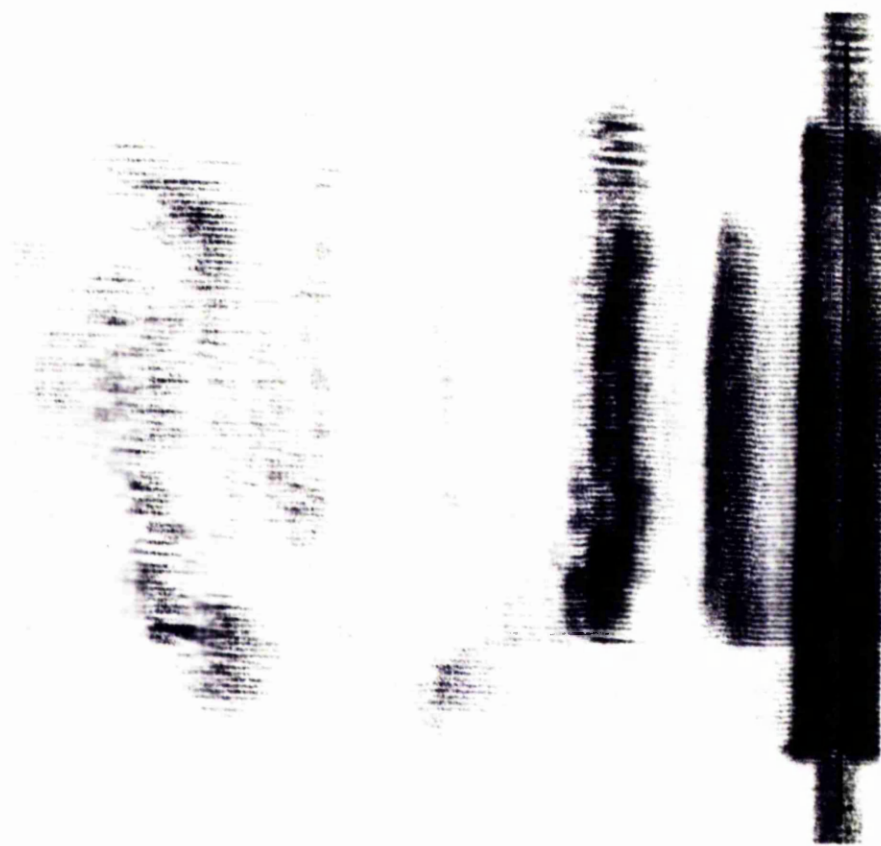

fig. 4.6 ivory



Fig. 4.7  $\wedge$ ba: [shoulder]

Fig. 4.8  $\wedge$ da: [to scold]



FIG. 4.9 la: [donkey]



FIG. 4.10 ra: [mould]



fig. 4.11 - ha:t [beach]

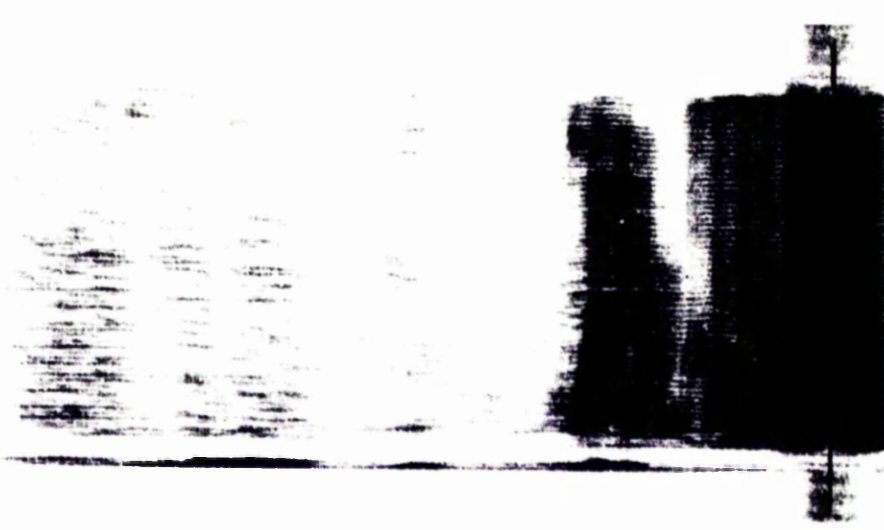

fig. 4.14 - 2a:t [to dare, brave]





Fig. 4.12 ~ja: [don't]

Fig. 4.13 ~wa: [a unit of measurement]

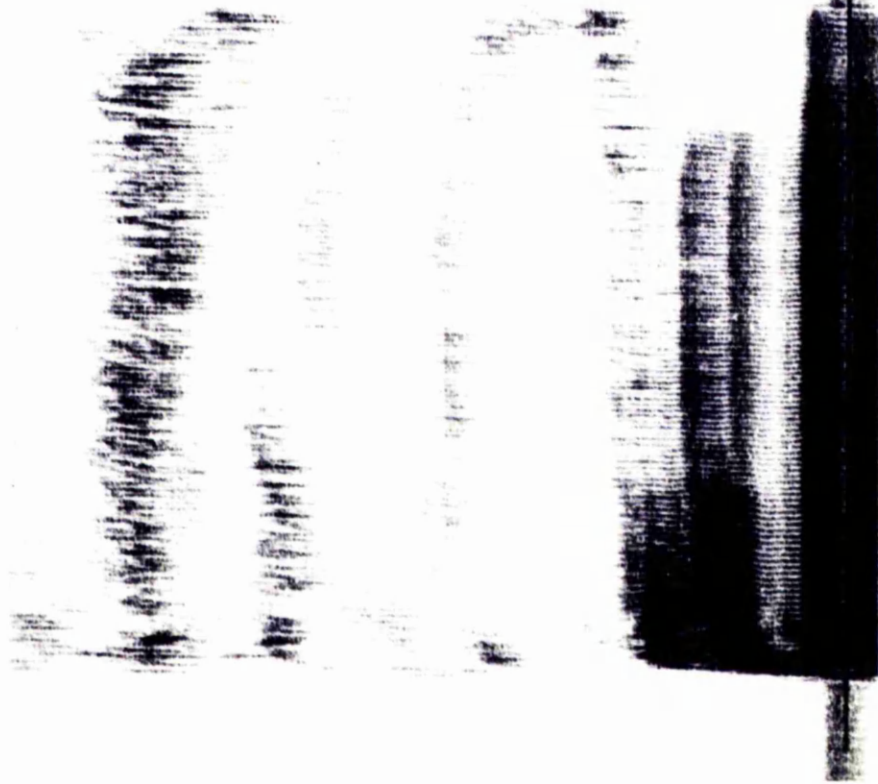

Fig. 4.15 ^pa: [forest]

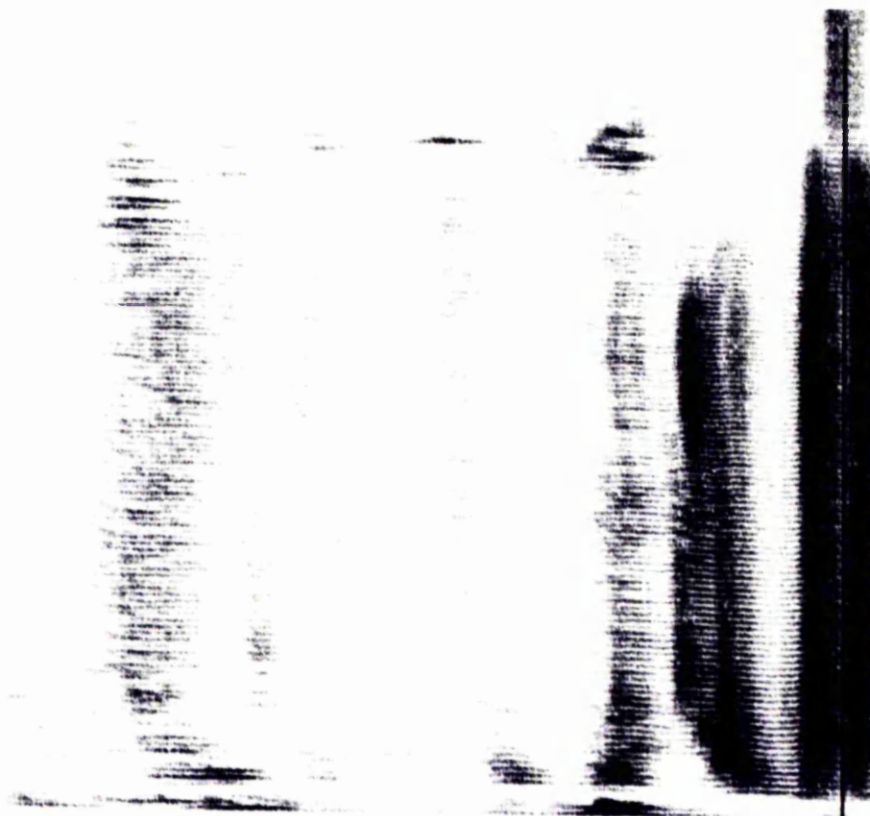

Fig. 4.16 ^ka: [crow]



Fig. 4.17  $\wedge$ ta: [eyes]

Fig. 4.18  $\wedge$ ca: [chief]



Fig. 4.19 \sa: [to sense]

Fig. 4.20 \fa: [wall]

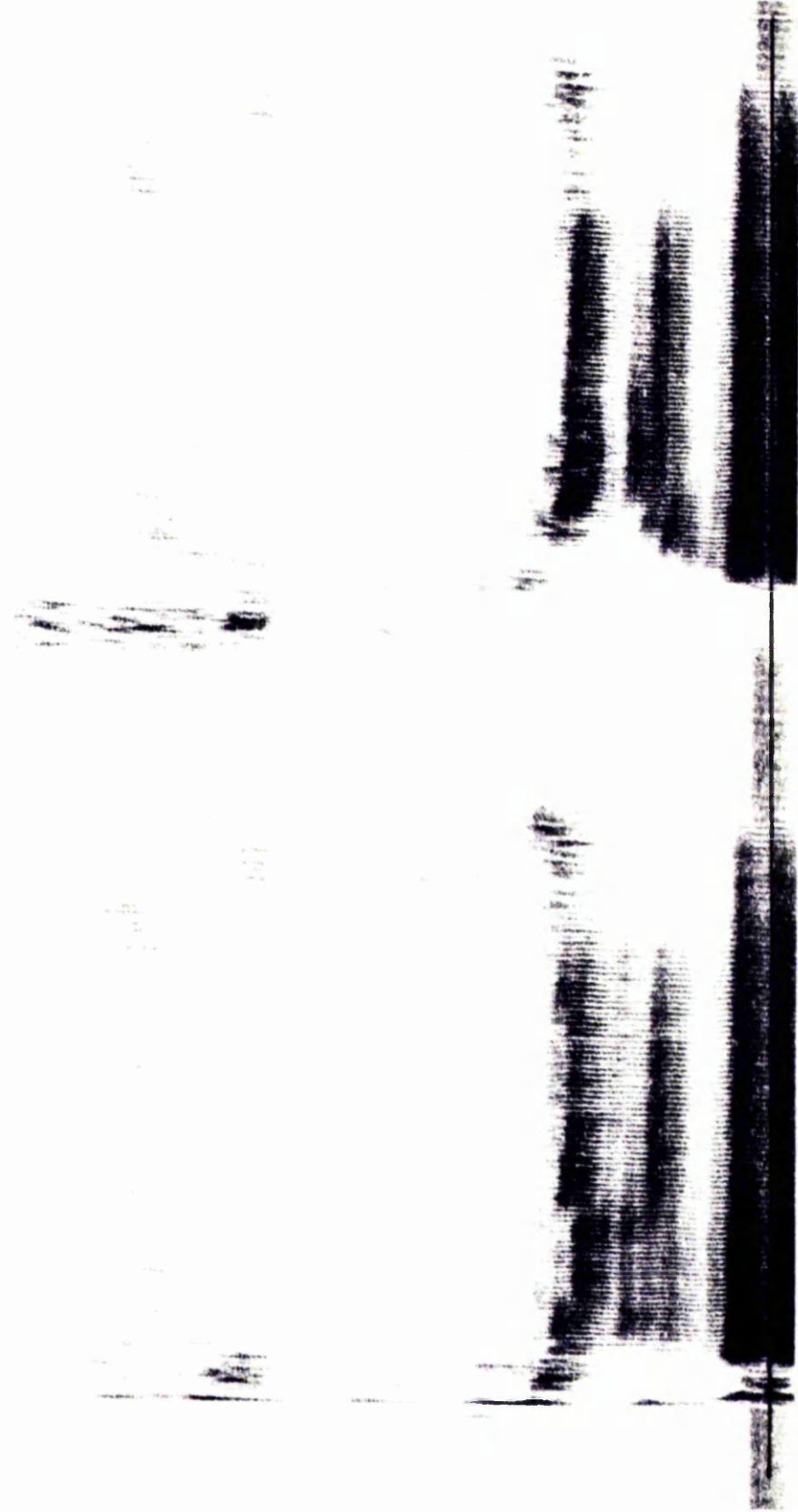

Fig. 4.21 tha: [to paint]

Fig. 4.22 cha: [to be numb]

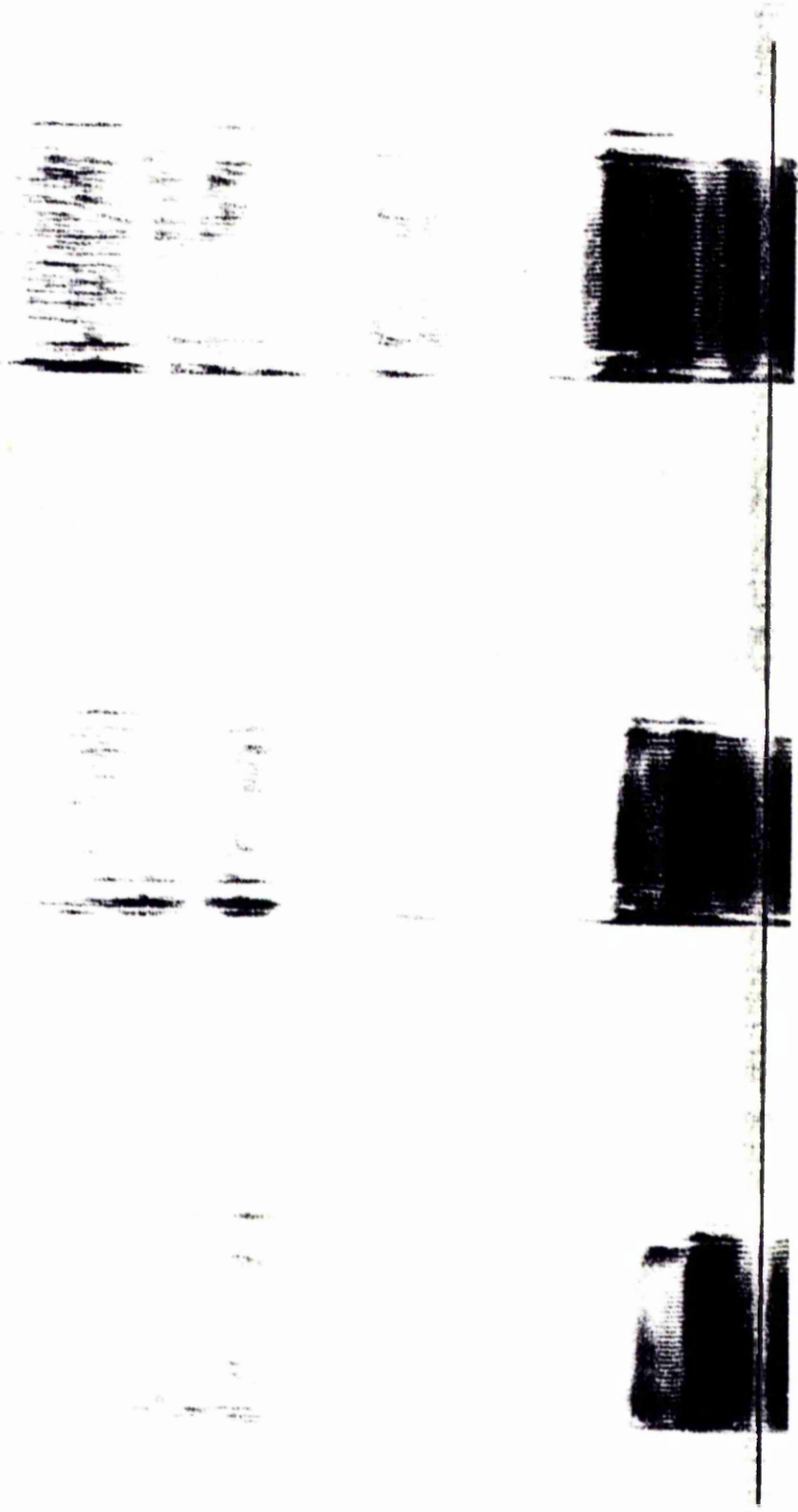

fig. 4.23 2u2

fig. 4.24 2o2

fig. 4.25 2o2

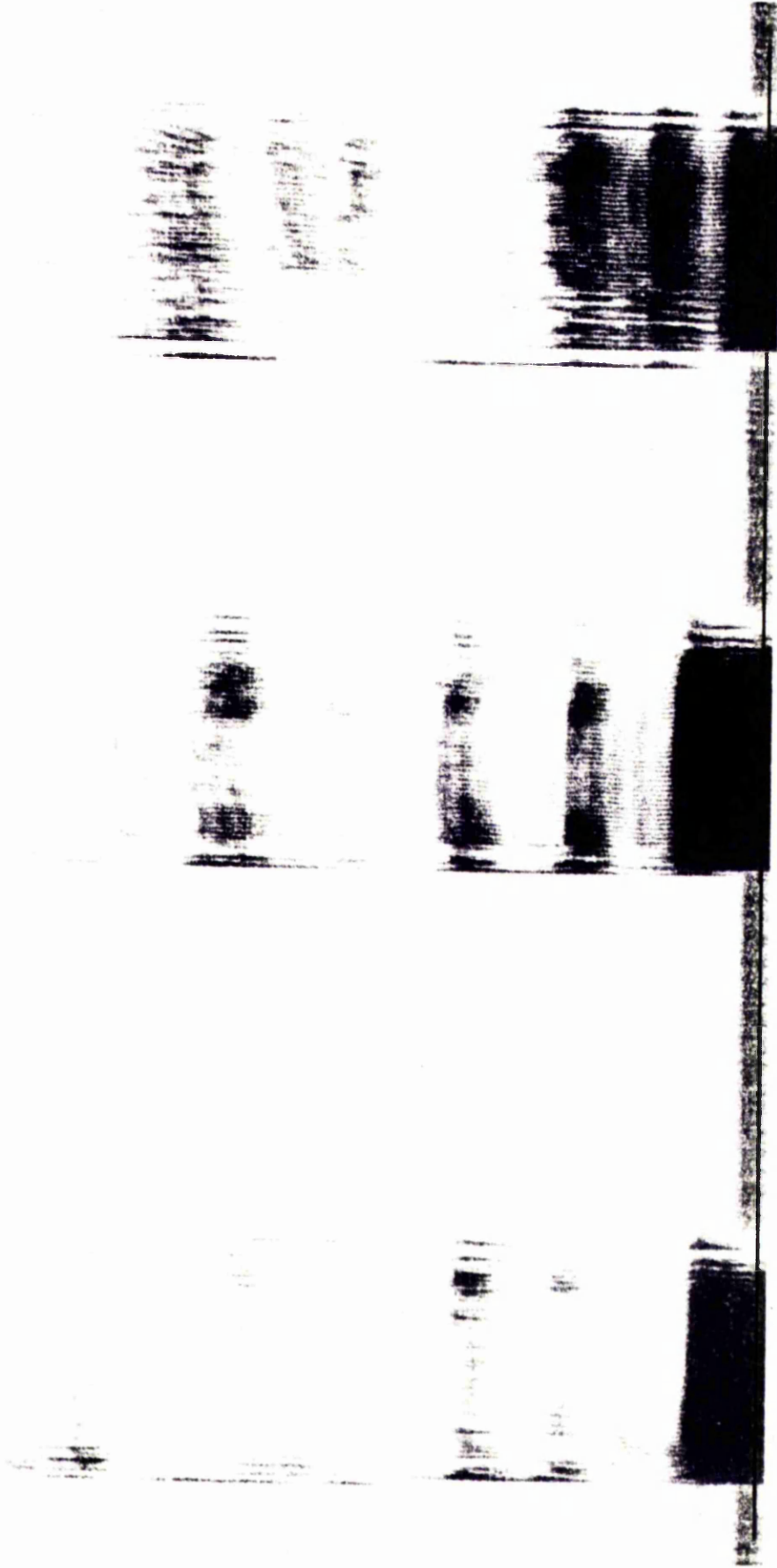

fig. 4.26 2m2

fig. 4.27 2r2

fig. 4.28 2a2

Table 4.1 Distinctive Features Matrix of Phaket Phonemes.

	i	e	e:	u:	ɔ:	a:	u:	o:	ɔ:	i	e	ɛ	u	ɔ	a	u	o	ɔ	l	r	j	w	p	h	f	ʃ	b	m	t	ʈ	d	n	k	ʎ	e	ə	s	f			
± Vowel	+	+	+	+	+	+	+	+	+	+	+	+	+	+	+	+	+	+	+	+	+	-	-	-	-	-	-	-	-	-	-	-	-	-	-	-	-	-	-	-	
± Consonantal	-	-	-	-	-	-	-	-	-	-	-	-	-	-	-	-	-	-	-	+	+	-	-	+	+	+	+	+	+	+	+	+	+	+	+	+	+	+	+	+	
± Voiced																				+	+	-	-	+	+	+	+	+	+	+	+	+	+	+	+	+	+	+	+	+	
± Subscripted																																									
± Tense	+	+	+	+	+	+	+	+	+	-	-	-	-	-	-	-	-	-	-																						
± Grave	-	-	-	-	-	-	-	-	-	-	-	-	-	-	-	-	-	-	-																						
± Flat																																									
± Diffuse	+	-	-	+	-	+	-	+	-	+	-	-	+	-	+	-	+	-	-																						
± Compact	-	-	+	-	-	-	-	-	-	-	-	-	-	-	-	-	-	-	-	+	+	-	-	-	-	-	-	-	-	-	-	-	-	-	-	-	-	-	-		

i: e: e: u: ɔ: a: u: o: ɔ: i e ɛ u ɔ a u o ɔ l r j w p h ʃ b m t ʈ d n k ʎ e ə s f



- 1 Vowels vs. Non-vowels
  - 2 Consonantal vs. Non-consonantal
  - 3 Vowel vs. Non-vowel
  - 4 Subscripted vs. Non-subscripted
  - 5 Tense vs. Non-tense
  - 6 Grave vs. Non-grave
  - 7 Flat vs. Non-flat
  - 8 Diphthong vs. Non-diphthong
  - 9 Compact vs. Non-compact
- Left branches represent minus values, and right branches, plus values for the particular factors.

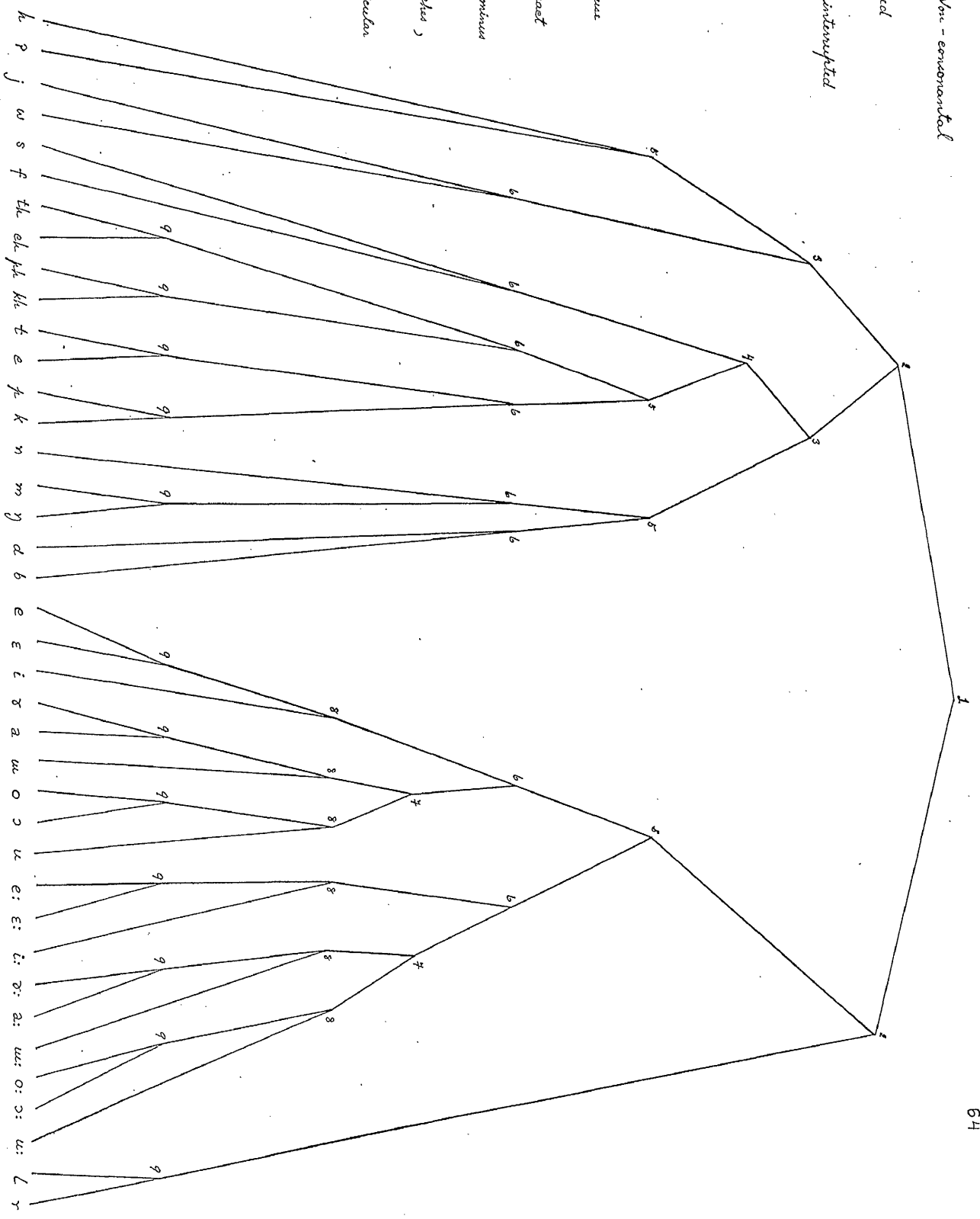

Branching diagram representing the phonemes of English

## Chapter 5

This chapter deals with phonological rules at the word level. By 'word', I mean a word of monosyllabic structure which is enclosed by a boundary symbol on both left and right-hand sides. Thus a word can be symbolized by

$$1 \quad / \# \text{ --- } \# /$$

where # represents a word boundary, and there contains no occurrence of # # in ---.

A word in Phuket represents a string of consonants (symbolized here by C) and vowels (symbolized here by V) and it can begin only with C.

In a word, between a vowel (V) and the preceding consonant (symbolized here by  $C_j^i$ )\*1 there may be another consonant (symbolized here by  $C_j^l$ )\*1.

After a vowel (V), there may or may not be consonant (symbolized here by  $C_j^i$ )\*1.

Therefore a word can be symbolized by a formula .

$$2 \quad / \# C_j^i ( C_j^l ) V ( C_j^i ) \# /$$

---

\*1 This type of notation is based upon Chomsky's use of  $X_m^n$  in 'The Sound Pattern of English' p. 62

This formula is expanded in the following sequence (3).

3	#C <sub>i</sub> C <sub>L</sub> V C <sub>i</sub> #	a
	#C <sub>i</sub> C <sub>L</sub> V C <sub>j</sub> #	b
	#C <sub>i</sub> C <sub>L</sub> V #	c
	#C <sub>i</sub> C <sub>j</sub> V C <sub>i</sub> #	d
	#C <sub>i</sub> C <sub>j</sub> V C <sub>j</sub> #	e
	#C <sub>i</sub> C <sub>j</sub> V #	f
	#C <sub>i</sub> V C <sub>i</sub> #	g
	#C <sub>i</sub> V C <sub>j</sub> #	h
	#C <sub>i</sub> V #	i
	#C <sub>L</sub> V C <sub>i</sub> #	j
	#C <sub>L</sub> V C <sub>j</sub> #	k
	#C <sub>L</sub> V #	l
	#C <sub>j</sub> V C <sub>i</sub> #	m
	#C <sub>j</sub> V C <sub>j</sub> #	n
	#C <sub>j</sub> V #	o

The ordering of ( 3 ) is totally disjunctive i.e. if one case applies , all other cases are inapplicable.

The vowels and consonants can be classified by the features\*2 ± vocalic and ± consonantal as in the following :

\*2 The abbreviations of the features

± voc. = ± vocalic ,      ± cons. = ± consonantal

± inter. = ± interrupted, ± comp. = ± compact

± diff. = ± diffuse

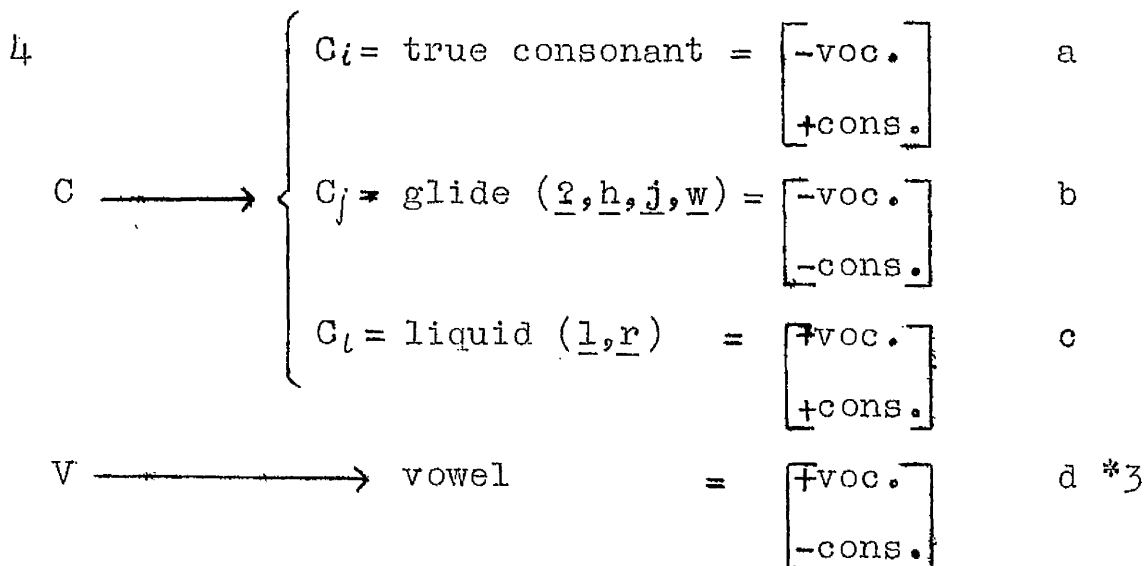

Given the word  $\sim$ khra:w 'time', rules (3b, 4a, c, d, and b) enable us to specify the vocalic and consonantal features of the item as in the following :-

	<u>kh</u>	<u>r</u>	<u>a:</u>	<u>w</u>
vocalic	-	+	+	-
consonantal	+	+	-	-

Words may begin with a cluster, consisting of a sequence of a [+grave] consonant followed by one of the liquids l, r or by the glide w. This gives rule (5) :-

5

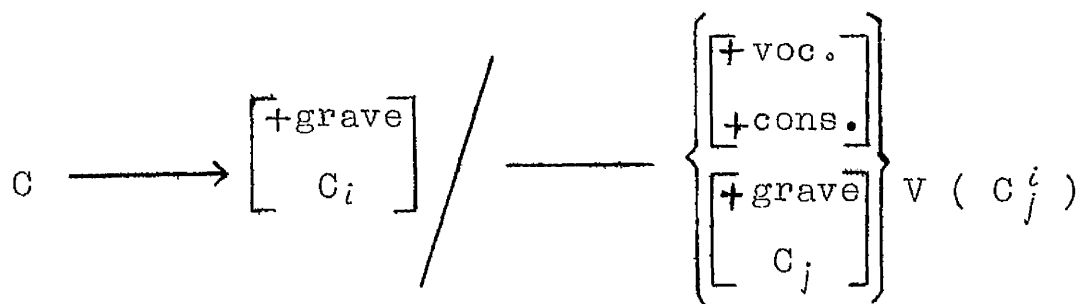

\*3 But see rule (14) on page 77

The above rule excludes the occurrence of the glides ʔ, h, and j as the second element of clusters. It will generate words like

^ <u>pla</u> :	'fish'
^ <u>pre</u> :	'to turn oneself over'
^ <u>phlɔ</u> :	'to cut a coconut seed'
- <u>phra</u> :	'jungle knife'
\ <u>mlaj</u>	'bangle'
- <u>kla</u> :	'young rice plant'
\ <u>kra</u> :	'mark'
^ <u>kwe</u> :	'onomatopoeia from sound of baby crying'
- <u>khla</u> :	'a kind of plant'
/ <u>khra</u> :	'to pull'
\ <u>khwa</u> :	'right'

and also words that begin with \*pw , \*phw , \*bl , \*br , \*bw , \*mr , \*mw , \*ɟl , \*ɟr , \*ɟw , \*fl , \*fr , \*fw . These latter clusters do not occur in the lexical items of the dialect. Thus rules ( 6 a , b , c ) are needed in order to exclude these inadmissible clusters :-

6a

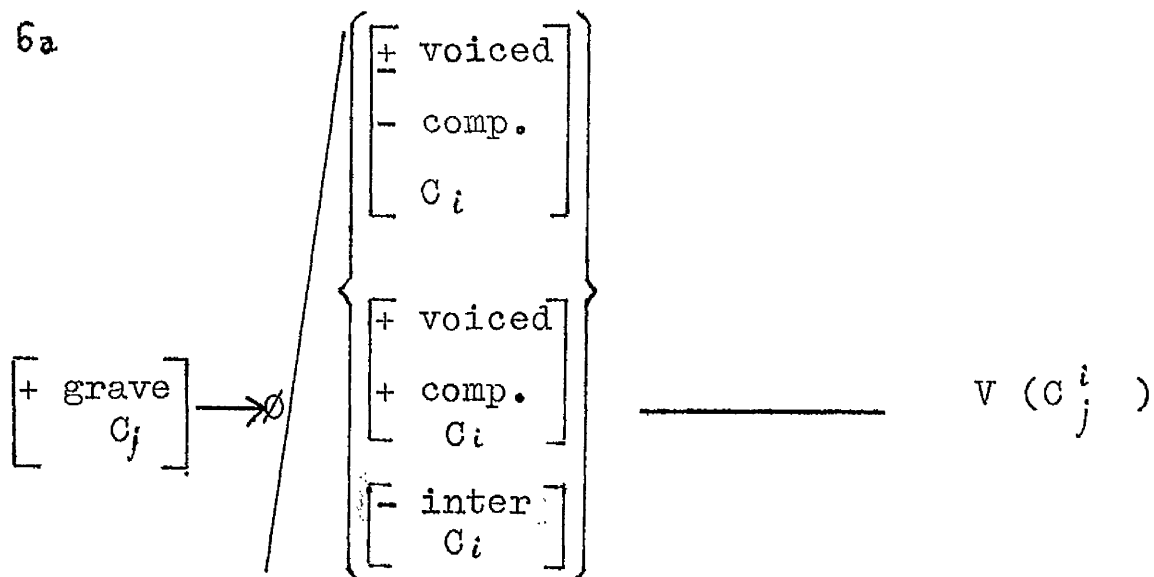

This rule excludes \*pw, \*phw, \*bw, \*mw, \*nw, \*fw,  
but still includes \*bl, \*br, \*mr, \*nl, \*nr, \*fl, \*fr.

6b.

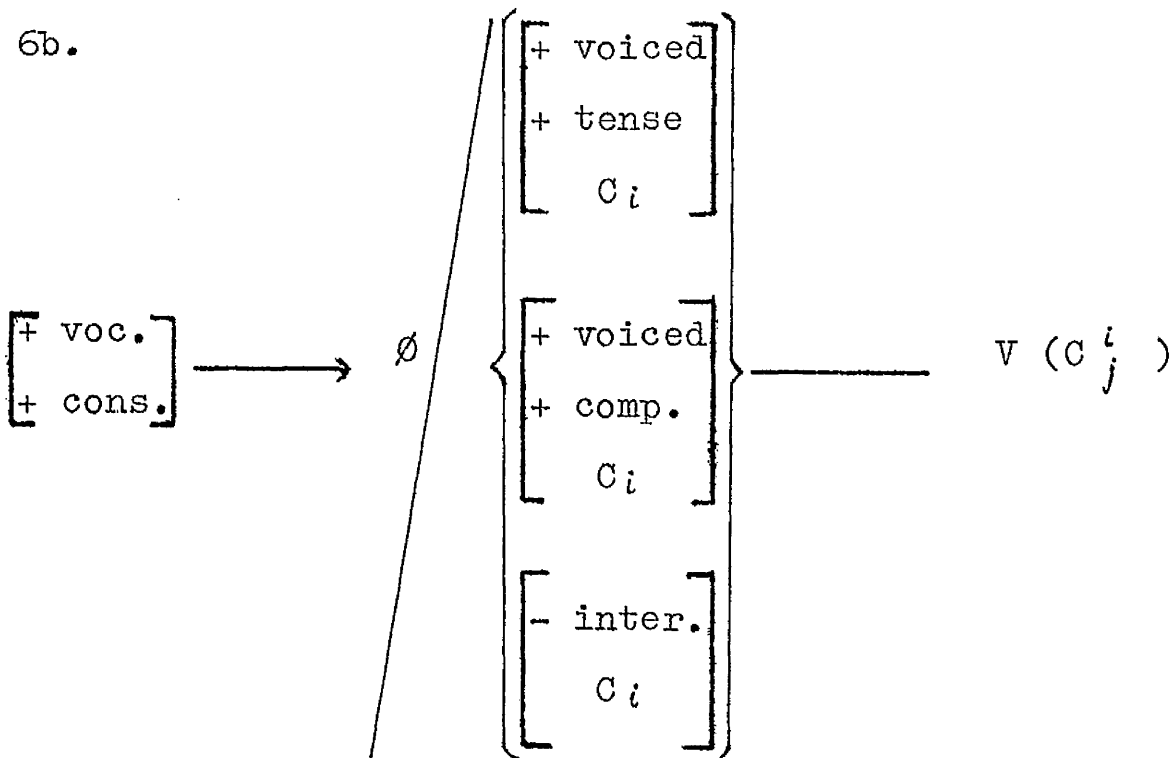

The above rule excludes all the rest but still  
leaves \*mr to be dealt with by rule (6c):-

6c.

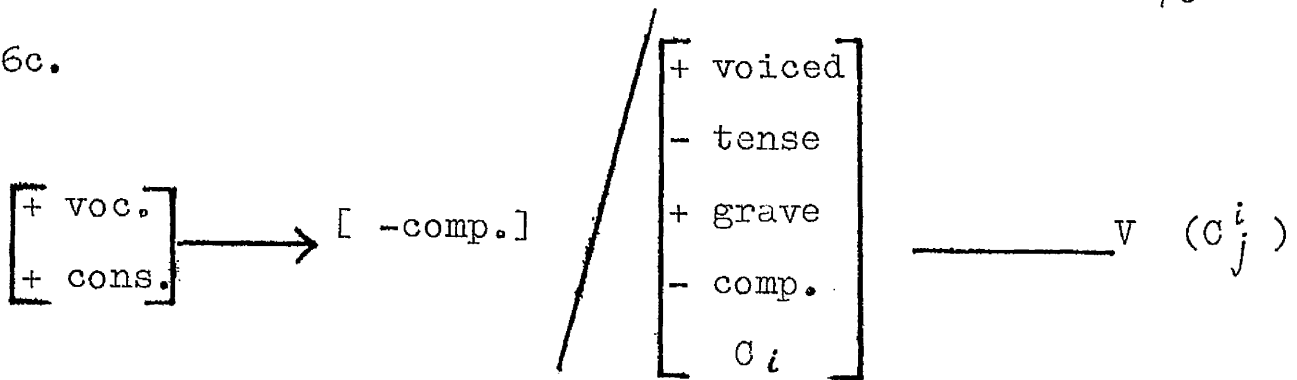

All consonants may precede a vowel. This gives rule (7):-

7.

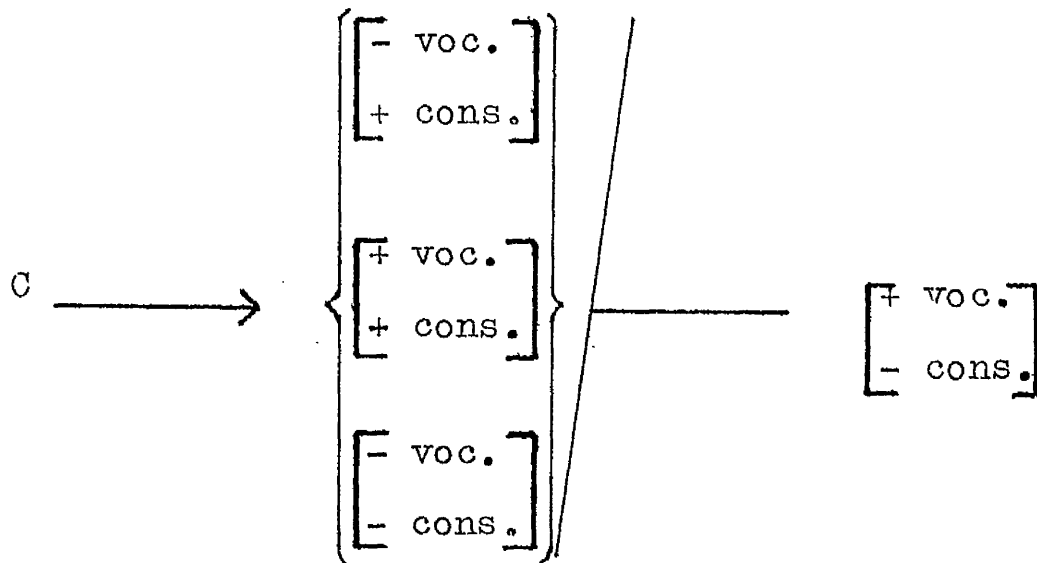

Rule (7) enables us to generate words like:

^ <u>pa:</u>	'forest'
^ <u>pha:</u>	'to bring along'
^ <u>ba:</u>	'shoulder'
^ <u>ma:</u>	'to come'
^ <u>ta:</u>	'eye'
^ <u>tha:</u>	'to point'
^ <u>da:</u>	'to scold'
^ <u>na:</u>	'thick'
^ <u>ka:</u>	'crow'

∕ <u>kha:</u>	'to equal to'
∩ <u>na:</u>	'ivory'
∧ <u>ca:</u>	'chief'
- <u>cha:</u>	'slow'
∩ <u>sa:</u>	'to sense'
∩ <u>fa:</u>	'wall'
∧ <u>ʔa:</u>	'father's younger brother or sister'
∩ <u>ha:</u>	'to look for'
∩ <u>ja:</u>	'medicine'
∩ <u>wa:</u>	'more'
- <u>la:</u>	'late'
∩ <u>ra:</u>	'mould'

Within a word, after a vowel only a nonvocalic segment can occur. This gives rule (8):-

8.

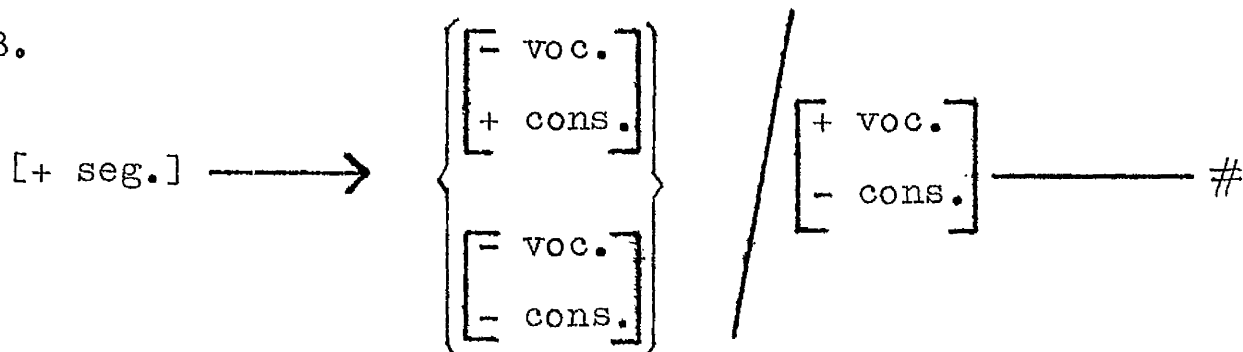

Rule (8) generates words like:

- <u>sak</u>	'to wash'
- <u>fat</u>	'to winnow rice'
- <u>ja:p</u>	'rough; rude'
∧ <u>ta:n</u>	'money'
∩ <u>sa:n</u>	'to weave (as with bamboo-strips)'
∩ <u>sa:m</u>	'three'



\ <u>sa:j</u>	'line'
^ <u>ba:w</u>	'young man'
/ <u>ma:ʔ</u>	<sup>many</sup> ' <del>money</del> , much'
* <u>fas</u>	
* <u>fath</u>	
* <u>saf</u>	
* <u>sas</u>	
* <u>sah</u>	
* <u>has</u>	
* <u>cach</u>	
* <u>chac</u>	
* <u>cac</u>	
* <u>cakh</u>	
* <u>khad</u>	

Rule (8) rules out words like \*lar, \*rar, \*mal, \*tal, etc. In order to rule out the inadmissible final consonants:- \*fas, \*fath, \*cad, etc., rule (9a) is needed:-

9a.

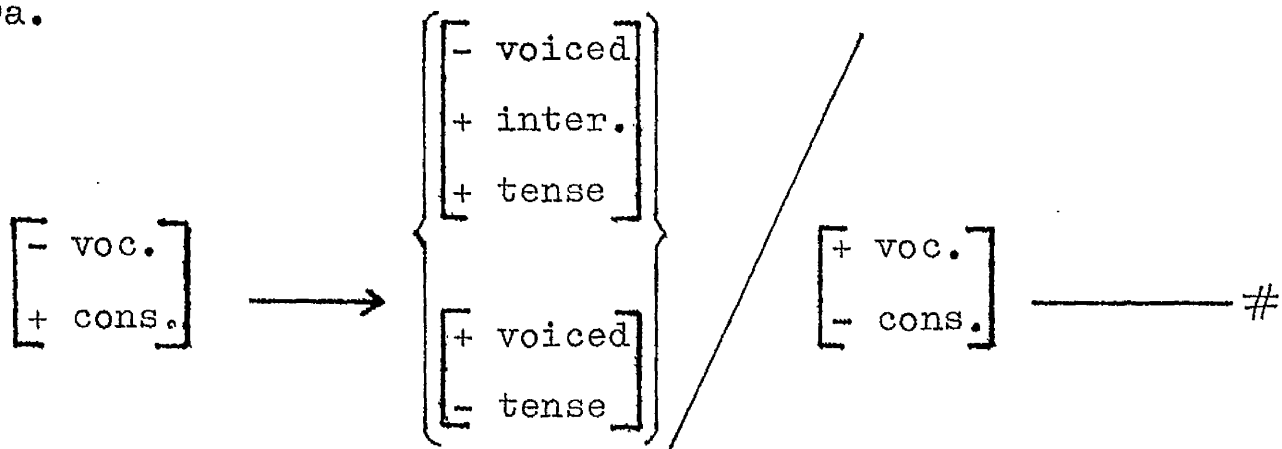

Rule (9a) specifies that final consonants are either [+ tense] consonants or nasals. It also accounts for

the problems left over from rule (8), but still allows the possibility of \*cac, \*chac, etc.

9b.

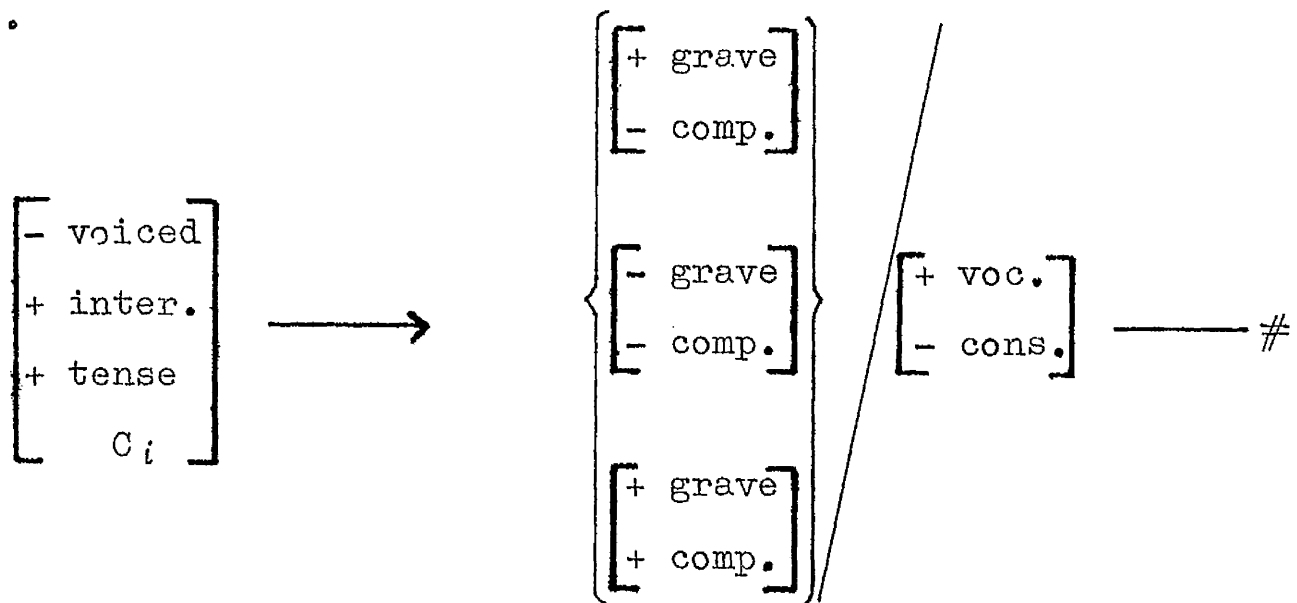

Rule (9b) accounts for the problems left over from rule (9a), and also presents the fact that when preceded by a vowel, only the plosives at the three points of articulations can occur. It generates words like:

- <u>khɔp</u>	'to bite'
- <u>sɔt</u>	'fresh'
- <u>chɔk</u>	'to box'
- <u>ʔa:p</u>	'to bathe'

As well as the plosives, when preceded by a vowel, the nasals at the three points of articulations may occur. This gives rule (9c):-

9c

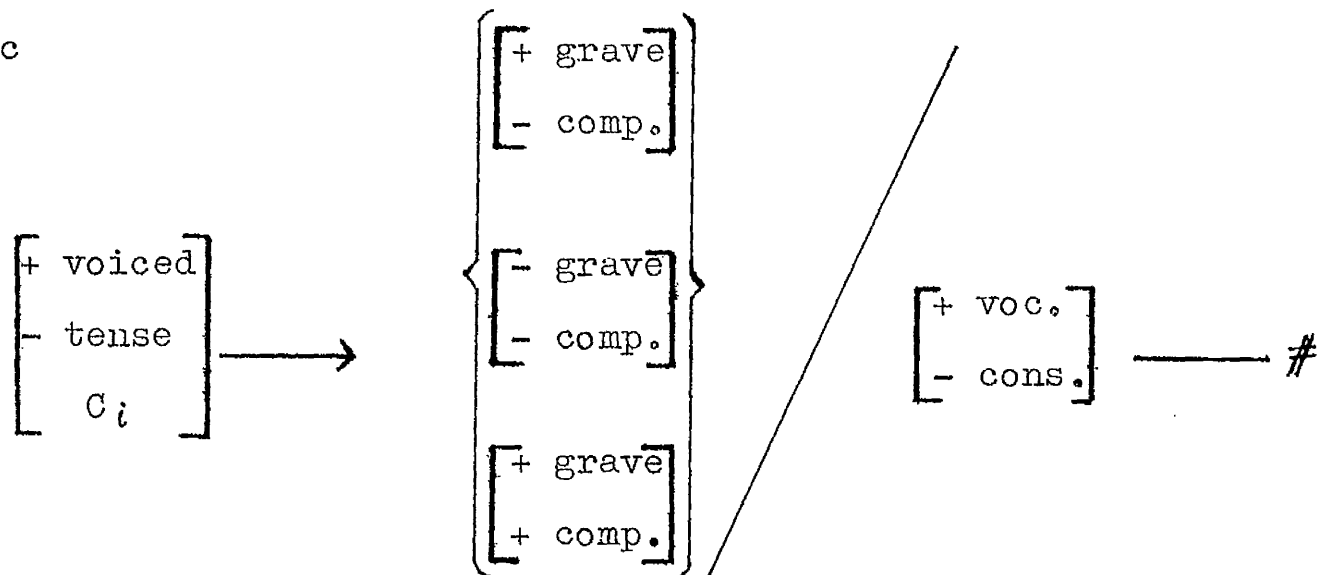

Rule No.9c generates words like

✓ <u>kam</u>	'to hold in hand'
✓ <u>than</u>	'in time'
✓ <u>jan</u>	'to have'
/ <u>ja:n</u>	'to step'

Carried over from rule (8), the permitted word-final glides are j, w, and ɹ, which are accounted for by rule (10a).

10a.

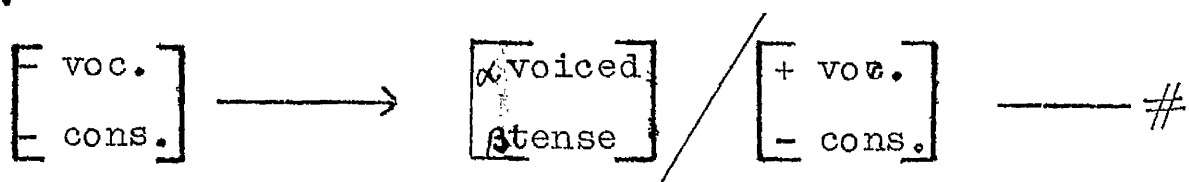

where the values + or - of  $\alpha$  and  $\beta$  are specified by the lexical entry. Rule (10a) rules out words ending in h (see also rule (8)). When the glides are [+voiced], another rule is required:-

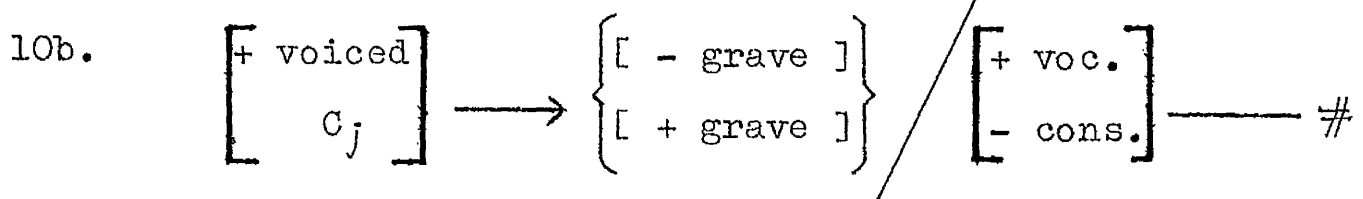

This rule generates words like:

↘ <u>kha:j</u>	'rough'
↘ <u>ja:j</u>	'maternal grand-mother'
↘ <u>ja:w</u>	'long'
↘ <u>ha:w</u>	'yawn'

The vowel may be either tense or non-tense in syllables of the structure  $C_j^i (C_j^i) V C_j^i$ .

This gives rule No.11:-

11.

$$\left[ \begin{array}{l} + \text{ voc.} \\ - \text{ cons.} \end{array} \right] \longrightarrow [ \pm \text{ tense} ] / C_j^i (C_j^i) \text{ --- } C_j^i$$

This rule will generate words like

— <u>mlak</u>	'to choke'
— <u>chat</u>	'to kick'
— <u>ʔa:p</u>	'to bathe'
↘ <u>tha:n</u>	'way'
↗ <u>ca:n</u>	'to pour (as to pour curry over rice)'
↗ <u>cam</u>	'to remember'
— <u>pa:j</u>	'label'
↗ <u>daj</u>	'to be used to'
↘ <u>raw</u>	'we'
↗ <u>pej</u>	'year'
↘ <u>lxw</u>	'rumour'
↘ <u>mow</u>	'pig'
↗ <u>du:j</u>	'navel'

The open front unrounded and back rounded vowels  $\underline{\epsilon}$  and  $\underline{\omega}$  do not occur either before glide  $\underline{j}$  nor glide  $\underline{w}$ . This gives rule (12):-

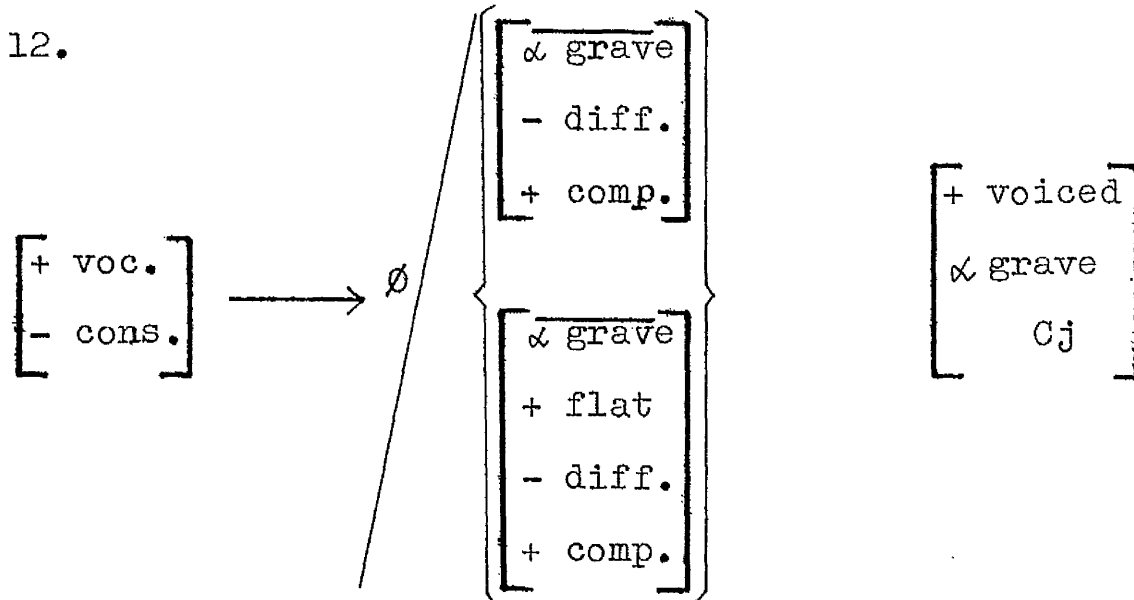

where  $\emptyset$  has a value of + or - as specified by the lexical entry. Rule (12) has ruled out the possibilities of  $*\underline{\epsilon}j$  and  $*\underline{\omega}w$ .

The vowel is always tense in syllables of the structure  $C_j^i (C_j^l) V$ . This gives rule (13):-

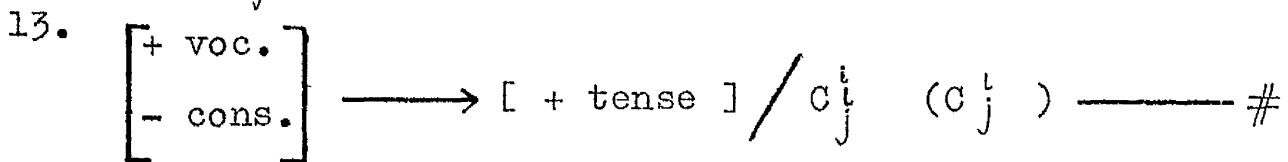

This rule generates words like:

- <u>ni</u> :	'debt'
~ <u>the</u> :	'to pour out'
/ <u>khε</u> :	'near'
- <u>su</u> :	'to buy'
/ <u>rɔ</u> :	'stupid'

\ <u>ja:</u>	'medicine'
- <u>nu:</u>	'yonder place'
\ <u>pho:</u>	'oven'
\ <u>thɔ:</u>	'to pole'

This leaves the question of the monophonemic iə , uə , and uɔ , still to be dealt with. One possible solution would appear to be to regard the second element of such forms as a 'non-syllabic' vowel. This would, however, entail adding the opposition '+ syllabic' to the number of features used, and changing rule (4d) to read:-  
14.

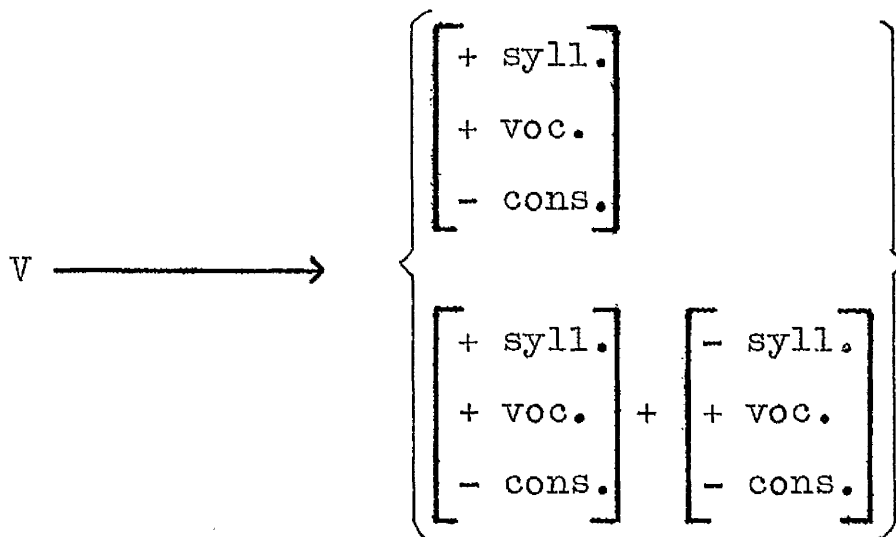

CHAPTER 6

This chapter deals with tones in the Phuket dialect and their phonological features. As I have tried to apply W. S-Y Wang's phonological features of tone<sup>\*1</sup> to the Phuket dialect, I would like to bring out some points from Wang's article.

Wang has presented a set of seven phonological features of tones, namely,  $\pm$  Contour,  $\pm$  High,  $\pm$  Central,  $\pm$  Mid,  $\pm$  Rising,  $\pm$  Falling, and  $\pm$  Convex which deals specially with bidirectional tones. In principle, these seven features can distinguish 128 items. Wang has regarded these tone features as features of individual syllables, and treated them differently from the segmental features. However tone features still have close relation with features which are controlled primarily at the larynx, e.g. voicing, aspiration, glottalization, length, breathiness, etc.

Tones in the Phuket dialect.

If the contextual restrictions described on page 28-9 and set out in the table on page 38-40(Ch. 3) are taken into account, the eight pitch patterns described in Chapter 3 can be grouped into 4 tones according to their pitches on isolated monosyllabic words, and may be handled in terms of

---

\*1. William S-Y Wang, 'Phonological Features of Tone', International Journal of American Linguistics, Vol. XXXIII, No.2, April 1967, 93-105.

three phonological feature oppositions : + falling, + rising, and + high.

Tone 1 is a tone which has its starting pitch lower than its ending pitch. The height of its rise can vary according to neighbouring tones. On the whole this variation does not influence its identification as a rising tone.

Tone 1 is the low rise pitch pattern in Chapter 3. The phonological features of this tone are

-	falling
+	rising

There are no contextual variants of this tone.

Tone 2 is a tone which has its ending point lower than its starting point. The speed, length, height, and steadiness of its fall depend on the characteristics of its allotones.

Tone 2 has 2 allotones: high fall, and rise fall. These 2 allotones occur in complementary distribution according to their restrictions or phonetic context (see Ch. 3).

The phonological features of tone 2 are

+	falling
$\alpha$	rising
$\beta$	high

Tone 3 is a tone which has its ending point lower than its starting point. The speed, length, height, and steadiness of its fall depend on the characteristics of its allotones.



Tone 3 has 2 allotones: mid fall, and low level. These 2 allotones occur in complementary distribution according to their phonetic context (see Chapter 3).

The phonological features of Tone 3 are

+	falling
-	rising
-	high

Tone 4 is a tone which sustains a level pitch throughout the syllable. A slight fall in pitch before a pause is not significant, although it happens with some allotones. This characteristic also occurs with the Mid Tone in Siamese\*<sup>2</sup> in general.

Tone 4 has 3 allotones: high level, higher mid level, and lower mid level pitch patterns. These 3 allotones also occur in complementary distribution according to certain restrictions as to phonetic context (see Chapter 3).

The phonological features of Tone 4 are

-	falling
-	rising

### Phonological Rules of Tones

Tones in the Phuket dialect belong to syllables symbolized by  $C \begin{smallmatrix} i \\ j \end{smallmatrix} (C \begin{smallmatrix} l \\ j \end{smallmatrix}) V (C \begin{smallmatrix} l \\ j \end{smallmatrix})$  as set out in Chapter 5. Thus the phonological rules of tones will operate over the whole syllable structure.

---

\*2. See footnote 1, Chapter 2.

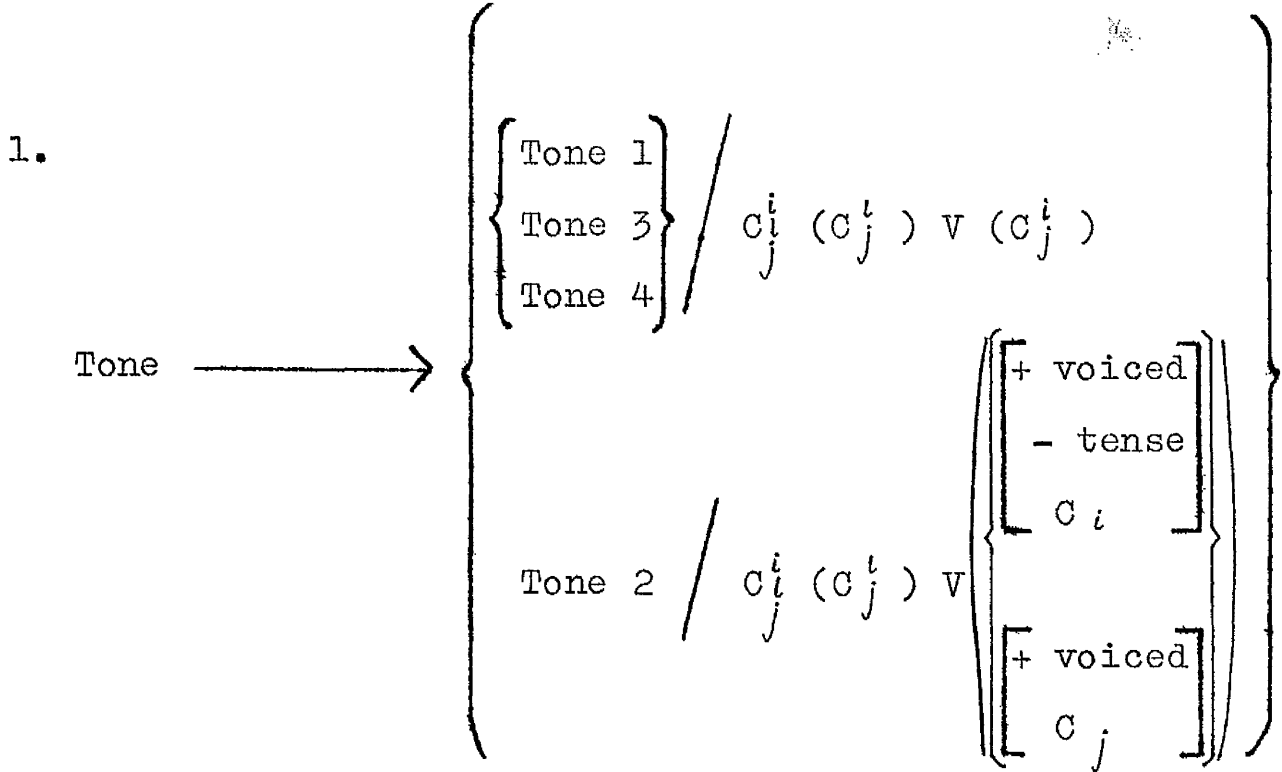

According to their phonological features we have

rules:-

- 2. Tone 1 →  $\left[ \begin{array}{l} - \text{falling} \\ + \text{rising} \end{array} \right]$
- 3. Tone 2 →  $\left[ \begin{array}{l} + \text{falling} \\ \alpha \text{ rising} \\ \beta \text{ high} \end{array} \right]$
- 4. Tone 3 →  $\left[ \begin{array}{l} + \text{falling} \\ - \text{rising} \\ - \text{high} \end{array} \right]$
- 5. Tone 4 →  $\left[ \begin{array}{l} - \text{falling} \\ - \text{rising} \end{array} \right]$

Rules (1), and (2) will generate words with Tone 1 like

∕ <u>tha:</u>	'harbour'
∕ <u>wa:t</u>	'to draw'
∕ <u>tat</u>	'to cut'
∕ <u>la:m</u>	'to fasten'

Rules (1), and (3) will generate words with  
Tone 2 like

∖ <u>saj</u>	'crystal (as of water)'
∧ <u>paj</u>	'to go'
∧ <u>ba:n</u>	'thin'

Rules (1), and (4) will generate words with  
Tone 3 like

∩ <u>kham</u>	'a mouthful'
∩ <u>cha:</u>	'to be numb'
- <u>khap</u>	'tight'
- <u>chup</u>	'to gild'

Rules (1), and (5) will generate words with  
Tone 4 like

- <u>jat</u>	'to trust'
- <u>ja:2</u>	'to be hungry'
- <u>pa:2</u>	'mouth'

Carried over from rule (3), Tone 2 has 2 allotones  
which occur according to the following contexts.

6a.

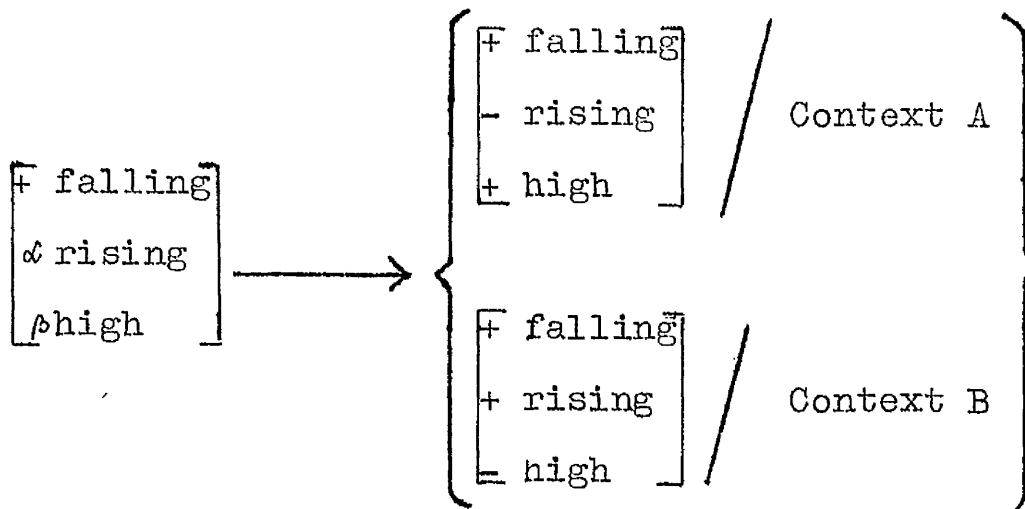

These 2 contexts may be specified by rules (6b), and (c).

6b.

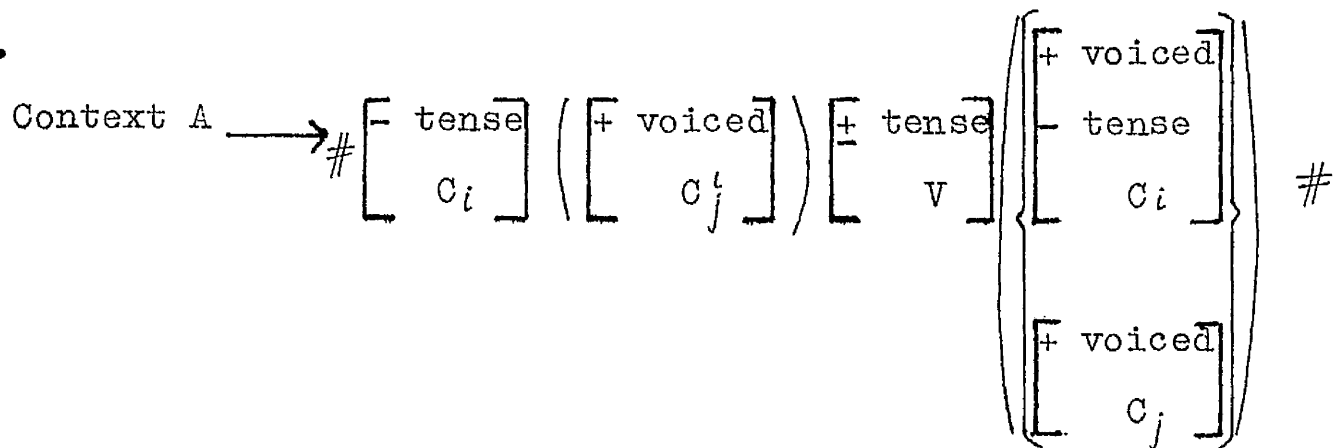

Rules (6a), and 6(b) will generate words like

<u>pha:</u>	'to split'
<u>tha:m</u>	'to ask'
<u>wa:n</u>	'sweet'
<u>phraŋ</u>	'European'
<u>ha:w</u>	'yawn'
<u>haj</u>	'jar'

6c.

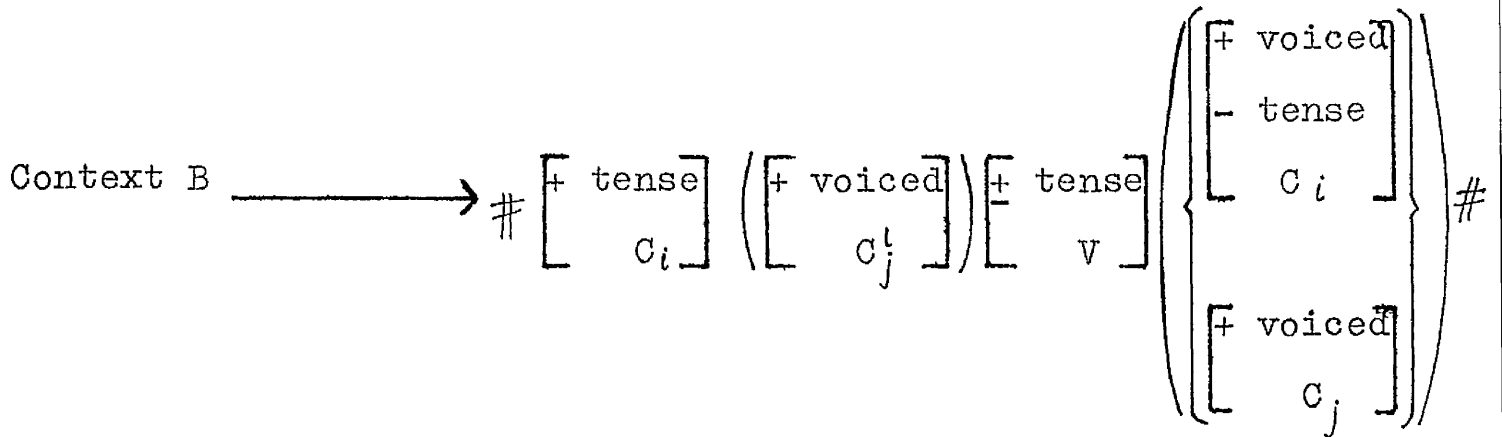

Rules (6a), and (6c) will generate words like

$\wedge$ <u>pa:</u>	'forest'
$\wedge$ <u>pla:</u>	'fish'
$\wedge$ <u>ba:n</u>	'thin'
$\wedge$ <u>ba:n</u>	'to open (as of flowers)'
$\wedge$ <u>ta:m</u>	'to follow'
$\wedge$ <u>ʔa:j</u>	'to be bashful'
$\wedge$ <u>ʔaw</u>	'to take'

Carried over from rule (4), Tone 3 has 2 allotones which occur according to the following contexts.

7a.

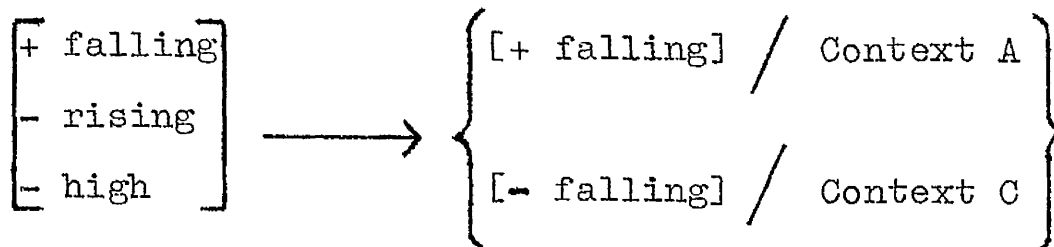

The above contexts, may be specified by rules (7b, and c).

7b.

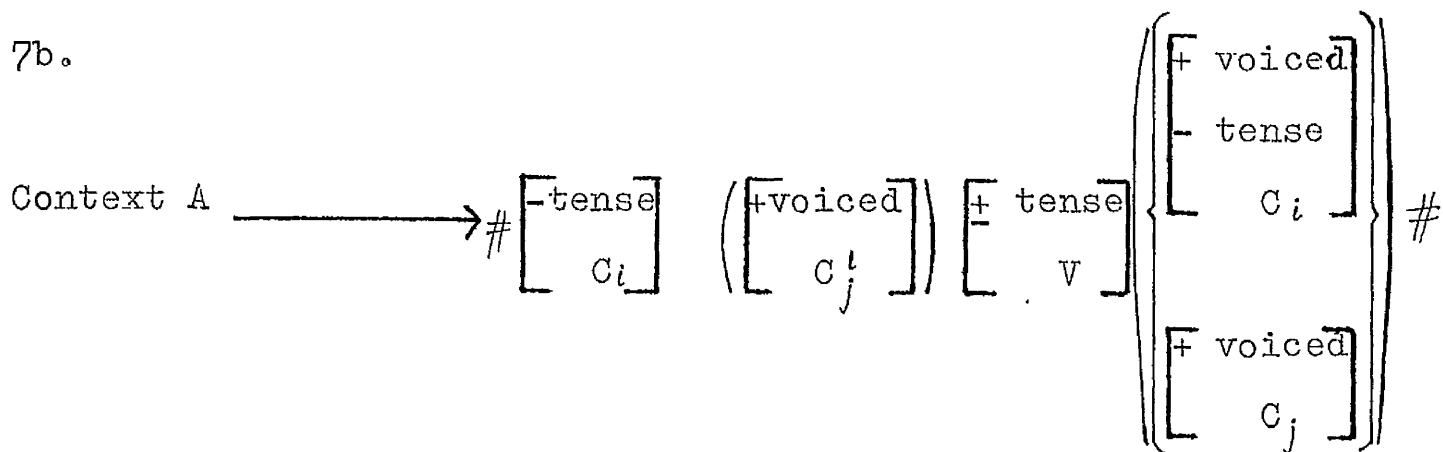

Rules (7a), and (7b) will generate words like

$\sim$ <u>ma:</u>	'to come'
$\sim$ <u>tham</u>	'to make'
$\sim$ <u>than</u>	'in time'
$\sim$ <u>khra:n</u>	'to groan'
$\sim$ <u>chaj</u>	'to sting'
$\sim$ <u>ja:w</u>	'long'

7c.

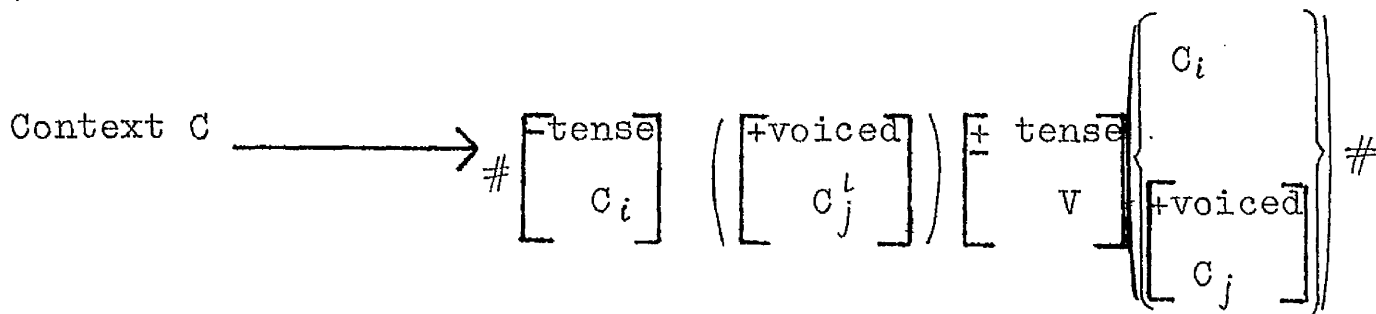

Rules (7a), and (7c) will generate words like

$\sim$ <u>ma:</u>	'horse'
$\sim$ <u>khap</u>	'tight'
$\sim$ <u>chat</u>	'distinct'
$\sim$ <u>thak</u>	'to greet'
$\sim$ <u>na:m</u>	'water'
$\sim$ <u>la:n</u>	'bald'

— <u>ra:n</u>	'to be deserted'
— <u>phra:w</u>	'coconut'
— <u>khla:j</u>	'to resemble'

In order to account for the allotones of Tone 4, it is necessary to add one more of Wang's features,

$\pm$  Mid, e.g.:—

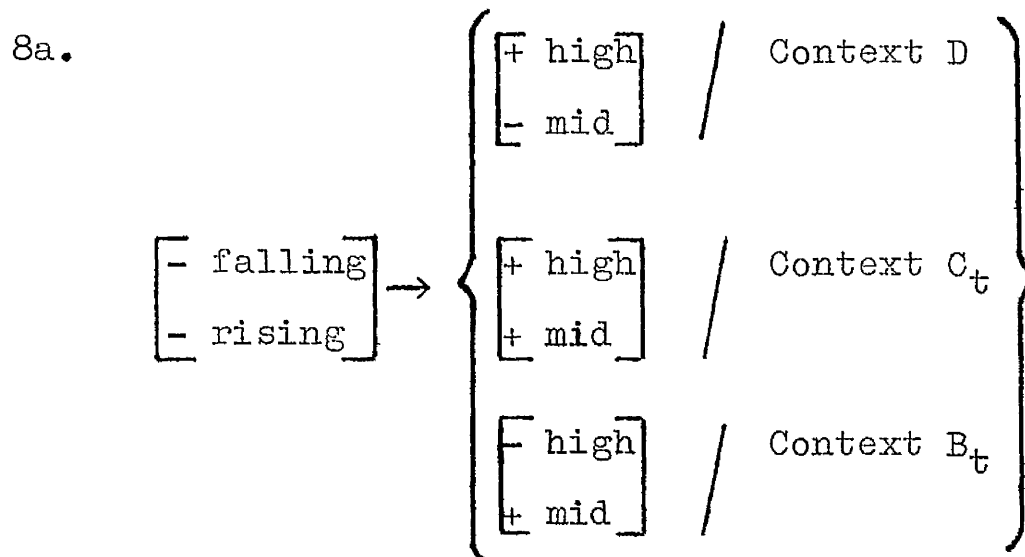

The above contexts, may be specified by rules (8b, c, and d) .

8b

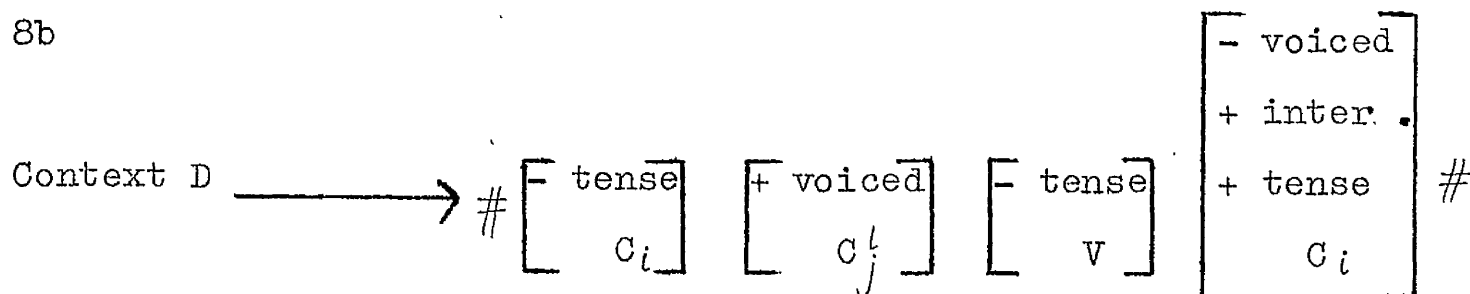

Rules (8a), and (8b) will generate words like

— <u>phit</u>	'wrong'
— <u>phlak</u>	'to p ush'
— <u>jat</u>	'to trust'
— <u>jip</u>	'to pick'

8c

Context  $C_t \longrightarrow \# \left[ \begin{array}{c} \text{[- tense]} \\ C_i \end{array} \right] \left( \left[ \begin{array}{c} \text{[+ voiced]} \\ C_j^l \end{array} \right] \right) \left[ \begin{array}{c} \text{[+ tense]} \\ v \end{array} \right] (C_j^i) \#$

Rules (8a) and (8c) will generate words like

- <u>ja:ʔ</u>	'to be hungry'
- <u>cha:t</u>	'to finish'
- <u>sa:t</u>	'mat'
- <u>ja:p</u>	'rough; rude'
- <u>pha:</u>	'cloth'
- <u>kha:n</u>	'side'
- <u>ha:m</u>	'to forbid'
- <u>ma:n</u>	'to betroth'
- <u>ma:j</u>	'to burn'
- <u>tha:w</u>	'old age'
- <u>khwa:m</u>	'to turn upside down'

8d

Context  $B_t \longrightarrow \# \left[ \begin{array}{c} \text{[+ tense]} \\ C_i \end{array} \right] \left( \left[ \begin{array}{c} \text{[+ voiced]} \\ C_j^l \end{array} \right] \right) \left[ \begin{array}{c} \text{[+ tense]} \\ v \end{array} \right] (C_j^i) \#$

Rules (8a) and (8d) will generate words like

- <u>da:p</u>	'sword'
- <u>ba:t</u>	'to injure'
- <u>pa:ʔ</u>	'mouth'
- <u>pla:m</u>	'to struggle'
- <u>pa:w</u>	'pocket'
- <u>ba:j</u>	'dumb'
- <u>da:n</u>	'stubborn'
- <u>pa:</u>	'parents' elder sister'



APPENDIX

Notes on the Frøkjøer-Jensen Pitch Meter,  
the Mingograph, and the Sound Spectrograph

by

Mr. A. W. Stone

The FRØKJÆR - JENSEN Pitch Meter is an electronic instrument for measuring PITCH. Basically, it converts varying frequencies into varying D.C. voltages, which when connected to a 'display' instrument such as an Oscilloscope or Mingograph, shows a visual record of the variations of frequency - reading the bottom of the trace. As it also has an 'in-built' frequency calibrator, a grid can be produced to show the frequency at any given point. These are represented by the horizontal lines overlaid on the traces within this Thesis. The Oscillogram shown on the lower channel (Osc.) is also produced by the Pitch meter.

\* \* \* \* \*

The Oscillomink or Mingograph used to produce these traces is an ink-writing Oscilloscope. It differs from the older style Pen-recorder in that there is no moving stylus and therefore no loss of energy in overcoming the inertia of the stylus arm. It is very sensitive and will operate at frequencies up to about 1000 Hz. It basically uses a high pressure jet of ink which is pivotted within the magnetic field of a highly sensitive galvanometer. The paper is driven at a fixed speed - which can be varied - and those within this thesis were at a speed of 10 cm. per second.

The Sonograph or Sound Spectrograph which produced the Sonograms within this thesis is an electronic instrument for displaying the total amount of energy within a given utterance between the frequencies of 85 Hz - 8kHz. Frequency is shown in the vertical direction and time in the horizontal. Variations in energy are shown by the degree of blackness of the trace, so that silence is shown by no marking of the paper at all.

BIBLIOGRAPHY.

- Brown, J. M., 1965, From Ancient Thai to Modern Dialects,  
Social Science Association Press of Thailand, Bangkok.
- Chomsky, N., and M. Halle, 1968, The Sound Pattern of English,  
Harper & Row, New York.
- Fant, G., 1960, Acoustic Theory of Speech Production,  
Mouton, The Hague.
- Fant, G., 1968, 'Analysis and Synthesis of Speech Process',  
in B. Malmberg, ed., Manual of Phonetics, North-  
Holland Publishing Company, Amsterdam, 173-227.
- Halle, M., G.W. Hughes, and J.P.A. Radley, 1957, 'Acoustic  
Properties of Stop Consonants', Journal of the  
Acoustical Society of America, 29, 107-116.
- Halle, M., 1959, The Sound Pattern of Russian, Mouton, The  
Hague.
- Halle, M., 1962, 'Phonology in Generative Grammar', Word,  
18, 54-72. Reprinted in Fodor and Katz (1964),  
334-352.
- Halle, M., 1964, 'On the Bases of Phonology', in Fodor and  
Katz (1964), 324-333.
- Henderson, Eugénie J.A., 1964, 'Marginalia to Siamese Pho-  
netic Studies', in D. Abercrombie et al., eds.,  
In Honour of Daniel Jones, Longmans, London,  
415-424.

Jakobson, R., and M. Halle, 1956, Fundamentals of Language,  
Mouton, The Hague.

Jakobson, R., G. Fant, and M. Halle, 1963, 'Preliminaries  
to Speech Analysis', Massachusetts Institute of  
Technology Press, Cambridge, Mass.

Wang, W. S.-Y., 1967, 'Phonological Features of Tone',  
International Journal of American Linguistics, Vol.  
<sup>No. 2</sup>  
33<sub>2</sub> 93-105.

SONOGRAPH GRID

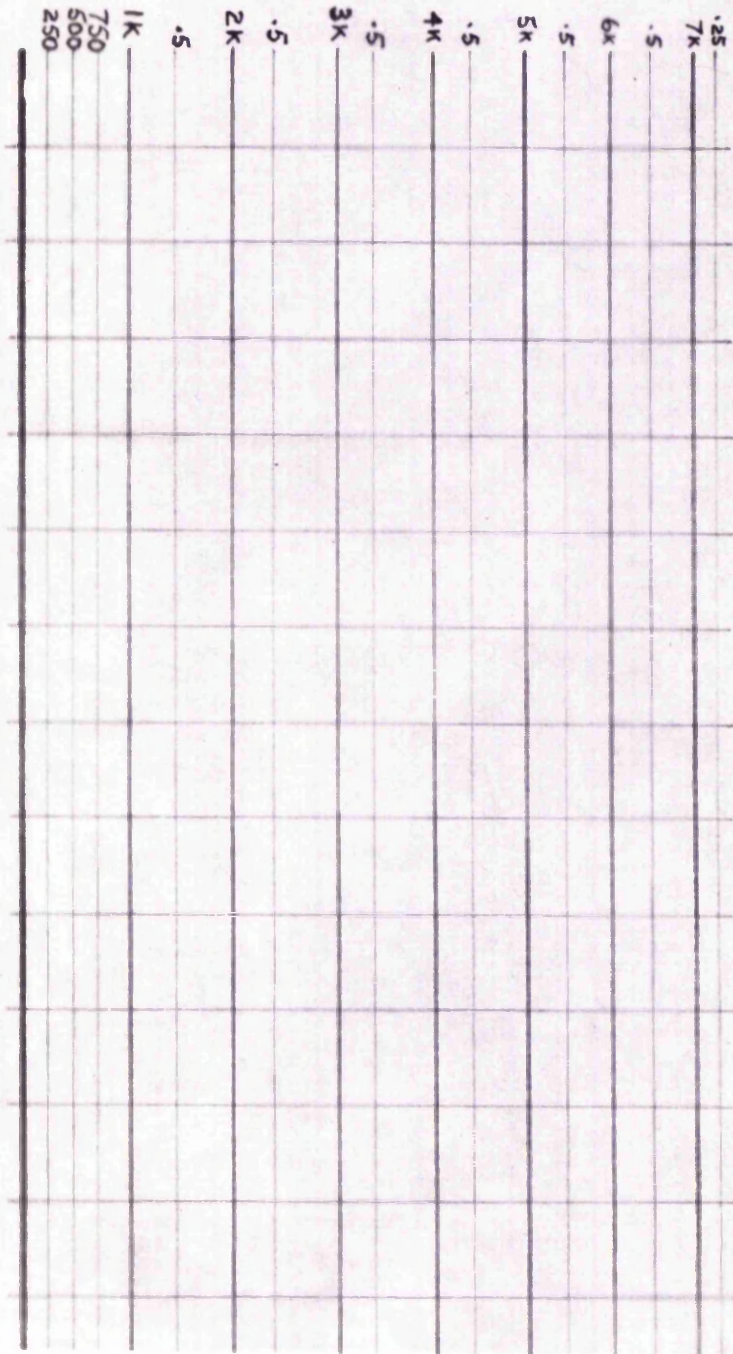

P R B Q U B N C Y I D H E R T Z

TIME in 0.1 SECONDS