

This PDF was created from the British Library's microfilm copy of the original thesis. As such the images are greyscale and no colour was captured.

Due to the scanning process, an area greater than the page area is recorded and extraneous details can be captured.

This is the best available copy

D 5320 5'85

Attention is drawn to the fact that the copyright of this thesis rests with its author.

This copy of the thesis has been supplied on condition that anyone who consults it is understood to recognise that its copyright rests with its author and that no quotation from the thesis and no information derived from it may be published without the author's prior written consent.

VI

AN INVESTIGATION OF NAVIGATIONAL DECISIONS.

By Captain J.L. Strange BSc.

This thesis was submitted in June 1984 to the Council for National Academic Awards in partial fulfilment of the requirements for the degree of PhD.

The report is based on work carried out in the Department of Maritime Studies at the City of London Polytechnic between September 1975 and June 1984.

Advanced studies undertaken during the period of the course:-

University of London Extra Mural Extension course in statistics and operational research, completed 1976.

Science and Technology of Navigation Diploma Course, completed 1976.

Declaration: during the period of this study I have not been a registered candidate for any other award and none of the material used in this thesis has been used in any submission for another award.

ABSTRACT.

An Investigation of Navigational Decisions by J.L. Strange.

This work is concerned with an examination of how the Merchant Navy Navigators use the information provided by the different aids.

It is divided into three main parts. First are a series of experiments where seafarers studying for their Master's certificate were presented with cards containing information from a number of different navigational aids, and asked to plot the position lines on a chart and then decide where they would consider the ships' position to be.

The second part was the design and construction of a simple non-interactive simulator based on slide displays and video recordings. The aids used were visual bearings, radar, Decca and the echo sounder. The information was taken from instrument readings recorded on board the training ship "Sir John Cass" during a voyage along the East coast from Southwold to Harwich. A number of flashing lights were included in the design to simulate the keeping of a lookout.

In the third part a similar group of subjects were asked to navigate a ship on two simulated voyages of half an hour's duration each, while at the same time to log the number of lights they observed. As a measure of their navigational ability they were asked to prepare a course to steer and an E.T.A. for a point about half an hour's steaming ahead of the position at the end of each exercise. A total of 17 dependent variables were identified during the experiment and these were tested in pairs for correlation.

From the results of these experiments it was possible to produce an order of the subjects' preference for the different aids, to demonstrate that the subjects preferred to use only two position lines when fixing their position and to examine how the subjects used these aids.

CONTENTS.

Section	Topic	Page
	Abstract	
	Acknowledgements	
	Introduction	1
Chapter 1	Literature Survey	9
Chapter 2	Experiment 1	38
Chapter 3	Bristol Channel Experiments	132
Chapter 4	Construction of the simulator	232
Chapter 5	The usefulness of the simulator	268
Chapter 6	Correlations of the variables	310
	Conclusions	365
	References	383
Appendix 1	Graphs of the relationships	1
Appendix 2	Data from the simulator	14
Appendix 3	Histograms of the variables	22
Appendix 4	The simulator lights	27
Appendix 5	Advance publications	34

ACKNOWLEDGEMENTS.

It would not have been possible to carry out this work without the advice and assistance of a large number of people both inside and outside the Polytechnic. The list of those who have assisted with both advice and encouragement is too large to name by individual and so where assistance has been given by a department only the department's name is mentioned.

First to the large numbers of students studying in the Polytechnic for their Master's certificate who generously gave their time thus making the project possible.

The two supervisors, Dr. J. Kemp and Dr. E. Goodwin for their efforts and patience during this work. Dr. J. Rolfe whose assistance as adviser was valuable in starting the work and designing the simulator.

Mr P. Davis Senior Technical Officer, who built the simulator and designed the system of lights described in Appendix No 4.

Mr. L. Glickman from the Department of Mathematics of the City of London Polytechnic who carried out the "Hotellings T" test described in chapter 5 and gave invaluable advice on the use of Minitab (47) for the

statistical calculations.

To the staff from the media-services department in the City of London Polytechnic for preparation of the video tapes and photographs used in the simulator and the drawings used in this text and in the two papers which have been presented on this work.

To the staff of the library at Tower Hill City of London Polytechnic for their assistance with the literature survey and Joyce Calvert for her advice on the preparation of the text.

To Captain Attwood and the crew of the training ship "Sir John Cass" for their assistance in obtaining the recordings used in the simulator.

To Shell International Marine for providing a grant which paid for the video recorders and other equipment used in the simulator.

INTRODUCTION

The problem of navigational decision making.

1. Historical Overview.

With the advent of electronic navigation systems and the digital computer there has been a radical change in the problems which face the navigator of a merchant ship today.

Ever since man first ventured out to sea, he lacked much of the information which he needed for his decisions and consequently navigation was considered as much a craft as a science. When navigation was taught to mariners the ability to extract all possible information from a given situation had to be the first priority, and very little time was spent on the qualitative aspects of this information. Today, in contrast, there is a vast range of equipment available to give the navigator information, an example of which, the Navstar system (1 and 2) will soon be capable of providing a position accurate to a few metres regardless of the weather, at any time, anywhere in the world. Yet in the teaching of Merchant Navy Navigations, little time is spent on the quality of the information.

The new equipment means that there has been a radical change in the problems facing the navigator, no longer is

he or she faced with an information shortage but rather with making the best use of what could prove an embarrassment of riches. Despite this, accidents still occur and strandings remain a considerable problem. This leads to questions about the design and provision of navigational equipment, questions which in the author's opinion cannot be properly answered without a prior knowledge of how the practising navigator makes use of the available information.

2. Strandings.

Today, despite the advent of high powered ships and the vast array of electronic systems which are available to the seafarer, ships still ground with a frequency which, although much reduced, is still a cause for concern. (2). Thankfully, today, loss of life from a stranding is relatively rare but the potential damage to the environment caused by some of the hazardous cargoes carried is something which could cause a disaster beyond the wildest imagination of previous generations of seafarers.

To put the danger of strandings in proportion, the following table of world wide total losses from various causes during 1981 of ships of 100 gross tons and over is taken from Lloyd's Annual Casualty return (3).

The number of strandings shown in the table are

obviously not all due to bad navigation, some of them will include ships that were wrecked as a result of engine failure and, unfortunately, at a time of low freight rates some of these losses may be deliberate.

Table 1. Total losses in the year 1981.

Cause	Number	Gross Tonnage	Percentage (Tonnage)
Foundered	120	243,822	19.7
Missing	10	24,545	2.0
Fire/Expl.	67	469,222	37.9
Collision	41	123,015	9.9
Contact	10	19,669	1.6
Stranded	100	232,029	18.7
Miscellaneous	11	125,948	10.2
Total	359	1,238,250	100.0

When these accidents are examined by nationality, the U.K. has always had one of the best records. Nevertheless, in the same year (1981) according to Department of Trade figures (4) 3 U.K. flag ships were lost and another 2 were classed as serious casualties as a result of strandings while the comparative figures for collisions were only 3 serious casualties. Over the period from 1972 to 1981 out of a total number of 105 U.K. ships lost, 32 were from strandings (4) against 14 from collisions. When a stranding occurs all the blame must attach to the one ship as unlike a collision, there is no other ship to share the blame.

It is very difficult to obtain information on casualties which have resulted in partial losses, but they are much greater than the number which have resulted in total losses. For instance in the year 1978 for which Giziakis (5) has noted 758 partial losses in an unpublished report in respect of ships of 500 tons gross and over worldwide, according to Lloyds (6) only 80 ships of 500 tons gross and upwards were total losses from this cause.

The author was first interested in this line of research when reading the reports of accident enquiries and being left with the feeling that in many cases the officers who were blamed and sometimes punished were not behaving very differently from the majority; it was just that they happened to be unlucky.

It was difficult to obtain evidence to prove or disprove this feeling, although there was a certain amount of information concerning accidents in the form of Department of Transport official enquiries and Chamber of Shipping Accident reports (7). Both these sources covered selected accidents only, and there was no evidence as to whether they were typical of accidents in general. Neither was there evidence as to whether their accidents were the result of isolated failures or if they were a symptom of bad navigational practices in general. An impression gained from reading what accident reports were available was that

in many cases there was sufficient information available for the navigator to prevent the accident from happening but for some reason it was neglected. This neglect of important information seemed likely to also be a feature of navigation in general but it is only brought to public attention when it results in an accident.

3. Equipment.

There was another reason why the author considered there was a need to investigate navigational practices in decision making. A considerable amount of research has been conducted into collision avoidance, some of which is discussed in Chapter 1, and one of the results of that research was the introduction of a computerised radar and collision avoidance system :ARPA (Automatic Radar Plotting Aid) (8). The introduction of the requirement to carry this system was considered premature by many people i.e. Cockcroft (9). He gave two main reasons in that he felt that the need for this system had not been properly demonstrated and that there was not the time to train seafarers in its use.

An integrated navigation system could be considered to be the logical next step from ARPA and since already by 1976 many manufacturers were designing this type of equipment, the author considered that there was a need for more investigations into how the navigators made use of the available information before legislation had the effect of

freezing the specifications into possibly unsuitable and even dangerous forms.

4. Outline of Research.

The research was started in 1976 and the first stage was a literature survey described in Chapter 1 to examine what other work had been carried out in this area and how it could assist in the planned investigation.

The first experiment was a pilot study described in Chapter 2, here the subjects were provided with a chart and a card providing information from the different aids. This experiment was designed to examine how the subjects treated the information from the different sources without being concerned with reading the aids themselves. This was used to examine the confidence the subjects placed in the different aids and their treatment of a situation where there was more than the minimum information needed to plot a position. This study produced some interesting and unexpected results so a second experiment using a larger sample and redesigned experiments was carried out, this experiment is described in chapter 3.

The construction and operation of a simple simulator is described in Chapter 4. The results from the first part of this work were used to select the aids and design the experiments used in this simulator.

Chapter 5 describes the tests used to validate the simulator, some of the tests were designed to verify the results of the card experiments. The other tests were designed to test whether the subjects were navigating in the simulator in a realistic manner.

Chapter 6 describes the experiments carried out in the simulator where the relationships between a number of variables which were identified in chapter 4 were examined. It was the relationships between these variables that provided much of the information concerning the use which the different subjects made of the information.

It was clear from the start of the work that the results would have to be analysed by statistical methods. The subjects would be drawn from students studying at the City of London Polytechnic for their Master's certificate and as time would limit the size of the sample available for each experiment so the work would have to be planned for statistical analysis from the start. This is described in Chapters 5 and 6.

It was accepted that this sample would not be fully representative of the population of navigators in general, as the students were expected to have between 6 and 12 years watchkeeping experience and be about 26 years old, whereas the total population would cover a much wider experience and age range. The subjects in the sample were

in the process of studying for their Master's certificate and knew that their actions were being examined so it was also expected that their performance would be slightly better than that of the general population. Any failings discovered in this sample, could therefore be assumed to be present in the larger population of navigators.

5. Treatment of errors by the subjects.

Although not taught in any detail for the professional examinations the statistical basis of navigational errors on which the selection of information depends is described by Anderson (10) and Fifield (11). The errors in the actual equipment are discussed by Sonnerberg (12), Wylie (13) and in the Admiralty Manual of Navigation Vol.3 (14).

CHAPTER 1

Published work in Navigational Decision Making and related topics.

1.1. Introduction.

The work that has been carried out on the uses of navigational aids falls into three classes. First there is the research which has been conducted in simulators on groups of subjects to investigate particular navigational problems: this was carried out mostly in the U.S.A. Second there are the questionnaire studies which have been conducted in several countries of which two of the best known are from the U.S.A. (16) and Japan (17). The third class comprises the investigations into bridge design and here there is a useful spin off in terms of research into navigational methods.

1.2. Simulators.

The first modern simulators were developed for the air forces and probably the best known is the Link trainer of the Second World War. Today the aircraft simulator is an extremely powerful tool capable of reproducing almost all

the characteristics of the aircraft which it represents.

The requirement for simulators was demonstrated by the need to teach pilots how to deal with emergency situations which are too dangerous to practice in the air. A good example is that of engine failure on take off, an event which, fortunately, is a rare occurrence but one which is potentially very dangerous to practice in an aircraft, particularly twin-engined and resulted in some fatal accidents before training was confined to the simulator (18). An additional bonus is that the running costs of the simulator are very much less than those of an aircraft as their utilization is better and there is a considerable fuel saving. Today it is possible for a trained pilot to qualify completely on a new type without actually flying the aircraft, as all the training can be carried out on the simulator.

Progress has been less spectacular in the marine field for two main reasons:-

To begin with it has not been possible to provide the same degree of realism on a ship simulator. The aircraft crew remain in their seats for the entire exercise so the graphics have to be realistic in one or two positions only. With a ship the crew move around the bridge to carry out their duties so the graphics have to appear realistic when viewed from any position on the ship's bridge. A level of

realism can be achieved by computer generated images (C.G.I.) or by a highly complex film projection system but this requires a very powerful computer which, although possible today, is very costly. Even so, there remains the problem of parallax associated with the changing viewpoints of the crew.

For this reason most simulators offer night, twilight or low visibility conditions only. This may be adequate when the simulator is only being used for training as navigation is usually more difficult under these conditions. When it comes to research however these systems suffer from a number of drawbacks. For instance most importantly much of the research has been needed to define the navigational requirements of port approaches yet in many circumstances, particularly when large ships and polluting cargoes are concerned, in practice navigation is restricted to daylight, clear weather conditions only. Another potential disadvantage is the difficulty of simulating the taking of visual bearings and the observation of transits, lack of which could produce misleading results, (see also 1.10.).

A further reason for the slower development in marine simulation is that the training requirements of the Merchant Navy deck officer are different from the airline pilots in that they have never been required to demonstrate their skills in a shipboard situation in front of an

examiner. Consequently there has never been a clear requirement for a complete ship simulator in the same way as there is for an aircraft. With the simulators in use today, there remains the impression that they were acquired because the technology was attractive and a role for them was sought afterwards. There does not seem to be the clear training benefits to justify the expense of this equipment.

The first use of simulators in the marine field was for radar training. After the Second World War shipowners started to fit radar to their ships, but it soon became apparent that this did not lead to any reduction in the frequency of accidents and after the collision between the Andrea Doria and the Stockholm in 1956, radar training became compulsory for all United Kingdom deck officers. A further development came with the introduction of the Radar Simulator in 1959. This was, and still is, a part task simulator and makes no attempt to do anything other than teach collision avoidance by the use of radar. It was probably because of these limited objectives that it has been so successful and is now a part of the deck officer's training. The next stage would seem to be the introduction of compulsory refresher training for all navigators.

1.3. Research Simulators.

The complete simulator is so expensive that in the U.K. most of the available time on the Simulators at Warsash and

South Shields is used for training, as that is the reason for which most of the simulators are funded. Thus it is not surprising that there is very little research time available and not much in the way of published material.

1.4. Computer Aided Operations Research Facility (C.A.O.R.F.)

CAORF was set up by the United States Maritime Administration to undertake work for the benefit of the U.S. Merchant Marine. The United States Maritime Administration is a government organisation whose objective is to stimulate the economic productivity and vitality of the U.S. Merchant Marine and as part of its research programme CAORF was set up. The funding of CAORF is partly by the U.S. Maritime Administration and partly by the organisations who sponsor the different research projects.

The aim of CAORF as stated was "to look at the man/machine interaction on board ship". It was set up when it became apparent what aircraft simulators could achieve and it was hoped that it could be used to examine the problem of human error which was stated in a Maritime Transportation Research Board report to be responsible for 80% of all accidents at sea (19).

The research programme started in 1976 and since then an impressive amount of work has been carried out (20), but

the cost of the simulator and the methods of financing the work means that most of the research must provide immediate returns to the sponsoring organisations, hence the experiments have been mainly concerned with the development of harbour approaches, the use of various radar plotting systems and the training of watchkeepers. The last two items have featured in discussion at I.M.O. (International Maritime Organisation) and have been incorporated in conventions concerned with the provision of Automatic Radar Plotting Aids ARPA (8) and the training of seafarers (21),(22). The United States' stand on these items was influenced by the results of experiments carried out at CAORF as well as by the environmental and other pressure groups which are part of the American political scene.

One of the difficulties with this type of research has been to obtain a large enough sample to produce realistic results. It takes a long time for the subjects to undertake the various tests and with some of the CAORF experiments training with the various aids was necessary before the experiments could be conducted. This placed a limit on the sample size and, therefore, on the number of replications which could be included in an experiment. Many of the CAORF experiments were therefore conducted with remarkably small numbers of subjects.

There are two CAORF experiments which are important to

the present work so they are discussed in detail not only because of the results of the experiments themselves but also to give some idea of the approach to research adopted by CAORF.

1.5. The Validation of Mate Behaviour on CAORF.

With all research conducted on a simulator there remains the question of validation since all of it is open to the accusation that the results relate to the simulator only. To counter these accusations the first experiment run by Hammell at CAORF(23) was to validate the simulator by testing a number of subjects and then comparing their reactions with data which had been collected at sea during a series of experiments concerned with bridge design.

The experiment consisted of three exercises, two of which were carried out in a simulated open sea situation while the third was carried out in the Dover Straits in order to simulate a congested sea area. Ten subjects were used, several having their Master's Certificates. They were divided into three groups each being assigned to one of the exercises.

The small sample size made some of the results open to question, particularly as only two subjects took part in the Dover Straits exercise, but in general terms the results gave some useful pointers to the present work.

First, in general, the validation was successful. The subjects' behaviour in the simulator was similar to that which had been observed at sea. The simulator was not fully operational at that stage as the only navigational aid available at the time was the radar, and if they wanted to consult another aid the subjects had to ask the supervisor for the readings. Consequently the main emphasis of the experiment was on collision avoidance by using radar but other navigational aspects were also included. As far as the present work was concerned it demonstrated that a simulator was capable of being used to model a navigational situation.

Second, the subjects were found to demonstrate a learning effect, for during the first two hours of the four hour experiment they showed a higher level of activity than would be normally expected at sea. This was put down to the fact that although they had been assured that it was a normal situation being simulated they were expecting some sort of surprise or "trick" to be played on them by the researchers, and it was not until they had spent about two hours in the simulator that they started to relax.

The same effect was found in the present work as the subjects plotted more positions and observed the aids more frequently than would have been the case at sea. Unlike the CAORF experiment the subjects were not given sufficient

time to relax. There was no evidence to suggest however that the subjects navigated any differently than they would at sea, only that they carried out the same tasks more frequently.

1.6. Comparison of Systems.

The second experiment related to the present work was:- "Effectiveness of three electronic systems as collision avoidance and grounding avoidance aids", conducted by Hayes and Wald (24). These experiments were designed to test the effectiveness of three different aids when the ship was navigating down a narrow channel in the presence of other ships.

The three systems were:-

- a) Radar Only.
- b) Radar with a collision avoidance system.
- c) Radar with a collision avoidance and a navigation system.

The subjects were twenty-four serving ship's Masters with Master's and Radar Observer's certificates who all had experience with tankers similar to the simulated 80,000 dwt. tanker used in the experiment.

The subjects were divided into three groups of eight and each group was assigned to one of the radar systems. As

they were not familiar with the newer radar systems each group was given two days training with their particular aid while the basic radar group were given refresher training in radar plotting.

The subjects were asked to navigate their ship down a narrow channel 12 miles long and 4,000 ft. wide with a visibility of 1/2 mile. There were a number of other ships about at the time and the subjects had to identify and avoid potential threats as well as to keep their ship within the channel. Each of the subjects carried out four runs with a different collision threat on each occasion making 4 X 3 X 8 = 96 replications.

The results of these experiments demonstrated that in this situation the subjects using the Radar + Collision avoidance + Navigation system had fewer incidents measured by collisions, near misses and groundings than either of the other two groups. Another advantage claimed of the collision avoidance system was that the subjects detected threats earlier and gave a wider berth to potential dangers. Those subjects without the navigation system however were put in a difficult situation by being expected to navigate along a narrow channel that was sparsely marked with buoys, by parallel indexing only as there was no other position fixing system available. It was not surprising therefore that the subjects chose to pass closer to another ship whose position was known rather than the poorly

defined channel edge.

The results also showed that although the group using the most sophisticated equipment had fewer incidents, the only group not to have a grounding were those operating with the conventional radar. As these experiments were mainly concerned with collision avoidance not much was made of this fact in the report and from this distance any comment must be speculative but it is possible that the more sophisticated systems were demonstrating some of the problems that were discovered in the early years of radar, namely the false sense of security and lack of appreciation of some of the shortcomings of the equipment. Should this prove to be the case there could be serious dangers with these systems because with this experiment it must be assumed that the equipment was always set up correctly before each exercise, which in practice might not always be the case. What these experiments did not examine was how a bridge "team" operating with two radar sets, one on true motion, would have managed the situation. This was how the problem might well have been tackled on a British ship.

1.7. Other Simulator Based Research.

Some time has been spent discussing CAORF experiments as they are one of the most important users of experimental simulators and their work has made a considerable impact on navigation equipment legislation through the American

influence at I.M.O.

The other series of experiments carried out in the U.S.A. and of interest to this study was entitled "Human Factors in Ship Control" by Mara (25). This series of experiments was primarily concerned with the design and layout of ships' bridges and how well the human can control the ship. The experiments were carried out in a simulator at the General Dynamics Corporation and were conducted for the ship operations research programme of the United States Maritime Administration. It was as a result of one of their experiments on ship handling in narrow waters that the idea of asking the subjects to log the lights observed as a side task, as described in Chapter 4, was developed. As used in the American experiment it was a measure of the subjects' work load. In the present work it was used to make the simulation more realistic by emphasising the fact that navigation was not the only task required of the watchkeeper.

Outside the U.S.A. the main published work on research carried out in navigational simulators has been in Japan (26), the Netherlands (27) and Norway (28). The Japanese experiments were concerned with collision avoidance in narrow channels and the Dutch with testing various bridge designs in different navigational situations. This work on bridge design was relevant to the present work and will be discussed later in this chapter.

Another use of a simulator was in Norway by Drager(28) where an experiment was made using it to investigate a stranding. Although the experiment was not successful because of lack of information it led to a recommendation that ships should be equipped with data recorders similar to those fitted on aircraft. This recommendation is currently before I.M.O. and may become law in a few years' time. Should data recorders become compulsory on ships it may lead to unemployment among the legal profession!

It is not surprising that so little research has been carried out on full navigational simulators when their cost is considered. In this country much of the cost is carried by shipowners and so they have the first call on simulator time for what they consider to be the priority need which is training. A new research simulator at U.W.I.S.T. has now been commissioned and so in due course there should be more published work on simulation in this country.

When the use of the part task simulator, particularly the radar simulator, is examined a different picture emerges. A considerable amount of published research has been carried out on these simulators and while much of this work has by its nature been concerned with collision avoidance, some of it is relevant to the present work. Kemp (29) investigated the relevance of some of the collision regulations while Hegart and Crawshaw (30) examined the

relationship between personality and ship handling behaviour. Important to this work is the experiment carried out by Curtis and Barratt of the National Maritime Institute (31) on the validation of simulator results. They demonstrated that the subjects behaved in the radar simulator in the same way as they behaved at sea and thus the radar simulator as an example of a part task simulator was an acceptable method of carrying out research into navigation problems, provided its limitations were understood. For a further discussion of these points see Chapter 5.

1.8. Research by Questionnaire.

A useful method of conducting research is by questionnaire, as it is possible to make use of a much larger sample than would be possible by other methods. Its results however tend to be imprecise because unless the researcher is present to amplify the questions it is not always possible to be certain that the subject will interpret the question in the way that the researcher intended. Thus, many questionnaires consist of only Yes/No types of question which tends to limit their usefulness.

A number of questionnaires have been used in navigational research, many as part of other experiments and they have provided some useful information. Some which

are relevant to the present work, are discussed below.

1.8.1. U.K. Survey. Holder, Liverpool U.K.(32).

As part of his research into navigational methods Captain Holder of Liverpool Polytechnic gave a questionnaire to twenty-six students studying for their Master's certificate at the Polytechnic. This was relevant to the present work because he drew his subjects from the same population as the present author, so their experiences and reactions should be similar.

He used the concept of a primary position fixing aid and a second aid to check the position. This is a concept which the author does not like because there is the danger that the information from the check aid will not be plotted and this could lead to the subjects navigating for some time using one aid and possibly two position lines only, with the dangers that this entails. (These dangers are discussed further in section 6.4.7.8.). A better method in the author's opinion is for the navigator to plot all the relevant information on the chart and then use his training and experience to decide what is the ship's most probable position.

The results of this study by Holder showed that a large proportion of those questioned (69%) considered that visual bearings were their preferred primary aid while 17%

preferred the Decca Navigator and 14% the radar.

When it came to the use of a check aid 58% preferred the Radar and 26% the Decca Navigator. The subjects considered that the Radio Direction Finder was only of use as a check on the other aids.

In the absence of any tests of significance, these results agree closely with those obtained from the present work although the preferences for the radar and Decca Navigator are probably connected with how the aids are used. It is easy for the navigator to plot a position using the Decca navigator and then check the position using a radar distance off a suitable point of land, while plotting a radar position and then checking with a Decca position is not so easy. This may lead to the danger of navigators just observing the radar without even plotting the position line on the chart, which could lead to blunders as demonstrated in sections 5.2.5. and 6.4.12.1.

Captain Holder in his report stated that he has a poor opinion of astronomical navigation. Although no reason was given it may be because it is less accurate than the satellite navigator and other electronic aids. Astro-navigation has the important advantage that its main errors are caused by abnormal refraction or misty weather leading to a poor horizon, conditions which are apparent to the navigator when he takes the observations. Thus they can

be taken into account when evaluating the results, a procedure not always possible when using most electronic aids. A second advantage of astronomical navigation is that most navigators are experienced in the techniques involved and have an appreciation of the errors in their results.

1.8.2. United States and Japanese surveys.

Important work was carried out by Carpenter and Waldo in America (16) and by Yonezawa and Miyoshi (17) in Japan. Again the results must be treated with caution because both surveys were concerned with the use of electronic aids and no questions about the role of visual bearings were included in the work. Thus what the present work has shown to be the most popular navigation aid in coastal navigation was omitted from these surveys.

The American survey consisted of a questionnaire sent to a number of serving Deck Officers on United States' merchant ships and, after the results were published, the identical questionnaire was given to a number of Japanese deck officers for the purpose of comparison. As well as providing information on the use of the different aids the surveys gave an indication of what equipment was fitted on the various ships and also some unquantified opinions on its reliability.

The first preference for an electronic aid was the

radar although in each case it was clear that this was due at least in part to the fact that it could be used for collision avoidance as well as for navigation. The second preference was for loran in the American survey and the echo sounder in the Japanese. This must be due, in part at least, to the fact that there was not complete loran coverage of the trade routes commonly followed by Japanese merchant ships, while most American ships were engaged on coastal voyages where there was complete cover. In both cases, although there was not complete Decca coverage on the routes followed by the ships examined in the survey, on the few ships where it was fitted it was used wherever possible.

In both studies the radio direction finder, although fitted, was seldom used by the Japanese but more frequently by the Americans. One reason seemed to be that, in general, the Japanese ships were newer and better equipped with navigational aids, in particular Loran and Decca, so there was no need to resort to the D.F. Another useful finding was that the Americans seemed to have problems of reliability with some of their aids so they tended to be forced to use the D.F.

1.8.3. Netherlands and Swedish Surveys.

As part of their research into bridge design, Moraal et al. of the Netherlands Ship Research Centre TNO, sent out a

detailed questionnaire to serving masters and pilots (33). This was used as a pilot study for their more detailed work on bridge design (section 1.9). In a similar manner to the Japanese study the Swedish Ship Research Foundation later gave the Dutch questionnaire to serving Swedish masters and pilots. (34)

The questionnaire was concerned with bridge design and the only parts of interest to the present work are:-

a) The importance of good visibility. All groups tested agreed with the statement that "everything in navigation depends on good perceptual conditions". This must tie in with the preference for visual bearings demonstrated in the present work (section 3.9.1.1.).

b) Use of radar: 58% of the Swedish masters and 64% of the Dutch masters considered that both true and relative motion radar displays were necessary for navigation in poor visibility. As this work was completed before the CAORF experiment, described in section 1.6, it was unfortunate that the use of two radar displays was not included in that work.

c) Lack of time: both the Swedish and Dutch groups agreed that there was not always enough time to make the correct decisions. This agreed with the relationship between the time spent watching the aids and the number of lights

observed in the present work (section 6.4.4.1) where it was apparent that the subjects were forced to allocate priorities.

1.9. Bridge Design Studies.

There has been more work carried out on bridge design than on the use of navigational aids, but this apparent contradiction can be explained by the fact that many of the aids are grouped together on the bridge and from the point of view of layout it is not important which aid, out of a particular group the navigator decides to use.

When sail gave way to steam the ship's bridge as we know it today first evolved. In sailing ships it was necessary for the watchkeeper to note every change of wind direction in order to ensure that the sails were properly adjusted if the ship was to sail her intended course. The need for this passed with the arrival of steam and it was possible to provide some form of weather protection for the navigating position. Tradition dies hard however and although shelter was provided for the helmsman, it was considered that the only way for the officer on watch to keep a proper lookout was by being exposed to the weather. This obviously absurd tradition continued until the 1960s when the introduction of electronic equipment, which required weather protection, forced the watchkeeper to come indoors in order to operate it. A relic of this attitude

today is that there are still large numbers of ships where the arrangements for keeping the bridge windows clear are totally inadequate. Another attitude which still persists is the idea that the watchkeeper should not be allowed to sit while keeping his watch in case he falls asleep during the night watches, despite the fact that for many years operators in other industries have been allowed to sit and have not fallen asleep.

With the advent of the enclosed bridge and the increase in electronic equipment carried in merchant ships it became obvious that some sort of ergonomic approach was necessary if the best use was to be made of this equipment.

One of the earliest references to the need for ergonomic navigational displays was contained in a paper presented to the then Institute of Navigation on the "Display and Use of Navigational Intelligence" by Majendie in January 1958.(35) In this paper the author described some navigational control systems and, what was more important to the present work, he called for closer collaboration between the designers and users of navigational equipment.

A point of interest is that the writer joined his first ship in the same month that this paper was presented. On this particular ship there was no electronic navigational equipment on the bridge: indeed a simple gyro

compass was all that distinguished this bridge from that of a ship of 50 years earlier. There was a primitive radar and Decca navigator but they were in the chart room which was separated from the bridge by a corridor. The radio direction finder was in the radio room, a situation which persisted for many years and resulted in this aid being considered the preserve of the radio operator. This was responsible, at least in part, to the reluctance of navigators to make a proper use of this aid, and could have contributed to the stranding of the Stancrown (36)

In 1964 a paper by Bentskowsky et al. entitled "A control system for ship's bridges" (37) anticipated much of the later work and indeed the bridge so described would be an improvement on many in service today.

Owners were quick to realise that apart from increased safety there was the additional bonus of reduced manpower if the bridge design was carried out properly. The first example of automation in navigation was the automatic helmsman which appeared before the second world war and now pays for itself, not only in reduced manpower but in the more important role of reducing fuel consumption which results from the more consistent steering.

Today, further work is being carried out in bridge automation with the ultimate aim of the unmanned bridge. Once this can be achieved it should be possible in

principle to run a ship without any crew. This could probably be achieved with the technology available today but the development costs are so high as to require government finance. There would be strong objections to such a ship on environmental and employment grounds so it seems unlikely that any government would finance such a project in the foreseeable future.

Most maritime countries are involved in some form of bridge design study. They usually start with an investigation to identify the defects in present bridge designs and from these findings work out an improved system. This is then tested either in a simulator or on a ship at sea, and leads to some form of standard bridge design. Unfortunately, every study leads to a different standard design! Of the various studies that were carried out two of the best known were by the Netherlands Ship Research Centre in Holland (27) and by the National Maritime Institute in England (38).

1.10. Bridge Design in the Netherlands.

In the Dutch study, (27) after an improved bridge had been designed a number of subjects were asked to evaluate several mock-ups. The subjects were drawn from three groups, Dutch masters and mates, Dutch pilots and foreigners. All the subjects from the first two groups had current sea experience but some of the foreigners had not

been to sea for some time and were employed in the industry in a capacity that was connected with the design of ship's bridges. The inclusion of pilots was important because although the ship spends a very small proportion of its time under pilotage it is during this period that, according to Cockcroft (39), the ship is most at risk as a high proportion of accidents occur in pilotage waters.

The subjects were asked to assess the relative importance of the different aids by means of a questionnaire. This questionnaire was more detailed than those used in the American and Japanese studies reported in section 8.2 of this chapter. It also had the benefit that the subjects completed the questionnaire while they were evaluating the bridge designs so the results should be more reliable. The results from this survey were similar to the preferences demonstrated in the present work with two important differences.

The first was that the preference for visual bearings was less than that shown in the present work. Unfortunately there was no explanation as to how they were treated as in the Dutch study they were grouped under the general term of "course setting" and this may be a clue as to how the subjects viewed these aids. In the Dutch study, "course setting" did not rate as highly as radar, although from the present work there was no doubt that the subjects considered that visual bearings were the most important

method of position fixing. With the Dutch study being concerned with bridge design, no attempt was made to distinguish between navigation and collision avoidance, because both functions have to be carried out simultaneously and the subjects were being asked to judge the suitability of the bridge for both tasks, thus the radar was being assessed for both functions, while visual bearings only play a minor role in collision avoidance. Whatever the reason, the neglect of this position fixing aid was an important omission from the Dutch study.

The second difference was that the Dutch Officers seemed to attach greater importance to the echo sounder than do the British Officers in the present study, which could well be because of the shoal water around the Dutch coast.

1.11. Bridge Design in the U.K.

The British Study conducted for the National Maritime Institute (N.M.I.) (38) was carried out at about the same time as the Dutch Study. A team of researchers visited a number of different ships and studied the movements of the navigators. From this study a pattern of movement was observed and a code of practice on bridge design was developed (40). A bridge design based on this work is now being tested at sea on board a coastal tanker. This work also forms the basis of a computerised

navigation system developed by Decca (38). Unfortunately there were little data available from this study so it was not possible to examine the pattern of observation of the navigational aids in the first data collecting exercises.

Unlike the Dutch experiment the Decca bridge is being tested at sea so it is not possible to monitor the reactions of as wide a number of navigators as in the other study. This is partly due to the lack of a suitable simulator in this country and it is hoped that when the simulator at U.W.I.S.T. is commissioned one of the early experiments will be to examine the recommendations which resulted from the N.M.I. study.

One finding from the N.M.I. study was that in a crisis the watchkeeper tended to stand in the middle of the bridge cutting himself off from the information available from the different aids. From the present work it seems that it is not only in emergencies that this occurs but rather it is a general problem. The N.M.I. noted that in some circumstances the subjects did not have the time to collect the necessary information. The problem is deeper than this and seems to be connected with the navigators lack of ability to make use of all the available information, which is discussed in section 6.5.2. in the light of results from the present work. A badly designed bridge will cause unnecessary difficulties for the organisation of information flows.

A weakness of all these bridge design studies has been that the importance of visual bearings has been understated. This is probably because they are difficult to integrate in a computerised navigation system and in the case of the Norcontrol bridge design (41) they have been omitted altogether from the integrated system. With the Manav system developed by Decca and the N.M.I. they are included, but unless future bridge designs include visual bearings there is the danger that this important navigational method could be lost. As the present generation of navigators place considerable reliance on these methods this must be sufficient reason for incorporating them in any future computerised bridge design.

1.12. Summary.

This review covers a wide range of work, but only the papers by Waldo and Carpenter (16) and Yonezawa and Miyoshi (17) are directly concerned with the preferences for different navigation aids and unfortunately they do not concern themselves with the use of visual bearings. This was partly because until now the choice of aid has never been a problem, as for many years there was no choice. Ships carried a limited number of aids and it was usually only when a ship was in an area covered by Decca and in sight of land that a decision by the navigator was

required. It is only comparatively recently that the electronic revolution has increased the number of aids and also the problem of choice.

In previous years the decision about what aids to fit was left to the shipowner but recently new legislation has taken this decision out of the his hands and the problem of the correct choice of aids by the navigator has now become universal.

From the published work a number of points have emerged which have an important bearing on the present work:-

a) Sample size. One of the problems when conducting experiments which involve using people as subjects is the length of time which it takes to build up a suitable size sample. With the present work all the subjects were volunteers and the experiments had to be conducted during their lunch hour thus only one subjected could be tested per day. Despite these problems the sample size used in the present work compares favourably with those of the other experiments described in this chapter.

b) Preferences for the different aids. Although there are slight differences because the work was intended for other purposes, the preferences for the different aids are very similar to those demonstrated in the present work. The

important difference is that the clear preference for visual bearings was demonstrated only by Holder (32)

c) Simulators are accepted as a method of conducting navigational research. There are a large number of experiments conducted in both full and part task simulators and both types have been validated (23), (31). There are differences between behaviour in a simulator and behaviour at sea and these are discussed in the appropriate parts of this report.

d) Underestimation of the importance of visual bearings. Only Holder (32) mentions that visual bearings are still considered to be the most important aid to navigation in coastal waters. Is this because only British Officers consider this to be the case or, more likely, has the tendency by researchers to concentrate on the more glamorous electronic aids obscured what the present work has demonstrated to be the most popular of all the aids?

CHAPTER 2

Experiment 1.

2.1. Background.

At the start of this work in 1976 the only published information available on which to base these experiments was in the form of accident investigations and reports. This information was not suitable for use in the design of the experiments for two main reasons. Firstly not all accidents are investigated, so the only published reports are those concerning accidents which the Department of Trade (now) Transport choose to investigate. Since the reasons as to whether a particular accident is to be the subject of a formal investigation are not published these reports cannot even be considered a representative sample of the different accidents which were a result of bad navigation, far less can they be used to give an insight into navigational practices aboard the average merchant ship. The second reason is that because the investigations are carried out in public it is possible that not all the information on the events leading up to the accident is available even though the primary cause may well be established.

What was needed therefore was a small scale experiment to examine how seafarers managed the information from the

different navigational aids and use this as the basis for the design of future experiments.

2.2 Objectives of the Experiment.

The Object of the experiment was to examine how the subjects decided on a position when given more information than was necessary for the particular task and were therefore forced to make decisions. There were two aspects of this process that were of particular interest:-

1) The subject's preference for a particular aid. Some work has already been published on preferences for different navigational aids, see Carpenter & Waldo (16), Yonezawa & Miyoshi (17) and Holder (32), but these and similar investigations discussed in Chapter 1 were carried out by means of questionnaire studies. In this exercise the intention was to investigate these preferences by examining how the subjects decided on a ship's position when given information purporting to come from more than one aid.

2) The other objective was to examine whether the subjects were making use of all the available information. In this experiment, it was expected to be demonstrated by the subjects' choice of either an intersection of position lines indicating that not all the information was used or a mean position among several lines indicating that the subjects were making a choice based on their experience and

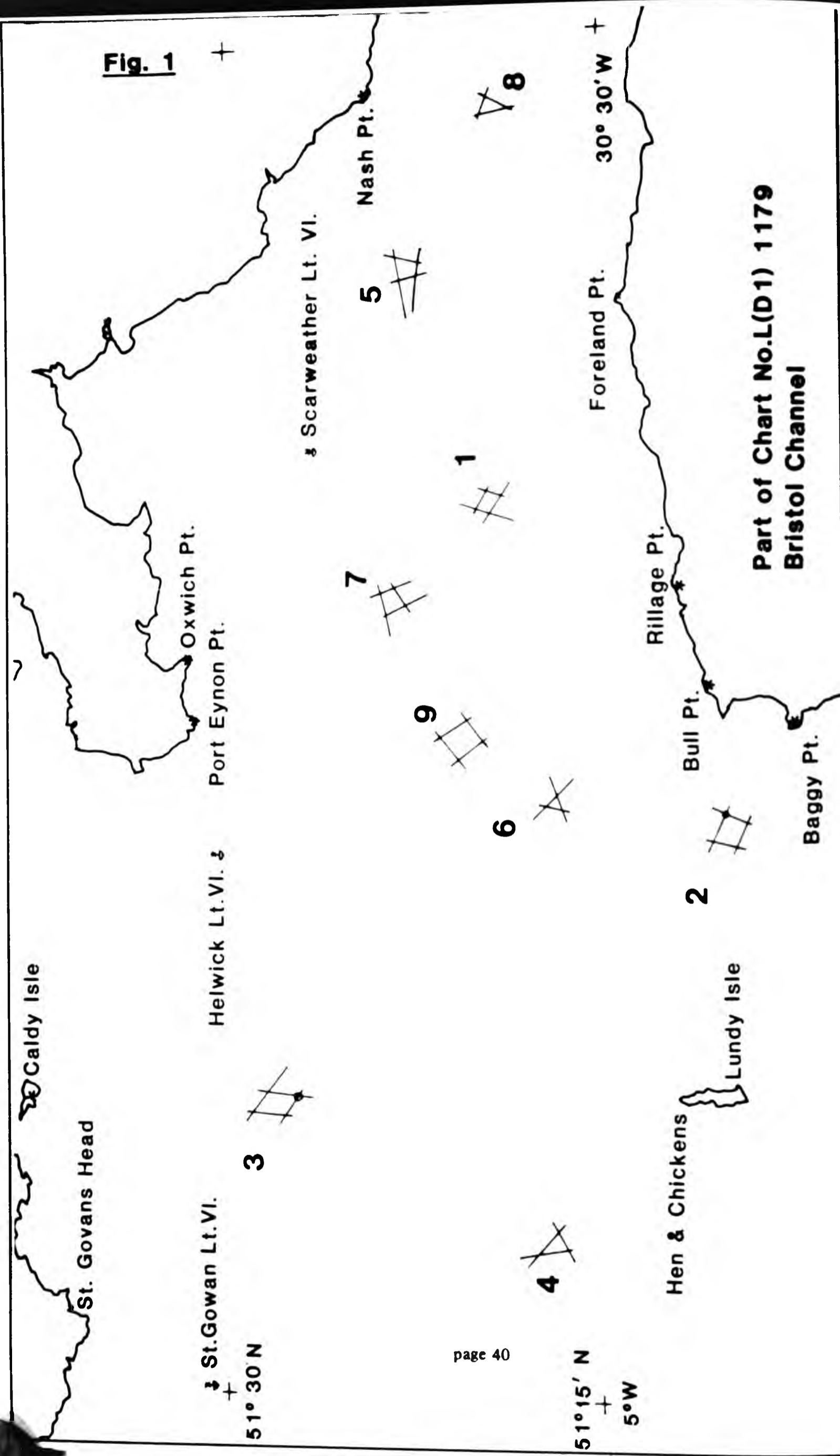

Fig. 1

giving some weight to all the available information.

The navigation aids used in the experiment were radar, Decca Navigator, radio direction finder and visual compass bearings. The method adopted was generally to test these aids in pairs so that preferences could be established and also generally to provide the subjects with four position lines in each test so that they had to make decisions on how to treat the relevant information.

There was the possibility that in some of the experiments the subject's preference for, or rejection of, a particular aid might influence his choice of an intersection or a mean position among several position lines so a number of experiments were devised where only one aid was examined and the subject's choice of position became more dependent on the geometry of the figure.

The experiment was devised to present a situation where the subjects were presented with navigational data for a ship on a series of cards. They were then asked to plot these data on Chart No. L(D1)1179 and indicate where they considered the ship's position to be. This provided the basis of an experiment that could be set up quickly because no apparatus was required apart from a chart. The Bristol Channel was chosen because there was a wide range of different navigational aids available while the configuration of the land and the different banks gave

considerable scope for the design of the exercises (see fig 1). The only alteration to the chart was to assume that there were beacons for use with radio direction finders on the St.Gowan, Helwick and Scarweather lightships.

2.3. Design of the Experiment.

Nine independent exercises were devised and presented to the subjects in random order (Fig 1) to ensure that the variation resulting from any learning effect was spread evenly among the results. In any one exercise the subject was presented with a card containing readings from different navigational aids and he was asked to plot the information on the chart and indicate where he considered the ship's position to be.

No attempt was made at this stage to ask the subjects to read the aids themselves as their opinion on the reliability of the aid itself was required not how easy it was to read or use.

When the information was plotted on the chart the position lines gave a "cocked hat", usually in the form of a quadrilateral. The size of the figure was important; too large and the subjects would consider it to be unreal; too small and it would be difficult to extract the necessary information. Four out of the twenty subjects complained

that the cocked hats in some exercises were too large and stated that they would "check the readings", but most of them accepted the figures without any comment.

2.4. Tests and Hypotheses.

The results were a scatter of positions around the figure produced by the four position lines that were usually given in the test. The statistical test chosen was the "Chi-squared goodness of fit" test (42) which was used to check whether the results showed random behaviour or not. If the distribution of the results was not random then the subjects were considered to be making reasoned choices based on their training and experience and it would be possible to interpret the results on that basis.

To standardise the analysis six pairs of hypotheses were chosen, and these were tested against the results of each of the nine exercises.

2.4.1. Test Number 1.

Did the results show any signs of a preference for a particular strategy in the treatment of the data on a first examination? Before the results were examined in detail this test was intended to look for signs of a preference amongst a number of different strategies, otherwise the results could be assumed to be random. This would then

indicate that there was no preferred method of navigating in the given situation.

H₀ The subjects showed no preference for a particular strategy or strategies.

H₁ The subjects preferred at least one strategy.

2.4.2. Test Number 2.

Among the subjects who chose corner positions, was there any evidence of a preference for one particular corner?

H₀ The subjects showed no preference for one particular corner.

H₁ The subjects preferred at least one of the corners.

2.4.3. Test Number 3.

Was there any evidence of a preference for one particular method of position fixing? In some tests this could indicate a preference for one aid or another, but in other cases, for example radar, this could indicate how the

aid was used. Where the circumstances warranted it, this test could be carried out in two parts, first among those subjects who used one aid only and, second, with those subjects who used several aids, with the preferences allocated among the different aids.

H₀ There was no preference for one particular aid.

H₁ The subjects preferred at least one of the aids.

2.4.4. Test Number 4.

Did the subjects base their positions on information taken from one aid only, or did they take all the aids into account when they fixed their positions? This test was not totally satisfactory because the subjects were asked to plot all the information on the chart before deciding on their position, a situation which would be unlikely to occur in practice. The result was important however because the use of one aid only can be dangerous if there are any errors in the readings, since they could go undetected for some time.

H₀ There was no preference for the use of one aid only, rather than a combination of aids.

H₁ The subjects preferred to use either one particular aid or a combination of aids.

2.4.5. Test Number 5.

Did the subjects prefer a position on an intersection of two position lines or did they prefer a central position among several lines? Because of the various errors the position lines do not all intersect at a point but rather cover an area of the chart and the ship's position would be somewhere in this area. A preference for an intersection of two lines would suggest that the subjects were unaware of this fact. A preference for a central position would suggest that the subjects had a better understanding of the problem. The test for preference was made against the null hypothesis that it was equally likely that the subjects would choose either a position line intersection or a central position.

H₀ There was no preference for either an intersection of position lines, or a mean position among several position lines.

H₁ The subjects preferred either an intersection of position lines, or a mean position among several lines.

2.4.6. Test Number 6.

This test followed on from Number 5. Of those subjects who chose a position among several position lines, did they choose the geometric centre or did they choose some other position? The geometric centre was only the most likely position if all the aids demonstrated an equal error, a situation which would be unlikely in practice. A position displaced from the centre could be considered to demonstrate that the subject made a considered choice and was favouring one of the aids. The test was made under the null hypothesis that the subjects would choose either the geometric centre or a weighted position with equal likelihood.

H₀ There was no preference for either the geometric centre or a weighted position.

H₁ The subjects preferred either the geometric centre or a weighted position.

An added advantage of using these standard tests for all exercises was that where the sample size was too small

in one exercise to conduct a viable test it was sometimes possible to combine the data from several exercises. In particular because the subjects demonstrated a dislike for a mean position it was not possible to carry out test No. 6 in any of the individual exercises and so this test was made at the end of the experiment on the combined results, see section 2.9.4.

2.5. Statistical Test.

The statistical test chosen for this work was the "Chi-squared Goodness of fit test."(42)

In this test the value of Chi-squared is calculated from :-

$$\chi^2 = \sum_{\text{CELLS}} \frac{(O_i - E_i)^2}{E_i}$$

where :-

O - The number of observations in a given cell.

E - The expected number of observations in the cell.

Where the expected value was less than 10 and the

degrees of freedom were unity, then the test was modified in the following manner to compensate for the small sample size (42):-

$$\chi^2 = \sum_{\text{CELLS}} \frac{((O_i - E_i) - 0.5)^2}{E_i}$$

The expected value was the number of observations that would be expected under H_0 . In this case, because the Null Hypothesis (H_0) was to assume that the data were randomly distributed, the expected value was taken to be the mean of the number of observations.

It is called the "goodness of fit test" because it compares the number of observations made in a given distribution with the expected number under (H_0). The value of Chi-squared so obtained is then tested for significance using tables (43).

2.6. Region of Rejection.

The region of rejection consisted of all values of Chi-squared such that the probability of rejecting H_0 when it was in fact true, α , was equal to or less than .05.
i.e. $\alpha \leq .05$

2.7. Significance Levels.

The significance values for Chi-squared are given in the following table (43):-

Table 1. Critical values of the Chi-squared statistic.

Alpha	Degrees of Freedom		
	1	2	3
.05	3.84	5.99	7.81
.01	6.63	9.21	11.34
.001	10.83	13.81	16.27

In this chapter a result significant at $\alpha = .05$ is denoted by *, at $\alpha = .01$ by ** and at $\alpha = .001$ by ***

2.8. The Nine Exercises.

For a list of the nine exercises see section 2.10.

2.8.1. Exercise Number 1.

2.8.1.1. Introduction.

The subjects were given a card with the following information:-

"You are bound inwards for the Breaksea Light Vessel with visibility about 4 miles and your radar is not

Fig 2 Decca and D.F.

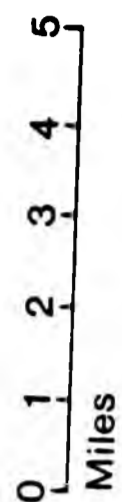

Scarweather 

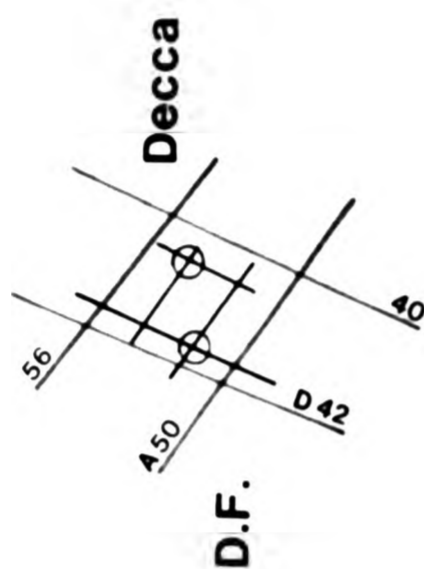

 Helwick

working. D.F. bearings (corrected) are Scarweather Light Vessel 021° true, Helwick Light Vessel 134° true and Decca readings are Purple A 55.2 and Green D 40.2 Mark your position on the chart."

This test was designed to look for a preference between the Decca and the radio direction finder (D.F.)

When plotted the bearings formed a diamond shape with a diagonal of about 1 mile. The D.F. and Decca positions were an equal distance, about 7 miles off the Devon coast (see fig.2). To prevent the subjects' choice being biased by the proximity of land, and deciding on a position which places the ship closest to the potential danger, the ship was designated as being bound inwards to the Breaksea Light Vessel where there was land on both sides. The other possible navigational effect was that the intersection of the Decca lines put the ship further ahead and there was a case for selecting this position as the most dangerous position. The rather unlikely choice of aids was justified by the poor visibility and the fact that the radar was not working.

2.8.1.2. Results.

The results divided into the following groups:-

Table 2. Subjects' identity numbers v combination of Position Lines.

1) Decca Only. 2,6,10,11,12,16,18 and 20	Total 8
2) Mean Position. 1,7,13, 15 and 17	Total 5
3) D.F. Helwick /Decca green. 5	Total 1
4) D.F. Scarweather /Decca purple. 4	Total 1
5) D.F. Only. 14	Total 1

Subjects numbers 3,8,9 and 19 had no current experience with Decca and so their results could not be used for this exercise.

2.8.1.3. Test Number 1.

This was to test the above groups to see if there was a preference for a particular strategy. The test used was the "Chi-squared goodness of fit test" (χ^2)

H_0 The subjects showed no preference for one particular strategy.

H_1 The subjects preferred at least one strategy.

It was not possible to test the groups as they stood because the cells were too small for a χ^2 test, so the data were combined into the following groups:-

Table 3. Observed and expected frequencies of navigational strategies.

Strategy	Observed	Expected
One aid only	9	5.33
Both aids	2	5.33
Mean Position	5	5.33
Total	16	16.00

This gave a value of χ^2 of 4.63 on two degrees of freedom, which was less than the critical value of 5.90. The result was non significant, the null hypothesis was accepted and the alternative hypothesis rejected. There was no evidence that the subjects chose a particular strategy.

2.8.1.4. Test Number 2.

Of the subjects who chose corners was there any evidence of a preference for a particular corner?

H₀ The subjects showed no preference for one particular corner.

H₁ The subjects preferred one of the corners.

The sample was too small to test the four corners independently so the results were combined.

Table 4. Observed and expected frequencies of the subjects' preferences for the different corners.

Corner	Observed	Expected
Decca	8	2.75
Others	3	8.75
Total	11	11.0

Testing gave a value of χ^2 of 13.36*** on one degree of freedom. The result was significant, the null hypothesis was rejected and the alternative hypothesis accepted. There was strong evidence that the subjects selected the Decca only corner.

2.8.1.5. Test Number 3.

This test looked for evidence of a preference for one of the aids. Because of the sample size, the test had to be carried out using all the data.

H₀ There was no preference for one particular aid.

H₁ The subjects preferred one of the aids.

The allocation for the two aids is given in the following table:-

Table 5. Subjects' choice between Decca and D.F.

Position	Decca	D.F.
Decca only	8	0
D.F. Only	0	1
D.F. Helwick/ Decca	0.5	0.5
D.F. Scarweather/ Decca	0.5	0.5
Centre Position 1, 7, 13 and 17	2	2
Centre Position 15	0.75	0.25
Total	11.75	4.25

Table 6 shows the above values in the form for the χ^2 test:-

Table 6. Observed and expected values for the subjects' choice of aid.

Aid	Observed	Expected
Decca	11.75	8
D.F.	4.25	8
Total	16.00	16

This gave a value of χ^2 of 3.32 on one degree of freedom. The result was not significant and the null hypothesis was accepted. From the look of the data a larger sample might demonstrate a preference for the Decca, particularly when the previous result is also considered.

2.8.1.6. Test Number 4.

Did the subjects base their decisions on information from one aid only, or did they take the information from both aids into account when fixing their position?

H_0 There was no preference for the use of one or both aids only, rather than a combination of aids.

H_1 The subjects preferred to use one particular aid or a combination of aids.

In this exercise the subjects who used one aid only

were those who chose the Decca only or the D.F. only position. All the other subjects combined the aids in some manner. The distribution is shown in table 7:-

Table 7. Subjects' choice between one aid or a combination of aids.

Strategy	Observed	Expected
One aid only	9	8
Both aids	7	8
Total	16	16

It was clear from the above data that the result was non-significant and the null hypothesis was therefore accepted. This finding was important in that no preference was found for the prudent strategy of combining the information from the two aids. More than half of the subjects were prepared to use one aid only when fixing their position, thus rejecting some valuable information that was readily available.

2.8.1.7. Test Number 5.

Did the subjects prefer an intersection of position lines or did they prefer some sort of mean position among several position lines?

H₀ There was no preference for an intersection of position lines, or a mean position among several lines.

H₁ The subjects preferred an intersection of position lines, or a mean position among several lines.

In this exercise the test was looking for a preference for either the corner or the centre position. As subject number 15 chose a position that was on a position line but not at an intersection his position was distributed 50/50. The distribution is given in the following table:-

Table 8. Subjects' choice between Position Line intersection or central position.

Position	Observed	Expected
Intersection	11.5	8
Mean Position	4.5	8
Total	16.0	16

This gave a value of χ^2 of 2.25 on one degree of freedom; the result was not significant, and the null hypothesis was accepted. Again this non-significant result was probably a consequence of the small sample size, but, as in the previous test, it demonstrated that many of the subjects neglected much of the information which they had been given.

2.8.1.9. Conclusion.

Although test number 3 (2.8.1.5) did not demonstrate a preference for either aid when the data were combined, eight out of the sixteen subjects taking the exercise selected the Decca only position while only one subject selected the D.F. only position so there was some evidence of a preference for the Decca navigator.

This exercise was inconclusive in some respects because of the small sample size. What started as a reasonable sample was reduced because four of the subjects had no current experience with Decca and so were unable to take part. Test number 1 was inconclusive, and tests 3 and 5 might well have been significant if the sample size had been larger, but it will be possible to repeat these tests later with larger samples. (see section 3.8.6.)

Two important facts emerged from this exercise. First there was a wide range of different strategies followed by the subjects. Second was the large number of subjects who used one aid only and so ignored much useful information.

2.8.2. Exercise Number 2.

2.8.2.1. Introduction.

The subjects were given a card with the following

Fig 3 Decca and Radar

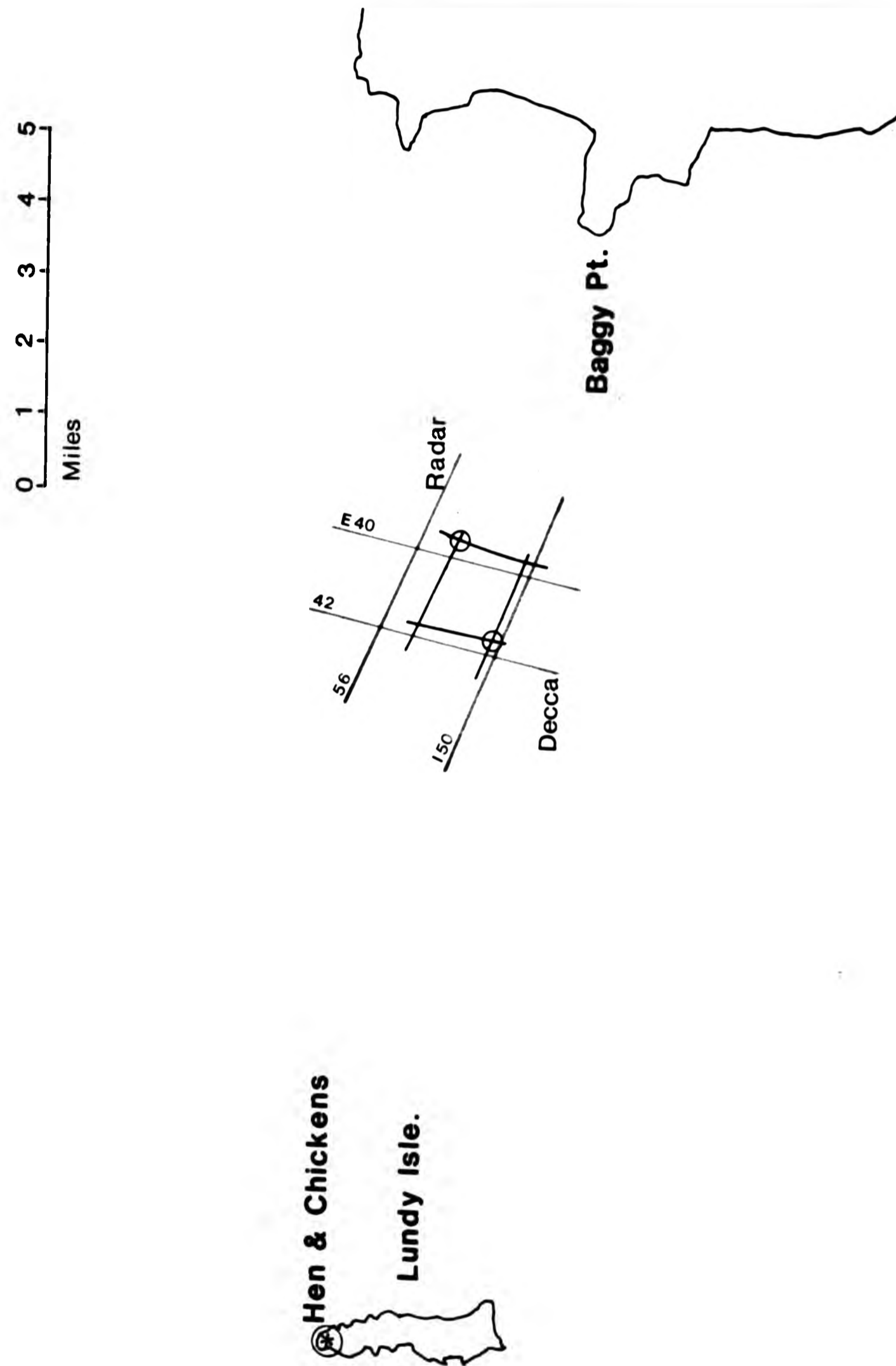

information:-

"Outward bound from Appledore to Milford Haven, Decca Readings are Purple I 50.2 and Green E41.9 while a radar bearing and distance off Baggy Point was 114° x 4.7 miles. Mark your position on the chart."

The results when plotted gave a diamond between Baggy Point and Lundy Island with the Decca Position closer to Lundy Island. The diamond measured 1.5 miles diagonally. The radar position put the ship closest to the land (fig.3).

The object of the exercise was to test for a preference between Decca and radar. In order to prevent the subjects from selecting the position closest to the land the ship was put on an outward course with the closest land astern, and the next nearest land at St.Govans Head.

2.8.2.2. Results.

The results divided into the following groups:-

Table 9. Subject identity numbers v Combination of Position Lines.

1 Radar Only.

1,2,4,11,12,13,14,15,16 and 18 Total 10

2 Decca Only.

6 and 10 Total 2

3 Radar distance and Decca purple.

20 Total 1

4 Centre Position.

5,7 and 17 Total 3

Subjects 3,8,9 and 19 had no current experience with Decca and so did not take part in this exercise.

2.8.2.3. Test Number 1.

This test examined the results to see if there was evidence of any particular strategy. Again the sample size was too small for a χ^2 test but an examination of the results suggested that there could have been a preference for the radar only position.

2.8.2.4. Test Number 2.

This test looked for a preference for a particular corner.

H₀ The subjects showed no preference for one particular corner.

H₁ The subjects preferred one of the corners.

In this exercise thirteen subjects had a choice of four possible corners so in order to carry out the χ^2 test the results were combined:-

Table 10. Subjects' preference for the Radar only or other corners.

Corner	Observed	Expected
Radar Only	10	3.25
Others	3	9.75
Total	13	13.00

Testing gave a value of χ^2 of 18.67*** on one degree of freedom, the result was significant, the null hypothesis was rejected and the alternative hypothesis was accepted. There was strong evidence that the subjects preferred the radar only corner.

2.8.2.5. Test Number 3.

This test examined whether a preference existed for one or other of the aids.

H₀ There was no preference for one particular aid.

H₁ The subjects preferred one of the aids.

The results were allocated among the two aids as shown in table 11:-

Table 11. Subjects' choice between Radar and Decca.

Position	Radar	Decca
Radar Only	10	0
Decca Only	0	2
Radar range/Decca	0.5	0.5
Mean	1.5	1.5
Total	12.0	4.0

These results were combined in table 12 for the χ^2 test:-

Table 12. Observed and expected values of the subjects' choice of aids.

Aid	Observed	Expected
Radar	12	8
Decca	4	8
Total	16	16

Testing gave a value of χ^2 of 3.06 on one degree of freedom. The result was not significant, the null hypothesis was accepted and the alternative hypothesis rejected. There was no evidence that the subjects preferred one of the aids. Had the sample size been larger a preference for the radar might have been demonstrated. The radar placed the ship closer to the land and this might have had an influence on the subjects' choice.

2.8.2.6. Test Number 4.

Did the subjects prefer to use one aid only or did they prefer to use both aids?

H_0 There was no preference for the use of one aid only, rather than a combination of aids.

H_1 The subjects preferred to use one particular aid or a combination of aids.

In this exercise the subjects that used one aid only were those who selected the Decca only or the Radar only positions. The results were allocated as shown in table 13:-

Table 13. Subjects' choice between one aid or a combination of aids.

Strategy	Observed	Expected
One aid only	12	8
Both aids	4	8
Total	16	16

Testing gave a value of χ^2 of 3.06 on one degree of freedom. The result was not significant, the null hypothesis was accepted and the alternative hypothesis rejected. There was no evidence that the subjects preferred to use one aid only. Had the sample size been larger it seems possible that a preference for one aid only would have been demonstrated.

2.8.2.7. Test Number 5.

This test examined whether the subjects preferred an intersection of position lines or a mean position.

H₀ There was no preference for either an intersection of position lines, or a mean position among several lines.

H₁ The subjects preferred either an intersection of position lines, or a mean position among several lines.

Table 14. Subjects' choice between Position Line Intersection and Central Position.

Position	Observed	Expected
Intersection	13	8
Mean Position	3	8
Total	16	16

This gave a value of χ^2 of 5.06* on one degree of freedom. The result was significant, the null hypothesis was rejected and the alternative hypothesis accepted. In this exercise there was evidence that the subjects showed a preference for an intersection of position lines.

This was an interesting result because in this situation two accurate and reliable aids were available so it was unlikely that the ship's position would be on an intersection of position lines.

2.8.2.8. Conclusions.

Fig 4 Visual and Decca

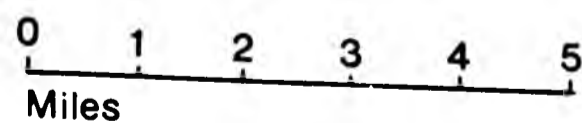
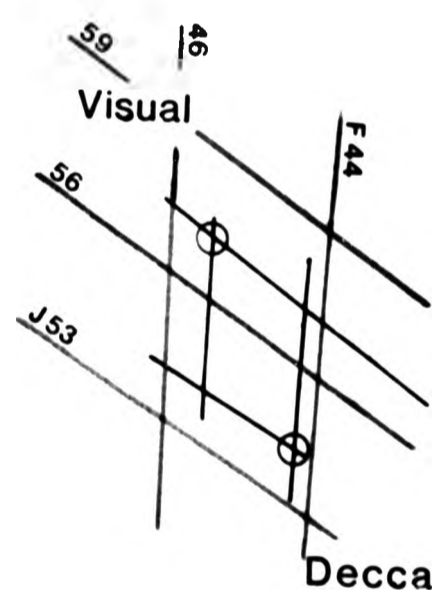
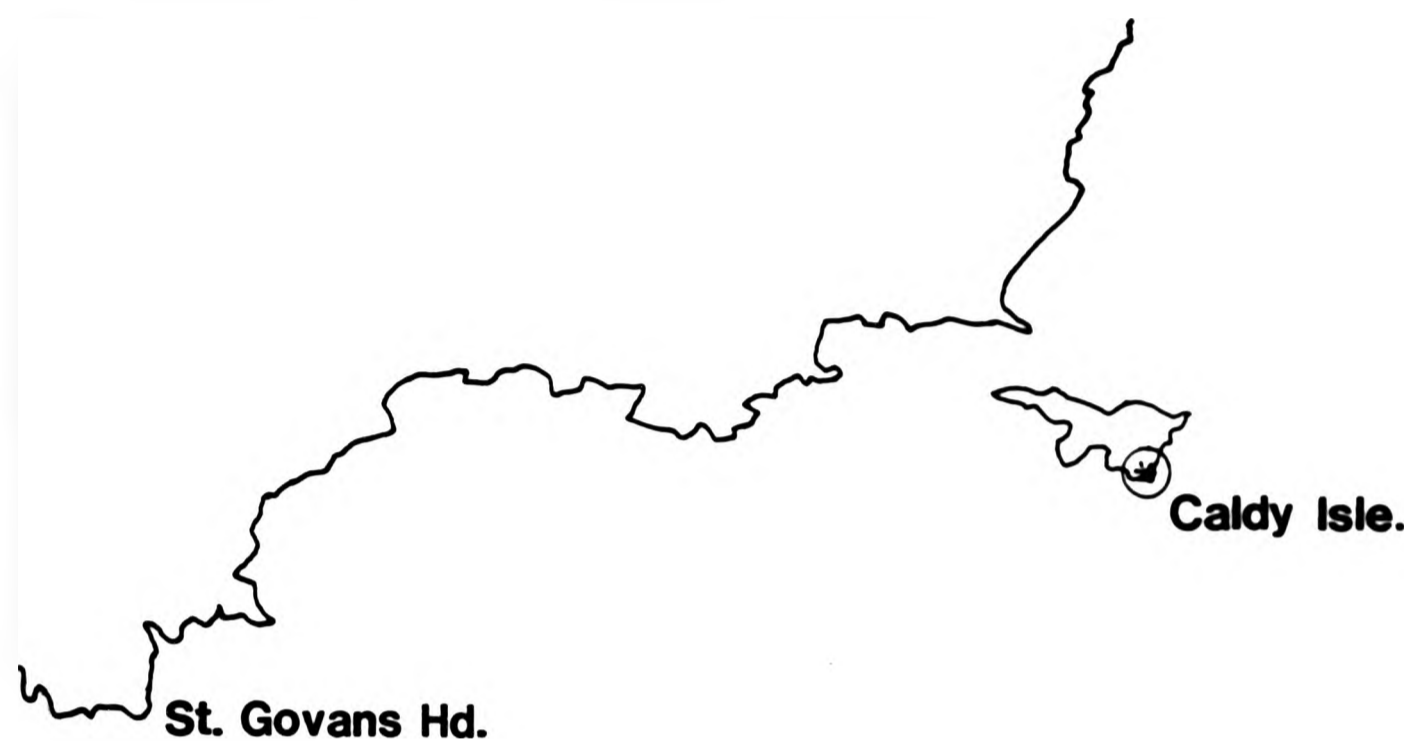

This exercise was designed to look for evidence of a preference between the Decca and the radar. Had there been a larger sample it was possible that a preference for the radar might have been demonstrated but it was possible that the subjects took the presence of the land into account so this test was repeated with the radar and Decca positions reversed. (Section 3.8.2)

The finding that the majority of the subjects chose to use only two out of the four available position lines for fixing their position suggests that this undesirable navigational practice may be frequently followed at sea.

2.8.3. Exercise Number 3.

2.8.3.1. Introduction.

The subjects were given a card with the following information:-

"Bound from Milford Haven to the Bristol Channel. St. Govans Head bore 308° true and Caldy Island Lighthouse bore 004° true. Decca readings were Purple J54.5 and Green G44.1. Mark your position on the chart."

When plotted the bearings formed a diamond shape 2 miles X 1.2 miles about 10 miles South of the Pembrokeshire coast. The north and south corners were formed by the

intersections of the visual and Decca bearings respectively (fig.4).

The exercise was intended to look for evidence of a preference between the Decca navigator and visual bearings. The ship was well clear of the land and bound for the Bristol Channel where there would be land on both sides of the ship, so the position of the land was not expected to influence the subjects' decisions. The figure was made as regular as possible with the angles of cut the same in order to make the visual and Decca positions equally attractive.

2.8.3.2. Results.

The subjects selected the following strategies:-

Table 15. Subject identity number v choice of position line.

1) Visual Only.

1, 4, 5, 10, 11, 13, 14, 16, 18 and 20.

Total 10

2) Decca Only.

12 and 15

Total 2

3) Bearing of Caldy Island/Decca Purple.

6

Total 1

4) Mean Position.

7 and 17

Total 2

Subjects 3, 8, 9 and 19 had no current experience of Decca so they were excluded from the exercise while subject Number 2 plotted the bearings incorrectly the results were not able to be used.

2.8.3.3. Test Number 1.

This test examined the results to see if the subjects

adopted any particular strategy.

H₀ The subjects showed no preference for one particular strategy.

H₁ The subjects preferred at least one strategy.

From the results there were four distinct strategies and with fifteen subjects it was not possible to use a χ^2 test so it was necessary to combine the results as shown in table 16:-

Table 16. Observed and expected frequencies of navigational strategies.

Strategy	Observed	Expected
One aid only	12	5
Mean Position	2	5
Both Aids	1	5
Total	15	15

This gave a value of χ^2 of 14.8*** on two degrees of freedom. The result was significant, the null hypothesis was rejected and the alternative hypothesis was accepted. There was evidence of the subjects selecting a particular strategy, which in this situation was for the use of one aid only.

2.8.3.4. Test Number 2.

Of the subjects who selected corners was there evidence of a preference for one particular corner?

H_0 The subjects showed no preference for one particular corner.

H_1 The subjects preferred one of the corners.

In this exercise thirteen subjects selected three corners so the results were combined for the χ^2 test.

Table 17. Subjects' preferences for the visual only and other corners.

Corner	Observed	Expected
Visual Only	10	3.25
Other	3	9.75
Total	13	13.00

Testing gave a value of χ^2 of 18.67*** on one degree of freedom, the result was significant, the null hypothesis was rejected and the alternative hypothesis accepted. There was strong evidence that the subjects preferred the visual only corner.

2.8.3.5. Test Number 3.

Was there any preference for one particular aid? In this exercise the subjects were given the choice of Decca or visual bearings.

H₀ There was no preference for one particular aid.

H₁ The subjects preferred one of the aids.

The results were allocated to the two aids, those subjects who chose mean positions and subject 6 who chose an intersection of both aids had their position allocated to the two aids according to their position on the chart.

Table 18. Subjects' choice between Decca and Visual Bearings.

Aid	Observed	Expected
Visual Bearings	11.75	7.5
Decca Navigator	3.25	7.5
Total	15.00	15.0

This gave a value of χ^2 of 3.75 on one degree of freedom. The result was not significant, the null hypothesis was accepted and the alternative hypothesis rejected. There was no evidence of a preference for either one the two aids. As more than three times as many of the

selected the visual bearings as the Decca Navigator, it seemed that a larger sample might have demonstrated a significant preference. In this exercise the visual bearings placed the ship closer to the land and the subjects may have been influenced by this.

2.8.3.6. Test Number 4.

This test examined whether the subjects based their position on information from one aid only, or whether they preferred to use both the aids. This differed from test number 1 because it only looked for a preference for either one or both of the aids, while test number one examined all the strategies followed by the different subjects.

H_0 There was no preference for the use of one aid only, rather than a combination of aids.

H_1 The subjects preferred to use either one particular aid or a combination of aids.

In this exercise the subjects who used one aid only were those who selected the visual bearings only or the Decca only positions. The data are given in the following table:-

Table 19. Subjects' choice between one aid or a combination of aids.

Method of fixing	Observed	Expected
One Aid Only	12	7.5
Both Aids	3	7.5
Total	15	15.0

This gave a value of χ^2 of 4.26* on one degree of freedom. The result was significant, the null hypothesis was rejected and the alternative hypothesis was accepted. There was evidence that the subjects selected their position using the information from one aid, mostly visual bearings, only.

2.8.3.7. Test Number 5.

This test examined whether the subjects preferred either an intersection of position lines or a mean position among several lines.

H_0 There was no preference for either an intersection of position lines, or a mean position among several lines.

H_1 The subjects preferred either an intersection of position lines, or a mean position among several lines.

The results were allocated for the χ^2 test as follows:-

Table 20. Subjects' choice between Position Line Intersection and Central Position.

Strategy	Observed	Expected
Intersection	13	7.5
Mean Position	2	7.5
Total	15	15.0

This gave a value of χ^2 of 6.67** on one degree of freedom. The result was significant, the null hypothesis was rejected and the alternative hypothesis was accepted. There was evidence that the subjects preferred an intersection of position lines to a mean position among several lines.

2.8.3.8. Conclusions.

These tests failed to produce a preference for one of the aids perhaps because of the limited sample size; however more of the subjects favoured the visual bearings compared with the Decca Navigator. The results must be slightly suspect because the visual bearings put the vessel closer to the land and a similar exercise was therefore

administered but with the positions reversed. (in section 3.8.3.)

Some of the subjects complained that the diamond was too large, and one said that he would suspect Decca lane slip (13). The problem was that it was difficult to design a regular figure that was an acceptable size, given the relative positions of the land and the Decca lanes.

The fact that most of the subjects demonstrated a preference for the visual bearings was evident in the results of all the other tests. This finding is surprising when it is considered that in the given circumstances the Decca would probably have been as accurate as the visual bearings. Hence the need to repeat the exercise with the positions reversed (see 3.8.3.).

The finding that the majority of subjects used only one out of the two available methods for fixing their position confirms the tendency of navigators to reject useful information as previously stated in section 2.8.2.8.

2.8.4. Exercise Number 4.

2.8.4.1. Introduction.

The subjects were given a card with the following information:-

Fig 5 Three D.F. Bearings

☉ St. Gowan

Helwick ☉



0 1 2 3 4 5
Miles

☉ Hen and Chickens
Lundy Island

"Outward bound for Capetown in moderate visibility without Decca or radar, the following corrected D.F. bearings were obtained. Helwick Lt./Vl. 049°, Hen and Chickens Lt. Ho. 129° St. Gowan Lt./Vl. 339°, find and plot your position."

When plotted the bearings formed an isosceles triangle about 1 mile x 0.75 miles situated 8 miles N.W. of Lundy Island (fig 5).

The object of the exercise was to examine whether the subjects gave any preference to the bearing from the Hen and Chickens Lt. Ho. on Lundy Island as it was the closest of the three beacons and should therefore give the most accurate bearing.

The ship was well clear of the land and the three D.F. bearings followed a direct path, not crossing any land, and gave a reasonable cross so the subjects should have had confidence in their position.

2.8.4.2. Results.

The results were divided into the following groups:-

Table 21. Subject identity numbers v. choice of strategies.

1) Mean Position.

5,6,8,9,11,14,16 and 18.

Total 8

2) Intersection of the bearings from the Hen and Chickens
and the Helwick.

3,10 and 15

Total 3

3) Intersection of the bearings from the Helwick and St.
Gowan Lightships.

20

Total 1

4) Bearing from the Helwick Lt./Vl. and a mean position
from the other two bearings.

2,7,12 and 13

Total 4

5) Bearing from the Hen and Chickens and a mean position
from the other two.

19

Total 1

Subjects numbers 1, 4 and 17 plotted the bearings

incorrectly so their results were excluded from this exercise.

2.8.4.3. Test Number 1.

There were a total of five different strategies, so with a sample size of seventeen, it was not possible to carry out the χ^2 test as the data could not be sensibly combined.

2.8.4.4. Test Number 2.

Of the subjects who chose corners was there any evidence of a preference for one particular corner? In this exercise only four subjects selected a corner position so it was not possible to carry out this test.

Tests three and four did not apply to this exercise as only one aid was used.

2.8.4.5. Test Number 5.

Did the subjects prefer a position on an intersection of position lines or did they prefer a position among several position lines? This exercise was complicated by the fact that some of the subjects selected a position on one bearing but not at an intersection. In this test the results were allocated 50/50.

H₀ There was no preference for either an intersection of position lines, or a mean position among several lines.

H₁ The subjects preferred either an intersection of position lines, or a mean position among several lines.

Table 22. Subjects' choice between Intersection of Position Lines and a mean position.

Strategy	Intersection	Mean
Mean	0	8
Hen&Chick/Hel.	3	0
Hel./St.G.	1	0
Helwick	2	2
Hen & Chick.	0.5	0.5
Total	6.5	10.5

This gave the following table for the χ^2 test:-

Table 23. Observed and Expected values of the different strategies.

Strategy	Observed	Expected
Intersection	6.5	8.5
Mean Position	10.5	8.5
Total	17.0	17.0

This gave a value of χ^2 of 0.53 on one degree of

freedom. The result was not significant, the null hypothesis was accepted and the alternative hypothesis was rejected. There was no evidence that the subjects preferred either an intersection of position lines or a mean position. Again this is an interesting result since it would have seemed logical for the subjects to select a mean position.

2.8.4.6. Test Number 7.

This was an additional test designed to see if there was a preference for one particular bearing. At the start it was suggested that the subjects might favour the bearing from the Hen & Chickens because it was the closest of the three beacons.

H_0 The subjects showed no preference for one bearing.

H_1 The subjects preferred one of the bearings.

All the results were allocated to the three bearings: those who selected an intersection of two bearings were allocated 50/50 while those who chose a mean position were allocated according to their choice of position.

Table 24. Subjects' preference for the different beacons.

Bearing	Observed	Expected
Helwick	7.42	5.67
St. Gowan	4.17	5.67
Hen & Chickens	5.42	5.67
Total	17.00	17.00

This gave a value of χ^2 of 0.95 on two degrees of freedom. The result was non-significant, the null hypothesis was accepted and the alternative hypothesis was rejected. There was no evidence that the subjects preferred one of the bearings.

This result demonstrated that the subjects showed no preference for any particular position line. Thus they gave no extra regard to what should have been the more accurate bearing.

2.8.4.7. Conclusions.

This exercise seemed to show that when only one aid was used there did not seem to be any accepted method of selecting a position. The possibility that the subjects might prefer the bearing from the closer beacon because of its greater accuracy was not demonstrated.

The non significant result from test number five may be

Fig 6 Radar Bearings and Distances

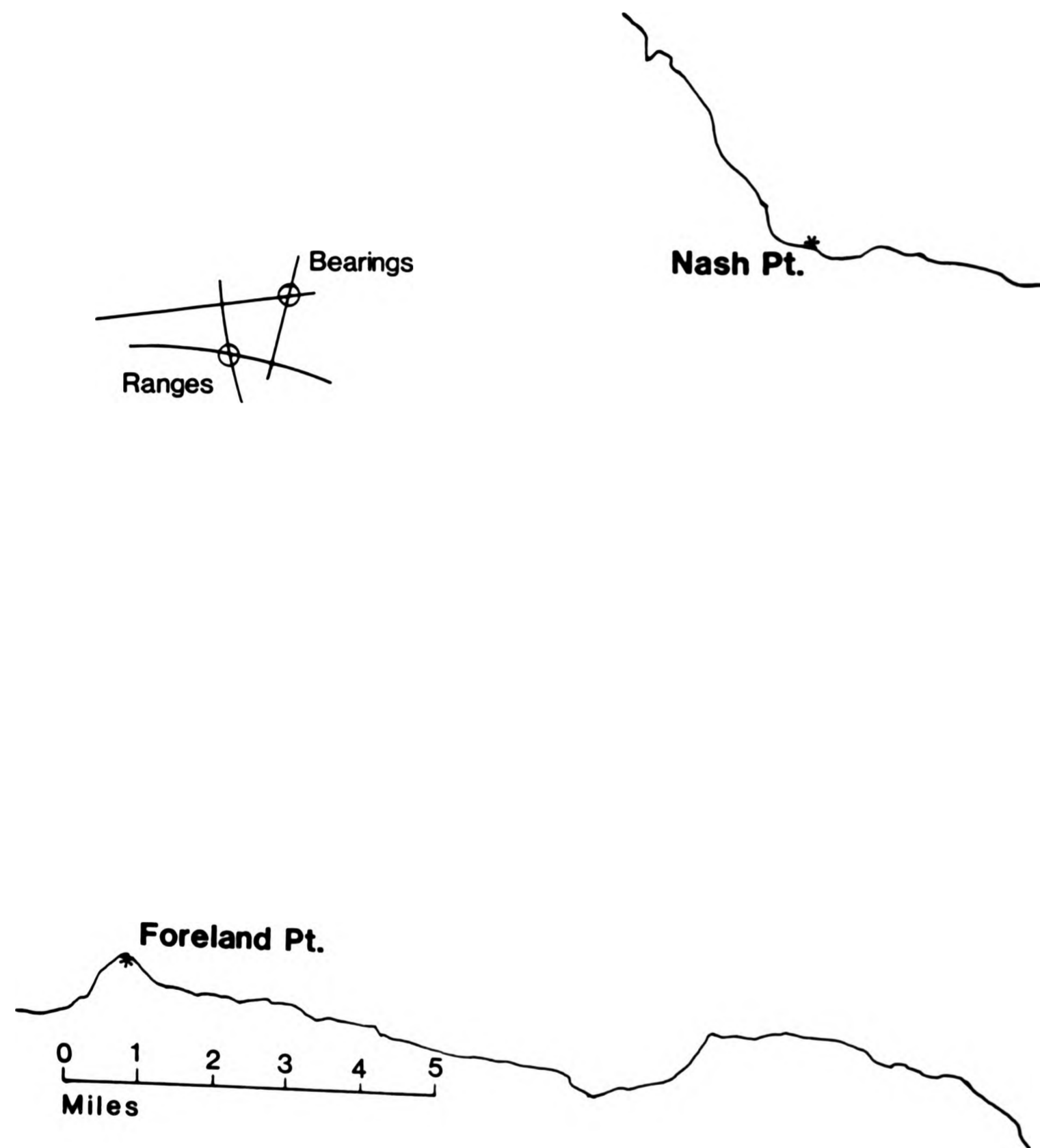

construed as showing that, where more than one aid is concerned, the subjects think more in terms of there being a choice between two separate positions rather than there being only one position and both aids giving useful information concerning its location.

2.8.5. Exercise Number 5.

2.8.5.1. Introduction.

The subjects were given a card with the following information:-

"Outward bound from Cardiff with visibility about 4 miles, radar bearings and distances off Nash Point were 083° x 7.5 miles and off Foreland Point were 194° x 7.8 miles. Plot your position on the chart."

The object of this exercise was to examine how the subjects made use of radar.

When plotted the position lines formed a kite shape about 1 mile across (fig 6). The intersection of the radar bearings was closer to, and about 5 miles from, the nearest point of land. The ship was outward bound so the land represented no danger and the subjects should not have been tempted to pick the position closest to the land.

The reduced visibility in the instructions was the reason that the subjects could not use visual bearings to verify their position.

There are three different methods of fixing a position by radar: an intersection of ranges, an intersection of bearings or a combination of range and bearing. In general radar bearings are considered to be less accurate than radar ranges (14).

2.8.5.2. Results.

The results were divided into the following groups:-

Table 25. Subject identity numbers v position fixing strategy.

1) Intersection of radar bearings.

8 and 16

Total 2

2) Intersection of radar ranges.

1,3,5,7,15,18,19 and 20.

Total 8

3) Position off Nash Pt.

4 and 12

Total 2

4) Position off Foreland Pt.

10 and 13

Total 2

5) Mean Position.

2,6,11,14 and 17

Total 5

Subject number 9 plotted the information incorrectly so his results could not be used.

2.8.5.3. Test Number 1.

This was to test the above groups to see if there was a preference for one particular strategy. Because there were five different strategies and nineteen subjects it was not possible to carry out a χ^2 test.

2.8.5.4. Test Number 2.

This test examined whether the subjects who chose corner positions demonstrated a preference for one particular corner.

H_0 The subjects showed no preference for one particular corner.

H_1 The subjects preferred one of the corners.

Because of the small sample size the subjects selecting the corner defined by the intersection of the radar ranges were tested against the combined results from the other three corners.

Table 26. Subjects' choice of corners.

Corner	Observed	Expected
Radar ranges	8	3.5
Others	6	10.5
Total	14	14.0

Testing gave a value of χ^2 of 7.7** on one degree of freedom. The result was significant, the Null Hypothesis was rejected and the Alternative Hypothesis accepted. There was evidence that the subjects preferred the corner defined by the intersection of radar ranges.

2.8.5.5. Test Number 3.

This test looked for a preferred method of position fixing. It was intended for situations where the subjects were given the choice of two different aids but in this situation it was used to examine how the subjects used the radar. In this exercise the subjects had the choice of using ranges only, bearings only or a range and a bearing and the test looked for evidence of a preference among those three.

H_0 There was no preference for one particular method of position fixing.

H_1 The subjects preferred one method of position fixing.

Table 27. Observed and expected frequencies of position fixing methods.

Strategy	Observed	Expected
Range Only	8	4.7
Bearing only	2	4.7
Range and Brg.	4	4.7
Total	14	14.0

This gave a value of χ^2 of 3.97 on two degrees of freedom. The result was not significant, the null hypothesis was accepted, and there was no evidence that the subjects demonstrated a preference for one method for fixing their positions.

This result was important because it demonstrated that despite being taught that radar ranges were the most accurate method of using the radar (38) a substantial number of subjects used other methods.

2.8.5.6. Test Number 4.

Test number 4 was intended for situations where more than one aid was used and was not appropriate for this situation.

2.8.5.7. Test Number 5.

This test examined whether the subjects preferred an intersection of position lines or a mean position among several position lines.

H₀ There was no preference for either an intersection of position lines, or a mean position among several lines.

H₁ The subjects preferred either an intersection of position lines, or a mean position among several lines.

The subjects who chose a mean position were those who chose the centre position with the exception of numbers 14 and 17 who chose positions on a position line but not at the centre. These two results were allocated 50/50 giving the following table:-

Table 28. Preferences for Position Line Intersection or Central Position.

Position	Observed	Expected
Intersection	15	9.5
Mean Position	4	9.5
Total	19	19.0

This gave a value of χ^2 of 5.26* on one degree of freedom. The result was significant, the null hypothesis was rejected and the alternative hypothesis accepted. There

was evidence that the subjects preferred an intersection of position lines. This result was in line with the results from the previous exercises where a similar result had been demonstrated.

2.8.5.9. Conclusions.

The main conclusion from this exercise is that despite being taught that radar ranges are more accurate than radar bearings (38) there did not seem to be any consistent method of handling this situation. Test Number 2 showed that when corners only were considered there was a preference for an intersection of radar ranges, but when all the results were examined, (test number 3), there was no evidence of a preferred method of using the radar.

The preference for an intersection of position lines, Test 5, continued to be demonstrated.

2.8.6. Exercise Number 6.

2.8.6.1. Introduction.

The subjects were given a card with the following information:-

"Heading North, bound for Milford Haven with a Decca warning indicating that the Purple chain was off the air.

Fig 7 Visual Decca and D.F.

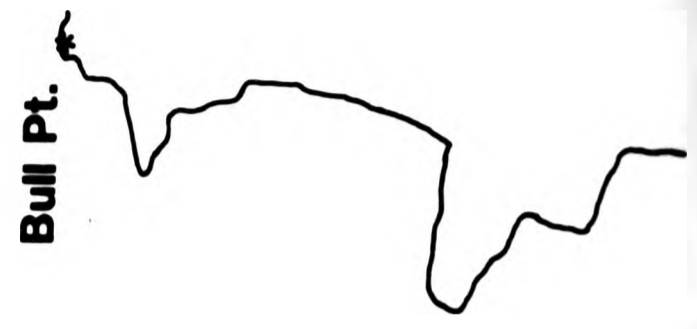
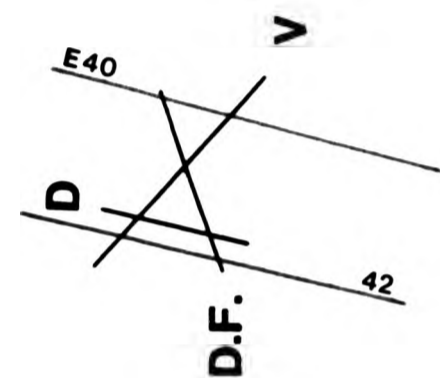
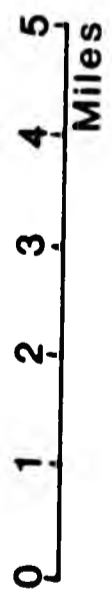

Bull Point Lighthouse bore 132° true, Decca reading green E 41.8 and a corrected D.F. bearing off Hen & Chickens beacon (Lundy Island) was 248° true. Plot your position."

When plotted the results gave an equilateral triangle with sides 0.6 miles. The triangle was situated about 8 miles N.W. off Bull Point (Fig 7). The ship was heading North and so clear of any danger from the Devon coast or Lundy Island, but she would have had to alter course at a later stage to head for Milford Haven.

The object of the exercise was to look for a preference among the three methods of obtaining position lines.

2.8.6.2. Results.

The results divided into the following groups:-

Table 29. Subject identity numbers v position fixing strategy.

1) Corner defined by the visual and Decca position lines.

4, 10, 12, 15, 18 & 20 Total 6

2) Corner defined by the visual and D.F. bearings.

1, 2, 14 & 16 Total 4

3) Centre position

5, 6, 7, 11, 13 & 17 Total 6

Total 16

Subjects number 3, 8, 9 & 19 had no current experience with the Decca navigator and they did not take part in the exercise.

2.8.6.3. Test Number 1.

This test examined whether there was any evidence of a preference among the above strategies. From an examination of the table it is clear that there was no evidence of any preference except that none of the subjects selected the Decca/D.F. corner.

2.8.6.4. Test Number 2.

Of the subjects who chose corners was there any evidence of a preference for any particular corner?

In this exercise there were 10 subjects who chose 3 corners giving an expected value of $10/3 = 3.33$ which was too low for a χ^2 test.

The fact that none of the subjects selected the Decca/D.F. corner demonstrated some sort of preference, which was probably related to the subjects' stated dislike of the D.F. while in this case there was not the strong preference for the visual to overcome this dislike.

Tests number 3 and 4 were not suitable for these particular circumstances.

2.8.6.5. Test Number 5.

This test examined whether the subjects preferred an intersection of position lines or a mean position among several lines.

H_0 There was no preference for either an intersection of position lines, or a mean position among several lines.

H_1 The subjects preferred either an intersection of position lines, or a mean position among several lines.

Referring to table 29 the data for the χ^2 test become:-

Table 30. Subjects' preferences for a Position Line Intersection or a Mean Position.

Strategy	Observed	Expected
Intersection	10	8
Mean Position	6	8
Total	16	16

This gave a value of χ^2 of 0.56 on one degree of freedom. The result was not significant. The null hypothesis was accepted and the alternative hypothesis rejected. There was no evidence that the subjects preferred an intersection of position lines or a centre position.

2.8.6.7. Conclusions.

This test was designed to look for a preference for a particular aid out of three possible choices. It was a rather unlikely situation and the lack of significant results indicates that the subjects had no clear idea of how to deal with it.

Fig 8 Visual and Radar

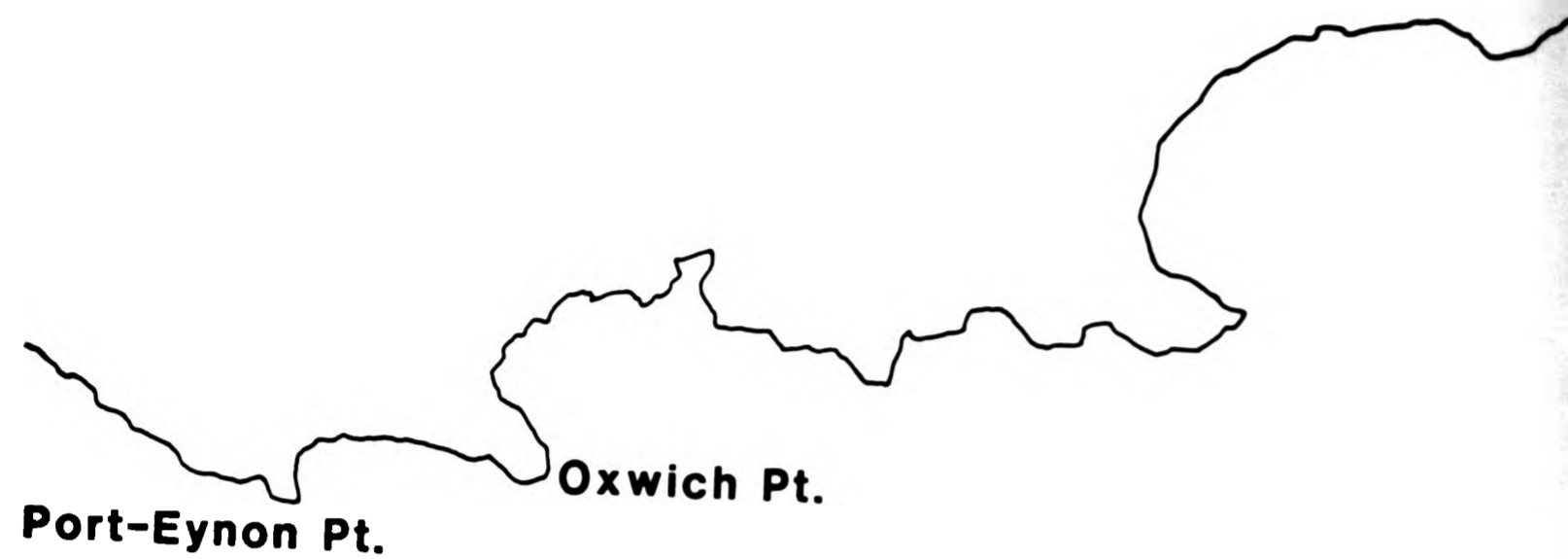

Scarweather 

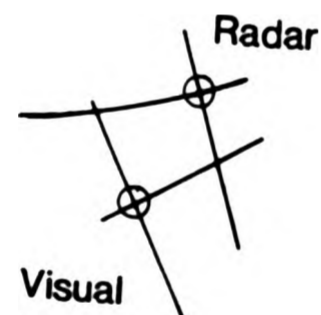

Part two of the present work demonstrates a strong preference for the use of two position lines only. (Section 6.4.7.3). As the results of the rest of Part one indicate the subjects had little confidence in the D.F. so it was likely that given the choice the subjects would not have bothered to plot the D.F. bearing at all, hence the confused results from this exercise.

2.8.7. Exercise Number 7.

2.8.7.1. Introduction.

The subjects were informed:-

"Outward bound from Cardiff to Liverpool, compass bearings off the Scarweather L/V1. and Port Eynon Point were 062° true and 335° true respectively. A radar observation of Oxwich Point gave 344° true x 8.4 miles. Plot your ship's position."

When plotted on the chart the position lines formed a rectangle about 1 mile x 0.8 miles. The centre was about 8.5 miles south off Oxwich Point (fig 8), the nearest land. The corner formed by the visual bearings was furthest from the land while the radar position was diagonally opposite

and closest to the land (Oxwich Point).

The object of the exercise was to look for a preference between visual bearings and a radar position. As the radar position put the ship closer to the land, there could have been a slight bias in favour of the radar position.

2.8.7.2. Results.

The results were divided into the following groups:-

Table 31. Choice of Position fixing strategy.

1) Radar Only.

1,5 and 16

Total 3

2) Visual Only.

2,4,6,8,9 and 14

Total 6

3) Visual bearing/radar range.

3,10,13,19 and 20

Total 5

4) Mean Position.

7,11,12,15,17 and 16

Total 6

Note: none of the subjects chose the fourth corner, visual

bearing and radar bearing. This would not have been a very accurate position so it was not a likely choice.

2.8.7.3. Test Number 1.

This test examined the data to look for evidence of a preference among the different strategies. It was clear from looking at the results that there was no preferred strategy in this exercise.

2.8.7.4. Test Number 2.

Of the subjects who chose corners was there any evidence of a preference for a particular corner? In this exercise although the visual bearing/radar bearing corner was rejected the sample size was too small for a χ^2 test.

2.8.7.5. Test Number 3.

This test examined whether there was a preference for one of the aids: in this case visual bearings or radar.

H_0 There was no preference for one particular aid.

H_1 The subjects preferred one of the aids.

The use of the aids is given in the following table:-

Table 32. Subjects' choice of Visual or Radar methods.

Position	Visual	Radar
Visual only	6	0
Radar only	0	3
Visual bearing/ Radar range	2.5	2.5
Centre 11,12, 15,17 & 18	2.5	2.5
Centre 7	0.25	0.75
Total	11.25	8.75

Allocating the data for a χ^2 test:-

Table 33. Observed and expected frequencies of Visual or Radar methods.

Aid	Observed	Expected
Visual	11.25	10
Radar	8.75	10
Total	20.00	20

This gave a value of χ^2 of 0.31 on one degree of freedom. The result was not significant, the null hypothesis was accepted and the alternative hypothesis was rejected. There was no evidence that the subjects preferred one of the aids.

This test was repeated in with the visual and radar bearings reversed in respect of their proximity to land, (see section 3.8.5.).

2.8.7.6. Test number 4.

This test examined whether the subjects preferred to use one aid only or whether they used information from both the aids.

H_0 There was no preference for the use of one aid only, rather than a combination of aids.

H_1 The subjects preferred to use either one particular aid or a combination of aids.

In this exercise the subjects who used one aid only were those who used either the radar only or visual bearings only. This gave the following table for the χ^2 test:-

Table 34. Subjects' choice of one or both aids .

Strategy	Observed	Expected
One aid only	9	10
Both aids	11	10
Total	20	20

The result was clearly not significant, there was no evidence that the subjects preferred to use one aid only. In this exercise there was equally no evidence that the subjects preferred to use more than one aid, and in fact there did not seem to be any preferred method of using the aids.

What was important was that in a situation where two good and reliable aids were available almost half the subjects based their position on information from one aid only (see section 6.4.7.3.).

2.8.7.7. Test number 5.

Did the subjects prefer a position at an intersection of position lines, a centre position, or did they select their positions in a more random manner?

H₀ There was no preference for either an intersection of position lines, or a mean position among several lines.

H₁ The subjects preferred either an intersection of position lines, or a mean position among several lines.

In this test the subjects who selected a corner position were considered to have selected an intersection while the remainder selected a mean position. This gave the following table for a χ^2 test:-

Table 35. Subjects' choice of Position Line Intersections or Mean Positions.

Strategy	Observed	Expected
Intersection	14	10
Mean Position	6	10
Total	20	20

Testing gave a value of χ^2 of 3.2 on one degree of freedom. The result was non-significant, and the null hypothesis was accepted. There was no evidence that the subjects preferred either an intersection of position lines or a mean position.

This result follows the general trend in that more than

twice as many subjects selected an intersection as a mean position but taken on its own the result falls short of significance.

2.8.7.9. Conclusions.

This exercise suffered from too small a sample size otherwise there could well have been more significant results.

It was not possible to demonstrate a preference between the radar and visual bearings for position fixing. This is a reasonable result because they are both reliable and accurate methods of position fixing. In this exercise the position of the land may have affected the results, so the test was repeated with the positions reversed (section 3.8.5.).

The fact that there were so few significant results again demonstrated that the subjects had no clear method of tackling the problem, which pointed to one aspect where the training of the navigators appeared to be inadequate.

2.8.8. Exercise Number 8.

2.8.8.1. Introduction.

The subjects were given a card with the following

Fig 9 Decca Position

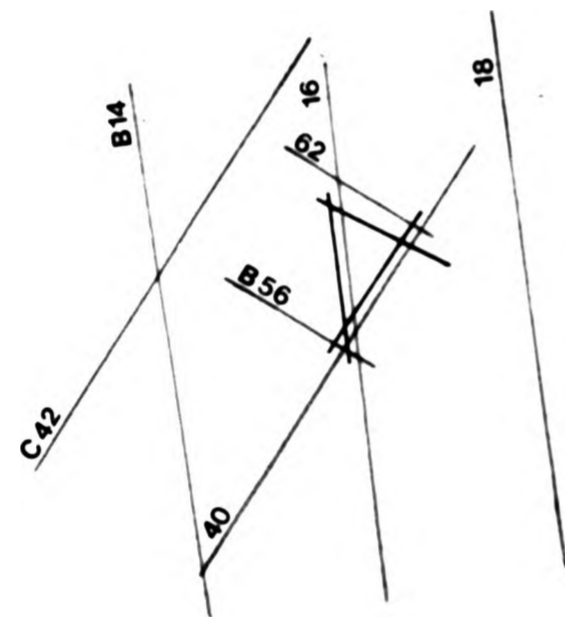

Foreland Point

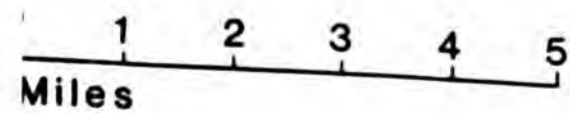

instructions:-

"Outward bound from Cardiff to Milford Haven Decca readings were Red B15.9, Green C40.1 and Purple B61.0. Plot the ship's position."

The subjects were presented with three Decca readings giving a small cocked hat in the form of an isosceles triangle with a base of about one mile in the N-S direction and about half a mile in the E-W direction (fig 9). The position was equally distant from the land, about five miles in each case and with the ship outward bound there were no immediate dangers close ahead that might affect the subject's choice of a position.

The object of this exercise was to examine how the subjects dealt with three position lines from the same aid. The overall accuracy was about 0.1 to 0.2 miles for 68% of the occasions according to the Decca data sheets (37), but they gave no indication as to the relative accuracy for the Decca lines in this area.

2.8.8.2. Results.

The results were divided into the following groups:-

Table 36. Choice of Position fixing strategy.

1) Corner defined by the red and green lines.

3, 4 and 18

Total 3

2) Corner defined by the green and purple lines.

6, 7, 8, 9, 11, 12, 15 and 16.

Total 8

3) Corner defined by the red and purple lines.

1, 10, 13 and 20.

Total 4

4) Mean position.

2, 5, 14, 17 and 19.

Total 5

Although subjects 3, 8, 9 & 19 had no current experience at sea with Decca they were included in this exercise for the following reasons:-

- a) They had all been taught how to use Decca and should understand its operations and limitations.
- b) The exercise was a test of how the subjects handled a position involving three position lines of a similar character and the aid used was of secondary importance.
- c) None of the subjects objected to using the Decca so it was assumed they must have had confidence in their ability

to complete the exercise.

2.8.8.3. Test Number 1.

This test looked to see if the subjects preferred any particular strategy. From the data it was clear that there were no signs of any preference for one particular strategy so there was no point in carrying out a formal test.

2.8.8.4. Test Number 2.

Of the subjects who chose corners was there any evidence of a preference for one particular corner? Again an examination of the data showed that none of the corners was favoured sufficiently to produce evidence for a preference.

Tests number 3 and 4 were designed for a situation where more than one aid was involved and therefore did not apply here.

2.8.8.5. Test Number 5.

Did the subjects prefer an intersection of position lines or did they prefer a mean position among several lines? This exercise involved testing those subjects who chose corner positions against the group who chose a mean position.

H₀ There was no preference for either an intersection of position lines, or a mean position among several lines.

H₁ The subjects preferred either an intersection of position lines, or a mean position among several lines.

This gave the following table for the χ^2 test:-

Table 37. Choice of Position Line Intersection or Central Position.

Position	Observed	Expected
Intersection	15	10
Mean Position	5	10
Total	20	20

Testing gave a value of χ^2 of 5* on one degree of freedom. The result was significant, the null hypothesis was rejected and the alternative hypothesis was accepted. There was evidence that the subjects preferred an intersection of position lines.

2.8.8.7. Conclusions.

This exercise demonstrated that there was no accepted method of treating this type of problem. The only significant result was that the subjects avoided the centre of the figure which in this case was a more likely position

Fig 10 Radar and D.F.

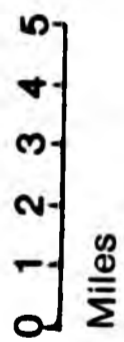

 Helwick

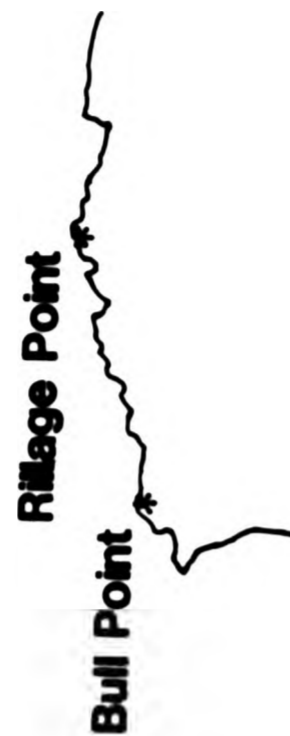
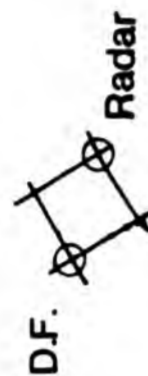

than any of the others. None of the subjects mentioned fixed errors or data sheets (37). More of the subjects selected the intersection of the Green and the Purple position lines than the others possibly because it placed the ship closer to the land, although in this case there was no danger because the ship was outward bound. In general it was a dangerous practice because the green/purple position might give the impression that the ship was behind her actual position and this has led to accidents in the past.

2.8.9. Exercise Number 9.

2.8.9.1. Introduction.

The subjects were given a card with the following information:-

"Bound inwards for Cardiff in moderate visibility without Decca. D.F. bearings of the Helwick Lt./Vl. were 326° true and of Lundy Island were 238° true. A radar observation off Rillage point was 149° x 9.6 miles. Plot your position on the chart."

When plotted the position lines formed a square with sides 1.2 miles, the mid point was 9.5 miles North of Bull Point in the middle of the channel (fig10). The radar position formed the Eastern corner and the D.F. position

the Western corner. The ship was bound for Cardiff so it was not important which side of the channel the ship was on but the radar position put the ship further ahead of the D.F. position and this could influence the subjects' choice of position as it would put the ship closer towards any potential dangers that might lie ahead. In the last exercise the subjects did not seem to take any account of this fact (2.8.8.7.).

The object of this exercise was to look for a preference between the D.F. and the Radar. The moderate visibility in the instructions explains why the visual bearings were not available.

2.8.9.2. Results.

The results were divided into the following groups:-

Table 38. Subjects' Choice of Strategy.

Radar only.	1,2,4,5,8,9,10,11,12,13,15,16	&	19
		Total	14
Radar range/D.F. Helwick	3,6 & 20		
		Total	3
Centre.	14, 17 & 18		
		Total	3

There were a number of possible strategies which the

subjects did not attempt. The most notable absence was the D.F. only position.

2.8.9.3. Test Number 1.

This test was to see if there were any signs of a preference among these three strategies.

H₀ The subjects showed no preference for a particular strategy or strategies.

H₁ The subjects preferred at least one strategy.

The table for the χ^2 test was:-

Table 39. Observed and expected values of the subjects' strategies.

Strategy	Observed	Expected
Radar Only	14	6.67
Radar range/D.F.	3	6.67
Mean Position	3	6.67
Total	20	20.00

This gave a value of χ^2 of 12.10** on two degrees of freedom. The result was significant, the null hypothesis was rejected and the alternative hypothesis accepted. There was evidence that the subjects favoured the radar only position.

2.8.9.4. Test number 2.

Of the subjects who chose corners was there any evidence of a preference for one particular corner? In this exercise only two out of the four possible corners were selected so the radar only position was tested for preference against the radar range/D.F. position.

H_0 The subjects showed no preference for one particular corner.

H_1 The subjects preferred at least one of the corners.

The table for the χ^2 test was:-

Table 40. Subjects' preferences for the different corners.

Corner	Observed	Expected
Radar Only	14	8.5
Radar range/D.F.	3	8.5
Total	17	17.0

Testing gave a value of χ^2 of 5.88* on one degree of freedom. The null hypothesis was rejected and the alternative hypothesis accepted. There was evidence that the subjects preferred the radar only corner.

2.8.9.5. Test Number 3.

This test examined whether there was a preference for one particular aid.

H_0 There was no preference for one particular aid.

H_1 The subjects preferred one of the aids.

Allocating the results from the different positions gave the following table:-

Table 41. Subjects' preferences for the different aids.

Position	Radar	D.F.
Radar Only	14.0	0.0
Radar range/D.F.	1.5	1.5
Mean 14 & 15	1.0	1.0
Mean 18	0.75	0.25
Total	17.25	2.75

Allocating this for the χ^2 test:-

Table 42. Observed and expected values of the subjects' preference for aids.

Aid	Observed	Expected
Radar	17.25	10
D.F.	2.75	10
Total	20.00	20

This gave a value of χ^2 of 10.51** on one degree of freedom. The result was significant, the null hypothesis was accepted and the alternative hypothesis rejected. There was strong evidence that the subjects preferred the radar to the D.F. This is underlined by the fact that none of the subjects had the confidence to select the D.F. position on its own.

2.8.9.6. Test Number 4.

This tested whether the subjects based their decision on information from one aid only or whether they took both aids into account when selecting their position.

H_0 There was no preference for the use of one aid only, rather than a combination of aids.

H_1 The subjects preferred to use one particular aid or a combination of aids.

In this exercise the subjects who used one aid only were those who selected the radar only position, while the ones who selected the other positions were the remainder. The table for the χ^2 test became:-

Table 43. Subjects' preference for one or both aids.

Strategy	Observed	Expected
One Aid only	14	10
Both Aids	6	10
Total	20	20

This gave a value of χ^2 of 3.2 on one degree of freedom. The result was not significant, the null hypothesis was accepted and the alternative hypothesis rejected. There was no evidence that the subjects preferred to use one aid only.

This result follows the general trend, in that more than twice as many subjects chose to use one aid only (radar) rather than giving some weight to each of the aids, but taken on its own the result falls short of significance.

2.8.9.7. Test Number 5.

Did the subjects prefer a position on an intersection of position lines, or did they prefer a mean position among several position lines?

H_0 There was no preference for either an intersection of position lines, or a mean position among several lines.

H_1 The subjects preferred either an intersection of position lines, or a mean position among several lines.

The radar only and the radar range/D.F. group were the subjects who preferred a position on an intersection of position lines, while the others preferred a mean position. The table for the χ^2 test became:-

Table 44. Choice of Position Line intersection or central position.

Position	Observed	Expected
Intersection	17	10
Mean Position	3	10
Total	20	20

This gave a value of χ^2 of 9.8** on one degree of freedom. The result was significant, the null hypothesis was rejected and the alternative hypothesis accepted. There was strong evidence that the subjects had a preference and, from the results, it was clear that they preferred an intersection of position lines.

2.8.9.9. Conclusions.

This exercise demonstrated a strong preference for the radar over the D.F. although the sample size was not large enough to demonstrate what may have been a preference for fixing their position using one aid only. As there was a slight bias for navigational reasons in favour of the radar this exercise was repeated (see section 3.8.7.).

2.9. Tests on the Combined Results.

2.9.1. Introduction.

Many of the results of the individual tests were inconclusive because of the small sample size. By combining the results from the nine exercises it became possible to increase the sample in some cases and thus carry out more realistic tests. These tests were carried out where the circumstances of the exercise made such a combination possible.

Tests 1, 2 & 3 were specific to each exercise and were not therefore suitable for combining in this manner.

2.9.2. Test Number 4.

Did the subjects base their positions on one aid only or did they use the information from all the aids?

H₀ There was no preference for the use of one aid only rather than a combination of aids.

H₁ The subjects preferred to use one particular aid or a combination of aids.

The results from the individual exercises were as follows:-

Table 45. Choice of either one aid or a combination of aids by exercise.

Exercise	One Aid	All Aids
1	9	7
2	12	4
3	12	3
7	9	11
9	14	6
Total	56	31

This gave the following table for the χ^2 test:-

Table 46. Observed and expected frequencies of subjects' choice of either one or a combination of aids.

Strategy	Observed	Expected
One Aid	56	43.5
All Aids	31	43.5
Total	87	87.0

Testing gave a value of χ^2 of 7.18** on one degree of freedom. The result was significant, the null hypothesis was rejected and the alternative hypothesis accepted. There was strong evidence that the subjects preferred to use one aid only. It was anticipated that in each situation one of the aids might prove to be more accurate than the others, but this was not considered to be sufficient reason for the subjects to totally reject the information from the less accurate aid.

2.9.3. Test Number 5.

Did the subjects prefer an intersection of position lines or did they prefer a mean position among several position lines?

H₀ There was no preference for either an intersection of position lines, or a mean position among several lines.

H₁ The subjects preferred either an intersection of position lines, or a mean position among several lines.

The results from the different exercises were as follows:-

Table 47. Choice of either position line intersection or mean position, by exercise.

Exercise	Intersection	Centre
1	11.5	4.5
2	13.0	3.0
3	13.0	2.0
4	6.5	10.5
5	15.0	4.0
6	10.0	6.0
7	14.0	6.0
8	15.0	5.0
9	17.0	3.0
Total	115.0	44.0

This gave the following table for the χ^2 test:-

Table 48. Observed and expected frequencies of subjects' choice of position line intersection or mean position.

Position	Observed	Expected
Intersection	115	79.5
Mean Position	44	79.5
Total	159	159.0

Testing gave a value of χ^2 of 31.7*** on one degree of freedom. The result was highly significant, the null hypothesis was rejected and the alternative hypothesis accepted. There was strong evidence that the subjects preferred an intersection of position lines rather than a mean position among several position lines.

2.9.4. Test Number 6.

Of the subjects who used a central position, did they choose the geometric centre or did they select some other position?

H_0 There was no preference for either the geometric centre or a weighted position.

H_1 The subjects preferred either the geometric centre or a weighted position.

The results of the separate exercises were:-

Table 49. Choice of geometric centre or weighted position, by exercise.

Exercise	Geometric Centre	Other
1	4	1
2	1	2
3	1	1
4	5	3
5	2	3
6	5	1
7	5	1
8	3	2
9	0	3
Total	26	17

This gave the following table for the χ^2 test:-

Table 50. Observed and expected values of the subjects' choice of central positions.

Position	Observed	Expected
Geometric Centre	26	21.5
Other Positions	17	21.5
Total	43	43.0

Testing gave a value of χ^2 of 1.88 on one degree of freedom. The result was not significant, the null hypothesis was accepted and the alternative hypothesis rejected. There was no evidence that the subjects preferred either the geometric centre or a weighted position.

2.10. Conclusions.

Because of the sample size there were fewer significant results than might otherwise have been obtained. However, as a first experiment the experiment was successful because there were a number of interesting results which had not been previously published and which were of assistance in the design of follow-up experimentation.

At this stage the conclusions must still be tentative because most of the exercises were conducted with rather small samples; the main conclusions to Part 1 of this work are discussed at the end of chapter 3.

Choice of positions. During these exercises it was considered likely that some of the subjects would select what they considered to be the "most dangerous position". Steps were taken to eliminate this unwanted variable in the design of the exercises but as the selection of the "most dangerous position" is subjective it was not possible to be certain that this variable was completely eliminated, or to test whether the subjects took this into account. The

exercises discussed in chapter 3 were designed to allow for this by reversing the positions from the different aids to see if this made any difference to the subjects' choice.

1) There seemed to be no generally accepted method of selecting a position when there was more than the minimum necessary information.

2) The subjects demonstrated a dislike of a mean position among several position lines.

3) The subjects preferred to use one aid only, even when information from more than one aid was available.

4) The results from this study were sufficiently promising to justify a second study along the same lines using a larger sample. This study is described in chapter 3.

2.10. List of Exercises.

Exercise	Aids Examined.
1	Decca and D.F.(5)
2	Decca and Radar.(2)
3	Decca and Visual.(3)
4	Three D.F. Bearings.
5	Radar bearings and Distances.(4)
6	Visual, Decca and D.F.
7	Visual and Radar.(5)
8	Decca only.
9	Radar and D.F.(7)

The numbers in brackets indicates the exercise in experiment number two where the situations were repeated.

CHAPTER 3

Experiment Number 2.

Further experiments using the Bristol Channel Chart.

3.1. Introduction.

Experiment 1 carried out in the spring of 1976 showed some promising results, which seemed to justify further experiments along the same lines using a larger sample. With the results from that work available it was possible to improve on the design of the experiment and to increase the realism by reducing the size of the "cocked hats."

The First Experiment had given some useful insights into which aids the subjects considered the most reliable, and how they treated the errors which are always present when navigational systems are used.

At the same time some of the exercises were redesigned. These were the ones in which an interesting result had been obtained and in which it was hoped that the result would be repeated under slightly different circumstances. Most of the alterations were concerned with the positions of the land relative to the different exercises as it was not always possible to be certain about how this had influenced

Fig. 1

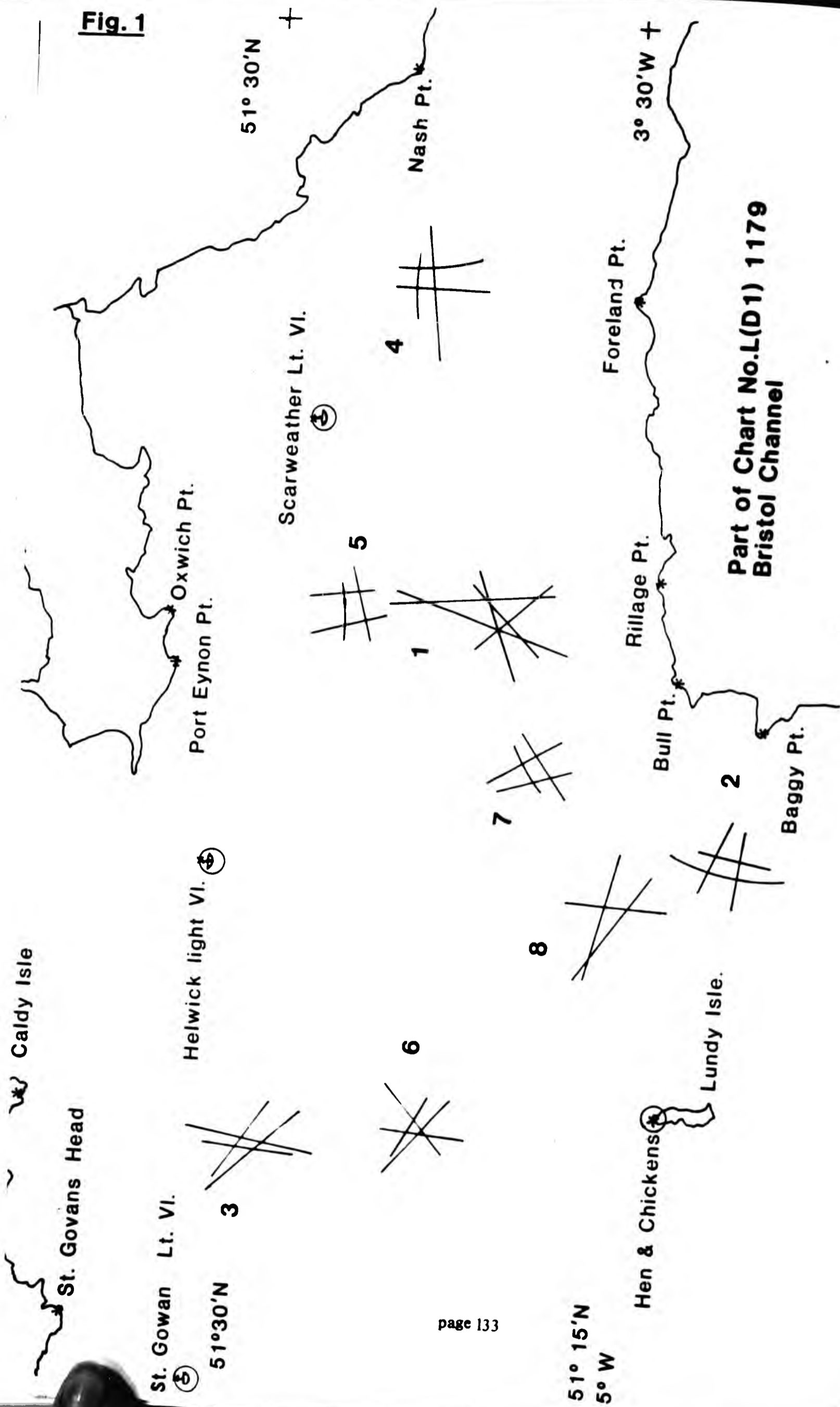

the subjects' behaviour in the earlier work.

3.2. Objectives of the experiment.

The objectives of the experiment were to confirm the preference among the aids, found in the first experiment and to confirm the finding that the subjects preferred to reject relevant information rather than to deduce a position fix on the basis of all the information provided. The general approach was similar to that for experiment Number 1 (see section 2.2.)

3.3. Design of the experiments.

The experiments were designed on the same basis as in Experiment 1 and the Bristol Channel chart No L(D1)1179 was again used because its suitability had already been demonstrated (fig 1). The number of exercises was initially reduced to seven with a further exercise (number 8) being added later when it was seen how strongly the subjects were rejecting the Radio Direction Finder (D.F.) in exercise No.1. It was decided not to repeat experiments 3, 6 and 8 from Experiment 1 because it was considered unlikely that they would contribute further information.

3.4. Tests and Hypotheses.

The same six standard tests that were used in

Experiment 1 were repeated in this experiment (2.4.). As in Experiment 1 it was found impossible to carry out test number 6 with the individual exercises so this test was postponed to the end of the experiment when it was carried out on the combined results.

To enable the results to be compared the " χ^2 goodness of fit test" (42) was used again because it had proved to be successful in analysing the results of Experiment 1 (2.5.).

3.5. Region of Rejection.

The region of rejection consisted of all values of χ^2 such that the probability of rejecting H_0 when it was in fact true, (α) was equal to or less than 0.5. i.e. $\alpha \leq .05$.

3.6. Significance Levels.

The significance values for χ^2 used in this experiment are given in the following table (43):-

Table 1. Critical values of the χ^2 statistic.

α	Degrees of Freedom		
	1	2	3
.05	3.84	5.99	7.81
.01	6.63	9.21	11.34
.001	10.83	13.81	16.27

In this chapter a result significant at $\alpha = .05$ is denoted by *, at $\alpha = .01$ by ** and at $\alpha = .001$ by ***.

3.7. The Eight Exercises.

(See section 3.11. for a complete list of the exercises.)

3.7.1. Exercise Number 1.

3.7.1.1. Introduction.

The subjects were given a card with the following instructions:-

Fig.2 Visual and D.F.

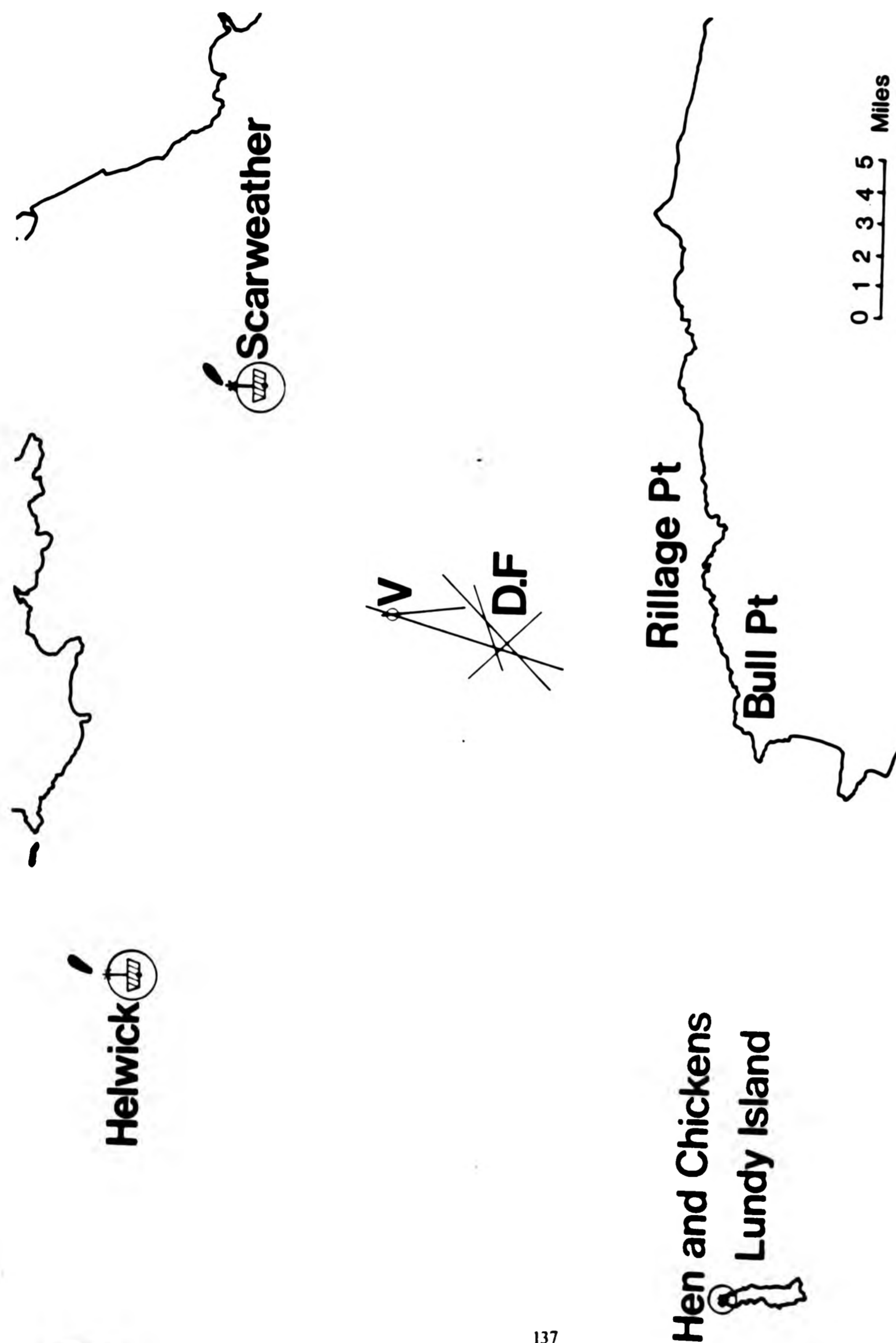

"You are bound inwards for Cardiff, visual bearings off Rillage Point and Bull Point lighthouses were 173° true and 196° true. D.F. bearings (corrected) were. Scarweather Light Vessel 045° true, Hen and Chickens Lighthouse 250° true and the Helwick Light Vessel 317° true."

When plotted these bearings made a kite shaped figure about 4 miles by 2 miles to the North of Rillage Point (Fig 2). The position and shape of the figure were designed as far as possible to neutralise any effect of the land on the subjects' choice of position. The visual bearings gave a poor cut and the identification of Rillage point could have been in doubt. The D.F. position was made as attractive as possible, and the three bearings made a small cocked hat, with good angles of cut while the position was further strengthened by the visual bearing off Bull Point Lighthouse passing through one corner.

The object of the exercise was to test the dislike of the D.F. demonstrated earlier in 2.8.1., 2.8.6. and 2.8.9. and to see how far the subjects were prepared to take this prejudice. The D.F. position was made as attractive as possible while the visual position was extremely doubtful.

The ship was bound inwards in order to minimise the

Exercise No. 1

Fig.3 Subjects' choice of position

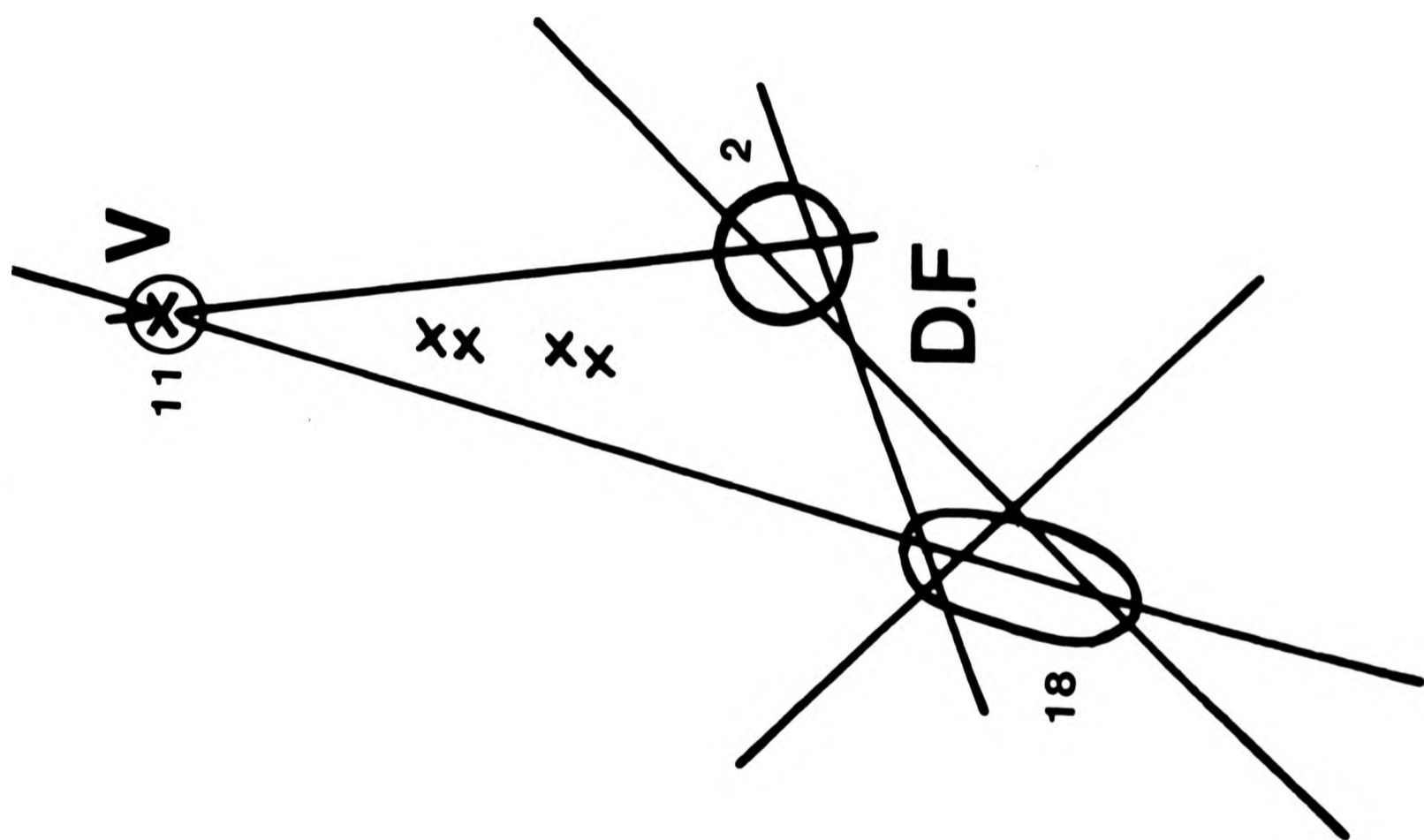

influence of the land on the subjects' decision as later she would be in the river with land on both sides. Thus at this point giving the benefit of the doubt to the position closest to the land would not have served any purpose.

3.7.1.2. Reults.

The results are given in fig 3 and table 2:-

Table 2. Subject numbers v choice of position.

1) Visual only.	
2,3,11,12,16,20,23,24,32,33 and 36	
	Total 11
2) Mean Position.	
1,9,25 and 26	
	Total 4
3) D.F. position and bearing of Bull Point.	
4,5,6,7,10,13,14,18,19,21,22,28,29,30,31,34,35, and 37.	
	Total 18
4) Visual bearing from Rillage Point and D.F. bearings from Hen and Chickens and Scarweather Light Vessel.	
17 and 27	
	Total 2
5) Did not plot a position on the chart.	
8 and 15	
	Total 2
	140

3.7.1.3. Test Number 1.

This examined the above groups to see if there was evidence of a preference for one particular strategy. The test used was the " χ^2 goodness of fit test".

H_0 The subjects showed no preference for one particular strategy or strategies.

H_1 The subjects preferred at least one strategy.

The results were tested from the following table:-

Table 3. Observed and expected frequencies of navigational strategies.

Strategy	Observed	Expected
Visual Only	11	8.75
Mean	4	8.75
D.F. and Visual(3)	18	8.75
D.F. and visual(4)	2	8.75
Total	35	35.00

Testing gave a value of χ^2 of 18.14*** on three degrees of freedom. The result was highly significant, the null hypothesis was rejected and the alternative hypothesis accepted. There was strong evidence that the results were

not random and the subjects preferred at least two of the strategies.

3.7.1.4. Test Number 2.

Of the subjects who selected corner positions was there any preference for one particular corner?

H_0 The subjects showed no preference for one particular corner.

H_1 The subjects preferred at least one of the corners.

This test was not ideal for this particular figure (fig 2) because although the corners defined by the visual bearings, the two D.F. bearings and the visual bearing from Bull point were acceptable, the third corner defined by the two D.F. bearings and the visual bearing from Rillage Point was an area rather than a corner but it was included in this test because it was expected that some subjects would select this position. The subjects' choice of corners is given in table 4:-

Table 4. Subjects' choice of corners.

Corner	Observed	Expected
Visual Only	11	10.3
D.F. and Bull Pt.	18	10.3
D.F. and Rillage Pt.	2	10.3
Total	31	31.0

Testing gave a value of χ^2 of 12.45** on two degrees of freedom, the result was significant, the null hypothesis was rejected and the alternative hypothesis was accepted. There was strong evidence that the subjects rejected the D.F. and Rillage Point bearing corner. In this result the preference was expressed in a negative sense, i.e. a rejection of a particular corner. The result was interesting in that although the subjects rejected one of the corners which was deliberately made unattractive, there was no evidence of a rejection of the visual only corner which was also doubtful as it was only defined by two bearings, with a poor angle of cut. Thus because of their prejudice against the D.F. a number of subjects chose a position which could not be justified by the geometry of the figure alone.

3.7.1.5. Test Number 3.

This test looked for a preference for one of the aids.

H₀ There was no preference for one particular aid.

H₁ The subjects preferred one of the aids.

In this exercise it was not possible for any of the subjects to select a D.F. only position so the information from the subjects' positions was allocated between the two aids in the following manner:-

Table 5. Allocation of the subjects' preference for the two aids.

Position	Visual	D.F.
Visual Only	11	0
Mean Position	2	2
D.F. and Bull Pt.	4.5	13.5
D.F. and Rillage Pt.	0.7	1.3
Total	18.2	16.8

Table 6. Observed and expected values of the subjects' preference for the two aids.

Aid	Observed	Expected
Visual	18.2	17.5
D.F.	16.8	17.5
Total	35.0	35.0

Testing gave a value of χ^2 of 0.6 on one degree of

freedom. The result was not significant, the null hypothesis was accepted, and there was no evidence that the subjects demonstrated a preference for one of the aids.

This exercise was strongly weighted in favour of the D.F. and the fact that the subjects were not offered a D.F. only position was probably why this particular test would seem at variance with those obtained in the Experiment 1 where the subjects rejected the D.F. (sections 2.8.1.9. and 2.8.9.9.).

3.7.1.6. Test Number 4.

Test Number 4 examined whether the subjects based their position on information from one aid only or whether they used both the aids.

H_0 There was no preference for the use of one aid only, rather than a combination of aids.

H_1 The subjects preferred to use either one particular aid or a combination of aids.

In this exercise the subjects who used one aid only were those who selected the visual only position. The data are given in the following table:

Table 7. Subjects' preference for one or both of the aids.

Preference	Observed	Expected
One Aid Only	11	17.5
Both aids	24	17.5
Total	35	35.0

Testing gave a value of χ^2 of 4.83* on one degree of freedom. The result was significant, the null hypothesis was rejected and the alternative hypothesis accepted. There was evidence that the subjects favoured one particular strategy, which in this exercise was to make use of both aids. What was of interest was that in this exercise which favoured the D.F. eleven subjects selected the Visual only position which had deliberately been made unattractive. Whether under similar circumstances at sea many of the subjects would have bothered to use the D.F. is an interesting question which must remain a possible subject for further research.

3.7.1.7. Test Number 5.

Did the subjects prefer an intersection of position lines or did they prefer a mean position among several lines?

H₀ There was no preference for either an intersection of position lines, or a mean position among several position lines.

H₁ The subjects preferred either an intersection of position lines, or a mean position among several lines.

In this exercise it was difficult to decide whether the subjects who chose the D.F./Visual bearing of Rillage Point position were selecting an intersection or a mean position. Fortunately there were only two subjects who chose that position and they were allocated to the mean position. The data are given in the following table:-

Table 8. Subjects' preference for a position line intersection or a mean position.

Position	Observed	Expected
Mean Position	6	17.5
Intersection	29	17.5
Total	35	35.0

Testing gave a value of χ^2 of 15.11** on one degree of freedom. The result was significant, the null hypothesis was rejected and the alternative hypothesis accepted. There was strong evidence that the subjects preferred an intersection of position lines to a mean position.

This result was affected by the fact that most of the

subjects who selected corners selected the position defined by the D.F./visual bearing of Bull Point and were therefore selecting an intersection of three position lines from two different aids which navigationally was a good decision.

3.7.1.8. Conclusions.

This exercise was designed to see how far the subjects' expressed dislike of the D.F. would be taken. Many of the subjects in the Experiment 1 made statements like "only consider the D.F. as a last resort". In this exercise, where the alternative to the D.F. was an unreliable position defined by visual bearings, most subjects took it into account but test Number 4 showed that even under these circumstances eleven of the subjects preferred to ignore this aid.

The other point of interest was that two subjects declined to provide a position. Presumably in practice they would have checked their information but in this circumstance there was a reliable position defined by the two D.F. bearings and the visual bearing off Bull Point.

This result demonstrated that there is little point in considering the Radio Direction Finder as a valid navigational aid for merchant ships unless considerable attempts are made to instil more confidence in its use. It is however an important aid for yachtsmen who have less

Fig.4 Radar and Decca

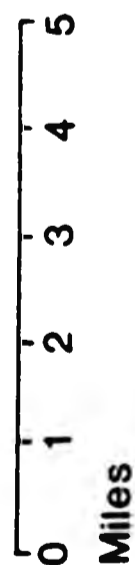
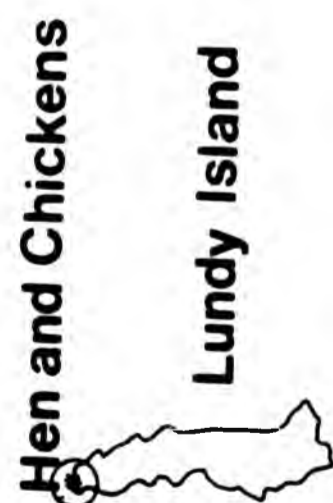
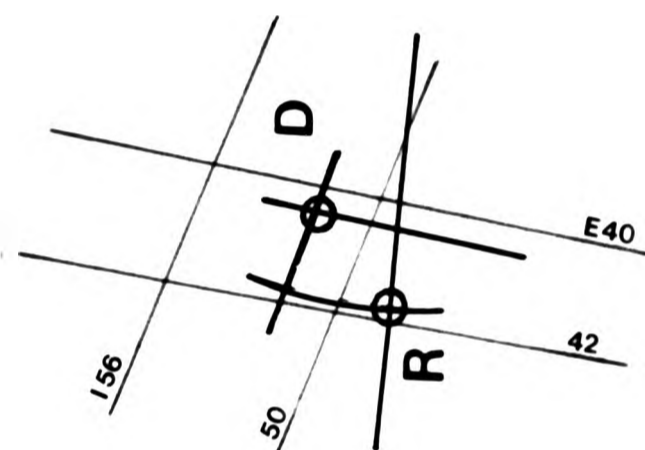
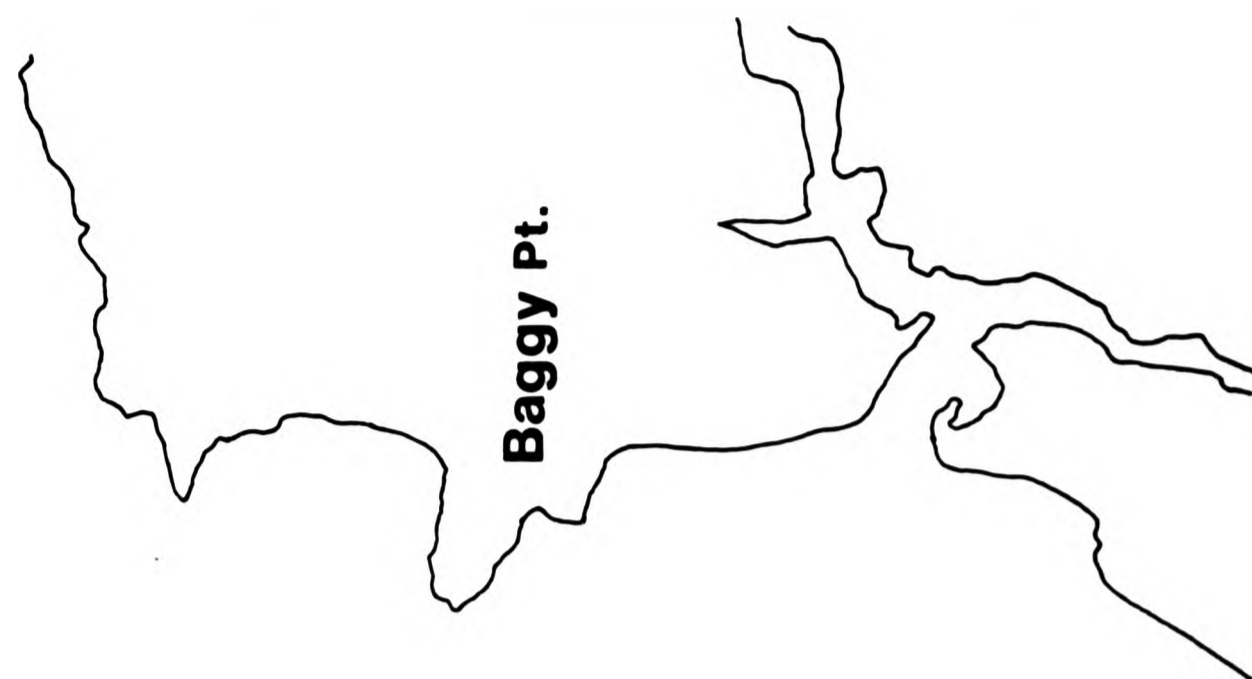

choice of alternative electronic aids.

3.7.2. Exercise Number 2.

3.7.2.1. Introduction.

The subjects were given a card with the following information:-

"Bound from Appledore to Milford Haven in moderate visibility, Baggy Point is 097° x 5.7 miles by radar and Decca readings are Green E 40.3 and Purple I 51.0."

When plotted on the chart the readings gave a square about one mile across situated four miles west of Baggy Point (Fig 4). The moderate visibility meant that there were no visual bearings available. The ship would be expected to pass about four miles off Lundy Island during the passage to Milford Haven so the land presented no particular danger on this passage.

The exercise was designed to look for evidence of a preference between radar and Decca and was a follow on to Exercise Number 2 in Experiment 1 (2.8.2) except that in this case the Decca and radar positions were reversed with the radar position putting the ship further out to sea.

3.7.2.2. Results.

The results divided into the following groups:-

Table 9. Subject numbers v choice of strategy.

1) Radar position Only.	
2,3,4,11,15,24,27,30,31 and 34	Total 10
2) Decca position Only.	
1,9,10,13,16,18,23,25,33 and 36	Total 10
3) Radar range and Decca position line.	
26 and 29	Total 2
4) Radar bearing and Decca position line.	
32 and 37	Total 2
5) Mean Position.	
5,6,14,17,20,,21 and 22	Total 7
6) Subjects with little experience of Decca or who did not plot a usable position.	
7,8,12,19,28 and 35	Total 6

3.7.2.3. Test Number 1.

This tested the above group to see if there were signs of a preference for a particular strategy or strategies. For the purpose of this test the subjects from group six were excluded.

H₀ The subjects showed no preference for a particular strategy or strategies.

H₁ The subjects preferred at least one strategy.

Table 10. Strategies grouped for χ^2 test.

Strategy	Observed	Expected
Radar Only	10	6.2
Decca Only	10	6.2
Radar range/Decca	2	6.2
Radar bearing/Decca	2	6.2
Mean Position	7	6.2
Total	31	31.0

Testing gave a value of χ^2 of 10.45* on four degrees of freedom, the result was significant, the null hypothesis was rejected and the alternative hypothesis accepted. There was evidence that the subjects were following several distinct strategies and that the results were not random.

3.7.2.4. Test Number 2.

Of the subjects who chose corners was there evidence of a preference for any particular corner?

H_0 The subjects showed no preference for one particular corner.

H_1 The subjects preferred at least one corner.

In this exercise the subjects who chose corners were those from the first four groups. Their results are given in table 11:-

Table 11. Subjects' choice of corners.

Corner	Observed	Expected
Radar Only	10	6
Decca Only	10	6
Radar range/Decca	2	6
Radar bearing/Decca	2	6
Total	24	24

Testing gave a value of χ^2 of 10.67* on three degrees of freedom. the result was significant. the null hypothesis was rejected and the alternative hypothesis accepted. There was evidence that the subjects showed a preference for the Radar only and the Decca only corners.

There was no valid reason for the subjects rejecting

the radar range/Decca corner, . although the radar bearing/Decca corner was not very reliable, but it looked as though the subjects were thinking in terms of one or another of the aids rather than combining the data in order to obtain a position.

3.7.2.5. Test Number 3.

This test looked for a preference for either one of the two aids, but in this case the preference for the aids was equally divided.

3.7.2.6. Test Number 4.

Test Number 4 examined whether the subjects based their positions on information from one aid only or whether they took the information from both aids into account when deciding on their position.

H_0 There was no preference for the use of one aid only, rather than a combination of aids.

H_1 The subjects preferred to use one particular aid or a combination of aids.

Assuming that the subjects who chose the mean position used both the aids the data are in table 12:-

Table 12. Subjects' selection of one or two aids.

Strategy	Observed	Expected
One Aid Only.	20	15.5
Both Aids.	11	15.5
Total	31	31.0

Testing gave a value of χ^2 of 2.61 on one degree of freedom. The result was not significant, the null hypothesis was accepted and the alternative hypothesis rejected. There was no evidence that the subjects preferred to fix their positions using information taken from one only or both of the aids.

Although this result was not significant it was important to note that almost twice as many subjects used one aid only as both aids. This must be of concern when it is considered that they had information from two accurate and reliable systems available for their use.

3.7.2.7. Test Number 5.

Did the subjects prefer an intersection of position lines or did they select a mean position among several lines?

H₀ There was no preference for either an intersection of position lines, or a mean position among several position lines.

H₁ The subjects preferred either an intersection of position lines, or a mean position among several lines.

In this test, the subjects who selected the four corners demonstrated a preference for an intersection. The group who chose a mean position were deemed to have chosen a position among several lines with the exception of subjects 14 and 17 who chose a position on a position line but not at an intersection. For the purpose of this exercise these two subjects were excluded from the test.

Table 13. Subjects' preference for an intersection or a mean position.

Strategy	Observed	Expected
Intersection	22	13.5
Mean Position	5	13.5
Total	27	27.0

Testing gave a value of χ^2 of 10.70** on one degree of freedom. The result was significant, the null hypothesis was rejected and the alternative hypothesis was accepted. There was strong evidence that the subjects preferred an

intersection of position lines to a mean position among several lines. Compared with test number 4 this result showed that the lack of preference for a particular aid was not tied in with preference for an intersection of position lines.

3.7.2.8. Conclusions.

One of the objectives of this exercise was to look for evidence of a preference for Decca or radar. However it was not possible to demonstrate any preference. The result needs to be examined in conjunction with exercise 2 of Experiment 1 (2.8.2.8.) where there was no evidence of a preference but possibly, given a larger sample a preference for the radar might have been demonstrated. The main difference between the two exercises was that in this case the Decca position put the ship closer to the land and possible danger. Thus it was possible that the subjects were reacting to this by selecting what they considered to be the more dangerous position, even though in this case the land presented no immediate threat. See section 5.2.4. for a further discussion on the preferences for the two aids.

There was a clear preference for an intersection of position lines rather than some sort of weighted position among several lines. Again it seems that the subjects were not making the best use of the information available, but

Fig.5 Visual and Decca

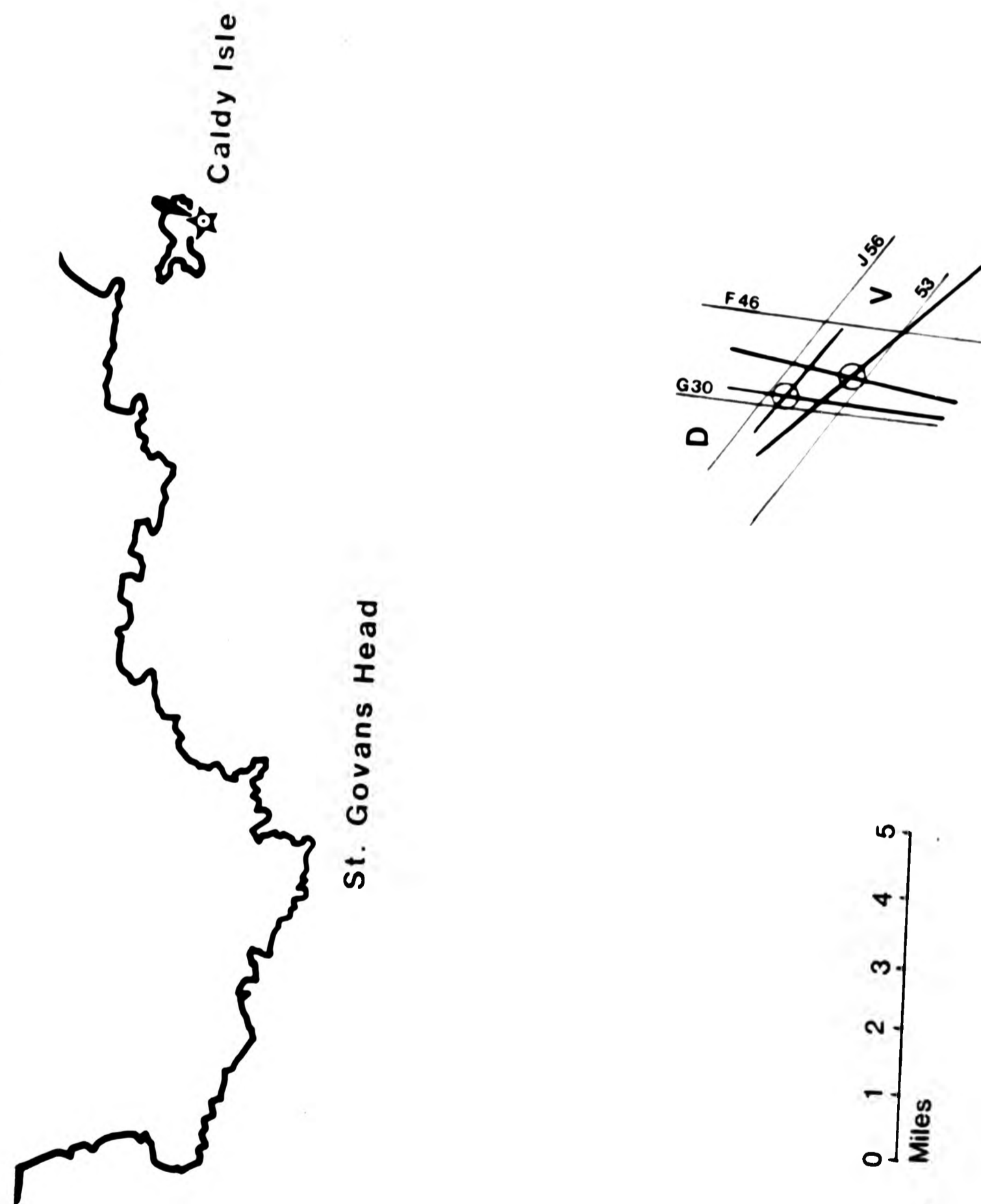

rather deciding their position on an either/ or basis.

3.7.3. Exercise Number 3.

3.7.3.1. Introduction.

The subjects were given a card with the following instructions:-

"Bound outwards for Milford Haven, visual bearings off St. Govans Hd. and Caldy Island Lt. Ho. are 316° true and 010° true. Decca readings are Green F47.7 and Purple J55.5."

When plotted the bearings gave a diamond shaped figure of about 1 mile across (fig 5). The nearest land was 7 miles to the North, but the ship would have to close the land later on her passage to Milford Haven. The Decca lines intersected to the North of the figure i.e. closest to the land while the visual bearings crossed at the southern corner of the figure. The angles of cut for the two aids were kept as close as possible to about 60°

The object of the exercise was to examine whether a preference existed for Decca or visual bearings. This was a repeat of exercise Number 3 in Experiment 1 with the Decca and Visual positions reversed. The diamond was made smaller than in the previous experiment because the subjects had criticised it as being rather large and stated that they would have expected Decca lane slip (13) to be present.

3.7.3.2. Results.

The results are given in Table 14:-

Table 14. Subject identity numbers v choice of position.

1) Intersection of visual bearings.

2,4,5,6,9,10,11,13,16,17,18,20,23,24,26,27,29,31,32,33 and
36.

Total 21

2) Intersection of Decca position lines.1,4 and 22.

Total 3

3) Position inside the diamond.

3,7,21,25,30,34 and 37

Total 7

4) Subjects who lacked current experience of the Decca and
did not participate.

8,12,15,19,28 and 35.

Total 6

3.7.3.3. Test Number 1.

This test examined the above groups to see if the
subjects followed any particular strategy or strategies.

H_0 The subjects showed no preference for a particular strategy or strategies.

H_1 The subjects preferred at least one strategy.

The data for the χ^2 test are given in table 15:-

Table 15. Observed and expected values for the different strategies.

Strategy	Observed	Expected
Visual Only	21	10.3
Decca Only	3	10.3
Mean Position	7	10.3
Total	31	31.0

Testing gave a value of χ^2 of 17.29*** on two degrees of freedom. The result was significant, the null hypothesis was rejected and the alternative hypothesis accepted. There was strong evidence that the subjects favoured a particular strategy, in this case the visual only position.

3.7.3.4. Test Number 2.

Was there any evidence that the subjects preferred one

particular corner?

H₀ The subjects showed no preference for one particular corner.

H₁ The subjects preferred at least one of the corners.

Table 16. Subjects' choice of corners.

Corner	Observed	Expected
Visual Only	21	8.3
Decca Only	3	8.3
Decca/Visual	1	8.3
Total	25	25.0

Testing gave a value of χ^2 of 29.12*** on two degrees of freedom. The result was significant, the null hypothesis was rejected and the alternative hypothesis accepted. There was strong evidence that the subjects favoured the visual only corner.

3.7.3.5. Test Number 3.

Did the subjects show any preference for one or other of the two aids or was their choice equally divided?

H_0 There was no preference for one particular aid.

H_1 The subjects preferred one of the aids.

With the subjects who used only one aid when fixing their position there was a clear preference of twenty one to three for the visual bearings, so the data from the subjects who chose mean positions were also included in the totals.

Table 17. Subjects' preference for aids.

Aid	Observed	Expected
Visual	24.5	15.5
Decca	6.5	15.5
Total	31.0	31.0

Testing gave a value of χ^2 of 10.45** on two degrees of freedom. The result was significant, the null hypothesis was rejected and the alternative hypothesis accepted. There was strong evidence that the subjects preferred the visual bearings. This result was in agreement with that from Experiment 1 (section 2.8.3.5.).

3.7.3.6. Test Number 4.

Did the subjects use one aid only when fixing their

positions or did they take information from both the aids?

H₀ There was no preference for the use of one aid only, rather than a combination of aids.

H₁ The subjects preferred to use either one particular aid or a combination of aids.

In this exercise the subjects who used one aid only were those who selected the visual only or the Decca only positions, the remainder made use of the information from both the aids.

Table 18. Subjects' preference for one or two aids.

Strategy	Observed	Expected
One Aid only	24	15.5
Both Aids	7	15.5
Total	31	31.0

Testing gave a value of χ^2 of 9.32** on one degree of freedom. The result was significant, the null hypothesis was rejected and the alternative hypothesis accepted. There was evidence that the subjects preferred to fix their positions using information from one aid only.

3.7.3.7. Test Number 5.

Did the subjects prefer an intersection of position lines or did they select a mean position among several lines?

H₀ There was no preference for either an intersection of position lines, or a mean position among several position lines.

H₁ The subjects preferred either an intersection of position lines, or a mean position among several lines.

In this exercise the results were clear; those subjects selecting the visual or Decca position and the subject (no. 34) who selected a combined position selected an intersection, the others selected a mean position.

Table 19. Subjects' choice of an intersection or a mean position.

Strategy	Observed	Expected
Intersection	25	15.5
Mean position	6	15.5
Total	31	31.0

Testing gave a value of χ^2 of 11.65*** on one degree of

freedom. The null hypothesis was accepted and the alternative hypothesis rejected. There was strong evidence that the subjects preferred an intersection of position lines.

This result was in agreement with the result obtained from Experiment 1, (section 2.8.3.7.). Again it seems that the subjects were fixing their position on the basis of one or other of the aids rather than taking some information from both and selecting the position which best fitted the data. In this exercise the strong evidence for an intersection must be partly due to the preference for visual bearings over the Decca navigator, also demonstrated earlier (2.8.3.5. and 3.7.3.5.).

3.7.3.8. Conclusions.

This exercise was designed to look for evidence of a preference between visual bearings and the Decca navigator. It was clear that the subjects preferred the visual bearings even to the extent, in many cases, of totally rejecting the information from the Decca navigator. Despite giving the Decca the benefit of any doubt by being closer to the land, the subjects rejected this aid in preference to the visual bearings. The question which this exercise raises is whether the subjects would navigate in this manner at sea or whether they have been conditioned by their seniors to reject information from electronic

Fig.6 Radar Position

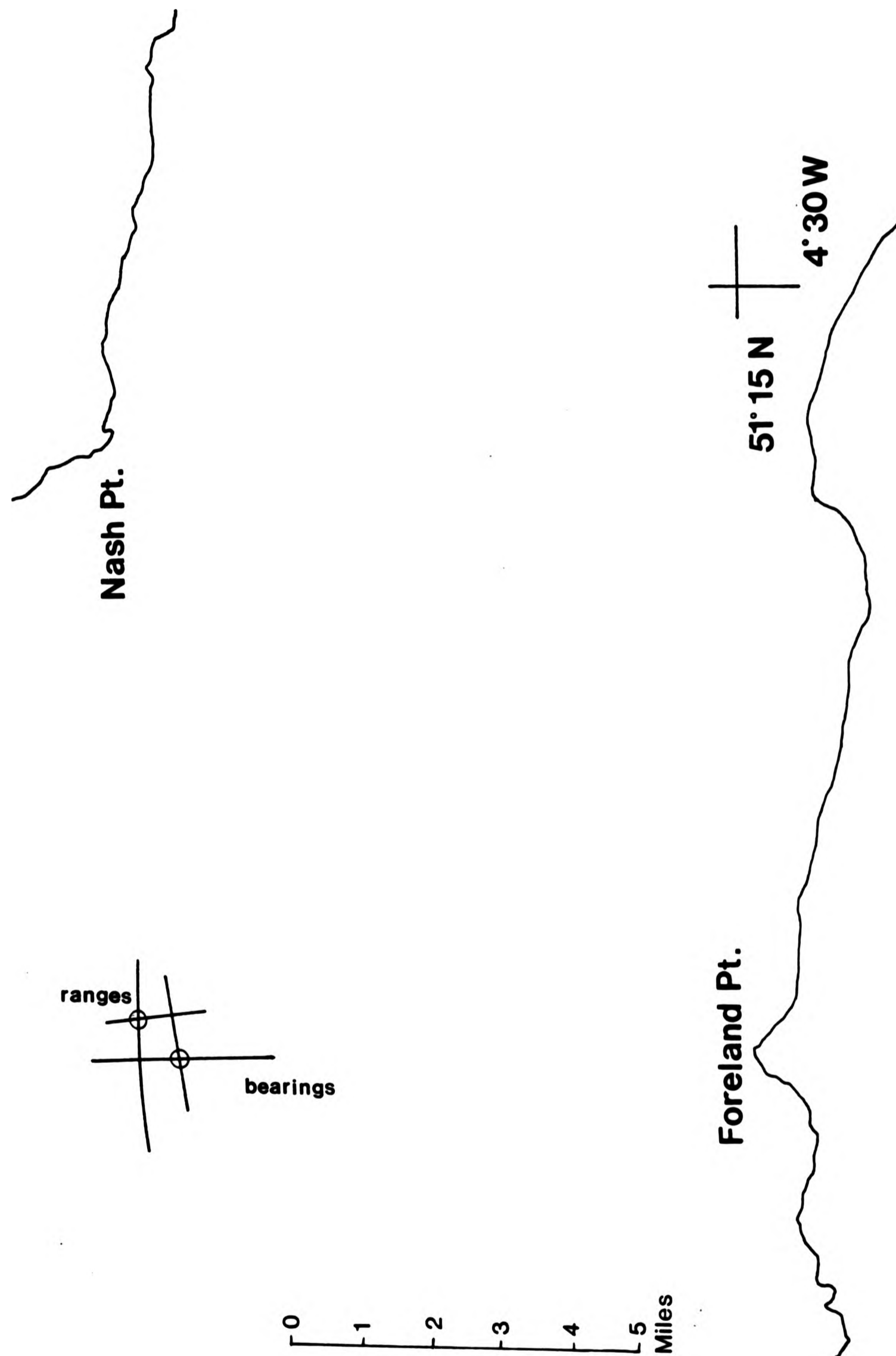

"devices" and were therefore reacting in what they considered to be the "correct" manner in this experiment.

3.7.4. Exercise Number 4.

3.7.4.1. Introduction.

The subjects were presented with a card containing the following information:-

"Bound outwards from Cardiff in moderate visibility, radar positions are Foreland Pt. 179° true x 8.8 miles and Nash Pt. 082° true x 8.0 miles."

When plotted on the chart the bearings made a square about 1 mile across to the North of Foreland Point (Fig 6). The channel is widening out at this point and so there was little danger from the land at this stage of the voyage. The moderate visibility explained why visual bearings were not available to check the ship's position.

The object of this exercise was to examine how the subjects used the radar information. This was a follow on from Exercise 5 in Experiment 1 (section 2.8.5.) with the radar ranges and bearings reversed in relation to the direction of the land.

3.7.4.2. Results.

The subjects selected the following strategies:-

Fig. 7
Exercise No.4 Subjects' choice of position

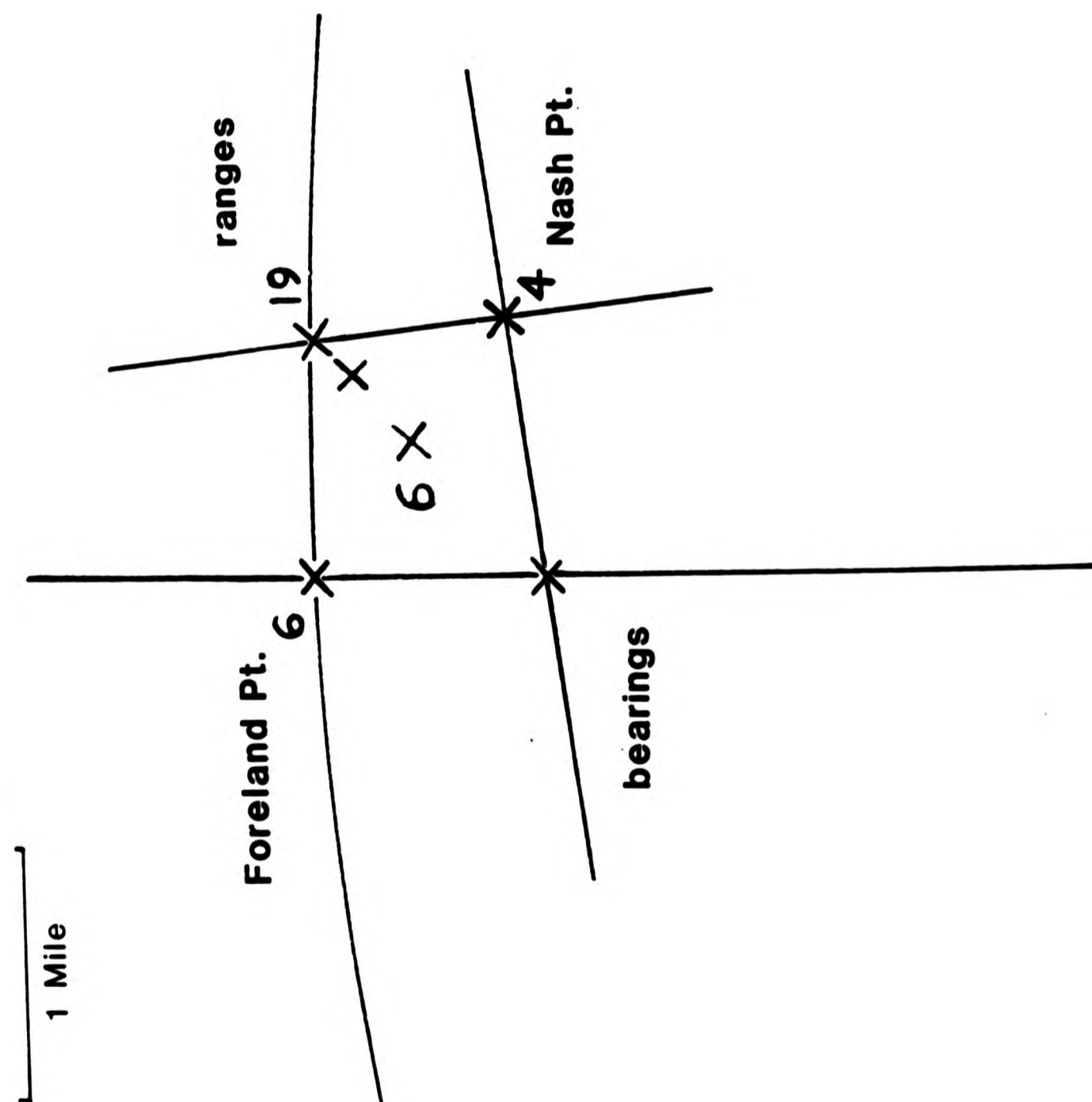

Table 20. Subject numbers v choice of strategy.

1) Those who chose the intersection of radar ranges.

1, 3, 4, 5, 9, 11, 12, 13, 17, 18, 26, 27, 29, 30, 31, 32, 34, 35 and 36.

Total 19

2) The subject who chose an intersection of radar bearings.

24

Total 1

3) Those who chose a mean position.

6, 8, 20, 22, 28 and 37.

Total 6

4) Those who used the information from Foreland Point only.

10, 14, 16, 21, 23, and 33

Total 6

5) Those who used the information from Nash Point only.

2, 7, 19 and 25.

Total 4

6) Could not select a position.

15

Total 1

3.7.4.3. Test Number 1.

Were there any signs that the subjects favoured a particular strategy or strategies? If not the data could be considered to be random.

H_0 The subjects showed no preference for one particular strategy or strategies.

H_1 The subjects preferred at least one strategy.

The data from table 20 were grouped as shown in table 21 for the χ^2 test:-

Table 21. Observed and expected values for the different strategies.

Strategy	Observed	Expected
Radar Ranges	19	7.2
Radar Bearings	1	7.2
Foreland Point	6	7.2
Nash Point	4	7.2
Mean Position	6	7.2
Total	36	36.0

Testing gave a value of χ^2 of 26.5*** on four degrees of freedom. The null hypothesis was rejected and the alternative hypothesis accepted. There was strong evidence that the subjects were following a particular strategy, in

this case the intersection of the radar ranges and rejecting another strategy, i.e. the intersection of the radar bearings, and the data were not random.

3.7.4.4. Test Number 2.

Of the subjects who selected corner positions, was there a preference for any particular corner?

H_0 The subjects showed no preference for one particular corner.

H_1 The subjects preferred at least one of the corners.

Table 22. Subjects' choice of corners.

Corner	Observed	Expected
Radar ranges.	19	7.5
Radar bearings	1	7.5
Foreland Point	6	7.5
Nash Point.	4	7.5
Total	30	30.0

Testing gave a value of χ^2 of 25.20*** on three degrees of freedom. The result was significant, the null hypothesis was rejected and the alternative hypothesis accepted. There was strong evidence that the subjects preferred the corner defined by the intersection of the radar ranges.

This result demonstrated that the subjects were following the method which they had been taught. An intersection of radar ranges is considered to be the most accurate method of position fixing using radar (14) and therefore their teaching has been of some value.

3.7.4.5. Test Number 3.

Was there any preference for one of the aids? This test was not suitable for this particular exercise so instead the data were examined to see if there was a preferred method of using the radar.

H_0 The subjects showed no preference for one particular method.

H_1 The subjects preferred at least one of the methods.

The different methods used by the subjects are given in table 23:-

Table 23. Methods of using the radar.

Method	Observed	Expected
Ranges only	19	10
Bearings only	1	10
Range and Bearing	10	10
Total	30	30

Testing gave a value of χ^2 of 16.2** on two degrees of freedom. The result was significant, the null hypothesis was accepted and the alternative hypothesis rejected. There was also strong evidence that the subjects rejected the intersection of bearings. The subjects who selected the mean position were excluded from this test because it was not possible to decide what method of fixing they were employing.

3.7.4.6. Test Number 4.

This tested whether the subjects used one aid or a combination of aids in fixing their position and was not appropriate for this exercise where only one aid was used.

3.7.4.7. Test Number 5.

Did the subjects prefer an intersection of position lines or a mean position among several?

H₀ There was no preference for either an intersection of position lines, or a mean position among several lines.

H₁ The subjects preferred either an intersection of position lines, or a mean position among several lines.

Table 24. Subjects' preferences for position.

Preference	Observed	Expected
Intersection	30	18
Mean Position	6	18
Total	36	36

Testing gave a value of χ^2 of 16*** on one degree of freedom. The result was significant, the null hypothesis was rejected and the alternative hypothesis accepted. There was strong evidence that the subjects preferred an intersection of position lines.

This result was probably influenced by the subjects' strong preference for an intersection of radar ranges. This has already been discussed in 3.7.4.4.

3.7.4.8. Conclusions.

H₀ There was no preference for either an intersection of position lines, or a mean position among several lines.

H₁ The subjects preferred either an intersection of position lines, or a mean position among several lines.

Table 24. Subjects' preferences for position.

Preference	Observed	Expected
Intersection	30	18
Mean Position	6	18
Total	36	36

Testing gave a value of χ^2 of 16*** on one degree of freedom. The result was significant, the null hypothesis was rejected and the alternative hypothesis accepted. There was strong evidence that the subjects preferred an intersection of position lines.

This result was probably influenced by the subjects' strong preference for an intersection of radar ranges. This has already been discussed in 3.7.4.4.

3.7.4.8. Conclusions.

Fig. 8 Visual and Radar

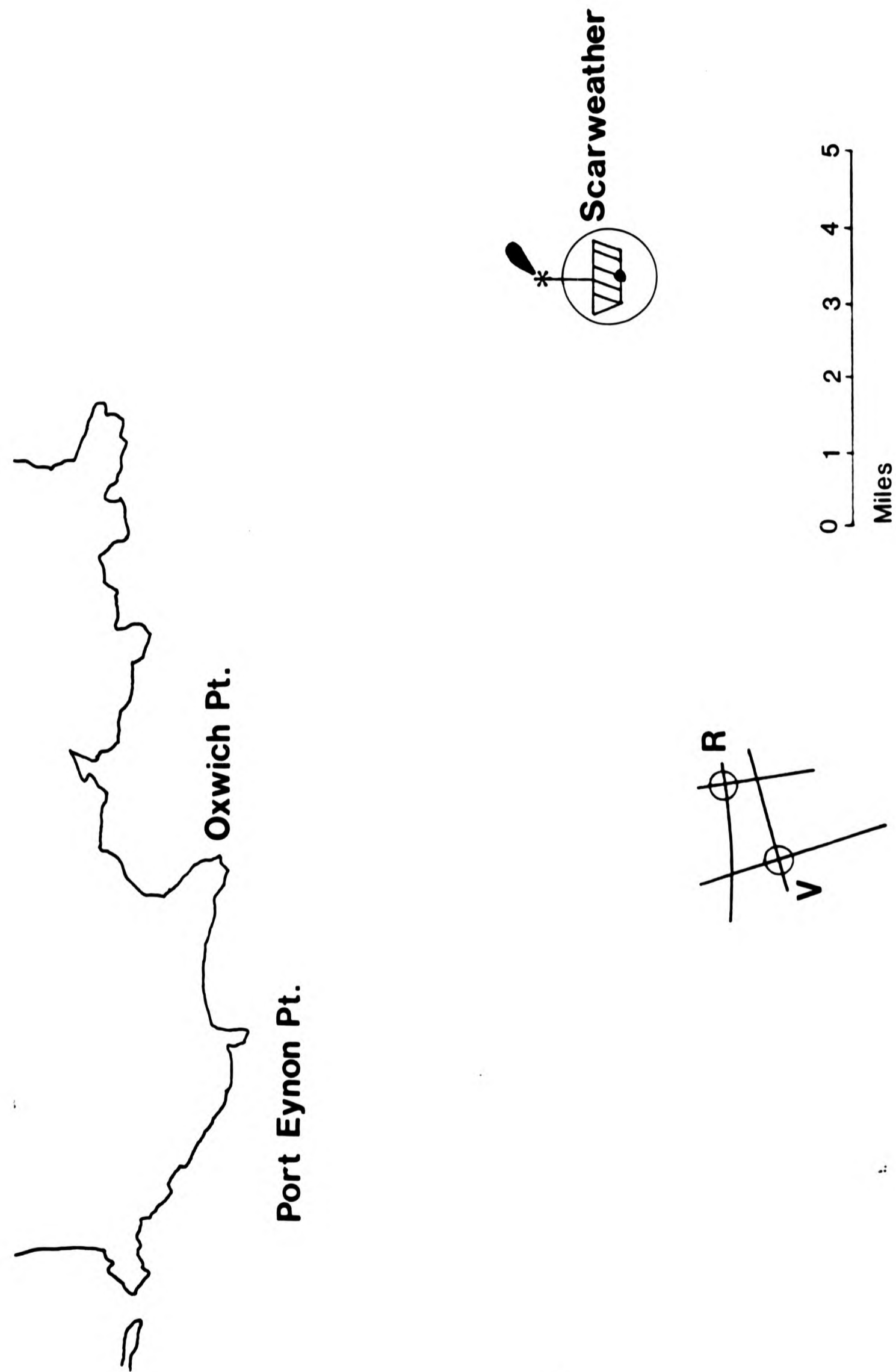

This exercise demonstrated similar results to exercise 5 in Experiment 1. The subjects showed a strong preference for the intersection of radar ranges regardless of whether it placed the ship closer to the land or not.

Despite the subjects' preference for this method of position fixing almost every other alternative was selected by at least one subject and it appears that even where the situation seems to be clear cut the subjects' choice of position is by no means unanimous.

3.7.5. Exercise Number 5.

3.7.5.1. Introduction.

The subjects were given a card with the following instructions:-

"Bound from Cardiff to Milford Haven, visual bearings off the Scarweather Lt./Vl. and Porth Eynon Pt. are 075° true and 342° true. A radar position off Oxwich Pt. is 351° x 7 miles."

When plotted the bearings gave a rectangular shape about 1 mile x 2 miles with the longer side running E - W, 7 miles off the land (fig 8). The ship was outward bound and well clear of the land.

The object of the exercise was to see if a preference

existed for either the radar or visual bearings. This exercise was a follow-on from exercise Number 7 in Experiment 1.

3.7.5.2. Results.

The subjects selected the following strategies:-

Table 25. Subject numbers v choice of position.

1) Position by visual bearings.

1, 2, 3, 4, 12, 13, 16, 19, 20, 23, 25, 28, 31, 33, 35 and 36.

Total 16

2) Position by radar only.

7, 10, 14, 22 and 24

Total 5

3) Mean position.

5, 6, 9, 17, 18, 27, 30 and 37

Total 8

4) Radar range and visual bearing .

11, 21, 26, 29 and 32

Total 5

5) Radar bearing and visual bearing of the Scarweather
Lt./Vl.

34

Total 1

6) Positions which could not be used because of incorrect
plotting by the subjects.

8 and 15

Total 2

3.7.5.3. Test Number 1.

Test number 1 examined whether the subjects followed selected strategies or whether the positions were chosen at random.

H_0 The subjects showed no preference for one particular strategy.

H_1 The subjects preferred at least one strategy.

Table 26. Observed and expected frequencies of Navigational strategies.

Strategy	Observed	Expected
Visual bearings	16	7
Mean Position	8	7
Radar position	5	7
Radar range/vis.	5	7
Radar brg./vis.	1	7
Total	35	35

Testing gave a value of χ^2 of 18.0** on four degrees of freedom. The result was significant, the null hypothesis was rejected and the alternative hypothesis accepted. There

was evidence that the subjects preferred one of the strategies.

3.7.5.4. Test Number 2.

Test Number 2 examined whether the subjects selected any particular corner.

H_0 The subjects showed no preference for one particular corner.

H_1 The subjects preferred at least one of the corners.

Table 27. Subjects' choice of corners.

Corner	Observed	Expected
Visual bearings	16	6.75
Radar position	5	6.75
Radar range/vis.	5	6.75
Radar brg./vis.	1	6.75
Total	27	27.00

Testing gave a value of χ^2 of 18.48** on three degrees of freedom. The result was significant, the null hypothesis was rejected and the alternative hypothesis accepted. There was evidence that the subjects favoured the corner defined by the visual bearings.

3.7.5.5. Test Number 3.

Test Number 3 examined whether the subjects demonstrated a preference for one of the aids.

H_0 There was no preference for one particular aid.

H_1 The subjects preferred one of the aids.

This test was conducted in two parts because in this exercise there were two situations, those subjects who used one aid only, and then the subjects who used both aids in some way to fix their positions.

Table 28. Subjects who used one aid only.

Aid	Observed	Expected
Visual	16	10.5
Radar	5	10.5
Total	21	21.0

Testing gave a value of χ^2 of 5.76* on one degree of freedom. The result was significant, the null hypothesis was accepted and the alternative hypothesis rejected. There was evidence that the subjects preferred the visual

bearings to the radar.

When all the results were used and the positions from those subjects who selected mean positions were allocated the results are in table 29:-

Table 29. Subjects' preferences for the two aids.

Aid	Observed	Expected
Visual	23.1	17.5
Radar	11.9	17.5
Total	35.0	35.0

Testing gave a value of χ^2 of 3.58. The result was not significant, the null hypothesis was accepted and the alternative hypothesis rejected. There was no evidence that the subjects preferred either aid.

Although this result was not significant, almost twice the number of subjects selected the visual bearings as the radar which lends weight to the first test which suggests that a preference exists for visual bearings over the radar.

3.7.5.6. Test Number 4.

Did the subjects prefer to use one aid only or did they take both aids into account when fixing their position?

H₀ There was no preference for the use of one aid only ,
rather than a combination of aids.

H₁ The subjects preferred to use either one particular aid,
or a combination of aids.

The subjects who used one aid only were those who
selected the visual or the radar only positions, the others
used both aids in some way.

Table 30. Subjects' use of one or both of the aids.

Strategy	Observed	Expected
One aid only	21	17.5
Both aids	14	17.5
Total	35	35.0

Testing gave a value of χ^2 of 1.4, on 1 degree of
freedom. The result was not significant, the null
hypothesis was accepted and the alternative hypothesis
rejected. There was no evidence of any particular strategy.

This result was alarming. The subjects were offered two
reliable methods of position fixing and yet the majority
chose to ignore one of these methods when selecting a
position.

3.7.5.7. Test Number 5.

Did the subjects select an intersection of position lines or did they prefer a mean position among several lines?

H₀ There was no preference for either an intersection of position lines, or a mean position among several position lines.

H₁ The subjects preferred either an intersection of position lines, or a mean position among several lines.

In this test the positions from subjects 18 and 30 were omitted from the data because they selected a position on a line but not at an intersection.

Table 31. Subjects' preference for an intersection or a mean position.

Strategy	Observed	Expected
Intersection	27	16.5
Mean position	6	16.5
Total	33	33.0

Testing gave a value of χ^2 of 13.36*** on one degree of freedom. The result was highly significant. There was strong evidence that the subjects preferred an intersection of position lines.

This result was in agreement with the general trend of this work.

3.7.5.8. Conclusions.

The test demonstrated that under some circumstances there was a preference for the visual bearings over the radar, a result that it was not possible to demonstrate in Experiment 1 (section 2.8.7.). It was not a marked preference but as they are both reliable methods of position fixing, there was no technical reason why there should be any preference at all.

3.7.6. Exercise Number 6.

3.7.6.1. Introduction.

The subjects were given a card with the following information:-

"Bound from Cardiff to Dublin, D.F. bearings

Fig.9 Decca and D.F.



Helwick

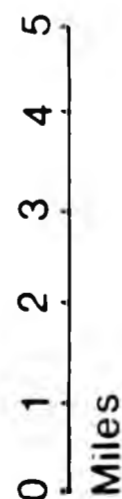
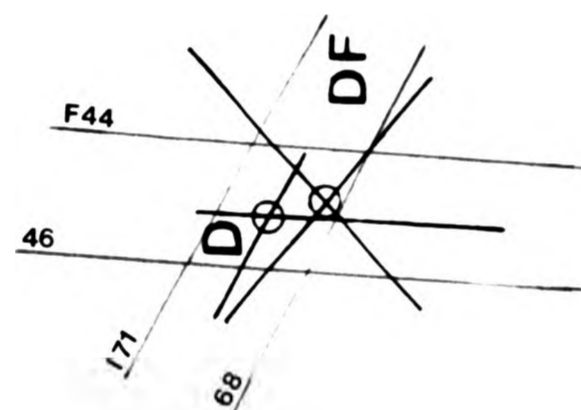

St. Gowans

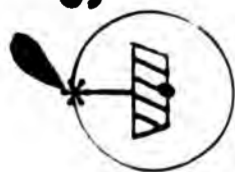

(corrected) are, St. Gowan Lt./ Vl. 310° true and Helwick Lt./Vl. 049° true while Decca Readings are Green F 45.1 and Purple I 70.0"

When plotted on the chart the bearings gave an irregular shaped quadrilateral about 1 mile across and situated about 1 mile north of Lundy Island (Fig 9). The ship was bound for Dublin and well clear of any dangers in the Bristol channel, so the position of the land should not have had any influence on this exercise. The quality of the information from the 2 aids was similar, the D.F. bearings intersected closer to 90° than the Decca and the two lightships were both close to the ship's position with no land in the way. The Decca coverage in this area was acceptable with a good angle of cut between the position lines.

The object of the exercise was to compare the subjects' attitude to the Decca and the D.F. This exercise did not relate directly to any in Experiment 1 but exercise 1 was similar although it was carried out further up the Bristol Channel.

3.7.6.2. Results.

The subjects' choice of strategies are shown in fig 10 and Table 32:-

Fig.10

Exercise No.6 Subjects' choice of position

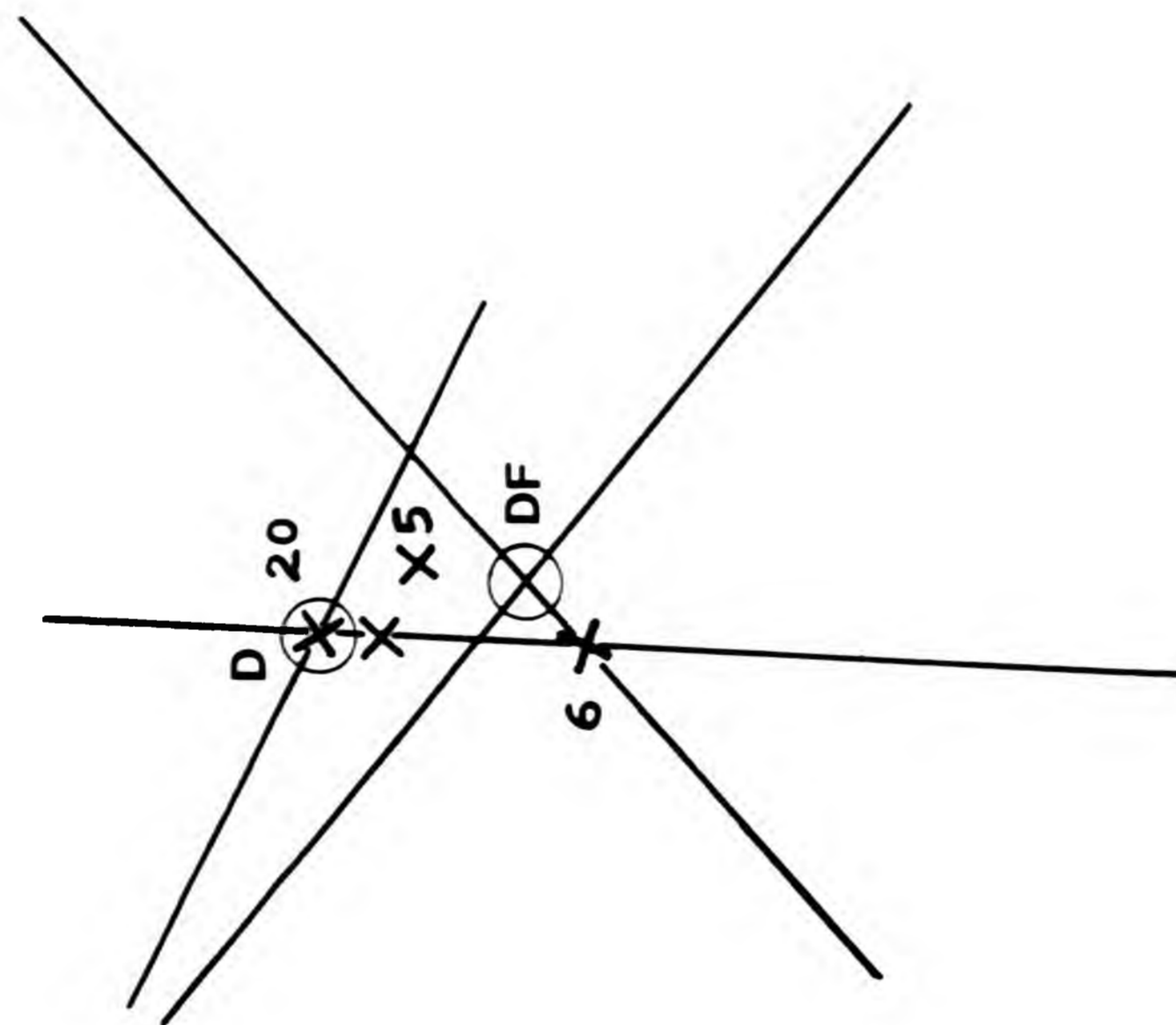

1 Mile

Table 32. Subject numbers v choice of strategy.

1) Decca Only.

1,2,3,4,6,7,10,11,13,16,18,24,25,27,29,32,33,
34,36 and 37.

Total 20

2) Combined D.F. and Decca position lines.

14,17,23,28,31 and 35.

Total 6

3) Mean Position.

5,20,22,26 and 30.

Total 5

4) Those subjects without experience of Decca or who failed
to plot a usable position.

8,9,12,15,19 and 21.

Total 6

It was noticeable that none of the subjects chose the
D.F. only position.

3.7.6.3. Test Number 1.

Was there any evidence among the above data that the
subjects were following a definite strategy or strategies?

H₀ The subjects showed no preference for one particular strategy.

H₁ The subjects preferred at least one strategy.

The different strategies followed by the subjects are given in Table 33:-

Table 33. Observed and expected frequencies of the subjects' navigational strategies.

Strategy	Observed	Expected
Decca Only	20	10.3
Decca/D.F.	6	10.3
Mean Position	5	10.3
Total	31	31.0

When the data were tested it gave a value of χ^2 of 13.61** on three degrees of freedom. The result was significant, the null hypothesis was rejected and the alternative hypothesis accepted. There was strong evidence that the subjects preferred one of the positions and the data were not random.

3.7.6.4. Test Number 2.

Of the subjects who selected corners was there any evidence of a preference for one particular corner?

In this exercise, although the figure had four corners, two of the corners were close together, the corner given by the intersection of the D.F. bearings and the corner given by the Green Decca line and the D.F. bearings. This meant that for practical purposes the figure was basically triangular.

H₀ The subjects showed no preference for one particular corner.

H₁ The subjects preferred at least one of the corners.

Table 34. Subjects' choice of corners.

Corner	Observed	Expected
Decca Only	20	13
Decca/D.F.	6	13
Total	26	26

Testing gave a value of χ^2 of 7.54** on one degree of freedom. The result was significant, the null hypothesis was rejected and the alternative hypothesis accepted. There was evidence that the subjects preferred the Decca only position. The third corner was the D.F. only and as none of the subjects selected this one it was not included in the

test.

3.7.6.5. Test Number 3.

Was there any preference for one particular aid? In this test, as none of the subjects selected the D.F. on its own, all the positions were allocated between the two aids. Those subjects who selected the Decca/D.F. corner were allocated 2:1 to the D.F. because there were two D.F. position lines and only one Decca line. The mean position was allocated according to the subjects' choice of position. These allocations are summarised in table 35:-

Table 35. Subjects' choice of Aid.

Aid	Observed	Expected
Decca	24.75	15.5
D.F.	6.25	15.5
Total	31.00	31.0

Testing gave a value of χ^2 of 11.04** on one degree of freedom. The result was significant, the null hypothesis was rejected and the alternative hypothesis accepted. There was evidence that the subjects preferred the Decca. Because of the construction of the figure the allocation of the subjects who selected the mean position tended to favour the D.F. slightly but not enough to influence this result.

3.7.6.6. Test Number 4.

Did the subjects prefer to use the information from one aid only, or did they take both into account when fixing their position?

H_0 There was no preference for the use of one aid only, rather than a combination of aids.

H_1 The subjects preferred to use either one particular aid or a combination of aids.

In this exercise the only subjects who used one aid only were the twenty who selected the Decca only position as none of the subjects selected the D.F. only position. All the other positions involved the use of information from both the aids.

Table 36. Subjects' preference for one or both of the aids.

Strategy	Observed	Expected
Decca only	20	15.5
Both aids	11	15.5
Total	31	31.0

Testing gave a value of χ^2 of 2.61 on one degree of freedom. The result was not significant, the null hypothesis was accepted and the alternative hypothesis

rejected. There was no evidence of a preference. Although non significant, almost twice as many subjects preferred to use the Decca only as preferred to use both the aids. This was further evidence that many subjects were not willing to make use of all the available information.

3.7.6.7. Test Number 5.

Did the subjects prefer an intersection of position lines or did they prefer a mean position among several lines?

H₀ There was no preference for either an intersection of position lines, or a mean position among several position lines.

H₁ The subjects preferred either an intersection of position lines, or a mean position among several lines.

In this exercise, because of the construction of the figure, there was some doubt as to whether the subjects who selected the combined Decca/D.F. position were in fact selecting an intersection or a mean position so the results from that position were allocated 50/50.

Table 37. Subjects' preference for an intersection or a mean position.

Preference	Observed	Expected.
Intersection	23	15.5
Mean Position	8	15.5
Total	31	31.0

Testing gave a value of χ^2 of 7.26** on one degree of freedom. The result was significant, the null hypothesis was rejected and the the alternative hypothesis accepted. There was evidence that the subjects preferred an intersection of position lines. Although this result might have been considered suspect because of the construction of the figure, it followed the general trend of a preference for an intersection of position lines.

3.7.6.8. Conclusions.

This test was in agreement with Exercise Number 1 in Experiment 1 (2.8.1.) where the subjects also demonstrated a preference for the Decca over the D.F. This exercise was designed to favour the D.F. as far as possible but it did not seem to make any difference to the result, so it must be assumed that the dislike for the D.F. is so deep-seated that this aid is unlikely to be used in practice except as a last resort.

Fig. 11 Radar and D.F.

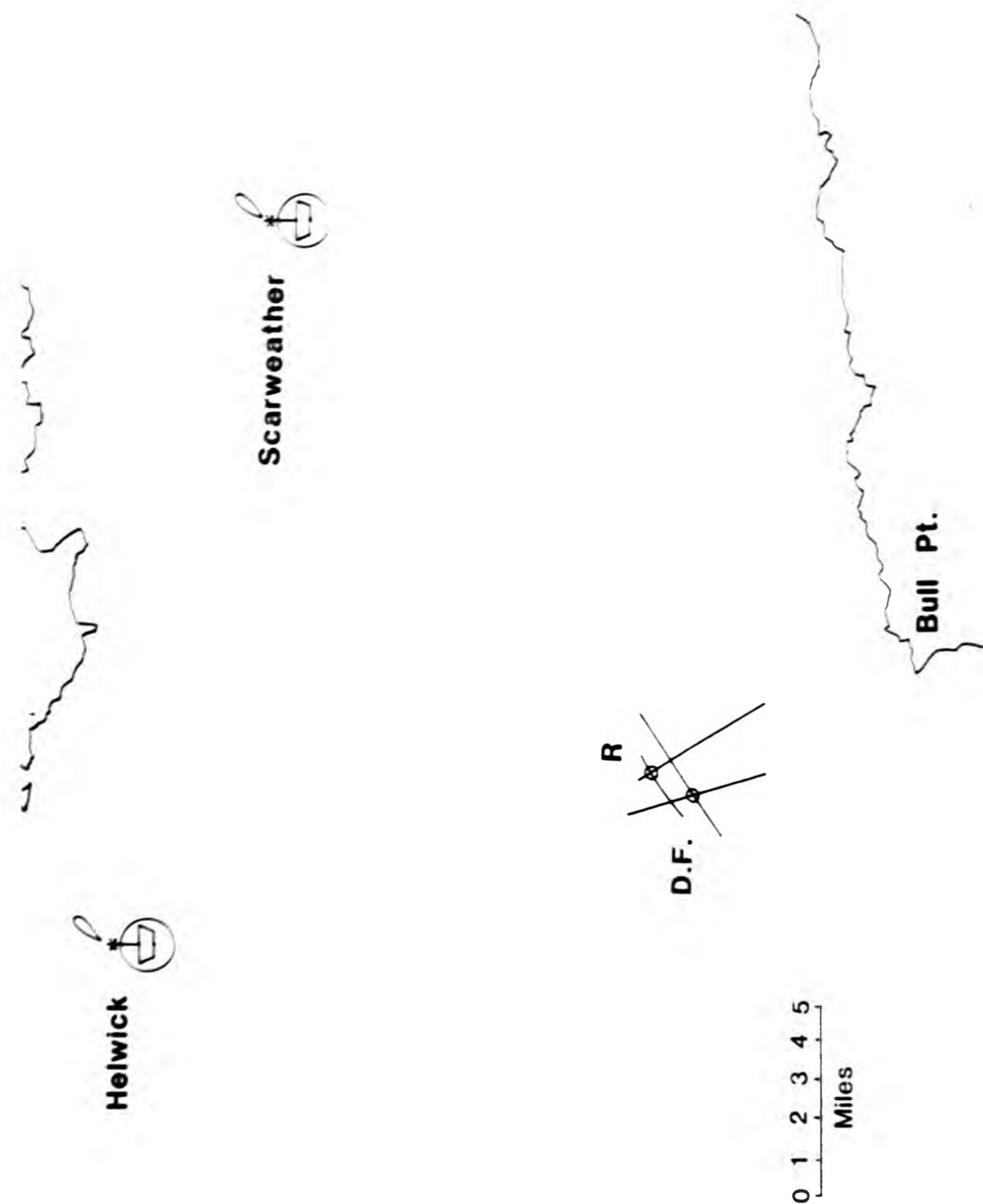

3.7.7. Exercise Number 7.

3.7.7.1. Introduction.

The subjects were presented with a card containing the following information:-

"Bound for Southampton, D.F. bearings (corrected) are Scarweather Lt./Vl. 055° true and Helwick Lt./Vl 343° true, while a radar position off Bull Point is 148°x 7.0 miles."

When plotted the bearings formed a rectangular shape about 1 mile across and 7 miles off the land (fig 11). The radar position put the ship further from the land than the D.F. position thus giving the benefit of any doubt to the D.F. The ship was outward bound and clear of the land so it should have minimum effect on the result.

The exercise was based on exercise number 9 in Experiment 1 (2.8.9.) and was intended to look for evidence of a preference for either the radar or the D.F.

3.7.7.2. Results.

The results were divided into the following groups:-

Fig. 11 Radar and D.F.

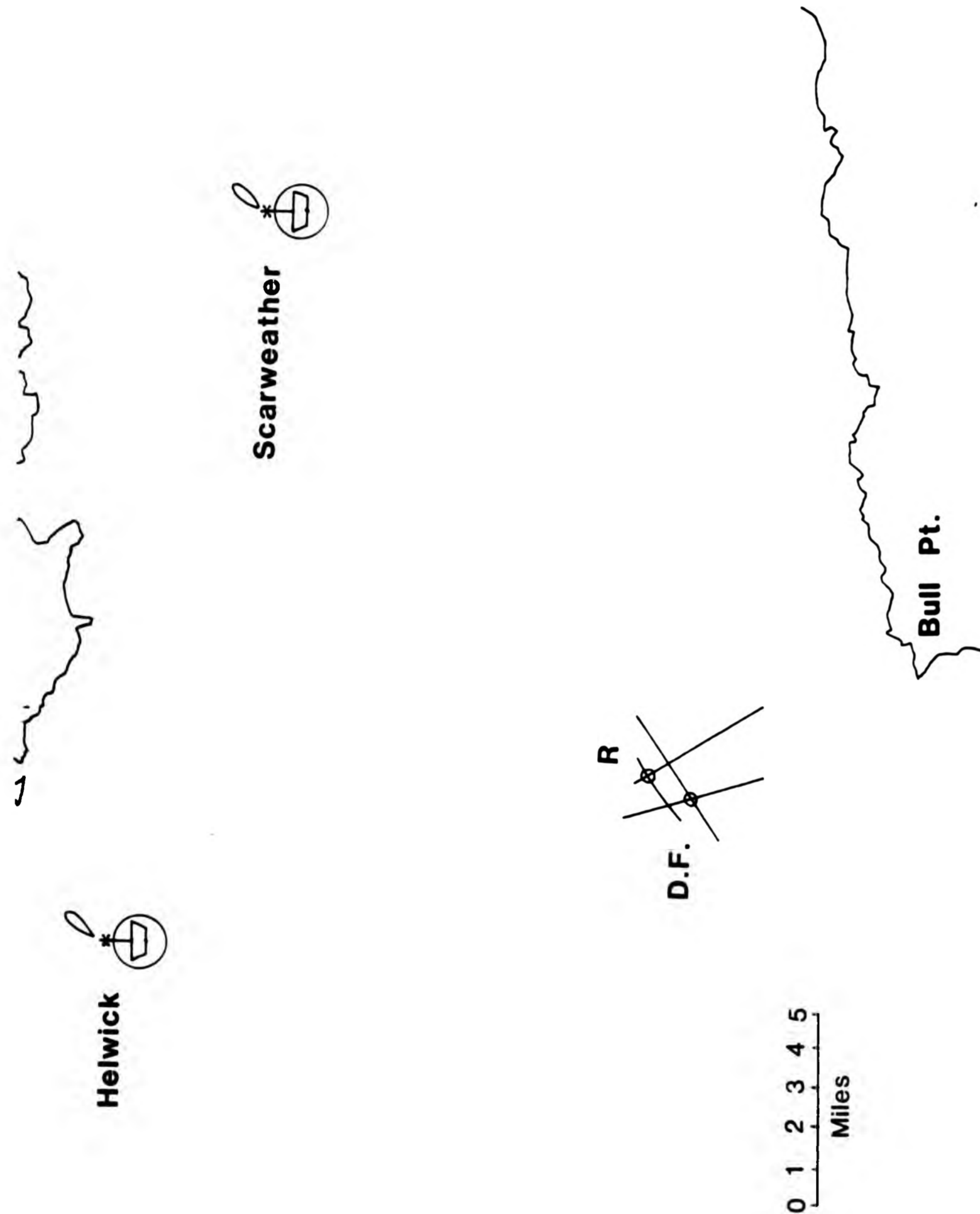

3.7.7. Exercise Number 7.

3.7.7.1. Introduction.

The subjects were presented with a card containing the following information:-

"Bound for Southampton, D.F. bearings (corrected) are Scarweather Lt./Vl. 055° true and Helwick Lt./Vl 343° true, while a radar position off Bull Point is 148°x 7.0 miles."

When plotted the bearings formed a rectangular shape about 1 mile across and 7 miles off the land (fig 11). The radar position put the ship further from the land than the D.F. position thus giving the benefit of any doubt to the D.F. The ship was outward bound and clear of the land so it should have minimum effect on the result.

The exercise was based on exercise number 9 in Experiment 1 (2.8.9.) and was intended to look for evidence of a preference for either the radar or the D.F.

3.7.7.2. Results.

The results were divided into the following groups:-

Fig. 12

Exercise No. 7 Subjects choice of position

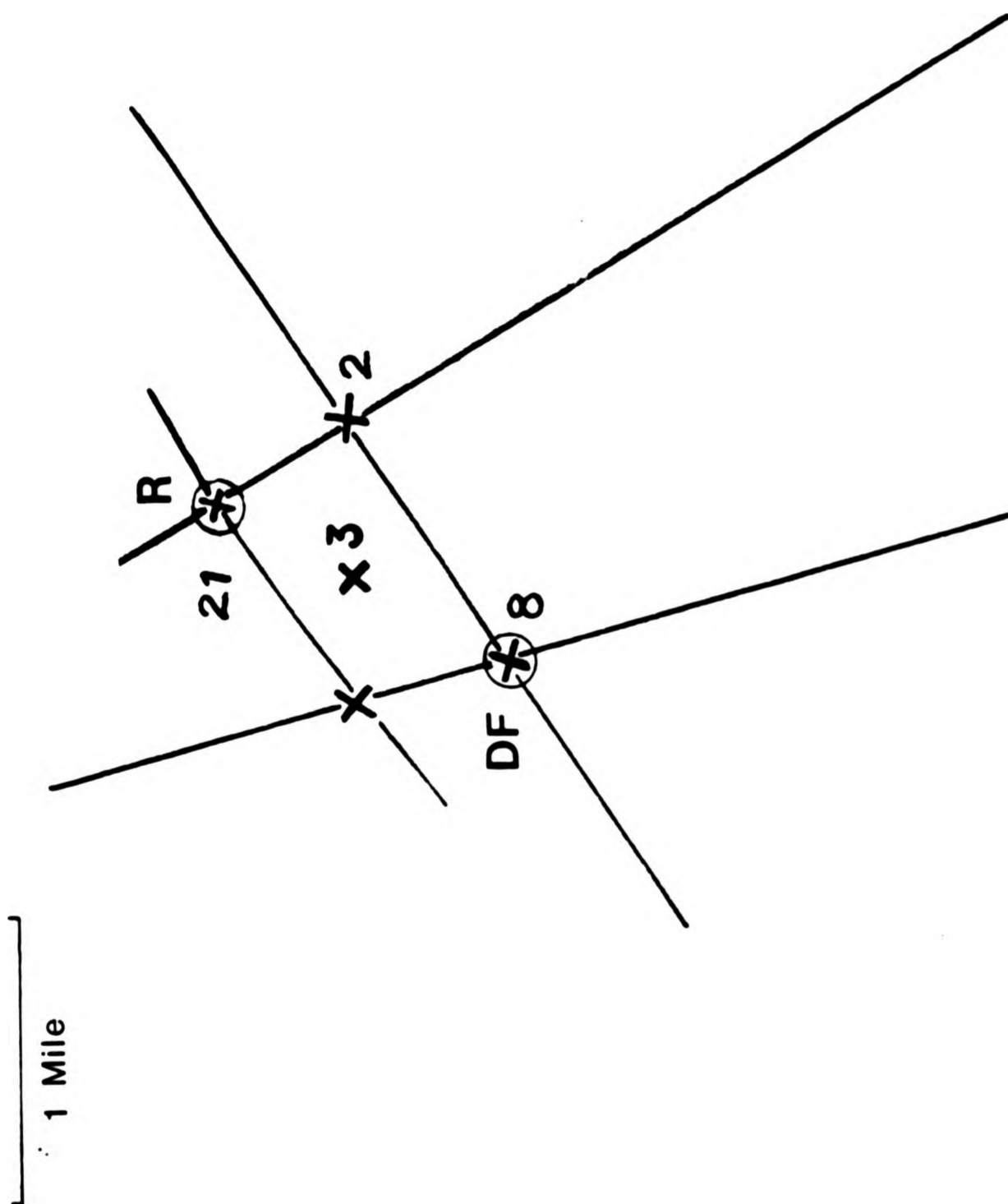

Table 38. Subject numbers v choice of strategy.

1) Radar Only.

2, 3, 4, 9, 10, 11, 13, 14, 17, 18, 19, 21, 23, 26, 27, 29, 31, 32, 33, 34 and 36.

Total 21.

2) D.F. only.

5, 7, 8, 12, 16, 22, 35 and 37.

Total 8.

3) Radar bearing and D.F. bearing off the Scarweather Lt./Vl.

25 and 28

Total 2

4) Radar range and D.F. off the Helwick Lt./Vl.

24

Total 1

5) Mean Position.

6, 20 and 30

Total 3

6) Not available because of subject errors or because the subject refused to decide on a position.

1 and 15

Total 2

3.7.7.3. Test Number 1.

Was there any evidence that the subjects were following a particular strategy or strategies?

H₀ The subjects showed no preference for one particular strategy.

H₁ The subjects preferred at least one strategy.

The test was carried out on all but the last of the groups from table 38:-

Table 39. Observed and expected values of the different strategies.

Strategy	Observed	Expected
Radar only	21	7
D.F. only	8	7
Radar range/D.F.	1	7
Radar brg./D.F.	2	7
Mean Position	3	7
Total	35	35

Testing gave a value of χ^2 of 39.14*** on four degrees of freedom. The result was significant, the null hypothesis

was rejected and the alternative hypothesis accepted. There was strong evidence that the subjects were following a particular strategy, in this case the Radar only position.

3.7.7.4. Test Number 2.

Of the subjects who chose corners was there evidence of a preference for one particular corner? In this test the subjects used all four corners .

H_0 The subjects showed no preference for one particular corner.

H_1 The subjects preferred at least one of the corners.

The subjects' selection of corners is given in table 40:-

Table 40. Observed and expected values of the subjects' choice of corners.

Corner	Observed	Expected
Radar Only	21	8
D.F. Only	8	8
Radar range/D.F.	1	8
Radar brg./D.F.	2	8
Total	32	32

Testing gave a value of χ^2 of 31.75*** on three degrees of freedom. The result was significant, the null hypothesis was rejected and the alternative hypothesis accepted. There was strong evidence that the subjects favoured the radar only corner.

This result showed that the subjects were not over influenced by the proximity of land, as the closest position to the land was the D.F. only corner so they were more influenced by their dislike of the D.F.

3.7.7.5. Test Number 3.

Was there any preference for one method of position fixing? In this exercise the subjects had the choice of the radar or the D.F.

The test was carried out in two parts, firstly with those subjects who used one aid only, and then with all the

data allocating each position according to the aids used.

H₀ There was no preference for one particular aid.

H₁ The subjects preferred one of the aids.

Table 41. Subjects who used one aid only.

Aid	Observed	Expected
Radar	21	14.5
D.F.	8	14.5
Total	29	29.0

Testing gave a value of χ^2 of 5.83*. The result was significant.

Table 42. Subjects' preferences for the aids using the complete data.

Aid	Observed	Expected
Radar	24.25	17.5
D.F.	10.75	17.5
Total	35.00	35.00

Testing gave a value of χ^2 of 5.21* on one degree of freedom. The result was significant, the null hypothesis was rejected and the alternative hypothesis accepted. There

was evidence that the subjects preferred the radar to the radio direction finder (D.F.)

3.7.7.6. Test Number 4.

This test was to see if the subjects preferred to use one aid only or whether they took the information from both the aids into account when deciding on their position.

In this exercise the subjects who used one aid only were those who selected the radar only or the D.F. only corners. The others used information from both the aids.

H_0 There was no preference for the use of one aid only, rather than a combination of aids.

H_1 The subjects preferred either one particular aid or a combination of aids.

Table 43. Subjects' use of one or both of the aids.

Strategy	Observed	Expected
One aid only	29	17.5
Both aids	6	17.5
Total	35	35.0

Testing gave a value of χ^2 of 15.11*** on one degree of freedom. The result was significant, the null hypothesis was rejected and the alternative hypothesis accepted. There was strong evidence that the subjects preferred to fix their position using the information taken from one aid only.

This must be considered to be further evidence that the subjects were rejecting the information from the D.F.

3.7.7.7. Test Number 5.

This test examined whether the subjects preferred an intersection of position lines to a mean position among several lines.

H_0 There was no preference for either an intersection of position lines, or a mean position among several position lines.

H_1 The subjects preferred either an intersection of position lines, or a mean position among several lines.

Table 44. Subjects' preference for an intersection or a mean position.

Strategy	Observed	Expected
Intersection	32	17.5
Mean Position	3	17.5
Total	35	35.0

Testing gave a value of χ^2 of 24.03*** on one degree of freedom. The result was significant, the null hypothesis was rejected and the alternative hypothesis accepted. There was strong evidence that the subjects preferred an intersection of position lines.

3.7.7.8. Conclusions.

In this exercise the subjects demonstrated a clear preference for the radar over the radio direction finder (D.F.) (3.7.7.5.). This was in agreement with exercise number 9 in Experiment 1 (2.8.9.5.). In this case any doubt would have favoured the D.F. rather than the radar.

Because of the number of subjects selecting the radar only position, the preference for the radar over the D.F. ran through the other tests and made it difficult to extract any other useful results.

Fig.13 Visual and D.F.

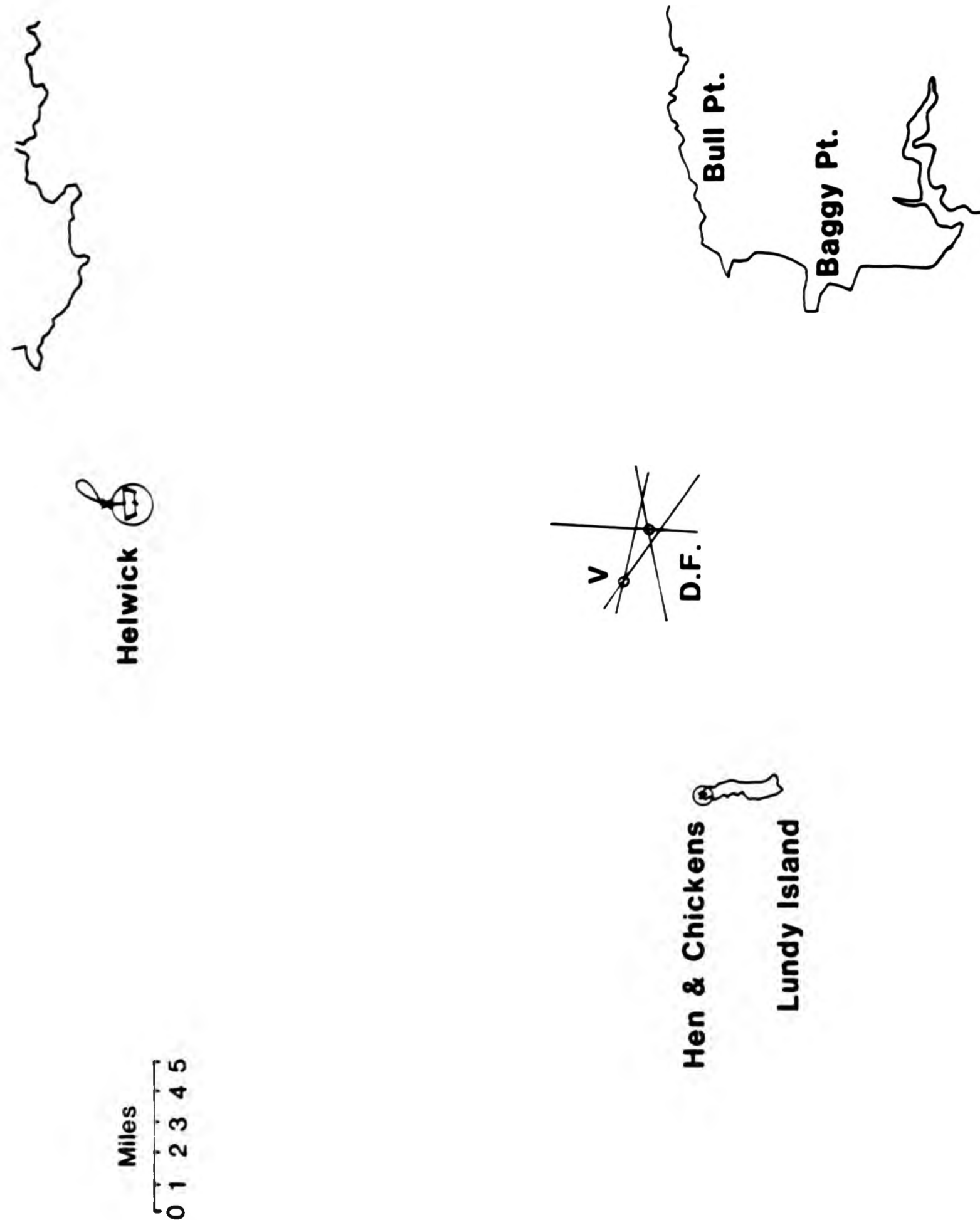

Exercise Number 8.

3.7.8.1. Introduction.

The subjects were given a card with the following instructions:-

"Bound from Appledore to Milford Haven, corrected D.F. bearings were Hen and Chickens 259° true Helwick Lt./Vl. 003° true. Visual bearings were Bull Point Lt. Ho. 104° true and Baggy Point 125° true."

When plotted the bearings gave a kite shaped figure about 2 miles x 1 mile. The visual bearings gave a narrow angle of cut at the apex while the D.F. bearings made a good angle at the base (fig 13). The two visual bearings passed close to the D.F. position in order to give confidence in that position. The figure was about halfway between Lundy Island and the mainland, and on the present course the ship was well clear of the land. The next landfall would be on the coast close to Milford Haven.

The test was designed halfway through the experiment when it became clear how strongly the subjects were rejecting the D.F. in exercise 1 and it was intended to present as favourable a D.F. position as possible in order to examine whether a preference for the D.F. could be demonstrated under any reasonable circumstances.

3.7.8.2. Results.

The subjects selected the following strategies:-

Table 45. Subject numbers v choice of strategy.

1) Visual Only

16,17,20,21,22,24,29 and 36

Total 8

2) D.F. Only.

11,13,14,15,18,23,31,32 and 35

Total 9

3) Mean Position.

19,25,26,27,28,30,33,34 and 37

Total 9

4) Unable to decide on a position.

12

Total 1

The experiment was not started until the first ten subjects had already completed the exercises.

3.7.8.3. Test Number 1.

The test was designed to examine the above groups for signs that the subjects demonstrated a preference for a particular strategy or strategies. From the data it was clear that there was no evidence for a preference and it was therefore assumed to be random.

3.7.8.4. Test Number 2.

Did the subjects demonstrate any evidence of a preference for one particular corner? In this exercise only 2 corners were chosen, the visual only and the D.F. position, and there was clearly no preference between the two.

3.7.8.5. Test Number 3.

Was there evidence of a preference for one of the aids? Because of the proximity of the visual bearings and the D.F. position it was not possible to decide whether the subjects who selected the D.F. position were favouring that aid or whether they were selecting a combination of D.F. and visual bearings so the test was not carried out.

3.7.8.6. Test Number 4.

Did the subjects use one aid only or a combination of aids? Because of the difficulty in deciding whether the D.F. position was really one aid only, the test was not

carried out.

3.7.8.7. Test Number 5.

Did the subjects prefer an intersection of position lines, or a mean position among several lines?

H₀ There was no preference for either an intersection of position lines, or a mean position among several lines.

H₁ The subjects preferred either an intersection of position lines, or a mean position among several lines.

In this test the subjects who preferred an intersection were those groups who chose the visual or the D.F. position.

Table 46. Subjects' preferences for an intersection or a mean position.

Strategy	Observed	Expected
Intersection	17	13
Mean Position	9	13
Total	26	26

Testing gave a value of χ^2 of 2.46 on one degree of

2.46 on one degree of freedom. The result was not significant, the null hypothesis was accepted and the alternative hypothesis rejected. There was no evidence that the subjects preferred either a mean position or an intersection of position lines. This was the only occasion in the experiment where there was no significant evidence of a preference for an intersection of position lines and probably demonstrated that the nearest some of the subjects were prepared to go to accepting the D.F. was by selecting a mean position.

3.7.8.8. Conclusion.

This test seemed to show that it was not possible to get the subjects to demonstrate a preference for the D.F. however attractive the circumstances were made. It was interesting in that this was the only occasion that there was no evidence of a preference for an intersection of position lines so it looked as though more subjects selected a mean position because of the more attractive D.F. position.

3.8. Tests on the combined data.

Because of the nature of the experiment it was possible to carry out certain of the tests on the combined results from the eight different exercises. In this way the sample size was increased and the results became more

generalised.

Only tests 4, 5, and 6 however were sufficiently general for this treatment.

3.8.1. Test Number 4.

Did the subjects prefer to use one aid only or did they take their information from both aids?

H_0 There was no preference for the use of one aid only, rather than a combination of aids.

H_1 The subjects preferred to use one particular aid, or a combination of aids.

The results from the different exercises are given in Table 47:-

Table 47. Subjects' preference for one or both of the aids by exercise.

Exercise	One Aid	Both Aids
1	11	18
2	20	11
3	24	7
5	21	14
6	20	11
7	29	6
Total	125	67

Exercises 4 and 8 were not suitable for this test because exercise 4 involved only one aid and in exercise 8 it was not possible to separate the preferences for the two aids.

The observed and expected values for the χ^2 test are given in table 48:-

Table 48. Observed and expected frequencies of the subjects' preferences for one or both aids.

Strategy	Observed	Expected
One aid only	125	96
Both aids	67	96
Total	192	192

Testing gave a value of χ^2 of 17.52*** on one degree of freedom. The result was significant, the null hypothesis was rejected and the alternative hypothesis accepted. There was strong evidence that the subjects preferred to use one aid only when fixing their position.

3.8.2. Test Number 5.

Did the subjects prefer an intersection of position lines or a mean position among several lines?

H_0 There was no preference for either an intersection of position lines, or a mean position among several lines.

H_1 The subjects preferred either an intersection of position lines, or a mean position among several lines.

The results from the different exercises are given in Table 49:-

Table 49. Subjects' preference for an intersection or a mean position by exercise.

Exercise	Intersection	Centre
1	31	4
2	25	6
3	25.5	5.5
4	30	6
5	27	8
6	26	5
7	32	3
8	17	9
Total	213.5	46.5

The data for the χ^2 test are given in table 50:-

Table 50. Observed and expected values for the subjects' preferences of intersections or mean positions.

Strategy	Observed	Expected
Intersection	213.5	130
Mean Position	46.5	130
Total	260.0	260

Testing gave a value of χ^2 of 107.27*** on one degree of freedom. The result was significant, the null hypothesis was rejected and the alternative hypothesis accepted. There

was strong evidence that the subjects preferred an intersection to a mean position among several position lines.

3.8.3. Test Number 6.

Did the subjects who selected a mean position prefer the geometric centre or did they select some other position? This was the first time that this particular test had been carried out because the sample sizes in the individual exercises were too small for testing.

H_0 There was no preference for either the geometric centre, or a weighted position.

H_1 The subjects preferred either the geometric centre, or a weighted position.

The data from the individual exercises are given in table 51:-

Table 51. Choice of geometric centre or weighted position by exercise.

Exercise	Centre	Other
1	2	2
2	6	0
3	4	1
4	5	1
5	3	3
6	4	1
7	2	1
8	3	6
Total	29	15

The data for the χ^2 test are given in table 52:-

Table 52. Observed and expected values of the subjects' preferences for the geometric centre or some other position.

Strategy	Observed	Expected
Centre	29	22
Other	15	22
Total	44	44

Testing gave a value of χ^2 of 4.45* on one degree of freedom. The result was significant, the null hypothesis

was rejected and the alternative hypothesis accepted. There was evidence that the subjects preferred the geometric centre to a weighted position.

3.9. Conclusions.

3.9.1. Choice of aids.

This experiment was designed to examine whether there was a definite and identifiable preference for any of the four methods of position fixing used in the exercise.

3.9.1.1. Visual Bearings.

In both Experiment 1 and in this exercise it was not possible to demonstrate a preference for any other aid over the visual bearings, despite efforts to present the other aids in as attractive a situation as possible. The two exercises in Experiment 1 (2.8.3.5. and 2.8.7.5.) showed a preference for the visual bearings although the sample size was not large enough to produce a significant result. In Experiment 2, exercise 1 deliberately favoured the D.F. but many of the subjects selected a poor visual only position instead of a good visual/D.F. position. (3.7.1.5.) Exercises 2 and 5 (3.7.3.5. and 3.7.5.5.) both demonstrated a preference for visual bearings.

There was evidence in both experiments to show that the

subjects' preferences for visual bearings was probably taken too far. (See conclusion for a discussion on the use of visual bearings).

3.9.1.2. Radio direction Finder (D.F.).

From Experiment 1 there was evidence that the subjects had little confidence in this aid (see 2.8.1.9. and 2.8.9.9.). This finding was confirmed by 3.7.1., 3.7.2., 3.7.6., 3.7.7. and 3.7.8.

Exercise 1 offered the subjects the choice between poor visual bearings and good D.F. bearings, three bearings with a good angle of cut further strengthened by a visual bearing from an easy to identify lighthouse passing close to the position. Despite this there was no evidence of a preference for that position: one subject did not even bother to plot the D.F. bearings. Because of these results exercise 8 was devised to try and discover whether it was possible under any circumstances to obtain a preference for the D.F. when another aid was available. Again an attractive D.F. position was combined with a poor visual position but there was no evidence of a preference for the D.F. position even though it was strongly supported by two visual bearings.

Exercise number 6 was designed to look for evidence of a preference between the D.F. and the Decca Navigator.

Exercise 1 (2.8.1.9.) of Experiment 1 indicated that there might be a preference for the Decca so this was repeated using a larger sample. Again, despite making the D.F. position more attractive than the Decca position, the subjects showed a strong preference for the Decca Navigator ($\alpha = .01$ section 3.7.6.5.).

Exercise Number 7 was designed to test for a preference between the Radar and the D.F. This was a repeat of exercise 9 in Experiment 1 (2.8.9.9.) except that this time the D.F. position put the ship closer to the land. This resulted in a significance level of $\alpha = .05$ (3.7.7.5.) while in Experiment 1 the significance level was $\alpha = .01$. This could have been because in this exercise the D.F. position put the ship closer to the land while in Experiment 1 the D.F. position put the ship further from the land, thus there was some evidence that the subjects were taking the position of the land or other dangers into account when deciding on their position.

The tests showed that the D.F. was not regarded as a viable aid in these circumstances, which was in agreement with remarks expressed by 12 of the subjects to the effect that they would only use the D.F. as a last resort.

In the Official Inquiry into the grounding of the "Stancrown" (36) the Experiment 1 where the subjects demonstrated a preference for the radar ($\alpha = .05$, section

2.8.2.5.). This was probably explained by the fact that in Experiment 1 the radar put the ship closer to the land while in this experiment the Decca position was closer to the land.

Exercise 3 was devised to look for evidence of a preference for either the Decca or visual bearings. The subjects demonstrated a preference for the visual bearings. ($\alpha = .01$, section 3.7.3.5.). This was a repeat of a like exercise in Experiment 1 (2.8.3.5.) where the sample size prevented a similar result but where there was some evidence of a preference for the visual bearings. In this exercise the visual position put the ship further from the land than the Decca position, a reversal of the situation in Experiment 1. It would seem therefore that the subjects' preferences for visual bearings were stronger than the need to select the most "dangerous" position.

In both Experiment 1 and the present study none of the subjects mentioned Decca fixed errors or data sheets (13), so it seems likely that they are not consulted very much at sea.

3.9.1.4. Radar.

Radar was involved in Exercises 2, 4, 5 and 7. Exercise 2 where the subjects' preferences for Radar or Decca were examined was discussed in section 3.9.1.3. and exercise 7

examined whether there was a preference for the Radar or the D.F. This was discussed in section 3.9.1.2.

Exercise 4 was devised to examine how the Radar was used. The subjects demonstrated a strong preference for the corner defined by the intersection of ranges. ($\alpha = .001$, section 3.7.4.4.). The results also demonstrated that almost all the other options were selected by one or more subjects. A similar finding was obtained from Experiment 1 (2.8.5.5.) but the sample size was too small for a significant result.

Exercise 5 was devised to examine whether a preference existed for radar or visual bearings. In this exercise those subjects who used one aid only demonstrated a preference for the visual bearings ($\alpha = .05$). With all the subjects' positions being included in the data it was not possible to demonstrate any preference (section 3.7.5.5.). The radar position put the ship closer to the land than did the visual position so this could have reduced the number of subjects selecting the visual position. The experiment (section 2.8.7.5.) in Experiment 1 was also non significant although the data suggested a preference for the visual bearings, particularly when the subjects were using only one aid.

3.9.1.5. Summary.

From these tests a ranking order of preference by the subjects for the different aids was produced:-

1) Visual bearings were preferred over all the other aids. In some situations, in particular where the D.F. was concerned, some of the subjects' preference for this aid bordered on the reckless.

2) There was a clear preference for the radar over the D.F. but as far as the Decca was concerned there may have been a preference for the radar but there was no significant evidence for this.

3) Decca was preferred to the D.F. It was a popular aid and many of the subjects seemed happy to rely on it, but none of the subjects asked for data sheets.

4) D.F. was the least popular aid, and this was demonstrated so clearly that there seems to be a good case for no longer fitting it to merchant ships as a navigational aid.

3.9.2. Use of Information.

Tests 4,5 and 6 were designed to examine how the subjects used the information provided. In general the problem with navigation today is that there is more information available than is strictly necessary to

navigate in a given situation, therefore the main problem which faces the navigator is one of information management.

3.9.2.1. Test Number 4.

Test number 4 examined whether the subjects used the information from one or both of the available aids. This is an important question because in practice the information from both aids contains errors and the most probable position lies on some sort of mean position derived from all the information that is available from the different sources.

Although many of the individual exercises did not provide evidence that the subjects were using information from one aid only, there was no case where there was evidence that the subjects preferred to use information from both the aids. When the data were combined there was strong evidence ($\alpha = .001$, section 3.8.1.) that the subjects preferred to use one aid only. This was also demonstrated in Experiment 1 ($\alpha = .01$, section 2.9.2.). Therefore there seems to be strong evidence that the subjects tend to use information from one aid only, a practice which is potentially very dangerous.

3.9.2.2. Test Number 5.

Test Number 5 examined whether the subjects preferred

an intersection of position lines or a mean position among several lines. In practice the ship's position need not necessarily be inside the "cocked hat" produced by the lines (14). None of the subjects selected a mean position outside the cocked hat, so it seemed that they were not generally aware of this fact.

In none of the exercises was there any evidence that the subjects preferred a mean position among several position lines. In fact apart from Number 8, all the exercises demonstrated that the subjects preferred an intersection of position lines. Exercise number 8 had been devised to try to persuade the subjects to accept the D.F. position but the only effect of this was to make enough subjects select a mean position that there was no evidence in favour of an intersection. When the data were combined there was strong evidence ($\alpha = .001$, section 3.8.2.) that the subjects favoured an intersection. There was equally strong evidence ($\alpha = .001$ section 2.9.2.) from Experiment 1 so it would seem that following from the preference for one aid only the subjects preferred an intersection of position lines, an equally dangerous procedure.

3.9.2.3. Test Number 6.

This test examined whether those subjects who selected a mean position chose the geometric centre or some other

position. Because of the small number of subjects who chose a mean position it was not possible to carry out this test in any of the individual exercises and the data had to be combined. The test showed that the subjects tended to prefer the mean position ($\alpha = .05$ section 3.8.3.) but this result was not demonstrated in Experiment 1 (section 2.9.4.9.). When the data from both experiments were combined a significant result was obtained ($\alpha = .05$). The preference was probably a continuation of the concept of an intersection, and instead of the subjects selecting an actual intersection of position lines they were mentally selecting an intersection at the Geometric centre of the figure. The area covered by the positions was small, and because there were slight variations in the shape of the figures plotted by each subject it was important that not too much should be read into this result.

3.9.3. Quality of Work.

In Experiment 1, 8 out of 180 positions plotted by the subjects had to be rejected because they were plotted incorrectly. In the second experiments 6 out of 272 positions were found to be at fault. These "blunders" are discussed further in section 6.4.5. but when it is considered that the subjects knew that their work was being observed this result gives some concern over the reliability of their work at sea where it is not being studied as closely.

3.10. List of Exercises.

3.10.1. Experiment 1.

- | | |
|---|---------------------------------|
| 1 | Decca and D.F.(6) |
| 2 | Decca and Radar(2) |
| 3 | Decca and Visual(3) |
| 4 | Three D.F. bearings |
| 5 | Radar bearings and distances(4) |
| 6 | Decca, Visual and D.F. |
| 7 | Visual and Radar(5) |
| 8 | Three Decca readings |
| 9 | Radar and D.F.(7) |

The number in brackets denotes the exercise in Experiment 2 where the work was followed up.

3.10.2. Experiment 2.

Exercise	Aids Examined
1	Visual and D.F.
2	Radar and Decca(2)
3	Decca and Visual(3)
4	Radar bearings and distances(5)
5	Visual and Radar(7)
6	D.F. and Decca(1)
7	D.F. and Radar(9)
8	Visual and D.F.

The number in brackets indicates the exercise in Experiment 1 on which it was based.

CHAPTER 4

The design, construction and operation of the simulator.

The first two experiments in the present work had demonstrated that it was possible to obtain useful information from what were very basic experiments without using any more complicated equipment than a chart. It was hoped to improve on this by the use of what was to be a very simple type of simulator.

4.1. Background.

Looking at the design of simulators that were in use at that time (1978) it was clear that the main expense was in making them interactive. This was because a computer was essential to carry out the calculations necessary to ensure that all the instruments read correctly regardless of the ship's position in the working area. At the time micro computers were not as cheap or as easy to use as they are today but even now a considerable programming effort is necessary. None of the simulators on the market then had facilities for the taking of visual bearings and even with the larger machines the subjects were forced to telephone the instructor for this information. Most of the existing simulators were for night or poor visibility only because of the difficulty of producing realistic graphics. An attempt was made in Germany to use a system of slide

projectors to produce a daylight system but for realism an enormous number of slides were required and there were difficulties in designing the equipment to provide a smooth changeover. There were still problems with the observation of transits and the taking of visual bearings. It was not until the aircraft industry produced "Computer Generated Images" (C.G.I.) that the daylight simulator became a possibility, but the visual scene is still somewhat primitive and the equipment very expensive so research time is likely to be restricted on these simulators for some time to come.

One of the results from the previous two experiments (3.10.1.4.) was that the subjects demonstrated a very strong preference for visual bearings so one of the objectives of the simulator was to verify these findings. It was obvious that even given the use of a large simulator it would not be possible to simulate the taking of visual bearings in a realistic manner.

It was decided that it would not be possible to design an interactive simulator with the resources available and therefore to concentrate on making the simulation of the navigation aids as realistic as possible in a non-interactive simulator. This decision implied that the type of experiment which could be carried out in the simulator would be limited. In particular it would not be possible to examine how the subjects manoeuvred their

ships. This was not considered too restrictive because most of the work which required a manoeuvring capability was concerned with collision avoidance and a considerable amount of research had already been carried out in this area using part task radar simulators (29, 30, 31).

A further reason for selecting a simulator which the subjects could not manoeuvre was so that each test would be a precise replication of the others in the series. This was important because the object of the project was to compare the subjects' choice and use of navigational aids under similar conditions. If the subjects had been able to make different manoeuvres then an additional variable would have been introduced which would have been difficult to allow for in the subsequent analysis.

4.2. Objectives.

There were three main objectives in the design of the simulator:-

4.2.1. To verify the results from Part 1 of the present work.

Part 1 of the present work had produced some useful results, in particular the order of preference for the different aids, and the subjects' liking for an intersection of position lines rather than a central

position among several lines (3.10.1.4.). It was hoped to be able to examine these preferences in further detail, especially where the subjects would have to decide which aids they wished to observe as well as what information they were going to use, given a situation where there was more information available than was required for the performance of the particular task.

The strong preference demonstrated by the subjects in the previous work for a position at the intersection of two position lines rather than a centre position would be further investigated (3.10.2.2.). In particular, the question of whether the same subjects normally plotted more than two position lines?

4.2.2. To design a realistic research simulator.

One of the problems of this part of the research was to try and design a simple, low cost simulator that was also capable of producing worthwhile results. For this reason the design of the experiments had to go hand in hand with that of the simulator. The most important difference between the research simulator and a teaching simulator is in the control of the variables between the different exercises. In the teaching situation it is not considered so important that each exercise is identical provided the students gain useful experience during their time in the simulator. In the research simulator it was vital that each

subject experienced exactly the same situation in order to keep the unknown variables to a minimum. This was seen to be a matter of how the experiments were designed rather than a construction feature of the simulator.

The most important requirement as far as the research was concerned was to be able to record as much information as possible without intruding into the experiment. In particular it was necessary to record how the subjects fixed their positions and what aids they consulted. The first part did not appear too difficult as it was intended that the subjects would plot their positions on the chart while recording the time beside the position and it was therefore possible to decide which aids were used by examination of the lines on the chart. The second part was more difficult because some sort of recording device was needed and it was expected that this could present problems. Asking the subjects to log which aids they observed had two main drawbacks. Firstly the method was unreliable, as it was not possible to ensure that the subjects logged every occasion when they observed one of the aids. Secondly, it would interfere with the experiment. The fact that the subject had to mark a log every time he examined one of the aids might discourage him from viewing it and at the least it would make the experiment less realistic. Thus it was considered essential to provide a system which recorded automatically whenever the subjects observed one of the different aids.

The choice of aids to be used in the simulator was largely decided by the need to repeat the first part of the present work when the Radar, Decca, Visual Bearings and the Radio Direction Finder (D.F.) were used. It was decided, however, that as in Part 1 the D.F. was so strongly rejected (3.10.1.1.) by the subjects, there would be little purpose in continuing to use this aid unless the simulated area was so deficient in other navigational aids that the subjects were forced to use this method. This left the visual bearings, Decca and radar. The echo sounder was included in this part of the work because it is found on every ship but was not used in Part 1 because it is not usual to plot information from this aid on the chart. There was the question of whether to use the satellite navigator, Omega or Loran C, but these were rejected for two reasons. Firstly it was important when it came to analysing the results to restrict the number of variables otherwise it would prove difficult to come to any firm conclusions. The main reason, however, was because it was intended to test at least twenty subjects and it was important that as far as possible they all had first hand experience of the different aids used in the simulator. Hence the aids were confined to those which are in common use.

4.2.3. To produce a simulator which should, if possible, have a potential for general use other than the present research project.



**simulated visual bearing of
Sizewell power stn.**

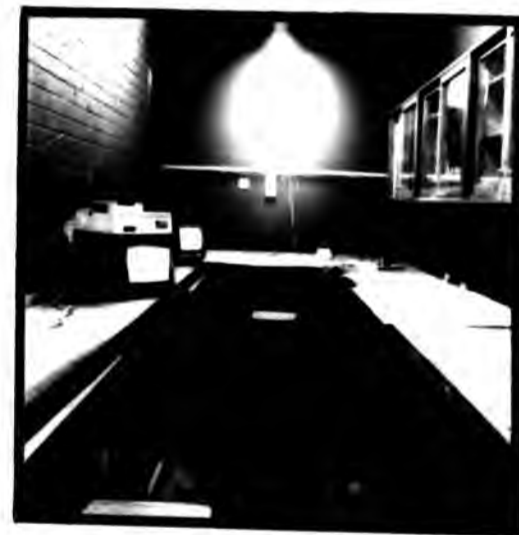

**view of the
simulator**



**video and pen
recorders**

There appeared to be a need to be able to teach the use of different aids in various navigational situations. For this role the simulator must present as realistic a view of the different aids as possible while at the same time it has to be cost effective, thus ruling out an interactive simulator whose high cost made it uneconomic for use as a simple teaching aid. It would appear that a simulator designed to meet the requirements set out in section 4.2.2., would therefore also have a useful teaching function.

4.2.4. Methods of simulating the different navigation aids.

4.2.4.1. The use of slide projectors.

This was the first method of simulating the navigation aids to be considered but it had the disadvantage that it was not possible to simulate the movement of the different instruments as the ship progressed during the exercise. This would have to be achieved by advancing the slides by means of a pulsed tape which would have given a jerky and unreal presentation.

4.2.4.2. The use of video recordings.

About this time the idea of video recordings was considered as lightweight recording equipment suitable for using on the ship had become available in the Polytechnic



**simulated visual bearing of
Sizewell power stn.**



**view of the
simulator**



**video and pen
recorders**

There appeared to be a need to be able to teach the use of different aids in various navigational situations. For this role the simulator must present as realistic a view of the different aids as possible while at the same time it has to be cost effective, thus ruling out an interactive simulator whose high cost made it uneconomic for use as a simple teaching aid. It would appear that a simulator designed to meet the requirements set out in section 4.2.2... would therefore also have a useful teaching function.

4.2.4. Methods of simulating the different navigation aids.

4.2.4.1. The use of slide projectors.

This was the first method of simulating the navigation aids to be considered but it had the disadvantage that it was not possible to simulate the movement of the different instruments as the ship progressed during the exercise. This would have to be achieved by advancing the slides by means of a pulsed tape which would have given a jerky and unreal presentation.

4.2.4.2. The use of video recordings.

About this time the idea of video recordings was considered as lightweight recording equipment suitable for using on the ship had become available in the Polytechnic

and thanks to a grant from Shell International Marine it was possible to purchase equipment for the simulator. There were certain advantages in the use of these methods, in that there would be continuous movement of the readings of the various aids and the display could be presented on a small television screen. The only problem was whether it would be possible to obtain an acceptable quality of recording. The main limitation was that it would not be possible to alter the speed of the presentation and so an exercise would have to be run at the same speed as that which the Polytechnic training vessel "Sir John Cass" maintained during the on-board recording operation. However, with a favourable tide it was possible for the ship to manage about twelve knots thus giving a run of six miles during the half hour of an exercise.

Recordings were tried out during a trip across the Thames estuary on the "Sir John Cass" with the the help of the members of the Polytechnic's media-services department and this proved that it was possible to make good quality video tapes of the different aids. The method chosen for displaying the information was to use three video recorders in parallel and to play video tapes of the radar, Decca and the echo sounder. It had been decided that it would not be possible to simulate the taking of visual bearings using the video because of the difficulty of including the compass card in any display. To reduce the equipment on the ship's bridge while recording the aids only the Decca and

the radar were recorded during the run. The echo sounder was taped separately. This instrument was kept running while the other aids were being televised and after the run the paper was wound back, the tip removed from the stylus, and the instrument run again while the trace was filmed.

The radar proved to be the most difficult aid to record by video. The Marconi radar in the ship's demonstration room was chosen because it was the easiest to black out and, after several trials to get the brilliance right, an acceptable recording was made.

The quality of the video was later judged to be acceptable by the subjects who were asked for their opinion of the different aids but it still remained the least satisfactory of all the recordings used in the experiment.

4.2.4.3. The visual bearings.

It was decided to use a slide projector for the visual bearings and this in fact proved to be more difficult than anticipated. The first set of photographs taken from the ship proved to be indistinct because the ship was too far from the marks when the photographs were taken and the use of a telephoto lens was ruled out because the vibration of the ship caused camera shake. A further voyage had to be undertaken using a yacht much closer to the shore in order to obtain the photographs. To simulate the compass card the centimetre scale on a transparent plastic ruler was

Fig 4 Block Diagram of the Simulator

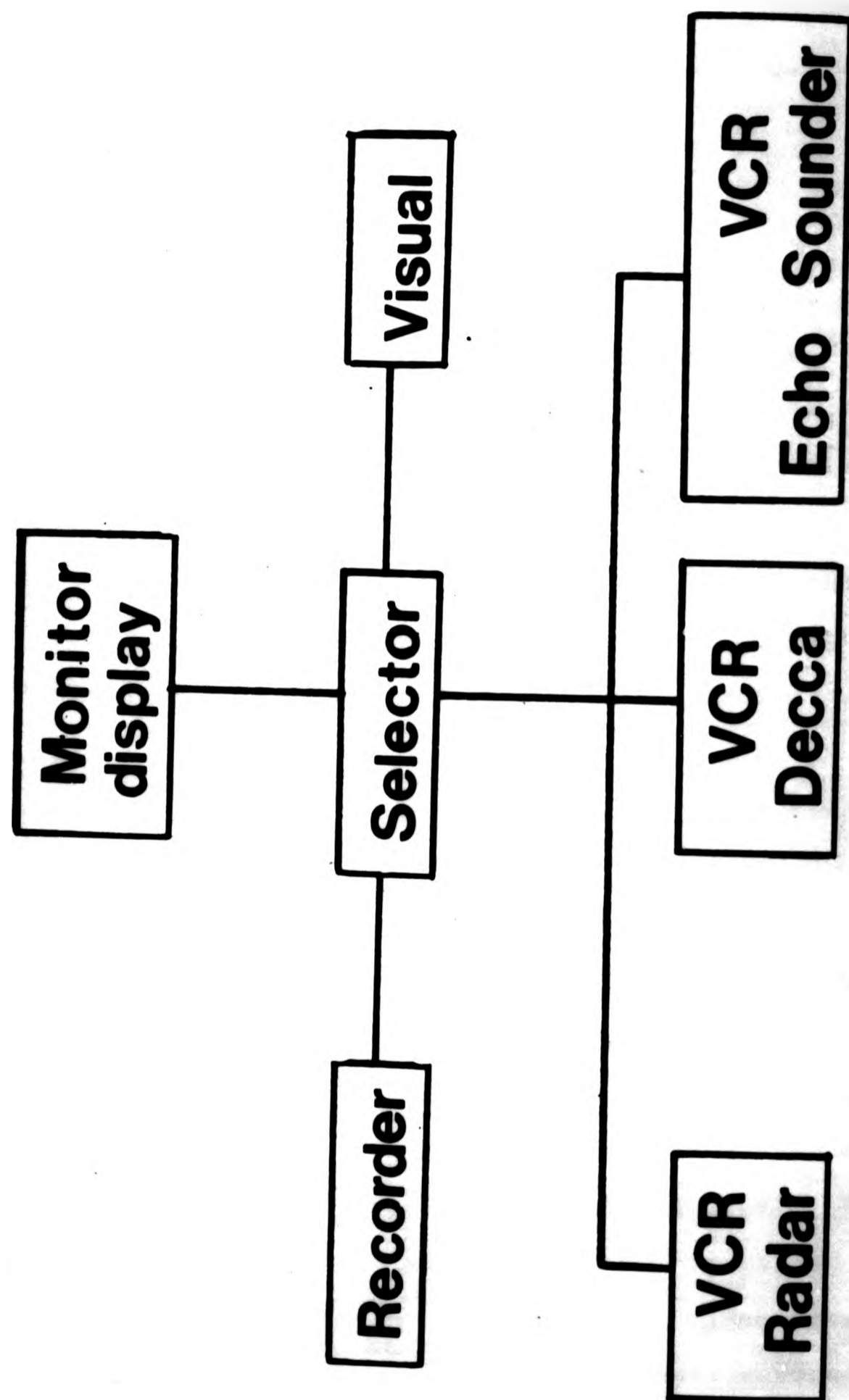

photographed and printed on clear plastic. The relevant part of this scale was then cut out and inserted in the slide mount so that the scale appeared superimposed on the view of the coastline (see fig 3). This proved to be a most realistic method of simulating a compass card.

4.2.4.4. The presentation of the information.

The three video tapes, radar, Decca and the echo sounder were played in synchronism on three separate video recorders (fig 4). If the subjects wanted to examine one of these aids, they had to press a button on a control box so that the corresponding picture was displayed on the monitor. At the same time a signal was sent to a pen recorder and the length of time the subjects held the switch down was recorded. When the switch was released the screen went blank. A circular scale marked in degrees and fitted with a movable pointer was attached to the monitor so that the subjects could measure radar bearings. The range rings had been switched on when the radar display was recorded so it was possible for the subjects to measure distances. Thus it was possible for the subjects to measure range and bearing of any desired object.

The visual bearings were displayed on a tape controlled slide-projector. Again the subjects were required to hold a spring loaded switch in order to illuminate the screen while at the same time the pen

recorder was activated and the time the subject spent watching the display was logged. This display did not show any continuous movement but it was reasonable at the chosen distance off the shore for the landmarks to appear stationary over short time intervals as no transits were available for this experiment. The slides were advanced by means of a pulsed tape so there was the slight problem of the subject having to wait for the tape to move the slides in order to take a series of bearings corresponding to different sections of the coastline but sufficient slides were used so that they changed every few seconds depending on which marks were being projected.

4.3. The design of the experiments.

In Chapter 1 it was shown that there was very little previous published work on which to base the experiments so they were designed to verify the results from Part 1 of the present work and also to answer some of the questions which arose from that work. There was the problem of obtaining sufficient results to allow a satisfactory analysis. Part 1 of this work had demonstrated the length of time it took to acquire data for this. The restriction was still that, in general, in order to obtain a large sample it would be necessary to test the subjects during their lunch period, which effectively reduced the length of time available to about half an hour. Because of this limited time it was necessary that the simulator be sufficiently realistic for

the subjects not to require any instruction or practice in its use.

One of the problems resulting from this sort of work is whether the results relate to that particular experiment only or whether they can be generalised to other situations. If it is not possible to generalise the results then the research would be of little value. (See 5.1.1.)

In order to make the results more general it was decided to test each subject twice, using two slightly different navigational situations. They had to be sufficiently similar for the subjects' reactions to be comparable but there had to be significant differences so that their behaviour could be examined under the different circumstances. The logistics of using the ship to record the situation meant that the two runs had to be physically close together in order that they could be recorded in one day. By using the two separate runs for the experiment and testing each subject twice, an additional variable was introduced which had a potential effect on the analysis and which would be particularly important if the results of the two runs proved not to be sufficiently similar to allow the data to be pooled.

4.3.1. The experimental area.

The area that was finally chosen for the experiment was

the Suffolk coast near Southwold. It was selected because it was close to where the ship was based at Harwich, and presented an interesting range of navigational marks. Also, the Decca coverage was good so this aid could be incorporated in the experiment in a realistic manner. Although the seabed did not vary a great deal there was enough information for the subjects to verify their position by echo sounder if they so desired.

4.3.2. Run 1.

The first run was selected from Southwold, south for half an hour (see fig 6). This had the advantage that the subjects were able to take visual bearings of the lighthouse at Southwold and Sizewell power station so at the start of the exercise they had a clear choice of aids and they could fix their positions using any one of the three aids or indeed any combination of aids. Later during the exercise the subjects had greater difficulty in identifying the different landmarks, particularly the churches, as there were a number of different churches available for the taking of bearings and the only way to identify them properly was for the subjects to run bearings from a known position, such as a Decca position. Throughout run 1 there were always at least two visual bearings available for the subjects if they wished to navigate by this method.

4.3.3. Run 2.

Run 2 was different because it included a course alteration. During this exercise the ship was rounding Orford Ness which is a spit of sand and shingle (see fig 7). It presented a radar mark which was easy to identify so the subjects could have been expected to make more use of the radar than they might have done during run 1. There was however a danger in that the shape of the spit varied according to the tide and the part of the spit visible on the radar was not necessarily the same as the charted portion (14). The other major difference was that for much of the run the only mark for visual bearings was Orford Ness lighthouse. At the beginning and right at the end it was possible for the subjects to obtain cross bearings with Orford castle but for most of the exercise the angle between the two was too narrow to be of much use navigationally and because of the distance off the coast the use of a transit was not considered appropriate.

4.3.4. Differences between the two runs.

1) In run 1 the ship was steering the same course throughout therefore the compass heading which in this experiment was obtained from the radar, was less important for monitoring changes in course. In run 2 the ship was altering course for part of the time and therefore the compass would require more frequent monitoring.

2) In run 1 there were always two visual bearings available for the subjects throughout the exercise. Some of these bearings, however, were of Churches and were difficult to identify unless the subjects plotted from known positions. In run 2, for most of the time, including the critical period when the ship was altering course, Orford Ness Lighthouse was the only mark available for visual bearings.

3) In run 2 Orford Ness was a clear and easily identifiable radar mark but there was no such equivalent mark available in run 1.

4.4. Lights.

One of the disadvantages of all simulator experiments is that they only represent part of the situation. This is considered acceptable in training when the object is to train the subjects in one particular aspect only but in research it can lead to misleading results if this fact is not taken into account.

In the present work the subjects were deliberately not placed under undue pressure as the object of the experiment was to examine how the subjects behaved in a typically normal situation with good visibility and no particular problems with the navigation. In this type of situation most merchant ships would probably navigate with only one officer on the bridge and a rating working close by to be available if needed. The steering would be by autopilot.

2) In run 1 there were always two visual bearings available for the subjects throughout the exercise. Some of these bearings, however, were of Churches and were difficult to identify unless the subjects plotted from known positions. In run 2, for most of the time, including the critical period when the ship was altering course, Orford Ness Lighthouse was the only mark available for visual bearings.

3) In run 2 Orford Ness was a clear and easily identifiable radar mark but there was no such equivalent mark available in run 1.

4.4. Lights.

One of the disadvantages of all simulator experiments is that they only represent part of the situation. This is considered acceptable in training when the object is to train the subjects in one particular aspect only but in research it can lead to misleading results if this fact is not taken into account.

In the present work the subjects were deliberately not placed under undue pressure as the object of the experiment was to examine how the subjects behaved in a typically normal situation with good visibility and no particular problems with the navigation. In this type of situation most merchant ships would probably navigate with only one officer on the bridge and a rating working close by to be available if needed. The steering would be by autopilot.

In this case, the single officer on the bridge would be responsible for the navigation which would consist of monitoring the ship's position and adjusting the course as necessary to keep the ship on the intended track. At the same time he would have to keep a lookout for other ships and manoeuvre his ship according to the "Regulations for the Prevention of Collisions at Sea" whenever it was necessary.

It is unlikely that they would be expected to carry out any other duties, when the ship was as close to land as she was placed in this experiment.

It was the aspect of keeping a lookout and avoiding other ships that had to be simulated, otherwise the subjects were likely to spend all their time on the navigation which would have been unrealistic and might have led to unrepresentative results. To simulate the keeping of a lookout a system of lights was devised (See 1.7.). These lights were spread along one wall in the simulator and were low power L.E.D. lights. They were in three colours, red, green and white as those are the colours which seafarers would be accustomed to look for. The lights were designed to switch on for about a second or two and then switch off again. A simple timing device controlled the switching (see appendix 4) and altogether there were nineteen lights for the subjects to observe including one flashing and one

Fig 5 Layout of the Simulator

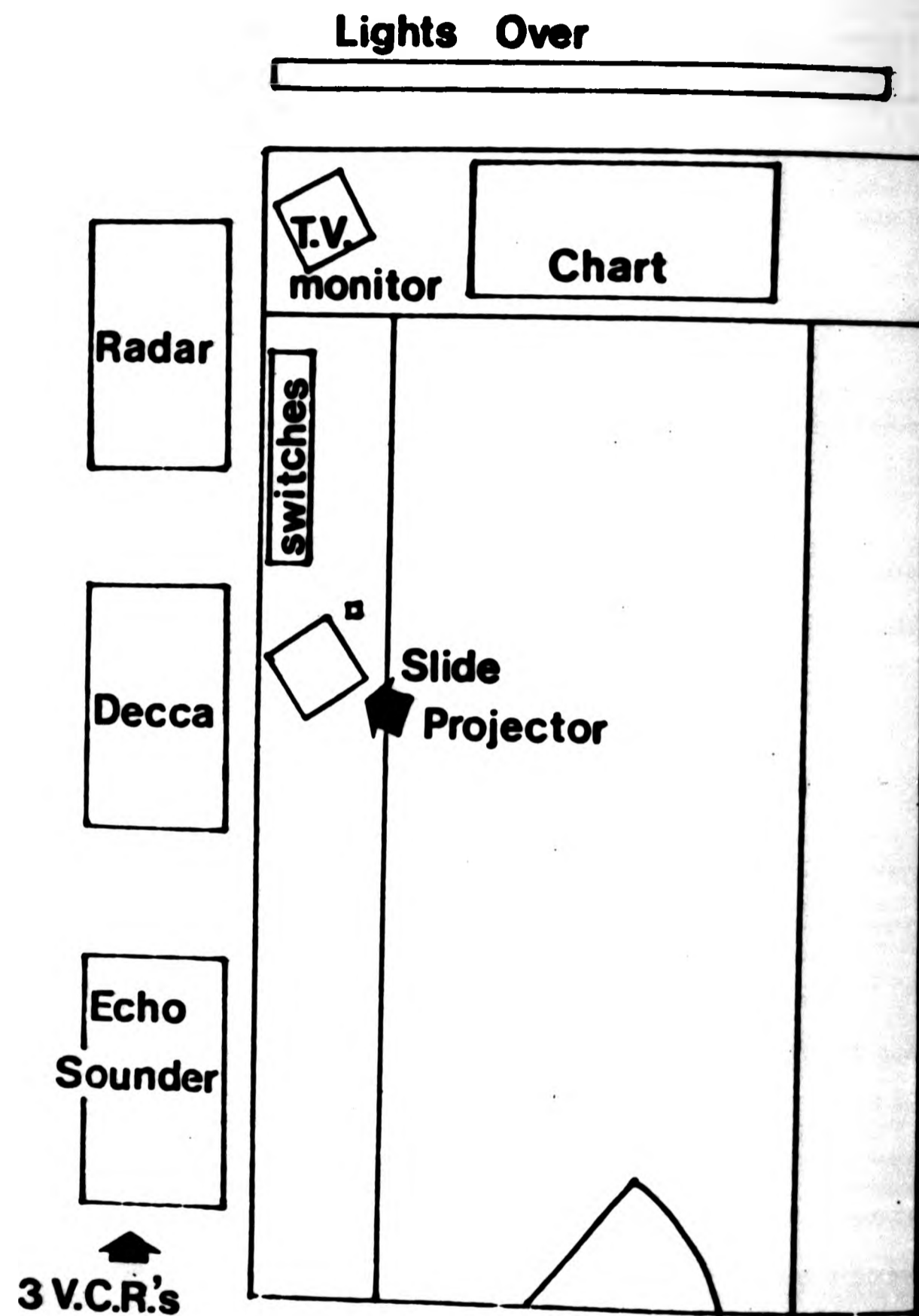

occluding light. (For a list of the lights see appendix 4). The lights had no particular navigational significance, indeed there was an anomaly in that the subjects were asked to observe lights during what was a daylight exercise but they provided the essential side task that was required to prevent the subjects from spending too much time on the navigation.

4.5. The layout of the simulator.

The simulator was housed in a disused darkroom which had been part of a science laboratory. The television screen, slide projector and control box for the different aids were placed on a side bench while the subjects were provided with a chart covered with tracing paper on the front bench. They were also provided with the normal drawing instruments, parallel rulers, pencils and a pair of compasses. For details of the layout see Fig 5.

4.6. Running the experiments.

The subjects were selected from students studying for their Master's certificate who agreed to spend half an hour during their lunch break taking part in these experiments. They were assured that the results would be confidential, and that their names would not be revealed. They were also told that there were no problems or pitfalls designed to trap them in these experiments: in other words

they were to navigate in the same manner as they would at sea.

The first four subjects were used to test the simulator and they were given run 1 only, as the intention was that any faults detected by these subjects would be remedied before run 2 was set up. In fact only two faults were detected by this method. First, the original switch for illuminating the slide projector to display the visual bearings was not spring loaded and subject No 1 left the light switched on for most of the run. The equipment was subsequently modified by the inclusion of a spring loaded switch to illuminate the projector. Second there was a fault in the Decca tape. It appeared that when the master tapes were copied there was a gap in the recordings which resulted in a "jump" in the Decca readings. The subjects identified this fault as "lane slip" (13) and it was cured by recopying from the master tapes on to another working tape, although it was not until after subject No 4 had completed his run that the nature of this fault was identified and finally cured. Because this operation proved to be relatively trouble free it was possible to include the data from these four subjects in the final analysis.

4.6.1. Measurement of Performance.

At first it was not considered practical to quantify the subjects' performance because with a non-interactive

simulator it was not possible during the course of the exercise to present the subjects with navigational tasks and then assess their performance in the execution of those tasks. It was however later realised that it would be possible to assess a subject's appreciation of his situation by asking him to make a quantifiable navigational decision at the end of a test run.

It was therefore decided to ask the subjects to produce a course to steer and an estimated time of arrival (E.T.A.) for a point about six miles ahead of the ship's position at the end of the exercise. This would test the subject's appreciation of the ship's course and speed, its final position and the effect of the tide.

The measurement evolved in two stages. From No. 5 onwards the subjects were just asked to produce an E.T.A. and later from subject No 10 onwards, the instructions were rewritten and they were asked for a course to steer as well as an E.T.A. Even so there were a number of the subjects who forgot to provide an E.T.A. during the exercise. It was decided that reminding them after the exercise was completed could result in the subjects making a separate calculation, when the object of asking for the E.T.A. was to test the subject's awareness of the tide and other factors affecting the ship during the exercise. Therefore, in general, if the subject forgot to complete an E.T.A. this was treated as missing data, although the subjects were reminded to produce an E.T.A. during the exercise.

Fig.6
Part of Chart No. L(D2-D5)1504 Cromer to Orford Ness

Run 1

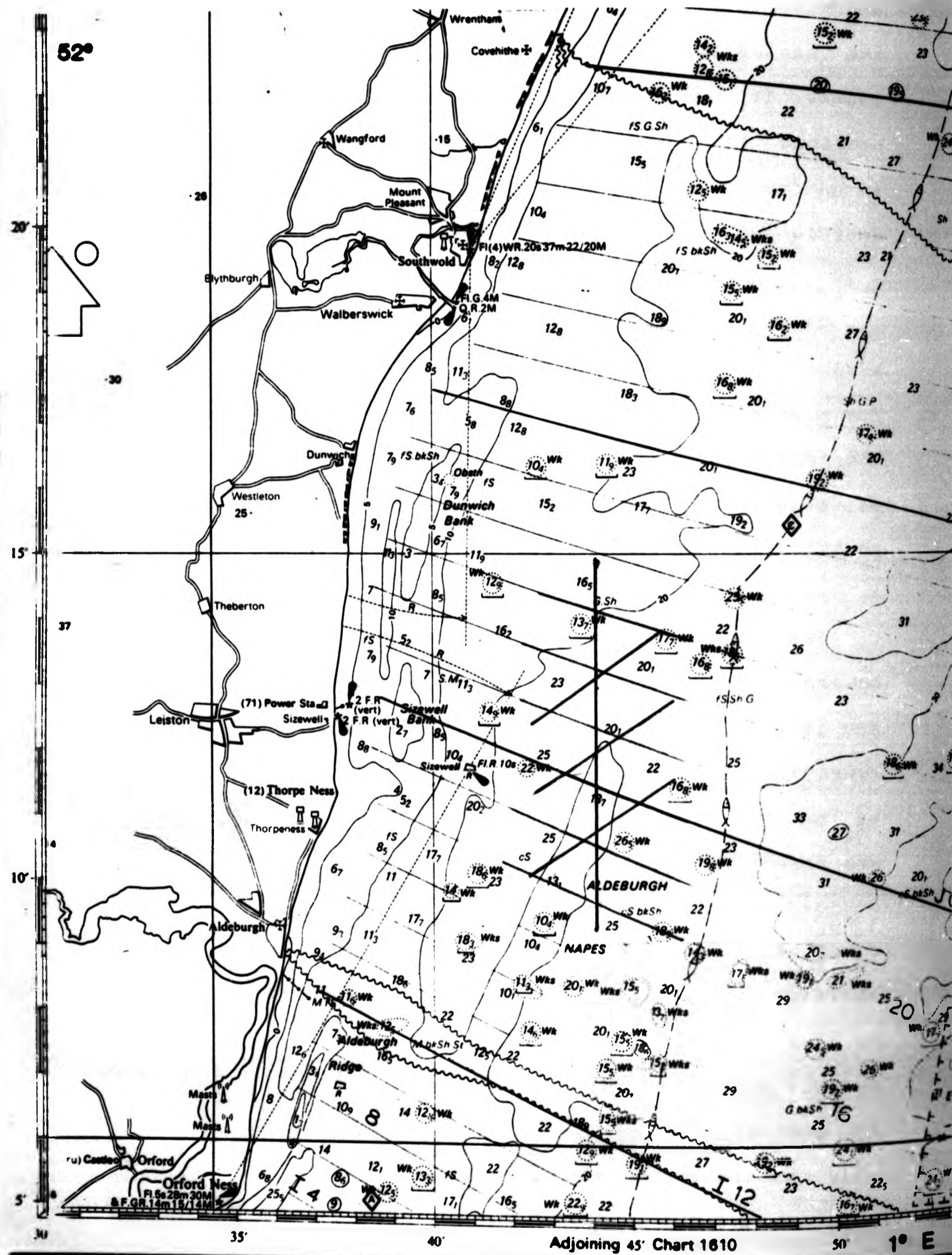

Thus the measurement of errors during this experiment was probably the least reliable of all the variables. No attempt was made to quantify the errors in absolute terms, but, rather, they were used for ranking purposes only. The measure served its purpose but in the design of follow-on experiments a better assessment of performance will be required.

The fact that some of the subjects forgot to carry out their instructions is further evidence of carelessness in carrying out the various tasks (see conclusions to Part 1, section 3.9.3.).

4.6.2. Instructions for carrying out the experiments.

4.6.2.1. Run 1. (Fig 6)

The subjects were given the following information, similar to that which they might expect on taking over a watch:-

"You are in D.R. position 51° 15' N. and 1° 43' E bound for Felixstowe. Your course is 185° true and compass and the engine revolutions are set for a speed of 10 knots. Southwold Lighthouse and Sizewell Power Station are available for bearings and other marks will be available later. The radar is set on the six mile range and the range

Fig. 7
Part of Chart No L(D5) 2052 Orford Ness to the Naze Run 2

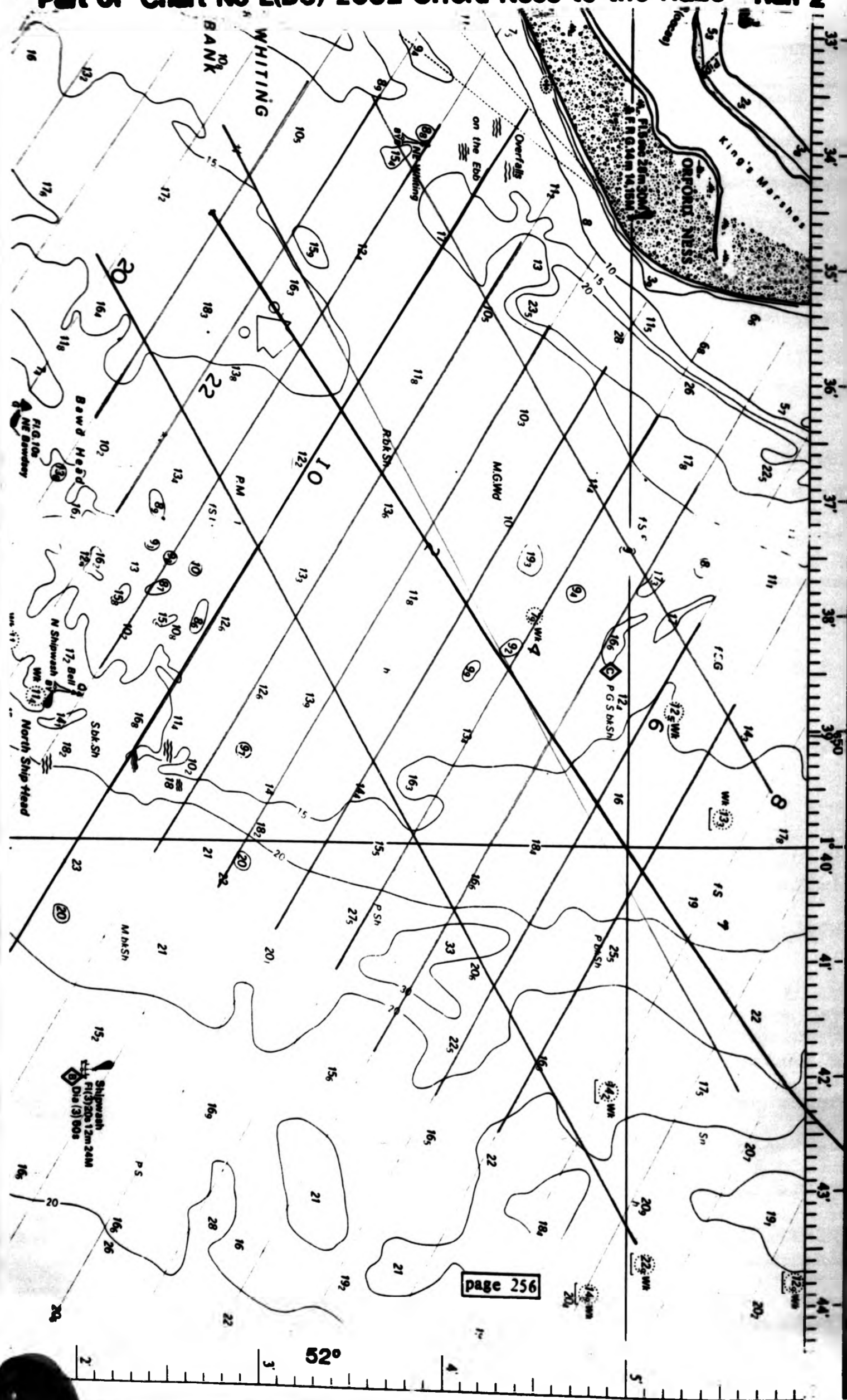

rings are set at one mile intervals. All the navigational aids are properly set up and have been checked.

The exercise will run for 30 minutes, during this period monitor the ship's position and deduce the course to steer from the end of the exercise to a position with Orford Ness Lighthouse bearing 090° x 5 miles, give an E.T.A. for this position.

Keep a proper lookout and log all the lights that you observe".

There was a potential ambiguity over the position for the E.T.A.. There is some confusion as to whether bearings should be named "to" or "from" a mark and this has caused some difficulty at sea. In the "Standard Marine Navigational Vocabulary" (44) bearings are always referred to as "from" a mark but this conflicts with what is often used in practice so the naming is not always clear. In this exercise there was no doubt because the alternative position was five miles inland.

4.6.2.2. Run 2 (Fig 7)

The subjects were instructed:-

"You are in D.R. position 52° 07' N and 1° 44' E bound for Felixstowe. Your course is 206° true and compass and the engine revolutions are set for a speed of 10 knots. Orford

Lighthouse and Castle are available for compass bearings. The radar is set on the six mile range with range rings at one mile intervals. All the navigational aids have been set up correctly and have been checked.

The exercise will run for 30 minutes, during this period, monitor the ship's position, and deduce the course to steer from the position at the end of the exercise to the Cork Lightfloat and prepare an E.T.A. at that position for the pilot station.

Keep a proper lookout and log all the lights that you observe".

The pilot station for Felixstowe was at the Cork Lightfloat and clearly marked on the chart so the subjects had no difficulty in identifying the required position.

4.7. Treatment of the results.

From the data recorded in the simulator it was possible to construct a number of meaningful variables that were used in the validation and analysis of results. (See chapters 5 and 6.)

These variables are discussed in the order that they were devised in the simulator and not in any particular order of merit. The variables discussed here are the

first-order or measured variables, as they were taken directly from the information recorded during the experiments. There were also four second order-variables which were obtained by a combination of these first order variables. The second order variables are discussed in chapter 6 where the data from the simulator are analysed.

4.7.1. Lights.

This was the number of lights the subjects recorded during the experiments. The subjects were instructed to log all the lights which they observed, although a few of the subjects had difficulty in observing the lights only one subject did not observe any at all. During the experiments there were no problems with the lights, as the equipment worked well and most of the subjects were able to observe the lights without undue difficulty. There were, however, some difficulties with the flashing and occulting lights where the subjects sometimes logged them several times.

4.7.2. Error.

The "error" resulted from the measure of performance used in this work. As already explained this was not an ideal method of measuring performance, so it was not considered appropriate to analyse the results from this too deeply. The error was obtained by plotting where the subjects' course and E.T.A. would have placed the ship and

then the distance between this and the ship's required position was measured. A more interesting method would have been to examine the error in terms of cross track and along track components but the data were not considered to be good enough for this purpose.

4.7.3. Time.

The signals from the switches on the different navigational aids were connected to a pen recorder. From this it was possible to calculate the total time the subjects spent watching the aids by measurement of the traces on the recorder chart. The points of starting and stopping each experiment were also noted on the recorder chart. The time which the subjects spent watching the aids was recorded as a percentage because the actual times for each experiment ranged from 29 to 32 minutes. It was therefore considered that the percentage of the total time of the experiment was the more useful measurement.

4.7.4. Toline.

The subjects plotted all their positions on charts which were overlaid with tracing paper. From this it was possible to obtain and retain a record of the number of positions and position lines plotted by each subject and to find the number of times that two position lines only were used. This variable was given the name "Toline". The importance of identifying this variable was that it relates

directly to the subjects' preference for corner positions as demonstrated in Part 1 of the present work. (3.10.2.2.).

4.7.5. Moline.

"Moline" was the number of positions plotted by the subjects using more than two position lines. In practice this meant positions with three position lines as there were a negligible number of positions plotted with four or more lines. Moline was obtained in a similar way to Toline, by counting the number of lines on the chart.

4.7.6. Position.

"Position" was the total number of positions plotted by the subjects taken from their charts. There was a certain amount of sloppy work on the charts, as not all the positions had a time beside them and it was not always clear whether the subjects intended them to be positions or not. Although the ambiguous positions were not frequent enough to affect the results of this experiment they were further evidence that navigation was being carried out in a careless manner. This was the more remarkable when it was considered that the subjects knew that their work was being observed and recorded.

4.7.7. Visual.

"Visual" was the number of times the subjects observed the visual bearings. This information was taken from the pen recorder trace and represented the number of times the subjects pressed the switch on the slide display. This did not necessarily represent the number of times the subjects observed a visual bearing because the projector was driven by a pulsed tape and therefore one observation could include up to three visual bearings, or it could represent one bearing only. Therefore, in fact, the variable "Visual" underestimated the number of visual bearings the subjects observed.

4.7.8. Decca.

"Decca" was the number of times the subjects observed the Decca Navigator, the information again being taken from the pen recorder chart. In this case the number of potential position lines was exactly twice the number of observations because the Decca Navigator always displays at least two position lines. In some cases there are three position lines available, but not in this experiment.

4.7.9. Radar.

"Radar" was the number of times the subjects observed the radar display during the exercise. The information was again taken from the pen recorder chart. There were a number of reasons for the subjects deciding to observe the

radar and they were not necessarily connected with navigation. A common use for radar at sea is as an aid in the keeping of a lookout for other ships or dangers. In this variable it was not possible to separate the different uses of the radar and therefore it tended to overestimate the number of times on which the radar was used as a means of fixing position.

4.7.10. Sounder.

It was not possible to identify any lines on the chart taken from the echo sounder so it was assumed that this aid was used as a visual check only. This variable was therefore a measure of the number of times the aid was consulted.

4.7.11. Visualp.

This was a record of the number of visual position lines plotted on the chart by the subjects. It was taken from the lines the subjects plotted on the chart and checked against the pen recorder trace as well as the log which some of the subjects kept during the exercise, to see whether they were in fact visual bearings.

4.7.12. Radarp.

This was the number of radar position lines plotted by

the subjects on their chart during an exercise. One of the results from Part 1 of the present work, (3.8.4.3) was that the subjects demonstrated a clear understanding of the errors in radar bearings by refusing to use them whenever possible. This was also demonstrated in the simulator where the subjects almost always plotted radar ranges and because they had been provided with a drawing compass almost all of the radar position lines were circles and so not too difficult to identify.

4.7.13. Deccap.

This was the number of Decca position lines plotted on the charts by the subjects. Because of their relationship to the Decca lattice pattern, these were easy to identify.

4.8. Evaluation of the variables.

The difficulty of deciding what the total number of observations of the aids really meant in terms of observing them for the purpose of navigation has already been stressed. This implied that the number of plotted position lines are more meaningful variables, but the problem here is that it was not always possible to be totally sure what a line on the chart represented. In most of the situations it was possible to identify the aid used, but on a few occasions it was difficult. Also there was the problem in deciding whether a particular line drawn by a subject on

his chart had any navigational significance. The dangers inherent in this type of sloppy navigation are discussed in the various texts (12). Fortunately as far as this work was concerned these ambiguous lines represented a very small proportion of the total number of position lines so they did not affect the final evaluation.

4.8.1. Methods of Evaluation.

Because they are the largest user of research simulators the model for this work was the published research from CAORF (45), but this work differs from that in one aspect which is relevant to the treatment of the data. The CAORF experiments were all designed with a particular object in view, typically to examine a harbour entrance or perhaps to examine whether a particular navigational aid would result in fewer collisions or strandings.

The present work however had the more general objective of trying to establish the information which navigators use when making their decisions, which meant it was not so easy to define specific objectives and therefore to design the experiments around these objectives.

In this work the run was the only independent variable, and this comprised only the two states of run 1 or run 2. The other variables which have been identified

are dependent as they all related to the subjects' performance. There was the danger of unwanted and unquantifiable variables affecting the results and this was reduced by the construction of the experiments. The possible influence of a learning effect was eliminated by reversing the order in which alternate subjects took the two runs.

The problem of nuisance variables (Wald 45) was eliminated by holding the experimental conditions constant. In this way any unwanted effect was spread across all the subjects and could be considered to have affected them equally. In any experiment it is unlikely that all these nuisance variables can be identified and so by concentrating in the results on comparisons between the measured variables their effect should be minimised.

4.9. Summary.

This work demonstrated that it was possible to construct a low cost non-interactive simulator. During the tests the subjects who all had considerable experience at sea were asked for their opinions on the realism of the simulation and they all agreed that it was acceptable.

It was also demonstrated that it was possible to obtain 13 meaningful variables from the simulator but it was necessary to validate the results before any further

analysis could be carried out. This validation is described in Chapter 5.

CHAPTER 5

The usefulness of the simulator results.

Before the data obtained from the simulator experiments could be examined, it was necessary to carry out some tests to determine whether the simulator could be considered to represent a realistic model of the navigational situation at sea.

The only way of completely verifying any simulator results would be to test the same subjects in a similar situation on board a ship but it was not possible to arrange for all 28 subjects to undertake a voyage so other methods had to be considered.

5.1. Comparison with other experiments.

It was hoped to make use of the data collected for the E.M.I. bridge design exercise (38) as there would have been records of which aids the ship's officers consulted but these data are not available, and unfortunately not even a synopsis has been published.

5.1.1. Other simulator work.

Both Hammell (23) and Curtis (31), have carried out experiments to compare the reactions of navigators in a

simulator with those observed at sea, and in both cases demonstrated that the simulator was a realistic representation of their behaviour at sea. In addition to these two, there are a number of other experiments (described in Chapter 1) where simulator results were accepted as a substitute for observations obtained at sea.

5.1.2. Other Published Work.

The other method which was considered while the work was being examined was to note how the results from the present work relate to other published data in the same field, and here the work by Holder (32) was particularly important because he drew his sample from the same population as the present work. For a more complete discussion on the work carried out by Holder see also section 1.8.1.

Although these results were not sufficient in themselves to validate this experiment, they provided a useful precedent for simulator research.

5.2. Preference for the different aids.

In Part 1 of the present work (section 3.9.1.) an order of preference for the different aids was established, the subjects demonstrating a clear preference for visual bearings whenever possible. (3.9.1.5.).

In those experiments it was not possible to find evidence for a preference between the radar and the Decca navigator as the subjects demonstrated considerable confidence in both aids. What these results seemed to demonstrate was that there was no intrinsic preference for either aid but rather the choice depended on the particular situation.

The Radio direction finder proved to be so unpopular that its use was dropped in the second experiment (see section 3.9.1.2.).

By comparing the preferences for the different aids demonstrated in Part 1 of the present work with those obtained from the simulator a degree of confidence in the results from both experiments could be demonstrated.

5.2.1. Subjects' preferences in Part 2.

Part 1 of the present work had demonstrated that the subjects exhibited certain preferences for the different aids. In fact so extreme was the rejection of the radio direction finder that its use was dropped from part 2.

Experiment 3 was devised in part to examine whether these preferences still existed in a situation where the subjects were given a free choice of when to fix their

position and which aids to use. In this experiment the preferences could be demonstrated by two methods: firstly, by noting how frequently the subjects observed each aid by examining the pen recorder trace, and secondly, by examining how many position lines from each aid were plotted by the subjects.

The subjects' choice of aids in the two runs are given in tables 1 and 2:-

Table 1. Number of occasions when the aids were observed during the two runs.

Aid	Run 1	Run 2
Visual	308	278.5
Decca	170	189
Radar	278	307.5
Echo Sounder	144	139.6

From observation it is clear that the echo sounder and the Decca were observed less frequently than the other two aids. The number of observations of each aid are, however of the same order for the two runs.

Table 2 Subjects' choice of aid by plotting.

Aid	Run 1	Run 2
Visual	181.7	157
Decca	194.6	193
Radar	74.8	120

In this case it was clear that the Decca was the first choice followed by the visual bearings in each run.

5.2.2. Summary.

Although it was not possible to carry out the same χ^2 test as in Part 1, from the data the order of preference for the aids was as follows:-

5.2.2.1. Aids observed by the subjects.

Table 3. Subjects preferences for the different aids by observation.

Aid	Run1	Run2	Combined
Visual	1-	1 -	1 -
Decca	3	3	3
Radar	1-	1-	1 -
Sounder	4	4	4

5.2.2.2. Aids plotted by the subjects.

Table 4. Subjects' preferences for the use of the different aids.

Aid	Run1	Run2	Combined
Visual	2	2	2
Decca	1	1	1
Radar	3	3	3

The fact that there was no difference in the order of the subjects' preference for the aids in the two runs further justifies the combination of the data for these runs. (see 5.2.4.).

5.2.3. Conclusions.

This results were compared with Part 1 where the subjects demonstrated a first preference for visual bearings followed by the Decca and Radar (section 3.9.1.). At a first glance they do not correspond with that finding and possible reasons for this are discussed in the next paragraph. On closer examination however, the above results are shown to be very similar when some of the circumstances of the two runs were taken into account.

These results were not as clear as the preferences

demonstrated in Part 1 of this work, mainly because in this experiment the number of variables was greater. In particular the subjects were free to decide when and where to plot their positions so the selection of aids by the different subjects was not always comparable. Also the subjects were not always free to select the aid of their choice because of the lack of suitable objects for visual bearings or radar marks. The only aid which always gave two position lines throughout both exercises was the Decca navigator. This was reflected in the greater number of Decca position lines plotted by the subjects. The fact that the subjects observed this less frequently than the other aids was explained by the ease of obtaining information from this instrument.

With the visual bearings, the subjects did not have the opportunity to use them as frequently as they might have chosen. When they did, as demonstrated in run 1 then the visual bearings were observed more frequently than the other aids. They were not observed as frequently in run 2 because for most of the exercise there was only one visual bearing available (sections 4.3.2. and 4.3.3.).

Thus the results were therefore similar to those obtained from Part 1 of the present work since during the first part of run 1 where two visual bearings were available, the subjects demonstrated a clear preference for this aid. When it was not as easy to obtain visual bearings

the subjects used the other aids, frequently resorting to the Decca when they were in difficulties. A preference for the Decca was demonstrated in the plotted position lines while a preference for the radar was demonstrated in the observed data. Thus, as in Part 1, it was not possible to distinguish between the two aids using these data (section 3.9.1.3.).

For the reasons previously explained it was not possible to obtain as clear an order of preferences as in Part 1. Nevertheless, when the different factors were taken into account, the preferences for the different aids were similar to those demonstrated in Part 1, and this consistency must, in part, help to validate both experiments.

The most interesting result was the large difference between the number of occasions when the subjects observed the radar and the radar position lines plotted on the chart. The most likely reason seems to be that the subjects were using the radar as a visual check on their position without plotting any of the information obtained. The other possible reasons were:-

- a) Because the radar was the only compass available in the simulator and so some of the observations could be a check on the ship's heading.

b) Although the subjects were told that the ships on the radar screen did not present a danger of collision they were probably still observing the radar for this purpose.

c) The quality of the radar picture in the simulator was not as good as the subjects were accustomed to at sea, hence the subjects might have observed this aid more frequently than they would at sea.

The other clear result was that the echo sounder was not consulted as frequently as the other aids. Although it does not give as much information, it can still be used to verify an otherwise doubtful position so it was probably not being used to its best advantage.

There were certain difficulties in obtaining the data on the use of the aids with reference to the number of times the aids were observed, as there were occasions when the pen recorder was not working properly. When the plotted position lines were examined it was not always clear from the charts which aid was being used. Indeed one subject did not plot any position lines so average values were used to complete both sets of data.

5.2.4 Combination of data.

As a result of difficulties with the simulator there were some missing data (section 4.6.) so the sample size

was rather small for some of the tests so the results of the two runs were combined thus giving a total of 51 replications. The two runs were tested by a "Hotelling's t" test (46) in order to examine whether the samples could be considered to be drawn from the same population. The "Hotelling's t" test was used rather than the simple "t" test because there were 17 variables and at a 5% level of significance there was a high probability that one of the results could appear to be significant when in fact it was not.

The two hypotheses were:-

H_0 There was no difference between the runs.

H_1 There was a difference between the runs.

When the test was carried out a value of "F" of approximately 1.82 was obtained, which is less than the critical value of 1.92 for $\alpha = .05$.

The result was not significant, and the null hypothesis was accepted, there was no difference between the two runs.

This result justified combining the data from the two

**REPRODUCED
FROM THE
BEST
AVAILABLE
COPY**

was rather small for some of the tests so the results of the two runs were combined thus giving a total of 51 replications. The two runs were tested by a "Hotelling's t" test (46) in order to examine whether the samples could be considered to be drawn from the same population. The "Hotelling's t" test was used rather than the simple "t" test because there were 17 variables and at a 5% level of significance there was a high probability that one of the results could appear to be significant when in fact it was not.

The two hypotheses were:-

H_0 There was no difference between the runs.

H_1 There was a difference between the runs.

When the test was carried out a value of "F" of approximately 1.82 was obtained, which is less than the critical value of 1.92 for $\alpha = .05$.

The result was not significant, and the null hypothesis was accepted, there was no difference between the two runs.

This result justified combining the data from the two

runs and was important because it meant that the results from this experiment could be generalised to other situations.

Although this test demonstrated that it was possible to combine the data from the two runs in order to increase the sample size, there were differences in the problems presented to the subjects so that they could be expected to navigate differently in the two situations. In order to look for any differences in technique which may result from these problems, as well as examining the combined data, each run was tested separately.

5.3. Time the subjects spent observing the aids.

This was another aspect that could assist with the validation of the simulator because the experiments were based on the assumption that the subjects were familiar with the different navigational aids therefore any evidence that there was a learning effect between the subjects' first and second runs would throw doubt on this premise.

The time the subjects spent watching the aids was recorded on the pen recorder and so was readily available for this test.

Because the order in which the subjects took the two exercises was alternated, half the subjects took run 1 as

their first exercise and half run 2, so any difference in difficulty between the two runs would not influence this test.

If there was any learning effect, it could be demonstrated by the fact that the subjects spent longer observing the aids in their first run in the simulator than in their second. If there was no difference in the time then it could be assumed that the subjects were familiar with the aids and knew how to obtain the required information. Thus the statistical test required was a one tailed test to look for evidence that the subjects spent longer watching the aids in their first exercise than in their second.

5.3.1. Methods of Testing.

A test was chosen that looked at the differences in the subjects times, but as not all the subjects completed two exercises in the simulator the sample size was restricted to 20 pairs.

There are two types of statistical test for looking at the difference between sample means. If the sample size is less than 30 and the population can be demonstrated to have a normal distribution then the test to use is the "t" test (42). If the sample does not have a normal distribution

then non parametric tests must be applied and in this case a suitable test to use would be the "Wilcoxon signed rank test" (48). Hence the first test to be carried out must be a test for normality.

5.3.2. Test for Normality.

Tests and Hypotheses.

Statistical Test.

The method chosen was to use the "Nscores" command in "Minitab" (47). This routine constructed a normal distribution which was as close as possible to the given data. This was then tested for correlation with the actual data. If the value of the correlation coefficient "r" was significant then the data could be considered to be normally distributed and the "t" test applied.

H₀: The correlation coefficient = 0

H₁: The correlation coefficient \neq 0

Region of Rejection.

The region of rejection consisted of all values of the

then non parametric tests must be applied and in this case a suitable test to use would be the "Wilcoxon signed rank test" (48). Hence the first test to be carried out must be a test for normality.

5.3.2. Test for Normality.

Tests and Hypotheses.

Statistical Test.

The method chosen was to use the "Nscores" command in "Minitab" (47). This routine constructed a normal distribution which was as close as possible to the given data. This was then tested for correlation with the actual data. If the value of the correlation coefficient "r" was significant then the data could be considered to be normally distributed and the "t" test applied.

H_0 The correlation coefficient = 0

H_1 The correlation coefficient $\neq 0$

Region of Rejection.

The region of rejection consisted of all values of the

correlation coefficient "r" which were so small that the probability of their occurring under H_0 was equal to or less than $\alpha = .05$

Treatment of Data.

The data for the time that the subjects spent watching the aids were sorted into two columns, one for the subjects taking their first test and the other for the second test. The Nscores for these columns were then calculated and plotted against the original data using the "plot" command in Minitab. (47). The correlation coefficient "r" for the two sets of data was then calculated using the "Correlate" command and then compared with the table printed in the Minitab handbook (47) to see if they were significant.

5.3.2.1. Results.

The correlation coefficients and significance levels obtained for the two runs are given in the following table:-

Table 5. Correlation coefficients and significance levels for the first and second tests.

Test	Correlation Coefficient	Significance Level
1	0.986	.01
2	0.956	.05

Both these results were significant, the null hypothesis was rejected, and the alternative hypothesis accepted. There was evidence that both correlation coefficients "r" were significantly different from 0. The data could be assumed to be normally distributed.

This result meant that it was possible to use the "t" test (42) on the differences in times that the subjects spent watching the aids.

5.3.3. Test for difference in times.

Region of Rejection.

The region of rejection consisted of all values of "t" such that their probability of rejecting H_0 when it was in fact true were less than $\alpha = .05$ which in this case was $t > 1.73$.

Statistical Test.

The "t" test used was where :-

$$t = \frac{\bar{x}_d - \mu_d}{s_d / \sqrt{n}}$$

and

$$\bar{x}_d = \frac{\sum x}{n}$$

and

$$sd = \sqrt{\frac{1}{n-1} (\sum x^2 - \frac{(\sum x)^2}{n})}$$

Where x is the difference between the time spent in watching the aids on the first and second run.

Results.

The data for the "t" test are given in table 6.

Table 6. Differences in time watching the aids between the subjects' first and second runs.

Subject	1st.Run	2nd.Run	Difference(x)
5	12	10	2
7	18	12	6
8	14	14	0
9	6	12.9	-6.9
10	12	6	6
12	24	19	5
13	14	20	-6
14	14	14	0
15	19.3	9.3	10
16	25	22	3
19	29	31	-2
20	29	39	-10
21	15.8	19.6	-3.8
22	17.7	11.6	6.1
23	21	16.7	4.3
24	10	11.3	-1.3
25	30	30	0
26	25	19	6
27	24.5	19.7	4.8
28	15	17.1	-2.1

This gave a value of $t = 0.18$ on 19 degrees of freedom. The result was not significant. the null hypothesis was

accepted and the alternative hypothesis rejected; there was no evidence of a difference in the time spent watching the aids between the subjects' first and second runs in the simulator.

This result demonstrated that the subjects did not need to learn how to use the aids in the simulator, otherwise they would have taken longer during their first attempt than the second. Thus it followed that the presentation of the navigational information was in a manner to which the subjects were accustomed, and as they had no previous experience of the simulator this meant that the presentation must have been in a similar manner to that which they were used to at sea. This was encouraging because, although it was possible to produce realistic simulations of the other aids, the radar proved to be difficult since it was not technically possible to make a good quality video recording of the radar display (see also section 4.2.4.2).

5.4. Errors.

5.4.1. Description of errors.

A measure of the quality of navigation in this experiment was devised by asking the subjects to calculate

a course to steer and the E.T.A. for a position about half an hour's steaming from their position at the end of the test. The ship's expected position according to the subject's answer, having taken the tide into account, was plotted and the distance between that and the actual position was measured. The difference was taken to be the subject's error. This measure was admittedly crude and no attempt was made to draw any conclusions about the absolute values, but it was considered to be a suitable scale for comparing the performance of the different subjects. When the errors were examined it was noticed there six errors were considerably larger than the others and these were provisionally distinguished by the term "blunder". For the purpose of this experiment a blunder was defined as an error which exceeded two standard deviations and in this experiment this came to about 3.5 miles. Unfortunately this was too small a sample on which to carry out any tests but it was possible that these six outriders could have had an undue effect on some of the results so they were always considered when the errors were discussed.

5.4.2. Use of errors in validation.

Another measure of the simulator's realism was whether the subjects navigated better during their second test in the simulator. In this experiment the measure of accuracy of navigation was the subject's error in E.T.A. If the subjects produced a smaller error during their second test

then it would be reasonable to infer that there was a learning effect and the realism of the simulator could be in doubt. As the subjects had an average of six years watchkeeping experience it was unlikely that their navigation would improve as a result of this experiment so any differences observed in this experiment must have been a result of the subjects learning how to use the simulator rather than an improvement in their navigation.

5.4.3. Test for Normality.

The first stage was to test the data for normality. The errors for the first and second tests were again placed in two columns, the Nscores calculated and the correlation coefficients "r" obtained using the programme "Minitab"(47) on the DEC10 computer.

Hypotheses and Tests.

H_0 The correlation coefficient = 0.

H_1 The correlation coefficient \neq 0.

Rejection Region.

The region of rejection consisted of all values of "r" such that the probability of rejecting H_0 when it was in

fact true were equal to or less than $\alpha = .05$

The results from this test are shown in table 7:-

Table 7. Correlation coefficients and significance levels for the subjects' tests in the simulator.

Test	Correlation Coefficient	Significance Level
Test1	.856	N.S.
Test2	.850	N.S.

The results of this test were not significant, the null hypothesis was rejected and the alternative hypothesis accepted. The correlation coefficient was not significantly different from 0.

This result meant that the "t" test could not be applied and the less powerful non parametric "Wilcoxon matched pairs" test (48) was used.

The observation is interesting because, according to Anderson and Parker (49), navigational errors have a normal distribution. This is assuming three main types of error, systematic, random and blunders, although in practice it is

not easy to separate them. In this experiment the "blunders" had already been identified and the remaining errors could be assumed to be a combination of the other two. It was assumed that the mean would be offset by the systematic errors, which in this case was mostly a result of the subjects not taking the tide into account. When the histogram of the errors is examined (see appendix no.3) there are two main peaks, the largest displaced from zero by about one mile which represented the subjects who did not take the tide into account and a second peak which occurred at about three miles and for which there was no obvious cause. It was probably this second peak which prevented the distribution from being normal. Later work by Anderson and Ellis (50) and Hsu (51) suggests distributions other than normal but they are all basically "Bell" shaped. The small sample size, the need to use estimated values and the relative crudeness of the measure prevented any firm conclusions from being made about the error distribution. Ignoring the tide seems to be a common practice at sea as well as in the simulator if the difficulty some students experience when practising chartwork for the Department of Transport examinations is any guide. This probably does not cause any trouble for most of the time but a number of accidents have occurred, perhaps the most notable being the grounding of the "Torrey Canyon", where the navigators did not take the tide into account and did not realise what was happening to the ship until it was too late (52).

5.4.4. Test for Differences.

The aim of these tests was the same as in the previous tests involving the time that the subjects spent watching the aids (5.3.3.), so similar hypotheses were used:-

H₀. There was no difference in the errors for the two runs.

H₁. The errors in the second run were smaller than in the first run.

Statistical Test.

A one tailed test was again chosen because, if there was a learning effect, the errors would be smaller in the second test than in the first.

The "Wilcoxon Matched Pairs Signed Ranks" test is described in Siegel (47) chapter 5. This test uses the differences between the errors in the subjects' first and second runs and by taking account of the magnitude and direction of these differences, tests whether the two samples can be considered to have come from the same population. Its chief drawback as far as the present work was concerned was that not all the subjects in fact completed an E.T.A. for both runs therefore it was not

possible to measure the differences in their errors.

Region of Rejection.

The region of rejection consisted of all values of "t" which were so extreme that the probability of rejecting H_0 when it was in fact true was equal to, or less than, $\alpha = .05$.

Treatment of Data.

Because of the complications with the blunders two different tests were carried out:-

5.4.4.1. Testing with blunders included.

This sample consisted of all the subjects who completed an E.T.A. for both runs. The column of errors for the subjects' first test was subtracted from the column for the second test and the differences were then ranked as shown in table 8:-

Table 8. Differences and ranks for the two tests, subjects who completed both tests, blunders included.

Difference	Rank
-7.65	-12
1.3	8
1.0	5.5
0.3	2.5
-0.3	-2.5
-4.6	-11
0.8	4
-1.0	-5.5
3.7	10
-1.1	-7
-1.9	-9
0.2	1

The - sign against a rank indicates a negative difference between the 2 columns.

The + and - ranks were then summed separately and the smaller of the two was tested against the values in table J in Haber and Runyon (53). The sum of the positive ranks was 31 and the negative was 47, so in this case 31 was tested with a sample size of 12 and the result found to be non significant and the null hypothesis was accepted. There was no evidence that the errors for the subjects taking the

test for the second time were less than for the first time.

5.4.4.2. Testing with blunders excluded.

The errors greater than 3.5 nautical miles which had been defined as blunders were then deleted from the data and the test repeated, the results after the columns were subtracted and ranked being given in table 9:-

Table 9. Differences and ranks for the subjects who completed both tests. Blunders excluded.

Difference	Rank
-1.3	-8
-1.0	-5.5
-0.3	-2.5
0.3	2.5
-0.8	-4
1.0	5.5
1.1	7
1.9	9
-0.2	-1

This gave a total of 21 for the sum of the ranks of numbers with negative differences and 24 for the sum of ranks with positive differences.

The sum of 21 was again tested against the values in Table J in Haber and Runyon (53), and the result found to be non significant and thus there was no evidence of any difference in the errors between the subjects first and second tests in the simulator.

5.4.5. Conclusion.

This test was complicated by the small sample size. What was an adequate sample for the whole experiment was reduced because the first four subjects were not asked for any E.T.A. and it was not until subject no. 10 that the instructions were finally settled. Some of the subjects ignored this instruction for one of their exercises and therefore it was necessary to introduce mean values in order that all the data could be used. It may have been because of this small sample that it was not possible to demonstrate a normal distribution (5.4.3).

Although it was possible to consider other variations for testing the errors, the fact that both of the tests gave non significant results was evidence that the subjects did not improve their performance in their second test in the simulator. Whether or not the blunders were included in the data made no difference to the results as there were two in the first test and four in the second test so their effect was evenly distributed.

Despite the data being rather crude neither of the results suggested that the subjects improved their performance in their second test, which would seem to indicate that they were not learning in the simulator and must have been navigating in the simulator in a manner similar to that which they used at sea.

5.5. Lights.

A number of lights were arranged in the simulator and were programmed to switch on and off nineteen times by a simple timing device. Low powered bulbs designed to be only just visible were used (see appendix 4) and as a side task the subjects were asked to log all the lights they observed. They did not have any navigational significance, rather the intention was to simulate the fact that the watchkeeper has other duties to attend to in addition to navigating the ship and to prevent the subjects from spending all their time observing the aids which would be a dangerous practice if allowed at sea.

As well as using the number of lights logged by each subject as a measure of performance (section 6.4.4.) they were also used to test the validity of the simulator, so it was considered relevant to examine whether the subjects showed any improvement in the number of lights which they

observed during their second test in the simulator. This test differed from those concerned with the time spent watching the aids and with the errors as those two variables were directly related to the use of navigational equipment while the number of lights observed by the subjects did not relate directly to any particular navigational task.

5.5.1. Tests and Hypotheses.

5.5.1.1. Test for normality.

The first stage of these tests was to test the data for normality in order to decide whether the "t" test or a non parametric test was appropriate.

H_0 The correlation coefficient = 0

H_1 The correlation coefficient \neq 0

Region of Rejection.

The region of rejection consisted of all values of "r" such that the probability of rejecting H_0 when it was in fact true were equal to, or less than, $\alpha = .05$

Treatment of Data.

As with the previous tests, the lights logged by the subjects in their first and second tests in the simulator were placed in two columns and entered into Minitab (47) on the DEC10 computer. The Normal scores were calculated using the "Nscores" command. These were then plotted against the original data and the correlation coefficient "r" calculated by the correlation command. The results of this correlation are given in table 10:-

Table 10. Correlation coefficients and significance levels for the first and second tests.

Test	Correlation coefficient	Significance Level
Test1	0.975	.01
Test2	0.962	.05

Both the results were significant, the null hypothesis was accepted, there was evidence that the distribution was normal so it was possible to use the "t" test to see if there was any improvement in the subjects' performance between the two tests.

5.5.1.2. Tests for an improvement in performance.

Region of Rejection.

The region of rejection consisted of all values of "t" such that their probability of rejecting H_0 when it was in fact true were less than $\alpha = .05$ which in this case was $t > 1.71$

Treatment of Data.

The two columns of data were tested using the "t" test(42). The data are given in table 11:-

Table 11. Numbers of lights observed by the subjects in their first and second runs.

Subject	1st.Run	2nd.Run	Difference(x)
5	14	14	0
6	5	5	12
7	9	16	7
8	9	13	4
9	7	12	5
10	15	18	3
11	2	9	7
12	12	19	7
13	14	18	4
14	11	15	4
15	12	16	4
16	11	13	2
18	2	7	5
19	0	2	2
20	0	4	4
21	14	15	1
22	11	11	0
23	6	14	8
24	13	14	1
25	11	3	-8
26	19	19	0
27	10	19	9
28	16	18	2

Testing gave a value of $t = 4.32$ on 22 degrees of freedom. The result was significant, the null hypothesis

was rejected and the alternative hypothesis accepted. There was evidence that the subjects observed more lights during their second test in the simulator.

The lights did not simulate any particular activity at sea and so it was reasonable for the subjects to demonstrate a learning effect. The fact that the experiment was able to demonstrate this increased the confidence in the simulator and supported the theory that any learning effect in the previous two examples would also have been detected.

5.6. Tests for a distribution of lights.

As well as examining the number of lights which each subject observed it was important to examine whether any one light or lights were observed more or less frequently than the others. This could have pointed to a particular part of an exercise where the subjects might have been experiencing difficulties and thus lead to some aspects of the task which needed further examination.

5.6.1. Tests and Hypotheses.

The object was to test the pattern of lights observed by the subjects in the two runs to see whether any of the lights were observed significantly more, or less, frequently than the others.

H_0 There was no difference in the number of times the different lights were observed.

H_1 Some of the lights were observed more frequently than others.

Statistical Test.

The test required was one that would demonstrate whether the pattern of observation of the lights was similar to a predetermined distribution. In this case the distribution adopted as standard was approximately rectangular which implied that all the lights would be observed an equal number of times. A common test for this purpose is the " χ^2 goodness of fit" test (42).

Region of Rejection.

The region of rejection consisted of all values of χ^2 such that the probability of rejecting H_0 when it was in fact true, α was equal to, or less than, .05 i.e. $\alpha \leq .05$.

There were 19 lights altogether which gave 18 degrees of freedom so in this test the result would be significant

at $\alpha = .05$ if the value of χ^2 was greater than 28.87 (43). A value of χ^2 of 42.31 or greater would indicate a value of $\alpha = .01$ or less and would be considered to be highly significant.

Treatment of Data.

The data were examined in three separate tests. Firstly the two runs were examined separately and then the data for the two runs was combined in order to see if the larger sample had any effect on the results. The number of times the different lights were observed is presented in table 12:-

Table 12. Number of lights observed in the two runs.

Light	Run1	Run2	Combined
1	11	9	20
2	15	16	31
3	18	19	37
4	19	13	32
5	12	11	23
6	20	14	34
7	18	14	32
8	17	16	33
9	17	19	36
10	18	13	31
11	16	14	30
12	19	16	35
13	17	14	31
14	18	17	35
15	18	17	35
16	14	15	29
17	18	12	30
18	15	17	32
19	12	9	21

5.6.2. Test for Run 1.

Using the χ^2 test on the data in Run 1 the following results were obtained:-

Total	=	312
Expected Value per cell	=	16.42
Total χ^2	=	7.35
Degrees of Freedom	=	18

When compared with the value of 28.87 for χ^2 .05 on 18 degrees of freedom the result was not significant and the null hypothesis was accepted. There was no evidence that any of the lights were observed more, or less, frequently than the others.

5.6.3. Test for Run 2.

Using the χ^2 test on the data in Run 2 the following results were obtained:-

Total	=	275
Expected value per cell	=	14.47
Total χ^2	=	10.41
Degrees of freedom	=	18

This was much less than 28.87 which is the critical value for χ^2 .05 on 18 degrees of freedom (43) so the result was not significant and the null hypothesis was accepted; there was no evidence that any of the lights were observed more, or less, frequently than the others.

5.6.4. Test on the combined data.

The results from the χ^2 test on the combined data are:-

Total	=	587
Expected value per cell	=	30.89
Total χ^2	=	13.46
Degrees of freedom	=	18

This was much less than 28.87 which is the critical value for χ^2 .05 on 18 degrees of freedom (43) so the result was not significant and the null hypothesis was accepted; there was no evidence that any of the lights were observed more, or less, frequently than the others.

5.6.4. Conclusions.

One of the objects of the above tests was to look for evidence that the subjects were observing significantly fewer lights at one or more particular points in the tests. Had this been the case it would have been expected that there were signs of difficulties in navigation at that point. As there was no evidence of this, it must be assumed that the navigation was reasonably straight forward and the subjects experienced no particular difficulties during the exercises. This did not mean that all the subjects observed the same number of lights, but this question is discussed further in the next chapter.

(6.4.4)

Although there was no significant statistical evidence, by looking at table 21 it is clear that lights 1, 5 and 19 were observed less frequently than the others. There was no navigational reason for this as it was common to both exercises so it points to a possible danger at the beginning and end of the watch where the navigator is probably less alert. Light no. 5 was the flashing light so it points to another possible danger, that if the period of the light is made too short it may not be as readily observed as a fixed light.

5.7. Summary and Conclusions to Chapter 5.

The object of these tests was to examine the validity of using this particular simulator for conducting experiments in navigation, and the basis for claiming that this was an acceptable method of conducting the experiments rests on the following points:-

5.7.1. Other simulator based research.

A considerable number of other experiments have been conducted in simulators including at least two specifically designed to test the validation of part task simulators (23) (31).

5.7.2. Preferences for the different navigational aids.

This was based on the experiments carried out in part 1 of this work and the preferences in general agree with those results (see section 3.9.1.5.) and with the work carried out by Holder (32). In this experiment it was further complicated because the number of times the aids were observed was examined as well as the type of aids used for plotting the ships position.

5.7.2.1. Preferences among the observed aids.

Here in both runs the preference was for the visual bearings and the radar with the Decca a third choice and

the echo sounder being used the least.

5.7.2.2. Preference among the plotted aids.

Again in both runs the preferences were for visual bearings and the Decca, with a stronger preference for the Decca in run 2 because there were fewer visual bearings available. The radar was a poor third.

5.7.2.3. Comparison with other work.

This compared directly with the results from Part 1 of this work where the visual bearings were the first choice, followed by the radar and Decca. The result was not so clear in the simulator experiment as there was a limited choice of aids, which would be the case at sea, so the subjects were forced to make use of what was available rather than their first preference. It did demonstrate that visual bearings appeared to be the first choice, followed by the radar as a check if it was only to be observed, and the Decca if it was necessary to plot a position line. This result was in agreement with Holder (32) whose work is discussed in section 1.8.1.

5.7.3. Time spent watching the aids.

There was no evidence that the subjects spent longer watching the aids during their first test in the simulator.

so this was taken to demonstrate that the subjects were already familiar with the way that the aids were presented and used them in the same way as they would at sea.

5.7.4. Errors in the subjects' E.T.A.

There was no evidence of an improvement in the subjects' accuracy of navigation in their second run. This was again taken to mean that the subjects were performing in a manner similar to the way they would at sea.

5.7.5. Number of lights observed by the subjects.

This was one aspect of the simulator where no attempt was made to simulate an actual situation at sea. Rather, it was designed as a method of loading the subjects. The fact that they showed an improvement in their second test was to be expected and confirmed that performance differences could be detected when present.

The author does not claim that the above tests form a complete validation for the simulator but, rather, the inclusion of this chapter is intended to point to the problem of validating marine simulators and, in particular, the need to provide a data bank of information on behaviour at sea against which to test the simulators without which any attempts at validation will be suspect.

CHAPTER 6

Tests with the seventeen variables.

From the results of the two runs a total of 17 variables was identified (section 4.7). It was decided to test the variables in pairs for correlation and this chapter examines the results of these tests. The temptation to use more sophisticated tests was resisted because the simulator used was a basic non-interactive type (chapter 4) and the simpler type of statistical test was considered more appropriate.

6.1. Tests and Hypotheses.

6.1.1. Hypotheses.

The tests were carried out for correlation between the 17 variables so the hypotheses were:-

H_0 There was no correlation between a pair of the variables.

H_1 There was a correlation between a pair of the variables.

6.1.2. Statistical Tests.

In order to increase the sample size the data from both runs were combined. It was then tested using the "Hotellings t test" in order to demonstrate that the two runs could be combined in this way. (see 5.2.1). Despite this test it was possible for there to be variations between the runs so each was also tested individually.

The tests were carried out on the Polytechnic Computer (see 5.3.1.) The variables were first plotted in pairs so that the relationship between them could be examined visually (Appendix 1). then the value of the correlation coefficient "r" was calculated. The correlation coefficient "r" is a measure of the linear relationship between the two variables; a value of 1 or -1 indicates a perfect correlation while a value of 0 indicates that there is no relationship. When there is a negative correlation it indicates that the relationship is indirect, i.e. one variable increases as the other decreases. (42)

To test the correlation for significance the value of t was calculated, using the following formula (42):-

$$t_{n-2} = r \frac{\sqrt{n-2}}{\sqrt{1-r^2}}$$

It was then tested for significance using statistical

tables (43).

The values of "t" vary depending on the number of observations included in a particular sample. The results were significant (i.e. lie in the rejection region) for the following values of "t", when α is the probability that H_0 is rejected when it is in fact, true:-

Table 1. Significant values of "t" for the different runs (43).

	Run1	Run2	Combined
Sample size	27	24	51
α			
.05	2.05	2.07	2.04
.01	2.77	2.80	2.75
.001	3.70	3.75	3.65

These were equivalent to the following values of the correlation coefficient "r":-

Table 2. Significance levels for the correlation coefficient with the different runs.

α	Run1	Run2	Combined
.05	0.38	0.42	0.28
.01	0.49	0.51	0.37
.001	0.60	0.62	0.47

In this chapter a significance level of $\alpha = .05$ only is denoted by *, a significance level of $\alpha = .01$ is denoted by ** and a significance level of $\alpha = .001$ by ***.

6.2. Treatment of Data.

A total of 28 different subjects took part in these experiments, of which 27 took part in run 1, and 23 of them also took part in run 2. 4 subjects undertook run 1 only and 1 subject undertook run 2 only.

Thus the sample was made up of:-

23 subjects taking both runs 1 and 2

4 subjects taking run 1 only.

1 subject taking run 2 only.

This gave the following sample size:-

Table 3. Subjects taking part in the different runs.

Combined data	51
Run 1	27
Run 2	24

There were some early difficulties with the simulator, and some of the subjects did not carry out all of their instructions so there were some gaps in the data. As the

computer package could not handle columns of unequal lengths, rather than reduce the sample size it was decided to substitute mean values for the missing data before the tests were carried out. For details of the mean values see appendix No.2

6.2.1. Justification of Results.

The 17 variables were tested in pairs thus giving a total of $(17 \times 16) / 2 = 136$ different tests. This was repeated for the two runs as well as the combined data, making a total of 408 tests for correlation. These results are summarised in table 4:-

Table 4. Numbers of correlations at different significance levels.

Data	Significance Level			Total
	.05	.01	.001	
Run 1	7	6	9	22
Run 2	9	10	7	26
Combined	13	10	12	35
Total	29	26	28	83

If the data were random, only about 6.8 of the correlations from each test set of 136 would be expected to give a value of the correlation coefficient "r" great enough to give a significance level of .05 or less. As the

results show not only are there considerably more significant correlations than this but many of them occur at the .01 and .001 level.

From this it was clear that the data were not random and therefore it was worthwhile examining the results in detail.

When these results were examined it was on the basis that the simulator was of a simple type and some of the missing data had been replaced with mean values so the results were interpreted in the light of these limitations.

6.3. The different variables.

The 17 variables were allocated the following names for use in the experiment:-

6.3.1. Oscore.

One of the results from the first part of this work was that many of the subjects demonstrated a strong preference for visual bearings and in discussion afterwards stated that "they preferred the more traditional methods". In this context "traditional methods" was taken to mean visual bearings, or a visual method of navigation as opposed to an electronic method (see 3.9.1.1.).

Oscore was therefore devised to quantify this

preference so that the subjects who preferred a more pictorial type of presentation scored lower than those who preferred one that was numerical. Oscore was calculated using the following formula:-

$$\text{Oscore} = \frac{V + 2R + 3S + 4D}{V + R + S + D}$$

where:-

V = The number of times the subjects observed visual bearings as indicated by the pen recorder.

R = The number of times the subjects observed the radar display as indicated by the pen recorder.

S = The number of times the subjects observed the echo sounder as indicated by the pen recorder.

D = The number of times the subjects observed the Decca navigator as indicated by the pen recorder.

This order was chosen as it ranked the different aids according to how pictorial the display was. The visual bearing was totally pictorial since the subject was taking measurements from some form of landmark. The radar was next on the scale as it showed a plan view of the area, although in some important aspects this plan was not the same as the outside world (14). The echo sounder provided contours of the sea bed although the vertical dimension was considerably exaggerated. The Decca navigator provided a

digital display which bore no relationship to the outside world. With this calculation no attempt was made to quantify the differences between the aids but, rather, an arbitrary scale was chosen to prevent any personal bias from entering the calculation.

6.3.2. Pscore.

Pscore was a repeat of Oscore but using information taken from the subjects' charts instead of the pen recorder. The number of position lines plotted by each subject from the different aids formed the basis of the calculation. Because the echo sounder readings are not usually plotted the calculation was made using the following formula:-

$$\text{Pscore} = \frac{V + 2R + 3D}{V + R + D}$$

where V, R, and D stand for Visual, Radar and Decca position lines.

6.3.3. Oscore2.

Oscore and Pscore were calculated on a different basis and from the first results it was feared that this might make a comparison difficult and, in particular, it was anticipated that the use of the echo sounder might prove to be irregular and thus interfere with the correlations, so Oscore2 was designed as an insurance. Oscore2 was calculated in the following manner:-

$$\text{Oscore2} = \frac{V + 2R + 3D}{V + R + D}$$

where V, R, and D stand for the number of times the different aids were observed, the data being taken from the pen recorder.

6.3.4. Lights.

During each exercise the subjects were asked to log the number of lights which they observed (See section 4.4 for a description of the lights). The variable "lights" was the total number of lights observed and logged by each subject out of a possible 19.

6.3.5. Error.

As part of the exercise the subjects were asked to calculate a course to steer and an E.T.A. for a position ahead of the ship at the end of the exercise. The error was the distance in miles between where the subjects' course and E.T.A. put the ship and the given position (See section 4.5.1.).

6.3.6. Time.

Time was the percentage of the time that the subjects spent watching the aids compared with the total time spent on the exercise. This was calculated as a percentage of the total time because, although each exercise lasted about thirty minutes, there were slight variations in the time taken by the different subjects. The information was taken

from the pen recorder charts.

6.3.7. Toline.

Toline was the number of positions plotted by each subject using two position lines only.

6.3.8. Moline.

Moline was the number of positions plotted by each subject using more than two position lines.

6.3.9. Permore.

Permore was the percentage of positions plotted by each subject using more than two position lines compared with the total number of positions plotted.

6.3.10. Position.

Position was the total number of positions plotted by each subject.

6.3.11. Visual.

Visual was the number of times that each subject observed visual bearings, information for which was taken from the pen recorder.

6.3.12. Decca.

Decca was the number of times that the subjects observed the Decca Navigator, the information being taken from the pen recorder.

6.3.13. Radar.

Radar was the number of times that the subjects observed the radar; the information was taken from the pen recorder.

6.3.14. Sounder.

Sounder was the number of times that the subjects observed the echo sounder; the information was taken from the pen recorder.

6.3.15. Visualp.

Visualp was the number of position lines plotted from visual bearings taken by each subject.

6.3.16. Radarp.

Radarp was the number of radar position lines plotted by each subject.

6.3.17. Deccap.

Deccap was the number of Decca position lines plotted by each subject.

6.4. Results from the correlations.

The significant correlations for each variable were then examined in detail. The values of the significant correlation coefficients obtained are presented in the

Correlations for the Combined Data

	OSCORE	PSCORE	LIGHTS	ERROR	TIME	TOLINE	MOLINE	PERMORE	POSITION	VISUAL	DECCA	RADAR	SOUNDER	VISUALP	RADARP	DECCAP
PSCORE	.23															
LIGHTS	-.04	-.16														
ERROR	.07	-.23	.02													
TIME	-.21	.04	-.51	-.17												
TOLINE	-.05	-.21	.06	.08	-.01											
MOLINE	.08	.27	-.02	-.22	.14	-.61										
PERMORE	.12	.20	-.01	-.23	.03	-.78	.90									
POSITION	.01	-.03	.04	-.09	.13	.73	.10	-.20								
VISUAL	-.59	-.20	.16	.14	.36	.18	.01	-.15	.22							
DECCA	.05	.16	-.23	-.19	.41	.08	.31	.19	.39	.24						
RADAR	-.37	-.07	-.34	-.02	.64	.09	.04	-.03	.15	.36	.39					
SOUNDER	.22	-.08	-.04	.01	.40	.28	.02	-.11	.37	.30	.20	.25				
VISUALP	-.13	-.66	.14	.05	.02	.29	.07	.02	.42	.19	-.15	-.01	.14			
RADARP	.10	-.30	.08	.21	-.04	.36	-.09	-.09	.37	-.04	.13	.29	.19	.22		
DECCAP	.12	.75	-.22	-.32	.19	-.04	.50	.29	.38	-.06	.45	.01	.06	-.29	-.27	
OSCORE2	.65	.27	-.14	.06	-.13	-.15	.09	.16	-.11	-.62	-.01	-.05	-.15	-.18	.21	.07

Correlations for Run 2.

	OSCORE	PSCORE	LIGHTS	ERROR	TIME	TOLINE	MOLINE	PERMORE	POSITION	VISUAL	DECCA	RADAR	SOUNDER	VISUALP	RADARP	DECCAP
PSCORE	.39															
LIGHTS	-.20	-.05														
ERROR	.18	-.48	-.03													
TIME	-.07	.08	-.49	-.37												
TOLINE	.02	-.16	.06	-.02	-.05											
MOLINE	.07	.31	.08	-.09	.19	-.70										
PERMORE	.10	.18	.08	-.08	.09	-.84	.90									
POSITION	.12	.07	.13	-.12	.15	.73	-.02	-.32								
VISUAL	-.56	-.16	.07	-.14	.44	.18	.13	-.13	.37							
DECCA	.34	.21	-.24	-.08	.54	.14	.30	.13	.52	.24						
RADAR	-.28	-.27	-.35	-.34	.71	-.03	.03	.04	.01	.42	.33					
SOUNDER	.14	-.03	-.09	-.01	.50	.24	-.02	-.16	.33	.42	.28	.33				
VISUALP	-.15	-.62	.22	.17	-.07	.24	.04	.04	.38	.27	-.05	.14	.12			
RADARP	.06	-.56	.01	.28	-.10	.56	-.43	-.41	.36	-.08	-.05	.20	.21	.59		
DECCAP	.29	.79	.01	-.36	.24	-.08	.55	.33	.42	.14	.55	-.13	.12	-.26	-.48	
OSCORE2	.61	.26	-.19	.01	-.15	-.17	.12	.26	-.10	-.60	.19	-.04	-.25	-.10	.16	.09

tables and discussed in the following sections. (Figs 1, 2, and 3)

6.4.1. Oscore.

The following significant correlations were obtained with Oscore:-

Table 5. Significant correlations observed with Oscore.

Variable	Run1	Run2	Combined
Oscore2	.67***	.61***	.65***
Visual	-.61***	-.56**	-.59**
Radar	-.49**	-.28	-.37**

6.4.1.1. Oscore2.

The correlation with Oscore2 was expected and followed from the method of calculating the two variables. (section 6.3.1. and 6.3.3.).

6.4.1.2. Visual and Radar.

The negative correlations with visual and radar were related to the weighting of the variables used to calculate Oscore (section 6.3.1.). They were negative because a low value of Oscore was designed to demonstrate a preference for pictorial as opposed to numerical types of display. The correlation suggests that the subjects who favoured visual aids consulted these aids very frequently. As expected the echo sounder did not show up in this result because it was

not used as frequently or consistently as the other two aids. More surprising was the lack of a correlation with Decca. This suggests that the subjects who favoured electronic aids saw less need to consult them too frequently, probably because the Decca display presented the information in a clear and unambiguous manner (section 5.2.2.).

6.4.2. Oscore2.

The following correlations were observed with Oscore2:-

Table 6. Significant correlations with Oscore2

Variable	Run1	Run2	Combined
Oscore	.67***	.61***	.65***
Visual	-.64***	-.60***	-.62***

The correlation with Oscore was discussed in section 6.4.1.1.

6.4.2.1. Visual.

The reasons for the correlations with visual were the same as for Oscore (6.4.1.2.).

An interesting factor was the lack of any other significant correlations with Oscore or Oscore2. In particular, with time, lights or error, it seemed that in these exercises, in which a straightforward navigation

situation was simulated, it did not matter whether the subjects preferred the more pictorial or the numerical type of display as far as their navigational performance was concerned. It is important to note that this was a straightforward exercise with no deliberate equipment failures or instrument errors introduced to confuse the subjects.

6.4.3. Pscore.

The following correlations were observed with Pscore:-

Table 7. Significant correlations observed with Pscore.

Variable	Run1	Run2	Combined
Error	-.04	-.48*	-.23
Visualp	-.70***	-.62**	-.66***
Radarp	-.16	-.56**	-.30*
Deccap	.72***	.79***	.75***

6.4.3.1. Error.

The correlation with error was probably connected with blunders as 4 out of the 6 blunders occurred in run 2. (see 6.4.5.1.)

6.4.3.2. Visualp, Radarp and Deccap.

It is appropriate to discuss all these correlations together as they are all linked in their relationship. Pscore was calculated by using these three variables

(section 6.3.2) so the correlations demonstrated that Pscore was a real measure of preference amongst the for the different types of display. Visualp gave a negative correlation and Deccap a positive correlation because of the way in which Pscore was calculated while Radarp did not correlate as well in run 1 because there was no obvious radar mark such as Orford Ness in run 2 for the subjects to use.

It was noticeable that in this case Radarp, although neutral in the calculation (6.3.2.), showed a negative correlation in Run 2. This was probably because some of the subjects fixed their position using a visual bearing off the lighthouse and a Radar distance off the land, a strategy that would produce a low Pscore.

This result showed that Pscore was a viable scale for measuring the subjects' preferences for pictorial or numerical displays and that such preferences exist. The lack of any correlation with Oscore or Oscore2 was probably because there was a considerable difference between the aidsthat the subjects observed and the information which they plotted on the chart. This was discussed in Section 5.2.5. where the subjects' preferences for the different aids were examined.

It was probably because the navigation was relatively simple and did not present the subjects with any undue

difficulties that the Pscore variable was of limited value in this experiment.

6.4.4. Lights.

The following correlations were observed with Lights:-

Table 8. Significant correlations observed with Lights.

Variable	Run1	Run2	Combined
Time	-.54**	-.49**	-.51***
Radar	-.35	-.35	-.34**
Deccap	-.52**	.004	-.22

6.4.4.1. Time.

This gave an interesting result. It was clear that there was an inverse relationship between the time that the subjects spent watching the aids and the number of lights which they observed. This relationship was important because it demonstrated that in both runs some of the subjects spent so long watching the aids that they were not able to keep a proper lookout.

The relationship demonstrated an important fact. The design of the simulator had been made as basic as possible and the number of navigational aids which the subjects had to choose from were very limited by today's standards in order to ensure that as far as possible they had experience of all the available aids. Also, the task was

quite straightforward. Despite this, the result demonstrated that it was quite easy to overload the navigator. There are important lessons both for bridge teamwork training and for the designers of navigational equipment on the priority of navigational information.

6.4.4.2. Radar.

This was clearly a case where sample size was important. Had the samples for Run 1 and Run 2 been larger it seems likely that there would have been significant correlations for all three groupings. The fact that the correlations were negative showed that the longer the subjects spent watching the radar the fewer lights they observed. This finding goes back many years when many captains used to warn officers not to spend too long looking at the radar but to keep a proper lookout as well. It seemed that some of the subjects were using the radar as a visual check on their navigation, without plotting the results and probably spent too much time observing the display. In these experiments they were told that the lights would not correspond to marks on the radar and so the subjects were aware that a visual as well as a radar lookout was required. This result was also discussed in Section 5.2.5 where the lack of a relationship between the time the subjects spent watching the radar and the number of radar position lines was examined.

6.4.4.3. Deccap.

This correlation was confined to Run 1 only and was probably connected with the fact that some of the subjects started the run fixing their positions by visual bearings from Southwold Lighthouse and Sizewell power station and when they were no longer able to use Southwold Lighthouse, they turned to other marks which consisted mainly of churches that were difficult to identify. There was evidence that, at this point, some of the subjects then turned to the Decca navigator thus demonstrating that they considered the Decca to be a second choice aid in this situation. The correlation with Lights was probably because the subjects spent some time attempting to identify the different marks and thus missing some lights before they turned to the Decca. There was no evidence that the subjects plotted bearings from the Decca position to identify the marks. This procedure should have been well understood by the subjects.

6.4.5. Error.

When the results with Error are considered, it must be noted that Error was the least reliable of the variables because some of the subjects did not complete an E.T.A. as instructed. Therefore more estimated values had to be used with this variable than with any of the others so the relationships must be viewed with caution.

This variable was more complicated than the others

because of the problems of blunders discussed in section 5.4.1. In practice this was a group of six subjects whose errors were four miles or greater. The data were therefore tested for correlations twice, first with the complete data and then with the blunders removed.

The results from these correlations are contained in tables 9 and 10:-

Table 9. Correlations observed with Error, blunders included.

Variable	Run1	Run2	Combined
Pscore	-.04	-.48*	-.23
Time	.13	-.37	-.17
Moline	-.45*	-.09	-.22
Permore	-.41*	-.08	-.23
Decca	-.51**	-.08	-.19
Radar	.17	-.34	.02
Deccap	-.37	-.36	-.32*

Table 10. Correlations observed with Error, blunders removed.

Variable	Run1	Run2	Combined
Pscore	-.15	-.24	-.10
Time	-.24	-.40	-.31*
Moline	-.49*	.06	-.22
Permore	-.43*	.02	-.13
Decca	-.20	.03	.09
Radar	-.32	-.46*	-.20
Deccap	-.18	.09	-.04

6.4.5.1. Pscore.

The only significant correlation with this variable was in run 2 with the blunders included. It was noted that this was a negative correlation, in other words, the lower the Pscore, the higher the error, suggesting that those subjects who had a higher Pscore, i.e. in this experiment preferred the Decca, produced smaller errors and were less inclined to blunder. As four out of the six blunders occurred in run 2, it is probably why there was no similar evidence from run 1. This demonstrated that the use of Decca was related to reliable navigation, perhaps because it always produced two position lines so that it was easy for the subjects to use in conjunction with another aid, which enabled a position to be plotted using three lines from two aids. The Pscore/Error correlation demonstrated the value of such a strategy.

6.4.5.2. Time.

Although there was only one significant correlation, it was interesting to note that the correlation coefficients increased with the removal of the blunders and it looked as though a larger sample could have shown a more definite negative correlation. It was of interest that, even in a simple exercise like this, there was evidence that the subjects who spent longer observing the aids produced generally better results although not greater freedom from blunders. but see section 6.4.4.1.

6.4.5.3. Moline.

This correlation was confined to Run 1 so it was probably related to the difficulties which the subjects experienced in trying to identify the different landmarks. It was a negative correlation, i.e. the more times the subjects fixed with more than two position lines the smaller the error was likely to be. This was an important finding in that it tended to support the second of the explanations offered for the Error/Pscore relationship (section 6.4.5.1.). Another aspect was the demonstration (6.4.7.) that the majority of subjects preferred to fix their position with two position lines only and while in theory this was an undesirable procedure it was of great value to have evidence of the dangers of this practice. The danger was of a wrong identification of landmarks and if the subjects used only two position lines this error could

go undetected for some time unless the position was so far out that it appeared as a blunder.

6.4.5.4. Permire.

As Permire was related to Moline the same relationship has been demonstrated and this verified the previous result.

6.4.5.5. Decca.

This result must be treated with caution because it was only significant with the blunders included, but it was probably connected with the correlation with Pscore, (section 6.4.5.1.) where the subjects who used the Decca tended to plot more than two position lines and produced more smaller errors as well as being less inclined to blunder. The fact that less interperation is needed by a navigator in fixing a position by Decca as compared with visual bearings or radar may also have been important.

Decca demonstrated a negative correlation in run 1 only which, again, was probably connected with the difficulty of identifying the visual marks in that exercise.

6.4.5.6. Radar.

Radar only demonstrated a significant correlation with run 2, but it was important as it illustrated that the more times the subject used the radar the smaller his error was likely to be. See section 6.4.4.2. where the danger of

spending too long watching the radar was discussed.

6.4.5.7. Deccap.

This result only showed a negative correlation with the combined data before the blunders were removed but it did seem to demonstrate again that the subjects who used this aid had a better idea of their position and were less likely to make a blunder than the others.

6.4.6. Time.

The correlations observed with Time are given in table 11:-

Table 11. Significant correlations obtained with Time.

Variable	Run1	Run2	Combined
Lights	-.54**	-.49*	-.51***
Visual	.31	.44*	.36*
Decca	.38*	.54**	.41**
Radar	.70***	.71***	.64***
Sounder	.28	.50*	.40**

The correlation with Lights was discussed in section 6.4.4.1.

6.4.6.1. Visual. Decca Radar and Sounder.

The relationships with visual, Decca, radar and sounder were to be expected. They were all positive correlations

and showed that the more frequently the subjects looked at the aids the longer the total time spent watching aids was likely to be.

What was of interest was that there were no further correlations. There was no evidence of a relationship between Time and Error, Toline, Moline or Position. It did not seem to matter how many position lines the subjects used or how frequently they plotted their positions. There was also no evidence of a relationship between Time and Error so it looked as though many of the subjects were spending longer watching the aids than was necessary for the navigation. The aids should have been checked during the exercise and this would have taken some time, in particular it takes about twenty seconds to check the lane identifier on the Decca navigator (13), but this was probably not a complete explanation for the unnecessary amount of time the subjects spent watching the aids.

It probably meant that the subjects observed more information than they needed. From the logs which the subjects kept during the exercises and the pen recorder charts they appeared to observe all the aids, with the possible exception of the echo sounder, as a matter of routine each time they fixed their position. As they only plotted some of this there was considerable wasted or redundant information noted on each occasion the aids were observed. This finding is important when it is related to

the relationship between the time watching the aids and the number of lights that the subjects observed (6.4.4.1) and the fact that observing this information caused them to miss a number of lights.

On this occasion all the aids were relatively close together which is not the situation which would apply on board a ship, so in this exercise the walking time between the aids was not simulated.

These results demonstrated that probably the more successful navigators were those who spent a minimum time watching the aids as this did not have any bearing on the final error while at the same time they were able to observe more lights.

6.4.7. Toline.

The following correlations were observed with Toline:-

Table 12. Significant correlations observed with Toline.

Variable	Run1	Run2	Combined.
Moline	-.51**	-.70***	-.61***
Permore	-.75***	-.84***	-.78***
Position	.70***	.73***	.73***
Sounder	.33	.24	.28*
Visualp	.41***	.24	.29**
Radarp	-.05	.56**	.36**

The large number of significant correlations demonstrated the subjects' preference for fixing their positions using two position lines only.

6.4.7.1. Moline.

The negative correlation demonstrated that the subject who fixed his position with only two position lines did not plot many positions with more than two lines. This meant that positions with only two lines were considered to be an alternative to positions with more than two lines, rather than the two methods of position fixing complementing each other.

6.4.7.2. Permore.

This was a verification of the previous result using a different method for calculating the subjects' preferences for two or more position lines.

6.4.7.3. Position.

This was very strong evidence that the subjects preferred to fix their positions using two position lines only. It was an important result because using two position lines only is bad practice as there is no indication of possible errors in the position. In certain circumstances even a blunder might not be noticed. The only check which the navigator has is to fix his position at frequent intervals but much of the value of this method is lost if

the subject is using the same aid or aids each time. In section 6.4.6.1. it was demonstrated that the subjects observed enough information to plot their positions with more than two position lines but that they obviously considered this to be unnecessary.

This result related to Part 1 of the present work (section 3.9.2.2.) where it was noted that the subjects preferred an intersection of two position lines rather than a position among several lines.

6.4.7.4. Sounder.

The result indicated that, although most of the subjects were satisfied with fixing their position using two lines only, some of them used the echo sounder as a check on the result although given the circumstances of this particular exercise it was not of much help.

6.4.7.5. Visualp.

This relationship was strongly demonstrated in run 1 because here it was possible for the subjects to fix their positions using two visual bearings only although most of the subjects only used this method for the first half of the exercise because of the difficulty of identifying marks in the second half (section 6.4.4.3.). This was a further demonstration of the confidence which the subjects had in this method of position fixing (or perhaps, as suggested in 6.4.7.3., overconfidence).

6.4.7.6. Radarp.

This correlation was confined to run 2 because there the subjects had Orford Ness point which was easy to identify on the radar screen while in run 1 Sizewell power station was the only conspicuous mark on an otherwise featureless coastline and this was only clear for part of the time. The result demonstrates the subjects' confidence (or, again, overconfidence) in the use of radar as an aid when using two position lines only.

6.4.7.8. General.

These results were further evidence that the subjects were observing far more information than they were using, as was shown by the correlations with the plotted position lines rather than with the aids themselves. It also confirmed that the subjects had a strong preference for using two position lines only. Coupled to this preference was the fact that they preferred to use visual bearings or radar range and a visual bearing. This is a bad practice because the misidentification of a landmark can go undetected for some time and possibly lead to large errors.

New section 6.5.8. Renumber subsequent sections accordingly.

6.4.8. Moline.

The following results were obtained with Moline:-

Table 13. Significant correlations observed with Moline.

Variable	Run1	Run2	Combined
Error	-.09	-.22	-.45*
Toline	-.51**	-.70***	-.61***
Permore	.91***	.90***	.90***
Decca	.33	.30	.31*
Radarp	.27	-.43*	-.09
Deccap	.40*	.55*	.50***

The correlations with Error and Toline were discussed in sections 6.4.5.3. and 6.4.7.1., the remainder are discussed below.

6.4.8.1. Permore.

The correlation with Permore was a result of the definition of Moline and it demonstrated the relationship between the two variables.

6.4.8.2. Decca.

This seemed to indicate that when the subjects fixed their positions with Decca they were less confident than with the other two aids and so plotted a third position line as a check. This strategy was simple to use because

the Decca always gave two position lines and throughout the experiment it was an easy matter to obtain a third line from another aid.

6.4.8.3. Radarp.

The negative correlation in run 2 was a result of the subjects' preference for fixing their positions using a visual bearing off Orford Ness Lighthouse and a radar distance from the point of land, despite there being obvious dangers in relying on a radar distance off a beach (14). In many cases the subjects did not use any other aids to check their positions. This further demonstrated the preference for two position lines only.

6.4.8.4. Deccap.

This correlation was similar to that for Decca. It did seem that although the Decca navigator is a well established and popular aid it was not generally trusted in the same way as the radar or visual bearings. There is no technical reason in this experiment for this lack of trust, so it seems possible that it is because the subjects instinctively preferred to trust a visual type of display where they could observe and identify the different marks. For whatever reason, it appears that subjects who used Decca for plotting their positions also tended more frequently to adopt the prudent practice of using more than two position lines.

6.4.9. Permore.

The following relationships were demonstrated with Permore:-

Table 14. Significant correlations observed with Permore.

Variable	Run1	Run2	Combined
Error	-.41*	-.08	-.23
Toline	-.41*	-.84***	-.78***
Moline	.91***	.90***	.90***
Deccap	.25	.33	.29*

6.4.9.1. Error, Toline and Moline.

The correlation made with Error was with the blunder data included. When the relationship was tested again without the blunders the value of the correlation coefficient "r" increased to $-.43^*$ in run 1.

These relationships were discussed in sections 6.4.5.4., 6.4.7.2. and 6.4.8.1.

6.4.9.2. Deccap.

This was more evidence that the subjects who used the Decca preferred to plot more than two position lines (see 6.4.8.2. and 6.4.8.4.). Although the result was only significant with the combined data, a larger sample might have given significant correlations with the two runs.

6.4.10. Position.

The following relationships were demonstrated with Position:-

Table 15. Significant correlations observed with Position.

Variable	Run1	Run2	Combined.
Toline	.70***	.73***	.73***
Decca	.06	.52**	.39**
Sounder	.43*	.33	.37**
Visualp	.55**	.38	.42**
Radarp	.17	.36	.37***
Deccap	.29	.42*	.38**

The correlation with Toline was discussed in section 6.4.7.3.

The above figures show how the different aids were used in the two runs and, in particular, the differences between the runs.

6.4.10.1. Decca.

The correlation related to run 2 only which suggested that the subjects had a more ordered approach, probably because they were able to plan one strategy for the whole run and carry it through. In run 1 those subjects who

started off fixing their position with two visual bearings were forced to change their strategy in mid run and use the Decca when they found that they could no longer identify suitable marks. Those subjects who chose to use more than two position lines in run 2 were forced to use at least one Decca line because that was the only other position line available.

6.4.10.2. Sounder.

Although the correlation applied mainly to run 1 from the value of "r" it was possible that, given a sufficient sample size, it could apply to run 2 as well. The use in run 1 was probably connected with the difficulty of obtaining marks for visual bearings so the subjects used the echo sounder to check their position although, in fact, there was a more distinct pattern of soundings available in run 2.

6.4.10.3. Visualp.

Visualp correlated strongly with position in run 1 and this was a further demonstration of the subjects' preference for visual bearings as their first choice method of position fixing. Given a larger sample size it was possible that a significant correlation could also have been obtained from run 2. In this run however, it was not possible for the subjects to use more than one visual bearing at a time, hence the lower value of "r".

6.4.10.4. Radarp.

This correlation only occurred in run 2 and again was probably connected with the fact that Orford Ness constituted an ideal radar mark, while there was no equivalent mark available in run 1.

6.4.10.5. Deccap.

Again the correlation only occurred in run 2 presumably for the same reasons as for Decca. This result did not mean that the Decca navigator was not used in run 1, but rather that its use was irregular, probably because the subjects only turned to it when they were unable to fix their position by visual bearings.

6.4.10.6. General.

It was not possible to demonstrate any significant correlations between Position and Visual or Radar, and neither of them was likely to have been significant even with a larger sample. This again suggested that the subjects were consulting these aids without plotting the resulting information on the chart. Care must therefore be taken in interpreting the result in that the subjects behaviour in the simulator could be different from the situation at sea because of (what was probably the biggest difference), the lack of windows in the simulator. Where it would be natural for the navigator to look out of the windows at sea to check the landmarks and keep a lookout for other ships, it was not possible in the simulator, so

it may be that the subjects used the radar and, to a lesser extent the slide projector as a substitute.

6.4.11. Visual.

The following correlations were observed with Visual:-

Table 16. Significant correlations obtained with Visual.

Variable	Run1	Run2	Combined
Oscore	-.61***	-.56**	-.59***
Oscore2	-.64***	-.60**	-.62***
Time	.31	.44*	.36*
Radar	.32	.42*	.36*
Sounder	.20	.42*	.30*

The correlations with Oscore, Oscore2 and Time were discussed in sections 6.4.1.2., 6.4.2. and 6.4.6.1. The further correlations are discussed below:-

6.4.11.1. Radar.

The use of a visual bearing and radar range is a popular method of fixing the ship's position as it combines the accuracy of the radar range while avoiding the less accurate radar bearing (14). In this experiment the correlations of visual and radar suggested that a number of the subjects used this method. Again because of the position of Orford Ness it was more popular in run 2 than

in run 1.

6.4.11.2. Sounder.

This correlation demonstrated that the subjects tended to observe the aids in groups. The correlation with run 2 only was probably because in run 1 the subjects made a number of extra observations of the visual bearings when trying to identify the different marks.

6.4.12. Decca.

The following relationships were demonstrated with Decca:-

Table 17. Significant correlations observed with Decca.

Variable	Run1	Run2	Combined
Error	-.51**	-.08	-.19
Time	.38*	.54**	.41**
Position	.06	.52**	.39**
Radar	.38*	.33	.39**
Deccap	.27	.55**	.45**

Note: the correlation with Error was with the blunder data included; when they were removed the correlation disappeared.

The correlations with Error, Time and Position have

already been discussed in sections 6.4.5.5., 6.4.6. and 6.4.10.1. The other correlations are discussed below:-

6.4.12.1. Radar.

This was the only aid which correlated with Decca and related to the preference for more than two position lines shown by the subjects who used the Decca. During this exercise there were only two position lines available from the Decca so they were forced to use another aid and, from this result, it looked as though the radar was the first choice for a check aid. This result was in line with Holder whose work was discussed in section 1.8.1.

6.4.12.2. Deccap.

In run 2 the correlation demonstrated that the observation of the Decca was related to the plotting of Decca position lines. In run 1 there were generally more aids available and the non-significant result probably demonstrated that the subjects tended to observe all the aids in groups regardless of whether they intended to use the information or not.

6.4.13. Radar.

The following correlations were observed with Radar:-

Table 18. Significant correlations with Radar.

Variable	Run1	Run2	Combined
Oscore	.49**	-.28	-.37**
Lights	-.35	-.35	-.34*
Time	.70***	.71***	.64***
Visual	.32	.42*	.36*
Decca	.39*	.33	.39**
Radarp	.25	.20	.29*

The following correlations have already been discussed.

Table 19. Previous discussions of the correlations with Radar.

Variable	Section
Oscore	6.4.1.2.
Lights	6.4.4.2.
Error	6.4.5.6.
Time	6.4.6.1.
Visual	6.4.11.1.
Decca	6.4.12.1.

6.4.13.1. Radarp.

The correlation demonstrated that the subjects who observed the radar also plotted the information. It was not very strong because of the observation of redundant

information. discussed in section 6.4.6.1.

6.4.14. Sounder.

The following relationships were demonstrated with Sounder:-

Table 20. Significant correlations observed with Sounder.

Variable	Run1	Run2	Combined
Time	.28	.50*	.40**
Toline	.33	.24	.28*
Position	.43*	.33	.37**
Visual	.20	.42*	.30*

These results which have already been discussed are given in table 21.

Table 21. Previous discussions of the correlations with Sounder.

Variable	Section
Time	6.4.6.1.
Toline	6.4.7.4.
Position	6.4.10.2.
Visual	6.4.11.2.

The fact that there were no more correlations was an

indication that the subjects used the Echo Sounder less frequently than the other aids, as demonstrated in section 5.2.5., and that no pattern of use has emerged from this work. The correlation with Toline rather than Moline suggested that it may be considered a check aid by some of the subjects who fixed their positions using two lines only.

6.4.15. Visualp.

The following correlations were observed with Visualp:-

Table 22. Significant correlations observed with Visualp.

Variable	Run1	Run2	Combined
Pscore	-.70***	-.62**	-.66***
Toline	.41*	.24	.29*
Position	.55**	.38	.42**
Radarp	-.04	.59**	.22
Deccap	-.34	-.26	-.29*

The correlations with Pscore, Toline and Position were discussed in sections 6.4.3.2., 6.4.7.5. and 6.4.10.3.

6.4.15.1. Radarp.

This correlation in run 2 further demonstrated that a number of the subjects used the visual bearing of Orford Ness Lighthouse and the radar distance of the point to fix

their position and underlines the subjects' preference for this method of position fixing. The popularity of this method was also referred to in sections 2.8.5.1 and 3.7.5.3. of the present work.

6.4.15.2. Deccap.

The negative correlation demonstrated that the subjects tended to use the Visual and the Decca as alternative methods of position fixing and agreed with Holder (Section 1.8.1.) where these aids were both considered as primary fixing aids while the radar was regarded as a check aid (Section 6.12.1.).

6.4.16. Radarp.

The following correlations were observed with Radarp:-

Table 23. Significant correlations observed with Radarp.

Variable	Run1	Run2	Combined
Pscore	-.16	-.56**	-.30
Toline	-.05	.56**	.36*
Moline	.27	-.43*	-.09
Position	.17	.36	.37**
Radar	.25	.20	.29*
Visualp	.04	.59**	.22
Deccap	-.18	-.48*	-.27

The following results have already been discussed.

Table 24. Previous discussions of the correlations with Radarp.

Variable	Section
Pscore	6.4.3.2.
Toline	6.4.7.6.
Moline	6.4.8.3.
Permore	6.4.9.2.
Position	6.4.10.4.
Radar	6.4.13.1.
Visualp	6.4.15.1.

6.4.16.1. Deccap.

This relationship also demonstrated the popularity of the radar as a check aid. Section 6.4.12.1.

6.4.17. Deccap.

The following relationships were observed with Deccap:-

Table 25. Significant correlations observed with Deccap.

Variable	Run1	Run2	Combined
Pscore	.72***	.79***	.75***
Lights	-.52**	.01	-.22
Error	-.37	-.36	-.32*
Moline	.40*	.55**	.50***
Permore	.25	.33	.29*

Table 25. Significant correlations observed with Deccap.

Variable	Run1	Run2	Combined
Pscore	.72***	.79***	.75***
Lights	-.52**	.01	-.22
Error	-.37	-.36	-.32*
Moline	.40*	.55**	.50***
Permore	.25	.33	.29*
Position	.29	.42*	.38**
Decca	.27	.55**	.45**
Visualp	-.34	-.26	-.29*
Radarp	-.18	-.48*	-.27

These correlations have already been discussed in the following sections:-

Table 26. Previous discussions of the correlations with Deccap.

Variable	Section
Pscore	6.4.3.2.
Lights	6.4.4.3.
Error	6.4.5.7.
Moline	6.4.8.4.
Permore	6.4.9.2.
Position	6.4.10.5.
Decca	6.4.12.2.
Visualp	6.4.15.2.

6.5. Summary and Conclusions.

6.5.1. These exercises were carried out in a simulator and the subjects knew that their methods were being examined, therefore they could be expected to navigate to higher standards than they would necessarily demonstrate at sea.

6.5.2. Although the subjects were provided with, what is by today's standards, a basic navigational system, the fact that there were not very strong correlations between the observation of the aids and the plotting of the position lines suggested that they were observing more information than they needed. This collection of redundant information should be taken as a warning to avoid assuming that the standards of navigation will automatically be improved by legislating for more and more navigational aids. From this experiment it looked as though the need was for better training in the efficient use of the aids with which they are already provided.

6.5.3. The number of lights which the subjects observed was in inverse proportion to the time which they spent watching the navigation aids. Although a reasonable conclusion, when this was examined in conjunction with the fact that most of the subjects observed more information than they used there was evidence that they were spending too much time

observing the different aids to the detriment of an efficient lookout. This reinforces the danger of overloading the man on the bridge. It must be emphasised that in this experiment the navigation was designed to be straightforward and a realistic representation of their task at sea.

6.5.4. The number of blunders; according to the definition of "an error exceeding two standard deviations", was only six out of thirtythree therefore any remarks must be accepted as speculative.

By examining the graphs (appendix 1) the following observations can be made:-

a) Those subjects who blundered tended to use two position lines only more frequently than the others.

b) The subjects who committed blunders tended to plot fewer positions than the others.

c) There was a tendency for those subjects who used the Decca to be less prone to blunders than the others, but this may also be connected with the tendency for the Decca to be used with more than two position lines.

The problem of blunders was of considerable importance and, although there were not enough data available from the

present work to draw any firm conclusions, it is a topic that should be the subject of future research. What was of concern was that, in the present work, out of thirtythree E.T.A. which the subjects presented six could be considered to be blunders.

6.5.5. There was no evidence of any relationship between the time that the subjects spent watching the aids and any preference for a particular aid or type of display. In these circumstances it did not seem to matter whether the subjects preferred a pictorial or a numerical type of display as far as the time needed to observe the navigational information was concerned.

6.5.6. Most of the subjects preferred to fix their positions using two position lines only. Out of a total of 380 position lines plotted, 265 were plotted using two position lines only. Some of the subjects did not plot any positions using more than two lines. This result relates to section 3.9.2.2. of the present work where the subjects' preference for an intersection of two position lines rather than a central position among several lines, is discussed.

This would seem to demonstrate a failure of the training system. The navigators seemed to consider a ship's position to be a point on a chart even though they should be aware of the possible errors in the navigational aids.

Coupled with the preference for two position lines only was the danger of relying on a method of position fixing that gave no indication of possible errors. In this experiment the subjects had enough information to use more than two position lines throughout. They knew that they were being observed and that their actions were being studied so it was reasonable to assume that they were probably being more careful with their navigation than they would have been at sea.

6.5.7. There was evidence that the subjects who used the Decca navigator tended to fix their position with more than two position lines while those subjects who used visual bearings or radar used two position lines. Although it was possible to check the Decca by using the lane identifier (13) the subjects demonstrated less confidence in this aid than in the other two. There was no reason in this experiment for this lack of confidence; it seemed that there was still a prejudice against this type of aid. Because of the danger of wrong identification of the different marks it is very important that visual and radar positions are checked by some other aid. The fact that such a check was frequently neglected was one of the more disturbing experimental findings.

6.5.8. The variables Toline and Moline represented the

number of positions that the subjects used with two position lines and more than two position lines respectively. In this experiment there were a total of 13 subjects who never used more than 2 position lines in one of the runs and only 4 subjects who never used less than 3 position lines in one of the runs. This situation is alarming for the reasons previously stated (see section 6.4.7.3.). Contingency tests with the other variables to look for differences in performance between the two groups proved to be non significant probably for the following reasons:-

a) The experiment was set up with no faults to trap the subjects, and the navigation was simple and straightforward; thus in this situation the main advantage of using more than two position lines, which is to detect errors in the equipment and plotting of the information, was not so apparent.

b) The runs only lasted about half an hour so there was not enough time to build up a sufficient sample to provide a significant result.

Some important observations of the differences between the two groups that are of interest and should be taken account of in further research are:-

a) Blunders. Three out of the six blunders occurred in the

13 out of 51 exercises which were carried out using two position lines only.

b) Lights and Time. There was no sign of any difference between the number of lights observed and the time that the subjects spent watching the aids for the two groups. Thus it did not appear that the Moline group were at a disadvantage in other aspects of the task because of their better navigation.

c) The Toline group seemed to observe the aids as least as frequently as the Moline group, and to spend about the same time observing the aids but they were not making use of this extra information.

When the Histogram of Permore (appendix 3) is examined it is remarkably skewed towards Toline thus demonstrating the subjects' tendency to use two position lines only for much of the time.

6.5.9. The use of the echo sounder was erratic and it seemed that the subjects did not know how to use this aid. Some of them used it frequently, every time they observed the other aids; others hardly at all. Again what could be a potentially useful source of information was not used systematically.

6.5.10. Pscore proved to be a valid measure for evaluating

the subjects' preferences for the different types of display. Although its use in this experiment did not lead to any direct results, probably because the navigation was relatively straightforward. It could be of value in future experiments.

6.6. List of Variables.

A brief list of the different variables is included for quick reference.

1) Oscore, numerical scale for measuring the subjects' preferences for different types of display: a low value indicates a preference for visual displays.

2) Oscore2, similar scale to Oscore but without using the echo sounder in the calculation.

3) Pscore a similar scale to Oscore2 but using the plotted position lines.

4) Lights, number of lights the subjects observed, out of a total of 19.

5) Error, distance in miles between the prescribed position and the position if the subject's course and speed had been followed.

6) Time, percentage of the total time which the subject spent observing the navigational aids.

7) Toline, number of positions plotted using two position lines only.

8) Moline, number of positions plotted using more than two position lines.

9) Permole, percentage of positions plotted using more than two position lines.

10) Position, number of positions plotted by the subject.

11) Visual, number of occasions that the subjects observed the visual bearings.

12) Decca, number of times the subjects observed the Decca navigator.

13) Radar, number of times the subjects observed the radar.

14) Sounder, number of times the subjects observed the echo sounder.

15) Visualp, number of visual bearings plotted on the chart.

16) Radarp. number of radar position lines plotted on the chart.

17) Deccap. number of Decca position lines plotted on the chart.

CONCLUSIONS.

7.1. Simulators.

This work has demonstrated that it is possible to design and construct a simple simulator based on recorded information and to use it for a research project. During the same period the same simulator was also successfully used for teaching the uses of the different navigational aids. In this work it was considered undesirable to make the simulator interactive because of the number of variables it would introduce. When the simulator was used for teaching it was found that in some situations the greater realism, particularly with the visual bearings, more than compensated for the subjects not being able to manoeuvre the ship.

7.1.2. Validation.

The difficulty which is always present with simulators is whether the results relate to the simulator only or whether they can be generalised. In this experiment the case for validation rests on the following points:-

- 1) The results obtained were, where applicable, in agreement with both of those obtained in the first part of

this work and also with Holder (sections 5.2.5. and 1.8.1.).

2) There was no evidence of a learning effect between the subjects' first and second trials in the simulator as far as time watching the aids and the subjects' navigational errors were concerned. This result was taken to demonstrate that the subjects were already familiar with the navigational methods available to them in the simulator and therefore that there were no material differences between reactions in the simulator and at sea. (sections 5.4.3 and 5.4.5)

3) When it came to the additional task of observing lights, there was evidence that the subjects logged more lights during their second trial in the simulator (section 5.5.1.2.). As the subjects were not familiar with this device it was reasonable to expect an improvement in this area. The logging of lights was, however, a side task and not directed to the navigational behaviour of the subjects. The fact that a learning effect was detected in this unfamiliar device suggests that it would also have been found in the simulated navigational aids if the subjects had also found these to be in an unfamiliar form.

Where the radar and navigational equipment simulators approved for training purposes by the Department of Transport are concerned, there are at present no

requirements for validation by comparing the subjects' behaviour in the simulator with that at sea. The specification simply lays down criteria for the different navigational systems (54) but there is no mention of using subjects' reactions as a test for validation.

4) The samples used in this work compare favourably with those used in similar experiments (section 1.5.).

7.2. Navigational aids.

The common navigational aids were examined in these experiments and the way that the subjects used them was analysed. The order of preference for the aids was as follows:-

7.2.1. Visual Bearings.

These proved to be the most popular method of position fixing, and it was not possible in any part of this work to identify a situation where the subjects demonstrated a preference for another aid over the visual bearings. In a number of situations some of the subjects' selection of visual bearings tended to the reckless (3.7.1.5. and 3.7.8.). In the simulator experiments the subjects also tended to select the visual bearings first and only turn to other aids where this method of position fixing was no

longer available (6.4.4.3.). One of the differences between the two runs was that in run 2 for most of the time, there was only one visual bearing so the subjects had to use other methods of fixing their positions (4.3.3.). Where two visual bearings were available, there was evidence that these were sufficient on their own, without the need for cross checking (6.4.7.5.).

There are some points which need considering when the use of visual bearings is discussed. There are strong advantages for these methods. To begin with they are based only on a compass whose error can be established without much difficulty. Also, many of the marks used are permanent features, either natural landmarks or artificial structures like lighthouses or beacons, and are unlikely to be removed, although at night the lights may be extinguished and, finally, the human eye is the most acute of all the sensors available to the navigator. Visual bearings suffer, however, two main disadvantages which are not always appreciated:-

First, there is the difficulty of making a proper identification of the chosen marks, which problem also exists to a greater extent with the use of radar.

Second, there is the difficulty that, unlike the Decca, many of the marks are not always positioned to give the best angle of cut for a given position. This can lead to

large errors and, particularly with a narrow angle of cut, the greatest error will be in the direction of the long axis of the "cocked hat", which can be dangerous as it is usually in the direction of the shore and the most immediate danger. Also, when all the bearings are taken from one side of the ship only, a situation which is most likely to occur with visual bearings, in two out of three occasions the ship's position will lie outside the "cocked hat" (15).

The dangers of relying on visual methods of navigation were clearly demonstrated by Lusted (55) in a paper on strandings. According to this paper the majority occurred in situations where the navigators were relying on visual methods only, and, in some cases, without the navigators plotting their positions on the chart.

This danger does not seem to be fully appreciated in a Department of Trade Publication (56) where they state "visual bearings are usually the most accurate method of position fixing" without warning about the dangers of this method. It is the author's opinion as a result of this work that, in general, visual bearings, radar and the Decca navigator are all capable of giving accurate results and the choice of aids must depend on the availability of aids or marks in any given situation. Whatever method or methods are used, there is no justification for using only two position lines for fixing a position when more than two

are available.

7.3.2. Radar.

This was an aid which was popular with the subjects because there was evidence that, although in general the subjects treated this aid as inferior to the visual bearings (2.8.7.5. and 3.7.5.5.), they had sufficient confidence to rely on it while plotting their positions using two position lines only (6.4.7.6. and 6.4.8.3.). The neglect of a third position line, at least as a check, is quite unjustifiable. Associated with radar is the danger of wrong identification of land marks and, because of the nature of the display, this danger is greater than with visual bearings (14). It has the advantage of a greater range, particularly in poor visibility, so the navigator has a greater choice of marks and does not need to rely on close and, possibly, unsuitable marks perhaps on one side of the ship only.

The danger, as far as the present work seemed to demonstrate, was that because it presented a pictorial display of the ship's position in relation to other objects many of the subjects did not plot the information on the chart (5.2.5.). Some of the subjects seemed to consider that when the radar was used as a "check aid" (1.8.1.) i.e. to check a position obtained by other means, there was no need to plot the information on the chart. This could

explain the finding by Lusted (55) where it appeared that in many of the strandings he reported, the navigators were using the radar in this manner. When parallel indexing is being used, as advocated in some circumstances (56), it must be remembered that the ship's position is being fixed by a single radar range and bearing only and should therefore be frequently checked by other position fixing systems. There was also evidence that subjects who performed poorly at logging the lights may have done so because they spent an excessive time looking at the radar (6.4.4.2).

7.3.3. Decca Navigator.

In general, the subjects were more cautious when using the Decca navigator than with the other aids, in that they accepted the prudent practice of fixing their positions using more than two position lines more frequently. This result was demonstrated by the correlation between Moline and Decca rather than with Toline which was the result from the visual and radar (6.4.8.2.). In Part 1 of this work there was no significant difference between the subjects' preference for Decca or radar although it appeared that on the whole they had more confidence in the radar. This result was reasonable as far as the subjects were concerned because of all the aids tested the Decca is the one which has the most mechanical output so that even after the lane identification has been monitored the navigator is

still presented with a "take it or leave it" digital type of display (13). The subjects' reluctance to use it more is nevertheless unfortunate because this is the only aid that always offered two reliable position lines with a good angle of cut. In their discussion after the experiment many of the subjects were proud of their attachment to the traditional methods of navigation and this appeared to be connected with their reluctance to use the Decca Navigator.

The Decca Navigator always provides two position lines so it is easier for the subjects to fix their position with more than two position lines when using this in conjunction with another aid and this may have been part of the reason for the subjects' preference for this strategy. There was no evidence from the present work to distinguish whether this preference was a result of caution when using the Decca or whether it was because it was comparatively easy to fix a position with more than two position lines when using the Decca, but in the author's view it was probably a combination of both. For whatever reason, the experimental evidence certainly suggested that the subjects who used Decca the most tended also to have smaller errors, including blunders (6.4.5.1., 6.4.5.5., 6.4.5.7.).

7.3.4. Radio Direction Finder.

It was demonstrated in Part 1 of this work that the subjects lacked any confidence in the Radio Direction Finder and many of them were prepared to select a position

which was unacceptable as far as the geometry was concerned only because the alternative consisted of having confidence in a position obtained from this aid (3.9.1.2.). The results from this work suggest that the D.F. is no longer viable as a navigational aid and once satellite systems become properly established for search and rescue there would seem to be no longer any reason for retaining it on merchant ships in its present form. The dislike of this aid is not only prejudice, as there are technical reasons why it is not as accurate as the Decca and satellite systems (13). and should be replaced by a satellite navigation system.

7.3.5. Echo Sounder.

Although this aid has been in use for many years, it does not indicate the ship's position so it is of less value to the navigator than the other aids. This was borne out in these experiments because there was no regular pattern for its use, the subjects resorting to it only when they were in difficulties. However, unlike the radio direction finder, there is no substitute for this aid and there are situations where the information which it provides is vital for the safety of navigation. Of greater value would be an aid that gave advance warning of shoals but judging from the difficulties in the aircraft industry in providing a similar aid it is unlikely that a device of this nature will become available in the near future.

7.4. Methods of Navigation.

These experiments demonstrated that there was no accepted method of navigating when more than the bare minimum of information was available.

In general it seemed that the subjects used only enough information to provide an uncorroborated position fix and rejected the rest.

7.4.1. Use of Information.

In the first part of the present work there was strong evidence that the subjects preferred an intersection of position lines rather than a mean position. (3.8.2.). In the simulator experiments this was demonstrated by the subjects' preference for fixing their position using two lines only (6.4.7.3.). This finding agrees with Lusted (55) where in a large proportion of the strandings he investigated only one method of position fixing was in use. The finding that, for the first run, the more times that the subjects fixed their positions using more than two position lines the smaller the error in their estimated course and E.T.A., confirmed that the general preference for using two position lines only was indefensible in practice as well as theory (6.4.5.3.).

In Part 1 there was a clear preference by the subjects for the use of information from one navigational aid only (2.9.2. and 3.8.1.). This result relates to the circumstances of those experiments but in the simulator experiments the subjects showed a similar tendency when using visual bearings (6.4.4.3.), but as they rejected the use of radar bearings, and there were few easily identifiable fixed targets, there were not the same opportunities to use radar alone. Again, Lusted (55) considered the use of only one navigational aid to be a factor in a large number of strandings.

These findings emphasise that, because of inadequate teaching, many of the subjects were navigating in what was a potentially dangerous manner and that they did not fully appreciate the need to plot their positions using more than two position lines, taking information from more than one aid.

7.4.2. Lights.

The very large differences in the numbers of lights observed by the different subjects indicated that some of them were overloaded in what should have proved to be a very simple exercise. This points to the dangers of bad bridge designs which are too complicated or which have too much equipment. A Dutch questionnaire survey (1.8.3.) highlighted this problem. It must also be noted that there

was no correlation between the time which the subjects spent observing the aids and their errors. This suggests that subjects who spent an excessive time observing the aids used this time unprofitably and perhaps generated their own overload. It would seem therefore that there is a need for training in the efficient management of time by navigators (6.4.6.1.).

7.4.3. Errors.

Another danger that appeared in this work was the frequency of blunders. Although it was expected that the subjects would make mistakes the fact that 18% of the E.T.A. calculations could be classed as blunders, was a surprise (see 6.5.4.), and also a matter of sufficient concern to suggest that further studies of the frequency of blunders in navigational procedures is urgently needed.

7.5. Recommendations.

A number of recommendations emerge from the present work in a number of areas:-

7.5.1. Bridge design.

This work did not attempt to look specifically into the problems of bridge design, which has been carried out elsewhere (section 1.9.) but a number of factors have

emerged which the author feels have not always been taken into account in bridge design studies:-

1) Despite the reductions in manpower which are now being planned it should be possible for one man to keep a proper watch. He should be able to plot positions using more than one aid and using more than two position lines for each fix while keeping a proper lookout and this has implications for both bridge design and the training of personnel (see section 7.6).

2) Visual bearings are a popular and, provided proper safeguards are taken, a reliable method of fixing a position and a centre line compass repeater in the wheelhouse with a clear view would be helpful.

3) It must be assumed that blunders will occur and, as far as possible, the instruments and systems must be designed for easy cross checking.

4) Proper lookout. This work has demonstrated how some of the subjects became distracted from the task of keeping a lookout, therefore there must be a clear view from all workstations for this purpose.

5) Integrated systems. There seemed to be a lack of willingness to make the best use of all the available information. A possible solution is an integrated system.

in which the information from several navigational aids is processed. but the author considers that this would make the problem worse because the navigators would then never learn to assess the information from each aid on its merits. A better solution would be improved training. The recent loss of Korean Airlines flight 007 (1st. September 1983) could be the result of a failure with an integrated system (57), where the crew, accustomed to a high order of reliability in their inertial navigation systems, were not checking their position by other methods.

7.6. Training.

The subjects used in this project, who were all experienced officers studying for their Master's certificate, did not in general make the best use of the information which was presented to them, and in some cases they neglected to use sufficient information for reliable navigation. The author considers that this situation can only be remedied by the use of training on a ship or in a simulator and because of the importance of visual navigation it would seem that a training ship is probably the best venue. The main points which have been identified in this project as needing attention are as follows:-

- 1) There appears to be overconfidence in the use of visual bearings. The dangers inherent in using only two such bearings for routine position fixing need to be

incorporated much more forcibly in education and training programmes at all levels (see section 7.2.1.).

2) There is a need for greater care in the use of radar for position fixing, and the tendency to use radar in isolation from other aids, often without plotting a position on a chart, suggests a deficiency in current teaching programmes. The danger of fixing a position from radar information using only two position lines also needs additional emphasis.

3) The Decca Navigator, when used, was generally used prudently. The training need appears to be to encourage its greater use in conjunction with visual and radar information to increase the reliability of fixes. This recommendation may clearly be extended to other radio aids where accuracy and coverage is sufficient.

4) If the radio direction finder is to be retained as a navigational aid on board merchant ships, (see 7.3.4.) then more practical training in its use under seagoing conditions is required to instill confidence in its use, otherwise, experimental results suggest that the established network of radio beacons will continue to be greatly underused except by yachtsmen.

5) There is an apparent need for training in the more systematic use of the echo sounder as an aid to navigation.

6) There is a need for additional training in the way in which a watchkeeper manages his time. The keeping of an efficient lookout appears to be inhibited in many cases by unnecessarily long periods spent observing navigational aids. The balance of time allocated between watching radar and keeping a visual lookout demands particular attention.

7) It appears vital that navigators should be taught more thoroughly on the subject of navigational errors. In particular they should be aware that fixes should always be made on the basis of three or more position lines except in cases (to be treated with caution) where only two are available. They should be also made more aware of the need for cross checking between methods of navigation. Greater understanding is required as to the likely distribution of a ship's position on the basis of information from a group of position lines.

8) Procedures need to be developed and taught to protect navigators from the consequences of large errors or blunders which experimental evidence suggests occur more frequently than is generally accepted. Procedures to detect large errors may include duplication of operations through two independent channels, using back-up personnel where available.

7.7. Further Research.

A number of areas for further research which arise out of this work, not necessarily in order of importance, are:-

1) To devise a method of measuring navigational performance. The use of projected position errors in the present work was not entirely satisfactory as it only took the end result into account and did not assess the effectiveness of the navigational methods used en route. Such a measure would be of value in the evaluation of training and also in the examination of different bridge designs.

2) To make a more detailed examination of the incidence of blunders at sea. Such an examination may be more concerned with behavioural science than navigation but this work has indicated its importance in navigation and the need for measures to reduce blunders.

3) The problem of the validation of simulators has been given some attention in this thesis, but more direct comparison with the situation on board ship would be desirable. With micro computers there is likely to be a proliferation of navigational simulators and the author considers that the Department of Trade specification for training simulators (54) is not always relevant. A data bank of navigational behaviour at sea could usefully be established against which to test the different simulators.

In the introduction it was suggested that many seafarers involved in accidents were navigating no differently from the rest, but they just happened to be unlucky. From the present work this appears to be generally true but it must be remembered that one of the reasons for carrying out this study was that stranding investigations are so rare that there is little information available about the navigational methods involved. All the subjects were experienced watchkeepers with many years of safe navigation behind them and it is hoped that this work will contribute to improving the already high standard of maritime safety.

REFERENCES.

- 1 Cook G.E. 1983. The Present status of Navstar. Journal of Navigation, Vol 36 No 3.
- 2 Maybourn R. 1983. GPS for Marine Navigation. Journal of Navigation, Vol 36 No 3.
- 3 De Bievre A. 1983. Navigational Safety in European Waters. Journal of Navigation Vol, 36 No.2.
- 4 Lloyd's Register of Shipping. Casualty Returns 1981. Pub. Lloyd's Register of Shipping.
- 5 Department of Trade. Casualties to Vessels and Accidents to Men. Vessels Registered in the United Kingdom. Return for 1981. H.M.S.O.
- 6 Giziakis K. 1983 CNAA Phd. Thesis. in preparation, unpublished. City of London Polytechnic.
- 7 Lloyd's Register of Shipping. Casualty Returns 1978. Lloyd's Register of Shipping.
- 8 International Chamber of shipping. Navigation Casualty Reports.

9 Bole A.G. and Jones K.D. 1981. Automatic Radar Plotting Aids: a mariner's guide to the use of ARPA. Heinemann. London.

10 Cockcroft A.N. 1979. Comments on the results of simulator experiments relating to the use of ARPA. Marine Traffic Research Unit Report No. 2. City of London Polytechnic.

11 Anderson E.W. 1979 the Principles of Navigation. Hollis and Carter.

12 Fifield L.W. 1980 Navigation for Watchkeepers. Heinemann.

13 Sonnenberg G.J. 1978. Radar and Electronic Navigation. Butterworth.

14 Wylie F.J. 1978. The use of Radar at Sea. Hollis and Carter.

15 Admiralty of Navigation Vol 3. 1955. H.M.S.O.

16 Carpenter M.H. and Waldo W.M. 1974. Electronic Navigational requirements of the Merchant Marine Deck Officer. Navigation, Vol. 21 No. 3.

17 Yonezawa Y. and Miyoshi Y. 1977. Electronic Navigation Requirements of the Japanese Marine Deck Officer. Navigation, Vol.24 No.3.

18 Bressy P.E.1976. Pilot Error ed. by Ronald Hurst. Lockwood Staples, London.

19 Maritime Transportation Research Board. 1976. Human Error in Merchant Marine Safety. National Technical Service. Springfield Va.

20 Puglisi J.J. 1981. CAORF Research for the Maritime Industry. Proceedings MARSIM'81 U.S. Department of Commerce, Maritime Administration.

21 I.M.O. 1978. International Conference on the Training and Certification of Seafarers.

22 I.M.O.1974. International Convention on the Safety of Life at Sea. Amendments 1978.

23 Hammell Thomas J.1976. The Validation of Mate Behaviour on CAORF. National Maritime Research Centre. Kings Point New York. U.S.A.

24 Hayes J. and Wald E. 1980. The Effectiveness of three electronic systems as collision avoidance and grounding avoidance aids. (Technical Report No.13 - 7811 - 01) National Maritime Research Centre, Washington Office of Commercial Development.

25 Mara. Thomas D. 1968. Human Factors in Ship Control. (MA - 4221) Vols 1 - 4 Electric Boat Technical Report 417 - 68 - 001.

26 Hara K. et al. 1981. Research and training of a collision avoidance manoeuvre with a shiphandling simulator. Proceedings of Marsim'81. National Maritime Research Centre, Kings Point, New York, U.S.A.

27 Lazet A. and Schuffel H. 1978. Dynamic Simulation: a tool in research in human behaviour. Journal of Navigation, Vol.31 No.1.

28 Drager K.H. 1981. Cause relationships of collisions and groundings, Norske Veritas, Report No 81 - 0097. Oslo.

29 Kemp J.F. 1974. Thesis for CNAA Phd. City of London Polytechnic.

30 Hagart J. and Crawshaw C.M. 1981. Personality factors and ship handling behaviour, Journal of Navigation, Vol.34

No. 2.

31 Curtis R.G. and Barratt M.J. N.M.I. 1981. The validation of Radar Simulator Results. Journal of Navigation. Vol.34 No. 2.

32 Holder L. 1975. Thesis for the degree of M.Phil. CNAALiverpool Polytechnic.

33 Moraal J. et al. 1975. Bridge Design on Dutch Merchant Vessels: an ergonomic study in 4 parts. Institute of Perception. TNO, Soesterberg. Netherlands.

34 Ivergard T. 1976. Bridge Design and Reliability, (a questionnaire study). The Swedish Ship Research Foundation. SSF Project 5311.

35 Majendie A. 1958. The display and use of Navigational Intelligence. Journal of the Institute of Navigation, Vol.11 No.1.

36 Report of Court (No 8033) M.V. Stancrown. 1965. H.M.S.O.

37 Bentskowsky J. et al. 1964. A Control System for Ship's Bridges. Journal of the Institute of Navigation, Vol.17. No.2.

38 Miller I.C. and Hansford R.F. 1981. An integrated Navigation System, the Manav project. Joint Institute of Navigation and Nautical Institute seminar on the selection and display of navigational information.

39 Cockcroft A.N. 1977. CNAA Thesis for M.Phil. City of London Polytechnic.

40 Department of Industry. 1977. Code of Practice for ship's bridge design. H.M.S.O.

41 Ludowyk P. 1981. Experience with the use of the Norcontrol integrated navigation system. Joint Institute of Navigation and Nautical Institute seminar on the selection and display of navigational information.

42 Goodwin E.M. and Kemp J.F. 1979 Marine Statistics Pub. Stanford Maritime, London.

43 Lindley and Miller. 1952. Cambridge Elementary Statistical Tables. Cambridge University Press.

44 Inter-Governmental Maritime Consultative Organisation. 1977. Standard Marine Navigational Vocabulary.

45 Wald E.D. 1979 Experiment Design and Analysis at CAORF. Proceedings Third Annual CAORF Symposium 1979. National Maritime Research Centre, Washington Office of Commercial Development.

46 Morrison D.F. 1976. Multivariate Statistical Methods (2nd. Edition). McGraw-Hill.

47 Ryan T.A. et al. 1980 Minitab Reference Manual. Pennsylvania State University.

48 Siegel S. 1956 Nonparametric Statistics for the behavioral sciences. Pub. McGraw Hill.

49 Anderson E.W. and Parker J.B. 1956. Observational Errors. The Institute of Navigation.

50 Anderson E.W. and Ellis D.M. 1971. Error Distributions in Navigation. Journal of the Institute of Navigation. Vol. 24 No. 4

51 Hsu D.A. 1979. An analysis of Error Distribution in Navigation. Journal of Navigation. Vol. 32 No. 3.

52 Oudet L. 1970 The Torrey Canyon Commission of Inquiry. Journal of the Institute of Navigation Vol 23. No. 2.

53 Haber and Runyon. 1973. General Statistics. Addison -
Wesley.

54 Department of Trade. 1980. Specification for a Marine
Navigational Equipments Simulator. H.M.S.O.

55 Lusted W.V. 1977. Strandings of British Merchant Ships.
Nautical Review, Vol 1 No 3.

56 Department of Trade. 1980. A guide to the Planning and
Conduct of Sea Passages. H.M.S.O.

57 Flight International, 24th. December 1983. Page 1662.
Business Press International.

APPENDIX No 1.

Graphs of selected relationships.

When the relationships between the 17 variables were examined, the computer was instructed to plot the two variables using the "plot" command in "Minitab" (47). This was because the correlations were for linear relationships only and there was always the possibility of higher order relationships occurring. The examination of the data for these relationships was considered to be beyond the scope of the present work because of the circumstances in which the data was obtained using a basic simulator but the possibility of a more complex relationship had to be considered hence the need for the plots.

The plots in this appendix were selected because the author considered that they illustrated an interesting relationship between the two variables concerned.

The reference numbers indicate the section of text where the relationship is discussed.

List of Graphs.

Graph	Relationship	Reference
1	Oscore/Visual	6.4.1.2.
2	Oscore/Radar	6.4.1.2
3	Pscore/Visualp	6.4.3.2.
4	Pscore/Deccap	6.4.3.2.
5	Lights/Time	6.4.4.1.
6	Lights/Radar	6.4.4.2.
7	Error/Toline	6.5.3.
8	Error/Position	6.5.3.
9	Error/Decca	6.4.5.5.
10	Error/Deccap	6.4.5.7.
11	Time/Visual	6.4.6.1.
12	Time/Radar	6.4.6.1.
13	Toline/Moline	6.4.7.1.
14	Toline/Position	6.4.7.3.
15	Toline/Visualp	6.4.7.5.
16	Toline/Radarp	6.4.7.6.
17	Moline/Deccap	6.4.8.4.
18	Position/Visualp	6.4.10.3.
19	Visual/Radar	6.4.11.1.
20	Visualp/Deccap	6.4.15.2.
21	Decca/Radar	6.4.12.1.
22	Decca/Deccap	6.4.12.2.

Oscore

Graph 1

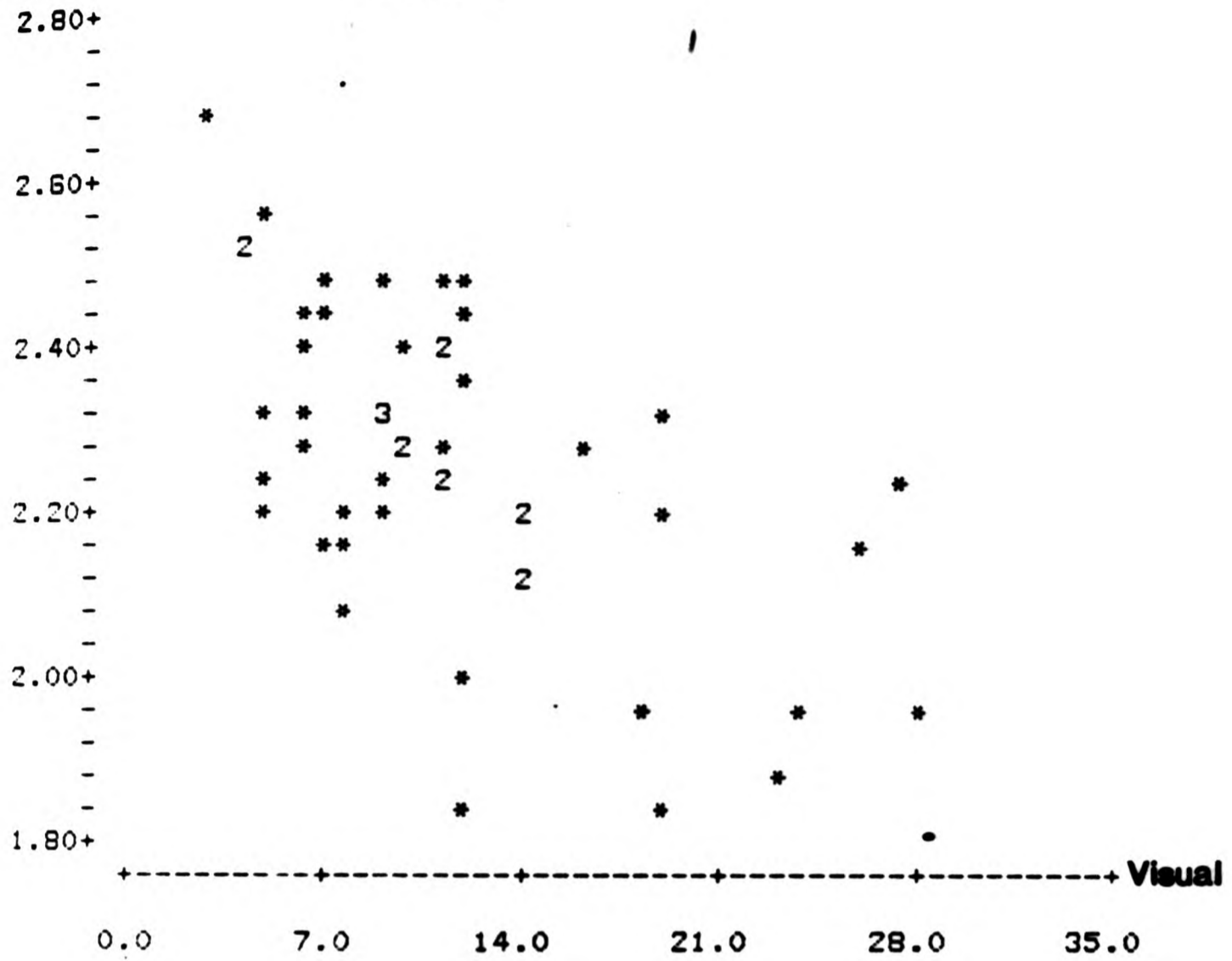

Oscore

Graph 2

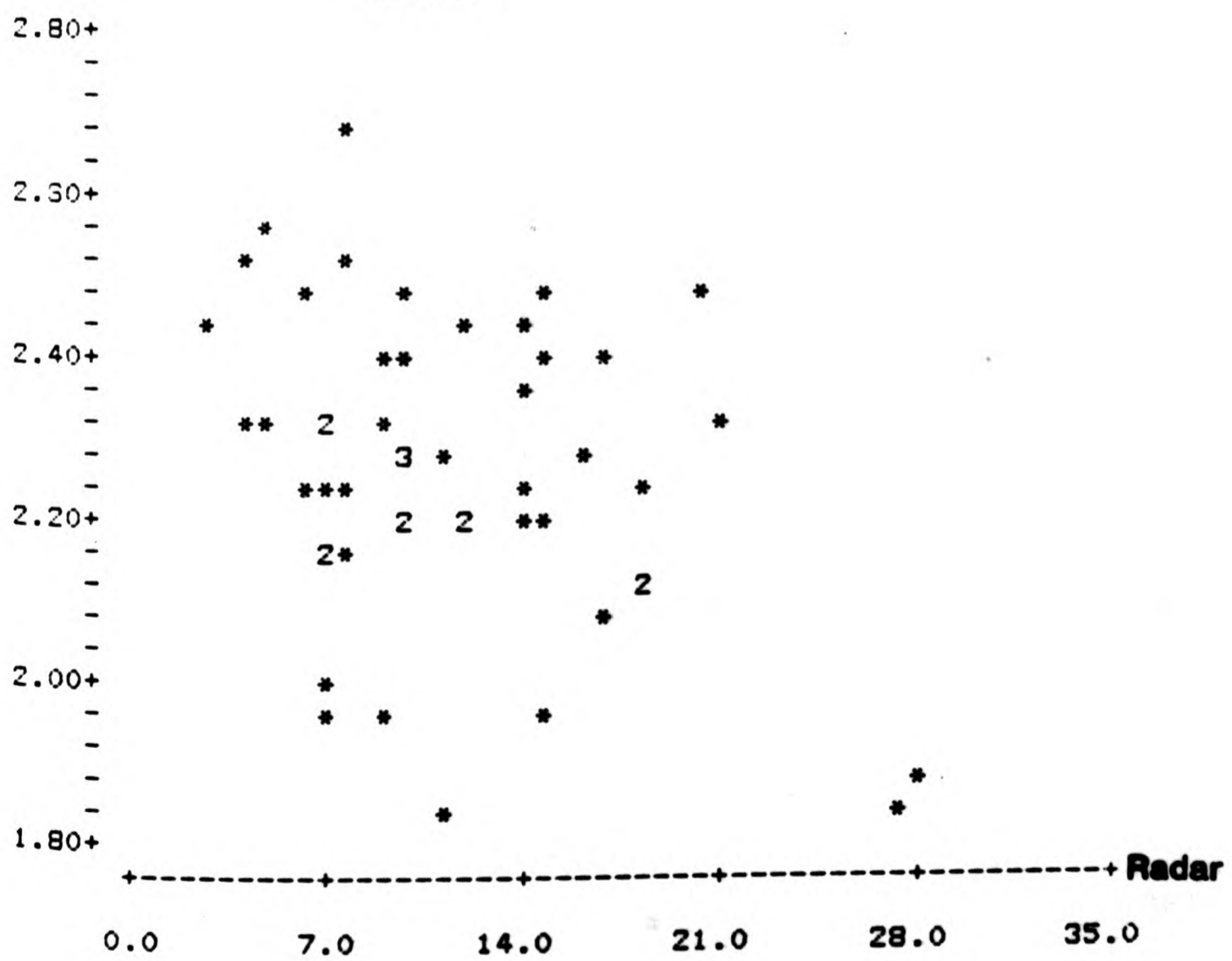

Oscore

Graph 1

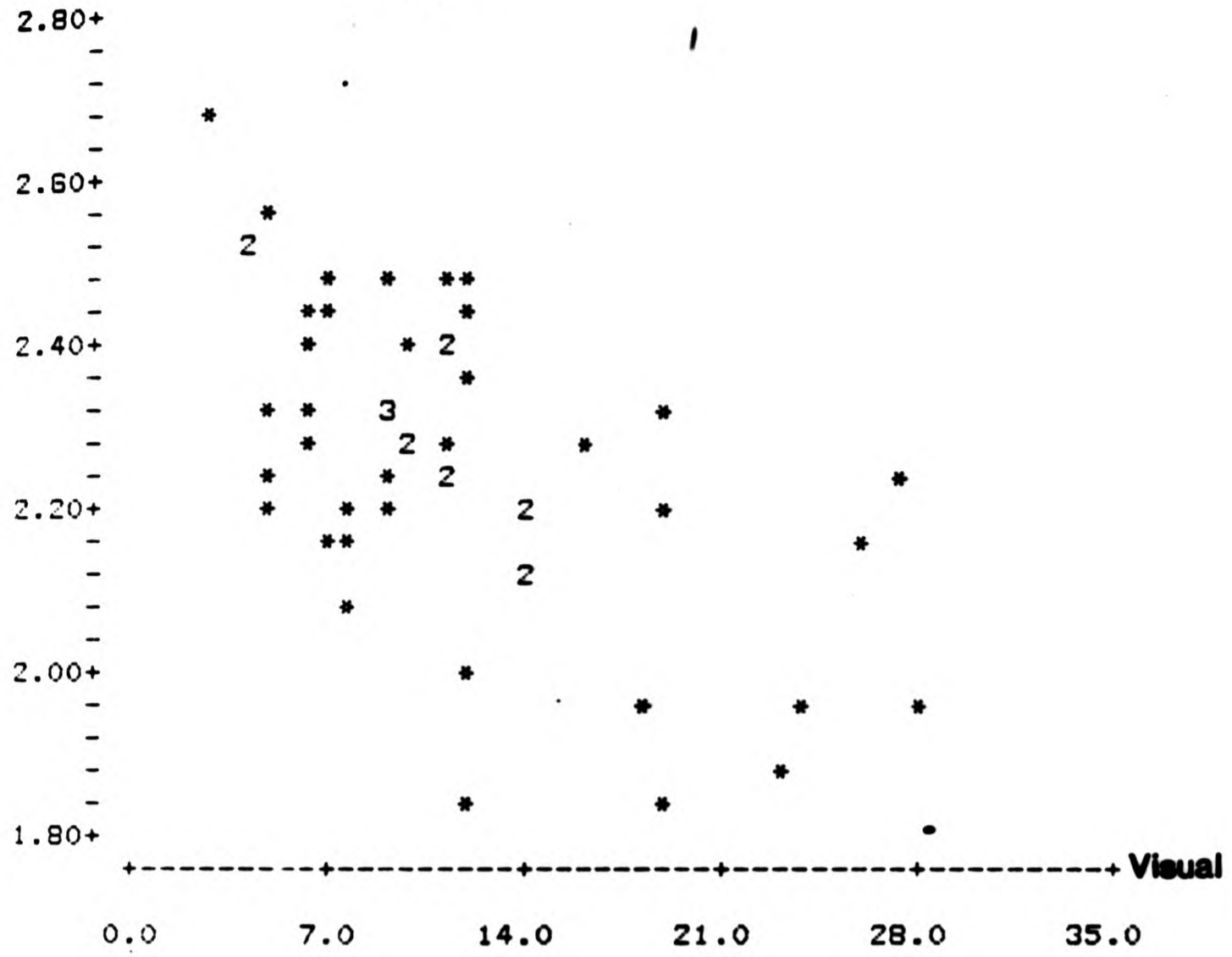

Oscore

Graph 2

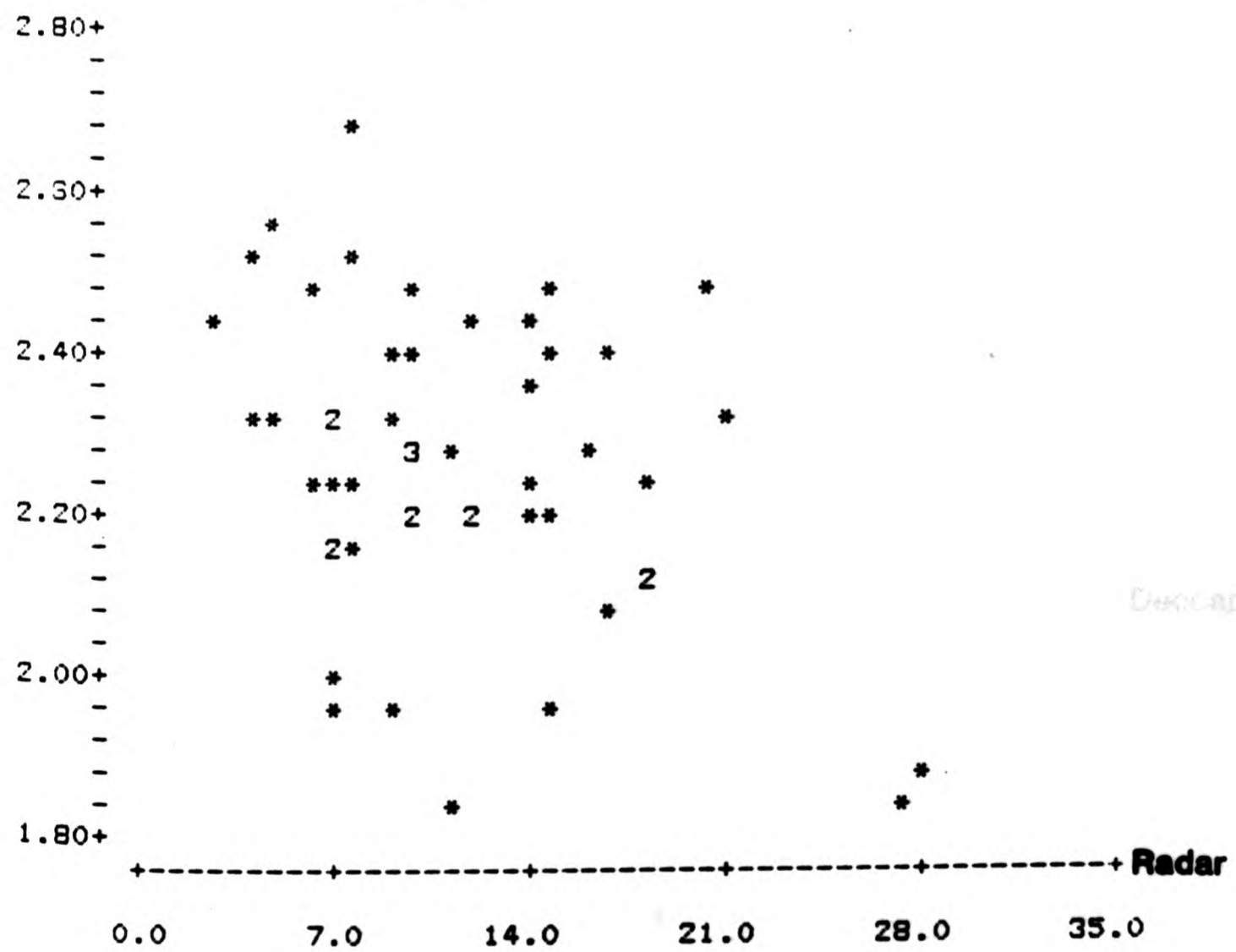

010000
 +08.5
 +08.5
 +09.5
 +05.5
 +08.5
 +08.5
 0.0
 010000
 +08.5
 +08.5
 +04.5
 +05.5
 +00.5
 +08.5
 0

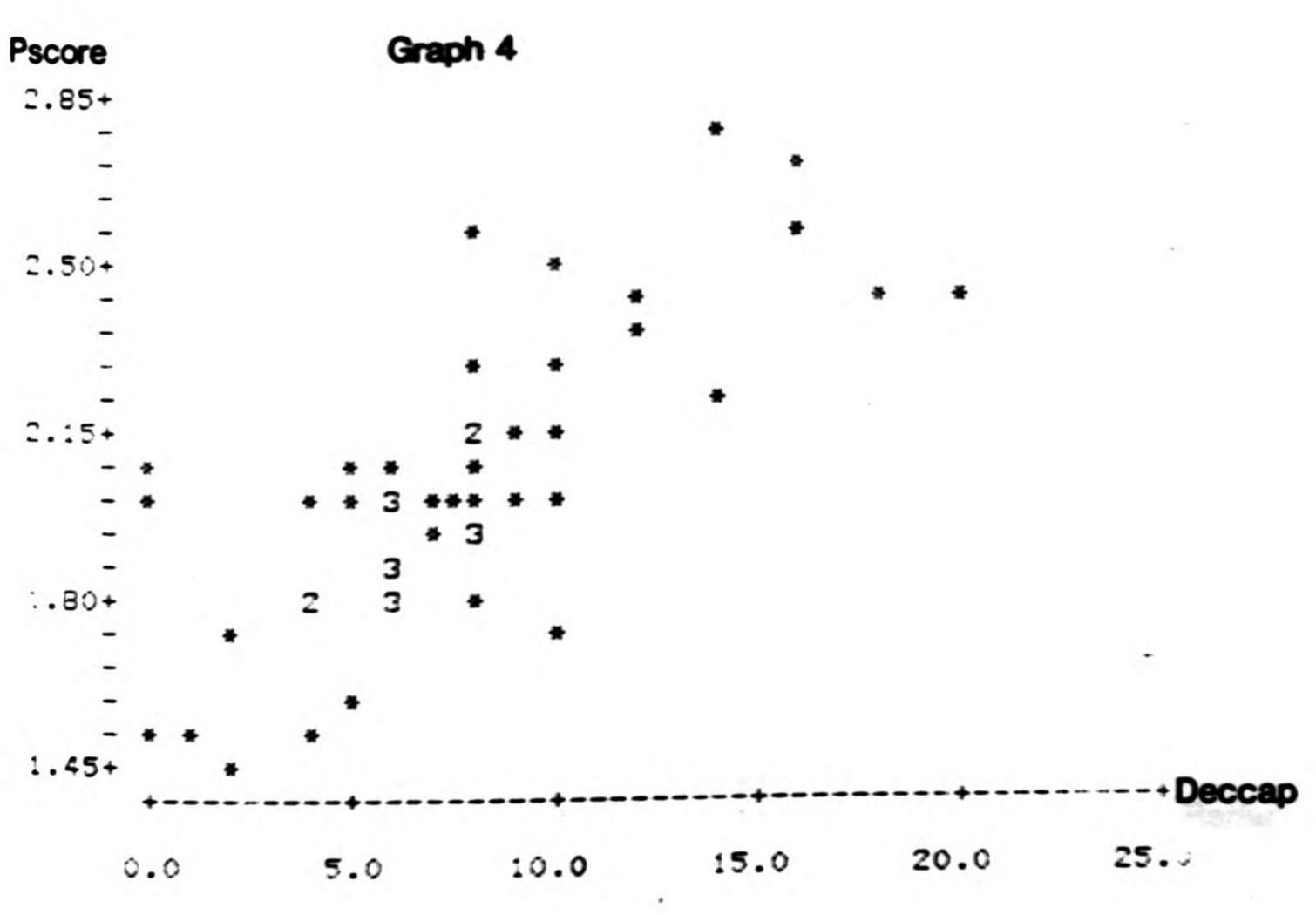
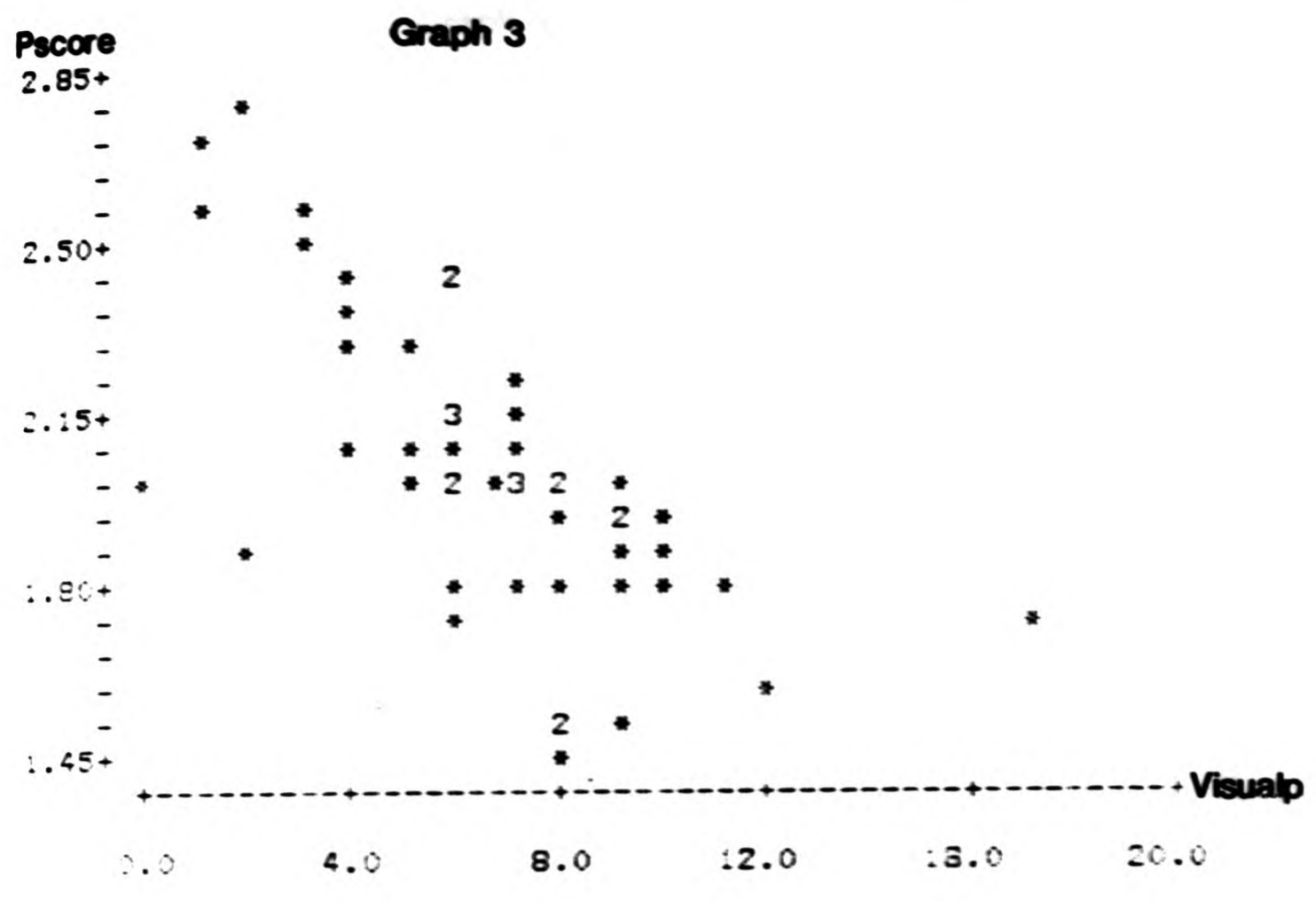

Lights

Graph 5

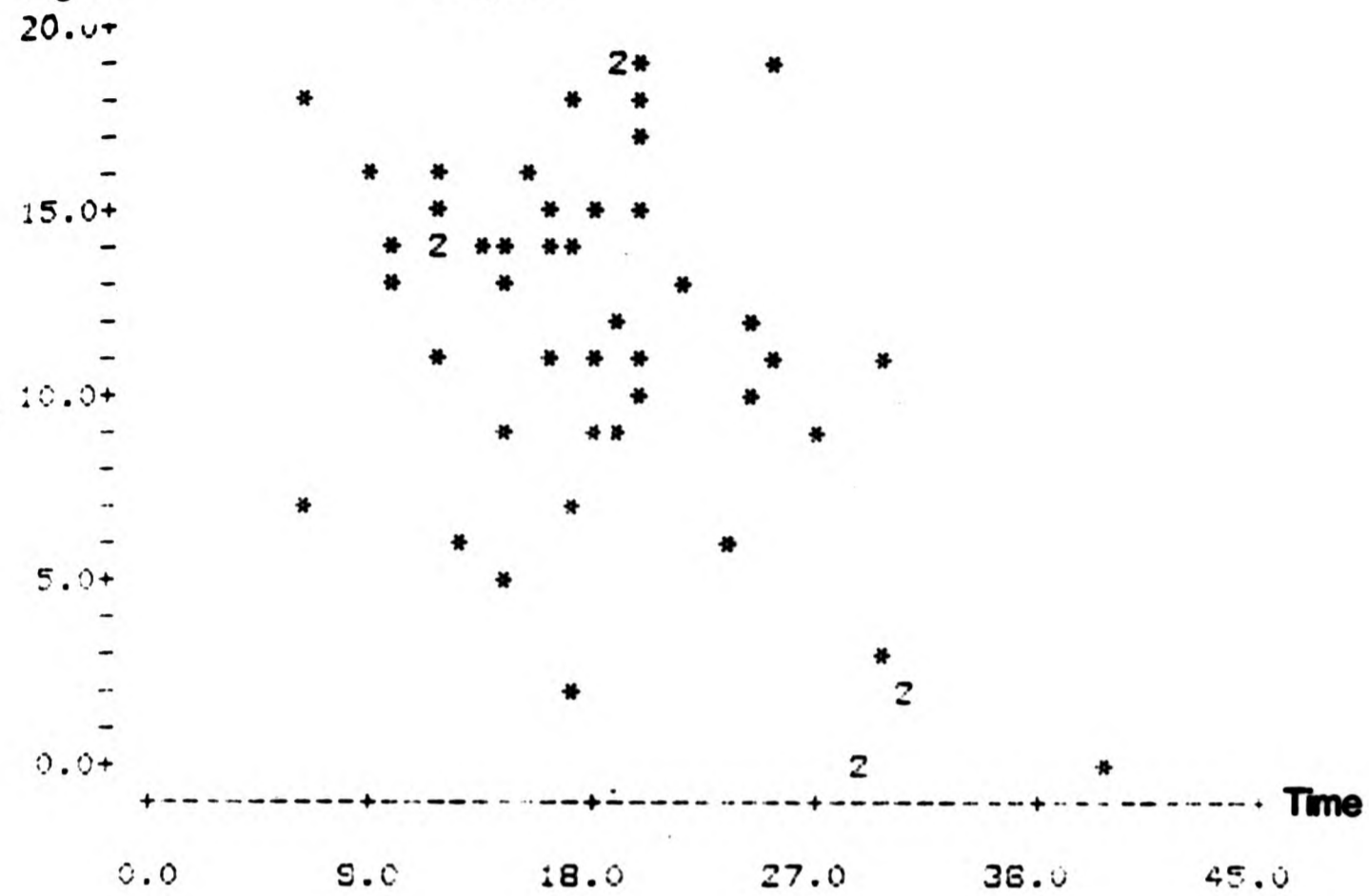

Lights

Graph 6

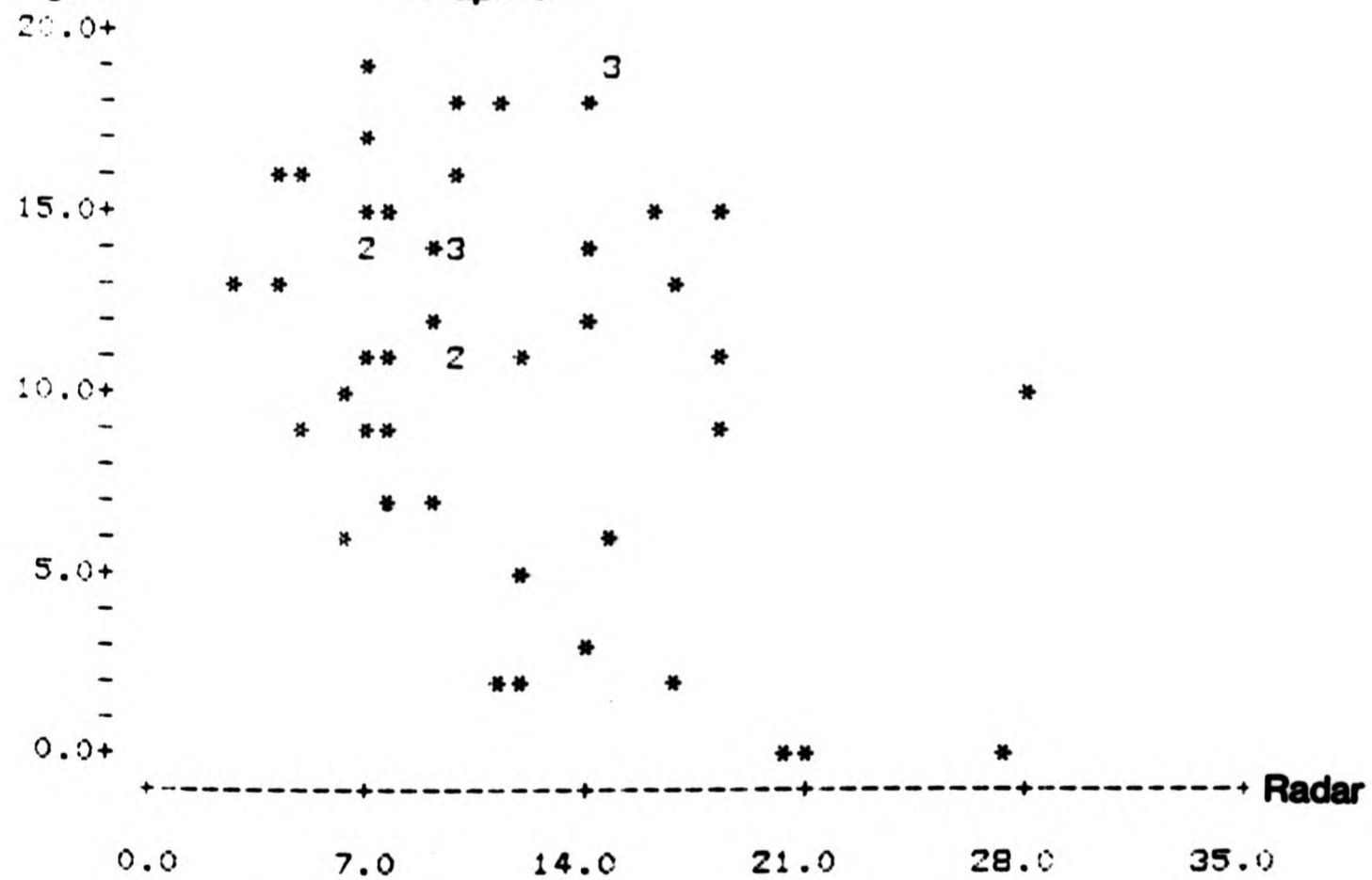

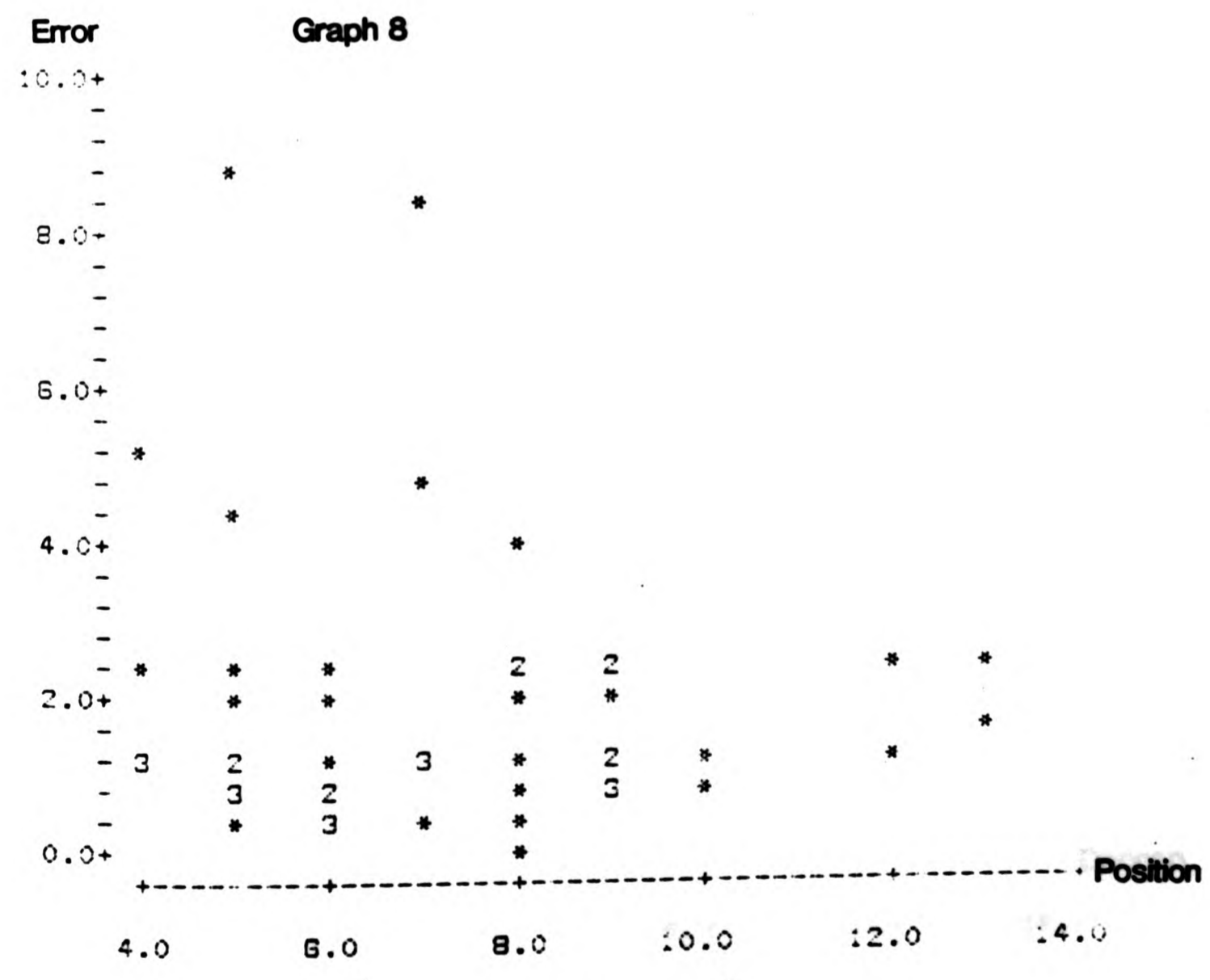
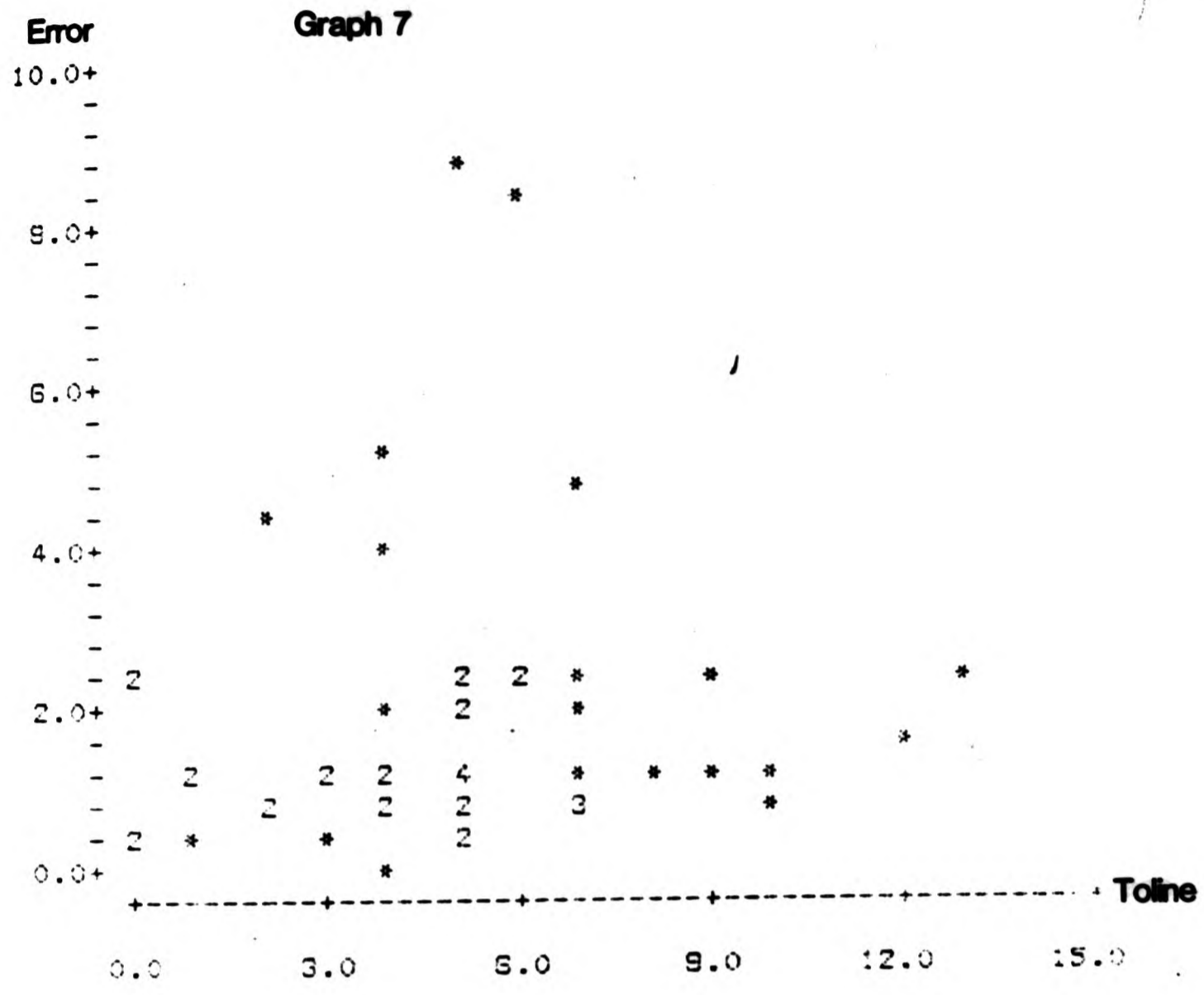

Error
 10.0+
 8.0+
 6.0+
 4.0+
 2.0+
 0.0+
 0.0
 0.0+
 2.0+
 4.0+
 6.0+
 8.0+
 10.0+

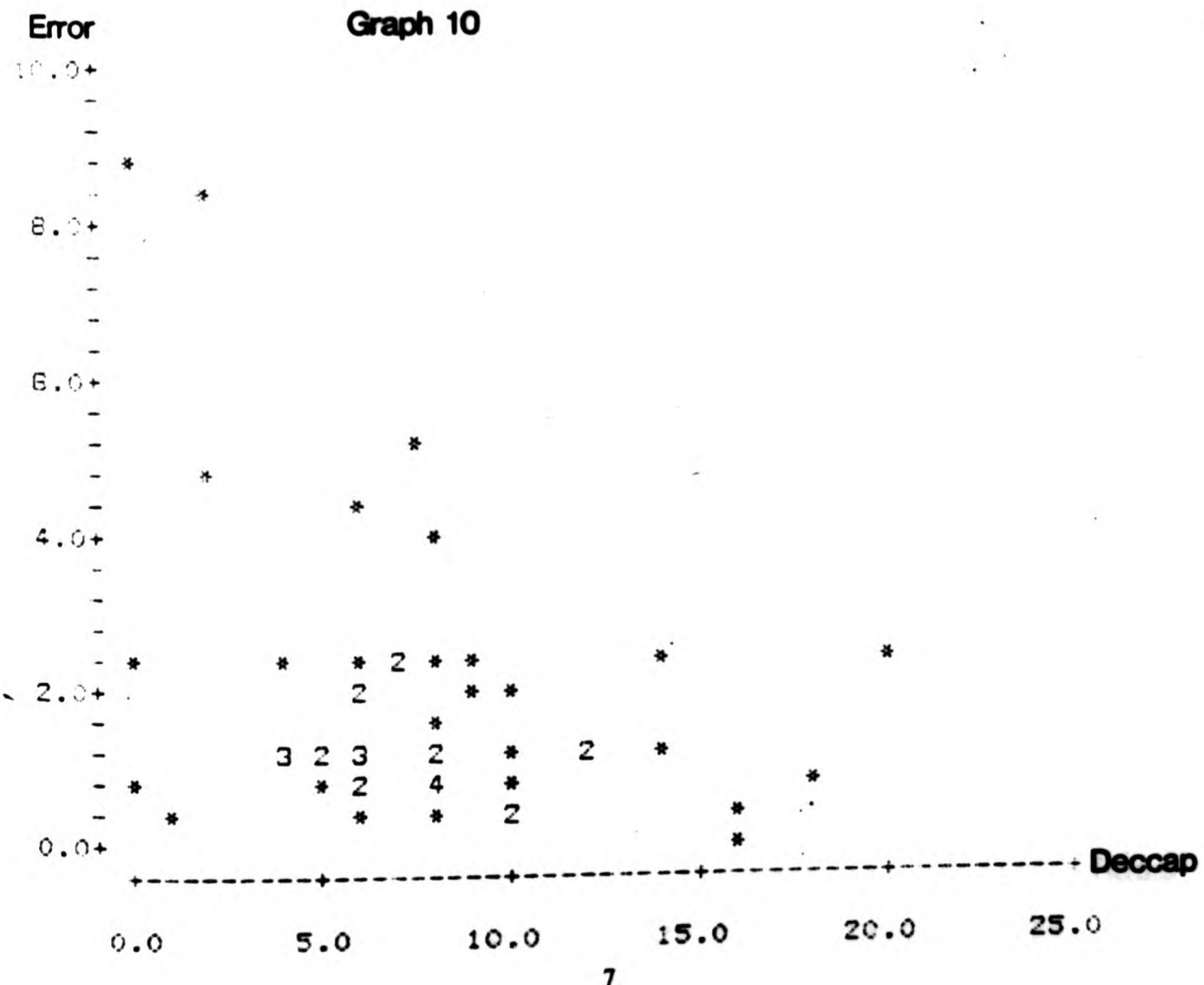
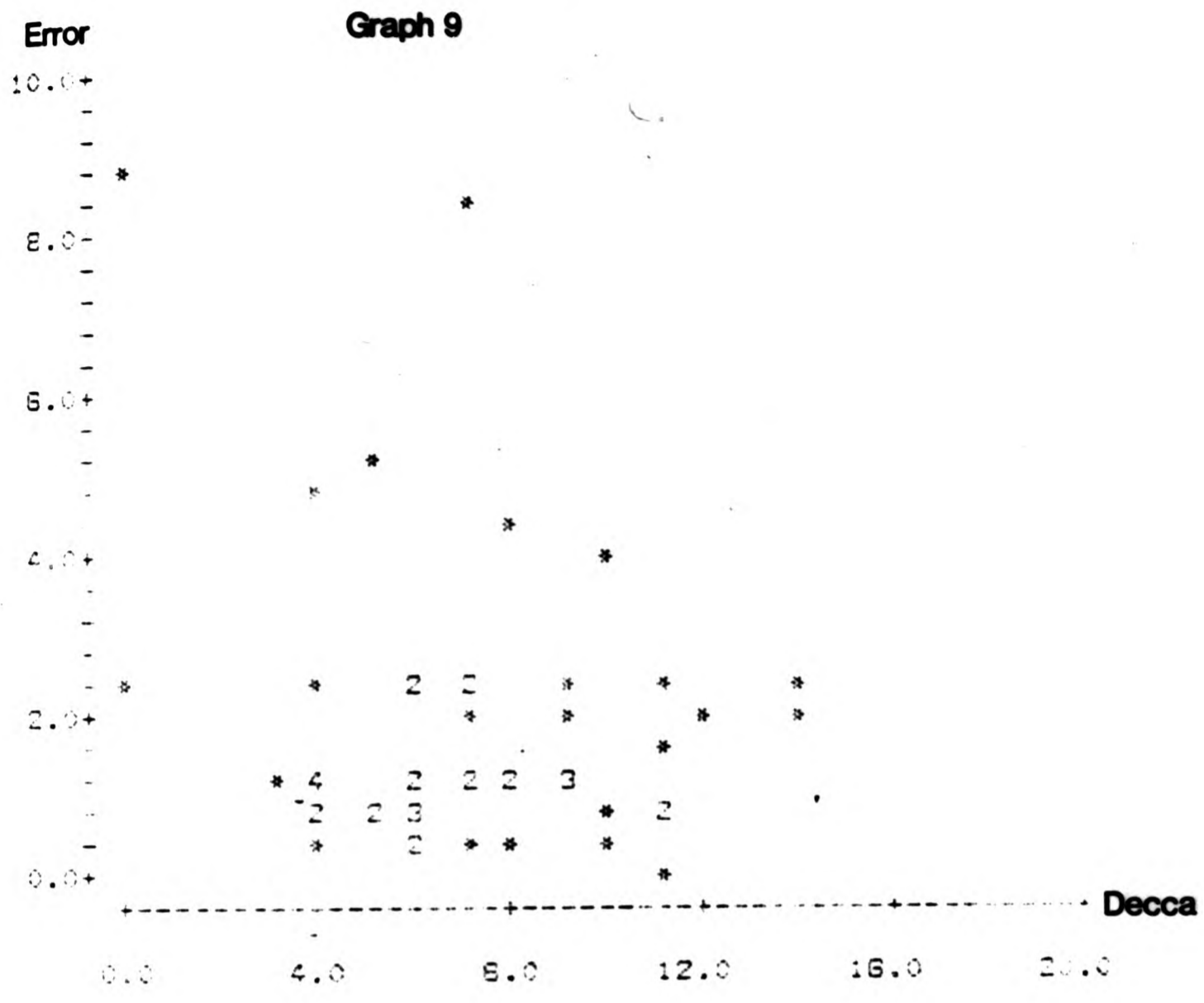

Time

Graph 11

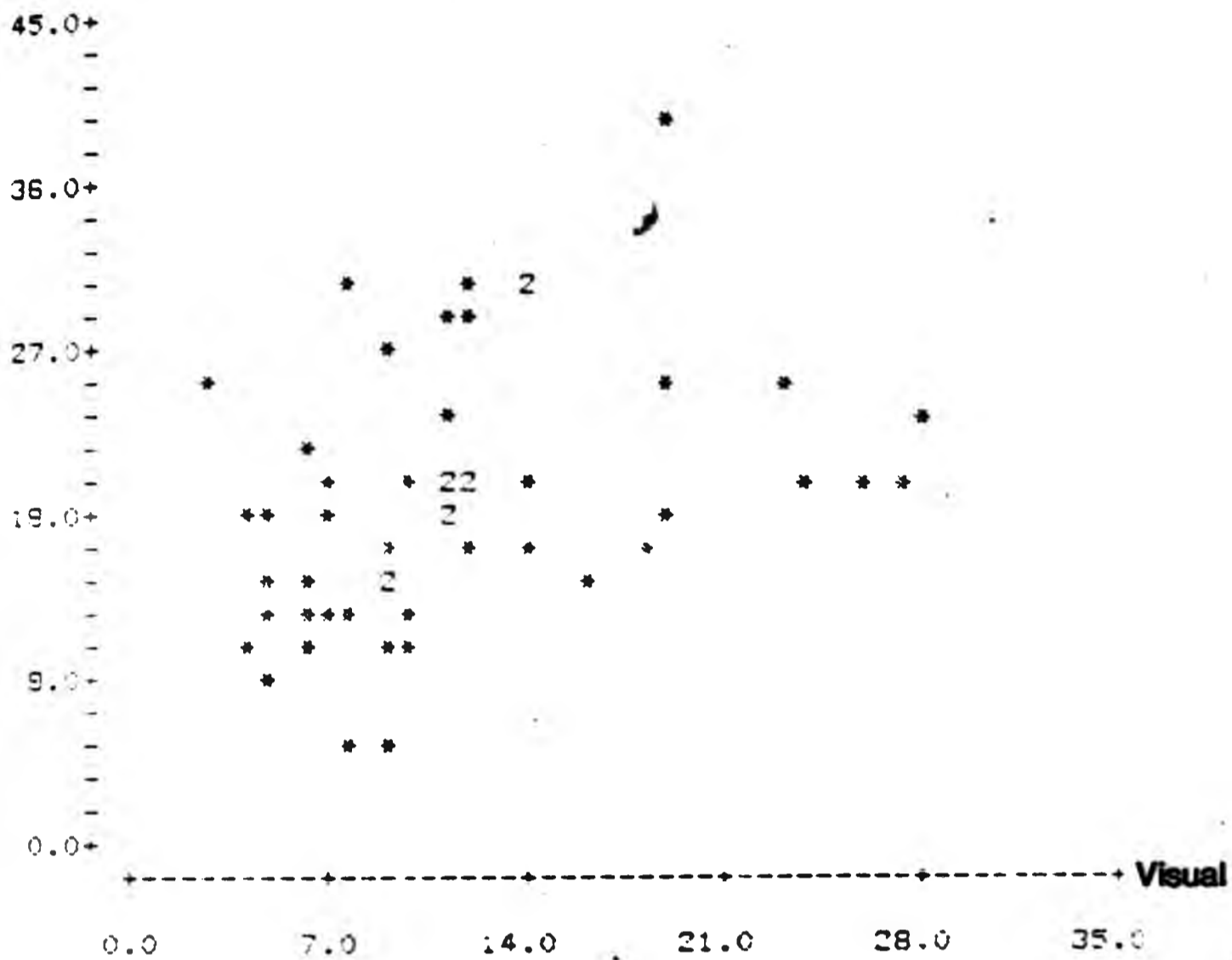

Time

Graph 12

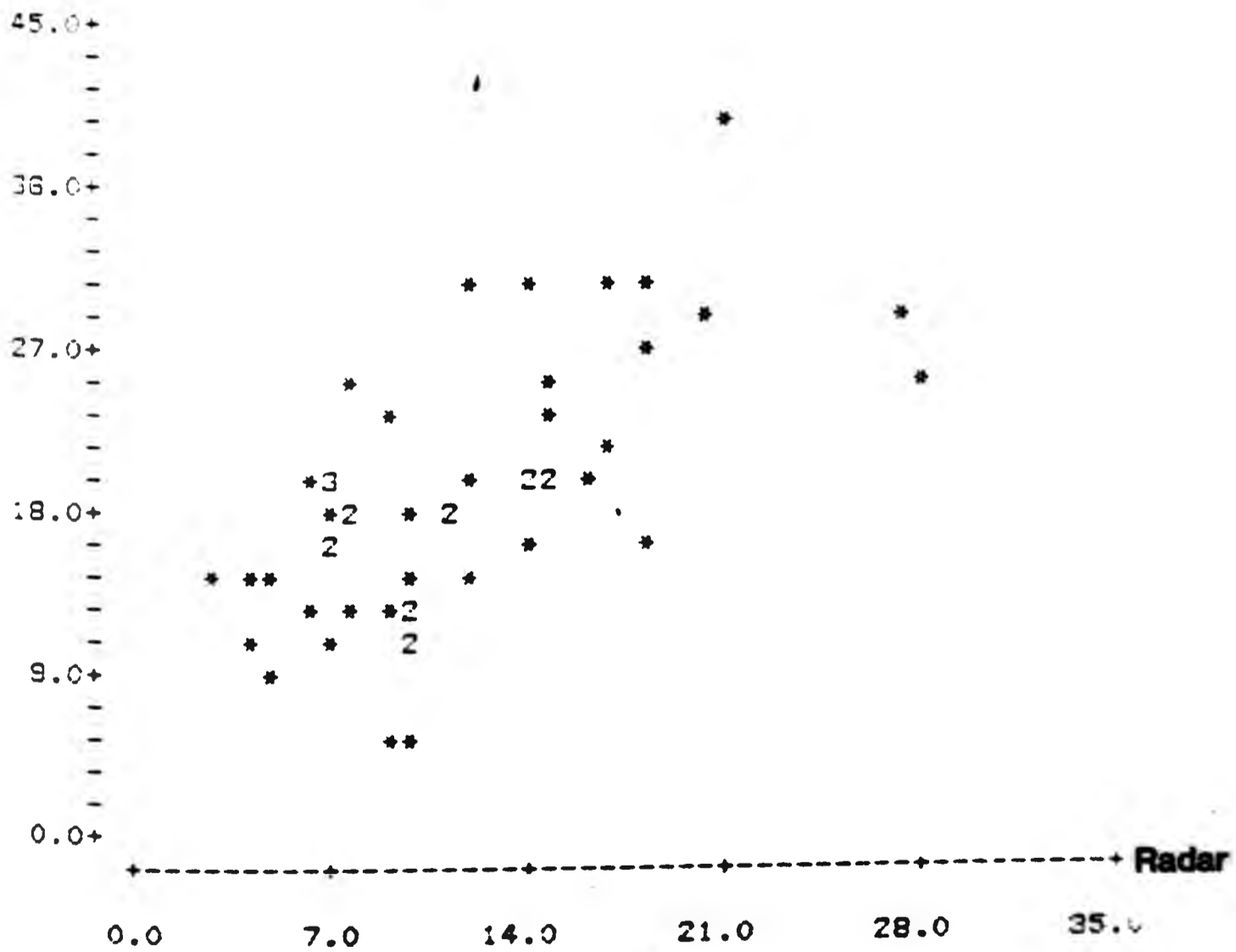

Time
+0.75
+0.80
+0.85
+0.81
+0.8
+0.0
0.0
Time
+0.75
+0.80
+0.81
+0.8
+0.0
0.0

Graph 13

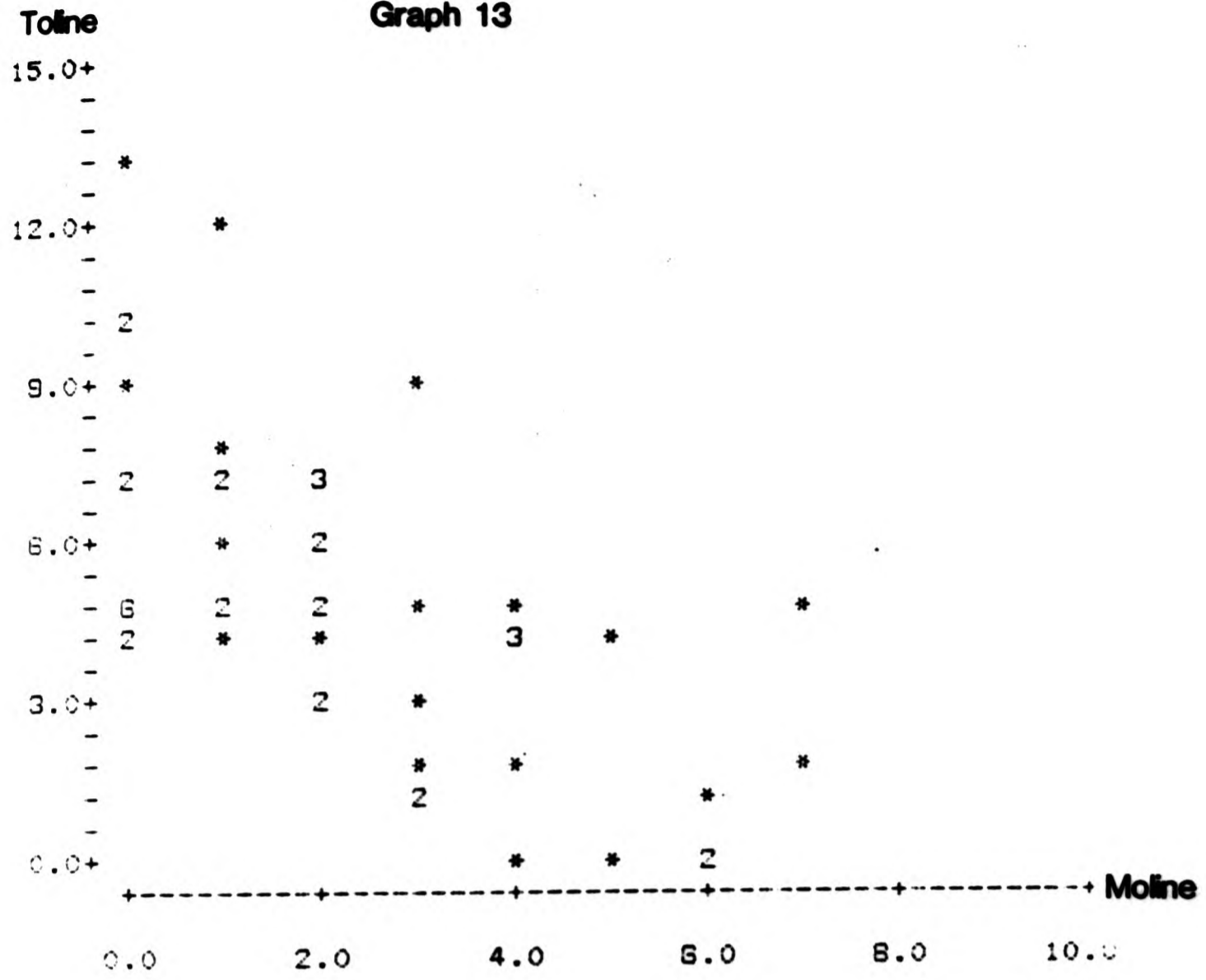

Graph 14

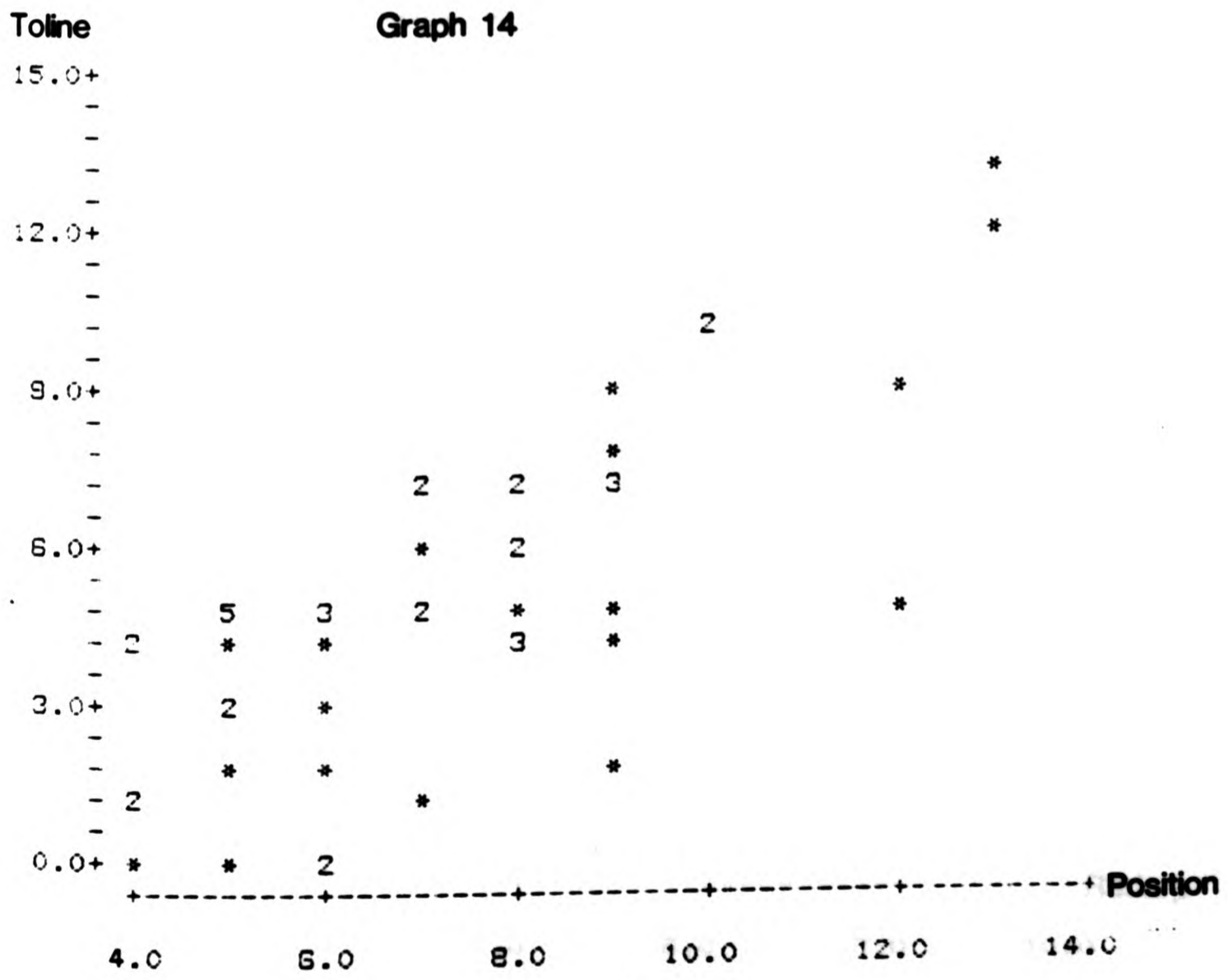

Toline

Graph 15

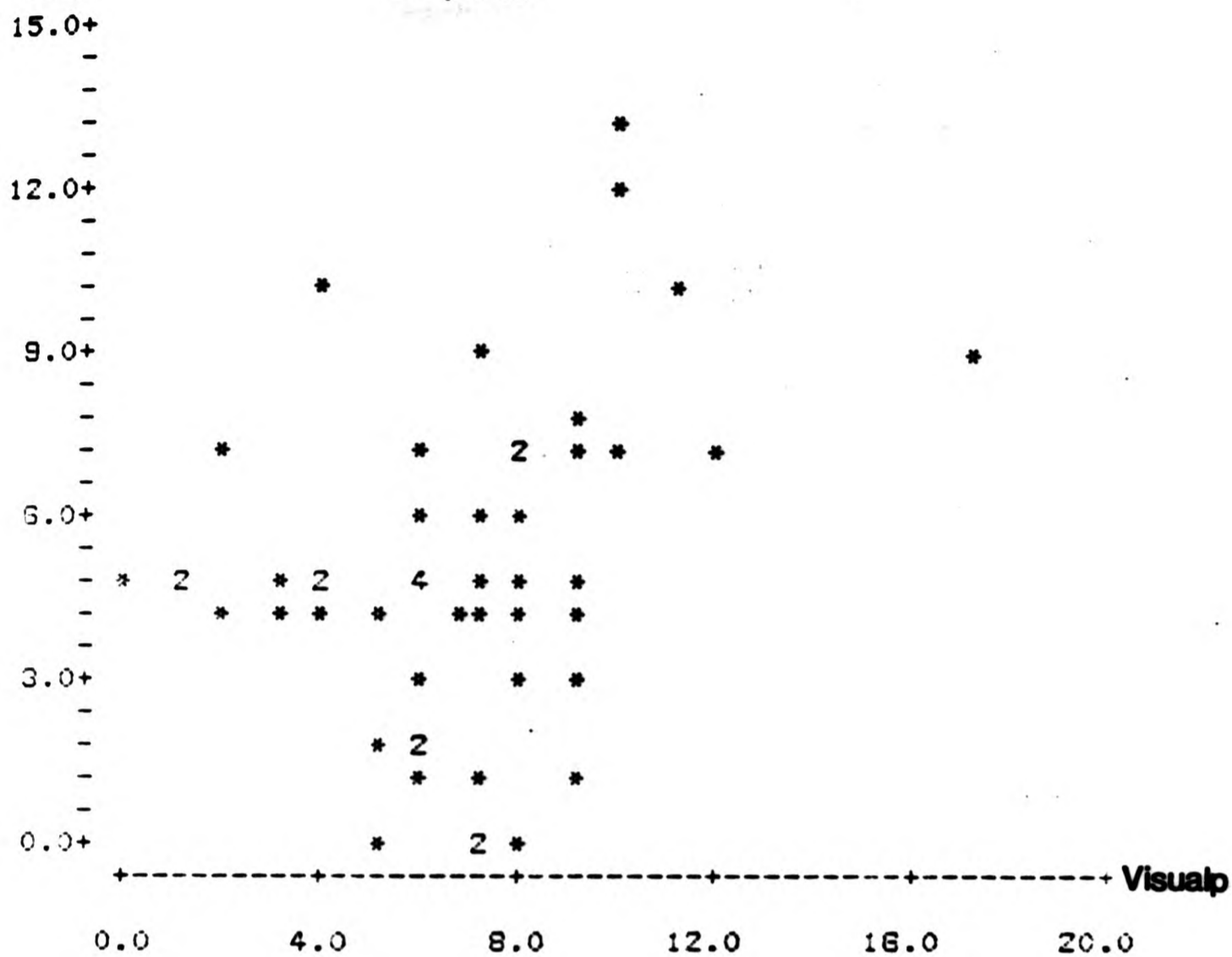

Toline

Graph 16

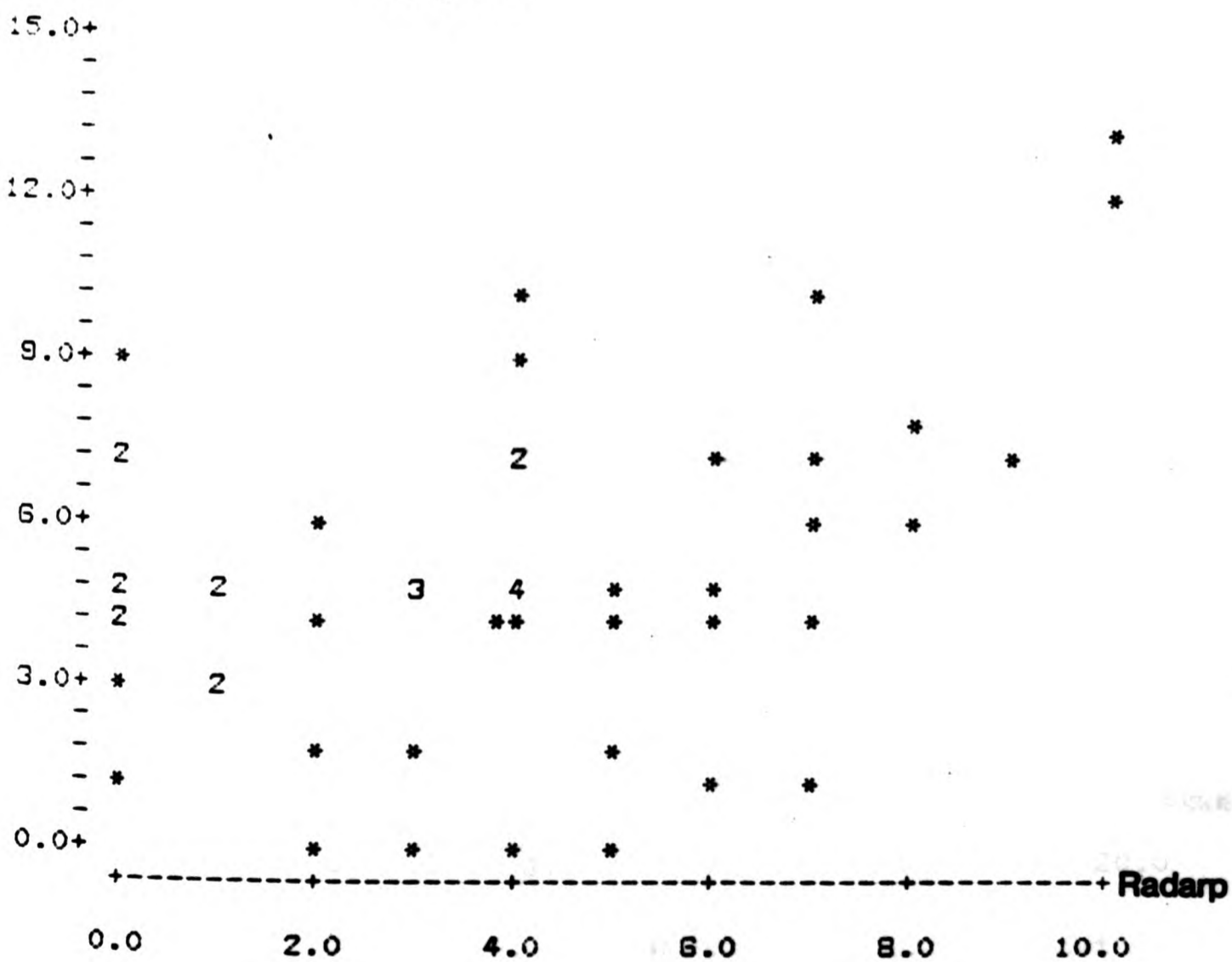

Moline

Graph 17

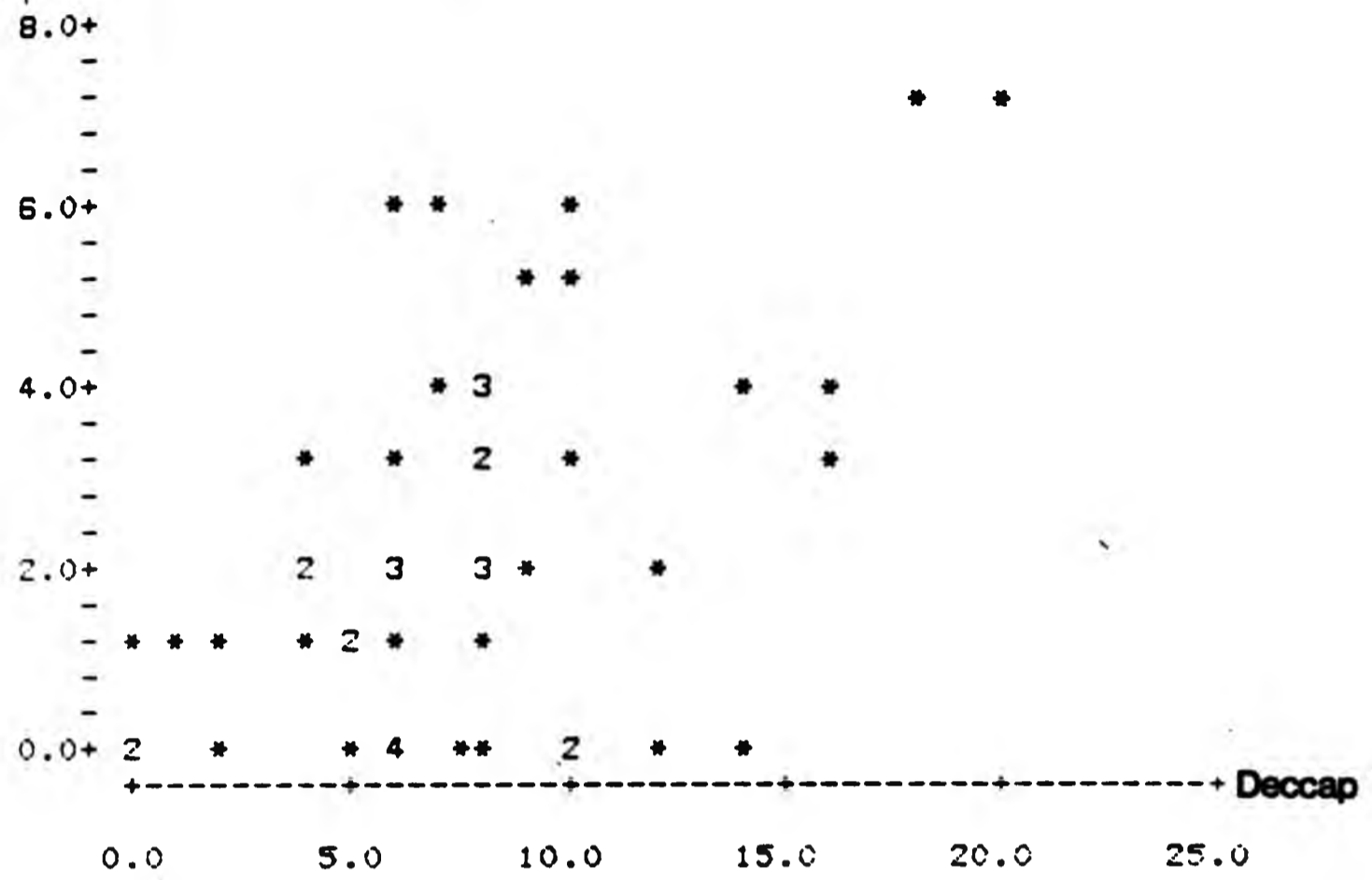

Position

Graph 18

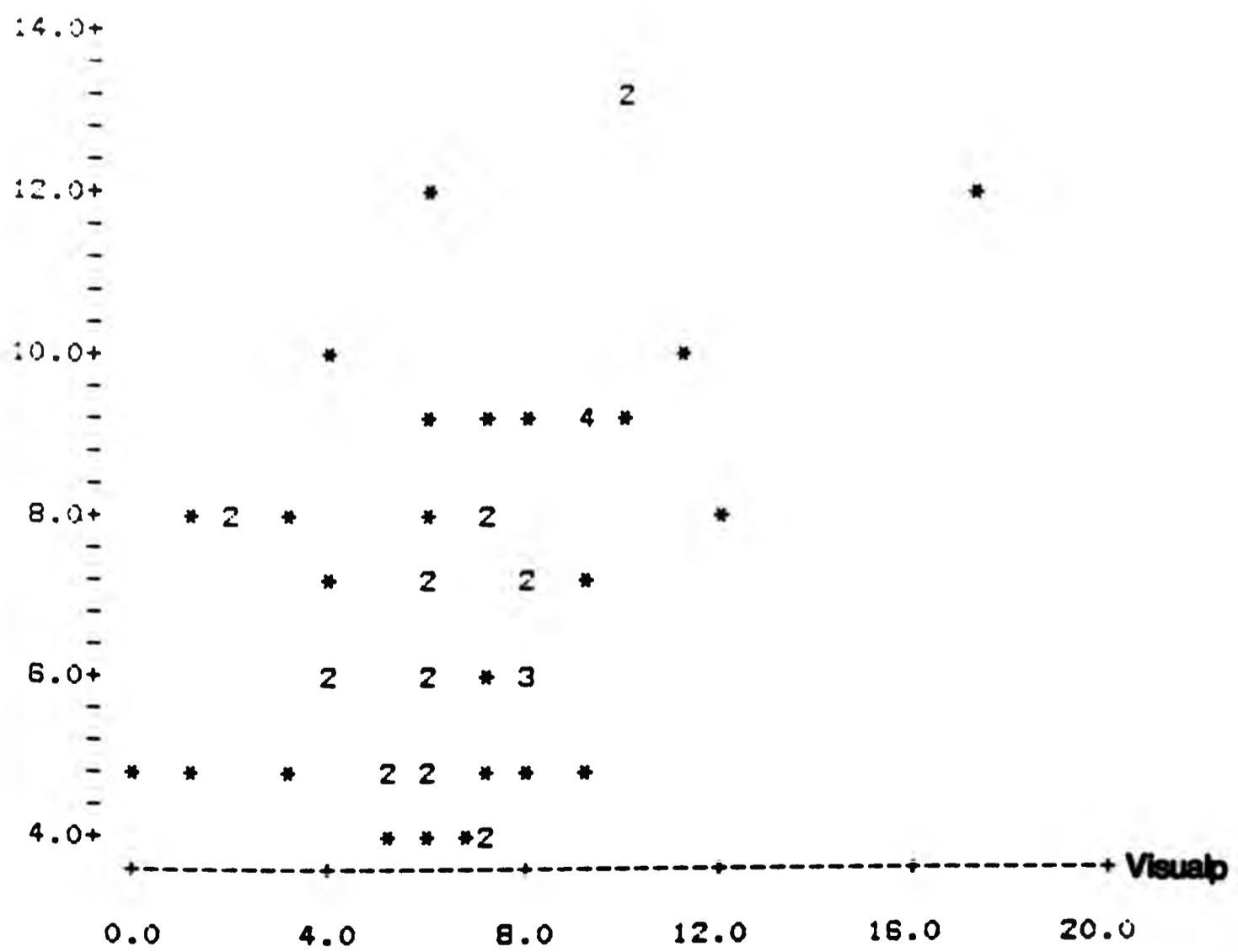

Visual

Graph 19

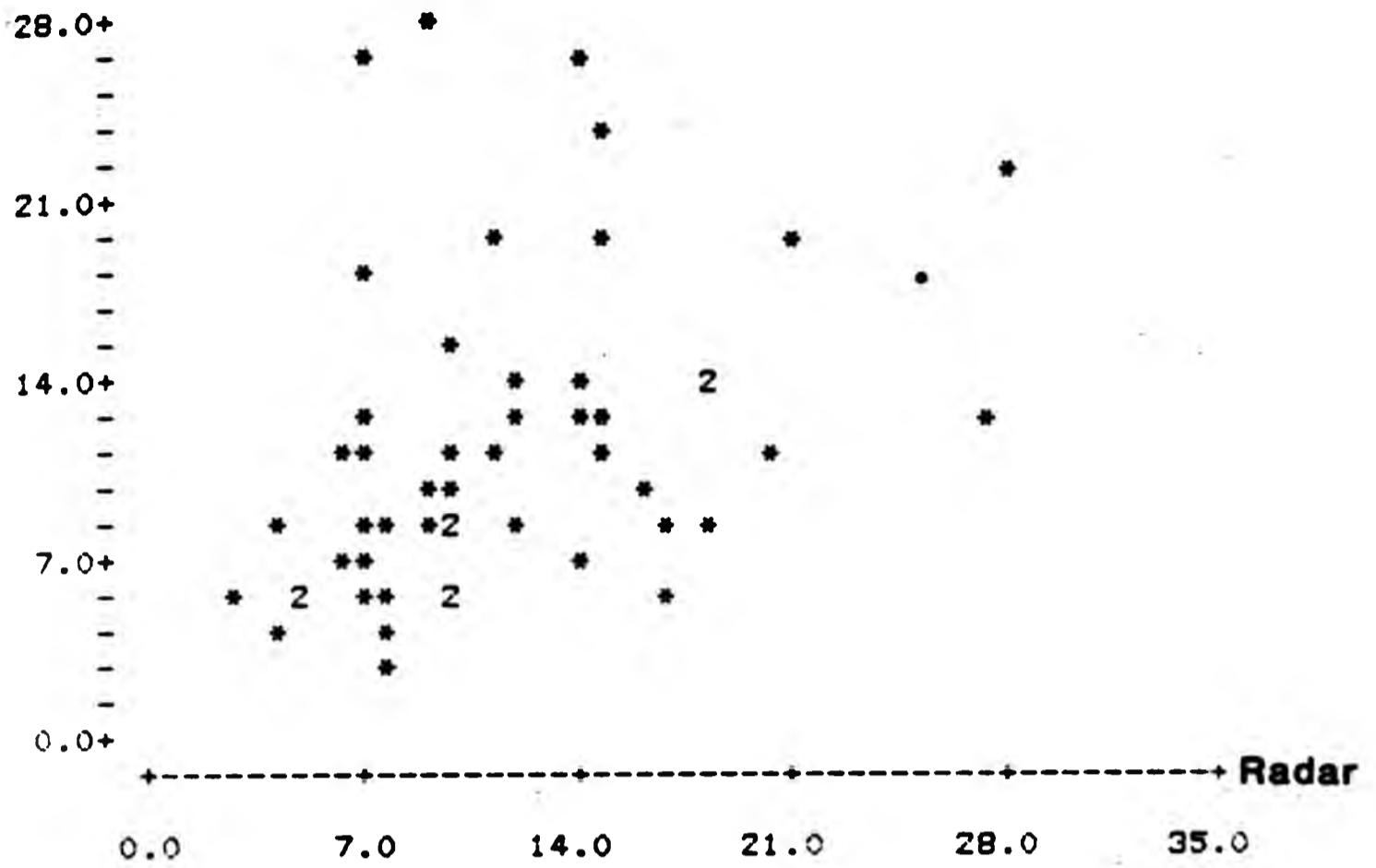

Visualp

Graph 20

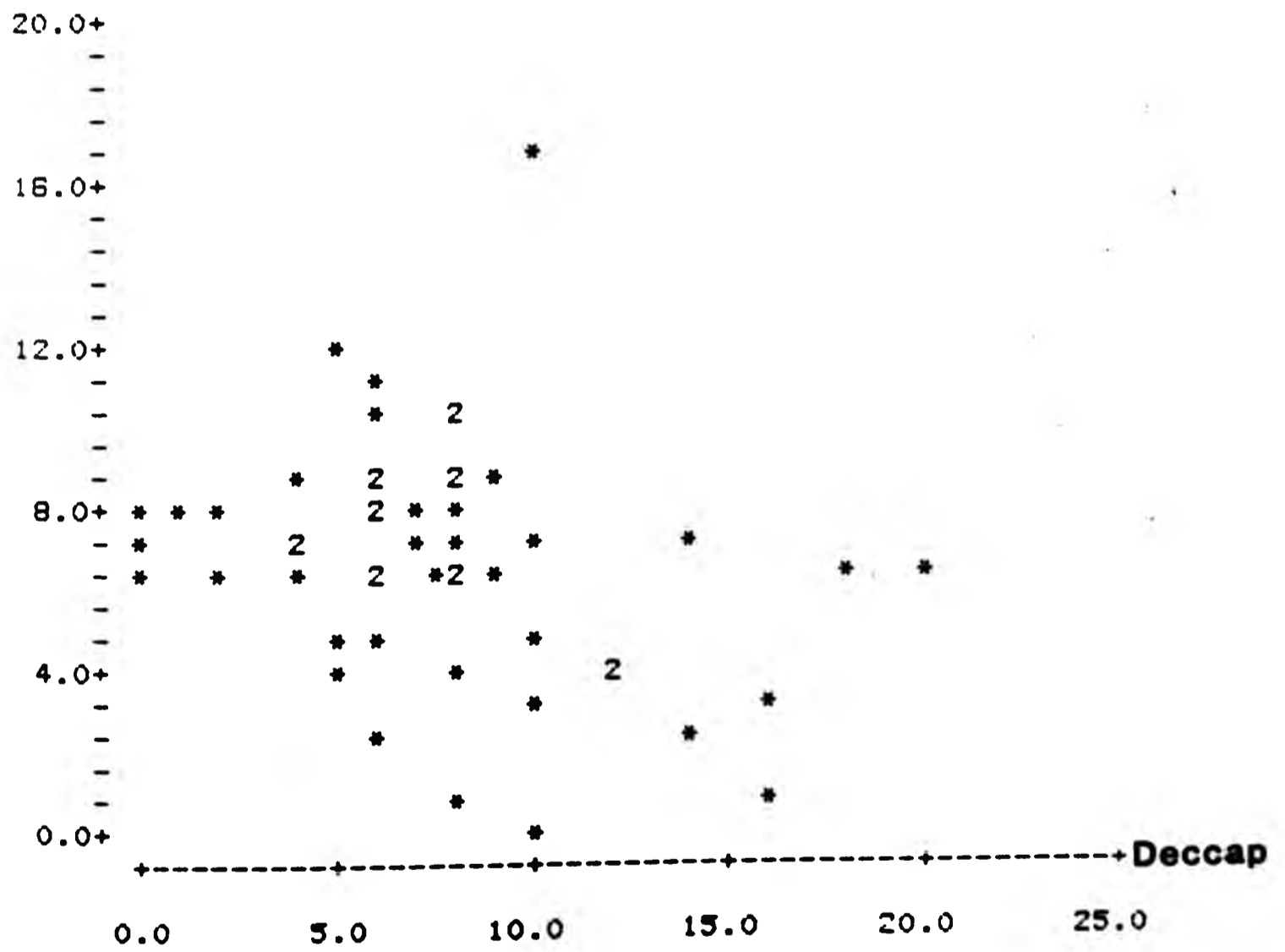

Decca

Graph 21

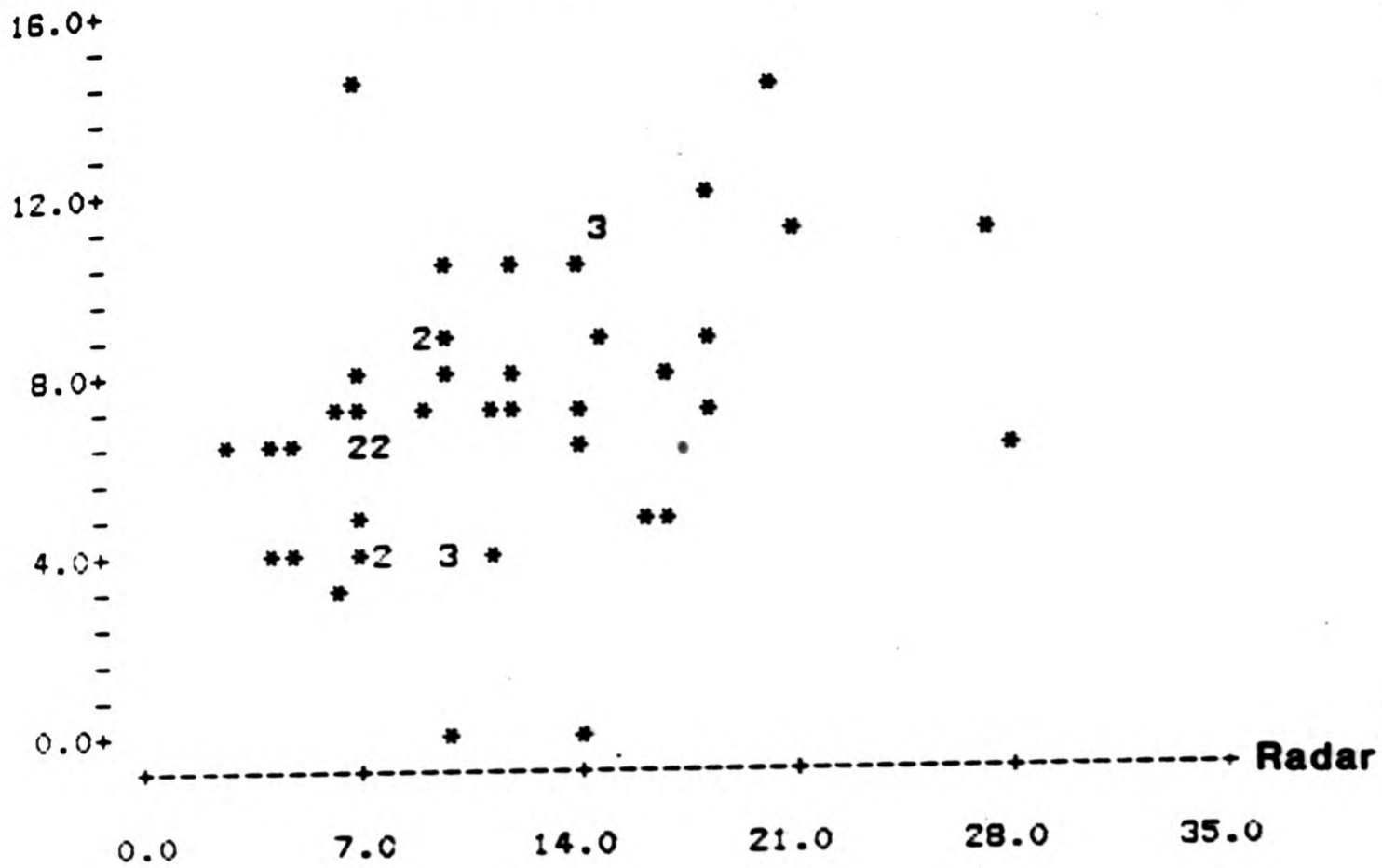

Decca

Graph 22

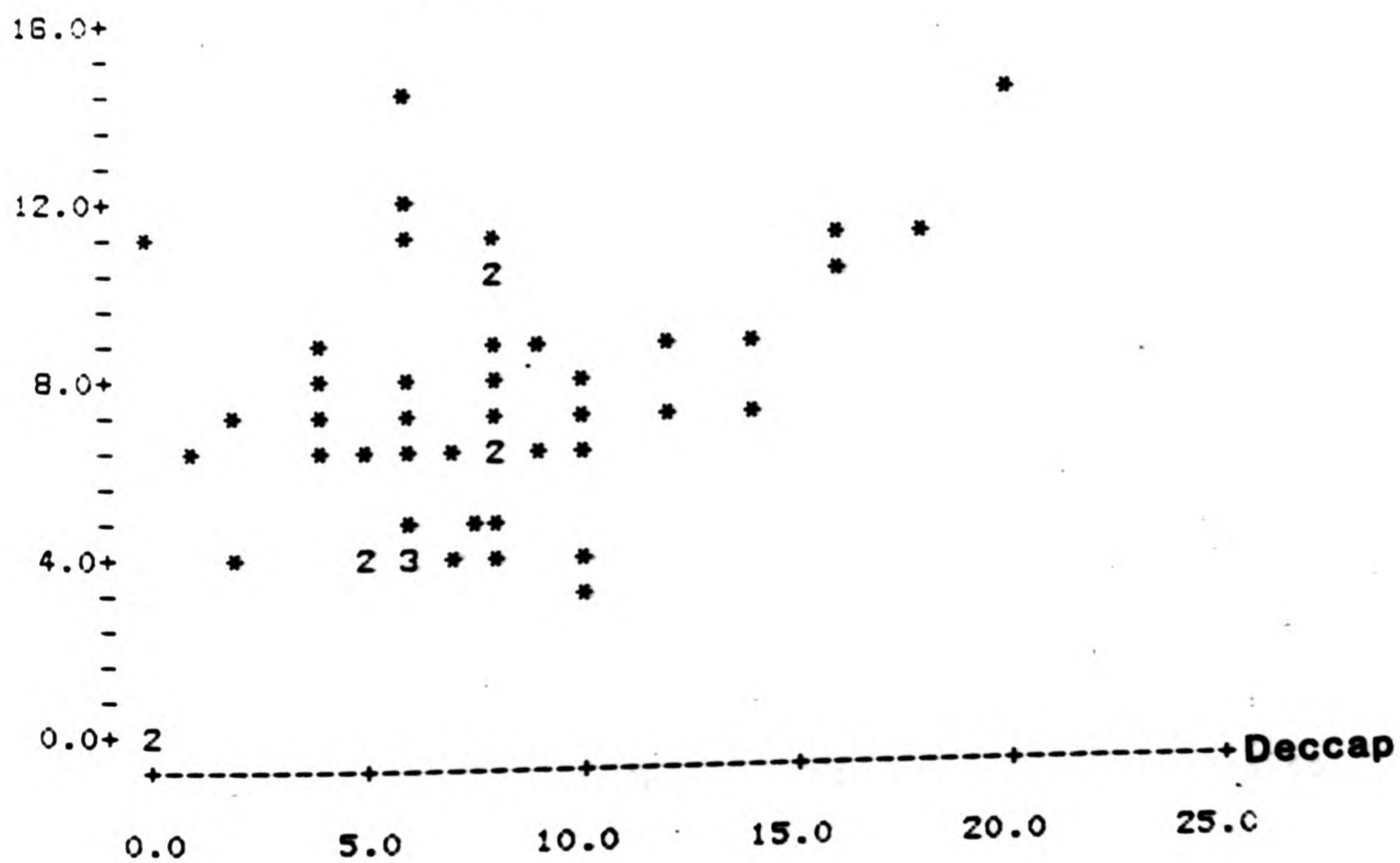

Appendix No. 2

THE 17 VARIABLES

(E) Indicates that the value was estimated.

Run 1

Subject	Oscore	Pscore	Lights	Error	Time
1	2.25(E)	1.74	10	1.25(E)	19.68(E)
2	2.15	2.00	15	1.25(E)	18.00
3	2.23	2.75	9	1.25(E)	27.00
4	2.20	1.82	11	1.25(E)	20.00
5	2.28	1.80	14	1.25(E)	12.00
6	2.25(E)	2.00	17	1.25(E)	19.68(E)
7	2.52	2.02(E)	9	1.25(E)	18.00
8	2.31	2.02(E)	9	1.25(E)	14.00
9	2.48	2.02(E)	12	2.20	12.9
10	2.17	2.08	15	1.25(E)	12.00
11	2.00	1.83	9	0.75	19.00
12	1.94	2.35	12	1.20	24.00
13	2.25(E)	2.02(E)	18	8.60	20.00
14	1.97	2.14	11	1.00	16.00
15	2.55	2.50	16	0.80	9.40
16	2.67	2.26	11	0.80	25.00
18	2.07	2.02(E)	2	5.20	

Run 1 continued.

Subject	Oscore	Pscore	Lights	Error	Time31.00
19	2.42	2.12	2	0.70	31.00
20	1.85	2.54	0	0.00	29.00
21	2.28	1.79	15	0.60	19.60
22	2.41	1.95	11	1.25(E)	17.70
23	2.31	1.86	14	0.50	16.70
24	2.50	2.26	13	0.5	10.00
25	2.20	1.59	3	0.80	30.00
26	2.19	1.50	19	1.25(E)	25.00
27	1.96	1.55	19	0.80	19.70
28	2.33	2.02(E)	16	0.40	15.00

Run 1 continued.

Subject	Toline	Moline	Permore	Position
1	9	3	25	12
2	4	0	0	4
3	4	4	50	8
4	3	2	40	5
5	3	2	40	5
6	5	2	28	7
7	1	3	75	4
8	7	0	0	7
9	5	0	0	5
10	5	1	17	6
11	7	2	22	9
12	5	2	28	7

13	5	0	0	5
14	1	3	75	4
15	5	0	0	5
16	4	2	33	6
18	4	0	0	4
19	2	4	66	6
20	4	4	50	8
21	7	2	22	9
22	5	4	44	9
23	1	6	86	7
24	0	5	100	5
25	7	1	14	8
26	8	1	13	9
27	4	1	20	5
28	3	3	50	6

Run 1 continued.

Subject	Visual	Decca	Radar	Sounder
1	11.5(E)	3	6	6
2	7	4	7	2
3	9	7	18	6
4	14	8	12	6
5	6	4	10	5
6	11.5(E)	6	7	5
7	4	6	8	3
8	5	4	5	2
9	7	7	6	5
10	8	4	8	4

11	12	5	7	2
12	28	9	9	7
13	27	0	14	8
14	18	8	7	3
15	5	6	5	5
16	3	6	8	7
18	8	5	17	0
19	12	10	12	11
20	12	11	27	2
21	10	5	16	12
22	11	9	10	9
23	9	7	7	3
24	4	4	4	4
25	14	6	14	11
26	19	9	15	11
27	24	11	15	0
28	9	6	4	5

Run 1 continued.

Subject	Visualp	Radarp	Deccap	Otwo
1	17	0	10	1.93
2	5	0	5	2.00
3	2	0	14	1.94
4	6	1	4	1.94
5	9	0	6	1.90
6	6	6	6	2.11
7	7	7	4	2.22
8	8	0	6	2.00

9	0	0	10	1.95
10	4	4	5	1.80
11	10	4	8	1.71
12	4	1	12	1.59
13	7	3	0	1.93
14	6	0	8	1.65
15	3	1	10	2.06
16	4	4	8	2.18
18	6.6(E)	3.8(E)	7.6(E)	1.90
19	6	3	8	1.94
20	3	5	16	1.98
21	8	7	6	1.84
22	9	4	8	1.93
23	9	6	6	1.91
24	5	4	10	2.00
25	12	0	5	1.77
26	9	8	4	1.77
27	8	2	0	1.74
28	8	1	8	1.74

Run 2

Subject	Oscore	Pscore	Lights	Error	Time
5	2.32	1.94	14	2.54(E)	10.00
6	2.21	1.83	5	2.54(E)	14.00
7	2.20	2.00	16	2.54(E)	12.00
8	2.44	2.18	13	2.54(E)	14.00
9	2.33	2.40	7	1.2	6.00
10	2.19	1.71	18	4.7	6.00
11	2.27(E)	1.47	2	8.4	17.54(E)
12	2.17	2.42	19	2.5	19.00
13	2.27(E)	2.05(E)	14	2.5	14.00
14	2.12	2.00	15	2.0	16.00
15	2.44	2.72	12	0.5	19.30
16	2.39	2.14	13	0.5	22.00
17	2.41	2.25	14	2.54(E)	13.20
18	2.22	2.58	7	0.6	17.54(E)
19	2.46	2.00	0	2.54(E)	29.00
20	2.30	2.46	4	0.8	39.00
21	2.34	1.96	14	2.54(E)	15.80
22	2.49	2.09	11	4.0	11.60
23	2.40	1.94	6	1.5	23.00
24	2.29	2.07	14	4.2	11.30
25	2.12	1.88	11	1.9	30.00
26	2.47	1.85	19	2.54(E)	19.00
27	1.87	1.55	10	0.4	24.50
28	1.85	1.79	18	0.6	17.10

Run 2 continued.

Subject	Toline	Moline	Permore	Position
5	0	6	100	6
6	6	2	25	8
7	0	4	100	4
8	6	2	25	8
9	10	0	0	10
10	7	0	0	7
11	6	1	14	7
12	5	7	58	12
13	5	0	0	5
14	4	5	56	9
15	5	3	38	8
16	0	6	100	6
17	9	0	0	9
18	5	0	0	5
19	5	0	20	6
20	2	7	78	9
21	7	2	22	9
22	4	4	50	8
23	12	1	8	13
24	2	3	60	5
25	7	1	13	8
26	13	0	0	13
27	5	1	20	6
28	10	0	0	10

Run2 continued.

Subject	Visual	Decca	Radar	Sounder
5	6	6	7	0
6	9	7	12	3
7	5	4	10	1
8	6	6	3	1
9	9	7	9	5
10	8	4	10	5
11	11.5(E)	7	11.5(E)	5.6(E)
12	26	14	7	7
13	16	0	10	11
14	14	9	18	1
15	7	10	14	1
16	6	8	17	6
17	10	9	9	6
18	5	4	8	1
19	11	14	20	7
20	19	11	21	18
21	12	7	14	14
22	9	10	10	6
23	11	11	15	3
24	10	8	10	3
25	14	12	18	12
26	12	11	15	15
27	23	6	28	3
28	19	4	11	5

Run 2 continued.

Subject	Visualp	Radarp	Deccap	Otwo
5	8	2	7	2.08
6	7	7	4	1.93
7	7	3	7	1.95
8	6	2	9	1.80
9	4	4	12	2.00
10	6	6	2	1.82
11	8	8	2	1.93(E)
12	6	0	20	1.75
13	6	5	0	1.93
14	9	7	9	2.10
15	1	3	16	2.10
16	7	5	10	2.03
17	7	4	14	1.96
18	1	3	8	1.93
19	6	4	6	2.07
20	6	2	18	1.84
21	9	9	8	1.85
22	7	6	8	2.03
23	10	10	8	2.00
24	5	5	6	1.93
25	2	4	6	1.85
26	10	10	6	1.97
27	8	4	1	1.70
28	11	7	6	1.76

Appendix No.3
Histograms of the different variables.

Oscore

MIDDLE OF INTERVAL	NUMBER OF OBSERVATIONS	
1.8	0	
1.9	4	****
2.0	3	***
2.1	3	***
2.2	14	*****
2.3	12	*****
2.4	7	*****
2.5	6	*****
2.6	1	*
2.7	1	*

Oscore2

MIDDLE OF INTERVAL	NUMBER OF OBSERVATIONS	
1.50	1	*
1.65	1	*
1.70	2	**
1.75	6	*****
1.80	3	***
1.85	4	****
1.90	3	***
1.95	15	*****
2.00	6	*****
2.05	4	****
2.10	4	****
2.15	0	
2.20	2	**

Pscore

MIDDLE OF INTERVAL	NUMBER OF OBSERVATIONS	
1.5	4	****
1.6	1	*
1.7	2	**
1.8	7	*****
1.9	4	****
2.0	13	*****
2.1	7	*****
2.2	1	*
2.3	3	***
2.4	3	***
2.5	3	***
2.6	1	*
2.7	1	*
2.8	1	*

Lights

MIDDLE OF INTERVAL	NUMBER OF OBSERVATIONS	
0.	3	***
1.	0	
2.	3	***
3.	1	*
4.	0	
5.	1	*
6.	2	**
7.	2	**
8.	0	
9.	4	****
10.	2	**
11.	6	*****
12.	2	**
13.	3	***
14.	7	*****
15.	4	****
16.	3	***
17.	1	*
18.	3	***
19.	4	****

Error

MIDDLE OF INTERVAL	NUMBER OF OBSERVATIONS	
0.	3	***
1.	28	*****
2.	5	*****
3.	9	*****
4.	2	**
5.	2	**
6.	0	
7.	0	
8.	:	*
9.	1	*

Time

MIDDLE OF INTERVAL	NUMBER OF OBSERVATIONS	
5.	2	**
10.	8	*****
15.	12	*****
20.	16	*****
25.	6	*****
30.	6	*****
35.	0	
40.	1	*

Toline

MIDDLE OF INTERVAL	NUMBER OF OBSERVATIONS	
0.	4	****
1.	3	***
2.	3	***
3.	3	***
4.	8	*****
5.	13	*****
6.	3	***
7.	7	*****
8.	1	*
9.	2	**
10.	2	**
11.	0	
12.	:	*
13.	:	*

Moline

MIDDLE OF INTERVAL	NUMBER OF OBSERVATIONS	
0.	14	*****
1.	8	*****
2.	10	*****
3.	6	*****
4.	6	*****
5.	2	**
6.	3	***
7.	2	**

Pernore

MIDDLE OF INTERVAL	NUMBER OF OBSERVATIONS	
0.	13	*****
10.	5	*****
20.	7	*****
30.	6	*****
40.	4	****
50.	4	****
60.	3	***
70.	1	*
80.	3	***
90.	1	*
100.	4	****

Position

MIDDLE OF INTERVAL	NUMBER OF OBSERVATIONS	
4.	5	*****
5.	10	*****
6.	8	*****
7.	6	*****
8.	8	*****
9.	8	*****
10.	2	**
11.	0	
12.	2	**
13.	2	**

Visualp

MIDDLE OF INTERVAL	NUMBER OF OBSERVATIONS	
0.	1	*
2.	4	****
4.	6	*****
6.	14	*****
8.	14	*****
10.	9	*****
12.	2	**
14.	0	
16.	0	
18.	1	*

Radarp

MIDDLE OF INTERVAL	NUMBER OF OBSERVATIONS	
0.	9	*****
1.	4	****
2.	4	****
3.	5	*****
4.	11	*****
5.	4	****
6.	4	****
7.	5	*****
8.	2	**
9.	1	*
10.	2	**

Deccap

MIDDLE OF INTERVAL	NUMBER OF OBSERVATIONS	
0.	3	***
2.	3	***
4.	4	****
6.	13	*****
8.	13	*****
10.	7	*****
12.	2	**
14.	2	**
16.	2	**
18.	1	*
20.	1	*

Toline

MIDDLE OF INTERVAL	NUMBER OF OBSERVATIONS
0.	4 *****
1.	3 ***
2.	3 ***
3.	3 ***
4.	8 *****
5.	13 *****
6.	3 ***
7.	7 *****
8.	1 *
9.	2 **
10.	2 **
11.	0
12.	1 *
13.	1 *

Moline

MIDDLE OF INTERVAL	NUMBER OF OBSERVATIONS
0.	14 *****
1.	8 *****
2.	10 *****
3.	6 *****
4.	6 *****
5.	2 **
6.	3 ***
7.	2 **

Permone

MIDDLE OF INTERVAL	NUMBER OF OBSERVATIONS
0.	13 *****
10.	5 *****
20.	7 *****
30.	6 *****
40.	4 *****
50.	4 *****
60.	3 ***
70.	1 *
80.	3 ***
90.	1 *
100.	4 *****

Position

MIDDLE OF INTERVAL	NUMBER OF OBSERVATIONS
4.	5 *****
5.	10 *****
6.	8 *****
7.	6 *****
8.	8 *****
9.	8 *****
10.	2 **
11.	0
12.	2 **
13.	2 **

Visual

MIDDLE OF INTERVAL	NUMBER OF OBSERVATIONS	
2.	0	
4.	3	***
6.	8	*****
8.	6	*****
10.	9	*****
12.	11	*****
14.	4	****
16.	1	*
18.	1	*
20.	3	***
22.	0	
24.	2	**
26.	:	*
28.	2	**

Decca

MIDDLE OF INTERVAL	NUMBER OF OBSERVATIONS	
0.	2	**
1.	0	
2.	0	
3.	:	*
4.	9	*****
5.	3	***
6.	9	*****
7.	7	*****
8.	4	****
9.	5	*****
10.	3	***
11.	5	*****
12.	1	*
13.	0	
14.	2	**

Radar

MIDDLE OF INTERVAL	NUMBER OF OBSERVATIONS	
2.	0	
4.	3	***
6.	4	****
8.	11	*****
10.	10	*****
12.	5	*****
14.	4	****
16.	5	*****
18.	5	*****
20.	1	*
22.	1	*
24.	0	
26.	0	
28.	2	**

Souder

MIDDLE OF INTERVAL	NUMBER OF OBSERVATIONS	
0.	3	***
2.	9	*****
4.	9	*****
6.	15	*****
8.	5	*****
10.	1	*
12.	6	*****
14.	1	*
16.	1	*
18.	1	*

Visualp

MIDDLE OF INTERVAL	NUMBER OF OBSERVATIONS	
0.	1	*
2.	4	****
4.	6	*****
6.	14	*****
8.	14	*****
10.	9	*****
12.	2	**
14.	0	
16.	0	
18.	1	*

Radarp

MIDDLE OF INTERVAL	NUMBER OF OBSERVATIONS	
0.	9	*****
1.	4	****
2.	4	****
3.	5	*****
4.	11	*****
5.	4	****
6.	4	****
7.	5	*****
8.	2	**
9.	1	*
10.	2	**

Deccap

MIDDLE OF INTERVAL	NUMBER OF OBSERVATIONS	
0.	3	***
2.	3	***
4.	4	****
6.	13	*****
8.	13	*****
10.	7	*****
12.	2	**
14.	2	**
16.	2	**
18.	1	*
20.	1	*

APPENDIX NO.4

The Simulator Lights.

1 The operation of the lights.

The bulbs were wired in groups of 5 on a board which stretched across the end of the simulator above the chart table (Chapter 4, figs 1 and 5). They were set to flash on and off by the controller in a manner which would appear random to the subjects who were asked to log all the lights they observed.

To make this task as realistic as possible the the subjects were asked to log the lights in the same manner as they would have at sea; thus the centre light was logged as "ahead". the lights at each end as on the port and starboard beam respectively. while the remaining lights were logged as 4 points (45 degrees) to port and starboard.

The order and approximate time in minutes into the experiment when the lights were exhibited is shown in the following table:-

Lights exhibited in the Simulator.

Number	Time	Colour	Bearing
1	01	Green	Ahead
2	03	White	4 Pts. Stbd.
3	05	Green	4 Pts. Stbd.
4	07	Green	Stbd. Beam
5	09	Fl.Red	Stbd. Beam
6	10	Green	Port Beam
7	11	Red	4 Pts. Port
8	13	Red	Stbd. Beam
9	15	White	Port Beam
10	18	White	Ahead
11	19	Red	Port Beam
12	20	Red	4 Pts. Port
13	21	White	Ahead
14	23	Red	4 Pts. Stbd.
15	25	Green	4 Pts. Stbd.
16	28	White	Stbd. Beam
17	29	White	4 Pts. Port
18	30	Occ. Green	Port Beam
19	31	Red	Ahead

2 The construction of the equipment.

Refer to diagrams 1 and 2.

IC1a was half of a dual timer connected to an astable, the output of which was connected to a divide by sixteen binary counter IC3.

The output of IC3 consisted of four binary coded lines which were fed into IC5 & IC6 which switched the normally high outputs to low for approximately 45 seconds. These outputs switch sequentially from 1 to 16 on IC5 and then are disabled by IC4 which was connected as a divide by 2 counter to switch on IC6 for a further count of 1 to 16 giving a total of 32 outputs.

The outputs of IC5 & IC6 were connected to a number of L.E.D. which had their cathodes connected to +5volts so that as each output went low it switched on the appropriate L.E.D.

IC1b was connected as a monostable and set to give an equal mark-space ratio of one to one which was connected to a medium flash L.E.D.

IC2 was a dual timer connected as a pair of astables one half of which was set to give a higher P.R.F. than

2 The construction of the equipment.

Refer to diagrams 1 and 2.

IC1a was half of a dual timer connected to an astable, the output of which was connected to a divide by sixteen binary counter IC3.

The output of IC3 consisted of four binary coded lines which were fed into IC5 & IC6 which switched the normally high outputs to low for approximately 45 seconds. These outputs switch sequentially from 1 to 16 on IC5 and then are disabled by IC4 which was connected as a divide by 2 counter to switch on IC6 for a further count of 1 to 16 giving a total of 32 outputs.

The outputs of IC5 & IC6 were connected to a number of L.E.D. which had their cathodes connected to +5volts so that as each output went low it switched on the appropriate L.E.D.

IC1b was connected as a monostable and set to give an equal mark-space ratio of one to one which was connected to a medium flash L.E.D.

IC2 was a dual timer connected as a pair of astables one half of which was set to give a higher P.R.F. than

I.C.1b which resulted in a faster flash rate than the medium flash L.E.D.

IC2b was set to give an unequal mark-space ratio so that the output was high for a longer period than the low (Occulting L.E.D.). A fast /reset switch was fitted so that the cycle of switching always started at L.E.D.1. The sequence of switching could be quickly checked by the fast position which would run IC1a at a higher P.R.F.

Circuit diagram of the Simulator Lights

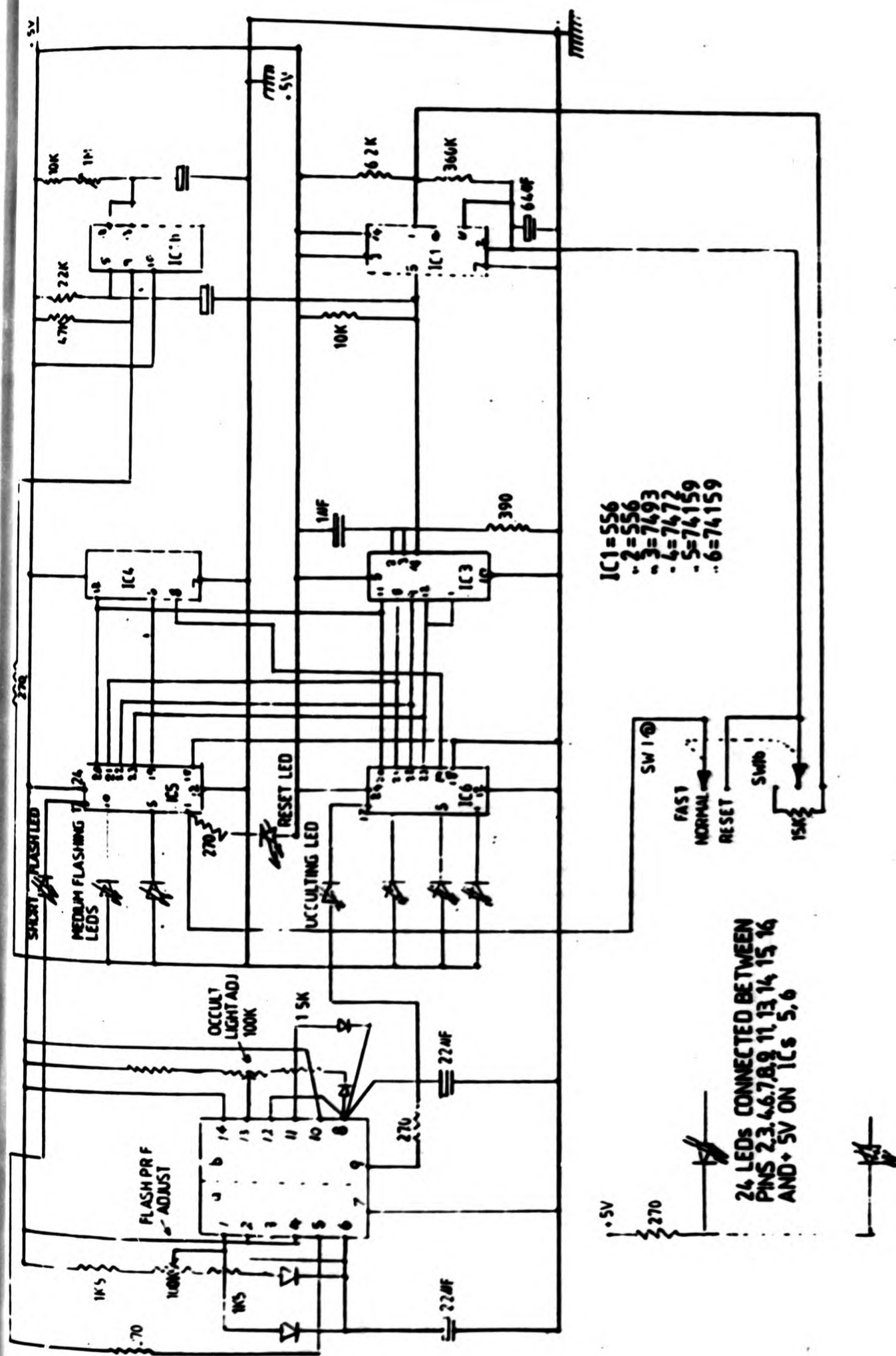

Circuit diagram of the Simulator Lights

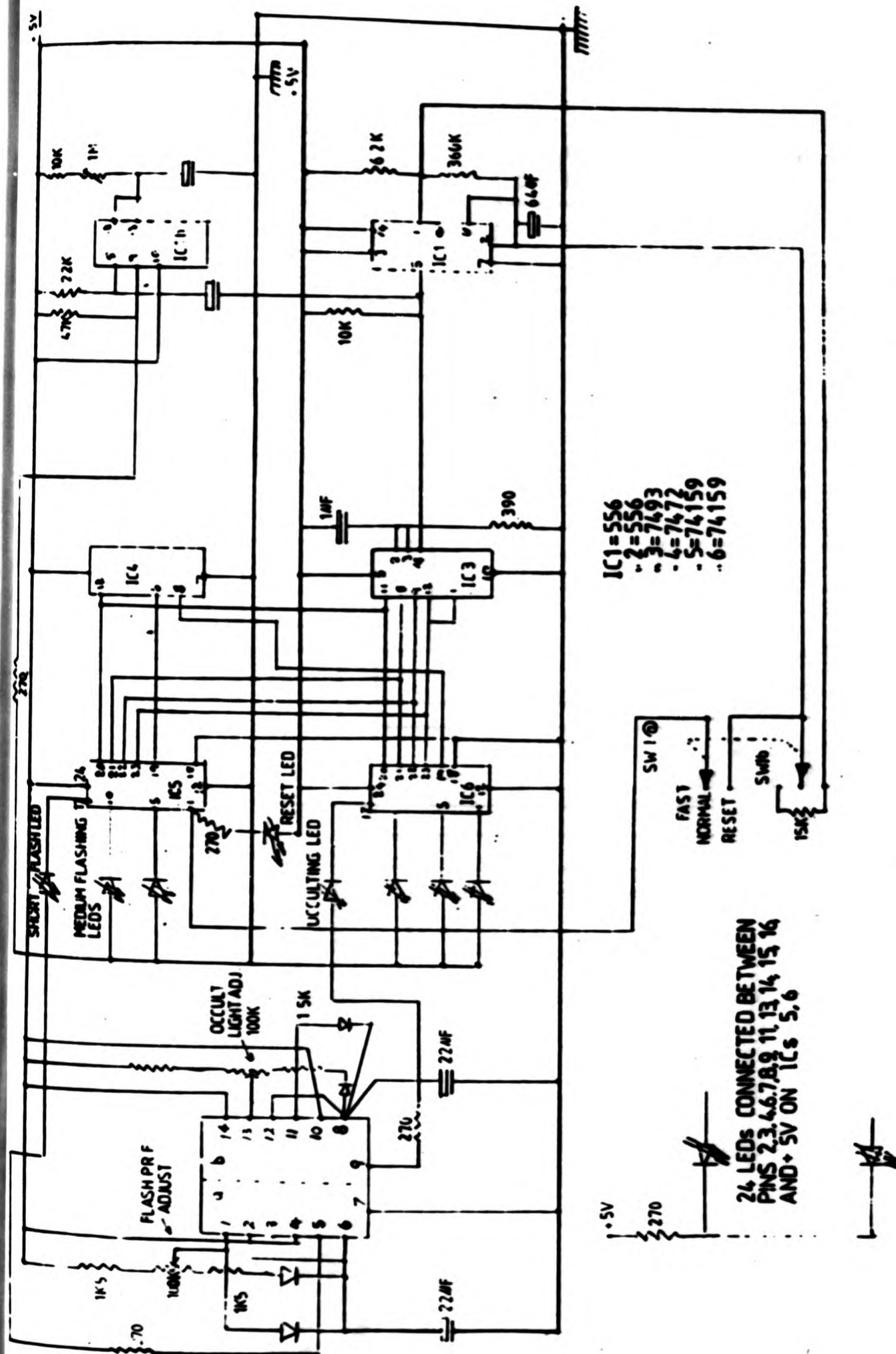

IC1=556
 IC2=556
 IC3=7493
 IC4=74159

24 LEDs CONNECTED BETWEEN
 PINS 2,3,4,6,7,8,9,11,13,14,15,16
 AND +5V ON ICs 5,6



Simplified System Diagram

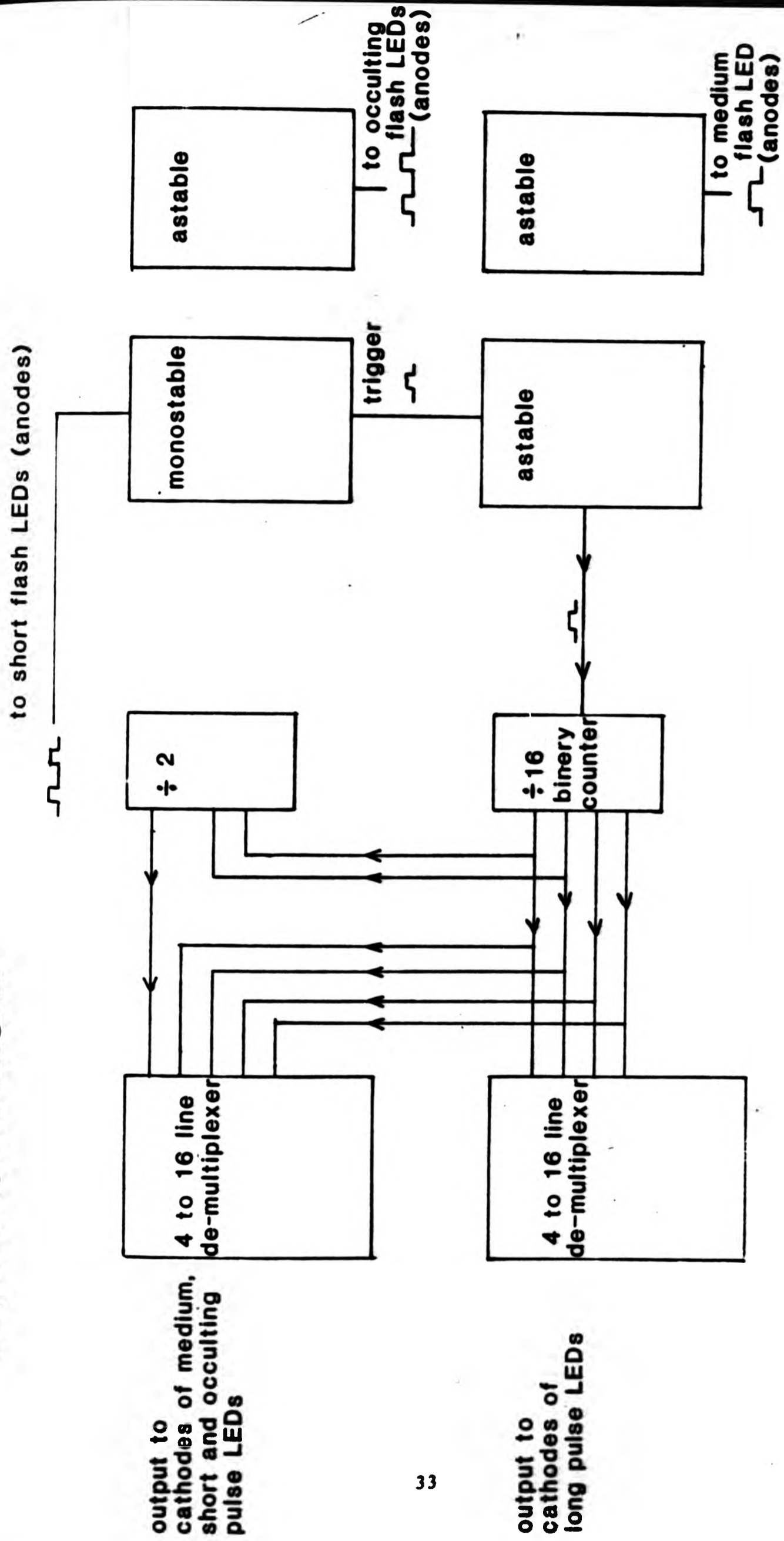

APPENDIX No. 5.

Advance Publications.

While the experiments described in this thesis were being carried out two papers were presented covering some of the work described here:-

1) "Coastal Navigation as practiced". Paper read to a joint seminar of the Royal Institute of Navigation and the Nautical Institute on Practical Navigation in Coastal Waters. London December 1978.

2) "Should Navigation Aids be Integrated?" paper read to a joint seminar of the Royal Institute of Navigation and the Nautical Institute on the Selection and Display of Navigational Information. London December 1981.

Coastal Navigation as Practiced

Captain J. Strange, BSc, MRIN, MNI

City of London Polytechnic

Most accident investigations point to the human element as being the main cause. Recently we have the Christos B grounding off the Coast of South Wales in a position that casts doubts on the methods of navigation employed. A common theme in most of the published reports on strandings is that the means available to prevent the stranding or at least alert the crew to the possible danger was available on board but had somehow been ignored. Today with the consequences of large scale pollution we are seeing a new interest in shipping safety and the old idea of interest in a stranding only being the concern of the owner and underwriter is no longer acceptable.

There are two current approaches to reducing accidents, one is to ensure that the ships are properly equipped and the equipment is in working order. Secondly it is important that ships crews are properly trained and able to operate the equipment.

The approach for the research described in this paper has been to examine how seafarers navigate in practice rather than in the artificial situation which exists for much of the chartwork teaching. This research is needed because of the pressure to improve standards. Some of the pressure relates to training but more seriously there are moves to require certain types of equipment to be fitted although there is no guarantee that this action will reduce accidents and it could make the situation worse by encouraging decisions based on an inadequate understanding. The research is divided into two parts. Firstly, and already completed is experimentation based on chart exercises to investigate the subjects' reaction to various aids. Secondly, and in the planning stage, is a more realistic approach where the subjects will be presented with video displays of the various aids and their use of the aids will be examined.

In the first part the subjects were presented with cards containing navigational information and they were asked to indicate on the chart provided what they considered their position was. They were presented with more information than necessary to fix their position and it was how they coped with the extra information and whether they rejected any, that was being examined. The area chosen for the experiments was the Bristol Channel and chart number L D1 1179 was used. The Bristol Channel has the advantage that there is land on both sides and so it is possible to use a number of different aids to produce various patterns of position lines. With the number of different ports and lack of separation schemes it is possible to put the ship on a number of different but realistic courses.

The subjects were taken from among students studying for their Master's certificate at the College. The group was chosen because of their watchkeeping experience, ranging from 5 years to 15 and it was expected that their reactions would be representative of the standards at sea today.

The experiments were conducted in two phases, firstly a pilot

study and when this confirmed the validity of the approach and showed some interesting results it was followed by a further experimental programme on a larger scale.

The results of the experiments were interesting for a number of reasons. The Navigational aid was found to be the most important factor in determining the choice of a position and from the results an order of preference can be built up. Visual bearings is the favourite, many of the subjects remarking that they would always use visual bearings where possible. Decca and Radar shared second place, a result that was surprising as Radar appears to have the advantage of giving a picture of the situation while Decca only gives a coordinate position. It seems that the subjects had considerable experience of Decca to give this confidence in the position. D.F. came last, many of the subjects remarking that they only considered it to be of use as a last resort. Some of the exercises were designed to see at what stage subjects would use the D.F. in preference to other aids and a number of subjects showed a preference for doubtful visual bearings instead of a good fix with three D.F. bearings. These results seem to show that instead of objectively using the best aid for any situation many of them have fixed opinions of the various aids which they apply, regardless of the situation. Whether these views are based on their own experience or were obtained from other seafarers is not known.

When it came to deciding on a position the main criteria was the aid used, most of the subjects choosing a position defined by their favourite aid and ignored the other information. Another possible influence was to take a position that was closest to a possible danger although in many cases because of the ship's course the ship was already clear of any threat. The similar method of deciding on a position that puts the ship furthest ahead was not taken up. Again this seemed to be an instinctive rather than a rational decision. The most interesting result was that the subjects tended to avoid the centre of a number of position lines or any position that represented a mean of several possible positions, and representing an estimate of the most probable position. It seemed that they were content to accept the position defined by their favourite aid and use the other information as a check on gross error, but not to try and use it in order to arrive at a better estimate of their position. Some of the exercises were more complicated, involving more than two aids, or involving one aid only with three position lines. In these cases the results showed a random choice without any clear preference for any particular strategy.

Two main conclusions seem to emerge from this work. Firstly that the seafarers choice of aid and position is arrived at as much by personal preference as by any appreciation of the situation. Secondly that seafarers have not learned how to use several aids together to get the best of each one. This work seems to indicate that better training might be a more effective way of reducing accidents than to put more equipment on a ship and possibly cause further confusion.

SHOULD NAVIGATION AIDS BE INTEGRATED?

Captain J.L. Strange, City of London Polytechnic

Today the navigator's problem is no longer one of lack of information, as with the technology available there need no longer be any doubt about a ship's position. Rather, the problem is that there can be too much information instead of too little. This revolution has not eliminated accidents, but the matter is now one of presentation, and navigational safety becomes a matter of communication and information management.

One method of improving communications would be to present all the navigational information in one integrated display. This would certainly eliminate some of the problems that exist today and could mean that the navigator needs less training, which should prove popular in today's economic climate. This would mean that, to some extent, the safety of the ship is transferred from the navigator to a computer programmer which might not necessarily be an advantage.

This paper is based on research carried out at the City of London Polytechnic. It was carried out in two stages, using students studying for their Master's Certificate as subjects for the experiments. They were chosen to give as homogeneous a sample as possible, both in terms of experience and age, without the group being too restricted.

The first stage of the work consisted of presenting the subjects with cards containing navigational information, which they were asked to plot on a chart and to decide on the basis of this information what they would consider to be the ship's position. In every case the information, when plotted, produced a 'cocked hat' and it was the subjects' estimate of position in relation to this cocked hat that was of interest. From this work a number of conclusions emerged:-

- 1) It was possible to establish an order of preference for the different navigational aids. Visual bearings were the most popular, followed by radar and Decca, but it was not possible to separate these two. The radio direction finder proved to be the least popular.
- 2) The subjects preferred an intersection of position lines for a position rather than some sort of weighted position among a number of lines.

The second stage of the work was the construction of a simple simulator with the help of some money from Shell International Marine. This was based on the use of three video recorders each playing a tape on which had been recorded information from the radar, Decca navigator and echo sounder on board the Sir John Cass. The subject was able to display any of this information on a television monitor by pressing the appropriate button. Visual bearings were simulated by means of a slide projector where a scale was superimposed on a photograph of the particular mark. A pen recorder was used to record the

time that the subjects spent watching each individual aid. In addition a number of lights were shown for short periods from different positions in the simulator and the subjects were asked to log the position and colour of each light which they observed. Each subject was asked to complete two separate half hour runs along the Suffolk coast, monitoring the ship's position during this period and finally producing an E.T.A. and a course to steer for a point further ahead.

The output of these experiments was the accuracy of the subjects' navigation based on the error in their E.T.A. and the number of lights which they observed. The inputs were the uses that the subjects made of the various aids which were available to them. The relationships between these parameters were used to try and build up a picture of how the subjects navigated.

When the errors in the E.T.A. were examined on their own they showed a bunching at the lower end of the scale, the majority being about one mile. For the purpose of this experiment errors of greater than four miles were treated as blunders and all the tests involving errors were carried out both with and without the blunders included. The accuracy of the navigation for the different subjects was correlated against the other parameters which were, preference for visual or electronic position fixing, time watching the aids, choice of two or more than two position lines and number of positions plotted during the experiment. The only significant result was a negative correlation of time watching the aids and errors, but when this test was repeated with the blunders removed it became non significant. It was not possible to come to any firm conclusions about the blunders because of the small size of the sample, only three out of a total of 25 runs but even so this seemed to be too many. It did seem that the majority of blunders occurred when the subjects spent less than the average amount of time watching the navigational aids so there may be some connection here.

The fact that it was not possible to demonstrate any other correlation between the errors and the other parameters demonstrates that the subjects, all qualified and experienced navigators, were able to manage a straight forward navigational task without any difficulty. The fact that it did not seem to make any difference how they navigated, whether they preferred electronic aids or visual bearings, whether they preferred to use two lines for a fix rather than three or more, or how frequently they fixed their position, seems to demonstrate that over the time that they have been watchkeeping they have evolved their own methods of navigation and under normal circumstances these produce acceptable results.

The second output was the number of lights observed. This differs from the navigational errors output in that there was a much wider distribution, some subjects observing all 19 lights while others observed very few. This seems to demonstrate that the subjects gave priority to the navigation and treated the task of logging the lights as of secondary importance, which in fact was the intention of the experiment. This particular result cannot be generalised to other situations, for a navigator's decision on priorities must depend on each set of circumstances.

The number of lights logged was correlated with the other parameters in the experiment, and this time there was a negative correlation between the number of lights observed and the time the subjects spent watching the navigational aids; the longer they spent watching the aids the fewer the lights they observed. This result when examined in conjunction with the errors in navigation suggests that, although the navigators managed to achieve acceptable results in terms of errors, the length of time they needed to study the aids in order to achieve those results varied and those who spent longer looking at them were less able to attend to the other watchkeeping duties as represented by the lights. This was the only correlation between the lights observed and the other parameters, and seems to show that it did not make much difference what aids the subjects watched although there could be some evidence that some of the subjects were unable to identify the marks for the visual bearings and this took time. There was no relationship between the time taken and the number of positions on the chart, whether the positions consisted of two or more position lines. From this it would seem that it does not take very long to plot a position on the chart so the subjects should be able to plot more than two position lines in the time available. What did emerge was that the subjects showed a preference for using only two lines to fix their position rather than the more generally accepted method of using at least three, although most subjects plotted a few positions with three lines, presumably as a check.

From this work a number of arguments for and against the integration of navigation systems appear.

The main arguments in favour are:-

- 1) Most navigators prefer a position at the intersection of two position lines, even to the extent of not plotting more than two lines. Even when more than two lines are plotted there is a strong rejection of some sort of weighted mean position. In an integrated navigation system this weighting could be carried out by a computer to produce more accurate results.
- 2) The choice of aids could be carried out more logically. From this work there is evidence that some of the subjects made rather unwise choices of aids. In particular the radio direction finder was not included in the second part of the work because of its almost complete rejection in the first part. There is also some evidence that the subjects' prejudices play a part in the selection of the aids.
- 3) Some of the subjects spent rather a long time watching the aids to the detriment of other aspects of the experiment. An integrated display could speed up the process while at the same time allowing the watchkeeper to attend to his other duties.
- 4) An integrated display could be designed to reduce the influence of blunders.

The arguments against an integrated system are:-

- 1) It would be difficult to produce a safe computerised system to deal adequately with the different situations which might occur.
- 2) Those subjects who are happy to navigate using mainly two position lines may accept positions from an integrated system without properly checking them. There may be a temptation for all navigators to omit checking, unless there is some system built in which requires it to be carried out.
- 3) A strong preference was demonstrated for visual bearings, but these would be difficult to integrate into the system and so the introduction of such a system might lead to their falling into disuse.
- 4) Most aids in use today give some indication of the reliability of their results; the mark for a visual bearing must be identified, and the quality of the radar picture gives some idea of the accuracy of the fix. One exception is the satellite navigation system where the navigator is usually presented with a 'take it or leave it' situation and he has no way of evaluating how good the information is. If this becomes the case with integrated systems then there will be some risks involved in using them.
- 5) In the experiments, some of the subjects performed very well, but if they were given an integrated system is there not a danger of boredom and reduced alertness?

Conclusion

There seem to be arguments both for and against an integrated system. Before it is possible to decide whether these systems are desirable the system itself must be defined, and the checks in the system examined. The work has demonstrated that the standards of merchant navy navigation could be improved. The question is whether to seek this improvement by using some sort of computer, by trying to improve the skills by better training, or, what is more likely, some combination of both that still leaves the navigator in the loop and being able to decide how his ship should be navigated.

APPENDIX No 1.

Graphs of selected relationships.

When the relationships between the 17 variables were examined, the computer was instructed to plot the two variables using the "plot" command in "Minitab" (47). This was because the correlations were for linear relationships only and there was always the possibility of higher order relationships occurring. The examination of the data for these relationships was considered to be beyond the scope of the present work because of the circumstances in which the data was obtained using a basic simulator but the possibility of a more complex relationship had to be considered hence the need for the plots.

The plots in this appendix were selected because the author considered that they illustrated an interesting relationship between the two variables concerned.

The reference numbers indicate the section of text where the relationship is discussed.

List of Graphs.

Graph	Relationship	Reference
1	Oscore/Visual	6.4.1.2.
2	Oscore/Radar	6.4.1.2
3	Pscore/Visualp	6.4.3.2.
4	Pscore/Deccap	6.4.3.2.
5	Lights/Time	6.4.4.1.
6	Lights/Radar	6.4.4.2.
7	Error/Toline	6.5.3.
8	Error/Position	6.5.3.
9	Error/Decca	6.4.5.5.
10	Error/Deccap	6.4.5.7.
11	Time/Visual	6.4.6.1.
12	Time/Radar	6.4.6.1.
13	Toline/Moline	6.4.7.1.
14	Toline/Position	6.4.7.3.
15	Toline/Visualp	6.4.7.5.
16	Toline/Radarp	6.4.7.6.
17	Moline/Deccap	6.4.8.4.
18	Position/Visualp	6.4.10.3.
19	Visual/Radar	6.4.11.1.
20	Visualp/Deccap	6.4.15.2.
21	Decca/Radar	6.4.12.1.
22	Decca/Deccap	6.4.12.2.

Appendix No. 2

THE 17 VARIABLES

(E) Indicates that the value was estimated.

Run 1

Subject	Oscore	Pscore	Lights	Error	Time
1	2.25(E)	1.74	10	1.25(E)	19.68(E)
2	2.15	2.00	15	1.25(E)	18.00
3	2.23	2.75	9	1.25(E)	27.00
4	2.20	1.82	11	1.25(E)	20.00
5	2.28	1.80	14	1.25(E)	12.00
6	2.25(E)	2.00	17	1.25(E)	19.68(E)
7	2.52	2.02(E)	9	1.25(E)	18.00
8	2.31	2.02(E)	9	1.25(E)	14.00
9	2.48	2.02(E)	12	2.20	12.9
10	2.17	2.08	15	1.25(E)	12.00
11	2.00	1.83	9	0.75	19.00
12	1.94	2.35	12	1.20	24.00
13	2.25(E)	2.02(E)	18	8.60	20.00
14	1.97	2.14	11	1.00	16.00
15	2.55	2.50	16	0.80	9.40
16	2.67	2.26	11	0.80	25.00
18	2.07	2.02(E)	2	5.20	

Run 1 continued.

Subject	Oscore	Pscore	Lights	Error	Time31.00
19	2.42	2.12	2	0.70	31.00
20	1.85	2.54	0	0.00	29.00
21	2.28	1.79	15	0.60	19.60
22	2.41	1.95	11	1.25(E)	17.70
23	2.31	1.86	14	0.50	16.70
24	2.50	2.26	13	0.5	10.00
25	2.20	1.59	3	0.80	30.00
26	2.19	1.50	19	1.25(E)	25.00
27	1.96	1.55	19	0.80	19.70
28	2.33	2.02(E)	16	0.40	15.00

Run 1 continued.

Subject	Toline	Moline	Permore	Position
1	9	3	25	12
2	4	0	0	4
3	4	4	50	8
4	3	2	40	5
5	3	2	40	5
6	5	2	28	7
7	1	3	75	4
8	7	0	0	7
9	5	0	0	5
10	5	1	17	6
11	7	2	22	9
12	5	2	28	7

13	5	0	0	5
14	1	3	75	4
15	5	0	0	5
16	4	2	33	6
18	4	0	0	4
19	2	4	66	6
20	4	4	50	8
21	7	2	22	9
22	5	4	44	9
23	1	6	86	7
24	0	5	100	5
25	7	1	14	8
26	8	1	13	9
27	4	1	20	5
28	3	3	50	6

Run 1 continued.

Subject	Visual	Decca	Radar	Sounder
1	11.5(E)	3	6	6
2	7	4	7	2
3	9	7	18	6
4	14	8	12	6
5	6	4	10	5
6	11.5(E)	6	7	5
7	4	6	8	3
8	5	4	5	2
9	7	7	6	5
10	8	4	8	4

11	12	5	7	2
12	28	9	9	7
13	27	0	14	8
14	18	8	7	3
15	5	6	5	5
16	3	6	8	7
18	8	5	17	0
19	12	10	12	11
20	12	11	27	2
21	10	5	16	12
22	11	9	10	9
23	9	7	7	3
24	4	4	4	4
25	14	6	14	11
26	19	9	15	11
27	24	11	15	0
28	9	6	4	5

Run 1 continued.

Subject	Visualp	Radarp	Deccap	Otwo
1	17	0	10	1.93
2	5	0	5	2.00
3	2	0	14	1.94
4	6	1	4	1.94
5	9	0	6	1.90
6	6	6	6	2.11
7	7	7	4	2.22
8	8	0	6	2.00

9	0	0	10	1.95
10	4	4	5	1.80
11	10	4	8	1.71
12	4	1	12	1.59
13	7	3	0	1.93
14	6	0	8	1.65
15	3	1	10	2.06
16	4	4	8	2.18
18	6.6(E)	3.8(E)	7.6(E)	1.90
19	6	3	8	1.94
20	3	5	16	1.98
21	8	7	6	1.84
22	9	4	8	1.93
23	9	6	6	1.91
24	5	4	10	2.00
25	12	0	5	1.77
26	9	8	4	1.77
27	8	2	0	1.74
28	8	1	8	1.74

Run 2

Subject	Oscore	Pscore	Lights	Error	Time
5	2.32	1.94	14	2.54(E)	10.00
6	2.21	1.83	5	2.54(E)	14.00
7	2.20	2.00	16	2.54(E)	12.00
8	2.44	2.18	13	2.54(E)	14.00
9	2.33	2.40	7	1.2	6.00
10	2.19	1.71	18	4.7	6.00
11	2.27(E)	1.47	2	8.4	17.54(E)
12	2.17	2.42	19	2.5	19.00
13	2.27(E)	2.05(E)	14	2.5	14.00
14	2.12	2.00	15	2.0	16.00
15	2.44	2.72	12	0.5	19.30
16	2.39	2.14	13	0.5	22.00
17	2.41	2.25	14	2.54(E)	13.20
18	2.22	2.58	7	0.6	17.54(E)
19	2.46	2.00	0	2.54(E)	29.00
20	2.30	2.46	4	0.8	39.00
21	2.34	1.96	14	2.54(E)	15.80
22	2.49	2.09	11	4.0	11.60
23	2.40	1.94	6	1.5	23.00
24	2.29	2.07	14	4.2	11.30
25	2.12	1.88	11	1.9	30.00
26	2.47	1.85	19	2.54(E)	19.00
27	1.87	1.55	10	0.4	24.50
28	1.85	1.79	18	0.6	17.10

Run 2 continued.

Subject	Toline	Moline	Permore	Position
5	0	6	100	6
6	6	2	25	8
7	0	4	100	4
8	6	2	25	8
9	10	0	0	10
10	7	0	0	7
11	6	1	14	7
12	5	7	58	12
13	5	0	0	5
14	4	5	56	9
15	5	3	38	8
16	0	6	100	6
17	9	0	0	9
18	5	0	0	5
19	5	0	20	6
20	2	7	78	9
21	7	2	22	9
22	4	4	50	8
23	12	1	8	13
24	2	3	60	5
25	7	1	13	8
26	13	0	0	13
27	5	1	20	6
28	10	0	0	10

Run2 continued.

Subject	Visual	Decca	Radar	Sounder
5	6	6	7	0
6	9	7	12	3
7	5	4	10	1
8	6	6	3	1
9	9	7	9	5
10	8	4	10	5
11	11.5(E)	7	11.5(E)	5.6(E)
12	26	14	7	7
13	16	0	10	11
14	14	9	18	1
15	7	10	14	1
16	6	8	17	6
17	10	9	9	6
18	5	4	8	1
19	11	14	20	7
20	19	11	21	18
21	12	7	14	14
22	9	10	10	6
23	11	11	15	3
24	10	8	10	3
25	14	12	18	12
26	12	11	15	15
27	23	6	28	3
28	19	4	11	5

Run 2 continued.

Subject	Visualp	Radarp	Deccap	Otwo
5	8	2	7	2.08
6	7	7	4	1.93
7	7	3	7	1.95
8	6	2	9	1.80
9	4	4	12	2.00
10	6	6	2	1.82
11	8	8	2	1.93(E)
12	6	0	20	1.75
13	6	5	0	1.93
14	9	7	9	2.10
15	1	3	16	2.10
16	7	5	10	2.03
17	7	4	14	1.96
18	1	3	8	1.93
19	6	4	6	2.07
20	6	2	18	1.84
21	9	9	8	1.85
22	7	6	8	2.03
23	10	10	8	2.00
24	5	5	6	1.93
25	2	4	6	1.85
26	10	10	6	1.97
27	8	4	1	1.70
28	11	7	6	1.76

APPENDIX NO.4

The Simulator Lights.

1 The operation of the lights.

The bulbs were wired in groups of 5 on a board which stretched across the end of the simulator above the chart table (Chapter 4, figs 1 and 5). They were set to flash on and off by the controller in a manner which would appear random to the subjects who were asked to log all the lights they observed.

To make this task as realistic as possible the the subjects were asked to log the lights in the same manner as they would have at sea: thus the centre light was logged as "ahead", the lights at each end as on the port and starboard beam respectively, while the remaining lights were logged as 4 points (45 degrees) to port and starboard.

The order and approximate time in minutes into the experiment when the lights were exhibited is shown in the following table:-

APPENDIX NO.4

The Simulator Lights.

1 The operation of the lights.

The bulbs were wired in groups of 5 on a board which stretched across the end of the simulator above the chart table (Chapter 4, figs 1 and 5). They were set to flash on and off by the controller in a manner which would appear random to the subjects who were asked to log all the lights they observed.

To make this task as realistic as possible the the subjects were asked to log the lights in the same manner as they would have at sea; thus the centre light was logged as "ahead", the lights at each end as on the port and starboard beam respectively. while the remaining lights were logged as 4 points (45 degrees) to port and starboard.

The order and approximate time in minutes into the experiment when the lights were exhibited is shown in the following table:-

Lights exhibited in the Simulator.

Number	Time	Colour	Bearing
1	01	Green	Ahead
2	03	White	4 Pts. Stbd.
3	05	Green	4 Pts. Stbd.
4	07	Green	Stbd. Beam
5	09	Fl.Red	Stbd. Beam
6	10	Green	Port Beam
7	11	Red	4 Pts. Port
8	13	Red	Stbd. Beam
9	15	White	Port Beam
10	18	White	Ahead .
11	19	Red	Port Beam
12	20	Red	4 Pts. Port
13	21	White	Ahead
14	23	Red	4 Pts. Stbd.
15	25	Green	4 Pts. Stbd.
16	28	White	Stbd. Beam
17	29	White	4 Pts. Port
18	30	Occ. Green	Port Beam
19	31	Red	Ahead

2 The construction of the equipment.

Refer to diagrams 1 and 2.

IC1a was half of a dual timer connected to an astable, the output of which was connected to a divide by sixteen binary counter IC3.

The output of IC3 consisted of four binary coded lines which were fed into IC5 & IC6 which switched the normally high outputs to low for approximately 45 seconds. These outputs switch sequentially from 1 to 16 on IC5 and then are disabled by IC4 which was connected as a divide by 2 counter to switch on IC6 for a further count of 1 to 16 giving a total of 32 outputs.

The outputs of IC5 & IC6 were connected to a number of L.E.D. which had their cathodes connected to +5volts so that as each output went low it switched on the appropriate L.E.D.

IC1b was connected as a monostable and set to give an equal mark-space ratio of one to one which was connected to a medium flash L.E.D.

IC2 was a dual timer connected as a pair of astables one half of which was set to give a higher P.R.F. than

I.C.1b which resulted in a faster flash rate than the medium flash L.E.D.

IC2b was set to give an unequal mark-space ratio so that the output was high for a longer period than the low (Occulting L.E.D.). A fast /reset switch was fitted so that the cycle of switching always started at L.E.D.1. The sequence of switching could be quickly checked by the fast position which would run IC1a at a higher P.R.F.

APPENDIX No. 5.

Advance Publications.

While the experiments described in this thesis were being carried out two papers were presented covering some of the work described here:-

1) "Coastal Navigation as practiced", Paper read to a joint seminar of the Royal Institute of Navigation and the Nautical Institute on Practical Navigation in Coastal Waters. London December 1978.

2) "Should Navigation Aids be Integrated?" paper read to a joint seminar of the Royal Institute of Navigation and the Nautical Institute on the Selection and Display of Navigational Information. London December 1981.

Coastal Navigation as Practiced

Captain J. Strange, BSc, MRIN, MNI

City of London Polytechnic

Most accident investigations point to the human element as being the main cause. Recently we have the Christos B grounding off the Coast of South Wales in a position that casts doubts on the methods of navigation employed. A common theme in most of the published reports on strandings is that the means available to prevent the stranding or at least alert the crew to the possible danger was available on board but had somehow been ignored. Today with the consequences of large scale pollution we are seeing a new interest in shipping safety and the old idea of interest in a stranding only being the concern of the owner and underwriter is no longer acceptable.

There are two current approaches to reducing accidents, one is to ensure that the ships are properly equipped and the equipment is in working order. Secondly it is important that ships crews are properly trained and able to operate the equipment.

The approach for the research described in this paper has been to examine how seafarers navigate in practice rather than in the artificial situation which exists for much of the chartwork teaching. This research is needed because of the pressure to improve standards. Some of the pressure relates to training but more seriously there are moves to require certain types of equipment to be fitted although there is no guarantee that this action will reduce accidents and it could make the situation worse by encouraging decisions based on an inadequate understanding. The research is divided into two parts. Firstly, and already completed is experimentation based on chart exercises to investigate the subjects' reaction to various aids. Secondly, and in the planning stage, is a more realistic approach where the subjects will be presented with video displays of the various aids and their use of the aids will be examined.

In the first part the subjects were presented with cards containing navigational information and they were asked to indicate on the chart provided what they considered their position was. They were presented with more information than necessary to fix their position and it was how they coped with the extra information and whether they rejected any, that was being examined. The area chosen for the experiments was the Bristol Channel and chart number L D1 1179 was used. The Bristol Channel has the advantage that there is land on both sides and so it is possible to use a number of different aids to produce various patterns of position lines. With the number of different ports and lack of separation schemes it is possible to put the ship on a number of different but realistic courses.

The subjects were taken from among students studying for their Master's certificate at the College. The group was chosen because of their watchkeeping experience, ranging from 5 years to 15 and it was expected that their reactions would be representative of the standards at sea today.

The experiments were conducted in two phases, firstly a pilot

study and when this confirmed the validity of the approach and showed some interesting results it was followed by a further experimental programme on a larger scale.

The results of the experiments were interesting for a number of reasons. The Navigational aid was found to be the most important factor in determining the choice of a position and from the results an order of preference can be built up. Visual bearings is the favourite, many of the subjects remarking that they would always use visual bearings where possible. Decca and Radar shared second place, a result that was surprising as Radar appears to have the advantage of giving a picture of the situation while Decca only gives a coordinate position. It seems that the subjects had considerable experience of Decca to give this confidence in the position. D.F. came last, many of the subjects remarking that they only considered it to be of use as a last resort. Some of the exercises were designed to see at what stage subjects would use the D.F. in preference to other aids and a number of subjects showed a preference for doubtful visual bearings instead of a good fix with three D.F. bearings. These results seem to show that instead of objectively using the best aid for any situation many of them have fixed opinions of the various aids which they apply, regardless of the situation. Whether these views are based on their own experience or were obtained from other seafarers is not known.

When it came to deciding on a position the main criteria was the aid used, most of the subjects choosing a position defined by their favourite aid and ignored the other information. Another possible influence was to take a position that was closest to a possible danger although in many cases because of the ship's course the ship was already clear of any threat. The similar method of deciding on a position that puts the ship furthest ahead was not taken up. Again this seemed to be an instinctive rather than a rational decision. The most interesting result was that the subjects tended to avoid the centre of a number of position lines or any position that represented a mean of several possible positions, and representing an estimate of the most probable position. It seemed that they were content to accept the position defined by their favourite aid and use the other information as a check on gross error, but not to try and use it in order to arrive at a better estimate of their position. Some of the exercises were more complicated, involving more than two aids, or involving one aid only with three position lines. In these cases the results showed a random choice without any clear preference for any particular strategy.

Two main conclusions seem to emerge from this work. Firstly that the seafarers choice of aid and position is arrived at as much by personal preference as by any appreciation of the situation. Secondly that seafarers have not learned how to use several aids together to get the best of each one. This work seems to indicate that better training might be a more effective way of reducing accidents than to put more equipment on a ship and possibly cause further confusion.

SHOULD NAVIGATION AIDS BE INTEGRATED?

Captain J.L. Strange, City of London Polytechnic

Today the navigator's problem is no longer one of lack of information, as with the technology available there need no longer be any doubt about a ship's position. Rather, the problem is that there can be too much information instead of too little. This revolution has not eliminated accidents, but the matter is now one of presentation, and navigational safety becomes a matter of communication and information management.

One method of improving communications would be to present all the navigational information in one integrated display. This would certainly eliminate some of the problems that exist today and could mean that the navigator needs less training, which should prove popular in today's economic climate. This would mean that, to some extent, the safety of the ship is transferred from the navigator to a computer programmer which might not necessarily be an advantage.

This paper is based on research carried out at the City of London Polytechnic. It was carried out in two stages, using students studying for their Master's Certificate as subjects for the experiments. They were chosen to give as homogeneous a sample as possible, both in terms of experience and age, without the group being too restricted.

The first stage of the work consisted of presenting the subjects with cards containing navigational information, which they were asked to plot on a chart and to decide on the basis of this information what they would consider to be the ship's position. In every case the information, when plotted, produced a 'cocked hat' and it was the subjects' estimate of position in relation to this cocked hat that was of interest. From this work a number of conclusions emerged:-

- 1) It was possible to establish an order of preference for the different navigational aids. Visual bearings were the most popular, followed by radar and Decca, but it was not possible to separate these two. The radio direction finder proved to be the least popular.
- 2) The subjects preferred an intersection of position lines for a position rather than some sort of weighted position among a number of lines.

The second stage of the work was the construction of a simple simulator with the help of some money from Shell International Marine. This was based on the use of three video recorders each playing a tape on which had been recorded information from the radar, Decca navigator and echo sounder on board the Sir John Cass. The subject was able to display any of this information on a television monitor by pressing the appropriate button. Visual bearings were simulated by means of a slide projector where a scale was superimposed on a photograph of the particular mark. A pen recorder was used to record the

time that the subjects spent watching each individual aid. In addition a number of lights were shown for short periods from different positions in the simulator and the subjects were asked to log the position and colour of each light which they observed. Each subject was asked to complete two separate half hour runs along the Suffolk coast, monitoring the ship's position during this period and finally producing an E.T.A. and a course to steer for a point further ahead.

The output of these experiments was the accuracy of the subjects' navigation based on the error in their E.T.A. and the number of lights which they observed. The inputs were the uses that the subjects made of the various aids which were available to them. The relationships between these parameters were used to try and build up a picture of how the subjects navigated.

When the errors in the E.T.A. were examined on their own they showed a bunching at the lower end of the scale, the majority being about one mile. For the purpose of this experiment errors of greater than four miles were treated as blunders and all the tests involving errors were carried out both with and without the blunders included. The accuracy of the navigation for the different subjects was correlated against the other parameters which were, preference for visual or electronic position fixing, time watching the aids, choice of two or more than two position lines and number of positions plotted during the experiment. The only significant result was a negative correlation of time watching the aids and errors, but when this test was repeated with the blunders removed it became non significant. It was not possible to come to any firm conclusions about the blunders because of the small size of the sample, only three out of a total of 25 runs but even so this seemed to be too many. It did seem that the majority of blunders occurred when the subjects spent less than the average amount of time watching the navigational aids so there may be some connection here.

The fact that it was not possible to demonstrate any other correlation between the errors and the other parameters demonstrates that the subjects, all qualified and experienced navigators, were able to manage a straight forward navigational task without any difficulty. The fact that it did not seem to make any difference how they navigated, whether they preferred electronic aids or visual bearings, whether they preferred to use two lines for a fix rather than three or more, or how frequently they fixed their position, seems to demonstrate that over the time that they have been watchkeeping they have evolved their own methods of navigation and under normal circumstances these produce acceptable results.

The second output was the number of lights observed. This differs from the navigational errors output in that there was a much wider distribution, some subjects observing all 19 lights while others observed very few. This seems to demonstrate that the subjects gave priority to the navigation and treated the task of logging the lights as of secondary importance, which in fact was the intention of the experiment. This particular result cannot be generalised to other situations, for a navigator's decision on priorities must depend on each set of circumstances.

The number of lights logged was correlated with the other parameters in the experiment, and this time there was a negative correlation between the number of lights observed and the time the subjects spent watching the navigational aids; the longer they spent watching the aids the fewer the lights they observed. This result when examined in conjunction with the errors in navigation suggests that, although the navigators managed to achieve acceptable results in terms of errors, the length of time they needed to study the aids in order to achieve those results varied and those who spent longer looking at them were less able to attend to the other watchkeeping duties as represented by the lights. This was the only correlation between the lights observed and the other parameters, and seems to show that it did not make much difference what aids the subjects watched although there could be some evidence that some of the subjects were unable to identify the marks for the visual bearings and this took time. There was no relationship between the time taken and the number of positions on the chart, whether the positions consisted of two or more position lines. From this it would seem that it does not take very long to plot a position on the chart so the subjects should be able to plot more than two position lines in the time available. What did emerge was that the subjects showed a preference for using only two lines to fix their position rather than the more generally accepted method of using at least three, although most subjects plotted a few positions with three lines, presumably as a check.

From this work a number of arguments for and against the integration of navigation systems appear.

The main arguments in favour are:-

- 1) Most navigators prefer a position at the intersection of two position lines, even to the extent of not plotting more than two lines. Even when more than two lines are plotted there is a strong rejection of some sort of weighted mean position. In an integrated navigation system this weighting could be carried out by a computer to produce more accurate results.
- 2) The choice of aids could be carried out more logically. From this work there is evidence that some of the subjects made rather unwise choices of aids. In particular the radio direction finder was not included in the second part of the work because of its almost complete rejection in the first part. There is also some evidence that the subjects' prejudices play a part in the selection of the aids.
- 3) Some of the subjects spent rather a long time watching the aids to the detriment of other aspects of the experiment. An integrated display could speed up the process while at the same time allowing the watchkeeper to attend to his other duties.
- 4) An integrated display could be designed to reduce the influence of blunders.

The arguments against an integrated system are:-

- 1) It would be difficult to produce a safe computerised system to deal adequately with the different situations which might occur.
- 2) Those subjects who are happy to navigate using mainly two position lines may accept positions from an integrated system without properly checking them. There may be a temptation for all navigators to omit checking, unless there is some system built in which requires it to be carried out.
- 3) A strong preference was demonstrated for visual bearings, but these would be difficult to integrate into the system and so the introduction of such a system might lead to their falling into disuse.
- 4) Most aids in use today give some indication of the reliability of their results; the mark for a visual bearing must be identified, and the quality of the radar picture gives some idea of the accuracy of the fix. One exception is the satellite navigation system where the navigator is usually presented with a 'take it or leave it' situation and he has no way of evaluating how good the information is. If this becomes the case with integrated systems then there will be some risks involved in using them.
- 5) In the experiments, some of the subjects performed very well, but if they were given an integrated system is there not a danger of boredom and reduced alertness?

Conclusion

There seem to be arguments both for and against an integrated system. Before it is possible to decide whether these systems are desirable the system itself must be defined, and the checks in the system examined. The work has demonstrated that the standards of merchant navy navigation could be improved. The question is whether to seek this improvement by using some sort of computer, by trying to improve the skills by better training, or, what is more likely, some combination of both that still leaves the navigator in the loop and being able to decide how his ship should be navigated.

Attention is drawn to the fact that the copyright of this thesis rests with its author.

This copy of the thesis has been supplied on condition that anyone who consults it is understood to recognise that its copyright rests with its author and that no quotation from the thesis and no information derived from it may be published without the author's prior written consent.

VI