



## WestminsterResearch

<http://www.wmin.ac.uk/westminsterresearch>

### Visualization of scientific arts and some examples of applications.

**N. Fujisawa<sup>1</sup>**  
**K. Brown<sup>2</sup>**  
**Y. Nakayama<sup>3</sup>**  
**J. Hyatt<sup>2</sup>**  
**T. Corby<sup>4</sup>**

<sup>1</sup> Visualization Research Center, Department of Mechanical Engineering, Niigata University

<sup>2</sup> Manchester Institute for Research and Innovation in Art and Design, Manchester Metropolitan University

<sup>3</sup> Future Technology Research Institute, Tokai University

<sup>4</sup> School of Media, Arts and Design, University of Westminster

Reprinted from Fujisawa, N. and Brown, K. and Nakayama, Y. and Hyatt, J. and Corby, T. (2008) Visualization of scientific arts and some examples of applications. Journal of Visualization, 11 (4). pp. 387-394, Copyright (2008), with permission from IOS Press. It is available online at:

[http://www.jov.jp/abstract/Vol11\\_No4/fujisawa.html](http://www.jov.jp/abstract/Vol11_No4/fujisawa.html)

---

The WestminsterResearch online digital archive at the University of Westminster aims to make the research output of the University available to a wider audience. Copyright and Moral Rights remain with the authors and/or copyright owners.

Users are permitted to download and/or print one copy for non-commercial private study or research. Further distribution and any use of material from within this archive for profit-making enterprises or for commercial gain is strictly forbidden.

---

Whilst further distribution of specific materials from within this archive is forbidden, you may freely distribute the URL of WestminsterResearch. (<http://www.wmin.ac.uk/westminsterresearch>).

In case of abuse or copyright appearing without permission e-mail [wattsn@wmin.ac.uk](mailto:wattsn@wmin.ac.uk).

## Regular Paper

# Visualization of Scientific Arts and Some Examples of Applications

Fujisawa, N.\*<sup>1</sup>, Brown, K.\*<sup>2</sup>, Nakayama, Y.\*<sup>3</sup>, Hyatt, J.\*<sup>2</sup> and Corby, T.\*<sup>4</sup>

- \*1 Visualization Research Center, Department of Mechanical Engineering, Niigata University, 8050 Ikarashi-2, Nish, Niigata, 950-2181, Japan.
- \*2 Manchester Institute for Research and Innovation in Art and Design, Manchester Metropolitan University, Righton Building, All Saints, Manchester, UK.
- \*3 Future Technology Research Institute; Tokai University, 3-56-2 Higashi-Oizumi, Nerima-ku, Tokyo 178-0063, Japan.
- \*4 Centre for Research in Education, Art and Media, University of Westminster, School of Media Art and Design, Northwick Park, Harrow, HA1 3TP, UK.

Received 30 November 2007  
Revised 25 May 2008

**Abstract** : In this paper, implementation and visualization of scientific arts are described using some examples of application in subject research areas, such as sculpture, archeology, fine arts and information aesthetics, which have been discussed through the Scientific Art Session at FLUCOME9, Tallahassee, Florida, 2007-9. In the application to sculpture, stereo visualization techniques, such as anaglyph stereo visualization and integral imaging technique, are introduced to realize the three-dimensional geometry of sculpture to enhance visual impact on the art. The second application is the flow visualization technique for archeology, where the vortices behind the river stones are studied to understand the origin of patterns on Jomon pottery. Interestingly, such vortex patterns also appear in the paintings of fine arts. The third example is the visualization of information aesthetics, where the Web information, such as public media and stock market, are visualized through scientific techniques. These examples of visualization of scientific arts provide the present state of the art in interdisciplinary visualization.

**Keywords** : Visualization, Scientific arts, Sculpture, Archeology, Fine arts, Information aesthetics.

## 1. Introduction

In recent years, the research field of visualization has extended to wider academic area, which covers art, social science, education, archaeology, literature and so on. Such academic areas of interests are called scientific arts in the society of visualization (Fujisawa and Nakayama, 2008). Therefore, there is a chance to expand the academic interests of scientists and artists through visualization research. Although there are several international conferences, which deal with the interdisciplinary concept for both the scientists and artists, there are few conferences focused on the visualization of invisible phenomena visible through scientific and artistic points of view. In September 2007, a special session was held focusing on the visualization of scientific arts at the 9<sup>th</sup> FLUCOME at Tallahassee, USA. The topic of interests at this special session was visualization of scientific arts, so that the academic specialists on visualization came together and discussed recent advances in the visualization of scientific arts, in areas of research such as sculpture, archeology, fine arts and information

aesthetics.

Visualization of scientific arts has been a topic of interests in recent years, since the application of flow visualization technique to the archaeology by Nakayama et al. (2004), who explain that the surface pattern on the Jomon pottery comes from the vortex pattern observed on the flow behind the reeds, stones, piles, etc. on the river. The other example is the interdisciplinary education for both engineering and art students through the images of fluid flow (Hertzberg and Sweetman, 2005). Later, Fujisawa et al. (2007) classified the flow visualization techniques into four groups, which are applicable to the generation of fluid art. Burge (2007) shows the flow visualization techniques for application to fluid art, and presents some examples of visualization. More recently, network pattern (Uchida and Shirayama, 2007) and rhythmical movement of gymnasts (Sakashita et al., 2007) are studied through the application of visualization techniques, which are originally developed in the scientific research field.

The purpose of this paper is to study the recent advances of interdisciplinary visualization through some examples of applications to scientific arts, such as sculpture, archeology, fine arts and information aesthetics. A special attention is placed on the three-dimensional imaging of sculpture, the role of vortices on the Jomon pottery and on the fine arts, and visualization of information aesthetics.

## 2. Three-Dimensional Visualization of Sculpture

### 2.1 Anaglyph Stereo Visualization

Anaglyph stereo visualization is one of most economical methods for visualizing the depth information of three-dimensional target objects. This method is most popular among three-dimensional visualization techniques, but it lacks the visual quality in comparison with other three-dimensional methods. The visual quality comes from the procedure for generating the anaglyphs. Usually, anaglyph stereo images are generated by simply synthesizing the image pair taken from a binocular camera having a lens distance of the human eyes. Therefore, the validity of the depth information on the anaglyph images has not been confirmed in the generated anaglyph images (Ideses et al., 2005). In order to overcome such a problem, a new technique of anaglyph stereo visualization has been developed using a single camera image in combination with depth information (Matsuura and Fujisawa, 2008). This method can remove the image noise from the depth information by filtering, so that the generated anaglyph image has accurate depth information without image noise. Therefore, this method fits the anaglyph stereo visualization of scientific art, such as sculpture.

Figure 1 shows an example of anaglyph stereo image generated by this method using depth information and a single image of sculpture taken by a CCD camera (648 x 494 pixels). Note that the depth information was taken from the stereo observation of sculpture using two parallel CCD cameras (648 x 494 pixels) placed side by side. The results are shown for the planar image of sculpture (a), depth information (b), and the generated anaglyph image. It should be mentioned that the depth information is obtained from the parallax displacement analysis between two images of the

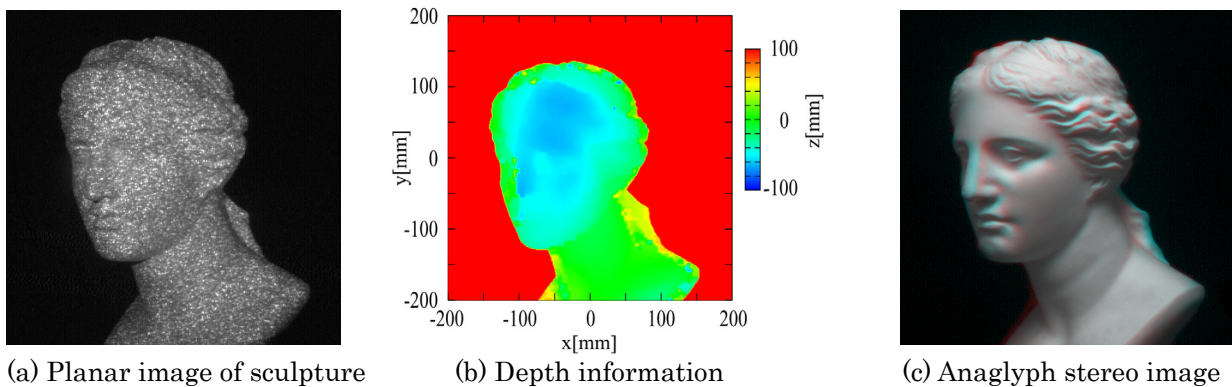

Fig. 1. Example of anaglyph stereo image of sculpture.

random-dot-pattern projected on the sculpture. The analysis was made by the correlation-based template matching technique with sub-pixel interpolation (Kiuchi et al., 2005), which allows the determination of the parallax displacement with high accuracy. Assuming that these two cameras are placed parallel, the depth information can be easily determined by the parallax displacement. The correlation window size is set to 23 x 23 pixels. The depth information of the generated anaglyph can be observed through the red-cyan glasses.

## 2.2 Integral Imaging Technique

With the advent of computer modeling and photorealistic rendering it has been possible to simulate this technique in order to visualize otherwise impossible 3D topologies, generated in the cyber environment, and to see them in a naturally sighted way in true space. Integral imaging is similar to holography but uses incoherent light, as opposed to coherent laser light, to realize 3D images.

3D computer generated models may be rendered by the integral imaging technique using special software and output as either printed screen based, or projected images (Fig. 2). In all three outputs formats the 3D images can be seen to exist in true space. In the case of print and screen based media the spectator may place their hand into the space of the image. In the case of large screen projection systems participants may be seen to occupy the same space as the 3D integral objects. One of the main differences between modeling in the cyber environment and traditional means of modeling is that objects and their surfaces are able to pass through each other without resistance. It is not possible outside of the computer to push a plastic material through another so that they both share the same x, y, z location in space. This digital possibility facilitates a completely new way to conceive of form, thus constituting a paradigm shift in the design of three-dimensional sculptural objects. In this technique the 3D integral object can be seen to straddle the picture plane (Fig. 3) and in the projection technique the whole of the integral object exists in true space. For computer generated source images to be used in the integral imaging large screen projection system,

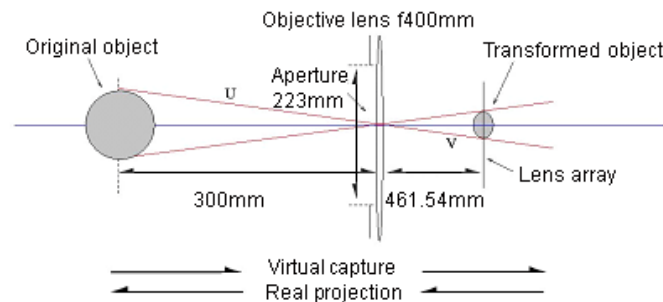

Fig. 2. Objective/projection lens parameters.

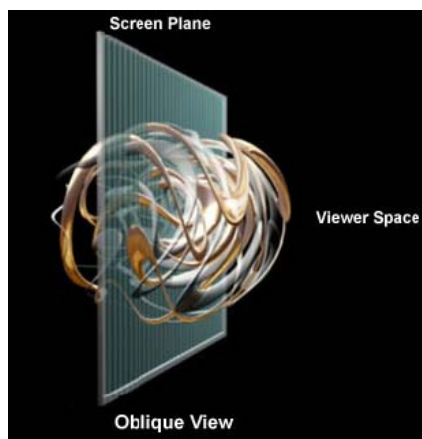

Fig. 3. Description of integral imaging technique.

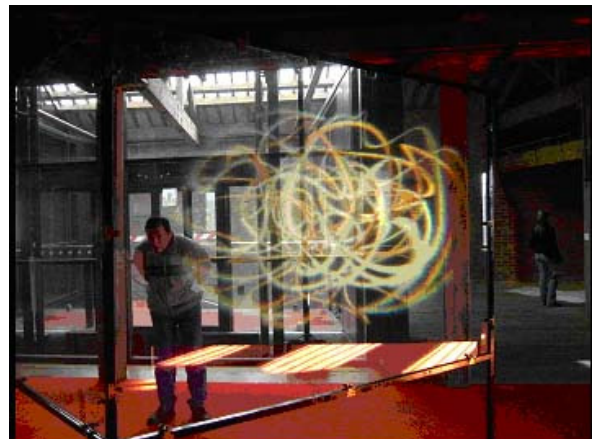

Fig. 4. 3D images at Museum of Science & Industry in Manchester.



the scene data has to be transformed (scaled) by a large aperture objective lens (Fig. 2). This “virtual” objective lens was created with the same parameters as the “real” projection lens used in the integral projector (as seen at the Museum of Science & Industry in Manchester) (Fig. 4), this ensures that the projected image is correctly scaled back to full life-size.

Being able to visualize semi-transparent objects, revealing their interior rather like an X-ray, makes visible otherwise obscured information. This presents new possibilities for the development of sculptural forms that can only be conceived with this degree of complexity in the cyber environment. The medium behaves rather like liquid or gas but is actually closer to a method for modeling light. Integral images exist in natural light and can be seen without the need to wear special viewing media to see the 3D element.

In the 3D image (Fig. 4) taken at the Museum of Science & Industry in Manchester, Professor Malcolm McCormick of Create-3D, can be seen to occupy the same space as the projected integral image. The image is a single frame from a twelve minute 3D animation developed especially to utilize this technique. The 3D projected integral images are seen to pass through each other. In an interdisciplinary Sci-Art project with Create-3D since 2000, when they were then part of the 3D Bio-Tech Imaging Group at De Montfort University. With innovation from both the art and science sides of the project we have developed sculpture unique to this environment and the process of visualization. For more detail discussion see Brown (2007).

### 3. Visualization of Vortices in Archeology and Fine Arts

#### 3.1 Vortices on Jomon Pottery

It is said that the Jomon period began 12,000 years ago and continued till 2,500 years ago. The potteries of that age are called Jomon pottery. Jomon pottery has been discovered in various parts of Japan. Among them, the pottery named Kaen-Suimon pottery discovered from Umataka ruin in Nigata prefecture of Japan in 1931 has an excellent shape as shown in Fig. 5. This pottery was made about 4,500 years ago. The splendid design on the side wall is the plastic arts patterned of twin and Kármán vortices. It is very likely that the Jomon people watched the twin vortex and Kármán vortex appearing on the river flow behind the reeds, stones and piles, etc. with the floating particles like pollens of cedar and pine trees, pollen leaves, petals, etc. acting as tracer as shown in Fig. 6. Then, the flow pattern seen on the rivers may have been copied on the Jomon pottery.

An experiment was performed to make sure of these phenomena. Using the recirculation type water tank, the vortices behind the reeds and various shapes of stones were visualized using the natural pollen of cedar and pine trees by the same method as 4,500 years ago. One example of the stones using the pollen of pine trees as tracer is shown in Figs. 7(a) and (b). For more examples of visualization see Nakayama et al. (2004 and 2007).

The vortex shown in Fig. 7(a) is the twin vortex of opposite rotating direction. The vortex shown in Fig. 7(b) is the mirrored S-shape Kármán vortex with alternately rotating vortices. The flow velocity of the latter is faster than that of the former (Yang and Lee, 2006; Zheng, 2007; Takama et al., 2007). It is understood that the Kármán vortex can be watched appearing as an S-shape and



(a) Side wall A (b) Side wall B  
Fig. 5. Kaen-Suimon pottery (Umataka ruin).



Fig. 6. Jomon people watching vortex.

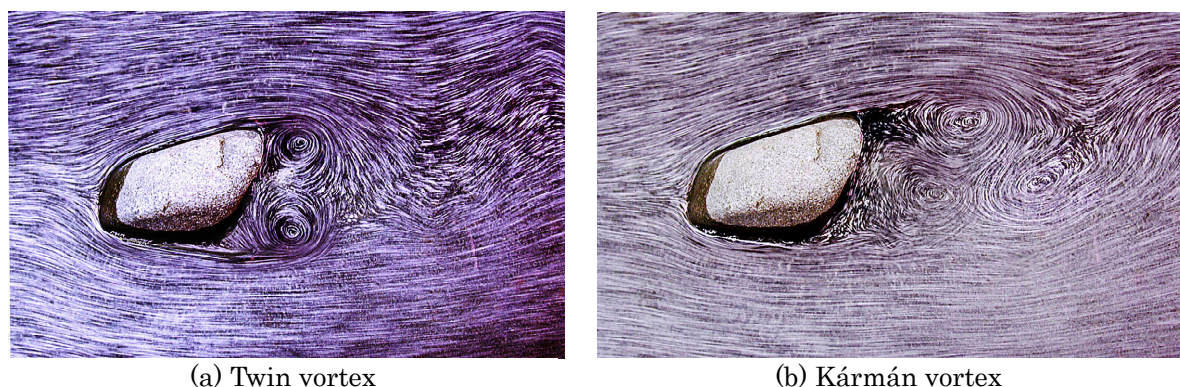

Fig. 7. Vortex behind a stone in a river visualized using pollen of pine trees.

a mirrored S-shape depending on the view points. During experiments, it was made clear that the stones in the river can produce the twin vortex at considerably high Reynolds number compared with the cylinder. The reason is thinkable by the effect of no symmetry shape and small vertical stripes for reeds and by the effect of the sharp rear edge and the upstream ramp for stones.

A Jomon man who recognized discriminating between twin vortex and Kármán vortex and made copies of them is a gifted man having as great powers of observation as Leonardo da Vinci. This discovery is very important to understand vortex phenomena and separated two kinds of vortex performed by the visualization.

### 3.2 Vortices in Fine Arts

Akin to the symbol for infinity, the twin spiral shape is a very basic abstract pattern that describes how sustainable development occurs. It can be applied to innumerable natural and therefore human processes. It is also well known that double spirals appear throughout the natural world in a Fibonacci sequence arrangement. This is seen everywhere in natural design from cauliflowers to galaxies. Within art and design the double spiral recurs as a formal device used sometimes consciously and other times instinctively. Double spirals appear not only in Jomon ceramics but also in, for example, prehistoric cave paintings; Chinese Buddhist temple carvings; Etruscan temples; William Morris' wallpaper patterns; Van Gogh's painted skies; Walt Disney's animations; and Nintendo's computer games. The original abstract shape from rock art is applied to depict multifarious media in growth or flow: plant tendrils, clouds, water, smoke, etc. Psychologically, it is hidden in plain view throughout human culture.

The experiment was carried out using a double spiral brush mark at varying scalar levels in the paint, which is shown in Fig. 8. Initially, watercolor paint was used because of the obvious flow properties. The image was allowed to emerge from the abstract spirals without premeditation applying as little conscious thought as possible during the physical involvement in the process. The resulting paintings were surprisingly beautiful and bore an uncanny resemblance to drawings by Leonardo da Vinci. Leonardo is an interesting case study in that he is also well known for being a polymath: an artist, engineer and scientist before the disciplines divided over the centuries.

Brain science tells us that we do not use both hemispheres of the brain to full capacity. The Turkish physicist, Bulent Atalay, talking of Leonardo in his book, *Math and the Mona Lisa*, suggests, "For artistic activity to thrive, the conjoining of both hemispheres of the brain appears to be important, or perhaps the various functions are not altogether the exclusive domain of one side or the other..." (Atalay, 2004). Intuition suggested, whilst engaged in the repetitive activity of painting the double spiral brushstroke, that this waking up of the other half of the mind was a reason for Leonardo writing backwards with his left hand. Therefore, both mindsets were used deliberately, as Leonardo did – attempting to link art and science.

The observation of Leonardo's drawing invited inquiry. It is hypothesized that possibly he was doing something that one cannot see immediately when viewing the work in the normal way from the front. The Hans Holbein's painting in the National Gallery of London depicts a distorted skull. When viewed from the front the skull in the center of the painting is not apparent but when viewed from



the right side the geometries reconfigure as the new perspective angle into the eyes reveals a perfectly painted human skull. Leonardo's drawings of landscapes were observed afresh and from the side, in the same way that the Mona Lisa's gaze looks out at us from her canvas. These were viewed closing the right eye, following a drawing in Leonardo's notebooks of a man is observing a landscape. Atalay (2004) has documented Leonardo's interest in the mathematical distortion of the visual: *anamorphosis*.

Let your mind go blank and your focus slip fractionally, close your right eye and view a Leonardo at an angle of some twenty-three degrees from where you hold it at your right hand side. Suffice to say, Leonardo's images are not solely what they appear to represent. Some landscape drawings also depict hidden interpretations. Hillsides, for example, can become dogs or lions and thunderstorms can become sets of godlike heads suggesting that flow patterns can simultaneously describe different natural forms depending upon one's viewpoint. Based on this research, it is suggested the geometries of flow are responsible for all natural manifestations of form dependent upon the position of the viewer.

Using Photoshop, specifically its twirl function, the Mona Lisa has been spun both clockwise and anti-clockwise making the rotations into transparent layers and overlaying them, which is shown in Fig. 9. A series of transformations can be done based on flipping the polar co-ordinates, which takes the middle to the perimeter and the edge to the center turning it inside out like kneaded bread dough. Then, the geometry is flipped from a square to a circle and back again repeatedly, literally squaring the circle and circling the square. One can observe from the results of the spiraling and spun Mona Lisa experiments that, when the geometry spirals in extremis into the center, eventually, the center starts to return back outward as a three-dimensional set of embedded object-like images. Then, the natural forms began to appear inside the spun and manipulated geometries, very much like the *anamorphosis* observed when studying Leonardo's work from the side. The resulting visualizations were reminiscent of those were previously studied in inquiry into the physics of flow. For more examples of visualization see Hyatt (2007).



Fig. 8. Underpainting, Hyatt, oil paint, 2007.

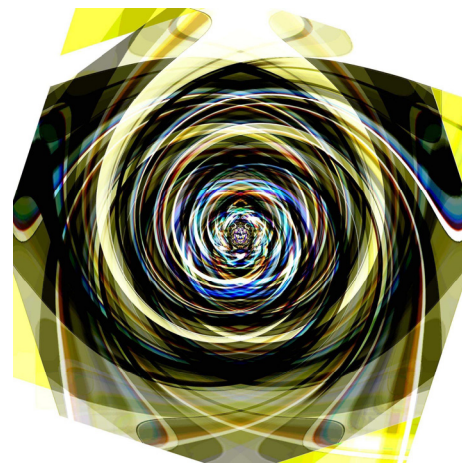

Fig. 9. Spun Mona Lisa, Hyatt, Photoshop, 2006.

#### 4. Visualization of Information Aesthetics

A series of projects that attempted to visualize social and behavioral relations on the Web was attempted by Corby and Baily (1995 - ongoing). *Reconnoitre* (Fig. 10), is an Open GL application written in C++, that combines an interactive 3D virtual environment, a dynamic behavioral model and a Web Spider search agent. The project takes textual information from Internet web pages and realigns it as an emergent three-dimensional structure in an installation environment. It functions by allowing a user to input search terms into a search term field which triggers a Web spider. This search engine returns relevant Web page "search hits" which are then parsed into readable word and

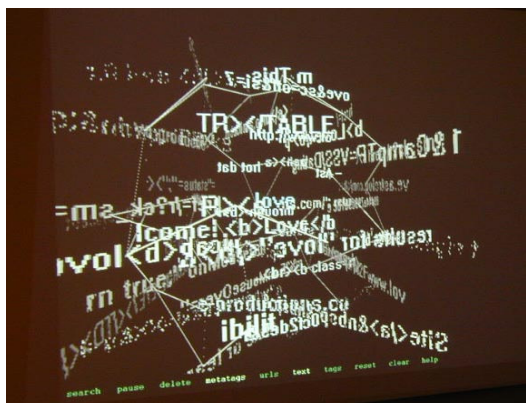

Fig. 10. Reconnoitre.



Fig. 11. Cyclone.soc.

sentence fragments of between 10 and twelve characters. This material is then given behavioral characteristics when seeded throughout the project’s three-dimensional environment in the form of search-term “result nodes”. Each of these nodes is charged with an electrostatic behavior that governs its relationship to the other search term results as positive and negative electrostatic interactions between nodes forces visual connections in the form of wireframe links. These structures dynamically re-configure in relation to the arrival of new search term material forming animated three-dimensional structures that metaphorically allude to the communication systems of the Internet. Each search term node also has a life-span, meaning that it decays through time and will eventually disappear from the environment. The overall effect is of an emergent textual structure, triggered by user search requests that continuously waxes and wanes in response to the underlying electrostatic mechanism. In doing so, the work re-imagines the Web as a living entity and introduces a metaphoric death into its technical infrastructures. This feature was designed to encourage users to develop “emotional relations” with the work through immersion in its behavioral and biological “rhythms”.

*Cyclone.soc* (Fig. 11) uses an edited concentrate of data from different storms derived from publicly available satellite forecasting for the eastern coast of the United States during the autumn of 2005. The information was then re-worked as vector animations traced from the original isobar projections using Adobe Illustrator and given depth, dimension and interactivity by being re-programmed using the Open GL platform. Conversations taken from Internet Newsgroups are then threaded along the vectored isobars in order to make the storm fronts appear as though they consist of the metaphoric swirl of human conversation. Navigating the work using the interactive controls then allows the audience to read and respond to these postings. In resituating newsgroup postings as weather precipitation, the project frees pictorial elements to act as metonyms for different types of cultural and ideological tension enabled and produced through technological domains and develops a suggestive link between these extreme belief systems and their potential wider ecological impacts on the material world.

Neither of the projects illustrated seek to produce visualizations for the traditional scientific purpose of spotting patterns and relationships in visual fields (cognition), i.e., there are no “results” to be inferred in the images. Rather both works provide opportunities for audiences outside of science to engage with the pictured phenomena on emotional and conceptual levels by employing visualization process to produce expressive works of visual art. For more examples and discussion see Corby (2007).

## 5. Conclusion

The recent progress of interdisciplinary visualization of scientific arts is described using some examples of application to the academic areas, such as sculpture, archeology, fine arts and information aesthetics. As examples of application to sculpture, the stereo visualization techniques, such as the anaglyph stereo visualization and integral imaging technique, are introduced to realize the three-dimensional geometry of target objects, which allow high visual impact in the art of



sculpture. The second application is the flow visualization technique to archeology, where the vortices behind the river stones are studied to understand the origin of patterns on Jomon pottery. Interestingly, such vortex patterns also appear in the field of fine arts and other fields, suggesting their importance to the visualization of all natural forms. The third example is the visualization of information aesthetics, where the Web information, such as public media and stock market, are visualized through the scientific techniques. These examples of visualization of scientific arts provide the present state of the art in interdisciplinary visualization.

### ***Acknowledgement***

The authors would like to thank Dr. F. Matsuura for his help in the preparation of anaglyph stereo image of sculpture.

### ***References***

- Atalay, B., *Math and the Mona Lisa, The Art and Science of Leonardo da Vinci*, (2004), Smithsonian Books, Washington, USA.
- Brown, K., *The Use of Integral Imaging to Realize Three Dimensional Images in True Space*, FLUCOME 2007 (Tallahassee), No. 160, (2007-9).
- Burge, P., *Hidden Pattern*, *Journal of Visualization*, 10-2 (2007), 171-178.
- Burkhardt, C. B. and Doherty, E. T., *Beaded Plate Recording of Integral Photographs*, *Applied Optics*, 8-11 (1969), 2329-2331.
- Corby, T., *Information Aesthetics: Data Visualization as Art*, FLUCOME 2007 (Tallahassee), No. 100, (2007-9).
- Fujisawa, N., Verhoeckx, M., Dabiri, D., Gharib, M. and Hertzberg, J., *Recent Progress in Flow Visualization Techniques toward the Generation of Fluid Art*, *Journal of Visualization*, 10-2 (2007), 163-170.
- Fujisawa, N. and Nakayama, Y., *Recent Progress in Visualization of Scientific Arts*, *Journal of Visualization Society of Japan*, 28-108 (2008), 15-21 (in Japanese).
- Hertzberg, J. and Sweetman, A., *Images of Fluid Flow: Art and Physics by Students*, *Journal of Visualization*, 8-2 (2005), 145-152.
- Hyatt, J., *The Application of Flow Geometries to Art Icons*, FLUCOME 2007 (Tallahassee), No. 192, (2007-9).
- Ideses, I. and Yaroslavsky, L., *Three Methods That Improve the Visual Quality of Color Anaglyphs*, *Journal of Optics A: Pure and Applied Optics*, 7 (2005), 755-762.
- Kiuchi, M., Fujisawa, N. and Tomimatsu, S., *Performance of a PIV system for combustor flow and its application to a spray combustor model*, *Journal of Visualization*, 8-3 (2005), 269-276.
- Matsuura, F. and Fujisawa, N., *Application of Anaglyph Stereo Visualization Technique Using Depth Information*, *Journal of Visualization*, 11-1(2008), 79-86.
- Nakayama, Y., Oki, M., Aoki, K. and Takayama, S., *Jomon Pottery Observed from the Point of View of Fluid Mechanics: Did Jomon People Discover Twin and Karman Vortices?*, *Journal of Visualization*, 7-4 (2004), 349-356.
- Nakayama, Y., Oki, M., Aoki, K. and Ratherkrishnan, E., *Vortices behind River Stones*, FLUCOME 2007 (Tallahassee), No. 91, (2007-9).
- Sakashita, R., Fujisawa, N., Matsuura, F. and Takizawa, K., *Anaglyph Stereo Visualization of Rhythmical Movements*, *Journal of Visualization*, 10-4 (2007), 345-346.
- Takama, Y., Suzuki, K. and Rathakrishnan, E., *Twin Vortices behind a Flat Plate*, *Journal of Visualization*, 10-3 (2007), 249.
- Uchida, M. and Shirayama, S., *Formation of Pattern from Complex Networks*, *Journal of Visualization*, 10-3 (2007), 253-255.
- Yang, C. J. and Lee, Y. H., *Vortex Flow Patterns of a Heaving Foil*, *Journal of Visualization*, 9-1(2006), 13-21.
- Zheng, Y., *The Visualization of Three-Dimensional Vortex Structures in a Mixing Layer*, *Journal of Visualization*, 10-1 (2007), 33-35.