

WestminsterResearch

<http://www.westminster.ac.uk/westminsterresearch>

Modelling the Perinatal Network System

Dalton, S.

This is an electronic version of a PhD thesis awarded by the University of Westminster.
© Dr Sarah Dalton, 2018.

The WestminsterResearch online digital archive at the University of Westminster aims to make the research output of the University available to a wider audience. Copyright and Moral Rights remain with the authors and/or copyright owners.

Whilst further distribution of specific materials from within this archive is forbidden, you may freely distribute the URL of WestminsterResearch: (<http://westminsterresearch.wmin.ac.uk/>).

In case of abuse or copyright appearing without permission e-mail repository@westminster.ac.uk

Modelling the Perinatal Network System

Sarah Jane Dalton

A thesis submitted in partial fulfilment of the requirement for the
degree of Doctor of Philosophy
in the
University of Westminster

This research was carried out in collaboration with Colchester Hospital University
NHS Foundation Trust.

April 2018

©Modelling the Perinatal Network System
SJ Dalton

SJ DALTON, 2018

Health and Social Care Modelling Group (HSCMG),
Department of Computer Science, Faculty of Science and Technology,
University of Westminster,
115 New Cavendish Street, London W1W 6UW, United Kingdom,
Telephone: +44 (0)20 7911 5000.

ABSTRACT

The topic is that hospital capacity for patient beds runs short. We wish to predict when this will occur. An inter-disciplinary approach to this problem is taken incorporating a Management Science / Operational Research perspective.

The subject is the Perinatal Network System, which is described, analysed and modelled. An illustrative Case Study is taken of an English local neonatal unit, where new-born babies are cared for. The focus is High dependency cots. Recommendations produced are subject to human factors and implementation difficulties.

In this work, Systems Thinking facilitates an understanding of relationships; Enterprise Architecture helps embed the context and address complexity; while Clinical Medicine underpins decision-making for individual patients.

Research outputs include the Conceptual Research Framework, a Quality Metric, a Cot Predictor Tool and a Markovian model Design, which can be adapted in the future. Furthermore there is the milieu or connective 'glue', to provide unity. The methodology or Enterprise Modelling helps address the issue by facilitating understanding of both overview and detail.

Table of Contents

Abstract.....	i
List of Figures.....	vi
List of Tables.....	ix
Acknowledgements.....	xi
Declaration.....	xii
List of Abbreviations.....	xiii
Chapter 1 Introduction.....	1
1.1 Introduction.....	1
1.2 Problem.....	2
1.3 Objective of the Study.....	3
1.4 Collaboration.....	3
1.5 Claim.....	4
1.6 Outline.....	4
Chapter 2 Literature Review.....	7
2.1 Introduction.....	7
2.2 Modelling in healthcare.....	9
2.2.1 Traffic Flow analogy for Patient Flow.....	12
2.2.2 Hospital traffic and shortage of capacity.....	13
2.2.3 Barriers to implementation.....	15
2.2.4 Development and use of models by clinicians.....	19
2.3 Modelling in intensive care.....	22
2.3.1 Modelling in Neonatology.....	23
2.3.2 Neonatal capacity.....	24
2.3.3 Non-clinical (capacity) transfers.....	25
2.3.4 Models of Patient flow.....	26
2.3.5 Length of Stay.....	28
2.3.6 Forecasting.....	30
2.4 Business Continuity.....	33
2.5 Mixed Methods Modelling.....	34
2.6 Enterprise Frameworks.....	37
2.6.1 Enterprise Architecture Frameworks.....	37
2.6.2 Enterprise Modelling Frameworks.....	39
2.6.3 Enterprise Modelling Frameworks in Healthcare.....	40
2.6.4 Operational Research Frameworks.....	41
2.7 Context of the Perinatal Network System as an Enterprise.....	47
2.8 Summary.....	48

Chapter 3 Conceptual Framework	49
3.1 Introduction.....	49
3.2 Research Question	50
3.3 Argument	51
3.3.1 The Ideal and imperfect	53
3.4 Proposed solution to research question.....	55
3.4.1 Enterprise Architecture Framework.....	56
3.4.2 Operational Research Framework.....	61
3.4.3 Enterprise Modelling Framework	70
3.5 Summary	82
Chapter 4 Case Study: Qualitative methods	85
4.1 Introduction.....	85
4.2 Case Study Framework	86
4.3 Formulation.....	87
4.4 Rationale, Informatics and Research Strategy	89
4.5 People.....	95
4.5.1 Ethics.....	95
4.5.2 Policy changes	96
4.6 Background to Case Study.....	98
4.7 Process mapping	100
4.7.1 System structure.....	103
4.7.2 Patient Flow	107
4.8 Quality / Complications	119
4.9 Quality Metric Recommendation.....	124
4.10 Summary	125
Chapter 5 Case Study: Quantitative Analysis	126
5.1 Introduction.....	126
5.2 Materials (Data and Software)	127
5.3 Methods.....	133
5.4 Newborn Population	135
5.5 Informatics Guide	138
5.6 Operational Analytics - Service	141
5.6.1 Intensive care cots.....	141
5.6.2 High Dependency cots	144
5.6.3 Special care cots.....	148
5.6.4 Daily changes in Cot occupancy	149
5.6.5 Length of Stay by level of Care	150

5.7 Patient Transitions	153
5.7.1 Definitions.....	153
5.7.2 Chart of Transitions	154
5.7.3 Arrivals to High Dependency care.....	157
5.7.4 High Dependency care stayers.....	158
5.7.5 Intensive care to High dependency transitions.....	160
5.7.6 Special care to high dependency care transitions.....	164
5.8 Medical Analytics	168
5.8.1 Length of Stay by Diagnostic Patient Group	168
5.8.2 Plurality, Birthweight and Social Conditions.....	174
5.8.3 Long-stayers.....	174
5.8.4 Effect of Corrected Gestation on Patient Transitions	176
5.9 Complications / Backward steps.....	181
5.10 Analytics Commentary	185
5.11 Analytics Discussion.....	187
5.12 Summary	188
Chapter 6 Cot Predictor Tool	189
6.1 Introduction.....	189
6.2 Prediction of Workload.....	190
6.3 Cot Predictor	191
6.3.1 Patient Flow Estimation.....	196
6.3.2 Definition of Terms.....	199
6.3.3 Assumptions.....	200
6.3.4 Conditions	201
6.3.5 Constraints	201
6.3.6 Basic Tool	203
6.4 Supply side. Operational data	205
6.5 Forecasting questions.....	211
6.5.1 Forecasting High Dependency cot Demand.....	213
6.5.2 Probability and proof of concept.....	214
6.5.3 Worked Example.....	217
6.6 Detailed Tool Specification	221
6.6.1 Distributions for Parameters	225
6.7 Further development of the Tool	227
6.8 Extensions of model with medical knowledge on individual patients.....	229
6.9 Summary	231
Chapter 7 Dynamic Modelling.....	233

7.1	Introduction.....	233
7.2	Dimension of Time	233
7.3	Markovian Modelling	234
7.4	Other Approaches	244
7.5	Dynamic Model Design	245
7.6	Data Considerations	245
7.7	Information Conundrums.....	246
7.8	Possible Experiments, scenarios and extensions.....	247
7.9	Summary	249
Chapter 8 Discussion		250
8.1	Introduction.....	250
8.2	Limitations of Method	250
8.3	Interpretation of Results.....	252
8.4	Critique of Research Framework	254
8.5	Healthcare Policy	256
8.5.1	Re-organisation of the NHS in England.....	257
8.5.2	Local Climate and Policy Implementation.....	258
8.6	Clinician-led Metrics	262
8.7	Recommendations.....	263
8.8	Clinician Reflection	264
8.9	Future Work.....	268
8.10	Summary	270
Chapter 9 Conclusion		271
9.1	Introduction.....	271
9.2	Contribution to Knowledge.....	271
9.3	Application.....	277
9.4	Dissemination	278
9.5	Publications during Research.....	279
Appendix.....		281
List of References		299

LIST OF FIGURES

Figure 1 Perinatal Network System Framework Model	62
Figure 2 Stocks and Flows within the local neonatal unit	66
Figure 3 Influences in Enterprise Modelling Framework for Perinatal Network System.....	73
Figure 4 Strategic Level.....	74
Figure 5 Operational Level	76
Figure 6 Patient Pathway	77
Figure 7 Generic Framework	78
Figure 8 Colchester General Hospital Timeline	97
Figure 9 Relationship between levels of care in a neonatal unit.....	101
Figure 10 Perinatal Network System	102
Figure 11 Local neonatal unit System.....	103
Figure 12 Case Study of local neonatal unit high dependency cots.....	103
Figure 13 Basic system	104
Figure 14 Basic factors in care processes	104
Figure 15 Relationships between dimensions	105
Figure 16 Case Study Systems Thinking	106
Figure 17 Patient Flow.....	108
Figure 18 Patient Pathway	108
Figure 19 Timeline for later gestation.....	111
Figure 20 Antenatal situation by gestation	111
Figure 21 Inter-hospital interaction diagram.....	112
Figure 22 Neonatal Admission Decision	113
Figure 23 Hypothetical neonatal capacity fluctuation	114
Figure 24 Neonatal unit Deadlock	115
Figure 25 Neonatal Network System Deadlock.....	116
Figure 26 Leverage points in Perinatal Network System.....	116
Figure 27 Neonatal processes by Birthweight	117
Figure 28 Process Mapping by Corrected Gestation.....	117
Figure 29 Diurnal Cycle of Neonatal unit work	118
Figure 30 Forward and backward patient flows.....	119
Figure 31 Quality and Complications	120
Figure 32 Pathways through the local neonatal unit	122
Figure 33 Live deliveries by gestation 2009-10 (HES)	136
Figure 34 Probability of birth gestation 2009-10.....	137
Figure 35 Arrivals by gestation and level of care at admission	139
Figure 36 Local neonatal unit's population Demand for care level by gestation	140
Figure 37 Range of daily intensive care cot occupancy 2009-12	142
Figure 38 Intensive care cot occupancy with standard error 2009-11	143
Figure 39 Comparative daily High dependency cot occupancy 2009-11	144
Figure 40 Probability of High dependency cot occupancy (2009-11) with standard error. 145	
Figure 41 Comparative Length of Stay at High dependency care 2009-11	145
Figure 42 Number of High dependency episodes by Length of Stay 2009-11	146
Figure 43 Proportion staying on High dependency care	146
Figure 44 Special care cot occupancy (2009-11) with standard error.....	148
Figure 45 Time trend in cumulative special care cot occupancy	148
Figure 46 Day to day changes in cot occupancies	149
Figure 47 Length of Stay for Intensive Care episodes.....	150

Figure 48	Length of Stay for High Dependency episodes	150
Figure 49	Length of Stay for Special care episodes.....	151
Figure 50	Markov transition diagram 2009	155
Figure 51	Stayer-mover model 2009-11	156
Figure 52	Linear model for direct Arrivals to High dependency.....	157
Figure 53	Proportion staying on High dependency truncated.....	158
Figure 54	Proportion staying on High dependency in full.....	159
Figure 55	Probability of leaving High dependency by elapsed LOS.....	159
Figure 56	Day of First transition from intensive care to High dependency care 2009-11 ..	160
Figure 57	Line diagram of intensive care stay prior to high dependency	161
Figure 58	Intensive care prior to high dependency 2009-11 – cumulative probability	162
Figure 59	Model of first patient transitions from intensive care to High dependency.....	163
Figure 60	Probability of move to High Dependency by elapsed LOS at intensive care.....	163
Figure 61	Length of stay at special care prior to first move to High dependency 2009-11	164
Figure 62	Line diagram of special care LOS prior to first move to High dependency	165
Figure 63	Special care stay prior to High dependency 2009-11 – cumulative probability .	165
Figure 64	Model of Transitions from special care to High dependency.....	166
Figure 65	Special care to High dependency move by elapsed LOS	167
Figure 66	Length of Stay at High dependency by medical condition.....	168
Figure 67	High dependency days per episode by condition and year.....	169
Figure 68	Average number of High dependency episodes by year and medical condition	170
Figure 69	Probability of leaving High dependency by elapsed LOS – long stayers.....	172
Figure 70	Probability of leaving High dependency by elapsed LOS - other	173
Figure 71	Cot Days by Corrected Gestation 2009	178
Figure 72	Destination by LOS at intensive care 2011	179
Figure 73	Local neonatal unit Decision making / neonatal pathway	180
Figure 74	Comparison of forwards and backwards steps by corrected gestation	181
Figure 75	Steps backwards by corrected gestation	181
Figure 76	High dependency and special care interplay by corrected gestation	182
Figure 77	Steps forward and backward from special care by corrected gestation.....	183
Figure 78	Percentage of backward steps by corrected gestation.....	183
Figure 79	Normal and Atypical pathways through the neonatal unit	184
Figure 80	System Diagram for local neonatal unit	192
Figure 81	Modelling local neonatal unit High dependency cots.....	194
Figure 82	Backward Steps in level of care	195
Figure 83	Clinician observed Neonatal Flow	196
Figure 84	Hypothetical annual neonatal unit flow.....	197
Figure 85	Systems Thinking - local neonatal unit activity	198
Figure 86	Probability that High dependency cot requirement exceeds a given level	204
Figure 87	Fluctuation of cot and staffing demand January 2011	205
Figure 88	Predicted skilled neonatal nursing shortage	207
Figure 89	Neonatal skilled nursing shortage validation.....	208
Figure 90	Neonatal nursing shortages forecast (2010-11 training data, 2012 validation) ..	209
Figure 91	Worked Example Forecast validation.....	218
Figure 92	Timeline for census and forecasting	220
Figure 93	Accumulation of Arrivals direct to High dependency (Linear model assumed)	221
Figure 94	High dependency stay model.....	222
Figure 95	Transition from intensive care to High dependency model.....	222
Figure 96	Transition from special care to High dependency care model.....	223
Figure 97	Cot Predictor Tool - populated	224
Figure 98	Semi-Markov model through the local neonatal unit 2009	243

Figure 99	Timeline for early gestation.....	283
Figure 100	Antenatal anomaly pathway decisions.....	286
Figure 101	Plurality and Corrected Gestation.....	286
Figure 102	The Post-natal ward: LOS mother and baby.....	287
Figure 103	Post-Terms LOS (and treatment).....	287
Figure 104	Probability of level of care by corrected gestation	288
Figure 105	Waves of demand for levels of care by corrected gestation	289
Figure 106	Corrected gestation of High dependency Day of care	290
Figure 107	Corrected gestation at transition from High dependency to special care.....	290
Figure 108	Corrected gestation of special care day	291
Figure 109	Pattern of discharge from special care.....	291
Figure 110	Probability of IH by elapsed LOS	292
Figure 111	Probability of SH by elapsed LOS	292
Figure 112	Logarithmic plot of probability of staying on High dependency care.....	293
Figure 113	Probability of SH Patient Transition by days since admission.....	294

LIST OF TABLES

Table 1 Thesis Outline	6
Table 2 Enterprise Modelling Frameworks relevant to Healthcare	45
Table 3 Embedded Research Framework	51
Table 4 Conceptual Framework connections	55
Table 5 Simplified Enterprise Architecture	56
Table 6 Zachman Architecture Framework for Modelling the Perinatal Network System ..	58
Table 7 Catalogue of Disciplines and Methods	59
Table 8 Perinatal Network System Operational Research Framework.....	61
Table 9 Determinants of Demand and Supply	65
Table 10 Gap in Patient Demand and Service Provision	72
Table 11 System Hierarchy.....	79
Table 12 Mixed Modelling steps for Healthcare.....	80
Table 13 Critique of Research Framework.....	81
Table 14 Research issues and their Modelling.....	89
Table 15 Colchester in-flows and out-flows	92
Table 16 Interplay of levels of care	107
Table 17 Number of intensive care cot days by patient 2009	141
Table 18 Range of daily High dependency cot occupancy in 2009	144
Table 19 Number of High dependency cot days by patient	147
Table 20 Exploratory Data Analysis January 2007.....	149
Table 21 Fit for Length of Stay.....	151
Table 22 Length of Stay and Cot Occupancy Summary data	152
Table 23 Probability of patient transitions in the local neonatal unit.....	154
Table 24 Cumulative direct Arrivals to High dependency.....	157
Table 25 Duration of Stay on High Dependency	158
Table 26 First move from intensive care to High dependency care by day of birth 2009 ..	160
Table 27 First move from special to High dependency care by day after admission 2009.	164
Table 28 Length of Stay and First Move Summary data	167
Table 29 Principal diagnosis at High dependency care 2009	171
Table 30 Neonatal Abstinence Syndrome Days 2009-11	174
Table 31 Corrected Gestational Age (weeks) at Transition in care level.....	176
Table 32 Probability of Patient Transition by corrected gestational week	177
Table 33 Patient Transitions	194
Table 34 Composition of Arrivals at Level of Care.....	195
Table 35 Definition of Terms.....	199
Table 36 Theoretic combinations of occupancy for critical care cots.....	203
Table 37 Actual nurse shortage 2009-12	210
Table 38 Validation of Worked Example Forecast.....	218
Table 39 Derivation of probabilities (exploratory analysis)	219
Table 40 Model Expectant probabilities over 7 day horizon	223
Table 41 Distributions for Parameters Summary.....	226
Table 42 Corrected Gestational Age (weeks) at Transition in level of care	235
Table 43 Patient Transitions Matrix.....	238
Table 44 Condition next day	239
Table 45 Cot Configuration Ratios	240
Table 46 Cot Configuration tolerances	241
Table 47 Critique of Research Framework.....	254

Table 48 Social Regulatory Constraints.....	259
Table 49 Steps in Generic Healthcare Framework	276
Table 50 Informatics Timeline of administration of maternal and neonatal pathways.....	282
Table 51 Risk factor lists for perinatal mortality and morbidity.....	284
Table 52 Patient transitions – admissions and transfers.....	285
Table 53 Cot Occupancy summary 2009-11.....	295
Table 54 Cot Predictor calculation.....	295
Table 55 Model equations and Binomial Theorem.....	296
Table 56 Pascale's Triangle.....	296
Table 57 Worked example calculation.....	297

ACKNOWLEDGEMENTS

I thank my supervisor Professor Thierry J Chausalet, for his support and Dr Salma Chahed, second supervisor for her comments and advice. I thank Dr Alan Lamont for breakthrough support on ethics approval. I thank Professor TJ David for laying important foundations for autonomous study. I thank Professor Tarzynski, Terstyanski, Dr Bolotov and Dr Ernie Abbott for their constructive discussions.

I thank members of the Health and Social Care Modelling Group for their helpful discussions. These include Eren Demir, Irfan Chishti, Mohsen Megaspour, Philip Worrall and Manisha Rathi. I thank my former secretary Gill Boniface for her support and paediatric colleagues at Colchester General Hospital for their initial support of this study. I thank Fiona Crump, Service Manager and Andrew May, Medical Director for their positive attitude towards this work, which enabled its initial funding for two years. Their successors were unenthusiastic about engagement on Demand, Capacity and Patient Flow although importantly two sessions were permitted for the research; the organisation was incapable of turnaround so languished in special measures for four years. The local CLAHRC was not interested in the work; I have valued the advice of my broker.

In particular I thank all my stalwart friends in Bromley for advising and standing by me.

DECLARATION

I DECLARE THAT THE WORK IS MY OWN.

A handwritten signature in black ink that reads "Sarah Dalton". The signature is written in a cursive style with a large initial 'S' and a long, sweeping underline.

SARAH DALTON

LIST OF ABBREVIATIONS

BAPM	British Association of Perinatal Medicine
CCG	Clinical Commissioning Groups
CGA	Corrected Gestational Age (time since conception)
CGH	Colchester General Hospital
CPAP	Continuous Positive Airways Pressure
DoH	Department of Health
ECS	School of Electronics and Computer Science, University of Westminster
FST	Faculty of Science and Technology, University of Westminster
GP	General Practitioner
HDU	High Dependency Unit
HES	Hospital Episode Statistics
ICU	Intensive Care Unit
IT	Information Technology
IUGR	Intra-Uterine Growth Retardation
LOS	Length of Stay
NHS	National Health Service
NICU	Neonatal Intensive Care Unit
NIHR	National Institute for Health Research
PCT	Primary Care Trust
SCBU	Special Care Baby Unit
SEND	Standardised Electronic Neonatal Database
SHA	Strategic Health Authority

CHAPTER 1 INTRODUCTION

1.1 INTRODUCTION

Birth attendance and resuscitation of the newborn have improved outcomes for babies over the years. Neonatal care is that care of the newborn, who may be premature, small or sick. The Perinatal System is composed of maternity beds on wards and neonatal cots in baby units in a regional group of hospitals.

Perinatal mortality rates allow national healthcare systems to be compared. Figures throughout the world differ between resource poor and industrialized nations and within countries depending on population demographics and practice. The Wellcome Museum on the History of Medicine housed in the Science Museum, London displays an early neonatal endotracheal tube, first used in the 1940s. Whilst made of metal, its form resembles modern versions. Thus neonatal intensive care has a relatively recent history.

The United Kingdom (UK) British Association of Perinatal Medicine (BAPM) lays down ideal ratios of babies to nurses depending on patient need. There has been social debate on adherence to these and their funding. The balance is between patient safety and the economics of matching supply to demand within a dynamic system. The types of care delivered are intensive care, high dependency care and special care. Examples of care include incubator care, invasive and non-invasive ventilation, nasal oxygen, intravenous and nasogastric tube feeding. Those staff required are doctors and nurses trained in specialist and normal neonatal care and support staff such as dieticians and pharmacists. It is essential for these staff to communicate with parents, midwives, obstetricians and health visitors. That equipment needed includes incubators, monitors, ventilators, CPAP and syringe drivers, the servicing of which must be maintained in a sustainable way. A reliable source of electricity is crucial.

Extremely premature babies fare better in centralized units staffed and equipped to give long-term intensive care (DoH, 2009), which necessitates their transport. Yet such policies as the UK National Service Framework for Children (DoH, 2003) directs children receive as much care as possible delivered locally, so following this intensive treatment, the patient should then be repatriated nearer home. Indeed Transport Medicine itself is a sub-specialism requiring both expertise and resourcing. Thus best practice introduces discontinuity of place which complicates patient pathways and also carries resource and logistic issues.

1.2 PROBLEM

In the UK, neonatal care is delivered in networks, which must balance the workload. These Perinatal networks suffer episodic shortage of capacity. Given concern over quality of patient care / family experience and pressure for both business continuity and efficiency in healthcare, a continued lack of understanding of this area is a weakness. The benefits of improving the current problematical situation are manifold including improved quality assurance, fewer unnecessary inter-hospital patient transfers, reduced Length of Stay and improvements in capacity and cost. This topic is investigated with a Conceptual Framework and Modelling. Further, addressing the common real-world problem of capacity yields generic dividends.

When demand surges, capacity goes short. For instance a regional intensive care centre in the Perinatal Network will attract intensive care cases; whilst for the local neonatal unit High dependency cots represent the middle of the system and their particular bottleneck. That is the rationale for this study of High dependency cot activity (by corrected gestation and patient pathway) within the English local neonatal unit. This component undertakes a significant workload within the Perinatal System. Understanding how cots are utilised by this population and how one might forecast short-term demand to avoid capacity going short could help. The vast majority of neonatal research has hitherto concentrated on neonatal intensive care units.

Now once developed, such methodology for a Perinatal Network might find application in other Healthcare networking situations. Since health service demands do increase, other areas of possible research lie in further refining it, with additional demographic, financial and staffing information. This research might assist those commissioning this complex, low volume and expensive service. A derivative generic Framework might also find application within the OR community.

1.3 OBJECTIVE OF THE STUDY

- Develop a Framework to model the healthcare system
- Model the local neonatal unit and Perinatal Network
- Design and develop a model which is robust and resilient
- Take account of system variability and its behaviour under the strain of surging demand or resource constraint
- Gain insight into improvements
- Support Decision making on shortage of capacity

1.4 COLLABORATION

This work began in collaboration with Colchester General Hospital (CGH)'s local neonatal unit which lies within the Eastern Perinatal Network of England. The original Case Study was approved by the CGH Caldicott guardian and the Essex 1 Research Ethics Committee and supported by the Eastern Perinatal Network Director. Standardised Electronic Neonatal Database (SEND) data was cleaned by the CGH neonatal unit ward clerks.

1.5 CLAIM

The research studies some aspects of Perinatal Networking by developing a suitable mathematical modelling approach which can forecast activity at a tactical level.

Inter-disciplinary work performed in areas of Systems Thinking, Enterprise Modelling, human neonatal development and Markovian processes leads to the claim that a conceptual model for the English Perinatal Network System has been developed and a Cot Predictor Tool and Markovian model of the local neonatal unit designed, which can help assess and guide capacity and quality of neonatal care.

The research outputs are a Conceptual Framework, a Quality Metric, a Cot Predictor Tool, a Markovian model Design and the milieu or connections.

1.6 OUTLINE

The research problem is pinned down using a structural review framework, which facilitates the solution. This is designed to support the thesis, which itself advances an inter-disciplinary framework.

Thus aligned and nested frameworks exist on different levels:

Thesis Outline.

The Literature Review incorporates a critique of the use of Frameworks in healthcare and the mixed methodological approaches in Operational Research to be used in our Conceptual Research Framework.

The Conceptual (inter-disciplinary) Framework of this thesis deals with the behaviour of the Perinatal Network system. This is explained using both operational and medical informatics, including the bundle of individual patient pathways, Length of Stay and medical course within the patient group or population, which flows through the Healthcare system.

In the Discussion, which is self-reflexive, a critique of this Research Framework is given.

An overview of neonatal networking and capacity issues and the relevance of this research work have been introduced in Chapter 1.

Chapter 2 gives a review of the current state of research in this context and surveys knowledge of Modelling the Perinatal Network System.

Chapter 3 provides the Conceptual Framework model of this research and the mixed methodological approach undertaken.

Chapter 4 introduces the background, launching point and qualitative aspects of the Case Study, which studies predictive modelling of High dependency cots in the local neonatal unit within the Perinatal Network System.

Chapter 5 gives operational and medical analytics; these are then fed into the Cot Predictor Tool in Chapter 6. This informatics might also inform the Dynamic Modelling outlined in Chapter 7.

Chapter 8 discusses limitations of method, the results and opportunities for future work; while Chapter 9 concludes with a summary of the contribution.

This thesis outline is set out in the Table below:

Chapter	Section	Contents
1	Introduction	Problem. Aims
2	Literature Review	Health Service and Patient Mixed Methods Modelling Critique of Frameworks
3	Conceptual Framework	Argument / narrative Model Selection Ideal 'to-be' System
4	Case Study: Qualitative Methods (i.e. language description)	'As-is' System Process Mapping and Quality
5	Case Study: Quantitative Analysis (i.e. mathematical description)	Operational and medical informatics
6	Cot Predictor Tool	Predictive modelling
7	Dynamic Modelling	Markovian methods
8	Discussion	Critique of research framework
9	Conclusion	Contribution

Table 1 Thesis Outline

Here the 'as-is' real-world Perinatal Network System and its challenges have been introduced. The Literature in this area is reviewed next.

CHAPTER 2 LITERATURE REVIEW

2.1 INTRODUCTION

Healthcare systems should be kept running and be resilient to challenges, which entails Business Continuity Planning. Understanding complex operations lies within the domain of Systems Thinking and Enterprise Architecture and Modelling, particularly where computerisation is involved (Zachman, 1987). These viewpoints (first used by IBM and much applied within Government and Defence) are invoked when insight, improvement and change are needed in a complex and distributed system like healthcare. They help connect overview with detail.

This Literature Survey produces scope for planning in the emergency healthcare sector and in Operational Research for modelling capacity, as exemplified by the research topic of the UK Perinatal Network Service. The component of the research problem identified is the pattern and timing of shortage of capacity episodes. We wish to forecast and predictively model them. This could produce an alert for flexing resources like nurses and equipment. We locate this within the difficulty of finding High dependency cots in the local neonatal unit of the English Perinatal Network, which was frequently encountered in professional life when an NHS hospital consultant.

In providing an inter-disciplinary treatment of the research question, the disciplines of Operational Research / Management Science and Clinical Medicine are drawn upon. Examples are taken from the literature, which move the narrative on to the next chapter crystallising the Conceptual Framework of this research. The structure of this Literature Review is geared toward solving the research problem and is designed to reflect and support the Thesis Outline. The survey incorporates Modelling in Healthcare, Frameworks and a Summary.

Of course, much of what is known is for consumption within the Department of Health and possibly kept by those evolving NHS bodies for the purpose of commissioning services. Knowledge garnered is drawn from medical textbooks and journals

consulted in the course of professional life and citation searching of published literature. This grounded and experiential method is more relevant and feasible than exhaustively systematic. As a metaheuristic strategy, it gravitates towards candidate tools to solve the problem. Keywords used included neonatal, hospital bed capacity, transfers, networks, patient flow, systems thinking, mixed methods modelling, enterprise modelling frameworks in healthcare, enterprise architecture and healthcare. Those databases searched were in English from 1966 and included ISIS web of knowledge, PubMed and Medline, IEEE, Emerald, et cetera. Searches began in 2009. The most effective and satisfying search method proved to be citation searching, which drew out canon, quality, milieu and comprehensiveness.

2.2 MODELLING IN HEALTHCARE

All models are wrong but some are helpful (Box, 1979). Modelling is an oversimplification but may be useful in producing insights since it can distil the essence of a system. Modelling approaches are a possible solution to tackle problems in the healthcare system. Models may evolve over time and be built on by different people. Approaches might be qualitative or quantitative, hard or soft. The mathematician or Operational Research practitioner might organise modelling by technique. The layman, manager or clinician might consider the area by the issue addressed. Either actor might solve a problem. A typical cycle might be Modelling, Analysis, Design and Implementation, encompassing description and representation of the system, analysis, design of an improvement and its implementation and evaluation.

Although this is an active research area, implementation of change (such as transformation) may lag or fail to occur. Indeed, there is little evidence of implementation in Healthcare (Jun et al, 2009), perhaps owing to miscommunication between actors. High profile examples of miscommunication have occurred with the interpretation of data and the implementation of computer systems. For instance, in the NHS, the Connecting for Health programme was less feasible than initially thought. Software (namely the Somerset Database) had been purchased, yet was neglected to be implemented for years, leading to unco-ordinated care for patients with cancer, which was life-shortening (Troop and Taylor-Brown, 2014). Data has been misapplied to close (albeit temporarily) an English children's cardiac surgery unit (Dominiczak 2013). Failure to migrate data has also lost sensitive patient scans and costing information at Addenbrooke's Hospital, Cambridge (HETT 2016).

Where attention to detail is neglected, clearly life-threatening issues of governance and security do arise. To deal with this lethal gap, Robert Francis has called for the regulation of NHS managers (Rimmer, 2017). It was only in 2014 that data manipulation became a crime under the Duty of Candour. The Secretary of State for Health, Hunt has suggested that the nineteen eighties general management model of the NHS may be inappropriate and has called for managers to have a clinical background (which would come with that pre-existing perspective, culture of responsibility and regulation) (Donnelly 2016).

A short high-level review follows on how Operational Research (OR) has worked in healthcare. Lagergren (1998) undertook a far-sighted general discussion of modelling in healthcare and its difficulties. Areas in hospitals have leant themselves to applications of Operational Research such as chaotic A&E departments and smooth-running operating theatres (Kolker, 2009). Healthcare applications have been extensively reviewed by Pierskalla (Pierskalla and Brailer 1994), Jun (Jun and Jacobsen, 1999), Millard (McClellan et al, 2009), Brailsford (2013), Mahdavi (2013) and Fakhimi and Probert (2013). Unfortunately Jun (2009) has drawn attention to the low rates of implementation by managers of changes recommended by Operational Research Consultants as only 16/201 scenarios. To justify modelling, managers must be willing to use it for planning decisions otherwise the time and cost of the approach may be justified only in academic terms as alluded to by Galvao (2002).

Clinicians are trained to adopt a patient-centred approach and BLISS, the baby charity has advocated family-centred care, acknowledged by the Department of Health to be desirable. Therefore it is unsurprising that studies looking at how healthcare workers relate to strategist's flow-charts show a patient centred flow is favoured (Jun et al, 2009). Other resources do flow such as the healthcare workers themselves or information; although this was a less acceptable way of depicting the system than using patient flows. One can conduct problem structuring and work process mapping to understand an issue (Anderson, 2008).

The range of healthcare applications and methodologies of Queueing Theory have been extensively reviewed by Lakshmi (2013).

The theoretical benefits of computer simulation have been argued (Pidd, 2004). Perhaps the most important is that models can be improved by others, in order to adapt to change for instance in complexity, policy or strategy. The principles of this approach in management have been described by Varun Grover (1997), who has discussed how the cardinal feature of Business Process Re-engineering is using Information Technology to effect significant change in process to improve performance.

A simulation should be grounded (Law, 2009). Simulation employing Discrete Events and System Dynamics has allowed the planning of new facilities and optimisation of efficiency through confirmation that additional resources are indeed required or that

processes be changed in order to enhance outcomes (Fournier and Zaric, 2013). It is quite hard for a paper about simulation to supply enough detail for the work to be replicated.

The extensive area of computer simulation has been reviewed (Fone, 2003) (Abouelijinane et al, 2013). A profile of those simulations developed has been proposed (Mustafee et al, 2010). Without such ways of structuring or navigating the kinds of work in this field, one risks being overwhelmed by its complex and diverse eclectic mix, examples of which are briefly touched on next to illustrate that point. This list is hardly exhaustive:

Computer simulation has proved valuable in modelling effects of epidemic diseases (such as HIV, SARS and swine flu) (Ercole et al, 2009) on Healthcare Demand. During the second wave of UK swine flu, it could be predicted that fewer resources than expected were required, permitting a timely stepping down response.

The effects of integration in geriatric services in France have been studied using an adaptable discrete event simulation (Franck et al, 2015), which recommended minimising patient transfers.

Other investigators have studied inter-departmental disposals, location of services (Galvao, 2002), level of provision and transporting patients.

Further applications lie in local authority planning of long-term care for the elderly and NHS walk-in-centres (Ashton and Hogue, 2005).

Whilst many reviews, using searching of databases on the applications of simulation to healthcare, are comprehensive, these amount to little more than superficial taxonomic shopping (or fishing) lists: any assessment or discussion of depth or quality is absent (Fone, 2003) (Fakhimi, 2013) (Mustafee, 2010). This issue of undue specific detail is tackled by Mahdavi et al (2013), who venture generic models. Yet these suffer the opposite problem of not being fleshed out in a specific way; and again depth and quality are scarce. There is apparently a gap in capability to sort the literature in a suitable way but there is no shortage of those seeking to address this conundrum. RIGHT reviews (2008) have been undertaken, which will be covered further in Section 2.6.4; the proof of their concept lies in closing the loop by monitoring their

use in the field and evaluating the actions implemented and measuring improvements made as a consequence.

In practice, verbal discussion (including at conference) between academics, practitioners and clients, with the purpose and users of the application in mind, helps hone the choice of method, which itself is an experienced judgment open to both some debate and risk of subjectivity.

2.2.1 Traffic Flow analogy for Patient Flow

This literature is extensive. One team in China looked at traffic control in cities (Zhang et al, 2009) applying Agent-Based Simulation, in which entities make decisions. For rush hours, traffic lights may be manipulated. Again a computer simulation model was produced through an algorithm which divided the city into grids each controlled by the agent. Only when these were over-capacity did they need to talk with neighbouring sectors. When the neighbour could not help, assistance from further afield was sought in the region. Ultimately, there was a central control centre but resort to it was not always required. A systematic approach was developed. The use of the method improved average waiting times. The role of Agent-Based Simulation in healthcare has been discussed by Bonabeau (2002). How the neonatal units of the Perinatal Network System negotiate and prioritise their work might draw on this kind of approach.

The concept of a shock wave travelling back through the system when traffic jams occur (Eleftriadou, 2014) is a useful analogy for delays in Network Systems; furthermore it is readily grasped by healthcare workers especially motorists. A conceptual framework for bottleneck analysis in queueing networks has been advanced (Anselmi and Cremonesi, 2009); it first found the sufficient and necessary conditions for a single bottleneck.

Gallivan has identified the connection between traffic-light control and patient streams through cardiac intensive care (Gallivan, et al, 2002).

The Nuffield Trust (2016) invoked the traffic flow analogy for Patient Flow in hospitals, explaining that faster flow rates require more space (or bed capacity).

2.2.2 Hospital traffic and shortage of capacity

The causes of shortage of capacity are well-known by frontline hospital workers. In a real-world situation, extra demand is absorbed (however safely) by the hospital unit until care can be transferred elsewhere. Indeed an A&E simulation showed that one episode of over-capacity on the wards had a knock-on effect on Length of Stay for those patients having waited in A&E for as long as four days downstream (Land et al, 2000). Another study applying stochastic simulation for modelling emergency admissions to hospital showed that over-crowded A&E led to unwanted effects for 28 days (Bagust et al, 1999).

Applying Auto-Regressive Integrated Moving Average (ARIMA) within A&E led to a recommendation that managers planning resources have reserve capacity (Abraham et al 2009). One assumption was that A&E demand was stationary and showed no changing time trend. One London group forecast A&E arrivals using structural time series models with good accuracy (Au-Yeung et al, 2009). Studies of A&E find application in the Perinatal System since the majority of its work is emergency. Yet one does not have queues, rather Loss Networks (Asaduzzaman and Chaussalet, 2010).

Utilisation of capacity within hospital networks has been investigated with semi-Markov models, Erlang's loss formula and feedback within Jackson Networks (Hershey et al, 1980); the authors suggested their methodology could help to validate simulations.

In this area, Kokangul has described a stochastic approach to optimise bed capacity in a hospital unit. Here probability distribution functions were determined using statistical modelling and a global solver used for non-linear optimization (Kokangul, 2008).

Another group claimed 38% more patient flow from 15% more beds using stochastic simulation through a balanced system. The model could allow for non-negative-exponential length of stay and users were involved (Cochran and Bharti, 2006).

One excellent paper by Professor Green (2002) poses the question, “How many Hospital beds?” and then proceeds to answer the question directly and with clarity. Applying the criterion of probability of delay at 1%, for New York State, then 90% of intensive care units and 40% of obstetric units had insufficient capacity to provide an appropriate bed when needed. Based on 1996 data, using M/M/s queueing (Markovian assumptions, which permit closed form expressions), then if target occupancy is run at 85% in a smaller obstetric unit, then 16% of patients would face delay, the average of which was 8 hours. In such small hospitals, the level of occupancy above which the situation for handling “surge capacity” become critical lies below the 85% of large institutions and may be as little as 45%.

Poisson processes modelled arrivals. In an exponential distribution, the mean equals the standard deviation. Delays depended only on size and server utilization. The greater the variability of service time, the worse the system’s performance. Small increases in occupancy levels can result in large increases in delays. Smaller hospitals may need to have lower target occupancy levels since they do not have the economies of scale of larger institutions.

It was observed that the average midnight census in the postpartum units was 10% less than the daily average. *It was asserted that a hospital must provide appropriate medical care with timeliness being a critical dimension of that. Decisions on capacity should be based first on clinically appropriate standards for bed availability. Urgent patients bump less critically sick patients from intensive care units to “step down units” (with less technical and nursing support). Sufficient beds should be planned to avoid off-service transfers, bumping and premature discharge.* Much of this knowledge does not appear to be recognised in today’s NHS but could usefully be applied.

2.2.3 Barriers to implementation

As touched on in Section 2.2 by Jun (2009) and Brailsford (2013), one pre-occupation in the literature lies with the implementation of Operational Research in healthcare especially simulation. Much confusion is laboured in this area. It appears possible that some of this is due to the significance of simulation for security interests and that issues of political control are at stake. It is likely that Western militaries applied OR for their supply lines in the treatment of Ebola in West Africa; it may not be judicious to share all intelligence with civilian healthcare.

Barriers to implementing changes in hospitals are presciently understood by OR professionals, who give forth on hospital management. Lowery (1994) drew out people's opinions around a table. A variety of actors exist with conflicting priorities. In that discussion, Hakes suggested there were few incentives to provide services efficiently and that computing budgets were small. Keller faced resistance when using statistics and cited the stigma of industrial time and motion studies which invariably precede redundancies. Simulation could appear as an inaccessible black-box to healthcare workers. Lilegdon drew attention to the existence of many systems with multiple customers and no clear decision-maker and how completion of projects with many masters and without clear priorities is difficult. Mabrouk suggested Operational Researchers might improve their sales skills. He feared that by the time the model was needed, the system would have changed so much that it would be invalid. He doubted whether one could expect clinicians to build simulation models (yet it is certain that managers will not). McGuire criticised executives and healthcare managers for failing to follow through on study's recommendations. Weak managers cannot overcome obstacles during implementation. To mitigate this, the Project Manager should ensure people are involved in verification to ensure the model is valid. Whilst expert opinion is considered Grade C evidence, the forthrightness of the viewpoints has meant that subsequent surveys have not beaten this advice, yet many have expanded this sub-specialism.

Proudlove (2007) states that poor performance is a consequence of poor system design. When investigating dynamic bed occupancy and access block, wait-for-bed times and elective cancellations due to no beds are poorly recorded and coded. Organisational structures are complex. He advocated OR focus be driven by problem, context and audience, which is hard to dispute.

In a paper describing dislocated practices, Eldabi (2010) discusses how problems are time and context bound and that health outcomes are the main driver, not only value for money. Debate permits tensions to surface, knowledge exchange, ideas generation and consensus building: stakeholder-modeller interaction is productive. Decisions taken at operational levels about specific results may involve policy and strategy levels. From the international perspective, there is a high job turnover in the English NHS as people switch roles. Indeed, project duration was not matched by the NHS post-holder, which undermined the exercise.

It is noted that 2/3 of organizations' efforts to implement change fail (Damschroder et al, 2009). Yet individuals might have a role in redesigning innovations. Suggestions for overcoming barriers were advanced in their Consolidated Framework for Implementation Research (CIFR), which represents expert or Grade C evidence.

In a perceptive and wide-ranging paper on implementation issues, Eldabi (2009) identifies unreliable data, complexity and multiple interactions, lack of uniformity of healthcare systems and fast changing national policies. Barriers to buy-in from the community include their conflicting interests and clashing objectives. There is no immediate and ultimate test of a solution to such wicked problems. Owing to the soft nature of methods, it is hard to evaluate the best since a variety exist. Given the changing behaviour of healthcare systems, the time-span required to solve the problem has a long feedback loop and existing methods may not work. The situation cannot be replicated. OR can involve back office calculations, limited transparency and lack of interactions with and between stakeholders. There is a vicious cycle for wicked problems. There is neither time nor budget to reach any solution. The policy-maker is omnipotent to the exclusion of many stakeholders. Yet resolution rather than

solution and consensus rather than optimisation is required when facing such wicked problems. Ability to manage differences and powers within and between various groups is necessary.

De Souza and Pidd (2011) considered barriers to implementing Lean in healthcare. Reasons given included: lack of ownership and resources, leadership failure and poor communication. There are cultural issues around the hierarchy of healthcare staff and management. There is fragmentation into professional and functional silos, which impede patient flow. Constant changes of strategy for improvement locally and nationally (the policy of fragmenting care) inhibit continuity for potentially successful programmes. The NHS fire-fighting mentality is another practical barrier. Healthcare managers ought to change their decision-making processes from experience-based to data/evidence-based. Healthcare executives refused to recognise that front-line staff understand the most about rock-face problems. Target culture is rightly viewed with suspicion (following mid-Staffs (Francis, 2009)). Yet clinicians could commit to change were decisions to be kept under their control.

In another article on Lean in healthcare, Radnor (2012) reports that healthcare is designed to be capacity-led with limited ability to influence demand. Lean might reduce non-value adding activities, process variation and poor work conditions such that the number of steps, amount of time and information needed to serve the client continually falls. Existing pitfalls comprise duplicate requests for information, readmission because of failed discharge and repeating tests since correct information is not provided. Management techniques for audit and quality assurance force the clinician to perform administrative tasks rather than patient care. Deeply institutionalised forces complicate and scupper reform. Cultural norms and organisational customs destroy attempts to introduce knowledge management systems. There is no formal process for improving processes between departments, nor any mandate from executives to conduct Lean in a structured way. Few hospital Trusts follow an integrated systems-wide approach to service improvement. It is difficult to influence or control delivery of services beyond individual organisations. Derived demand for healthcare relies upon decisions on capacity made by the provider

and quick wins rather than sustained service improvements are rewarded. Clinical leaders found it easier to introduce tools where improvement could be implemented independently from other departments.

Jahangirian et al (2015) surveyed stakeholder engagement with simulation and received a 41% effective response rate. This reported the varying, dynamic, multi-dimensional nature of healthcare. The most useful contribution was a cause-effect diagram incorporating as obstacles: lengthy project, inflexible model, poor management support, high stakeholder workload, scepticism towards classic management approaches and difficulty in aligning views and objectives.

Another survey (Tako and Robinson, 2015) posed the question of whether simulation in healthcare differs from that of other sectors. There was a 29% response rate by experts to certain leading questions. It was found that problems change more and are messier. There is difficulty with research ethics, the influence of political events and study results become obsolete faster. There is less incentive to initiate change, more resistance to it, difficulty in developing generic models, implementing results and more effort is needed for data collection. The respondents were a restricted class: it might have also been interesting to hear healthcare clients' feedback. Surveys of Operational Researchers still amount to Grade C evidence.

Monks (2016) has lamented poor availability of data and people problems such as limited service user involvement, lack of managerial awareness and ineffective communication between research users and OR modellers. Given limited evidence on OR interventions and their practice and impact being unevaluated, he suggested overcoming these obstacles with community OR.

2.2.4 Development and use of models by clinicians

One antidote for barriers to implementing Operational Research is the development and use of models by clinicians. There has been much empire-building and largesse in unaccountable Foundation Trusts in which managers neither see nor reveal the bigger picture. They keep clinicians in one departmental silo in order to maintain power. Use of multiple methods and models represents merger or overlap between stakeholders' perceptions such as that of clinician/modeller and manager, which empowers the clinician and flouts restrictive managerial boundaries. Where clinicians model, this would serve to fill the vacuum of unfilled data analyst posts and unregulated, unaccountable interim healthcare managers.

Stakeholder input, inter-clinician communication, implementation and maintenance of models can prove obstacles. Stakeholders should interface with conceptual modelling aspects of OR. With such input to conceptual modelling, there is buy-in and greater likelihood of implementation for service improvement. The relationship between OR professionals and clinicians might be strengthened and rendered Lean by taking out the middle person: retardant interim healthcare managers. This would free up accountant healthcare managers who do not balance their books for that work. Should clinicians exert a management remit, this could shake up the organisation.

An organizational environment where clinicians are encouraged to creatively solve problems was significantly associated with lower risk-standardised mortality rates (RSMRs) (Bradley et al, 2012). This would contrast with the cultural position adopted by special measures Foundation Trusts whom demote clinicians to production-line machines. There are notable examples of clinicians developing and implementing models though not often mixed ones. In collaboration, Professor Millard, a physician in healthcare for seniors, developed and implemented a tool modelling variability in bed occupancy in Adelaide, Australia (Harrison et al, 2005).

Workflow is considered linear, with little consideration of the multi-tasking, interruption prone nature of most medical environments according to Pickering (et al 2015). Himself

a clinician, an electronic medical record for intensive care patients was devised and implemented, which streamlined information gathering and shortened ward-rounds.

Kuljis et al (2007) have advocated a participatory approach with stakeholders, a healthcare oriented methods selection framework and dissemination. Tako et al (2010) also argued that stakeholder involvement as part of conceptual modelling could lead to a more successful simulation study with better prospects for implementation.

On this theme in a Case Study on intermediate care, Eldabi et al (2011) identified incohesive data and informational structure, a policy of fragmentation of service provision and little reported multi-agency modelling. Intermediate services might reduce unscheduled admissions and a comprehensive, optimised service might have impact on the long term care sector. Validation was conducted through iterations with stakeholders.

Pagel et al (2013) found that timely and routine monitoring of risk-adjusted mortality after paediatric cardiac surgery is feasible. A PRAiS model was built applying data on surgical procedure, diagnosis, age, weight and co-morbidity to give a variable life-adjusted display (VLAD). Multidisciplinary clinical teams then used it independently to inform local governance processes and quality improvement initiatives.

Mathematical capacity planning methods can incorporate patient complexity, admission rates and delayed discharges. Available, intuitive techniques for capacity planning may be exploited to determine capacity bottlenecks affecting patient flow. Monks et al (2016) investigated these for stroke patients. Their SIMUL8 model produces a daily audit of occupancy in each stroke ward or service and constructs the occupancy probability distribution function. Since the model has no capacity limits i.e. demand is unfettered, daily occupancy is Poisson distributed. Stat::Fit was applied to LOS data. Exponential distributions were used to model the time between arrivals of new admissions and lognormal distributions for LOS. Face validation was by clinicians and the hospital's own analyst for stroke. In one scenario, complex neurological patients were excluded from the pathway in order to assess their impact on bed requirements. Results were expressed as the probability of delay versus the number of acute beds

available. The paper was well-presented and clear to the clinician. One contribution was to increase the time clinicians could focus on patient care as opposed to bed management.

Uriarte et al (2017) sought to reduce LOS and waiting times for Swedish A&E patients using a mix of DES, data mining and Simulation-Based Multi-Objective Optimization (SMO). Their simulation showed that additional triage had the biggest effect, next more physicians. One lesson learnt was that multi-objective optimization should have been applied earlier in the project. They recognised that decision making should be timely and that budget or objectives can change during a project. As is so often the case, the political target for the hospital was unrealistic. That poor decisions lead to critical situations for patients was understood; such lessons could usefully be acknowledged by NHS managers.

Rycroft-Malone (2004) states that learning organizations have facilitative management style, cultures that pay attention to individuals, group processes and organizational systems and de-centralized decisions making. Furthermore clarity of roles, valuing of staff, transformational leaders and reliance on multiple sources of information may make successful implementation of research more likely. The (Promoting Action on Research Implementation in Health Systems) PARIHS Framework emphasises trialability: the ability to reverse course if warranted (i.e. undo implementation). Prescient observations were that unsurprisingly, centralisation (concentration of decision-making autonomy) is negatively associated with innovation. Tension for change was the extent to which stakeholders perceived the current situation as intolerable or needing change. In a learning climate, leaders express their own fallibility and the need for team members' input. Team members are actually valued, it is psychologically safe for staff to try new methods and there is time and space for reflection and evaluation. Organisational justice is individual's perception of distributive and procedural fairness in an organization. Managerial patience is required to take the long view (so interim managers would never achieve that.) The author notes the risk of passive resistance by staff where these positive conditions do not exist.

2.3 MODELLING IN INTENSIVE CARE

Perpetual working beyond certain occupancies leads to raised patient risk (UKNSS Group, 2002). The UK Intensive Care Society recommended 85% maximal occupancy for facilities.

A margin to absorb random fluctuations in demand as well as time to make, change and clean bed-spaces between patients is required. Yet below these thresholds, provision of costly resources is inefficient. To this end use of a discharge planning nurse to speed and co-ordinate discharges to reduce length of stay and facilitate better flow had been advocated and further discussed by Goldschmidt and Gordin (2006). Even time taken to compute discharge summaries and order take home prescriptions electronically can add to a patient's Length of Stay, unless such tasks are initiated prior to discharge.

Thresholds for admissions are raised and those for discharge lowered when staff must manage over-capacity in hospitals. Profit et al showed how discharge behaviour changed with occupancy (Profit et al, 2007). In the highest quintile of unit census, infants were more likely to be discharged. In the lowest quintile of unit census, infants were less likely to be discharged. So discharge criteria depended on unit workload, a point many frontline healthcare workers would concede. Yet this coping mechanism is inconsistent and may compromise quality of care; it amounts to a fix to cope with working beyond the design capacity of the organisation, as discussed by Wolstenholme (2007).

Work on an Australian intensive care unit has shown the benefit of pre-emptive discharge planning and sound medical decision taking on Length of Stay and unit throughput (Lin, 2009). This described intensive care outflow problems and the dangers of discharge by triage owing to resource constraints, which raises morbidity and mortality for such patients. Similarly, infants admitted at full neonatal intensive care capacity are 50% more likely to die (UK Neonatal Staffing Study Group, 2002). Further Watkin points out that "no prospective studies have related outcome to required versus actual nurse provision per infant throughout stay" (Watkin, 2005). Flexing up capacity when demand surges is not without cost and Akcali provides a useful discussion of optimization and shuttering (2006).

Patient Flow through critical care has been optimised for one hospital using data analytics and mathematical modelling (Shahani et al, 2008). Perspicacious comments in the discussion remain relevant in the current UK healthcare climate.

2.3.1 Modelling in Neonatology

Basic modelling of a system may involve input, output, mechanism and control such as feedback; neonatal patients could represent flow entities. Those problems investigated in the academic literature have included Demand Forecasting and Capacity Management. Demand was studied for the population of Trent in Nottingham (Burton and Draper, 1995). In the area of Capacity Management, the cot requirement for an English regional population has been estimated (Laing et al, 2004). The charity BLISS comments each year in its Baby Reports on this important issue (BLISS, 2007 and 2015). On direct observation, related sub-problems with capacity include bed blocking (social care delays), early discharge (outreach availability) and re-admission (provision of community services, premature hospital discharge).

In the related area of optimisation of Patient Flow, work has been conducted by neonatal nurses in Western Australia (Simmer, 2009) as well as the Queen's mathematics team in Belfast (Marshall, 2004). Within-hospital patient flow has been studied by applying System Dynamics simulation, for example for forward infant flows to lesser care levels within the Mount Sinai Hospital in Ontario (Adaikappan, 2005).

On direct observation, overflow occurs with Transport and is not helped by lack of co-operation between Foundation Trust hospitals in the less collaborative NHS designed within the 2012 Health and Social Care Act. The real world backdrop is Health and Social Care strain namely hospital complications, limited social care, re-housing waiting lists, court delays, transport shortage, climate of perpetual (winter) pressures (Triggle, 2015) and industrial discontent (2013-6).

Those approaches undertaken to tackle these problems have been partial and unsustainable. In practice in the Perinatal Network System, they include telephone communication between neonatal units, exchange transfers of patients and approaches reliant on goodwill such as calling extra staff in from home, which can interfere with

future tactics for hours worked, rostering, safe practice and human relationships. Select academic methods/techniques used to tackle these important problems are described next.

2.3.2 Neonatal capacity

The context of English neonatal networks has been reviewed (Marlow, 2007). Roles proposed for managed neonatal networks have included advising on strategy, service, design and promoting equality of access (Thakkar and O'Shea, 2006). Another paper (Laing et al, 2004) on the design of a neonatal unit has offered population predictions for desired ratios of intensive care, high dependency and special care cots as 0.75, 0.7 and 4.4 per 1000 birth population respectively. Such predictions are influenced by demographics and deprivation. Further population projections for Neonatal Intensive Care requirement have been made. A pragmatic determination of cot requirement for Trent was produced in 1995 (Burton and Draper, 1995) in which was debated the disadvantages of assuming a Poisson distribution for Length of Stay and bed utilisation. This work looked more at establishment rather than being able to apply data on a shorter-term feedback.

Seminal papers (Kempley et al, 2004) which laid the foundation for London's Neonatal Transfer Service (NTS) have argued the integral role of safe and responsive transport in networking. (They did acknowledge undesirable capacity transfers at eight per cent.)

In Western Australia, Neonatal Capacity has been improved (Simmer, 2010) by attention to co-ordination of cot management, call conferencing, workforce recruitment and retention, infrastructure, staff rotations and dedicated transport service. These measures were adopted in principle by UK neonatal networks.

A cross border assessment of Neonatal Capacity was conducted in British Columbia using Discrete Event Simulation (Fournier and Zaric, 2013). This resulted in a call to expand capacity in Canada to defray the expense of treating Canadians in the United States.

2.3.3 Non-clinical (capacity) transfers

The Trent neonatal network was one of the first to identify that long transfers were being undertaken unnecessarily within a region owing to a lack of joined up working (Fenton et al, 2002).

The Bliss Poppy report on parents' needs and the Neonatal Toolkit (DoH, 2009) on principles to which the neonatal service should aspire were published in tandem, accompanied by discussions with stakeholders on how to implement them. The Bliss "Weigh Less. Worth Less" report (BLISS, 2006) found 78% of neonatal units were closed to admissions once in six months, while 90% of neonatal intensive care units were closed to new admissions. Network capacity transfers were as frequent as once every three days. Data was lacking on appropriate versus inappropriate transfers; however one baby was sent 286 miles away. Transfers out of network were caused by shortages of staff, maternal beds and cots.

Subsequently the situation deteriorated with the BLISS Baby Report 2015 showing that 64% of neonatal units lacked nurses to meet national standards on safe staff levels. 70% of neonatal units were caring for more babies than considered safe. There were 855 non-clinical capacity transfers in 2014. Another frequent directly observed problem is that the neonate in-utero ought to have been transferred but decision-making is delayed and/or midwives are unavailable to transfer in a timely way leading to the delivery of extremely premature often plural neonates in the less optimal local neonatal unit environment. Obstetric standards thus influence neonatal ones. Not only are capacity transfers undesirable but not transferring when one should also increases risk.

The Neonatal Toolkit (2009) mentions how 24% of transferred women did not deliver at the receiving hospital and remained pregnant a week after transfer. Acute maternal transfer between consultant-led obstetric units resulted in 19% of very preterm deliveries in 1999. Five women were transferred twice. 29 transfers were out of tertiary units and 3 out of region. Fenton found a regional acute antenatal transfer rate of 3.7 per 1000 deliveries for foetal reasons but also influenced by distance and availability of paediatric staff (Fenton et al, 2002). Preterm labour without rupture of membranes was less likely to deliver and then to need neonatal intensive care. When

no foetal fibronectin is detected, then below one per cent of women deliver in the following fortnight (Peaceman, 1997), which holds especial relevance for in-utero transfers. One paper (Ting et al, 2007) comparing two clinical tests found a beneficial negative predictive value of absence of foetal fibronectin for delivery within the week.

So unnecessary transfers are made for capacity rather than clinical reasons, which is inefficient (BLISS, 2006) (Fenton et al, 2004) (Fenton et al, 2002). Unfortunately in England during 2016, maternity wards being closed to labouring women became more frequent (BBC News, 2017). Most hospitals declined to respond to this Freedom of Information request but 42 Trusts closed necessitating transfers for 382 women.

2.3.4 Models of Patient flow

Patient density and rate of flow through the system determine its efficiency and like any traffic, bottlenecks cause delays and queueing, which increase Length of Stay, density and worsen quality of care. This area has been reviewed (Bhattacharjee and Ray, 2014).

The Nuffield Trust (Karakusevic and Edwards, 2016) has studied the flow of patients through hospitals in England. Capacity is the number of patients in beds and those moving in and out of beds. It found that reserve capacity of up to 94.5% occupancy allows the four hour A&E waiting time target to be met, commenting that 85% occupancy is not feasible in the prevailing environment of retrenchment. Patients moving faster through the system require more space. Peak occupancy occurs at 8am with peak flow at 2-6pm owing to diurnal cyclicality in hospital processes. Future projections and solutions to problems in flow were suggested using road traffic analogy. The Nuffield Trust recommended that workforce, capacity and demand should be aligned; operational research methods to achieve such alignment are discussed in following sections.

Chausalet and team (Asaduzzaman et al. 2010) looked at data from the University College London neonatal unit from 2006. The model shows the cot requirement to obtain various percentages of acceptance. It was believed that admission acceptance could improve by 8% were Length of Stay reduced by two days. Unfortunately, not all cases are the same. Since current network standards demand less than 5% of

medical patients move network (and this allowance is to account for surgical transfers) the cot capacity for any pre-determined refusal rate of admission can be found. In an ideal world, none would be turned away by an intensive care unit for ongoing local care there (CSAG, 1993). Unfortunately, this particular study had to use combined data on intensive care and high dependency. The discussion drew out the difficulties faced in modelling random arrival rates, lengths of stay and cot occupancy. The need for rejection data was highlighted.

This group applied loss overflow to modelling (Asaduzzaman and Chausalet, 2010) based on blocking and overflow mechanism as occurs in telecommunications networks. The aggregated UCLH data of intensive and high dependency care was used. It was assumed Admissions followed a Poisson and Length of Stay a negative exponential distribution. In loss networks, if arrival is Markovian (i.e. memoryless), then loss probability is insensitive to service-time distribution. The model estimated rejection probabilities and was validated. Variations on Markov chains have been used elsewhere. These rely on certain assumptions, which tend not to be really met in complex healthcare systems in which the steady-state is approached but not achieved, so their practical use may be limited. The Department of Health was developing a Capacity Planning Toolkit to test scenarios of bed-blocking and occupancy based on Queueing Theory (DoH, 2009). Obvious areas of interest are the boundaries between networks. Yet anecdotal experience in different regions suggests that all available cots are not always declared, meaning the load balancing function of a network is suboptimal as information on cot availability is neither real-time nor accurate. Since problems in one hospital affect possibilities in another, it has been proposed (DoH, 2009) to set up perinatal bureaux to improve resource management of maternal beds and neonatal cots.

Using simulation, one research group has looked at location of services in the rural area of Peninsula and the dependency of the Perinatal Network System on service-users' family's private cars (Allen et al, 2015). They found 20% under-staffing of neonatal nurses. Using Simul8, they estimated Length of Stay at levels of care as following a log normal distribution. It was concluded that spare Network Capacity in intensive care would have the biggest impact on neonatal mortality. They were able

to run their model backwards and claimed this had little effect on results. This appears counter-intuitive to a clinician, since complications do prolong neonatal Length of Stay.

2.3.5 Length of Stay

Length of Stay is relevant since long stayers prevent patient flow. Recognising its impact and variability, advice from the Nuffield Trust on how to optimise this within hospitals has been published (Lewis and Edwards, 2015). Long Stayers may have chronic conditions, avoidable complications or intractable social problems, the latter which are outside the existing boundaries of the Healthcare system. Wolstenholme (2007) has written a most accessible paper on this issue, concluding that it might be in the interests of powerful hospitals to invest in Social Care. Yet such coalition of Health and Social Care, advocated by the WHO Health Systems Framework (2007) remains unrealised in England.

The weighting of medical determinants of neonatal Length of Stay has been investigated using linear regression by Powell et al (Powell, 1992) and included first gestation, next weight and then respiratory difficulties.

The method of two-component mixture regression modelling was applied to neonatal Length of Stay (Yau, 2003). This recognized short and long-stay subgroups leading to variability in Length of Stay. It proposed a two-component normal mixture regression model with random effects applying a generalized linear mixed model. Mathematical models have been developed to predict Length of Stay in low birth-weight babies using univariate analysis and multiple regression (Bannwart et al, 1999).

The Senior Data Analyst at the London Perinatal Networks, presented his model¹ in which optimising admission temperature in Extreme Prematurity was claimed to save on average four intensive care days per patient. This illustrated how Healthcare analytics can inform clinical practice.

Random effects can be dealt with in various ways and this is a subject in itself. Some have explained Length of Stay by covariates and captured it through a Coxian-phase

¹ verbal communication Ian de Vega, 3/9/2009 National Neonatal Network Management Teams Conference, London

type distribution (Adeyemi, 2010) (Marshall, 2004) It has been argued that within a larger sample such as a population served by a managed clinical network, random effects are somewhat smoothed so then it is reasonable to speak of Patient Flows. For operations and tactics within one neonatal unit, a time-slice of interest is that before steady state is attained. Both Discrete Event Simulation and System Dynamics approaches may find application. However, some processes thought to be stochastic may really be deterministic, such as the timing of elective Caesarean deliveries by obstetricians.

One question is how to statistically sample data and determine how it is distributed. In mixed populations, phase-type distributions and clusters of Patient Groups with similar characteristics have been identified (Gorunescu et al, 2002). Patient Length of Stay is often assumed to follow a negative-exponential or Poisson distribution, although an empiric distribution may be preferable (Schulman, 2006). Unwarranted variations in operational performance among hospitals including patient pathways, Length of Stay and complication rates have been identified and actions for their mitigation suggested (Carter, 2016) (BAPM, 2009). This is not a new problem and was recognised by the paediatrician, Professor A.G.M. Campbell in his doctorate (1985).

Perhaps the world gold standard of Length of Stay for neonates is the Californian data (Goyal, 2013). Length of Stay at special care level may be curtailed, hopefully not at the expense of hospital re-admission. Measures facilitating early discharge include effective neonatal care, neonatal outreach nursing and suitable discharge planning with the community (Lin, 2009). Social cases are not usually discharged Friday to Sunday inclusive owing to some community services not being available at weekends: there are thus weekly time-trends for some discharges. The community midwife or social worker may have sometimes devised a plan for child protection, parenting or support from vetted relatives beforehand to mitigate the length of such social stays (Lin, 2009).

2.3.6 Forecasting

Logistic regression has been used to predict neonatal survival by using a number of early available parameters. The CRIB score (Cockburn et al, 1993) used six parameters and although an enhanced version, SNAP-II used twenty-five, a study comparing the two showed no additional benefit. Further such statistical logistic regression methodology, based on linear relationships was compared with artificial neural networks, which make no such linear assumptions for predictive power and the two were often similar and fairly evenly matched (Ambalavanan and Carlo, 2001). One group compared the two methodologies for prediction of neonatal Length of Stay (Zernikow et al. 1999). Yet clinicians would distrust a neural network since the relationships it has formed on its training data are hidden or black box, as discussed by Walker and Frize (2004). The benefit of the former methodology is that results can be published and more openly shared. A complementary approach has been suggested. It was believed that a Case-Based Reasoning Tool could identify subjects with similar characteristics and their histories once a matching patient is admitted (Catley et al, 2004). Unfortunately, no two patients share exactly the same profiles and one could foresee other issues of doctor time taken for computer-searching, computing power and confidentiality.

There is a need to forecast cot occupancy and so availability on a tactical planning horizon of hours to days. This subject is well discussed by Mackay (2005). The ambition to predict hospital bed and nursing requirements over a four day time horizon has been taken up by Littig (2007). In this work, information from labour ward is obviously vital.

Timing of semi-elective and emergency Caesareans is unpredictable (O Donoghue, 2008). This study in Cork, Eire looked at the timing of deliveries, analysing four hour time-spells. Births peaked between 5 – 9 am. Those longer labours were more likely to result in perinatal death. Emergency section for foetal distress was more likely out of hours, as was an APGAR score (an index of condition at birth) below 5 at one minute. Most induced labours delivered out of hours. Those born out of hours needing neonatal unit admission, were more than four times as likely to have been delivered in the time-spell 4.30 – 8.29 hours compared with 8.30 – 12.29 hours. Thus greater risk arose when fewer resources were available, an important consideration for labour ward

/ neonatal unit interactions. Out of hours, weekend and public bank holiday working accounts for more than two-thirds of overall time compared with normal working hours (9-5).

Maternal or foetal disease comes to light in antenatal and foetal screening clinics, giving predictive warning of neonatal size, anaemia or congenital abnormalities for example. The Confidential Maternal and Child Enquiry (CMACE) Reports (CMACE, 2009) show the risk factors for a baby requiring neonatal unit admission. These include past obstetric history, multiple pregnancy and maternal conditions like diabetes and drug addiction. Use of risk factors (CMACE, 2009), given for instance for instrumental or Caesarean delivery, corrected gestation, socio-economic status and diagnosis by way of published Odds Ratios for neonatal admission (Lang, 1996) as well as historical data helps hone the prediction for neonatal unit admission and incoming care level. Applying research findings on the outcome of pregnancy alerts the neonatal team to the range of resources potentially required. Delivery suites should communicate with the neonatal unit on in-patients, the progress of high risk labours and their estimated time of delivery. Obstetric decision-making is a craft in which inter-operator variability exists. There may be scope for standardising midwifery and obstetric management.

Neonatal literature is full of calls for more national resourcing, talk of improvements made and examples of less good use of resources. It is acknowledged that information which is missing is adequate denominator data to garner insight on unmet need (DoH, 2009). The British Association of Perinatal Medicine (BAPM) defines levels of care. Those feeding, growing, tube-feeding and receiving low amounts of oxygen are special care babies. Those receiving non-invasive respiratory support (nasal back pressure) or close observation for drug withdrawal are High dependency. Babies artificially ventilated or undergoing exchange blood transfusion receive intensive care. The baby: nurse ratio for these levels of care is currently accepted to be for intensive care, high dependency and special care, 1, 2 and 4 babies: 1 nurse respectively. This 2001 BAPM standard (BAPM, 2001) is an ideal to work towards and currently is not being met nationally. Expert guidance on staffing of English neonatal units has been devised (BAPM, 2014): actualite and ideal differ. The general supply of clinical staff to the workforce has been investigated (NAO, 2016). Not surprisingly, as well as such

ratios, the management of nurses on a busy unit influences organisational efficiency (Goldschmidt and Gordin, 2006).

2.4 BUSINESS CONTINUITY

Business Continuity Planning is a necessary component of good hospital clinical governance (Rijpma, 2003). Emergency Healthcare services must be kept running throughout every hour of every day (24/7). There are legal standards for Business Continuity Planning for organisations such as hospitals and banks (original British Standard BS2599-2 becoming ISO22301). External and internal threats such as surging demand should be assessed and a plan for their mitigation developed. Of course, hospitals closing to labouring women is unacceptable. Loss of continuity of care occurs when emergency patients cannot be accommodated and must be transferred for non-clinical reasons perhaps on ventilators, which is a risk. Where rota-gaps are run, business discontinuity arises by design or circumstances. This threatens the purpose of the organisation's operations: care of human life. Management and planning actions are needed to address risk and develop contingency plans for what is foreseeable.

The historical development of Business Continuity Planning (BCP) has been traced (Herbane, 2010). This is essentially organisational resilience and reached prominence after 9/11, when so many lives and livelihoods were lost and threatened. It began with the need to back up electronic data in the seventies and has been successively tested by natural disasters like storm (Spedale, 2006), quake and flooding and man-made disasters such as war and terrorism. Commercially banks lead the way. The subject is all-encompassing and must take account of water, power, gas and communications being down as well as violent threats, shooting (Mc Kittrick, 1996), looting (NHS hospital equipment *is* stolen), Cyberattack (ransomware in NHS, BMA News, 2017) and further unfolding events. There should be sufficient investment to maintain infrastructure, including electrical engineering and computer security contracts; hence also the importance of financial governance and sustainability.

One should learn from experience, ensuring the organisation has a memory (DoH, 2000) otherwise the same fault may be repeated. This supports a virtuous (positive feedback) loop of information sharing, an idea found in Systems Thinking. So from the perspective of Management Science, Business Continuity Planning holds relevance for the Perinatal Network System in terms of continuity of care, risk and contingency planning.

2.5 MIXED METHODS MODELLING

Historically a single use model has been developed to address a problem in one department. It has not been generic across the system. There is Grade C evidence (expert support) for mixed methods modelling in healthcare (ISPOR-SMDM, 2012): for some problems, combinations of model types, hybrid models and other modelling methodologies are appropriate (II-7e); indeed, models must be complex enough to ensure differences in health or cost are covered (II-8). One editorial (Health Services Research, 2013) asserts that mixed methods research can help capture the complex interactions among system components, including those among multiple levels of analysis and over time.

It is necessary to incorporate alpha and numeric data into healthcare models hence the need for qualitative and quantitative approaches. Advice is given on principles and practices for achieving integration at the design, methods, interpretation and reporting levels for qualitative and quantitative input by Fetters et al (2013). For instance in their paradigm, this thesis will adopt a “contiguous” approach in reporting qualitative then quantitative aspects in sequential Chapters. Its fit of data integration between these two aspects might be termed “expansion”.

Crowe et al (2017) examine the combination of qualitative and quantitative methods in multiple settings employing a CATWOE (Customers, Actors, Transformation, World-view, Owners, Environment) rich picture. Their Case Study is for children’s congenital heart disease services and enabled consensus to be reached on quality improvement goals, which informed national commissioning.

In one perceptive paper detailing a survey (Eldabi, Paul and Young, 2007), respondents advocated a whole system approach: mixing modelling techniques, working across disciplines and using data from disparate sources. Health service managers should attach more importance to modelling for the planning and delivery of healthcare services. The clinical-management divide is apparent. A Multilevel framework for seeing both detail and the whole would help. Now RIGHT (2008) did commission methodological research. In connecting different modelling methodologies, it might

operate like that Life-Cycle framework proposed by Harper and Pitt (2004). Joined-up modelling or mixed methods to tackle problems were favoured above single-solution-based practices. It was considered that options-led methods might identify barriers to strategy and engender debate.

In one excellent, thought-provoking, fresh-paradigm paper from Rio, Lobo and Lins (2010) confront the gap between OR analyst and healthcare manager, diagnosing the need for epistemic dialog between the two. Ackoff (1979) had conceded that OR had become abstracted from real-world implementation and there is a need to “emancipate from institutional, cultural and power relationships, which limit our options”. OR often fails to be implemented owing to its disconnection from managerial and political imperatives. There is weak institutionalization of the OR discipline within healthcare operations management. Policy-making processes obstruct the utilisation of research results. There is a need for pluralistic research systems with improved interfaces between researchers and policy-makers. In Post-Normal science, where disputed values, high stakes and the need for urgent decisions exist, community dialogue is needed and results of health services research ought to be applied by health policy decision makers.

In another pertinent paper on mixed OR methods, Howick (2011) notes the implications for client value of using different facilitators/modellers and mixing of methods. It is feasible and desirable to mix methods for OR practitioners and academics. Their rationale for mixing methods included: interesting insights, complexity through time, space, people, departments, different stages of a process, complementariness and overcoming weaknesses of individual methods, that one method potentiates another, the approach just evolved, to test a framework or consider the wider system. The mix may integrate at the What? How? and Why? level. Pros include enhanced user confidence in the model, transparency of process, decision-maker involvement, generation of commitment to action, transferability, leverage and scope. Having a multi-disciplinary background was the norm for those practitioners mixing methods.

Mustafee et al (2015) offered deep thinking on the issues involved in mixed methods. The sometimes subtle distinctions between multi-paradigm, multi-modelling, hybrid

and mixed-method were discussed, with Agent-based models being rule-driven. Systems do span multiple levels, aggregations, scopes and phases and the combined model is greater than the sum of its parts. Their higher level of detail facilitates the asking of questions not answerable by a general model. Pluralism exists insofar as there are diverse perceptions of reality, different systems definitions and values for outcomes. Stakeholders, researchers and practitioners should interact. Challenges in hybrid modelling include the representation of time and multiple resolutions such as mixing entity level with aggregate level. There is a need for an integrated, inter-disciplinary approach to systems modelling. Allusion is again made to the Holy Grail of Operational Research which signifies different things to different people.

In summary, multiple models are needed to visualise different actors' perspectives and qualitative and quantitative aspects. Since healthcare is a complex multi-agent enterprise, an array of approaches from mixed models can reflect this. Engagement with the multitudinous stakeholders lends face validity. It has also been claimed that mixed models carry potential for mining the counter-intuitive or hidden knowledge of a system. Whilst multiple methods permit comprehensive visualisation of detail in systems they do require connection: in structure, time, place and inter-operability. Furthermore, a balance has to be struck between complexity and simplicity.

2.6 ENTERPRISE FRAMEWORKS

Consideration is now given to a way of seeing the wood for the trees within complex systems. To the layman or Business Director, the word framework conjures “an outline of things in which you hold the whole construction; without the framework the things will collapse.” (personal communication Dowd, B. FIoD, 2016). Frameworks imply purpose and approach. Ideally they should be embedded, adaptive and resilient to loss or change of a component. They must not be self-serving and kept as simple as is possible since, if misunderstood by users, hindrance rather than help results. Frameworks help provide a roadmap to put things and ideas together. Considering these could help generate an approach to tackling the problems identified in the Perinatal Network System, which have been set out in the Introduction. In any framework, one needs to take account of the definition, division and integration of component modules. These aspects are covered next.

2.6.1 Enterprise Architecture Frameworks

Enterprise Architecture Frameworks may be concerned with perspectives, structure and relationships (Graves, 2009). Such frameworks provide a comprehensive approach for contextualising and evaluating a system. They facilitate understanding, alignment, change and improvement within an enterprise, including its computerisation. In that case, there may be existing computer technology; the “as-is” system; and any transformation or computer systems migration to the “to-be” system has to be accomplished in a timely fashion. Consideration of an enterprise architecture framework can help one move from data to information and to the knowledge used for decision support, expert systems and even systems reconfiguration and organisational change. Viewpoints of a system could incorporate economic, ethical and scrutiny perspectives. Compliance with the law, policy and regulation are also necessary in the real world.

A number of different systems have emerged from the base IBM Zachman Framework™, whose evolution since 1984 has been described by Zachman (2009). It represents a complete ontology or schema. The basic questions of ‘What? How? Where? Who? When? And Why?’ are addressed from different perspectives. Within a Conceptual

Data Model for instance, there might exist entities, their attributes, relationships and interactions, object definitions and integrity rules.

Other well-known kinds of framework include reference frameworks such as The Open Group Architecture Framework (TOGAF), geared towards addressing business needs and the US Federal Enterprise Architecture (FEA), which aligns federal government departments. The advantages and pitfalls of Enterprise Architecture Frameworks have been compared (Sessions, 2004).

A Zachman Framework for Informatics in Healthcare has been offered (Diehl, 1997), in which it was understood that the pitfall was that different proponents might place information in different cells of the framework. The relevance of Enterprise Architecture for Healthcare has been studied (Ahsan and Shah, 2010) using 'Archimate', an ontological framework which is based on the Zachman Framework. This work is further developed (Sajid and Ahsan, 2014). The use of Enterprise Architecture in medical diagnosis has also been described (Sajid and Ahsan, 2016).

2.6.2 Enterprise Modelling Frameworks

Within an enterprise, architecture is the more or less steady structure within which dynamic models may be located. Enterprise Modelling Frameworks represent the conceptual infrastructure that supports integration and interoperability in complex systems. *Just such a complex system is the Perinatal Network.*

Since the nineteen seventies, a number of different Enterprise Modelling Frameworks have been developed; and these all can suffer similar problems to Enterprise Architectures insofar as if concepts are not clearly defined to stakeholders then misunderstanding, confusion, contradiction and misalignment can arise (Sessions, 2004). This practical disadvantage has led to their becoming less favoured. Yet an engineered model or framework need not be perfect, only workable.

Encompassed in the concept of an enterprise model are function, resource, behaviour, information and organisation. Enterprise models enable processes and the relationships between entities to be understood. As with Systems Thinking, they permit differing views of an Enterprise to be taken. Efforts have been made to develop general enterprise models (Dewhurst and Barber, 2002) which are adaptable with “plug and play” design. Systems Thinking has been recruited as a method of ensuring sustainability in interoperability for enterprise models (Ducq and Chen, 2012).

GRAI (Graphs with results and actions inter-related) methodology (Girard and Merlo, 2003) has been devised. GRAI decomposes complexity, forms a model then re-constitutes this. Obviously, information is lost so the model must retain face-validity. GRAI focusses on decisional aspects. Within a GRAI system, there are Inconsistencies rules: for instance the K rule. This one states that the system should be open (information obtained from external environment) and looped (information fed back from physical processes, for instance outcomes of treated patients). There should be opportunities for learning from both within and outside the system. (The corollary is that insular organisations which do not train, discuss or audit cannot learn or improve and do fail (DoH, 2000).) The role of GRAI in improving enterprise efficiency has been discussed (Doumeingts and Ducq, 2001). GRAI-Integrated Methodology (GIM) (Chen and Doumeingts, 1996) advanced four dimensions: physical, decision, information and functional, with each dimension focussing on particular aspects of organisations, which are then combined.

An Object Model is both functional and dynamic; interactions are not static but change over time. Processes may treat patients who flow through the system; also, their data flows. That data requires analysis. In database analyses (e.g. OLAP) data fields can be grouped in order to generate information for Decision-making.

In Service orientated computing (Erol et al, 2009), the semantic model is specified. UML adopts five different views namely use-case, design (of interest in this research), process, implementation and deployment. UEML (Unified Enterprise Modelling Language) has been envisaged for Information Systems (Opdahl, 2007). In Systems Design Engineering methodology (for example the IDEF8 framework), human-system interaction design (ICAM) is specified, relevant in Healthcare Enterprises. The information requirements for enterprises using these kinds of framework have been identified (Shen, 2004). In EEML (Extended Enterprise Modelling Language), there is process, data, resource and goal modelling.

So Enterprise Modelling Frameworks facilitate different ways of viewing and depicting a system and build a foundation for (and are synonymous with) its logical description in computer language.

2.6.3 Enterprise Modelling Frameworks in Healthcare

The difficulties of integrating mixed models in Healthcare have been highlighted; and an approach to evaluating database integration proposed (Fetters and Curry, 2013). Harper has proposed a Framework for combining models of resources from different hospital departments for integrated patient flow management (Harper, 2002). The need for models of hospital departments to be integrated, in order to achieve organisational efficiency has been discussed and web-based process-mapping in a service-orientated architecture applied (Benyoucef et al, 2011).

In Healthcare literature, a variety of heterogeneous Enterprise Modelling Frameworks have been proposed; and a select comparison with critique is given in Table 2 which follows, whose abbreviations are defined in the following Key. Just a few quality papers emerge yet each provides insight and many describe the obstacle of complexity. Some Frameworks are custom built as hybrids; and apply and extend established methodologies. Of interest is that Frameworks from Defence are applied in

Healthcare. The common pitfalls appear to be difficulty in agreeing terms and definitions, lack of development and implementation, or insufficient information for replication. This survey lets stand that “A framework is a framework” if authors consider it is one. This underscores the need for one to define a framework clearly to others, at least its purpose and approach. At the end of the Table lies a self-reflexive anticipatory teaser of this Research Thesis, offered with similar critique. The context of the Perinatal Network System as an enterprise is discussed in the penultimate section.

2.6.4 Operational Research Frameworks

A Framework to combine how Systems Dynamics and Discrete Event Simulation models interact, share and exchange data has been proposed (Eldabi and Young, 2007). These two kinds of system models may proceed in an independent or cyclical manner and then interface at certain points in space and time. That viewpoint of an Enterprise Architecture Framework addressed is the Systems Design layer. This topic is an Operational Research staple amenable to on-going development (Morgan, 2011).

A plethora of reviews exists; a particularly exhaustive one on the use of Operational Research/ Management Science (OR/MS) in Decision-making in Healthcare has been undertaken (Hulshof et al, 2012); this has led to a taxonomic classification being derived, which could help Healthcare managers know where to seek research answering their specific issue. The aim of the RIGHT project was to develop an evidence-based “model selection toolkit”. (Brailsford et al 2009). To close this particular loop, one would need to test the correctness and efficacy of its use by hospital managers, research which is likely to prove challenging in the current NHS climate. An international comparison of OR in Healthcare delivery systems has also been set out (Sainfort et al, 2005).

Enterprise Modelling Frameworks relevant to Healthcare

Framework	purpose	method	situation	Criteria specified?	Implemented?	validation	pitfall	Development?	reference
Information System Architecture	Healthcare organisation	Collaborative care model, TOGAF	Generic overview. Useful theory	Very proscriptive	no	no	Not covered, English	Need for	Arman and Dwiyanti 2015
PartiSim	Facilitated stakeholder involvement in simulation	DES SSM	Distributed, English hospitals	Defined Steps in process defined	2 examples within study including obesity services	intrinsic stakeholder feedback	Time taken to learn and practice for facilitating the workshops	Identifying human distress in workshops	Tako and Kotiadis 2015
		DES MCDA SSM						WIKIs	Tako and Kotiadis 2012
Conceptual model hybridization	Facilitate hybridization at conceptual stage for non-expert	SD DES	healthcare	limited	no	no	English	ABS Proposed for AnyLogic	Zulkepli and Eldabi 2015
Enterprise Systems Engineering	System of Systems (SoS). Macroeconomic effect of policies and programs	Multi-scale hybrid data analytics: Agent-based, SD, DE, econometric	US healthcare system	yes	Type 2 diabetes management	no	Requires development	Comparative Effectiveness Research. Coupling to economy	Dougherty et al 2012
Analysis	Hospital Patient flow logistics	Literature review comparative	Italy	Specific inclusion criteria	Within this study	Developed with stakeholders	Artificial variability of elective work. Indicators unstandardized	Reserve capacity. Real-time information control.	Villa 2014
Data	Patient journey modelling	Event driven process chain	Surgical clinic in Australia	unclear	no	no	Simplistic Unable to replicate	Proposed for hospital in Bangkok	Samaranayake and Kiridena 2011

Framework	purpose	method	situation	Criteria specified?	Implemented?	validation	pitfall	Development?	reference
medBPM	Healthcare reliability improvement	Six-Sigma BPM HFMEA	Dispensing by pharmacy	yes	Case study	With stakeholders	Alternatives are available	Not discussed	Atallah and Ramudhin 2010
	Healthcare development	Microsoft Visio	US hospital pharmacy	no	Pilot of medication distribution in US	Yes with studies	No critical reflection	Dynamic DES	Ramudhin et al 2006
“Architecture Framework”	Risk management in healthcare technology	MODAF	Clinical Engineering. Human factors	Yes but not open to replication	no	no	Under-developed, english	Fault Tree analysis	Signori and Garcia 2010
Service Oriented Architecture for internet	Workflow lab model for IHE domain	BPEL 4PPL language	Cancer registry	Yes, IHE	Example laboratory request	no	security	security	Aftab et al 2009
EPOCH	Integration of outcomes research and healthcare delivery	Web-based. MS.NET	Applying healthcare research findings	elsewhere	Yes, many institutions including US cardiac centres	Not covered	Not discussed	underway	Soto and Spertus 2009
ePRISM Personalised Risk Information Services Management	Risk modelling and decision support system		Modelling library		On cardiac wards			Clinical tools	Soto and Spertus 2007
Model-driven ontology	Computerisation of Clinical Practice Guidelines (CPG)	GEM (XML)	healthcare	yes	More theoretical	no	CPG not being applied	Generic, so development possible	Hashmi and Zrimec 2008

Framework	purpose	method	situation	Criteria specified?	Implemented?	validation	pitfall	Development?	reference
Zachman Framework	Healthcare informatics standard	Not stated	theoretical	yes	no	none	Definitions of cells may overlap	rudimentary	Diehl 2007
RIGHT	Selection of tools, Service Design	Prospective Hazard Analysis	Healthcare service simulation	preliminary	Pilot on integrative modelling	Not described	funding	Underway slowly	Eldabi and Young 2007
Service Orientated Architecture SOA-enhanced NHIN-2	Systems Information network	ARCES DoD	US healthcare records	theoretical	Planned in US, 2014	no	Security, loss of wireless connection	Stores data to overcome communications difficulties in tunnels	Sloane et al 2007
Systems Dynamics	Healthcare Information Systems	Meta-analysis	Electronic medical records in US	Search strategy	no	Face-validation through discussion	System counter-intuitive. Managers parochial and coercive	simulation	Obal and Lin 2005
Operational Modelling of Hospital Resources	Integrated hospital capacity management	PROMPT Apollo CART	Surgical bed allocation	Detailed specification	UK hospitals	Developed with users. Compared with actual data	Unpredictability, nurse and bed resource constraint	Patient classification techniques, simulation	Harper 2002
ISO/IEC 15288	Common Language for Systems Life Cycle Management	MODAF	Defence procurement	-	By NATO	-	-	Modelling and simulation	Nordqvist 2002
Reference Enterprise Model in healthcare	Applying Enterprise Viewpoint Language	OLAP By committee	Hospital Information Systems in Japan	Yes	Radiological community	no	Not discussed	Case study	Tanaka et al 2001

Framework	purpose	method	situation	Criteria specified?	implemented	validation	pitfall	Development?	reference
Hospital resource management decision taking	Capacity management	Anthony's 3 level hierarchical planning approach	Hospital specialisms	Yes, higher level	Partially, served as a catalyst for discussion	Theatre timetable, surgeon master schedule	Hawthorne effect	Build management support into information system	Visser 1995
This Research Ontological	Modelling the Perinatal Network System	Mixed OR, Systems Thinking	Shortage of neonatal capacity	Conceptual Framework Chapter	Cot Predictor model proposed	with actual data	Unfunded, Climate of retrenchment	Other neonatal units / networks	Dalton, Chahed and Chausalet 2012-16

Table 2 Enterprise Modelling Frameworks relevant to Healthcare

Key to abbreviations in Table 2

ARCES = Advanced Research for Computing Enterprise Services

BPM = Business Process Modelling

CART = Classification and Regression Tree

CPG = Clinical Practice Guidelines

DES = Discrete Event Simulation

DoD = Department of Defence

EPOCH = European Parallel Operating System Based on Chorus

HFMEA = Modelling Enterprise Architecture

IHE = Integrating the Healthcare Enterprise

ISO/IEC = International Standard for Systems Engineering

MCDA = Multi-Criteria Decision Analysis

MODAF = Ministry of Defence Architecture Framework

NATO = North Atlantic Treaty Organisation

NHIN-2 = Nationwide Health Information Network

OLAP = Online Analytical Processing

PROMPT = Patient and Resource Operational Management Planning Tool

SD = System Dynamics

SoS = System of Systems

SSM = Soft Systems Methodology

TOGAF = The Open Group Architecture Framework

2.7 CONTEXT OF THE PERINATAL NETWORK SYSTEM AS AN ENTERPRISE

So what is the relevance of Frameworks to the research problem? If a complex system is to be improved, then computerisation is required. Prerequisites for this are its clear description in language and mathematics, strategic direction and resourcing. Here, by way of illustration, this idea of Enterprise Modelling Frameworks is applied to the case of the Perinatal Network System (previously described in the Introduction). Within that Enterprise, products, activities, resources and time exist; and the “product” is the discharged treated patient, whose clinical outcome is amenable to quality assurance. Using GIM dimensions, we have: its function is to treat and discharge patients well. Its physical manifestation is a group of hospitals working together with similar protocols, guidelines and philosophy of care. Both managers and clinicians may take decisions. Information is found in legacy “as-is” systems and is used for costing *but not for clinical improvement or operational and tactical management, for which it could be exploited.*

In Model Dimension Architecture, dimensions include policy (which may lapse in the real world), process (of care), data (not real-time yet) and structure. *That dimensional analysis using Time would align naturally to the Perinatal Network’s main work of care and Length of Stay emanating from prematurity.* (The warrant for this is that, as previously mentioned, as the weeks of gestation pass, the neonate naturally develops more and care needs are expected to diminish).

Within a Healthcare system such as the Perinatal Network, information may be depicted either with individual patient pathways in a discrete manner or on a larger scale, with flows of patient traffic through the system as in System Dynamics, or even by a mixture of the two. Entities and objects might be data, patients, beds, nurses and equipment. System interactions within a relational architecture include within-hospital inter-departmental (for instance between labour ward and neonatal unit), through-unit patient pathways (for example between cots at different levels of care, with their attendant nurse resources within one neonatal unit) and inter-hospital interactions. The analogy and argument began here is taken up in the next chapter, which advances a Conceptual Framework for Modelling the Perinatal Network System.

2.8 SUMMARY

Business Continuity Planning is a necessary component of good hospital clinical governance (British Standard 25999-2 2006) (Rijpma, 2003). A mix of methodological approaches furthers understanding of complex systems in Healthcare. Operational Research applied to neonatal care exists but is not extensive. Those techniques and models developed were originally for intensive care problems (Kolker, 2009). There is a gap in understanding physical networking within the Perinatal Network System (Marlow, 2007) (Thakkar and O'Shea, 2006). Existing literature lays its emphasis on intensive care centres rather than taking into consideration all the component neonatal units within the network (Cusack et al, 2007) (Burton and Draper, 1995).

Interdisciplinary approaches to understanding the mechanism of the Perinatal Network System, combining Management Science and its managerial / operational / demographic information with Medicine and clinical knowledge have not been undertaken. There is no forecasting of Demand based on existing local information. Forecasting Demand for Neonatal cots from Obstetric information is piecemeal and un-coordinated. The connection between neonatal acuity, complications, outcomes and nurse staffing resource has not been thoroughly explored since this data has not been joined-up. The effect on services of managers assuming averages when planning, rather than taking account of real-time fluctuations is not known (Shahani et al, 2008). Real-time data Tools need to be developed (Nuffield Trust, 2016).

Dealing with complexity is a difficult task; and models can simplify things. Enterprise Architecture and Modelling Frameworks have helped join up Conceptual Models in Business and Information Technology. Such perspectives are yet to adequately connect complex organisations like Healthcare; where there is slippage in implementation of the proposed change (including that devised by OR/MS academics). A minority of computer simulations lead to successful implementation in the real world (Jun and Jacobsen, 1999) (Brailsford et al, 2011). Obstacles include communication and continuity between staffing groups within the timescale of changing organisational and policy imperatives.

CHAPTER 3 CONCEPTUAL FRAMEWORK

3.1 INTRODUCTION

This Chapter advances a Conceptual Framework or organised model. It shows how ideas are assembled to achieve the research project's purpose. This frames the problem and gives the grounds for this thesis. It mediates between and seeks to align the Literature Survey on the state of Operational Research and Modelling in Healthcare, critical thinking on the research question and the specific work and data collection undertaken.

Sifting information systematically and obtaining a logical and relevant way (Framework) to exploit its intelligence are challenges for the connected environment. Without this ability, big health data appears eclectic and overwhelming and learning is impeded. Furthermore data handling depends upon oversight of strategic objective despite outcome uncertainty, so flexibility is necessary. This conundrum is addressed by drawing upon soft systems engineering. Since the situation is complex, some (expert) judgment is required to estimate the weight of the various components. This kind of process should be progressive and iterative. The ideal Framework is itself dynamic and its evolution determined by the plastic interactions of models. Thus there is a necessary tension between adopting a Framework and Systems Thinking.

This Chapter is further structured as follows. The research question is re-iterated. The Thesis / argument is set out. Criteria for the ideal Perinatal Network System, Perinatal Network Information System and perfect Model are set out. A solution is proposed to the research question applying both Enterprise Architecture and Operational Research Frameworks. An Enterprise Framework for Modelling the Perinatal Network System is designed and its generic counterpart distilled. The specific formulated research framework is applied to an exemplar Case Study of the local neonatal unit. That work is demonstrated in the conceptual design domain in the Case Study Chapters 4-7.

3.2 RESEARCH QUESTION

Healthcare System Deadlock occurs every winter in the Perinatal Network in which patients are backed up in units of the wrong care level. At such times, there is also pressure on the transport service. Congestion is such that exchange transfers must be undertaken to improve efficiency. It may take several days for patients to be moved to the correct hospital and this can increase overall Length of Stay and decrease efficiency in the system. Bliss Baby Charter standards draw attention to the separation of twins and triplets (whom by definition are premature), their parents and long distance transfers of over a hundred miles and between countries (BLISS, 2012).

When and wherever this arises in the Perinatal Network, it threatens the operation of the system and the upstream working of intensive care centres. This results in poor quality care and staff stress. Currently managers and workers are not alert over when capacity issues might arise. That logjams / deadlock will occur is certain and predictable; we wish to predict *when*. The purpose of the research is to address the episodic problem of shortage of capacity. We need to pre-empt and respond to that situation. One aim is to predictively model it. An alert for pre-emptive resource planning is required. This would allow nurses to be deployed ahead so that patient care is kept safe and the intra- and inter-hospital Network Flow of patients is not jeopardised; beds are unblocked permitting freedom to admit and system integrity is not jeopardised.

We need to visualise the system. We describe and analyse it in order to understand resource use. One objective is an Operational Research Framework for dealing with shortage of capacity (behaviour) in the Perinatal Network System (mechanism). We locate this research by applying the exemplar Case Study of the English local neonatal unit, where shortage of capacity is observed to be within High dependency care. This might help improve pro-activity by generating an alert through an early warning system. This practical problem is pressing, topical, feasible and professionally interesting and one has access to relevant historic data.

3.3 ARGUMENT

Research may have manifold objectives; and the Conceptual Framework must take regard of this. Table 3 shows such generic purposes, their theoretical conceptual framework and specifies how these are incorporated into this Research (Shields and Rangarjan, 2013).

Research Purpose	Conceptual framework	Modelling the Perinatal Network System	Thesis Chapter
Explanation	Working hypothesis	Lack of insight/control over system in real-world	Conceptual Framework 3, Case Study 4
Description	Categorisation	Classification, 'as-is' description	Case Study 4
Gauging	Practical ideal type	Best functioning	Conceptual Framework 3
Decision making	Operational Research models	Alert/Decision support to overcome shortage of capacity.	Case Study 6, 7
Analysis, Inductive reasoning	Formal hypothesis	Underlying behaviour (Markov)	Case Study 4, 5, 7

Table 3 Embedded Research Framework

The basic argument is derived: Real-time control over the health care system is lacking. We describe the system as it is, though ideally this should be better. We would like an alert or decision support when capacity is short. To get this, we find the system's underlying behaviour through analysis first, then predictively model it.

This is expanded to give:

There is lack of insight into and control over the local neonatal unit and Perinatal Network System despite one having detailed and big but as yet, not fully exploited, service data. We can gauge what the ideal system would look like. Real life shows us how it deviates from this ideal.

Those different OR methodologies which are relevant (by heuristics or rule of thumb) to its working / mechanism may be classified. Shortage of capacity can be understood and explained by discovering the underlying behaviour of the system. Data collection has occurred on: arrivals, fluctuation and LOS. The medical behaviour of patients within the system explains the pattern of cot utilisation. We combine routinely collected medical data on prematurity, diagnosis and level of care with service data and perform statistical analysis. Employing an array of OR methods for Decision making can help to overcome recurrent shortage of capacity. Dynamic modelling might assist Decision support for shortage of capacity, including management intervention and possible re-configuration.

So the aim is to provide a methodology for viewing and understanding the mechanism of the Perinatal System. In emulating a Perinatal Network this tool could help to forecast workload, reduce uncertainty and improve management of resources. Those areas of interest are interactions between labour ward and neonatal unit admission, Patient Flow within the local neonatal unit and interactions between the local neonatal unit and neonatal intensive care unit. Shortage of neonatal unit capacity is the crucial area to investigate, looking at its causes, effects and any remedies. The focus is a local neonatal unit in a large geographic area network.

To summarise, one objective is an OR Framework for dealing with shortage of capacity (behaviour) in the Perinatal Network System (mechanism). This could permit smart applications namely predictive modelling and forecasting.

3.3.1 The Ideal and imperfect

The perfect or ideal system guides the “to-be” vision, which is:

The ideal perinatal network system

Ideal characteristics of this system are: fully staffed, no equipment breakdown, no budgetary constraint, no complications in patients, no social care delays, no refusals to admit or transport, optimal communication and correct cot configuration for current population demographic. Meeting these criteria requires information. The ideal system is not attained in the real world; however it can be optimised.

The imperfect Perinatal Network System

This is at odds with the ideal. It suffers poor systems flow such as bottlenecks, blocks to inflow (complications in patients and high cot occupancy), blocks to outflow (Social Care), and deficiencies in staffing and skills mix.

The ideal Information System for the Perinatal Network

Characteristics of an ideal Perinatal Network Information System would be one which: links sufficient databases to give real-time information. Specifically this might include eCAM, Standardised Electronic Neonatal Database (SEND), Patient Administration System (PAS) and computerised maternity notes. This live data should link with the server, replenish and update the service. It should analyse, benchmark and audit variations, ideally online. It should be responsive to patient need and clinicians’ reasonable requests. It must serve clinical outcomes. It might offer Decision support and suggest improvements. It has to be specified (for instance in which information should be exchanged upstream or downstream) and secure.

The imperfect Information System of the Perinatal Network

Unfortunately information on the Perinatal Network System is found in many different systems of software, live, archived and even paper records with no inter-operability, common architecture or linkage (Healthcare through Technology Expo, 2012).

The perfect model

The perfect model should be useful and fill a gap. This might be for instance between data, information, decision-making, planning and resources. It might help predict changes, both those expected and unexpected. It should be verified and validated against empirical data. It must harness up-to-date information from different sources (in this case along the Patient Pathway). It should allow analysis of past patterns. It ought to be open and accessible. It should be self-improving and able to learn in domains such as quality. Further it must be adaptable, a project to be built on, future proof and visionary. A model does have to make assumptions, which should be specified and open to challenge.

Without modelling, existing information may not be exploited systematically to best health and economic advantage. Candidate Management Science/ Operational Research (MS/OR) methods which help approach and support this ideal are explored in following sections.

3.4 PROPOSED SOLUTION TO RESEARCH QUESTION

Three components to the solution are proposed:

1. Application of Zachman Architecture Framework (1987) to help contextualize the issues.
2. Operational Research Framework to deal with interfaces and guide informatics for the prediction of workload.
3. The formulation is a Conceptual Research Framework for Modelling the Perinatal Network System. This constitutes an Enterprise Modelling Framework, which comprehensively provides the overview, detail and connections of a dynamic system. It may be regarded as a System of Systems (SoS) and rendered generic.

The validity of the Conceptual Framework is demonstrated by applying it for utility in the Case Study which follows. The connections in the Conceptual Framework are shown in Table 4.

Method	Model	Application area
Enterprise Architecture	Zachman Framework (next Section 3.4.1)	Location of models
Enterprise Modelling	Conceptual Research Framework (see Section 3.4.3)	Modelling the Perinatal Network System
Business Continuity Planning	(discussed Section 2.4)	Keep services running 24/7
Contingency Planning	(discussed Section 2.4)	Mitigate shortage of capacity / power outage
Mixed OR methods	Operational Research Framework (see Section 3.4.2)	Modelling the Perinatal Network System
Systems. Analysis. Dynamic Modelling/ Simulation (SAS)	Framework for Case Study (Section 4.2)	High dependency cot capacity in the local neonatal unit

Table 4 Conceptual Framework connections

3.4.1 Enterprise Architecture Framework

The advantages of applying an Enterprise Architecture Framework have been covered in the Literature Review. Benefits include contextualising the system, describing it, comparing it over time and pinpointing change in a large organisation. Mastery of complexity, the vantages of different actors and Systems Thinking are possible. Knowledge of an organisation’s communications and Architectural Framework is necessary and will permit the contrasting perspectives of stakeholders to be taken on Board and also facilitates improved computerisation and resource allocation.

This Research calls for the ‘to be’ situation of better harnessed Informatics. This depends on the organisation’s Board being open, transparent and honest about its data, otherwise it lacks integrity (Troop and Taylor-Brown, 2014). Deliberate manipulation of data by managers was made a criminal offence following the 2013 Colchester cancer debacle where no audit trail was kept.

Here the Zachman Architecture Framework, a complete ontology, is applied and developed. It is represented as a two-dimensional grid, whose real-world analogy is ideas organised in postal pigeon-holes. The Conceptual layer has to work and be logical. Table 5 below shows a simplified version and Table 6 offers more detail.

Basic Questions	<u>How?</u>	<u>Who?</u>	<u>When?</u>	<u>Thesis Chapter</u>
Overview				Background
Theory				Literature survey
Logic	Systems diagrams			Conceptual Framework
Computer solution	Design			Case Study Chapters
Realworld deployment	Built code			
Practical Pitfall e.g. NHS	Gets complicated, loses linkage and can then fail Complex, boundaries blurred, cohesion lost, fluid, confusing			Discussion

Table 5 Simplified Enterprise Architecture

The Perinatal Network System may be regarded as having nodes representing levels of care, which are linked by patient journeys. One feature of the Enterprise is logistics, moving the neonatal patient between hospitals. Operationally, different levels of care carry implications for the workflow model mandated by detailed BAPM policy laying down nurse-patient ratios for level of care.

When working with the Zachman Architectural Framework, only relevant cells need be specified depending on the problem to be addressed. In the case of shortage of capacity in the Perinatal Network System, the dimension of Time namely “when” is the most important to understand. The essence of the system may be limited to these relevant and important cells. Various modules or models can be fitted into the Architectural Framework. Models help decompose, simplify and represent the complex system; a model needs face validity.

Thus the functioning system’s main work is emergency, which appears unpredictable. Its scope is human gestational development. For the weeks of prematurity, certain care needs are implied and different levels of care carry different resource implications such as nursing and equipment. Arrivals are stochastic although elective Caesarean sections are determined by obstetricians sometimes in consultation with the neonatologist in relation to available resources like nurses. Ventilation has certain resource implications.

The Enterprise Architecture Framework can incorporate policy and topicality. The following Table 6 shows what is known about strategy. Agility and flexibility are needed to re-mould the Network System for evolving demands, for instance when healthcare, expectations and understanding, society, economics, funding and technology changes or is re-organised. So today’s best estimate is not tomorrow’s. This Framework could support a Network System over time. It facilitates review and illustrates how change might be dealt with. It has the potential to be dynamic. It allows checking that the approach of the Enterprise stays aligned to its purpose. Alignment generates trust in a complex organisation; on the other hand disparate non-communicating silos produce distrust and organisational failure.

	What? Data	How? Function	Where? Network	Who? Organisation	When? Schedule	Why? Strategy
Planning Scope Context	Equipment Consumables Communication Patients Technological advances	Deliver care Resuscitation Ventilation Baby check Feeding	Level 1-3 neonatal units, English networks	Hospital Neonatal units, Birth centres, Ambulances, clinicians	Human gestational development, Birth, Discharge planning	Survival, Health, Provides future tax- payers
Owning Business Enterprise	Semantic (language) model	Hospital neonatal unit process model, Logistics	Logistics, Transport system (ODN)	Work flow, All stakeholders	Emergency trumps elective care, Event/cycle model	Quality outcome, Efficiency, Business Plan
Designing Systems, Logical, Platform independent	Logical Data model	User views, TACTICS, Application architecture	Distributed system, Agent-based simulation	Common portal, PAS, Human link, Nurse-care ratios (BAPM)	System event specification, stochastic, Control (if any), Decision-making	Minimum quality standards
Building Technology/ Platform specific	Physical data model	Computer function	Local SEND National HES	User screen, upgrades, Password security	Discrete Event Simulation, Markovian, System triggers	Benchmarking, consistency
Sub-contractor /Realworld/ functioning	NNAP minimum data set	HEALTHCARE ANALYTICS	System re- configuration	New actors / Short staffing	Ward work - unpredicted	Improvement, Audit, Working strategy

Table 6 Zachman Architecture Framework for Modelling the Perinatal Network System

The Conceptual Research Framework is inter-disciplinary and incorporates a mix of methodologies from OR/MS, Healthcare Analytics and empirical data from Perinatal Medicine. Aspects of these disciplines drawn upon are detailed in Table 7:

Operational Research	Informatics	Clinical Medicine	Management Tool	Policy
Systems Thinking, Systems Dynamics, Dynamic Modelling, Predictive modelling, Forecasting,	Metrics Linkage, Common portals, Statistics e.g. Binomial, Markovian	Odds Ratios, Case Based Reasoning, Empirical data <u>Specialties</u> Midwifery Obstetrics Transport Neonatology	Business Continuity Planning, Contingency planning, Risk, Systems Analysis	Quality improvement, Audit Localism Re-configuration Retrenchment

Table 7 Catalogue of Disciplines and Methods

It is useful at this point to consider where all this is leading. How good is prior knowledge within the neonatal unit? This might incorporate communication from obstetricians, knowledge on local rates of prematurity, any common clinical portal or linkage of computer systems. The ideal is real-time information.

Can we harness past knowledge in order to predict expectations for a population on the background of natural fluctuation and changes in services in hospital and community, models of care and funding, networks and health policy?

Can we use this information to help us manage resources at a tactical level to best guarantee Business Continuity for the service under conditions of resource constraint?

How can we disseminate and embed learning so remote units in a distributed system deliver best practice in regard of resource (i.e. staff) management? This is interesting in cases where small units need to assimilate the wider system's practice, and also to control networking effects.

What kind of Framework is needed to understand this from all relevant angles?

Which Tools help us visualise the system and its mechanics?

Detailed events and Patient Flow may have their dynamics depicted by Markov Chains, which underlie Monte Carlo Markov modelling. Unfortunately the system's control structure is ad hoc and could be improved to facilitate forecasting.

Technology is not currently harnessed to allow predictive modelling although this has been successfully developed for Accident and Emergency work in Wigan in the North West of England (Healthcare Efficiency through Technology, 2016) and investigated for cardiac intensive care (Gallivan, 2002).

We adopt an inter-disciplinary approach incorporating mathematical techniques (binomial theorem and Markov modelling), Operational Research methods (Systems Dynamics) and medical Case Based Reasoning to model the English Perinatal Network System.

3.4.2 Operational Research Framework

The Operational Research Framework comprises a mix of qualitative and quantitative methods, which are set to work together for the purpose of Modelling the Perinatal Network System. It is shown in Table 8 and Figure 1:

Perinatal Network System Operational Research Framework			
	Methodology of component model	Role / application of module in framework	Output feeds into / produces
1	Systems Thinking	Inter-hospital interactions	Dynamic Model, 8
2	Odds Ratios / risk analysis (Obstetric data)	Neonatal admissions forecast	Demand, 3,4,7
3	Systems Dynamics	Patient progression / mover-stayer model	Cot Predictor, 7 Patient volume
4	Mathematical modelling, Case Based Reasoning, Medical diagnosis	Neonatal Length of Stay estimate	Cot Predictor, 7 Dynamic Model, 8
5	Markovian methods	Time in neonatal system estimate, Recurring underlying signature behaviour of system, Invariant distribution of time in system, Underlying LOS behaviour	Dynamic Model, 8
6	Patient pathway mapping	Partition of straightforward from complicated	Quality management Dynamic Model, 8
7	Binomial Theorem Stochastic arrivals (SEND data) Mover-stayer flow model, Predictive modelling	Cot Predictor Tool	Forecasts Patient volume Cot activity Nurse staffing, 8
8	Dynamic Modelling (SEND data)	Tactical time horizon forecast for local neonatal unit	Models Cot activity Nurse staffing Reconfiguration of resource constraints

Table 8 Perinatal Network System Operational Research Framework

Figure 1 shows how information outputs flow and how these modules are connected and integrated within the Conceptual Operational Research Framework. Here is the rationale for the mixture of models produced.

Systems Thinking connects things together. For instance, where inter-hospital interactions are called upon then there are interesting questions of boundaries both within a network and between entities such as Foundation hospitals. This influences how any model is built.

Chain logistics means the successive steps in the logistic process. Those factors influencing the rate of admission to the neonatal unit dictate the patient volume and are relevant to this.

System Dynamics is one way of visualising patient volumes and Patient Group progression. These feed into the Cot Predictor capacity Tool, which is discussed in the Case Study that follows. Again Length of Stay modelling is vital for chain and unit logistics and this amounts to the individual's pathway, whether optimal, normal and good quality or complicated, circuitous and costly. Markovian modelling helps one predict time spent in the system and this is relevant for a Dynamic Model and the tactical time forecast it could generate. A Mover-Stayer Model feeds into the Cot Predictor Tool, which forecasts nursing resources for the expected demand. Depending on how all this proceeds, then the models may indicate suitable reconfiguration of the system.

So Systems Thinking (Checkland, 1981) is used to generate a Conceptual Model using mixed approaches and mathematically model it in order to produce inputs for a Dynamic model such as Monte Carlo Markov (Stewart, 2009); this achieves a working model of the neonatal unit, a test-bed used to gain insight into it. Now the system is dynamic and Markovian concepts permit the introduction into the model of patient journeys within the neonatal unit and between hospitals. A Markovian approach can help describe networking between cots at different levels of care (intensive, high dependency and special), which are associated with differing equipment and staffing resources. If it can be shown how a group of cots work together in a local neonatal unit serving a particular population then (with validation) this can be applied on a larger scale to better understand patient and system variability within the Perinatal Network System itself.

The rationale for the order in which the methods are given derives from the natural patient pathway and how the clinician might follow it: from patient admission, treatment through to discharge, as just described. The component models of the Framework are introduced, mapped to Chapter and their verification considered. How they are integrated and work together is discussed later in the Enterprise Modelling Framework Section 3.4.3.

Model 1 Systems Thinking

This is a necessary model which incorporates causal loops, positive and negative feedback, influence diagrams, mind and concept mapping (over-arching). The Perinatal Network System has both a hard and a soft structure. One is physical and concrete such as geographical location whereas the other takes in policy, thresholds and communication. There are time, space and problem boundaries. A higher level aggregate view is developed employing Systems Thinking.

The Department of Health patient centric diagram and the King's Fund cartoon of the current organisation of the NHS in England are well known. The Perinatal Network System should disseminate best practice to all its hospitals and patients must be transported between them. Relevant learning occurs through parent feedback. The network of care may be regarded in terms of node-link connections.

The whole system is captured using process mapping and problem structuring. It is formalised using flow charts depicting patients, which is how healthcare workers seem to best understand the system. A hybrid model is needed to map and record the system. Soft methods are used to describe it and are verifiable by the clinician. The value of Systems Thinking lies in conceptualising the system. It appears in the Case Study Qualitative Methods Chapter 4.

Constraints on the system include its historic configuration, transport, information, lack of forecasting and numbers and skills mix of nurses deployed. These contribute to mismatched supply with demand.

Demand	Supply
Demographics	Policy / implementation
Fluctuation	Service configuration
Medical complications	Budget / cuts
IVF multiple pregnancy/ tourism	Winter pressures
Elective care planning	Staffing
Knock-on effects	Staff sickness
Predictive modelling	Procedure
Forecasting	Quality

Table 9 Determinants of Demand and Supply

Model 2 Odds Ratios (obstetric data)

This information may be drawn from published literature and HES data. Obstetric Odds Ratios might guide neonatal admission rate and unit throughput. Since published literature may be quite historical and databases not that clean, drawbacks with real-time, accuracy and generalisability exist. These represent obstacles to both reproducibility and evaluation of the performance of Odds Ratios.

Model 4 Mathematical modelling, Case-Based Reasoning (CBR), medical diagnosis

Published literature on Risk and SEND data are sources.

Analysis of the existing, 'as-is' routinely collected Healthcare data: local SEND and national HES data is conducted in the Quantitative Analysis Chapter 5; and incorporated into the hospital neonatal unit process model. Methods included are mathematical modelling and statistics, expectant/conditional probability, Decision trees and forecasting. These fulfil mathematical logic. Although diagnoses may overlap, this field is a neonatal group segregator relevant for patient progression, LOS and unit throughput. Furthermore SEND data is amenable to regional benchmarking by specialist commissioners.

Model 5 Markovian methods

Markov Chain Modelling, Semi-Markov modelling and the useful application of martingales are discussed in detail in the Case Study Dynamic Modelling Chapter 7. They are useful for conceptualising throughput in a dynamic system.

Model 6 Patient Pathway mapping

System interactions within a relational architecture include within-hospital inter-departmental (for instance between labour ward and neonatal unit), through-unit patient pathways (for example between cots of different levels of care, with their attendant nurse resources within one neonatal unit) and inter-hospital interactions. Such pathways may be verified by clinicians and iterated.

Normal patient pathways are faster and more direct than complicated ones. Yet the distinction between these groups remains to be defined. Some example sketches are shown in the Case Study Qualitative Methods Chapter 4. This model has important implications for the outcomes of capacity, throughput and LOS.

Model 7 Cot Predictor

This Tool uses SEND data and is developed in the Cot Predictor Tool Chapter 6. LOS is used as an explanatory variable for the response variable of cot occupancy. This Tool is developed using training data and its performance evaluated with separate test data. Thus informatics is applied to understanding the mechanism and forecasting the activity of the local neonatal unit of the Perinatal System.

Model 8 Dynamic Modelling

The Design for this Tool is specified in the Dynamic Modelling Chapter 7. A possible way of studying detailed patient pathways is set out.

Description of Discrete events is easy, permits scenarios to be considered like changing shift and diurnal work patterns and one can see how the system behaves. A combination of time-slicing with a discrete-event approach is feasible when using the routine midnight snapshot data. Markovian processes are fundamental to dynamics. The model could be populated by empiric data in order to analyse system behaviour. Mathematical modelling is used to forecast cot activity. We specifically estimate neonatal admission, patient pathway and Length of Stay and demonstrate underlying system behaviour. This could form the basis of an Expert system.

The approach of Agent-Based simulation to improve network efficiency might find application in Perinatal Networks. Each local neonatal unit can be regarded as having Agent-Based Decisions, which help move the patient through the system of care towards discharge. When Demand outstrips Supply of resources or the neonate needs to move up or down a care level between hospitals, then the neonatal units whose principal work is autonomous must engage and interface. Sometimes the recognized care centre on the patient pathway is facing similar difficulties in over-capacity and the work must be sent further afield to the next nearest suitable hospital. Where to search next is decided upon medical need and geographic proximity as well as transport links. For instance if you have a car and wish to use it, Cambridge would be preferred but for public transport, London is easier for families in Colchester. Where extended family is located might also enter into the family's preferred choice. Intensive care is a privileged resource and in situations of shortage of capacity no choice is available. Ultimately Network Directors may need to pool resources and involve more remote networks. Within the network, distributed working could mean similar level neonatal units might share resources rather than necessarily resorting to the hierarchical control of the intensive care centre. While each neonatal unit works autonomously, where capacity or expertise is exceeded, neonatal units within and even between Perinatal Networks negotiate and transfer work. Thus an Agent-Based simulation perspective is applicable to the pooling of resources and improvement of Perinatal Network efficiency. Agent-Based Simulation has been covered in the Literature Review (Deadman, 1999) (Shoham, 2009).

A caveat is that the incorporation of these OR Tools into the model is not intended to be seamlessly logical nor ideal. It is but one imperfect engineered solution. That there is overlap or lack of clarity reflects the soft nature of engineering within the Perinatal Network System.

Human factors are crucial in healthcare services; both as necessity and strength and source of error, confusion and weak leadership. This is taken up in the Discussion Chapter 8.

3.4.3 Enterprise Modelling Framework

Implicit in a Framework are purpose and approach, aim and method, direction and tactic. It is useful to consider structure and function: Enterprise Architecture and Enterprise Modelling. A framework does require that its components are connected, communicating and also aligned. Wherever an approach is inter and/or multi-disciplinary, then all must be clear how their efforts feed into the overall purpose; in the real world that is the Board's task.

To improve a complicated system, you require an exact overview: the Enterprise Architecture. One could then simplify it, re-distribute its power, or both. Each area has detail which must be grasped. Various viewpoints or layers and component modules may be synthesised in an Enterprise Modelling Framework, which is described in the following legend and synthesised in Figure 3.

The Perinatal Network System is amenable to Enterprise Modelling. This approach helps deal with complexity, so planners can take an overview and see the detail in order to gain leverage. In this Thesis, an over-arching Conceptual Framework is engineered, employing OR/MS methods including Systems Thinking to connect the system and its informatics in order to serve patient flow and service quality. To accomplish this, the system is specified in language and mathematics (for instance by summary statistics and representations of its behaviour).

Products, activities, resources and time might all be considered within this Enterprise. To recapitulate, the "product" is the discharged treated patient. As covered in the Literature Survey, in Model dimension architecture, dimensions include policy, process, data and structure. Two dimensions which are relevant are patient flow and geographic space. Location and its dependent logistics have been investigated by Galvao in Rio (2002) and Pitt at Peninsula (Allen et al, 2015); and we do not concern ourselves with them so much here.

That dimensional analysis using Time aligns naturally to the Perinatal Network's main work of care and Length of Stay emanating from prematurity. We age as time passes. As the weeks of gestation pass, the neonate matures, develops and requires less support. The natural progression is from higher to lower levels of care, for

example from intensive care, through high dependency care, special care, (transitional care) and to normal care at home.

So the neonate's prematurity and / or medical condition determine their Length of Stay; the medical diagnosis explains the behavior of the patient. Medical complications prolong Length of Stay and constrain Patient Flow through the system. The medical course / Pathway of the patient within their Group determines Patient Flow through that department in the hospital system. Mathematical modelling might describe this behavior; and this is demonstrated in the Case Study.

Therefore Time is a unifying dimension. In real life this is continuous. With computers and recordings, it is discrete. There is much literature on interfacing continuous time with discrete time, as discussed in the Survey in Chapter 2.

Given certain characteristics such as maternal health and socio-economic status, birth-weight and gestation, there is a range of what can be expected for the neonate's trajectory: their care needs, patient pathway, LOS and clinical outcome. For the geographic population, how one individual patient relates to another is determined by local conditions, including chance, resources and quality of care. There are natural fluctuations in demand.

The patient receives care. A department or particular service deals with a group of patients with similar needs. Regionally the Healthcare System should be configured for the needs of the local population. The combined effects of individual clinical judgments for the catchment area determine the resource requirement for that population. Managers should have control in the system. Having a strategic direction and sufficient resources is fundamental. How the system is established (supply) and what healthcare the individual patient needs (demand) ought to match but gaps exist. Please see the following Table 10, which shows where these might arise.

Demand	Supply
Patient	Personalised care
Bundle of patients	Local neonatal unit service
Weight, gestation, diagnosis	Population demographics
Level of care	Cot configuration
Consequent nurse resources	Establishment (sickness, rota gaps, rostering)
Control	Board
Social problems	Social care (support)

Table 10 Gap in Patient Demand and Service Provision

The Perinatal System adds value if care and outcome are optimal. The baby is a member of a Patient Group, which has an expected trajectory from which they will deviate if complications arise. Historic data can indicate the Mover-Stayer Model. Length of Stay and cost are increased by medical complications and suboptimal Social Care. *Were learning to result from undertaking analysis then repeat instances of suboptimal care could be avoided and quality improved.*

Patient Pathways and work processes can be mapped and inter-hospital transfers studied. Population Demand, admission patterns and Length of Stay can be forecast and an alert for raised Demand devised. Basic mathematical analysis can help with predicting activity over a tactical time horizon. This dictates resources such as nurses and equipment like ventilators. Obviously nurse staffing and skills mix should match patient acuity and number. Yet variability in Demand and establishment mean that it does not, nor is it responsive or able to be flexed in many localities.

The Enterprise Modelling Framework for the Perinatal Network System has been discussed. It is depicted in the influence diagram, Figure 3 which also shows connections between the overview, strategic, tactical and operational levels. These are next summarised from that perspective.

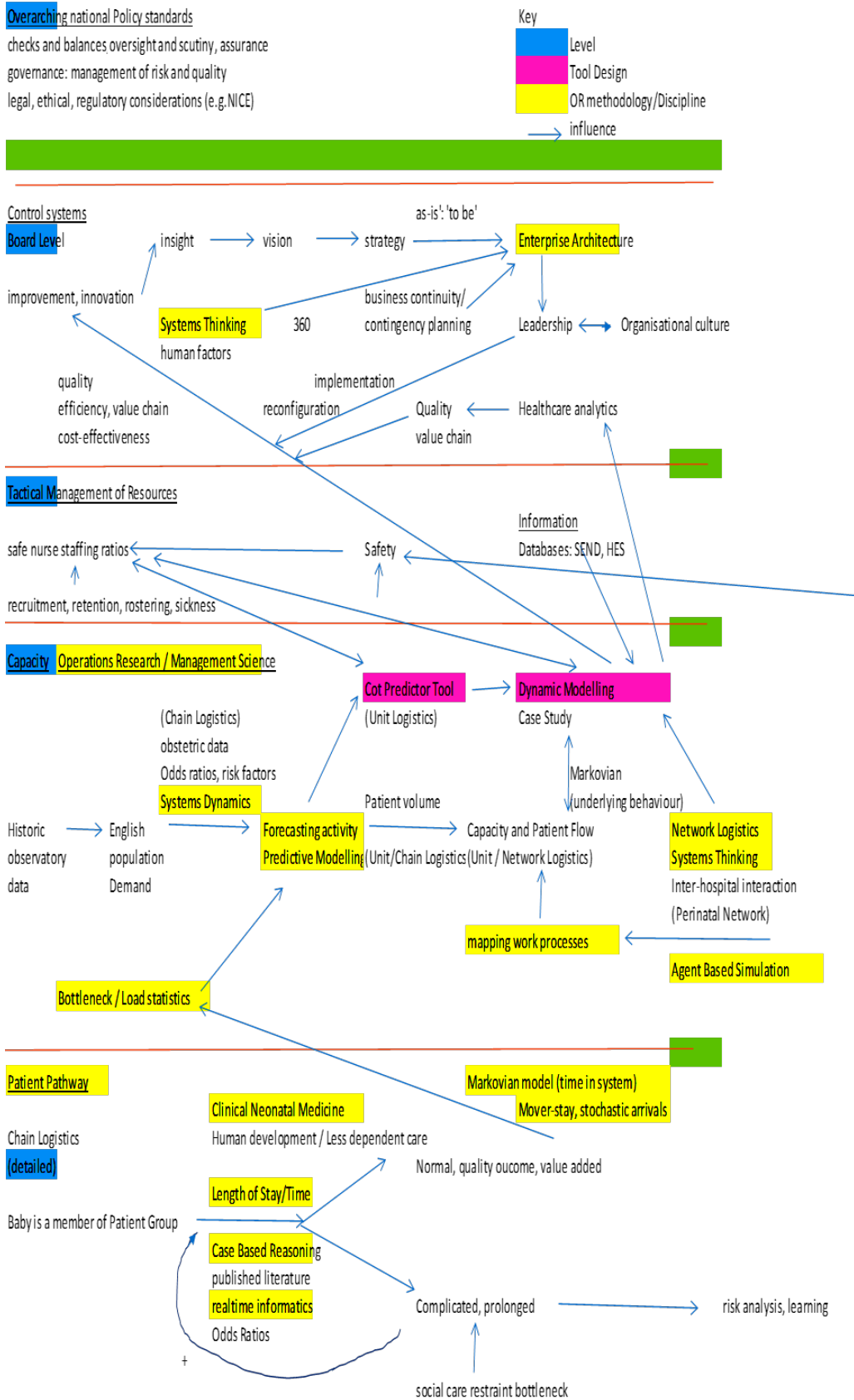

Figure 3 Influences in Enterprise Modelling Framework for Perinatal Network System

Overarching level

Overarching national policy standards do exist and are not met. Ideally there are checks and balances, oversight and scrutiny, assurance, governance, management of risk and quality. There are also legal, ethical and regulatory considerations. Adherence to NICE and CQC guidance ought to occur. The Board should have its finger on the pulse.

Strategic overview

The Board must innovate and improve areas such as Quality (value chain), efficiency and cost-effectiveness. This requires insight, vision, strategy and implementation of the 'to-be' system. For this an understanding of the Enterprise Architecture and effective leadership to promote a positive organisational culture are helpful. Healthcare Analytics ought to be taken on Board. The Board should undertake Business Continuity and contingency planning and take into account stakeholder input. It may need to implement investment, re-configuration or retrenchment. Simulating scenarios for proposed changes in systems first rather than imposing them practically could be useful. Figure 4 summarises the strategic level.



Key

- Level
- Tool Design
- OR methodology/Discipline
- influence

Figure 4 Strategic Level

Tactical management of resources

On the tactical management of resources, the most important are the human kind: nurses. Nurse staffing levels are determined by establishment, rostering, recruitment, retention, sickness, leave and morale. Skills and ratios are specified by BAPM. The Cot Predictor Tool (Chapter 6), which is discussed in the Case Study, could improve forecasting of both cot activity and Demand for nursing staff. The Tool draws on SEND data.

Operational capacity

The OR/MS approach to Capacity has been discussed. Figure 5 shows the Operational Level. Historic observatory data and English population Demand, Systems Dynamics, Odds Ratios, risk factors and obstetric data influence Chain Logistics and activity forecasting. For the local neonatal unit, a Cot Predictor Tool is proposed, whose output it is suggested, could feed into a dynamic model. These tools are described in the Case Study.

For network logistics, inter-hospital interaction within the Perinatal Network may be understood employing agent-based simulation and Systems Thinking. Work processes are mapped. Forecasting activity assists an understanding of Patient volume, capacity and flow relevant for unit, chain and network logistics. The underlying Markovian behaviour underpins Dynamic Modelling.

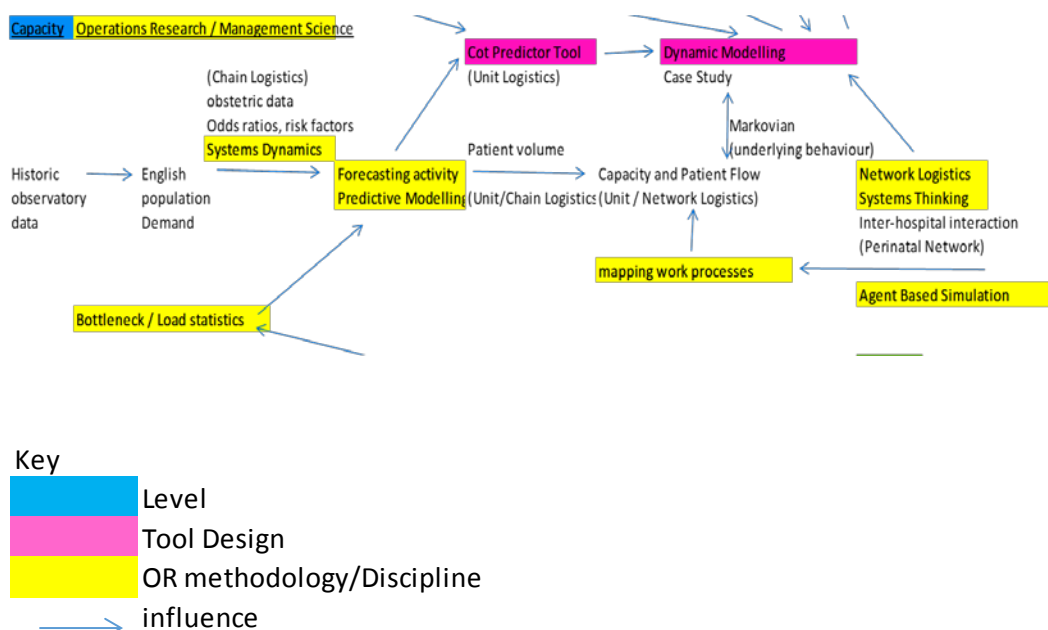

Figure 5 Operational Level

Patient pathway

At a detailed level, the pathway (chain logistics) for the individual patient is as follows in Figure 6. The baby is a member of a patient group. Case based reasoning, published literature, such as Odds Ratios and real-time informatics can help predict Neonatal admission and Length of Stay. Human gestational development means that over time, there is lower dependency in care. If the pathway is straightforward and normal, quality is satisfactory and value added. Prolonged stays are caused by Social Care delays and complications, from which there should be learning and risk analysis. Time spent in the system can be modelled using a Markovian approach: arrivals are stochastic and a Mover-Stayer Model can be devised. Such a Markovian approach can indicate load statistics and bottlenecks, which are useful in predictive modelling.

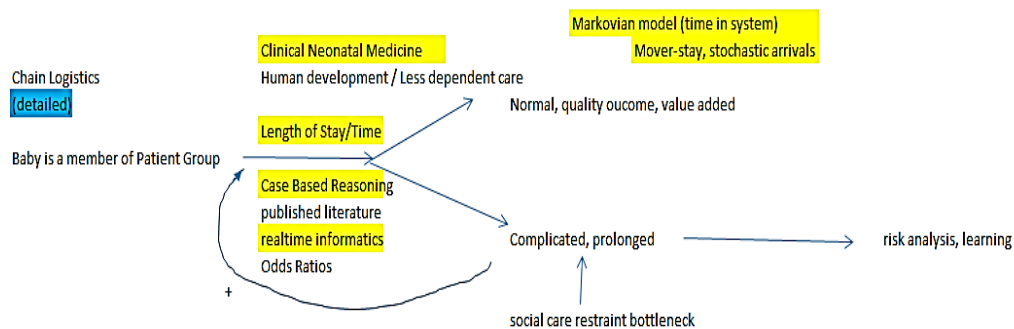
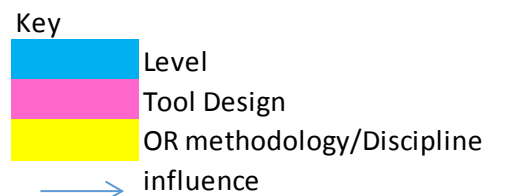

Figure 6 Patient Pathway



These layers are connected and synthesised in Figure 3, which is rendered generic and adaptable in Figure 7. This abstraction is inductive since a bottom-up approach to modelling was taken in practice.

Overarching national Policy standards

checks and balances oversight and scrutiny, assurance
 governance: management of risk and quality
 legal, ethical, regulatory considerations (e.g. NICE)

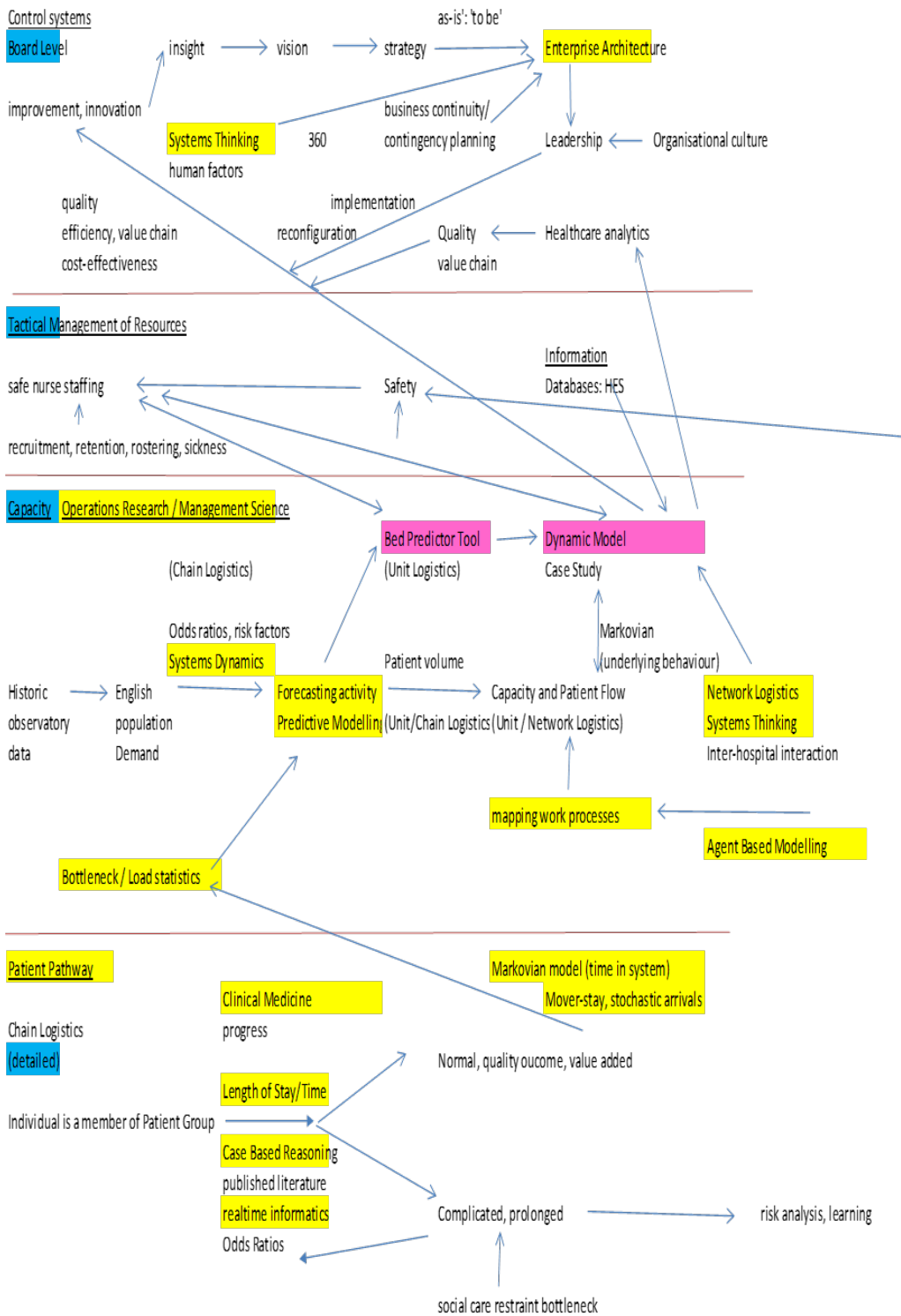
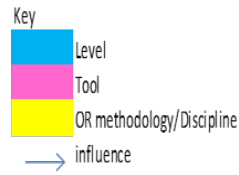

Figure 7 Generic Framework

Therefore when viewing this research from the perspective of a System of Systems, one might consider each level of system and its key component in the following hierarchical manner in which the key components of one level connect with the system in the line beneath (Table 11):

System	Key components
Thesis Outline	Conceptual Framework
Enterprise Architecture Framework	Logical systems design layer: How? When?
Enterprise Modelling Framework	Tactics (nurse staffing) Operations (cot activity) Patient pathway
Operational Research Framework	Systems Thinking mathematical modelling
Case Study	Healthcare Analytics
Neonatal group segregators	Corrected gestational age Diagnosis

Table 11 System Hierarchy

The foregoing viewpoints are further focussed in Table 12, which comprises a mix of Systems Thinking and Modelling steps that is healthcare sensitive.

Building blocks to Framework	Case Study	
Generic	Specific healthcare application	Chapter
The System	Perinatal Network	1
System boundary	Local neonatal unit	1
Problem	Unpredicted shortage of High dependency capacity	1
Purpose	Improve foreknowledge of this	1
Management buy-in: obtain and maintain	Suitably supportive management culture and climate necessary	8
Critical Thinking / Conceptual Framework 1. Context 2. Informatics 3. Factors to be modelled	System of Systems Enterprise Architecture Framework Operational Research Framework Enterprise Modelling Framework e.g. number/skill mix of nursing workforce	3
Select method	Apply Conceptual Framework in Case Study	4
Draw System structure	Qualitative Aspects sketches	4
Determine behaviour over time	Process mapping	4
Get data	Ethics and Governance	4
Prepare data (timely, cleaned, connected information) Select variables Fit model	Analytics	5
Develop predictive model - outline - detail e.g. static / dynamic	Case Study – Introduction Cot Predictor, Dynamic Model Design	4 6,7
Evaluate model	Discuss qualitative and quantitative aspects in terms of performance measures e.g. Quality, efficiency	8
Validate. Criticise	Clinician verification, Discussion	8
Deploy	Conceptual Design domain	7, 8
Improve - User feedback, iteration	Infeasible, hospital special measures climate and culture	8

Table 12 Mixed Modelling steps for Healthcare

Framework	purpose	method	situation	Criteria specified?	implementation	validation	pitfalls	development
Modelling the Perinatal Network System (This research)	To address shortage of capacity	Ontological Enterprise Modelling, Mixed OR, Systems Thinking	English local neonatal unit	In Conceptual Framework Chapter	Cot Predictor Tool proposed	with actual data	Healthcare climate	Other neonatal units / networks

Table 13 Critique of Research Framework

A self-reflexive critique in line with that in the Literature Review is shown in Table 13. What distinguishes this Research Framework from existing ones is that it is interdisciplinary (OR, Informatics and Clinical Perinatal Medicine). It is applied for a specific purpose; the research question has not been previously tackled in this way.

3.5 SUMMARY

Modern Healthcare is increasingly complex. Health Policy now emphasises Business Continuity Planning, Quality improvement and sustainability for services. Intensive care must be immediately available to save life and defend the neurological outcome of patients including those born unexpectedly early, small or sick. Delivering best quality within a budget depends on prioritisation and resource allocation, which vary locally.

Hard higher level Perinatal Networks comprise component units giving straightforward, intermediate or complex care between which the specialised Transport service moves patients following telephone communication. Each baby is entitled to equitability of access whilst simultaneously population need must be met. While a Network can serve a load balancing function, when demand surges that may be across the piece. Units may be viewed as autonomous agents having distributed management powers until they need to network co-operatively or are amorously re-configured.

Offering this over-arching Conceptual Framework in Systems Thinking and mixed Operational Research methods, it is next shown how routinely collected data can be applied to model the English Perinatal Network System and solve common capacity problems. We adopt an inter-disciplinary approach incorporating mathematical techniques such as the binomial theorem and Markov modelling, the Operational Research technique of Systems Dynamics and medical Case Based Reasoning to model the Perinatal Network System.

This chapter on the Conceptual Framework has:

- located the research question within its context using Enterprise Architecture and Systems Thinking
- devised a mix of Operational Research methodologies from the palette of OR techniques
- advanced an Enterprise Modelling Framework
- developed insight into the Perinatal Network System

Specifically this Conceptual Framework model for the Perinatal Network System incorporates its complex, variable and uncertain aspects. The Framework which has been developed is composed of a mixed methodology of component models, which are summarised in Section 3.4.2 Table 8. The distributed management approach has been taken of optimising the local neonatal unit operating environment to improve upstream system efficiency (Model 1) of the intensive care centre and Perinatal Network. A novel inter-disciplinary linkage of the Time perspective intrinsic to human neonatal development (manifesting as prematurity namely gestational age) with Operational Research methodologies (Models 2, 3 and 4) has been undertaken.

Use of this Framework could offer a persuasive argument for change. There will be alternative ways of viewing the system within these disciplines over time, so any problem-solving approach is usefully plastic and dynamic. Pragmatic justification that the Framework works is found in its utility.

In the next chapter, this Conceptual Framework is applied in a Case Study to address the problem of capacity. This seeks to justify the mix of models produced in the Framework by demonstrating its application. The Case Study looks at the local neonatal unit's High dependency cots in the Perinatal Network as opposed to intensive care work in a centre. It combines patient management system data with clinical information. Data for forecasting are drawn from big databases such as HES and cleaner regional ones like the SEND. This links Time perspectives in gestational development with Patient Flow and mathematical modelling. We specifically estimate Neonatal admission, Patient Pathway and Length of Stay and demonstrate underlying system behaviour. For example, this Model is applied to produce an operational cot Forecast.

CHAPTER 4 CASE STUDY: QUALITATIVE METHODS

4.1 INTRODUCTION

The utility of this Conceptual Framework is demonstrated through a real-world Case Study producing a tactical cot forecast.

The component models of the Operational Research Framework are re-iterated below.

1. Systems Thinking
2. Odds Ratios (Obstetric Data)
3. Systems Dynamics
4. Mathematical Modelling, Case-Based Reasoning, Medical Diagnosis
5. Markovian Methods
6. Patient pathway Mapping
7. Cot Predictor
8. Dynamic Modelling

These are applied in the Case Study and discussed over four chapters in which steps taken to develop the models are described. The numbers in brackets refer to the above models.

In this Chapter 4 Qualitative methods are covered. This includes an overview of the Systems Analysis Simulation (SAS) Framework (1), its People and Ethics. Systems, Process, Patient Pathway Mapping (6) and the idea of “Normality” (3) are described.

Chapter 5 provides Quantitative Analysis. The Input Data (2, 4) is drawn from Operational analytics and Medical Informatics. Medical Knowledge and Operational Research are combined for Healthcare service improvement.

The Cot Predictor Tool in Chapter 6 incorporates Expectant probability and the Binomial Theorem (7).

In the Dynamic Modelling of Chapter 7, the dimension of Time is discussed together with Markovian Methods (5) and their possible application (8).

Basically the system is described in language and mathematics. Static and dynamic models are devised. The subject of the Case Study is unique, that local neonatal unit perspective within a distributed system, mandated on the idea that fixing a downstream bottleneck assists upstream bottlenecks.

4.2 CASE STUDY FRAMEWORK

In OR/MS there is the Systems Analysis Simulation (SAS) 8 Levels Framework (Kavur, 2009) (Bell, 2015). This ranges from retrospective enquiry and alerts, through statistical analysis, to forecasting, predictive modelling and optimisation. That approach has been taken here; and framing the argument in this way for the Case Study gives:

What happens is that every winter there is system deadlock in the Perinatal Network. In the English local neonatal unit, this causes a shortage of high dependency cots. An alert for the problem could help resource planning. Quantitative Analysis permits understanding of resource use. If the trend continues and no action is taken, then it threatens capacity in intensive care centres. With modelling, log jams are predictable. The optimal situation is that managers pre-empt them and respond.

The “as-is” system is described with System processes depicted and explained to provide insight in this Qualitative Methods Chapter.

Data collection was performed using HES and SEND. Within the Perinatal Networks System, Badger Net is the deployed Information System. In the Quantitative Analysis Chapter 5, neonatal data is analysed both from an operational and a medical informatics perspective.

We next model and design Tools. Outputs include the Cot Predictor Tool (Chapter 6), and Markov model Design (Chapter 7). One can mathematically model the underlying

behaviour of the system by deploying Markov Chains and stochastic arrivals. Alerts and forecasting can be developed for Decision support using predictive modelling to pre-empt shortage of capacity. The need is for an Expert early warning 'to-be' system. This could help plan, optimize and reconfigure the system. An alert designed to warn of impending shortage of capacity could enable action to avert this. Managers should communicate, instruct, co-ordinate, facilitate, support and act (i.e. respond by flexing staff). Where managers do run rota gaps, such an alert system would of course fail.

4.3 FORMULATION

This is a dynamic resource allocation problem in a local baby unit. We need to match staff and beds to varying patient requirements. The bottleneck is High dependency cot capacity, which we seek to mitigate. We wish to maximise work with safe occupancy and minimise idleness, refusals (baulking) and renegeing (rule-breaking) given limited resources. We might need to re-configure the unit's cot allocation. There are both planned and emergency arrivals. Patient pathway is either optimal or complicated. There are intensive care, high dependency and special care cots, for which different patient: nurse ratios are required. Skilled nurses may look after any patient. Constraints exist. Other nurses care only for special care patients. There is no immediate buffer to flex nurses for unforeseen demand. Of course there is equipment breakdown and servicing, staff training and sick leave. It is skilled nursing, ventilators and monitors rather than the physical cot or incubator, which run short in practice. This work considers the nurse resource. Both operational and medical information is incorporated into the model. We apply data on neonatal admission, transitions between the levels of care, Length of Stay, system capacity, throughput and nurse shortage. Candidate methods are stochastic linear programming in weakly polynomial time and dynamic modelling. If it can be shown how a group of cots work together in one neonatal unit then with scalability one could better understand the Perinatal Network System itself.

Aspects of this formulation are now covered in more detail.

Arrival of patients is either planned or Poisson.

The model paradigm is Systems Dynamics and Discrete Event processes.
Stochastic programming assists understanding of Decision making under risk.

The capacity of lines is set. Capacity is constrained to integers. The ratio of intensive care: High dependency: special care cots changed over the course of the study. The topology of the network is not addressed since one is powerless to change its structure.

A modest number of scenarios with probabilities are offered in a deterministic equivalent of a stochastic problem. Monte-Carlo Markov and sample average approximations could be made.

To validate the modelling, out of sample data is used. For validation, we face the problem of how to measure the quality of optimal solutions with respect to the true optimum.

Software which could be used includes Mathcad, Anylogic and Simul8.

Input parameters include unit configuration, batch rules i.e. ward rounds and nurse staffing: baby compatibility rules (BAPM).

Outcome measures might include capacity, throughput and Length of Stay (LOS). The essence lies in the orchestration of workforce with activity using informatics. High dependency occupancy should not exceed 100%. Throughput should be a safe volume. Social care failure should not frustrate discharge for medically fit patients.

In regard of outcomes, we wish to discover bottlenecks, evaluate options for their mitigation such as changes in rules, assess and measure upstream/downstream effects, adapt and/or adjust to changing conditions for instance through re-configuration.

There is ability to extend / scalability with respect to patient pathways, additional units, networks and relationships. CGH conditions might be reproduced or exceptional; yet no generic ODN exists for England.

Ideally we need to integrate models in operations extension cycles in real-time in order to give additional infrastructure demands/resources and investigate the influence of changed flowing behaviour on the network.

The model could be adjusted to new conditions, organisational and policy change. Expected equipment breakdowns and nurse sickness should be covered with spare capacity.

Finally one could reframe the problem and experiment with the model to solve other challenges. This could assist problems in other hospitals and lead to data warehousing.

4.4 RATIONALE, INFORMATICS AND RESEARCH STRATEGY

When demand surges, capacity goes short. For instance a regional intensive care centre will attract intensive care cases whilst for the local neonatal unit High dependency cots represent the middle of the system and their particular stress point or bottleneck. This is the rationale for this exemplar Case Study of High dependency cot activity (by Corrected Gestation and Patient Pathway) within the local neonatal unit at Colchester General Hospital, Essex which lay within the Eastern Perinatal Network. Table 14 shows the issues which need to be addressed in order to manage resources for the local neonatal population:

Issue	Particular determinant	Modelling
Admission rate	Premature demographic	Probability, linear stochastic
Length of Stay (LOS)	Diagnosis	Analytics
resources	nurses	Binomial theory Cot Predictor Tool
capacity	Occupancy, variability	Markov Chain Modelling, Binomial Theorem
Patient Flow	Complications Resources Social care	Semi-Markov Modelling

Table 14 Research issues and their Modelling

Considering these aspects and dimensions such as time and weight helps tackle those specific issues identified in neonatal care. The Case Study uses existing information

to produce fresh understanding, gain new insights, reduce uncertainty and undertake predictive modelling in order to improve patient flow. If adopted, this could improve running of the service. Some specifics are re-iterated.

Stakeholders are essential participants. Such Agents should take decisions but may fail to do so if lacking in planning and foresight. There are policies and integrity rules, which ought to be followed but in practice are broken i.e. rota gaps. One decision may be to flex nurses.

Processes are variable, occur on demand, are emergency and often stochastic. They are planned where there is repatriation or elective Caesarean delivery. Activities are not all evidence-based. Quality Assurance is inadequate for long-term neuro-developmental outcome owing to follow-up attrition, a national problem.

Premature babies naturally trigger a Time perspective since they may achieve the essentials of living, for instance feeding and maintaining their body temperature at certain Corrected Gestations. On a population basis this gives predictive knowledge on the kind of care needed, their level of dependency and so the staff and equipment resource required.

Using the patient's age and condition on admission, then the required resources can be predicted. Such information is not taken into account currently in the running of NHS services, which rely on establishment, 'make do and mend' and firefighting approaches. This is neither agile, smart, strategic nor responsive. We looked at day by day data. This reveals that patients are changing between levels of care; so Demand for specialist nursing varies over a day within the then three nurse shifts. Outcomes are poorer when nursing ratios are breached (DoH, 2017). Indeed Rafferty (2007) found that those hospitals with the highest patient to nurse ratios had 26% higher mortality. When foreseeable Demand has not been anticipated, travelling by necessity for reasons of hospital capacity does not help the individual patient.

Hospital in-patient figures are counted at midnight lending themselves to a time-slicing approach but existence and hospital care are continuous through time. If a population is large enough then the continuous stocks and flows of Systems Dynamics

[Model 3] can help to map it and where data is limited then discrete events can be looked at; hybrid models of System Dynamics and Discrete Event Simulation are possible. As well as counting probabilistic data within the unit, outside interactions and influences operate from other hospitals, networks and Social Care; such a qualitative approach may be captured using Systems Thinking [Model 1]. Here we concentrate on these methodological aspects of the Perinatal Network System and their application. An inside-out approach to modelling has been taken.

Business Continuity means not closing the neonatal unit and maintaining a 24/7 service. Population demographics dictate predictable albeit variable demand. Such questions as the risk/certainty and duration of a bottleneck in flow might arise in operational practice and inform Business Continuity Planning and forecasting. The proposed model might be developed to allow timely prediction of need for increased nurse staffing and external support, load balancing within the perinatal network and improved efficiency.

For High dependency cots, the local neonatal unit is a hub in the middle of the neonatal network system. Local neonatal units must absorb all in-born High dependency work immediately and repatriate cases from neonatal intensive care centres within 48 hours. Yet cases accepted today could produce a cot block in the future. Use of High dependency care is rising and it can be a longer duration form of care for some. We wish to know when a patient might move to and from High dependency care, in order to better plan the nursing resource.

Routes into the neonatal unit include hospital and occasionally home deliveries, the postnatal ward and repatriations from other hospitals. (See Table 15).

Inflows	Outflows
A&E	Cardiac surgery in London
Elective CDU	Home network
Emergency CDU	Foster care
Childrens' ward	Ventilation at intensive care centre
Childrens' Day Unit	Eye surgery patient
Postnatal ward	Postnatal ward
GP / community midwife	Abdominal surgery / opinion. Eastern / London
Illegitimate (Do not meet admission criteria) e.g. winter pressures, swineflu	Palliative care
Repatriations from intensive care centre (born elsewhere)	Death
Midwifery-led units	Home

Table 15 Colchester in-flows and out-flows

Babies needing High dependency care in the local neonatal unit originate from different areas: intensive care, delivery suite, the post-natal ward, special care or are back-transfers from the intensive care centre. High dependency care should give way to special care following treatment. On leaving one level of care, treated patients require the next; normal patient flow is I > H > S > Outreach > Home.

There is flow or cycling of entities such as patients, nurses and cots. The cot is either occupied or not. The nurse is either working appropriately, over-burdened, slack or idle. Nursing supply is either optimal or short in numbers or skills mix. The patient is treated, transferred or waiting (not being served). The patient is on their personal trajectory at a particular level of care. For the individual, a backward step from High dependency care means intensive care and predicts future need for High dependency care. Moves from intensive care to special care direct without passing through High dependency also occur.

Now the local neonatal unit must take inborn for urgent intensive care and cannot refuse any special care. In regard of High dependency care there is a short window to accept repatriations and one can negotiate the timing of elective deliveries, whether induced or Caesarean, though a routine delivery may require emergency care. The eCAM system gives information on patients being conveyed to hospital by the ambulance service. Neonatal admissions are usually emergency so arrivals are

stochastic. Other likelihoods are multiple deliveries usually inborn twins but occasionally repatriated triplets.

The national rate of neonatal admissions from Labour Ward is about 11% (Department of Health, 2009). Upstream denominator data for the neonatal unit is available from Hospital Episode Statistics (HES). Obstetricians have investigated the Odds Ratios of conditions bringing a baby to the neonatal unit, such as instrumental or Caesarean delivery, prematurity or maternal illness [Model 2]. Though ultrasound is not a guide to expected birth-weight, unless the pregnancy is unbooked, gestation is known, which can assist preparation for care of the newborn. One possible way of augmenting the determination of neonatal admissions is Case-Based reasoning.

Approximately 25% of deliveries are by Caesarean: a proportion is planned. There may be certain scheduled Caesarean section lists most days in a week but not at weekends. Induction of labour is unreliable. Other than the planned Caesarean deliveries, deliveries show diurnal variation but the day to day delivery rate is stochastic. Other particular influences include proximity to a high risk obstetric unit and an airport, which may signify In-Vitro Fertilisation (IVF) conception or triplet tourism respectively. As well as clinical need, neonatal admission may be based on family social circumstances such as maternal drug addiction, mental illness and learning disability. Genetic stock and socio-economic factors influence birth-weight, gestation and neonatal condition and so health and neonatal Length of Stay. For those admitted to neonatal units, data is available on the proportions for categories of weight and gestation. In some garrison towns, there might be surges in deliveries and those born prematurely requiring neonatal unit admission but otherwise the distribution of prematurity is random.

Routinely collected Standardised Electronic Neonatal Database (SEND) data from one local neonatal unit - Colchester General Hospital from 2009-11 is used [Model 4]. We have complete and clean data ascertainment. We dealt with data beyond the year's boundaries by truncation. Occupancy is the bundle of patient journeys. Patient throughput was captured in a semi-Markov process (Section 7.3 Figure 98). Backward steps to higher care levels (which may be regarded as discrete state spaces) do occur.

The year's activity is simplified in a discrete time Markov chain in Quantitative Analysis Chapter Section 5.7.2 Figure 50. For each level of care, Lengths of Stay and their variance for repeat episodes or across later years may be compared (Quantitative Analysis Chapter Section 5.6.5). Distributions of Length of Stay may be tested for exponential fit, which if satisfied could introduce the possibility of modelling in continuous time. Here Kolmogorov-Smirnov and Chi-squared testing produced good fits for intensive and high dependency care stays but not those at special care, as will be shown in the Quantitative Analysis Chapter Section 5.6.5 Table 21.

A Markovian approach to modelling this system appears useful since it might permit dynamic visualisation, mathematical manipulation and analytic solution of variance. Also one might exploit the concept of reversibility, examining the effect of both origin and destination on Length of Stay at each particular care level. Furthermore it could provide inputs for designing a Monte Carlo Markov model of this neonatal unit. Iterations of this technique could allow one to see the effect of factors such as equipment repair, increased staff sickness, plurality, population growth and cot re-configuration on system performance.

A trade-off exists between describing the system of patient throughput in a pragmatic way stakeholders understand, harnessing Markovian methods for gain versus being exhaustively rigorous and meticulously verifying the validity of every assumption made. Hospital managers deal with average Length of Stay, which can give the baseline situation at best. Yet Length of Stay data has greater variance than an homogenous Markov chain could envisage. Both High dependency and special care Length of Stay data is long-tailed so other testing methods such as Anderson-Darling could be sought. However, the provision of data in the Quantitative Analysis Chapter Section 5.7.2 Figures 50-1 will illustrate how a Markovian view contributes to system description and assessment and that further enquiry is warranted. This idea is taken further in the Dynamic Modelling Chapter 7.

We turn back to Qualitative aspects of the Case Study in this Chapter.

4.5 PEOPLE

People were those within the Perinatal Network System, namely pregnant women, newborn babies and their family members.

Staff stakeholders in the Perinatal Network System include midwives, obstetricians, healthcare assistants, nursery nurses, neonatal nurses, ward managers, ward clerks, paediatricians, neonatologists and ambulance drivers.

Collaborating organisations were Colchester General Hospital neonatal unit 2009-13, labour ward and postnatal ward, Eastern Perinatal Network and the University of Westminster.

Those excluded were those opting out of having their child's information computerized, none of whom did to which we are aware.

4.5.1 Ethics

Rightly patients' medical data must not be shared without due purpose. However, healthcare planners like Specialised and Clinical Commissioning Groups need to understand the healthcare needs of the population to adequately commission services for the benefit of patients and anonymised data is already used for this purpose.

SEND data is imported anonymised from Edinburgh to the Eastern Perinatal Network using Excel. All patient identifiable data was anonymised and the Colchester General Hospital Caldicott Guardian consented to its use.

We have exploited SEND and HES data following NHS ethical approval and its release by stakeholders namely the Clinical Development Group and the Eastern Perinatal Network. Ethical approval for the use of local SEND data was not required from the NHS Essex 1 Research Ethics Committee, who considered this work Service Evaluation.

Data governance issues include its cleaning, extraction, transfer, encryption, storage and destruction. Whilst important, it is not the main concern of this work.

4.5.2 Policy changes

Now the system under study and its policies have evolved in a number of areas. The Essex Neonatal Network was absorbed into the Eastern and North East London Perinatal Networks. The Eastern Perinatal Network comprising 17 neonatal units became an Operational Delivery Network on 1/4/13. In order to standardise the service, network performance indicators were introduced, such as the perinatal dashboard on metrics like time to transfer (Department of Health 2009) (National Institute of Clinical Excellence 2010). Business Continuity Planning and neonatal clinical governance were adopted in principle by units within the regional Perinatal Network.

The ambulance service e-CAM system was extended, which allowed ambulance journeys to be detailed, thus permitting some forecast of arrival on labour ward. National Institute of Clinical Excellence (NICE) guidance permitted longer labours, which led to raised neonatal admissions (NICE, 2011). There was the backdrop of introduction of new technology – fibronectin screening, which helped optimise the antenatal transfer process (Peaceman, 1997) and in the Eastern Region, this cost-effective measure had some success.

Economic retrenchment resulted from the Great Recession. From 1/12/2011 the number of special care cots at Colchester was cut from 16 to 12. Pressure was applied to Length of Stay and additional resource put into neonatal outreach nursing (Langley, 2002). From 1/4/13 the three levels of neonatal care were to become five Health Resource Groups (HRGs). There was somewhat improved in-hospital business Informatics.

Austerity Britain questioned the function of English Perinatal Networks. Massive Health service re-organisation (creating fragmentation) resulted from the Lansley reforms in the 2012 Health and Social Care Act. Specialised Commissioning Groups (SCG) had resided within the reduced number of Strategic Health Authorities (SHAs).

Rather than dealing with Primary Care Trusts (PCTs), these became Operational Delivery networks which dealt with General Practitioner led Clinical Commissioning Groups (CCGs). Private providers and social care enterprises were commissioned by the CCGs to provide ancillary support, whose scope was reduced. Locally, from 2012, gaps in the neonatal nurse and junior doctor rota were left unfilled by managers. Colchester General Hospital was placed in special measures on 5/11/13 during the Coalition administration and the whole Essex Healthcare economy was deemed to be failing and placed on a ‘success’ regimen in the next administration on 1/6/15. Monitor, the arm’s length government body was unable to turn the hospital around either in terms of finance or quality. After two and a half years, special measures was deemed to have failed and liquidation into special administration avoided by the hospital being subsumed by another local hospital in the neighbouring county, Ipswich. Scrutiny, punitive regulation, workforce and leadership upheaval, business discontinuity in particular disinvestment in strategy and research; and prolonged junior doctor industrial action occurred in England. A Timeline for events is shown in Figure 8.

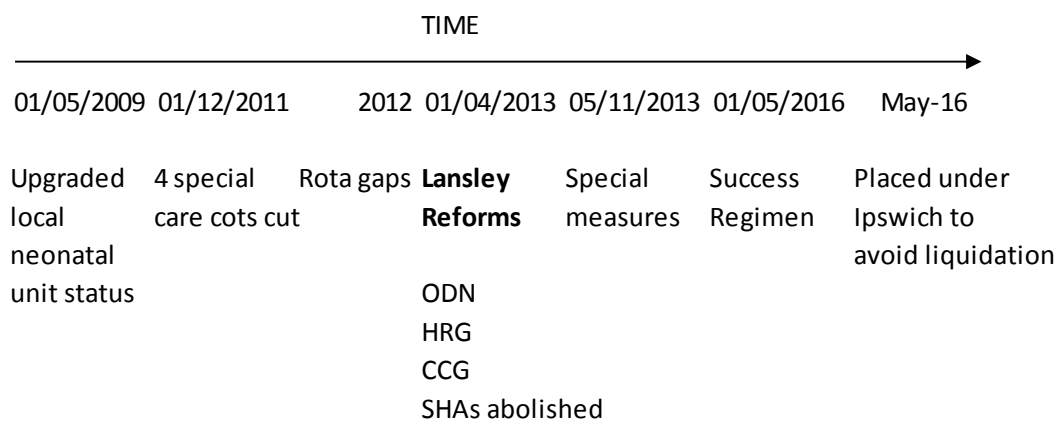

Figure 8 Colchester General Hospital Timeline

4.6 BACKGROUND TO CASE STUDY

The Neonatal System is problematical because Patient Flow is incompletely understood and Deadlock may arise particularly when winter pressures are operating. The resource is costly, labour intensive, low throughput and should be used efficiently. As it is so expensive for society to offer intensive care, thought is needed in planning and marshalling this key resource. At best, well-delivered neonatal intensive care can save life and optimise neurological outcome and subsequent health and well-being through a lifetime. Premature babies risk neurological, hearing and visual impairment yet good intensive care mitigates this.

The investigation of labour ward / neonatal unit interactions and perinatal inter-hospital communication and networking is a somewhat neglected area. To some extent the answer does lie in running sufficient cots to meet the expected needs of a growing population, keeping safe levels of occupancy, flexing capacity at times of pressure yet not over-provisioning services or draining resources. At quiet times there is no problem. Responsiveness and common sense are vital.

The Perinatal System can suffer shortage of capacity and disruption. Demand can surge. Provision of resources runs short. There may be delays in transfer for intensive care and repatriation. Short staffing might be due to under-establishment and a management policy of running rota gaps, nurse sickness and poor rostering, for instance during school half-term holidays. Inadequate communication between obstetricians, midwives, neonatal paediatricians and nurses, inefficient use of resources, poor decision taking and inadequate co-ordination between local neonatal units and neonatal intensive care units also contribute. Problems which arise include insufficient equipment like monitors and alarms and insufficient staff when cot physically available. Outbreaks of infection leading to unit closure do occur and need to be communicated and managed pro-actively. Forecasting of Demand is an allied and neglected area.

Public services should be efficient. There are operational and tactical issues within the Perinatal Service. There are pressures to shorten Length of Stay, extend care in the community and reduce re-admission. System behaviour is unpredictable and subject to fluctuation. Real-time data and improved co-ordination of communications are

needed. Both complicated patient pathways and social problems prolong Length of Stay, which increases demand for resources. Other issues and challenges are information systems interoperability and Business Continuity.

In summary, Perinatal Networks suffer unpredicted episodic shortage of capacity. This results in non-clinical patient transfers between hospitals and attendant increased costs for transport, longer Lengths of Stay and poor family experience (BLISS, 2012). Given concern over quality of patient care and NHS pressure for efficiency, a continued lack of understanding in this area is a weakness.

4.7 PROCESS MAPPING

For overview, a higher level aggregate model was developed incorporating Systems Thinking in the OR Framework Figure (See Conceptual Framework Chapter Section 3.4.3 Figure 3).

On the different levels, the individual patient has a journey or pathway of care. Given the patient's group by diagnosis, there is an expected trajectory, which is amenable to predictive modelling. A diagnosis carries certain resource requirements.

In one place at any time, there is a case mix. This could be determined by chance, weather, environment (street drugs availability via nearby ports) or the garrison returning. Patient pathways can be modelled (for instance by Markovian and Semi-Markovian methods) and categorised by gestation and time.

For the geographic area, there are expectations from the local population demographics and community services. As asserted in the Neonatal Toolkit (2009), this kind of predictability “may occur year-on-year but not day-by-day for a perinatal network”.

So Patient-centred care should be given but neighbouring cases on the hospital ward can affect the care the individual receives. Poor planning of nurse rostering and suboptimal ratios affect patient experience and outcome. A local hospital ought to cater for its population; and that premature population is fairly predictable.

In following sub-sections, the structure of the system is mapped and detailed in the sketches. Patient Flow and processes are set out.

Babies born sick or prematurely move through different levels of care within a hospital and also between hospitals. For instance, ventilated patients receive intensive care. Intermediate cases are high dependency. Patients needing tube-feeding support are special care.

In each neonatal unit (Figure 9), intensive care, high dependency and special care cots are used to provide care for patients, some of whom need not just one but two or more iterating cycles of critical care during their admission. That intensive care delivered in special care baby units is usually short-term stabilisation only.

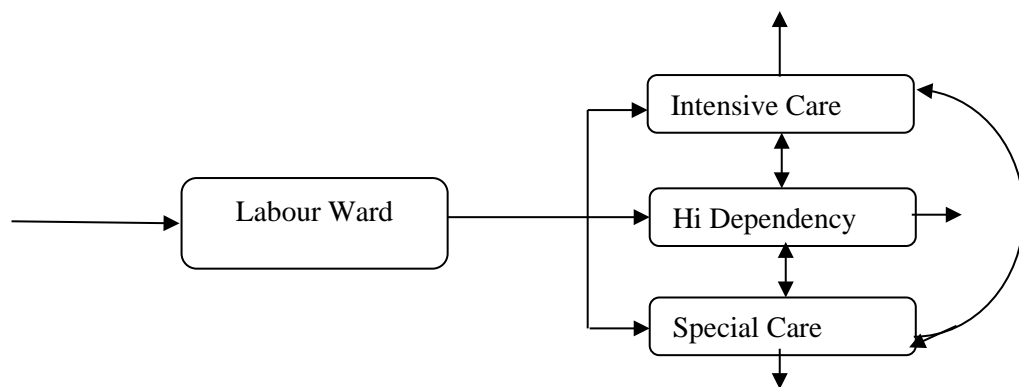

Figure 9 Relationship between levels of care in a neonatal unit

There is telephone, transport and limited data communication between neonatal units. Whilst having few patients, work is labour intensive. That equipment required is high technology: monitors, ventilators, syringe pumps and ultrasound probes. Those human resources needed are trained specialist clinicians, which are normally in short supply (BLISS, 2015). Whilst ideal staffing is specified, ratios are not met. Other characteristics of neonatal care units are their complex processes and low volume of traffic by way of Patient Flow. There are emergency calls and the subject is emotive. Premature babies have long Lengths of Stay. There are technical difficulties owing to the small scale of the patient. The service is susceptible to winter pressures. There is episodic shortage of neonatal cot capacity.

The English Neonatal Network can be thought of as the philosophy of care, ideas, common guidelines and protocols on the one hand and the physical network of

different level neonatal units in the geographic area and their communications on the other.

The UK Perinatal Network System (Figure 10) connects the group of hospitals termed neonatal intensive care centres (or tertiary units), local neonatal units and special care baby units. England is composed of several Perinatal Networks. Within a Perinatal Network local neonatal units link with intensive care centres and on the obstetric side, midwifery and consultant units relate to high risk obstetric units. An in-utero transfer (before baby born) must combine an obstetric bed with a neonatal cot in the receiving hospital and takes a midwife from the referring hospital in suitable transport. Following transfer, the timing of delivery may be uncertain. An ex-utero (after baby born) transfer requires a neonatal transport team. After treatment at intensive care centres surviving neonates are repatriated back to the local neonatal unit as soon as practicable (POPPY Steering Group, 2009).

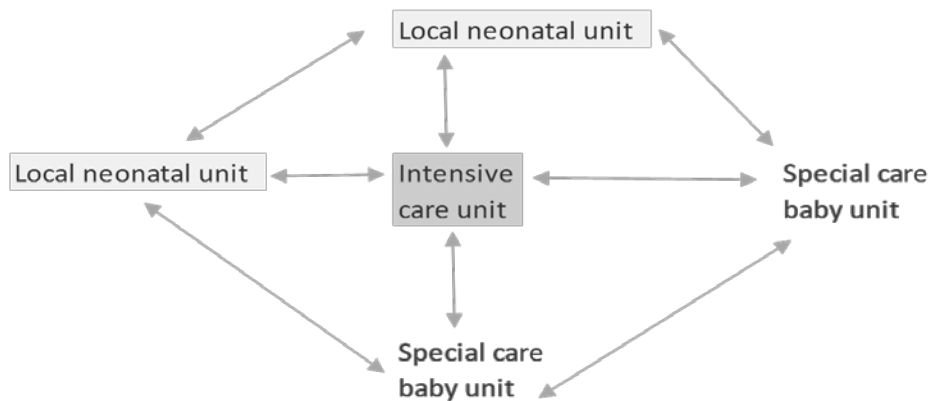

Figure 10 Perinatal Network System

So hospitals of different sizes and types network their intensive, high dependency and special care cots together within a regional Perinatal Network. Neighbouring hospitals should co-operate when one unit has surging activity or needs to share risk such as unit refurbishment, power outage or closure due to infection or staff shortage. Furthermore there is traffic between networks particularly at hospitals lying near geographical boundaries.

4.7.1 System structure

That structure of the local neonatal unit is shown in Figure 11 in which arrows portray patient pathways.

Local Neonatal Unit System

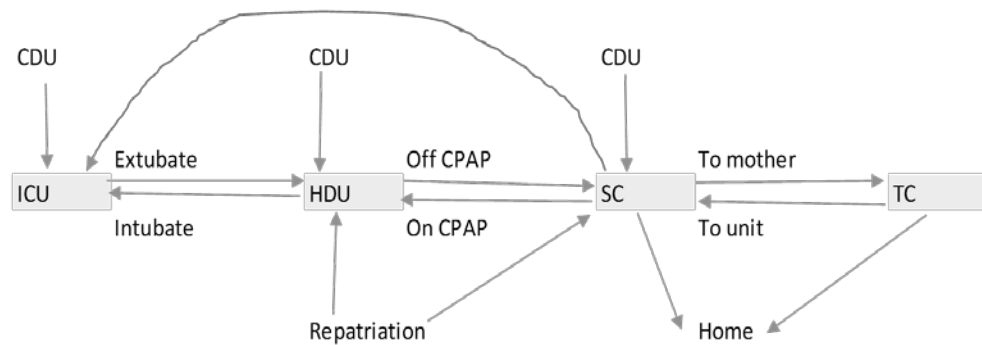

TC = transitional care

Figure 11 Local neonatal unit System

Case Study of Local Neonatal Unit High Dependency Unit.

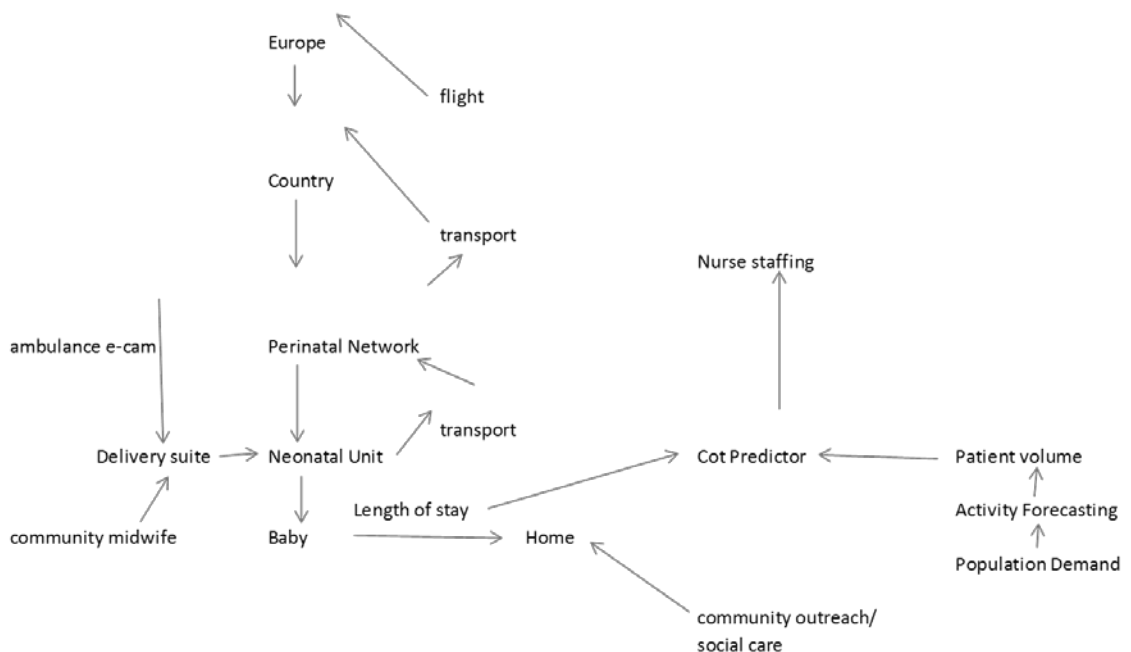

Figure 12 Case Study of local neonatal unit high dependency cots

The relationships and communications of the neonatal unit are shown in Figure 12. A basic systems diagram of the Enterprise is shown in Figure 13:

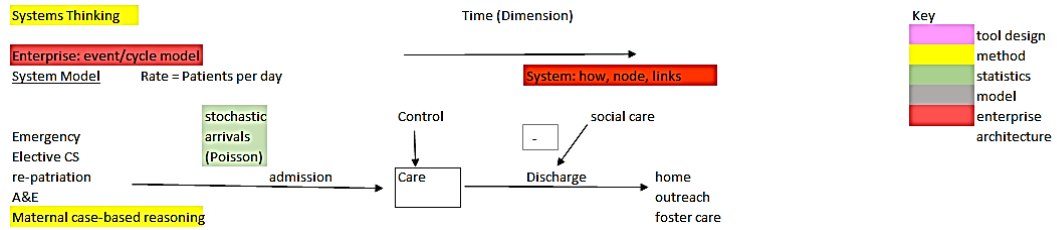

Figure 13 Basic system

Factors in the Basic care System are shown in Figure 14 below:

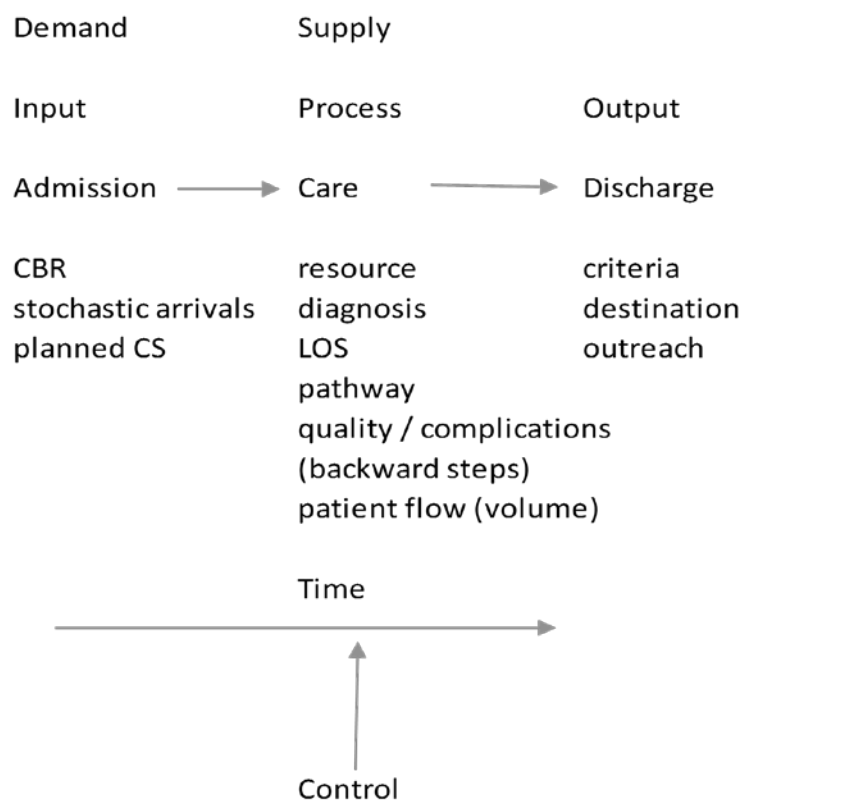

Figure 14 Basic factors in care processes

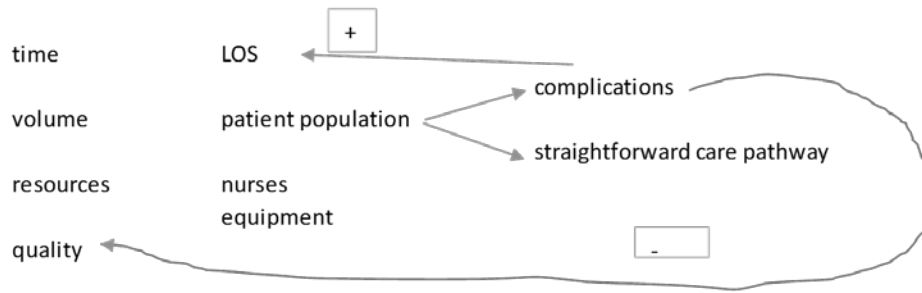

Figure 15 Relationships between dimensions

The relationship between dimensions is depicted above in Figure 15. The most significant dimension is Time. How Systems Thinking provides insight into the different layers of detail of the enterprise is shown in the synthetic diagram, Figure 16. Its other components are discussed in detail in following Case Study Chapters 5-7.

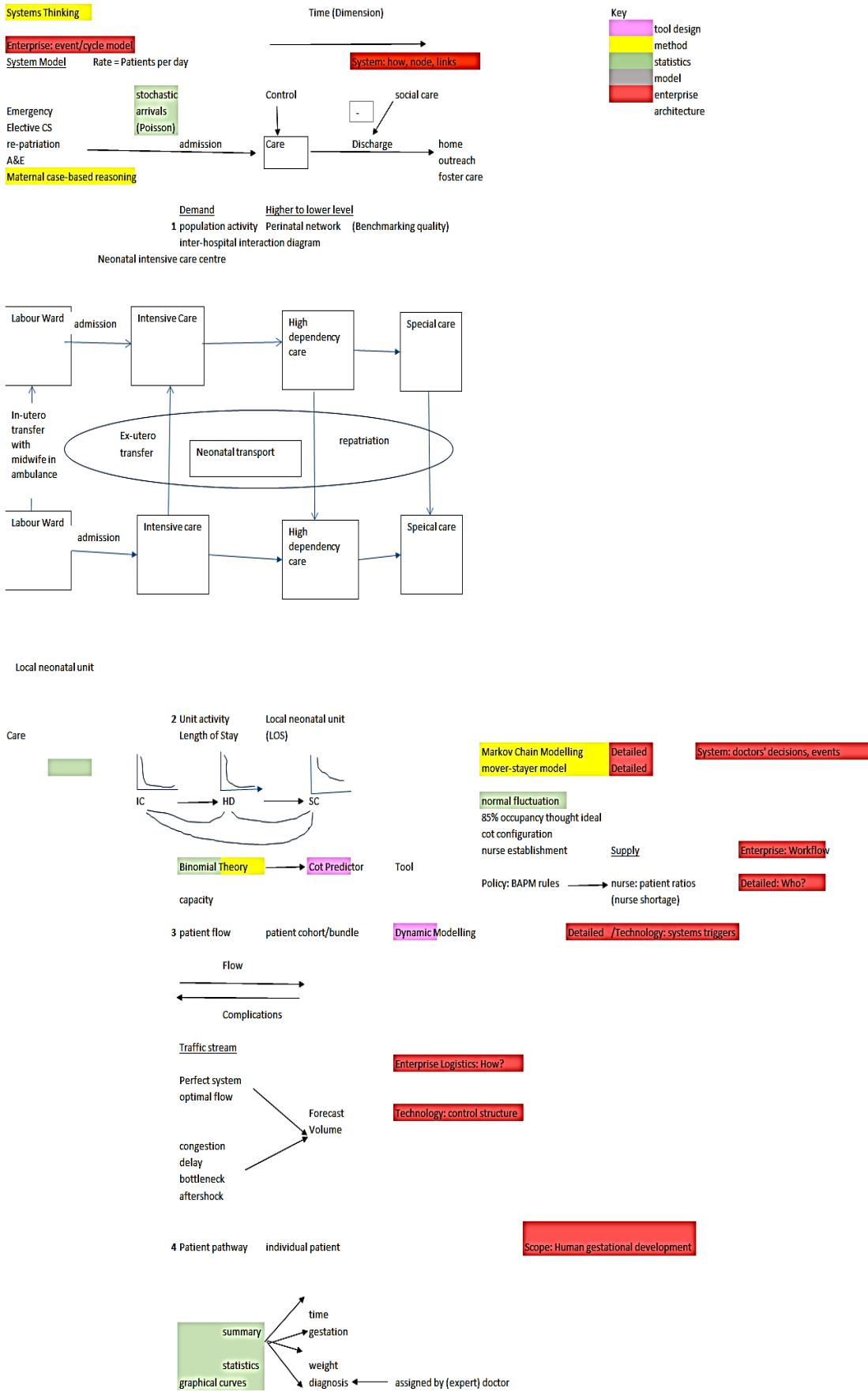

Figure 16 Case Study Systems Thinking

4.7.2 Patient Flow

Flow is system throughput, which may be considered as number of patients a year.

Free flow is ‘considered’ to exist below 0.85 capacity.

If outflow exceeds inflow, then over-supply of capacity arises, which wastes resources.

If inflow exceeds outflow, then blockage or queueing occur. The rate at which this propagates through the system may be represented as the Shockwave velocity = density x flow.

The effect of complications is to lengthen stay, increase acuity and resource Demand and to impede Patient Flow.

Patient Flow rate, traffic density and cot capacity are related (Elefteriadou, 2014).

The origins and destinations for the three levels of care are detailed in Table 16 below. Both linear journeys and inefficient iterative cycling occur.

Origin	Level of Care	Destination
Admission High dependency Special care Continuing	Intensive (I)	Transfer High dependency Special care
Admission I S Continuing	High dependency (H)	Rare transfers I S
Admission I H Continuing	Special (S)	I H Home

Table 16 Interplay of levels of care

Transitions of patients between care levels can be measured in number of patients per year and sorted by corrected gestation at that time.

So concepts from Traffic Flow Theory which are useful include journey, stream speed, density, capacity, delay, bottleneck and after shock.

Quantitative Analysis is given in Chapter 5. Figure 17 outlines patient flow for which vehicular traffic is a useful analogy.

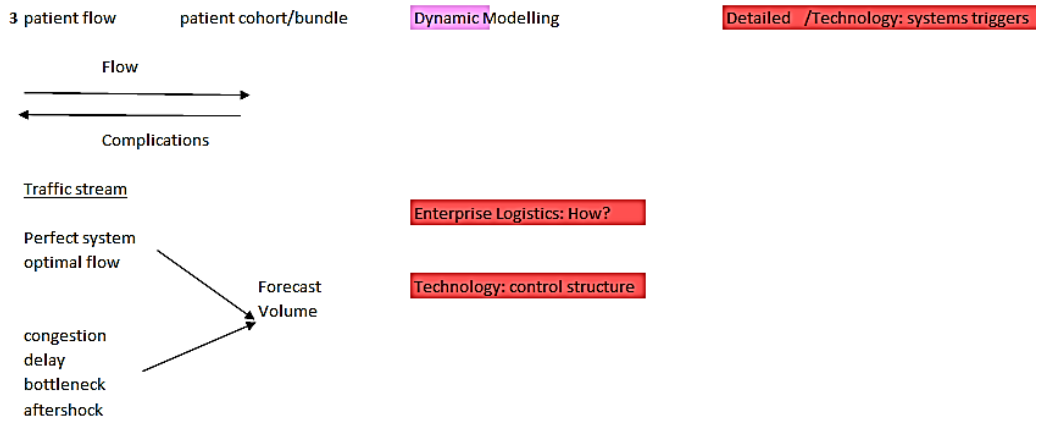

Figure 17 Patient Flow

For large numbers of patients, such as those at special care level, one could visualise this as continuous flow. For the smaller numbers receiving intensive care and high dependency, regarding their processes as discrete events is useful.

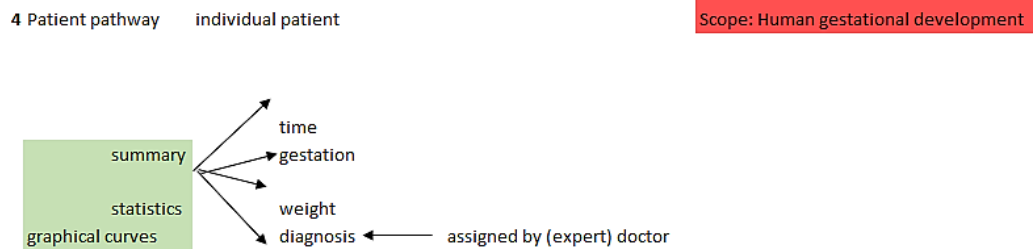

Figure 18 Patient Pathway

Figure 18 shows determinants of the patient’s pathway. Each individual has dimensions or characteristics of weight and Time such as Corrected Gestation. Medical knowledge of human gestational development informs prognosis (outlook).

- Key
- tool design
 - method
 - statistics
 - model
 - enterprise architecture

The term, Corrected Gestational Age is an important concept in this work. It refers to the age quoted in weeks and days since conception. With IVF, the exact date of conception is known but otherwise is usually estimated. That estimation by ultrasound at around ten weeks is thought to be within four days. That historically known from womens' diaries is considered less reliable, which may be since it is now known that the duration of human gestation naturally varies. As time passes, we mature and age. For an embryo, foetus, viable neonate and term baby, corrected gestation yields information essential for estimation of weight, behaviour, condition, resources required, possible complications and Length of Stay.

Premature babies invite a time perspective since foetal and neonatal human development matures as the weeks of gestation pass. Similar gestations might share certain care needs for instance ventilation, intravenous feeding, incubator care, tube feeding, et cetera. Knowing the gestation and size of a neonate can help predict care requirements (Manktelow et al, 2010). Illness and disease superimpose additional care needs beyond those of straightforward prematurity. With advances in respiratory support, intensive care (ventilation) is required for a shorter time nowadays and that of High dependency (non-invasive respiratory support such as nasal CPAP) for longer.

The categorisation of babies of particular gestational ranges is helpful since their level of immaturity tends to dictate which treatments will be required. For instance, those extremely premature 23 – 28 weeks will be ventilated for less than a day at the local neonatal unit before moving to the neonatal intensive care centre. Those 28 – 32 weeks gestation will most usually require some respiratory support. Those 32 – 33 weeks may need intravenous feeding. Those 34 – 36 weeks gestation will commonly be special care. Term babies admitted will tend to have a minimum stay of a least a day but rarely longer than a week, usually at special care level. The average gestational age at discharge is in the 35th week of gestation. These groups may overlap.

The following diagrams map processes and offer qualitative information, some of which is extraneous to the quantitative models developed in subsequent chapters of the Case Study. Those diagrams which are less relevant to the argument are found in the Appendix. Figures 19 and 20 show the neonatal and antenatal timeline for later gestation care processes. Figure 21 shows the interplay between different levels of neonatal units in the perinatal network and their patient flow.

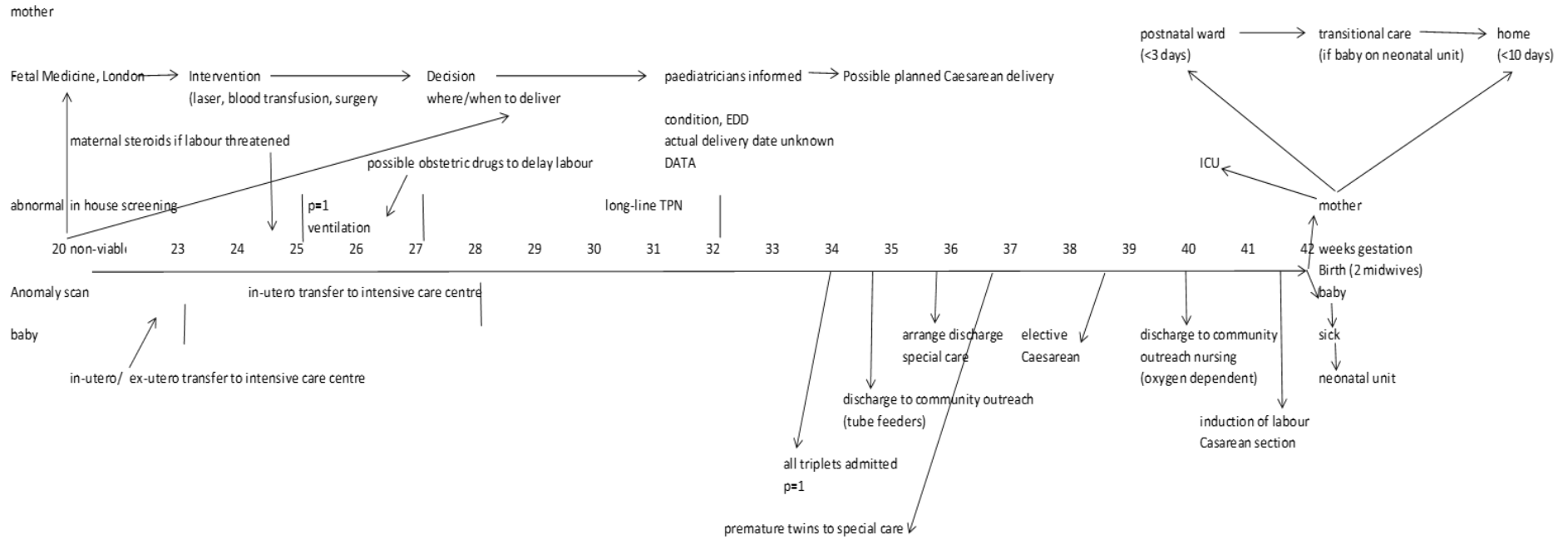

Figure 19 Timeline for later gestation



Figure 20 Antenatal situation by gestation

• Demand
population activity

Higher to lower level
Perinatal network

(Benchmarking quality)

Figure 21 Inter-hospital interaction diagram

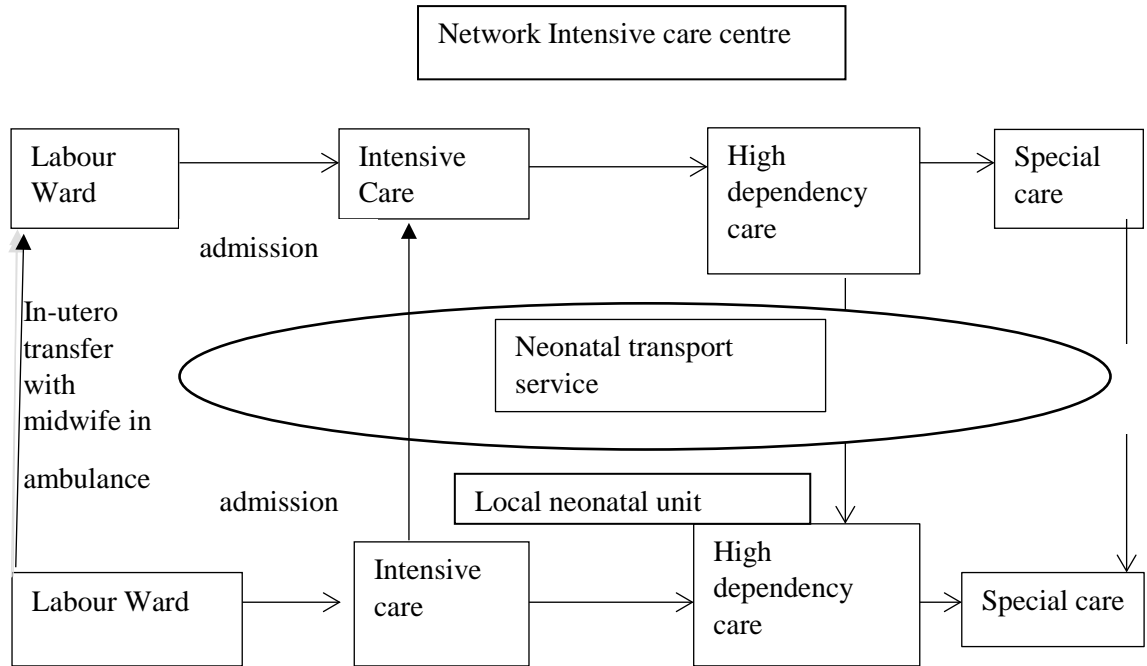

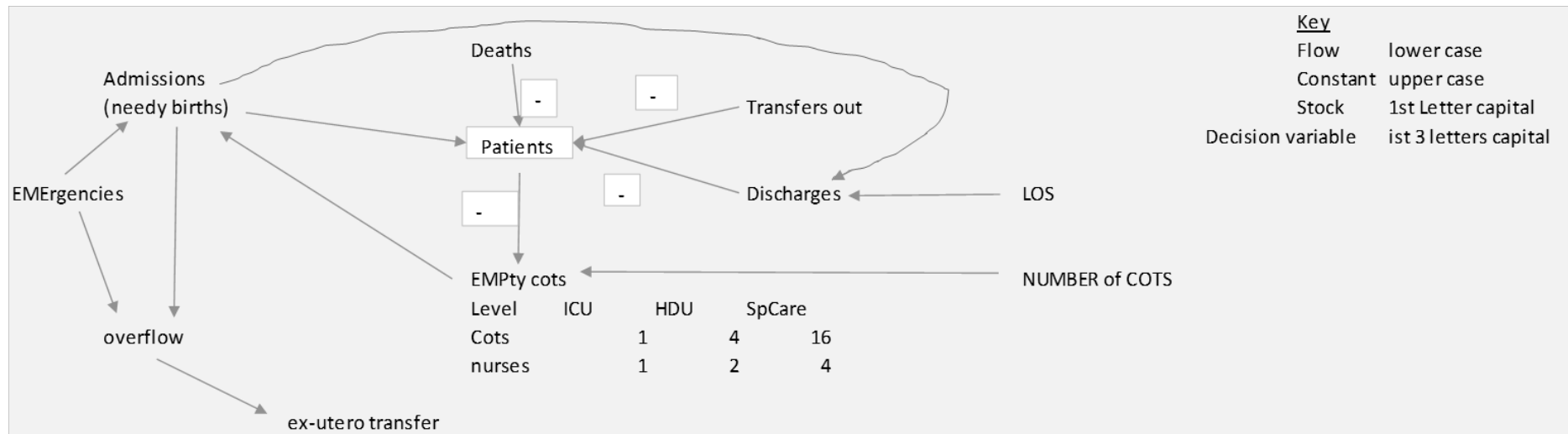

Figure 22 Neonatal Admission Decision

Figure 22 sets out basic operational decision making for neonatal admission in terms of Systems Dynamics.

Operations – Seasonal pattern

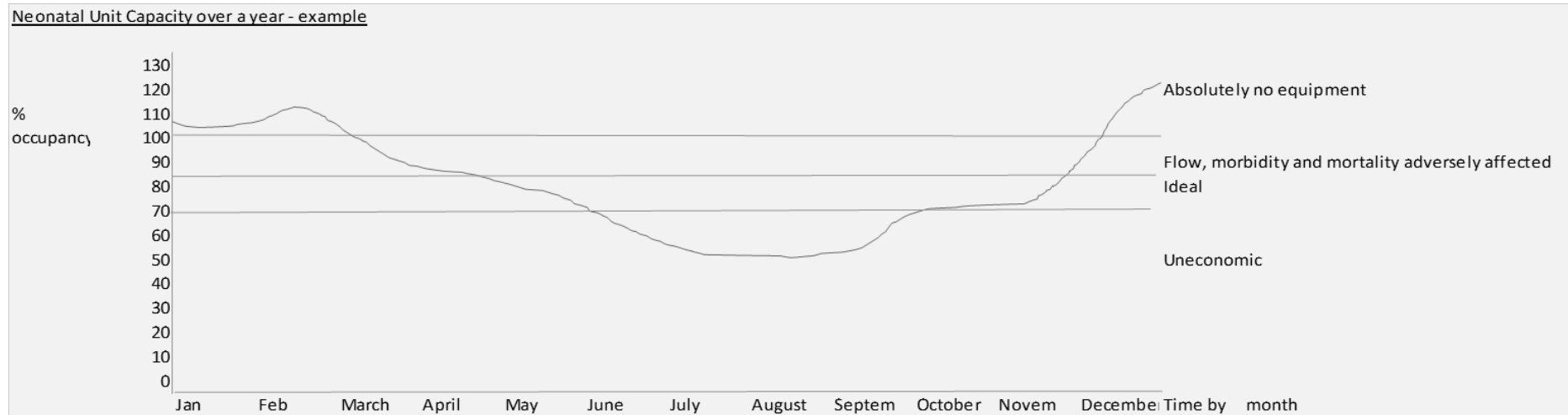
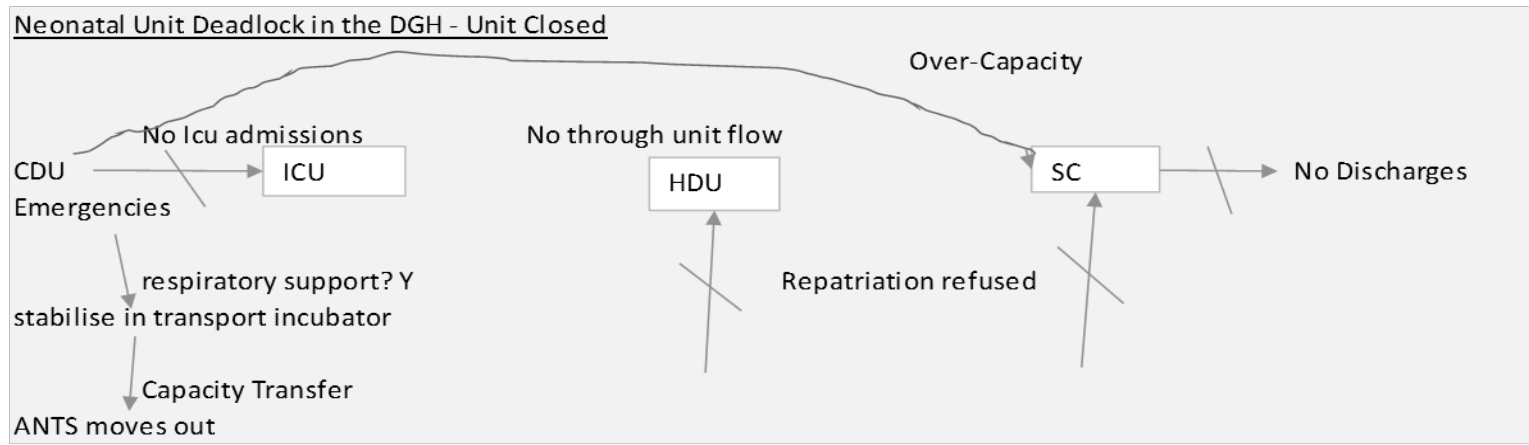

Figure 23 Hypothetical neonatal capacity fluctuation

Figure 23 demonstrates how work in small neonatal units fluctuates and those difficulties this causes when system design capacity is exceeded. The x-axis shows month of year while the y-axis depicts percentage occupancy. Both low and high occupancy have their associated issues.



Key

CDU = central delivery unit

ICU = intensive care

HDU = high dependency care

SC = special care

ANTs = Anglian Neonatal Transport Service

Figure 24 Neonatal unit Deadlock

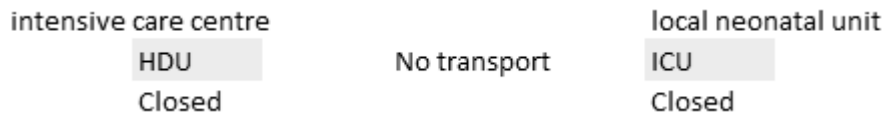

Figure 25 Neonatal Network System Deadlock

Figures 24 and 25 portray deadlock, the end-game of unopposed shortage of capacity. In this event, the Perinatal Network refuses patients and is not fit for purpose.

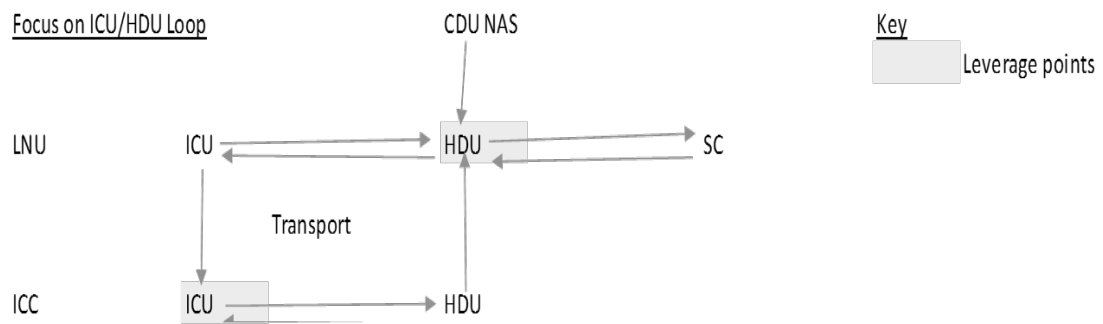

Figure 26 Leverage points in Perinatal Network System

It has not been much acknowledged that local neonatal units repatriating neonates from regional intensive care centres at High dependency care level face competing demands for their High dependency cots which can be a stress point in the system and if not handled well, lead to upstream cot blocks. When the system faces gridlock, High dependency cases are backed up at regional intensive care centres whilst local neonatal units are ventilating the extremely premature who cannot be transferred to any longer term intensive care cot. Exchange transfers by transport teams might take days to resolve this problem when rota gaps are run and perpetual (winter) pressures are operating like respiratory illnesses, staff sickness and bank holiday rostering. Figure 26 shows the leverage points possible to lift the deadlock, namely local neonatal unit high dependency and intensive care centre intensive care cots. Where different hospitals are involved in the patient pathway, then the upstream hospital (intensive care centre) could be working over capacity because the downstream hospital (local neonatal unit) is capacity constrained, so that eliminating the second bottleneck can create a virtuous circle (Wolstenholme, 2007).

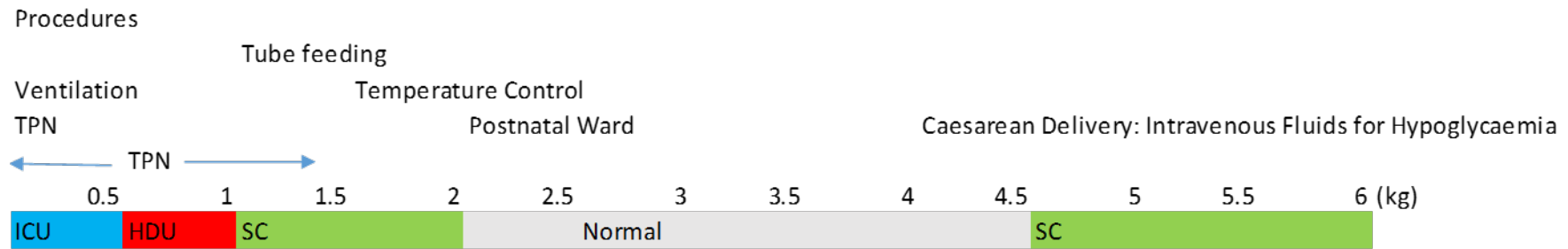

Figure 27 Neonatal processes by Birthweight

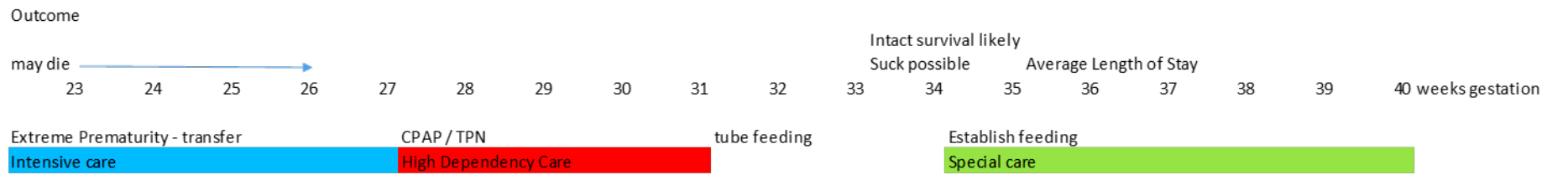

Figure 28 Process Mapping by Corrected Gestation

Birth-weight and corrected gestational age in weeks are neonatal segregators of groups, as shown in Figures 27 and 28. Neonatal unit support is required at the extremes of birth-weight as shown in Figure 27. In Figure 28, as the weeks of gestation pass, less intensive neonatal support is required.

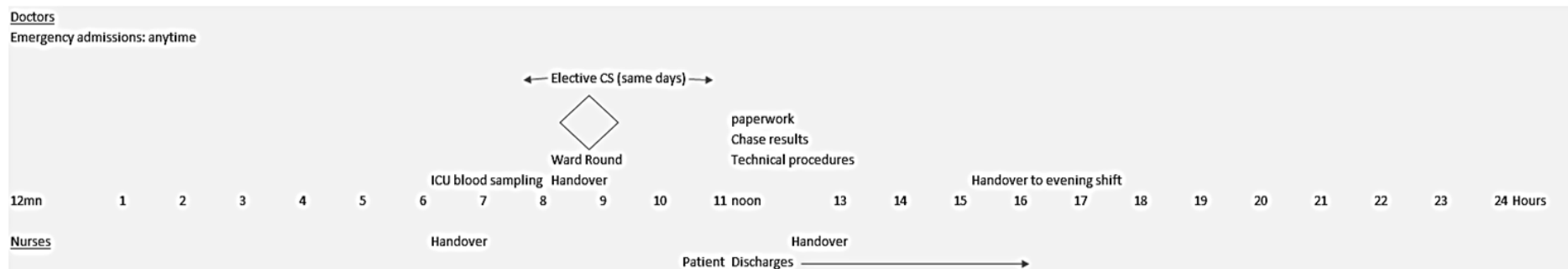

Figure 29 Diurnal Cycle of Neonatal unit work

Figure 29 shows the strongly diurnal cycle of the neonatal unit's work processes. Work is clustered from 6am to 5pm. Less routine work is performed overnight.

4.8 QUALITY / COMPLICATIONS

The English Perinatal Network System exhibits variability between regions, hospitals and patients (BAPM, 2009). This may be due to differing practices, demographics, policies and organisation of services.

Premature babies at particular gestations have certain care needs. The duration of their uncomplicated care is predictable. Care should generally improve patients but backward steps do occur (See Figure 30): these complications increase demand for resources and *can arise in the first place because of inadequate or untimely resources*. This may create a vicious cycle during winter pressures.

So complications are an inverse measure of quality. The more severe the patient's condition, the longer the LOS. Backward steps obviously prolong LOS. Conversely premature discharge from hospital leading to re-admission is a false economy and causes increased resource use. Here a balance must be struck and such judgments are clinical and hence subject to variability between doctors.

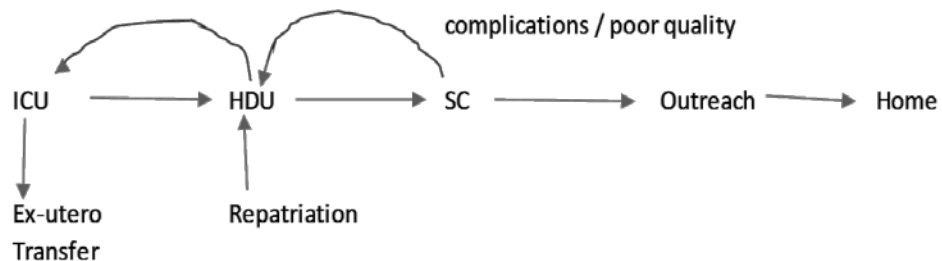

Figure 30 Forward and backward patient flows

The longitudinal profile of cot use at the three levels of care within a neonatal unit is a bundle of patient journeys (Dalton and Chausalet, 2011). Arrivals are stochastic and present at different corrected gestations. Patient pathways might be considered straightforward and par for the course (i.e. normal) or complicated, circuitous and prolonged (i.e. abnormal) (Dalton et al, 2013). Proportions which are complicated might be influenced by natural variation, demographics, obstetric practice, staffing, case mix, health policy and standards of care. Now the boundary between these straightforward and complicated groups is yet to be defined. Babies within the system

pass forwards through it in accordance with maturation over time, weight, growth and extent of disease; and may sometimes take a step back, requiring a higher level of care. Most admissions are emergencies and exacerbation of disease is unpredictable. Neonates are either admitted and treated or stabilised and transferred.

Determinants of flow through the neonatal system are gestation, respiratory disease, neurological function and the establishment of feeding. Pre-emptive medical decision taking, prompt action to resuscitate and treat and good nursing care such as warmth can optimize progress. Conversely, slower, less aggressive decision taking, poor intensive care and attention to hygiene cause setback. A move backwards is more likely to take place out of working hours owing to unexpected infection and a sanctioned move forwards through the care levels might follow a decision on a ward round. There is also the concept of a usual patient pathway. For instance two episodes of infection might be considered par for the course for an extremely premature neonate but unusual in a term baby.

Little work has been done to distinguish a normal Neonatal Pathway, given birth and condition from a more complicated journey. We do not know the proportions of cases which are not straightforward or their determinants. Normal forward flows to lesser care levels free up resources like nurses and equipment, while complications lead to unanticipated resource demands. Re-ventilations, surgery for gut complications and repeated interruptions in feeding can create quite complicated loops in the Neonatal Pathway. The concept of a normal Patient Pathway through the system is a useful way of looking at things since it can suggest ways to improve safety and efficiency. See Figure 31.

Quality / complications

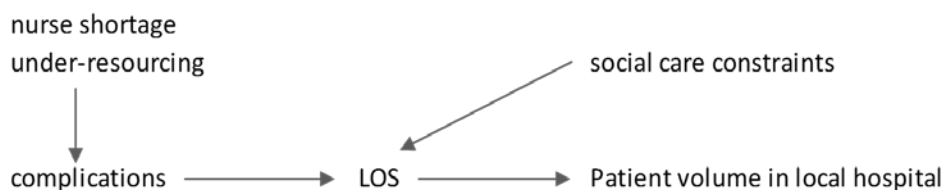

Figure 31 Quality and Complications

In the wake of the Francis Report (2009), analysing “normality” in a Systems context suggests ways to improve capacity and quality of healthcare. Given that an illness has occurred, what pathway should a patient follow? What is within the realm of expectation and constitutes only natural variation/common deviation? What means serious complications, poor care and prolongs Length of Stay? Now the rate of backward steps and complications are inbuilt to Healthcare system capacity currently. Knowing what constitutes the normal Patient Pathway suggests improvements for quality of care and assists in the planning of resources such as nursing. Aspects of this question are addressed using the local neonatal unit of a district general hospital as a case in point.

Normal care is given by the baby’s mother. Unfortunately transitional care is a poorly defined half-way house between special and normal care and most organisations have struggled to define what is meant by this. It is non-homogenous and varies locally.

Now what might be understood by normal is quite clear to a statistician. For a Healthcare worker, trivial deviation does not matter: yet a hospital should not be an outlier on benchmarking. A normal Patient Pathway would be common, able to be predicted and straightforward. All this is compared with what is known, where this is often quite little and must evolve in the case of hospital Metrics and Business Intelligence.

Key stages in the patient pathway entail assessment and diagnosis, determining the severity of the condition and its response to treatment. Backward steps or complications will occur: prematurity may well be experienced as “two steps forward, one step back”.

In the particular case of admissions to the neonatal unit, straightforward pathways include: Ex-utero transfers to the intensive care centre undertaken for Extreme Prematurity – these patients are born in the ‘wrong’ place. A backward adjustment step following initial assessment can occur. There might be a helpful early move from special to High dependency care associated with intravenous feeding with the object of bridging the nutrition gap and building up the patient.

There are also (later) backward steps due to complications like infection. Iterative cycling between levels of care is observed in association with certain medical conditions, for example Neonatal Abstinence Syndrome and Chronic Lung Disease, which prolong Length of Stay: the evidence for this is presented in the Medical Informatics Section of the next chapter on Quantitative Analysis.

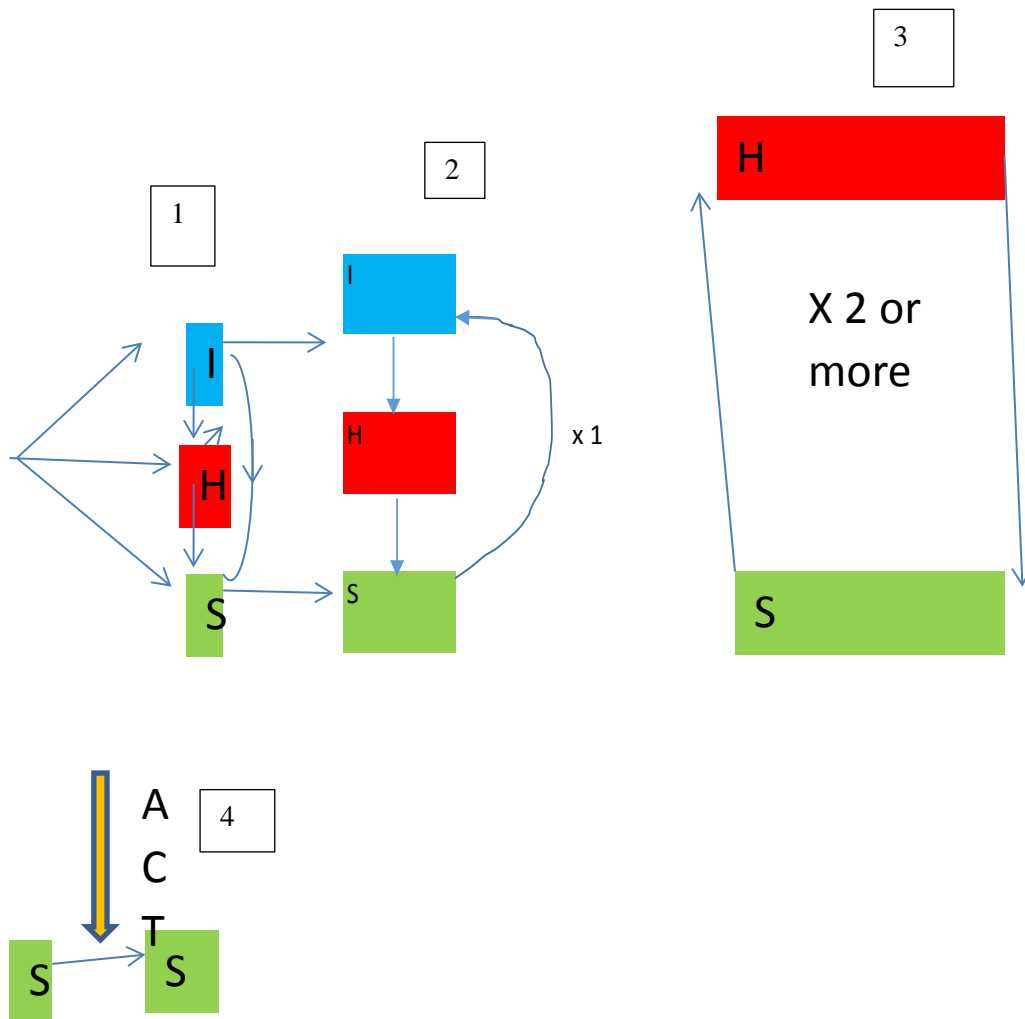

Figure 32 Pathways through the local neonatal unit

Figure 32 shows some pathways through the local neonatal unit. The first is normal. The second involves a backward step from special to intensive care: a common reason might be sepsis. The third diagram shows oscillations between High dependency and special care. The last shows a prolonged stay at special care: the first portion is medical whilst subsequent days are “social”.

(From the clinical perspective, when neonatal re-admission is considered, common themes emerge, namely: parental concern, difficulty in establishing breast-feeding, jaundice, seasonal bronchiolitis and other sepsis, exacerbation of chronic condition or previously undiagnosed congenital condition. These difficulties may be ameliorated by basic safeguards such as vigilance and responsiveness. This involves different areas such as community midwifery, primary and additional immunisation if entitled, early recognition of illness, health visiting, neonatal outreach nursing, assurance of quality in examination and screening, a healthcare system giving timely access to experienced clinical assessment as well as parental empowerment.

Other causes of avoidable term admissions include insistence on normality and dropping postnatal ward observation and testing. Is this best for the baby or does it save midwifery time on hard-pressed postnatal wards? Not checking the baby after transfer to another hospital, or home, not weighing until Day 5 are other causes. Non-patch Social Enterprise Health Visiting will lower standards of surveillance.)

Medical conditions govern LOS; and plurality, birth-weight, gestation, transfer and sepsis all exert their effects. There is a range of Corrected Gestational age at discharge, when certain rules might be obeyed, such as gestation above so many weeks, weight above so much, temperature maintained, feeding, gaining weight and well. There are natural fluctuations and both weekend and week day working. There is pressure on LOS, community outreach nursing and offloading on another service. The hospital at home is decentralised and not a cheap option since travelling costs fuel.

So what constitutes a normal Patient Pathway is historic and to some extent arbitrary. It has been based on expert judgment. A branch point on a Patient Pathway which leads to a complication might be apparent on review: for instance the next ward round but may not be immediately apparent to the busy clinician at the time. All this is essential to know for Patient Safety. If we aspire towards an improving, responsive service, it will be dynamic and evolve over time. It must be benchmarked and transparent. Where co-morbidities do not exist, then it converges to the ideal of no setbacks beyond the Presenting Complaint. It is probably open to learning techniques. The historic claim that certain rates of complications are unavoidable is open to challenge since old estimates in medical textbooks nowadays have reduced scientific

validity and lack localism. It should not be accepted that certain levels of complications cannot be improved upon. Instead the modern measure of normality should rest on current rolling local benchmarked data guided by knowledge of the highest standards achieved.

4.9 QUALITY METRIC RECOMMENDATION

Complications are seen operationally by backward steps and increased care dependency, which is recorded in a discrete way. An obvious Quality Metric is the proportion of resources deployed on complications, which might be nursing hours or patient cot days expressed as a percentage. This kind of Metric would certainly focus stakeholders' minds. Of course lack of staff to stabilise a patient itself causes complications, in which case, applying an optimisation, it might be found to be cost-effective to deploy more trained staff in order to defray the cost of such complications.

There is no acceptable floor for complications. Given a local neonatal unit's data, one can extrapolate for its population and determine either a breakeven size for the catchment or the proportion of the unit's resources given over to complications, or optimise these two. A smaller catchment population or a greater local rate of complications might render operations inefficient. The crux issue is complication rate: if this exceeds a certain threshold, then a hospital's work is unsustainable and doing more harm than good. Backward steps in the patient's pathway lead to human suffering and demand for extra resources. One might claim that 13% of in-patients taking backward steps equates to 10% additional Demand for resources for instance after overheads and running costs have been taken into account.

In the English local neonatal unit, the computer records patient treatments i.e. neuro-observations, ventilation and intravenous infusions. These might indicate the need for increased dependency in nursing i.e. critical care. SEND assigns dependency according to rules on recorded treatments. Certain heuristics emerge for the difference between normal and abnormal patient pathways, as will be described in Section 5.10 and which could be applied in machine learning or data mining algorithms. In neonatal care, backward operational steps include $S > H$, $H > I$ after 2nd day, $S_{\text{medical}} > S$

social, where the reason for the delay is due to social care institutional or family delay when the patient is medically fit for discharge.

The ideal baseline is no referrals or complications beyond the normal patient pathway for the presenting complaint. This overlooks multi-morbidity for instance in the aged. The guidance for applying this operational Quality Metric would depend on the context. In the general case, there will be deviance from the normal patient pathway, if this is defined, which for example is the case for fractured neck of femur. At worst, it would rely on doctors' estimation from practical experience.

As will be mentioned further, what is pressing to know for quality and funding purposes is the genuine healthcare need of the population rather than that emanating from the imperfect/wrongly configured/self-serving healthcare system itself.

4.10 SUMMARY

This research facilitates Quality assurance through mapping of straightforward and complicated Patient Pathways (Model 6) thus offering improved contingency planning and Business Continuity. Quantitative Analysis is conducted in the next Chapter.

CHAPTER 5 CASE STUDY: QUANTITATIVE ANALYSIS

5.1 INTRODUCTION

The aim of this Chapter is to demonstrate which operational and medical information is available, its pattern and to lay the foundations for the static and Dynamic Modelling Chapters which follow. The intention is to develop this from first principles at undergraduate medical statistics or mathematics level. Interpretation and synthesis lie at the end of the Chapter. Exposition of the reasons for data choice lies in Chapter 6.

This Chapter is further organised as follows:

- Materials (Data and Software)
- Methods
- Newborn Population
- Informatics Guide
 - Operational Analytics
 - Patient Transitions
 - Medical Analytics
- Complications / Backward steps
- Commentary and Discussion

5.2 MATERIALS (DATA AND SOFTWARE)

Data resources are from HES, the Standardised Electronic Neonatal Database (SEND) and lower down this hierarchy, “expert” data. Denominator data was drawn from the Hospital Episode Statistics (HES) database for maternity and neonates, which is collected nationally. The HSCMG has access to HES data. Detailed neonatal data from the SEND which is cleaned, is the local existing data collection system in use within South East England. Naturally new data is created every day. Data collection and analysis of the SEND data from Colchester General Hospital was undertaken from the years 2009-11. Its size was about 1200 neonatal admissions to a medium sized district general hospital serving a population of 400,000 delivering about 4000 babies a year at that time.

Those data fields which answer the most pressing questions the model needs to address have been identified from both the Literature Review and practical experience. Crucial fields include:

on admissions: source, birth-weight, gestation, emergency versus elective caesarean section, congenital abnormality, date of birth, date of admission, origin, medical diagnosis

Data on stay incorporates: patient pathway (journey through the levels of care and any transfer), any complications, Length of Stay, current weight and gestation, number of nurses/shift and skills, rate of weight gain.

Data on discharge is destination, (discharge weight), Corrected Gestational age, (need for neonatal nurse outreach care), date.

Data on re-admissions and delays are also relevant and harder to obtain.

Data Preparation

Inclusions: at least one day on High dependency care.

Exclusions: no days on high dependency care.

Sorting was by Corrected Gestation, level of care, Diagnosis and Patient Transitions between levels of care.

It was manual and time-consuming.

Data Theory

Some aspects of data collection, the handling of Time and Information Systems to support decisions are considered next. Time passes continuously for us all; yet the recording of events is discrete and digital computers treat time discretely. Though care is a continuous process, the snapshot is taken with the midnight care level and occupancy figures. Millard (1996) has long argued that this under and misrepresents activity (especially that of a day-case nature) and this point has more latterly been made by the Nuffield Trust (2016). All actions performed until that point in the preceding 24 hours are used to judge a patient's level of care. Since that time envelope is short, rounding of data has a relatively big effect. Yet the true time at which the patient actually changed level of care is not captured. So the data collected and used to record the system in UK hospitals has always misrepresented the true continuous nature of patients' care. The existence of the midnight bed figures lend themselves to a time-slicing approach, which is the routine way things are currently done and looked at. An alternate way of considering the system might be more realistic and permit additional analyses. Yet for a discrete-event approach, empirical data would have to be collected prospectively.

Illness and recovery may be gradual or abrupt and interventions dealing with it are discrete events, which may occur at any point in time. Whilst babies may have continuous monitoring, this is summarized in the paper medical record at certain time-points. More elective tasks follow a diurnal cycle, such as ward rounds where decision taking on planning patients' care is batched up but which may be subject to set back during the out of hours service run during weekends and bank holidays.

The Robert Francis Inquiry into mid-Staffordshire Hospital (Francis, 2013) produced over 10% of its recommendations on Information. It advocated comparative

information methodologies, provision of detailed clinical breakdown and that Metrics be transparent, accessible and real-time. There should be accreditation for Healthcare statistical methodologies, which ideally carry official statistics status and are available for public consumption in much the same way as households know the measure of inflation in the economy. If this were realised, then hospitals could be fairly compared, efficiency improved and capacity planning enabled. Furthermore hospitals could be scrutinised when manipulating figures and gaming targets and both governance and public accountability improved. Additionally common definitions facilitate computerisation, which is lagging in the paper heavy National Health Service (NHS). Improved informatics is aspirational (Nuffield Trust, 2016).

It is conceded within the Neonatal Toolkit (DoH, 2009) that “demographic data allows predictions of year on year demand quite well. *Yet day-to-day demand is less predictable resulting in over-capacity*”. That data whose collection was proposed included: episodes of inappropriate transfer such as out of network, cot closure exceeding 48 hours, nurse levels, use of agency staff, sickness levels and refusals of transfer requests (in-utero and post-natal) with reasons. Service process would incorporate median and 95th percentile activity levels at each care category, shift-by-shift analysis of nursing numbers against activity and rate of understaffed shifts. Network Outcomes would be audited to include admissions, transfers and those which were inappropriate or delayed. The neonatal clinical dashboard would record this. Unfortunately such aspirational proposals have not all been implemented.

Data input, cleaning, completeness and quality is fundamental to sound decision-making. It should be considered whether the pre-collected Metric necessarily answers the question posed? Is it scientific, independent and clinically intuitive? Is the Metric a robust discriminator, tried and tested, widely understood and trusted? Does the Metric serve the patient and quality of care? or solely financial and political imperatives? Is its collection productive? Many routinely collected data items have emerged to serve finance rather than being designed by clinicians to answer important questions on quality of care. In fortunate institutions, clinicians can request informatics to produce those Quality Metrics they require, as for instance in Birmingham; this innovation is not offered to many but ought to be (Varlow, 2014). There is scope for exploitation of information for intelligent feedback; neonatal data governing Clinical Outcomes has already been specified (Spencer and Modi, 2012).

Data Analysis

Inputs

Corrected Gestation at delivery had the range: 23-41 weeks. The range of LOS was from birth to 3 months. Days spent at the three levels of care and journeys between them are investigated.

Methods used included the Binomial Theorem and conventional Bayesian medical statistics (for: mean, mode and median). Timings and the likelihood or probability of events given other factors such as Corrected Gestation were also important.

Results were imported/expressed using Excel, the main spreadsheet software available in the NHS in England. @Risk software was used to ascertain the distribution of Length of Stay (LOS) for instance whether negative exponential, Poisson or stochastic, etc. Another software tool used was Ithink.

We specifically estimate neonatal admission, Patient Pathway and Length of Stay and demonstrate underlying system behaviour. For example, this model is applied to produce an operational cot Forecast. Tools have been developed: Cot Predictor and Markovian modelling, which will be presented in Chapters 6-7.

Reasons for selecting the particular approach include being acceptable, feasible, pragmatic and based on expert (clinical) judgment. Whilst quantitative models might permit relative weighing and a cost function to be assigned to their combination, given that the Enterprise Modelling involved significant Systems Thinking qualitative aspects, this was considered arbitrary so was not conducted. Yet since data collection through the SEND has improved (Spencer, 2012), this permits improved prediction.

Counting quirks

Now owing to the way in which data has been counted, even if an intensive care patient moves to High dependency care, the next midnight figure will record intensive care. So for each patient counted at census they could appear to be better in health than the system records. Yet this also has implications for provision of High dependency cots as the true need can be greater than the data suggests when looking from the perspective of flows from intensive care. It is the same skilled nurses who care for both kinds of patients, yet the prediction for High dependency cot demand is potentially under-estimated.

The midnight figure is the highest intensity level of care in the 24 hours leading up to this. All High dependency patients transferred out are counted as having had that day but will not be actually found in the practical ward count. (Seven instances of this occur and could be removed from the denominator but this has not been done as it accounts for a small proportion.)

Owing to the way in which the data capture counts within the system, any fraction of a day divided between special care and High dependency care will always be counted at the higher care level as High dependency care. This could have the effect of shifting the record by a day. So for the way in which data is recorded, to which care level the patient moves has differing resource implications.

5.3 METHODS

Much previous work has looked at intensive care cots in intensive care centres. High dependency cots in a local neonatal unit are important since they represent another node in the middle of the Perinatal Network System. We wish to model the occupancy of such cots in order to better forecast their use. What work you decide to accept today could produce a High dependency cot block tomorrow. We would like to predict the probability of cot blocks on a tactical time horizon. As described in the Process Modelling section of the previous chapter, while there are few routes out for such patients there are many more routes in, which can lead to congestion and has adverse upstream implications for intensive care cots in neonatal intensive care units. A kind of short-term futures market for the commodity of High dependency cots could be quite useful. We explore patient pathways through High dependency care in a local neonatal unit.

As mentioned, the longitudinal profile of cot use at various care levels within a neonatal unit is a bundle of patient journeys. To take one example, in the past Essex neonatal network, the East of England Specialist Commissioning Group (personal communication Ruth Ashmore) commissioned 2009 activity by summing each hospital's past year's cot days at each level: intensive care, high dependency and special care, multiplied these by 10/7, which was assumed to take account of annual, maternity, study and sickness leave for the established staff and to average 70% occupancy, then supported that particular number of cots:

10/7 (ICU + HDU +SC cot days)

Unfortunately this method is quite crude and disaggregates patient journeys. Indeed Extremely Premature neonates can be transported between different hospitals, which disaggregates intra-patient data and confuses planning. Also if in past years there were problems with capacity, (which there were) then this method perpetuates that.

None would argue that an intensive care centre accepting babies for intensive care from the region might not require additional intensive care cots (Cusack et al, 2007), or that a special care baby unit running over-capacity requires more of these; yet it has never been argued that a local neonatal unit aiming to repatriate its own extremely

premature population promptly might need additional High dependency cots to minimize congestion at this important node in the Perinatal System. For a local neonatal unit, there is a time lag before which it may begin to care again for its extremely premature neonates who had been sent to a neonatal intensive care unit for ventilation. There is a need to better understand this aspect of the system. An evidence-based recommendation for amending the basic calculation is provided in Section 7.3.

High dependency stayers can be considered to fall into two groups: those whose stay is brief or long. It is the long stayers who perturb perinatal system flows. The effects of raised High dependency demand include refusal to elective deliveries, capacity transfers of intensive care cases and delayed back-transfers. Another issue is Demand for skilled neonatal nursing resource.

Day on day High dependency cot occupancy and patient pathways were investigated. 2009 data on high dependency admissions in the local neonatal unit from the Standardised Electronic Neonatal Database (SEND) was examined for the reason that Hospital Episode Statistics (HES) denominator data for this year was also available. Now Corrected Gestational age is liable to be known in all but the unbooked. With the use of dating scans, its accuracy is considered to be within four days. It is now understood however that the duration of normal gestation varies (Jukic, 2013).

Data was analysed on certain patient characteristics of those needing High dependency, namely gestation and whether any low birth-weight (centile) did delay discharge, Length of Stay there, origin by care level, whether a re-admission or repatriation, destination by level of care and any subsequent hospital transfer. We looked at some candidate explanatory factors such as plurality, maternal drug use, intensive care duration of stay, local discharge from intensive care cot, main diagnosis whilst in High dependency, corrected gestation/ time to estimated date of delivery (EDD) and overall Length of Stay. Other fields looked at were long-line total parenteral nutrition (intra-venous feeding) and respiratory support. Non-contiguous

days at intensive care or High dependency care are atypical and were of special interest.

We tried to predict when an individual would move between levels of care in particular High dependency and when they could go home. Given current occupancy, this could inform an estimation of each day's cot Demand. We have knowledge of range of cot occupancy, Length of Stay (LOS), age and diagnosis. Having warning of peaks in Demand would be quite useful for timing decisions on elective deliveries as well as repatriations from other hospitals.

The general equation for High dependency cot demand is

$$H_t = H_o + H_a + I_H + S_H - H_d$$

where H_t and H_o are High Dependency census at time t and time zero; H_a is arrivals direct, I_H and S_H those arrivals there via intensive and special care respectively and H_d is those leaving high dependency care, all within the time-spell t over which a forecast is required.

5.4 NEWBORN POPULATION

Information on population is given so neonatology may be seen in the wider context. These graphs show how the majority of births are around term. Neonatal units treat those who are sick, small or early.

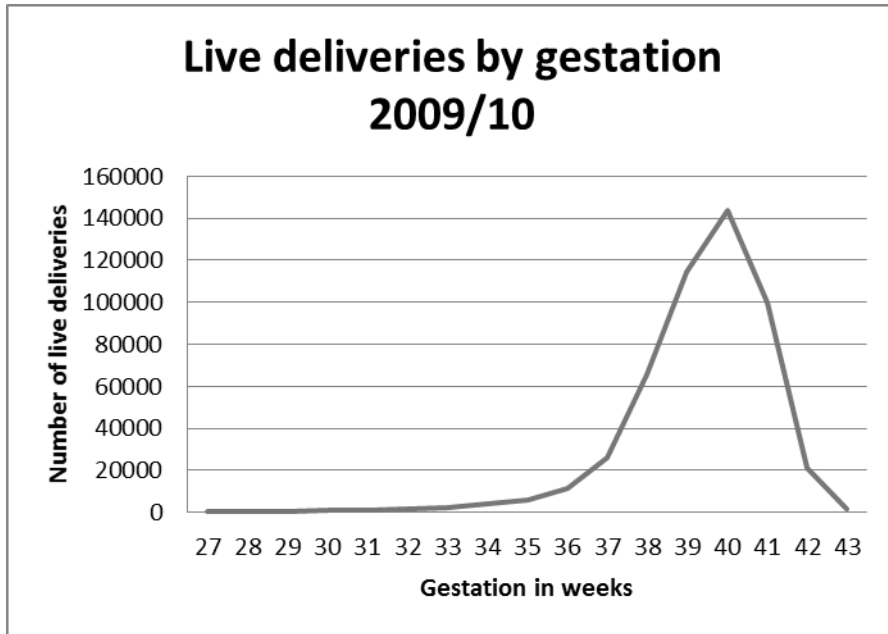

Figure 33 Live deliveries by gestation 2009-10 (HES)

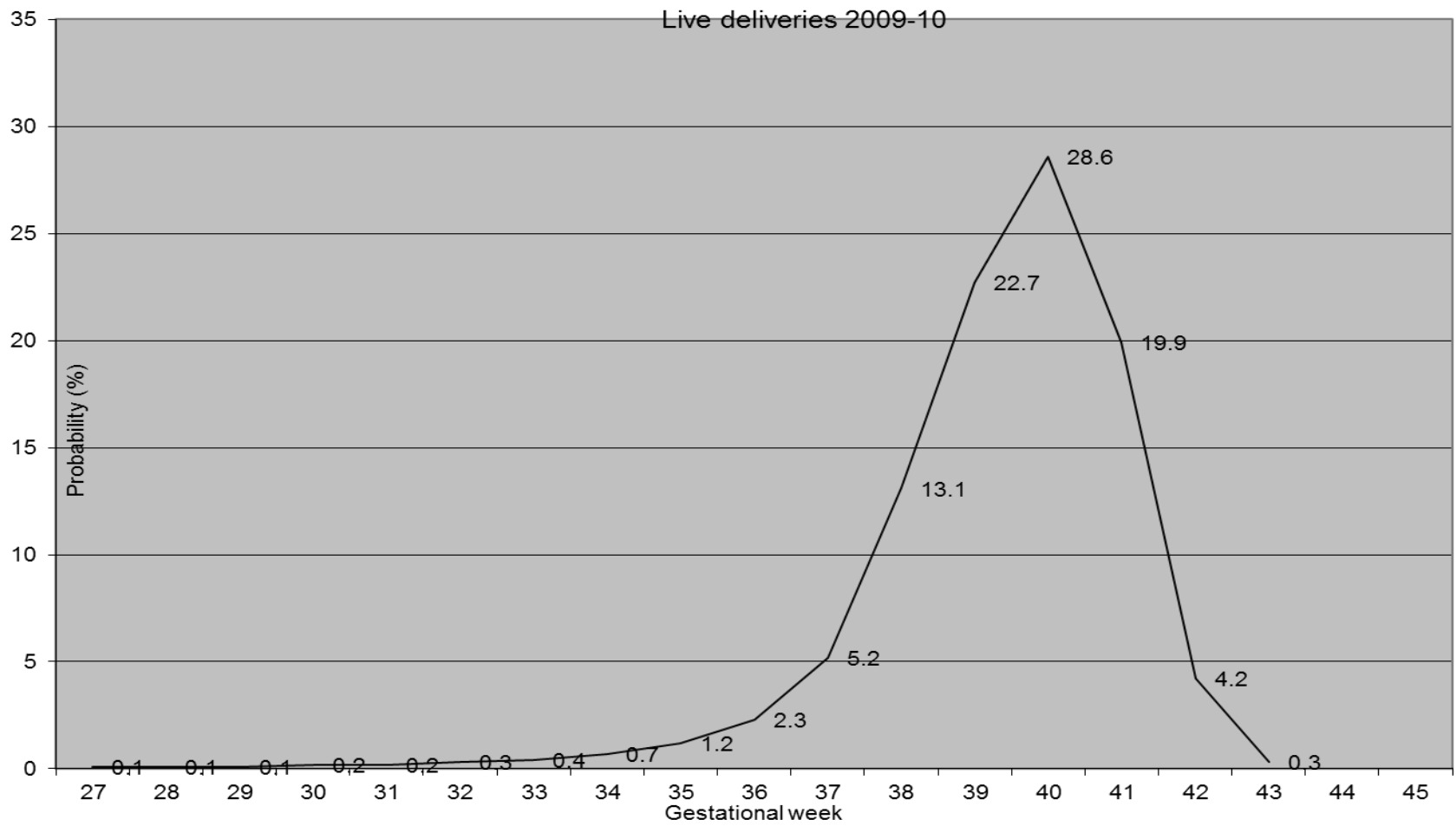

Figure 34 Probability of birth gestation 2009-10

This graph shows the small size of the premature population.

5.5 INFORMATICS GUIDE

The modelling applies Informatics, which is now provided in the following categories:

- Arrivals by corrected gestation
- Level of care by corrected gestation

Operational Analysis

- Intensive Care cots
- High dependency care cots
- Special care cots
- Day to day changes in cot occupancy
- LOS at Care level
- Cot occupancy

Patient transitions

- Definitions of transitions.
- Transitions chart
- Graphed transitions
- Mover-Stayer Model
- Arrivals to High dependency care
- High Dependency stayers
- Intensive care to High dependency patient transitions (IH)
- Special care to High dependency patient transitions (SH)

Medical Informatics

Patient group

- Length of Stay by Diagnosis
- High dependency days / episodes by condition.
- Medical Conditions: Neonatal Abstinence Syndrome (NAS), Chronic Lung Disease (CLD), plurality, Birthweight
- Long-stayers
- Corrected gestation and Destination. Intensive care to High dependency
- Complications / Backward steps

Results Commentary, Synthesis, Discussion and Summary

A narrative account of the results analysis is given. Select Figures and Tables illustrate key findings. Peripheral information is placed in the Appendix.

Figure 35 is for the years, 2009-11 (if one day on High dependency care). The subscript, 'a' denotes arrivals at that level of: S (special care), H (high dependency), I (intensive care).

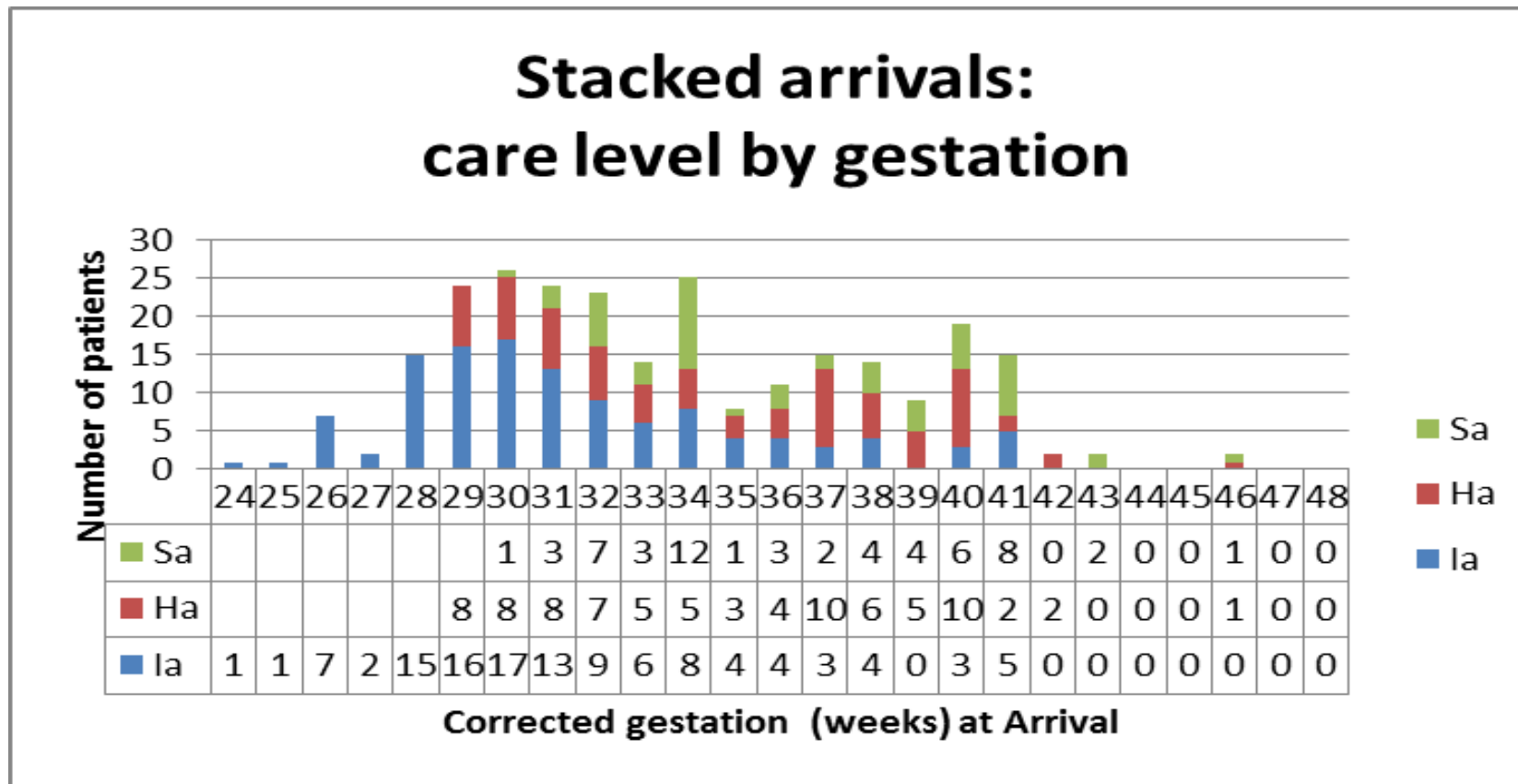

Figure 35 Arrivals by gestation and level of care at admission

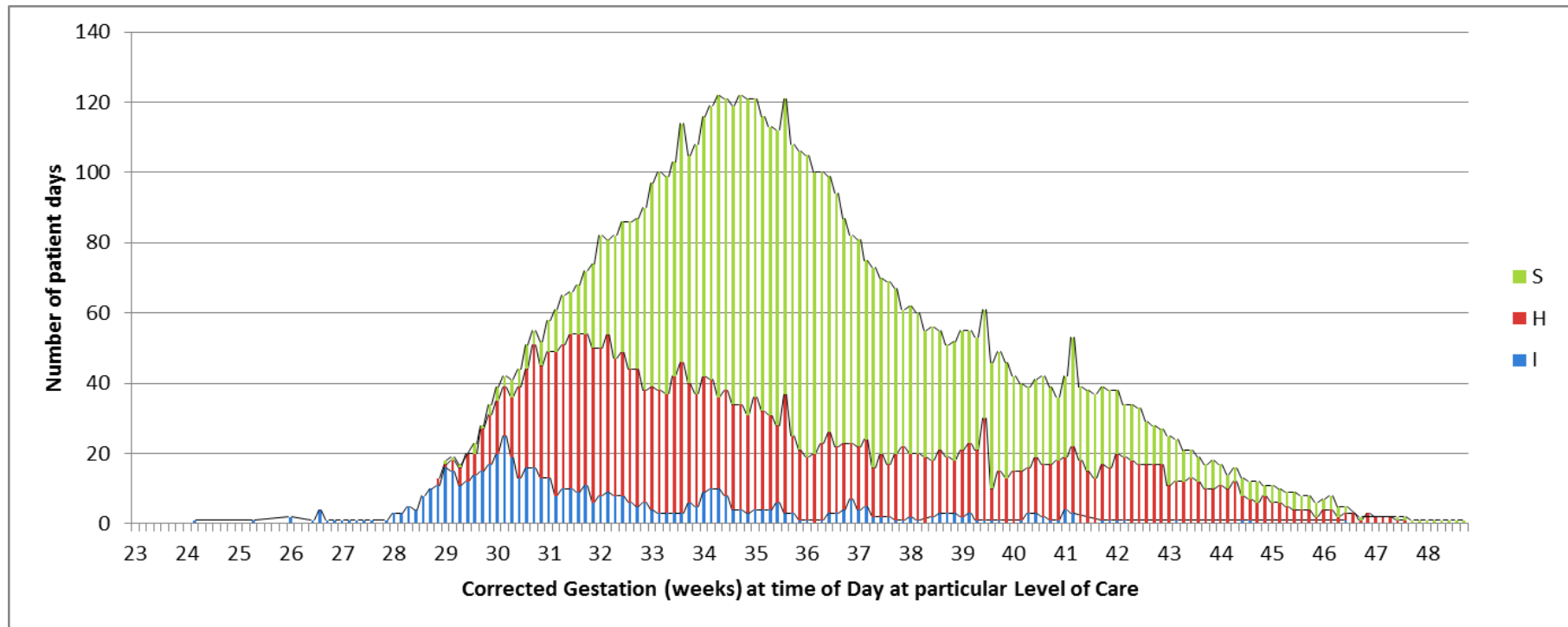

Figure 36 Local neonatal unit's population Demand for care level by gestation

Figure 36 shows that as corrected gestation increases, intensive care days fall whilst special care days rise. This depicts the pattern of Demand for resources by the local population. The neonatal unit's work represents just a small portion of the curve for the live-born population shown in Section 5.4 Figure 34. Please see the Appendix Figures 104-5 for allied graphs.

5.6 OPERATIONAL ANALYTICS - SERVICE

5.6.1 Intensive care cots

intensive care cot days	0	1	2	3	4	5	6	7	8	11	12	15
Patient number	42	6	13	2	15	3	3	1	1	1	2	1

Table 17 Number of intensive care cot days by patient 2009

Table 17 shows that 42 patients did not require intensive care. 36/48 patients required 1-4 days of intensive care. 12/48 required 5-15 total days of intensive care.

The number of patients where the first need for intensive care was subsequent to Day 2 of life was just two.

30 patients had 34 episodes of intensive care, which led to High dependency care. 23 days accounting for 8 episodes resulted in transfer out. 29 days comprising 13 episodes led direct to special care. So intensive care cot days not leading direct to in-house high dependency care were 52 days.

These 90 patients had a total of 189 in-house intensive care cot days. Just seven patients returned to intensive care; yet 37 patients returned to High dependency care.

Figure 37 shows the years' range of daily intensive care cot occupancy.

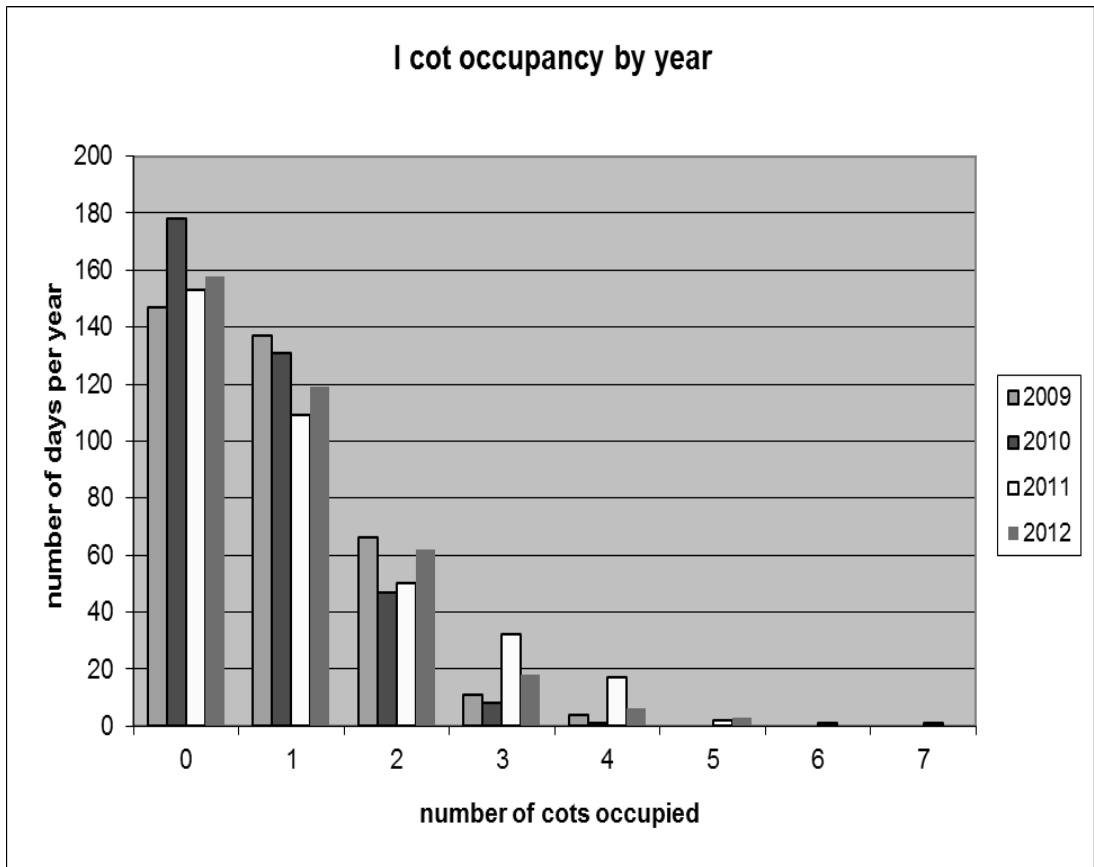

Figure 37 Range of daily intensive care cot occupancy 2009-12

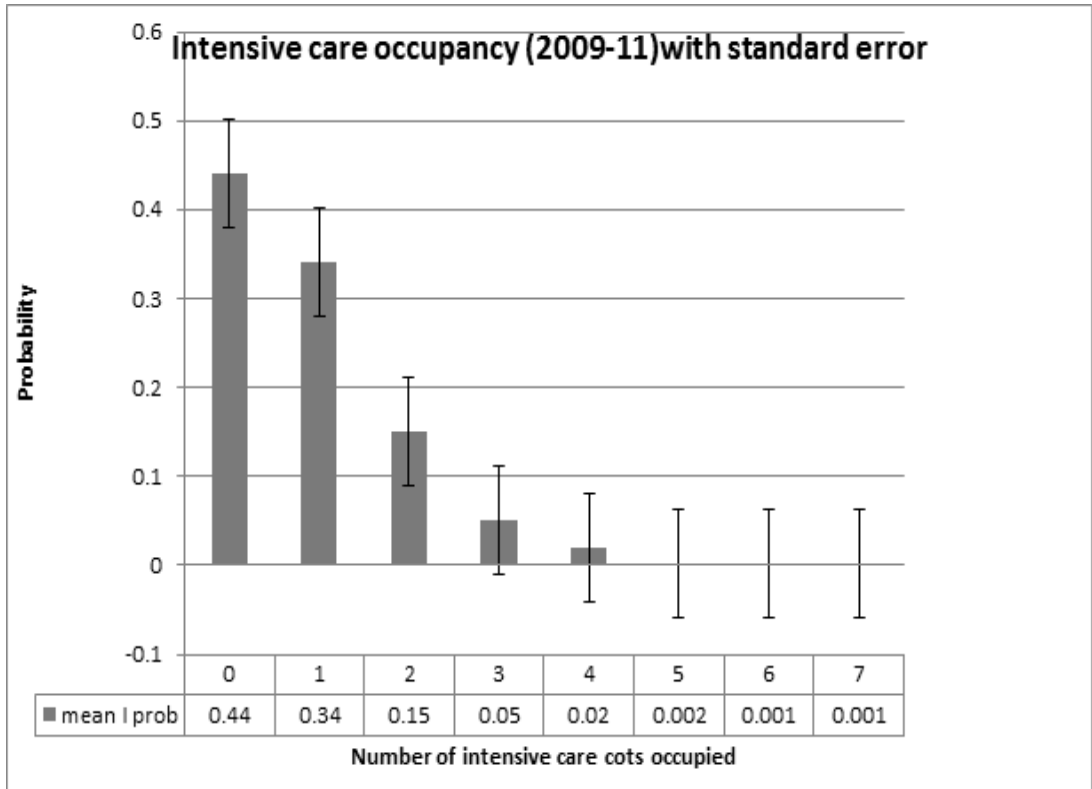

Figure 38 Intensive care cot occupancy with standard error 2009-11

Figure 38 shows that whilst time idle is 44% of days, over-subscription is 22% of the time. This shows the disproportionate effect of variation in small units.

5.6.2 High Dependency cots

Next we look at high dependency care, the main focus. Table 18 shows the year's range of daily High dependency cot occupancy for which the median and mode are two cots. It should be pointed out that the High dependency cot configuration at this time was four, not more.

High dependency cot occupancy	0	1	2	3	4	5	6	7
Number of days	37	67	103	83	33	18	5	3

Table 18 Range of daily High dependency cot occupancy in 2009

Figure 39 shows comparative annual high dependency cot occupancy.

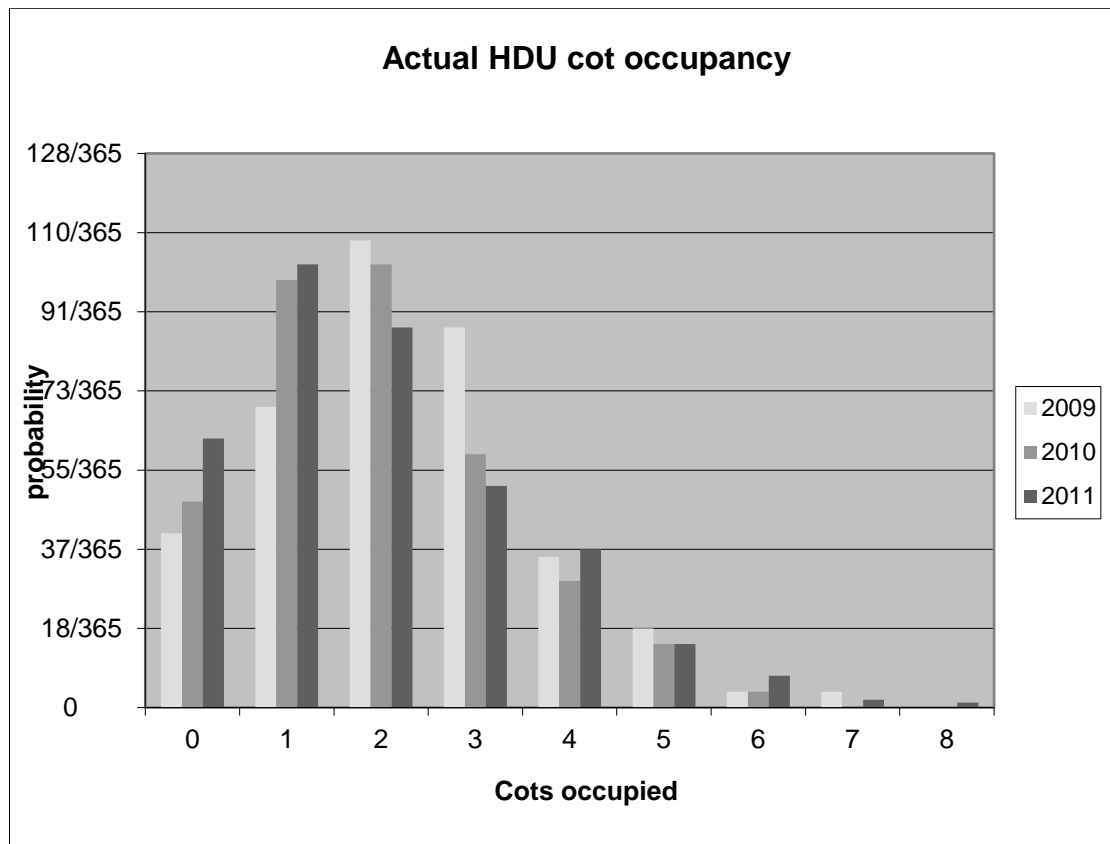

Figure 39 Comparative daily High dependency cot occupancy 2009-11

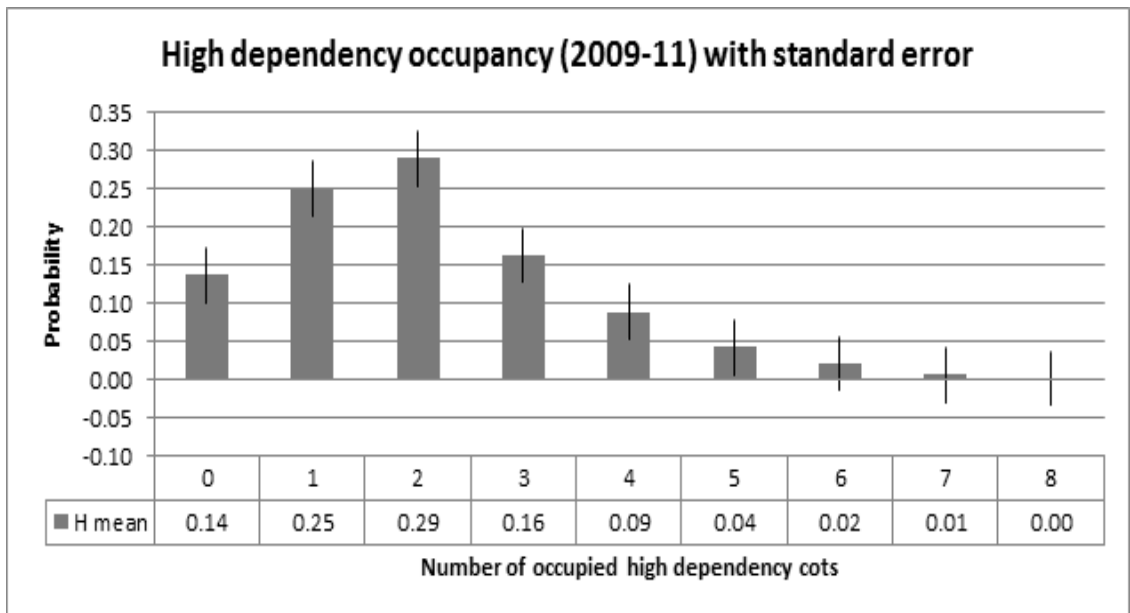

Figure 40 Probability of High dependency cot occupancy (2009-11) with standard error

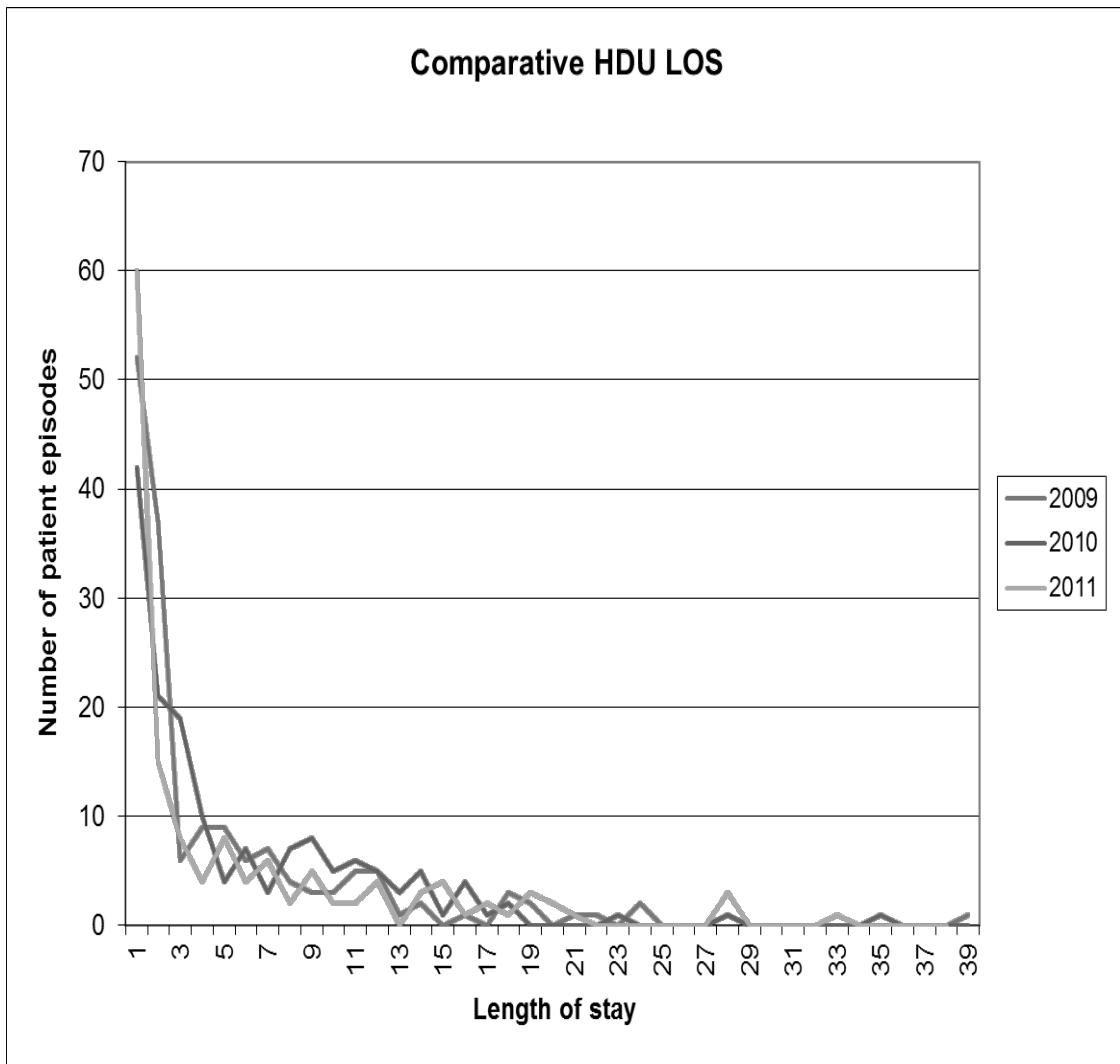

Figure 41 Comparative Length of Stay at High dependency care 2009-11

Whilst a histogram, the lines are joined in Figure 41 to show each year's data, variability and a comparison.

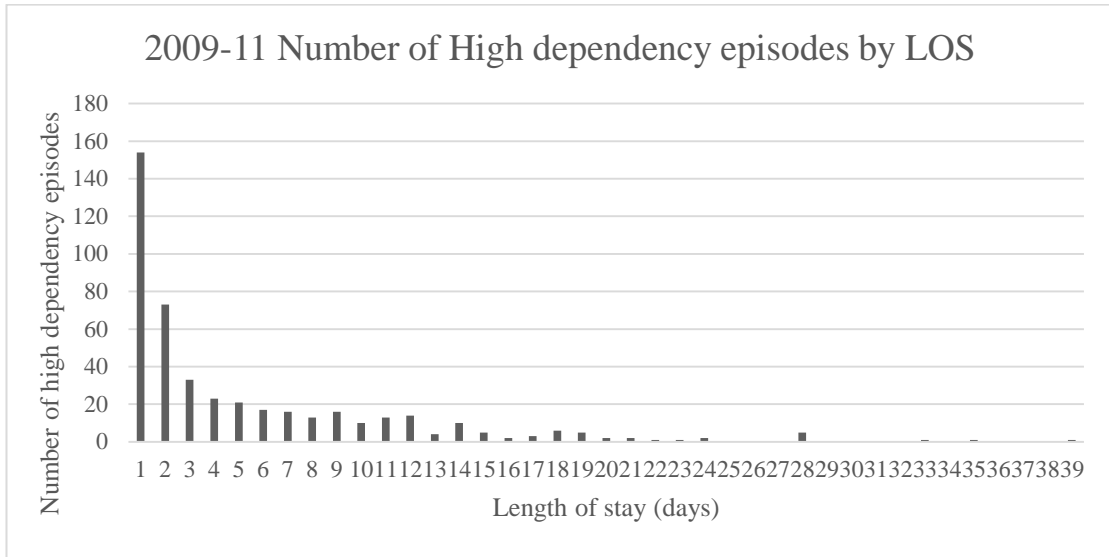

Figure 42 Number of High dependency episodes by Length of Stay 2009-11

Figure 42 above gives the number and duration of each high dependency episode.

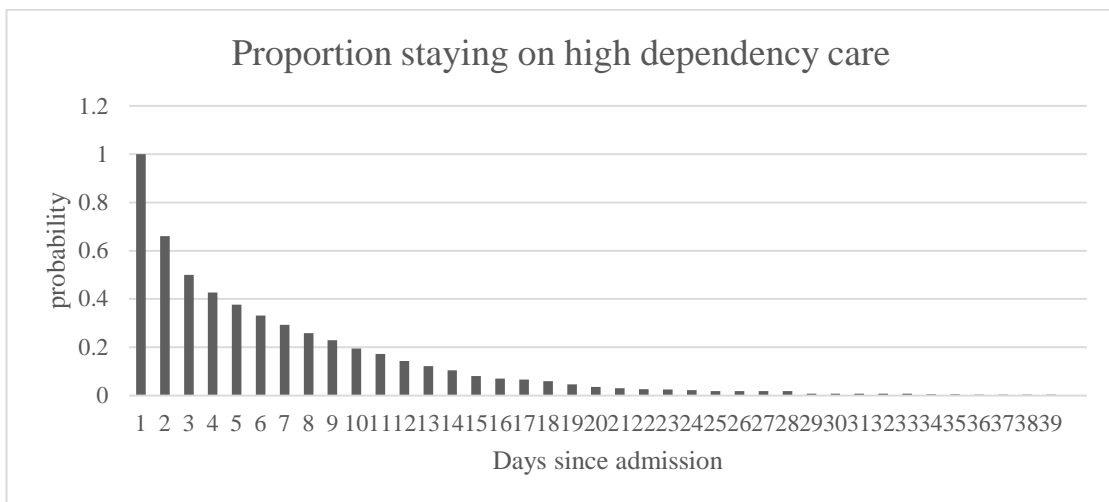

Figure 43 Proportion staying on High dependency care

Figure 43 shows the proportion staying on High dependency, which has a long tail.

A basic preliminary data analysis is described. For 2009, 90 neonatal patients met the inclusion criteria of needing some High dependency care on the neonatal unit.

Table 19 gives the number of high dependency cot days by patient.

High dependency cot days	1	2	3	4	5	6	7	8-82
Number of patients	19	14	6	7	5	4	6	29

Table 19 Number of High dependency cot days by patient

In this sample, the modal number of high dependency cot days was one. 61/90 patients needed 1-7 days of high dependency care. 33 patients had 1-2 days at high dependency and 28 patients 3-7 days at high dependency. 29/90 needed more than 7 days at high dependency care.

The 90 patients had 161 episodes of high dependency care. Of these High dependency patients, 24 (27%) were admitted direct to high dependency care, 39 (43%) initially to intensive care and 27 (30%) first to special care. There were a total of 823 High dependency cot days. The range of gestations treated was 28 weeks +5 days to Term (40 weeks) + 9 weeks +5 days. The range of patient stays at high dependency was 1-39 days continuously and the range of the total number of days at this level was 1-82 days. Thus patients might leave then return to this care level. Further analysis can investigate more thoroughly these returnees.

5.6.3 Special care cots

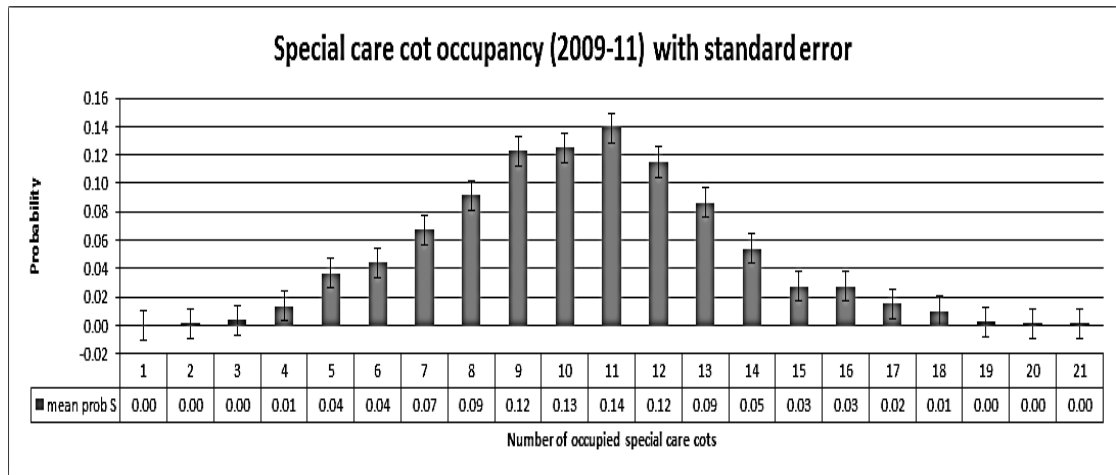

Figure 44 Special care cot occupancy (2009-11) with standard error

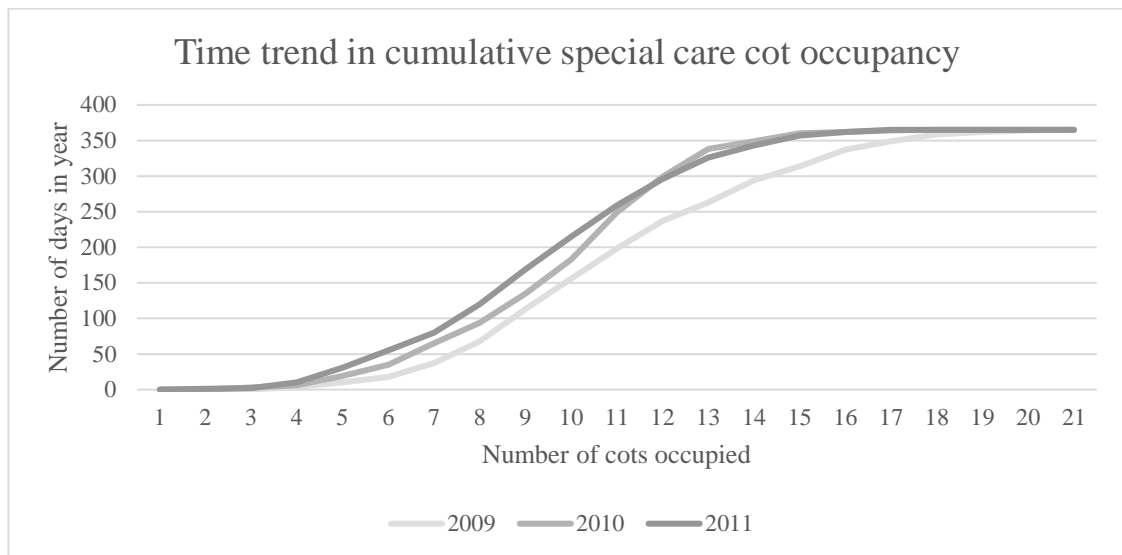

Figure 45 Time trend in cumulative special care cot occupancy

From May 2009, the addition of staff in order to upgrade from special care to local neonatal unit status are likely to have contributed to changes in occupancies and attendant shorter Length of Stay. There is a time trend for earlier discharge and shorter Length of Stay over the time of the study as evidenced from changing occupancies for intensive, high dependency and special care cot occupancy (example Figure 45).

5.6.4 Daily changes in Cot occupancy

Daily changes in cot occupancy (relevant for attendant nursing staff requirements) were investigated. These daily changes in cot occupancy for each level of care were normally distributed with differing standard deviations, as shown from Figure 46:

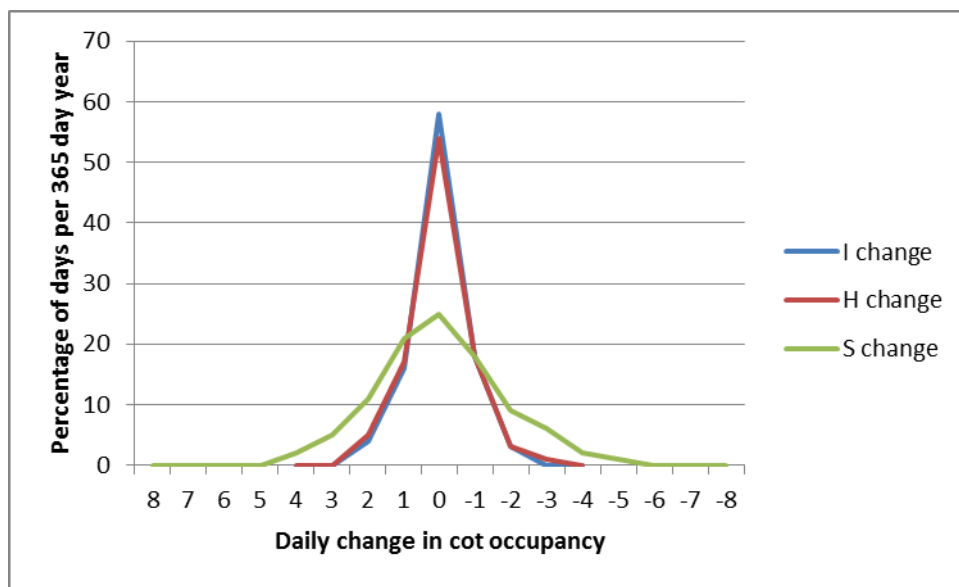

Figure 46 Day to day changes in cot occupancies

We know the past limits of occupancy and how day-on-day levels of cot use change incrementally. For instance the change in high dependency cots has not moved by more than a certain number day on day and the highest number of special care discharges has not exceeded a certain figure. Since 2007 these (oversubscribed) figures have never been exceeded:

Movements	Range
SHome	0 – 4
HS	0 – 2
IH	0 – 1
Admitted to Special Care (Sa)	0 – 3
Admitted to High dependency care (Ha)	0 – 3
Admitted to Intensive care (Ia)	0 – 2
IS	0 / 2

Table 20 Exploratory Data Analysis January 2007

5.6.5 Length of Stay by level of Care

The pattern of Length of Stay from past data is shown. This shows all intensive care and high dependency episodes during 2009-11. For the intensive care data, the peak in number of episodes of 4-5 days arises due to the way in which it is counted at certain extreme gestation.

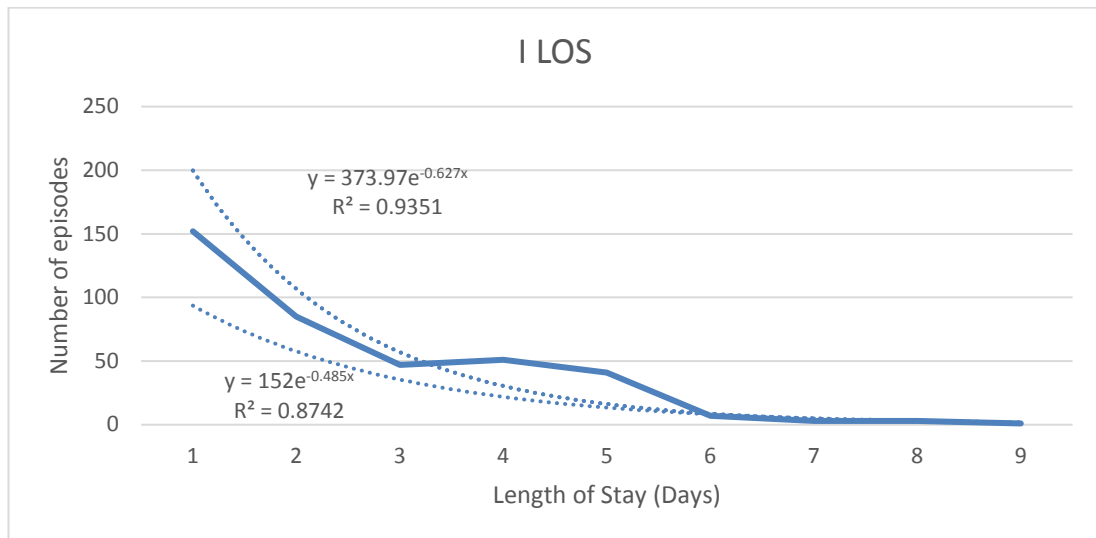

Figure 47 Length of Stay for Intensive Care episodes

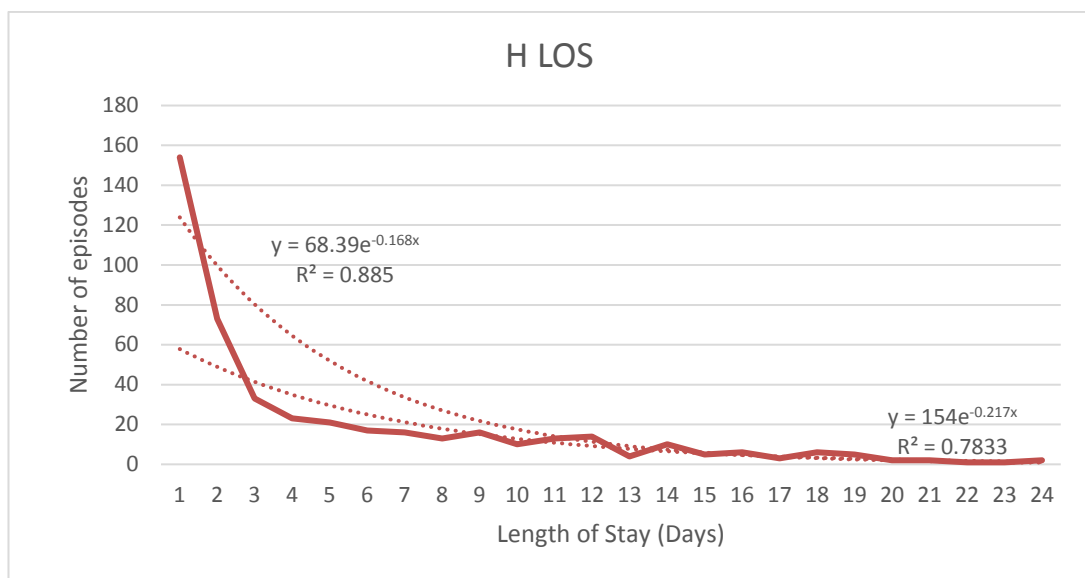

Figure 48 Length of Stay for High Dependency episodes

For the special care episodes, only those requiring high dependency care during 2009-11 are incorporated. The reason for this is to make the counting of the vast number of special care episodes tractable.

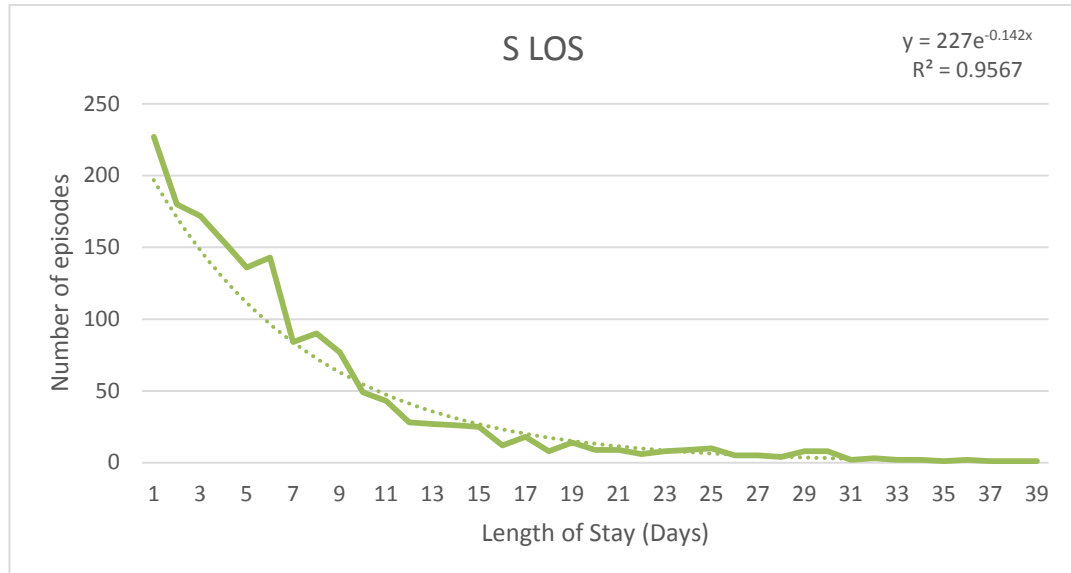

Figure 49 Length of Stay for Special care episodes

Fitted functions have been plotted, truncating data prior to a zero field to enable exponential visualisation. One day LOS are the most common: an intercept has been placed at this figure for each level of care. Only with special care does this match the computer generated fit for the negative exponential.

Intensive care and High dependency Length of Stay data have also been fitted to exponential distributions with the method of @Risk testing (Table 21). The interest in exponential fit lies in examining the possibility of whether there is any justification for modelling in continuous time. It cannot be claimed that it does given the small amount of data.

	Exponential fit		
	mean	K-S	Chi-squared
I	2.69	0.3829	1499
H	5.47	0.1897	1139
S	6.5	not yet calculated	

Table 21 Fit for Length of Stay

In taking a microscopic look at the local neonatal unit, intensive care, high dependency and special care episodes, Lengths of Stay (Table 22) and transitions between these levels of care were determined.

Intensive care, high dependency and special care lengths of stay and cot occupancy			
Length of Stay (Days)	Intensive care	High dependency care	Special care
mean	2.7	5.5	6.5
median	2	3	5
25 th centile	1	1	2
75 th centile	4	8	34
maximum	20	39	52
Total number of days (2009-11)	1071	2508	10508
Total number of episodes	397	458	1620
Inter-arrival time (days)	2.76	2.39	0.68
Cot occupancy	Intensive care	High dependency care	Special care
Mean	0.9	2.1	10.5
median	1	2	10
Inter-quartile range	0-1	1-3	8-12
Maximum	7	8	21
Actual configuration	1	4	12

Table 22 Length of Stay and Cot Occupancy Summary data

5.7 PATIENT TRANSITIONS

5.7.1 Definitions

During their stay, patients change their level of care dependency, which is referred to here as Patient Transitions. Definitions are as follows. Any consecutive in-patient days are called a stay. Within this there may be consecutive days run at a particular level of care we call an episode. Days at the care level and numbers of patients are also counted. Some simple statistical indices indicate how the data is spread. I_a , H_a and S_a are patients arriving at the respective level of care. Patient Transitions are represented by the initial of the origin followed by the destination care level, i.e. IH moves from intensive care to high dependency.

5.7.2 Chart of Transitions

There are many day to day Patient Transitions as shown in Table 23:

Day to day Patient transitions 2009-11 N=7071		To			
		Intensive care I	High Dependency H	Special care S	Transfer out to
From	Intensive care I	II 0.735	IH 0.156	IS 0.061	Ito 0.048
	High Dependency H	HI 0.009	HH 0.827	HS 0.155	Hto 0.009
	Special care S	SI 0.004	SH 0.057	SS 0.887	Home 0.052
	Transfer in a = arrival	Ia 0.444	Ha 0.303	Sa 0.253	-

Table 23 Probability of patient transitions in the local neonatal unit

The significance of Table 23 is that it is the fundamental matrix for Markov Chain Modelling, which helps conceptualise dynamics into the system. This is taken forward in the Dynamic Modelling Chapter 7.

The 2009 data is shown in the Markov Chart, Figure 50. This combined data for 2009-11 is shown in the Stayer-Mover chart, Figure 51.

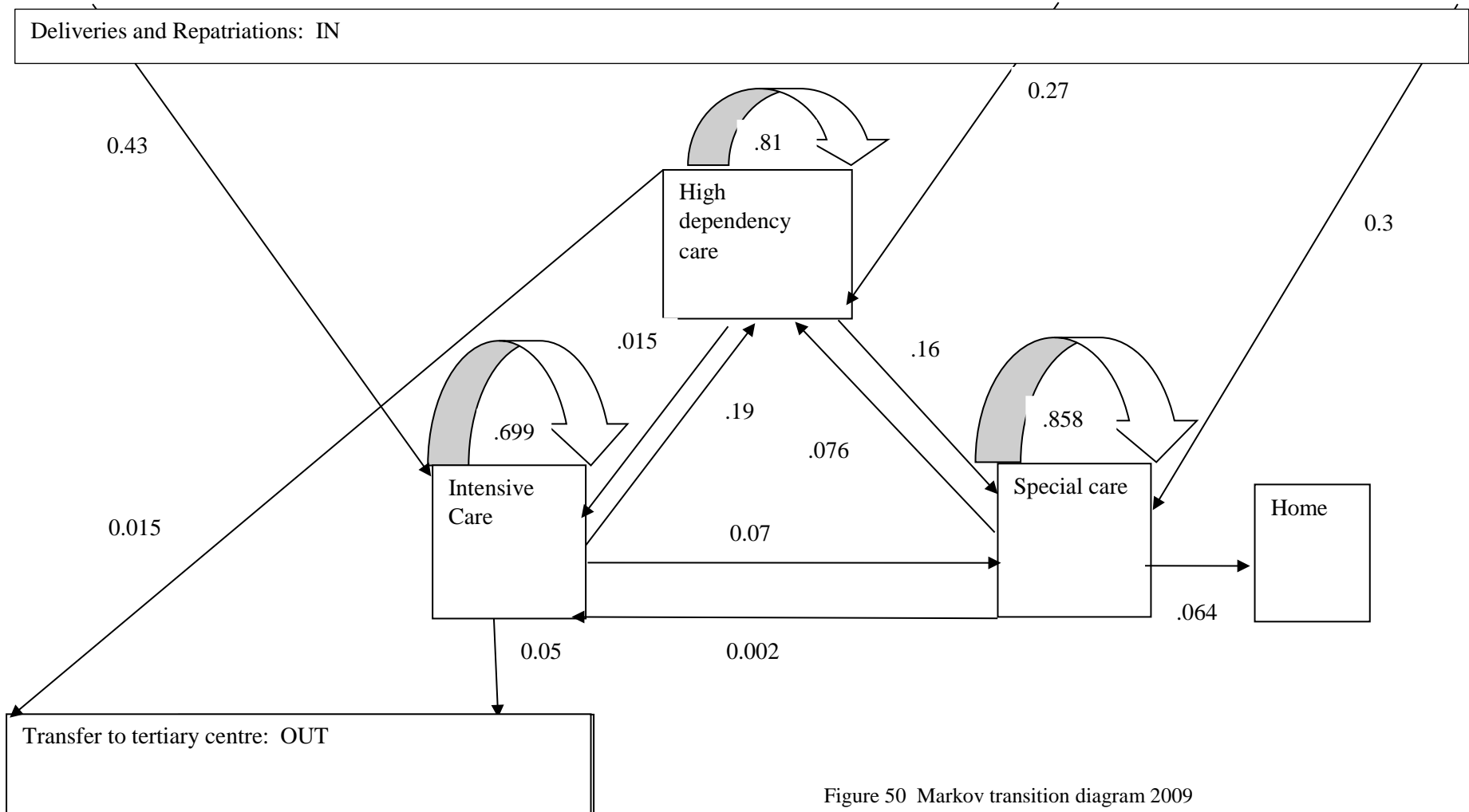

Figure 50 Markov transition diagram 2009

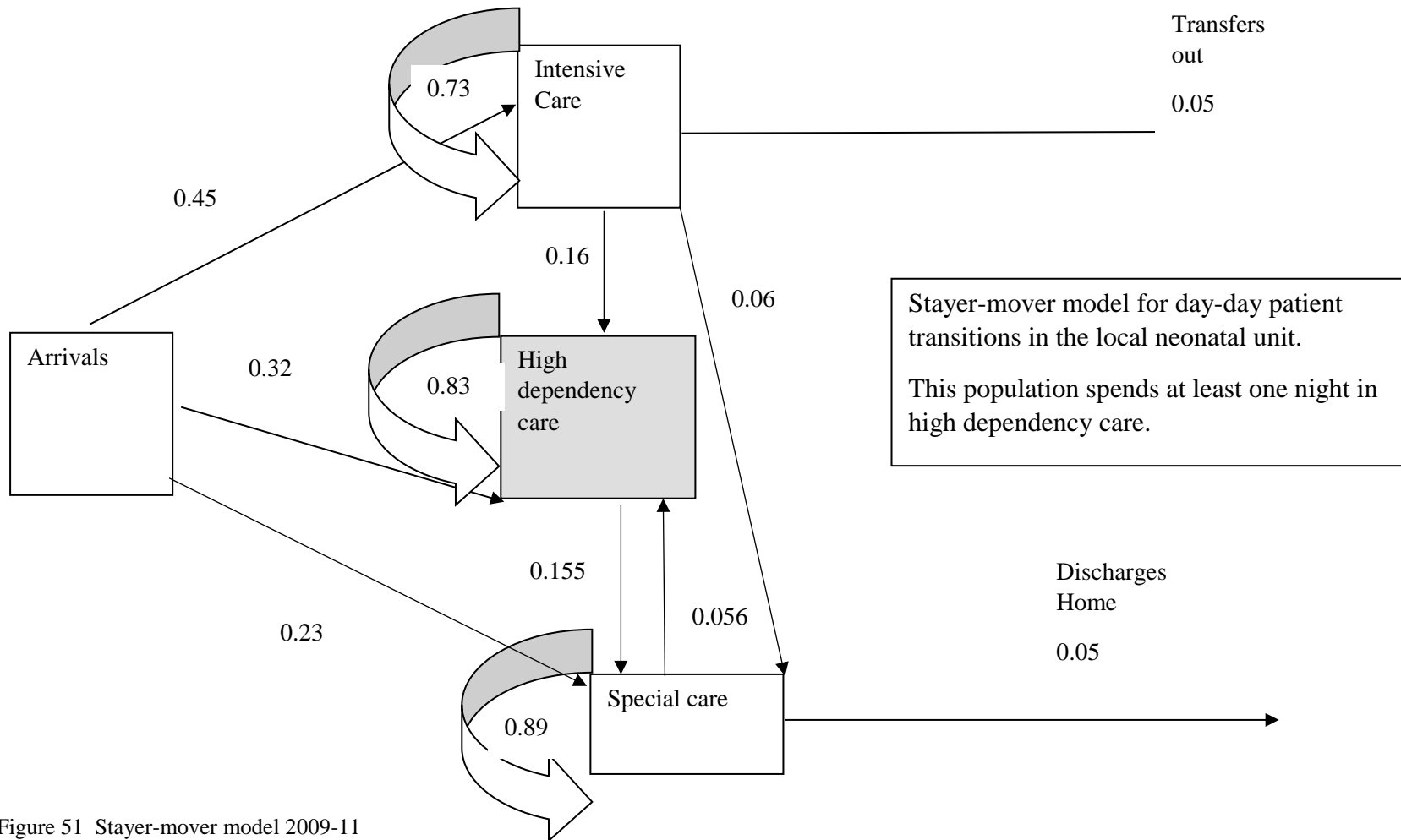

Figure 51 Stayer-mover model 2009-11

Important patient transitions are now discussed in detail, namely for High dependency care: arrivals direct, stayers and arrivals from intensive care and special care. The purpose of this explorative analysis is to lay the foundation for the Cot Predictor Tool in the next chapter.

Graphs show the Length of Stay profiles on high dependency care and for those destined for high dependency care and arriving there from intensive care or special care. For day of stay, the probability of a patient moving can be shown. Curve-fitting has produced equations and calculation has been used to generate the probabilities in these models.

5.7.3 Arrivals to High Dependency care

Arrivals direct to High dependency care are stochastic and a linear rate per day is assumed over the short timescale in the small system for the sake of simplicity. There were 84 in the three years 2009-11, giving a probability per day of 0.077. The equation for H_a is $y=0.077t$.

t	1	2	3	4	5	6	7 Days
H_a	0.077	0.154	0.231	0.308	0.385	0.462	0.539 $y=0.077t$

Table 24 Cumulative direct Arrivals to High dependency

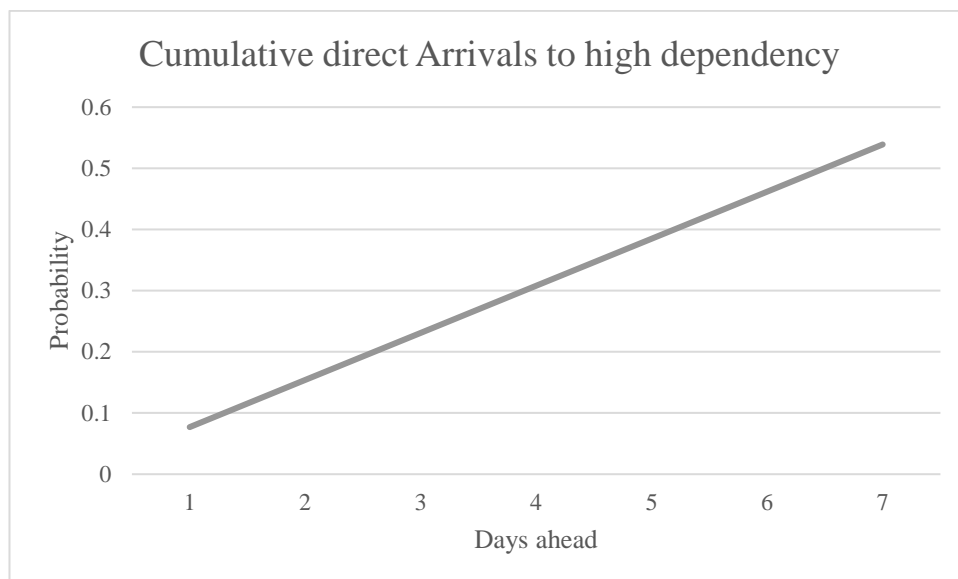

Figure 52 Linear model for direct Arrivals to High dependency

5.7.4 High Dependency care stayers

Days	H stay 2009-11	2011	2010	2009
mean	5.5	5.62	5.7	5.13
median	2	2	2	2
75 th centile	8	8	9	7
95 th centile	18	19	16	18
99 th centile	28	28	28	28
mode	1	1	1	1

Table 25 Duration of Stay on High Dependency

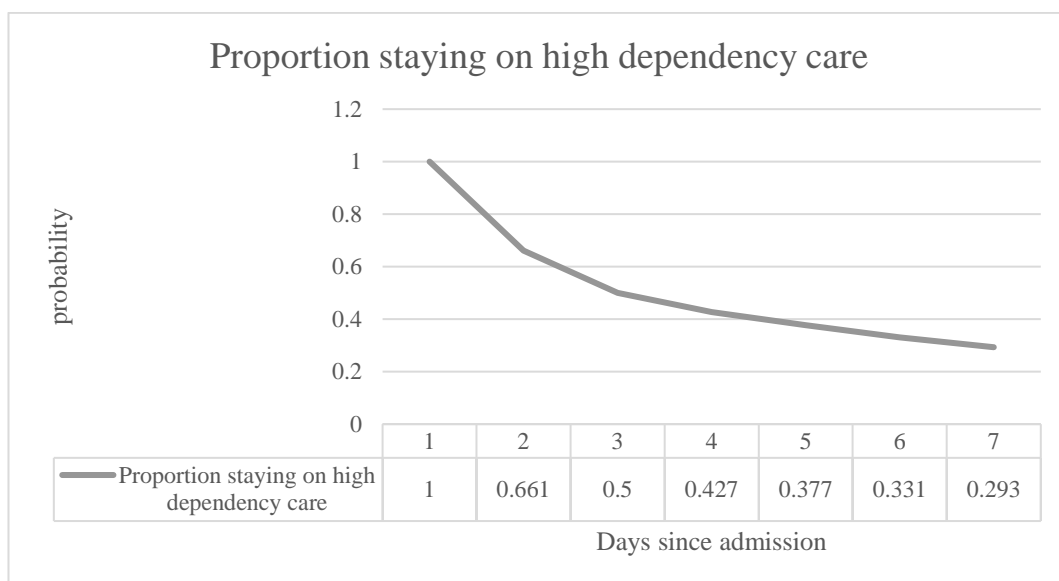

Figure 53 Proportion staying on High dependency truncated

Figure 53 is truncated since the modelling is aimed over a tactical time horizon. The full data with its long tail is seen in Figure 54.

The next type of graph, Figure 55 giving the probability of leaving high dependency care based on an individual's elapsed Length of Stay there, might prove useful for individual forecasts.

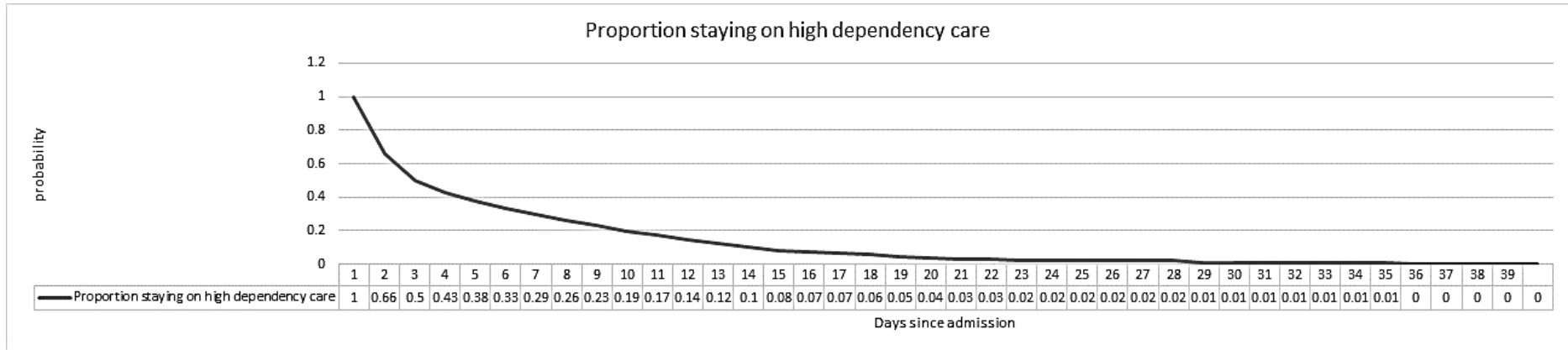

Figure 54 Proportion staying on High dependency in full

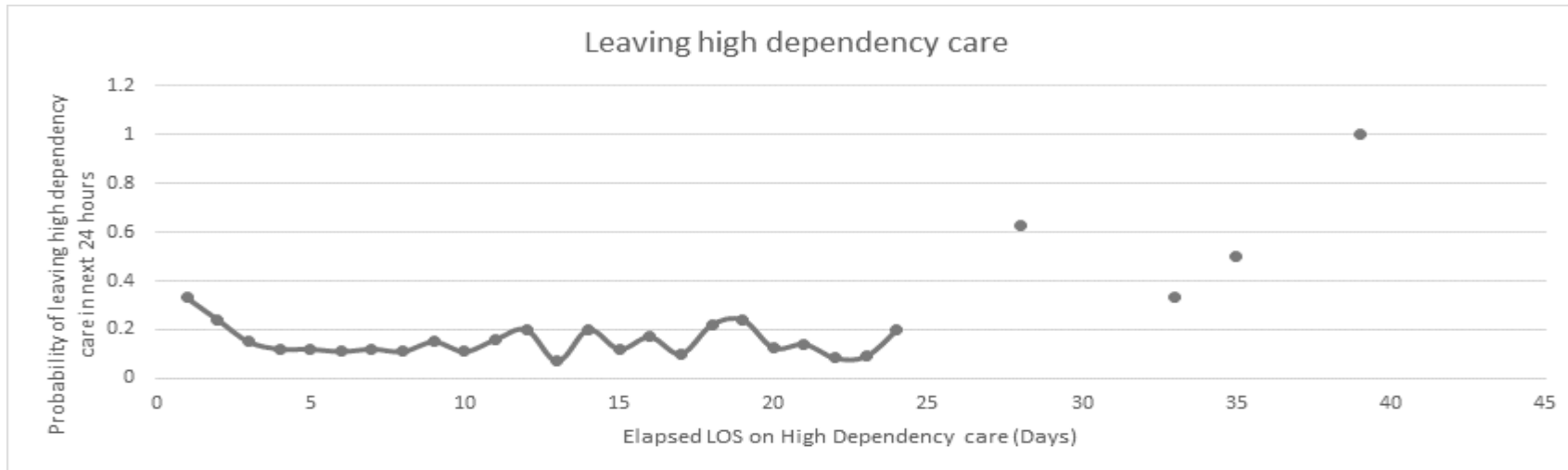

Figure 55 Probability of leaving High dependency by elapsed LOS

When a patient changes their level of care, the time at which they first moved to and from High dependency care and the chances of this given their elapsed days' stay were calculated (Harrison 2012).

5.7.5 Intensive care to High dependency transitions

The influence of intensive care on high dependency care is assessed:

Day after birth	2	3	4	5	7	12	13	15
Patient number	1	6	3	15	1	1	1	1

Table 26 First move from intensive care to High dependency care by day of birth 2009

Table 26 shows that for this group, 25/29 (96%) had made the transition from intensive care to High dependency care by Day 5 of life.

118 patients during 2009-11 were first admitted to intensive care prior to requiring High dependency care: the probability per day of this event was 0.108.

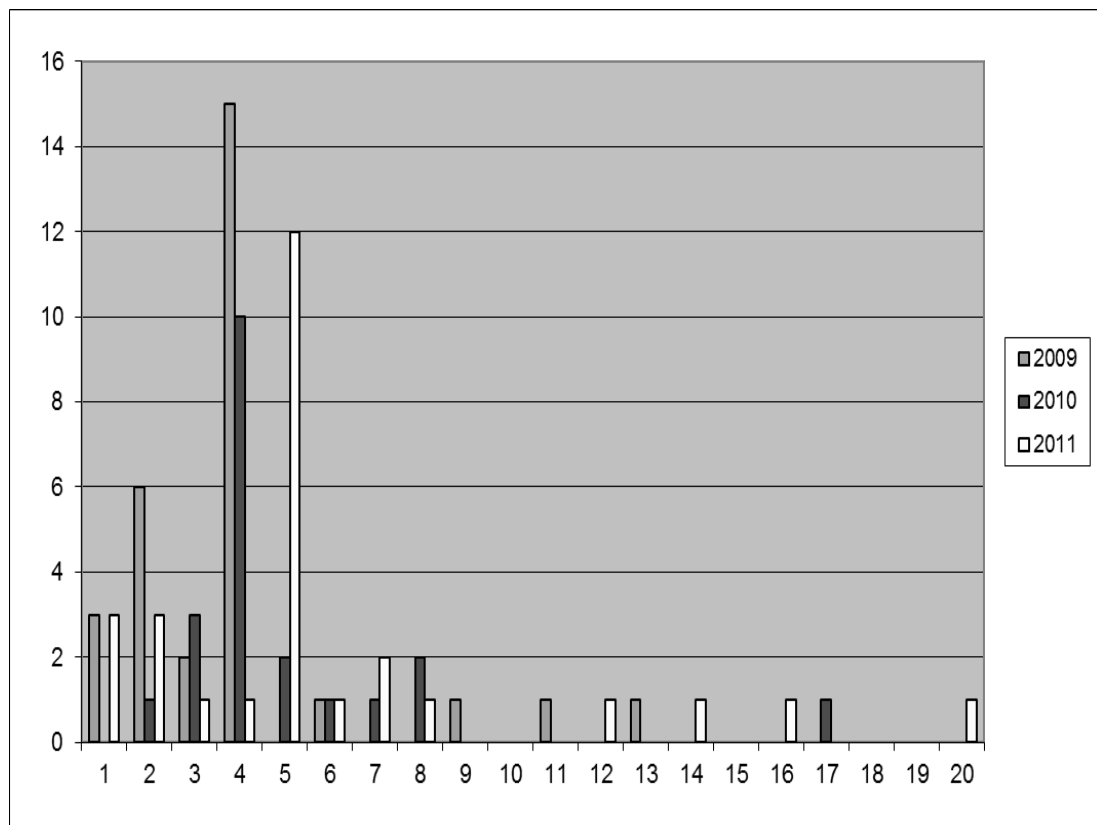

Figure 56 Day of First transition from intensive care to High dependency care 2009-11

The jump in the data at 4/5 days is likely to be due to the anomalous way in which the data is created. Neonates on non-invasive respiratory support (CPAP) below five days of age are classed as receiving intensive care. The pattern of this histogram is shown in the line chart below:

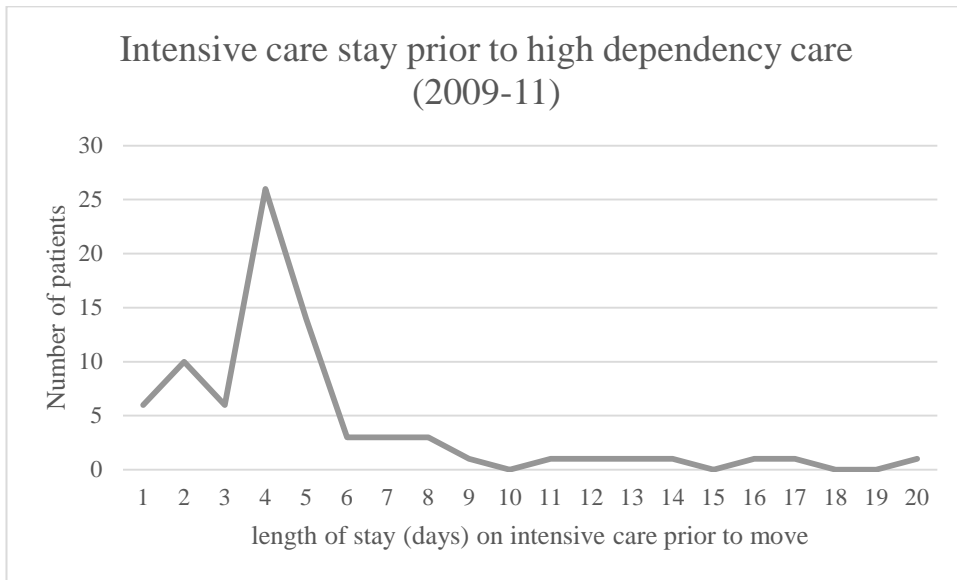

Figure 57 Line diagram of intensive care stay prior to high dependency

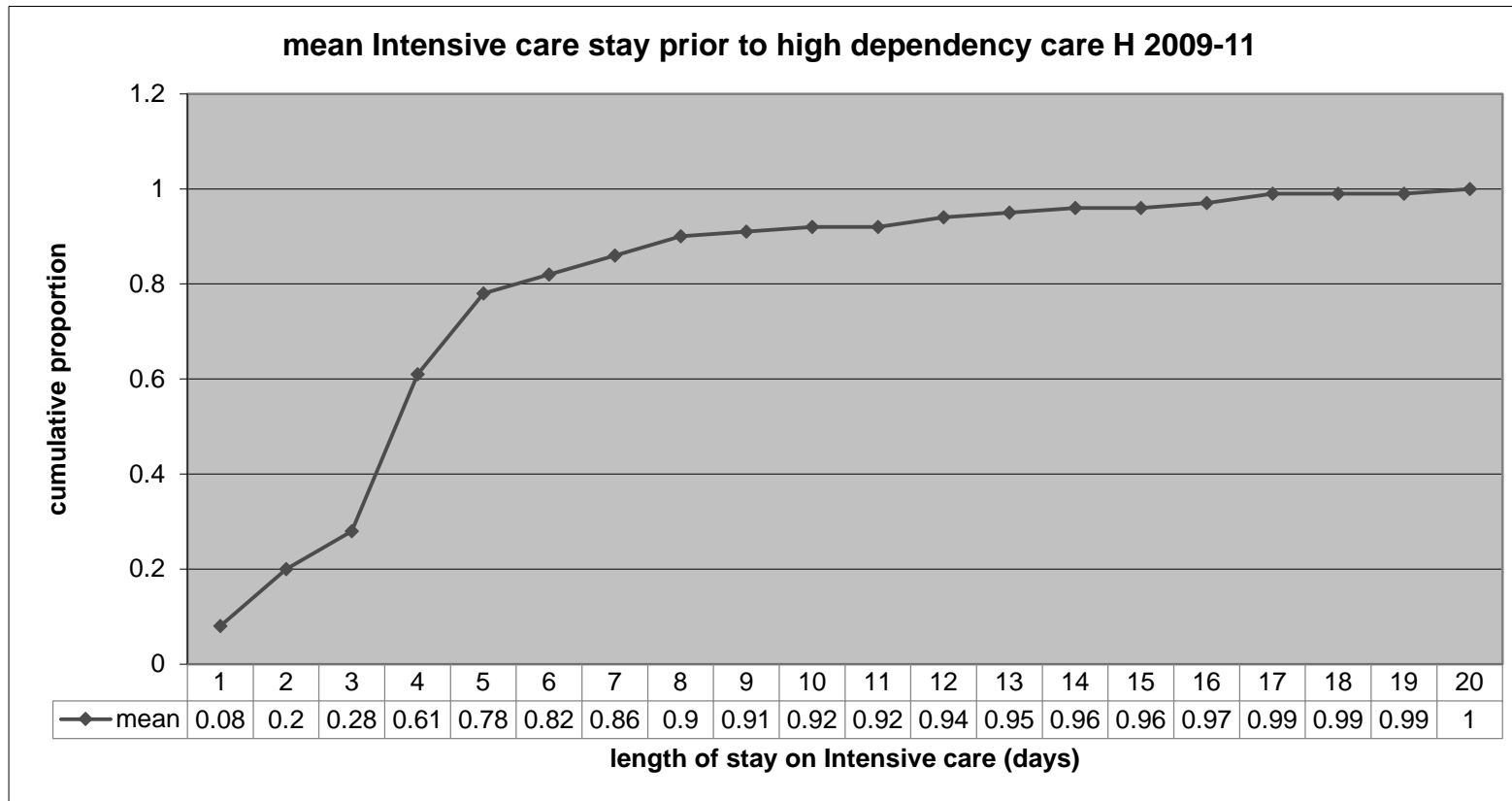

Figure 58 Intensive care prior to high dependency 2009-11 – cumulative probability

The cumulative proportion of this population moving from intensive care to High dependency care over time is shown in Figure 58 above.

This curve is not amenable to modelling so use of empiric data is appropriate.

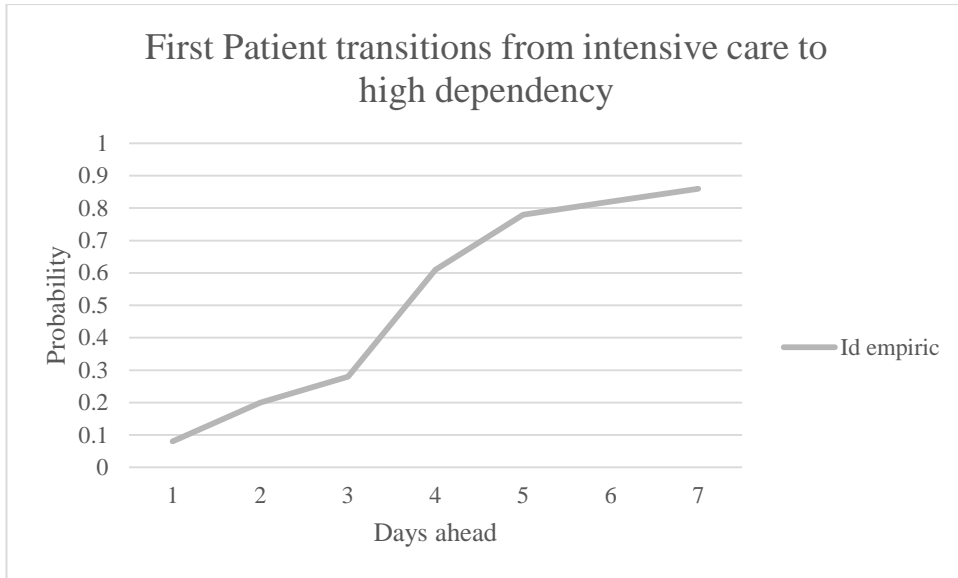

Figure 59 Model of first patient transitions from intensive care to High dependency

The truncated chart above, Figure 59 shows the position over a tactical time horizon. The data is expressed in a different manner below in Figure 60:

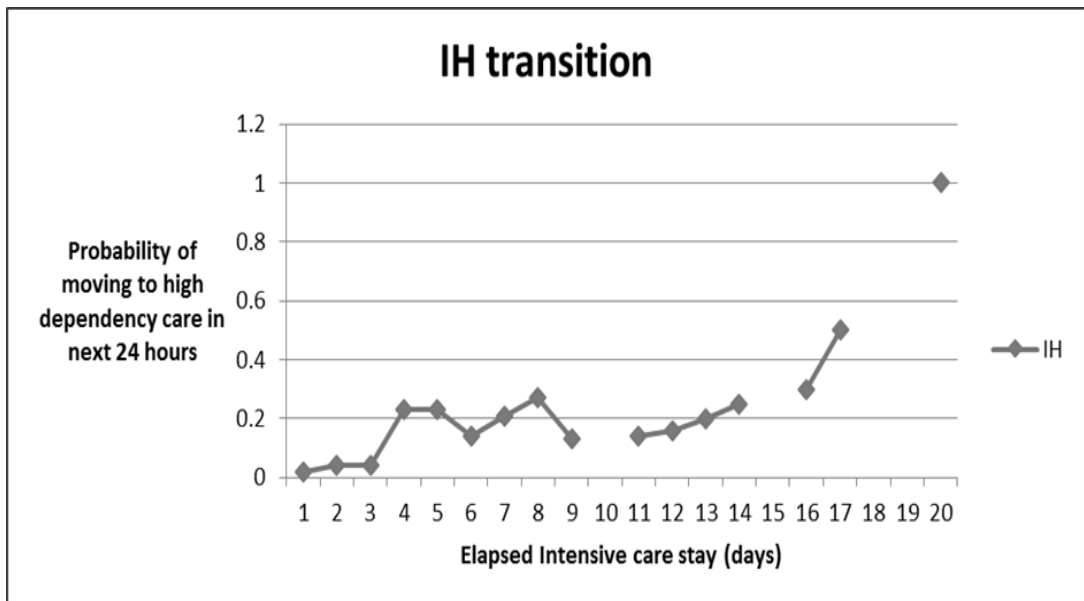

Figure 60 Probability of move to High Dependency by elapsed LOS at intensive care

Figure 110 in the Appendix shows the situation for the next five days.

5.7.6 Special care to high dependency care transitions

In regard of the group of patients who needed High dependency care after having been admitted at special care level, 18/20 (90%) had needed it by Day 2-6 after admission to the neonatal unit. This exploratory analysis is shown in Table 27.

Day after admission	2	3	4	5	6	15	17
Number of patients	8	4	1	3	2	1	1

Table 27 First move from special to High dependency care by day after admission 2009

It should be pointed out that most patients on a local neonatal unit are receiving special care and do not need High dependency.

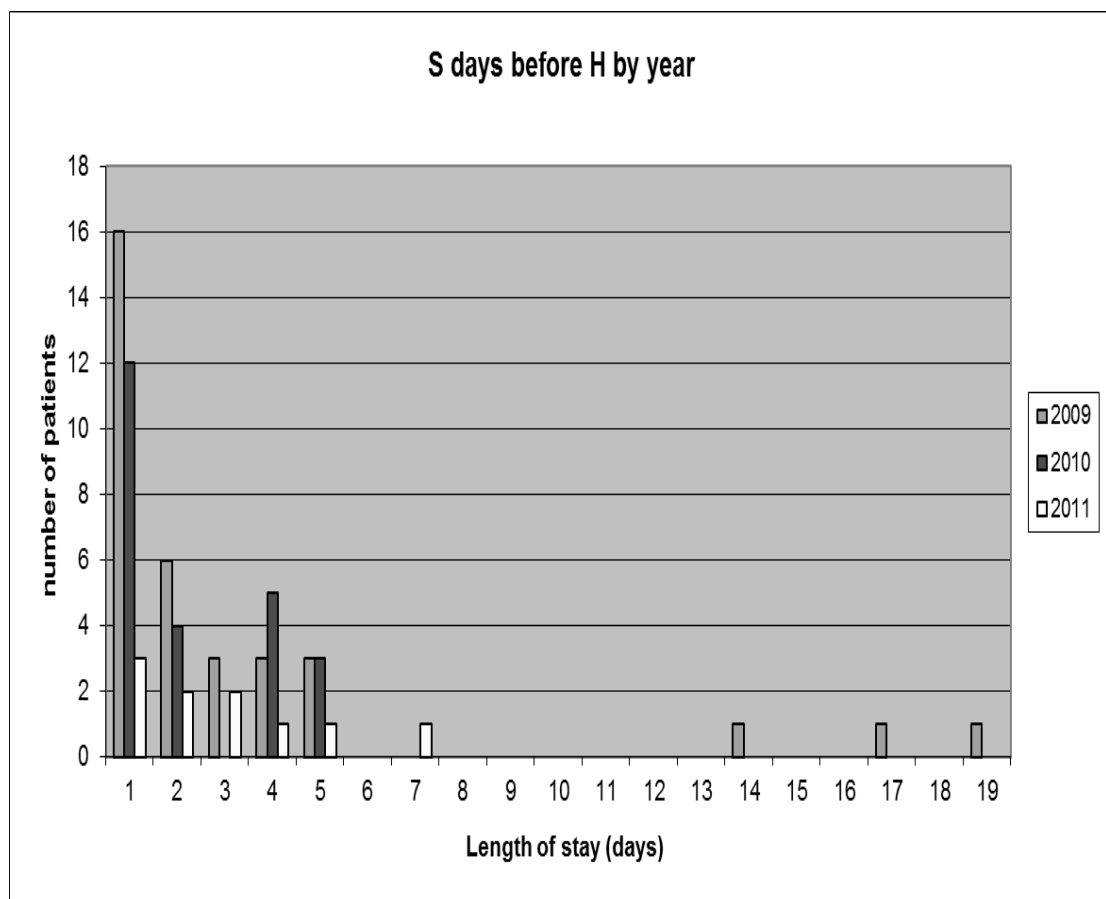

Figure 61 Length of stay at special care prior to first move to High dependency 2009-11

57 patients during 2009-11 were first admitted to special care but later required High dependency care, producing a probability for that group of 0.052 per day. The position is outlined in the line chart:

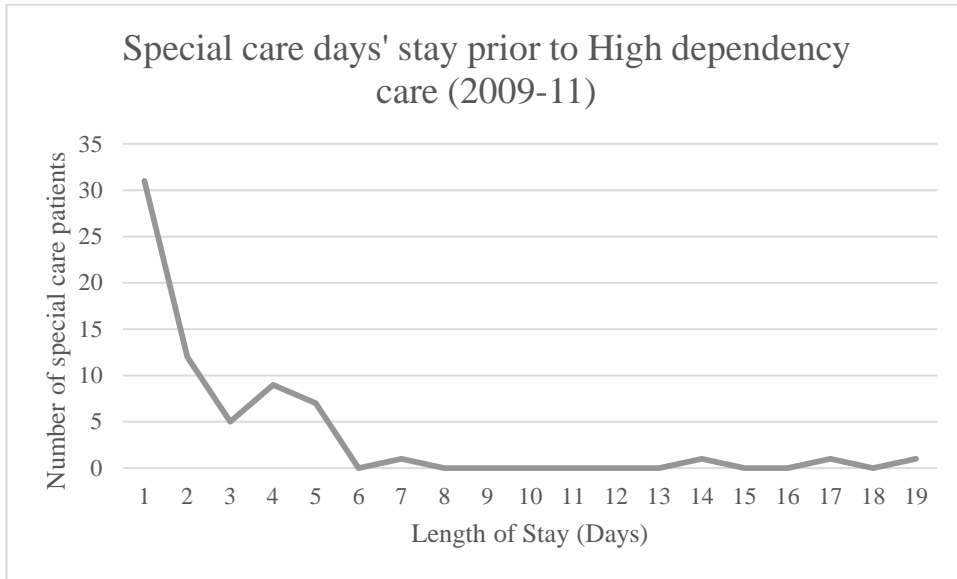

Figure 62 Line diagram of special care LOS prior to first move to High dependency

The cumulative proportion of this population moving from special care to High dependency care over time is shown in Figure 63 below:

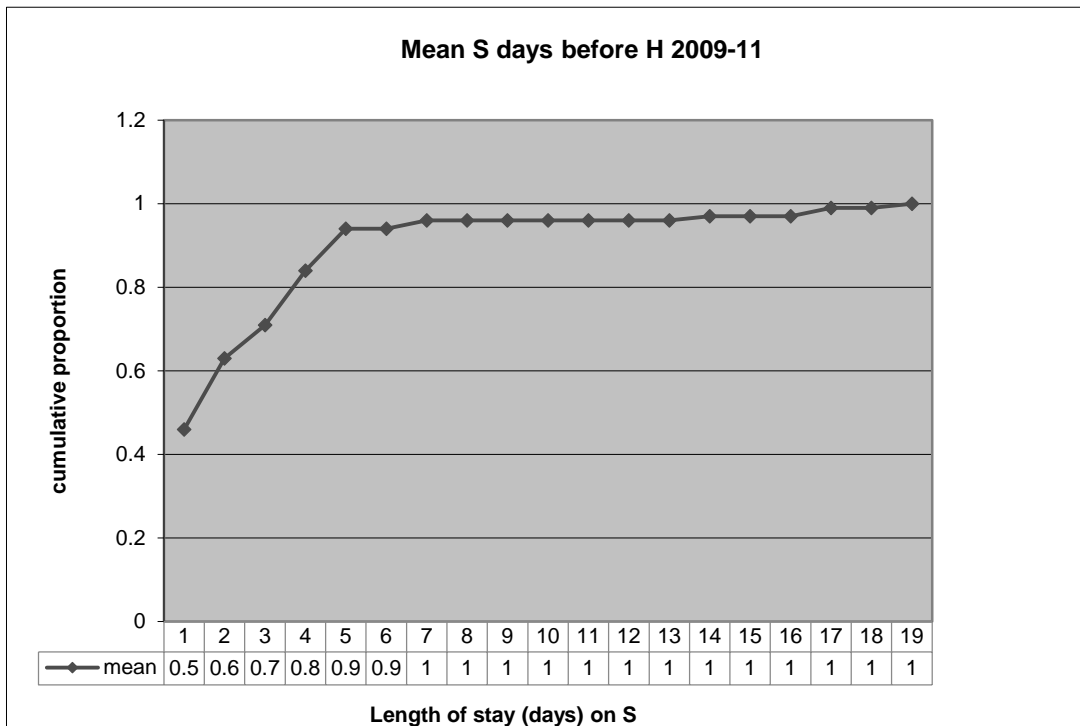

Figure 63 Special care stay prior to High dependency 2009-11 – cumulative probability

Figure 64 shows how the first five days may fit a linear model:

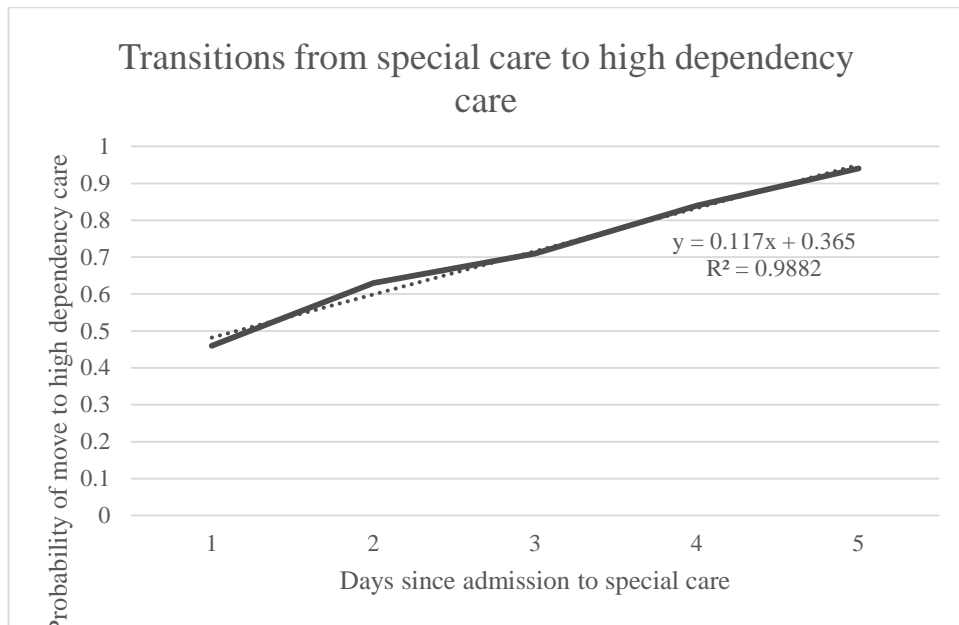

Figure 64 Model of Transitions from special care to High dependency

So the equation for S_d is $y = 0.052(0.117t + 0.365)$ for the individual for the range of Days since admission of 1-5. That just four individuals in three years were admitted at special care level and then required high dependency care after this time is one pragmatic justification for not modelling this aspect further.

Now Figure 65 below shows the detail of that group moving from in-house special care to High dependency care for which the absolute numbers are small. Days ahead represents the time intervening from unit admission at special care to the backwards step of High dependency care.

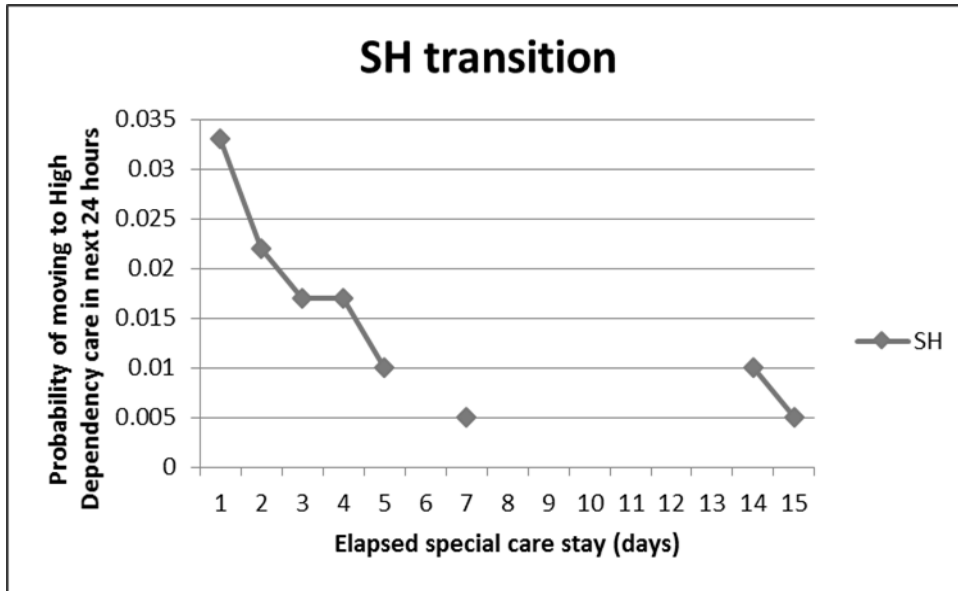

Figure 65 Special care to High dependency move by elapsed LOS

The situation for this move in the next five days is shown in Figure 111 in the Appendix. Data on Length of Stay both at High dependency care and in those admitted to intensive care and special care prior to their first move to high dependency care are summarised for years 2009-11 in Table 28:

Days	Hstay	IH	SH
Mean	5.5	4.7	2.9
Median	2	4	2
75 th centile	8	5	4
95 th centile	18	14	7
99 th centile	28	20	19
mode	1	4	1

Table 28 Length of Stay and First Move Summary data

N = 269

This Analysis lays the foundation for the Cot Predictor Tool discussed in the next Chapter.

5.8 MEDICAL ANALYTICS

5.8.1 Length of Stay by Diagnostic Patient Group

Now need for High dependency care arises for example because of non-invasive respiratory support, intravenous feeding and observation for Neonatal Abstinence Syndrome. Furthermore Corrected Gestation during the care episode offers some information on the likely reason for the High dependency care: for instance prematurity is a cause of Respiratory Distress Syndrome and subsequently a risk factor for Necrotizing Entero-Colitis, which itself necessitates long line feeding, a High dependency procedure.

Diagnosis determines for how long the patient may need the cot. Figure 66 shows LOS curves by Diagnosis. This addresses issues of individual Patient Progression given medical presentation (Conceptual Framework Model 4).

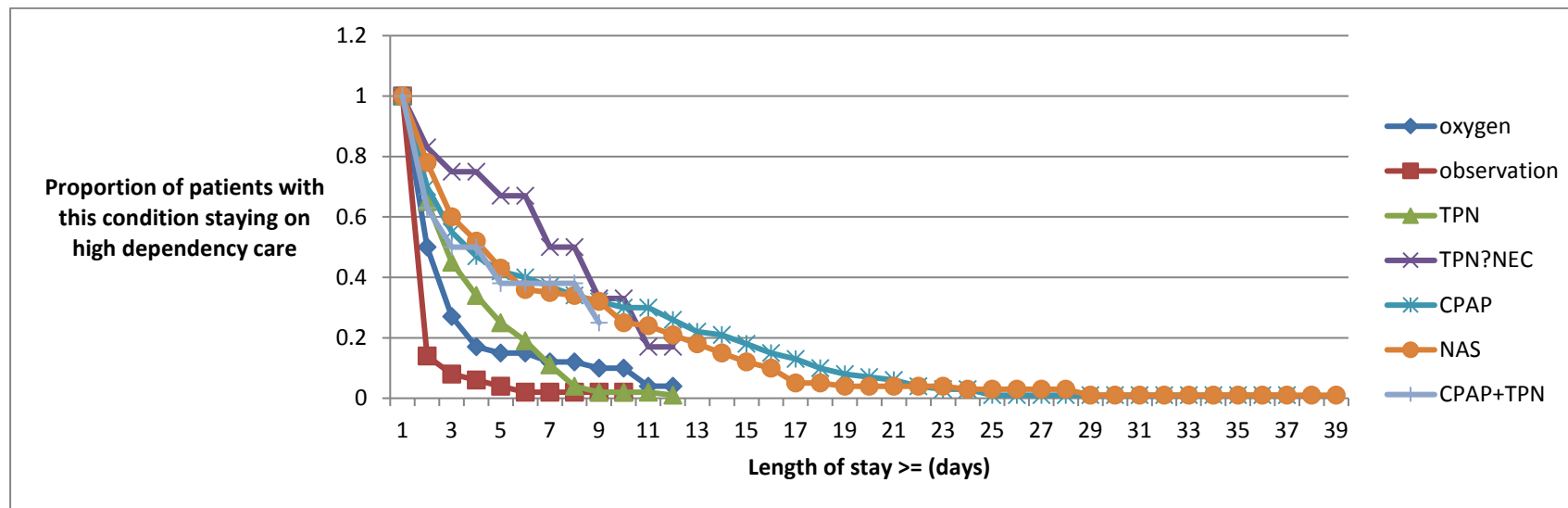

Figure 66 Length of Stay at High dependency by medical condition

Abbreviations used: TPN (total parenteral nutrition, i.e. intravenous feeding), NEC (necrotizing enterocolitis), NAS (Neonatal Abstinence Syndrome, i.e. drug withdrawal), CPAP (Continuous Positive Airways Pressure, i.e. non-invasive respiratory support)

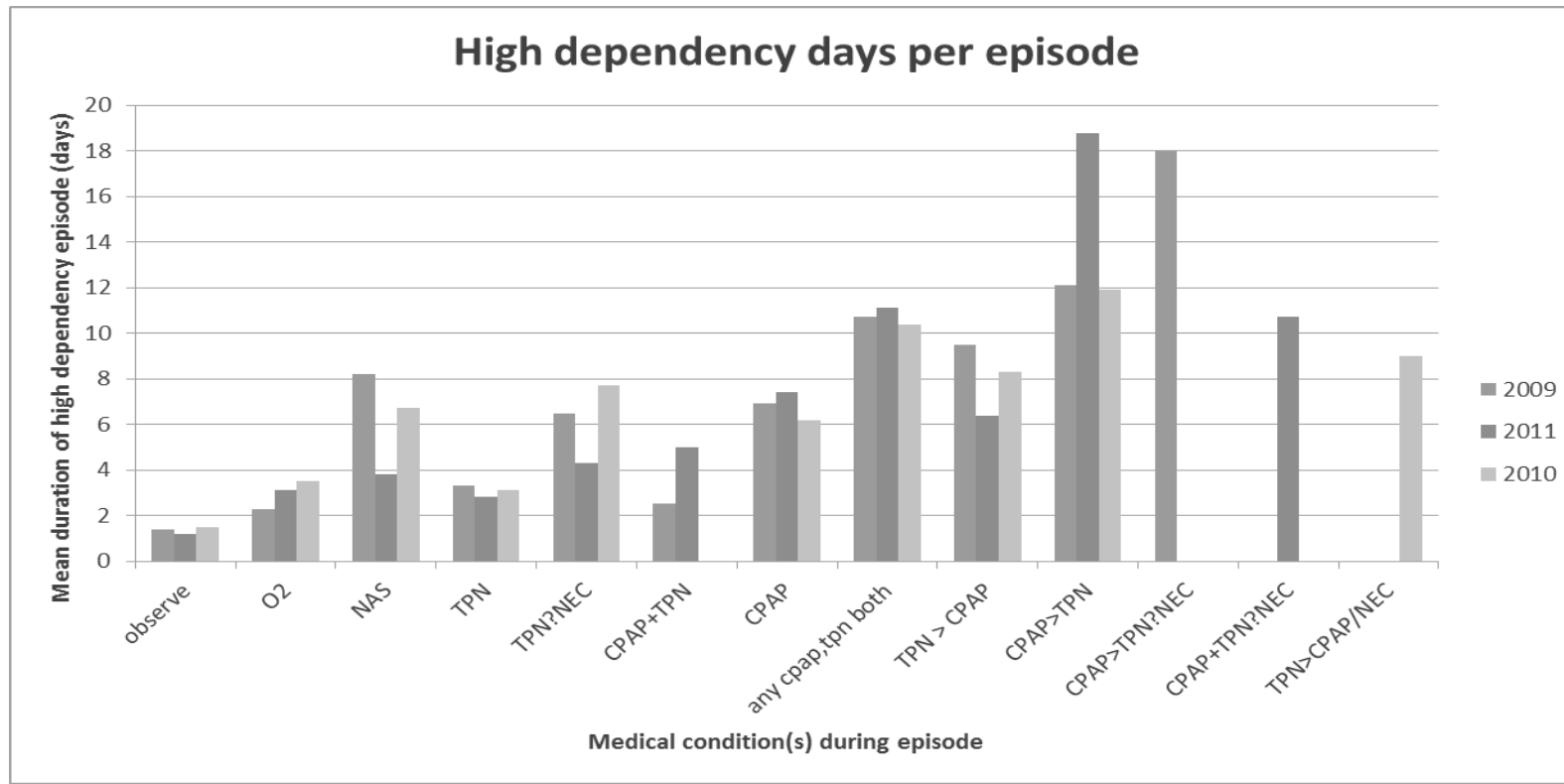

Figure 67 High dependency days per episode by condition and year

The mean duration of the High dependency episode is broken down by diagnostic group in the above graph.

NEC always adds days. NAS averages more days than TPN only.

CPAP only is longer than with TPN for all days of an episode: one possible explanation might be under-nutrition.

A mixture of CPAP and TPN produces the longest lengths of stay. One problem is of overlapping categories between CPAP and TPN. Another is the difficulty of retrospective assessment of textual clinical information.

Backward steps in Patient Pathways and their associations. Iterative High dependency episodes.

Patients with particular conditions suffered exacerbations leading to steps backward in their dependency as shown in Figure 68.

With Neonatal Abstinence Syndrome (NAS), there are 1-2 return episodes of high dependency care per patient. For non-invasive respiratory support with CPAP, about half of patients had a return episode of high dependency care.

NAS and CPAP may be regarded as relapsing conditions. They involve weaning of support, which may be: 1 step forwards, 2 steps back.

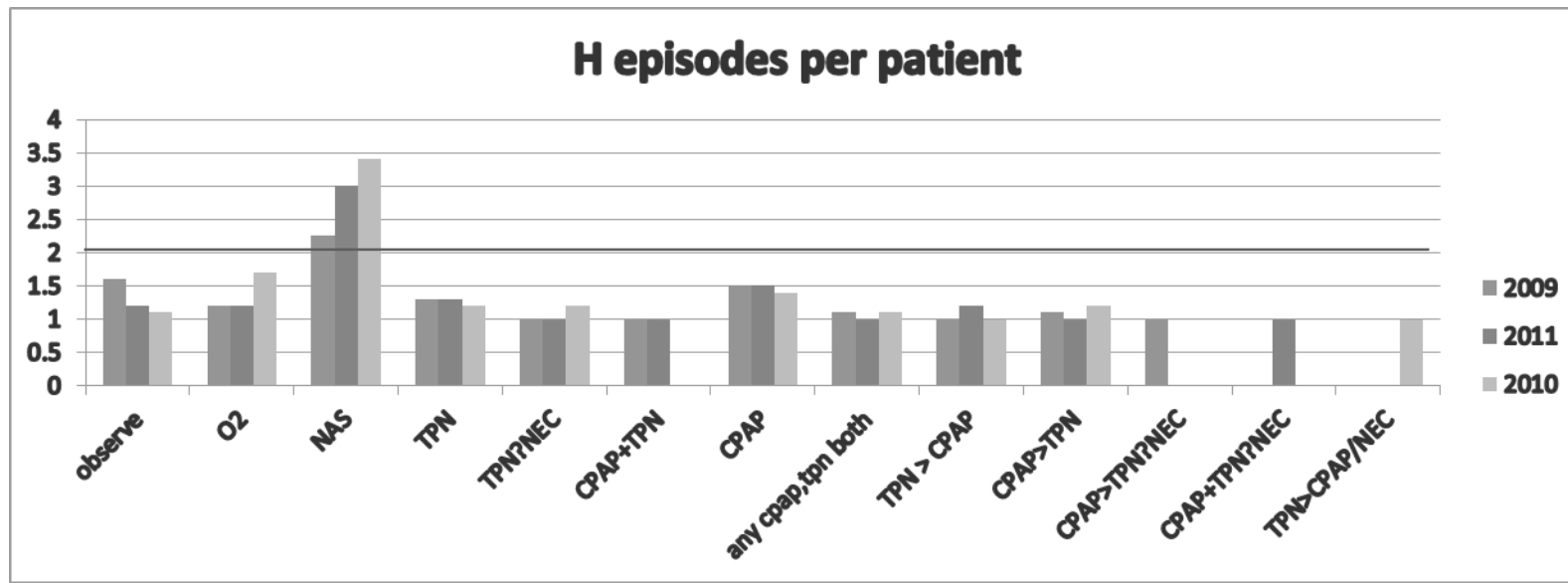

Figure 68 Average number of High dependency episodes by year and medical condition

Table 29 shows the principal diagnosis at High dependency care. The commonest are respiratory conditions (Resp.). Neonatal Abstinence syndrome (NAS) refers to withdrawal symptoms the neonate might face due to maternal drugs. Necrotising enterocolitis (NEC) is a gut condition where treatment entails gut rest from milk and intravenous nutrition. A multiple (multi) delivery could be a twin or a triplet (and so likely to be earlier and smaller). Congenital abnormalities may require High dependency care.

High dependency care diagnosis	Resp alone	Resp + possible NEC	Possible necrotising enterocolitis only	NAS	multi	Cong. abnorm	misc
Number of patients	32	16	2	10	6	4	18

Table 29 Principal diagnosis at High dependency care 2009

Figures 66-8 show how medical diagnosis associates Length of Stay and number of returns to a particular level of care. For instance non-invasive respiratory support (CPAP) for Chronic Lung Disease and treatment of Neonatal Abstinence Syndrome (NAS) produce the longest Lengths of Stay at High dependency care (Figure 69) (Dalton and Chaussalet 2011). In Figure 70, Lengths of Stay for other treatments like Total Parenteral Nutrition (TPN) (for gut conditions such as Necrotising Enterocolitis (NEC)) and combinations thereof are also shown. Such knowledge assists predictive modelling of Capacity.

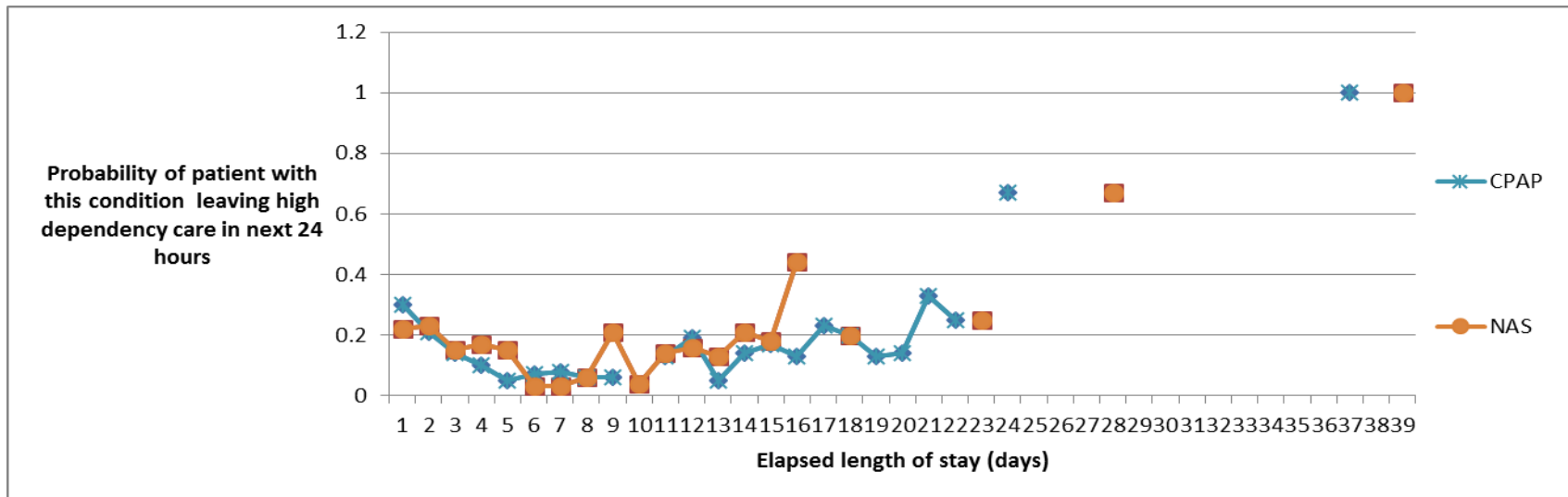

Figure 69 Probability of leaving High dependency by elapsed LOS – long stayers

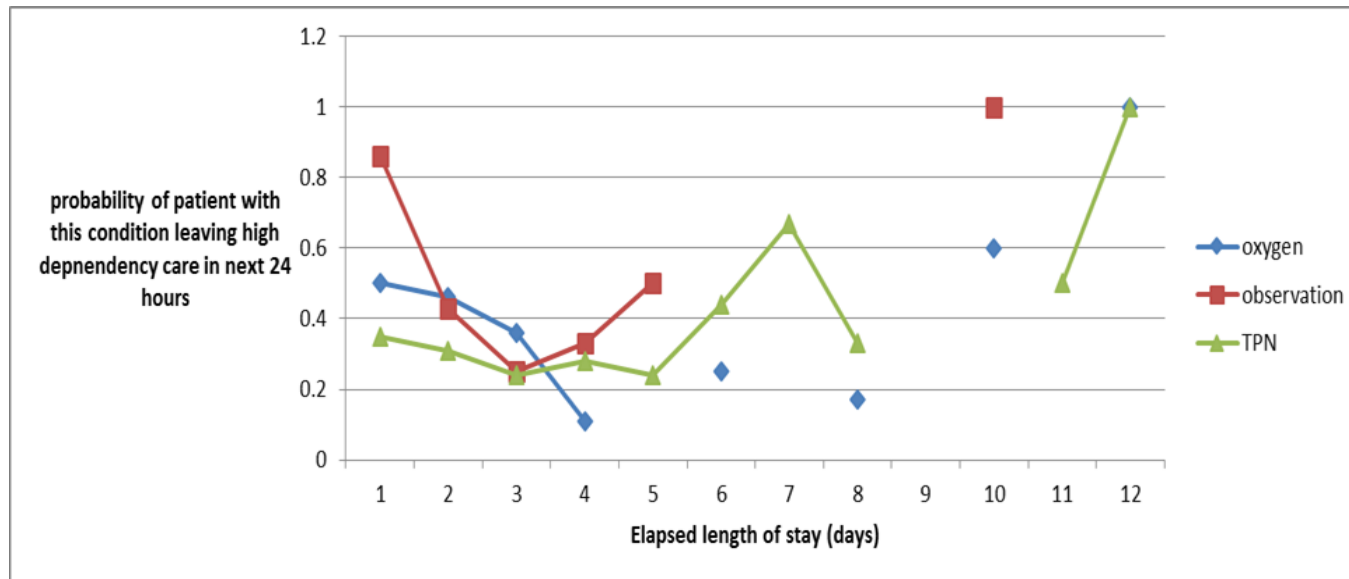

Figure 70 Probability of leaving High dependency by elapsed LOS - other

Unfortunately the amount of data is small.

5.8.2 Plurality, Birthweight and Social Conditions

The relationship between duration of stay at High dependency and diagnosis is assessed. Medical conditions especially focussed on were Neonatal Abstinence Syndrome (NAS), birth-weight < 0.2nd centile and plurality (twins or triplets). Birth-weight and plurality do not seem to have an appreciable effect on Length of Stay in this particular population. 1 in 9 admissions are a multiple and this has implications for simultaneous Demand for resources i.e. nurses and equipment, which batches work and so stresses the system. The effect of IVF cannot be underestimated in bringing multiples to a neonatal unit.

5.8.3 Long-stayers

Medical diagnosis is not only a determinant of Length of Stay but also whether iterative transitions between levels of care levels occur. Those with Neonatal Abstinence Syndrome (drug withdrawal) having Social Care needs and usually born at Term, cycle two or three times through the system and have among the longest Lengths of Stay. In practice long stays at High dependency for NAS were caused by treatment of withdrawal symptoms and those at special care by retarded Social Care and court processes.

In 2009, of those needing more than 6 contiguous days at High dependency care after 40 weeks Corrected Gestation, 5/6 had a diagnosis of Neonatal Abstinence Syndrome. Thus drug addiction is responsible for much work on the High dependency unit of this neonatal unit at that time.

NAS 2009-11 Days.

NAS	All days	H episod	H days
mean	23.93548	2.774194	16.83871
median	23	2	16
sum	742	86	522
patients	31		
mean days per H episode			6.1

Table 30 Neonatal Abstinence Syndrome Days 2009-11

Table 30 shows how 31 patients had 742 days' stay, 522 of these days were at High dependency care, at which there were 86 episodes. The summary statistics are provided: the average number of days for each High dependency episode attributable to Neonatal Abstinence Syndrome was just over six days.

Of course prolonged Lengths of Stay at High dependency care (and indeed special care) on the neonatal unit were also associated with the diagnosis of Chronic Lung Disease. The position is shown in Section 5.8.1 Figure 69. More data would be useful.

5.8.4 Effect of Corrected Gestation on Patient Transitions

Now the influence of Corrected Gestation on the timing of transitions between levels of care is relevant: see Table 31 below.

Corrected Gestational Age (weeks in the range 27 – 37 weeks) for the Patient Transition event: i) Most likely ii) and shown below lower bound, if different						
		to				
	transition	Intensive care	High dependency care	Special care	Transfer out	Home
from	Delivery	28	29	35 (>32)		
	Intensive care	30 (>27)	31 (>28)	33 (>31)	27	
	High dependency care	31 (>29)	30–32 (>29)	37 (>29)	29	
	Special care		29	34–35 (>29)	31	36–37 (>34)

Table 31 Corrected Gestational Age (weeks) at Transition in care level

All those below 28+5 weeks corrected gestation were intensive care babies. All those below 29+5 weeks corrected gestation had been ventilated. For those with an admission birth-weight centile for gestation below the second, the earliest corrected gestation of discharge was 37+3 weeks.

Detailed breakdown of the probability of the particular Patient Transition event by corrected gestational age in weeks is shown in Table 32. This Table is restricted to those neonates with a corrected gestation up to and including 37 weeks +6 days. That data 38weeks to Term + 3 months is large and denominators harder to determine. Thus it tends to exclude that group with Neonatal Abstinence Syndrome, who are normally term.

Patient Transition Probability	Corrected Gestation (weeks)										
	27	28	29	30	31	32	33	34	35	36	37
Ia	1	1	0.56	0.6	0.83	0.5	0.5	0.3	0.25	0.33	0.33
Ha			0.44	0.4	0.17	0.17	0.25	0.2		0.17	0.33
Sa						0.33	0.25	0.5	0.75	0.5	0.33
II	0.8	0.83	0.73	0.97	0.6	0.73	0.6	0.88	0.66	1	0.4
IH		0.17	0.23	0.03	0.3	0.27		0.06	0.17		0.2
IS					0.05		0.4	0.06	0.17		0.2
Ito	0.2		0.03		0.05						0.2
HI			0.1	0.027	0.04						0.029
HH			0.3	0.92	0.9	0.92	0.77	0.78	0.86	0.79	0.714
HS			0.5	0.027	0.06	0.08	0.22	0.2	0.125	0.21	0.228
HTo			0.1	0.027			0.01	0.02	0.015		0.029
SI					0.05					0.005	
SH			0.75	0.375	0.1	0.12	0.11	0.04	0.025	0.05	0.01
SS			0.25	0.625	0.75	0.88	0.89	0.95	0.944	0.89	0.93
SHome								0.01	0.031	0.055	0.06
STo					0.1						

Table 32 Probability of Patient Transition by corrected gestational week

Figure 71 below shows the number of cot days at intensive care and high dependency level by the Corrected Gestational age of the patient at that point. This reveals the preceding influence of intensive care for High dependency care. The maximal Corrected Gestations when the highest cot demands occur can be seen. The first peak indicates those earliest gestational ages for which the local neonatal unit can cater. The second peak for intensive care at 34 weeks Corrected Gestation can perhaps be interpreted to represent iatrogenic intervention, i.e. when obstetricians can more safely intervene to deliver a baby by Caesarean section. The third peak for High dependency care seems to represent that term group of neonates being treated for Abstinence. The lag for High dependency care following intensive care appears to be about a week. Just one year's data is given but since this the line is not smooth, the pattern is shown.

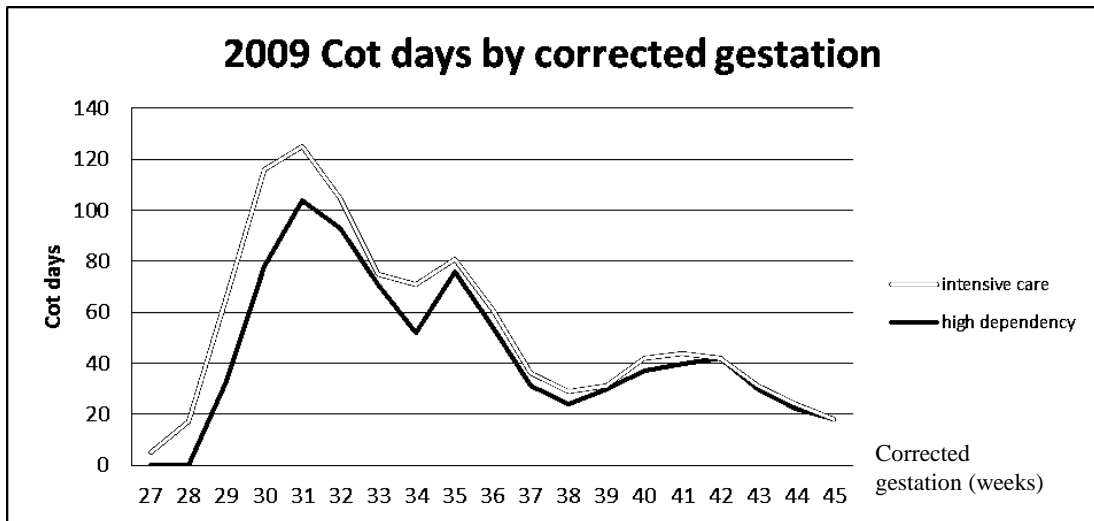

Figure 71 Cot Days by Corrected Gestation 2009

Figure 72 looks at destination given Length of Stay on intensive care. After seven days of intensive care, all transitions are for High dependency care.

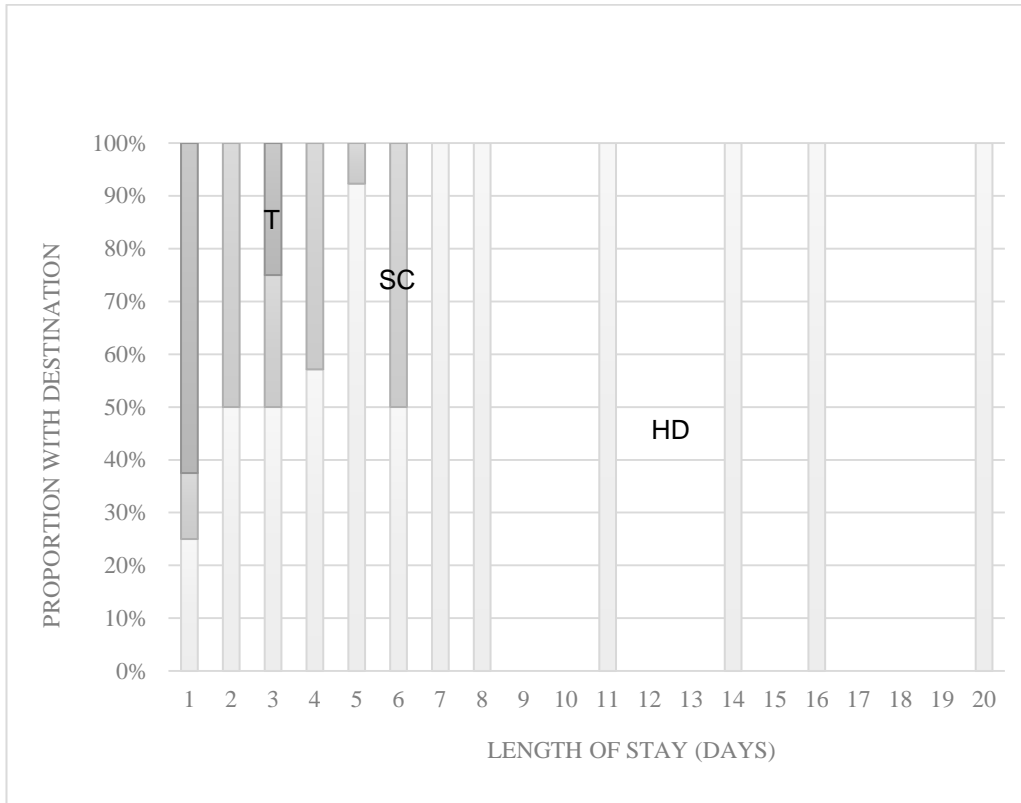

Figure 72 Destination by LOS at intensive care 2011

Key

- TO = Transfer Out,
- HD = High Dependency Care,
- SC = special care

Common patient pathways by corrected gestational age, weight, pathway and condition are shown in the flow chart, Figure 73.

CGH local neonatal unit Decision making / Neonatal pathway

Information = Time, gestation, weight, level of care

Key: Intensive Care Unit (ICU), Chronic Lung Disease (CLD)

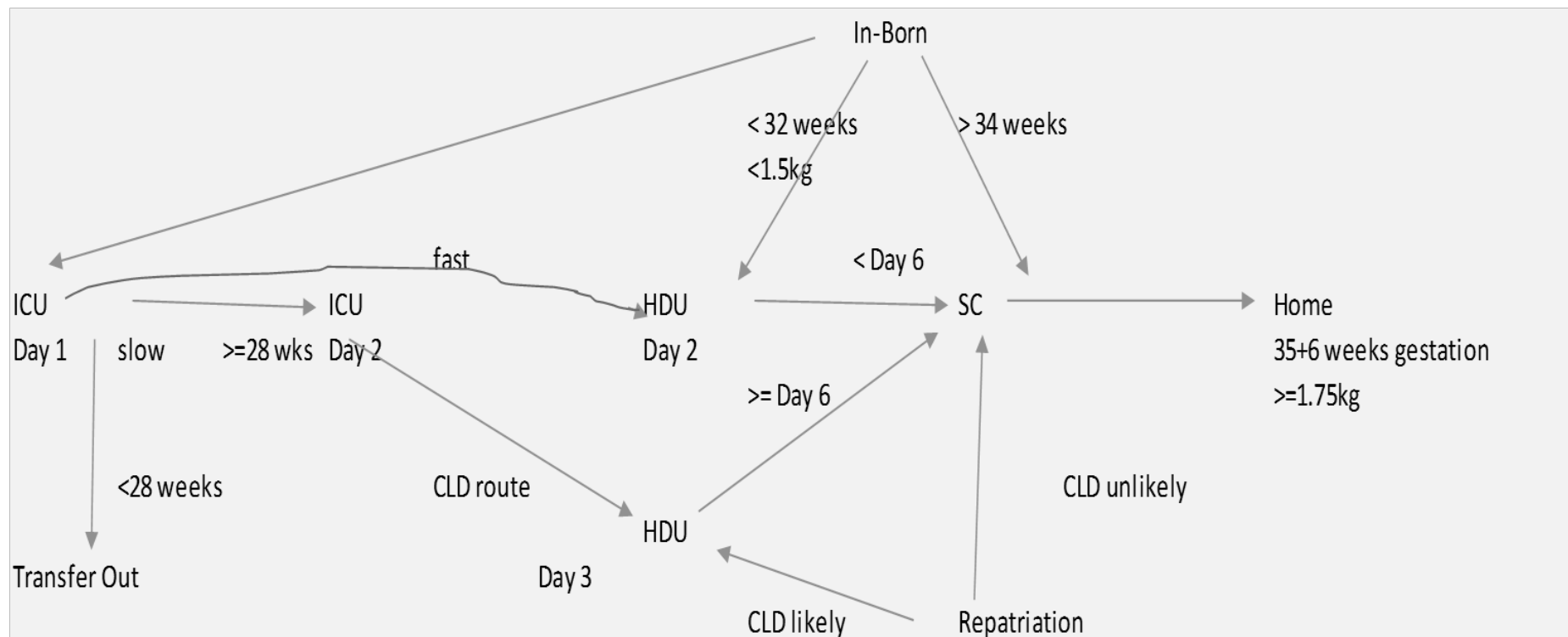

Figure 73 Local neonatal unit Decision making / neonatal pathway

5.9 COMPLICATIONS / BACKWARD STEPS

A distinction in Length of Stay between normal (or straightforward) and abnormal Patient Pathways (circuitous and complicated by retrograde steps) emerged. A high number of patients notably those with NAS oscillate between High dependency and special care: here backward steps mean increased Length of Stay.

In 2009, 63 patients took a backward step to a higher care level. Forty patients had non-contiguous High dependency days.

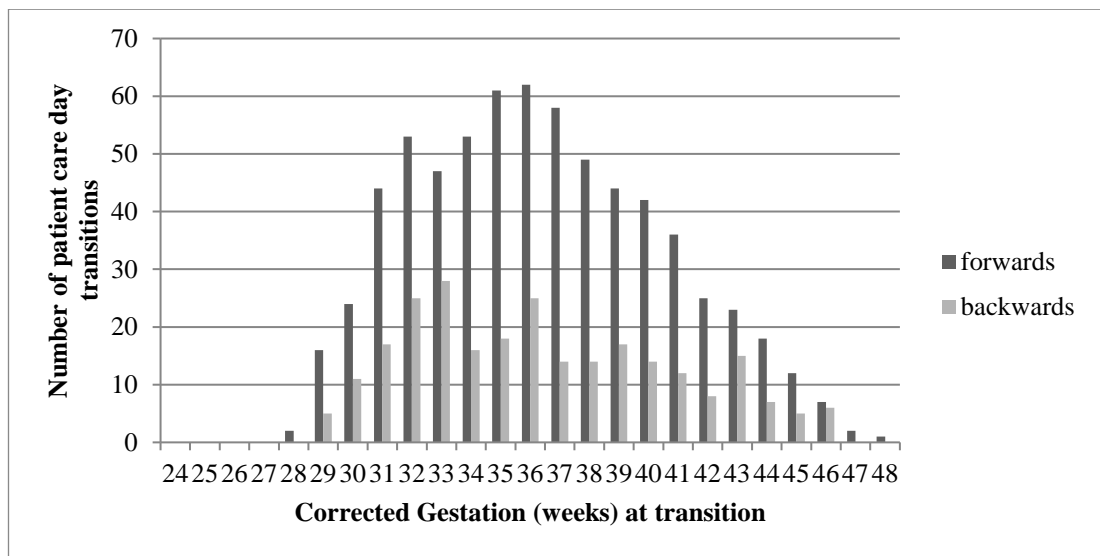

Figure 74 Comparison of forwards and backwards steps by corrected gestation

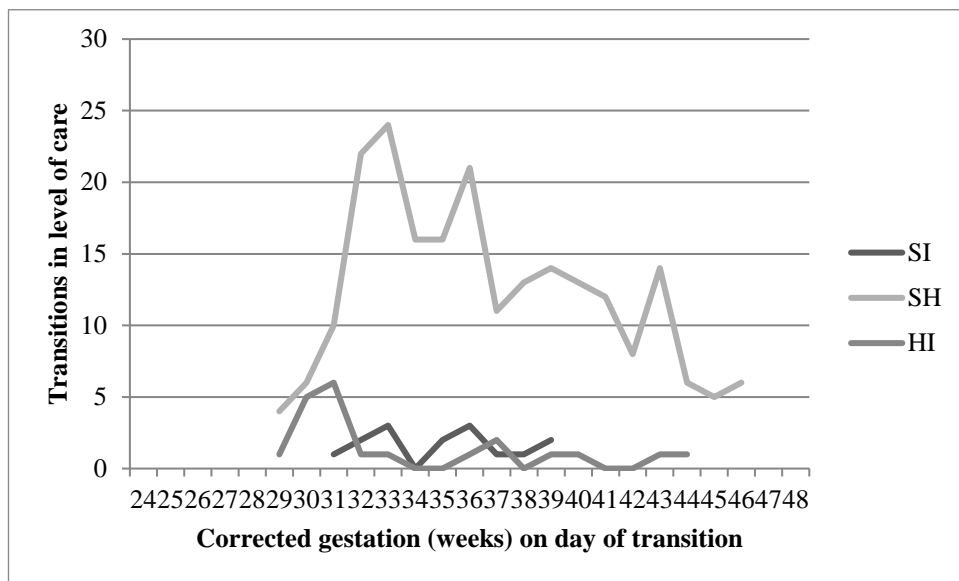

Figure 75 Steps backwards by corrected gestation

Those SH transitions are numerically not inconsiderable. These are compared with the forwards step HS in Figure 76:

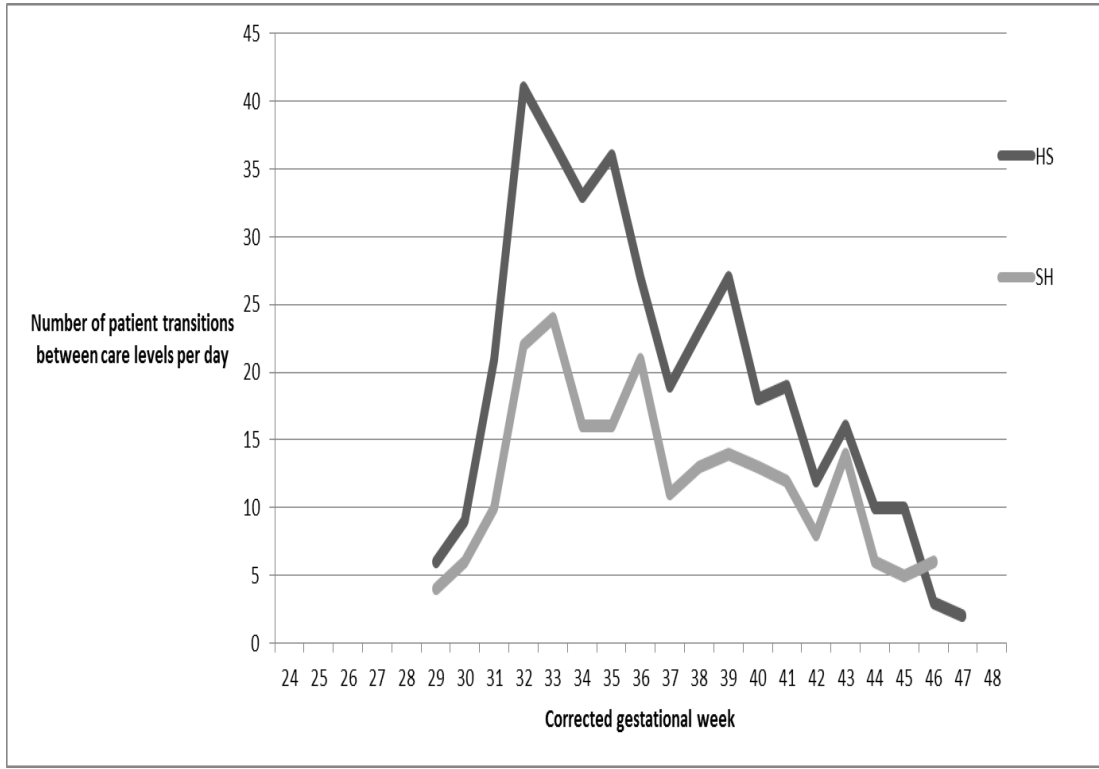

Figure 76 High dependency and special care interplay by corrected gestation

Such complications / backward steps have a significant effect on work, care days, LOS and resource Demand.

Figure 77 compares forwards steps from special care to home with backward steps from special care to High dependency or intensive care by Corrected Gestation at the time of transition.

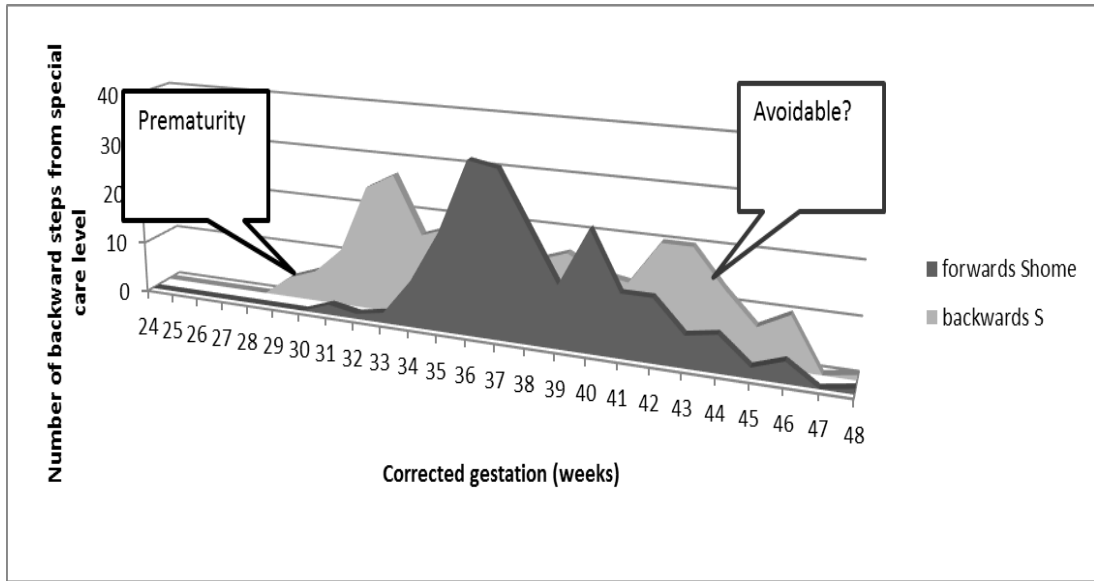

Figure 77 Steps forward and backward from special care by corrected gestation

Whilst for the premature, relapsing Chronic Lung Disease is likely to be responsible, where this phenomenon occurs post-terms, potentially avoidable maternal drug use is the likely cause.

Within the group of patients needing any High dependency care, 4.7% of the daily Patient Transitions were steps backwards. This proportion offers some idea of the resources taken up by complications.

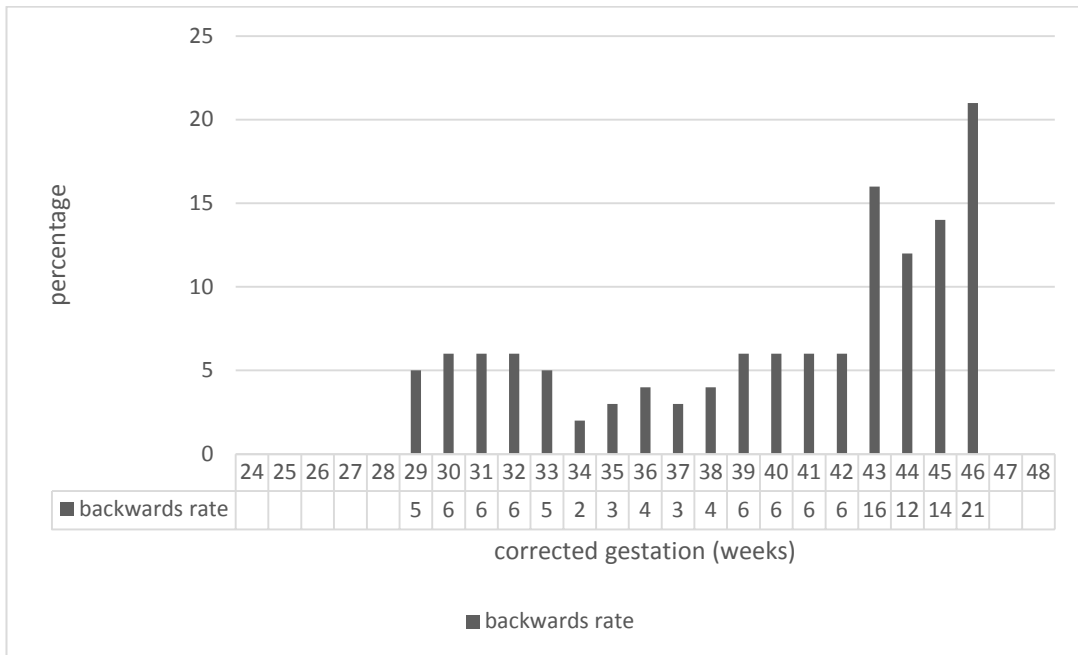

Figure 78 Percentage of backward steps by corrected gestation

5.10 ANALYTICS COMMENTARY

High dependency cot occupancy, both its distribution and error are shown in Section 5.6.2 Figure 40. Idle time is 14%, whilst cot shortage (>4 required) is 9% of the time. The daily change in cot occupancy at each care level appears to be normally distributed (Section 5.6.4 Figure 46). 90% of daily changes in High dependency are by up to one cot. The goodness of fit of Length of Stay for the exponential distribution is given (Section 5.6.5 Table 21). Curves for high and special care have long tails (Section 5.6.5 Figure 48-9). Knowing the High dependency treatment or diagnosis helps to group and so further refine a specific Length of Stay forecast (Section 5.8.1 Figure 66). Stays for CPAP for Chronic Lung Disease and NAS represent the longest (Section 5.8.1 Figure 69). Knowing the Day of age of patients helps with an estimate of whether and when a move to High dependency care occurs. Longer stays at intensive care (whose treatment contributes to lung disease) guarantee this (Section 5.7.5 Figure 60) whilst longer stays at special care (presumably indicating stability) gravitate against it (Section 5.7.6 Figure 65).

Analysis of the effect of Corrected Gestational age has also been undertaken and is summarized in Section 5.8.4 Table 31.

Long stayers / Complications

Long stayers on High dependency could be predicted by a diagnosis of Neonatal Abstinence Syndrome delivering after term and were also associated with Corrected Gestations of 29-30 and 34 weeks. Backward steps to higher levels of care are quite common in the Patient Pathways. We now have more information on when a baby at intensive care might require High dependency care and duration of stay at High dependency.

People have counted patient cot days per year at various care levels for each hospital. More than half of a neonatal network's activity is performed in local neonatal units. Little work has looked at integral patient pathways, steps backward or focused on High dependency cots in the local neonatal unit. The Perinatal Network System is complex, expensive, low volume and subject to random fluctuation. One patient journey could

involve pathways through two or more hospitals within or between networks. High dependency care in the local neonatal unit can involve looping patient pathways to which nursing staffing must respond flexibly. Ideally redundant capacity and the ability to flex in the short-term could be helpful. Why can't managers forecast this need rather than clinicians being forced to respond by fire-fighting? We have undertaken some exploratory data analysis to try to address this issue.

We have found that a significant cause of shortage of capacity is relapsing conditions (not only Chronic Lung Disease of prematurity but also Neonatal Abstinence Syndrome, a potentially avoidable social condition) and backwards steps (complications) in the Patient Pathway. Were the latter to be abolished, then the number of cot days at particular care levels would be reduced. Of the group studied requiring high dependency, 13% of neonates discharged from special care had experienced a return visit to high dependency. This operational feature is a useful proxy Quality Metric, which might equate with a maximal complication rate and provide an indication of where quality improvement work might be focussed.

When sorting by the dimension of time or corrected gestational age, common patient pathways were followed. Certain rules emerged when the operational component of patient pathway was set against diagnosis:-

If an intensive care patient is neither transferred nor moved to High dependency today, then a move to High dependency care will likely occur tomorrow. Given a stay of seven days on intensive care, the next kind of care required will be high dependency. If High dependency care for respiratory support lasts beyond four days, then the patient's behaviour is following the pattern of Chronic Lung Disease. If this is the case, then either the prior pathway has been longer ventilation, and/or back-transfer. Where a patient is re-admitted from special care to high dependency care for respiratory support, then Chronic Lung Disease is likely. The patient pathway is not straightforward given Day 3 on intensive care, Day 5 at High dependency care or admission from the postnatal ward not at special care level. Days in special care after being fit for medical discharge imply social care problems.

5.11 ANALYTICS DISCUSSION

The results show us that a certain complement of interlinked cots: intensive care, High dependency care, special care is used interchangeably by that portion of the neonatal population passing through High dependency care. Those older gestation neonates only requiring special care could be considered as a separate sub-group and overall straightforward special care was by far the greatest contributor to cot days on the unit.

Where numbers were sufficiently large, year on year variance was little. Since the amount of data for a medium sized DGH local neonatal unit was small, where certain patient events were uncommon, variances were quite broad. All it took was one complicated patient, for instance with Extreme Prematurity or severe congenital abnormalities to put up the years' demand for cots and days. Furthermore economies of scale are not possible in small neonatal units.

Looking at day on day transitions, that proportion continuing at the same level of care was steady since numbers were great. Transition between levels of care showed more variance since numbers involved were smaller. Had one been able to study a sufficiently large population then these rates of change might have settled. To this end, one could look at HES data on augmented care episodes in the hospitals in the home Perinatal Network *if only one were able to derive the temporal sequence of care from it.*

Information has been offered on important questions such as:

What is the population pattern of prematurity found on the local neonatal unit? Is this changing?

What is the hospital interplay? (yet numbers too small to study.)

What are the rates of over-subscription (baulking and renegeing) and under-utilisation (idleness)? What is the effect of multiple or batched (elective Caesarean section list) deliveries on resilience?

What is the relative chance of arrival at a particular care level, given Corrected Gestation and maternal drugs?

What is the chance of particular transition by Corrected Gestation and/or given preceding duration of stay?

5.12 SUMMARY

So how far does this work take us? Data-driven work on patient pathways has been undertaken. Utilisation of High dependency cots in the local neonatal system was the focus. Knowing census at each level of care, age of patient and reason for which the care is given permit refinement of the prediction of Demand for High dependency.

Insight into the dynamic complexity of the Perinatal Network System has been gained by a microscopic look at Patient Transitions between levels of care within one local neonatal unit, which conceptualises backward as well as forward steps. There were common pathways which patients followed. Indeed, the expert could pick out the likely medical diagnosis from the pattern of days spent at the levels of care by the patient, sorted by corrected gestational age. This carries important implications for data mining and machine learning insofar as the pattern of days at each dependency alone will indicate the likely diagnosis. The power to overcome past difficulties lies in harnessing computed data intelligently to pre-empt issues.

Harnessing existing data efficiently to predict activity, matching resources to Demand, reducing hospital Length of Stay and improving family experience such that the newborn is treated promptly and discharged home safely and sooner are becoming increasingly important.

CHAPTER 6 COT PREDICTOR TOOL

6.1 INTRODUCTION

The Chapter builds on the Quantitative Analysis Chapter in which 2009-11 SEND data has been summarised and compared. This data is used to develop a Cot Predictor Tool for predicting High dependency cot Demand and nursing requirement.

Steps taken to develop the Tool are finding the probability of High dependency care overload, nurse shortage resulting from cot occupancies and refinements based on patient data. This Chapter is further organised to incorporate:

- Prediction of Workload and Patient Flow estimation

- Modelling High dependency cots: Cot Predictor Tool.

- Nurse shortage

- Forecasting questions, scenario and example

- Detailed Tool specification and distributions for parameters

- Further development of Tool and Extensions with knowledge on individual patients

6.2 PREDICTION OF WORKLOAD

We draw on the work of Gallivan and Utley on the determination of intensive care base bed use for paediatric cardiology patients (Gallivan, et al. 2002). In our system, there are historical background rates of change across levels of care, which could help predict change in cot occupancy over time. Knowing these, the current case mix and the nature of pending deliveries on Labour Ward could influence decisions to accept elective deliveries and repatriations or to request ex-utero transfers. One could conceivably flex up nurses for contingency cots at some point in the near future. When individual patients move between care levels or go home could be predicted (Powell 1992). So today's cot census, information known on current in-patients and expected deliveries inform each day's cot Demands. Backward steps are taken in Patients' Pathways and cannot be ignored when considering system configuration or benchmarking standards of care.

Another relevant dynamic forecasting paper calculated different combinations of patients staying and leaving so many days in the future (Pagel, Utley and Gallivan n.d.); graphs of the probability of the patient still receiving intensive care versus the logarithm of days since admission were generated.

Our situation is analogous to that described in the Gallivan paper, which shows considerable variation in Length of Stay at paediatric intensive care. This implies both operational overload, which we would like below 5% of the time or ideally never for reasons of care and logistics; as well as reserve capacity, which should lie below 30% for reasons of economy (Bagust, Place and Posnett 1999). There is an on-going trade-off between these requirements, pertinent in the low volume environment of a local neonatal unit. Commissioners can specify precise and desirable limits for these measures. As shown in the Quantitative Analysis of Chapter 5, in the real-world, standards are not met.

6.3 COT PREDICTOR

In order to model High dependency cot Demand, a Cot Predictor Tool was developed, whose primary outcome measure was High dependency activity and whose secondary outcome measure was intensive care cot use. From that the nursing requirement for the work followed.

The Tool was based on historic annual data: in particular, daily changes in patients' level of care and daily changes in occupied cot number. Data could be sorted by prematurity, in-coming care level and age in days. For the model, one needs to know current cot census, expected number and kinds of new patients and leavers and the variability in the rate of emergencies.

The Systems Diagram is shown in Figure 80:

Systems Diagrams

Figure 80 System Diagram for local neonatal unit

a=arrivals, d=discharges

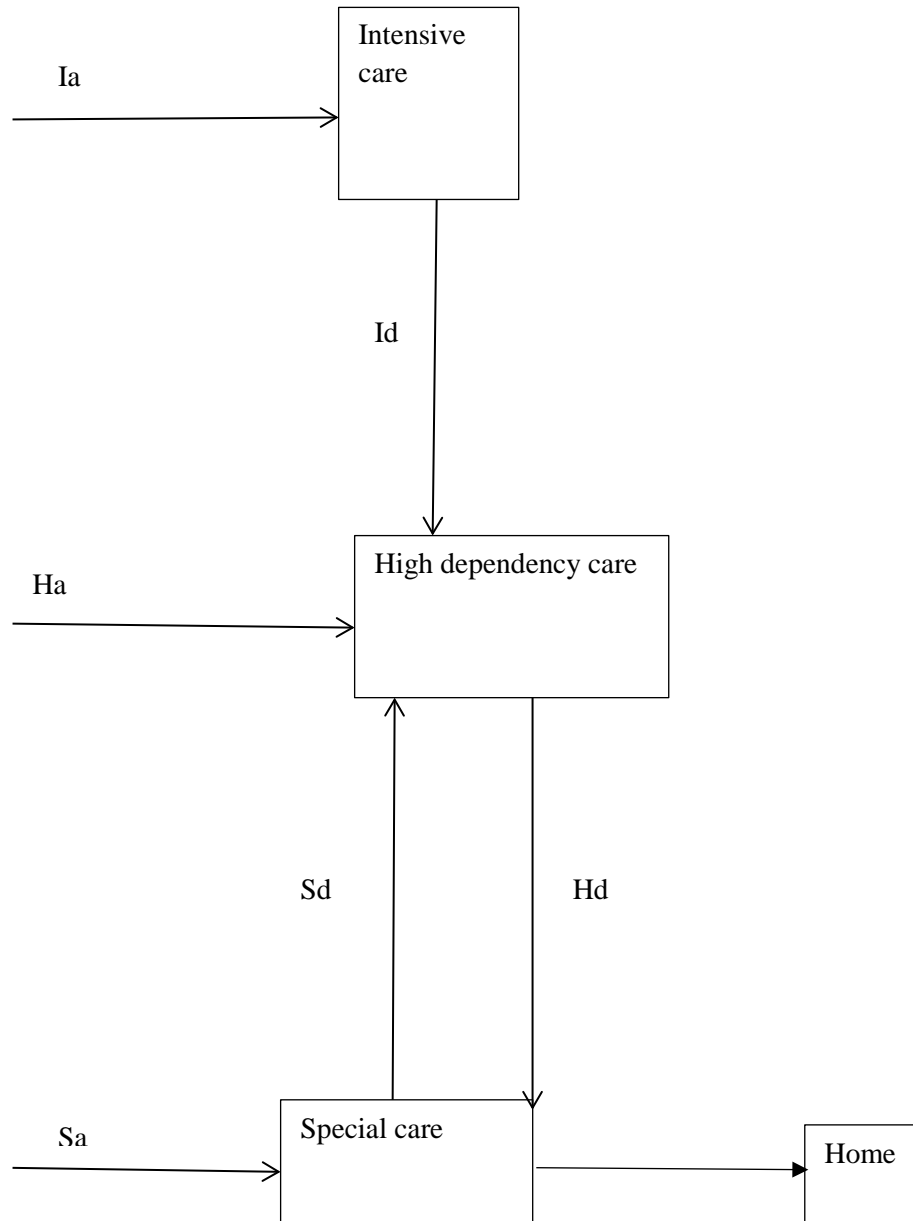

High dependency care lies in the middle of the system in a local neonatal unit. The probability of arrivals, stayers and discharges has been given (Quantitative Analysis Chapter 5). Over an interval, new patients will arrive at intensive care, High dependency and special care. Existing High dependency patients may stay or leave. Intensive care and special care patients may move to High dependency. Obstetricians may negotiate elective deliveries and inductions. Other hospitals may request repatriations. By determining the probability of such events, one might be better informed to decide which work can be accepted today and which requires negotiation tomorrow. Also the effect of both managers' cot cuts and nursing shortage can be predicted.

The daily changes in cot occupancy for the three levels of care are shown in the Quantitative Analysis Chapter Section 5.6.4 Figure 46. High dependency cot shortage is certain to arise. Which days these are can be foreseen in the short-term by looking at past patterns. Once certain combinations of cots or conditions are reached, then sustained shortage of High dependency cots is inevitable. One caveat is that predictions do rest on the commissioned cot configuration, which are subject to change.

Adding Corrected Gestational age, age in days, origin, destination and Diagnosis can refine the prediction. For instance, Corrected Gestation at birth predicts incoming care level (Quantitative Analysis Chapter Section 5.5 Figure 35). For instance all those below 29 weeks gestation are admitted at intensive care level.

That detail for High dependency cots is extracted in Figure 81. Id1st and Id2nd refer to a first and any second transition of that patient from intensive care to High dependency. Definitions are listed in Table 35 in Section 6.3.2 following.

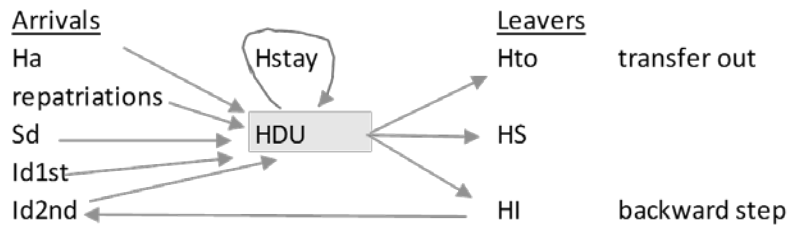

Key
 Id2nd = 2nd transition from intensive care to high dependency care by same patient

Figure 81 Modelling local neonatal unit High dependency cots

In a notional steady state, arrivals (about 400 per year) equal discharges. In a closed system one would have these patient transitions:

Patient transitions		to		
		Intensive care	High dependency	Special care
from	Intensive care	II	IH	IS
	High dependency	HI	HH	HS
	Special care	SI	SH	SS

Table 33 Patient Transitions

By far the commonest day to day transition is ongoing care at the same level. These stayers are denoted by II, HH and SS.

Uncomplicated net forward flow for the neonatal unit is $(IH - HI) > (HS - SH) > (SH_{Home} - 0)$.

(Re-admissions from community to neonatal unit should be nil; yet this represents another rule broken in winter).

Transfer out at intensive care commonly leads to return at High dependency care, occasionally special care. Transfers out at High dependency care are negligible, as are transitions from special care to intensive care. Please see Table 23 Quantitative Analysis Chapter Section 5.7.2.

In-house backward steps from High dependency to intensive care are occasional (approximately 1 in 16) but will usually lead to a subsequent High dependency episode. Whilst transitions from special care to intensive care are negligible in the studied population of those needing any high dependency care, backward steps from special care to High dependency (representing 6%) are common enough to warrant a plan. Figure 82 demonstrates such backward steps.

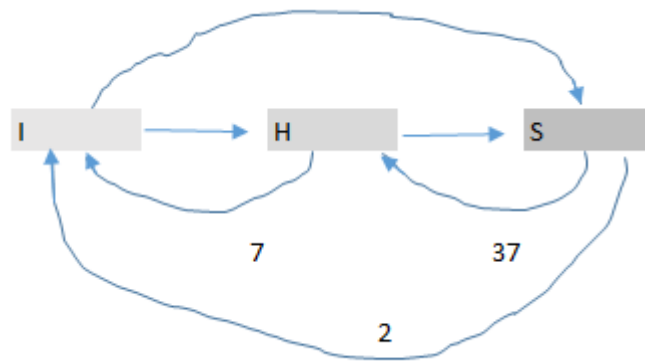

Figure 82 Backward Steps in level of care

Table 34 reveals that 1% of arrivals to intensive care have worsened. 11% of arrivals to High dependency care have worsened.

	composition			
intensive care	II	HI	SI	1% of arrivals have worsened in-house
high dependency	HH	IH	SH	11% of arrivals have worsened in-house
special care	SS	IS	HS	

Table 34 Composition of Arrivals at Level of Care

6.3.1 Patient Flow Estimation

Clinician-observed estimates of Patient Flow are given.

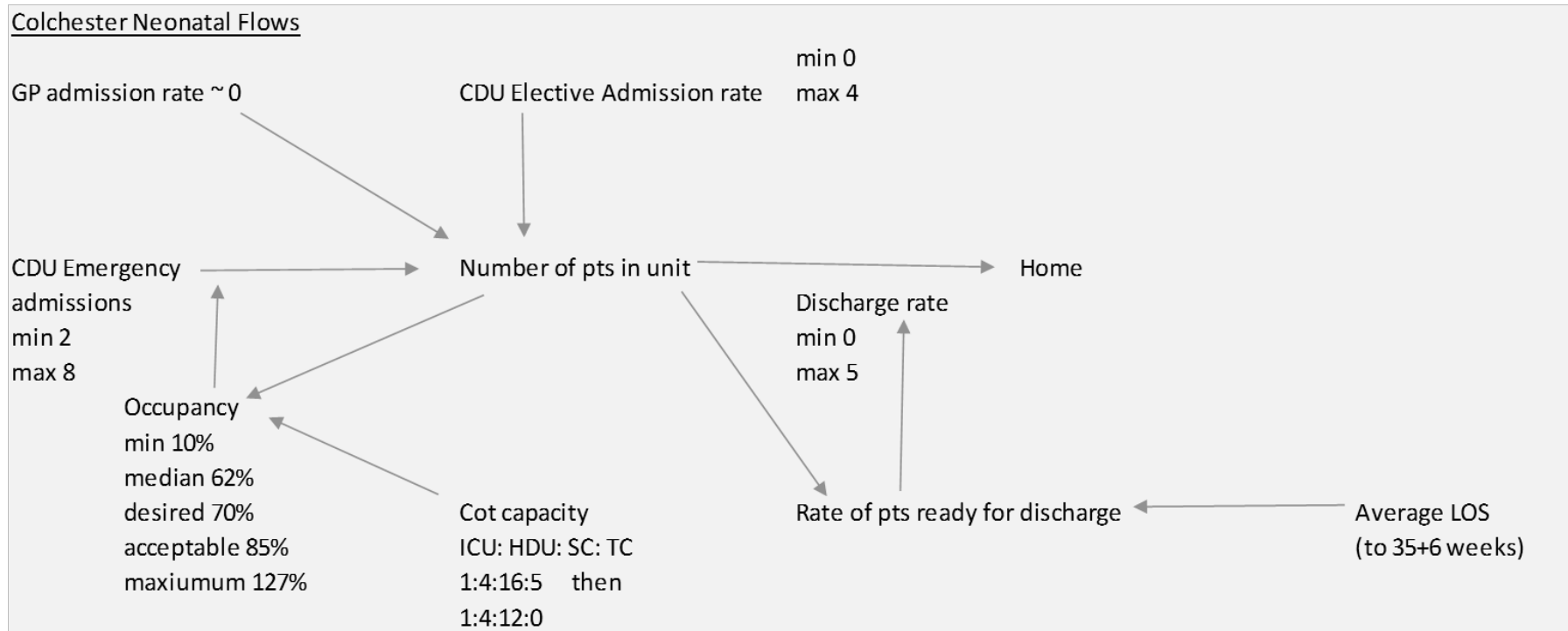
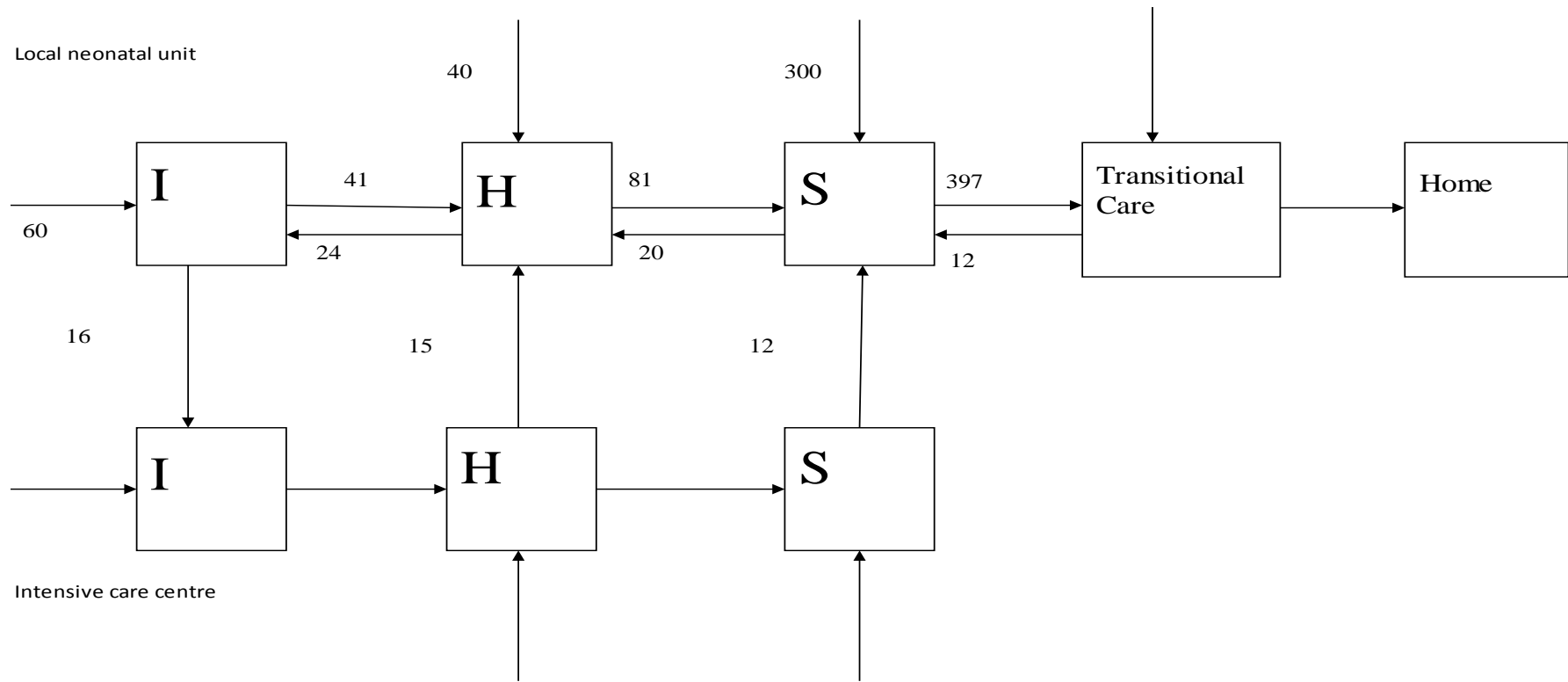

Figure 83 Clinician observed Neonatal Flow

Key

Rate = number per day



Hypothetical model based on estimated data for a local neonatal unit. Numbers represent patient flows per year.

Figure 84 Hypothetical annual neonatal unit flow

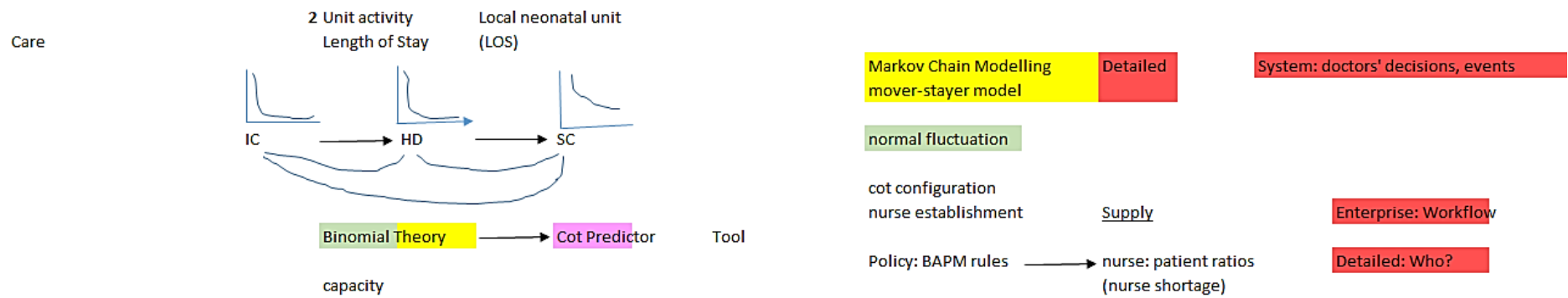

Figure 85 Systems Thinking - local neonatal unit activity

Figure 85 recapitulates Systems Thinking Figure 16 from Section 4.7.1.

6.3.2 Definition of Terms

Io	Intensive care census now
Ho	high dependency census now
So	Special care census now
I1	I at t=1 day
I2	I at t=2days
I3	I at t=3 days
H1	H at t=1 day
H2	H at t=2 days
H3	H at t=3 days
S1	S at t=1 day
S2	S at t=2 days
S3	S at t=3 days
pHa1	probability of arrival to H at t=1 day
pHa2	p of arrival to H at t=2 days
pHa3	p of arrival to H at t=3 days
pIa1	probability of arrival to I at t=1 day
pIa2	p of arrival to I at t=2 days
pIa3	p of arrival to I at t=3 days
pId1	p of discharge from I to H at t=1 day
pId2	p of discharge from I to H at t=2 days
pId3	p of discharge from I to H at t=3 days
pHs1	probability of staying on H at t=1 day
pHs2	p of staying on H at t=2 days
pHs3	p of staying on H at t=3 days
1-pHs1	p of leaving H at t=1 day
1-pHs2	p of leaving H at t=2 days
1-pHs3	p of leaving H at t=3 days
pSd1	p of leaving S for H at t=1 day
pSd2	p of leaving S for H at t=2 days
pSd3	p of leaving S for H at t=3 days
to	At t=0
t1	at t=1 day
t2	at t=2days
t3	at t=3 days
t	at time t

Table 35 Definition of Terms

6.3.3 Assumptions

The unit is occupied at the start of the modelling time.

All patients stay in one-day aliquots. (This is owing to the midnight bed figures and how the data is collected and recorded.)

There is a steady pool from which special care babies flow to High dependency care. (The greatest number of admissions are at special care level).

We do not consider batched deliveries i.e. twins and triplets at this time. The rationale for this is that while 11% of neonatal unit admissions are a multiple, those needing High dependency care that are multiple account for just 3.6%.

Arrivals are stochastic. All patients are emergencies: their arrivals are considered Poisson. The rationale for this is that semi-elective or planned Caesarean deliveries of premature babies are more likely to need respiratory support but this is hard to predict.

In the basic model, no calculations are based on birth-weight, gestation or diagnosis. These modulators have been considered in the Quantitative Analysis Chapter 5.

Over each time-spell of 1, 2 or 3 days, we either get new arrivals at intensive care, High dependency care or a special care patient moves to High dependency care or they don't.

Treatment at intensive care and High dependency care is treated as discrete events and census figures are used in the forecast.

Training data is at first for the calendar year 2009 from the Standardised Electronic Neonatal Database (SEND). Ideally the pool of test and training data should be great enough i.e. over 20 for each kind of case.

6.3.4 Conditions

If safe occupancy is 0.85 (Waldmann, 2017), then this gives idleness of 0.15.

Refusals (baulking) should be nil. Reneging rate ideally nil i.e. No rules are broken (which is not the case in the real world).

There are limited nursing resources: skilled neonatal nurses (In UK, 405 trained) = 3 +/- supervisor as extra; and nursery nurses = 3 at any time.

Exceptionally one intensive care patient needs two skilled neonatal nurses. This real-world scenario is not covered.

There are limited cots: I = 1, H = 4, S = 12.

(When there are rota gaps, then there is effective further compromise of this constraint.)

The notice for a planned admission e.g. elective Caesarean delivery or repatriation is less than 24 hours. There is no useful notice for Emergencies.

6.3.5 Constraints

Physical resources: equipment (e.g. ventilators, monitors and incubators)

Delivery rooms

Theatre time

Midwives and critical care trained neonatal nurses

Staff sickness

Human factors (management)

Rota gaps

Some data on critical care trained neonatal nurses and staff sickness was available.

There was variability in the availability of equipment, which depended on the Medical Physics department, which suffered staffing cut-backs. The only way to approach that would be to count or perform a stock take. The frequency of audits by Medical Physics had increased ahead of possible asset-stripping. Delivery rooms and theatres were closed to permit reconfiguration and rebuilding; and time for cleaning them would have to be taken into account. In regard of managerial human factors, theatre time, delivery rooms and midwifery information, obtaining accurate data required other

departments to collect this accurately and be willing to share it. The underdeveloped state of computing and data analytics in that area limited this possibility. Furthermore at this time, maternity notes were the last in England to be computerised: midwives lacked the training, time and available hardware to input or look at data on computers. Rota-gaps were unpredictable and information on this never openly ceded, unless demanded by the CQC.

Therefore some of these constraints might be easier to co-opt into a Prediction Tool than others. Certainly it is not possible to do so in a concrete quantitative manner. To overcome these difficulties there would have to be management buy-in and an open climate, conditions which were not met within the prevailing chronic special measures culture. Were figures to be obtainable, then one might estimate ranges of time for which the service would be unavailable for each reason and feed it into a dynamic model based on stochastic statistical distributions. Since the most important resources were the neonatal skilled nurses and there was some minimal data on staff sickness, this was able to be taken into account in the modelling which follows.

6.3.6 Basic Tool

The basic Tool rests on probability theory and the Binomial Theorem. The SEND system provides a list of daily cot occupancy broken down by level of care. For instance, one day might read 0:5:11 for I: H: S respectively and the occasions when the next day was overloaded may be seen. Information on these occupancy levels is summarised for 2009-11 in the Appendix Table 53.

Now the theoretical combinations of occupancies for High dependency and intensive care cots based on historical figures from 2007 were given in Table 20 Section 5.6.4. In the past, up to four intensive care cots and seven high dependency cots have been occupied, which shows the unfettered demand when managers permit rules on cot configuration to be broken. Those hypothetical cot combinations of intensive care, high dependency (and special care), which resulted in over-subscription for the nursing resource are shown in the shaded area of Table 36. This foreknowledge might form the basis of an alert.

Occupancy	High dependency cots							
	0	1	2	3	4	5	6	7
Intensive care cots								
0	0 0	0 1	0 2	0 3	0 4	0 5	0 6	0 7
1	1 0	1 1	1 2	1 3	1 4	1 5	1 6	1 7
2	2 0	2 1	2 2	2 3	2 4	2 5	2 6	2 7
3	3 0	3 1	3 2	3 3	3 4	3 5	3 6	3 7
4	4 0	4 1	4 2	4 3	4 4	4 5	4 6	4 7

Table 36 Theoretic combinations of occupancy for critical care cots

Initially a pilot study of 90 High dependency patients, who needed care in 2009 was performed, looking at their transitions between levels of care. To illustrate the concept, an example from this work is set out in Section 6.5.3. The final Detailed Tool specification incorporates 2009-11 data and appears in Section 6.6.

One useful way of expressing findings is the cumulative probability for the forecast activity exceeding a certain threshold number of cots, as shown in Figure 86:

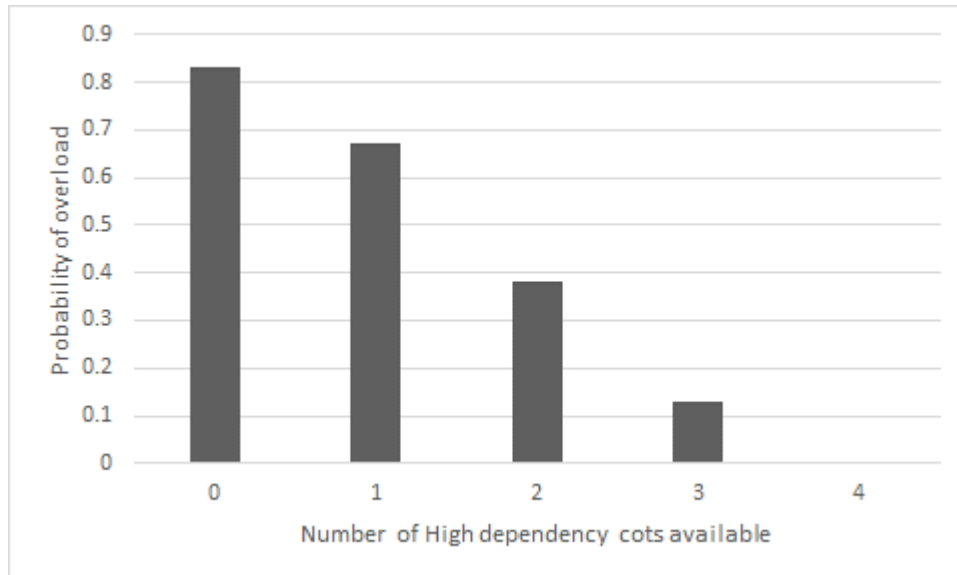

Figure 86 Probability that High dependency cot requirement exceeds a given level

Figure 86 is drawn from 2009-11 data which is given in Appendix Table 53. The interpretation of this simple model is that for the High dependency cots, if you are to have a less than even chance of overload, spare capacity of two cots is needed. If you only have one unoccupied high dependency cot then there is a 67% probability of overload. Not only does this offer guidance on how these cots might be managed, it also shows the impact of variability on small neonatal units. Having shown the situation with High dependency cot overload, attendant nurse staffing is next modelled.

6.4 SUPPLY SIDE. OPERATIONAL DATA

Nurse shortage

The goal is the upcoming forecast for High dependency cot demand. Both over-subscription for High dependency cots and attendant nursing shortages are certain for the forthcoming year for a proportion of days (as is over-provision of service) owing to natural fluctuations within a low volume service, which are depicted in Figure 87 below:

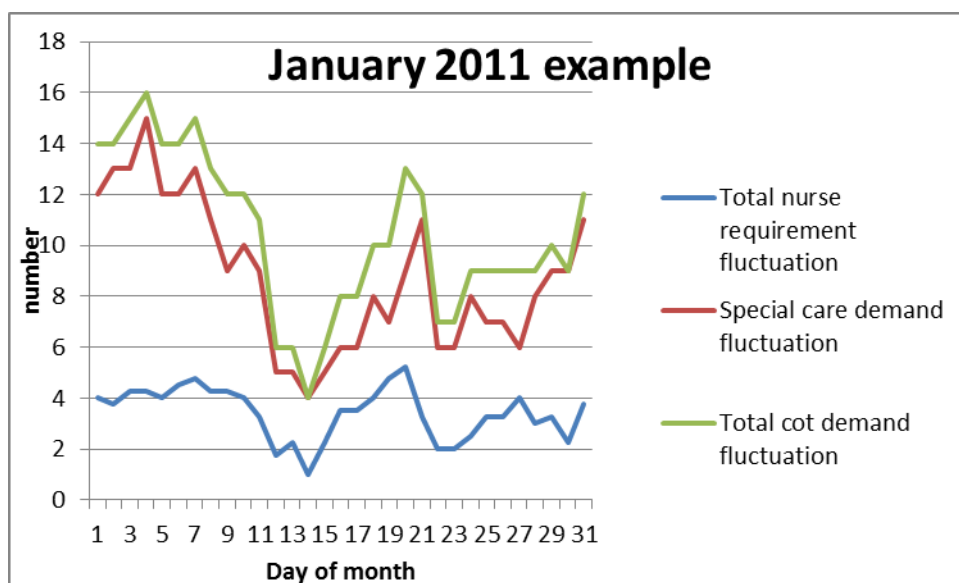

Figure 87 Fluctuation of cot and staffing demand January 2011

Special care is a big contributor to total cot demand.

This model forecasts High dependency cot Demand and consequent nursing requirement using current census and historical information (2010-11) on patient arrivals and transitions from other care levels which has been recorded on the SEND system.

The annual forecast for expected skilled neonatal nursing shortages is given in Figure 88, assuming no sickness and no requests to bring additional nurses beyond establishment for the shift at short notice. (In practice, this kind of short-term responsiveness, historically known as NHS Goodwill was frequently relied upon for the smooth running of neonatal units). Now obviously having insufficient nurse numbers with the correct skills leads to effective compromise in cot availability (even if equipment is available) which is an important operational issue.

Figure 88 has been calculated in the following way. Data on cot occupancy for intensive care and high dependency care for 2009-11 was used. This was given in Figure 38 of Section 5.6.1 and Figure 40 of Section 5.6.2 respectively. The approximation was made that there was independent assortment of intensive care and high dependency care occupancy in order to give the most optimistic scenario for staff shortage. The occupancy of intensive care was multiplied by that for high dependency care for each combination. Under the BAPM rules one skilled neonatal nurse may look after one intensive care patients or two high dependency patients. A two-dimensional table was thus compiled, whose denominator was $1199025 = (3 \times 365) \times (3 \times 365)$. Using the BAPM rules, the resultant staffing shortage was determined. Full details are laid out in the Appendix Table 54. Figures were converted to percentages, expressed as number of days per 365day year, whose graph is given (Figure 88). At least 52 days a year (14%) are expected to be short of one or more skilled neonatal nurses.

Predicted

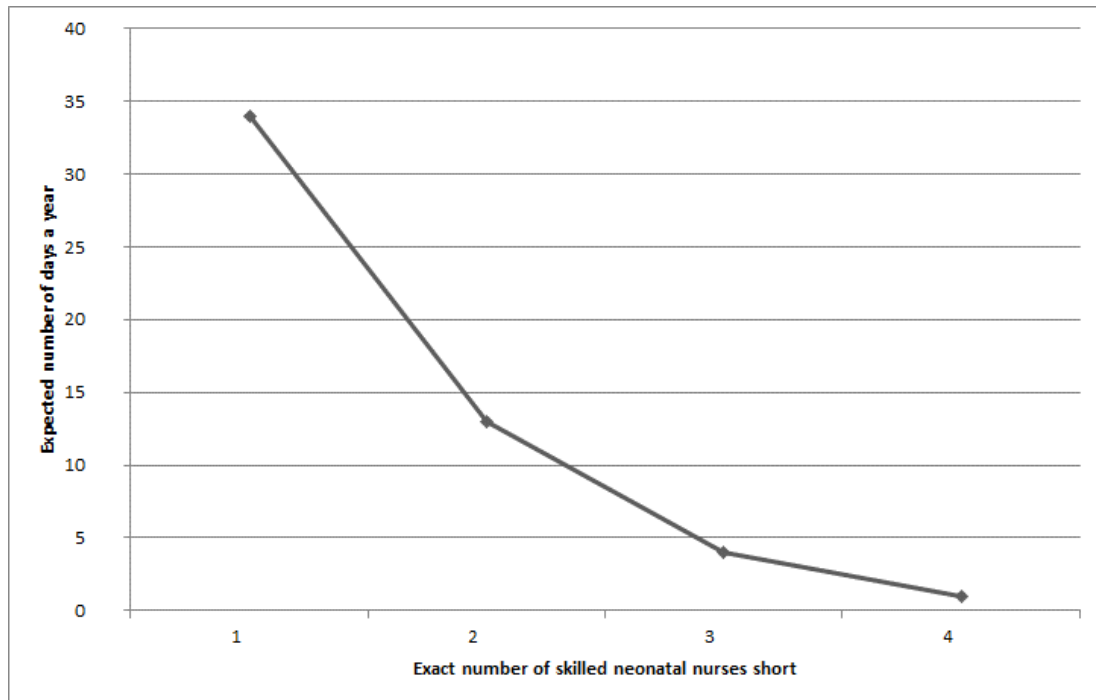

Figure 88 Predicted skilled neonatal nursing shortage

Figure 89 shows both the actual (Intensive care – high dependency care temporally linked) and model predicted (disaggregated) data. The benefit of disaggregating the data is to make the calculation more tractable. The comparison shows that this approximation in the model is good enough. Cot occupancy translates into annualised neonatal nursing workforce for the unit's cot configuration of 1 intensive care cot and 4 high dependency cots. Shortage is a certain occurrence for which the manager *could* produce a contingency plan.

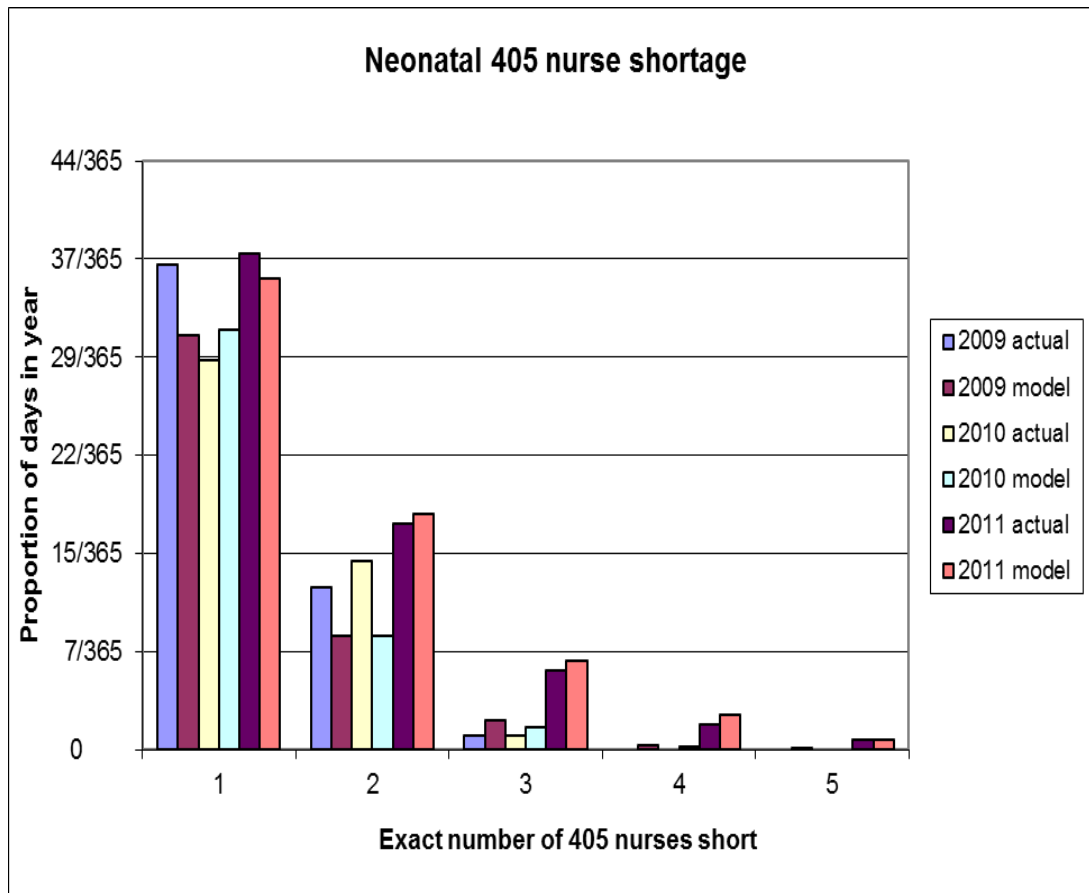

Figure 89 Neonatal skilled nursing shortage validation

So to recapitulate, owing to variability, even when configuration is based on average occupancy, staffed to 100% BAPM requirements and there is no staff sickness, approximately 14% of days in the year will be affected by skilled (405-trained) neonatal nurse shortage, a finding in line with the BLISS SOS 2011/2 document. The model assumes the variability in simultaneous intensive care and High dependency cot occupancy are independently associated: it is based on disaggregated data. Now need for High dependency care usually follows that for intensive care: that time-lag may be about a week (anecdotal evidence: see Quantitative Analysis Chapter Section 5.8.4 Figure 71). This model would therefore tend to underestimate the real demand for skilled nurses at busy times. However, this model was useful for understanding nurse shortage. It is a crude way of predicting for how many days extra planning is required. The predictive value of the model for 2012 is shown in Figure 90:

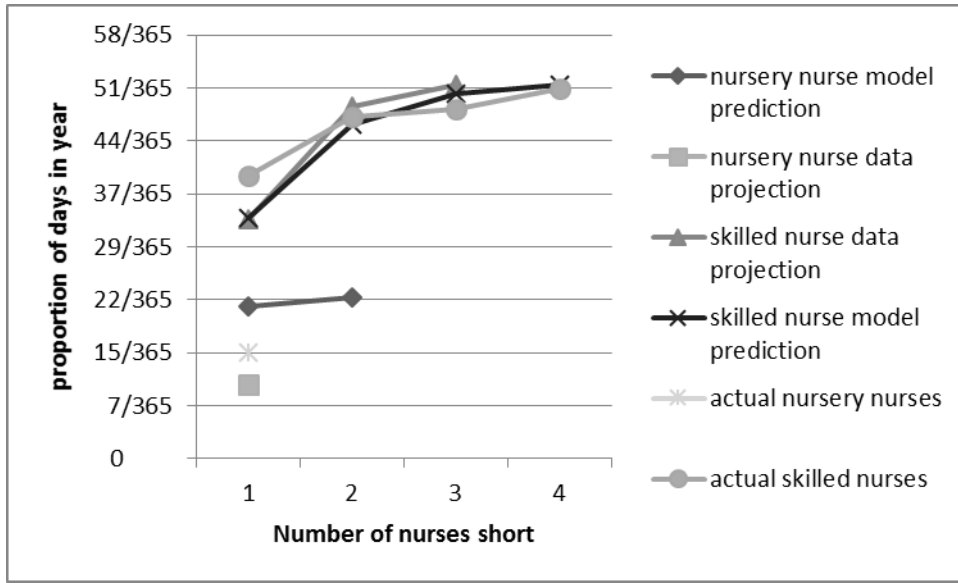

Figure 90 Neonatal nursing shortages forecast (2010-11 training data, 2012 validation)

Skilled neonatal nurses may look after a special care baby if unoccupied with critical care. One nurse may look after four special care babies. Please see Figure 44 Section 5.6.3 on special care cot occupancy. In Figure 90, ‘data projection’ denotes actual 2010-11 data, while ‘model prediction’ indicates that 2010-11 data on intensive and high dependency care has been disaggregated. Actual 2012 data is used for the test. Figure 90 shows how the model underestimates the skilled neonatal nursing shortage and overestimates the nursery nurse shortage. Perhaps the predicted nursery nurse shortage is greater than the actual owing to a policy change in neonatal outreach nursing and Length of Stay. Also it is easier and faster to train and obtain nursery nurses than more skilled (405-trained) neonatal nurses.

Actual

Actual nurse shortage	Number of days for year			
	2009	2010	2011	2012
1 neonatal skilled (405)	36	29	37	39
2	12	14	17	8
3	1	1	6	1
4	0	0	2	3
5	0	0	1	0
Total = any neonatal skilled	49	44	63	51
1 nursery nurse	2	13	8	15

Table 37 Actual nurse shortage 2009-12

Actual nurse sickness was 6% in the Paediatric Department (which did include the children's ward as well), a figure up to 43% higher than elsewhere in the hospital. Table 37 gives the data for days rather than for nursing shifts. Amongst the nursing workforce over this time there was a mix of full-time and part-time workers. Furthermore over the course of the study the managers imposed a change on the duration of nursing shifts from eight to twelve hours so that the hospital might save money. Thus early on, one day had three nursing shifts, later that was two. Data is given in days to accommodate this change in working hours.

6.5 FORECASTING QUESTIONS

We can predict the likely incoming level of care for a patient on features such as diagnosis. Need for intensive care and High dependency care may depend on gestation, size, time from birth and origin, whilst discharge from special care depends on baby maturity, the Corrected Gestational age. Data on deliveries and repatriations can be estimated from previous months and years. The daily range of inflow and outflow for High dependency care is known from 2007.

Some questions concern us. When a particular patient enters the system now, will that cause a downstream cot block at a certain care-level in the future? What is the anticipated cot usage for the unit on a tactical time horizon of three days or so? After a ward-round up to date information has been gathered; so how may it be utilised to amend the prediction? Data over the same time is potentially available from the delivery suite, postnatal ward and e-CAM system. The East of England ambulance service has this latter information system which describes the reason for conveyance of patients to hospital, their age, condition, destination whether A&E or delivery suite and estimated time of arrival. Of those being conveyed to hospital, deliveries within a certain time-span may or may not result. Women in early labour might phone ahead and be driven in by private car. The e-CAM system has permitted capacity management and trend analysis in Oxford.

What is the most, least, commonest and safely probable amount of work expected? Does occupancy influence rate of change through level of care? (It is known to influence overall neonatal admission and discharge thresholds (Profit, 2007)). Given the admission of patients with a certain probable pathway, do we make a downstream problem certain? Unless the need for emergency care has arisen through poor care, we cannot influence its demand, yet we can predict where it will lead. Where the need for emergency care has arisen due to avoidable complications due to inadequate skills or numbers of staff, then a vicious cycle operates; how much do lapsing operational standards contribute to workload?

What are the background rates of change for level of care expected based on past data? How will cot occupancy change in one, two and three days' time? (It is known that a

long stay at intensive care predicts a long stay at High dependency care (Adeyemi, 2010)). Can we deliver the baby and when, or do we move out in-utero? Can we repatriate or do we refuse? Must we have a capacity transfer? Do we need to flex up nurse numbers at some time in the future?

To illustrate this work, we take an exemplar real-world problem with which the clinician may be faced. It is Monday. A 32-week IUGR mother is in labour. The obstetrician needs to section 29 week triplets this week. They could all need initial ventilation but will likely quickly become High dependency care. Which day is it best to deliver them? What happens if they are born before this? Current occupancy is 1 ICU cot, 1 HDU cot and 15 special care cots. Unit is configured for 1 ICU cot, 3 HDU cots, 17 special care cots.

Should nursing numbers be flexed up? When is this possible?

What emergency arrivals and routine discharges are envisaged?

Who at which level of care is awaiting repatriation?

What happens if there is a power-cut, or if we close one area due to an outbreak of infection?

6.5.1 Forecasting High Dependency cot Demand

Some underpinning points on the Tool are now brought together:

1. The primary outcome measure is the forecast for High dependency cot demand in upcoming days up to four.
2. The secondary outcome measure is the forecast made for intensive care cot demand over a similar time-spell. It is not reported here.
3. The local neonatal unit is assumed to be occupied at the beginning of the study period. Further assumptions made have been covered in Section 6.3.3.
4. Various pre-existing combinations of intensive care and high dependency cot census, unit over-capacity and the arrival of multiples like twins and triplets are scenarios up for consideration.
5. The system diagram has been shown in Section 6.3 Figure 80. The systems diagram helps to validate the logic or interactions between levels of care on which the model rests.
6. The notation has been defined in Section 6.3.2 Table 35. The principles of the calculation in a general form are given for proof of concept in Section 6.5.2.
7. To assist understanding a worked example has been provided in Section 6.5.3.
8. Relevant data which is routinely collected is used to show how the model works.
9. The model has been input into Excel.
10. Whether the conceptual system is a good enough mimic of reality depends on validation. The examples could lead to further iterative calibration.
11. Other scenarios might be considered and a suitable dynamic model developed to enquire further into variability, given the fact our system is relatively small and both training and test data consequently limited.
12. Model performance can be compared with heuristic and dynamic approaches.
13. Further modification could be undertaken on an individual in-patient's basis with other simple data such as Day of age, gestation and main diagnosis at High dependency. What-if? enquiry could stress-test the system for when cots are closed due to events such as an outbreak of infection, power outage, staff sickness or triplets arriving.
14. Explanation is offered on how the model operates and how it could change.
15. This model might have been implemented and audited on the unit had the managers supported that.

16. Further refinement might adopt the standpoint of various scenarios such as unit already full and arrivals bringing multiples.
17. The model might provide evidence for a business case on high dependency cots.

6.5.2 Probability and proof of concept

$$H_t = H_a + H_s + I_d + S_d - H_d$$

The census at time t of High dependency cots, H_t combines arrivals and stayers less leavers. Arrival sources are patients being delivered and repatriated at High dependency care level, H_a and those joining, previously having arrived at Intensive care level, I_d and special care level, S_d .

To find H_o , count those patients currently having high dependency care. (This will normally be undertaken during the in-hours working day).

I_o is those currently having intensive care. If we know that the transport team is on its way to transfer out a patient at intensive care (for those gestations or weights which are normally initially ventilated in an intensive care centre, such as those below 28 weeks' gestation), then such I patients will not lead to a direct discharge to in-house high dependency care.

For $t=1$ day, I_d is the probability of those intensive care patients destined for high dependency care being in the last day of their admission. Now there are an annualised number of intensive care days comprising episodes of intensive care for patients. In theory one patient could have more than one episode of intensive care. Any intensive care patient we find is having an intensive care episode, which could be on its last day. The numerator for this time-spell is the number of individuals having intensive care episodes in the year, destined for transition to high dependency care.

$$I_d = \frac{\text{number of individuals having intensive care episodes in a year}}{\text{number of intensive care days in a year}}$$

number of intensive care days in a year

For $t= 2$ days, Id_2 is the probability of those intensive care patients destined for high dependency care being on the penultimate day of their admission. This cannot occur if the patient is only staying on intensive care for a day so those episodes are excluded from the numerator.

$$Id_2 = \frac{\text{number having intensive care episodes in a year} - \text{episodes lasting one day}}{\text{Number of intensive care days in a year}}$$

Number of intensive care days in a year

For $t= 3$ days, Id_3 includes the probability of those intensive care patients destined for high dependency care and being on the day before their penultimate day on intensive care. We exclude those stays of exactly one and two days

$$Id_3 = \frac{\text{number having intensive care episodes in a year} - \text{episodes lasting 1 and 2 days}}{\text{Number of intensive care days in a year}}$$

Number of intensive care days in a year

Now we consider those patients who arrived at special care who later need High dependency. Rather than regard this like the discrete events of intensive care patients moving to high dependency care, since there is always a pool of special care patients in a local neonatal unit, S_d could just depend on time elapsed. So then the likelihood of any patient moving from special care to high dependency care is greater if a longer time interval is taken within a tactical time horizon.

$$S_{dt} = \frac{\text{number of special care patient transitions to high dependency care in one year}}{\text{Number of days in year}}$$

Number of days in year

$$S_{d2} = 2S_{d1}$$

$$S_{d3} = 3S_{d1}$$

If this proportion is small, then the chance of two patients moving from special care to high dependency care in this interval is small (unless perhaps the arrival to special care has been a multiple delivery).

For any individual, once their Length of Stay on special care has been long enough, then there will never be a need for High dependency care: twenty days in our case (Quantitative Analysis Chapter Section 5.7.6 Figure 61).

Finally we turn to the H census itself. We have shown the contribution of Id and Sd. We have found H census at t=0. For Hs1, this is the probability of not leaving after just one day.

$$Hs1 = 1 - \frac{\text{number of individuals having high dependency episodes in one year}}{\text{Number of high dependency cot days in one year}}$$

For t= 2days,

$$Hs2 = 1 - \frac{\text{number having high dependency episodes of two days or more in one year}}{\text{Number of high dependency cot days in one year}}$$

To be remaining on high dependency care at t=2 days, the stay cannot have been only one day.

A similar argument is taken for t=3 days, where

$$Hs3 = 1 - \frac{\text{number having high dependency episodes of three days or more in one year}}{\text{Number of high dependency cot days in one year}}$$

6.5.3 Worked Example

An example worked during the exploratory analysis investigating 2009 data (as summarised in Section 5.7.2 Figure 50) and validating this on 2010 data is shown for illustrative effect. Equations arising from this more limited data are set out in Table 55 in the Appendix and Table 39 following. (They are different from that presented in the final model, which follows in Section 6.6 and incorporates training data from 2009-11.)

Now supposing today's cot census is one intensive care and four high dependency patients, i.e. full, what is the chance of High dependency cot shortage in two days' time?

From the census, up to 4 patients could stay at high dependency care, Hs.

Either the intensive care patient will move to high dependency or they won't.

A patient could move from special care, Sd. This is uncommon so the possibility of one only is considered over this short time horizon.

For arrivals direct to high dependency care, where the inter-arrival time is known, a linear model is assumed.

So the sum of arrivals at high dependency direct and from special care could be 0, 1 or 2 patients.

From past occupancy data, Figure 40 in Section 5.6.2, the range of potential patients at high dependency is 0-7, but which is the most likely forecast?

The output parameters for the model are probabilities for 0,1,2,3,4,5,6 and 7 patients in High dependency.

Apply the prediction equations (See Appendix Table 55), use the Binomial Theorem (See Appendix Tables 55-6) and do the calculation (which is tedious). That calculation for the model's prediction based on 2009 data appears in the Appendix Table 57. The forecast is 14%. See Figure 91 and Table 38 which follow. The actualite was 11%. Actual 2010 occupancy data was looked at for all of the instances of one intensive care and four high dependency care cots being occupied and what actually followed after 48 hours in the data.

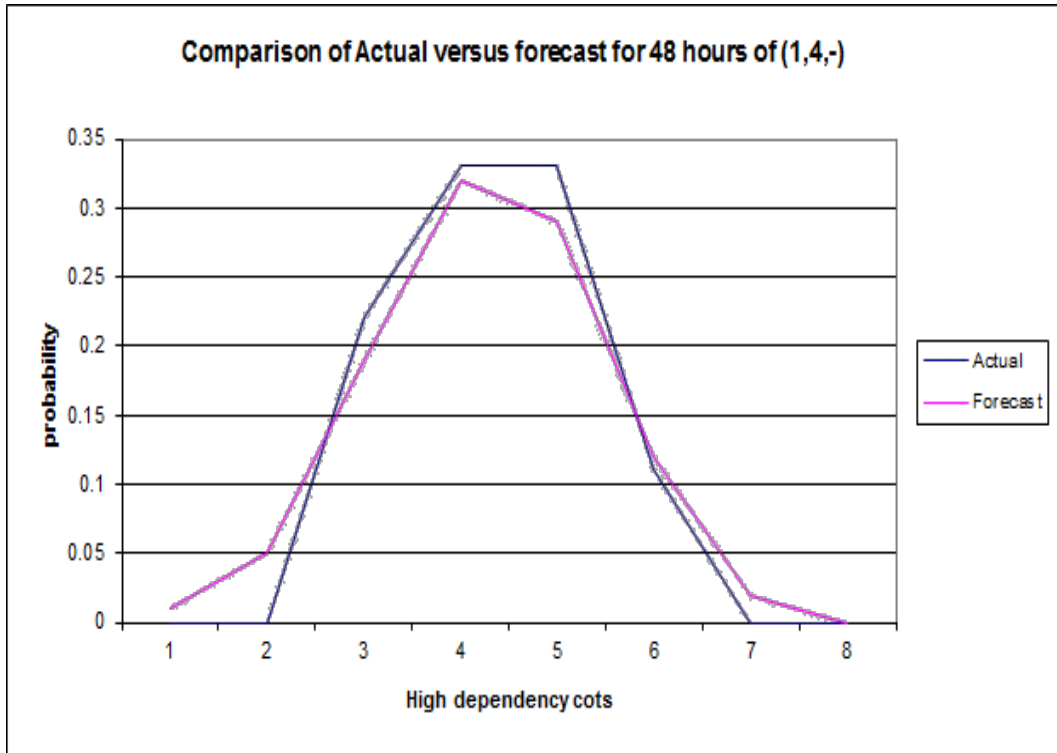

Figure 91 Worked Example Forecast validation

2 day forecast for High dependency cot demand for census 1,4,15					
Actual 2010		Forecast (%)			
0	0	0.01			
1	0	0.05			
2	0.22	0.19			
3	0.33	0.32			
4	0.33	0.29			
5	0.11	0.12			
6	0	0.02			
7	0	0			

Table 38 Validation of Worked Example Forecast

Derivation of probabilities from data. Exploratory analysis
Please see Mover-Stayer Model of 2009 SEND data in the Quantitative Analysis Chapter Section 5.7.2 Figure 50.
Arriving at High dependency care, Ha
0.27 of the 90 patients passing through High dependency care entered at this level.
$0.27 \times 90 / 365 = 0.066$
Ha1=0.066
Over two days this is twice as many and over 3 days, thrice.
Ha2=0.132
Ha3=0.198
High dependency stayers, Hst
Day on day 0.81 of high dependency patients stay.
Hs1=0.81
After 2 days, the proportion staying on high dependency care is 0.81×0.81 . Hs2=0.66
After 3 days, the proportion staying on high dependency care is $0.81 \times 0.81 \times 0.81$. Hs3=0.53
Leaving Intensive care for high dependency care, Idt
Day on day 0.19 of patients on intensive care move to high dependency care.
Id1=0.19
Over two days this is twice as many and over 3 days, thrice.
Id2=0.38
Id3=0.57
Leaving special care for high dependency care, Sdt
Given our sample of 90 patients needing High dependency care, day on day 0.076 of the patients leaving special care will need high dependency care
Sd1=0.076
Over two days this is twice as many and over three days, thrice.
Sd2=0.152
Sd3=0.228

Table 39 Derivation of probabilities (exploratory analysis)

Figure 92 Timeline for census and forecasting

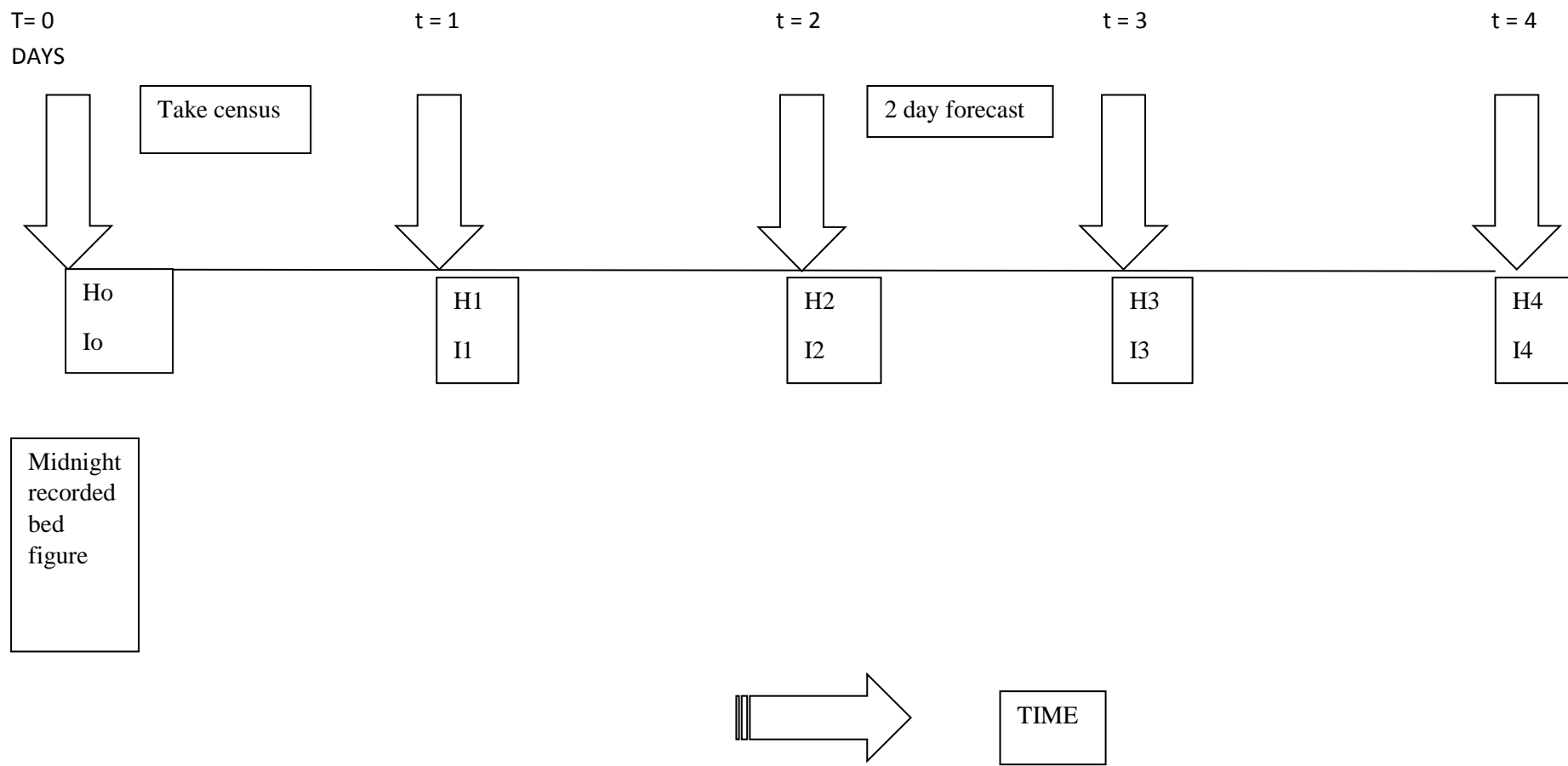

6.6 DETAILED TOOL SPECIFICATION

This Section specifies the detailed Tool based on 2009-11 data. The following Figures 93-6 show probabilities associated with High dependency patients as days pass over a tactical time horizon. Figure 93 shows the probability at a certain time of a patient arriving direct to high dependency care, H_a which is assumed linear, while Figure 96 shows those arriving there via special care, S_d which is near linear for Days 1-5. Since special care is always occupied, constant stocks are assumed here.

For an individual in High dependency, the probability of the duration of their Length of Stay is given, H stay in Figure 94. Those moving to High dependency care from intensive care, I_d have the probabilities for that transition given in Figure 95. Finding a patient in intensive care or high dependency care at the census is a discrete event; these cots can sometimes be empty. The foundations for these graphs are provided in the preceding Quantitative Analysis Chapter Section 5.7. The model and equations are summarised in Table 40.

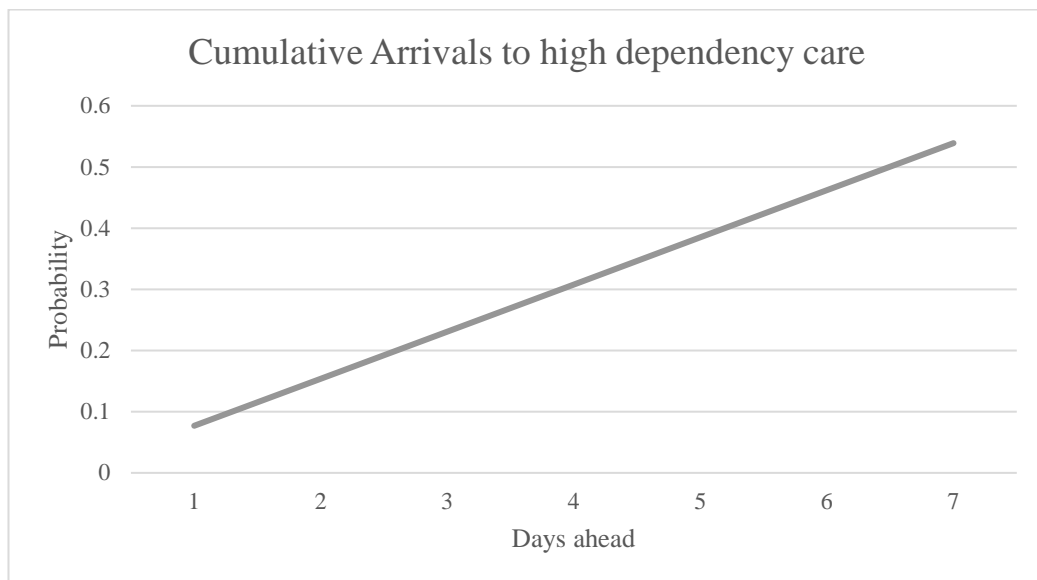

Figure 93 Accumulation of Arrivals direct to High dependency (Linear model assumed)

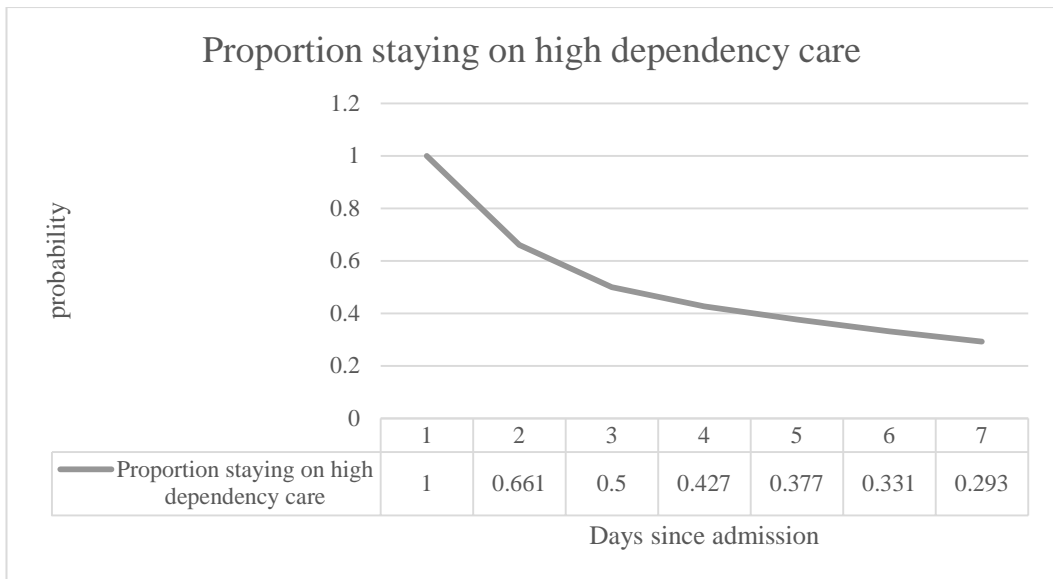

Figure 94 High dependency stay model

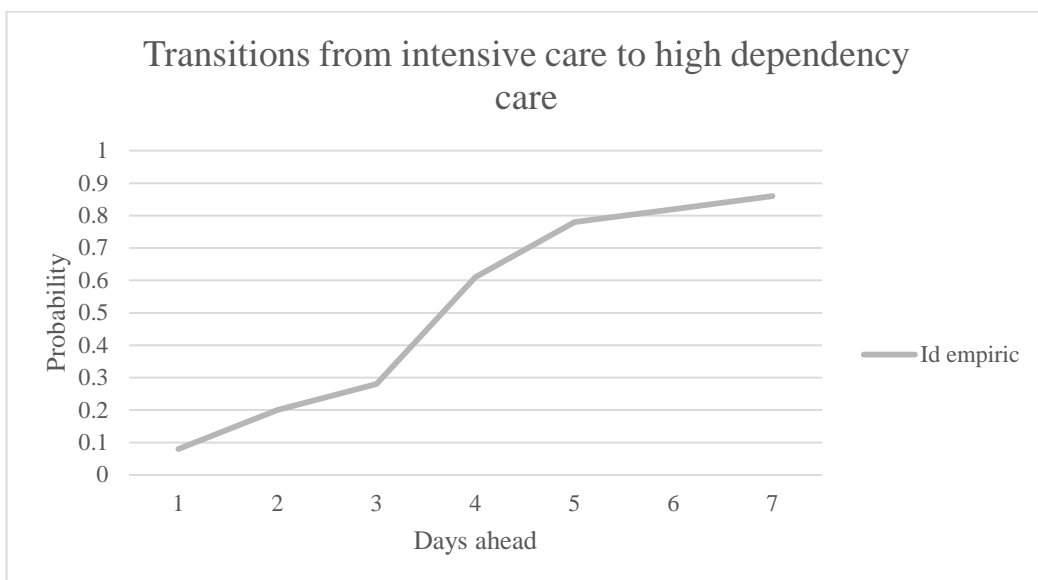

Figure 95 Transition from intensive care to High dependency model

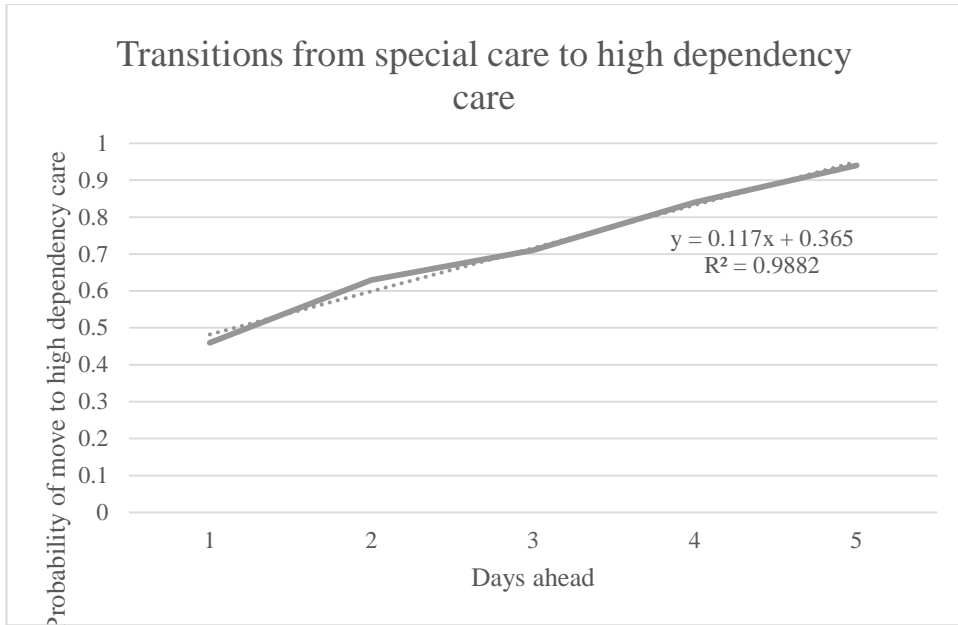

Figure 96 Transition from special care to High dependency care model

Summary of model and equations

t (days)	1	2	3	4	5	6	7	Equation or empiric	
Ha	0.077	0.154	0.231	0.308	0.385	0.462	0.539	y=0.077t	
Hstay	1	0.661	0.5	0.427	0.377	0.331	0.293	empiric	
ld	0.08	0.2	0.28	0.61	0.78	0.82	0.86	empiric	
Sd	0.46	0.63	0.71	0.84	0.94	0.94	0.96	empiric	
Sd	0.48	0.6	0.72	0.83	0.95	no	no	y= 0.117t + 0.365	for t=1-5

Table 40 Model Expectant probabilities over 7 day horizon

The Cot Predictor Tool is re-iterated, populating it with the quantitative modelling:

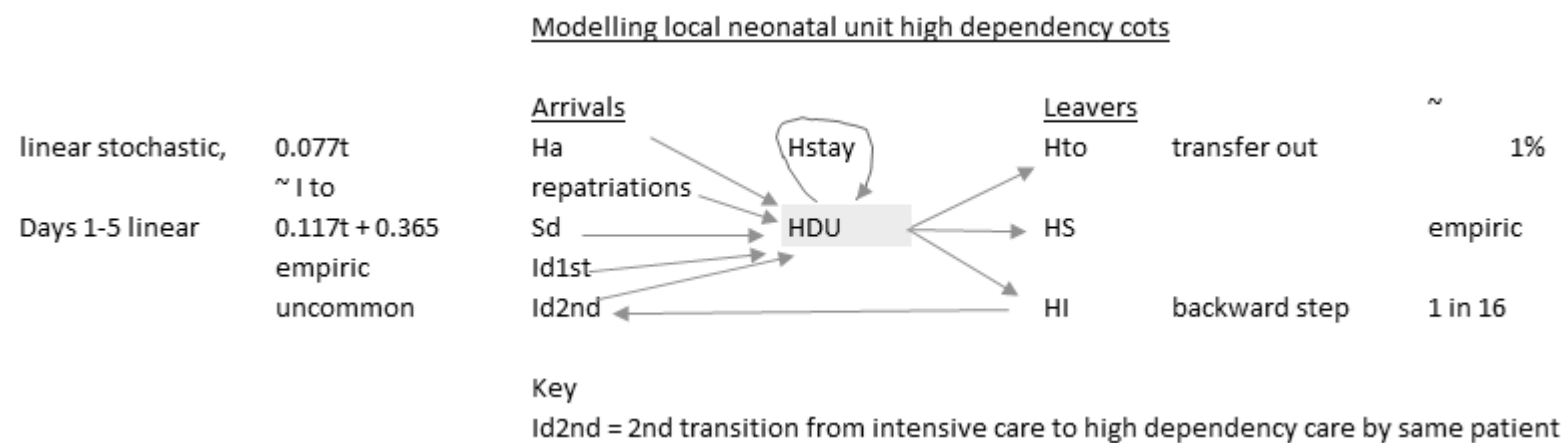

Figure 97 Cot Predictor Tool - populated

6.6.1 Distributions for Parameters

The day to day probability of the particular Patient Transition (given the patient having any stay on High dependency) is expressed. The first letter is the origin. The second letter indicates the destination. These figures also provide the basis for the design of Dynamic Models discussed in the next Chapter.

Parameter	Distribution	Empiric Parameters	Standard deviation	Gestational profile (weeks) Most probable (and lower bound)
Ia	Empiric probability	0.415	0.06	28
Ha	Linear stochastic	0.31	0.04	29
Sa	Empiric probability	0.275	0.08	35 (>32)
Day to day changes				
I stay = II	Negative exponential	0.705	0.02	30 (>27)
H stay = HH	Negative exponential (~ power)	0.815	0.01	30-32 (>29)
S stay = SS	Long-tailed empirical	0.865	0.02	34-35 (>29)
Id = IH	Empiric probability	0.14	0.03	31 (>28)
IS	Empiric probability	0.061		33 (>31)
Id2nd	uncommon			
Ito	Empiric probability	0.0575	0.02	27
HI	Empiric probability	0.011		31 (>29)
HS	Empiric probability	0.123	0.01	37 (>29)
Hto	Empiric probability. Ad hoc	0.0105		29
SI	Empiric probability	0.0045	0	
Sd = SH	Empiric probability	0.062	0.01	29
SHome	Empiric probability	0.062	0.01	36-37 (>34)
I occupancy change	Normal		Not calculated	N/A
H occupancy change	Normal			
S occupancy change	normal			

Table 41 Distributions for Parameters Summary

6.7 FURTHER DEVELOPMENT OF THE TOOL

In the case of in-patients if you know their date of admission, then you have information on their elapsed Length of Stay at that care level. Therefore using the Quantitative Analysis Chapter Figures 59, 64 and 53 (in Sections 5.7.5, 5.7.6 and 5.7.4 respectively) on probability of a move from intensive care or special care to High dependency care and the probability of leaving High dependency care in the next 24 hours, may inform the individual estimate. The case mix of different ages of neonates will make the calculation quite onerous. There will be a tipping point between feasibility and granularity although pre-calculated algorithms for common possibilities could help.

The model can be applied where the only knowledge to hand is census and basic information on gestation at birth, date of birth and so age in days. At admission the patient is an unknown individual in the catchment population, yet medical knowledge of the neonate accrued over the following days of their stay will supersede that. Once you get to know the neonate's difficulties and the pathway of care they are following (for instance that of Chronic Lung Disease) then their contingent rate of progress can become more obvious. Heuristic predictions by clinicians due to their assimilated on-the-spot knowledge might then produce a better estimate than a model. Yet managers would need to afford them the time for this; staff cannot plan when there is no redundant capacity or idle time.

Additional medical information could help refine the Tool's effectiveness. The model might incorporate obstetric information such as mode of delivery, APGAR, cord gas, past obstetric history, maternal drug history and medical diagnoses e.g. diabetes, obesity, addictions and past prematurity. It might also draw upon the information on Length of Stay given Diagnosis presented in the Quantitative Analysis Chapter Section 5.8.1.

Various refinements are possible:

1. Batched arrivals (twins and triplets). These can often strain the system.
2. Extend training data set by another year so we have 2 years' training data and 1 year test data.
3. A better fit. We should beware not to over-fit or calculate small probabilities.
4. We have taken into account time and level of care for the population.
 - i) Other features to be considered will be kind of High dependency care: for example CPAP (short-term and long-term i.e. for Chronic Lung Disease), long-line TPN and NAS (Neonatal Abstinence Syndrome)
 - ii) Corrected Gestation
 - iii) time already spent since admission

6.8 EXTENSIONS OF MODEL WITH MEDICAL KNOWLEDGE ON INDIVIDUAL PATIENTS

So far this Tool has included knowledge of census, past annual history for that population at the local neonatal unit and time. It thus disregards changing future trends in population growth, treatment practice or policy and medical knowledge of the individual patients currently on the unit.

Diagnosing different conditions alters the survival curve at High dependency care (Section 5.8.1 Figure 66). (These are for oxygen and non-invasive respiratory support namely CPAP for acute and chronic respiratory distress, low birth-weight and necrotising enterocolitis and neonatal abstinence syndrome). Please see Figure 70 showing the reasons for High dependency care: on oxygen, intravenous feeding and close observation. Adding a complication like sepsis or finding CLD or NAS leads to prolonged lengths of stay (Figure 69).

Were there sufficient resources available to look at critical care patients in more detail, then their probabilities of leaving intensive care for High dependency care or staying on High dependency care could be taken into account using readily available information, some of which is described below:

Is the arrival expected a multiple – twin or triplet?

Triplets will be sectioned and more likely to need respiratory help.

Multiples will be smaller and more likely to need intravenous feeding support.

What is the incoming gestation and expected size based on ultrasound growth monitoring?

Smaller babies more likely to need intravenous feeding support.

Younger gestations more likely to require respiratory support.

Appendix Figure 104 can help the clinician predict the likely incoming care level by gestation, given known historical information.

What day of life is it? The following is derived from data supplied in the Quantitative Analysis Chapter Sections 5.6.1-3.

96% of special care babies bound for high dependency care first move there by Day 7.

85% of intensive care babies bound for high dependency care first move there by Day 5.

96% of high dependency care episodes are for less than 20 days.

What is the oxygen requirement of a ventilated (intensive care) patient? Medical knowledge can help.

If below 30%, probably improving so extubation might be possible tomorrow.

If above 30%, further treatment and weaning of ventilation will be required prior to extubation and a step down to a lesser care level.

What is the base excess on a blood gas of a CPAP patient? Medical knowledge can help.

If negative patient could be in special care tomorrow.

If positive, unlikely to be in special care tomorrow.

For high dependency care, why is this level of care needed? Medical experience is assumed.

Is it for Neonatal Abstinence Syndrome at term for which a social worker and a discharge planning meeting would be needed? Prolonged stays are associated with this group.

Is it for continuous CPAP for chronic lung disease or cycling CPAP if weaning from this level of support?

Is the CPAP treating a milder case of acute respiratory distress syndrome? If so, likely to be short-lived.

Has intravenous nutrition through a long line been needed for small size or possible necrotising enterocolitis? What course is envisaged?

Here graphical plots of probability against logarithmic time could help.

6.9 SUMMARY

This Case Study focusses on High dependency cot use in an English local neonatal unit. Using data routinely collected in the Standardised Electronic Neonatal Database (SEND) for 2009-2011, a model has been developed mimicking Patient Flows to and through High dependency care, the chief node in our system. Although we have to immediately accept all demand for intensive care and special care cases, there is some latitude to control High dependency traffic in regard of repatriations and elective deliveries. Having warning of a certain sustained cot block might permit flexing up of nursing staff in the near future in order to better match Demand.

So how do you predict High dependency cot demand in upcoming days? Empirical data on Patient Transitions and survival curves have extended understanding. Forecasts can be modified according to the reason for High dependency care. The pattern for Diagnostic Groups such as Respiratory Distress Syndrome, Chronic Lung Disease, suspected Necrotising Entero-Colitis and Neonatal Abstinence Syndrome is available in the Quantitative Analysis Chapter Section 5.8.1.

Corrected Gestation at birth, plurality, abnormally low weight, age in days, census, origin, destination and the past pattern of the system are taken into account. Use is made of probability theory, normal and binomial distributions and mathematical modelling to help predict the likely future situation and attendant nursing resource demand in upcoming days. An example scenario is solved and validated, showing the methodology, its applications and shortcomings. The Cot Predictor Tool is able to provide input data for a Dynamic Model, whose Design is presented in the next Chapter. This might help overcome the pitfalls of the Cot Predictor Tool, which is clunky since analytical and whose pool of data for training and testing is limited.

The Cot Predictor Tool offers an elementary solution to the unique challenge of forecasting High dependency demand in the local neonatal unit within the Perinatal Network System. SEND informatics has been exploited to provide inputs (Conceptual Framework Model 7) for a detailed-level illustrative prototype Decision support tool. A Dynamic model could assist clinicians to predict and map cot activity and originally, attendant skilled nurse staffing over a tactical time horizon and permit reconfiguration

of resource constraints (Conceptual Framework Model 8). Its Design is discussed in the next Chapter.

CHAPTER 7 DYNAMIC MODELLING

7.1 INTRODUCTION

High dependency cot activity by corrected gestation and patient pathway in the local neonatal unit has been studied. A Markovian model can assist an understanding of how cots are utilised by this population and how one might forecast short-term Demand to avoid capacity going short for these cots.

Patient Flows between levels of care within the local neonatal unit can be modelled using Markov chains. The model has face validity and is verifiable by clinicians. It allows a prediction of High dependency occupancy given a starting census.

First we discuss the Dimension of Time, then consider the foundation for Markovian methods, which underlie a dynamic model like Monte Carlo Markov.

7.2 DIMENSION OF TIME

The problem distils to “Time in system” since resources (such as nurses) and cot configuration follow from that. Time is real, experienced continuously and may be modelled in discrete or continuous time. Dynamics may be incorporated through System Dynamics and Markov Chain modelling in continuous time.

The time in the cot: whether intensive care, High dependency or special care is led by diagnosis and is summarised by gestation here. Relevant data fields are LOS, diagnosis and/or complications. LOS is broken down by level of care, Corrected Gestation and patient pathway. Where LOS follows a negative exponential distribution, then this permits its modelling in real-time.

The local neonatal unit is dealing only with small numbers of patients and so proportionately more vulnerable to random fluctuation compared with the larger (intensive care) centres. Variability may be expressed using Bayesian statistical summary measures such as maximum, minimum and median. Aspects which are

uncertain include stochastic arrivals, the particular mix of diagnoses / social problems on the ward at one time and complications prolonging LOS.

Events which are predictable include:

Screening detects a certain proportion of congenital abnormalities

Rates of prematurity in population

Planned Caesarean deliveries

Duration of normal patient pathways given medical diagnosis

Behaviour of premature babies given gestation

Resource planning should also occur.

7.3 MARKOVIAN MODELLING

Markov processes provide insight into background rates of how patients move through this system (Norris 1997). For the admitted neonatal population, the memoryless assumption is made in order to help conceptualise dynamism into this model. Day to day midnight bed figures are used in a discrete Markov chain model.

Markovian methods namely Markov Chains and Semi-Markov processes were applied and detailed balance equations compiled. With a semi-Markovian approach, first the destination is chosen then the probability of going there.

Both time in the system and time before return to a particular care level were derived. Martingales approximate average rates of patient transit. Assuming day to day homogeneity, using martingales as a way of visualising average patient pathways, the number of days required to achieve a stationary distribution of cot kinds were calculated. The system is tending toward that steady state but never reaching it perhaps owing to both fluctuations and its small scale.

Variations exist and such transitions may become more or less likely over time for a patient; here sub- and super-martingales might assist an understanding of these trends. For those patients joining the system at intensive care or special care level and subsequently needing high dependency care, super and sub-martingales respectively

could be a useful way of visualising these patient transitions since longer stays at intensive care make high dependency care certain, whilst longer stays at special care make high dependency care unlikely. This is intuitively correct since the longer you ventilate a neonate, the greater is the chance of Chronic Lung Disease requiring non-invasive respiratory support. The longer their stay at special care, then the more likely they are to have a stable condition which does not relapse.

So the underlying behaviour of the local neonatal unit system was tending to settle down: the invariant distribution of time in the system was eleven days (calculated with a programmable calculator using the Markovian matrix given in the Quantitative Analysis Chapter Section 5.7.2 Table 23 and reproduced here on page 238). Thus the actual characteristics of system behaviour have been determined by Markovian methods (Model 5 Conceptual Framework).

Markov transition and embedded matrices with their probabilities were compiled for all 2009-11 SEND data. Admission and change in level of care by corrected gestational age were investigated and a hierarchy formed for the frequency of these events. A Markov transition matrix for corrected gestational age was found (Table 42).

Corrected Gestational Age (weeks in the range 27 – 37 weeks) for the Patient Transition event: i) Most probable ii) and shown below lower bound, if different						
		to				
	transition	Intensive care	High dependency care	Special care	Transfer out	Home
from	Delivery	28	29	35 (>32)		
	Intensive care	30 (>27)	31 (>28)	33 (>31)	27	
	High dependency care	31 (>29)	30–32 (>29)	37 (>29)	29	
	Special care		29	34–35 (>29)	31	36–37 (>34)

Table 42 Corrected Gestational Age (weeks) at Transition in level of care

Discharge home, transfer to a different hospital and death all represent absorbing states within a Markov model. Each care level represents both a transitional and communicating state. The unit of time over which data is recorded is one day. The midnight record of data produces the daily care level. The nursing standards for level of care which applied during that time (British Association of Perinatal Medicine 2001) were used.

Transitions between levels of care were recurrent, aperiodic and communicating and so ergodic. For the purposes of forecasting cot demand over a 72 hour period, we may assume that the system is aperiodic, random, ergodic and memoryless. Now it has been found that a longer stay at neonatal intensive care predicts a longer stay at high dependency (Adeyemi 2010) and barotrauma risks chronic lung disease. Were this memoryless assumption to be challenged, then this could be addressed by introducing additional categories into the model, as per tenet II-7b of ISPOR-SMDM (2012). Such a compartmental model would have less restrictive assumptions (Utley, n.d.).

If a long enough time-spell is studied, then one can assume that those admitted are discharged and a steady state census could be reached. We studied High dependency for 2009 and 2010 where numbers spending at least one day at that level were 90 and 76 respectively, i.e. small. With larger numbers, equilibrium might settle more. The mean first passage time would be the expected number of transitions before reaching a particular state, for instance going home. The average Length of Stay at each level of care can be broken down by gestation. Given equilibrium conditions, the starting point within the system could be irrelevant. The expected number and duration of transient states before the absorbing state of discharge (whether transfer out or home) might be found, taking into account the corrected gestation for the individual at the time.

What a Markov approach can offer is:

- prediction of steady state cot equilibrium configuration for the local neonatal unit
- invariant behaviour / stationary distribution
- time to reach steady state
- mean first passage time
- average time before transition to next level of care
- time to discharge in number of days
- “hitting probabilities”
- Insight into common pathways and proportions that are either atypical or normal

So the relative risk of arrival at a particular level of care, given factors such as corrected gestation, (mode of delivery, condition at birth (APGAR score), maternal drugs and size) can be found. The chance of particular transition to a different level of care by corrected gestation and/or given preceding duration of stay may be calculated. Such a model is then extended based on individual patient knowledge. The following questions might be addressed. Given gestation at arrival, corrected gestation, birth-weight, age in days, level of care, what is the patient’s expected Length of Stay? (Schulman 2006) Given cot census, what is the prediction for cot activity and staffing over a certain time horizon?

We can derive and solve equations to find the ratio of the different kinds of cots required. There are fifteen kinds of patient transitions and certain probabilities exist for their iterations. Please see again this matrix in Table 43. (See Notation Key in Cot Predictor Chapter Section 6.3.2.)

Day to day Patient transitions 2009-11 N=7071		To			
		Intensive care I	High Dependency H	Special care S	Transfer out to
From	Intensive care I	II 0.735	IH 0.156	IS 0.061	Ito 0.048
	High Dependency H	HI 0.009	HH 0.827	HS 0.155	Hto 0.009
	Special care S	SI 0.004	SH 0.057	SS 0.887	Home 0.052
	Transfer in a = arrival	Ia 0.444	Ha 0.303	Sa 0.253	-

Table 43 Patient Transitions Matrix

A martingale based on average flow and transitions over three years is shown in Table 43. This can help predict cot requirement from activity. A Markov chain has no memory. A semi-Markov model (Figure 98 following) allows one to determine destination then the conditions for going there; this could be a useful model for the sub-group of the population who cycle back and forth and suffer multiple readmissions to High dependency care. These are patients with Chronic Lung Disease and Neonatal Abstinence Syndrome.

Events may be common, rare or intermediate and occur with similar probabilities year on year i.e. stayers at special care (See Appendix Figure 108). One can find balancing equations, in which patients arriving at a particular level of care will leave these transient states, for example:

$$Ia = IS + IH + Ito$$

$$Ha + IH + SH = Hd$$

$$Sa + IS + HS = SH + SHome$$

Proportion whose condition is:	Same	better	worse
Intensive care	0.78	0.22	-
High dependency care	0.84	0.15	0.01
Special care	0.89	0.05	0.06

Table 44 Condition next day

Table 44 shows that, day on day with inertia, the likelihood is that the patient repeats a day at the same level of care. Transfer out from intensive care is about 5%. Transfers out from HDU are about 1%. Discharge home from special care is 5% of the proportion per day.

Of intensive care patients 16% go to high dependency care while 6% go straight to special care. (Yet the data sample implies at least one day on H, so it follows that the patient joining has been H>I>S or will be I>S>H).

Of High dependency patients about 1% go to intensive care, while 15% go to special care.

Of special care patients less than 0.5% need intensive care but about 6% need High dependency care, which appears to be a high figure and one for which quality improvement might be made.

We can derive and solve equations to find the ratio of cots required at each level of care for those spending at least one night at High dependency care. This generates four equations in three unknowns, as for the *notional* closed system using 2009 data:

$$q_1 = 0.75 q_1 + 0.16 q_2 + 0.05 q_3$$

$$q_2 = 0.01 q_1 + 0.83 q_2 + 0.14 q_3$$

$$q_3 = 0.002q_1 + 0.06q_2 + 0.89q_3$$

$$q1 + q2 + q3 = 1$$

and gives

$$q1 = 11/39$$

$$q2 = 1/3 = 13/39$$

$$q3 = 5/13 = 15/39$$

where $q1 : q2 : q3 = 11:13:15$ is the ratio for the cot days for I, H and S respectively.

2009-11 data	Cot days	Desired ratio	Ideal cot ratio
Intensive care	585	11	1
High dependency care	2476	13	5
Special care	3965	15	10

Table 45 Cot Configuration Ratios

We are talking about the group which had any high dependency care. Even disregarding the unit's fluctuations until its theoretical steady state is reached, the High dependency cot allocation of four appears insufficient to permit free patient flow.

(A similar approach based on historic data could be used for those moving direct from intensive care to special care *were* enough data on this group to become available in the future).

Cot Demand

About 11% of neonates born require neonatal unit admission. For these admitted arrivals:

Intensive care need:

44% of arrivals, 73.5% of existing, 0.9% H, 0.4% S.

High dependency care need:

30% of arrivals, 83% of existing, 16% I, 6% S.

Special care need:

25% of arrivals, 89% of existing, 6% I, 16% H.

The proportion of those leaving the care level are:

Intensive care leavers: 26.5%

High dependency care leavers: 17%

Special care leavers: 11%.

For equilibrium balance the demand with the leavers in which B denotes arrivals:

$$0.265I = 0.44B + 0.009H + 0.004S$$

$$0.17H = 0.3B + 0.16I + 0.06S$$

$$0.11S = 0.25B + 0.06I + 0.16H$$

This produces a ratio of B: I: H: S of 1225: 7:24: 42 which reduces to:-

175: 1: 4: 6

This gives the steady state but there is a need to either allow for fluctuations, or enforce a rule that over-capacity occupancies are either not tolerated or provided for with essential resources. The following data from 2009-11 indicates that rules were broken on maximal cot occupancies:

Intensive care: maximum 7, minimum 0.

High dependency care: maximum 7, minimum 0.

Special care: maximum 21, minimum 2.

Combining these two analytical estimates in order to offer system tolerance yields:

Born, requiring any High dependency care	Intensive care Cot number	High dependency care	Variation in high dependency cot requirement	Special care range
175	1	4 - 5	1	6 - 10
350	2	7 - 9	2	12 - 17
525	3	11 - 13	2	18 - 25
700	4	14 - 17	3	24 - 33

Table 46 Cot Configuration tolerances

As shown by the Quantitative Analysis Chapter Section 5.6.1 Figure 38, four or more intensive care cots are occupied 2% of the time. The cot configuration chart above (Table 46) shows that the High dependency cot base should be extended by one. In addition one high dependency cot should be kept free for emergency admissions, as

per Section 6.3.6 Figure 86. This might equate with an additional neonatal skilled nurse per shift. One alternative might be amalgamation with another neonatal unit. The status quo position is to do nothing and leave episodic shortage of capacity to chance. In the light of this knowledge, this kind of inertia is unethical and perpetuates poor quality of care.

So we undertook some data-driven work looking at utilisation of high dependency cots and patient journeys through the local neonatal system and applied a Markovian model.

Figure 98 shows the pathways for those patients passing through High dependency care in 2009. This shows that a proportion are re-admitted to higher levels of care sometimes multiple times. These real-world pathways demonstrate that what occurs is more semi-Markovian than pure Markovian. Indeed Weiss (Weiss 1982) went to great lengths to outline all the conditions which must be satisfied to fulfil a Markovian approach. This is one reason for resort to those dynamic methods, which can apply statistical sampling like Monte Carlo Markov.

Figure 98 Semi-Markov model through the local neonatal unit 2009

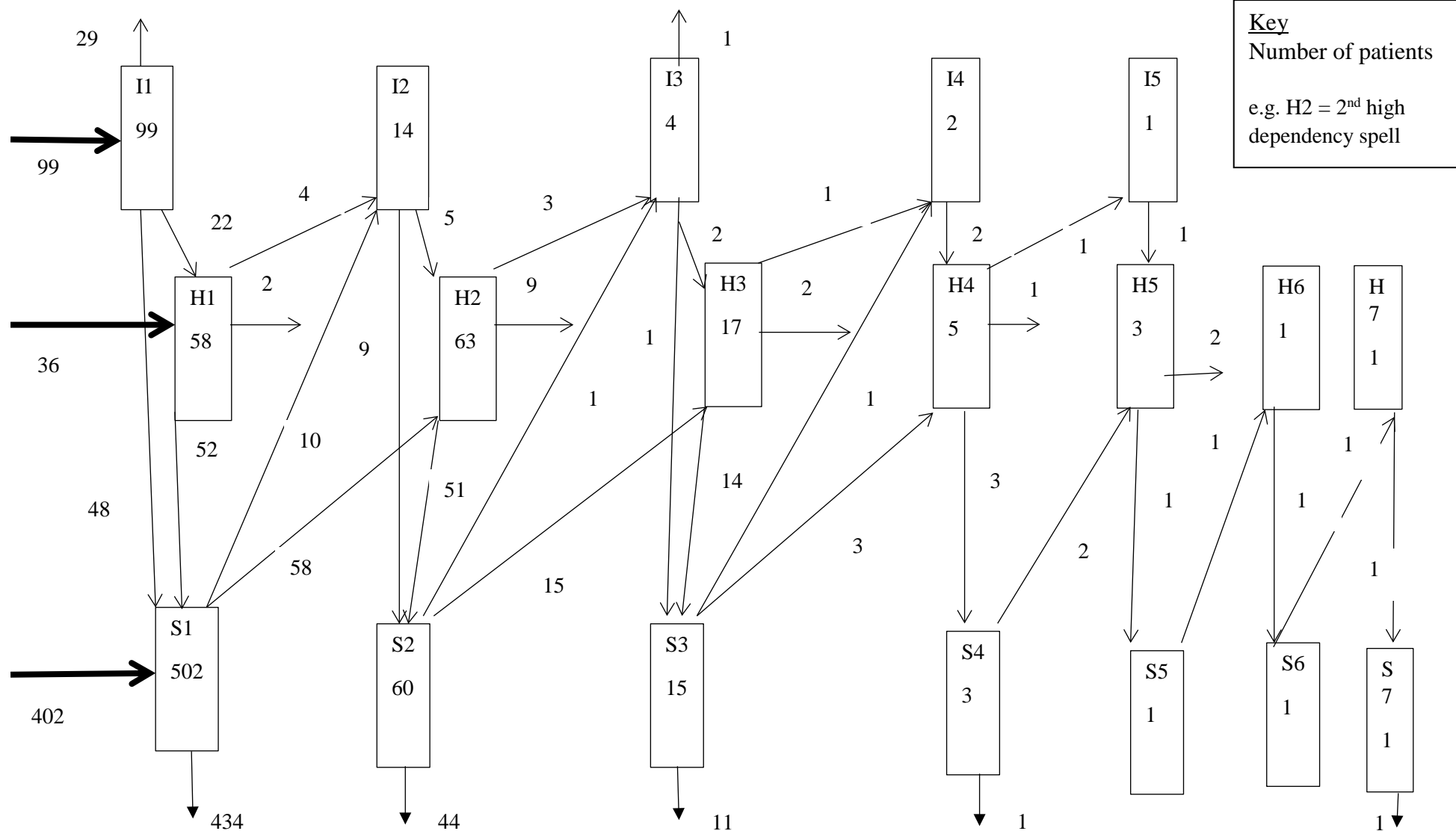

7.4 OTHER APPROACHES

A dynamic model or computer simulation of interactions between labour ward and the baby unit and between different neonatal units might offer one safe and credible way to improve efficiency in managing resources by harnessing information to support decision making. A computer Tool might promote better communication cross boundaries and help manage patient flow and for instance allow intensive care centres to give more consistent notice of a required repatriation so it can be clinically prioritised within the local neonatal unit's workload and vice versa. The investigation of such networking is a somewhat neglected area.

For High dependency cots, the local neonatal unit is a hub in the middle of the system for this increasingly used and longer duration form of care. One question to address is why high dependency cots in a local neonatal unit are not raised to avoid congestion? We have captured examples of bi-directional intra- and inter-hospital flows (and sub-optimal cases) whereas other work, such as Adaikappan's study using System Dynamics (2005), concentrated on within hospital forward flows to lesser care levels.

With such a specific and detailed approach as computer simulation, it is insufficient to have a lone clinician/ developer perspective; such a task would be better fulfilled by a team with coders. Research should not be isolated; development ought to be social and involve user/other viewpoints. Practical considerations of management support, funding, time and what the literature teaches in relation to implementation mean that dynamic modelling of High dependency cots in the local neonatal unit of the Perinatal network system is scoped and defined at the conceptual layer. It is with this caveat of feasibility that the following Design is outlined. It lays the foundation for a viewpoint from another angle.

7.5 DYNAMIC MODEL DESIGN

A Dynamic model studying detailed patient pathways is feasible. Computer simulation might facilitate understanding of how the Perinatal Network System works in regard of resource utilisation and time, which may be idle or spent by the patient at a particular level of care (El-Darzi et al, 1998) (Pidd, 2004) (Vasilakis et al, 2011). An existing computer simulation (Allen et al, 2015) is undergoing refinement, whose protocol has been published by NIHR (Villeneuve et al, 2015).

What could be done by way of dynamic modelling in this research is illustrated in the conceptual design domain here [Model 8]. It might further elucidate the system tolerances for High dependency cot configuration in the local neonatal unit just determined analytically.

7.6 DATA CONSIDERATIONS

Real data might be incorporated into the model, which could be used to optimise cot configuration in order to avoid baulking, queueing and bottlenecks. Input variables could be drawn from data presented in the Quantitative Analysis Chapter 5 of this Case Study. Distributions have also been given (Section 6.6.1 Table 41). In regard of stochasticity, up to 8 admissions a day have been observed. The System throughput estimate is about 400 patients per year. The system's warm-up time would need to be at least a 20% margin above that duration for the steady state to be reached: i.e. 11 days + 20% = 13-4 days.

For those arriving on the neonatal unit, their origin (delivery suite, antenatal ward, casualty, home), in-coming level of care and inter-arrival time is known. Any schedule of Caesareans could inform potential work.

For the nursing work, its priority, timing and distribution and their shift patterns might be considered.

Factors influencing Length of Stay include corrected gestational age, birth-weight, diagnosis and social situation as seen in Chapters 4 and 5.

Transfer metrics influencing the system include: time of request, delays and reasons, time of departure of transport team, travel time, time for stabilisation, handover time and whether in-utero or ex-utero.

When leaving the system, the LOS compared with the expected range for that gestation is a relevant metric.

7.7 INFORMATION CONUNDRUMS

It is useful to pose questions around the other way: can you re-create what actually happens from the data itself? Not quite. Data collection disaggregates sequential information in the Patient Pathway. Whilst for some purposes, this does not matter, the contention is that this under-estimates the effect of patient complications on service provision. Improved co-ordination and integration of data excluding its duplication are required.

What would the System be like if unbounded and free? The problem is that the data arises within the context of an already determined system (Utley, n.d.) somewhat constrained by its cot configuration; not that this is followed since service managers never do close a neonatal unit if it is overloaded.

Hospital data is from all. The ideal system would have neither suboptimal care nor avoidable patient complications. Service provision is for all but may become self-serving where the system itself causes patient complications and a need for its own service. This self-serving (or complication-generating) aspect is unmeasured, uncosted and unsustainable.

Backward steps do mean the patient stays longer. They include transitions from special care to high dependency or intensive care, from high dependency to intensive care after the first day and neonatal admission after Day 2 of life. This has been established in Section 5.9.

So it would be useful to know what proportion of work is generated by patient complications. By having sufficient staff for the cots which will surely be required, this would reduce complications, shorten Length of Stay, satisfy cot Demand and yield a virtuous circle (Systems Thinking concept).

To recapitulate, while each neonatal unit works autonomously, where capacity or expertise is exceeded, neonatal units within and between Perinatal Networks should negotiate and transfer work. Agent-based simulation finds application here to pool resources and improve Perinatal Network efficiency. The advanced behaviour of Agent-based choice is required to direct the patient through network, particularly when the neonatal unit interacts with external units. Yet rather than this being especially planned, in the real-world it is expedient and haphazard. Therefore there is room for enquiry, improvement and optimisation of this aspect.

7.8 POSSIBLE EXPERIMENTS, SCENARIOS AND EXTENSIONS

As an illustration of what could be done, the dynamic model might incorporate co-variates of patient attributes such as Gestation, as detailed in Section 5.8.4 Table 32 (and birth-weight, respiratory support and total parenteral nutrition (TPN)), which are clinically relevant.

Experiments could be run to look at system behavior, given common “What if?” questions, which arise in practice such as:

1. plurality especially triplets, which strain resources by batching care of premature neonates,
2. 2% rise in 30-weekers, which might increase demand for intensive care
3. unit closure or outbreak of infection, which lowers effective cot availability and might lead to transfers and increased need for transport resources
4. need for patient isolation, thus tending to increase the patient: skilled nurse ratio to 1:1,
5. six nurses on maternity leave,
6. pre-existing overload, which challenges critical surge capacity, flow, LOS and quality

7. 30% rise in community re-admissions, whom require isolation measures and so affect nursing ratios.
8. The tipping point for resources and activity below which small units become less economic and viable.
9. The unit configuration changed from 1:3:17:5 to 1:4:16, then 1:4:12. These were for intensive care, high dependency, special care and transitional care cots respectively. There was disinvestment in transitional care. The ramifications could perhaps have been explored in advance of the policy change.

What effect do these have on the toy system?

It was during 2011, that the policy change of a cut in four special care cots was imposed by managers. The role of community neonatal outreach nursing was extended to facilitate earlier discharge and mitigate the raised risk of re-admission. This kind of model might answer the “when” (rather than the “what if?”) question of how mean Length of Stay would need to fall to support the newborn within a similar population given that stringency. Such analysis could have usefully preceded that change.

As mentioned in Section 7.3, outputs such as cot utilisation, Patient journey time and density through the system (throughput), waiting (queueing) and proportion of time for which the system was over-subscribed and baulked, could be analysed. Reneging behaviour of the system might also be studied.

A possible application of Dynamic Modelling, for instance the Monte Carlo Markov method of simulation lies in using statistics to understand the system’s variability, for instance in the areas of occupancy, admission and LOS and then dynamically rather than analytically determine the optimal cot configuration i.e. the ratio between the different kinds of cots for the local population. It might also permit the assessment of Quality through determining the resources deployed on complications. This sort of development is discussed further in Section 8.9.

Would such a model be fit for purpose? Verification and validation may be by user, rule of thumb/ common sense or expert knowledge. Yet a model must not be refuted by real-world events. It could provide useful insight but would not be sufficient in itself chiefly due to behavioural aspects such as the influence of human and political factors to be discussed.

7.9 SUMMARY

The Markovian model design could help assess where capacity of the nursing resource in the English local neonatal unit is exceeded. Past experience tells us that this is sure to occur but the times are not well predicted. Once particular combinations of in-patients and destined arrivals co-exist, then a bottleneck is certain and predictable for so many days down the line. This information should be acted on by managers in a timely way and could be usefully known by other Agents in the System to allow load balancing within the Perinatal Network in order to keep cots open and Patient Flow running. Re-configuration of resources to mitigate extreme variability in the system could help all those subservient to it.

So the conceptual design for dynamic modelling might mimic the mechanics of the local neonatal unit and model its fluctuating demand for High dependency cots in particular. Next comes a Discussion, which incorporates the limitations, challenges and possibilities in such work.

CHAPTER 8 DISCUSSION

8.1 INTRODUCTION

The Discussion is a Retrospective. It is opened with the Limitations of methodology, which are described and suggestions made for their mitigation. Key results are interpreted. As ventured in the Literature Survey, a critique of the Conceptual Framework of this research is presented including its purpose, pitfalls, implementation and performance. Possible future enquiry is raised.

8.2 LIMITATIONS OF METHOD

The context, assumptions made in modelling, limitations of its practical application and sources of error are discussed.

Just one unit has been studied by a lone researcher. Like the stock market, past performance is not necessarily a guide to future functioning. This particular modelling is an “inside out” or “bottom up” approach. Where practice and policy change, predicting the future behavior of the system becomes less reliable so modification might then be needed. Validation would be required before application to another hospital. That would certainly need management support and ethical approval, which are slow.

Unlike the research of the Peninsula team (Allen et al, 2015), instead of looking at the journey times, which are largely borne by the parents and were a significant feature of that work, we concentrated more on the medical pathway. Complication rate is inversely associated with quality. Much variability exists. Unfortunately neonatal developmental outcome data is collected in a patchy and inconsistent manner across the UK. However significantly patients took backward steps in their pathways, which obviously added to their care needs, resource requirements and Length of Stay as well as adversely influencing the family experience. This has not been demonstrated or recognised to this extent before perhaps since a less microscopic analytical approach has hitherto been undertaken. The study of complications and backward steps in the Patient Pathway has significant implications for the resourcing of neonatal units, their outcomes, quality improvement and sustainability. Perinatal Medicine must not be self-serving. Any proposed introduction of seven day working could change the pattern of obstetric deliveries and so neonatal births, admissions and complications. Were the timing of birth less dependent on consultant obstetrician convenience, then it might be more influenced by consensus discussion of the needs not only of the mother but also the baby. Thus our work differs from that of the Peninsula team insofar as it seeks to fuse more local medical intelligence with operational information. Our findings do mean that backward steps taken in the Patient Pathway will increase Length of Stay and this contrasts with the assertion made by the Peninsula team when they ran their (reversible) Markov model backwards.

Further differences between this research and that of Pitt are that this was just one quarter funded by Colchester Hospital University NHS Foundation Trust and rejected by the local CLAHRC. Theirs was collaborative and supported by the NIHR. This breaks down gestation by the week; theirs also combines these categories. Theirs looks from the national, central and network perspective. This looks from the distributed local neonatal unit perspective; the argument as to why this is important has been eloquently made by Wolstenholme (2007) as discussed. Further they look at location and transfers; this focus is more on quality.

8.3 INTERPRETATION OF RESULTS

Please see Sections 5.10 and 5.11 for Commentary and Discussion respectively of the Case Study Quantitative Analysis.

The Perinatal Network System is complex, expensive, low volume and subject to random fluctuation. To determine established nurse staffing, people have counted patient cot days per year at various levels of care for each hospital. Yet shortages are all too common. Despite more than half of a neonatal network's activity being performed in local neonatal units, little work has looked at integral patient pathways, steps backward or focused on High dependency cots in such local neonatal units. The Patient Pathway may run through two or more hospitals within or between Networks. High dependency care can involve looping patient pathways to which nurse staffing must respond flexibly. Redundant capacity and the ability to flex resources in the short-term could be helpful. Could managers forecast this need ahead of it being required rather than always forcing frontline staff to respond by fire-fighting?

We have undertaken some data analysis and modelling to try to answer this question. Thinking downstream, we now have more data on when a baby at intensive care might require and leave High dependency care. We found that long stayers on High dependency could not only be predicted by Chronic Lung Disease arising from prematurity but also a diagnosis of Neonatal Abstinence Syndrome delivering at term. Backward steps to higher levels of care are quite common in the Patient Pathways. Furthermore this analysis underscores how occupancy lurches between extremes owing to the small scale of the local neonatal unit.

The consequent small scale of the exploratory data analysis raises the reasonable question of whether the findings are reproducible. Another risk is becoming bogged down with intricacies, which are unlikely to be statistically significant. Yet in the absence of easy to mine data and the underdeveloped state of Healthcare Analytics in the NHS, if a clinical question is worthy, there must be a starting point for the learning. Feasibility lies in the proof of the pudding: the method has to work easily.

The methodology of multi-state modelling has been used on English population data for the neonatal pathway (Seaton et al, 2016). Transition specific hazard rate curves were shown by gestational week for the level of care required and survival to discharge or death projected. 27 weeks gestation was chosen arbitrarily as the baseline group. Unlike our research work, backward steps in the patient pathway were not considered. Seaton quoted data for 31 weekers' at 7 days of life, which showed a ratio for those receiving the levels of care, namely intensive, high and special was 0.2: 0.29: 0.49 respectively. For our research data for all those in-patients with a corrected gestation of 32 weeks at the time of the day of care, this ratio lay from (0.05 – 0.1): (0.35 – 0.5): (0.4 – 0.6). The number of 31 weekers' in the three years in the local unit was 24. The groups being compared differ somewhat. Yet the figures are comparable for those receiving special care. Similar principles are at stake however in using the information to project neonatal unit activity.

Confounding factors in operation

Are comparisons legitimate? Standardisation is needed for local demographics. The component neonatal units of the Perinatal Network System are set up differently. There is local variation in community resources, disciplines and agencies within the Healthcare system in terms of education, general practice, midwifery, obstetrics, health-visiting, outreach nursing and Social Care. Other differences lie in terrain, communications, climate and culture.

The Cost of Drug Addiction

In this Case Study, drug addiction consumed 20% of high dependency care days, a high cost. Drugs implicated include SSRIs and opioids. The impact of amphetamine abuse has been described (Phupong and Darojn, 2007). Epidemiological studies have shown that maternal recreational drug use is an independent predictor of neurodevelopmental disability and increased costs following preterm delivery in the range 32-36 weeks (Field et al, 2016). The extent of this problem and the demand for services is growing: in the US an affected neonate is born every 25 minutes (Huybrechts, 2017).

8.4 CRITIQUE OF RESEARCH FRAMEWORK

Framework	purpose	method	situation	Criteria specified?	implementation	validation	pitfalls	development
Modelling the Perinatal Network System (This research)	To address shortage of capacity, Chapter 1	Ontological Enterprise Modelling, Mixed OR, Systems Thinking, Chapter 3	English local neonatal unit, Chapter 4	In Conceptual Framework, Chapter 3	Cot Predictor Tool, Chapter 6	with actual data, Chapter 5	Risk-averse climate of retrenchment. No strategic planning or oversight in the healthcare organisation. Chapter 8	Other neonatal units / networks, Chapter 8

Table 47 Critique of Research Framework

This Operational Research Framework for Modelling the Perinatal Network System arises in the context of its purpose. The historic collection of neonatal data has been devised centrally and tied up with financing intensive care, benchmarking and obtaining value for money. The clinician has not been enabled to autonomously pose questions as to how local difficulties can be improved. With hospital analytics this becomes possible where there is not management obstruction.

In the Case Study looking at how to better manage the fluctuating and lynch-pin resource of High dependency cots, OR and Systems Thinking methods are set to work to answer specific clinical and tactical management questions. The focus of this enquiry is clinician led; this aspiration was met with initial management support (2009-11) then lack (2012-5), which was a challenge to the research. That change in culture was temporally associated with change in Health Policy in England, the so-called Lansley Reforms of 2012, defined in the Health and Social Care Act for the National Health Service in England and described by Sir David Nicholson in 2010 as “a re-organization so big you could see it from outer space” (Cameron, 2014). One measure was to abolish the Strategic health Authorities, whose remit had been longer term planning and co-ordination. This led to fragmentation, systems failure, increased managerialism and over-regulation. It has also created opportunities for private sector service providers in the assistive technology field.

There is a trade-off between bearing the cost of under-occupancy versus undertaking high-resource, low reputation, potentially unsafe and low quality capacity transfers. A balance must be struck to obtain the correct weighting between individual right for care and population’s need for service.

In theory, at least twenty-eight possible Modelling methods exist (Jun et al, 2011), sixteen of which have been applied here. The argument and rationale for the mixed methodology has been presented; is each method in the OR mix useful? Some methodologies appear more helpful than others. Systems Thinking is vital. The point has already been made regarding the tension between that loose distributed perspective and the more rigid approach implied by a Framework. The first is plastic and the second brittle; and again a balance needs to be struck. Odds Ratios in published literature would likely be superseded by more (potentially) sustainable quality information from local data. Systems Dynamics is a useful viewpoint for the

population but not for the small numbers in a local neonatal unit. There is much scope for Mathematical Modelling related to Medical Diagnosis and fast future developments seem likely to occur in this area. Purists would argue that Markovian methods are invalid since criteria cannot be satisfied in the real world. Mapping the Patient Pathway is important for insight and the assessment of quality and duration of care. Forecasting, prediction and Markovian modelling are tested and tried methods. One cannot quantify the contribution within the mix of each particular method; hence the need for the qualitative perspective.

There is no comparative literature investigating High dependency cots in the local neonatal unit. However both as cited in related literature and in one's expert opinion (having practised as a consultant paediatrician with neonatal interest), the contention is that this Conceptual Framework is logical, relevant and feasible. Its generic carnation aligns with steps recognised in Systems Thinking and Modelling and the building blocks of the WHO Health Services Framework (2007). Reflection on the development of OR methods in the Framework is offered in Section 8.8.

8.5 HEALTHCARE POLICY

Consideration has to be given to the interface between research and healthcare culture and policy, one component of the emergent subspecialty of Behavioural Operational Research. An important challenge for the work was the disruptive Lansley Reforms, especially their delayed local implementation. The milieu was one of international judgment of data manipulation, the Colchester Cancer Debacle, in which the commission of the Somerset Database was neglected for years leading to life-shortening inaccessibility for the local adult population to co-ordinated Cancer Services (Troop and Taylor-Brown, 2014).

Research findings cannot be adopted or implemented in a hospital run with interim managers. Since the demise of the Strategic Health Authorities and the managerialist expediency of short-termism, system re-configuration has not been supported. Laudable aims of quality improvement and system efficiency have not been imperatives.

An organization or system with capacity issues ought to address them. Without acceptance of new ideas, there is preservation of the status quo and inertia. Radical bottom-up ideas do appear as a threat and elicit managerial resistance. Implementing organisational change is a subject in itself. If healthcare managers *did* wish to solve the problem of capacity (and it is unclear if there is any will for implementation of either service reconfiguration or computer systems), then this is how you might go about it. Actors such as taxpayers, politicians, policy makers and those subservient to the system such as patients and frontline healthcare workers will have their own viewpoint. Fora for such social debate could usefully be stimulated. Independent Think Tanks such as the King's Fund and Nuffield Trust play an important role in shining a light on Healthcare Policy.

8.5.1 Re-organisation of the NHS in England

Healthcare Policy is chosen by the politicians we vote for but there is a long lead-in time and some policies may never be implemented before the world moves on. Direction of travel in the Healthcare system is susceptible to re-organisation and non-consensual policies, which may be badly devised and opinion can be genuinely divided. Organisations may appear unaligned and have implicit contradictions, conflicting imperatives and generate perverse incentives, resulting in confusion inbuilt by design and distrust. This appears to generate a need for increased regulation. Control systems do work better if a Board is responsive, agile, consistent and substantive.

Following the (uncosted and invalidated) re-organisation of the NHS in England and abolition of the Strategic Health Authorities, (which had hitherto planned health services and workforce) overall co-ordination and orchestration was disrupted by design. Two aims were to shed 10% of the workforce and to make the worker feel like a "square peg in a round hole", as cited in the White Paper. The 2012 Health and Social Care Act introduced fragmentation to the system perhaps in the hope of Small and Medium Enterprises (SMEs) start-ups moving into gaps in the Healthcare landscape. Yet difficulties such as the Great Recession, Healthcare inflation and regulation hampered this.

In the words of the Chair of the parliamentary health committee, Sarah Wollaston, there has been an:

“Unprecedented period of efficiency savings against a headwind of rapidly rising demand and costs. The incoming coalition government then imposed a disruptive and demoralising reorganisation that distracted from the key challenges” (Wollaston, 2016).

Improved efficiency is needed at the very time that to obtain better quality for similar cost is rejected by interim managers at a hospital kept permanently in special measures; really transformation is key. It is preferable to have managers serving clinical ideas rather than the managerialist diktat of constraining clinicians to mere technicians serving managers’ conflicted imperatives. Reductionist, pacesetting managerialism is the status quo. The prevailing NHS climate disfavours reform. Clinical imperatives *could* lead the direction of travel within the Perinatal Network, which faces recurring problems such as shortage of High dependency cot capacity in the local neonatal unit. Database configuration ought to empower stake-holding client and rock-face clinician, not solely remote disinterested interim manager. At present, the Healthcare system in England tends to exclude the service user/carer and frontline worker from reaping the benefits of the information they have created and input. An improved Health and Social Care Act for England has been mooted (HSJ, 2017); however there is neither political nor economic appetite for this (Timmins, 2012).

8.5.2 Local Climate and Policy Implementation

Exceptions made to following Healthcare Policy are arbitrarily made by managers with little comeback (Troop and Taylor-Brown, 2014) hence the recurrent call by Francis for their regulation (BMJ, 2017).

An executive Board of a hospital ought to give assurance that it is correctly governed. 360 degree sight is required, a Systems Thinking idea. Foundation Trust Boards were free to take their own decisions; however failing hospitals must be governed from outside. Boards could avoid failure by listening to patients and staff and seeking feedback. Analysing and avoiding complaints optimises the service. Unless the Board and governors connect with frontline work, the hospital does fail on quality of care, which leads to mortality, morbidity, deficit and bail-ins. Overarching policy standards

and control systems are represented in the Enterprise Framework. This area cannot be scrutinised unless there is an open culture.

Financial oversight	Clinical quality audit	Public Scrutiny	Strategy	Governance
NAO ODN	2 year outcomes Mortality LOS complaints	Council HOSC PHSO	Policy Future proofing Technological developments Re-configuration Flexibility/agility	Assurance Quality performance

Table 48 Social Regulatory Constraints

Key to Abbreviations

NAO = National Audit Office

ODN = Operational Delivery Network

LOS = Length of Stay

HOSC = Health and Oversight Scrutiny Committee

PHSO = Parliamentary and Health Services Ombudsman

The Board should monitor performance. It requires both an overview and attention to detail, ways of (Systems) Thinking which see both wood and trees. The individual might be expected to lack proficiency in performance in some aspects of these manifold and contrasting areas. However the group as a whole can compensate, so power is distributed and all angles are covered. Directive hierarchical autonomous top-down managerialist models do not facilitate this approach (Rycroft-Malone, 2004). Yet flatter organisational grid structures could permit cross-disciplinary collaboration and project work. How an organisation functions depends upon its structure. We are dealing with Enterprise Modelling, which can unfortunately be constrained by organisational structure, which may either invest or disinvest power to its employees. *Were the Healthcare system to loosen its rigid hierarchical structure, then mind-set and culture might change and workers' ideas and patients' suggestions could be exploited.* The historic Knowledge culture will give way to creativity, innovation and Information Technology.

An unstable organisation without strategic direction is neither amenable to computerisation nor improvement. An organisation 'without a memory' (DoH, 2000),

functional governing body or settled autonomous Board will struggle to meet standards or sustain Business Continuity. Middle managers within this culture will refrain from implementing “can do” actions when it comes to supplying resources. Such a climate disempowers workers to improve systems of patient care; and malalignment breeds distrust. Unaligned organisations with high staff turnover find it hard to focus on their main business, maintain trust and confidence within working relationships, continuity in standards or to marshal resources; they are unresponsive when workers ask for any help like essential resources to do their work. When a Board is unsure of its strategy, then it undermines workers’ efforts. Managers ought to respond if a worker needs more resources to maintain quality of care. Yet operations management may be poor. Managers do not necessarily invest in the right places or debate this with patients or staff. In the prevailing NHS climate, unregulated managers demand clinicians deliver the impossible then blame them if they cannot by referring them to regulators; which amounts to bullying by NHS process. Where workers cannot influence their own work, then the system undervalues their care for patients, which compromises patient safety.

The outgoing Inspector of the Care Quality Commission, Professor Richardson has said that the State of Care in the NHS lies on a “burning platform” (Richardson, 2017). This evokes the Piper Alpha disaster. That burning platform was isolated and cut off. Help was needed from above (by helicopters) and from below (by lifeboats). There was firefighting in preference to suitable planning. The workers risked their lives by drowning in an effort to survive. There were both design and managerial safety flaws. Mortality was high.

Lacking inclination, time or support to reflect upon data hinders learning and improvement. Clinician led Metrics and Operational Research could improve this situation. The need for co-operation between strata within the system rather than competition between resource-hungry Foundation hospitals is left fallow where previously oiled connections are dislocated by design. The menial rock-face clinician dealing with the patient observes the situation and could improve it were there only substantive management. It is practically difficult to provide adequate handling of resources when for years, management positions are run solely as interims. Longer-term projects like research addressing these issues are sacrificed first at times of retrenchment and strain: this is a vicious cycle.

Causes of perpetual (winter) pressures and bed crises are well-known. They include suboptimal contingency planning, un-joined up working between Health and Social Care and risk aversion by the 111 service, which not only sends undue numbers of patients to hospital but has also deliberately delayed sending emergencies by the illegitimate manipulation of twenty thousand calls and ambulance protocols (SECamb). Lack of admission prevention and avoidance, rota gaps being run by managers in order to save money, system not understood by stakeholders, poorly signposted to users and fragmented by design, supply/demand mismatch and untimely access to primary care are also responsible. This list is not exhaustive.

In the interests of national resilience and security, hospitals must not turn patients away and should maintain a 24/7 service. NHS intensive care patients do require the same nursing ratio as those patients abroad treated for Ebola by the British armed forces. Neonatal critical care is a privileged resource. Quality outcomes are expected. Capacity transfers are unhealthy.

The advantages of using medical information to plan resources are improved care, Business Continuity and efficiency. Barriers to this include patient confidentiality, cultural resistance to change, inadequate investment in OR and IT, fragmented services, silo working (absence of Systems Thinking), implementation difficulties and political short-termism; hence the need for Enterprise Modelling as the antidote. It is vital for Enterprise Modelling to be embedded in the next Health and Social Care Act.

8.6 CLINICIAN-LED METRICS

Each year the neonatologist tries to improve their unit's average Corrected Gestational age at discharge. Figures vary depending on the mix of prematurity admitted. One aspires towards the Californian average although East of England has a different Healthcare system. And what is the meaning of Corrected Gestational age at discharge where there is an increasing trend for term babies to find themselves admitted? On admission, their Corrected Gestational age is greater than premature neonates being discharged. And it only takes one Long Stayer with complex anomalies or adverse social factors to distort the picture. When reporting Corrected Gestational age at discharge isn't it time to match this with detailed gestation at admission? Now data is as good, shouldn't we as a community generate normal ranges for expected patient pathways? One can then better decide whose care is a statistical outlier.

Should we not also break down the medical component of Length of Stay from those waiting for social care reasons, usually in special care? Could that not give a truer picture of service provision? Let's quantify the delay to neonatal Length of Stay caused by (retarded and inefficient) Social Care processes. With the joined up working the Health and Social Care Act promised and the inseparable position of a baby from their family's social circumstances, shouldn't that also be compared across networks and countries? Poor Social Care provision prolongs a unit's Length of Stay while modern, smooth cross-disciplinary working effects synergy, also preventing neonatal re-admission to the children's ward.

Another suggestion is to measure how neonatal unit staffing levels determine not only mortality, but also morbidity, Length of Stay and parent experience. It is known that higher occupancy leads to mortality and that busier units discharge patients sooner. This is a call for Clinician input in Metric development and for improvement of "on the ground" knowledge of local neonatal care in order to benefit the patient.

8.7 RECOMMENDATIONS

That informatics be exploited in the following ways:

- Gather precise data on stays of critical care patients by the hour to find the exact timing of admission and discharge. This will likely depend on human factors within the organisation such as the timing of doctors' ward rounds and nurses' shifts.
- Collect data on actual neonatal nurse staffing
- Collect data on Refusals / Delays of transfers i.e. baulking.
- Enterprise Modelling of Information Systems to give real-time data on patient journey. There is scope for units/agents to 'talk' more.
- Exploit existing clinical data; balance this with the potential service benefit of improved Decision-making versus patient confidentiality and the ethics of not doing it.
- Connect operational and clinical information
- That NHS healthcare managers apply Operational Research Tools to exert 'intelligent' interest and responsive control over healthcare services.
- Plan for what is predictable. Flex staffing for what is not.
- That frontline clinical staff should have input to designing an 'alert system' to improve control over the intensity of their own work.
- That Quality be assured by matching patient outcome to record of patient acuity and neonatal unit staffing

8.8 CLINICIAN REFLECTION

Reflection on the development of OR methods in the Framework is offered. To the clinician, an OR method should appear logical, feasible, useful and straightforward to understand and explain and seem applicable through analogy for instance with patient processes. It might be pragmatic, experiential, heuristic (trial and error as opposed to optimal) and must rely on the available real-world clinical or operational connection of data, which is not to deny that this would risk being judged as subjective by an OR professional. Yet, those frameworks developed by OR professionals could suffer flaws and biases insofar as an OR practitioner will be better trained in one method than another and have personal preferences, open to debate by other members of the OR community.

Even if the development of the mix of OR methods were done by a computer using Artificial Intelligence with a neural network or machine learning, then this would have to be initiated, a goal specified and the rationale for connections explained. A human would have to verify the relevance and validity of the method to the application, scrutinise and assure it. A computer might come up with a combination faster and sooner but if it were black box that would create ethical problems within healthcare. The computer would need to reflexively explain the logic of its approach and provide a critique or at least weighted alternatives and even a rationale for not adopting them. Such a task might be more qualitative than quantitative. We are talking about boundary issues for which Systems Thinking is useful. There is a tension between Systems Thinking and any Framework as previously covered in Section 3.1 and 8.4. Looser concept maps and network thinking rather than the rigid hierarchical connections of a framework appear beneficial in realising such an endeavour.

It might be conceded that a medical doctor could exert a useful role in interpreting results from data analysis and designing decision-making within an expert system. Yet Healthcare managers may not subscribe to any relinquishment of power to clinicians. Furthermore the viewpoint of Operational Researchers might be more academic than

practical. Human factors including the relationships between actors are obviously highly relevant within Healthcare systems, as described by Carter (2016).

Some similarities exist between the professions of Operational Research and Clinical Medicine insofar as information must be gathered in the vernacular from the client: there exist signs and symptoms. The diagnosis or formulation is made. Feasible methods and treatments tailored to the individual situation are then devised. Both may need quite long timescales. Either professional may wish to guard their profession. OR, Computer Science and Medicine are all patriarchal in the UK. So model selection by the clinician may be by analogy and feasibility. It would tend to make the assumptions of that discipline, which have perhaps become intuitive and not necessarily apparent to those from other disciplines. That by OR professional may depend on their particular interest and area of expertise. Certain models outlined by Hulshof (2012) such as petri-nets or those having non-intuitive mathematics will be less accessible to a non-Masters mathematician. The approach of neither professional nor the clinician model developer is necessarily comprehensive but more utilitarian. Patient, inter-disciplinary communication is required to remain cognisant of and to bridge any gaps in the connection between models. Indeed a fragmented healthcare system jeopardises health.

Systems Thinking deals with boundary issues. As a medical doctor building these models compared with OR professionals, my perspective was more ethical than theirs: they often lacked information governance. They seemed to favour data-mining rather than exploiting obvious connections between data in real-world problem-solving. They favoured pontificating on theoretical methods rather than real-world applications like quality improvement. Some OR professionals have no real interest or motivation towards life-saving aspects of healthcare. They undertake a back-office function rather than front-line patient facing work. Similarly, many medical doctors have little experience of OR. OR may remain a closed world to medical doctors, who can struggle to gain any acceptance by OR professionals. Those OR and medical doctors who do interface are perceived as mavericks within their base discipline. English Government OR departments have even been deployed politically to destabilise and

close healthcare institutions without consultation or democratic accountability, thus harming patients, their families and workers.

One lesson learned through having done this work is that one might not be accepted in either group. Whilst I believe multi-disciplinary research work is cutting edge, this is not accepted at large by UK academia at this time. On one hand, OR professionals and unregulated hospital managers do not accept the concept of medical knowledge; whilst on the other, OR professionals would rather deal with abstracted data fields which seem infeasible and irrelevant to a medical doctor.

In the local chronic special measures culture, both hospital managers and colleague clinicians opposed a research position. Yet it was well supported by that remnant of managers in the East of England Clinical Senate Assembly. Whilst in the local chronic special measures culture, there could be no buy-in from one clinician to modelling by another; however, elsewhere, a common shared language and clinical credibility could be envisaged. Persistence is essential to head off threats and discouragement from most quarters.

Another lesson learned by the clinician is potential healthcare applications with this kind of generic modelling framework. Moving from clinician to model developer, there is the opportunity to reach out across interfaces, merge disciplines and gain interdisciplinary dividends. The obverse is that a petrified culture impedes implementation and innovation. In that instance, the response is to give up and leave. It may be necessary to let go of past thinking in order to change mind-set and liberate outlook. There is a time for scattering stones rather than gathering them in an adverse climate. This enables one to meet more receptive people in a more favourable setting, point in time or the healthcare economic cycle, when different drivers facilitating OR might have arisen.

Operational Research in civilian Healthcare is a hard nut to crack due to complexity, narrow (silo) disciplinary working, confidential patient information and secretive culture. This could be ameliorated given a modern non-expert connected world mindset in which the divide between academic science and poly-technology is softened and bridged. Design asks which way? And why this way? The answer is not objective for there is usually no uniquely right way of accomplishing any task: it is thus applied rather than pure. Notwithstanding this Systems Design Technology in Healthcare faces obstacles of political undermining related to its public funding, professionalism, the unwieldy size of organisational bureaucracy and multiple stakeholders. Finance, time, management support, credibility within the inter-disciplinary community and political motivation to solve the problem are essential. By necessity, data is usually worked in Excel: alternatives are possible yet not feasible. There are no criteria for making a choice, no political impetus for having to and no evaluation of healthcare policy in England.

The mix of methods chosen here are intuitive, feasible and permit visualisation by the clinician through practical analogy. Whilst development of models by the clinician combats counteraction by the healthcare manager, implementing them remains in jeopardy.

8.9 FUTURE WORK

Further analysis could look at other years' activity and investigate more thoroughly those returning to High dependency care. One could relate findings to the intensive care centre, compare it with other local neonatal units, deduce modifiable factors and see the effect on High dependency cot usage of any policy change. Important outcomes would be understanding, efficiency and actions in the event of shortage of High dependency cot capacity.

Other Perinatal Networks might be looked at and the effects of any re-configuration, re-organisation and outreach (i.e. extension of transitional or special neonatal care to the home). One might incorporate costs and national and international comparisons, for instance with the South-West and the Americas, Australasia and Europe.

The use of more relevant commercial software could be explored. Working with the input of a team collaboratively, the dynamic model design could be developed, built, iterated and refined. The effect on service of Modelling could be incorporated, including on clinical outcome / family satisfaction.

Questions of efficiency hold especial relevance given long running healthcare stringencies. Modelling is usefully plastic to render it future proof and flexible in areas of technological developments, policy, prioritisation and finance.

Comparative benchmarking work on the posterior probabilities by gestation of arrivals at the particular levels of care could be undertaken. One could control for normal patient pathways for the hospital population as well as analyse the variability of looping pathways. Such work could assist Quality Improvement. In the event of any future integrated network, maternity data might also be used.

It is not possible to develop the dynamic model in its setting, whose conceptual design is considered in Sections 7.5 – 7.9. That would be contingent upon the feasibility of collaboration in a challenged hospital with NHS managers, whom are interim, which has proved a limitation. The ideal would entail collaboration with users and a team from an array of disciplines to develop an Expert System. The Monte Carlo Markov model might then be utilised in a simulation, which could test system configuration.

Whilst barriers proliferate, including policy change, clinician powerlessness to influence the local system and its failures: bail-ins, inferior quality of care, rota-gaps, high staff sickness and turnover and insufficient retention of skilled staff, it could be argued that there has never been a greater need for the UK healthcare systems to learn from Operational Research.

It is easier and requires fewer resources for an analytic approach to the research problem. This kind of microscopic approach looking at one hospital's local neonatal unit has not previously been undertaken perhaps owing to the obstacle of data preparation. In work on mixed sequential exponentials expounded by researchers like Marshall (2004), patients might join the system at any level of care; and LOS for the population may be predicted. One implication of realisation or use of the Dynamic Modelling Design might be Perinatal Network System re-configuration. A barrier is the feasibility of developing this design in a limited time-scale without ongoing funding or management support. A business case would have to be accepted to implement the dynamic model. The risk is that the real-world moves on regardless of the lack of strategic perspective.

Pathways of patients moving between two hospitals could be studied particularly. Each neonatal intensive care centre within a Perinatal Network might interact with many local units. Such pathways between two hospitals in a network are outlined in the Qualitative Case Study Chapter Section 4.7.2 Figure 21. Game Theoretic (Binmore, 2007) (Shoham, 2009) (Knight, 2011) can show whether hospitals are behaving co-operatively or competitively and where there is room for improvement in resource utilization, particularly downstream (Wolstenholme 2007). In this vein, Knight has pointed out that "the optimization of a single hospital's resources is not necessarily best for the overall system". Furthermore Green (2002) has explained how the threshold for critical surge capacity in smaller institutions is met below the 85% occupancy permitted for that of large hospitals. Research on synergistic load balancing for the Perinatal Network System to achieve best flow for all its patients might entail allocating different target occupancies for each component neonatal unit and could prove useful. These ideas could be combined in a complementary manner with the sort of Dynamic modelling approach outlined in Chapter 7. All this is highly relevant for future enquiry into national healthcare, given its distributed nature.

Certainly patient transfers for reason of capacity management are undesirable; and this Case Study of one local neonatal unit has provided insight into anticipating cot shortage, in order to pre-empt that situation. This work could help tactical cot management, efficiency and resilience.

8.10 SUMMARY

Accepting the learning points discussed, this research demonstrates a mixed OR approach to improving management of High dependency cots. Additional focus of this work is offered in the Conclusion.

CHAPTER 9 CONCLUSION

9.1 INTRODUCTION

This Chapter provides some closing remarks. The meaning of the findings and their value is highlighted. The research outputs are a:

1. Conceptual Framework,
2. Quality Metric,
3. Cot Predictor Tool,
4. Markovian model Design and
5. the milieu or 'glue', which represents connections between models.

9.2 CONTRIBUTION TO KNOWLEDGE

This research represents an original combination and interpretation of pre-existing information. Analysis and Modelling have been applied in the fresh context of the local neonatal unit, a downstream component of the Perinatal Network. Ideas from Operational Research / Management Science and Perinatal Medicine have been combined by the Clinician to give new insight. A Conceptual Research Framework is advanced, which is feasible and has utility insofar as it has been implemented and demonstrated in practice through the Case Study. The Case Study showed that the neonatal unit was working beyond its system design capacity.

Enterprises should be resilient to change and pressure. Business Continuity Planning means 24/7 services must be kept running and threats like shortage of capacity mitigated. Enterprise Architecture provides a framework to contextualise the research problem, permitting both overview and detail to be grasped. The underlying behaviour of the Perinatal Network System is described. There is a lack of intelligent handling of staffing based on available data, which is already routinely collected. Yet operational data and medical informatics could be linked.

Specifically, an operational Markov Chain Model of the local neonatal unit and developmental progression with age (in gestational weeks for the local population of premature and “term” neonates) have been matched through time. A mix of methodologies comprising Systems Thinking and OR Tools can help predict neonatal unit activity. Operational and medical informatics have been combined in the Tool, which is used for predicting the behaviour of patient flow within the neonatal unit. The Case Study on the question of tactical prediction of High dependency cot Demand demonstrates that the Conceptual Framework for modelling this system is appropriate and useful.

In analysing the mechanism of the Perinatal Network System, the fluctuation of High dependency cot activity within the local neonatal unit was empirically described and the stationary distribution of the unit’s underlying Markov chain determined. It is feasible to combine SEND information using OR methods. We posed the research question, applied the Conceptual Framework and reviewed it.

This Case Study of High dependency care and nursing in the local neonatal unit and its Perinatal Network connections is original in contrast to previous studies, which concentrate on intensive care centres. We advance the Quality Metric of backward steps by patients; this is drawn from operational data and might be expressed as a percentage of deployed resources. Research outputs include the Cot Predictor Tool and Markovian model Design, which are open to future modification by others.

Contributions are formulated as:

Methodological

- Conceptual Framework model for the Perinatal Network System, incorporating its complex, variable and uncertain aspects.
- Development of a mixed methodology of component models within the framework. Models are summarised in the Conceptual Framework Chapter Section 3.4.2 Table 8.

- Novel inter-disciplinary linkage of time perspective intrinsic to human neonatal development manifesting as prematurity namely gestational age with Operational Research methodologies (Models 2,3,4)
- Solution to unique challenge of forecasting High dependency demand in the local neonatal unit within the Perinatal Network System.
 - Addresses issues of individual patient progression given medical presentation (Model 4).
 - Determination by Markovian methods of actual characteristics of underlying system behaviour: the invariant distribution of time spent in the system (Model 5).
- Exploitation of SEND informatics to provide inputs (Model 7) for a detailed-level illustrative prototype Decision support tool. This Tool could assist clinicians to dynamically predict and map cot activity and attendant skilled nurse staffing over a tactical time horizon and permit reconfiguration of resource constraints (Model 8).

Management

- Distributed management approach of optimising the local neonatal unit operating environment to improve upstream system efficiency (Model 1) of the intensive care centre and Perinatal Network.
- Facilitation of Quality Assurance through mapping of straightforward and complicated patient pathways (Model 6) thus offering improved contingency planning and Business Continuity.
- Naturalistic /experiential account of OR Modelling by Clinician

Novelty

- Combines approaches from different disciplines (namely MS/OR, Healthcare Analytics and Neonatal Medicine) to take a whole systems approach from the local neonatal unit perspective.
- routinely collected data is applied to gain intelligence
- Deals with delivery suite-neonatal unit interactions and inter-hospital patient flows

- Captures examples of bi-directional intra- and inter-hospital flows (and sub-optimal cases) whereas other work, such as Adaikappan's study (2005), have concentrated on within hospital forward flows to lesser care levels.
- The modeling, by examining the treatment of time within the system examines the feasibility of next-event rather than the historic time-slicing approach.
- Linkage between entry level of care, Length of Stay and progression with gestational age in the premature local population with Time flowing through the neonatal system's signature Markov Chain.
- The bulk of literature has been generated from intensive care centres and considered from their angle. Much less research exists on the physical neonatal network system. For High dependency cots the local neonatal unit is a hub in the middle of the system for this increasingly used and longer duration form of care. Focuses in Systems Thinking ought to lie within the middle of the system, rather than its peripheries. This research contributes to local neonatal unit blueprinting.
- Shows downstream working beyond system design capacity
- Ability to predict when capacity will be exceeded permitting the pre-emptive flexing of nursing in contrast to existing late fire-fighting once escalation is obvious
- Enables development of Expert Early-warning system
- Leaves a model which can be built on in the future, adapted to another area's needs and, may add to knowledge on random variability in neonatal Length of Stay and Perinatal Networking
- Provides a Pluri-potential Generic Conceptual Framework (Table 49)
- Develops and uses Mixed Methods Modelling by the Clinician

To recapitulate, work has been performed in the areas of Systems Thinking, Enterprise Modelling, human neonatal development and Markovian modelling. A conceptual model for the English Perinatal Network System has been developed and some Tools designed, which can help assess and guide capacity and quality of neonatal care.

The Conceptual Research Framework supports informatics, is robust and has the potential to be dynamic. It is resilient to changes such as loss of a component cell. The specific design focussing on relevant cells within an Enterprise Architecture and Modelling Framework might be pivoted: rendered generic and applied to another setting or serve a different purpose. For example, this might be forecasting children's intensive care bed demand during a 'flu' epidemic or respiratory cases related to weather conditions, in which context, definitions of terms and big data would be pertinent. The Framework lays the foundation for and reaches out to the edge with conceptive Artificial Intelligence. It has been implemented in a Case Study, which adopted a local perspective within a distributed network system to predict activity and nurse staffing for the English population.

When applying the generic Framework in a healthcare context, some tips are to address management buy-in, ethics and governance. The Pluri-potential Generic Framework is distilled in Table 49:

Building blocks to Framework	Case Study
Generic	Specific healthcare application
The System	
System boundary	
Problem	e.g. Unpredicted shortage of capacity
Purpose	Improve foreknowledge
Management buy-in: obtain and maintain	Suitably supportive management culture and climate necessary
Critical Thinking / Conceptual Framework 1. Context 2. Informatics 3. Factors to be modelled	System of Systems Enterprise Architecture Framework Operational Research Framework Enterprise Modelling Framework e.g. number/skill mix of workforce
Select method	Apply Conceptual Framework in Case Study
Draw System structure	Qualitative Aspects sketches
Determine behaviour over time	Process mapping
Get data	Ethics and Governance
Prepare data (timely, cleaned, connected information) Select variables Fit model	Analytics
Develop predictive model - outline - detail e.g. static / dynamic	
Evaluate model	Discuss qualitative and quantitative aspects in terms of performance measures e.g. Quality, efficiency
Validate. Criticise	Clinician verification, Discussion
Deploy	
Improve - User feedback, iteration	

Table 49 Steps in Generic Healthcare Framework

9.3 APPLICATION

This lies in OR/MS. Ahead of their happening, the effect of disturbances on the Perinatal System could be assessed; threats include rota gaps, unit closure due to infection, staff sickness, winter pressures and expected surges in demand such as with triplets and IVF.

Control over modulating resources to more efficiently flex to match demand might then be improved. In more consistently meeting unit and Perinatal Network responsibilities, patient safety is better maintained (UK Neonatal Staffing Study Group, 2002) (Hamilton and Redshaw, 2007). It might permit forewarning of when occupancies will be exceeded. One could weigh up options and suggest actions to improve outcomes. It would be possible to associate staffing and financial data with patient journeys and to cost proposed changes.

An Expert System incorporating this Design could help refine operational management by allowing capture of rule breaking within the Perinatal System and an understanding of actions needed when capacity is short. It might benefit tactical bed management, strategists who commission and also on interim timescales, management control over capability and resilience. This might contribute to Decision support for the Perinatal Network System for a regional population, particularly to predict Demand, manage capacity and assess quality of care (Shahani et al, 2008).

Alternatively, such a Generic Conceptual Framework combining medical and operational informatics to infer intelligence may be adapted to solve an Operational Research problem in a different (hospital) System or Enterprise.

9.4 DISSEMINATION

The UK neonatal community should be informed of the research and its applications. To this end, the work has been disseminated to the RCPCH paediatrician's conference in case it can be applied for quality improvement. The possibility of exploitation of the work, in terms of its application to an expert system for decision support, collaborating with colleagues in University, industry and the neonatal community could be explored.

9.5 PUBLICATIONS DURING RESEARCH

Poster Presentations and Abstract

1. Dalton, S., Chahed, S. and Chausalet, T. (2018). Modelling high dependency in the local neonatal unit. *Royal College of Paediatrics and Child Health Conference*. Glasgow, UK. 14 March 2018.
2. Dalton, S. and Chausalet, T. (2012). How to predict high dependency cot demand in upcoming days (Abstract and Poster). *38th International conference of the Operational Research Applied to Health Services High Tech Human Touch*, University of Twente, The Netherlands. July 2012, 21.
3. Dalton, S., Chahed, S. and Chausalet, T. (2016). Modelling the Perinatal Network System. *University of Westminster Faculty of Science and Technology Postgraduate Fair*. 2016

Oral Presentation and Paper/ Extended Abstracts

1. Dalton, S. Paradox and the concept of proportionality. (2016). *Cybersecurity Ethics*. University of Hull. 20-21 October 2016.
2. Dalton, S., Chahed, S and Chausalet, T. (2016). Is the NHS in England too big to fail? *8th IMA (Institute of Mathematics and Its Applications) Conference on Quantitative Modelling in the Management of Health and Social Care*. London. 21-23 March 2016.
3. Dalton, S., Chahed, S and Chausalet, T. (2015). Toward simulating the English neonatal unit. *27th European conference on Operational Research. EURO2015* University of Strathclyde, Glasgow. 12-15 July 2015.
4. Dalton, S., Chahed, S and Chausalet, T. (2013). What constitutes a normal patient pathway? *7th IMA (Institute of Mathematics and Its Applications) Conference on Quantitative Modelling in the Management of Health and Social Care*. London. 25-27 March 2013.
5. Dalton, S and Chausalet, T. (2011). Towards Modelling Patient Pathways through the Perinatal Network System focusing on high dependency cots in the local neonatal unit. *37th Operational Research Applied to Health Services conference Operational Research Informing National Health Policy Conference*

Proceedings. University of Cardiff, UK. July 2011, 150-160. ISBN 9780956915801

- 6 . Dalton, S., Chahed, S and Chausalet, T. (2014). Framework for Modelling the Perinatal Network System. *University of Westminster Faculty of Science and Technology conference 2014*. London.
- 7 . Dalton, S., Chahed, S and Chausalet, T. (2012). Methodological aspects of modeling the Perinatal Network System. *University of Westminster ECS conference 2012*. London
8. Dalton, S., Chahed, S and Chausalet, T. (2011). Modelling high dependency care in the neonatal unit. *University of Westminster ECS conference*. 2011. London.
9. Dalton, S., Chahed, S and Chausalet, T. (2010). Modelling the perinatal network system. *University of Westminster Electronics and Computer Science (ECS) conference*. 2010. London.

APPENDIX

1. Qualitative processes p 282 - 287
2. Quantitative Analysis p 288 - 291
3. Cot Predictor Tool p 292 - 298

Weeks' gestation	8-10		20		23-	24	24-27	37			48
Woman	Pregnant woman	Antenatal clinic	Fetal clinic	ambulance	In-utero transfer	Premature delivery		Term delivery		Post-natal ward	Hospital discharge
Neonate	Fetus		Multiple/ Congenital abnormality			Premature neonate	Ex-utero transfer	Neonatal admission	Medical discharge planning	Neonatal outreach nursing	Social care delay e.g. fostering, safeguarding
Data	letter	letter	letter	e-Cam	HES	SEND				PAS Community nursing notes	Hospital discharge summary
Information stakeholder: patient +		midwife	Fetal Medicine	Ambulance service	midwife	obstetrician	Neonatal transport team	Neonatal unit		midwife	ward staff

Table 50 Informatics Timeline of administration of maternal and neonatal pathways

Key

e-CAM = ambulance service software

HES = Hospital Episode Statistics

PAS = Patient Administration System

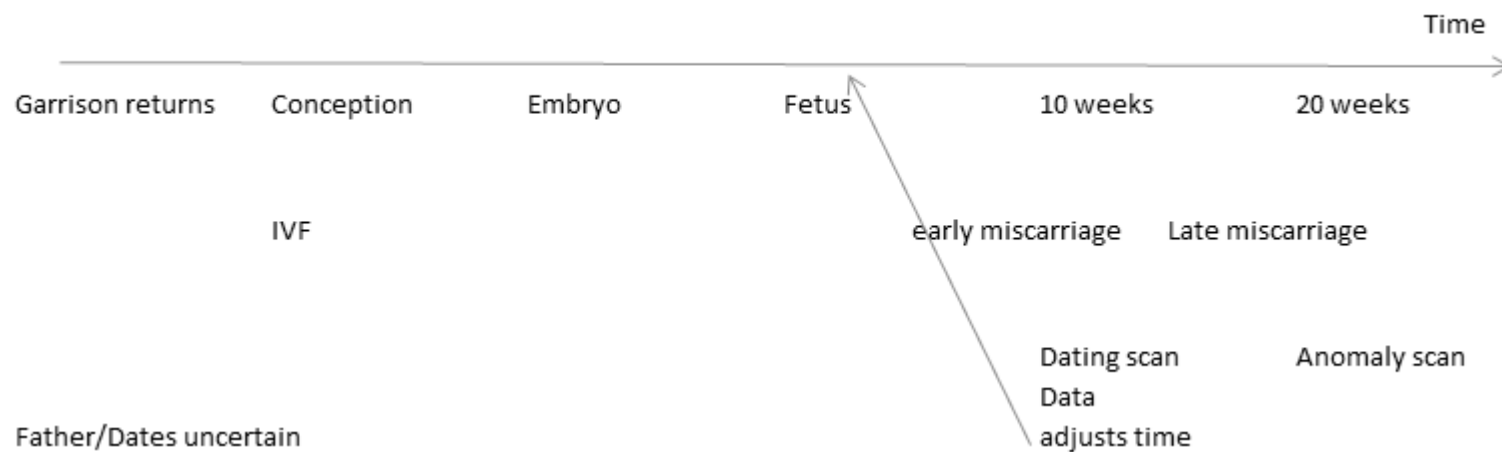

Figure 99 Timeline for early gestation

Maternal Factors increasing Perinatal Morbidity

CEMACH Odds Ratio Data

diabetes
High BMI
hypertension
epilepsy
co-morbidity
born in developing country
bad obstetric history i.e. past prematurity, IUGR, sepsis, haemorrhage
multiple pregnancy
ethnicity
eating disorder
drug use
mental health problems
past blood group incompatibility and same father
domestic violence
PROM
social class

Risk factors for maternal death

epilepsy
haemorrhage
RTA
cardiac

Table 51 Risk factor lists for perinatal mortality and morbidity

DGH transfers out

When Transport service refuses
neurosurgery (paediatric registrar)
out patients
burns
unstable airway (consultant anaesthetist)

Transfers out

cardiology opinion, treatment
retinopathy (eye) treatment
surgical opinion/treatment NEC
hernia repair

occasional palliative care to home

Admissions

out-borns
repatriations from intensive care centre (Standard >95% by 48 hours)
occasional community re-admission
(sepsis, children's ward understaffed, temporary ventilation, winter pressures)

Table 52 Patient transitions – admissions and transfers

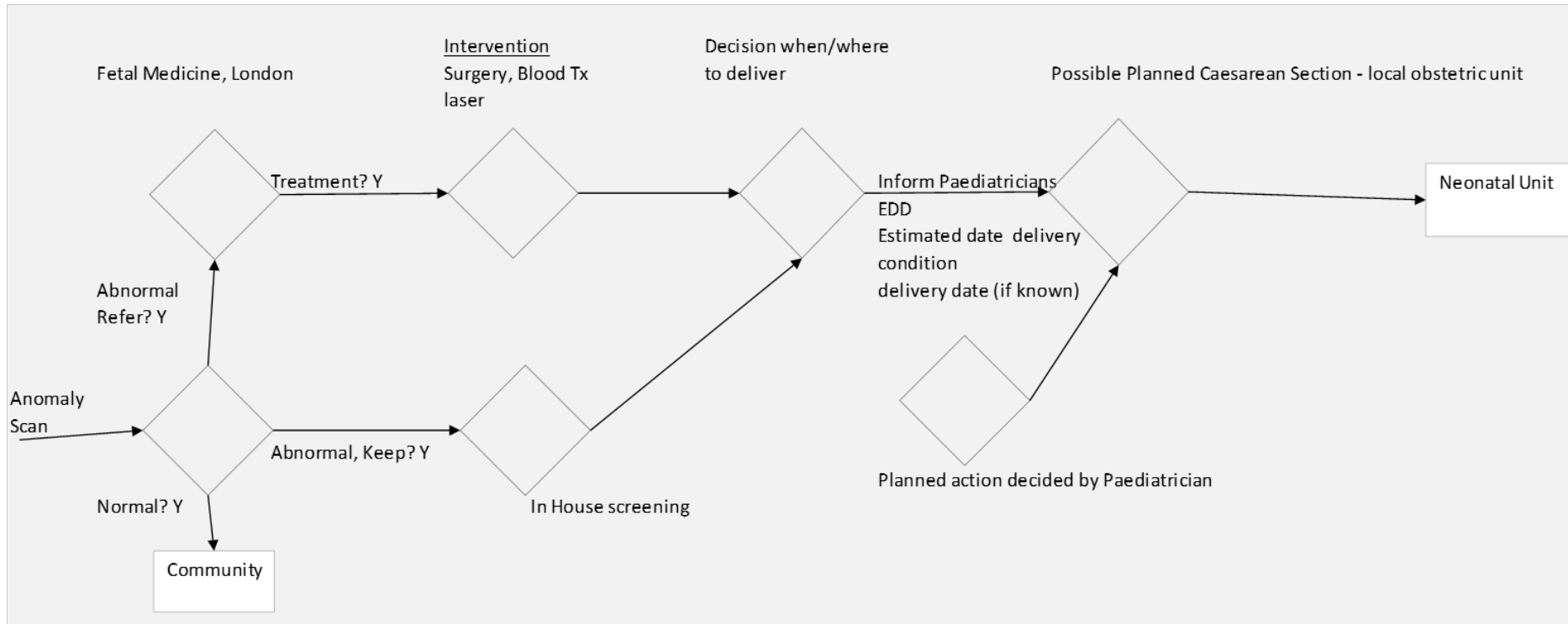

Figure 100 Antenatal anomaly pathway decisions

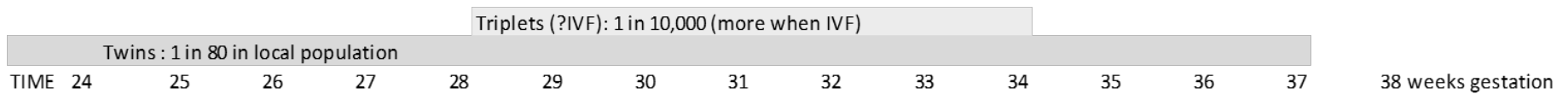

Figure 101 Plurality and Corrected Gestation

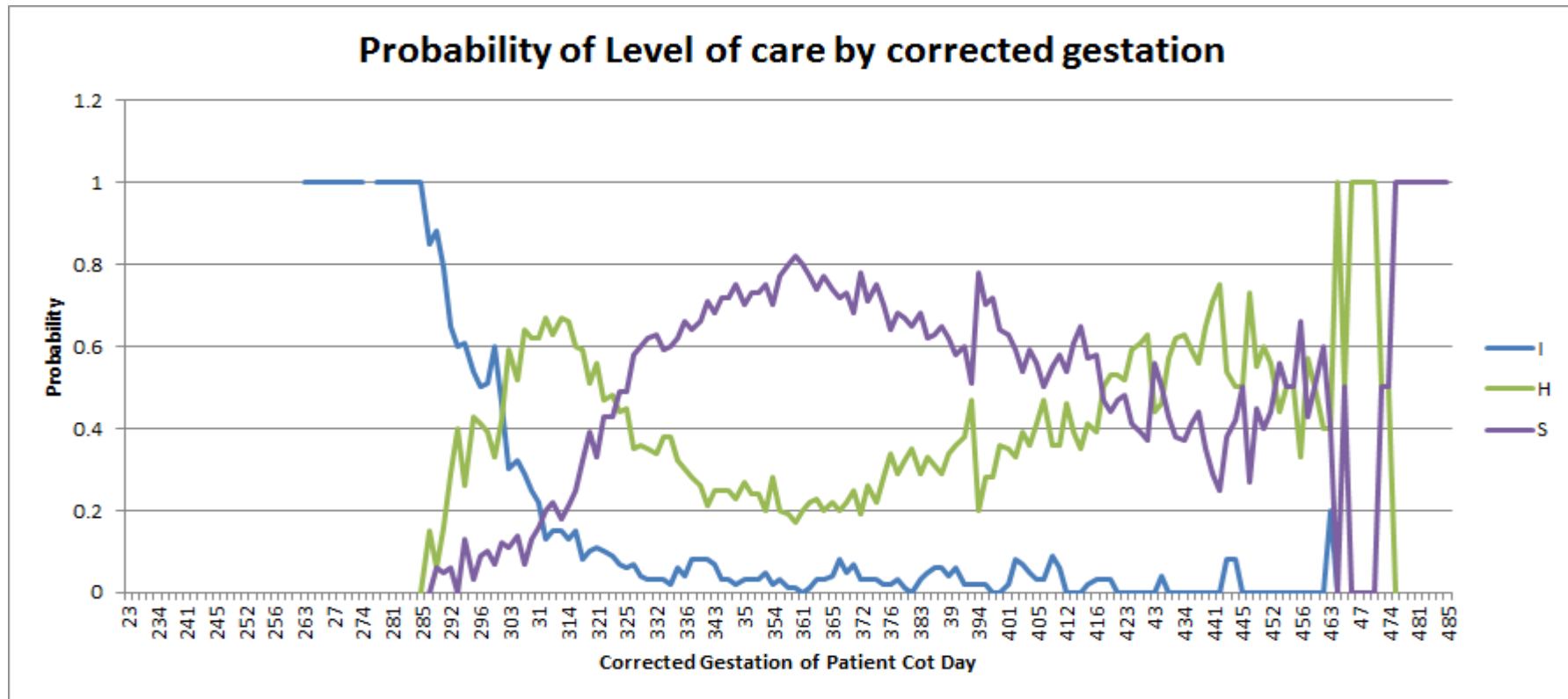

Figure 104 Probability of level of care by corrected gestation

Figures 104 and 105 offer the same information in different formats in order to support the narrative.

Figure 104 shows that in regard of corrected gestation and the three levels of care: I below 28+5: $p = 1$. I appears to fall away between these points i.e. from 28+5 - 32+6 weeks. 33-45 weeks, maximal $p=0.08$ for I. I and H essentially mirror one another from 28+6 to 30+2 weeks. From 30+2 to 31 weeks inclusive, I and S appear to mirror one another, while H increases steeply. H and S essentially mirror one another from 31+1 weeks.

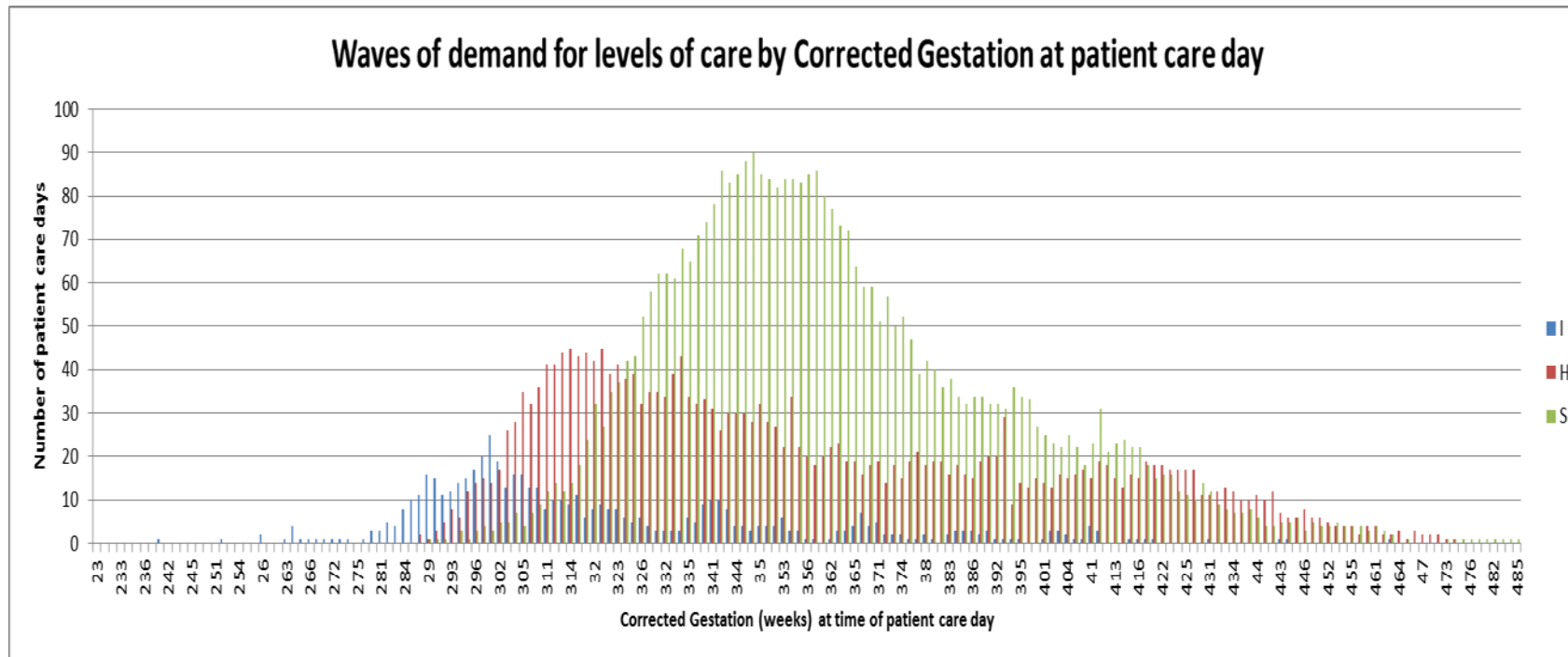

Figure 105 Waves of demand for levels of care by corrected gestation

Figure 105 shows how care is needed in waves, with progressive peaks in numbers over time for Intensive care (I), High dependency (H) and special care (S). Obstetric policy is relevant.

- I greatest at 30+1. Begins 26+3
- H greatest at 31+4. Begins 28+6
- S greatest at 34+6. Begins 29
- < 30+2, mainly I
- 30+3 - 32+3, mainly H
- 32+4 - 40 weeks, predominantly S

The following charts, Figures 106-109 show how patient care days and Patient Transitions may adopt a pattern when related to the Corrected Gestation at the time.

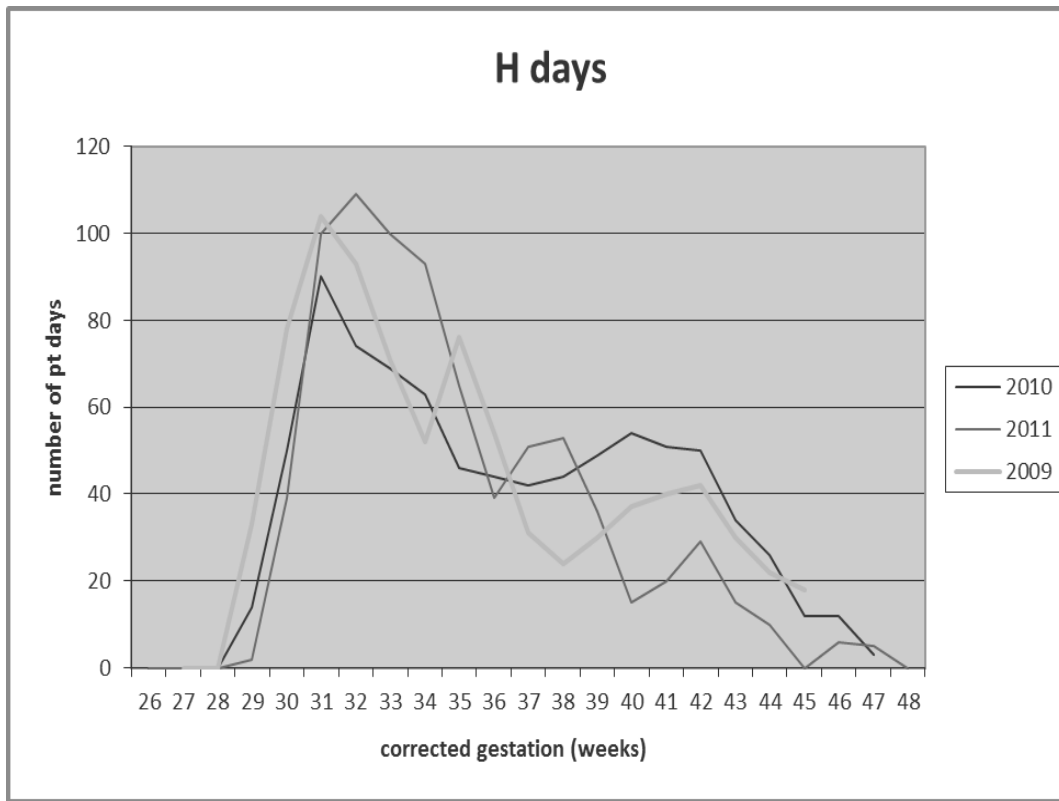

Figure 106 Corrected gestation of High dependency Day of care

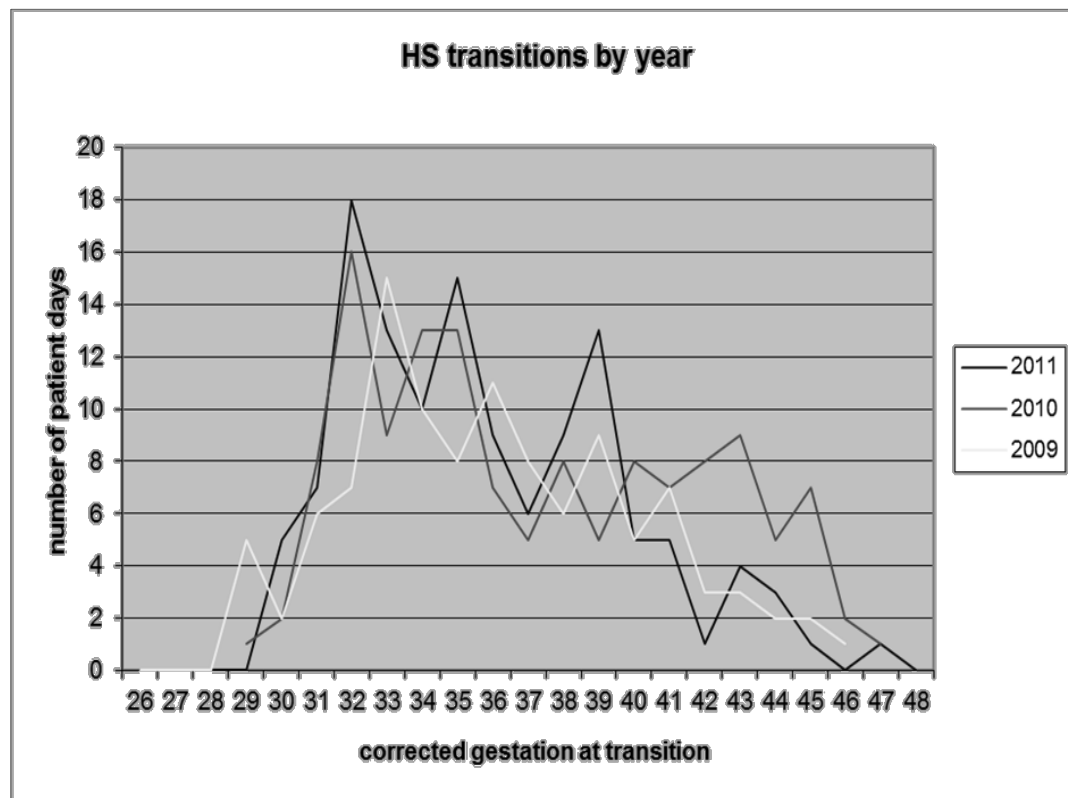

Figure 107 Corrected gestation at transition from High dependency to special care

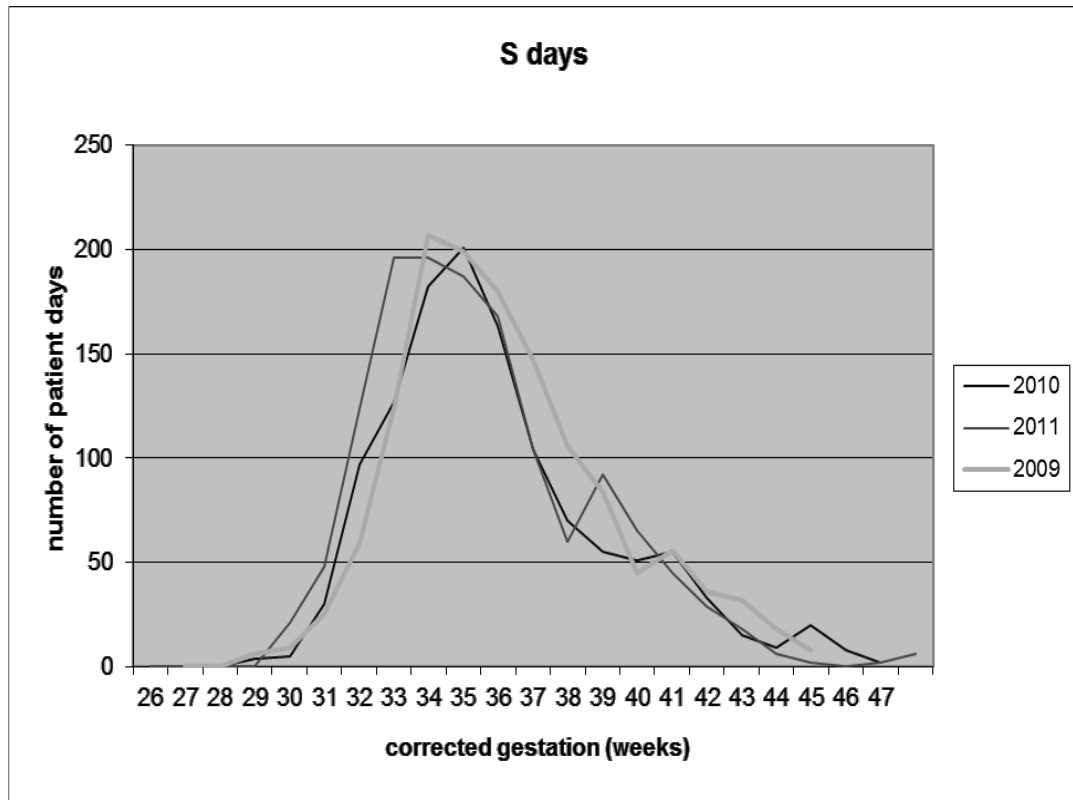

Figure 108 Corrected gestation of special care day

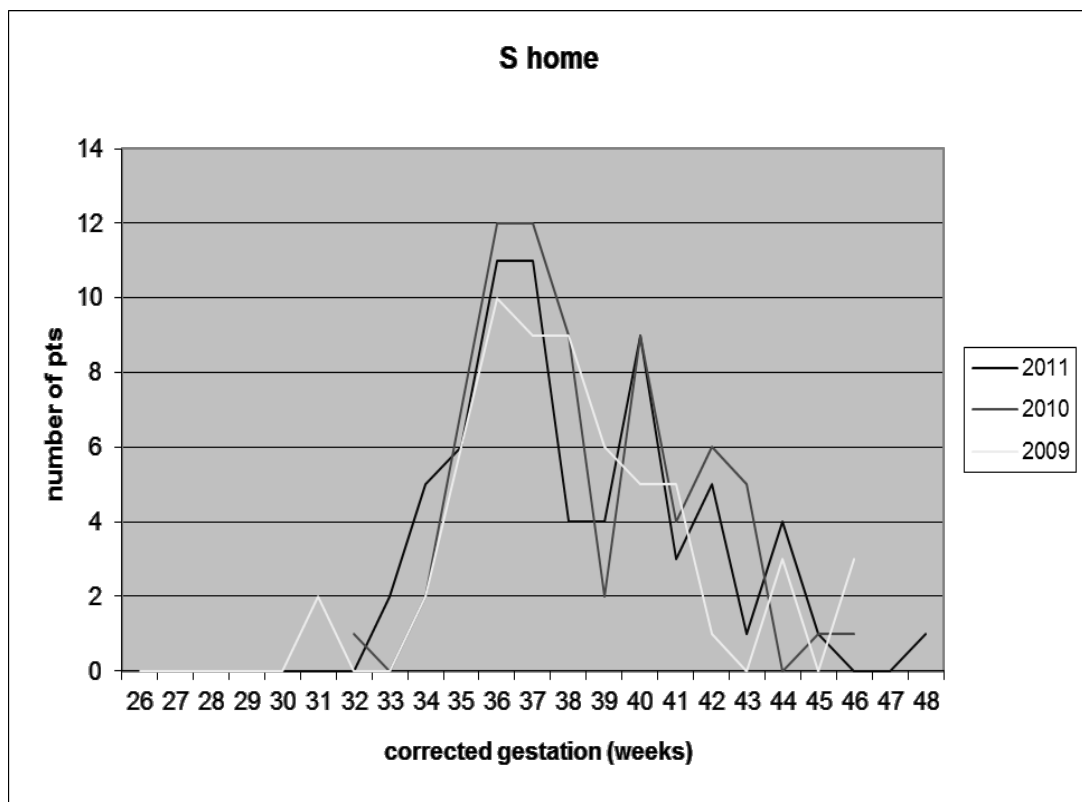

Figure 109 Pattern of discharge from special care

Figures 110 and 111 show the probability of the timing of the Patient Transition in the inclusive group who spent at least one day on High dependency care and thus in whom the move is certain to occur at some time. This is in contradistinction to Figure 65, which takes in a denominator (since special care is always occupied and may be considered a stock and flow).

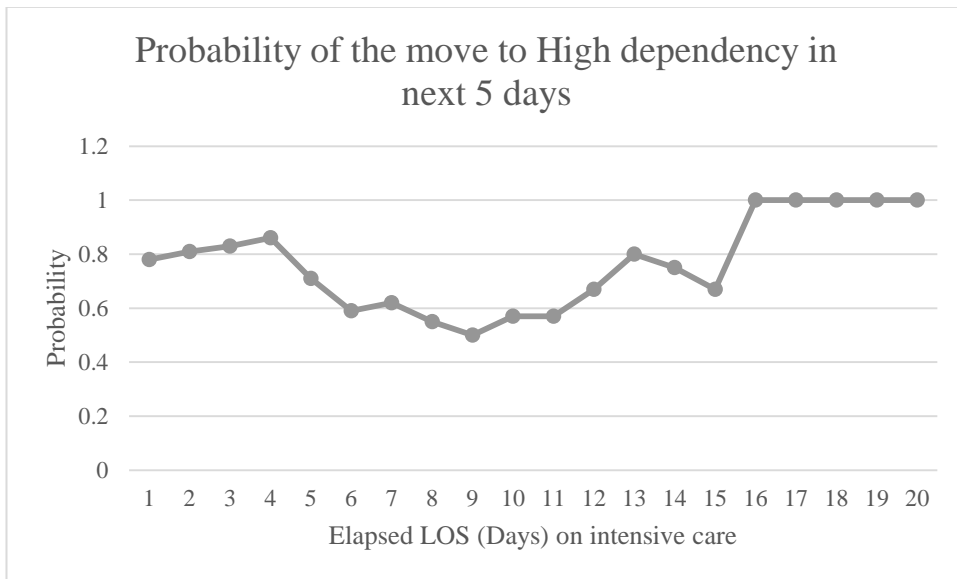

Figure 110 Probability of IH by elapsed LOS

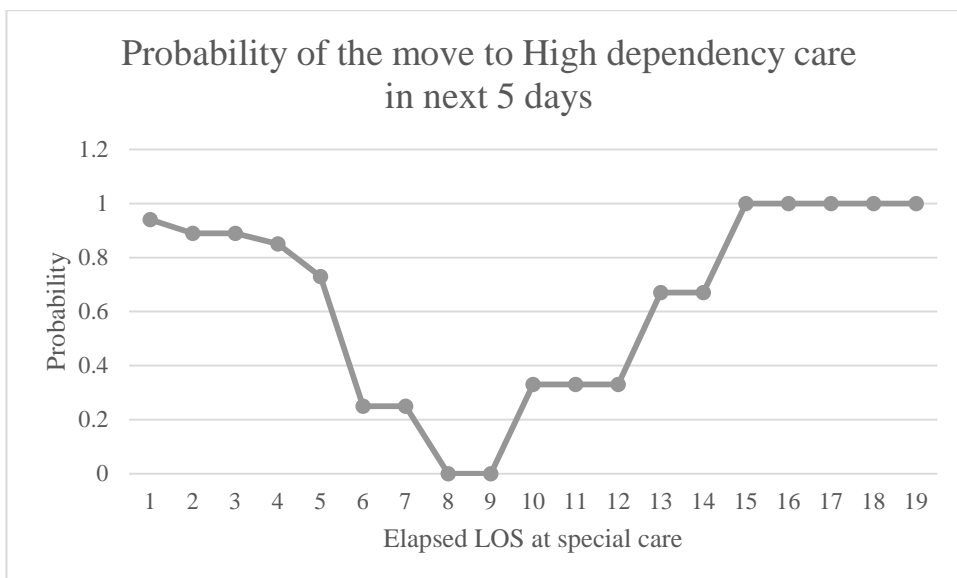

Figure 111 Probability of SH by elapsed LOS

Figure 112 shows the changing probability of patients remaining on High dependency care so many days since being admitted there. The horizontal axis is logarithmic. 2011 data has been compared with that for 2009 and 2010 combined.

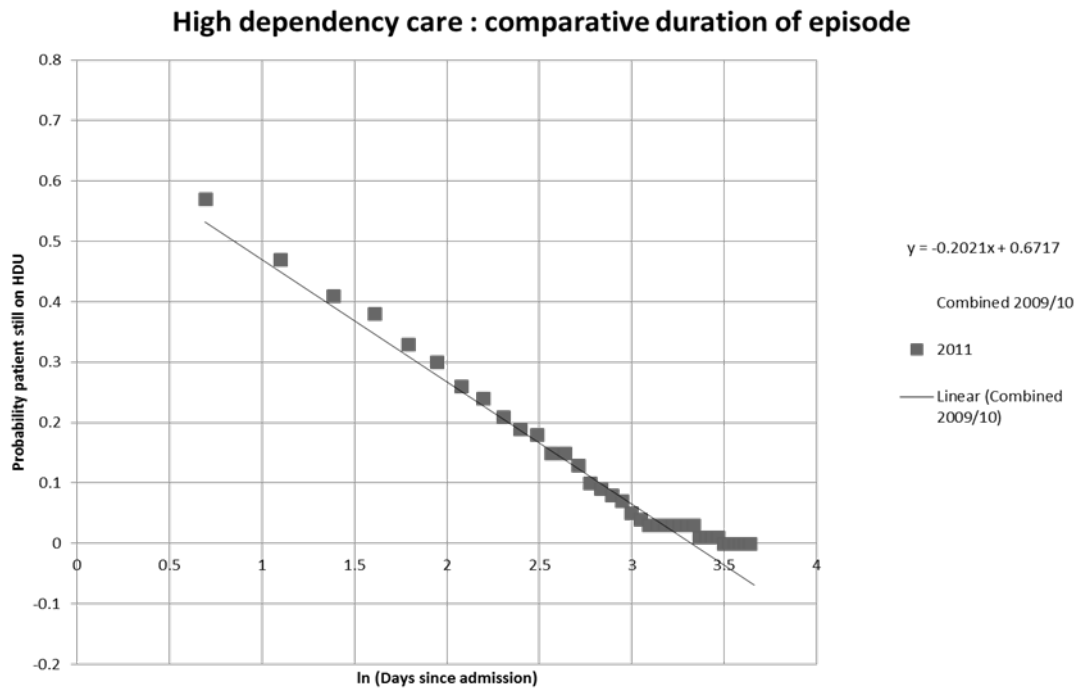

Figure 112 Logarithmic plot of probability of staying on High dependency care

Figure 113 shows how the probability of transition is related to time since first admitted; this is for that group admitted at special care, who will require high dependency care.

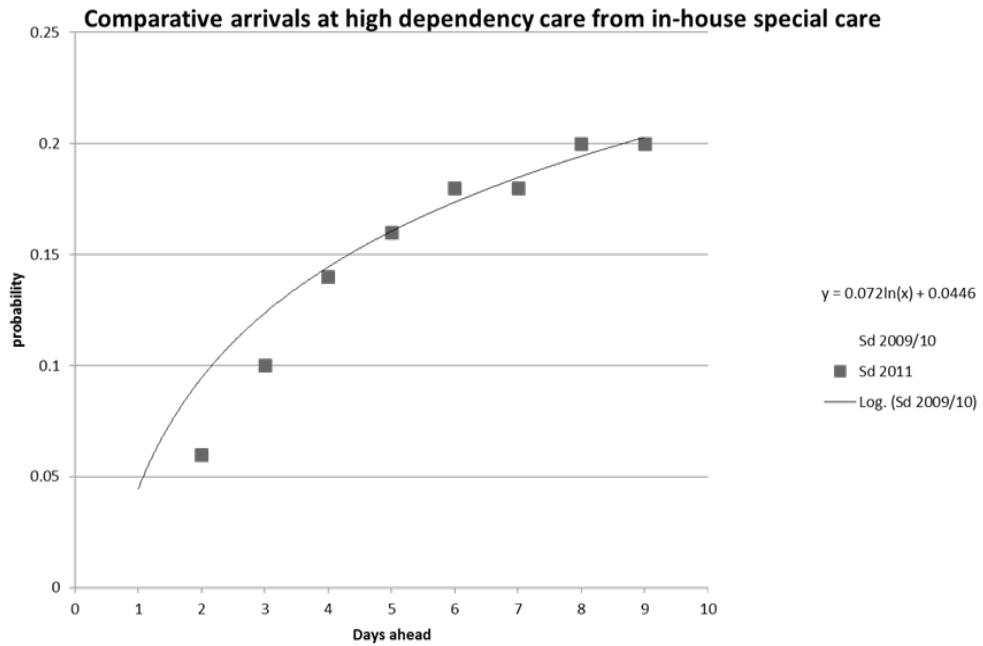

Figure 113 Probability of SH Patient Transition by days since admission.

Cot occupancy sum	2009-11		
	i	h	s
0	478	146	0
1	377	271	0
2	163	318	1
3	51	178	4
4	22	98	15
5	2	48	40
6	1	27	48
7	1	7	74
8		2	100
9			135
10			137
11			152
12			126
13			95
14			59
15			45
16			30
17			17
18			11
19			3
20			2
21			1
	1095	1095	1095

Table 53 Cot Occupancy summary 2009-11

s	1/1095													
2	1								%	days/yr				
3	4			nn short	1			229	21	76				
4	15				2			33	3	11				
5	40				3			1	0	0			1/1095	
6	48													
7	74							263	24%	87				
8	100													
9	135													
10	137								%	days/yr				
11	152				1			110816	9.2	34				
12	126		%		2			42944	3.6	13				
13	95	229	21		3			12688	1.1	4				
14	59				4			3396	0.3	1				
15	45				5			1213	0.1					
16	30				6			369	0					
17	17	33	3		7			84	0					
18	11				8			9	0					
19	3													
20	2							total	171519	14.30%	52			
21	1	1	0											
	405 nursing				H									
	0	1	2	3	4	5	6	7	8					
i	146	271	318	178	98	48	27	7	2					
478	69788	129538	152004	85084	46844	22944	12906	3346	956	0			x 1/1095x1095	
377	55042	102167	119886	67106	36946	18096	10179	2639	754	1				
163	23798	44173	51834	29014	15974	7824	4401	1141	326	2			1/1199025	
51	7446	13821	16218	9078	4998	2448	1377	357	102	3				
22	3212	5962	6996	3916	2156	1056	594	154	44	4				
2	292	542	636	356	196	96	54	14	4	5			405 nurses short	
1	146	271	318	178	98	48	27	7	2	6				
1	146	271	318	178	98	48	27	7	2	7				

Table 54 Cot Predictor calculation

Basic equations and underpinning mathematical formulae (namely the Binomial Theorem and Pascale's triangle) used in the Cot Predictor calculations are given below.

Equations						
	SUM					
H1=	Ha1	ld1	Sd1	Hs1		
H2=	Ha2	ld2	Sd2	Hs2		
H3=	Ha3	ld3	Sd3	Hs3		
Ht=	Hat	ldt	Sdt	Hst		the general case
Binomial Theorem						
$(a + b)^n$	sum					
a^n	$n(a)^{n-1}b$		$n(n-1)/2!$	$a^{n-2}b^2$...	b^n
a=probability p						
b=(1-p)						

Table 55 Model equations and Binomial Theorem

Pascale's Triangle										
					1					
				1	2	1				
			1	3	3	1				
		1	4	6	4	1				
	1	6	15	10	10	5	1			
	1	6	15	20	15	6	1			
1	7	21	35	35	21	7	1			

Table 56 Pascale's Triangle

Worked Example										
Given (1,4,15) produce the 2-day forecast										
Hs	ld	Ha+Sd	Ht		product	x	x	value	sum total	approx
4	1	2	7	p(7)=	0.21	0.26	0.01	0.000546		0
4	1	1	6	p(6)=	0.21	0.26	0.2	0.01092		
4	1	0	5		0.21	0.74	0.01	0.001554		
4	0	2	6		0.4	0.28	0.01	0.00112	0.013594	0.02
4	0	1	5	p(5)=	0.21	0.28	0.79	0.046452		
4	0	0	4		0.21	0.74	0.2	0.03108		
3	1	2	6		0.4	0.26	0.2	0.0208		
3	1	1	5		0.4	0.74	0.01	0.00296		
3	1	0	4		0.28	0.26	0.01	0.000728	0.10202	0.12
3	0	2	5	p(4)=	0.21	0.74	0.79	0.122766		
3	0	1	4		0.4	0.26	0.79	0.08216		
3	0	0	3		0.4	0.74	0.2	0.0592		
2	1	2	5		0.28	0.26	0.2	0.01456		
2	1	1	4		0.28	0.74	0.01	0.002072		
2	1	0	3		0.09	0.26	0.01	0.000234	0.280992	0.29
2	0	2	4	p(3)=	0.4	0.74	0.79	0.23384		
2	0	1	3		0.28	0.26	0.79	0.057512		
2	0	0	2		0.28	0.74	0.2	0.04144		
1	1	2	4		0.09	0.26	0.2	0.00468		
1	1	1	3		0.09	0.74	0.01	0.000666		
1	1	0	2		0.02	0.26	0.01	0.000052	0.33819	0.32
1	0	2	3	p(2)=	0.28	0.74	0.79	0.163688		
1	0	1	2		0.09	0.26	0.79	0.018486		
1	0	0	1		0.09	0.74	0.2	0.01332		
0	1	2	3		0.02	0.26	0.2	0.00104		
0	1	1	2		0.02	0.26	0.01	0.000052	0.196586	0.19
0	1	0	1	p(1)=	0.09	0.74	0.79	0.052614		
0	0	2	2		0.02	0.26	0.79	0.004108		
0	0	1	1		0.02	0.74	0.2	0.00296	0.059682	0.05
0	0	0	0	p(0)=	0.02	0.74	0.29	0.004292		0.01
										1
Relevant summary data t=2										
t=2	Ha+Sd			1	4	6	4	1		
0.01	2			0.213814	0.314432	0.4624	0.032768	0.020851		
0.2	1				0.32	0.1024	0.68			
0.79	0				4	6	4			
					0.402473	0.284099	0.089129			
0.26	ld2			0.21	0.4	0.28	0.09	0.02		
0.68	Hs2									

Table 57 Worked example calculation

Disclaimer: In these Excel extracts (Tables 54 and 57), the use of colour is not being matched. It was for the purpose of making the calculation easier.

Background clinical information on forecasting Patient Pathways:

What can you expect for the particular patient?

Medical determinants of cot demand

number of women in labour,
the rate of daily admissions of labouring women and their distribution of gestation,
their rate of Rupture of Membranes (ROM),
the time of labour (whether primiparous or multiparous),
the rate of placental abruption and the use of isolation rooms.
raised BP, ROM / infection, Mental illness,
if gestation < 35 weeks, birthweight < 1.8 kg, twins or triplets
Known congenital abnormality in fetus like congenital heart disease
Medical ICU for mother
High risk obstetrics: EDD
Maternal clinical and social risk factors:
BMI, DM, epilepsy, age, past obstetric history, Drug History, NAS,
medical history,
socio-economic status, postcode, learning difficulty, social worker

When forecasting activity, there is the background of random work expected for the population. Experience tells us that at half-term and doctor's change-over, staff shortages are certain. Conceptions coincide with holidays like Christmas. Population grows. Seasonal 'flu' exacerbates winter pressures. A hospital's neonatal unit may be downgraded, re-locating, not up to capacity perhaps owing to refurbishment, leaking roof, power outage and equipment damage, infection outbreak or rota-gaps.

At what time will patient enter the system?

This is usually after the planned time. There are delays in theatre. With practical logistics, things take longer than predicted. With transfers, one should consider refusal by transport team, organizing/ scrambling transport team, transport team waiting for change of shift (frequent), staffing difficulties and sickness. There are also delays in leaving, travelling time and that spent in traffic jams.

Repatriations

intensive care centre – progress on a transferred patient
average corrected gestation at return
average duration of time away
dependency – tube-feeding, TPN, O₂, CPAP
Clinician estimated probabilities of repatriated level of care: $p(\text{intensive care}) = 0$,
 $p(\text{high dependency}) = 0.9$, $p(\text{special care}) = 0.1$

Other Demand

unexpected short-term intensive care for A&E collapse / bridging unit for CATS
transfer of small baby

LIST OF REFERENCES

- Aboueljinnane, L., Sahin, E. and Jemai, Z. (2013). A review on simulation models applied to emergency medical service operations. *Computers & Industrial Engineering*, 66, 734-750.
- Abraham, G., Byrnes, G.B. and Bain, C.A. (2009). Short-Term Forecasting of Emergency Inpatient Flow. *IEEE Transactions on Information Technology in Biomedicine*, May 2009, 13(3), 380-8.
- Ackoff, R.L. (1979). The Future of Operational Research is Past. *JORS*, 30, 93-103.
- Adaikappan, N. G. (2006). Modeling Neonatal Patient Flow Using System Dynamics. Department of Mechanical and Industrial Engineering. Toronto. Master of Applied Science. Library and Archives Canada.
- Adeyemi, S., Demir, E., Chahed, S., Chaussalet, T. (2010). Analysis of Variability in neonatal Care Units: A Retrospective Analysis. *Health Care Management (WHCM) IEEE Workshop on*. 1-6.
- Adeyemi, S., Demir, E. and Chaussalet, T. (2013). Towards an evidence-based decision making healthcare system management: Modelling patient pathways to improve clinical outcomes. *Decision Support Systems*, 55(1), 117-125.
- Aftab et al. (2009). Mapping Integrating the Healthcare Environment (IHE) to Business Process Execution Language for People (BPEL 4PPL). *IEEE 13th International Multitopic Conference*, Dec 2009, 1-6.
- Ahsan, K., Shah, H. and Kingston, P. (2010). Healthcare Modelling through Enterprise Architecture: A Hospital Case. 7th International conference on Information Technology: New Generation. April 2010. 460-5.
- Akcali, E., Cote, M. et al. (2006). A network flow approach to optimizing hospital bed capacity decisions. *Health Care Management Science*, 9, 391-404.
- Allen, M., Spencer, A., Gibson, A., Matthews, J., Allwood, A., Prosser, S. et al. (2015). Right cot, right place, right time: improving the design and organisation of neonatal care networks – a computer simulation study. *Health Serv Deliv Res*, 3 (20).
- Ambalavanan, N. and Carlo, W.A. (2001). Comparison of the prediction of extremely low birth weight neonatal mortality by regression analysis and by neural networks. *Early Hum Dev*, 65(2), 123-137.
- Anderson, B., Fagerhaug, T., Henriksen, B. and Onsøyen, L.E. (2008). *Mapping Work Processes*, Second Edition. ASQ. ISBN: 978-0-87389-687-0.
- Anselmi, J. and Cremonesi, P. (2010). A unified framework for the bottleneck analysis of multiclass queueing networks. *Performance Evaluation*, 67, 218-234.
- Arman, A. and Dwiyaniti, L. (2015). Framework of Information System Architecture for Healthcare Organisation based on Collaborative Care Model. In: *The 5th*

International Conference on Electrical Engineering and Informatics. Bali, Indonesia. 10-11 August 2015. 710-15.

Asaduzzaman, M., Chaussalet, T.J., Adeyemi, S., Chahed, S., Wood, D., Hawdon, J. and Robertson, N.J. (2010). Towards effective capacity planning in a perinatal network centre. *Archives of disease in Childhood, Fetal Neonatal Edition*, 95(4), F283-F287.

Asaduzzaman, M., Chaussalet, T. et al. (2010). A Loss network model with overflow for capacity planning of a neonatal unit. *Annals of Operations Research*, 178(1), 67-76.

Ashton, R. and Hogue, L. (2005). NHS Walk-in-Centre, Liverpool. *Journal of the Operational Research Society*, 56(2), 153-161.

Atallah, Z. and Ramudhin, A. (2010). Improving Healthcare Reliability by Integrating Six-Sigma in a Business Process Modeling and Business Strategy. *Proceedings of the 2010 IEE IEEM*. 2234-8.

Au-Yeung, S.W.M., Harder, U., McCoy, E.J. and Knottenbelt, W.J. (2009). Predicting patient arrivals to an accident and emergency department. *Emergency Medicine Journal: EMJ* 2009, 26(4), 241-4.

Bagust, A., Place, M. et al. (1999). Dynamics of bed use in accommodating emergency admissions: stochastic simulation model. *BMJ*, 319, 155-158.

Bannwart, D. D. C., Rebello, C.M. et al. (1999). Prediction of length of hospital stay in neonatal units for very low birth weight infants. *J Perinatol*, 19(2), 92-96.

BBC News (2017). Maternity wards closed 382 times last year in England. Available at <http://www.bbc.co.uk/news/health-40854631>. [Accessed 8 August 2017].

Benyoucef, M. et al (2011). Modelling healthcare processes as service orchestrations and choreographies. *Business Process Management Journal*, 17(4), 568-597. Doi.org/10.1108/14637151111149438.

Bhattacharjee, P., Ray, P.K. (2014). Patient flow modelling and performance analysis of healthcare delivery processes in hospitals: A review and reflections. *Computers & Industrial Engineering*, 78, 299-312.

Binmore, K. (2007). *Game Theory: a very short introduction*. Oxford: OUP.

Bland, M. (1995). *An Introduction to Medical Statistics*, 2nd Ed. Oxford: Oxford University Press.

BLISS. (2006). Weigh Less. Worth Less? A study of neonatal care in the UK. Baby Report Retrieved 16/05/2010, 2010, from www.bliss.org.uk/page.asp?section=6768sectionTitle=Weigh+Less%2C+worth+less%3F.

BLISS. (2007). *Special Delivery or Second Class: are we failing special care babies in the UK?*

- BLISS. (2012). *Baby SOS Report*. London: BLISS. www.bliss.org.uk. Accessed 4/5/2017.
- BLISS. (2015). *Baby Report Hanging in the balance*. London: BLISS. www.bliss.org.uk
- Bonabeau, E. (2002). Agent-based modelling: methods and techniques for simulating human systems. *Proceedings of the National Academy of Sciences of the United States of America*, May 14 2002, 99(3), 7280-87.
- Box, G.E.P. (1979). Robustness in the strategy of scientific model building in Robustness in Statistics. In: Launer, R. L. and Wilson, G.N. (Eds). Academic Press.
- Brailsford S.C., Harper P.R., Patel B., Pitt M. (2009). An analysis of the academic literature on simulation and modelling in health care, *Journal of Simulation*, 3,130-140.
- Brailsford, S. C., T. Bolt, N. A. D. Connell, J. H. Klein, and B. Patel. (2009). Stakeholder engagement in health care simulation. In: Rossetti, M.D., Hill, R.R., Johansson, B., Dunkin, A. and Ingalls, R.G, Eds, *Proceedings of the 2009 Winter Simulation Conference*, Forthcoming, Piscataway, New Jersey: Institute of Electrical and Electronics Engineers, Inc.
- Brailsford, S.C. and Vissers, J. (2011). OR in healthcare: a European perspective. *European Journal of Operational Research*, 212(2), 223-234.
- Brailsford S., Bolt T., Bucci G., Chausalet T., et al. (2013). Overcoming the barriers: a qualitative study of simulation adoption in the NHS. *Journal of the Operational Research Society*, 64, 157–168.
- British Association of Perinatal Medicine. (2009). *Neonatology: Clinical responses to the downturn*. London, Accessed 14/12/10.
- British Association of Perinatal Medicine. (2001). *Standards for hospitals providing neonatal intensive and high dependency care (second edition) and categories of babies requiring neonatal care*. London.
- British Association of Perinatal Medicine. (2014). *Optimal Arrangements for Neonatal Intensive Care Units in the UK including guidance on their Medical Staffing. A Framework for Practice*. June 2014.
- British Medical Association. (2017). IT: the price of under-investment. *BMA News*, 22 July 2017, 2.
- British Standard 25999. (2006). *Business Continuity Planning Code of Practice*.
- Burton, P. R., Draper, E. et al. (1995). Neonatal intensive care cots: estimating the population based requirement in Trent, UK. *J Epidemiol Community Health*, 49(6), 617-628.
- Cameron, S. (2014). David Nicholson - the man who believed in being ruthless with the NHS. *Daily Telegraph*, 26 March. Available at

<http://www.telegraph.co.uk/news/nhs/10724504/David-Nicholson-the-man-who-believed-in-being-ruthless-with-the-NHS.html>. [Accessed on 2 August 2017].

The Carter Review. (2016). *Operational Productivity and Performance in English NHS acute hospitals: unwarranted variations*. Lord Carter of Coles. February 2016. Department of Health.

Catley, C., Frize, M. et al. (2004). Towards a Web Services Infrastructure for Perinatal, Obstetrical, and Neonatal Clinical Decision Support. *Proceedings of 2003 International Conference of the IEEE EMBS*, 3334-3337.

Checkland, P. (1981). *Systems Thinking, Systems Practice*. Chichester: Wiley.

Chen, D. and Doumeings, G. (1997). The GRAI-GIM reference model, architecture and methodology. In: Bernus, P. et al (eds.) *Architectures for Enterprise Integration*.

Clarkson, J. (2017). Five things healthcare can learn from engineering. *British Medical Journal Careers*, 20 Jan. Available from www.careers.bmj.com. Accessed 4/5/2017.

CMACE. (2009). Perinatal Mortality Report 2007. Retrieved 16/05/2010, 2010, from www.cmace.org.uk/getattachment/1d2c0ebc-d2aa-4131-98ed-56df8269e529/Perinatal-Mortality-2007.aspx.

Cochran, J and Bharti, A. (2006). Stochastic bed blocking of an obstetrics hospital. *Health Care Management Science*, 9(1), 31-45.

Cockburn, F., Cooke, R. et al. (1993). The CRIB (clinical risk index for babies) score: a tool for assessing initial neonatal risk and comparing performance of neonatal intensive care units. *Lancet*, Sep 4, 342 (8871), 626.

Crowe, S., Brown, K., Tregay, J., Wray, J., Knowles, R., Ridout, D.A., Bull, C. and Utley, M. (2017). Combining qualitative and quantitative operational research methods to inform quality improvement in pathways that span multiple settings. *BMJ Qual Saf*, published Online First 6 January 2017. Doi: 10.1136/bmjqs-2016-005636.

Cusack, J., Field, D. et al. (2007). Impact of service changes on neonatal transfer patterns over 10 years. *Archives of Disease in Childhood, Fetal and Neonatal Edition* 92(3), F181-F184.

Dalton, S., and Chausalet, T. (2011). Towards Modelling Patient Pathways through the Perinatal Network System focusing on high dependency cots in the local neonatal unit. *Operational Research Applied to Health Services, Conference Proceedings*. Cardiff, Wales. 150-160.

Dalton, S., Chahed, S. and Chausalet, T. (2012). How to predict high dependency cot demand in upcoming days. *High Tech Human Touch: ORAHS*. Enschede, Netherlands. 21.

Dalton, S., Chahed, S. and Chausalet, T. (2013). What constitutes a normal patient pathway? Quantitative Modelling the Management of Health and Social Care. London: IMA,

- Damschroder, L.J., Aron, D.C., Keith, R.E., Kirsh, S.R., Alexander, J.A., Lowery, J.C. (2009). Fostering implementation of health services research findings into practice: a consolidated framework for advancing implementation science. *Implementation Science*, 4, 50. Doi: 10.1186/1748-5908-4-50.
- Deadman, P.J. (1999) Modelling individual behaviour and group performance in an intelligent agent-based simulation of the tragedy of the commons. *J Environmental Management*, 56, 159-172.
- Department of Health. (2000). *An organisation with a memory*. London: HMSO.
- Department of Health. (2003). *National Service Framework for Children*. London: HMSO.
- Department of Health. (2009). Toolkit for High-Quality Neonatal Services. www.healthcareworkforce.nhs.uk/index.php?option=com_docman&task=docdownload&gid=208. (accessed May 10, 2010).
- Department of Health (2017). Available from www.doh.gov.uk. [Accessed 31/05/2017].
- De Souza, L.B. and Pidd, M. (2011). Exploring the barriers to lean healthcare implementation, *Public Money & Management*, 31:1, 59-66. DOI:10.1080/09540962.2011.545548.
- Dewhurst, F.W. et al. (2002). In search of a general enterprise model. *Management Decision*, Vol 40(5), 418-427.
- Diehl. (2007). Zachman ISA Framework for Healthcare Informatic Standards. 12/22/97
- Dominiczak, P. (2013). Sir Bruce Keogh admits that 'inaccurate data' led him to suspend children's heart surgery. *Daily Telegraph*, 9 April. Available from <http://www.telegraph.co.uk/news/health/news/9980869/Sir-Bruce-Keogh-admits-that-inaccurate-data-led-him-to-suspend-childrens-heart-surgery.html>. [Accessed 2 August 2017].
- Donnelly, L. (2016). Jeremy Hunt: Doctors and nurses should be put in charge of hospitals. *Daily Telegraph*, 30 November. Available from <http://www.telegraph.co.uk/news/2016/11/30/jeremy-hunt-doctors-nurses-should-put-charge-hospitals/>. [Accessed 2 August 2017].
- Dougherty et al. (2012). Modeling the US Healthcare System as an Enterprise. The MITRE Corporation IEEE Systems Conference (SysCon). Vancouver, BC, Canada. 19-22 March 2012. IEEE International, 1-6. Accessed 4/5/2017. DOI:10.1109/SysCon2012.6189452.
- Doumeingts, G. and Ducq, Y. (2001). Enterprise modelling techniques to improve efficiency of enterprises, *Production Planning and Control: The Management of Operations*, 12(2), 146-163. DOI:10.1080/09537280150501257.

- Ducq, Y., Chen, D. and Doumeingts, G. (2012). A contribution of system theory to sustainable enterprise interoperability science base. *Computers in Industry* 63, 844-857.
- Eldabi, T. and Young, T. (2007). Towards a framework for healthcare simulation. *WinterSim 2007: 39th conference on Winter simulation: 40 Years! The best is yet to come*. Washington DC, U.S.A. 9-12 December 2007. IEEE Press, 1454-1460.
- Eldabi, T., Paul, R.J. and Young, T. (2007). Simulation modelling in healthcare: reviewing and investigating futures. *JORS*, 58, 262-270. Doi: 10.1057/palgrave.jors.2602222.
- Eldabi, T. (2009). Implementation issues of modelling Healthcare problems: misconceptions and lessons. In: Rossetti, M.D., Hill, R.R., Johansson, B., Dunkin, A. and Ingalls, R.G., eds, *Proceedings of the 2009 Winter Simulation Conference*. 1831-1839.
- Eldabi, T., Jun, G.T., Connell, C. and Klein, J.H. (2010). Model driven healthcare: disconnected practices. In: Johansson, B., Jain, S., Montoya-Torres, M., Hagan, J. and Yucesan, E., eds, *Proceedings of the 2010 Winter Simulation Conference*.
- Eldabi, T., Lacey, P., Naseer, A., Jahangirian, M. (2011). Integrated care development using systems modelling – A case Study of intermediate Care. In: Jain, S., Creasey, R.R., Himmelspach, J., White, K.P. and Fu, M., eds, *Proceedings of the 2011 Winter Simulation Conference*.
- El-Darzi, E., Vasilakis, C., Chausalet, T. and Millard, P.H. (1998). A simulation modelling approach to evaluating length of stay, occupancy, emptiness and bed blocking in a hospital geriatric department. *Health Care Management Science*, 1(2), 143-149.
- Elefteriadou, L. (2014). *An Introduction to Traffic Flow Theory*. New York: Springer.
- Ercole, A., Menon, D.K. et al. (2009). Modelling the impact of pandemic influenza A (H1N1) on UK paediatric intensive care demand. *Arch Dis Child*, 94(12), 962-964.
- Erol, O., Mansouri, M. and Sauser, B. (2009). A Framework for Enterprise Resilience Using Service Oriented Architecture Approach. *3rd Annual IEEE International Systems Conference*. Vancouver, Canada. 23-6 March, 2009. 127-132.
- Fakhimi, M. and Probert, J. (2013). Operations research within UK healthcare: a review. *Journal of Enterprise Information Management*, Vol. 26 (1/2), 21-49.
- Fenton, A. C., Ainsworth, S.B. et al. (2002). Population-based outcomes after acute antenatal transfer. *Paediatr Perinat Epidemiol*, 16(3), 278-285.
- Fenton, A.C., Leslie, A. and Skeoch, C.H. (2004). Optimising neonatal transfer. *Arch Dis Child Fetal Neonatal* Ed 89, F215-F219.
- Fetters, M.D. Curry, L.A. and Creswell, J.W. (2013). Achieving Integration in Mixed Methods Designs – Principles and Practices. *Health Services Research*, December 2013, Vol.48 (6pt2), 2134-2156

- Field, D. et al. (2016). Towards reducing variations in infant mortality and morbidity: a population-based approach. *NIHR Programme Grants for Applied Research* 4(1) March, 1-252. ISSN 2050-4322.
- Fone, D., Hollinghurst, S., Temple, M., Round, A., Lester, N., Weightman, A., Roberts, K., Coyle, E., Bevan, G. and Palmer, S. (2003). Systematic review of the use and value of computer simulation modelling in population health and health care delivery. *Journal of Public Health Medicine*, 25(4), 325–335. DOI: 10.1093/pubmed/fdg075.
- Forrester, J.W. (1961). *Industrial Dynamics*. Cambridge, MA. The M.I.T. Press.
- Fournier, D.L and Zaric, G.S. (2013). Simulating neonatal intensive care capacity in British Columbia. *Socio-Economic Planning Sciences*, 47, 131-141.
- Francis, R. (2013). *Report of the Mid Staffordshire NHS Foundation Trust Public Inquiry*. London: The Stationery Office.
- Franck, T., Augusto, V., Xie, X., Gonthier, R. and Achour, E. (2015). Performance Evaluation of an Integrated Care for Geriatric Department using Discrete-Event Simulation. *Proceedings of the 2015 Winter Simulation Conference*.
- Frank, W., Dewhurst K.D., Barber and Pritchard, M.C. (2002). In search of a general enterprise model. *Management Decision*, 40(5), 418-427.
- Frize, M, and Walker, R. (2000). Clinical decision-support systems for intensive care units using case-based reasoning. *Medical Engineering & Physics*, 22, 671-677.
- Gallivan, S., Utley, M., Treasure, T. and Valencia, O. (2002). Booked inpatient admissions and hospital capacity: mathematical modelling study. *BMJ*, 324(7332), 280-282.
- Galvao, R. D. (2002). A hierarchical model for the location of perinatal facilities in the municipality of Rio de Janeiro. *European Journal of Operational Research*, 138, 495-517.
- Girard, P. and Merlo, C. (2003). GRAI Engineering methodology for design performance improvement. In DS 31: *Proceedings of ICED 03, the 14th International Conference on Engineering Design*, Stockholm.
- Goldschmidt, K. A. and Gordin, P. (2006). A model of nursing care microsystems for a large neonatal intensive care unit. *Adv Neonatal Care*, 6(2), 81-88.
- Gorunescu, F., McClean, S. et al. (2002). A Queueing model for bed-occupancy management and planning of hospitals. *Journal of the Operational Research Society*, 53(1), 19-24.
- Goyal, N. et al (2013). Length of Stay and Readmission among late Preterm Infants: A Variable Approach. 7-15. *Hospital Paediatrics*, Jan, 3 (1), 7-15.
- Graves, T. (2009). *Enterprise Architecture*, IT Governance Ltd. Published 16 June 2009. ISBN 1849280177, 9781849280174.

- Green, L.V. (2002). How many hospital beds? *Inquiry*, 39, 400-412.
- Griffiths, J.D., Price-Lloyd, N., Smithies, M. and Williams, J. (2006). A queueing model of activities in an intensive care unit. *IMA Journal of Management Mathematics*, 17, 277-288. Doi:10.1093/imaman/dpi042.
- Hakes B., Keller, L., Lilegdon, W.R., Mabrouk, K., McGuire, F. and Lowery, J.C. (1994). Barriers to implementing simulation in health care. In: Tew, J.D., Manivannan, S., Sadowski, D.A. and Seila, A.F., eds, *Proceedings of the 1994 Winter Simulation Conference*. Piscataway, New Jersey. Institute of Electrical and Electronics Engineers, Inc., 868-875.
- Hamilton, K.E. and Redshaw, M.E. et al. (2007). Nurse staffing in relation to risk-adjusted mortality in neonatal care. *Arch Dis Child, Fetal Neonatal Ed* 92, F99-F103.
- Harper, P. (2002). A Framework for Operational Modelling of Hospital Resources. *Health Care Management Science*, 5, 165-173.
- Harper, P. and Pitt, M. (2004). On the challenges of healthcare modelling and a proposed project life cycle for successful implementation. *Journal of the Operational Research Society* 55, 657–661.
- Harrison, G.W., Shafer, A. and Mackay, M. (2005). Modelling variability in hospital bed occupancy, *Health Care Management Science*, Nov, 8(4), 325-334.
- Harrison, G.W. (2012). Hazard Curves. Measuring and Modelling Patient Flow in Healthcare. *IMA*, London, March 2012.
- Harrison, G.W. (2012). The effect of unplanned transfers to a higher level of care on patient survival and length of stay. *Maths and Medicine: Measuring and Modelling Patient Flow in Healthcare*. St. George's Hospital, University of London. 2/4/12. Open Lecture.
- Hashmi, Z. and Zrimec, T. (2008). Ontology-driven Modeling of Clinical Practice Guidelines towards Computerisation of CPG knowledge sources via GEM Model. *IEEE*
- Health Services Research Editorial (2013). *HSR: Health Services Research*, 48(6): Part II (December 2013), 2125-2133. DOI:10.1111/1475-6773.12123.
- Health Services Journal. (2017). Available at www.hsj.co.uk. [Accessed 5 June 2017].
- Healthcare Efficiency through Technology Expo. (2012). London
- Healthcare Efficiency through Technology Show. (2016). London. www.hettshow.co.uk
- Herbane, B. (2010). The evolution of Business Continuity management: a historical review of practices and drivers. *Business History*, 52(6), 978-1002.
- Hershey, J.C., Weiss, E.N. and Cohen, M.A. (1981). A stochastic service network model with application to hospital facilities. *Operations Research*, 29(1), 1-22.

Howick, S. and Ackermann, F. (2011). Mixing OR methods *in practice*; past, present and future directions. *European Journal of Operational Research*, 215, 503-511.

Hulshof, P. et al (2012). Taxonomic classification of planning decisions in healthcare: a structural review of the state of the art in OR/MS. *Health Systems*, 1, 129-175. DOI:10.1057/hs.2012.18.

Huybrechts, K.F., Bateman, B.T., Desai, R.J. et al. (2017). Risk of neonatal drug withdrawal after intrauterine co-exposure to opioids and psychotropic medications. *BMJ*, 358, 228-229. Available at <http://dx.doi.org/10.1136/bmj.j3326>. [Accessed 7 August 2017].

Jahangirian, M., Borsci, S., Shah, S.G.S. and Taylor, S.J.E. (2015). Causal factors of low stakeholder engagement: a survey of expert opinions in the context of healthcare simulation projects. *Medical Simulation: Transactions of the Society of Modeling and Simulation International* 91(6), 511-526. DOI: 10.1177/0037549715583150.

Jukic, A.M., Baird, D.D., Weinberg, C.R., McConnaughey, D.R. and Wilcox, A.J. (2013). Length of human pregnancy and contributors to its natural variation. *Human Reproduction*, 28 (10), 2848-2855. doi:10.1093/humrep/det297.

Jun, J., Jacobsen, S. et al. (1999). Application of discrete-event simulation in healthcare clinics: A Survey. Review of benefits of simulation in healthcare. *Journal of the Operational Research Society*, 50(2), 109-123.

Jun, G. T., and Ward, J. et al. (2009). Health care process modelling: which method when? *Int J Qual Health Care*, 21(3), 214-224.

Jun, G.T., Morris, Z., Eldabi, T., Harper, P., Naseer, A., Patel, B., and Clarkson, P. (2011). Development of modelling method selection tool for health services management: From problem structuring methods to modelling and simulation methods. *BMC health Services Research*, 11: 108. Available at <http://www.biomedcentral.com/1472-6963/11/108>. [Accessed 15 August 2017].

Karlsson, J.C.H. (2011). *Organizational Misbehaviour in the workplace - narratives of dignity and resistance*. New York: Palgrave Macmillan. www.palgraveconnect.com.

Kavur, J. (2009). Eight levels of analytics. October 29. *IT World Canada*. Available from <http://www.itworldcanada.com/article/eight-levels-of-analytics/39740>. Accessed 31/05/2017.

Kempley, S. T., Sinha, A.K. et al. (2004). Census of neonatal transfers in London and the South East of England. *Arch Dis Child, Foetal Neonatal* Ed 89(6), F521-526.

Kirandeep, S., Eldabi, T. and Young, T. (2014). A conceptual framework for hybrid system dynamics and discrete event simulation for healthcare. *Journal of Enterprise Information Management*, Vol 26 (1/2), 50-74.

Knight, V. (2011). A Game Theoretical Approach to the Emergency Medical Vehicle – Emergency Department Interface. Screen-cast for ORAHS 2012. 1-7.

- Kokangal, A. (2008). A combination of deterministic and stochastic approaches to optimise bed capacity in a hospital unit. *Computer Methods and Progress in Biomedicine*, 90, 56-65.
- Kolker, A. (2009). Process Modelling of ICU Patient Flow: Effect of Daily Load Levelling of Elective Surgeries on ICU Diversion. *J Med Syst*, 33, 27-40.
- Kuljis, J., Paul, R.J. and Sergioulas, L.K. (2007). Can health Care benefit from Modelling and Simulation Methods in the same way as business and manufacturing has? In: Henderson, S.G., Biller, B., Hsieh, M-H., Shortle, J., Tew, J.D., Barton, R.R., eds, *Proceedings of the 2007 Winter Simulation Conference*. 1449-1453.
- Lagergren, M. (1998). What is the role and contribution of models to management and research in the health services? A view from Europe. *European Journal of Operational Research*, 105, 257-266.
- Laing, I., Ducker, T. et al. (2004). *Designing a Neonatal Unit*. British Association of Perinatal Medicine, May 2004.
- Land, D., Monefeldt, C. et al. (2000). Looking in the wrong place for healthcare improvements: A System Dynamics Study of an Accident and Emergency Department. *Journal of the Operational Research Society*, 51(5), 518-531.
- Lane, D.C and Husemann, E. (2008). System Dynamics Mapping of Acute Patient Flows. *JORS*, 59(2), 213-24.
- Lang, J.M., Lieberman, E. and Cohen, A. (1996). A Comparison of Risk Factors for Preterm Labour and Term Small-for-Gestational-Age Birth. *Epidemiology*, Vol 7(4 - Jul), 369-376.
- Langley, D. and Hollis, S. et al. (2002). Impact of community neonatal services: a multicentre survey. *Arch Dis Child, Foetal, Neonatal Ed*, 87 (3), F204-F208.
- Lakshmi, C. and Sivakumar, A. I. (2013). Application of queueing theory in health care: A literature review. *Operations Research for Health Care* 2, 25–39.
- Law, A.M. (2009). How to build valid and credible Simulation Models. *Proceedings of the 2009 Winter Simulation Conference*. 24-33.
- Lin, F. and Chaboyer, W. et al. (2009). A literature review of organisational, individual and teamwork factors contributing to the ICU discharge process. *Aust Crit Care*, 22(1), 29-43.
- Littig, S.J and Isken, M.W. (2007). Short term hospital occupancy prediction. *Health Care Management Science*, 10, 47-66.
- Litvak, N., van Rijsbergen, M., Boucherie, R.J. van Houdenhoven, M. (2008). Managing the overflow of intensive care patients. *European Journal of Operational Research*, 185(3), 998-1010.
- Lobo, M.S.dC. and Lins, M.P.E. (2010). Epistemic dialog between health services and operations research. *Pesquisa Operacional*, 30(2), 371-386. online ISSN 1678-5142.

- Mackay, M. and Lee, M. (2005). Choice of Models for the Analysis and Forecasting of Hospital Beds. *Health Care Management Science*, 8, 221-230.
- Mahdavi, M., Malmstrom, T., van de Klundert, J., Elkhuizen, S. and Vissers, J. (2013). Generic operational models in health service operations management: A systematic review. *Socio-Economic Planning Sciences*, 47, 271-280.
- Manktelow, B, Draper, E.S., Field, C. and Field, D. (2010). Estimates of length of neonatal stay for very premature babies in the UK. *Arch Dis Child, Foetal neonatal Ed* 95, F288 -292.
- Marlow, N. and Gill, B. (2007). Establishing neonatal networks: the reality. *Arch Dis Child, Fetal Neonatal Ed* 92(2), F137-142.
- Marshall, A. (2004). Using Coxian Phase-Type Distributions to Identify Patient Characteristics for Duration of Stay in Hospital. *Health Care Management Science*, 7(4), 285-9.
- McClellan, S., Millard, P. et al., Eds. (2009). *Intelligent Patient Management*. Berlin: Springer.
- McKittrick, D. (1996). IRA shoots police guard in hospital. www.independent.co.uk/news/ira-shoots-police-g
- Millard, P.H. and McClellan, I.S. (1996). *Go with the Flow*. RSM Press.
- Millard, PH. (1993). Flow rate modelling: a method of comparing performance in developments of geriatric medicine. PhD Thesis. St. George's Hospital Medical School, London.
- Monks, T. (2016). Operational research as implementation science: definitions, challenges and research priorities. *Implementation Science* 11, 81. DOI: 10.1186/s13012-016-0444-0.
- Monks, T., Worthington, D., Allen, M., Pitt, M., Stein, K. and James, M.A. (2016). A modelling tool for capacity planning in acute and community stroke services. *BMC Health Services Research*, 16, 530. Doi 10.1186/s12913-016-1789-4.
- Moore, A. (2013). Leeds child heart surgery suspended after NHS England intervention. *Health Services Journal*.
- Moore, P.G. (1986). *Basic Operational Research*. London. Pitman.
- Morgan, J., Howick, S. and Belton, V. (2011). Designs for the complementary use of system dynamics and discrete-event simulation. In *Simulation Conference (WSC), Proceedings of the 2011 Winter*. December 2011. IEEE, 2710-2722.
- Mustafee, N., Katsaliski, K. and Taylor, S.J.E. (2010). Profiling Literature in Healthcare Simulation. *Simulation*, 86(8-9), 543-558.
- Mustafee, N., Powell, J., Brailsford, S.C., Diallo, S., Padilla, J. and Tolk, A. (2015). Hybrid Simulation studies and hybrid simulation systems: definitions, challenges, and

benefits. In: Yilmaz, L., Chan, W.K.V., Moon, I., Roeder, T.M.K., Macal, C. and Rossetti, M.D., eds, *Proceedings of the 2015 Winter Simulation Conference*.

National Audit Office (2016). *Managing the supply of NHS clinical staff in England*. 5 February. London: Department of Health. Available at <https://www.nao.org.uk/report/managing-the-supply-of-nhs-clinical-staff-in-england/> [Accessed 2 August 2017].

National Institute of Clinical Excellence. (2010). *Specialist Neonatal Quality Standards*.

National Institute of Clinical Excellence. (2011). *Clinical Guideline 132: Caesarean Section*. November 2011, updated August 2012. Accessed 4/5/2017.

Nordqvist, T. et al. (2002). *Systems Engineering, Architecture Frameworks and Modelling & Simulation*. Sweden. Accessed 24/04/2017.

Norris, J.R. (1997). *Markov Chains*. Cambridge: Cambridge University Press.

Nuffield Trust: Lewis, R. and Edwards, N. (2015). *Improving Length of Stay: What can hospitals do?* London. www.nuffieldtrust.org.uk

Nuffield Trust: Karakusevic, S. and Edwards, N. (2016). *Understanding patient flow in hospitals*. London. www.nuffieldtrust.org.uk

O Donoghue, K., Sheridan, C. et al. (2008). Timing of Birth Related to Obstetric Practice and Neonatal Outcome. *Irish Medical Journal*, 101(7), 205-207.

Obal, L. and Lin, F. (2005). A Framework for Healthcare Information Systems: exploring a Large System of Systems using Systems Dynamics. *Communications of the IIMA*, 5(3), 35-46.

Opdahl, A.L. and Berio, G. (2007). A roadmap for UEMML. In *Enterprise Interoperability*. Springer London, 169-178.

Pagel, C., Utley, M. and Gallivan, S. (n.d.) The Dynamic Forecasting of short to medium term workload based on current case mix. In (Proceedings) 33rd meeting of the European group on operational Research Applied to Health Services.

Pagel, C., Utley, M., Crowe, S., Witter, T., Anderson, D., Samson, R., McLean, A., Banks, V., Tsang, V., Brown, K. (2013). Real time monitoring of risk –adjusted paediatric cardiac surgery outcomes using variable life-adjusted display: implementation in three UK centres. *Heart* 99, 1445-1450. Doi: 101136/heartjnl-2013-303671.

Peaceman, A. M., Andrews, W.W. et al. (1997). Fetal fibronectin as a predictor of preterm birth in patients with symptoms: a multi-center trial. *Am J Obstet Gynecol*, 177(1), 13-18.

Phupong, V. and Darojn, D. (2007). Amphetamine abuse in pregnancy: the impact on obstetric outcome. *Arch Gynecol Obstet* 276, 167–70. <http://dx.doi.org/10.1007/s00404-007-0320-x>

- Pickering, B.W., Dong, Y., Ahmed, A., Giri, J., Kilickaya, O., Gupta, A., Gajic, O. and Herasevich, V. (2015). The implementation of clinician designed, human-centred electronic medical record viewer in the intensive care unit: A pilot step-wedge cluster randomized trial. *International Journal of Medical Informatics*, 84, 299-307.
- Pidd, M. (2004). *Computer Simulation in Management Science*, 5th Ed. Chichester: John Wiley and Sons Ltd.
- Pierskalla, W.P. and Brailer, D.J. (1994). Applications of Operations Research in Health Care Delivery. In: Pollock, S.M. et al (eds.) *Handbooks in OR & MS*, 6. Elsevier Science B.V, Chapter 13, 469-505.
- Pohjolainen, S. (2016). *Mathematical Modelling*. Switzerland: Springer International Publishing.
- POPPY Steering Group. (2009). *Family-centred care in neonatal units: a summary of research results and recommendations from the POPPY project*. London: NCT. ISBN: 978-0-9550328-8-1.
- Powell, P. J., Powell, C.V. et al. (1992). When will my baby go home? *Arch Dis Child*, 67(10 Spec No), 1214-1216.
- Profit, J., McCormick, M.C. et al. (2007). Neonatal intensive care unit census influences discharge of moderately preterm infants. *Pediatrics*, 119(2), 314-319.
- Proudlove, N., Black, S. and Fletcher, A. (2016). OR and the challenge to improve the NHS: modelling for insight and improvement in in-patient flows. *JORS*, 58(2), 145-158. DOI: 10.1057/palgrave.jors.2602252.
- Radnor, Z.J., Holweg, M. and Waring, J. (2012). Lean in healthcare: The unfilled promise? *Social Science & Medicine*, 74, 364-371.
- Rafferty, A.M. et al. (2007). Outcomes of variation in hospital nurse staffing in English hospitals: Cross-sectional analysis of survey data and discharge records. *Int Journal of Nursing Studies*, 44, 175-182.
- Ramudhin, A. et al (2006). A Framework for the Modeling, Optimization and Analysis of Pathways in Healthcare. *2006 International Conference on Service Systems and Service Management*. October 2006. IEEE (1), 698-702.
- Richardson, M. (2017). *The State of Care in NHS acute hospitals: 2014-2016*. www.cqc.org.uk. Accessed 4/5/2017.
- RIGHT. (Research into Global Healthcare Tools) (2008). Modelling and Simulation Techniques for Supporting Healthcare Decision Making: A Selection Framework. www.right.org.uk. Available at <https://www-edc.eng.cam.ac.uk/downloads/right.pdf>. [Accessed 5 March 2018]
- Rijpma, Jos A. (2003). From Deadlock to Dead End: The Normal Accidents - High Reliability Debate Revisited. *J of Contingencies and Crisis Management*, 203,11,1, 37-45.

- Rimmer, A. (2017). NHS managers should face the same regulation as doctors, says Francis. *British Medical Journal*, 28 April 2017, 257, j2101. Available from doi: 10.1136/bmj.j2101. [Accessed 31/07/2017].
- Roberts, M., Russell, L.B., Paltiel, A.D., Chambers, M, McEwan, P, Krahn, M on Behalf of the ISPOR-SMDM Modelling Good Research Practices Task Force. (2012). Conceptualising a Model: A Report of the ISPOR-SMDM Modelling Good Research Practices Task Force -2. *Medical Decision Making*, 32, 678-689.
- Rycroft-Malone, J. (2004). The PARIHS Framework – A Framework for Guiding the Implementation for Evidence-based practice. *J Nurs Care Qual*, 19(4), 297-304.
- Sainfort, F., Blake, J., Gupta, D. and Rardin, R.L. (2005). Operations research for health care delivery systems. *World Technology Evaluation Center Panel Report*. Available at; www.wtec.org/or/report/OR-report.pdf. [Accessed 2 August 2017].
- Sajid, M. and Ahsan, K. (2014). Enterprise Architecture for Healthcare Organisations. *World Applied Sciences Journal*, 30(10), 1330-3.
- Sajid, M. and Ahsan, K. (2016). Role of Enterprise Architecture in healthcare Organizations and Knowledge-Based Medical Diagnosis System. *JISTEM*, 13(2), 181-192. ISSN 1807-1775.
- Samaranayake, P. and Kiridena, S. (2011). Patient Journey Modelling using Integrated Data Structures in Healthcare Service Operations. *IEEE Colloquium on Humanities, Science and Engineering Conference*. Penang. 5-6 December 2011. 597-602.
- Sanderson, C. and Gruen, R. (2006). Analytical Models for Decision Making. Open University Press.
- Schulman, P. (2006). Studying determinants of length of hospital stay. *J Perinatology*, 26, 243-245.
- Seaton, S.E., Barker, L., Draper, E.S., Abrams, K.R., Modi, N., Manktelow, B.N. et al. (2016). Modelling neonatal Care Pathways for Babies Born Preterm: An Application of Multistate Modelling. *PLoS ONE* 11(10): e0165202 doi:10.1371/journal.
- Sessions, R. (2004). An exclusive interview with John A. Zachman in *Perspectives of the International Association of Software Architects*, April 2007, 2-12.
- Shahani, A.K., Ridley, S.A. and Nielsen, M.S. (2008). Modelling patient flows as an aid to decision making for critical care capacities and organisation. *Anaesthesia* 63, 1074-1080.
- Shen, H., Wall, B., Zarembab, M., Chena, Y., and Browne, J. (2004). Integration of Enterprise Modeling methods for enterprise information system analysis and user requirements gathering. *Computers in Industry*, 54, 307–323.
- Shields, P., Rangarjan (2013). *A Playbook for Research Methods: Integrating Conceptual Frameworks and Project Management*. Stillwater. OK: New Forums Press.

- Shoham, Y. and Leyton-Brown, K. (2009). *Multi-agent Systems*. Cambridge: Cambridge University Press.
- Signori M. and Garcia, R. (2010). Clinical Engineering and Risk Management in Healthcare Technological Process using Architecture Framework. *32nd annual conference IEEE EBMS*. Buenos Aries, Argentina. 31 Aug – 4 Sep, 2010. 418-421.
- Silbiger, S. (1993). *The 10-Day MBA*. London: Judy Piatkus (Publishers) Ltd.
- Simmer, K. (2010). Improving neonatal capacity in Western Australia. Retrieved 10/05/10, 2010, from www.changechampions.com.au/resource/Karen_Simmer_Mat0207.pdf.
- Sloane, E. et al. (2007). Conceptual SOS model and simulation systems for a next generation national healthcare information network (NHIN-2): creating a net centric, extensible context aware, dynamic discovery framework for robust, secure, flexible, safe and reliable healthcare. *1st annual IEEE Systems Conference*. Honolulu, Hawaii, USA. 9-12 April, 2007. 1-6.
- Sobolev, B., Sanchez, V. and Kuramoto, L. (2012). *Health Care Evaluation Using Computer Simulation: Concepts, Methods, and Applications*. New York: Springer Science and Business media.
- Soto, G.E. and Spertus, J.A. (2007). EPOCH and ePRISM: A rule-based translational framework for bridging outcomes research and clinical practice. *Computers in Cardiology*, Sept. 2007, 2005-8.
- Soto and Spertus. (2009). EPOCH: A web-based platform for integrating outcomes research and healthcare delivery. *Computers in Cardiology*, 36, 257-260.
- Spedale, S.B. (2006). Caring for Displaced neonates: Intrastate. *Pediatrics*, 117(5), S389-S395.
- Spencer, A. and Modi, N. (2012). National neonatal data to support specialist care and improve infant outcomes. *Arch Dis Child Foetal Neonatal Ed*: doi:10.1136/archdischild-2011-300872.
- Stewart, W.J. (2009). *Probability, Markov Chains, Queues, and Simulation*. Princeton: Princeton University Press.
- Stirzaker, D. (2005). *Stochastic Processes and Models*. Oxford: Oxford University Press.
- Tako, A.A., Kotiadis, K. and Vasilakis, C. (2010). A participative modelling framework for developing conceptual models in healthcare simulation studies. In: Johansson, B., Jain, S., Montoya-Torres, J., Hukan, J. and Yucesan, E., eds, *Proceedings of the 2010 Winter Simulation Conference*. 500-512.
- Tako, A. and Kotiadis, K. (2012). Proposing a participative Modelling Framework for DES Studies. *45th Hawaii International Conference on System Scenarios*. IEEE Computer Society, 207-215. DOI:10.1109/HICSS.2012.489.

- Tako, A. and Kotiadis, K. (2015). PartiSim: A multi-methodology framework to support facilitated simulation modelling in healthcare. *European Journal of Operational Research*, 244(2), 555-564.
- Tako, A.A. and Robinson, S. (2015). Is simulation in health different? *Journal of the Operational Research Society*, 66(4), 602-614.
- Tanaka et al. (2001). Applying ODP Enterprise Viewpoint Language to Hospital Information Systems. *IEEE* 188-192.
- Thakkar, M. and O'Shea, M. (2006). The role of neonatal networks. *Seminars in Foetal & Neonatal Medicine*, 11, 105-110.
- Timmins, N. (2012). *Never Again? The story of the Health and Social Care Act 2012*. The King's Fund. London: The Institute for Government. Available from https://www.kingsfund.org.uk/sites/files/kf/field/field_publication_file/never-again-story-health-social-care-nicholas-timmins-jul12.pdf. [Accessed 31 July 2017].
- Ting, H. S., Chin, P.S. et al. (2007). Comparison of bedside test kits for prediction of preterm delivery: phosphorylated insulin-like growth factor binding protein-1 (pIGFBP-1) test and foetal fibronectin test. *Ann Acad Med Singapore*, 36(6), 399-402.
- Triggle, N. (2015). How bad has winter been for the NHS? 13 March 2015. www.bbcnews.co.uk. Accessed 5/5/2017.
- Troop, P. and Taylor-Brown, C. (2014). *Report of the Independent Investigation into Management Response to Staff Concerns Relating to the Validation of the Cancer Waiting List 2011/2 at Colchester Hospital University NHS Foundation Trust*. September 2014. Accessed 4/5/2017.
- Turabian, K.L. (2007). *A Manual for Writers*, 7th Ed. Chicago: The University of Chicago Press.
- UK Neonatal Staffing Study Group. (2002). Patient volume, staffing, and workload in relation to risk-adjusted outcomes in a random stratified sample of UK neonatal intensive care units; a prospective evaluation. *Lancet*, 359 (9301), 99-107.
- Uriarte, A.G., Zuniga, E.R., Moris, M.A. and Ng, A.H.C. (2017). How can decision makers be supported in the improvement of an emergency department? A simulation, optimization and data mining approach. *Operations Research for Health Care*, 15, 102-122. DOI: 10.1016/j.orhc.2017.10.003.
- Utley, M. (n.d.) CORU. Methods for modelling health service delivery: approaches, shortcomings and emerging opportunities. Available at <https://www.mrc.ac.uk/documents/pdf/utley-health-service-modelling-vignette/> [Accessed 5 March 2018].
- van Sambeek, J.R.C., Cornelissen, F.A., Bakker, P.J.M. and Krabbendam, J.J. (2010). Models as instruments for optimizing hospital processes: a systematic review. *International Journal of Health Care Quality Assurance*, 2010, 23(4), 356-377.

- Varlow, J. (2014). Using Clinical Quality Indicators, Metrics and Dashboards to measure quality. *Measuring and Monitoring Quality conference*. Birmingham, UK. 21 May. Available at www.healthcareconferencesuk.co.uk/news/using-clinical-quality-indicators-metrics-and-dashboards-to-measure-quality. [Accessed 2 August 2017].
- Varun Grover, M. K. M. (1997). Business Process Re-engineering. *Journal of Operations Management*, 15, 193-213.
- Vasilakis, C, Chausalet, T. and Baker, R. (2011). Editorial: IMA Health 2010. *Health Care Management Science*, July, 1-3.
- Veral, E.A., Millhiser, P. and Velanti, B.C. (2012). Assessing Appointment Systems' Operational Performance with Policy Targets. *IIE Transactions on healthcare Systems Engineering*, 2 (4), 274-289.
- Villa, S. et al. (2014). A framework to analyse hospital-wide patient flow logistics: Evidence from an Italian comparative study. *Health Policy*, 115, 196-205.
- Villeneuve, E., Pitt, M., Allen, M. and Carter, S. (2015). PenCHORD - NeoNet: Providing a national demand/capacity model for neonatal care in England. Available at <http://clahrc-peninsula.nihr.ac.uk/research/penchord-neonet-providing-a-national-demand-capacity-model-for-neonatal-care-in-england>. [Accessed 10 August 2017].
- Vissers, J.M.H. (1995). Patient flow based allocation of hospital resources. *Math Med Biol*, 12 (3-4), 259-274. Available at DOI: <https://doi-org.ezproxy.westminster.ac.uk/10.1093/imammb/12.3-4.259>
- Vissers, J and Beech, R. (2005). *Health Operations Management: Patient Flow Logistics in Health Care*. Routledge: Oxon. ISBN 10: 0415323967.
- Waldmann, C. (2017). Intensive care stretched "to the limit". *Daily Mail*, 30 Jan. Available from www.pressreader.com/uk/daily-mail/20170130/281586650320485. [Accessed 31/05/2017].
- Walker, C. R. and Frize, M. (2004). Are artificial neural networks "ready to use" for decision making in the neonatal intensive care unit? Commentary on the article by Mueller et al. and page 11. *Pediatr Res*, 56(1), 6-8.
- Watkin, S. L. (2005). Managing safe staffing. *Seminars in Foetal & Neonatal Medicine*, 10, 91-98.
- Weiss, E.N., Cohen, M.A. and Hershey, J.C. (1982). An Iterative Estimation and Validation Procedure for Specification of Semi-Markov models with Application to Hospital Patient Flow. *Operations Research*, 30(6): 1082-1104.
- Weiss, F. and Glanville, D. (2002). The Need for Descriptions of a System's Dynamic - Behaviour on Projects involving the Integration of Large and Complex Systems. *Systems Engineering, Test & Evaluation Conference*. Sydney, Australia. October 2002.

- Wollaston, S. (2017). Commentary: “The political response has been dismal”. *BMJ*, 356, 7 Jan, 12 doi: <https://doi.org/10.1136/bmj.j5> (Published 03 January 2017)
- Wolstenholme, E., Monk, D., McKelvie, D. and Arnold, S. (2007). Coping but not coping in health and social care: masking the reality of running organisations beyond safe design capacity. *System Dynamics Review*, 23(4), 371-389.
- World Health Organisation Health Services Framework (2007). Available at www.wpro.who.int/health_services/health_systems_framework/en/ [Accessed 5 March 2018]
- Yau, K. K. (2003). Finite mixture regression model with random effects: application to neonatal hospital length of stay. *Computational statistics and Data analysis*, 41, 359-366.
- Young, T. and Brailsford, S.C., Connell, C, Davies, R., Harper, P., and Klein, J.H. (2004). Using industrial processes to improve patient care. *BMJ (Clinical research ed.)*, 17 January 2004, 328(7432), 162-4.
- Zachman, J.A. (1987). A framework for information systems architecture. *IBM Systems Journal*, 26(3), 276-292.
- Zachman, J. (2009). The Evolution of the Zachman Framework. Available at www.zachman.com , Accessed 24/04/2017.
- Zernikow B, H. K., Michel, E., Hornschuh. F., Groote, K. and Hennecke, K.H. (1999). Predicting length-of-stay in preterm neonates. *Eur J Pediatr*, 158, 59-62.
- Zhang, H.T., Yu, F. et al. (2009). Step co-ordination algorithm of traffic control based on multi-agent system. *International Journal of Automation and computing*, 6(3), 308-313.
- Zulkepli, J. and Eldabi, T. (2015). Towards a Framework for Conceptual Model Hybridization in Healthcare. *Proceedings of the 2015 Winter Simulation Conference (WSC)*. IEEE. December 2015. 1597-1608.