

WestminsterResearch

<http://www.westminster.ac.uk/westminsterresearch>

**Rectifiers Based on Quadrature Hybrid Coupler with Improved
Performance for Energy Harvesting**

Unich, G., Olukoya, O. and Budimir, D.

This is a copy of the author's accepted version of a paper subsequently published in the proceedings of the *IEEE Wireless Power Transfer Conference (WPTC2018)*, Montreal, Quebec, Canada, 0e7 June 2018 to 3 July 2018.

The final published version will be available online at:

<https://dx.doi.org/10.1109%2FWPT.2018.8639267>

© 2018 IEEE . Personal use of this material is permitted. Permission from IEEE must be obtained for all other uses, in any current or future media, including reprinting/republishing this material for advertising or promotional purposes, creating new collective works, for resale or redistribution to servers or lists, or reuse of any copyrighted component of this work in other works.

The WestminsterResearch online digital archive at the University of Westminster aims to make the research output of the University available to a wider audience. Copyright and Moral Rights remain with the authors and/or copyright owners.

Whilst further distribution of specific materials from within this archive is forbidden, you may freely distribute the URL of WestminsterResearch: (<http://westminsterresearch.wmin.ac.uk/>).

In case of abuse or copyright appearing without permission e-mail repository@westminster.ac.uk

Rectifiers Based on Quadrature Hybrid Coupler with Improved Performance for Energy Harvesting

Guido Unichi¹, Oludotun Olukoya², Djuradj Budimir^{3,4}

^{1,2,3}Wireless Communications Research Group, University of Westminster, 115 New Cavendish Street, London, W1W 6UW, United Kingdom. d.budimir@wmin.ac.uk

⁴School of Electrical Engineering, University of Belgrade, Belgrade, Serbia

Abstract— This paper presents a method for enhancing RF-dc conversion efficiency of the rectifier based on inkjet-printed quadrature based hybrid coupler (QHC) for wireless energy transfer systems. The input matching network and output load of the rectifier are optimized for optimal RF-dc conversion efficiency. Improvement of about 16 dB input power range is achieved for RF-dc conversion efficiency of 60%. The simulated efficiencies of the rectifiers with and without coupler for 3 MHz LTE signals and output power spectra densities at 1.5 GHz are illustrated.

Index Terms—Quadrature hybrid Coupler (QHC), RF-dc conversion efficiency, Nonlinear distortion.

I. INTRODUCTION

The emergence of microwave power transmission (MPT) plays a vital role in wirelessly powered circuits such as RF identification (RFID) and other low power wireless sensors [1]. The total efficiency of the microwave wireless system depends mainly on the RF-dc conversion efficiency of the rectifier circuits which has made high efficiency rectifier design very important.

Recent researches have focused on different topologies to improve RF-dc conversion efficiency performance [2]. Some of such topologies and models have been proposed in [3] – [6]. It was found that the electromagnetic energy is generally not constant due to the varying input power and operating frequency which leads to input impedance variation. The impedance variation degrades the rectifier performance due to the nonlinearity of the rectifying device. Another drawback from some of these improvements was due to load variation at the output of the rectifier which also leads to input impedance modification that can cause efficiency to deteriorate. To overcome the drawbacks and boost robustness against the input power and output load variations, some further techniques were developed. Some of those solutions included resistance compression networks [7] which helped to improve the input impedance variation issue but still had bandwidth efficiency issues.

Recent works have now focused on the performance of rectifiers under different signal types rather than just considering the matching network and device selection. Previous work had considered single and two tone modes of operation. It has been observed when investigating multi tone

signals that high peak-to-average power ratio (PAPR) may lead to a higher RF-dc conversion efficiency than its equivalent signal with the same input power [8]. This work optimizes the RF-dc efficiency performance by identifying the optimal load resistance whilst achieving a high PAPR using digitally modulated signals.

In this paper, a compact inkjet-printed quadrature hybrid coupler (QHC) is used alongside a novel rectifier design to improve efficiency over a wider range of input power, output load and frequency bandwidth. This rectifier will be tested using multi tone, 3 MHz LTE signals for RF-dc conversion efficiency and nonlinear distortion verification.

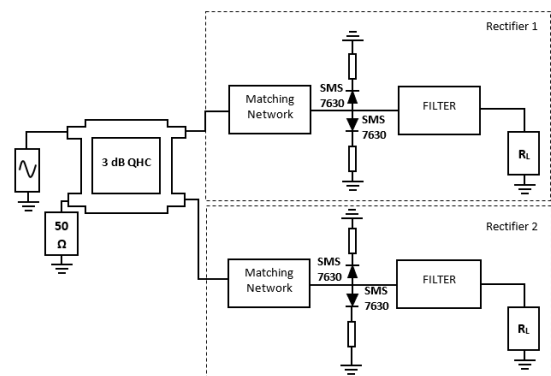

Fig. 1. The block diagram of the proposed rectifier configuration

The proposed rectifier consists of a 3 dB QHC with a grounded isolation port whose outputs are feeding two sub-rectifier circuits as shown in Fig. 1. Any change in input power (P_{in}) and output load (R_{LOAD}), leads to varying input impedance which distorts the impedance. The reflected waves which ensue from both sub-rectifiers can be introduced back to each sub-rectifier with the aid of the coupler. This re-injection leads to improved efficiency as the reflected power can be utilised again. With this, the proposed rectifier will be able to sustain high efficiency over a wider range of input power, frequency and load.

II. INKJET-PRINTED COUPLERS

The conventional 3-dB quadrature hybrid coupler consists of four quarter wavelength ($\lambda_g/4$) transmission line segments as shown in Fig. 2.

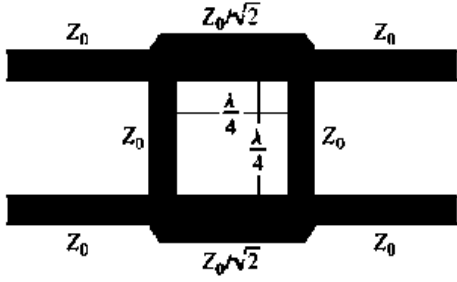

Fig. 2. Conventional quadrature hybrid coupler

The conventional coupler's size is very large for frequencies mainly below 4 GHz. To achieve compactness, the four quarter wavelength segments of the conventional coupler is modified to reduce the overall size of the coupler. The proposed compact quadrature hybrid coupler is shown in Fig. 3. To reduce the size of the coupler, U-shaped transmission line units shown in Fig. 3 are used instead of $\lambda/4$ transmission lines in Fig. 2 and its dimensions are shown in Table I.

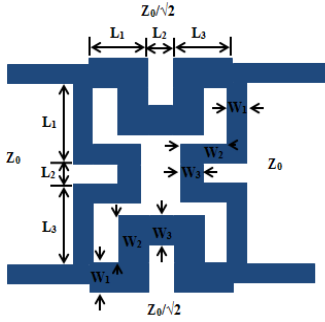

Fig. 3. Layout of USTL quadrature hybrid coupler structure

TABLE I. USTL PARAMETERS

Characteristics impedance (Ω)	W1 (mm)	W2 (mm)	W3 (mm)	L1 (mm)	L2 (mm)	L3 (mm)
50 (Z_0)	0.32	8.7	0.32	6.0	5.3	6.0
35.35($Z_0/\sqrt{2}$)	0.54	5.2	0.54	5.5	7	5.5

The QHC is implemented using inkjet printing technology. Metal lines are printed on the Flexible Polyethylene terephthalate (PET) substrate with thickness of 140 μm , relative permittivity of $\epsilon_r = 3.4$, a loss factor ($\tan\delta$) of 0.0021 and silver nanoparticles thickness of 35 μm .

III. RECTIFIER DESIGN

The design of the rectifier circuit is essential in order to achieve the best RF-dc conversion efficiency, for this purpose a single stage, full-wave; peak to peak rectifier has been used

[8]. A single stage rectifier with/without coupler is designed. Full wave rectifiers can achieve higher RF to DC efficiency than the half-wave. In this design the zero-bias Schottky diodes (Skyworks SMS7630) have been selected as the rectifying components. A comparison between three commercial available Schottky diodes are shown in Table II. The selection has been made considering the lowest zero-bias capacitance C_{j0} and the highest saturation current I_s , since these are the two parameters directly responsible for the RF-dc conversion efficiency.

TABLE II. SCHOTTKY DIODES COMPARISON

	Skyworks SMS7630	MACOM MA4E2054	Avago HSMS2852
I_s	5 μA	0.03 μA	3 μA
C_{j0}	0.14 pF	0.13 pF	0.18 pF
V_j	0.34 V	0.4 V	0.35 V
N	1.05	1.05	1.05
R_s	20 Ω	11 Ω	25 Ω
I_{bv}	100 μA	10 μA	300 μA
V_{bv}	2 V	5 V	3.8 V

Fig. 4 shows the schematic of the designed and optimised rectifier. At the input of the rectifier a T-type matching network was used to assure the highest power transfer between input power and output power through converting the 50 Ω input impedance of the antenna to match the conjugate input impedance of the rectifier. The quadrature hybrid coupler (QHC) described in section II and the rectifier described in section III are combined. The results are obtained and analysed in the next section for efficiency performance.

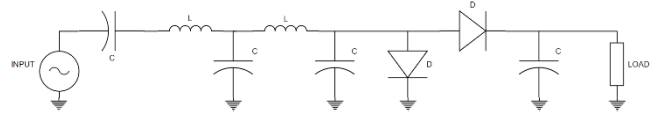

Fig. 4. Schematic of the rectifying circuit

IV. RESULTS

Two tone and digitally modulated 4G LTE signals with 3 MHz bandwidth (QPSK, 16-QAM and 64-QAM) are used to evaluate the efficiency for varying loads and input power levels from -10 to 25 dBm. The RF-dc conversion efficiency of the proposed rectifier based on the coupler is compared with the efficiency of rectifier without the coupler. Fig. 5 shows the RF-dc conversion efficiency of the proposed rectifier configuration versus input power for a two tone input power. At the same input power of 15.5 dBm, they have almost the same peak values. However, the rectifier with the coupler achieves a higher RF-dc conversion efficiency over the one without the coupler. Improvement of about 16 dB input power range is achieved at 60% RF-dc conversion efficiency for 3 MHz LTE signals.

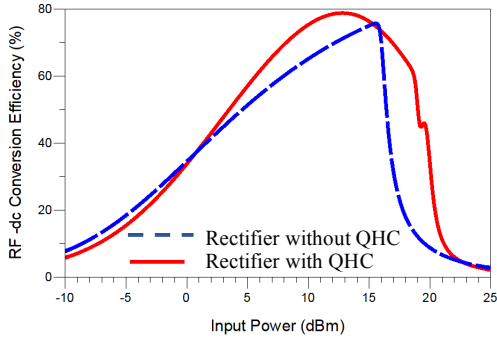

Fig. 5. Simulated efficiencies of the rectifiers with and without coupler versus input power for load (R_{LOAD}) of $5\text{ k}\Omega$ at 1.5 GHz .

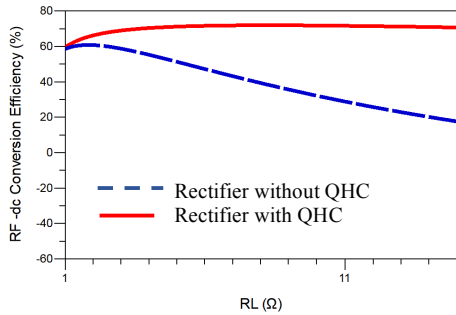

Fig. 6. Simulated efficiencies of the rectifiers with and without coupler rectifier versus output load (R_{LOAD}) in $\text{k}\Omega$ with for input power of 12.2 dBm at 1.5 GHz .

Fig. 6 also shows the RF-dc conversion efficiency of the rectifier with coupler versus output load (R_{LOAD}) for a two-tone input power. To further evaluate efficiency performance, the proposed rectifier is tested with 3 MHz LTE (QPSK, 16-QAM and 64-QAM) digitally modulated signals. For the rectifiers with and without coupler for input power (P_{in}) of 10 dBm , and 3 MHz LTE QPSK signal the efficiency is around 50% and 60%, respectively as shown in Fig. 7. Higher efficiencies of the same rectifiers are achieved for digitally modulated 3 MHz LTE 16-QAM and 64-QAM signals and the same input power as shown in Fig. 8 and Fig. 9 respectively.

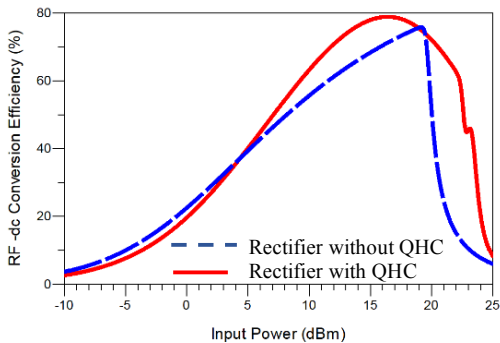

Fig. 7. Simulated efficiencies of the rectifiers with and without coupler versus input power for 3 MHz LTE QPSK signal.

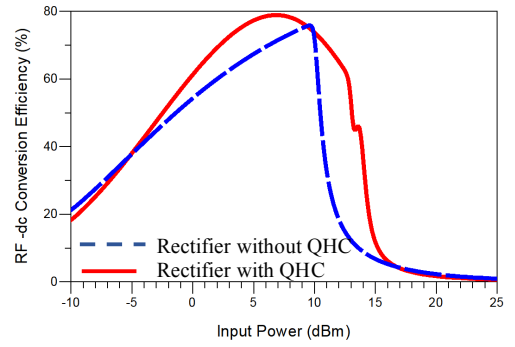

Fig. 8. Simulated efficiencies of the rectifiers with and without coupler versus input power for 3 MHz LTE 16-QAM signal.

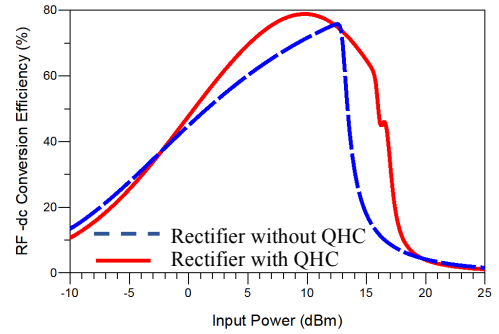

Fig. 9. Simulated efficiencies of the rectifiers with and without coupler versus input power for 3 MHz LTE 64-QAM signal.

To evaluate the nonlinear distortion of rectifiers with and without couplers, a 3 MHz LTE signal is used. The simulated output power spectra densities of the rectifiers for the input power of 10 dBm are shown in Fig. 10.

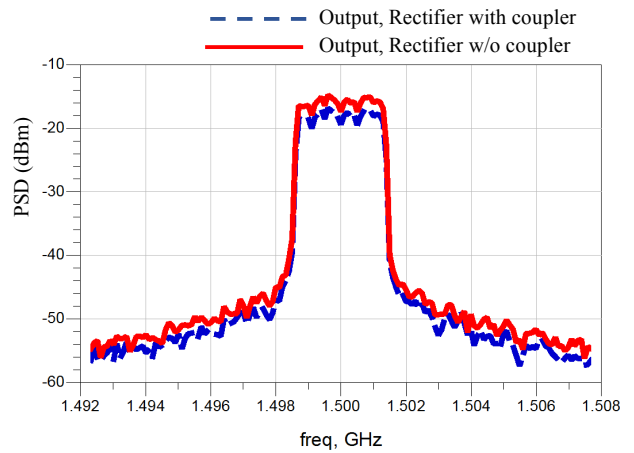

Fig. 10. Simulated output power spectra densities of the rectifiers with and without coupler versus frequency for 3 MHz LTE signal.

CONCLUSION

In this paper we have presented a method for increasing RF-dc conversion efficiency of the rectifier for wireless energy transfer systems. A 16 dB improvement of the input power range for RF-dc conversion efficiency of 60% was achieved. Simulated efficiencies of the rectifiers with and without coupler for 3 MHz LTE QPSK, 16-QAM and 64-QAM signals and output power spectra densities at 1.5 GHz have been presented. The proposed rectifier configuration will be very effective for the next generation low power sensor networks, IoT (Internet of Things) and 5G applications.

ACKNOWLEDGMENT

This work was supported by UK India Education Research Initiative University Grants Commission under grant IND/CONT/G/16-17/63.

REFERENCES

- [1] F. Bolos, J. Blanco, A. Collado and A. Georgiadis, "RF Energy Harvesting From Multi-Tone and Digitally Modulated Signals," *IEEE Microwave and Wireless Components Letters*, vol. 64, no. 6, pp. 1918–1927, June 2016.
- [2] X.Y. Zhang, Z.-X. Du and Q. Xue, "High-Efficiency Broadband Rectifier with Wide Ranges of Input Power and Output Load based on Branch-Line Coupler," *IEEE Trans. Circuits and Systems*, vol. 64, no. 3, pp. 731–739, March 2017.
- [3] Y.-J. Ren and K. Chang, "5.8 GHz circularly polarized dual-diode rectenna and rectenna array for microwave power transmission," *IEEE Trans. MTT*, vol. 54, no. 4, pp. 1495–1502, June 2006.
- [4] M. Roberg, T. Reveyrand, I. Ramos, E.A. Falkenstein and Z. Popovic, "High-efficiency harmonically terminated diode and transistor rectifiers," *IEEE Trans. MTT*, vol. 60, no. 12, pp. 4043–4052, Dec. 2012.
- [5] B. Li, X. Shao, N. Shahshahan, N. Goldsman, T. Salter and G.M. Metzger, "An antenna co-design dual band RF energy harvester," *IEEE Trans. Circuits and Systems*, vol. 60, no. 12, pp. 3256–3266, Dec. 2013.
- [6] J. Guo, H. Zhang and X. Zhu, "Theoretical analysis of RF-DC conversion efficiency for class-F rectifiers," *IEEE Trans. MTT*, vol. 62, no. 4, pp. 977–985, Apr. 2014.
- [7] K. Niotaki, A. Georgiadis, A. collado, and J.S. Vardakas, "Dual-band resistance compression networks for improved rectifier performance," *IEEE Trans. MTT*, vol. 62, no. 12, pp. 3512–3521, Dec. 2014.
- [8] C. R. Valenta, M. M. Morys, and G. D. Durgin, "Theoretical energy-conversion efficiency for energy-harvesting circuits under power-optimized waveform excitation," *IEEE Trans. MTT*, vol. 63, no. 5, pp. 1758–1767, May 2015.