

**UCC Library and UCC researchers have made this item openly available.
Please [let us know](#) how this has helped you. Thanks!**

Title	A 10Gbps optical burst switching network incorporating ultra-fast (5ns) wavelength switched tunable laser sources
Author(s)	Ryan, Neil; Todd, Michael; Farrell, Tom; Lavin, Adrian; Rigole, Pierre-Jean; Corbett, Brian M.; Roycroft, Brendan; Engelstaedter, Jan-Peter
Publication date	2017
Original citation	Ryan, N., Todd, M., Farrell, T., Lavin, A., Rigole, P.-J., Corbett, B., Roycroft, B. and Engelstaedter, J.-P. 'A 10Gbps optical burst switching network incorporating ultra-fast (5ns) wavelength switched tunable laser sources', SPIE Proceedings Volume 10566, International Conference on Space Optics 2008, 1056616 (9pp). doi: 10.1117/12.2308209
Type of publication	Conference Item
Link to publisher's version	https://www.spiedigitallibrary.org/conference-proceedings-of-spie/10566/2308209/A-10Gbps-optical-burst-switching-network-incorporating-ultra-fast-5ns/10.1117/12.2308209.full?SSO=1 http://dx.doi.org/10.1117/12.2308209 Access to the full text of the published version may require a subscription.
Rights	© 2017, Society of Photo-Optical Instrumentation Engineers (SPIE). All rights reserved.
Item downloaded from	http://hdl.handle.net/10468/6728

Downloaded on 2021-11-27T05:48:28Z



UCC

University College Cork, Ireland
Coláiste na hOllscoile Corcaigh

International Conference on Space Optics—ICSO 2008

Toulouse, France

14–17 October 2008

Edited by Josiane Costeraste, Errico Armandillo, and Nikos Karafolas



A 10Gbps optical burst switching network incorporating ultra-fast (5ns) wavelength switched tunable laser sources

Neil Ryan

Michael Todd

Tom Farrell

Adrian Lavin

et al.



International Conference on Space Optics — ICSO 2008, edited by Josiane Costeraste, Errico Armandillo, Nikos Karafolas, Proc. of SPIE Vol. 10566, 1056616 · © 2008 ESA and CNES
CCC code: 0277-786X/17/\$18 · doi: 10.1117/12.2308209

Proc. of SPIE Vol. 10566 1056616-1

A 10 GBPS OPTICAL BURST SWITCHING NETWORK INCORPORATING ULTRA-FAST (5ns) WAVELENGTH SWITCHED TUNABLE LASER SOURCES.

Neil Ryan⁽¹⁾, Michael Todd⁽¹⁾, Tom Farrell⁽¹⁾, Adrian Lavin⁽¹⁾, Pierre-Jean Rigole⁽²⁾, Brian Corbett⁽³⁾, Brendan Roycroft⁽³⁾, Jan-Peter Engelstaedter⁽³⁾

(1)Intune Networks Ltd., 12b Beckett Way, Parkwest, Dublin12, Ireland. E-mail: neil.ryan@intunenetworks.com

(2) Syntune AB, Torshamnsgatan 30A, S-164 40 Kista, Sweden. E-mail: pierre-jean.rigole@syntune.com

(3)Tyndall National Institute, Prospect Rd, Cork, Ireland. E-mail: brian.corbett@tyndall.ie

ABSTRACT

This paper outlines the development of a prototype optical burst mode switching network based upon a star topology, the ultimate application of which could be as a transparent payload processor onboard satellite repeaters. The network architecture incorporates multiple tunable laser sources, burst mode receivers and a passive optical router (Arrayed Waveguide Grating). Each tunable optical signal should carry ≥ 10 Gbps and be capable of wavelength switching in c. 5ns timescales. Two monolithic tunable laser types, based upon different technologies, will be utilised: a Slotted Fabry Perot laser (a Fabry Perot laser with slots added in order to introduce controlled cavity perturbations); and a Modulated Grating Y-Branch Laser (MGY: a widely tunable, multi-section device similar to the DBR laser). While the Slotted Fabry Perot laser is expected to achieve the required switching times, it is an immature technology not yet capable of achieving tunability over 80 ITU channels from a single chip. The MGY device is a more mature technology and has full C-band ITU channel coverage, but is not capable of the required short switching times. Hence, in order to facilitate the integration of this more mature technology into the prototype breadboard with the requisite switching time capabilities, a system of 'dual laser' transmitters is being developed to enable data transmission from one MGY laser while the other switches and vice-versa. This work is being performed under ESA contract AO 1-5025/06/NL/PM, Optical Technologies for Ultra - fast Processing.

1. INTRODUCTION

To meet the growing bandwidth requirements in telecommunication networks, transparent switching processors are being considered in order to circumvent the need for signal demodulation and regeneration, which are bottlenecks in scaling a high-throughput switch. All-optical monolithic techniques offer obvious advantages to achieving the high throughput requirements because of the high speed reconfigurability, high data capacity of optical fibre, as well as being amenable to scaling and flexibility. These advantages include compactness, low power consumption and mass, and EMC immunity, all of which are attractive for broadband satellite systems.

ESA initiated a project under ARTES-5 entitled "Optical technologies for Ultra-fast Processing" to address the bandwidth and scalability problems in next generation networks. The task of the project is to design a solution that is "future-proof", meaning that the solution must address the projected network requirements during the course of the mission lifetime of telecommunication satellites. The envisioned processor is based on a hybrid optical-electronic solution that incorporates transparent burst switching, channel multiplexing and bandwidth asymmetry. Transparency of the switch is essential for high-throughput high-speed processors since only burst header information is demodulated while the payload is routed directly. Transparent switching also accommodates different services which is important for a future-proof solution. Channel multiplexing and bandwidth asymmetry minimises the amount of on-board buffering that is needed. Table 1 below is lifted from the statement of work and summarises the performance requirements. The highlighted sections emphasize the main optical specifications. Two key requirements are:

- ≤ 1 ns optical switching
- ≤ 37.5 ns reconfiguration time

As defined in the statement of work, switching time is the time between the when a switching instruction is issued to when the optical configuration of the switch is valid for the selected wavelength. The reconfiguration time is the time needed to reconfigure an optical component from one wavelength to another, and includes the switching time. During the reconfiguration time, the optical switch transmits optical packets at the previous configuration settings while the new configuration is being loaded. An optical packet comprises a number of 16-bit samples, along with encoding and overhead, and is termed a supertimeslot. The supertimeslot length plus switching time must all occur within the reconfiguration time.

This paper will first introduce the design of the optical burst switching star network. It incorporates multiple tunable transmitters, a passive optical router in the form of an arrayed waveguide grating (AWG) and burst mode

receivers. The remainder for the paper will then focus on current work that is being carried out on the development of two monolithic tunable laser types that can deliver the required optical performance, and the schemes that are being employed to meet the ultra-fast switching and short reconfiguration times. The current work is being carried out by a consortium led by Intune Networks and including Syntune AB, Tyndall National Institute and LioniX BV.

Table 1. Requirements specifications of the switch breadboard. The key optical specs are highlighted.

Ultra-fast processor	
	Requirement
Number of input beams	up to 200
Number of output beams	up to 200
Number of input channels per beam	Up to 168 input channels per beam (of 1MHz)
Number of output channels per beam ¹	Up to 192 output channels per beam (of 1MHz)
Channel granularity	1MHz
Switching type	Transparent burst switching
Burst length	in the order of 3msec
Connectivity type	from any input channel of any uplink beam to any output channel of any downlink beam
Non-blocking	the switch system must be non-blocking
Multicast	Desirable
Internal requirements	
Beam rate ² (at TMUX output)	1.25MHz/Ch x 2 (oversampling) x 16bits/complex sample x 168channels = 6.72Gbps
Beam rate ² (at laser output)	≥10Gbps (6.72Gbps x 192/168 (non-blocking) x 1.3 encoding&overhead factor)
Switching time (of the optical switch)	≤1nsec
Reconfiguration time ³ (of the optical switch)	≤37.5nsec (considering supertimeslot of 18 samples of 16 bits/sample, 8B10B encoding and overhead)
Number of supertimeslots per frame	192
Frame period	37.5nsec x 192 = 7.2µsec
Number of frames per burst	300

2. ARCHITECTURE

2.1 Breadboard

The optical architecture of the switch fabric is based on Passive Wavelength Routing and incorporates ultra-fast tuneable lasers. Routing from transmitter to receiver is governed by the transmitted wavelength using an arrayed waveguide. This optical component will, depending on the carrier wavelength, passively route optical signals to the desired destination. Passive wavelength routing offers non-blocking functionality while also imposing minimum insertion losses compared with a broadcast and select architecture, which employs optical couplers; the insertion loss in AWGs does not scale with the number of ports as do optical couplers.

The architecture is illustrated in Fig. 1 and consists of a central MxM AWG, N-port broadband couplers at each of the AWG's inputs, and N-skip-0 cyclic AWGs at each of the outputs. The total number of ports is therefore NxM. There are many possible configurations for >100 ports using different dimensions of AWGs and couplers. The breadboard demonstrator in this project will be a scaled down version to prove functionality of the architecture. A 4x4 AWG will be used along with

four 4-skip-0 cyclic AWGs – no couplers are needed. Four tunable laser modules will be fabricated, each transmitting up to 16 wavelengths. In this way, non-blocking routing to 16 possible destinations will be demonstrated.

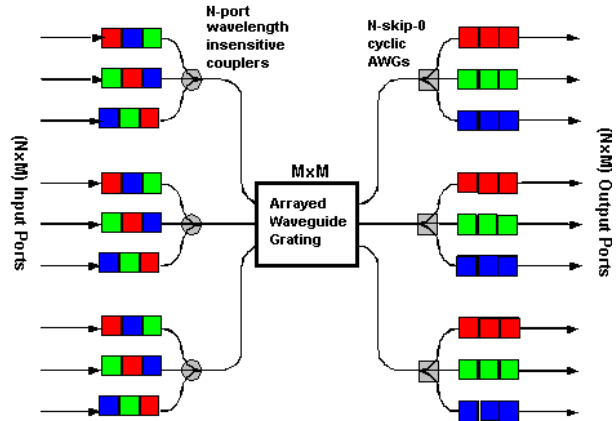

Fig. 1. Scaled passive wavelength routing network using combination of MxM AWG, couplers at the input and cyclic AWGs at the output.

Two separate optical source technologies are being investigated in order to meet both the ultrafast (<1ns) wavelength switching and scaling requirements of the project. The two technologies are Syntune's MG-Y widely tunable laser technology and Tyndall's Slotted Fabry-Perot (SFP) laser technology. The MG-Y is a widely tunable laser based on established DBR technologies. Syntune have incorporated the MG-Y tunable laser with a 10Gbps Mach Zehnder modulator and wavelength locker, integrated into a mini-butterfly package, making it a scalable solution to a 100-transmitter breadboard. It offers switching speeds on the order of 10s of ns. The SFP laser from Tyndall on the other hand is an emerging technology at a prototype stage that can delivery very fast switching in <2ns and ultimately can be integrated into a similar package as Syntune's MGY laser. Due to the relative immaturity of this laser type, it is not expected that packaged SFP lasers will include modulator or locker.

The switching speed of the MGY laser is clearly too slow to meet the breadboard requirements. To circumvent this, Intune is developing a tunable laser module that uses two MG-Y lasers for each transmitter, so that while one laser is on and used for transmission of data, the other laser is configured for the next wavelength. This sort of pipelining means that each laser has an additional 37.5ns of reconfiguration time. The switching time, i.e. the time between the instruction to switch, and laser output at the desired wavelength, remains ≤ 1ns. As the lasers incorporate an SOA at the output, this can be used to enable and disable the output of the laser and can therefore be used for the switching

process. A diagram of this dual laser concept can be observed in Fig. 2.

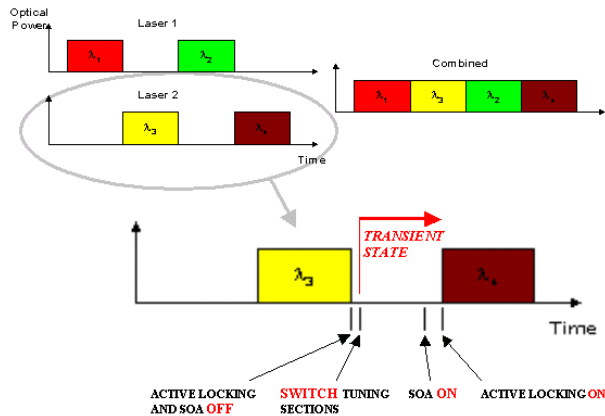

Fig. 2. Pipelined operation of two tunable lasers in a single module that enables ultrafast wavelength switching.

2.2 Laser design

Most widely tunable laser modules (i.e. tuning range > 30 nm) available today are CW sources or integrated with a modulator to provide modulated output. The technology for CW tunable lasers can broadly be classified into 4 groups:

- Monolithic DBR and widely tunable DBR-like lasers.
- External cavity lasers (ECL) tuned by an external grating or an external filter.
- Vertical cavity surface emitting lasers (VCSELs) mechanically tuned by a MEMS structure.
- Arrays of lasers (usually DFB lasers) where each element has some degree of tuning (usually thermal).

The monolithic structures with electronic tuning are the only laser technology used today for providing fast tuning over a wide tuning range [1]. These devices are also highly manufacturable and use the same manufacturing processes as today's standard fixed wavelength Distributed Feedback (DFB) Lasers. They provide flexible, cost-effective solutions without compromising quality and reliability, by taking advantage of the existing capacity in semiconductor laser fabs around the world. This technology platform provides the small size, low cost, low power consumption and fast switching tunable lasers in the industry. The "standard" 3 section DBR laser can give high optical power, but the tuning range is limited to about 15nm.

2.2.1 MGY laser

Syntune's patented tunable laser design, the Modulated Grating Y-branch (MG-Y) laser, is very similar to a normal distributed Bragg reflector (DBR) laser. The tunable laser is featured on the right half of Fig. 3. In order to extend the tuning range, the single grating reflector of the DBR laser is replaced by a parallel coupling of two modulated grating (MG) reflectors, labelled Right and Left reflector [1]. The tuning principle of the MG-Y laser is based on the Vernier effect. The right and left reflectors have a comb-shaped reflectivity spectrum. The combs have slightly different peak separations, such that only one pair of peaks overlaps at any time. Both reflections are combined using a multi-mode interference (MMI) coupler. A large reflection only occurs at the frequency where a reflectivity peak from the left reflector is aligned with a reflectivity peak from the right reflector. The laser will thus emit light at the frequency of the longitudinal cavity mode that is closest to the peak of the aggregate reflection.

By tuning one of the reflectors by an amount equal to the difference in peak separation, an adjacent pair of peaks can be aligned, i.e. a large tuning of the emission frequency is obtained for a relatively small tuning of a single reflector. The intermediate range can be covered by tuning both reflectors simultaneously. The phase section is used to align a longitudinal cavity mode with the overlapping reflectivity peaks. By combining the tuning action of the three sections a frequency range of more than 5 THz (a wavelength range of more than 40 nm) can be covered.

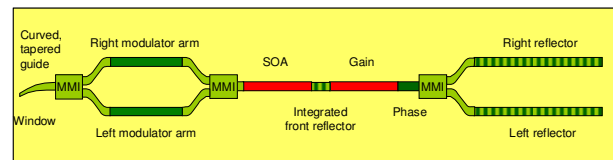

Fig. 3 Schematic of the tunable modulated laser (TML laser)

The device is manufactured using standard semiconductor laser processing technology, as is used to manufacture standard distributed Bragg reflector (DBR) lasers or distributed feedback (DFB) lasers with integrated electro-absorption (EA) modulators. No additional processing steps are required, which means that the manufacturing is very cost-effective and yields high device reliability.

The design of the MG-Y laser allows a wide tuning range to be covered with low tuning currents. This means power consumption will be low and little heat will be generated in the tuning sections. The latter is important when one wants to tune the laser rapidly, since slow thermal transients will be minimal. The

tuning speed is essentially limited by the carrier lifetime in the tuning sections. By scanning across operation points on a predetermined frequency grid, a very rapid swept frequency source can be obtained.

In summary, Syntune's modulated grating Y-branch lasers exhibit following features:

- Standard, reliable telecom laser processing;
- Minimum 40 nm / 5 THz tuning range (1528 – 1568 nm / 191.2 – 196.2 THz);
- High CW optical output power, > 20 mW ex-facet, > 10 mW fibre-coupled;
- Low power consumption;
- Fast wavelength switching (<50ns)

A key advantage of Syntune's laser is the ability to be monolithically integrated with additional functions such as amplification and high speed modulation (10Gb/s). These functions are shown on the left hand side of Fig. 3. This technology platform provides the smallest size, lowest cost, lowest power consumption, and fastest switching tunable transmitters in the industry.

2.2.2 SFP laser

This laser operates on the principle of the modulation of the Fabry-Perot (F-P) modes by the presence of controlled cavity perturbations forming weakly coupled sub-cavities. These cavity perturbations are created by etching holes (slots) in the waveguiding ridge at predetermined locations. The slots are introduced by an optical lithography process during the definition of the waveguiding ridge thus minimizing the fabrication complexity, increasing the device yield and therefore reducing the cost of the devices. A schematic of the laser structure is shown in Fig. 4 where a T shape is employed to deal with inadequacies in older fabrication equipment. The slots cause a periodic modulation of the emission spectra, with a modal frequency given by the reciprocal of the slot-to-facet and slot-to-slot spacing as a proportion of cavity length. The slot locations are referenced to the facet either within the fabrication process or using the precision cleaving available on modern tools. It is known that it is not necessary that the widths of such features be smaller than the wavelength in the waveguide, as a significant modulation effect can be observed from longer defects or intra-cavity mirrors.

To date the SFP laser work carried out at Tyndall has concentrated on single mode, single contact devices. Recently attention has turned to tuneable devices based on a Vernier effect using at least two contacts and deep slot geometries.

With single contact chips, it is possible to pre-design the laser to operate in a single longitudinal mode with SMSR > 40dB, output power >10mW with a minimal

increase in threshold. The slot in the SFP platform permits good electrical isolation between sections of the ridge especially in the case of deeply etched slots. Therefore, multiple electrical contacts to different sections of the ridge on a single device can be easily implemented. First studies have used Vernier-like two and three contact configurations targeting channels with mode spacings of 400GHz. Substantial coverage of the spectrum in between these channels has been achieved but full coverage has yet to be demonstrated. Fine-tuning current elements will be employed to address channels on the ITU grid.

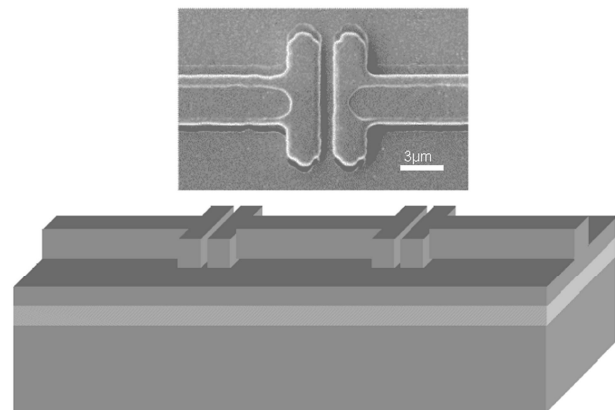

Fig. 4. Schematic of a ridge waveguide (lower) with slot defined by T bar structures and (upper) Scanning Electron Micrograph image of a fabricated slot.

Of particular interest is the characteristic switching time between wavelengths in these lasers. We have shown that switching between the super-modes occurs in <5ns across multiple channels. This fast switching behaviour is likely to be due to the all-active nature of these devices and thus is not limited by spontaneous emission events.

3. EXPERIMENTAL

Custom tunable laser modules have been designed and built at Intune Networks to support both the MGY and the SFP lasers. Each module consists of a laser control board, incorporating FPGA and microprocessors and a host board for interfacing. The FPGA controls the operation and switching of the laser, while the microprocessors store calibration tables and also control the temperature circuitry of the laser. The host board provides serial interface between the control board and the user as well as a clock and fast wavelength interface, which enables fast, reconfigurable remote control of channel switching.

The SFP-based system features a single laser chip on carrier remotely driven by a control module, while the MG-Y based system features two control modules (dual-laser) each driving an integrated packaged laser.

Each tunable laser module is then characterised in order to identify the final channel set specific to that module. This channel set is stored in a lookup table (LUT) on local memory. Characterisation is achieved by mapping the modal behaviour across multiple dimensions for each active/passive section (mode map) and extracting stable regions of tuning. From these regions, channels on a pre-defined ITU (or otherwise) grid may be identified and the multi-section DAC values stored in each LUT entry.

Fig. 5 shows the experimental setup, specific to the dual-laser configuration. Each control board accepts three external inputs via the host board: distributed clock (88.47 MHz), chip select and wavelength bus. These inputs are all generated from an arbitrary waveform generator.

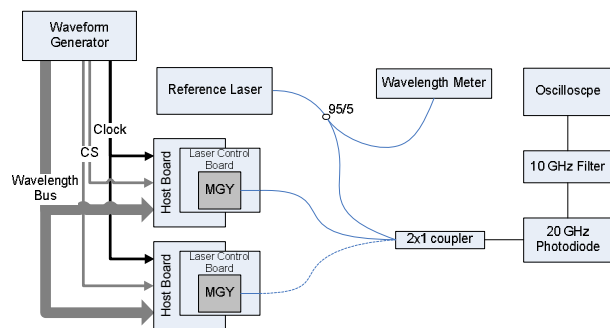

Fig. 5. Experimental setup of fast switching tunable laser, whose optical frequency is measured by heterodyne detection.

To measure the fast wavelength switching, the optical output from each laser is, in turn, coupled with a reference laser and passed to a fast photodiode (20GHz), low pass filtered before observing the beat signals on an oscilloscope. The filter in this case has 10 GHz bandwidth, such that a beat is seen when the MGY laser is within 10 GHz of the reference laser. In this way, by setting the reference laser to a destination wavelength, it is possible to see the time evolution of a switch from each MGY laser.

The specifications in Table 1 require careful synchronisation of the optical packets from each of the transmitters. Each packet must be exactly aligned in time so that there is no temporal overlap, which can lead to collisions at the receiver. The specified reconfiguration time must be ≤ 37.5 ns which includes 1 ns switching. The target optical packet length is therefore ≤ 36.5 ns, with 1 ns guardband in between each packet during which time switching transients occur. Ensuring synchronisation of the transmitters requires a distributed clock. In this way, each transmitter can be synchronised to within the jitter of the clock. Since switching events (such as turning on and off the laser,

tuning to a new destination wavelength etc) are triggered by clock edges, the length of the optical bursts and guard bands will be multiples of the clock period. As such, the clock frequency and data rate must be chosen to most closely deliver the required performance specifications summarised in Table 1:

1. Effective 6.72 Gbps data rate including 8B/10B encoding, 192/168 bandwidth asymmetry, and overhead (including ≤ 1 ns wavelength switching).
2. Reconfiguration time ≤ 37.5 ns to minimise buffering of the transparent data processor.

The clock of the FPGA in the laser modules is configured at 88.47 MHz, based on hardware limitations on the control board. Table 2 outlines the overall throughput and supertimeslot length that can be achieved at 88.47 MHz clock, with both 9.95 Gbps and 11.05 Gbps line rate. Since the clock period is 11.3 ns the closest achievable supertimeslot length to 37.5 ns is 39.56 ns, which equals 3.5 clock cycles. Here, a guardband of half a clock cycle is used, which is equivalent to 5.65 ns. In this time, 16 samples of 16-bit words can be transmitted at 9.95 Gbps with 8B/10B encoding. The amount of data that is effectively transmitted during this time is less. First, the number of data bits excludes the encoding bits. Second, overhead, including a 168/192 asymmetry factor, must be included to ensure non-blocking. Therefore the effective throughput is 5.66 Gbps. Increasing the line rate to 11.05 Gbps raises the throughput to 6.37 Gbps.

Under these conditions (88.47 MHz clock, 39.56 ns supertimeslot length), the overall throughput is 84% and 95% of the required 6.72 Gbps at 9.95 Gbps and 11.05 Gbps, respectively. The performance can be readily improved to $>100\%$ by simply reducing the guardband time, which currently is a large proportion of the supertimeslot length.

Table 2. Composition of packet length, guard band and effective throughput based on synchronisation with a distributed clock.

Bit Rate	Gbps	9.95	11.05
Clock	MHz	88.47	88.47
No. clock cycles/packet		3	3
Packet length	ns	33.91	33.91
No. samples/packet		16	18
No. clk. cycles total		3.5	3.5
Guardband	ns	5.65	5.65
Supertimeslot length	ns	39.56	39.56
Effective Throughput	Gbps	5.66	6.37

The purpose of the guardband is to protect against any indeterminate states, including clock/timing jitter wavelength uncertainty during switching events. Using the current clock rate of 88.47 MHz provides a method to demonstrate fast switching, including jitter, in

<5.65 ns. With a stable distributed clock the jitter is anticipated to be <0.5ns. The required guardband is therefore mainly defined by the duration of switching events, such as power and wavelength transients. Depending on the duration, it can be shortened using faster clock rates, which improves the timing granularity. This is intended for future work.

While the above timings hold true for both transmission system types, the remainder of this section focuses on the extra timing requirements of the dual-laser configuration due to the increased complexity of synchronising two modules.

The timing sequence of an optical channel switch within the dual laser setup is illustrated in Fig. 6. The **Wavelength Bus** is to be shared between both modules in the dual laser setup. This will be a ribbon cable of eight parallel lines made up of address identifier bits. **CS (Ch.A)**, and **CS (Ch.B)** each represent chip select control lines for modules 1 and 2 respectively. They are active low controls.

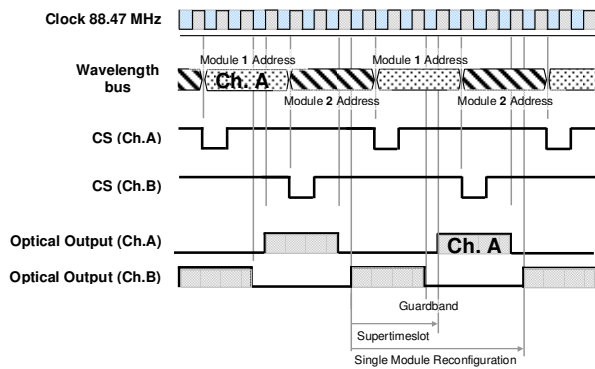

Fig. 6 Timing diagram of dual laser fast switch setup.

Fig. 6 incorporates a timing diagram for the setting of Module 1 to optical Channel A. The 88.47 MHz **Clock** is distributed to both modules and a period of 3.5 clock cycles per supertimeslot have been assumed. To initiate a switch, Channel A is loaded onto the common **Wavelength Bus** and **CS (Ch.A)** is simultaneously set low 107ns (9.5 clock cycles) prior to transmission at that wavelength. Both signals are sent to the control board FPGA. The address data is latched from the bus to the module FPGA at the next clock edge and immediately initiates the internal switching sequence of the DACs. It takes 56 ns (5 clock cycles) for the FPGA to actually blank the laser and update the DAC settings. In this time, the previous channel will be transmitting. After a further 4 clock cycles from the time of blanking (45 ns), the SOA is turned on and the laser emits at channel A for 3 clock cycles (33.9 ns). Module 2 follows the same switching sequence as Module 1, except that it is delayed by 3.5 clock cycles so its optical output occurs while Module 1 is off. In keeping with

the assumed timing scenario described above, the guard band is half a clock cycle, or 5.65 ns. While the optical signals alternate between the two Modules every 39.56 ns (33.91 + 5.65), it can be seen that the reconfiguration time of each laser is twice this value, at 79.12 ns, which is equivalent to seven clock cycles. Observe both **CS (Ch.A)** and **CS (Ch.B)**, which initiate the switching processes, and it is clear that they occur every other supertimeslot.

4. RESULTS

4.1 SFP Laser Switching

In the course of mapping this two section device, four distinct operating points were identified. Due to the relative immaturity of this technology it was decided not to attach the criterion of each operating point sitting at an ITU channel to this particular test. The four operating points occupied a frequency range of just under a terahertz, between 192.96 and 193.86 THz. A LUT consisting of these points was written to the control board and switching tests performed.

The destination channel beat evolution resulting from one switch event is shown in Fig. 7. The switch transition begins at 2.0ns. Notice that the beat signal peak outline for the source channel is also shown. The transition time from the 3dB point on one beat signal to the equivalent point on the other is the switching time. In this particular instance, it is approximately 1ns.

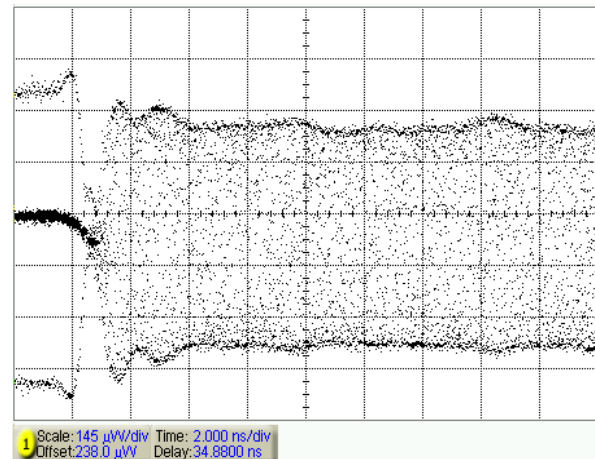

Fig. 7. SFP switching event beat signal evolution.

A full set of switching tests was performed for all combinations of switching between pairs of the four channel set. This resulted in 16 (4 x 4) distinct switching events. The switching time for each transition is summarised in Fig. 8. As can be seen, the worst case transition occurs in 3ns, with the average transition taking 2.3ns. While this does not meet the 1ns switching time as specified in Table 1, it falls well below the guardband of 5.65ns as defined in Section 3. Indeed, if

the guardband were to be reduced, overall throughput of a system based upon this laser type could improve substantially.

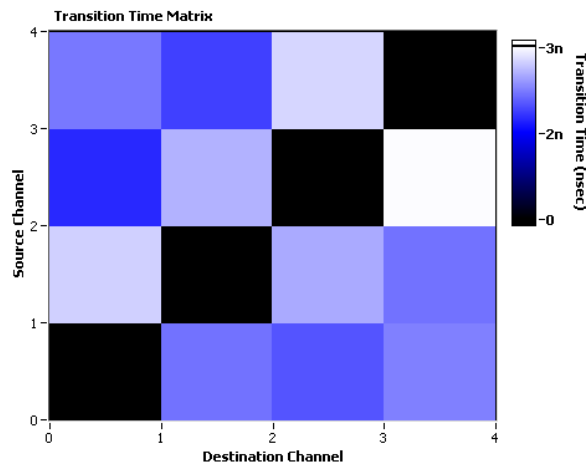

Fig. 8. Switching time matrix for four channels of SFP.

4.2 Dual Module Setup incorporating MG-Y Laser Switching

Two modules, each incorporating a control board and MG-Y laser were built. More than 70 ITU channels spanning between 192 and 196.2 THz were extracted from each module, following characterisation.

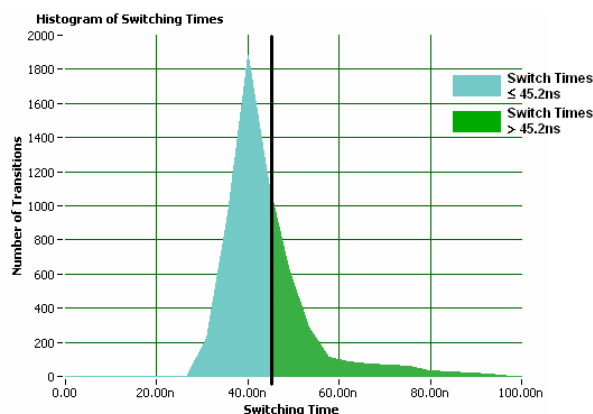

Fig. 9: Histogram of switching times for every transition within module 1.

As with the SFP-based system, a full set of switching tests was performed on every possible transition. As stated in Section 3, the reconfiguration time for each laser within a dual laser setup is seven clock cycles, of which four clock cycles are devoted to switching. While the spread of switching times varied between 25 and 90ns, 75% of transitions were found to be at or below the required four clock cycles. These results are shown in Fig. 9. Further work will investigate methods to maximise the proportion of switches which meet

requirements. This work may include methodologies for positioning destination channel voltages dependent on the source channel as well as utilising the internal reference etalon to enable some form of active wavelength locking.

Following the characterisation and test of each module, a sequence of control inputs for the dual module configuration was designed and loaded onto the arbitrary waveform generator. The digital outputs of the generator were then interfaced with the fast wavelength bus of each module, and a sequence of consecutive ITU channels set. In the sequence, each module transmitted alternate bursts at each channel. A montage overlaying the resulting successive bursts as a sequence of beat signals can be seen in Fig. 10. Each different coloured signal represents a different destination channel. The observed packet lengths are between 24 – 32 ns and switching times from 8 – 13 ns. One beat signal (Module 2; Channel B) is shorter than the others by 8ns due to a slower switching time to this destination channel. The proposed improvements to the switching methodology should reduce the likelihood of such anomalies. Indeed if transition is ignored, the results agree to within 1 ns, with packet lengths between 32 – 33 ns and switching times between 8 – 9 ns. It is important to note that currently turn-off of one laser occurs a half clock cycle prior to turn-on of the other. In future tests both events will occur synchronously in order to ensure that all visible power/wavelength transients overlap within the guardband region. This has the potential to improve performance targets through the reduction in necessary guardband length relative to supertimeslot length.

5. DISCUSSION

In this paper, two approaches to ultra-fast switching of tunable lasers is demonstrated. The dual-laser architecture proves that nanosecond level switching is possible using current DBR-based technologies, specifically Syntune's MG-Y laser. Initial results show switching times on the order of 5 – 15 ns, depending on the destination channel. It has already been identified that synchronising turn-off of one laser and turn-on of the second laser can immediately recover 5ns from the switching time. Further techniques such as adjustment of the section voltages for particular transitions and active locking, offer scope to reducing the overall switching time further.

The SFP laser is fast-switching by design and we have shown <3ns switching between 4 channels. These tests were carried out on Tyndall's first-generation product, which a single-slot device tailored for 400GHz channel spacing. Tyndall have since made improvements to the laser design, primarily in the area of tunability, and it is anticipated that further switching tests will show good

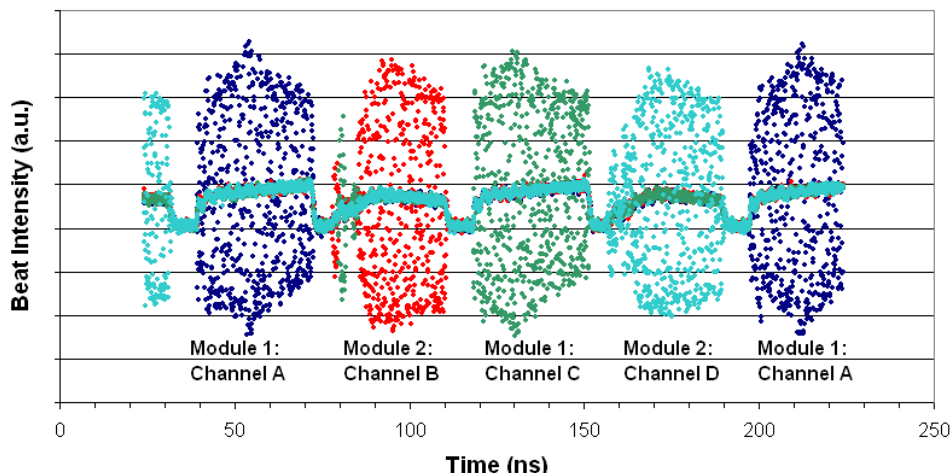

Fig. 10. A sequence of optical bursts at successive ITU channels, as generated by the dual module.

repeatability across a growing number of channels. Target switching times of <5 ns for all transitions can be expected. After incorporating the expected 5 ns switching time into the model described by Table 2, the potential throughput that can be achieved using the SFP laser becomes 6.46 Gbps with a reconfiguration time of 39 ns which is close to the design specifications. These values are summarised in Table 3.

Table 3 also compares the designed and measured results using the dual-MGY switching configuration. As a first attempt, the results show promise towards meeting the requirements. The measured reconfiguration time is close to the designed value of 39.6 ns, however switching time is approximately 2 ns longer than expected. The consequence of the longer switching time (and same reconfiguration time) is that the amount of data that is transmitted per supertimeslot is reduced, which affects overall throughput.

The most challenging specification, to achieve a switching time of ≤ 1 ns, is an aggressive target with current laser technologies. Future work will not only focus on reducing the switching times, as described above, but also on enabling faster distributed clock for higher timing granularity and 11.05 Gbps modulation rates. Doing so will alleviate the need to meet <1 ns switching since it is interrelated with reconfiguration

and throughput; the switching and reconfiguration times determine how much data can be transmitted during a given supertimeslot. The specified times were arrived at assuming target throughput of 6.72 Gbps and 10 Gbps line rate. With a higher line rate (i.e. 11.05 Gbps), a longer switching time is permissible while maintaining the throughput or reconfiguration time. As a result, it is anticipated that the final optical switch breadboard, using both MGY and SFP lasers, will meet the target specifications.

Table 3. Comparison of measured performance to required specifications of the dual-MGY switching configuration.

	Target	Design	Measured	
			MGY	SFP
Switching time (ns)	≤ 1	5.65	8-9	< 5
Reconfiguration time (ns)	≤ 37.5	39.6	40	39**
Throughput (Gbps)*	6.72	6.37	5.95	6.46**

* Expected throughput based on 11.05 Gbps beam rate and measured supertimeslot length.

** Calculated values based on optimised timing model after incorporating measured switching time.

References

1. J. Simsarian, et al. Fast Switching Characteristics of a Widely Tunable Laser Transmitter, *IEEE Photonics Technology Letters*, Vol. 15, No. 8, August 2003.