

Technical University of Denmark



## Specimen for cyclic delamination crack growth rates from ply-drops Paper

**Goutianos, Stergios; Sørensen, Bent F.**

*Published in:*

I O P Conference Series: Materials Science and Engineering

*Link to article, DOI:*

[10.1088/1757-899X/388/1/012010](https://doi.org/10.1088/1757-899X/388/1/012010)

*Publication date:*

2018

*Document Version*

Publisher's PDF, also known as Version of record

[Link back to DTU Orbit](#)

*Citation (APA):*

Goutianos, S., & Sørensen Bent, F. (2018). Specimen for cyclic delamination crack growth rates from ply-drops: Paper. I O P Conference Series: Materials Science and Engineering, 388(1), [012010]. DOI: 10.1088/1757-899X/388/1/012010

## DTU Library

Technical Information Center of Denmark

---

### General rights

Copyright and moral rights for the publications made accessible in the public portal are retained by the authors and/or other copyright owners and it is a condition of accessing publications that users recognise and abide by the legal requirements associated with these rights.

- Users may download and print one copy of any publication from the public portal for the purpose of private study or research.
- You may not further distribute the material or use it for any profit-making activity or commercial gain
- You may freely distribute the URL identifying the publication in the public portal

If you believe that this document breaches copyright please contact us providing details, and we will remove access to the work immediately and investigate your claim.

PAPER • OPEN ACCESS

## Specimen for cyclic delamination crack growth rates from ply-drops

To cite this article: Stergios Goutianos and F. Sørensen Bent 2018 *IOP Conf. Ser.: Mater. Sci. Eng.* **388** 012010

View the [article online](#) for updates and enhancements.

### Related content

- [Delamination initiated by a defect](#)  
A Biel and H Toftegaard
- [The behavior of delaminations in composite materials - experimental results](#)  
A S Chermoshentseva, A M Pokrovskiy and L A Bokhoeva
- [Delamination Analysis of a Multilayered Two-Dimensional Functionally Graded Cantilever Beam](#)  
V Rizov



**IOP | ebooks™**

Bringing you innovative digital publishing with leading voices to create your essential collection of books in STEM research.

Start exploring the collection - download the first chapter of every title for free.

# Specimen for cyclic delamination crack growth rates from ply-drops

**Stergios Goutianos and Bent F. Sørensen**

Department of Wind Energy, Section of Composite Mechanics and Structures, Technical University of Denmark, Risø Campus, DK-4000 Roskilde, Denmark

E-mail: [gout@dtu.dk](mailto:gout@dtu.dk); [bsqr@dtu.dk](mailto:bsqr@dtu.dk)

**Abstract.** The cyclic growth rate of delaminations initiated from ply-drops under tensile cyclic load was experimentally measured using a test specimen geometry, with internal ply-drops, that allows stable crack growth. It is found that the fatigue delaminations grow at a constant rate.

## 1. Introduction

In many applications, the external geometrical shape of lightweight composite structures (e.g. aerofoil shape for a wind turbine rotor blade) is specified by aerodynamic considerations. An additional requirement is usually to minimize the weight of the structure but without significant decrease in the structural stiffness and strength or fatigue life [1, 2]. To achieve these requirements, the thickness of the load-carrying composite laminates is varied along the length of the structure by terminating or dropping off plies (ply-drops) at specific locations. Ply-drops result in material and geometrical discontinuities which induces stress concentrations. As a result, delaminations can potentially start at these locations and propagate [3], reducing the load carrying capability of the composite laminates/structures.

Due to the significant effect on the load carrying capability of composite structures, the initiation and propagation of delaminations in composites with ply-drops (tapered composites) has been the subject of research for many years [4–10]. Despite, however, the large amount of research on the effect of ply-drops on the structural strength, challenges still exist a) in accurate structural predictions of *e.g.* the safe lifetime of composite structures with ply-drops and b) in designing more damage tolerant tapered composites by investigating the parameters that influence the onset and growth of the delaminations.

The present work, is an ongoing effort towards the development of a fracture mechanics based methodology to predict the initiation and propagation of delaminations starting from ply-drop locations. Such an approach can potentially allow the development of composites with ply-drops that possess high damage tolerance by engineering the interface properties between the different plies. A high damage tolerance is a prerequisite in damage tolerance design of composite structures where damage is accepted as long it can be detected and its growth will be stable and can be accurately predicted [11]. To identify the failure mechanisms, simplified composite specimens with ply-drops are manufactured and tested under cyclic loading. The present work focuses on the measurement of the delamination growth rates under cyclic loading at different applied stress levels. The initiation of delaminations and the delamination growth



rate change when the thickness of the specimen changes (due to the presence of ply-drops) are not discussed.

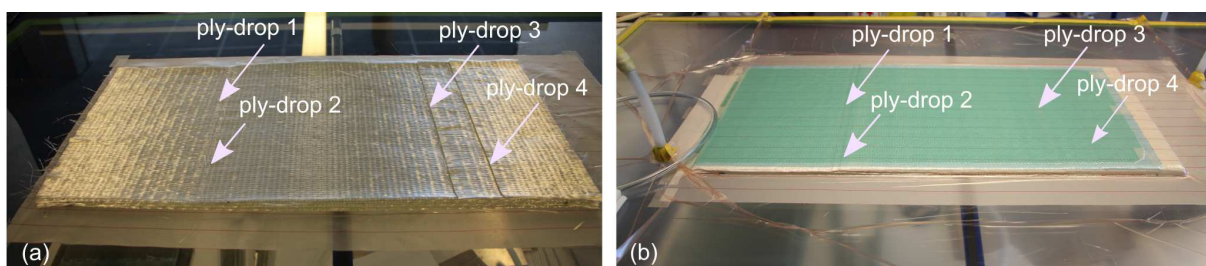
## 2. Experimental Details

### 2.1. Materials

A nearly unidirectional glass fibre fabric (2400 tex) with area weight equal to  $1134 \text{ g/m}^2$  was obtained from Saertex. The fibre diameter was  $17 \mu\text{m}$ . The area weight of the  $90^\circ$  fibres was  $54 \text{ g/m}^2$  and the tex value was 68. The fibre diameter was  $10 \mu\text{m}$ . The sewing threads were made of polyester fibres (110 dtex) with an area weight equal to  $12 \text{ g/m}^2$ . The stitching type was tricot-warp. A biaxial fabric ( $\pm 45^\circ$ ) with a total area weight equal to  $720 \text{ g/m}^2$  was provided by Ahlstrom. The area weight of the  $\pm 45^\circ$  fibres (600 tex) was  $592 \text{ g/m}^2$ , of the  $90^\circ$  fibres (200)  $19 \text{ g/m}^2$ , of chopped strand mat ( $< 30 \text{ tex}$ )  $592 \text{ g/m}^2$  and of the stitch yarns (7.6 tex)  $10 \text{ g/m}^2$ . The diameter of the glass fibres in the  $\pm 45^\circ$  and  $90^\circ$  layers was equal to  $16 \mu\text{m}$ . In the chopped strand mat, the fibres had a diameter equal to  $12 \mu\text{m}$ . The stitching type was tricot-warp. The epoxy matrix material, Araldite LY 1568, and the hardener, Aradur 3489 CH, were provided by Huntsman.

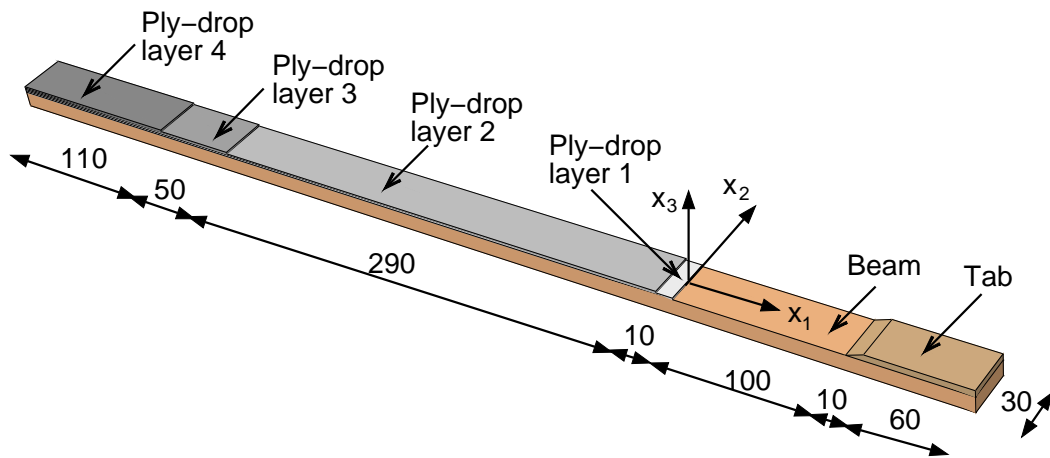
### 2.2. Test specimen

Ten unidirectional fabrics/plies were placed on the vacuum infusion table as shown in Fig. 1a. Then, four unidirectional plies, each with different length, were placed one by one on top of the ten unidirectional plies. The distance between the ply-drops is shown in Fig. 2. It should be mentioned that all the unidirectional plies were placed with the  $90^\circ$  fibres face down. A continuous biax fabric, with a length equal to the length of the ten unidirectional plies, was afterwards placed on top of the four unidirectional plies and the epoxy resin was infused (see Fig. 1b). The curing cycle, after vacuum infusion, was 19 hrs at  $40^\circ\text{C}$  followed by 5 hrs at  $75^\circ\text{C}$ . After curing, the thickness of each unidirectional (UD) layer was approximately 0.9 mm and the thickness of the biax layer was approximately 0.6 mm.

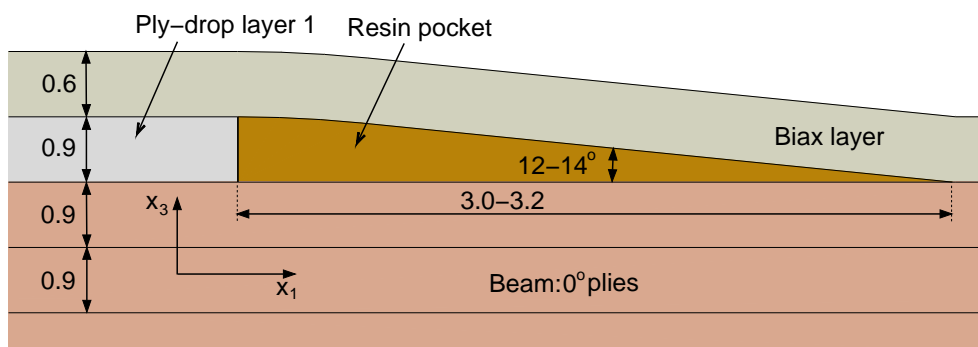


**Figure 1.** Ply layup to manufacture the composite specimens with ply-drops by vacuum infusion.

The ply-drop specimens were cut-out from the vacuum infused plate (Fig. 1b). The specimen has had a total length equal to 630 mm and a width equal to 30 mm (see Fig. 2). The distance between ply-drops 1 and 2 was approximately 10 mm, the distance between ply-drops 2 and 3 was equal to 290 mm and between ply-drops 3 and 4 equal to 50 mm. Glass fibre epoxy composite tabs (height equal to 4 mm) were glued on the right-end of the ply-drop specimens. The dimensions of the ply-drop specimens *e.g.* length, height, distance between ply-drop 1 and tab were designed to minimise bending of the specimens during testing. The bending ratio in the thin section of the ply-drop specimens (at  $x_1 = 60 \text{ mm}$ , see Fig. 2) was less than 0.03 under static tensile load. The bending ratio was calculated from the strains measured by two strain gauges on opposite faces of the ply-drop specimens.



**Figure 2.** Specimen dimensions and position of the ply-drops. The biax layer that is on top is not shown (all dimensions in mm).



**Figure 3.** Schematic illustration of the material and geometric discontinuity at the ply-drop location (all dimensions in mm).

As mentioned above, a continuous biax layer was placed on top of the four unidirectional plies. Fig. 3 shows schematically the geometry at the location of ply-drop 1. As can be seen at the ply-drop location there exist both a material and a geometric discontinuity. It should be noted, that no effort was made to control the geometry of the ply-drop *e.g.* length of the resin pocket, and steepness of the biax layer. The shape of the geometric discontinuities was dictated by the vacuum infusion process with the variation from specimen to specimen not being significant based on SEM observations.

### 2.3. Cyclic loading

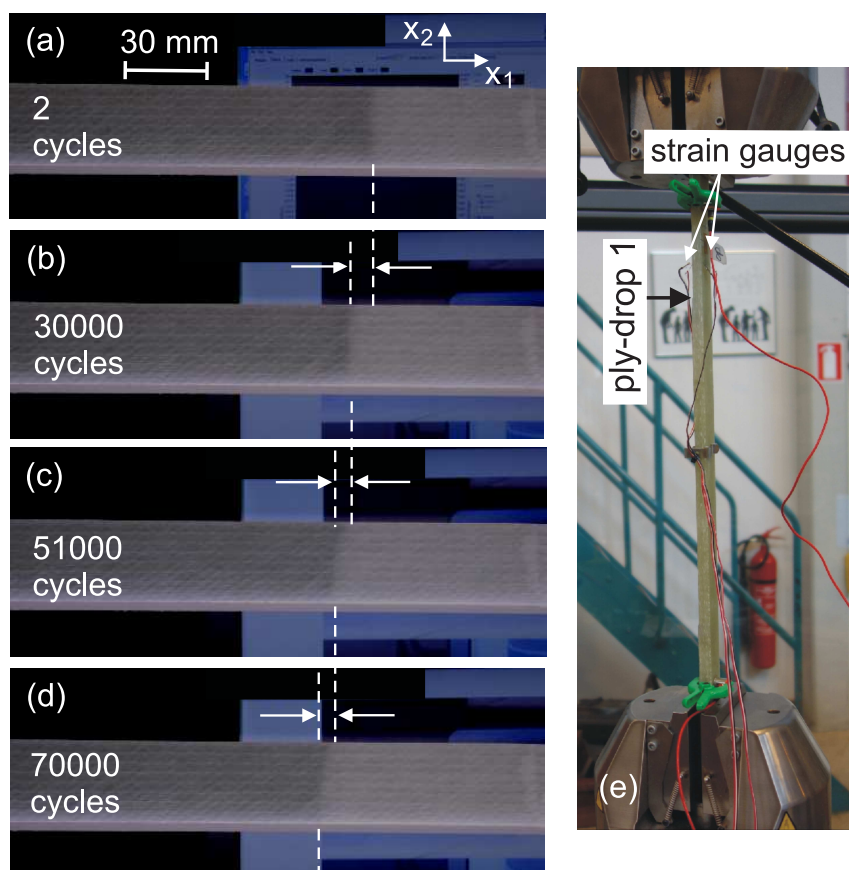
Two ply-drop specimens were first tested under monotonic static tensile loading in order to measure the stiffness of the specimens, measure the bending ratio and find the stress level at which a delamination initiates at the location of the ply-drop 1. The tests were conducted on an Instron servo-hydraulic testing machine with a 250 kN load cell at displacement rate of 0.0166 mm/min. The load, the position of the cross-head and the strain-gauge signals were acquired at a sampling rate of 10 Hz.

The cyclic tests were performed between fixed stress values (lower than the stress level at which delamination initiates under static loading) at a frequency of 3 Hz. The R-ratio was equal

to 0.1. The cyclic tests were performed on the same machine as the static tests. The position of the cross-head and maximum and minimum loads for each cycle were recorded. Photographs of the specimen were obtained at a predefined number of cycles in order to measure the fatigue delamination crack length. By default 1 photograph per cycle was acquired for the first 100 cycles, 1 photograph for every 10 cycles in the range 100 to 1000 cycles, 1 photograph for every 100 cycles in the range 1000 to 10000 cycles etc. However, it was possible to change the acquisition rate during the experiments if necessary. It was found that it was easier to identify the delamination front by taking photographs at the  $x_1 - x_2$  plane (see Fig. 2) instead at the  $x_1 - x_3$  plane. Prior to each cyclic test, a photograph with a scale bar on the surface of the specimen ( $x_1 - x_2$  plane) was taken. The photographs from the cyclic tests were then calibrated using the ImageJ software [12] and the delamination lengths were measured. Several crack growth measurements at different maximum applied load could be obtained from a single specimen when the delamination was in the region between ply-drops 2 and 3 (see Fig. 2).

### 3. Results and Discussion

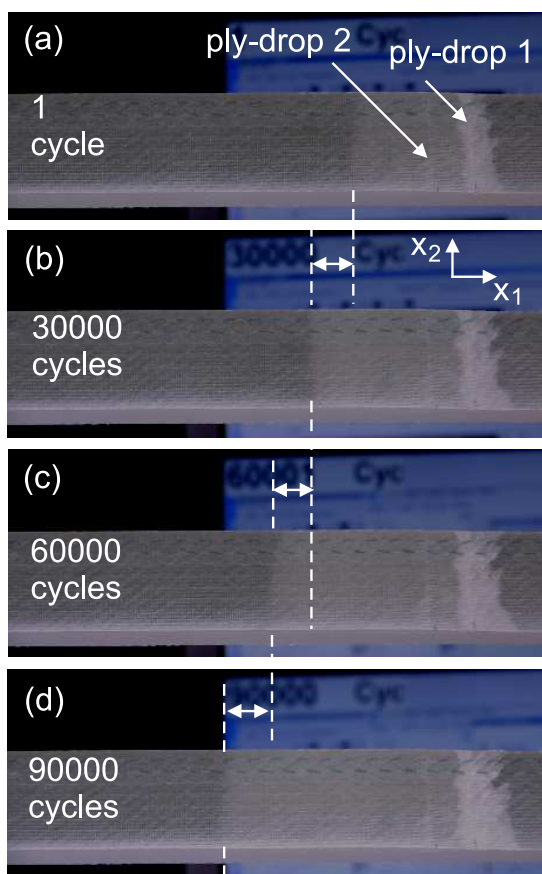
Fig. 4 shows a series of photographs taken from a ply-drop specimen tested under tensile cyclic loading.



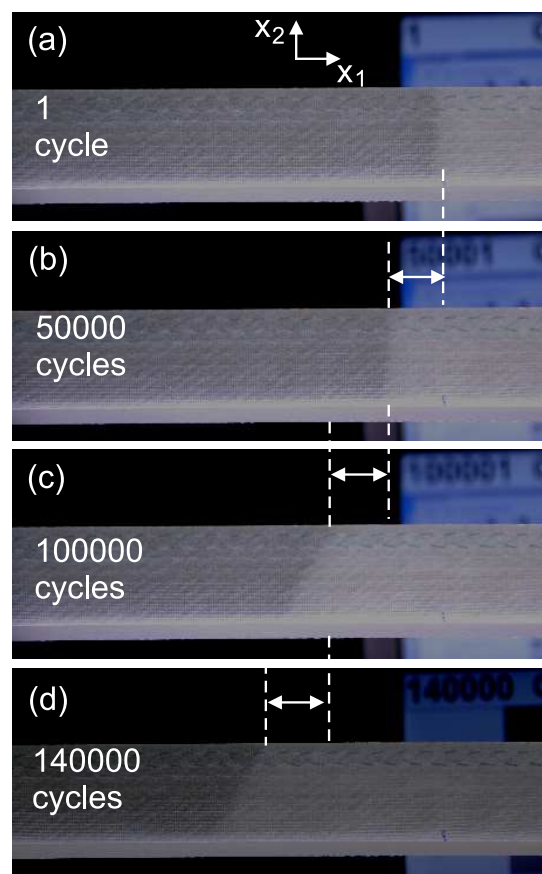
**Figure 4.** Measurement of fatigue delamination crack growth: a) 2 cycles, b) 30000 cycles, c) 51000 cycles, d) 70000 cycles. e) Specimen mounted on the hydraulic testing machine. The maximum applied stress,  $\sigma_{max}$ , is 142.9 MPa,  $R=0.1$  and frequency,  $\nu$ , is 3 Hz.

As mentioned above, the current work focuses on the measurement on the fatigue

delamination growth rates when the delamination is between ply-drops 2 and 3 (see Fig. 2). The maximum applied stress,  $\sigma_{max}$ , is 0.75 of the stress,  $\sigma_u$ , where the delamination initiates between the first ply-drop layer and the  $0^\circ$  plies (beam, see Fig. 3) under static tensile loading.  $\sigma_u$  is in the range of 205 to 250 MPa. As Fig. 4a shows, the delamination has already grown (under cyclic loading) to the constant thickness region between ply-drops 2 and 3 and delamination growth rate is measured from this point. Fig. 4b-d shows the delamination extension at 30000, 51000, and 70000 cycles, respectively. It can be seen that the crack front is nearly constant across the specimen width ( $x_2$  direction) and clearly visible allowing accurate measurement of the delamination growth with the number of cycles. It should be mentioned that the delamination had initiated between the first ply-drop layer and the  $0^\circ$  plies (beam) and had remained at this plane when it reached the region between ply-drops 2 and 3 (Fig. 4) and it stays in this plane Fig. 4b-d.

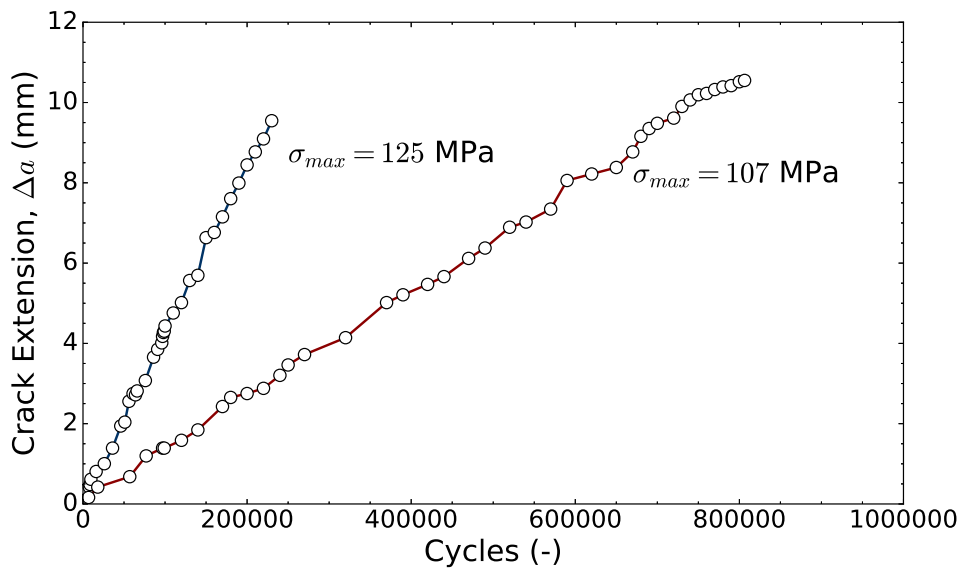


**Figure 5.** Measurement of fatigue delamination crack growth: a) 1 cycle, b) 30000 cycles, c) 60000 cycles, d) 90000 cycles. The maximum applied stress,  $\sigma_{max}$ , is 146.4 MPa,  $R=0.1$  and frequency,  $\nu$ , is 3 Hz.

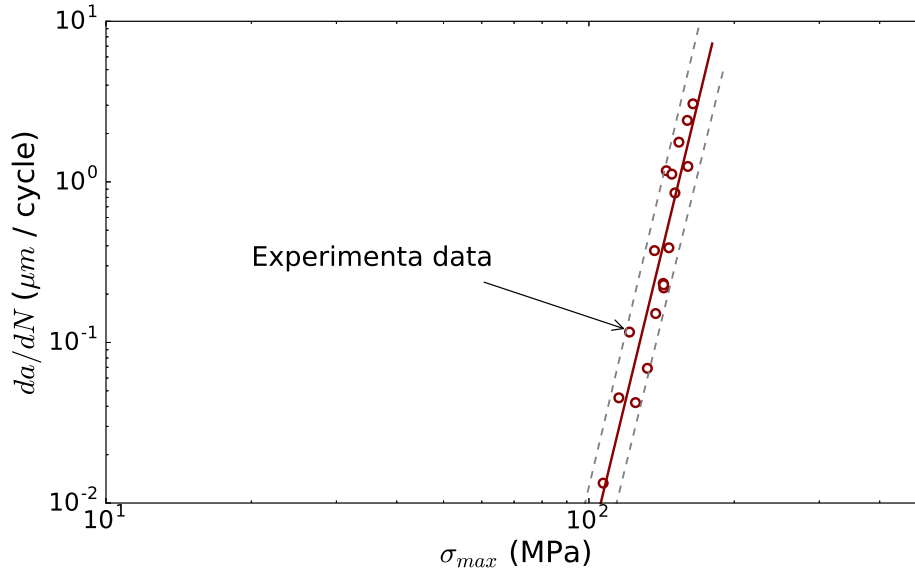


**Figure 6.** Measurement of fatigue delamination crack growth: a) 1 cycle, b) 50000 cycles, c) 100000 cycles, d) 140000 cycles. The maximum applied stress,  $\sigma_{max}$ , is 136.7 MPa,  $R=0.1$  and frequency,  $\nu$ , is 3 Hz.

Fig. 5 shows a series of photographs, at different number of cycles, from a another specimen. As in Fig. 4, the delamination has already grown in the region between ply-drops 2 and 3. The maximum applied stress is equal to 0.77  $\sigma_u$ . As mentioned above, several measurements of the delamination fatigue growth rates could be made in the region between ply-drops 2 and 3



**Figure 7.** Measured cyclic delamination (crack) growth as a function of the number of cycles for two different maximum applied stress levels.



**Figure 8.** Cyclic delamination (crack) growth rate as function of the maximum stress level,  $\sigma_{max}$ , normalised with the Young's modulus of the unidirectional plies,  $E_{UD}$ .

since this region is relatively long. After 90000 cycles (Fig. 5d), the test was interrupted, the maximum applied stress was set equal to  $0.71 \sigma_u$  and thereby a new cyclic test was started. A series of photographs are shown in Fig. 6 at 1 cycle, 50000 cycles, 100000 cycles and 140000 cycles, respectively. Unlike the specimen shown in Figs. 4 and 5, for this specimen the crack



front is not perpendicular to the  $x_1$  direction. Such a behaviour was observed in few cases but usually the crack front after a number of cycles became again perpendicular to  $x_1$ .

From measurements such as shown in Figs. 4, 5 and 6, the fatigue crack growth rate can be derived. Two examples are shown in Fig. 7 for  $\sigma_{max}$  equal to 0.66 and 0.56 of  $\sigma_u$ , respectively. It can be seen that the delamination (crack) growth rate is constant and as expected it increases with increasing the maximum applied stress. It should be noted that delamination growth rate is constant for large number of cycles (larger than 800000 cycles) showing that the ply-drop specimen developed is a steady-state specimen allowing accurate measurement of the cyclic delamination growth rate.

The cyclic delamination growth rate can be calculated from a linear fit of the experimental data shown in Fig. 7. The results are shown in Fig. 8 and follow a straight line in a log-log plot. Upper and lower bounds estimates are drawn.

As mentioned in Section 2, during manufacturing the unidirectional plies were placed with the  $90^\circ$  fibres on the bottom face. This probably creates a weak interface by preventing fibre bridging between the plies. Examination of the crack surfaces after the fatigue tests showed that there were no fibres bridging the crack faces and thus the cyclic crack growth can be treated using Linear Elastic Fracture Mechanics (LEFM) and Paris Law to predict the cyclic delamination growth rate.

#### 4. Conclusions

A test specimen with multiple ply-drops was designed to allow stable cyclic delamination crack growth. The specimen was used to measure the tension-tension delamination fatigue crack growth rate initiated from a ply-drop. It was shown that delamination growth rate is constant when the delamination grows in a region of constant thickness and can be described by Paris Law.

#### Acknowledgments

This work has received funding from the European Unions Horizon 2020 Research and Innovation Programme under Grant Agreement No 761072 (DACOMAT). Leonardo Di Crescenzo is acknowledged for manufacturing the test specimens and Hans Christian Jensen for technical assistance in the mechanical testing.

#### References

- [1] Gan K W, Allegri G and Hallett S R 2016 *Materials and Design* **108** 570-80
- [2] Helmy S and Hoa S V 2014 *Composites Science and Technology* **102** 10-19
- [3] He K, Hoa S V and Ganesan R 2000 *Composites Science and Technology* **60** 2643-57
- [4] Fish J C and Lee S W 1989 *Engineering Fracture Mechanics* **34** 43-54
- [5] Murri G B, O'Brien T K and Salpekar S A 1993 *Journal of the American Helicopter Society* **38** 29-37
- [6] Wisnom M R, Jones M I and Cui, W 1995 *AIAA Journal* **33** 911-18
- [7] Murri G B, O'Brien T K and Rousseau C Q 1998 *Journal of the American Helicopter Society* **43** 146-155
- [8] Thomsen O T, Rits W and Eaton D C G 1996 *Composites Science and Technology* **56** 407-22
- [9] Thomsen O T and Mortensen F 1999 *Composites Science and Technology* **59** 1213-26
- [10] Murri G B and Schaff J R 2006 *Composites Science and Technology* **66** 499-508
- [11] McGugan M, Pereira M, Sørensen B F, Toftegaard, H and Branner, K. 2015 *Philosophical Transactions A* **373** 20140077
- [12] Rueden C T, Schindelin J, Hiner M C, DeZonia B E, Walter A E, Arena E T and Eliceiri K W 2017 *BMC Bioinformatics* **18** 529