

## Accepted Manuscript

An upwind cell centred Total Lagrangian finite volume algorithm for nearly incompressible explicit fast solid dynamic applications

Jibrán Haider, Chun Hean Lee, Antonio J. Gil, Antonio Huerta, Javier Bonet

PII: S0045-7825(18)30308-6  
DOI: <https://doi.org/10.1016/j.cma.2018.06.010>  
Reference: CMA 11948

To appear in: *Comput. Methods Appl. Mech. Engrg.*

Received date: 19 December 2017  
Revised date: 2 June 2018  
Accepted date: 6 June 2018

Please cite this article as: J. Haider, C.H. Lee, A.J. Gil, A. Huerta, J. Bonet, An upwind cell centred Total Lagrangian finite volume algorithm for nearly incompressible explicit fast solid dynamic applications, *Comput. Methods Appl. Mech. Engrg.* (2018), <https://doi.org/10.1016/j.cma.2018.06.010>

This is a PDF file of an unedited manuscript that has been accepted for publication. As a service to our customers we are providing this early version of the manuscript. The manuscript will undergo copyediting, typesetting, and review of the resulting proof before it is published in its final form. Please note that during the production process errors may be discovered which could affect the content, and all legal disclaimers that apply to the journal pertain.



# An upwind cell centred Total Lagrangian finite volume algorithm for nearly incompressible explicit fast solid dynamic applications

Jibran Haider<sup>a</sup>, Chun Hean Lee<sup>a,1</sup>, Antonio J. Gil<sup>a,2</sup>, Antonio Huerta<sup>b</sup>, Javier Bonet<sup>c</sup>

<sup>a</sup> Zienkiewicz Centre for Computational Engineering, College of Engineering,  
Swansea University, Bay Campus, SA1 8EN, United Kingdom

<sup>b</sup> Laboratori de Càlcul Numèric, Universitat Politècnica de Catalunya,  
Campus Nord, Barcelona, 08034, Spain

<sup>c</sup> University of Greenwich, London, SE10 9LS, United Kingdom

---

## Abstract

The paper presents a new computational framework for the numerical simulation of fast large strain solid dynamics, with particular emphasis on the treatment of near incompressibility. A complete set of first order hyperbolic conservation equations expressed in terms of the linear momentum and the minors of the deformation (namely the deformation gradient, its co-factor and its Jacobian), in conjunction with a polyconvex nearly incompressible constitutive law, is presented. Taking advantage of this elegant formalism, alternative implementations in terms of entropy-conjugate variables are also possible, through suitable symmetrisation of the original system of conservation variables. From the spatial discretisation standpoint, modern Computational Fluid Dynamics code “OpenFOAM” [<http://www.openfoam.com/>] is here adapted to the field of solid mechanics, with the aim to bridge the gap between computational fluid and solid dynamics. A cell centred finite volume algorithm is employed and suitably adapted. Naturally, discontinuity of the conservation variables across control volume interfaces leads to a Riemann problem, whose resolution requires special attention when attempting to model materials with predominant nearly incompressible behaviour ( $\kappa/\mu \geq 500$ ). For this reason, an acoustic Riemann solver combined with a preconditioning procedure is introduced. In addition, a global a posteriori angular momentum projection procedure proposed in [1] is also presented and adapted to a Total Lagrangian version of the nodal scheme of Kluth and Després [2] used in this paper for comparison purposes. Finally, a series of challenging numerical examples is examined in order to assess the robustness and applicability of the proposed methodology with an eye on large scale simulation in future works.

*Keywords:* First order conservation laws, Large strain solid dynamics, Finite Volume Method, Riemann solver, OpenFOAM

---

## 1. Introduction

Current commercial (displacement-based) Finite Element Method (FEM) codes are extensively used for the simulation of large strain fast solid dynamic problems in the aerospace, automotive, defence and manufacturing industries. However, these commercial codes present a number of shortcomings [3, 4], namely (1) reduced order of convergence for strains and stresses in comparison with that of displacements [5, 6], (2) high frequency noise in the vicinity of shocks [7–10], and (3) hour-glassing and pressure checkerboarding modes [11–17].

---

<sup>1</sup> Corresponding author: c.h.lee@swansea.ac.uk

<sup>2</sup> Corresponding author: a.j.gil@swansea.ac.uk

1  
2  
3 In order to overcome some of these drawbacks, a number of methodologies have been proposed over the  
4 years. One very popular option used in industry is to resort to a selective reduced integration procedure  
5 [3, 18–21] along with (tri-linear) hexahedral elements. In this case, a reduced number of Gauss integration  
6 points is utilised in order to under-integrate the volumetric component of the stress. However, as it is well  
7 known, the resulting formulation is still incapable of addressing the existence of shear locking in bending  
8 dominated scenarios [20, 21].  
9

10 Alternatively, Bonet and Burton [22] introduced a FEM based nodally integrated procedure where  
11 the pressure field is under-integrated at nodes when employing the linear tetrahedral element (usually  
12 preferred in the case of complex geometries). Although this methodology was found to perform extremely  
13 well in nearly incompressible impact problems, it behaved poorly in bending dominated scenarios resulting  
14 in the appearance of hourglassing-like modes [23–25]. Several variants of the nodal pressure approach have  
15 since followed, including the averaged nodal deformation gradient [26], the F-bar method [27] and the  
16 Smoothed Finite Element Method [13]. However, all of these methods still suffer from spurious hydrostatic  
17 pressure fluctuations when attempting to model nearly incompressible materials [14].  
18  
19

20 On another front, several attempts have also been reported at aiming to solve solid mechanics problems  
21 via the use of (displacement-based) finite volume based discretisations [28–33]. Some interesting work has  
22 also been recently explored using the open source platform “OpenFOAM”, with special attention paid  
23 to the simulation of contact mechanics [34], orthotropic materials experiencing moderate strains [35] and  
24 metal forming applications [36].  
25

26 The earliest attempt at employing a (mixed) hyperbolic system of first order conservation laws in solid  
27 dynamics originates from the work of Trangenstein and Colella [37, 38], where the conservation variables  
28 were the linear momentum  $\mathbf{p}$  and the deformation gradient tensor  $\mathbf{F}$ . A second order Godunov-type finite  
29 volume framework in conjunction with the use of a Riemann-based upwinding stabilisation was presented.  
30 However, the examples presented in the paper were restricted to the case of small strain linear elasticity  
31 in two dimensions [38]. With a similar philosophy, a node based Finite Volume Method (FVM), originally  
32 proposed by Mazeran and Després [39] in gas dynamics applications [40–44], was adapted to the context  
33 of hyperelastic solids in [2, 45]. Scovazzi and co-authors [46–49] also used a mixed based methodology for  
34 a linear tetrahedral element by utilising a Variational Multi-Scale method.  
35

36 In recent years, some of the authors of this manuscript have pursued the same  $\{\mathbf{p}, \mathbf{F}\}$  mixed-based  
37 approach whilst exploring a wide range of spatial discretisation techniques, including: upwind cell centred  
38 FVM [1, 50], Jameson–Schmidt–Turkel vertex centred FVM [51], upwind vertex centred FVM [52],  
39 two step Taylor–Galerkin FEM [53], stabilised Petrov–Galerkin FEM [54–57], Jameson–Schmidt–Turkel  
40 SPH [58] and Streamline Upwind Petrov–Galerkin SPH [59]. Very recently [1], a mixed-based  $\{\mathbf{p}, \mathbf{F}\}$   
41 cell centred finite volume algorithm, entitled TOUCH, was successfully developed for three dimensional  
42 applications, with a tailor-made implementation into the open source platform “OpenFOAM”. Crucially,  
43 in order to fulfil the satisfaction of the inherent involutions within the system (also known as compatibility  
44 conditions [60, 61]), two variants of the TOUCH scheme were proposed, namely (a) Constrained-TOUCH  
45 (C-TOUCH) and (b) Penalised-TOUCH (P-TOUCH). In addition, an alternative Total Lagrangian version  
46 of the node based scheme presented in [2], namely X-GLACE, was also explored and implemented  
47 within the OpenFOAM environment. However, the methodologies introduced in [1] have been found to  
48 be inefficient when approaching the extreme limit of incompressibility ( $\kappa/\mu \geq 500$ ).  
49  
50

51 With this in mind, the main aim of this paper is the improvement of the robustness and effectiveness of  
52 both TOUCH and X-GLACE schemes, extending their applicability to quasi incompressibility scenarios.  
53 To achieve this, we propose to incorporate two additional geometric conservation laws, one for the co-factor  
54 of the deformation (or area map)  $\mathbf{H}$  and the other for the Jacobian of the deformation (or volume map)  
55  $J$ . From a spatial discretisation point of view, a cell centred finite volume algorithm in conjunction with  
56 a monotonic slope reconstruction is employed. Discontinuity of the conservation variables across control  
57 volume interfaces leads to a Riemann problem [1, 50, 52, 62], whose resolution however requires special  
58 attention when attempting to model materials with nearly incompressible behaviour ( $\kappa/\mu \geq 500$ ). In this  
59 paper, an acoustic Riemann solver combined with a preconditioning procedure is introduced, with the aim  
60  
61  
62  
63  
64  
65

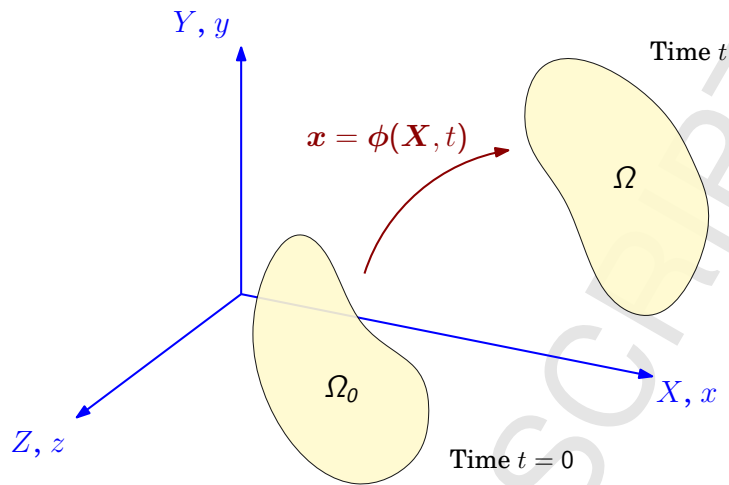

Figure 1: Motion of a continuum body

to recover a correct scaling of the numerical upwinding stabilisation. This preconditioning procedure has been previously used for the numerical simulation of the compressible Euler equations in the low Mach number limit [63–66]. For a fair comparison across the various schemes (TOUCH and X-GLACE), a global a posteriori angular momentum preserving procedure presented in Ref. [1] is now suitably adapted to the case of the node based X-GLACE scheme. An alternative approach was introduced by Després and Labourasse [67], which incorporates an angular momentum preserving reconstruction procedure within every cell via the use of a Lagrange multiplier.

The paper is organised as follows. Section 2 summarises the extended  $\{\mathbf{p}, \mathbf{F}, \mathbf{H}, J\}$  system of first order hyperbolic conservation laws for solid dynamics. Section 3 details some fundamental aspects of the finite volume spatial discretisation procedure used in this work. An acoustic Riemann solver in conjunction with a preconditioning procedure is shown in Section 4. Section 5 describes the one-step two-stage TVD Runge–Kutta time integrator used for temporal discretisation. Section 7 presents the algorithmic description of the complete  $\{\mathbf{p}, \mathbf{F}, \mathbf{H}, J\}$  TOUCH and  $\{\mathbf{p}, \mathbf{F}, \mathbf{H}, J\}$  X-GLACE schemes. For benchmarking purposes, an extensive set of challenging numerical examples is examined in Section 8. Finally, Section 9 presents some concluding remarks and future directions of research.

## 2. Reversible elastodynamics

Consider the three dimensional deformation of an elastic body of material density  $\rho_0$  moving from its initial undeformed configuration occupying a volume  $\Omega_0$ , of boundary  $\partial\Omega_0$ , to a current deformed configuration at time  $t$  occupying a volume  $\Omega$ , of boundary  $\partial\Omega$  (see Fig. 1). The motion is defined through a deformation mapping  $\mathbf{x} = \phi(\mathbf{X}, t)$  which satisfies the following mixed based set of Total Lagrangian conservation laws [50–52, 54–59]



$$\frac{\partial \mathbf{p}}{\partial t} = \text{DIV} \mathbf{P} + \rho_0 \mathbf{b}; \quad (1a)$$

$$\frac{\partial \mathbf{F}}{\partial t} = \text{DIV} \left( \frac{\mathbf{p}}{\rho_0} \otimes \mathbf{I} \right); \quad (1b)$$

$$\frac{\partial \mathbf{H}}{\partial t} = \text{CURL} \left( \frac{\mathbf{p}}{\rho_0} \times \mathbf{F} \right); \quad (1c)$$

$$\frac{\partial J}{\partial t} = \text{DIV} \left( \mathbf{H}^T \frac{\mathbf{p}}{\rho_0} \right); \quad (1d)$$

$$\frac{\partial E}{\partial t} = \text{DIV} \left( \mathbf{P}^T \frac{\mathbf{p}}{\rho_0} \right). \quad (1e)$$

Here,  $\mathbf{p}$  is the linear momentum,  $\mathbf{F}$  is the deformation gradient (or fibre map),  $\mathbf{H}$  is the co-factor of the deformation (or area map),  $J$  is the Jacobian of the deformation (or volume map),  $E$  is the total energy,  $\mathbf{P}$  is the first Piola-Kirchhoff stress tensor,  $\mathbf{I}$  is the identity tensor and  $\mathbf{b}$  is the material body force per unit of mass. The operators DIV and CURL denote the material divergence and material curl, respectively, and  $\times$  denotes a tensor cross product between vectors and/or second order tensors as that presented in Ref. [68].

In this paper, we restrict ourselves only to the use of isothermal elasticity. Expression (1e) is thus redundant and is fully decoupled from the rest of the system equations (1a-1d). However, from a numerical viewpoint, the above energy equation (1e) is still extremely useful when monitoring the numerical dissipation (entropy) of the algorithm. Finally, the current geometry  $\mathbf{x}$  can be obtained through time integration of the velocity field as

$$\frac{\partial \mathbf{x}}{\partial t} = \frac{\mathbf{p}}{\rho_0}. \quad (2)$$

It is now possible to combine all the balance equations described in (1a-1e) into a hyperbolic system of first order conservation laws written under a Total Lagrangian formalism

$$\frac{\partial \mathbf{u}}{\partial t} + \frac{\partial \mathcal{F}_I}{\partial X_I} = \mathcal{S}; \quad \forall I = 1, 2, 3, \quad (3)$$

where the Einstein's summation convention is used such that the repeated indices  $I$  are to be summed from 1 to 3. Here,  $\mathbf{u}$  denotes the vector of conservation variables,  $\mathcal{F}_I$  is the flux vector in the  $I$ -th material direction and  $\mathcal{S}$  is a possible source term, described as follows

$$\mathbf{u} = \begin{bmatrix} \mathbf{p} \\ \mathbf{F} \\ \mathbf{H} \\ J \\ E \end{bmatrix}; \quad \mathcal{F}_I = - \begin{bmatrix} \mathbf{P} \mathbf{E}_I \\ \frac{1}{\rho_0} \mathbf{p} \otimes \mathbf{E}_I \\ \mathbf{F} \times \left( \frac{1}{\rho_0} \mathbf{p} \otimes \mathbf{E}_I \right) \\ \mathbf{H} : \left( \frac{1}{\rho_0} \mathbf{p} \otimes \mathbf{E}_I \right) \\ \mathbf{P} : \left( \frac{1}{\rho_0} \mathbf{p} \otimes \mathbf{E}_I \right) \end{bmatrix}, \quad \mathcal{S} = \begin{bmatrix} \rho_0 \mathbf{b} \\ \mathbf{0} \\ \mathbf{0} \\ 0 \\ 0 \end{bmatrix}. \quad (4)$$

The corresponding flux vector associated with the material unit outward normal  $\mathbf{N}$  can now be expressed as

$$\mathcal{F}_N = \mathcal{F}_I N_I = - \begin{bmatrix} \mathbf{P} \mathbf{N} \\ \frac{1}{\rho_0} \mathbf{p} \otimes \mathbf{N} \\ \mathbf{F} \times \left( \frac{1}{\rho_0} \mathbf{p} \otimes \mathbf{N} \right) \\ \mathbf{H} : \left( \frac{1}{\rho_0} \mathbf{p} \otimes \mathbf{N} \right) \\ \left( \frac{1}{\rho_0} \mathbf{P}^T \mathbf{p} \right) \cdot \mathbf{N} \end{bmatrix}. \quad (5)$$

1  
2  
3 Additionally, in the presence of non-smooth solutions, all of the above conservation laws described in  
4 (1a-1e) are accompanied by appropriate Rankine Hugoniot jump conditions across a discontinuous surface  
5 propagating with speed of  $c$  [1, 50–52, 57], defined as  
6

$$7 \quad c [[\mathbf{p}]] = -[[\mathbf{P}]]\mathbf{N}; \quad (6a)$$

$$8 \quad c [[\mathbf{F}]] = -\frac{1}{\rho_0} [[\mathbf{p}]] \otimes \mathbf{N}; \quad (6b)$$

$$9 \quad c [[\mathbf{H}]] = -\mathbf{F}^{\text{Ave}} \times \left( \frac{1}{\rho_0} [[\mathbf{p}]] \otimes \mathbf{N} \right); \quad (6c)$$

$$10 \quad c [[J]] = -\mathbf{H}^{\text{Ave}} : \left( \frac{1}{\rho_0} [[\mathbf{p}]] \otimes \mathbf{N} \right); \quad (6d)$$

$$11 \quad c [[E]] = - \left( \frac{1}{\rho_0} [[\mathbf{P}^T \mathbf{p}]] \right) \cdot \mathbf{N}. \quad (6e)$$

12 Here,  $[[\cdot]] := [\cdot]^+ - [\cdot]^-$  denotes the jump operator across a discontinuity surface with normal  $\mathbf{N}$  moving  
13 with speed  $c$  in the reference space and  $[\cdot]^{\text{Ave}} := \frac{1}{2} ([\cdot]^+ + [\cdot]^-)$  being defined as an average state between  
14 the left and right states of a discontinuity surface.

15 It is clear from equations (1b-1c) that two sets of involutions [60] must be satisfied by the geometric  
16 strain variables  $\{\mathbf{F}, \mathbf{H}\}$  of the system as  
17

$$18 \quad \text{CURL} \mathbf{F} = \mathbf{0}; \quad \text{DIV} \mathbf{H} = \mathbf{0}. \quad (7)$$

19 As a consequence, equations (1c) and (1d) can be further reduced to the non-conservative form of the  
20 differential equations presented as follows  
21

$$22 \quad \frac{\partial \mathbf{H}}{\partial t} = \mathbf{F} \times \text{GRAD} \left( \frac{\mathbf{p}}{\rho_0} \right); \quad \frac{\partial J}{\partial t} = \mathbf{H} : \text{GRAD} \left( \frac{\mathbf{p}}{\rho_0} \right), \quad (8)$$

23 where GRAD is the material gradient operator defined as  $\text{GRAD} := \frac{\partial}{\partial \mathbf{X}}$  [19].

24 For the particular case of a reversible process, the closure of the system described in (1a-1e) requires  
25 the introduction of a suitable constitutive law relating the stress tensor  $\mathbf{P}$  with the geometric strain  
26 measures  $\{\mathbf{F}, \mathbf{H}, J\}$ , obeying the principle of objectivity [19] and thermodynamic consistency (via the  
27 Coleman-Noll procedure) [69]. In this work, a polyconvex nearly incompressible constitutive model is  
28 employed and will be summarised in Section 2.1. It is interesting to remark how the complete set of first  
29 order conservation laws in (1a-1e) in conjunction with the polyconvex nature of the constitutive model (i.e.  
30 a guarantor of material stability [70]), can be used for the transformation of the system of conservation  
31 laws into a symmetric set of hyperbolic equations expressed in terms of the entropy conjugates of the  
32 conservation variables [56, 57]. Finally, for the complete definition of the initial boundary value problem,  
33 initial and boundary (essential and natural) conditions must also be specified as appropriate.  
34

### 35 2.1. Constitutive model: Polyconvex elasticity

36 Polyconvexity [70] is a well accepted mathematical requirement that is satisfied by admissible multi-  
37 variable strain energy functions used to describe large strain deformation of elastic materials. For a  
38 polyconvex (nearly incompressible) Mooney-Rivlin material, the multi-variable strain energy  $W$  can be  
39 decomposed into the summation of deviatoric  $\hat{W}(\mathbf{F}, \mathbf{H}, J)$  and volumetric  $U(J)$  contributions [56, 57, 70]  
40

$$41 \quad W = \hat{W} + U, \quad (9)$$

42 with

$$43 \quad \hat{W} = \zeta J^{-2/3} (\mathbf{F} : \mathbf{F}) + \xi J^{-2} (\mathbf{H} : \mathbf{H})^{3/2} - 3 \left( \zeta + \sqrt{3} \xi \right); \quad U = \frac{\kappa}{2} (J - 1)^2, \quad (10)$$

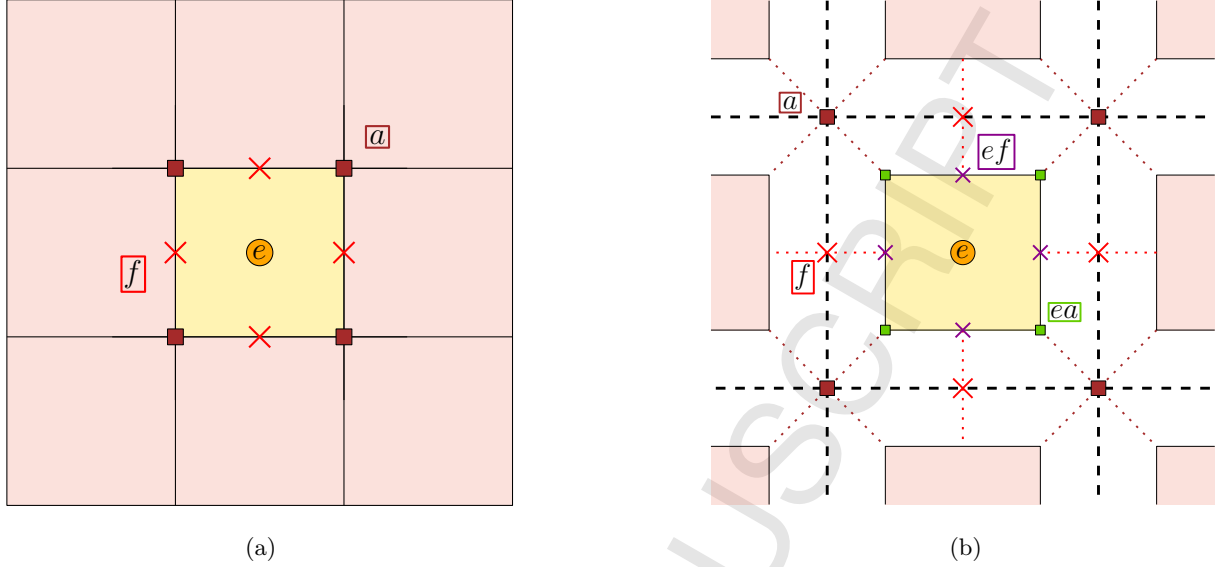

Figure 2: Nomenclature used for the finite volume spatial discretisation of (a) a quadrilateral mesh, and (b) an exploded view of (a).

where  $\zeta$ ,  $\xi$  and  $\kappa$  (bulk modulus) are positive material parameters. By comparison of the tangent elasticity operator at the initial undeformed configuration with that of classical linear elasticity [70], appropriate values for the material parameters  $\zeta$  and  $\xi$  can be defined in terms of the shear modulus  $\mu$ , that is,  $2\zeta + 3\sqrt{3}\xi = \mu$  [56, 58, 59].

Following Reference [56, 68] (see Section 3 on pg. 149), the first Piola-Kirchhoff stress tensor  $\mathbf{P}$  can be expressed as

$$\mathbf{P} = \boldsymbol{\Sigma}_{\mathbf{F}} + \boldsymbol{\Sigma}_{\mathbf{H}} \times \mathbf{F} + \Sigma_J \mathbf{H}, \quad (11)$$

where the conjugate stresses  $\{\boldsymbol{\Sigma}_{\mathbf{F}}, \boldsymbol{\Sigma}_{\mathbf{H}}, \Sigma_J\}$  with respect to  $\{\mathbf{F}, \mathbf{H}, J\}$  become

$$\boldsymbol{\Sigma}_{\mathbf{F}} := \frac{\partial \hat{W}}{\partial \mathbf{F}} = 2\zeta J^{-2/3} \mathbf{F}; \quad \boldsymbol{\Sigma}_{\mathbf{H}} := \frac{\partial \hat{W}}{\partial \mathbf{H}} = 3\xi J^{-2} (\mathbf{H} : \mathbf{H})^{1/2} \mathbf{H}, \quad (12)$$

and  $\Sigma_J := \hat{\Sigma}_J + p$  with

$$\hat{\Sigma}_J := \frac{\partial \hat{W}}{\partial J} = -\frac{2}{3}\zeta J^{-5/3} (\mathbf{F} : \mathbf{F}) - 2\xi J^{-3} (\mathbf{H} : \mathbf{H})^{3/2}; \quad p := \frac{\partial U}{\partial J} = \kappa(J - 1). \quad (13)$$

It is worth noticing that the strain energy described in (9) degenerates to the case of a nearly incompressible neo-Hookean model by imposing the values of  $\zeta = \frac{\mu}{2}$  and  $\xi = 0$  [56].

### 3. Finite volume spatial discretisation

#### 3.1. Preliminaries

In order to present the spatial discretisation procedure used in this work, some basic nomenclature will need to be introduced. For simplicity, let us consider a domain discretised with a quadrilateral mesh in two dimensions. In Fig. 2a,  $e$  represents the control volume of cell  $e$ ,  $f$  represents the surface  $f$  connecting cell  $e$  and its neighbour, and  $a$  represents the node  $a$  of the underlying quadrilateral mesh. For further clarification, an exploded view of Fig. 2a is illustrated in Fig. 2b. In this figure,  $ef$  represents the elemental surface  $f$  associated with cell  $e$  and  $ea$  represents the elemental node  $a$  corresponding to any given cell  $e$ .

### 3.2. Finite volume method

Using a standard finite volume discretisation procedure [62, 71], the hyperbolic system described in (3) is spatially integrated within a given control volume (cell)  $e$ , to give

$$\frac{d\mathbf{U}_e}{dt} = -\frac{1}{\Omega_0^e} \int_{\Omega_0^e} \frac{\partial \mathcal{F}_I}{\partial X_I} d\Omega_0 + \mathcal{S}_e. \quad (14)$$

Here,  $\Omega_0^e$  denotes the material volume corresponding to cell  $e$ ,  $\mathbf{U}_e$  and  $\mathcal{S}_e$  are, respectively, the average values of the conservation variables and the source term within the cell  $e$ .

Application of the classical Green-Gauss divergence theorem on the flux term of (14) results in

$$\frac{d\mathbf{U}_e}{dt} = -\frac{1}{\Omega_0^e} \int_{\partial\Omega_0^e} \mathcal{F}_N dA + \mathcal{S}_e, \quad (15)$$

with  $\mathcal{F}_N$  as defined in (5). For evaluation of the surface flux integral in (15), we will restrict to integrands which require only one Gauss quadrature point (placed at the centroid of a surface) for exact integration, seeking computational efficiency of the overall scheme. With this in mind, above surface integral (15) can now be approximated by means of a Godunov-type spatial discretisation [50] as

$$\frac{d\mathbf{U}_e}{dt} \approx -\frac{1}{\Omega_0^e} \sum_{f \in \Lambda_e^f} \mathcal{F}_{N_{ef}}^C(\mathbf{u}_{ef}^-, \mathbf{u}_{ef}^+) \|\mathbf{C}_{ef}\| + \mathcal{S}_e, \quad (16)$$

where  $\Lambda_e^f$  represents the set of faces  $f$  associated with cell  $e$ ,  $\mathbf{N}_{ef} := \mathbf{C}_{ef} / \|\mathbf{C}_{ef}\|$  and  $\|\mathbf{C}_{ef}\|$  represent the material outward unit normal vector and the surface area associated with face  $f$  of cell  $e$ , respectively, and  $\mathcal{F}_{N_{ef}}^C$  represents the Godunov-type numerical flux evaluated at the centroid of the surface  $f$  belonging to cell  $e$ . Upper index  $C$  will be used in the remainder of this paper to emphasise the notion of interface or ‘contact’ flux. The accuracy of  $\mathcal{F}_{N_{ef}}^C$  depends on the values of the left and right states of the variable  $\mathbf{U}$  at face  $f$ , namely  $\mathbf{u}_{ef}^-$  and  $\mathbf{u}_{ef}^+$ .

For completeness, equation (16) can now be particularised for each individual component of  $\mathbf{U}$ , yielding

$$\frac{d\mathbf{p}_e}{dt} = \frac{1}{\Omega_0^e} \sum_{f \in \Lambda_e^f} \mathbf{t}_f^C \|\mathbf{C}_{ef}\| + \rho_0 \mathbf{b}_e; \quad (17a)$$

$$\frac{d\mathbf{F}_e}{dt} = \frac{1}{\Omega_0^e} \sum_{f \in \Lambda_e^f} \frac{\mathbf{p}_f^C}{\rho_0} \otimes \mathbf{C}_{ef}; \quad (17b)$$

$$\frac{d\mathbf{H}_e}{dt} = \mathbf{F}_e \times \frac{1}{\Omega_0^e} \sum_{f \in \Lambda_e^f} \frac{\mathbf{p}_f^C}{\rho_0} \otimes \mathbf{C}_{ef}; \quad (17c)$$

$$\frac{dJ_e}{dt} = \mathbf{H}_e : \frac{1}{\Omega_0^e} \sum_{f \in \Lambda_e^f} \frac{\mathbf{p}_f^C}{\rho_0} \otimes \mathbf{C}_{ef}; \quad (17d)$$

$$\frac{dE_e}{dt} = \frac{1}{\Omega_0^e} \sum_{f \in \Lambda_e^f} \left( \frac{\mathbf{p}_f^C}{\rho_0} \cdot \mathbf{t}_f^C \right) \|\mathbf{C}_{ef}\|, \quad (17e)$$

where  $\{\mathbf{t}_f^C, \mathbf{p}_f^C\}$  are the Godunov-type numerical approximation [1] for traction and linear momentum. The new supplemented geometric strain updates for  $\mathbf{H}$  (17c) and  $J$  (17d) are obtained through the use of the non-conservative form of the differential equations presented in (8). As a result, the updates of (17c) and (17d) now exclusively depend on the evaluation of  $\mathbf{p}_f^C$ , exactly in the same way as those presented in (17b) for the fibre map evolution.

1  
2  
3 Finally, the current deformed geometry can be recovered by integrating in time the discrete (cell-based)  
4 velocity field

$$5 \quad \frac{d\mathbf{x}_e}{dt} = \frac{\mathbf{p}_e}{\rho_0}. \quad (18)$$

6  
7  
8 In order to guarantee the existence of a single-valued deformation mapping  $\phi$ , the time evolution  
9 of  $\{\mathbf{F}_e, \mathbf{H}_e\}$  in (17b-17c) must ensure the discrete satisfaction of a set of compatibility conditions (also  
10 known as involutions [60, 72]) in time

$$11 \quad \text{CURL}\dot{\mathbf{F}}_e = \mathbf{0}; \quad \text{DIV}\dot{\mathbf{H}}_e = \mathbf{0}, \quad (19)$$

12  
13 where overdot represents differentiation with respect to time. Above conditions need only be satisfied by  
14 the time evolution operator provided that they are met by the initial conditions [60]. This implies that  
15 expression (19), as opposed to a classical constraint, is not necessary to close the system of conservation  
16 laws, but must be an inherent property of the evolution operator. This will be presented in Section 6.  
17  
18  
19  
20  
21

22 *Remark 1:* As presented in Ref. [1], the spatial discretisation of Eq. (16) can be alternatively expressed  
23 in terms of so-called nodal fluxes  $\mathcal{F}_{N_{ea}}^C$  (see Fig. 3b) [2, 40, 44]

$$24 \quad \frac{d\mathbf{u}_e}{dt} = -\frac{1}{\Omega_0^e} \sum_{a \in \Lambda_e^a} \mathcal{F}_{N_{ea}}^C(\mathbf{u}_{ea}^-, \mathbf{u}_{ea}^+) \|\mathbf{C}_{ea}\| + \mathbf{s}_e, \quad (20)$$

25  
26  
27  
28  
29 where the material nodal area normal vector  $\mathbf{C}_{ea}$  is defined as  $\mathbf{C}_{ea} := \sum_{f \in \Lambda_a^f} \left(\frac{1}{A_f^a} \mathbf{C}_{ef}\right)$  [2, 40–42, 44, 67].  
30 Here,  $\Lambda_e^a$  and  $\Lambda_f^a$  represent the number of nodes  $a$  associated with cell  $e$  and face  $f$ , respectively,  $\Lambda_a^f$   
31 represents the set of faces  $f$  corresponding to node  $a$  and  $\mathbf{N}_{ea} := \mathbf{C}_{ea}/\|\mathbf{C}_{ea}\|$  represents the material  
32 outward nodal unit normal vector. For completeness, the system of semi-discrete nodal updates for the  
33 enhanced  $\{\mathbf{p}, \mathbf{F}, \mathbf{H}, J\}$  formulation presented in this paper, named eXtended GLACE (X-GLACE), reads  
34  
35  
36  
37

$$38 \quad \frac{d\mathbf{p}_e}{dt} = \frac{1}{\Omega_0^e} \sum_{a \in \Lambda_e^a} \mathbf{t}_{ea}^C \|\mathbf{C}_{ea}\| + \rho_0 \mathbf{b}_e; \quad (21a)$$

$$39 \quad \frac{d\mathbf{F}_e}{dt} = \frac{1}{\Omega_0^e} \sum_{a \in \Lambda_e^a} \frac{\mathbf{p}_a^C}{\rho_0} \otimes \mathbf{C}_{ea}; \quad (21b)$$

$$40 \quad \frac{d\mathbf{H}_e}{dt} = \mathbf{F}_e \times \frac{1}{\Omega_0^e} \sum_{a \in \Lambda_e^a} \frac{\mathbf{p}_a^C}{\rho_0} \otimes \mathbf{C}_{ea}; \quad (21c)$$

$$41 \quad \frac{dJ_e}{dt} = \mathbf{H}_e : \frac{1}{\Omega_0^e} \sum_{a \in \Lambda_e^a} \frac{\mathbf{p}_a^C}{\rho_0} \otimes \mathbf{C}_{ea}; \quad (21d)$$

$$42 \quad \frac{dE_e}{dt} = \frac{1}{\Omega_0^e} \sum_{a \in \Lambda_e^a} \left( \frac{\mathbf{p}_a^C}{\rho_0} \cdot \mathbf{t}_{ea}^C \right) \|\mathbf{C}_{ea}\|. \quad (21e)$$

43  
44  
45  
46  
47  
48  
49  
50  
51  
52  
53  
54  
55 Finally, the current deformed geometry  $\mathbf{x}$  can be simply recovered through time integration of the discrete  
56 (node based) velocity as

$$57 \quad \frac{d\mathbf{x}_a}{dt} = \frac{\mathbf{p}_a^C}{\rho_0}. \quad (22)$$

58  
59  
60 Given the fact that the discrete velocity field expressed in terms of its nodal values is continuous across the  
61 entire computational domain, the material curl of (21b) is thus naturally curl-free, and so is the material  
62  
63  
64  
65

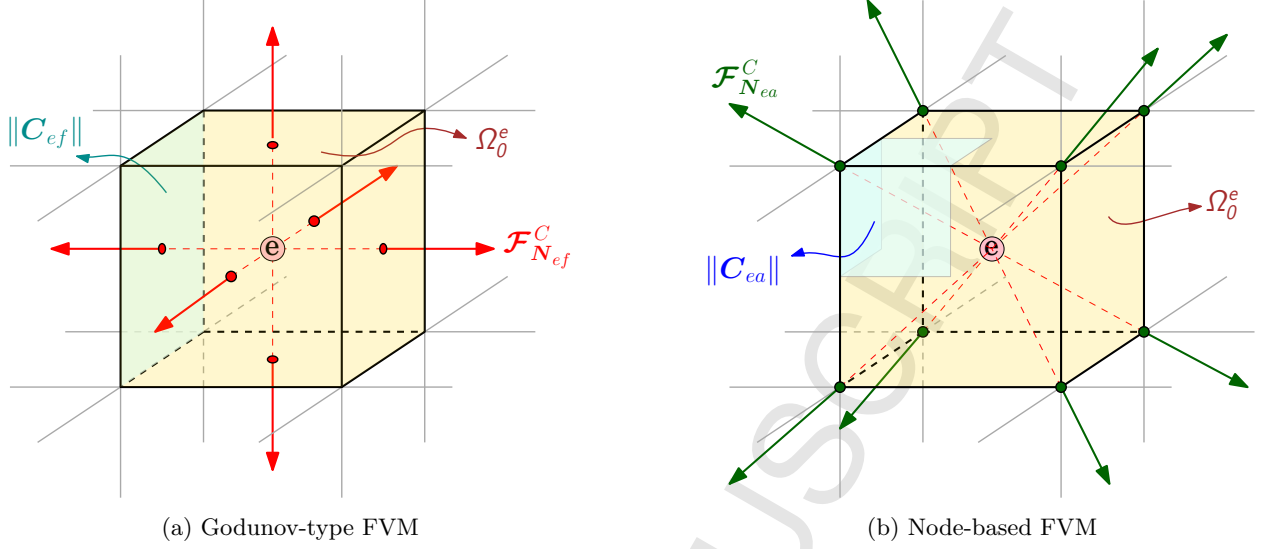

Figure 3: Two families of cell centred Finite Volume Methods: (a) Godunov-type FVM; and (b) node-based FVM.

divergence of (21c), as their updates are formulated in terms of a discrete gradient of a continuous field [72].

For evaluation of the interface values  $\mathbf{u}_{ef}^{+,-}$  described in (16) (or  $\mathbf{u}_{ea}^{+,-}$  in (20)), it is well known that a piecewise constant approximation of the Godunov-type scheme leads to excessive numerical dissipation [73, 74]. The physics of the problem can no longer be captured accurately unless excessively fine meshes are used, which is clearly undesirable. To overcome this drawback, and to guarantee second order accuracy in space, a linear reconstruction procedure in conjunction with an appropriate slope limiter is used. A detailed discussion of this monotone reconstruction procedure can be found in Ref. [1].

The remaining unknowns to be discussed in equations (17a-18) (or (21a-22)) are the Godunov-type numerical flux evaluation for  $\{\mathbf{t}_f^C, \mathbf{p}_f^C\}$  (or node based numerical flux approximation for  $\{\mathbf{t}_{ea}^C, \mathbf{p}_a^C\}$ ). This can be approximated via an acoustic Riemann solver and will be discussed in the following section.

## 4. Riemann solver

### 4.1. General remark

The finite volume spatial discretisation procedure presented in this paper requires an approximate Riemann solver [62] for the evaluation of  $\{\mathbf{t}_f^C, \mathbf{p}_f^C\}$  in (17a-18) (or  $\{\mathbf{t}_{ea}^C, \mathbf{p}_a^C\}$  in (21a-22)). To achieve this, recall first that the numerical interface (contact) flux across a discontinuous surface with normal  $\mathbf{N}_{ef}$ , namely  $\mathcal{F}_{\mathbf{N}_{ef}}^C$ , is generally described as [71, 73]

$$\mathcal{F}_{\mathbf{N}_{ef}}^C = \underbrace{\frac{1}{2} \left[ \mathcal{F}_{\mathbf{N}_{ef}}(\mathbf{u}_f^-) + \mathcal{F}_{\mathbf{N}_{ef}}(\mathbf{u}_f^+) \right]}_{\text{Unstable flux}} - \underbrace{\frac{1}{2} \int_{\mathbf{u}_f^-}^{\mathbf{u}_f^+} |\mathcal{A}_{\mathbf{N}_{ef}}| d\mathbf{u}}_{\text{Upwinding stabilisation}}, \quad (23)$$

where the absolute value component of the flux Jacobian matrix being defined as  $|\mathcal{A}_{\mathbf{N}_{ef}}| := \left| \frac{\partial \mathcal{F}_{\mathbf{N}_{ef}}}{\partial \mathbf{u}} \right| = \frac{1}{2} \sum_{\alpha=1}^6 |c_\alpha| \mathcal{R}_\alpha \mathcal{L}_\alpha^T$  (refer to Appendix A).

In this work, evaluation of  $|\mathcal{A}_{\mathbf{N}_{ef}}|$  is carried out at the initial undeformed configuration (i.e. origin) by adopting  $\mathbf{F} = \mathbf{H} = \mathbf{I}$  and  $J = 1$ . For this reason, the above numerical interface flux (23) can be



reduced to

$$\mathcal{F}_{N_{ef}}^C = \underbrace{\frac{1}{2} [\mathcal{F}_{N_{ef}}(\mathbf{u}_f^-) + \mathcal{F}_{N_{ef}}(\mathbf{u}_f^+)]}_{\text{Unstable flux}} - \underbrace{\frac{1}{2} |\mathcal{A}_{N_{ef}}| (\mathbf{u}_f^+ - \mathbf{u}_f^-)}_{\text{Upwinding stabilisation}}. \quad (24)$$

The first term on the right hand side of (24) denotes the unstable flux, whereas the second term (i.e. upwinding stabilisation) can be interpreted as a numerical stabilisation that counterbalances non-physical instabilities arising from the first term. A detailed derivation of the upwinding stabilisation term in (24) can be found in Reference [1] (see pg. 417 to pg. 420 in Section 4.3).

Following the exact same procedure presented in Reference [1], and after some algebraic manipulations, the Godunov-type numerical traction and linear momentum can be summarised here for completeness

$$\mathbf{t}_f^C = \mathbf{t}_f^{\text{Ave}} + \mathbf{t}_f^{\text{Stab}}; \quad \mathbf{p}_f^C = \mathbf{p}_f^{\text{Ave}} + \mathbf{p}_f^{\text{Stab}}. \quad (25)$$

The average (unstable) states of both the traction and linear momentum are

$$\mathbf{t}_f^{\text{Ave}} := \frac{1}{2} (\mathbf{t}_f^- + \mathbf{t}_f^+); \quad \mathbf{p}_f^{\text{Ave}} := \frac{1}{2} (\mathbf{p}_f^- + \mathbf{p}_f^+), \quad (26)$$

and the corresponding upwinding stabilisation terms are

$$\mathbf{t}_f^{\text{Stab}} := \frac{1}{2} \mathbf{S}_{ef}^p (\mathbf{p}_f^+ - \mathbf{p}_f^-); \quad \mathbf{p}_f^{\text{Stab}} := \frac{1}{2} \mathbf{S}_{ef}^t (\mathbf{t}_f^+ - \mathbf{t}_f^-), \quad (27)$$

with the (acoustic) stabilisation matrices being defined as

$$\mathbf{S}_{ef}^t := \left[ \frac{1}{c_p} (\mathbf{n}_{ef} \otimes \mathbf{n}_{ef}) + \frac{1}{c_s} (\mathbf{I} - \mathbf{n}_{ef} \otimes \mathbf{n}_{ef}) \right]; \quad \mathbf{S}_{ef}^p := [c_p (\mathbf{n}_{ef} \otimes \mathbf{n}_{ef}) + c_s (\mathbf{I} - \mathbf{n}_{ef} \otimes \mathbf{n}_{ef})]. \quad (28)$$

In this case,  $c_p$  and  $c_s$  represent the elastic pressure wave speed and the elastic shear wave speed

$$c_p := \sqrt{\frac{\lambda + 2\mu}{\rho_0}}; \quad c_s := \sqrt{\frac{\mu}{\rho_0}}, \quad (29)$$

respectively.

*Remark 2:* In the case of the nodal scheme [39–42, 44, 67], the nodal linear momentum  $\mathbf{p}_a$  can first be obtained by solving the following system of equations (see Section 6.2.2 on pg. 423–426 in Ref. [1])

$$\mathbf{A}_a \mathbf{p}_a^C = \mathbf{b}_a, \quad (30)$$

where

$$\mathbf{A}_a = \sum_{e \in \Lambda_a^e} \|C_{ea}\| \mathbf{S}_{ea}^p; \quad \mathbf{b}_a = \sum_{e \in \Lambda_a^e} \|C_{ea}\| \mathbf{S}_{ea}^p \mathbf{p}_{ea} - \sum_{e \in \Lambda_a^e} \mathbf{P}_{ea} C_{ea}. \quad (31)$$

The elemental nodal traction  $\mathbf{t}_{ea}^C$  then follows as

$$\mathbf{t}_{ea}^C := \mathbf{P}_{ea}^C \mathbf{N}_{ea} = \mathbf{P}_{ea} \mathbf{N}_{ea} + \mathbf{S}_{ea}^p (\mathbf{p}_a^C - \mathbf{p}_{ea}). \quad (32)$$

Notice that the above stabilisation matrix  $\mathbf{S}_{ea}^p$  is identical to  $\mathbf{S}_{ef}^p$  presented in (28), but replacing the subscript of  $ef$  with  $ea$  since  $\mathbf{n}_{ef} \neq \mathbf{n}_{ea}$ .

#### 4.2. Preconditioned dissipation

As will be shown in the numerical examples of this paper, the acoustic Riemann solver previously presented is inefficient in the region of near incompressibility when the value of  $\frac{\tilde{\kappa}}{\mu}$  tends to infinity. One possibility to rectify this numerical shortcoming is the introduction of a preconditioning for the numerical dissipation [63–65], which aims to recover a correct scaling for the stabilisation matrices  $\{\mathbf{S}_{ef}^t, \mathbf{S}_{ef}^p\}$  in (28). To achieve this, the upwinding stabilisation term of the flux approximation  $\mathcal{F}_{N_{ef}}^C$  described in (24) can be modified by preconditioning [63–65], resulting in

$$\mathcal{F}_{N_{ef}}^C = \frac{1}{2} \left[ \mathcal{F}_{N_{ef}}(\mathbf{u}_f^-) + \mathcal{F}_{N_{ef}}(\mathbf{u}_f^+) \right] - \frac{1}{2} \mathcal{P}^{-1} |\mathcal{P} \mathbf{A}_{N_{ef}}| \left( \mathbf{u}_f^+ - \mathbf{u}_f^- \right), \quad (33)$$

where  $\mathcal{P}$  is a preconditioning matrix. With respect to the original flux computation (24), only the upwinding stabilisation terms (also known as high order corrections) are altered and thus, the finite volume spatial discretisation procedure presented in Section 3 still remains a consistent approximation for the enhanced  $\{\mathbf{p}, \mathbf{F}, \mathbf{H}, \mathbf{J}\}$  system.

In this paper, a very simple (diagonal) preconditioner is postulated

$$\mathcal{P} = \begin{bmatrix} \mathbf{I} & \mathbf{0} & \mathbf{0} & \mathbf{0} \\ \mathbf{0} & \beta^2 \mathbf{I} & \mathbf{0} & \mathbf{0} \\ \mathbf{0} & \mathbf{0} & \beta^2 \mathbf{I} & \mathbf{0} \\ \mathbf{0} & \mathbf{0} & \mathbf{0} & \frac{1}{\beta^2} \end{bmatrix}, \quad (34)$$

where the dimensionless parameter  $\beta$  is defined as  $\beta := \frac{\tilde{\kappa}}{\kappa}$  and  $\tilde{\kappa}$  is a user-defined material constant, usually taken in the neighbourhood of the bulk modulus  $\kappa$  of the material. The aim of this diagonal preconditioner (34) is to re-scale the stabilisation coefficients of the system (i.e.  $c_p$  and  $c_s$  wave speeds) by means of the dimensionless ratio  $\frac{\tilde{\kappa}}{\kappa}$ , without altering the characteristic structure (i.e. streamline direction) of the upwinding method.

---

*Remark 3:* This simple preconditioner approach leads to a numerical scheme which can remind of the artificial compressibility (AC) method [75, 76]. However, it is important to realise that contrary to the AC method, the preconditioner only acts on the upwinding stabilisation flux and not on the averaging flux. Hence, the size of the time step will still be dictated by the real volumetric wave speed. In the AC approach, originally designed to deal with incompressible flows, the averaging flux is also modified as a new (artificial) nearly incompressible constitutive law is put forward.

---

Referring to Appendix A, three pairs of non-zero eigenvalues corresponding to the volumetric and shear waves are modified accordingly as

$$c_{1,2} = \pm \tilde{c}_p, \quad \tilde{c}_p = \frac{1}{\beta} \sqrt{\frac{\lambda + \mu(\beta^4 + 1)}{\rho_0}}; \quad c_{3,4} = c_{5,6} = \pm \tilde{c}_s, \quad \tilde{c}_s = \beta \sqrt{\frac{\mu}{\rho_0}}. \quad (35)$$

In the case of near incompressibility, the stabilisation matrices (28) must be re-scaled by replacing  $\{c_p, c_s\}$  with  $\{\tilde{c}_p, \tilde{c}_s\}$  presented in (35). Notice that the original elastic pressure wave speed  $c_p$  (29a) and shear wave speed  $c_s$  (29b) can be simply recovered by equating the value of  $\tilde{\kappa}$  with the bulk modulus  $\kappa$  of the material.

## 5. Time integration

In order to update in time the resulting set of semi-discrete equations described in (17a-18) (or (21a-22)), an explicit one-step two-stage Total Variation Diminishing Runge-Kutta (TVD-RK) time integrator

has been used [1, 50–52, 77]. This is described by the following time update equations from time step  $t^n$  to  $t^{n+1}$

$$\mathbf{u}_e^* = \mathbf{u}_e^n + \Delta t \dot{\mathbf{u}}_e^n(\mathbf{u}_e^n, t^n); \quad (36a)$$

$$\mathbf{u}_e^{**} = \mathbf{u}_e^* + \Delta t \dot{\mathbf{u}}_e^*(\mathbf{u}_e^*, t^{n+1}); \quad (36b)$$

$$\mathbf{u}_e^{n+1} = \frac{1}{2}(\mathbf{u}_e^n + \mathbf{u}_e^{**}). \quad (36c)$$

The maximum time step  $\Delta t := t^{n+1} - t^n$  is governed by a standard Courant-Friedrichs-Lewy (CFL) condition [78] to be computed as

$$\Delta t = \alpha_{\text{CFL}} \frac{h_{\min}}{c_{p,\max}}, \quad (37)$$

where  $c_{p,\max}$  is the maximum  $p$ -wave speed,  $h_{\min}$  is the minimum (or characteristic) length within the computational domain and  $\alpha_{\text{CFL}}$  is the CFL stability number. For the numerical computations presented in this manuscript, a value of  $\alpha_{\text{CFL}} = 0.3$  has been chosen to ensure both accuracy and stability of the algorithm [50].

In this paper, the first Piola–Kirchhoff stress tensor is expressed as a function of a set of (weakly related) geometric strain measures, that is  $\mathbf{P} = \mathbf{P}(\mathbf{F}, \mathbf{H}, J)$ . Thus, the resulting system does not intrinsically fulfil conservation of angular momentum. In order to rectify this, a global a posteriori projection procedure as that presented in [1] (see Section 7 on pg. 429–432) is introduced and, moreover, has also been adapted to the node based Total Lagrangian X-GLACE scheme.

## 6. Involutions

One of the challenging issues in the process of the time-evolving expressions (17b–17c) is the ability to control the onset and propagation of spurious mechanisms over a long term response. Following recent work by the authors [1], two different strategies are used in this work where the geometric strain updates for  $\{\mathbf{F}, \mathbf{H}\}$  described in (17b–17c) are solved subjected to the fulfilment of specific involutions (7) [1, 50, 61].

The first algorithm, named Constrained-TOUCH (C-TOUCH), is based on the use of a constrained transport algorithm [1], where the spatial discretisation is tailor-made to discretely satisfy the involutions by construction. In this approach, the evolution of  $\mathbf{F}$  and  $\mathbf{H}$  is re-formulated in terms of a material discrete gradient of a continuous velocity field. This can be achieved by replacing the Godunov-type numerical linear momentum  $\mathbf{p}_f^C$  described in (17b–17d) with a projected linear momentum  $\tilde{\mathbf{p}}_f^C$ , ensuring that this specific update exactly coincides with the classical finite element discretisation when considering linear interpolation with only one Gauss quadrature point at the centroid of the element [1, 50]. The whole process for the computation of  $\tilde{\mathbf{p}}_f^C$  is illustrated in Algorithm 2 of Reference [1] (see pg. 423 in Section 6.2.1).

The second algorithm, named Penalised-TOUCH (P-TOUCH), relies on the explicit addition of a residual based artificial dissipation to the evolution equations of  $\{\mathbf{F}, \mathbf{H}\}$ . The main aim of this approach is to control the accumulation of non-physical involution errors, whilst still preserving the standard finite volume update for the fibre map (17b) and area map (17c) equations, without the need to resort to projecting interface values of the linear momentum. In this case, a geometrical penalisation of the time-integrated fibre map equation is added to (17b), which gives

$$\mathbf{F}_e^{n+1} = \mathbf{F}_e^n + \frac{\Delta t}{\Omega_0^e} \sum_{f \in \mathcal{A}_e^f} \left( \frac{\mathbf{p}_f^{C,n}}{\rho_0} \right) \otimes \mathbf{C}_{ef} + \xi_{\mathbf{F}} \underbrace{[\nabla_0 \mathbf{x}_e^n - \mathbf{F}_e^n]}_{\text{Penalisation}}. \quad (38)$$

Similarly, another geometrical penalisation of the time-integrated area map equation can also be incorporated in (17c)

$$\mathbf{H}_e^{n+1} = \mathbf{H}_e^n + \frac{\Delta t}{\Omega_0^e} \left[ \mathbf{F}_e^n \times \sum_{f \in \mathcal{A}_e^f} \left( \frac{\mathbf{p}_f^{C,n}}{\rho_0} \right) \otimes \mathbf{C}_{ef} \right] + \xi_H \underbrace{\left[ \frac{1}{2} (\nabla_0 \mathbf{x}_e^n \times \nabla_0 \mathbf{x}_e^n) - \mathbf{H}_e^n \right]}_{\text{Penalisation}}, \quad (39)$$

where  $\nabla_0 \mathbf{x}_e^n := \frac{1}{\Omega_0^e} \sum_{f \in \mathcal{A}_e^f} \mathbf{x}_f^n \otimes \mathbf{C}_{ef}$  and the non-dimensional parameters  $\{\xi_F, \xi_H\}$  are usually defined in the range of  $[0, 0.5]$  [53–57, 59]. By setting the values of  $\xi_F = \xi_H = 0$ , the standard finite volume update presented in (17b) and (17c) can be recovered.

## 7. Algorithmic description

For ease of understanding, Algorithm 1 summarises the complete algorithmic description of the following three methodologies, namely: (a)  $\{\mathbf{p}, \mathbf{F}, \mathbf{H}, J\}$  C-TOUCH, (b)  $\{\mathbf{p}, \mathbf{F}, \mathbf{H}, J\}$  P-TOUCH and (c)  $\{\mathbf{p}, \mathbf{F}, \mathbf{H}, J\}$  X-GLACE.

## 8. Numerical examples

In this section, a series of challenging numerical examples is presented in order to assess the accuracy, robustness and efficiency of the proposed  $\{\mathbf{p}, \mathbf{F}, \mathbf{H}, J\}$  mixed-based methodologies, namely: (a) C-TOUCH, (b) P-TOUCH and (c) X-GLACE. In this paper, we exclusively focus on the simulation of isothermal processes that enable the total energy  $E$  of the system to be decoupled from the rest of the system equations. This energy balance principle (1e) however can still be employed to measure the numerical dissipation of the proposed methodologies.

In the following numerical computations, a piecewise linear reconstruction procedure (see Section 4.2.1 on pg. 416-417 of [1]), Barth Jespersen slope limiter (see Section 4.2.2 on pg. 417 of [1]) and the global a posteriori angular momentum projection algorithm (see Section 7 on pg. 429-432 of [1]) are activated unless otherwise stated.

### 8.1. Convergence

The main objective of this example is to assess the convergence behaviour of the following three  $\{\mathbf{p}, \mathbf{F}, \mathbf{H}, J\}$  methodologies, namely C-TOUCH, P-TOUCH and X-GLACE. A unit cube is considered (see Fig. 4a) with symmetric boundary conditions (restricted normal displacement) at faces  $X = 0$ ,  $Y = 0$  and  $Z = 0$  and skew-symmetric boundary conditions (restricted tangential displacement) at faces  $X = 1$  m,  $Y = 1$  m and  $Z = 1$  m. For small deformations, the problem has a closed-form displacement field of the form [1, 47, 50–52, 54, 56–59, 79]

$$\mathbf{u}(\mathbf{X}, t) = U_0 \cos\left(\frac{\sqrt{3}}{2} c_d \pi t\right) \begin{bmatrix} A \sin\left(\frac{\pi X_1}{2}\right) \cos\left(\frac{\pi X_2}{2}\right) \cos\left(\frac{\pi X_3}{2}\right) \\ B \cos\left(\frac{\pi X_1}{2}\right) \sin\left(\frac{\pi X_2}{2}\right) \cos\left(\frac{\pi X_3}{2}\right) \\ C \cos\left(\frac{\pi X_1}{2}\right) \cos\left(\frac{\pi X_2}{2}\right) \sin\left(\frac{\pi X_3}{2}\right) \end{bmatrix}; \quad c_d = \sqrt{\frac{\lambda + 2\mu}{\rho_0}}. \quad (40)$$

Parameters  $\{A, B, C\}$  are user-defined arbitrary constants, chosen such that  $A=B=C$  which ensures the existence of a non-zero pressure field. For values of  $U_0 < 0.001$  m, the solution can be considered to be linear and the closed-form expression (40) holds. The problem is initialised with the displacement field  $\mathbf{u}^0 \equiv \mathbf{u}(\mathbf{X}, 0)$  according to Eq. (40) (see Fig. 4b) and subsequently, the initial deformation gradient, its co-factor and its Jacobian can be obtained as  $\mathbf{F}^0 = \mathbf{I} + \nabla_0 \mathbf{u}^0$ ,  $\mathbf{H}^0 = \frac{1}{2} \mathbf{F}^0 \times \mathbf{F}^0$  and  $J^0 = \frac{1}{6} (\mathbf{F}^0 \times \mathbf{F}^0) : \mathbf{F}^0$ . A linear elastic material is chosen with a Poisson's ratio of  $\nu = (1 - \mu/\kappa)/2 = 0.3$ , Young's modulus  $E = 17$  MPa and density  $\rho_0 = 1100$  kg/m<sup>3</sup>. The solution parameters are set as  $A=B=C=1$  and  $U_0 = 5 \times 10^{-4}$  m.

**Algorithm 1:** Time update of conservation variables

**Input** :  $\mathbf{u}_e^n$  where  $\mathbf{u} = [p \ F \ H \ J \ E]^T$

**Output:**  $\mathbf{u}_e^{n+1}, \mathbf{P}_e^{n+1}$

(1) Calculate time increment:  $\Delta t^n \leftarrow$  Eq. (37)

(2) Store conservation variables:  $\mathbf{u}_e^{\text{old}} = \mathbf{u}_e^n$

**for** Runge Kutta stage = 1 **to** 2 **do**

(3) Evaluate wave speeds:  $\tilde{c}_p, \tilde{c}_s \leftarrow$  Eq. (35)

(4) Apply linear reconstruction procedure: Sections 4.2.1 & 4.2.2 in Ref. [1]

(5) Apply acoustic Riemann solver:

**if** (algorithm = TOUCH) **then**

• Calculate face fluxes:  $\mathbf{p}_f^C, \mathbf{t}_f^C \leftarrow$  Eq. (25)

• Compute projected contact linear momentum:  $\tilde{\mathbf{p}}_f^C \leftarrow$  Section 6.2.1 in Ref. [1]

• Compute nodal linear momentum:  $\mathbf{p}_a \leftarrow$  Section 6.2.1 in Ref. [1]

**else if** (algorithm = X-GLACE) **then**

• Calculate nodal fluxes:  $\mathbf{p}_a^C, \mathbf{t}_{ea}^C \leftarrow$  Eqs. (30) and (32)

**end**

(6) Enforce strong boundary conditions on nodal linear momentum  $\mathbf{p}_a$  or  $\mathbf{p}_a^C$

(7) Apply angular momentum projection algorithm: Section 7 on pg. 429 in Ref. [1]

(8) Solve governing equations:

**if** (algorithm = C-TOUCH) **then**

•  $\mathbf{u}_e = \mathbf{u}_e + \Delta t^n \dot{\mathbf{u}}_e (\tilde{\mathbf{p}}_f^C, \mathbf{t}_f^C)$

**else if** (algorithm = P-TOUCH) **then**

•  $\mathbf{u}_e = \mathbf{u}_e + \Delta t^n \dot{\mathbf{u}}_e (\mathbf{p}_f^C, \mathbf{t}_f^C) \leftarrow$  Eqs. (17a)–(17e) and (18)

•  $\mathbf{F}_e = \mathbf{F}_e (1 - \xi_F) + \xi_F (\nabla_0 \mathbf{x})_e$

•  $\mathbf{H}_e = \mathbf{H}_e (1 - \xi_H) + \frac{1}{2} \xi_H (\nabla_0 \mathbf{x} \times \nabla_0 \mathbf{x})_e$

**else if** (algorithm = X-GLACE) **then**

•  $\mathbf{u}_e = \mathbf{u}_e + \Delta t^n \dot{\mathbf{u}}_e (\mathbf{p}_a^C, \mathbf{t}_{ea}^C) \leftarrow$  Eqs. (30)–(32)

**end**

**end**

(9) Update conservation variables:  $\mathbf{u}_e^{n+1} = \frac{1}{2}(\mathbf{u}_e + \mathbf{u}_e^{\text{old}})$

(10) Compute PK1 stresses:  $\mathbf{P}_e^{n+1} \leftarrow$  Eq. (11)

Fig. 5 shows the expected second order convergence pattern (e.g.  $L^1$  and  $L^2$  norm errors) of the velocity  $\mathbf{v}$  and the first Piola-Kirchhoff stress tensor  $\mathbf{P}$ , as compared to the closed-form solution described in Eq. (40)<sup>3</sup>. It can be clearly seen that the C-TOUCH and P-TOUCH schemes produce practically identical convergence patterns for both velocities and stresses. Their solutions are slightly more accurate than the results obtained from the X-GLACE scheme, as can be observed by noticing the higher translation error in the convergence patterns.

### 8.2. Momentum conservation

Following Reference [80], the motion of a satellite-like structure is studied in order to demonstrate the momentum conservation characteristics of the proposed algorithm. The structure consists of a central cylindrical section of diameter  $D = 1.5$  m and height  $H = 3$  m, along with four attached arms of cross-section  $1 \times 1$  m<sup>2</sup> that extend 6.5 m from the center of the structure (see Fig. 6a). The problem is simulated with an initial angular velocity field  $\boldsymbol{\omega}_0 = [0, 0, 1]^T$  rad/s resulting in an initial velocity distribution shown in Fig. 6b. A neo-Hookean constitutive model is chosen to model the structure with material parameters defined by density  $\rho_0 = 1000$  kg/m<sup>3</sup>, Young's modulus  $E = 50.05$  kPa and Poisson's ratio  $\nu = 0.3$ .

The time evolution of the deformation along with the expected smooth pressure representation is shown in Fig. 7. It can be observed that the arms of the structure undergo large deformation without experiencing spurious hourglassing-like modes. The cylindrical part of the structure is however dominated by a rotational motion. Additionally, a mesh refinement study with respect to both the deformation pattern and pressure resolution is presented in Fig. 8. Sequentially refined meshes of 4032, 16960 and 51336 hexahedral elements are used with the purpose to compare resolution of the deformed structure at time  $t = 5.5$  s. The use of finest mesh produces a very similar deformation pattern to that of the coarsest mesh, but with a noticeably better pressure representation at the bending region of the four arms. Figs. 9 and 10 show the time history of the components of the global linear and angular momenta of the system, simulated using both C-TOUCH and X-GLACE schemes. As expected, the global linear momentum fluctuates around zero machine accuracy, whereas the angular momentum is perfectly conserved with the use of angular momentum projection algorithm. Otherwise, significant reduction in angular momentum

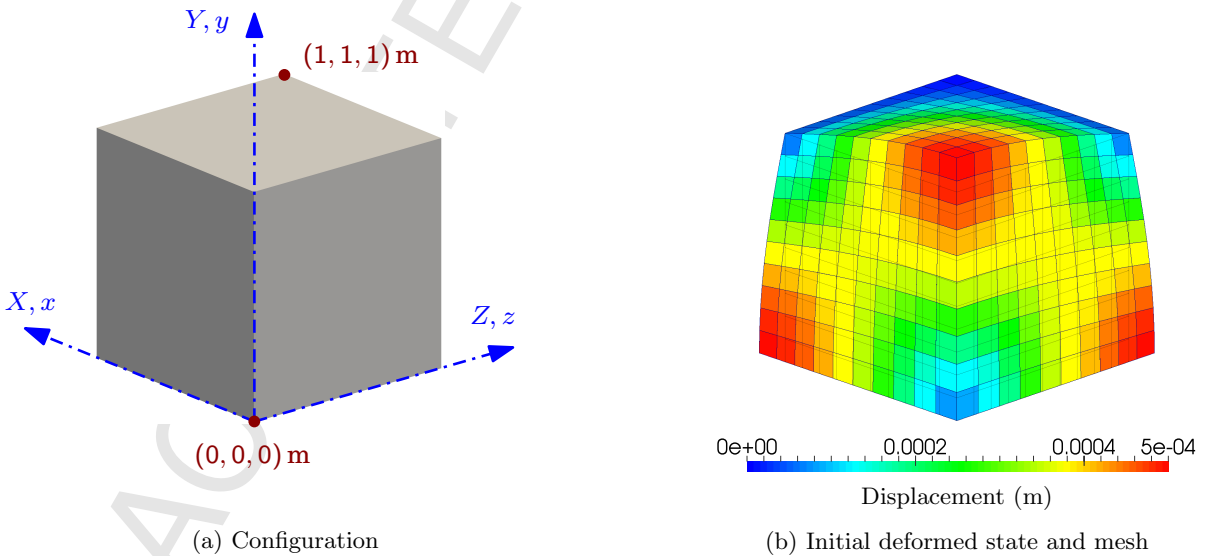

Figure 4: Low dispersion cube: Problem setup.

<sup>3</sup> Given the fact that  $A=B=C$ , all the three components of velocities and stresses are of the same magnitude (i.e.  $v_x=v_y=v_z$  and  $P_{xx}=P_{yy}=P_{zz}$ ).



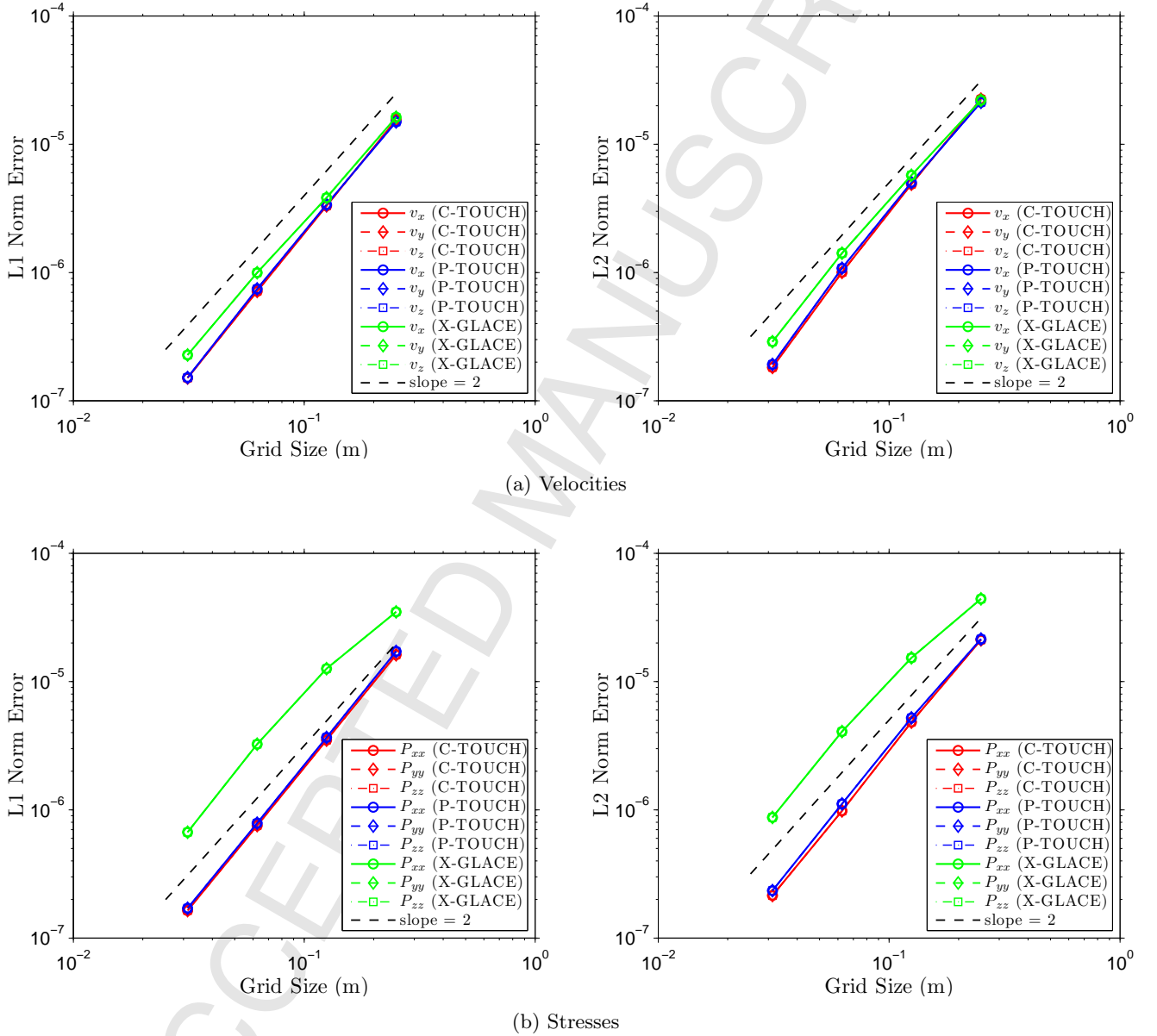

Figure 5: Low dispersion cube:  $L_1$  and  $L_2$  norm convergence of components of (a) velocities; and (b) stresses using the  $\{\mathbf{p}, \mathbf{F}, \mathbf{H}, \mathbf{J}\}$  C-TOUCH, P-TOUCH ( $\xi_{\{\mathbf{F}, \mathbf{H}, \mathbf{J}\}} = 0$ ) and X-GLACE schemes. Results obtained with  $A = B = C = 1$  and  $U_0 = 5 \times 10^{-4}$  m at time  $t = 4$  ms. A linear elastic material is used with  $\rho_0 = 1100$  kg/m<sup>3</sup>,  $E = 17$  MPa,  $\nu = 0.3$  and  $\alpha_{\text{CFL}} = 0.3$ .

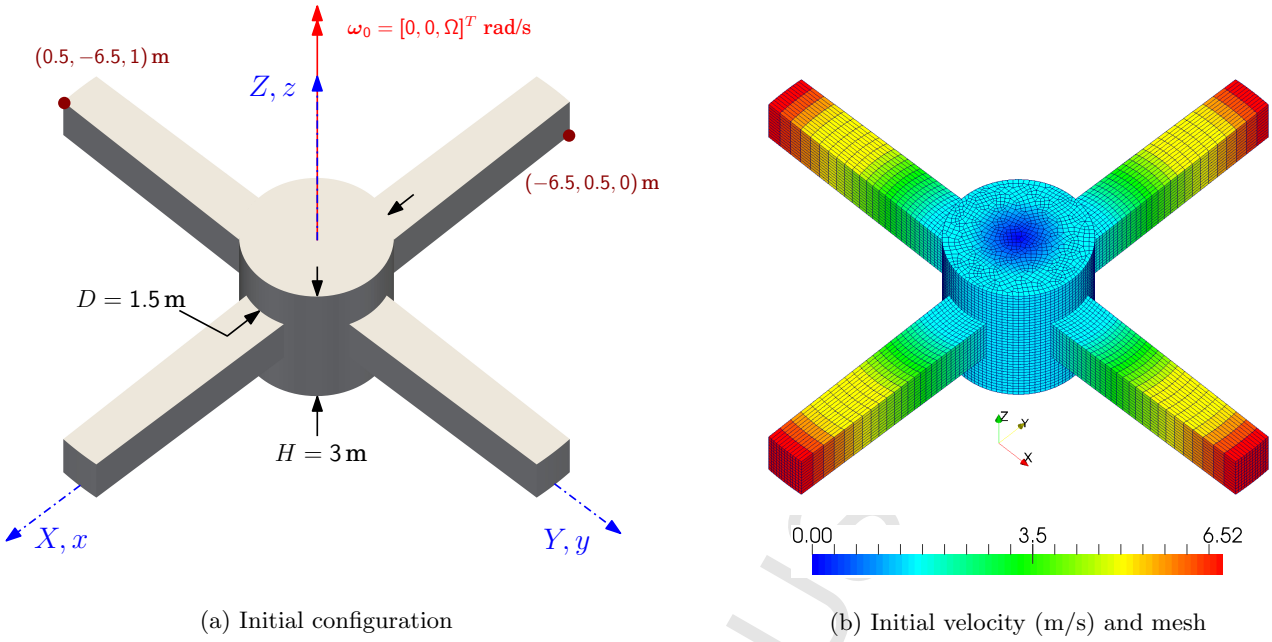

Figure 6: Satellite-like structure: Problem setup.

can be noticed (denoted as dashed lines in Figs. 9a and 10a), specially in the case of X-GLACE scheme.

### 8.3. Bending dominated scenario

In this example, performance of the proposed scheme is assessed in nearly incompressible bending dominated scenarios. Following [1, 52, 54, 55, 57], a 1 m squared cross section column clamped at the bottom and free on all other sides is presented (see Fig. 11a). The column is subjected to bending by the application of an initial linearly varying velocity profile given by  $v_0 = V[(Y/H), 0, 0]^T$  m/s, where  $V$  m/s is the maximum velocity applied and  $H$  m is the height of column (see Fig. 11b). A nearly incompressible neo-Hookean constitutive law is used where the material parameters are density  $\rho = 1100$  kg/m<sup>3</sup>, Young's modulus  $E = 17$  MPa and Poisson's ratio  $\nu = 0.45$ .

In the first part of this example a thick column of height  $H = 6$  m is considered. The time evolution of deformation along with pressure distribution is shown in Fig. 12. It is remarkable to observe the locking-free deformation behaviour obtained by employing only 2 elements across the thickness of the column. A mesh refinement is also carried out in Fig. 13 to show the deformation along with normal (see Fig. 13a) and shear (see 13b) components of stresses. Both cases show that better stress resolution is obtained as the mesh is refined without the appearance of any oscillations. Moreover, evolution of horizontal displacement  $u_x$  and horizontal velocity  $v_x$  at the tip of the column  $\mathbf{X} = [0.5, 6, 0.5]^T$  m is shown in Fig. 14a. As the mesh is refined convergence can be clearly observed. Furthermore, bending of a thin column of height  $H = 30$  m is also investigated. The mesh refinement of deformation of the column along with normal and shear stresses are plotted in Figs. 15 and 16, respectively. Again, the horizontal displacement  $u_x$  and horizontal velocity  $v_x$  of the tip of the column  $\mathbf{X} = [0.5, 30, 0.5]^T$  m is monitored in Fig. 14b. As the mesh is refined, practically identical solutions are obtained showing mesh convergence.

### 8.4. Highly non-linear scenario

A well documented twisting column example has been explored in References [1, 47, 48, 51, 52, 55–59], which aims to examine the effectiveness of the proposed methodologies in highly nonlinear scenarios. A unit squared cross section column of height  $H = 6$  m is considered (see Fig. 17a). The problem is simulated with an initial sinusoidal angular velocity field relative to the origin given by  $\omega_0 = \Omega[0, \sin(\pi Y/2H), 0]^T$  rad/s, where  $\Omega = 105$  rad/s represents the magnitude of initial angular velocity (see Fig. 17b). The main objective of this problem is to assess the capability of the proposed methodologies when approaching the limit of incompressibility ( $\kappa/\mu \geq 500$ ). To effectively handle this scenario, a preconditioned Riemann

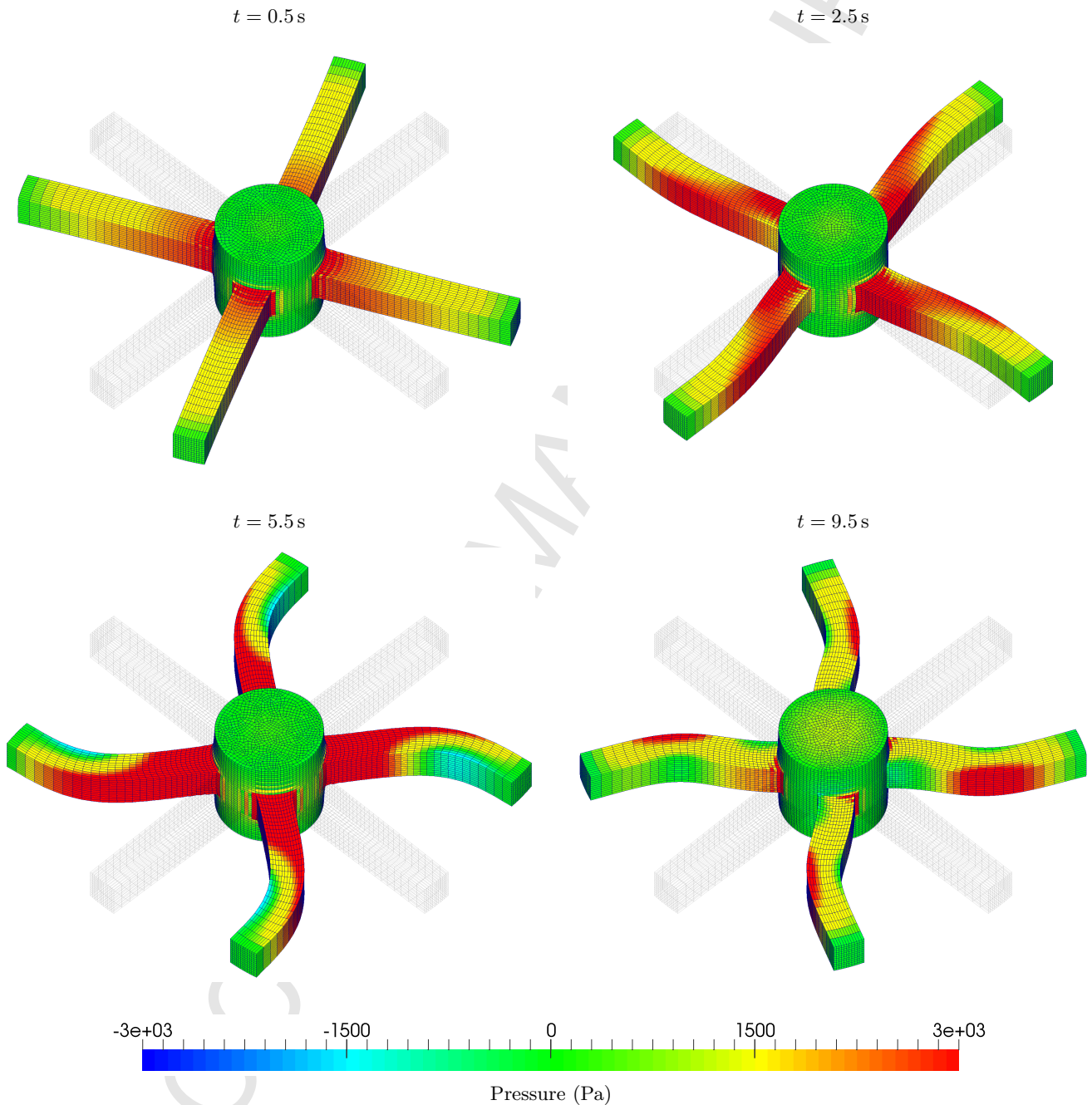

Figure 7: Satellite-like structure: Time evolution of the deformation along with the pressure distribution using the  $\{p, \mathbf{F}, \mathbf{H}, J\}$  C-TOUCH scheme. Results obtained using a discretisation of 51336 hexahedral elements with an angular velocity  $\boldsymbol{\omega}_0 = [0, 0, 1]^T$  rad/s. A neo-Hookean material is used with  $\rho_0 = 1000$  kg/m<sup>3</sup>,  $E = 50.05$  kPa,  $\nu = 0.3$ ,  $\alpha_{\text{CFL}} = 0.3$  and  $\Delta t \approx 1.3 \times 10^{-3}$  s.

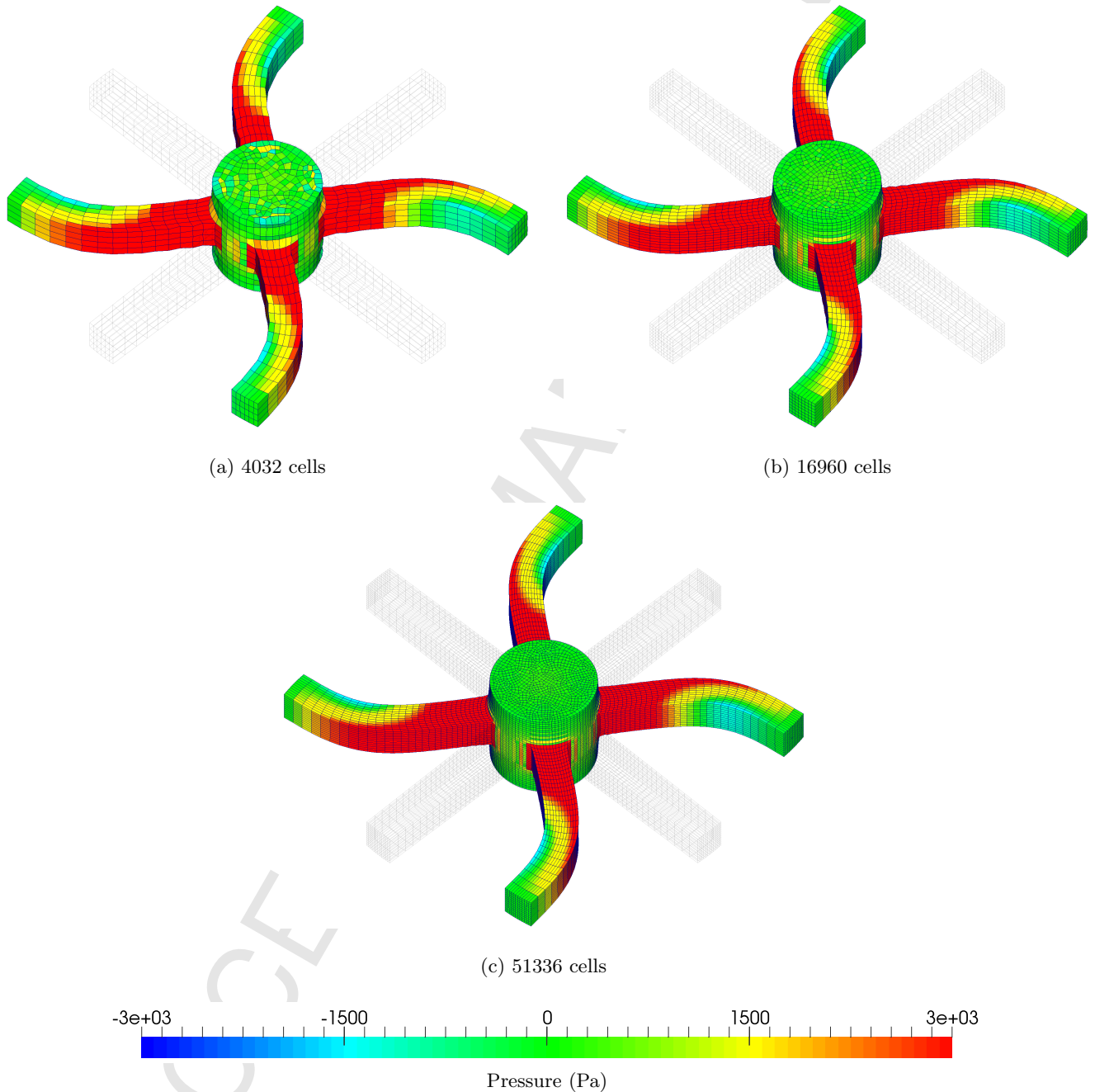

Figure 8: Satellite structure: Mesh refinement of deformed shapes along with pressure distribution at time  $t = 5.5$  s using various mesh sizes: (a) 4032; (b) 16960; and (c) 51336 hexahedral elements. Results obtained using the  $\{p, \mathbf{F}, \mathbf{H}, J\}$  C-TOUCH scheme with an angular velocity  $\boldsymbol{\omega}_0 = [0, 0, 1]^T$  rad/s. A neo-Hookean material is used with  $\rho_0 = 1000$  kg/m<sup>3</sup>,  $E = 50.05$  kPa,  $\nu = 0.3$  and  $\alpha_{\text{CFL}} = 0.3$ .

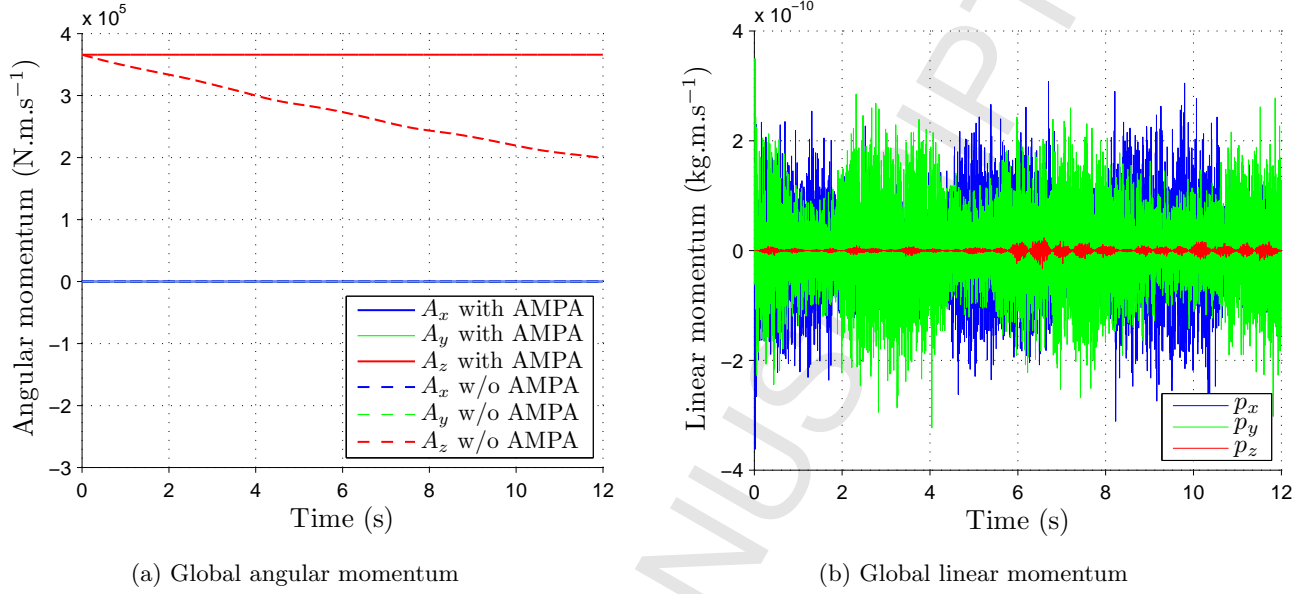

Figure 9: Satellite-like structure: Time evolution of the components of (a) global angular momentum with and without the consideration of discrete angular momentum projection algorithm (AMPA); and (b) global linear momentum using the  $\{\mathbf{p}, \mathbf{F}, \mathbf{H}, \mathbf{J}\}$  C-TOUCH scheme. Results obtained with an angular velocity  $\boldsymbol{\omega}_0 = [0, 0, 1]^T$  rad/s with a discretisation of 51336 hexahedral elements. A neo-Hookean constitutive model is utilised with  $\rho_0 = 1000$  kg/m<sup>3</sup>,  $E = 50.05$  kPa,  $\nu = 0.3$  and  $\alpha_{\text{CFL}} = 0.3$ .

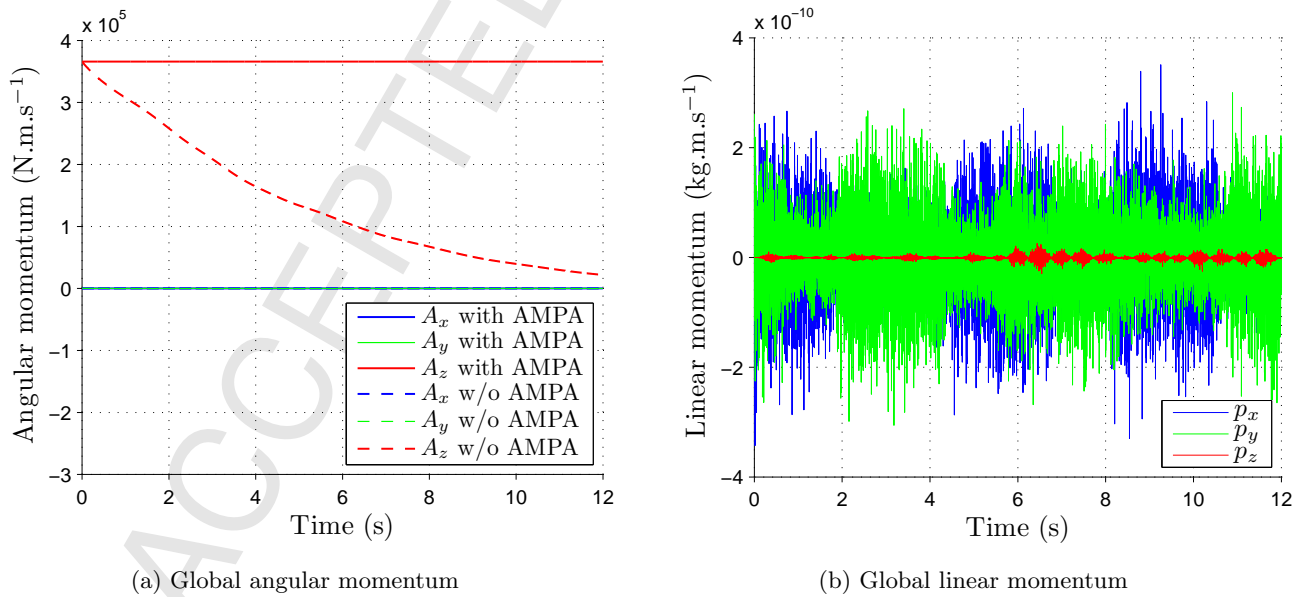

Figure 10: Satellite-like structure: Time evolution of the components of (a) global angular momentum with and without the consideration of discrete angular momentum projection algorithm (AMPA); and (b) global linear momentum using the  $\{\mathbf{p}, \mathbf{F}, \mathbf{H}, \mathbf{J}\}$  X-GLACE scheme. Results obtained with an angular velocity  $\boldsymbol{\omega}_0 = [0, 0, 1]^T$  rad/s with a discretisation of 51336 hexahedral elements. A neo-Hookean constitutive model is utilised with  $\rho_0 = 1000$  kg/m<sup>3</sup>,  $E = 50.05$  kPa,  $\nu = 0.3$  and  $\alpha_{\text{CFL}} = 0.3$ .



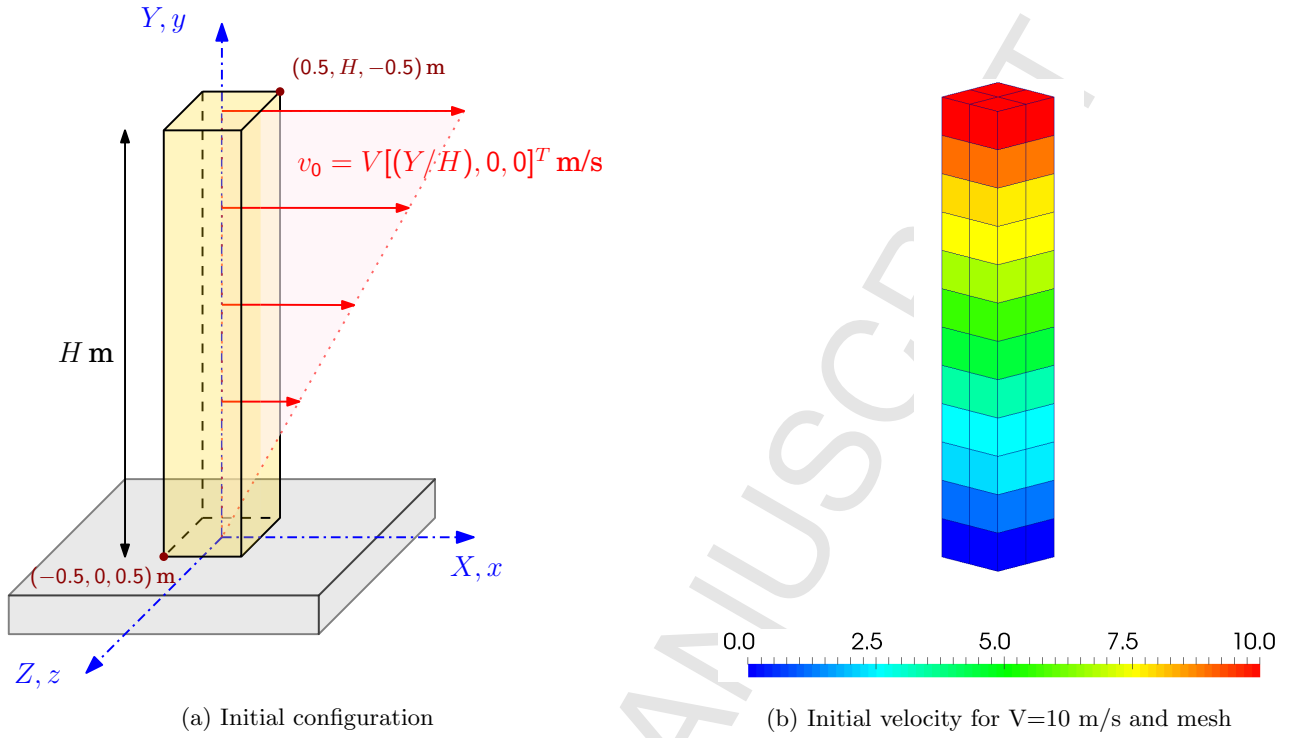

Figure 11: Thick column: Problem setup.

solver (see Section 4.2) is thus required. A neo-Hookean material is used with material density  $\rho_0 = 1100$  kg/m<sup>3</sup>, Young's modulus  $E = 17$  MPa and Poisson's ratio  $\nu = 0.4999$ , unless otherwise stated.

In Fig. 18a,b, two different formulations, namely  $\{\mathbf{p}, \mathbf{F}\}$  and  $\{\mathbf{p}, \mathbf{F}, \mathbf{H}, \mathbf{J}\}$ , are presented. Both the deformation and pressure field obtained are practically identical. Notice that the slightly discontinuous cell pressure distribution along the longitudinal direction of the column does not correspond to any spurious pressure instability, as it gets eliminated after mesh refinement (see Fig. 18c). Alternatively, a nodal averaging (smoothing) process could have been used to display the results (refer to Fig. 18d). However, it is known that this can lead to the removal of possible pressure fluctuations. It is for this reason why we have explicitly decided not to do so in this paper, and we always depict cell values contour plots (see 18a,b)

For benchmarking purposes, Fig. 19 depicts a comparison of the proposed C-TOUCH, P-TOUCH and X-GLACE methodologies against the recently proposed JST-SPH [58] and SUPG-SPH [59] mesh-free methods. For completeness, the column is also simulated using the non-LBB compliant B-bar hexahedral method (see Fig. 19d) and the LBB compliant Q2-Q1 hexahedral FEM (see Fig. 19e). Remarkably, all the schemes described above produce very similar results both in terms of deformed shape and pressure field. Insofar as an axisymmetric hexahedral mesh is employed, the column is expected to prevent out-of-plane deformation. This can be easily shown by monitoring the displacement of a point located at the top surface of the column along the central axis. Fig. 22 shows that the evolution of planar displacement components (e.g.  $u_x$  and  $u_z$ ) at point  $\mathbf{X} = [0, 6, 0]^T$  m is within zero machine accuracy.

The problem becomes significantly more challenging by increasing the initial angular velocity to a value of  $\Omega = 200$  rad/s, thus leading to a pronounced twisting behaviour. A mesh refinement study is shown in Fig. 20 at time  $t = 90$  ms. In particular, the number of twists shown in the column is captured extremely well even with the use of a coarse mesh. Aiming to prove mesh convergence, Fig. 21a illustrates the time evolution of the ratio of current and initial heights of the column by using successive meshes of  $4 \times 24 \times 4$ ,  $8 \times 48 \times 8$  and  $16 \times 96 \times 16$  hexahedral elements. Moreover, the global numerical dissipation introduced in the algorithm can be assessed by taking the difference between total conserved energy and



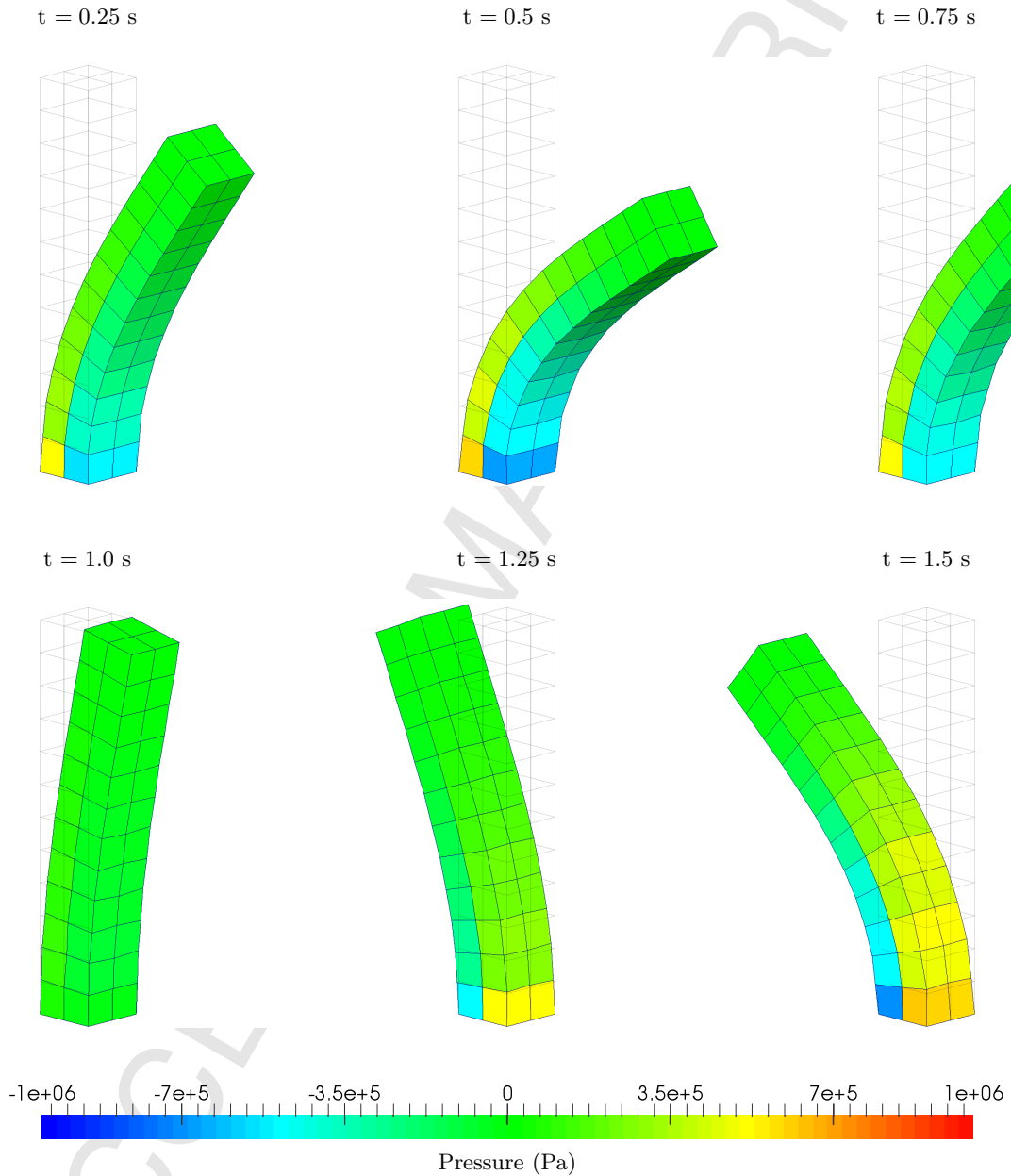

Figure 12: Thick column: Time evolution of deformation along with pressure distribution using  $\{p, F, H, J\}$  C-TOUCH scheme. Results obtained with velocity  $\mathbf{v}_0 = V[(Y/H), 0, 0]^T$  m/s where  $V = 10$  m/s and  $H = 6$  m using a discretisation of  $2 \times 12 \times 2$  hexahedral elements. A neo-Hookean material is used with  $\rho = 1100$  kg/m<sup>3</sup>,  $E = 17$  MPa,  $\nu = 0.45$  and  $\alpha_{\text{CFL}} = 0.3$ .

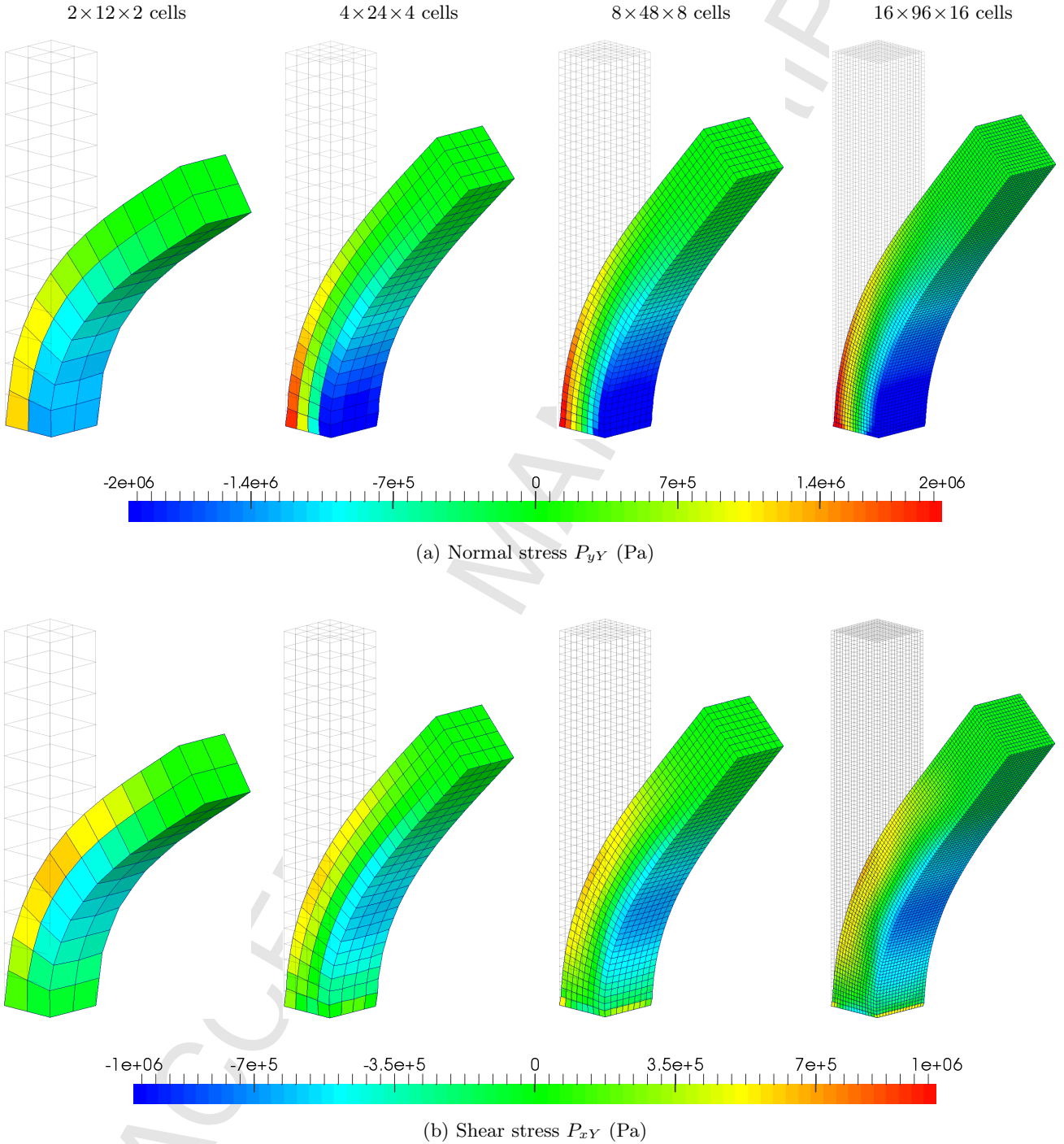
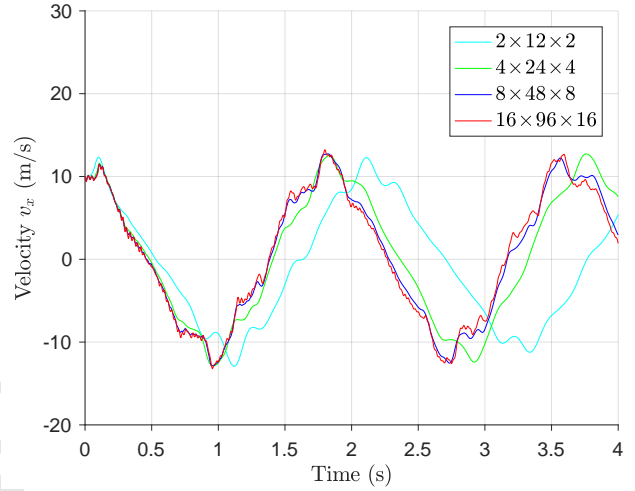
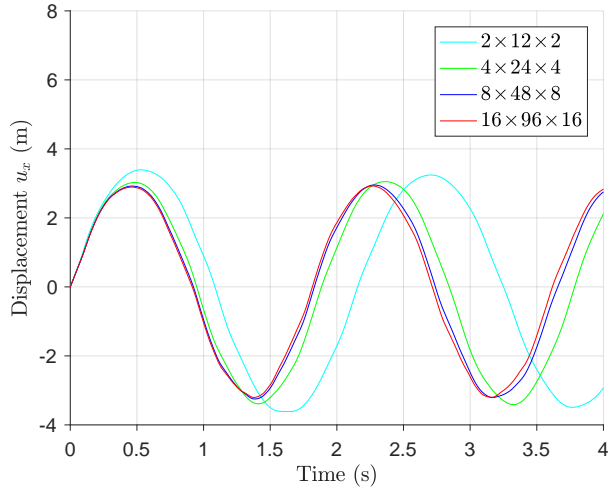
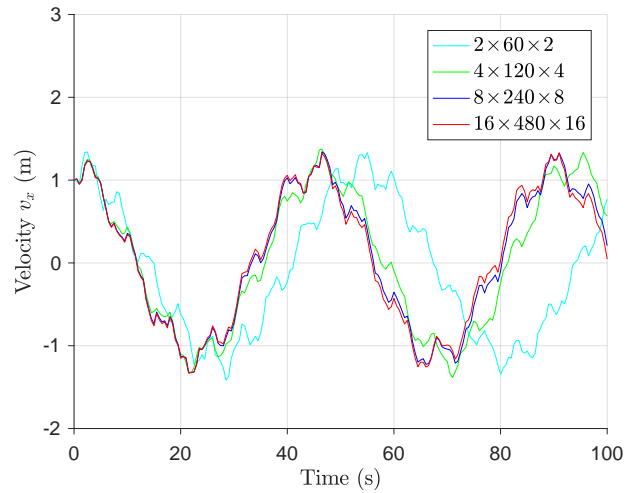
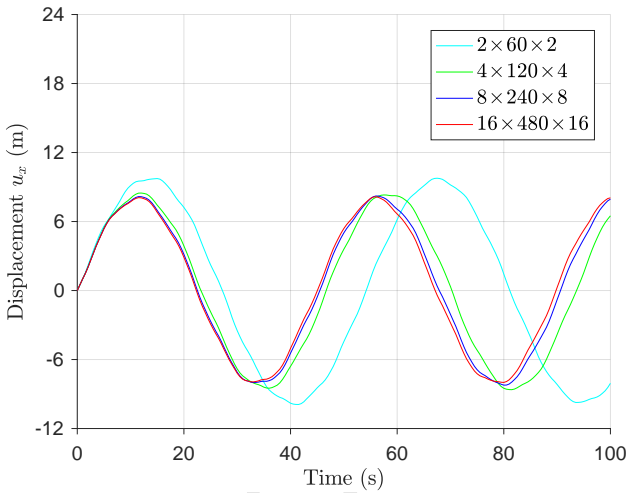

Figure 13: Thick column: Mesh refinement of deformation plotted with (a) normal stress  $P_{yY}$ ; and (b) shear stress  $P_{xY}$  using  $\{\mathbf{p}, \mathbf{F}, \mathbf{H}, J\}$  C-TOUCH scheme at time  $t = 0.5$ s. Results obtained with velocity  $\mathbf{v}_0 = V[(Y/H), 0, 0]^T$  m/s where  $V = 10$  m/s and  $H = 6$  m using a discretisation of  $2 \times 12 \times 2$ ,  $4 \times 24 \times 4$ ,  $8 \times 48 \times 8$  and  $16 \times 96 \times 16$  hexahedral elements. A neo-Hookean material is used with  $\rho = 1100$  kg/m<sup>3</sup>,  $E = 17$  MPa,  $\nu = 0.45$  and  $\alpha_{CFL} = 0.3$ .



(a) Thick column: Horizontal displacement and velocity



(b) Thin column: Horizontal displacement and velocity

Figure 14: Thick and thin columns: Time evolution of (a) horizontal displacement  $u_x$  (thick column); (b) horizontal velocity  $v_x$  (thick column); (c) horizontal velocity  $u_x$  (thin column); and (d) horizontal velocity  $v_x$  (thin column) at material point  $\mathbf{X} = [0.5, H, 0.5]^T$  m where  $H = 6$  m and  $H = 30$  m for thick and thin columns respectively. Results obtained using  $\{\mathbf{p}, \mathbf{F}, \mathbf{H}, \mathbf{J}\}$  C-TOUCH scheme with velocity  $\mathbf{v}_0 = V[(Y/H), 0, 0]^T$  m/s where  $V = 10$  m/s for thick column and  $V = 1$  m/s for thin column. A neo-Hookean constitutive model is utilised with  $\rho_0 = 1100$  kg/m<sup>3</sup>,  $E = 17$  MPa,  $\nu = 0.45$  and  $\alpha_{\text{CFL}} = 0.3$ .

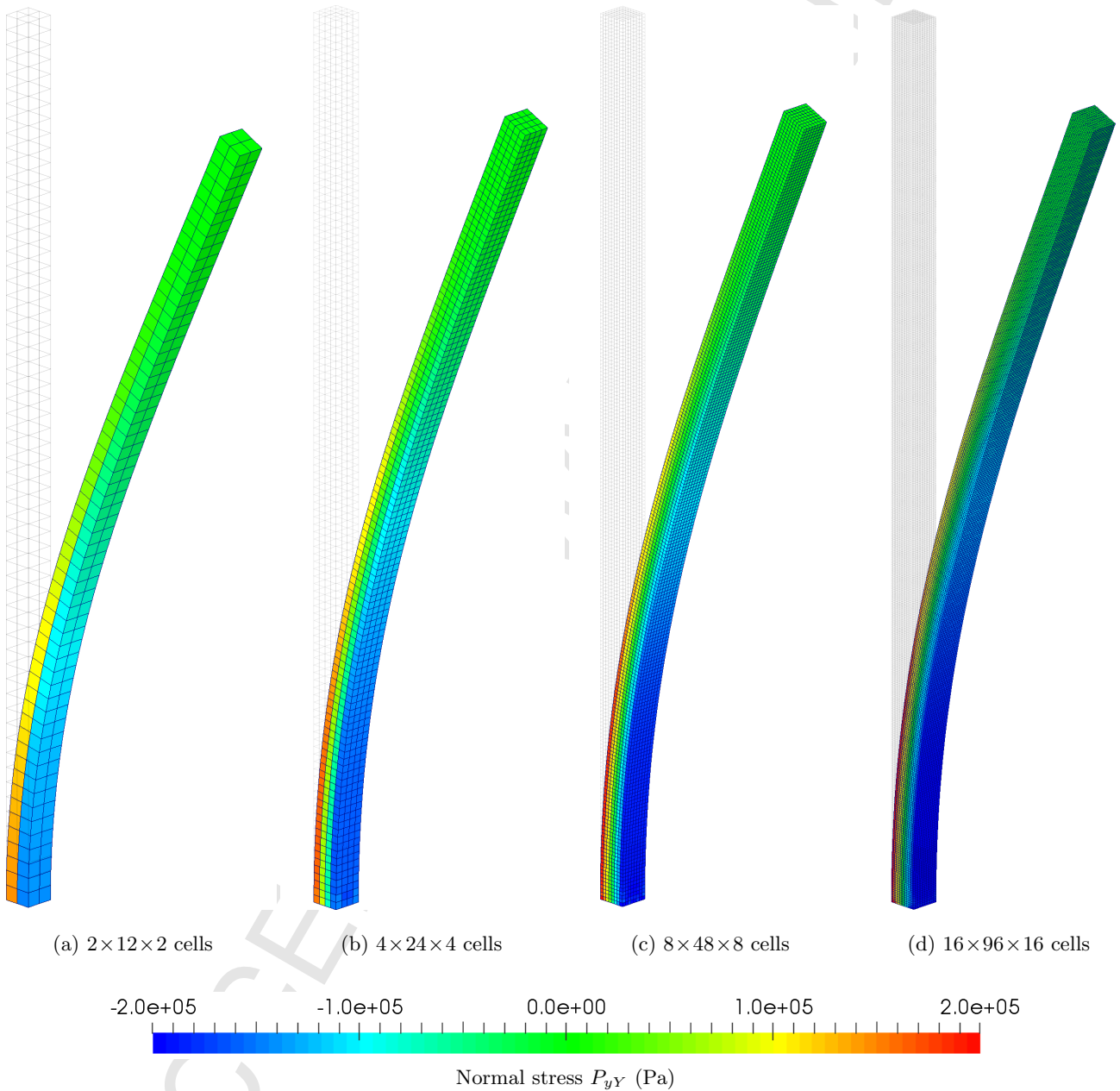

Figure 15: Thin column: Mesh refinement of deformation plotted with normal stress  $P_{yY}$  using (a)  $2 \times 12 \times 2$ ; (b)  $4 \times 24 \times 4$ ; (c)  $8 \times 48 \times 8$ ; and (d)  $16 \times 96 \times 16$  hexahedral elements. Results obtained at time  $t = 12$  s using  $\{\mathbf{p}, \mathbf{F}, \mathbf{H}, \mathbf{J}\}$  C-TOUCH scheme with velocity  $\mathbf{v}_0 = V[(Y/H), 0, 0]^T$  m/s where  $V = 1$  m/s and  $H = 30$  m. A neo-Hookean material is used with  $\rho = 1100$  kg/m<sup>3</sup>,  $E = 17$  MPa,  $\nu = 0.45$  and  $\alpha_{\text{CFL}} = 0.3$ .

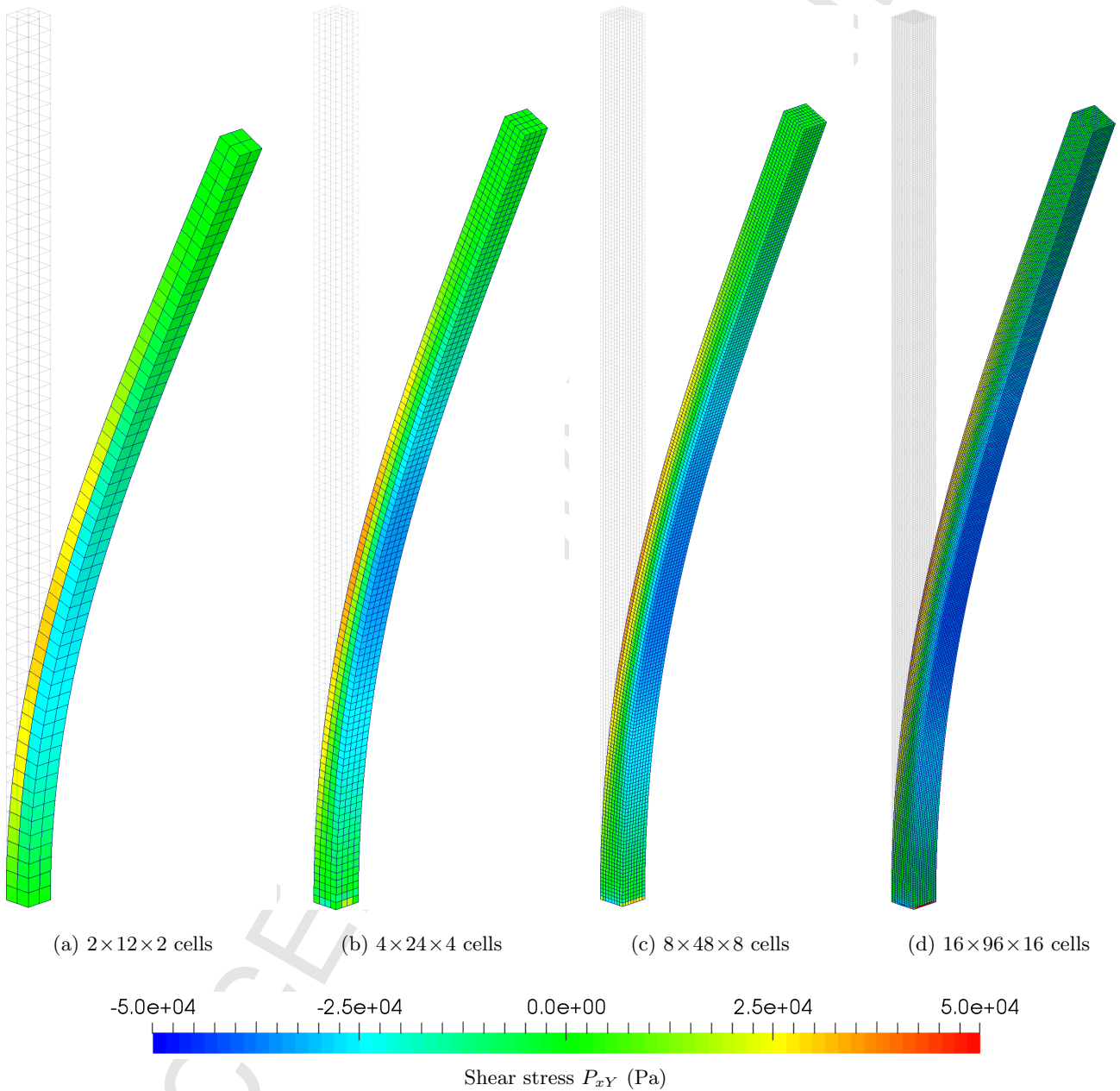

Figure 16: Thin column: Mesh refinement of deformation plotted with shear stress  $P_{xy}$  distribution using (a)  $2 \times 12 \times 2$ ; (b)  $4 \times 24 \times 4$ ; (c)  $8 \times 48 \times 8$ ; and (d)  $16 \times 96 \times 16$  hexahedral elements. Results obtained at time  $t = 12$  s using  $\{p, \mathbf{F}, \mathbf{H}, J\}$  C-TOUCH scheme with velocity  $\mathbf{v}_0 = V[(Y/H), 0, 0]^T$  m/s where  $V = 1$  m/s and  $H = 30$  m. A neo-Hookean material is used with  $\rho = 1100$  kg/m<sup>3</sup>,  $E = 17$  MPa,  $\nu = 0.45$  and  $\alpha_{CFL} = 0.3$ .

the summation of internal and kinetic energies. This is shown in Fig. 21b where the numerical dissipation of the algorithm is reduced when increasing the mesh density.

### 8.5. Contact capability

Previously explored in [82] in two dimensions, an extension of this contact example to three dimensions is carried out by considering the rebound of a hollow circular bar of outer diameter  $D_0 = 6.4$  mm, inner diameter  $D_i = 2$  mm and height  $H = 32.4$  mm (see Fig. 23). The bar impacts against a rigid frictionless wall with an initial velocity of  $\mathbf{v}_0 = [0, -100, 0]^T$  m/s where the separation distance between the bar and wall is 4 mm. Upon impact, the bar undergoes large compressive deformation until  $t = 150 \mu\text{s}$  when all the kinetic energy of the bar is converted to internal strain energy. Soon afterwards, tensile forces start developing and a bounce-off motion begins. At approximately  $t = 250 \mu\text{s}$  the bar completely detaches from the wall and continues to deform. A neo-Hookean constitutive model is chosen with density  $\rho_0 = 8930$  kg/m<sup>3</sup>, Young's modulus  $E = 585$  MPa and Poisson's ratio  $\nu = 0.45$ . Due to the existence of two symmetry planes, only a quarter of the domain is modelled with appropriate symmetric roller support and free boundary conditions.

A sequence of snapshots displaying the deformation of the hollow bar along with its pressure distribution is shown in Fig. 24. No spurious pressure instabilities can be observed. In Fig. 25, a mesh convergence study is carried out with a progressive level of refinement. It is remarkable that the deformation obtained with the coarse mesh agrees extremely well with the fine mesh, although the pressure contour is clearly enhanced as we increase the mesh density. In Fig. 26 and Fig. 27, two sequentially refined hexahedral meshes of 512 and 13824 are used. Fig. 26 shows the time evolution of the global linear and angular momenta, whereas Fig. 27 shows the time history of vertical displacement  $u_y$  at the bottom plane  $\mathbf{X}_B = [1/\sqrt{2}, 0, 1/\sqrt{2}]^T$  mm (shown as red lines) and at the top plane  $\mathbf{X}_T = [1/\sqrt{2}, 32.4, 1/\sqrt{2}]^T$  mm

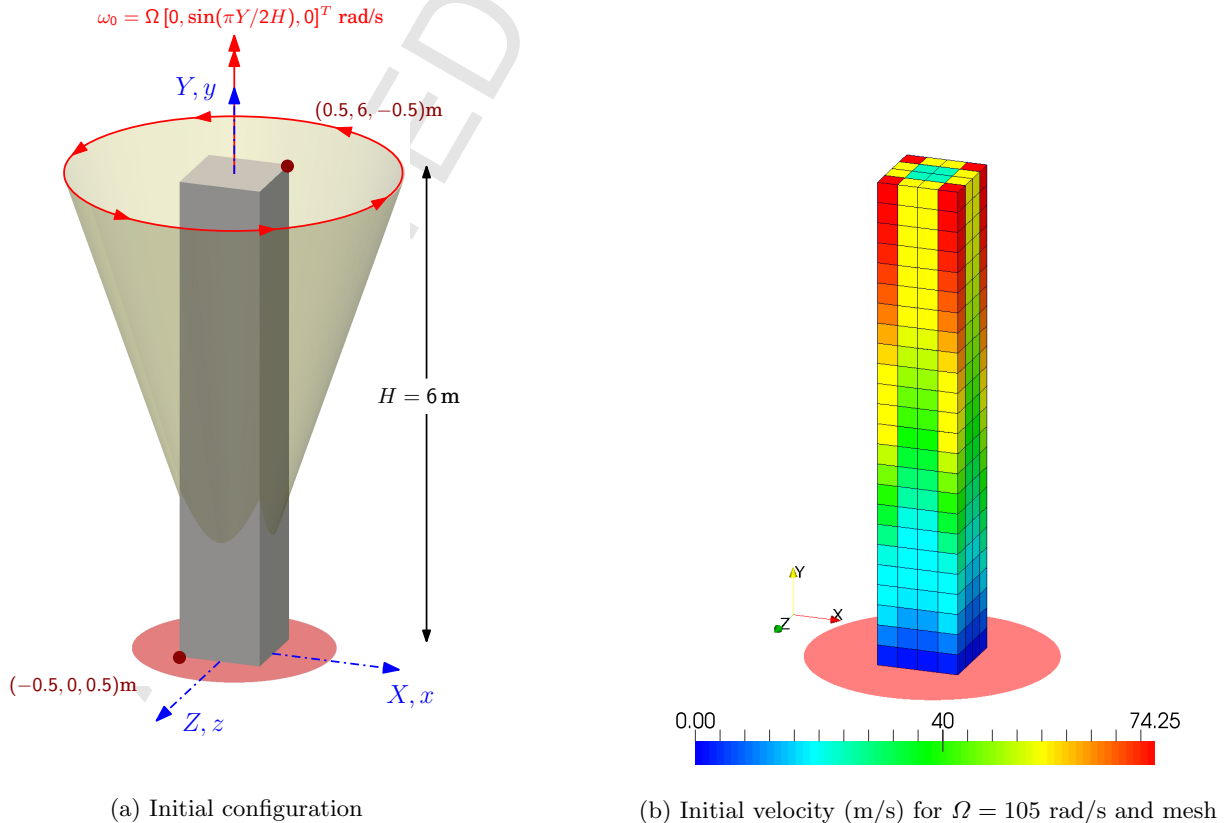

Figure 17: Twisting column: Problem setup.



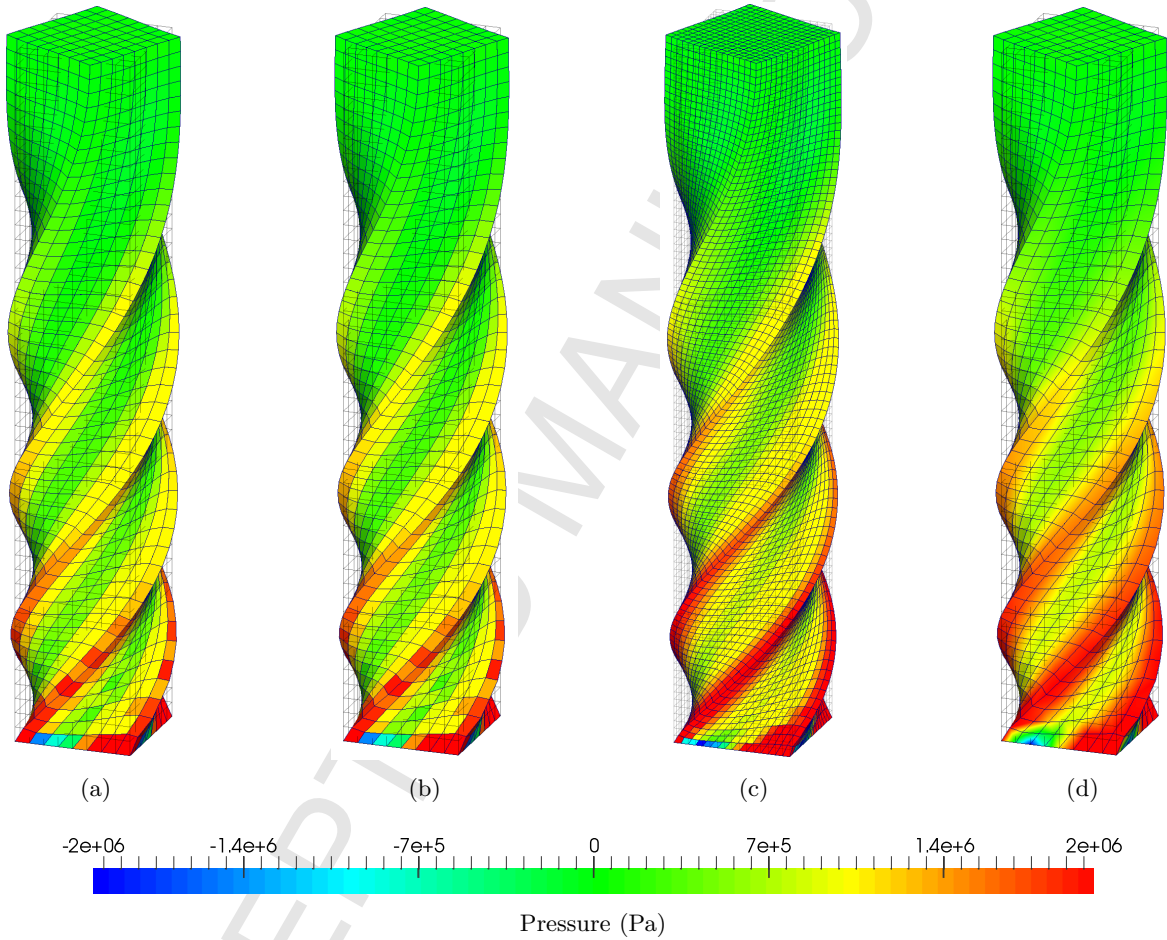

Figure 18: Twisting column: Comparison of deformed shapes along with the pressure distribution using (a)  $\{\mathbf{p}, \mathbf{F}\}$  ( $8 \times 48 \times 8$ , cell based pressure); (b)  $\{\mathbf{p}, \mathbf{F}, \mathbf{H}, J\}$  ( $8 \times 48 \times 8$ , cell based pressure); (c)  $\{\mathbf{p}, \mathbf{F}, \mathbf{H}, J\}$  ( $16 \times 96 \times 16$ , cell based pressure) with fine mesh; and (d)  $\{\mathbf{p}, \mathbf{F}, \mathbf{H}, J\}$  ( $8 \times 48 \times 8$ , node based pressure) using C-TOUCH scheme. Results obtained at time  $t = 0.1$  s with an angular velocity  $\boldsymbol{\omega}_0 = \Omega [0, \sin(\pi Y/2H), 0]^T$  where  $\Omega = 105$  rad/s and  $H = 6$  m. A neo-Hookean constitutive model is used with density  $\rho_0 = 1100$  kg/m<sup>3</sup>,  $E = 17$  MPa,  $\nu = 0.4999$ ,  $\alpha_{\text{CFL}} = 0.3$  and  $\Delta t \approx 1.3 \times 10^{-5}$  s.

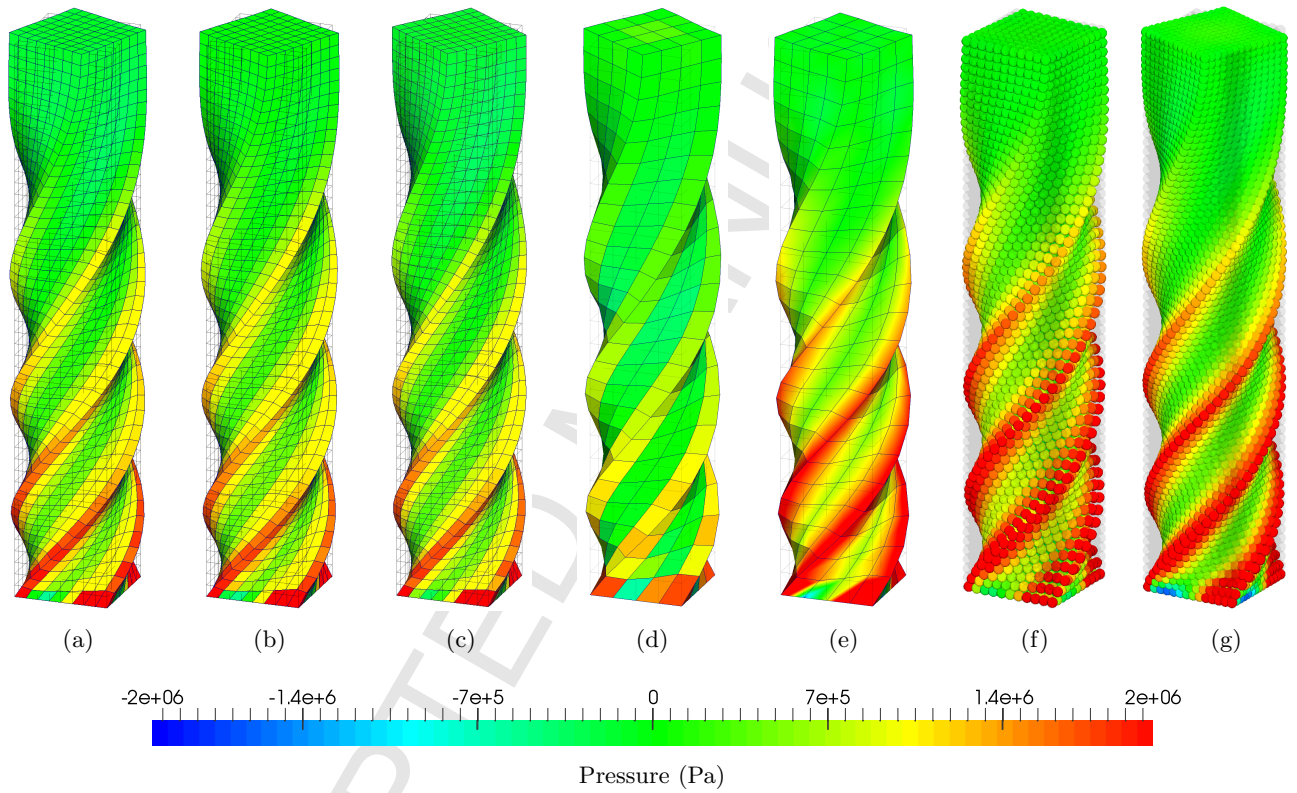
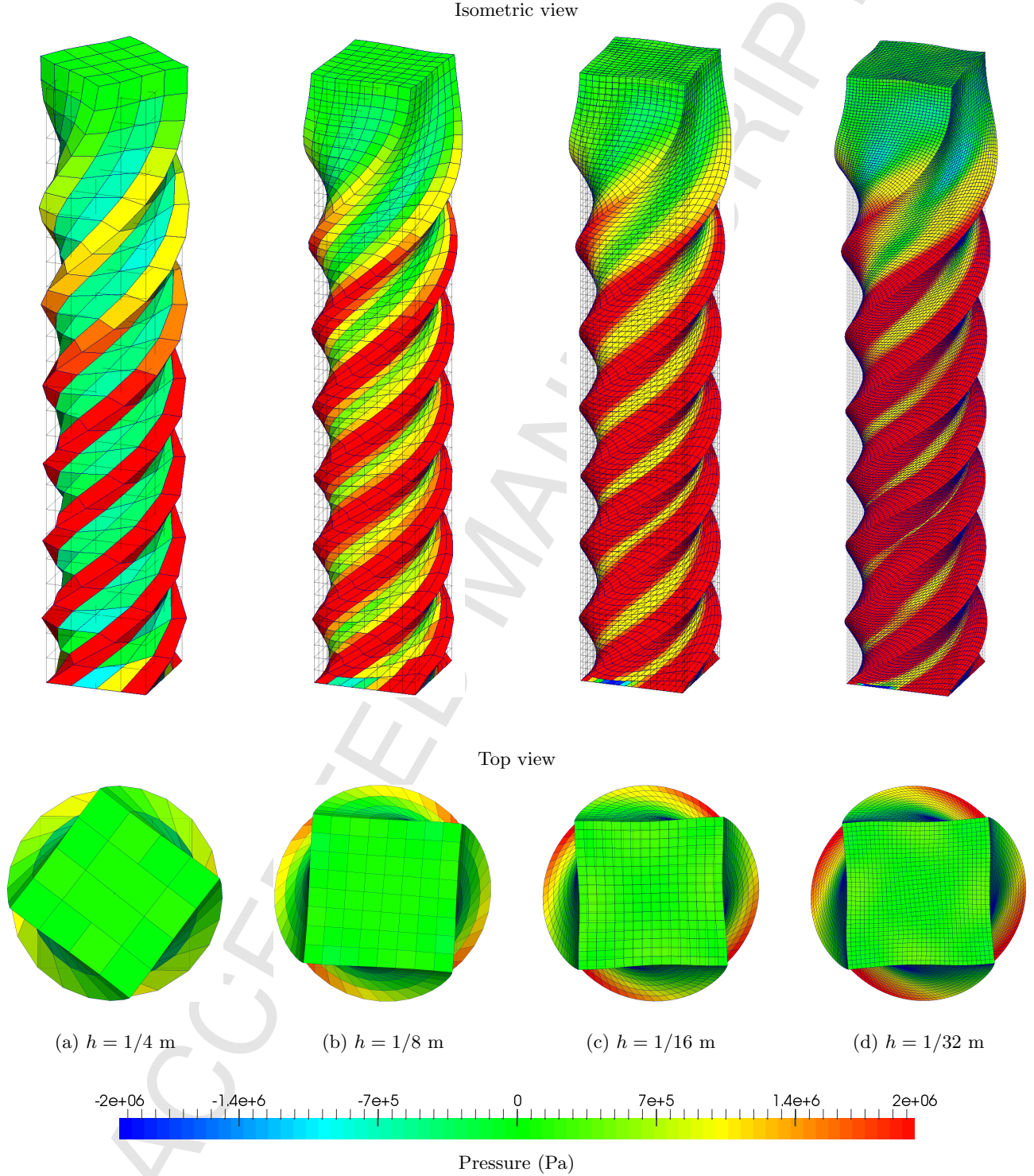

Figure 19: Twisting column: Comparison of deformed shapes along with the pressure distribution using various numerical schemes namely; (a)  $\{\mathbf{p}, \mathbf{F}, \mathbf{H}, J\}$  C-TOUCH ( $\tilde{\kappa} = 3\kappa$ ); (b)  $\{\mathbf{p}, \mathbf{F}, \mathbf{H}, J\}$  P-TOUCH ( $\xi_{\mathbf{F}} = \xi_{\mathbf{H}} = 0.1$ ); (c)  $\{\mathbf{p}, \mathbf{F}, \mathbf{H}, J\}$  X-GLACE ( $\tilde{\kappa} = 3\kappa$ ); (d) B-bar hexahedral method; (e) Q2-Q1 hexahedral FEM [81]; (f) JST-SPH [58]; and (g) SUPG-SPH [59] numerical schemes. Results obtained at time  $t = 0.1$  s with an angular velocity  $\boldsymbol{\omega}_0 = \Omega [0, \sin(\pi Y/2H), 0]^T$  where  $\Omega = 105$  rad/s and  $H = 6$  m. A neo-Hookean constitutive model is used with density  $\rho_0 = 1100$  kg/m<sup>3</sup>,  $E = 17$  MPa,  $\nu = 0.495$  and  $\alpha_{\text{CFL}} = 0.3$ .



56 Figure 20: Twisting column: Mesh refinement of deformed shapes with pressure distribution obtained using an increased  
 57 angular velocity  $\boldsymbol{\omega}_0 = \Omega [0, \sin(\pi Y/2H), 0]^T$ , where  $\Omega = 200$  rad/s and  $H = 6$  m. Results obtained at  $t = 90$  ms using the  
 58  $\{\mathbf{p}, \mathbf{F}\}$  C-TOUCH scheme with  $\tilde{\kappa} = 3\kappa$  using meshes with (a)  $4 \times 24 \times 4$ ; (b)  $8 \times 48 \times 8$ ; (c)  $16 \times 96 \times 16$ ; and (d)  $32 \times 192 \times 32$   
 59 hexahedral elements. A neo-Hookean material is used with  $\rho_0 = 1100$  kg/m<sup>3</sup>,  $E = 17$  MPa,  $\nu = 0.499$  and  $\alpha_{CFL} = 0.3$ .

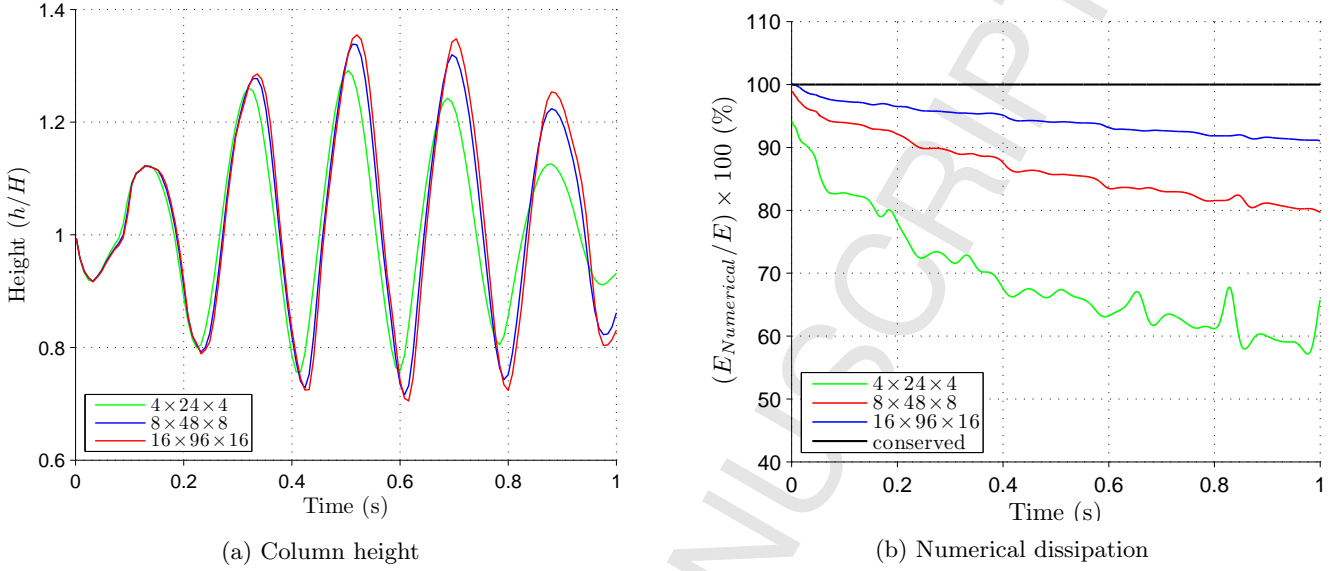

Figure 21: Twisting column: Time evolution of (a) non-dimensionalised height of the column measured at the material point  $\mathbf{X} = [0, 6, 0]^T$  m; and (b) numerical dissipation using the  $\{\mathbf{p}, \mathbf{F}\}$  C-TOUCH scheme with  $\tilde{\kappa} = 3\kappa$ . Results obtained using a discretisation of  $4 \times 24 \times 4$ ,  $8 \times 48 \times 8$  and  $16 \times 96 \times 16$  hexahedral elements with an increased angular velocity  $\boldsymbol{\omega}_0 = \Omega [0, \sin(\pi Y/2H), 0]^T$ , where  $\Omega = 200$  rad/s and  $H = 6$  m. A neo-Hookean material is used with  $\rho_0 = 1100$  kg/m<sup>3</sup>,  $E = 17$  MPa,  $\nu = 0.499$  and  $\alpha_{\text{CFL}} = 0.3$ .

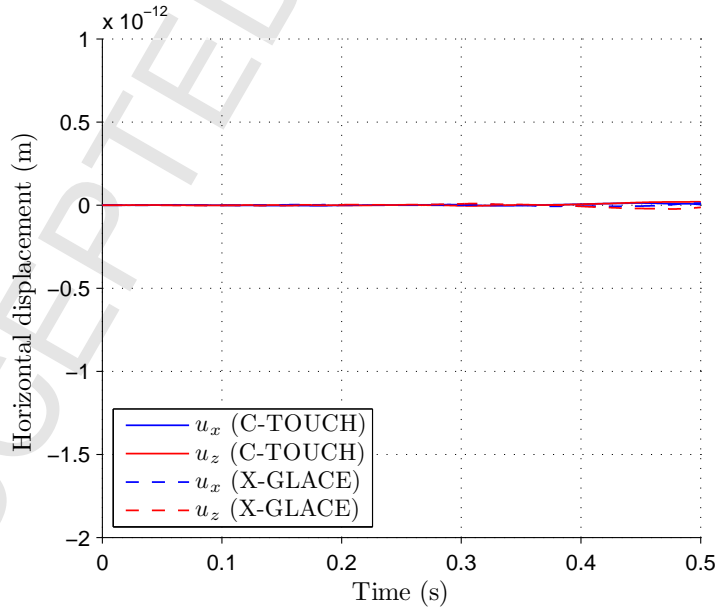

Figure 22: Twisting column: Comparison of time evolution of horizontal displacements  $\mathbf{u}_x$  and  $\mathbf{u}_z$  of the point at top of column along the central  $Y$  axis  $\mathbf{X} = [0, 6, 0]^T$  m using the  $\{\mathbf{p}, \mathbf{F}, \mathbf{H}, \mathbf{J}\}$  C-TOUCH and X-GLACE schemes with  $\tilde{\kappa} = 3\kappa$ . Results obtained using a discretisation of  $8 \times 48 \times 8$  hexahedral elements with an angular velocity  $\boldsymbol{\omega}_0 = \Omega [0, \sin(\pi Y/2H), 0]^T$ , where  $\Omega = 105$  rad/s and  $H = 6$  m. A neo-Hookean material is used with  $\rho_0 = 1100$  kg/m<sup>3</sup>,  $E = 17$  MPa,  $\nu = 0.495$  and  $\alpha_{\text{CFL}} = 0.3$ .

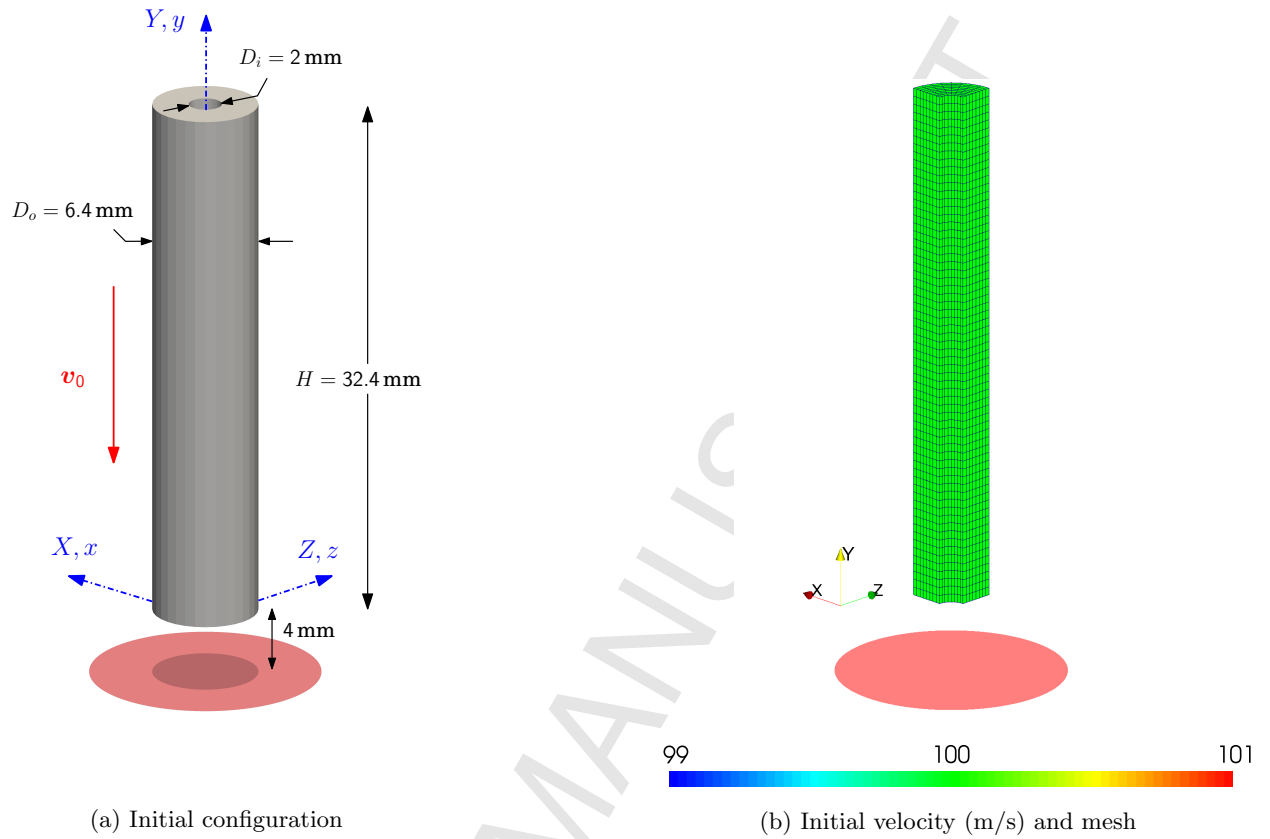

Figure 23: Bar rebound: Problem setup.

(shown as blue lines). The difference between the red and blue lines indicates the amount of elongation/reduction in bar length. Reasonably accurate deformation is obtained using a coarse mesh, showing optimal convergence for the proposed method. Finally, we further examine this problem using a large value of the Poisson's ratio  $\nu = 0.499$ . Fig. 28 shows a series of deformed states without experiencing any locking difficulties.



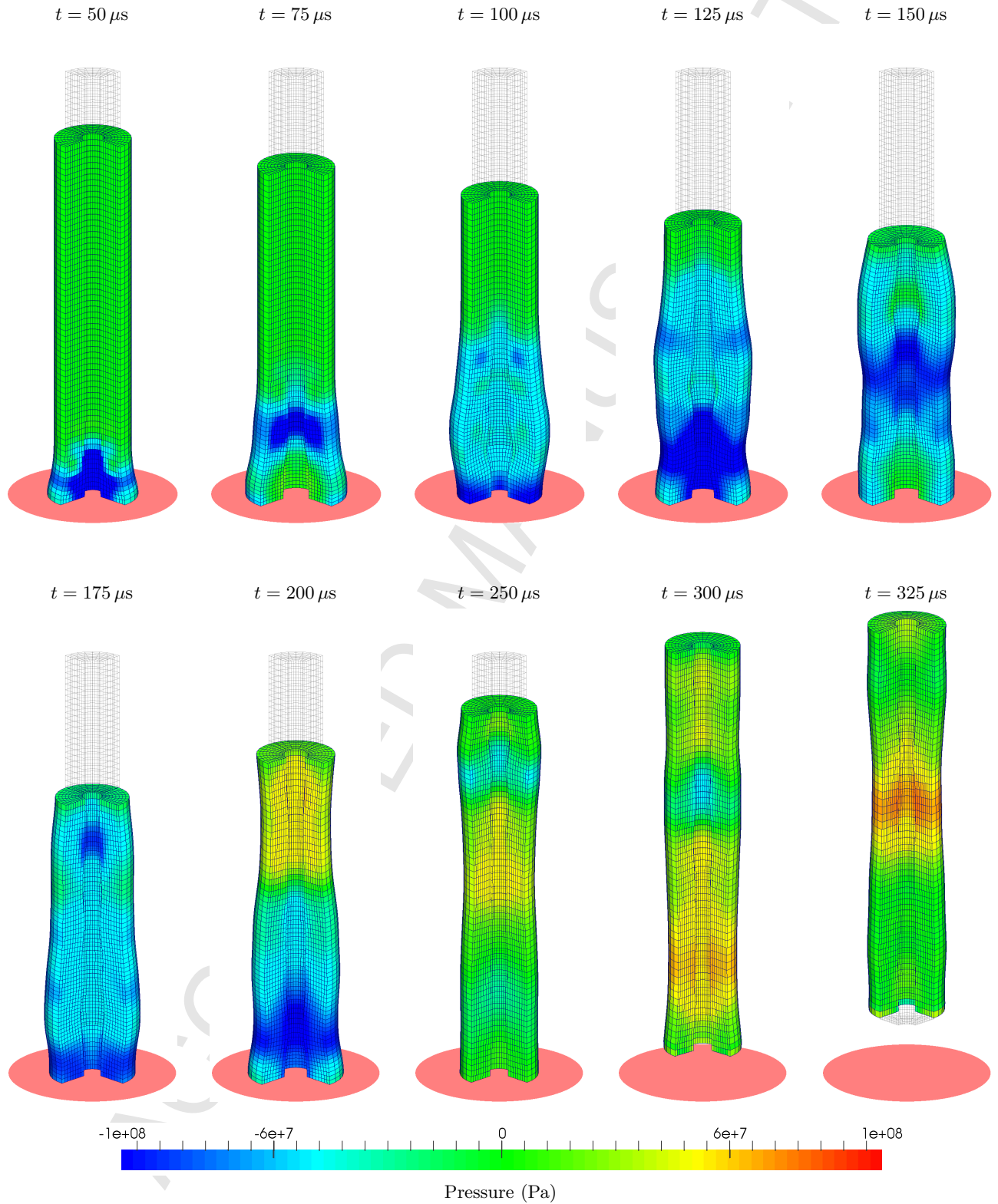

Figure 24: Bar rebound: Time evolution of the deformation along with the pressure distribution using the  $\{p, \mathbf{F}, \mathbf{H}, J\}$  C-TOUCH scheme. Results obtained with velocity  $\mathbf{v}_0 = [0, -100, 0]^T$  m/s using 4096 hexahedral elements in quarter domain. A neo-Hookean constitutive model is used with  $\rho_0 = 8930 \text{ kg/m}^3$ ,  $E = 585 \text{ MPa}$ ,  $\nu = 0.45$ ,  $\alpha_{\text{CFL}} = 0.3$  and  $\Delta t \approx 7 \times 10^{-8} \text{ s}$ .



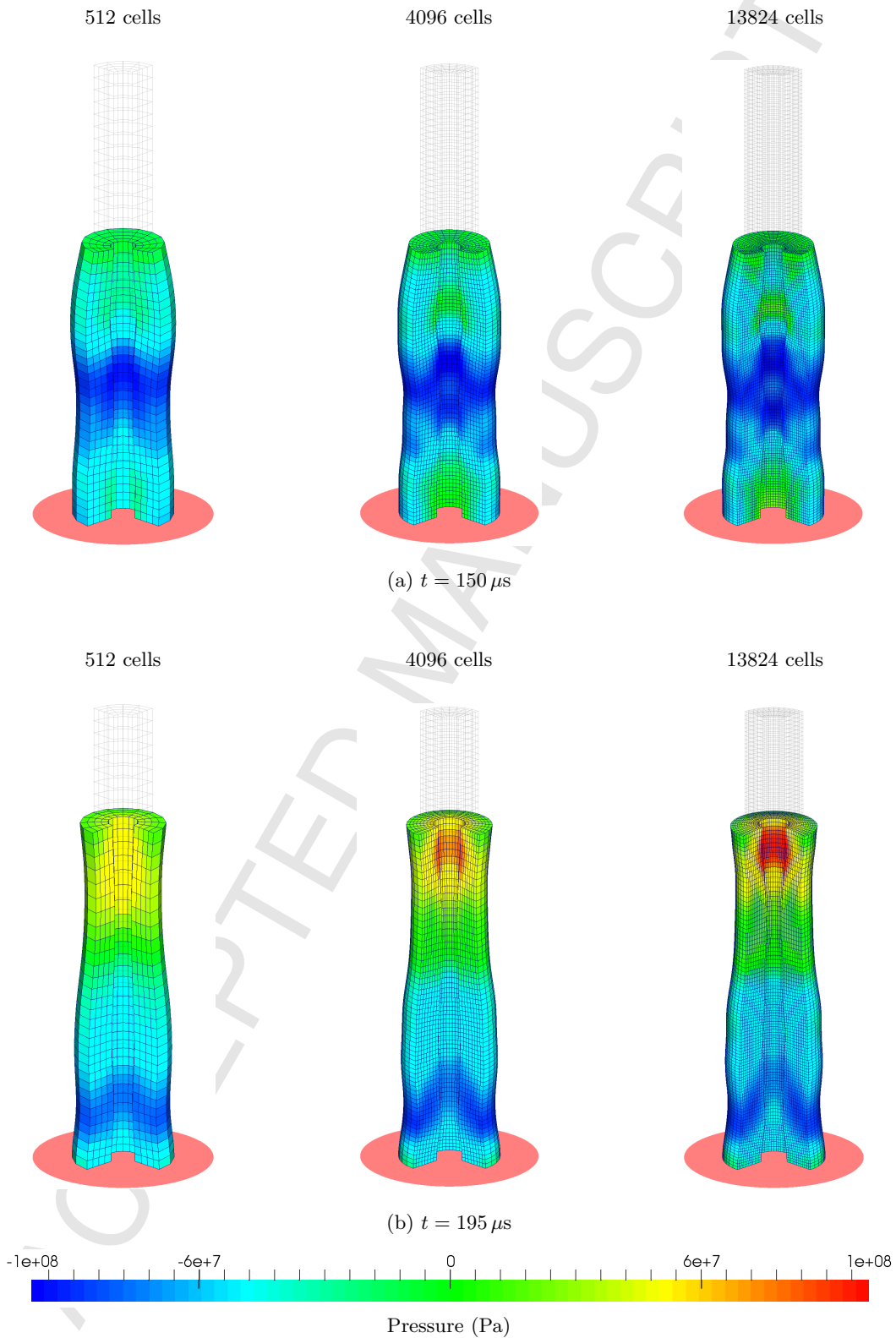

Figure 25: Bar rebound: Mesh refinement of deformed shapes along with pressure distribution at times: (a)  $t = 150 \mu\text{s}$ ; and (b)  $t = 195 \mu\text{s}$  using meshes of 512, 4096 and 13824 hexahedral elements in quarter domain. Results obtained using the  $\{\mathbf{p}, \mathbf{F}, \mathbf{H}, J\}$  C-TOUCH scheme with velocity  $\mathbf{v}_0 = [0, -100, 0]^T$  m/s. A neo-Hookean material is used with  $\rho_0 = 8930$  kg/m<sup>3</sup>,  $E = 585$  MPa,  $\nu = 0.45$  and  $\alpha_{\text{CFL}} = 0.3$ .

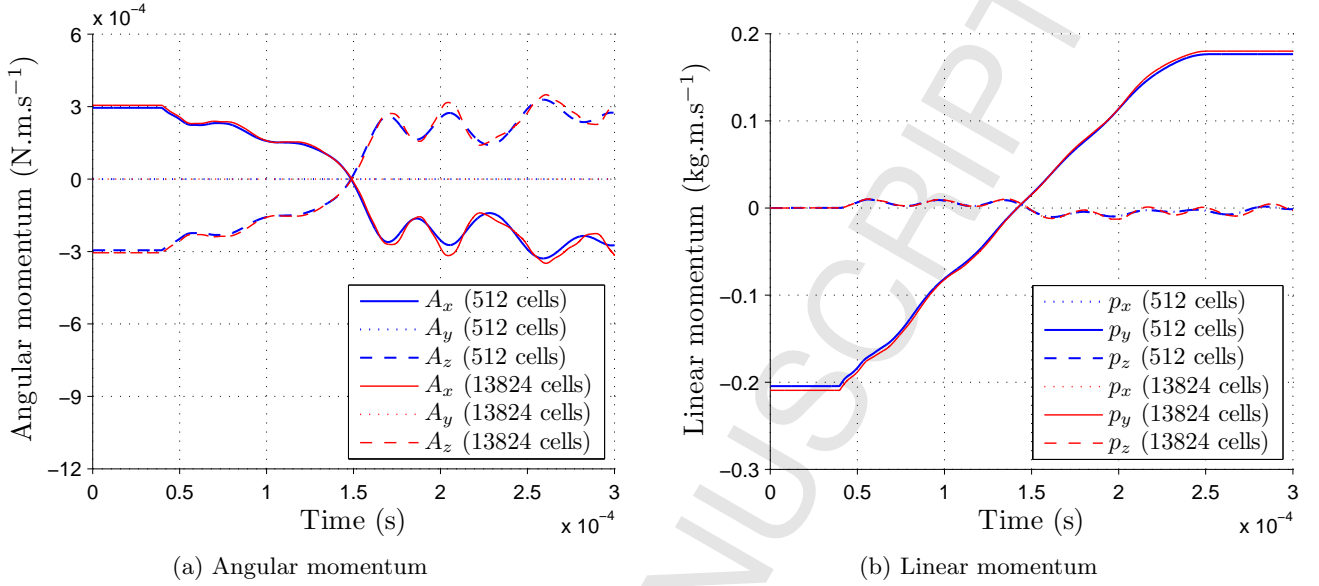

Figure 26: Bar rebound: Time evolution of components of (a) global angular momentum; and (b) global linear momentum using meshes of 512 and 13824 hexahedral elements in quarter domain. Results obtained using the  $\{\mathbf{p}, \mathbf{F}, \mathbf{H}, J\}$  C-TOUCH scheme with velocity  $\mathbf{v}_0 = [0, -100, 0]^T$  m/s. A neo-Hookean constitutive model is used with  $\rho_0 = 8930$  kg/m<sup>3</sup>,  $E = 585$  MPa,  $\nu = 0.45$  and  $\alpha_{\text{CFL}} = 0.3$ .

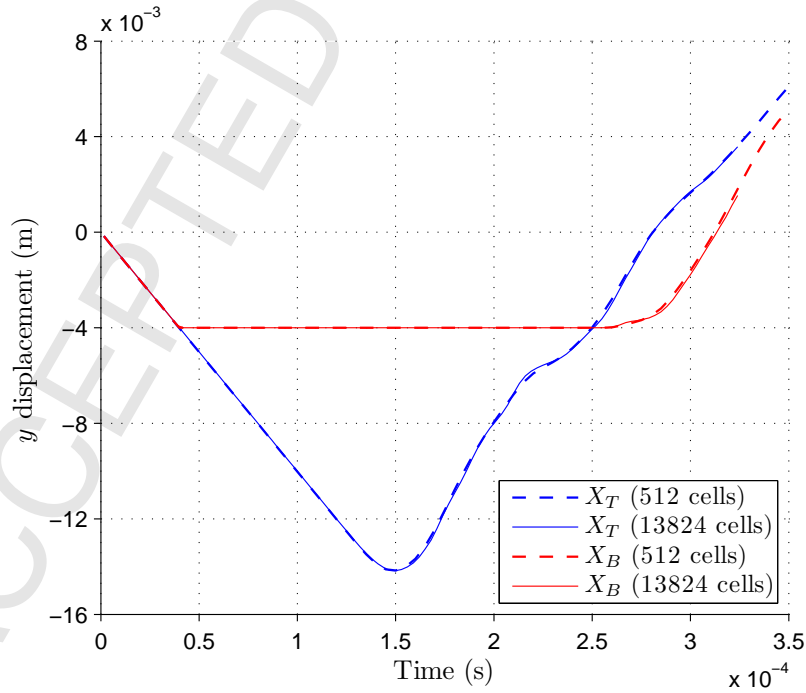

Figure 27: Bar rebound: Time evolution of vertical displacements  $u_y$  of the points on the top plane  $\mathbf{X}_T = [1/\sqrt{2}, 32.4, 1/\sqrt{2}]^T$  mm and the bottom plane  $\mathbf{X}_B = [1/\sqrt{2}, 0, 1/\sqrt{2}]^T$  mm. Results obtained with velocity  $\mathbf{v}_0 = [0, -100, 0]^T$  m/s using the  $\{\mathbf{p}, \mathbf{F}, \mathbf{H}, J\}$  C-TOUCH scheme. A neo-Hookean constitutive model is used with  $\rho_0 = 8930$  kg/m<sup>3</sup>,  $E = 585$  MPa,  $\nu = 0.45$  and  $\alpha_{\text{CFL}} = 0.3$ .

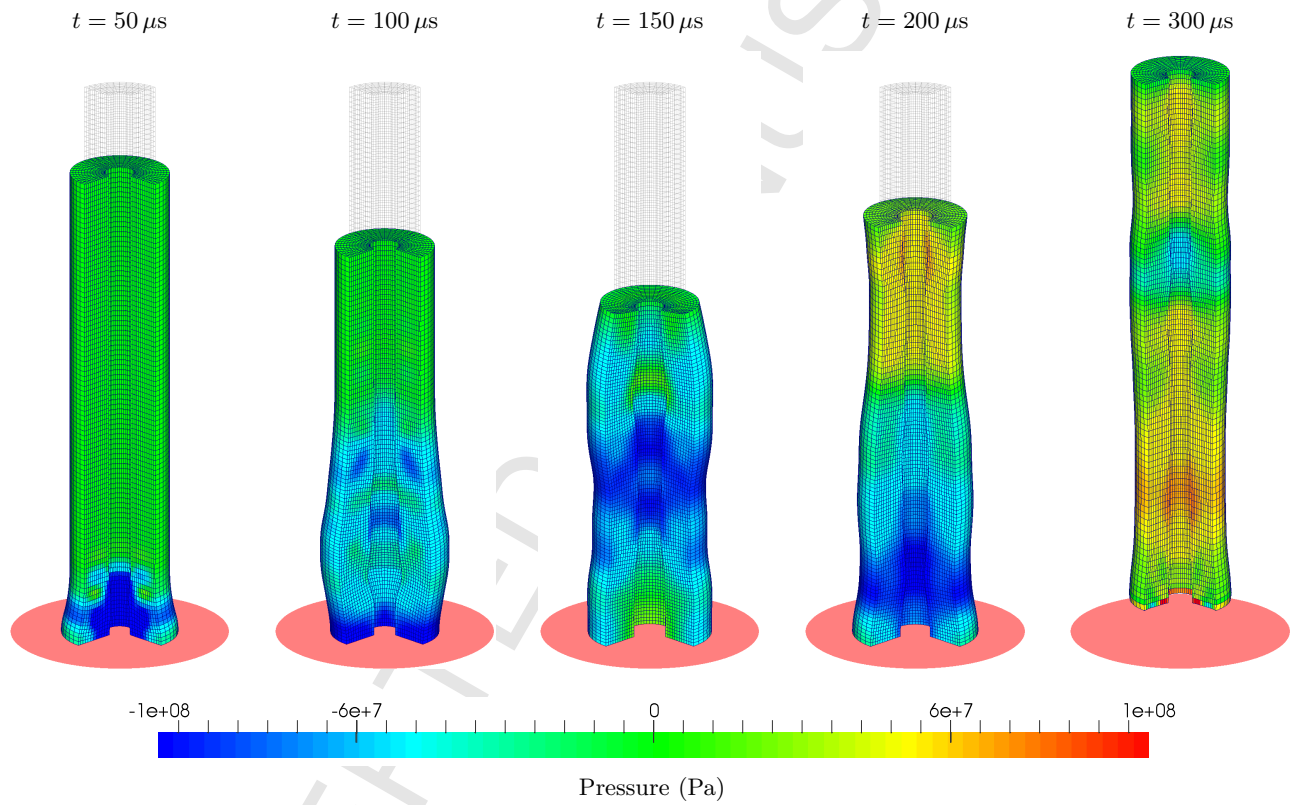

Figure 28: Bar rebound: Time evolution of the deformation along with the pressure distribution using the  $\{\mathbf{p}, \mathbf{F}, \mathbf{H}, J\}$  C-TOUCH scheme ( $\tilde{\kappa} = 3\kappa$ ). Results obtained with velocity  $\mathbf{v}_0 = [0, -100, 0]^T$  m/s using 4096 hexahedral elements. A neo-Hookean constitutive model is used with  $\rho_0 = 8930$  kg/m<sup>3</sup>,  $E = 585$  MPa,  $\nu = 0.499$ ,  $\alpha_{\text{CFL}} = 0.3$  and  $\Delta t \approx 5 \times 10^{-8}$  s.

### 8.6. Algorithm robustness

In order to assess the robustness of the algorithm, two challenging examples are presented in this section. A block, of  $1 \times 1 \text{ m}^2$  unit squared cross section with a height of  $H = 0.5 \text{ m}$ , with nine equally spaced holes of diameter  $0.2 \text{ m}$  is considered (see Fig. 29a). The block is punched with a (compressive) linear velocity profile of  $\mathbf{v}_0 = -V[0, 0, (Z/H)] \text{ m/s}$  in quarter of the domain ( $X \geq 0, Y \geq 0$ ) (see Fig. 29b). A neo-Hookean constitutive model is used where the material properties are density  $\rho = 1100 \text{ kg/m}^3$ , Young's Modulus  $E = 17 \text{ MPa}$  and Poisson's ratio  $\nu = 0.499$ .

Fig. 30 shows the time evolution of the deformation pattern with its pressure plot. The proposed method can clearly capture the extreme deformation of holes near the bottom plane ( $Z = 0$ ), as shown in Fig. 31. No spurious pressure instabilities are observed despite simulating a complex geometry which is made of a nearly incompressible material. A mesh refinement study has also been carried out in Fig. 32. In this figure, right half of the domain has been partially clipped to show the interior pressure distribution inside the domain whilst the wireframe mesh displays the deformed configuration. Remarkably, it is clear that despite increasing the number of elements from 32400 to 86400, both the deformation and pressure resolution obtained are practically identical. More importantly, Fig. 33 highlights the importance of the dimensionless parameter  $\beta := \frac{\tilde{\kappa}}{\kappa}$  used in the preconditioned Riemann solver. When using the value of  $\tilde{\kappa} = \kappa$  (which recovers the elastic wave speeds  $\{c_p, c_s\}$  presented in (29)), spurious pressure mode is accumulated over time which would eventually lead to breakdown of the numerical scheme. This shortcoming can be eliminated when resorting to preconditioning with the value of  $\tilde{\kappa} = 3\kappa$  in order to obtain a correct scaling for numerical stabilisation.

In the very last example, robustness of the proposed C-TOUCH scheme on a rather complex geometry is shown. The geometry<sup>4</sup> displayed in Fig. 34a is very similar to a cardiovascular stent widely used in biomedical applications. This stent-like structure has an initial outer diameter of  $D_O = 10 \text{ mm}$ , a thickness of  $T = 0.1 \text{ mm}$  and a total length of  $L = 20 \text{ mm}$ . For clarity, the dimensions of one of the repeated patterns on a planar surface are shown in Fig. 34b. In this problem, we show crushing behaviour of the stent-like structure by applying a constant traction of  $\mathbf{t}_b = [0, 0, -100]^T \text{ kPa}$  at the top and bottom of the structure along the  $X$ - $Z$  plane. Due to the presence of three symmetry planes, one eighth of

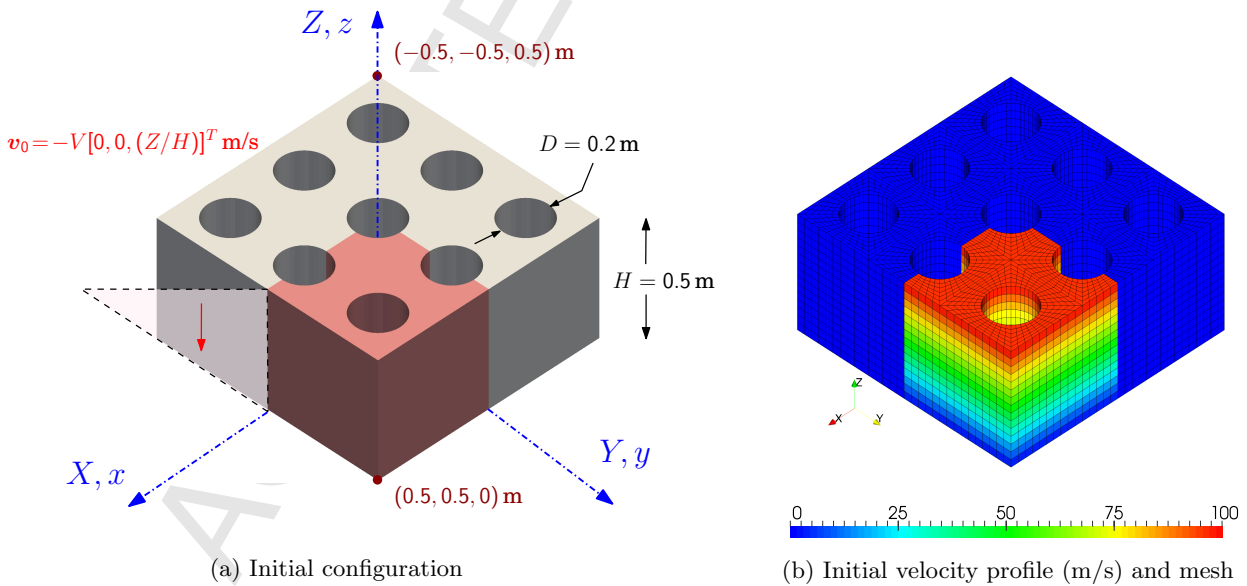

Figure 29: Punch test: Problem setup.

<sup>4</sup> The CAD is freely available at [www.grabcad.com](http://www.grabcad.com)

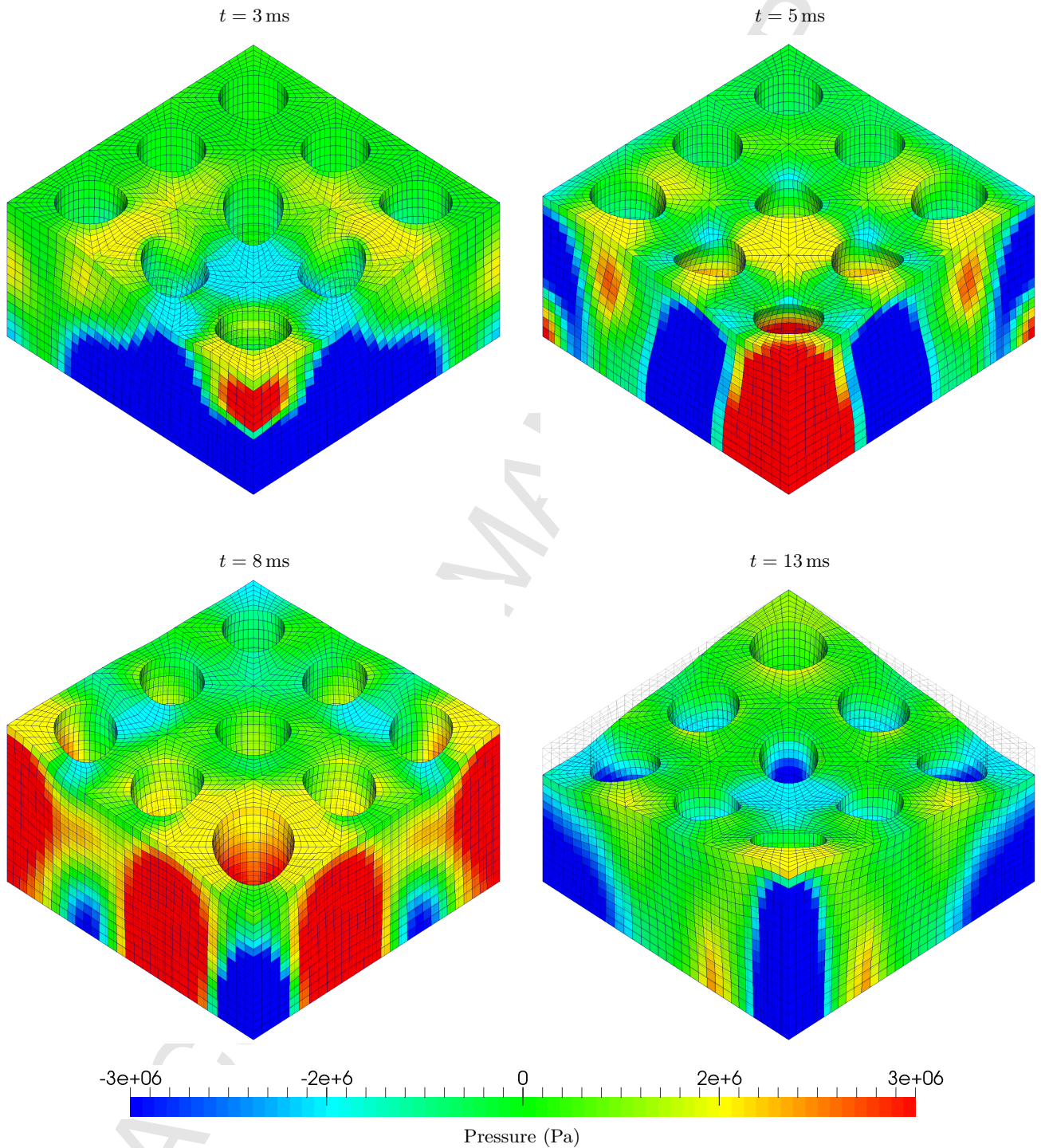

Figure 30: Punch cube: Sequence of deformed shapes plotted with pressure distribution using the  $\{\mathbf{p}, \mathbf{F}, \mathbf{H}, J\}$  C-TOUCH scheme with  $\bar{\kappa} = 3\kappa$ . Results obtained with a discretisation of 32400 hexahedral elements using velocity  $\mathbf{v}_0 = -V[0, 0, (Z/H)]^T$  where  $V = 100$  m/s and  $H = 0.5$  m. A neo-Hookean constitutive model is used with  $\rho = 1100$  kg/m<sup>3</sup>,  $E = 17$  MPa,  $\nu = 0.499$  and  $\alpha_{\text{CFL}} = 0.3$ .



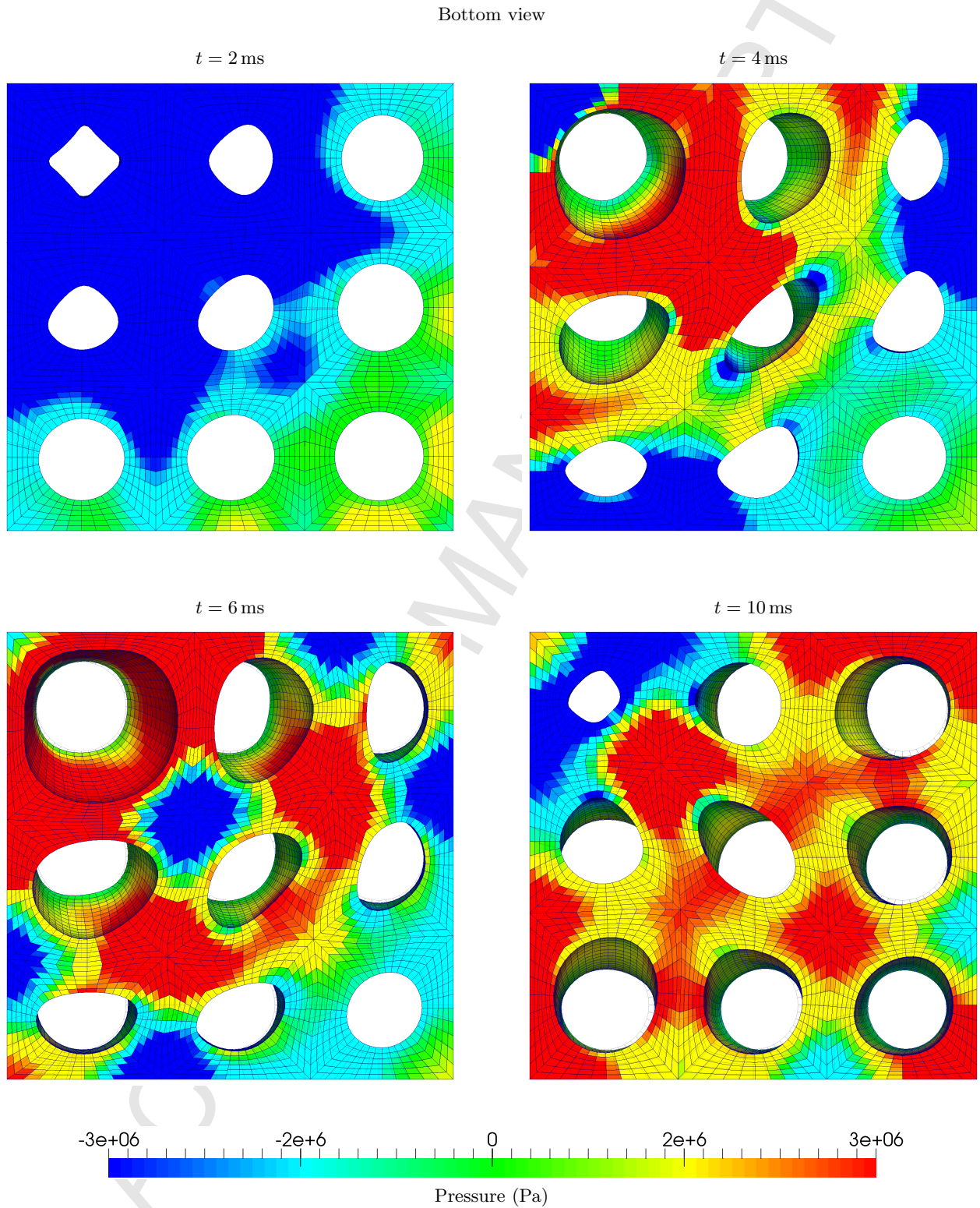

Figure 31: Punch cube: Sequence of deformed shapes plotted with pressure distribution emphasising bottom view using the  $\{p, \mathbf{F}, \mathbf{H}, J\}$  C-TOUCH scheme with  $\tilde{\kappa} = 3\kappa$ . Results obtained with a discretisation of 32400 hexahedral elements using velocity  $\mathbf{v}_0 = -V [0, 0, (Z/H)]^T$  where  $V = 100$  m/s and  $H = 0.5$  m. A neo-Hookean constitutive model is used with  $\rho = 1100$  kg/m<sup>3</sup>,  $E = 17$  MPa,  $\nu = 0.499$  and  $\alpha_{\text{CFL}} = 0.3$ .



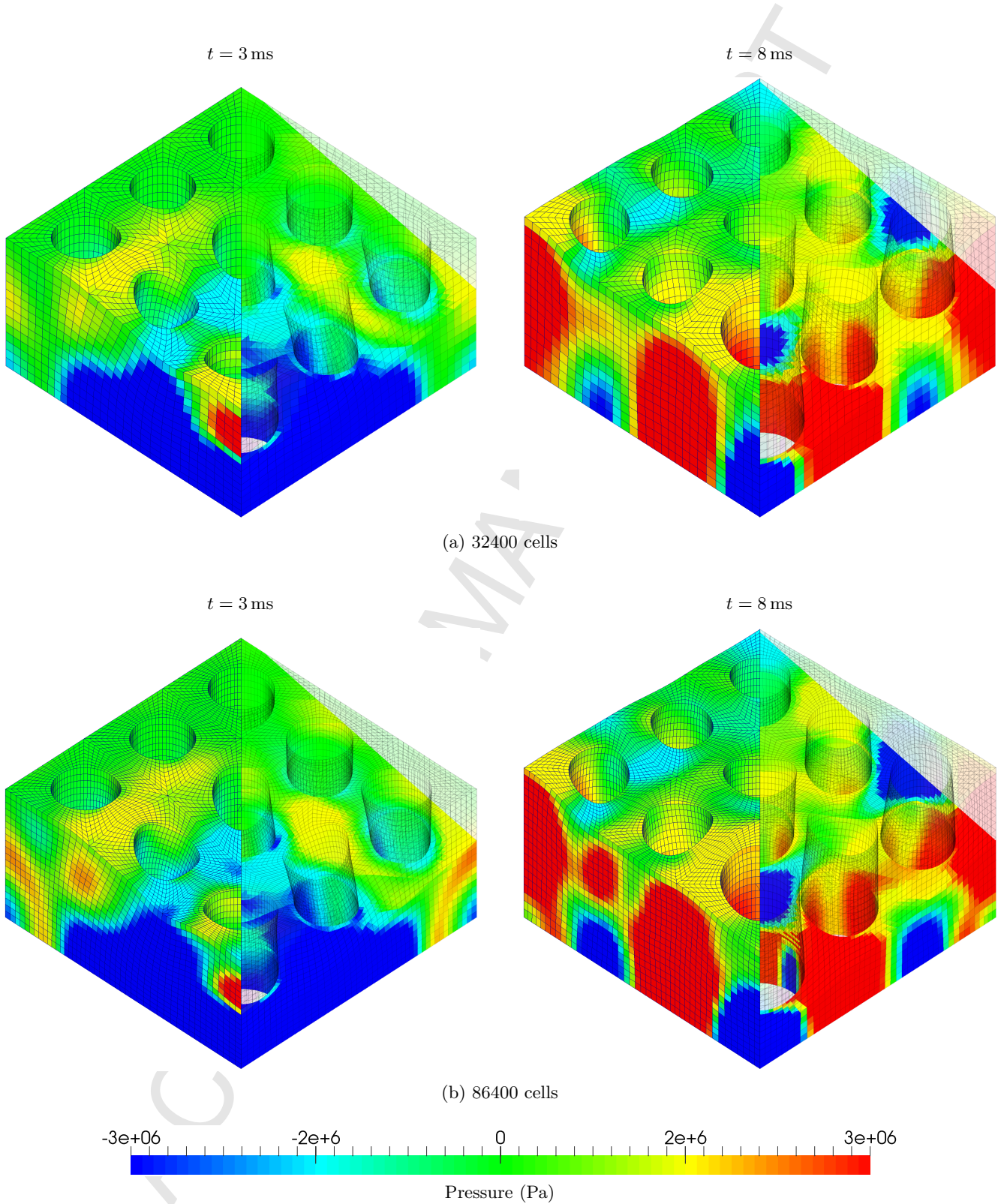

Figure 32: Punch cube: Mesh refinement of deformed shapes along with pressure distribution at times  $t = 3$  ms and  $t = 8$  ms using mesh sizes of (a) 32400; and (b) 86400 hexahedral elements. Results obtained using the  $\{p, \mathbf{F}, \mathbf{H}, J\}$  C-TOUCH scheme using  $\tilde{\kappa} = 3\kappa$  with velocity  $\mathbf{v}_0 = -V [0, 0, (Z/H)]^T$  where  $V = 100$  m/s and  $H = 0.5$  m. A neo-Hookean constitutive model is utilised with  $\rho = 1100$  kg/m<sup>3</sup>,  $E = 17$  MPa,  $\nu = 0.499$  and  $\alpha_{CFL} = 0.3$ .

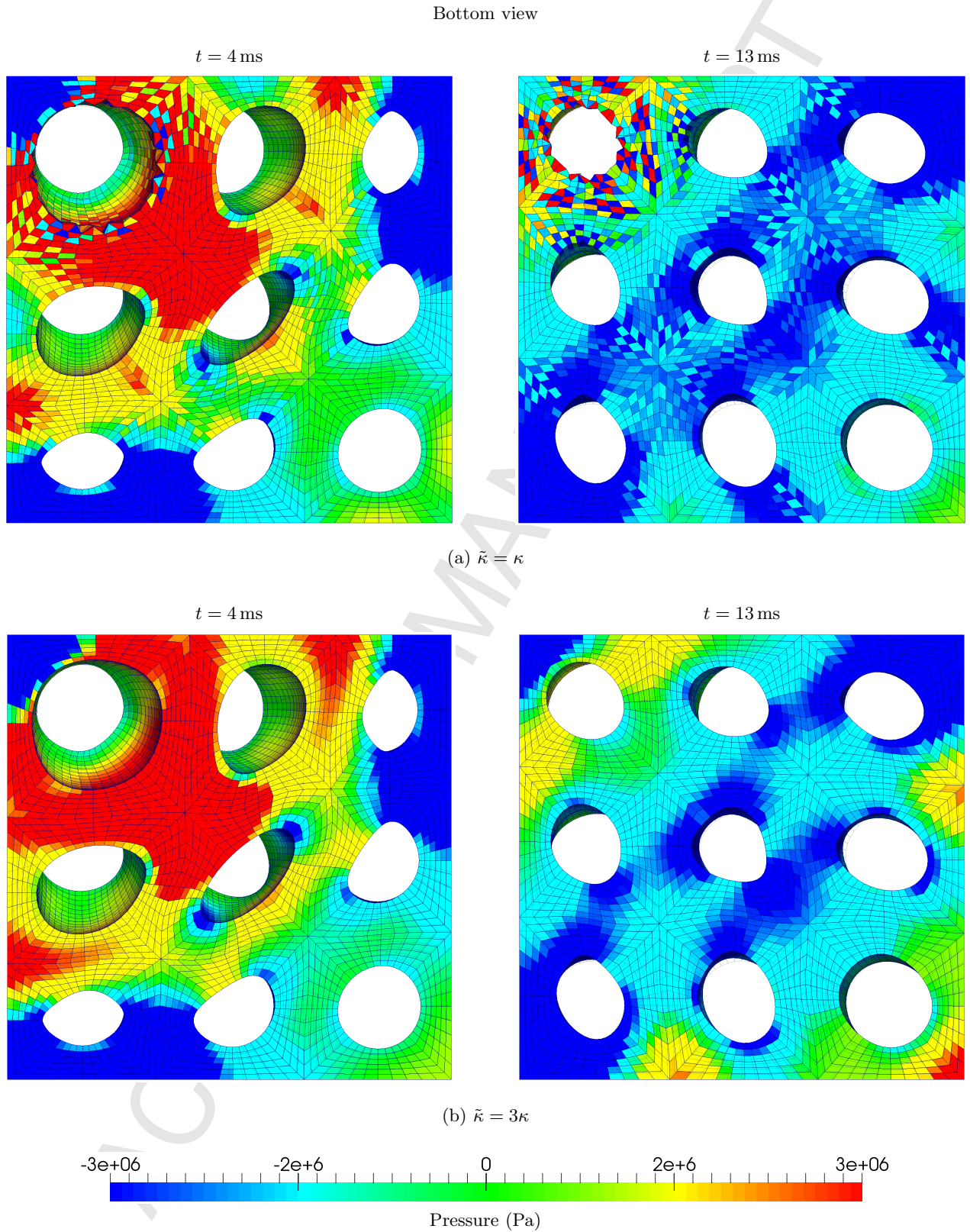

Figure 33: Punch cube: Comparison of deformed shapes plotted with pressure distribution using the  $\{p, \mathbf{F}, \mathbf{H}, J\}$  C-TOUCH scheme with (a)  $\tilde{\kappa} = \kappa$ ; and (b)  $\tilde{\kappa} = 3\kappa$ . Results obtained with a discretisation of 32400 hexahedral elements using velocity  $\mathbf{v}_0 = -V[0, 0, (Z/H)]^T$  where  $V = 100 \text{ m/s}$  and  $H = 0.5 \text{ m}$ . A neo-Hookean constitutive model is used with  $\rho = 1100 \text{ kg/m}^3$ ,  $E = 17 \text{ MPa}$ ,  $\nu = 0.499$  and  $\alpha_{\text{CFL}} = 0.3$ .

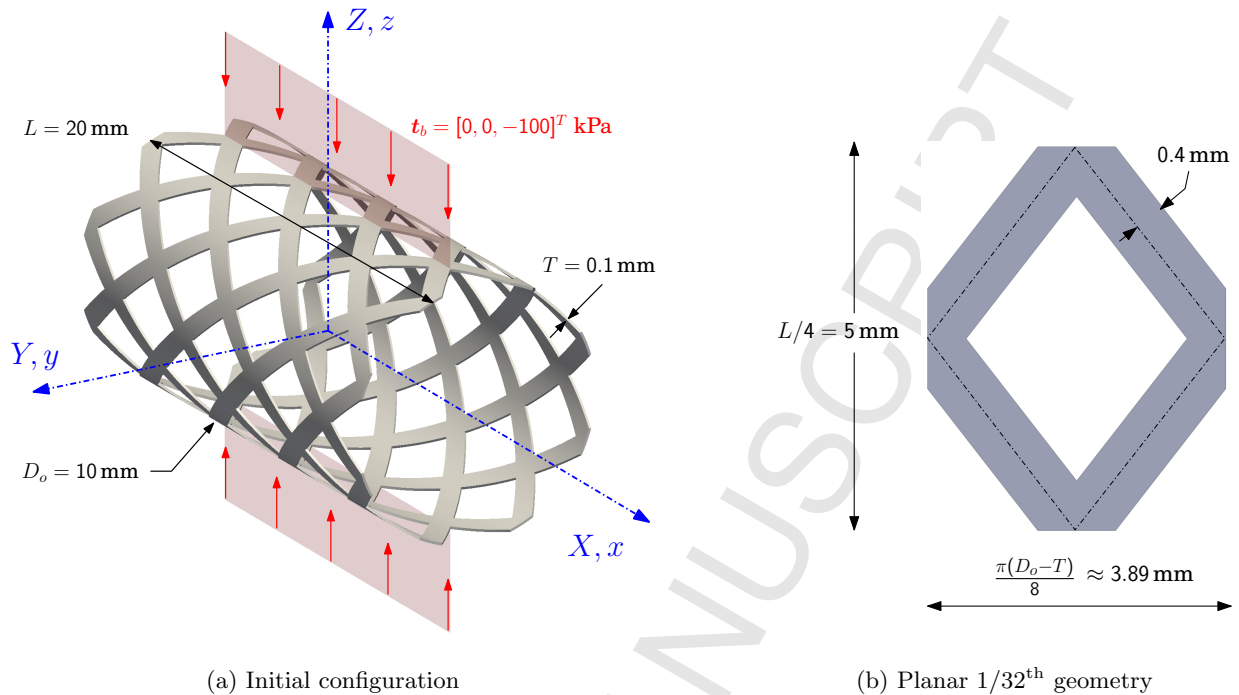

Figure 34: Stent-like structure: Problem setup.

the problem is simulated with appropriate boundary conditions. The structure is modelled with a neo-Hookean material defined with density  $\rho_0 = 1100 \text{ kg/m}^3$ , Young's Modulus  $E = 17 \text{ MPa}$  and Poisson's ratio  $\nu = 0.45$ .

Fig. 35 shows the crushing behaviour pattern of the stent-like structure. Following the bending problem analysed earlier in Section 8.3, only two elements (cells) are employed across the thickness to deform the stent. It is remarkable seeing how the deformation behaviour of the structure can be captured on a rather complex geometry. For visualisation purposes, Fig. 36 displays the overall deformation of the stent-like structure at time  $t = 500 \mu\text{s}$ , with zoomed views in critical areas of sharp spatial gradients. Very smooth pressure field is observed around sharp corners of the structure. A grid independence study has also been carried out in Fig. 37 at time  $t = 400 \mu\text{s}$ . As the mesh is refined from 6912 elements (2 cells across the thickness) to 43648 elements (4 cells across the thickness), practically identical deformation is obtained. However, as expected, the pressure resolution is enhanced when more elements are employed. To further examine the robustness of the algorithm, we use a larger value of Poisson's ratio  $\nu = 0.499$  which leads to the incompressible limit of  $\frac{\kappa}{\mu} \approx 500$ . As can be observed in the first row of Fig. 38, the pressure field is plotted constant per cell without resorting to any sort of visual nodal interpolation. Alternatively, a nodal averaging process could also be used to display the results, refer to the second row of Fig. 38. The proposed framework, once again, seems very efficient when handling nearly incompressible materials on complicated geometries. This will provide a platform for the modelling of biomedical applications in the near future.

## 9. Conclusions

In this paper, we present a new computational framework for the numerical analysis of large strain fast solid dynamics, with special attention paid to the case of near incompressibility. A complete set of first order conservation laws [56–59] is presented, where the linear momentum  $\mathbf{p}$  conservation equation is solved in conjunction with three geometric conservation equations for the minors of the deformation tensor (e.g. one for the deformation gradient  $\mathbf{F}$ , one for the co-factor of the deformation gradient  $\mathbf{H}$  and one for the Jacobian of the deformation gradient  $J$ ). For closure of the system, a polyconvex model is employed



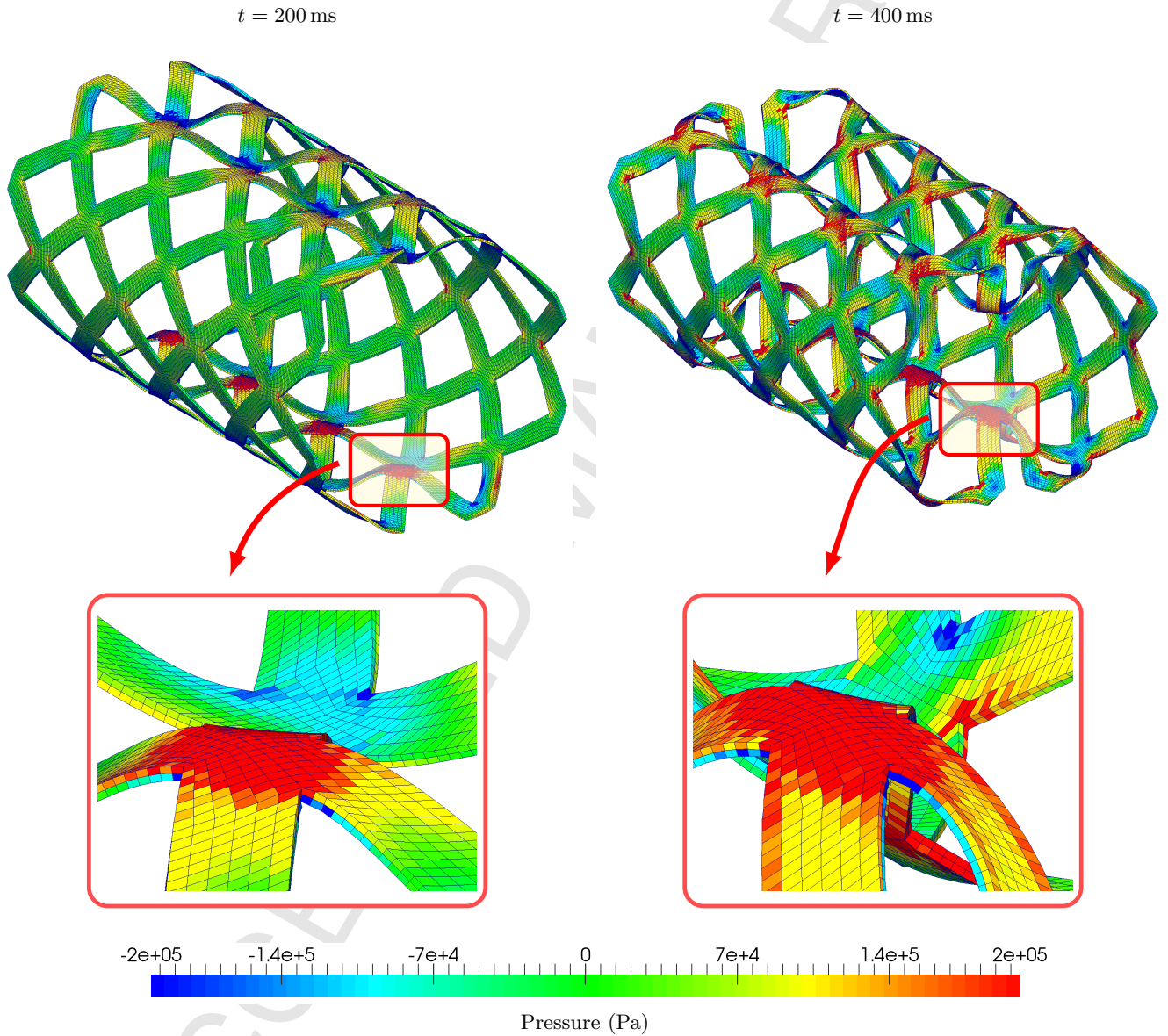

51 Figure 35: Stent-like structure: Sequence of deformed shapes plotted with pressure distribution using the  $\{p, \mathbf{F}, \mathbf{H}, J\}$  C-  
 52 TOUCH scheme. Results obtained with a discretisation of 6912 hexahedral elements using traction loading  $\mathbf{t}_b = [0, 0, -100]^T$   
 53 kPa. A neo-Hookean material is used with  $\rho = 1100$  kg/m<sup>3</sup>,  $E = 17$  MPa,  $\nu = 0.45$ ,  $\alpha_{\text{CFL}} = 0.3$  and  $\Delta t \approx 5 \times 10^{-8}$  s.  
 54  
 55  
 56  
 57  
 58  
 59  
 60  
 61  
 62  
 63  
 64  
 65

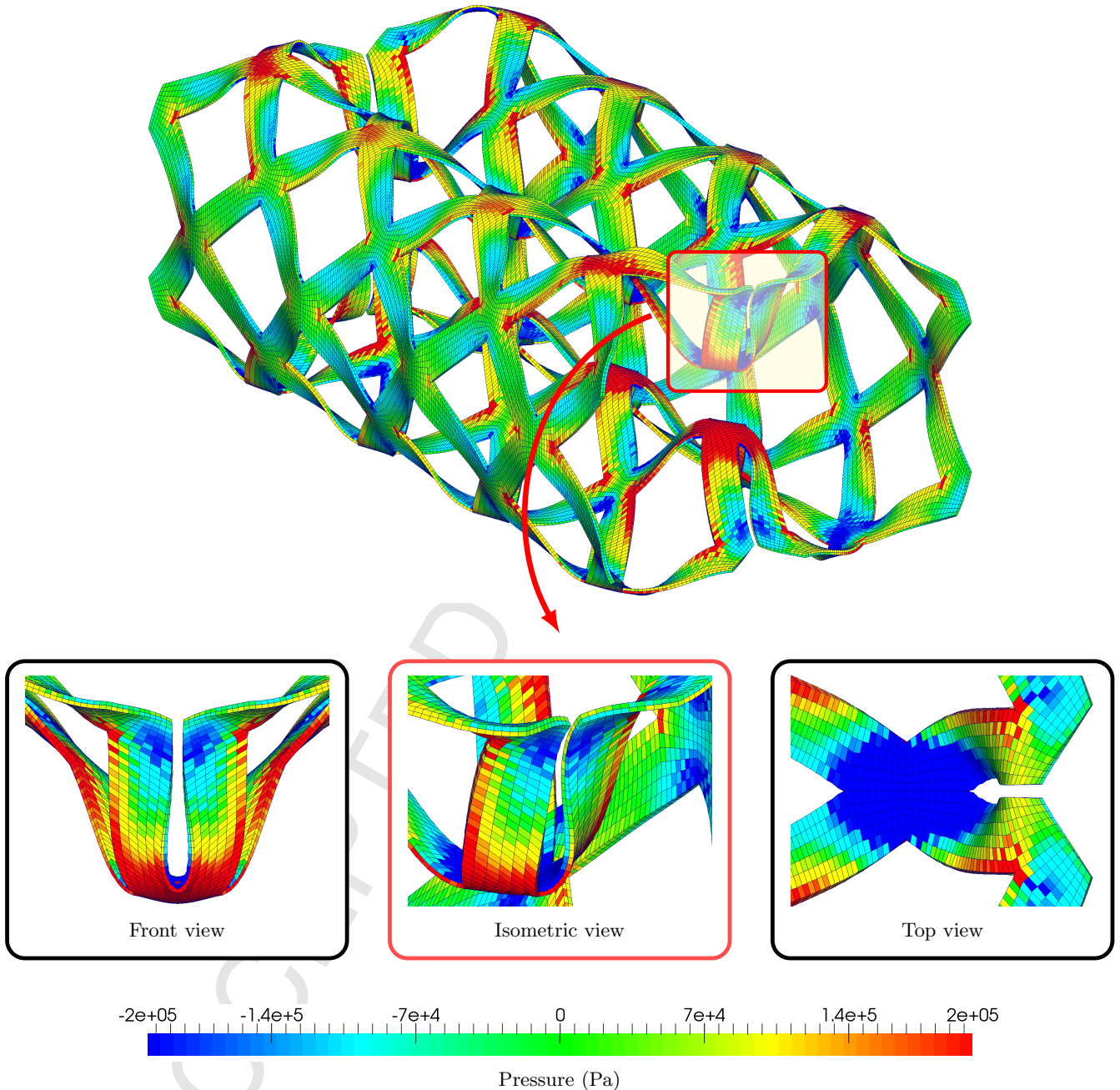

Figure 36: Stent-like structure: Snapshot of deformed shape highlighting the pressure distribution in key region using  $\{\mathbf{p}, \mathbf{F}, \mathbf{H}, J\}$  C-TOUCH scheme at time  $t = 500 \mu\text{s}$ . Results obtained with a discretisation of 6912 hexahedral elements using traction loading  $\mathbf{t}_b = [0, 0, -100]^T$  kPa. A neo-Hookean material is used with  $\rho = 1100 \text{ kg/m}^3$ ,  $E = 17 \text{ MPa}$ ,  $\nu = 0.45$  and  $\alpha_{\text{CFL}} = 0.3$ .



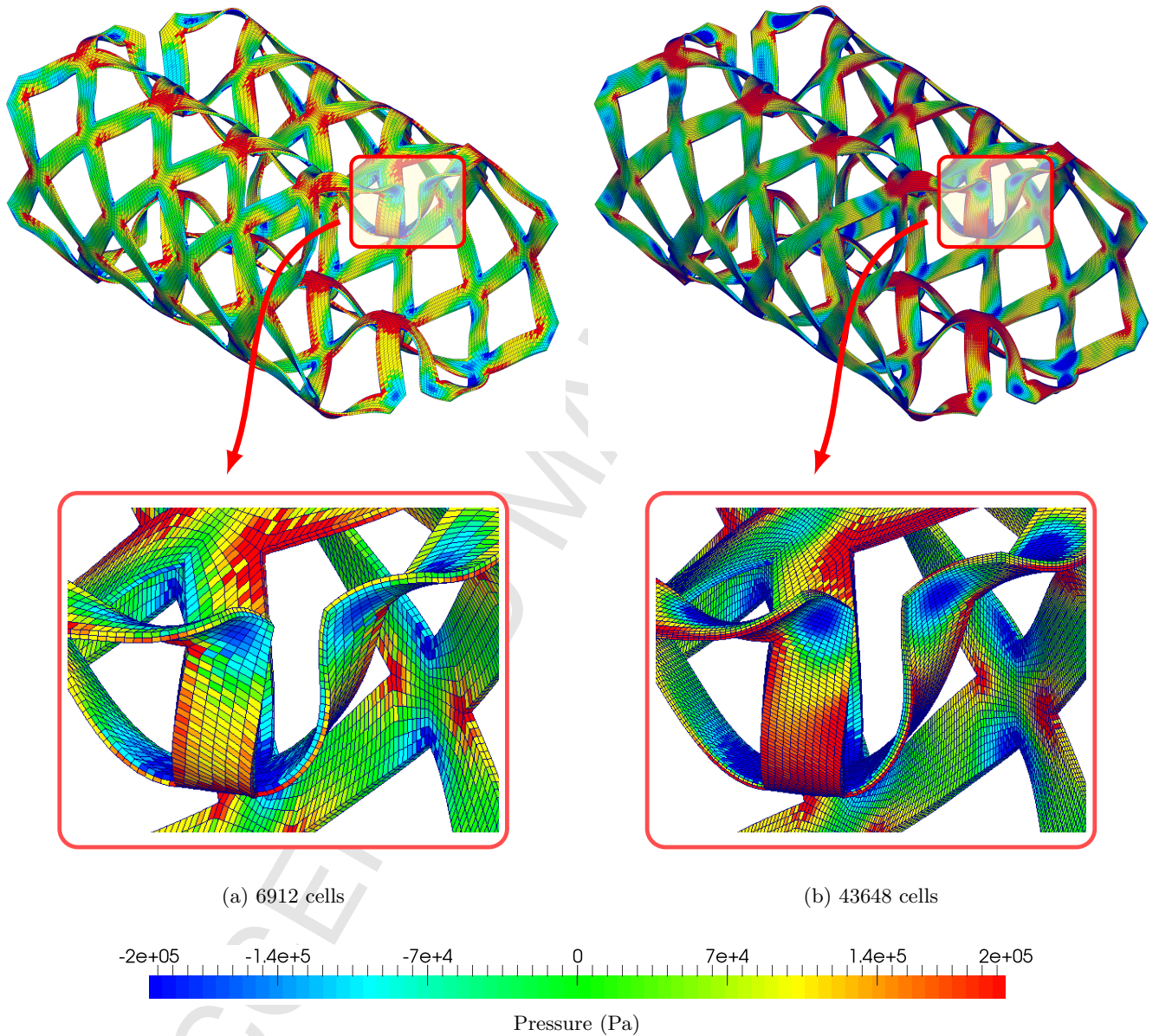

Figure 37: Stent-like structure: Mesh refinement of deformed shapes plotted with pressure distribution at time  $t = 400 \mu\text{s}$  using the  $\{\mathbf{p}, \mathbf{F}, \mathbf{H}, J\}$  C-TOUCH scheme. Results obtained with a discretisation of 6912 and 43648 hexahedral elements using traction loading  $\mathbf{t}_b = [0, 0, -100]^T$  kPa. A neo-Hookean material is used with  $\rho = 1100 \text{ kg/m}^3$ ,  $E = 17 \text{ MPa}$ ,  $\nu = 0.45$  and  $\alpha_{\text{CFL}} = 0.3$ .

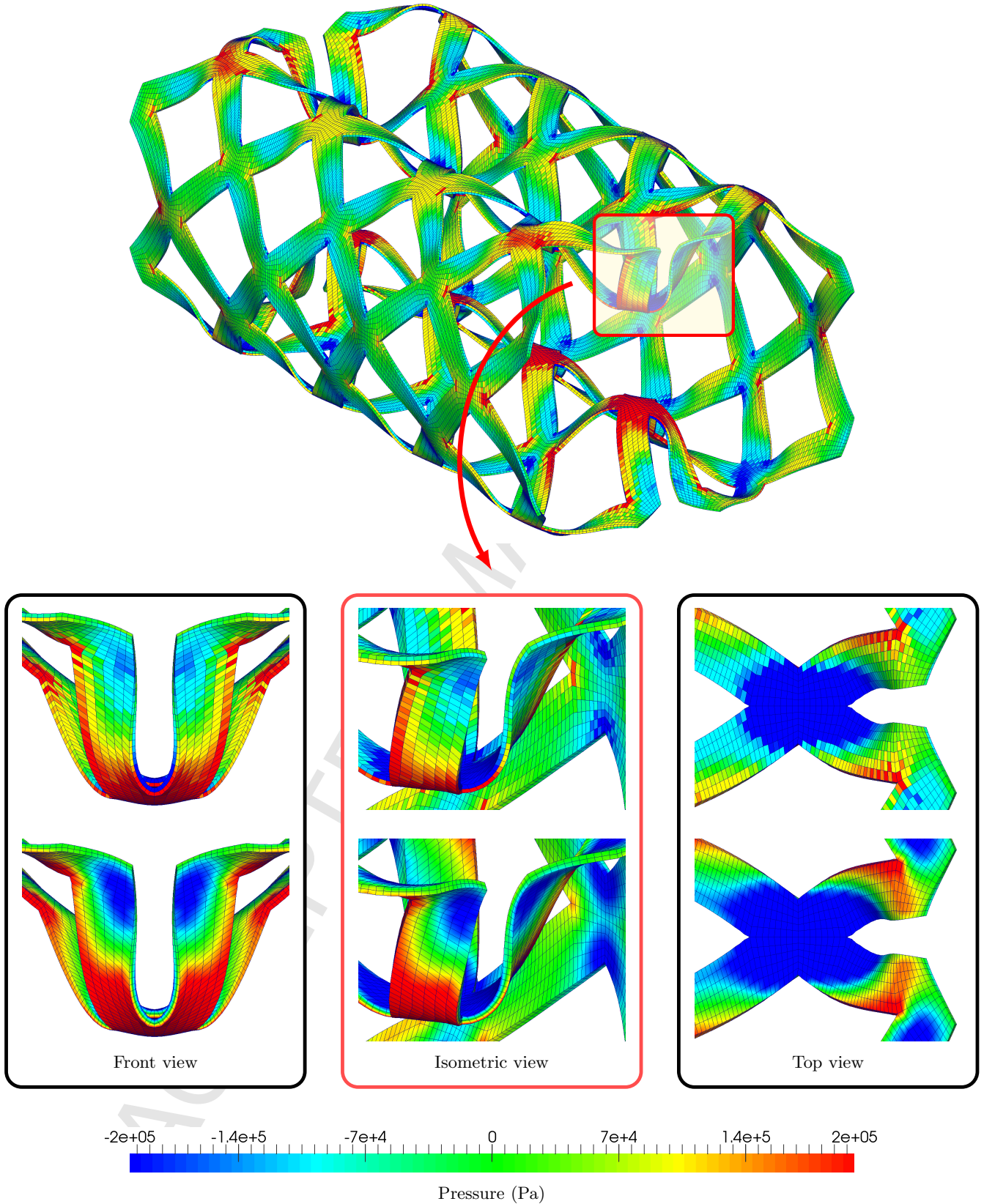

Figure 38: Stent-like structure: Snapshot of deformed shape highlighting the pressure distribution in key region using  $\{\mathbf{p}, \mathbf{F}, \mathbf{H}, J\}$  C-TOUCH scheme ( $\tilde{\kappa} = 3\kappa$ ) at time  $t = 500 \mu\text{s}$ . The first row shows the cell center pressure whereas the second row displays the interpolated/extrapolated pressure at the nodes. Results obtained with a discretisation of 6912 hexahedral elements using traction loading  $\mathbf{t}_b = [0, 0, -100]^T \text{ kPa}$ . A neo-Hookean material is used with  $\rho = 1100 \text{ kg/m}^3$ ,  $E = 17 \text{ MPa}$ ,  $\nu = 0.499$  and  $\alpha_{\text{CFL}} = 0.3$ .

1  
2  
3 guaranteeing the existence of real wave speeds, and thus material stability [2, 57]. The formulation has  
4 an eye on bridging the gap between Computational Fluid Dynamics and large strain solid dynamics, with  
5 its tailor-made implementation from scratch within the modern Computational Fluid Dynamics code  
6 “OpenFOAM”.

7  
8 From the spatial discretisation viewpoint, an acoustic Riemann solver combined with a preconditioning  
9 procedure [63–65] is presented. It has been shown that the preconditioned Riemann solver (with a correct  
10 scaling of the numerical stabilisation) effectively alleviates the appearance of spurious pressure modes  
11 when attempting to model nearly incompressible solids ( $\kappa/\mu > 500$ ). For comparison purposes, an  
12 alternative Total Lagrangian version of the nodal scheme presented in [2], in conjunction with a global  
13 posteriori angular momentum projection algorithm, has also been implemented in “OpenFOAM”. Finally,  
14 an extensive set of challenging numerical examples is presented in order to assess the accuracy, reliability  
15 and robustness of the proposed methodologies. The proposed framework shows excellent behaviour in  
16 nearly incompressible bending dominated scenarios, yielding second order of convergence for velocities,  
17 deviatoric and volumetric components of the stress.

18  
19 Taking advantage of the new  $\{\mathbf{p}, \mathbf{F}, \mathbf{H}, J\}$  computational framework, the authors will now further  
20 explore (1) the adaptation of Roe-type Riemann solvers [83] to solids, (2) the ability to model large  
21 strain thermoelasticity problems, and (3) an alternative Arbitrary Lagrangian-Eulerian description in  
22 large strain solid dynamics [15–17].  
23  
24

## 25 26 10. Acknowledgements

27  
28 The first author acknowledges the financial support provided by “The Erasmus Mundus Joint Doc-  
29 torate SEED” programme and the European Regional Development Fund (ERDF) funded project “AS-  
30 TUTE 2020 Operation”. The second and third authors would like to acknowledge the financial support  
31 received through the Sér Cymru National Research Network for Advanced Engineering and Materials,  
32 United Kingdom.  
33  
34

## 35 36 Appendix A. Hyperbolicity

37  
38 This Appendix is included to present the eigen-structure (consists of eigenvalues and eigenvectors) of  
39 a modified flux Jacobian matrix  $\mathcal{A}_N$ . This is necessary when considering the acoustic Riemann solver in  
40 conjunction with a preconditioning procedure, described as follows  
41

$$42 \quad \mathcal{F}_N^C = \frac{1}{2} [\mathcal{F}_N(\mathbf{u}^-) + \mathcal{F}_N(\mathbf{u}^+)] - \underbrace{\frac{1}{2} \mathcal{P}^{-1} |\mathcal{P} \mathcal{A}_N| (\mathbf{u}^+ - \mathbf{u}^-)}_{\text{Preconditioned numerical stabilisation}}. \quad (\text{A.1})$$

43  
44  
45  
46 To achieve this, and for simplicity, a compressible Mooney Rivlin model described in Reference [57] (refer  
47 to equations (20), (22), (24) and (27) in Section 3.3 on pg. 694-695) is considered [57]  
48

$$49 \quad W(\mathbf{F}, \mathbf{H}, J) = \alpha(\mathbf{F} : \mathbf{F}) + \gamma(\mathbf{H} : \mathbf{H}) + f(J), \quad (\text{A.2})$$

50  
51 where  $f(J) = -4\gamma J - 2\alpha \ln J + \frac{\lambda}{2}(J - 1)^2$ ,  $\{\alpha, \gamma, \lambda\}$  are material parameters defined such that  $\alpha + \gamma = \frac{\mu}{2}$   
52 [57] and  $\mu$  represents the shear modulus.  
53

54 Analogously to the procedure presented in [1] (see Appendix A from pg. 451 to pg. 453), with the aid  
55 of (34) and (A.2), the modified eigen-problem by considering each individual component of this system  
56  
57  
58  
59  
60  
61  
62  
63  
64  
65



becomes

$$c_\alpha \mathbf{p}_\alpha = -2\alpha \mathbf{F}_\alpha \mathbf{N} - (2\gamma \mathbf{F} \times \mathbf{H}_\alpha) \mathbf{N} - f'' J_\alpha \mathbf{H} \mathbf{N}; \quad (\text{A.3a})$$

$$c_\alpha \mathbf{F}_\alpha = -\frac{\beta^2}{\rho_0} (\mathbf{p}_\alpha \otimes \mathbf{N}); \quad (\text{A.3b})$$

$$c_\alpha \mathbf{H}_\alpha = -\frac{\beta^2}{\rho_0} [\mathbf{F} \times (\mathbf{p}_\alpha \otimes \mathbf{N})]; \quad (\text{A.3c})$$

$$c_\alpha J_\alpha = -\frac{1}{\beta^2 \rho_0} \mathbf{p}_\alpha \cdot \mathbf{H} \mathbf{N}, \quad (\text{A.3d})$$

with  $f'' := \frac{d^2 f}{dJ^2} = \lambda + \frac{2\alpha}{J^2}$ .

As a consequence of the high level of redundancy in the system of equations being considered, only six wave speeds are different from zero. These can be readily identified by substituting the last three geometric strain equations (A.3b-A.3d) into (A.3a) to give:

$$\left[ 2\alpha\beta^2 \mathbf{p}_\alpha + \frac{f''}{\beta^2} \Lambda_A^2 (\mathbf{n} \otimes \mathbf{n}) \mathbf{p}_\alpha + 2\gamma\beta^2 (\Lambda_T^2 \mathbf{I} - \Lambda_T) \mathbf{p}_\alpha \right] = \rho_0 c_\alpha^2 \mathbf{p}_\alpha, \quad (\text{A.4})$$

where the following notations have been used

$$\begin{aligned} \Lambda_A \mathbf{n} &= \mathbf{H} \mathbf{N}; \\ \Lambda_A^2 &= \mathbf{H} \mathbf{N} \cdot \mathbf{H} \mathbf{N}; \\ \Lambda_T &= \mathbf{F} \mathbf{T}_1 \otimes \mathbf{F} \mathbf{T}_1 + \mathbf{F} \mathbf{T}_2 \otimes \mathbf{F} \mathbf{T}_2; \\ \Lambda_T^2 &= \mathbf{F} \mathbf{T}_1 \cdot \mathbf{F} \mathbf{T}_1 + \mathbf{F} \mathbf{T}_2 \cdot \mathbf{F} \mathbf{T}_2 = \text{tr} \Lambda_T. \end{aligned} \quad (\text{A.5})$$

Note that  $\mathbf{T}_{1,2}$  denote an arbitrary pair of orthogonal unit vectors on the reference plane with surface normal  $\mathbf{N}$  and  $\mathbf{n}$  is a unit vector orthogonal to the vectors  $\mathbf{F} \mathbf{T}_{1,2}$  which lie on the propagation surface. The first set of eigenvalues corresponding to  $p$ -waves is obtained by taking  $\mathbf{p}_\alpha = \mathbf{n}$  to give,

$$c_{1,2} = c_p; \quad c_p = \pm \sqrt{\frac{(2\alpha\beta^2 + 2\gamma\beta^2 \Lambda_T^2 + \frac{f''}{\beta^2} \Lambda_A^2)}{\rho_0}}. \quad (\text{A.6})$$

The remaining four eigenvalues correspond to shear waves where the vibration takes place on the propagation plane. The corresponding velocity vectors are orthogonal to  $\mathbf{n}$  and in the directions of the unit eigenvectors  $\{\mathbf{t}_1, \mathbf{t}_2\}$  of the rank two tensor  $\Lambda_T$ . The wave speeds are given by  $c_{3,4} = c_{s_1}$  and  $c_{5,6} = c_{s_2}$ , where

$$c_{s_1} = \pm \beta \sqrt{\frac{(2\alpha + 2\gamma(\Lambda_T^2 - \lambda_1^2))}{\rho_0}}; \quad c_{s_2} = \pm \beta \sqrt{\frac{(2\alpha + 2\gamma(\Lambda_T^2 - \lambda_2^2))}{\rho_0}} \quad (\text{A.7})$$

and  $\lambda_{1,2}^2$  are the eigenvalues of  $\Lambda_T$ .

In the case of neo-Hookean model (i.e. by imposing the values of  $\alpha = \frac{\mu}{2}$  and  $\gamma = 0$ ), both the pressure and shear wave speeds evaluated at the initial undeformed configuration ( $\mathbf{F} = \mathbf{H} = \mathbf{I}$  and  $J = 1$ ) become

$$c_{1,2} = \frac{1}{\beta} \sqrt{\frac{\lambda + \mu(\beta^4 + 1)}{\rho_0}}; \quad c_{3,4} = c_{5,6} = \beta \sqrt{\frac{\mu}{\rho_0}}, \quad (\text{A.8})$$

where the dimensionless parameter  $\beta$  is defined as  $\beta := \frac{\tilde{\kappa}}{\kappa}$  and  $\tilde{\kappa}$  is a user-defined material constant, usually taken in the neighbourhood of the bulk modulus  $\kappa$  of the material. The wave speeds  $c_{1,2}$  presented in (A.8a) reduces to

$$c_{1,2} \approx \frac{1}{\beta} \sqrt{\frac{\kappa}{\rho_0}}, \quad (\text{A.9})$$

when approaching the limit of incompressibility ( $\kappa \gg \mu$ ).

Utilising equation (A.3), the corresponding right eigenvectors are obtained after some simple algebra

$$\mathcal{R}_{1,2} = \begin{bmatrix} \mathbf{n} \\ -\frac{\beta^2}{\rho_0 c_{1,2}} \mathbf{n} \otimes \mathbf{N} \\ -\frac{\beta^2}{\rho_0 c_{1,2}} \mathbf{F} \times (\mathbf{n} \otimes \mathbf{N}) \\ -\frac{\Lambda_A}{\beta^2 \rho_0 c_{1,2}} \end{bmatrix}; \quad \mathcal{R}_{3,4} = \begin{bmatrix} \mathbf{t}_1 \\ -\frac{\beta^2}{\rho_0 c_{3,4}} \mathbf{t}_1 \otimes \mathbf{N} \\ -\frac{\beta^2}{\rho_0 c_{3,4}} \mathbf{F} \times (\mathbf{t}_1 \otimes \mathbf{N}) \\ 0 \end{bmatrix}; \quad (\text{A.10})$$

$$\mathcal{R}_{5,6} = \begin{bmatrix} \mathbf{t}_2 \\ -\frac{\beta^2}{\rho_0 c_{5,6}} \mathbf{t}_2 \otimes \mathbf{N} \\ -\frac{\beta^2}{\rho_0 c_{5,6}} \mathbf{F} \times (\mathbf{t}_2 \otimes \mathbf{N}) \\ 0 \end{bmatrix}.$$

Finally, evaluation of the set of left eigenvectors now follows in an analogous manner [1]

$$\mathcal{L}_{1,2} = \begin{bmatrix} \mathbf{n} \\ -\frac{2\alpha}{c_{1,2}} [\mathbf{n} \otimes \mathbf{N}] \\ -\frac{2\gamma}{c_{1,2}} [\mathbf{F} \times (\mathbf{n} \otimes \mathbf{N})] \\ -\frac{f'' \Lambda_A}{c_{1,2}} \end{bmatrix}; \quad \mathcal{L}_{3,4} = \begin{bmatrix} \mathbf{t}_1 \\ -\frac{2\alpha}{c_{3,4}} [\mathbf{t}_1 \otimes \mathbf{N}] \\ -\frac{2\gamma}{c_{3,4}} [\mathbf{F} \times (\mathbf{t}_1 \otimes \mathbf{N})] \\ 0 \end{bmatrix}; \quad (\text{A.11})$$

$$\mathcal{L}_{5,6} = \begin{bmatrix} \mathbf{t}_2 \\ -\frac{2\alpha}{c_{5,6}} [\mathbf{t}_2 \otimes \mathbf{N}] \\ -\frac{2\gamma}{c_{5,6}} [\mathbf{F} \times (\mathbf{t}_2 \otimes \mathbf{N})] \\ 0 \end{bmatrix}.$$

## Bibliography

- [1] J. Haider, C. H. Lee, A. J. Gil, J. Bonet, A first order hyperbolic framework for large strain computational solid dynamics: An upwind cell centred Total Lagrangian scheme, *International Journal for Numerical Methods in Engineering* 109 (2017) 407–456.
- [2] G. Kluth, B. Després, Discretization of hyperelasticity on unstructured mesh with a cell-centered Lagrangian scheme, *Journal of Computational Physics* 229 (2010) 9092–9118.
- [3] T. J. Hughes, *The finite element method: Linear static and dynamic finite element analysis*, Courier Corporation, 2012.
- [4] D. J. Benson, Computational methods in Lagrangian and Eulerian hydrocodes, *Computer Methods in Applied Mechanics and Engineering* 99 (1992) 235–394.
- [5] D. J. Payen, K. J. Bathe, Improved stresses for the 4-node tetrahedral element, *Computers and Structures* 89 (2011) 1265–1273.
- [6] D. J. Payen, K. J. Bathe, A stress improvement procedure, *Computers and Structures* 112–113 (2012) 311–326.
- [7] H. M. Hilber, T. J. R. Hughes, R. L. Taylor, Improved numerical dissipation for time integration algorithms in structural dynamics, *Earthquake Engineering and Structural Dynamics* 5 (1977) 283–292.



- 1  
2  
3 [8] W. L. Wood, M. Bossak, O. C. Zienkiewicz, An alpha modification of Newmark's method, *International Journal for Numerical Methods in Engineering* 15 (1980) 1562–1566.  
4  
5  
6 [9] J. Chung, G. M. Hulbert, A time integration algorithm for structural dynamics with improved  
7 numerical dissipation: The generalized- $\alpha$  method, *Journal of Applied Mechanics* 60 (1993) 371–375.  
8  
9 [10] D. D. Adams, W. L. Wood, Comparison of Hilber-Hughes-Taylor and Bossak ' $\alpha$ -methods' for the  
10 numerical integration of vibration equations, *International Journal for Numerical Methods in Engi-*  
11 *neering* 19 (1983) 765–771.  
12  
13 [11] F. M. Andrade Pires, E. A. de Souza Neto, J. L. de la Cuesta Padilla, An assessment of the  
14 average nodal volume formulation for the analysis of nearly incompressible solids under finite strains,  
15 *Communications in Numerical Methods in Engineering* 20 (2004) 569–583.  
16  
17 [12] K. J. Bathe, *Finite element procedures*, Prentice Hall, 1996.  
18  
19 [13] Y. Onishi, K. Amaya, A locking-free selective smoothed finite element method using tetrahedral  
20 and triangular elements with adaptive mesh rezoning for large deformation problems, *International*  
21 *Journal for Numerical Methods in Engineering* 99 (2014) 354–371.  
22  
23 [14] Y. Onishi, K. Amaya, Performance evaluation of the selective smoothed finite element methods using  
24 tetrahedral elements with deviatoric/hydrostatic split in large deformation analysis, *Theoretical and*  
25 *Applied Mechanics Japan* 63 (2015) 55–65.  
26  
27 [15] A. Huerta, F. Casadei, New ALE applications in non-linear fast-transient solid dynamics, *Engineering*  
28 *Computations* 11 (1994) 317–345.  
29  
30 [16] A. Rodríguez Ferran, F. Casadei, A. Huerta, ALE stress update for transient and quasistatic pro-  
31 cesses, *International Journal for Numerical Methods in Engineering* 43 (1998) 241–262.  
32  
33 [17] A. Rodríguez Ferran, A. Pérez Foguet, A. Huerta, Arbitrary Lagrangian Eulerian (ALE) formulation  
34 for hyperelastoplasticity, *International Journal for Numerical Methods in Engineering* 53 (2002)  
35 1831–1851.  
36  
37 [18] T. Belytschko, W. K. Liu, B. Moran, *Nonlinear finite elements for continua and structures*, John  
38 Wiley and Sons, 2000.  
39  
40 [19] J. Bonet, A. J. Gil, R. D. Wood, *Nonlinear solid mechanics for finite element analysis: Statics*,  
41 Cambridge University Press, 2016.  
42  
43 [20] T. Belytschko, J. S. Ong, W. K. Liu, J. M. Kennedy, Hourglass control in linear and nonlinear  
44 problems, *Computer Methods in Applied Mechanics and Engineering* 43 (1984) 251–276.  
45  
46 [21] D. Flanagan, T. Belytschko, A uniform strain hexahedron and quadrilateral with orthogonal hour-  
47 glass control, *International Journal for Numerical Methods in Engineering* 17 (1981) 679–706.  
48  
49 [22] J. Bonet, A. Burton, A simple average nodal pressure tetrahedral element for incompressible and  
50 nearly incompressible dynamic explicit applications, *Communications in Numerical Methods in*  
51 *Engineering* 14 (1998) 437–449.  
52  
53 [23] M. W. Gee, C. R. Dohrmann, S. W. Key, W. A. Wall, A uniform nodal strain tetrahedron with  
54 isochoric stabilization, *International Journal for Numerical Methods in Engineering* 78 (2009) 429–  
55 443.  
56  
57 [24] M. A. Puso, J. Solberg, A stabilized nodally integrated tetrahedral, *International Journal for*  
58 *Numerical Methods in Engineering* 67 (2006) 841–867.  
59  
60  
61  
62  
63  
64  
65

- 1  
2  
3 [25] C. Dohrmann, M. Heinstein, J. Jung, S. Key, W. Witkowski, Node-based uniform strain elements  
4 for three-node triangular and four-node tetrahedral meshes, *International Journal for Numerical*  
5 *Methods in Engineering* 47 (2000) 1549–1568.  
6
- 7 [26] J. Bonet, H. Marriott, O. Hassan, An averaged nodal deformation gradient linear tetrahedral element  
8 for large strain explicit dynamic applications, *Communications in Numerical Methods in Engineering*  
9 17 (2001) 551–561.  
10
- 11 [27] E. A. Souza Neto, D. Perić, M. Dutko, D. R. J. Owen, Design of simple low order finite elements for  
12 large strain analysis of nearly incompressible solids, *International Journal of Solids and Structures*  
13 33 (1996) 3277–3296.  
14
- 15 [28] Y. Fryer, C. Bailey, M. Cross, C.-H. Lai, A Control Volume procedure for solving the elastic stress-  
16 strain equations on an unstructured mesh, *Applied Mathematical Modelling* 15 (1991) 639–645.  
17
- 18 [29] C. Bailey, M. Cross, A Finite Volume procedure to solve elastic solid mechanics problems in three  
19 dimensions on an unstructured mesh, *International Journal for Numerical Methods in Engineering*  
20 38 (1995) 1757–1776.  
21
- 22 [30] A. Slone, C. Bailey, M. Cross, Dynamic solid mechanics using Finite Volume Methods, *Applied*  
23 *Mathematical Modelling* 27 (2003) 69–87.  
24
- 25 [31] G. A. Taylor, C. Bailey, M. Cross, A vertex-based Finite Volume Method applied to non-linear  
26 material problems in computational solid mechanics, *International Journal for Numerical Methods*  
27 *in Engineering* 56 (2003) 507–529.  
28
- 29 [32] H. Jasak, H. Weller, Application of the finite volume method and unstructured meshes to linear  
30 elasticity, *International Journal for Numerical Methods in Engineering* 48 (2000) 267–287.  
31
- 32 [33] I. Bijelonja, I. Demirdžić, S. Muzaferija, A finite volume method for incompressible linear elasticity,  
33 *Computer Methods in Applied Mechanics and Engineering* 195 (2006) 6378–6390.  
34
- 35 [34] P. Cardiff, A. Karač, A. Ivanković, Development of a finite volume contact solver based on the  
36 penalty method, *Computational Materials Science* 64 (2012) 283–284.  
37
- 38 [35] P. Cardiff, A. Karač, A. Ivanković, A large strain finite volume method for orthotropic bodies with  
39 general material orientations, *Computer Methods in Applied Mechanics and Engineering* 268 (2014)  
40 318–335.  
41
- 42 [36] P. Cardiff, Z. Tuković, P. D. Jaeger, M. Clancy, A. Ivanković, A Lagrangian cell-centred finite volume  
43 method for metal forming simulation, *International Journal for Numerical Methods in Engineering*  
44 (2016).  
45
- 46 [37] J. A. Trangenstein, P. Colella, A higher-order Godunov method for modeling finite deformation in  
47 elastic-plastic solids, *Communications on Pure and Applied Mathematics* 44 (1991) 41–100.  
48
- 49 [38] J. A. Trangenstein, A second-order Godunov algorithm for two-dimensional solid mechanics, *Com-*  
50 *putational mechanics* 13 (1994) 343–359.  
51
- 52 [39] B. Després, C. Mazeran, Lagrangian Gas Dynamics in Two Dimensions and Lagrangian systems,  
53 *Archive for Rational Mechanics and Analysis* 178 (2005) 327–372.  
54
- 55 [40] P.-H. Maire, R. Abgrall, J. Breil, J. Ovadia, A Cell-Centered Lagrangian Scheme for Two-Dimensional  
56 Compressible Flow Problems, *SIAM Journal on Scientific Computing* 29 (2007) 1781–1824.  
57  
58  
59  
60  
61  
62  
63  
64  
65

- 1  
2  
3 [41] G. Carré, S. Del Pino, B. Després, E. Labourasse, A cell-centered Lagrangian hydrodynamics scheme  
4 on general unstructured meshes in arbitrary dimension, *Journal of Computational Physics* 228 (2009)  
5 5160–5183.  
6
- 7 [42] P.-H. Maire, A high order cell-centered Lagrangian scheme for two-dimensional cylindrical geometry,  
8 *Journal of Computational Physics* 228 (2009) 6882–6915.  
9
- 10 [43] D. E. Burton, T. C. Carney, N. R. Morgan, S. K. Sambasivan, M. J. Shashkov, A cell-centered  
11 Lagrangian Godunov-like method for solid dynamics, *Computers and Fluids* 83 (2013) 33–47.  
12
- 13 [44] P.-H. Maire, R. Abgrall, J. Breil, R. Loubère, B. Rebourecet, A nominally second-order cell-centered  
14 Lagrangian scheme for simulating elastic–plastic flows on two-dimensional unstructured grids, *Jour-  
15 nal of Computational Physics* 235 (2013) 626–665.  
16
- 17 [45] G. Georges, J. Breil, P.-H. Maire, A 3D finite volume scheme for solving the Updated Lagrangian  
18 form of hyperelasticity, *International Journal for Numerical Methods in Fluids* 84 (2017) 41–54.  
19
- 20 [46] X. Zeng, G. Scovazzi, N. Abboud, O. Colomès, S. Rossi, A dynamic variational multiscale method  
21 for viscoelasticity using linear tetrahedral elements, *International Journal on Numerical Methods in  
22 Engineering* (2017).  
23
- 24 [47] G. Scovazzi, B. Carnes, X. Zeng, S. Rossi, A simple, stable, and accurate tetrahedral finite element for  
25 transient, nearly and fully incompressible solid dynamics: A dynamic variational multiscale approach,  
26 *International Journal for Numerical Methods in Engineering* 106 (2015) 799–839.  
27
- 28 [48] S. Rossi, N. Abboud, G. Scovazzi, Implicit finite incompressible elastodynamics with linear finite ele-  
29 ments: A stabilized method in rate form, *Computer Methods in Applied Mechanics and Engineering*  
30 311 (2016) 208–249.  
31
- 32 [49] G. Scovazzi, T. Song, X. Zeng, A velocity/stress mixed stabilized nodal finite element for elastodyna-  
33 mics: Analysis and computations with strongly and weakly enforced boundary conditions, *Computer  
34 Methods in Applied Mechanics and Engineering* 325 (2017) 532–576.  
35
- 36 [50] C. H. Lee, A. J. Gil, J. Bonet, Development of a cell centred upwind finite volume algorithm for  
37 a new conservation law formulation in structural dynamics, *Computers and Structures* 118 (2013)  
38 13–38.  
39
- 40 [51] M. Aguirre, A. J. Gil, J. Bonet, A. A. Carreño, A vertex centred finite volume Jameson–Schmidt–  
41 Turkel (JST) algorithm for a mixed conservation formulation in solid dynamics, *Journal of Compu-  
42 tational Physics* 259 (2014) 672–699.  
43
- 44 [52] M. Aguirre, A. J. Gil, J. Bonet, C. H. Lee, An upwind vertex centred Finite Volume solver for  
45 Lagrangian solid dynamics, *Journal of Computational Physics* 300 (2015) 387–422.  
46
- 47 [53] I. A. Karim, C. H. Lee, A. J. Gil, J. Bonet, A two-step Taylor-Galerkin formulation for fast dynamics,  
48 *Engineering Computations* 31 (2014) 366–387.  
49
- 50 [54] C. H. Lee, A. J. Gil, J. Bonet, Development of a stabilised Petrov–Galerkin formulation for con-  
51 servation laws in Lagrangian fast solid dynamics, *Computer Methods in Applied Mechanics and  
52 Engineering* 268 (2014) 40–64.  
53
- 54 [55] A. J. Gil, C. H. Lee, J. Bonet, M. Aguirre, A stabilised Petrov–Galerkin formulation for linear  
55 tetrahedral elements in compressible, nearly incompressible and truly incompressible fast dynamics,  
56 *Computer Methods in Applied Mechanics and Engineering* 276 (2014) 659–690.  
57
- 58  
59  
60  
61  
62  
63  
64  
65

- 1  
2  
3 [56] A. J. Gil, C. H. Lee, J. Bonet, R. Ortigosa, A first order hyperbolic framework for large strain  
4 computational solid dynamics. Part II: Total Lagrangian compressible, nearly incompressible and  
5 truly incompressible elasticity, *Computer Methods in Applied Mechanics and Engineering* 300 (2016)  
6 146–181.  
7  
8 [57] J. Bonet, A. J. Gil, C. H. Lee, M. Aguirre, R. Ortigosa, A first order hyperbolic framework for  
9 large strain computational solid dynamics. Part I: Total Lagrangian isothermal elasticity, *Computer*  
10 *Methods in Applied Mechanics and Engineering* 283 (2015) 689–732.  
11  
12 [58] C. H. Lee, A. J. Gil, G. Greto, S. Kulasegaram, J. Bonet, A new Jameson–Schmidt–Turkel Smooth  
13 Particle Hydrodynamics algorithm for large strain explicit fast dynamics, *Computer Methods in*  
14 *Applied Mechanics and Engineering* 311 (2016) 71–111.  
15  
16 [59] C. H. Lee, A. J. Gil, O. I. Hassan, J. Bonet, S. Kulasegaram, A variationally consistent Streamline  
17 Upwind Petrov Galerkin Smooth Particle Hydrodynamics algorithm for large strain solid dynamics,  
18 *Computer Methods in Applied Mechanics and Engineering* (2017).  
19  
20 [60] C. M. Dafermos, *Quasilinear hyperbolic systems with involutions*, Springer, 1989.  
21  
22 [61] M. Torrilhon, Locally divergence-preserving upwind finite volume schemes for magnetohydrodynamic  
23 equations, *SIAM Journal on Scientific Computing* 26 (2005) 1166–1191.  
24  
25 [62] E. F. Toro, *Riemann solvers and numerical methods for fluid dynamics: A practical introduction*,  
26 Springer-Verlag, Third edition, 2009.  
27  
28 [63] H. Guillard, C. Viozat, On the behaviour of upwind schemes in the low Mach number limit, *Com-*  
29 *puters & fluids* 28 (1999) 63–86.  
30  
31 [64] H. Guillard, A. Murrone, On the behavior of upwind schemes in the low Mach number limit: II.  
32 Godunov type schemes, *Computers & fluids* 33 (2004) 655–675.  
33  
34 [65] H. Guillard, On the behavior of upwind schemes in the low Mach number limit. IV: P0 approximation  
35 on triangular and tetrahedral cells, *Computers & Fluids* 38 (2009) 1969–1972.  
36  
37 [66] F. Rieper, A low-Mach number fix for Roe’s approximate Riemann solver, *Journal of Computational*  
38 *Physics* 230 (2011) 5263–5287.  
39  
40 [67] B. Després, E. Labourasse, Angular Momentum preserving cell-centered Lagrangian and Eulerian  
41 schemes on arbitrary grids, *Journal of Computational Physics* 290 (2015) 28–54.  
42  
43 [68] J. Bonet, A. J. Gil, R. Ortigosa, On a tensor cross product based formulation of large strain solid  
44 mechanics, *International Journal of Solids and Structures* 84 (2016) 49–63.  
45  
46 [69] J. E. Marsden, T. J. R. Hughes, *Mathematical foundations of elasticity*, Dover Publications, 1994.  
47  
48 [70] J. Bonet, A. J. Gil, R. Ortigosa, A computational framework for polyconvex large strain elasticity,  
49 *Computer Methods in Applied Mechanics and Engineering* 283 (2015) 1061–1094.  
50  
51 [71] R. J. LeVeque, *Finite volume methods for hyperbolic problems*, volume 31, Cambridge University  
52 Press, 2002.  
53  
54 [72] F. Vilar, P.-H. Maire, R. Abgrall, A Discontinuous Galerkin discretization for solving the two-  
55 dimensional gas dynamics equations written under Total Lagrangian formulation on general unstruc-  
56 tured grids, *Journal of Computational Physics* 276 (2014) 188–234.  
57  
58 [73] J. Blazek, *Computational Fluid Dynamics: Principles and applications*, Elsevier, 2005.  
59  
60  
61  
62  
63  
64  
65

- 1  
2  
3 [74] R. J. LeVeque, Numerical methods for conservation laws, volume 132, Springer, 1992.  
4  
5 [75] A. J. Chorin, A numerical method for solving incompressible viscous flow problems, Journal of  
6 Computational Physics 2 (1967) 12 – 26.  
7  
8 [76] Z. Zhang, A. Gil, O. Hassan, K. Morgan, The simulation of 3d unsteady incompressible flows with  
9 moving boundaries on unstructured meshes, Computers & Fluids 37 (2008) 620 – 631.  
10  
11 [77] B. Engquist, S. Osher, One-sided difference approximations for nonlinear conservation laws, Mathe-  
12 matics of Computation 36 (1981) 321–351.  
13  
14 [78] R. Courant, K. Friedrichs, H. Lewy, On the partial difference equations of mathematical physics,  
15 Mathematische Annalen 100 (1928) 32–74.  
16  
17 [79] S. K. Lahiri, J. Bonet, J. Peraire, L. Casals, A Variationally Consistent Fractional Time-Step Inte-  
18 gration Method for Incompressible and Nearly Incompressible Lagrangian Dynamics, International  
19 Journal for Numerical Methods in Engineering 63 (2005) 1371–1395.  
20  
21 [80] J. Simo, N. Tarnow, The discrete energy-momentum method. Conserving algorithms for nonlinear  
22 elastodynamics, Zeitschrift für angewandte Mathematik und Physik ZAMP 43 (1992) 757–792.  
23  
24 [81] J. Donea, A. Huerta, Finite element methods for flow problems, John Wiley & Sons, 2003.  
25  
26 [82] S. K. Lahiri, J. Bonet, J. Peraire, A Variationally Consistent Mesh Adaptation Method for Trian-  
27 gular Elements in Explicit Lagrangian Dynamics, International Journal for Numerical Methods in  
28 Engineering 82 (2010) 1073–1113.  
29  
30 [83] P. L. Roe, Approximate Riemann solvers, parameters vectors, and difference schemes, Journal of  
31 Computational Physics 43 (1981) 357–372.  
32  
33  
34  
35  
36  
37  
38  
39  
40  
41  
42  
43  
44  
45  
46  
47  
48  
49  
50  
51  
52  
53  
54  
55  
56  
57  
58  
59  
60  
61  
62  
63  
64  
65