

GPS Buoy Campaigns for Vertical Datum Improvement and Radar Altimeter Calibration

by

Kai-chien Cheng

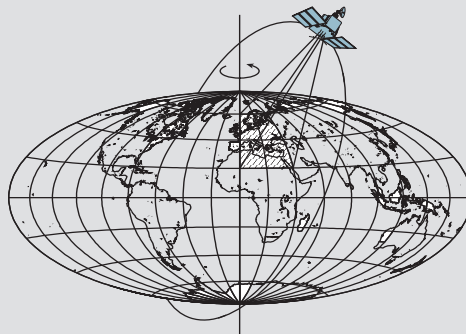

Report No. 470

Geodetic and GeoInformation Science
Department of Civil and Environmental Engineering and Geodetic Science
The Ohio State University
Columbus, Ohio 43210-1275

January 2004

GPS Buoy Campaigns for Vertical Datum Improvement and Radar Altimeter Calibration

Kai-chien Cheng

Report No. 470

Geodetic and GeoInformation Science
Department of Civil and Environmental Engineering and Geodetic Science
The Ohio State University
Columbus, Ohio 43210-1275, USA

January 2004

ABSTRACT

This report summarized three Global Positioning System (GPS) buoy campaigns in the Great Lakes from 1999 to 2003 that were carried out by the Laboratory of Space Geodesy and Remote Sensing Research in the Department of Civil and Environmental Engineering and Geodetic Science (CEEGS), at the Ohio State University. The report focuses on the field work procedure of GPS buoy operation in these past campaigns and is intended to provide experience for similar applications in the future.

The campaigns in this report include the Holland Campaign in Lake Michigan in 1999, the Marblehead Campaign in Lake Erie in 2001, and the Cleveland Campaign in Lake Erie in 2003. The major objective of these campaigns is to establish a calibration site for multiple satellite altimeters by using the GPS buoy to and the existing tide gauges provided by the Center for Operational Oceanographic Products and Services (CO-OPS) in the National Oceanic and Atmospheric Administration (NOAA). The campaigns provide useful information to the applications including radar altimeter absolute calibration, the establishment of the safe navigation in the Great Lakes, and the development of an integrated shoreline information in a spatial information database for coastal management and decision making. Since the report focuses primarily on the field work procedure, only limited results are presented. The published calibration results using the data from these campaigns are cited in this report.

Generally, the GPS buoy is defined by putting GPS equipments on a floating object, which includes different types of buoys and could even be a moving vessel. The use of GPS buoys is a relatively new technique for the marine applications and its designs and operations vary from one application to another. For example, its platform could range from a small life-saver type to an autonomous ruggedized type buoy. However only the OSU waverider GPS buoy, a life-saver type buoy that was used in these campaigns, is stressed in this report.

The OSU waverider GPS buoy is a fairly simple design: it is built by attaching a Dorne/Margolin Element with Choke Ring antenna on top of a 2-foot (diameter) life-saver buoy covered with a transparent radome. The buoy is tethered to a boat where the receiver, power supply and the operators reside. Marks are made on four sides of buoy and their offsets to the antenna reference point (ARP) are carefully measured in the laboratory. The operator needs to observe the water surface with respect to these marks in order to accurately refer ARP to the water surface. The buoy data is post-processed with differential GPS (DGPS) in kinematic mode after the field work.

The campaign-related documents, including National Geodetic Survey (NGS) data sheets, GPS Station Observation Log, Visibility Obstruction Diagram, campaign proposal, and field work log, are attached in the Appendices.

PREFACE

The report was prepared by Kai-chien Cheng, a graduate research associate in the Laboratory for Space Geodesy and Remote Sensing, at the Ohio State University, under the supervision of Professor C. K. Shum. This report was supported by the National Oceanographic Partnership Program Grant (Dynalysis of Princeton #865618), National Aeronautics and Space Administration TOPEX/POSEIDON Extended Mission Grant (NAG 5-6910/JPL961462), National Aeronautics and Space Administration Earth Science Information Partnership CAN Grant (CIT #12024478), National Aeronautics and Space Administration Interdisciplinary Science Project (NAG5-9335), National Science Foundation Digital Government Grant (EIA-0091494, and the Ohio Sea Grant Program (R/CE-5).

ACKNOWLEDGMENT

I would like to express my gratitude to Prof. C. K. Shum, my academic advisor for his generous support and encouragement throughout these campaigns. I would also like to acknowledge Dr. Michael Parke of the College of Engineering at the Ohio State University, for building the buoy, participating in the Holland and Marblehead Campaigns, and sharing experience in field work as well as in data processing. I appreciate the kind help and instructions of Dr. Yuchan Yi in our department for altimeter data retrieval. I thank Dr. Gerald Mader and Doug Martin of the National Geodetic Survey, National Oceanic and Atmospheric Administration, for providing Kinematic And Rapid Static (KARS) software and field work assistance in the Holland and Marblehead campaigns. I give thanks to Dr. Jeffrey Reutter, Director of the Ohio Sea Grant College Program for supporting the ship expense in the Cleveland Campaign. Also, I acknowledge David Conner, National Geodetic Survey Ohio Geodetic Advisor, for providing very useful reconnaissance information and supporting us two batteries in the Cleveland Campaign.

I would like to thank my colleagues: Yiqun Chen, Shengjie Ge, Chung-Yen Kuo, Justin Shum, Hong-Zeng Tseng, and Harsh Vangani for their participation and assistance in the field work of these campaigns. Special thanks go to Joktan Kwiatkowski for reviewing the grammar of this report.

TABLE OF CONTENTS

ABSTRACT.....	iii
PREFACE.....	v
ACKNOWLEDGMENT	vii
LIST OF FIGURES	xi
1. Introduction	1
2. The OSU Waverider GPS Buoy.....	3
3. Past Campaigns	9
3.1 Fiducial Site Selection	11
3.2 GPS Buoy Campaign in Holland	15
3.3 GPS Buoy Campaign in Marblehead.....	21
3.4 GPS Buoy Campaign in Cleveland	28
4. Summary.....	33
References	35
Appendix A. Holland Campaign Documents	39
Appendix B. Marblehead Campaign Documents	47
Appendix C. Cleveland Campaign Documents	57

LIST OF FIGURES

Figure 2.1. The OSU Waverider GPS Buoy.	5
Figure 2.2. Diagram of the OSU Waverider GPS Buoy.....	5
Figure 2.3. The pulling rope and floaters. The rope is taped to a 30 m antenna cable to avoid pull to the antenna cable while operating.	6
Figure 2.4. The deployment of the buoy.	6
Figure 2.5. Data collection session of the buoy. The yellow antenna cable can be seen underneath the floaters.....	7
Figure 2.6. The battery pack. The power connectors (black and red) that are able to connect a 12 volt standard automobile battery to the receiver. The yellow silver end goes to the power port of Trimble 4000 SSi receiver.	7
Figure 3.1. NGS visibility obstruction diagram sample.....	13
Figure 3.2. NGS GPS station observation log sample.....	14
Figure 3.3. The GPS buoy campaign in Holland, Lake Michigan.	16
Figure 3.4. The GPS buoy deployments in Lake Michigan.	17
Figure 3.5. The Holland West tide gauge (one of the CO-OPS acoustic sounding gauges in the Great Lakes) producing 6-minute water level continuously.....	17
Figure 3.6. The fiducial site at MBYC, close to Holland West tide gauge, was established with the GPS network. The receiver and battery were inside the building.	18
Figure 3.7. The GPS network for the buoy campaign at Holland.	18
Figure 3.8. The GPS buoy height solution on the 20th with a one-hour window centered at the TCA of the satellite. An order three polynomial was used to smooth the raw GPS height solution in order to filter the high-frequency effect such as waves. The blue line is the smoothed solution and the blue circle is the height at TCA.	19
Figure 3.9. GPS buoy campaign at Marblehead and at Cleveland in Lake Erie..	23

Figure 3.10. The GPS buoy campaign in Marblehead.....	23
Figure 3. 11. The Marblehead tide gauge located in the Marblehead Coast Guard Base. The white box to the left of the boat is the gauge house.....	24
Figure 3.12. The GPS height solution on the Topex Reference Ellipsoid on Oct. 20th , 2001. The tide gauge data were shifted by -35.293 m.	24
Figure 3.13. The GPS height solution on three bins along the TP/Jason track on Oct. 21st , 2001.	25
Figure 3.14. Cleveland gauge house.	25
Figure 3.15. The ship track and the planned GPS buoy deployed location in the campaign at Cleveland.	27
Figure 3.16 The GPS network at Cleveland Campaign.....	28
Figure 3.17. The GPS network for the Cleveland Campaign	29
Figure 3.18 The GPS height solution of the GRS Reference Ellipsoid on Sept. 17 th , 2003.....	30
Figure 3.19 The GPS buoy height solution on P1 and P2 in Lake Erie.....	30

1. Introduction

The report is intended for the purpose of storing records for the past GPS buoy campaigns in the Great Lakes, carried out by the Laboratory of Space Geodesy and Remote Sensing Research, of the Geodetic and GeoInformatic Science Section, in the Department of Civil and Environmental Engineering and Geodetic Science (CEEGS), at the Ohio State University (OSU), from 1999 to 2003. The main objective of these campaigns is to establish the calibration sites in the Great Lakes for multiple satellite altimeters. This report emphasizes the field work procedures of each campaign leaving the technical details to the respective articles published (e.g., Shum et al., 2003; Cheng et al., 2002). Thus only limited results are shown in this report.

A Global Positioning System (GPS) Buoy System is defined as a floating buoy equipped with a geodetic GPS receiver and one or more antennae near-shore capable of measuring its position and velocity, and hence the instantaneous sea surface height (ssh) as a function of time, in a geocentric earth-fixed coordinate system, or within the International Terrestrial Reference Frame (ITRF). Using other sets of GPS receivers and antennae at the so-called reference or fiducial stations, where the geocentric coordinates are precisely determined, their relative position vector to the buoy can be determined using differential GPS (DGPS). Therefore, the absolute three-dimensional position of the buoy, as a function of time, can be acquired and thus the GPS buoy is able to provide the time series of absolute water level height as well as its horizontal coordinates. Since the buoy position and velocity are determined using DGPS techniques, their accuracy depends on the assumption that the atmospheric condition, especially tropospheric delay, at both ends of a baseline is similar and will be significantly canceled out when differentiated. This assumption becomes invalid when the baseline length increases. Therefore, the recent GPS buoy applications are limited in the coastal area.

Schone (2000) points out that GPS buoy systems are still a new technology, especially in the absolute calibration of satellite altimetry. Its design and implementation varies and its applications include absolute calibration of satellite altimeters, observing oceanic phenomena such as water surface height, coastal circulation, ocean tide studies, and other coastal applications (Shum and Parke, 1999). For example, in the area where the GPS buoy system is used to calibrate satellite altimeters, its size could range from a small life-saver type with the receiver and power supply on the tethered boat to big, ruggedized types that accommodate all of the equipment as well as the other sensors providing its orientation and meteorological and auxiliary data for long-term deployment. It could require dedicated personnel for a campaign style design while it could also be an autonomous design that transmits its observations automatically to the base station in the vicinity. GPS buoys have been implemented for

altimeter calibration in the past (e.g., Shum et al., 2003; Watson et al., 2003; Cheng et al., 2002; Haines et al., 2002; Liebsch et al., 2002; Kruizinga, 1997; Schutz et al., 1995; Born et al., 1994; Hein, 1992; Rucker et al., 1990). Kelecy et al., (1994) showed the equivalent ssh measurements between a waverider (a life-saver type) and a spar design for altimeter absolute calibration. However, Schone (2000) notes that an intercomparison of the different designs is still needed.

For the observations of oceanic phenomena, GPS buoy have demonstrated, among others, by Young et al. (1986) in bathymetry mapping, by Hein et al., (1990) in wave height observations and sea state determination, and, by Born et al. (1994) in wave height spectrum analysis. Key et al. (1998) and Shum et al. (2003) used GPS buoys to determine absolute sea surface and mean lake surface height gradient, respectively.

In addition, the GPS buoy can be used in geodetic applications in the coastal region. For example, a height modernization project performed by the National Geodetic Survey (NGS) seeking the use of GPS data on land and oceans to improve the determination of local geoid height and thus to promote GPS applications on measuring elevation, which is traditionally done by spirit leveling. Zilkoski and D'Onofrio (1996) implemented a GPS-equipped ship and a buoy (ruggedized type) in the San Francisco Bay for NGS height modernization project with an ultimate goal to map the bottom of the Bay in the geocentric reference frame such as ITRF and use GPS on ships in an electronic chart display to transit the Bay and dock during zero visibility. Li et al. (2002) combined different data sources in the coastal region including a hydrodynamic model, the GPS buoy ssh measurements, satellite altimeters, satellite remote sensing images, a digital elevation model (DEM) and bathymetry, and tide gauges to map the shoreline of Lake Erie in a digital format and integrate different data sources into one reference frame. Gesch and Wilson (2001) and Hess (2001) use the data from a GPS buoy with the numerical interpolation methods and geoid model to link DEM to bathymetric data and generation of a tidal datum in Tampa Bay respectively. Parke et al. (2003) proposed the expansion of the VDatum (Milbert, 2002), a National Oceanic and Atmospheric Administration (NOAA) vertical datum conversion tool that is currently available for a certain testing areas in the U.S., to the nation-wide coverage in order to seamlessly integrate the coastal and offshore spatial data regardless of the vertical datum they used to refer. The data from GPS buoy is among the various data sets that involved. One of the requirements of these coastal applications is the accurate local geoid height when it comes to convert the orthometric height to the ellipsoidal height or vice versa. Shum et al. (2003) collocated a GPS buoy at a tide gauge in Lake Erie simultaneously to measure the lake level with 1 Hz GPS data for 8 hours in order to determine the local geoid height at the gauge. They show the formal error of <1 cm considering the insignificance of the lake surface topography and the result was used in the absolute calibration of Jason-1. Similar applications for the determination of the local geoid height can be found in, for example, Bisnath et al. (2003).

Despite the potential applications that a GPS buoy can be used for, the OSU waverider GPS buoy was only used in calibrating satellite altimeters in the Great Lakes. Section 2 discusses the technical details of the OSU waverider GPS buoy including its specifications, accessories and operating details. The pros and cons of the buoy compared to the ruggedized type buoy are also presented. Section 3 addresses three campaigns in which the OSU waverider

GPS buoy was involved: in Holland (Lake Michigan), in Marblehead and in Cleveland (in Lake Erie) with the emphasis of the field work in the campaign. Section 4 summarizes the report.

2. The OSU Waverider GPS Buoy

The OSU waverider GPS buoy (illustrated in Figures 2.1 and 2.2) was originally built by Dr. Michael Parke in the Laboratory of Space Geodesy and Remote Sensing Research, of the CEEGS department at OSU. It is designed to minimize the height from the water line to the antenna in order to minimize the phase center changes caused by the tilt of the buoy and also the possible multipath effect. Similar designs can be found in, for example, Key et al. (1998) and Kelecy et al. (1994). By attaching a Dorne/Margolin Element with a Choke Ring antenna on a life saver type buoy, it needs to be tethered to a boat where the data storage and power supply reside. The antenna identifications are TRM 29659.00 and TRMDMG on the NGS Antenna Calibration (Mader, 1999) and Table of antenna phase center offsets in GAMIT (University of California, 2002). The dome is fixed on top of the buoy with 8 ¼-inch screws and is sealed with water-proof caulk like Silicone. Marks on four sides of the buoy were made and their vertical offsets to the antenna reference point (ARP), the bottom of the antenna mount for the Choke Ring antenna in this case, were carefully measured. The operator must keep track of the water line with respect to the marks during the survey to measure the antenna height above the water line. Mader (1999) points out that the misuse of antenna type or offsets could result in 10 cm errors in height component. Thus, it is very important to observe the water line location to the marks. For example, the L1 phase center is about 60 mm above the water line when deployed in the Holland Campaign.

It is a campaign-style design that needs special personnel to deploy and to collect the data. Based on the experience that we had from the past GPS buoy campaigns, the OSU waverider GPS buoy requires 2 persons, though it is possible to carry out the campaign individually, especially when a 30-m cable is used. Several floaters are attached to the pulling rope which is taped with the antenna cable with the purpose of avoiding the pulling on the antenna cable to secure the connection from the buoy to the GPS receiver (Figure 2.3). Its deployment is done by putting it carefully on the water (Figures 2.4 and 2.5). If deployed from a vessel, it has to be done after the anchor is fully engaged unless the buoy and vessel are to free-float intentionally. Depending on the directions of the currents, winds and other factors, the buoy may move in front of the vessel and become tangled with the anchor. Since the body of the vessel could cause the multipath effect to the buoy, the operators need to push the buoy away from the vessel whenever that happens. Based on the past experience, that only occurred once in about 10 deployments.

The Trimble 4000 SSi receiver is currently used to work with the OSU waverider GPS Buoy, and its memory was upgraded to 40 MB. When downloaded to a computer, the resulting Trimble binary DAT file is approximately 1 MB per hour with L1, L2, C/A and P2

observations from 6 satellites at a 1 Hz logging rate. Although special compression techniques may have been used to reduce the physical size of the files on the receiver internal memory, 40 MB memory ensured approximately 40 hours of operation having to download the data in the field. The battery charger (Trimble model 20669-XX) is able to work with the 4000 SSi receiver by providing 12 volt DC power as long as indoor 120 volt AC power is available. Alternatively, the specially made battery pack (Figure 2.6) is made to connect a 12 volt standard automobile battery to power the receiver in the field. This provides flexibility in the power supply to the receiver since the standard automobile batteries are widely available in auto shops nationwide.

The advantages of the OSU waverider GPS buoy include simplicity, compact size, reusability, and great maneuverability in deployment. In addition, it is economical, because it collects the water level measurements for altimeter calibration applications that are equivalent to that of a more complex and expensive spar buoy, as Kelecy et al. (1994) have proven. Also, one can connect a tide gauge to an absolute geocentric reference frame by collocating it on the gauge, allowing them to simultaneously measure the water surface. It is a campaign-style buoy that inevitably needs special personnel to deploy and operate it. As opposed to a ruggedized buoy that is designed to stay on water surface for a longer period of time, it is usually impractical to deploy a campaign-style buoy repeatedly due to its extensive human involvement. Also, a campaign-style design is less weather resistant due to safety precautions.

The OSU waverider GPS buoy previously used in radar altimeter calibrations includes TOPEX/Poseidon Side B (TSB) in Lake Erie in Cheng et al. (2002), and in Lake Michigan in Cheng (2001), and Jason-1 in Lake Erie in Shum et al. (2003) at OSU. The field work from the recent campaign in Cleveland in September 2003 is completed and is in the data processing stage. Generally, the OSU waverider GPS buoy can be deployed at the satellite ground track to catch the over flight of the satellite establishing a direct comparison on the ssh measurement at the over flight. The along- and cross-track gradients from the altimeter ssh time series may need to be applied to ensure the consistency of the location. However, there was no direct over flight occurred in these past campaigns at the OSU. It was planned in the latest campaign in Cleveland to catch Jason-1 over flight at 6:16 UTC on September 19th (Cycle 62) but it was canceled due to weather conditions. These calibrations turned out to be using the nearby tide gauge data, with proper vertical datum conversion applied using GPS buoy data, to calibrate altimeters. The same set of GPS buoy data was also used, along with various data sources including aerial photos, remote sensing satellite imagery, satellite radar altimeters, a digital elevation model (DEM) as well as bathymetric data, and a hydraulic model for Lake Erie, to create a seamless digital shoreline database in the land-lake interfacing area to support decision making for governmental agencies (Li et al., 2002).

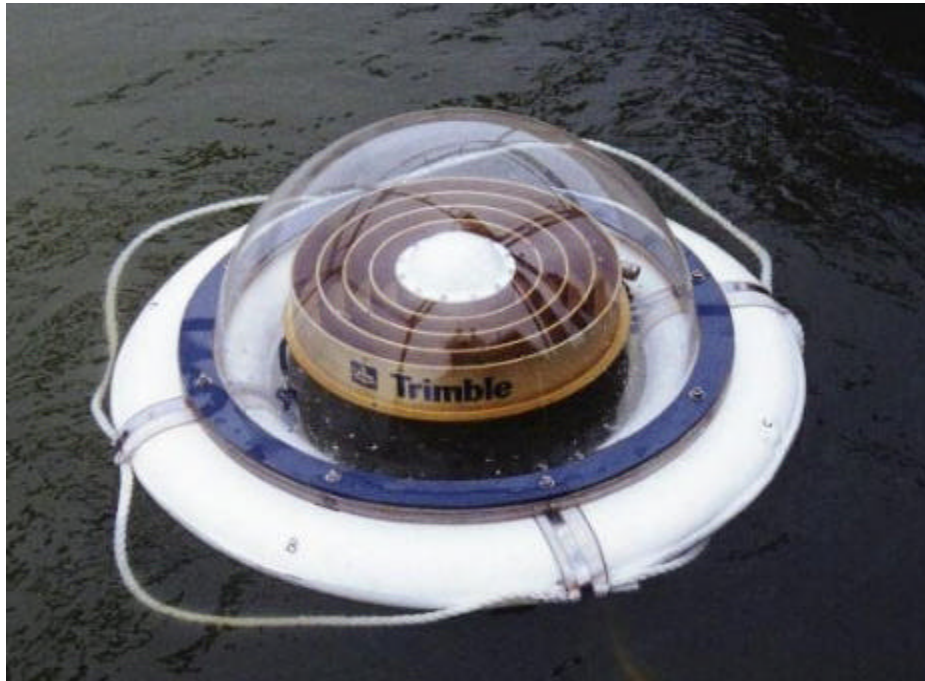

Figure 2.1. The OSU Waverider GPS Buoy.

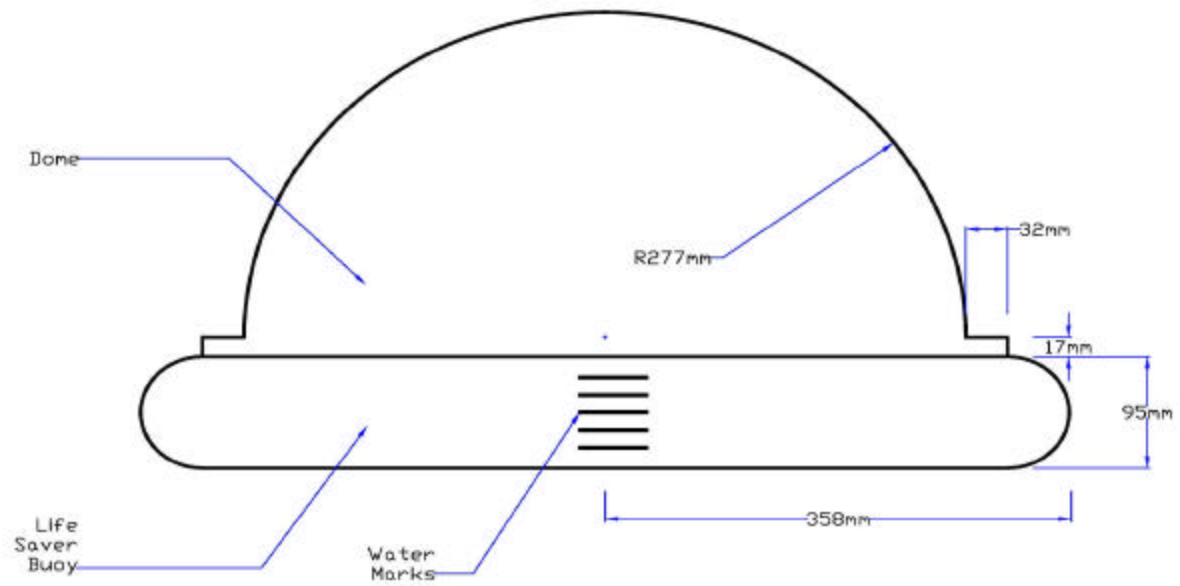

Figure 2.2. Diagram of the OSU Waverider GPS Buoy.



Figure 2.3. The pulling rope and floaters. The rope is taped to a 30 m antenna cable to avoid pulling on the antenna cable while operating.



Figure 2.4. The deployment of the buoy.



Figure 2.5. Data collection session of the buoy. The yellow antenna cable can be seen underneath the floaters.



Figure 2.6. The battery pack. The power connectors (black and red) that are able to connect a 12 volt standard automobile battery to the receiver. The yellow silver end goes to the power port of Trimble 4000 SSi receiver.

3. Past Campaigns

This section provides the information of the past GPS buoy campaigns carried out by the Laboratory of Space Geodesy and Remote Sensing Research of the CEEGS at OSU in Lake Erie near Cleveland and near Marblehead, and in Lake Michigan near Holland. The main objective of these GPS buoy campaigns is for absolute calibration of radar altimeters. One tide gauge from Center for Operational Oceanographic Products and Services (CO-OPS) of the NOAA was selected in each campaign as the *in situ* data to compare with the altimeter lake surface height in its closest approach in each satellite visit. The CO-OPS tide gauge records the water level every 6 minutes continuously in the vertical datum called International Great Lakes Datum (IGLD) 1985, which is a dynamic height system representing the geopotential difference in terms of height (Jekeli, 2002). In order to compare the tide gauge water level to the altimeter-measured lake surface, it is necessary to convert the tide gauge height to the geocentric one, to which the altimeter refers. Generally, the procedure includes two steps: i) local geoid height determination and ii) application of mean water surface gradient from the tide gauge to the altimeter nominal footprint. Both steps require GPS buoy deployment. The details can be found in Shum et al. (2003). Table 3.1 summarizes campaign details. As mentioned before, the GPS buoy can be used to catch a direct over flight of the satellite altimeter and the buoy height solution can be used to compare directly with altimeter ssh. On the other hand, the GPS buoy can be used to survey the mean water surface gradients in order to link a tide gauge to the altimeter footprint to complete the calibration. There are two main objectives in each of these past campaigns: The buoy was deployed at the altimeter nominal footprint in an attempt to catch an altimeter over flight for direct calibration when possible. On the other hand, the buoy was used to survey the water surface gradients to establish a calibration site using the nearby tide gauge. With the gradients applied, it enables a time series comparison between the gauge level measurements and the altimeter ssh observations that is especially essential for altimeter drift estimation.

The fiducial sites were selected in each campaign to be as close to the altimeter nominal footprint as possible in order to shorten the baseline length in the positioning of the buoy. We usually selected the NGS control points that have been surveyed with GPS as the fiducial sites. Despite the fact that NGS data sheet provides the up-to-date coordinates of the main fiducial sites, a network adjustment composed of the fiducial sites and the NGS Continuously Operating Reference Stations (CORS) in the vicinity were carried out to ensure the consistency of the coordinates. In the case that there is no suitable NGS control point in the experimental area, as in the campaign in Holland, new points need to be established as the fiducial sites for GPS buoy kinematic positioning. Snow (2002) shows the use of weighted partial Minimum Norm Least Squares Solution (MINOLESS), which minimizes the residuals in the observations and

in the estimated position vector of each CORS in the network by least squares, to estimate the unknown coordinates of the new points in the GPS network as favorable for GPS buoy applications.

Subsection 3.1 describes the fiducial site selection and getting control data from the NGS web site. The campaign details at Holland, Marblehead and Cleveland will be discussed in the subsections 3.2, 3.3 and 3.4 respectively.

	Holland	Marblehead	Cleveland
Date	Mar. 20-24, 1999	Oct. 20-21, 2001	Sept. 17-19, 2003
Location	Lake Michigan	Lake Erie	Lake Erie
Number of field work personnel	7	5	6
Altimeter to be calibrated	T/P Side B, GFO	T/P Side B, Jason-1	Envisat, ERS-1/-2, Geosat, Icesat
Altimeter over flight during the campaign	For Topex Side B (Cycle 239) but the buoy was off the mark by 10 km.	No over flight was planned.	For Jason-1 (Cycle 62) but was canceled due to weather condition.
NOAA tide gauge	Holland West	Marblehead	Cleveland
Tide gauge sampling interval	6 min	6 min	6 min
Main fiducial point	MBYC (new point) and G317	Z317	G321
Horizontal order	B	B	B
Vertical order	First, Class II	First, Class II	First, Class II
NGS latest adjustment	Sept. 1995	Aug. 1996	Aug. 1996

Table 3.1. Summary of the past GPS buoy campaigns carried out at the OSU.

3.1 Fiducial Site Selection

The fiducial site is used in the DGPS data processing for the GPS buoy positioning. Its precise coordinates are provided by NGS or are estimated from the GPS network adjustment. Since the precision of buoy positions primarily depends on the baseline length from the fiducial site to the GPS buoy, it is selected to be as close to the buoy deployed location as possible. Generally the fiducial sites were selected from the NGS ground control points that have been surveyed with GPS and the adjustments were done as close to the campaign date as possible. Despite the coordinates of these control points can be found on the NGS web site, a geodetic network adjustment was performed to ensure the consistency of the coordinates. For example, the campaigns in Marblehead and in Cleveland, there were NGS GPS points that were within 1 km of the tide gauge. They were consequently selected at the fiducial site for the campaign. On the other hand, Snow (2002) established three new points next to the Holland West tide gauge for the campaign in Holland.

The web site of NGS (on <http://www.ngs.noaa.gov>) offers the data sheet for the control point, benchmark, tide gauge and others. The information includes point ID, USGS Quad, coordinates in North American Datum 1983 (NAD83), ellipsoidal height, geoid height (from a model), adjusted date and station description. Most importantly, the data sheet for CORS contains data such as the coordinates and velocity in both ITRF and NAD83, type of GPS receiver and antenna, antenna code, and offsets of antenna phase center etc. The web site also offers a geodetic tool kit and PC software packages that are commonly used by surveyors.

Horizontal Time-Dependent Positioning (HTDP), developed by Snay (1999), is used to transform the published coordinates of the control point to the ITRF to the specified time epoch considering the tectonic movements that are derived from the NGS crustal motion models as well as the accurate continuous GPS observations from the stations nationwide. This step is to ensure that the terrestrial reference system of the fiducial sites for GPS buoy positioning is consistent with that of the altimeter. Although the program's name suggests transforming the horizontal components, it is based on the linear formula of Euclidean similarity of seven parameters that International Earth Rotation and Reference Systems Service (IERS) adopts for the transformation between two terrestrial reference systems (McCarthy, 2003). The formula, Eq. (3.1), consisting of three translation components (T_1 , T_2 and T_3), one scale factor (D) and three rotation angles (R_1 , R_2 and R_3), transforms the coordinate vector X_1 expressed in terrestrial reference system (1) to the coordinate vector X_2 expressed in terrestrial reference system (2) in the same time epoch.

$$X_2 = X_1 + \begin{bmatrix} T_1 \\ T_2 \\ T_3 \end{bmatrix} + DX_1 \begin{bmatrix} 0 & -R_3 & R_2 \\ R_3 & 0 & -R_1 \\ -R_2 & R_1 & 0 \end{bmatrix} X_1 \quad (3.1)$$

Good record-keeping for each campaign provides good data management and improves efficiency for its processing after the field work. A visibility obstruction diagram and a GPS station observation log need to be completed by the surveyor during the field work. The sample page from NGS can be seen in Figures 3.1. and 3.2. Other similar forms can be found on the NGS web site (<http://www.ngs.noaa.gov/PROJECTS/GPSmanual/data.htm>). The visibility obstruction diagram provides information of the sky visibility during the campaign. It helps to determine the suitable satellite mask angle, whose default value is 15° above the horizon in most of the software packages, if the default does not yield good solution. The GPS station observation log provides essential site information for data processing including point name, published coordinates, date, time, session number, receiver and antenna number, and most importantly the antenna height measurements.

The data sheets, GPS station observation logs and visibility obstruction diagrams for the campaigns can be found in Appendices.

NATIONAL GEODETIC SURVEY VISIBILITY OBSTRUCTION DIAGRAM

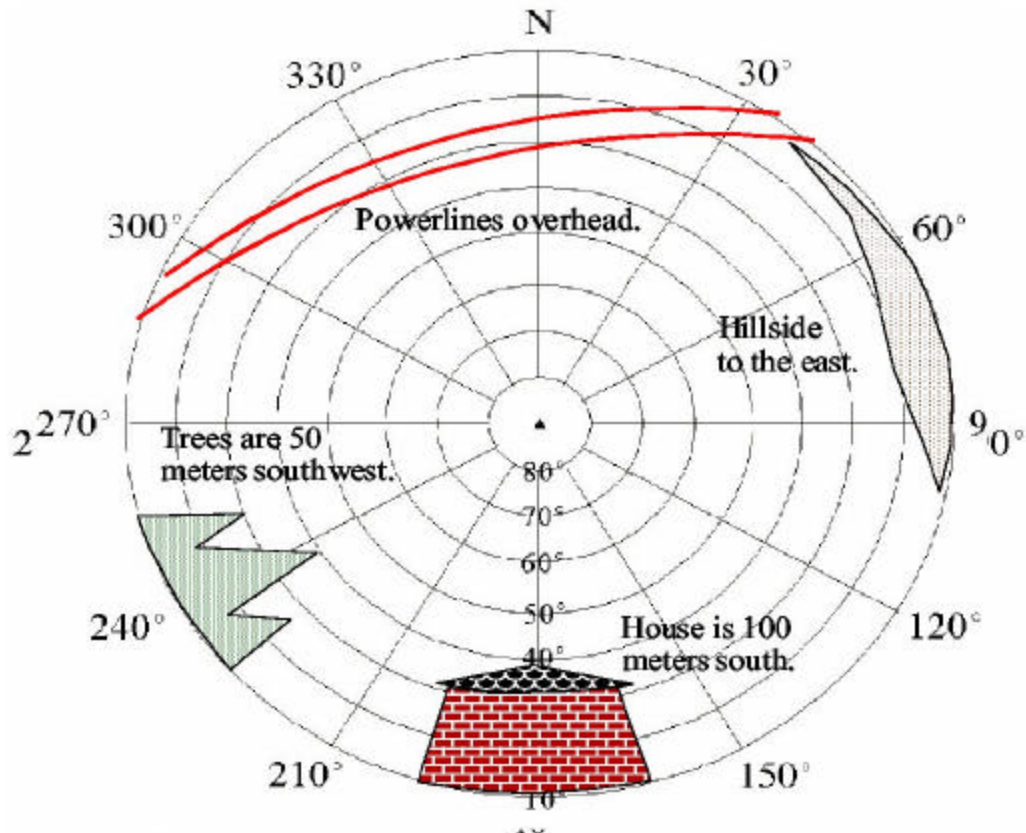

INSTRUCTIONS:

Identify obstructions by azimuth (magnetic) and elevation angle (above horizon) as seen from station mark. Indicate distance and direction to nearby structures and reflective surfaces (potential multipath sources).

4-char ID: BALD Designation: BALD 2 RESET
 PID: QE2736 Location: Boiler Bay Wayside
 County: LINCOLN Reconnaissance By: John Q. Surveyor
 Height above mark, meters: 2 Agency/Company: Oregon DOT
 Phone: () (301) 713-3194 Date: 1998-12-31
 Check if no obstructions above 10 degrees

Figure 3.1. NGS visibility obstruction diagram sample.

 GPS STATION OBSERVATION LOG April 16, 2003	Station Designation: (check applicable: <input type="checkbox"/> FBN <input checked="" type="checkbox"/> CBN <input type="checkbox"/> PAC <input checked="" type="checkbox"/> SAC <input checked="" type="checkbox"/> BM)	Station PID, if any:	Date (UTC):																												
	BALD 2 RESET General Location: Boiler Bay Wayside	Airport ID, if any: ---	QE2736	31 Dec 2002																											
Project Name: Sample GPS, 2002	Project Number: GPS- 1234	Station 4-Character ID: BALD	Day of Year: 365																												
NAD83 Latitude: 44 49 49.17802	NAD83 Longitude: 124 03 56.23447	Station Serial # (SSN): leave blank	Session ID:(A,B,C etc): A																												
NAD83 Ellipsoidal Height: -6.44 meters NAVD88 Orthometric HL: 17.0 meters GEOID99 Geoid Height: -23.52 meters	Agency Full Name: Oregon DOT Operator Full Name: John Q. Surveyor Phone #: () () () e-mail address: jqs@ordot.gov																														
Observation Session Times (UTC): Sched. Start 12:00 Stop 17:30 Actual Start 11:55 Stop 17:32	Epoch Interval: 15 Seconds Elevation Mask = 10 Degrees																														
Receiver Brand & Model: Leica SR530 p/n 667122 S/N: s/n 0030354 Firmware Version: Version 3.0 <input checked="" type="checkbox"/> CanCorder Battery, <input type="checkbox"/> 12VDC, <input type="checkbox"/> 110V AC, <input type="checkbox"/> Other	Antenna Code*, Brand & Model: Trimble Choke Ring p/n 29659-00 S/N: s/n 02200-63591 Cable Length, meters: 30 meters Vehicle is Parked 25 meters N (direction) from antenna.	Antenna plumb before session? <input checked="" type="checkbox"/> (Y/N) Circle Antenna plumb after session? <input checked="" type="checkbox"/> (Y/N) Yes or No Antenna oriented to true North? <input checked="" type="checkbox"/> (Y/N) if no, explain Weather observed at antenna ht. <input checked="" type="checkbox"/> (Y/N) Antenna ground plane used? <input checked="" type="checkbox"/> (Y/N)																													
Tripod or Antenna Mount: Check one: <input checked="" type="checkbox"/> Fixed-Leg Tripod, <input type="checkbox"/> Collapsible-Leg tripod, <input type="checkbox"/> Fixed Mount Brand & Model: SECO P/N: none S/N: 97-G Last Adjustment date: 2002-11-01 Psychrometer (if used) Brand & Model: P/N: Psychrodyne S/N: J.Q.S. Last Calibration or check Date:	** ANTENNA HEIGHT ** <table border="1"> <thead> <tr> <th></th> <th>Before Session Begins:</th> <th colspan="2">After Session Ends:</th> </tr> <tr> <th></th> <th>Meters</th> <th>Feet</th> <th>Meters</th> </tr> </thead> <tbody> <tr> <td>A = Datum point to Top of Tripod (Tripod Height)</td> <td>2.000</td> <td></td> <td>2.000</td> </tr> <tr> <td>B = Additional offset to ARP if any (Tribrach/Spacer)</td> <td>-0.003</td> <td></td> <td>-0.003</td> </tr> <tr> <td>H = Antenna Height = A + B = Datum Point to Antenna Reference Point (ARP)</td> <td></td> <td></td> <td></td> </tr> </tbody> </table> Meters = Feet x (0.3048) Height Entered Into Receiver = 2.000 meters. Note &/or sketch ANY unusual conditions. Be Very Explicit as to where and how Measured!				Before Session Begins:	After Session Ends:			Meters	Feet	Meters	A = Datum point to Top of Tripod (Tripod Height)	2.000		2.000	B = Additional offset to ARP if any (Tribrach/Spacer)	-0.003		-0.003	H = Antenna Height = A + B = Datum Point to Antenna Reference Point (ARP)											
	Before Session Begins:	After Session Ends:																													
	Meters	Feet	Meters																												
A = Datum point to Top of Tripod (Tripod Height)	2.000		2.000																												
B = Additional offset to ARP if any (Tribrach/Spacer)	-0.003		-0.003																												
H = Antenna Height = A + B = Datum Point to Antenna Reference Point (ARP)																															
Barometer (if used) Brand & Model: pretel altiplus A2 S/N: J.Q.S. none. 01-Nov-02	<table border="1"> <thead> <tr> <th>Weather Data</th> <th>Weather Codes</th> <th>Time (UTC)</th> <th>Dry-Bulb Temp Fahrenheit Celsius</th> <th>WetBulb Temp Fahrenheit Celsius</th> <th>Rel. % Humidity</th> <th>Atm. Pressure inches Hg millibar</th> </tr> </thead> <tbody> <tr> <td>Before</td> <td>00000</td> <td>12:00</td> <td>74.0</td> <td>68.0</td> <td>74</td> <td>29.44</td> </tr> <tr> <td>Middle</td> <td>00001</td> <td>14:45</td> <td>77.0</td> <td>72.5</td> <td>81</td> <td>29.55</td> </tr> <tr> <td>After</td> <td>00102</td> <td>17:30</td> <td>82.5</td> <td>78.0</td> <td>82</td> <td>29.66</td> </tr> </tbody> </table>	Weather Data	Weather Codes	Time (UTC)	Dry-Bulb Temp Fahrenheit Celsius	WetBulb Temp Fahrenheit Celsius	Rel. % Humidity	Atm. Pressure inches Hg millibar	Before	00000	12:00	74.0	68.0	74	29.44	Middle	00001	14:45	77.0	72.5	81	29.55	After	00102	17:30	82.5	78.0	82	29.66		
Weather Data	Weather Codes	Time (UTC)	Dry-Bulb Temp Fahrenheit Celsius	WetBulb Temp Fahrenheit Celsius	Rel. % Humidity	Atm. Pressure inches Hg millibar																									
Before	00000	12:00	74.0	68.0	74	29.44																									
Middle	00001	14:45	77.0	72.5	81	29.55																									
After	00102	17:30	82.5	78.0	82	29.66																									
Remarks, Comments on Problems, Sketches, Pencil Rubbing, etc: 1. Winds, calm at start, gradually increased to 20 knots by end of session. 2. Semi-trailer parked 12 meters SSE of antenna from 15:17 to 15:32 UTC, possibly blocking satellites and causing multipath environment. Weather codes are required. Weather data are optional but encouraged. *Antenna code comes from ant_info file furnished by project coordinator.																															
Data File Name(s): BALD365A.dat <small>(Standard NGS Format = aaaaaddds.xxx) where aaaa=4-Character ID, ddd=Day of Year, s=Session ID, xxx=file dependent extension</small>		Updated Station Description: <input checked="" type="checkbox"/> Attached <input type="checkbox"/> Submitted earlier Visibility Obstruction Form: <input checked="" type="checkbox"/> Attached <input type="checkbox"/> Submitted earlier Photographs of Station: <input checked="" type="checkbox"/> Attached <input type="checkbox"/> Submitted earlier Pencil Rubbing of Mark: <input checked="" type="checkbox"/> Attached																													
LOG CHECKED BY: JQE																															
Table of Weather Codes Examples: 00000 = No problem, good visibility, normal temp, clear, calm wind 12121 = Problems, poor visibility, hot, overcast, moderate wind	<table border="1"> <thead> <tr> <th>CODE</th> <th>PROBLEM</th> <th>VISIBILITY</th> <th>TEMPERATURE</th> <th>CLOUD COVER</th> <th>WIND</th> </tr> </thead> <tbody> <tr> <td>0</td> <td>did not occur</td> <td>Good, over 15 miles</td> <td>Normal, 32° F- 80° F</td> <td>Clear, below 20%</td> <td>Calm, under 5mph (8km/h)</td> </tr> <tr> <td>1</td> <td>did occur</td> <td>Fair, 7-15 miles</td> <td>Hot, over 80° F (27 C)</td> <td>Cloudy, 20% to 70%</td> <td>Moderate, 5 to 15 mph</td> </tr> <tr> <td>2</td> <td>- not used -</td> <td>Poor, under 7 miles</td> <td>Cold, below 32° F (0 C)</td> <td>Overcast, over 70%</td> <td>Strong, over 15 mph (24km/h)</td> </tr> </tbody> </table>			CODE	PROBLEM	VISIBILITY	TEMPERATURE	CLOUD COVER	WIND	0	did not occur	Good, over 15 miles	Normal, 32° F- 80° F	Clear, below 20%	Calm, under 5mph (8km/h)	1	did occur	Fair, 7-15 miles	Hot, over 80° F (27 C)	Cloudy, 20% to 70%	Moderate, 5 to 15 mph	2	- not used -	Poor, under 7 miles	Cold, below 32° F (0 C)	Overcast, over 70%	Strong, over 15 mph (24km/h)				
CODE	PROBLEM	VISIBILITY	TEMPERATURE	CLOUD COVER	WIND																										
0	did not occur	Good, over 15 miles	Normal, 32° F- 80° F	Clear, below 20%	Calm, under 5mph (8km/h)																										
1	did occur	Fair, 7-15 miles	Hot, over 80° F (27 C)	Cloudy, 20% to 70%	Moderate, 5 to 15 mph																										
2	- not used -	Poor, under 7 miles	Cold, below 32° F (0 C)	Overcast, over 70%	Strong, over 15 mph (24km/h)																										

Figure 3.2. NGS GPS station observation log sample.

3.2 GPS Buoy Campaign in Holland

A GPS buoy campaign in Holland, Michigan for Lake Michigan was conducted by the Laboratory for Space Geodesy and Remote Sensing Research of the CEEGS at OSU in cooperation with the NGS on March 20th to 24th, 1999. Figure 3.3 illustrates the campaign location and altimeter nominal ground tracks. Figure 3.4 shows the GPS buoy deployed locations in Lake Michigan. The black and gray dots in Figure 3.4 are the nominal footprints of TSB and GFO in 1 Hz. The triangles are fiducial sites that are established by Snow (2002) through the weighted partial MINOLESS solution from the GPS network. The blue squares in Figure 3.4 are actual buoy deployed locations on the 20th (DOY 079) and 24th (DOY 083) respectively. Note that there was only one TSB descending track that passes the lake on the 20th (Cycle 239) when the buoy was deployed in the lake. The TSB ascending track passes the lake on the 22nd.

The campaign was intended to provide independent water level measurements in Lake Michigan with the GPS buoy and with the Holland West, a CO-OPS tide gauge (Figure 3.5), for the absolute calibration of satellite radar altimeters including TOPEX Side A (TSA), Side B (TSB) and Geosat Fallow-On (GFO). As reported in Cheng (2001), the buoy deployed locations were off the nominal altimeter footprints by about 6-10 km due to the use of the approximate satellite orbits of Topex and of GFO in the planning stage. Consequently, an optimal spatial extrapolation, namely Kriging, had to be applied and thus degraded the overall calibration precision by ± 43 cm in the formal error. The TSB over flight was at cycle 239 on March 20th despite the buoy was off by about 10 km. GFO data were unavailable on the 24th and no calibration was performed.

Since there was no suitable NGS GPS control point for TSB, two fiducial sites MBYC (Figure 3.6 about 100 m to the Holland West tide gauge) and G317 were established for buoy positioning with a GPS network (Figure 3.7) designed by Snow (2002). G317 was an existing NGS GPS control point whose published coordinates were also verified by this GPS network adjustment. After completing the field work for the GPS buoy, field work for the GPS network was conducted three months thereafter. Six CORS in the vicinity ranging from 155 km to 428 km were adopted. Triangles in Figure 3.7 represent the CORS in the network whereas the circles represent the new points to be estimated. GPS code and carrier phase observations of these CORS were carried out and three new points were collected in static mode for three consecutive days with a daily 8-hour observation period, which complies with the NGS standard for control point densification. As a result, the baseline from MBYC to the TSB footprint is approximately 21 km. The weighted partial MINOLESS solution for the GPS network was performed, the residuals in the observations, and the estimated position vector of each CORS in the network were minimized by the least squares adjustment. The adjusted ITRF coordinates of MBYC and their formal errors are summarized in Table 3.2. Latitude, longitude and ellipsoidal height are expressed on the Topex Reference Ellipsoid (Centre National d'études Spatiales and National Aeronautics and Space Administration, 2001).

Lake Michigan Radar Altimeter Calibration Campaign

(March 20 - 24, 1999)

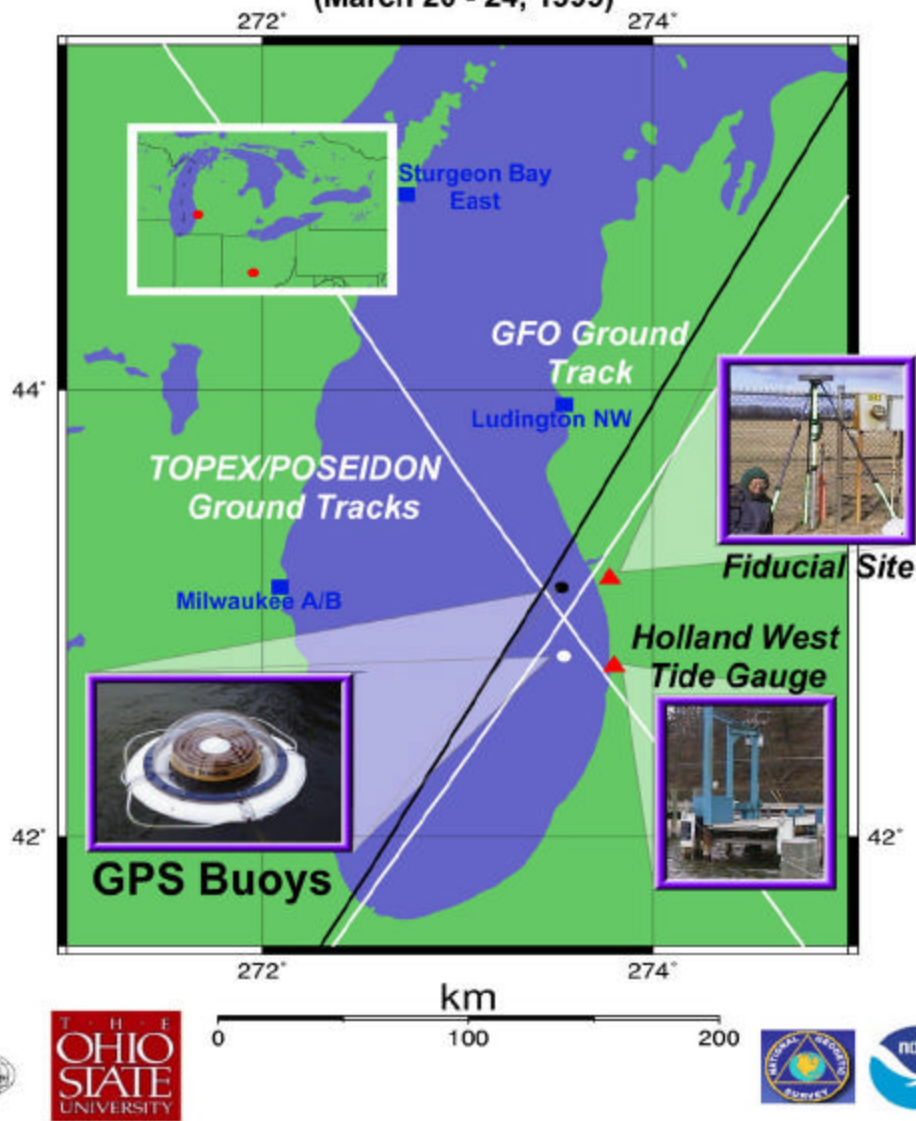

Figure 3.3. The GPS buoy campaign in Holland, Lake Michigan.

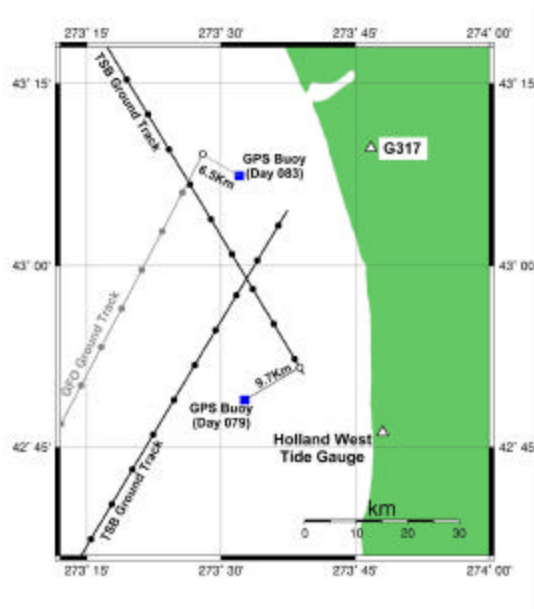

Figure 3.4. The GPS buoy deployments in Lake Michigan.



Figure 3.5. The Holland West tide gauge (one of the CO-OPS acoustic sounding gauges in the Great Lakes) producing 6-minute water level continuously.



Figure 3.6. The fiducial site at MBYC, close to Holland West tide gauge, was established with the GPS network. The receiver and battery were inside the building.

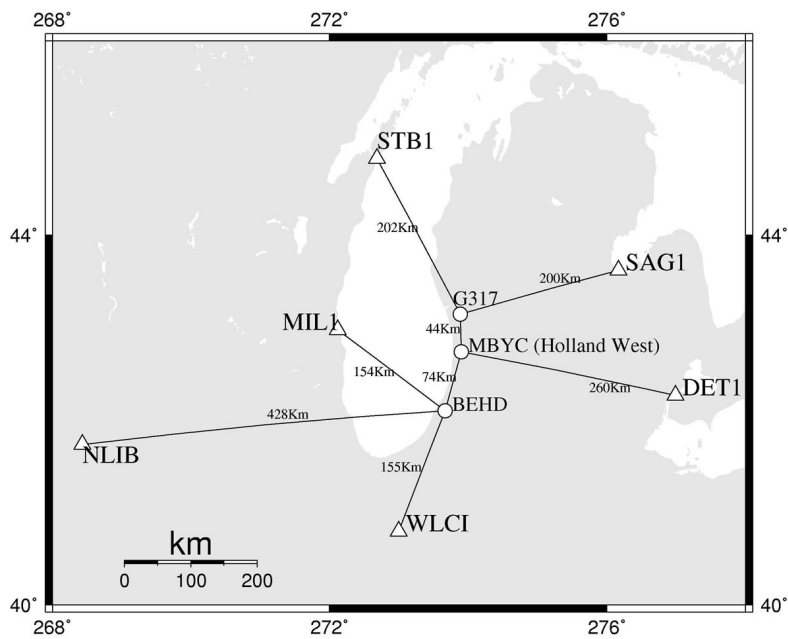

Figure 3.7. The GPS network for the Holland Campaign.

	Coordinates	Formal errors
X	310880.092 m	3.4 mm
Y	-4679085.777 m	19.3 mm
Z	4308925.669 m	17.3 mm
Latitude	42.461413 deg.	0.130 msec.
Longitude	-86.115581 deg.	0.150 msec.
Ellipsoidal Height	143.254 m	25.6 mm

Table 3.2. The ITRF coordinates of MBYC, the fiducial site for TSB, and its geodetic coordinates are calculated on the Topex Reference Ellipsoid.

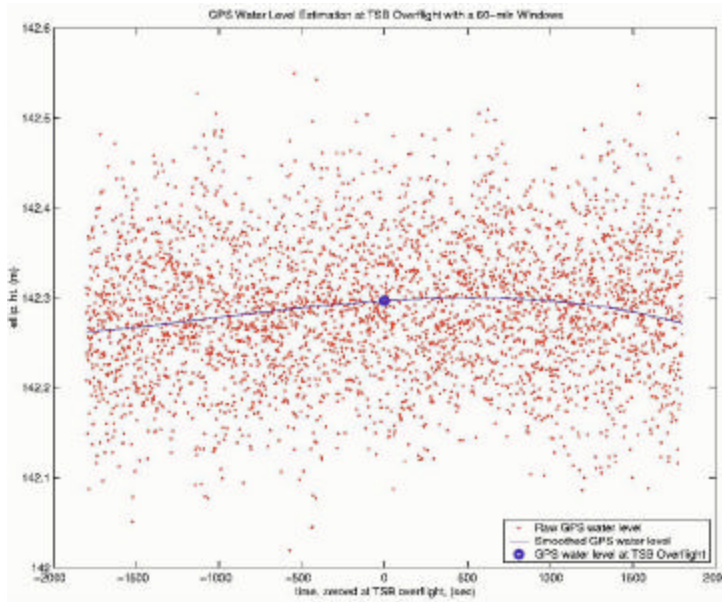

Figure 3.8. The GPS buoy height solution on the 20th with a one-hour window centered at the TCA of the satellite. An order three polynomial was used to smooth the raw GPS height solution in order to filter the high-frequency effect such as waves. The blue line is the smoothed solution and the blue circle is the height at TCA.

The buoy kinematic data was processed with Kinematic and Rapid Static (KARS) developed by Mader (1986). KARS employs a Kalman filter to include the platform movements in the on-the-fly (OTF) kinematic solution. It is especially favorable in GPS buoy applications because its constraints are especially designed for the platform on the water surface. Figure 3.8 shows the GPS height solution in an one-hour window. The high-frequency effect that was by the wave can also be seen in the figure. In order to estimate the GPS height solution at the time of the closest approach (TCA) of the satellite, Cheng (2001) analyzed different window sizes with different low-pass filters for the height component and concluded that a one-hour window with an order-three polynomial provide sufficient solution at TCA. The blue line represented the smoothed GPS height solution and the blue circle is the one at TCA, which is later used to calibrate TSB altimeter. The result for the calibration of TSB is published in Cheng (2001) and Cheng et al. (2002). The campaign documents and data sheets of this campaign can be found in Appendix A.

3.3 GPS Buoy Campaign in Marblehead

There were two GPS buoy campaigns that were conducted by the Laboratory of Space Geodesy and Remote Sensing Research of the CEEGS at OSU in Lake Erie (see Figure 3.9). The Marblehead campaign was from October 20th and 21st, 2001 and the second in Cleveland was from September 17th – 19th, 2003. This section focuses on the Marblehead campaign and its map is shown in Figure 3.10. The objective of this campaign was to connect the Marblehead tide gauge (Figure 3.11) to the altimeter footprint on pass 76 of Jason-1 and TSB for the absolute calibration of both altimeters. This campaign was on a weekend and no satellite over flight occurred during that time. Therefore, the use of the GPS buoys was focused on the survey of the mean lake surface gradients from the Marblehead tide gauge to the satellite nominal footprint.

Two NGS ground control points surveyed with GPS: Z317 and 3079 located in the Marblehead Coast Guard Base were selected as the fiducial sites. Z317 was selected as the main one for its better sky visibility and 3079 was served as the backup. These 2 sites were equipped with Trimble 4000 SSi receivers combined with Dorne/Margolin Element with Choke Ring antennae, the same type as on the GPS buoy, for 8 hours on the 20th in 1 Hz sampling rate when the buoy was deployed next to the Marblehead tide gauge. Since they are located in the Coast Guard Base, its security enables us to leave the equipment overnight for additional 10 hours without buoy deployment. These data were used in the GPS network (see Figure 3.12). During this time, site 3079 was switched to a 30 sec sampling rate to save memory and was switched back to 1 Hz rate on the 21st when the buoy was deployed in the lake. Table 3.3 shows the partial weighted MINOLESS solution of Z317 and the formal errors.

	Coordinates	Formal errors
X	604849.546 m	4 mm
Y	-4742507.212 m	42 mm
Z	4207835.815 m	32 mm
Latitude	41.542936 deg.	1.2 msec.
Longitude	-82.731853 deg.	0.3 msec.
Ellipsoidal Height	141.371 m	37 mm

Table 3.3. The ITRF 97 coordinates of Z317, the main fiducial site for Marblehead Campaign. Its geodetic coordinates are calculated on the Topex Reference Ellipsoid.

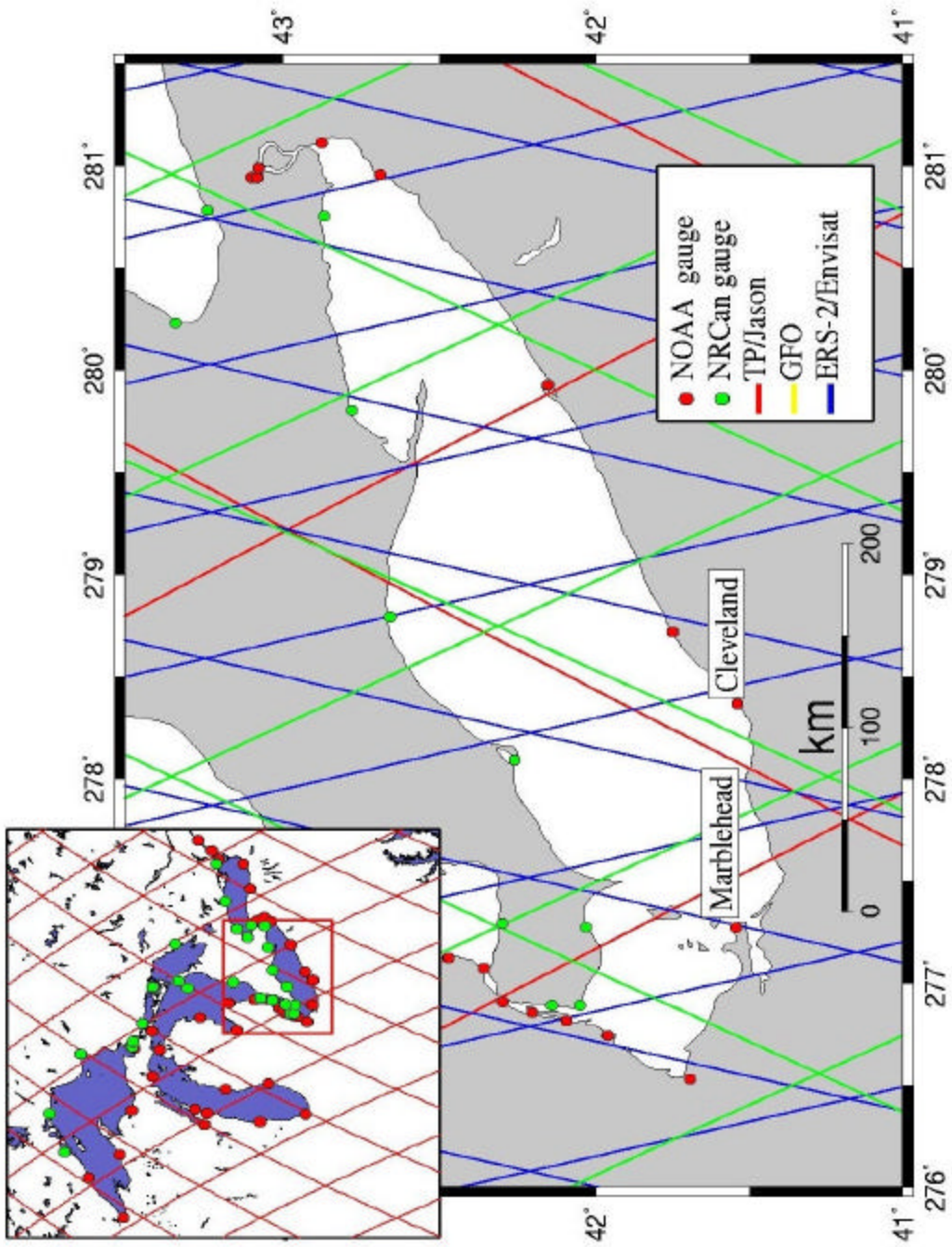

Figure 3.9. GPS buoy campaigns in Lake Erie.

Lake Erie GPS Buoy Campaign (Oct. 21, 2001)

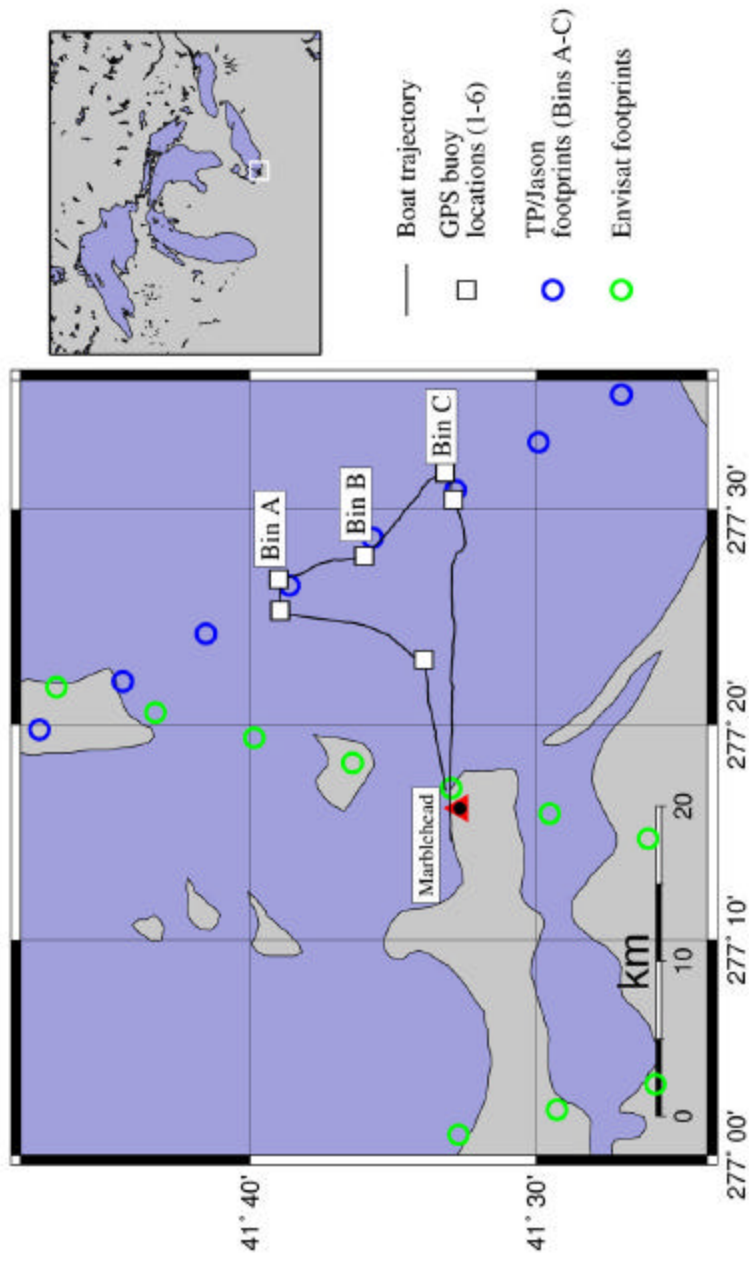

Figure 3.10. The GPS buoy campaign in Marblehead.



Figure 3.11. The Marblehead tide gauge located in the Marblehead Coast Guard Base. The white box to the left of the boat is the gauge house.

GPS Network for Marblehead Campaign

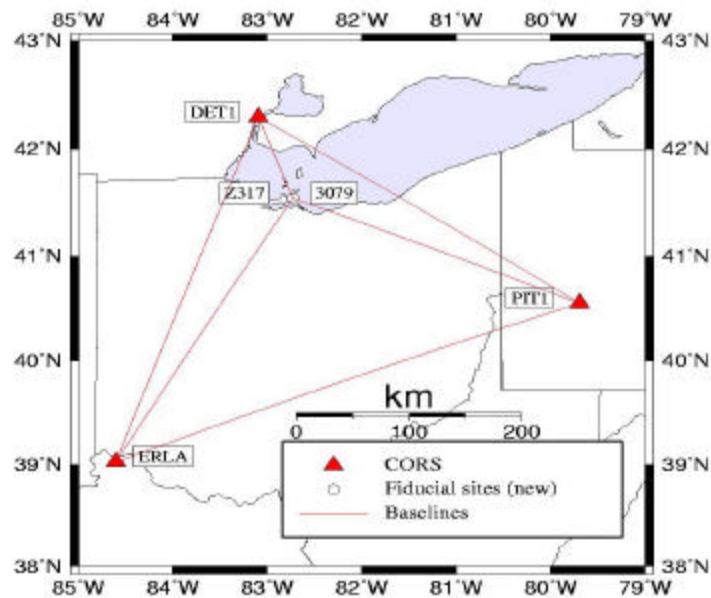

Figure 3.12. The GPS network for Marblehead Campaign.

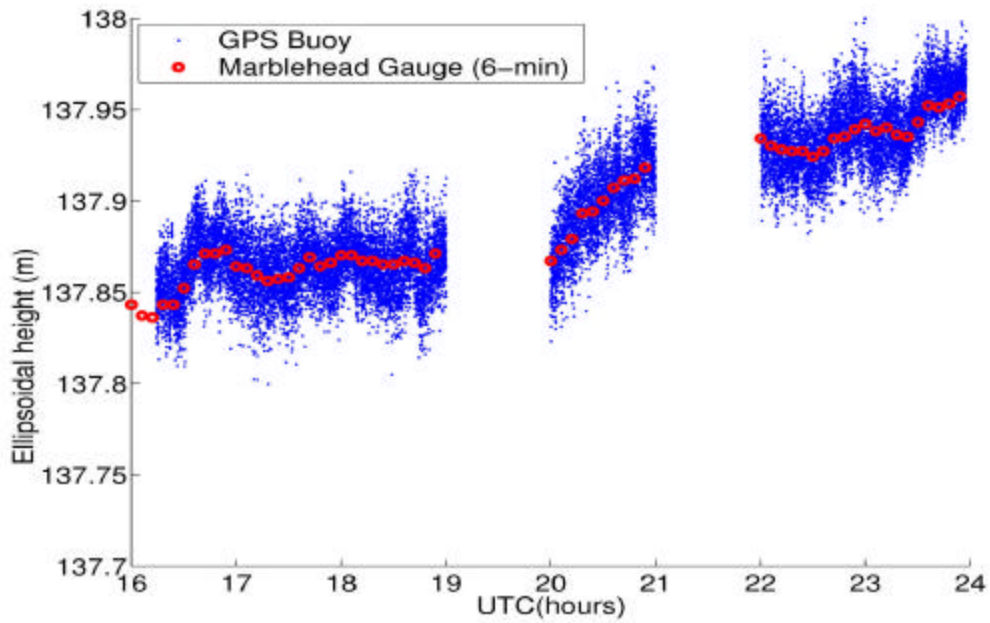

Figure 3.13. The GPS height solution on the Topex Reference Ellipsoid on Oct. 20th, 2001. The tide gauge data were shifted by -35.293 m.

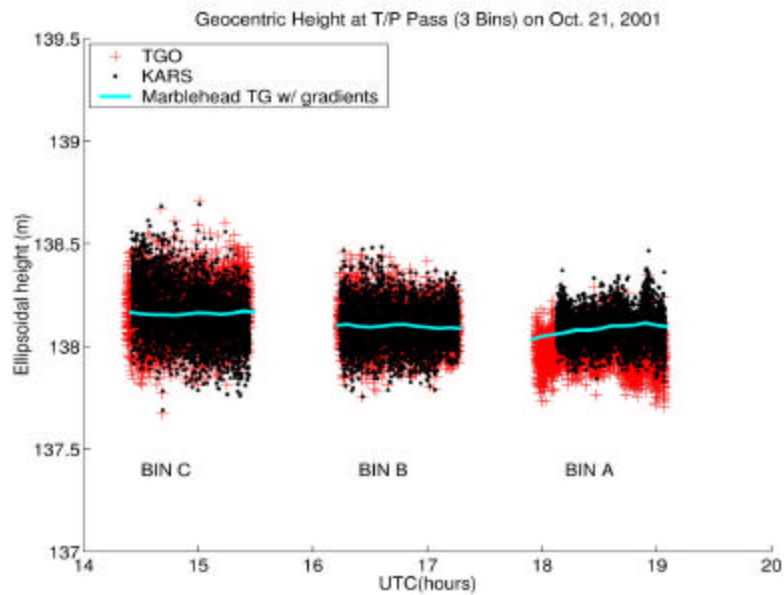

Figure 3.14. The GPS height solution on three bins along the TP/Jason track on Oct. 21st, 2001.

The buoy data on the 20th will be used to determine the geoid height, or more precisely, the geoid height and the secular part of the lake surface topography, at the gauge that will later be used to convert tide gauge data to the geocentric height for altimeter calibration.

On the 20th and the GPS buoy were deployed at 3 different locations to survey on three bins along TP/Jason pass 076 as well as one location on the way back from the altimeter pass. A bin is the nominal area that used in the OSU stackfile (Yi, 2000) to accommodate the altimeter footprint of each visit in every cycle. The size of a bin is approximately 6 km by 2 km in the along- and cross-track directions. The locations and the ship track are shown in Figure 3.10 and the baselines from them to the reference station Z317 are within 20 km.

Kinematic solutions on the 20th when the buoy was sitting next to the Marblehead gauge are shown in Figure 3.13, which shows the agreement between the GPS buoy height and the water level measurements from the Marblehead tide gauge with the geoid height applied. The geoid height, the separation between the North American Vertical Datum (NAVD) 1988 and the Topex Reference Ellipsoid, was estimated to be -35.293 m with an uncertainty of <1 mm. Since TSB and Jason-1 refer to Topex Reference Ellipsoid, it was adopted in this campaign to represent the ellipsoidal height.

Kinematic GPS data were processed with KARS and Trimble Geomatic Office (TGO) with International GPS Services (IGS) precise ephemerides (final orbits). The results from both software packages show similar results (e.g., see Figure 3.14). The complete calibration result can be found in Shum et al. (2003). The campaign documents and data sheets of this campaign can be found in Appendix B.

3.4 GPS Buoy Campaign in Cleveland

The Laboratory of Space Geodesy and Remote Sensing Research of the CEEGS at OSU conducted a GPS buoy campaign in Lake Erie near Cleveland, Ohio on September 17th – 19th, 2003. This is their second campaign in Lake Erie. The previous one was at Marblehead in 2001 (see Figure 3.9 for map in Lake Erie and Figure 3.16 for map of the campaign). Its objective is to connect the Cleveland tide gauge (Figure 3.15) to the altimeter absolute calibration.

The campaign includes the GPS deployment next to the tide gauge to determine local geoid and also the survey of the altimeter ground tracks. The buoy deployed locations, P1 to P6 in Figure 3.16, were planned to cover these altimeter ground tracks including Envisat, GFO, Icesat (91-day repeat orbit) and Jason-1. If the weather permitted, the buoy could be deployed at P5 at the Jason-1 over flight at 4:16 (UTC) on the 19th. Each location in the lake was planned to be occupied by the GPS buoy for 2 hours and it has been decided to deploy the GPS in three locations per day. However, due to the visit of a Class III hurricane on the 19th, the campaign has to be cut short and only P1 and P2 were successfully surveyed on the 18th by the GPS buoy. An attempt was made on 18th to reach P5 but it was fail because that the waves had become very rough (about 4 to 6-foot height based on the captain's observation) and the weather had turned bad. Thus, the rest of the plan was abandoned.



Figure 3.15. Cleveland gauge house.

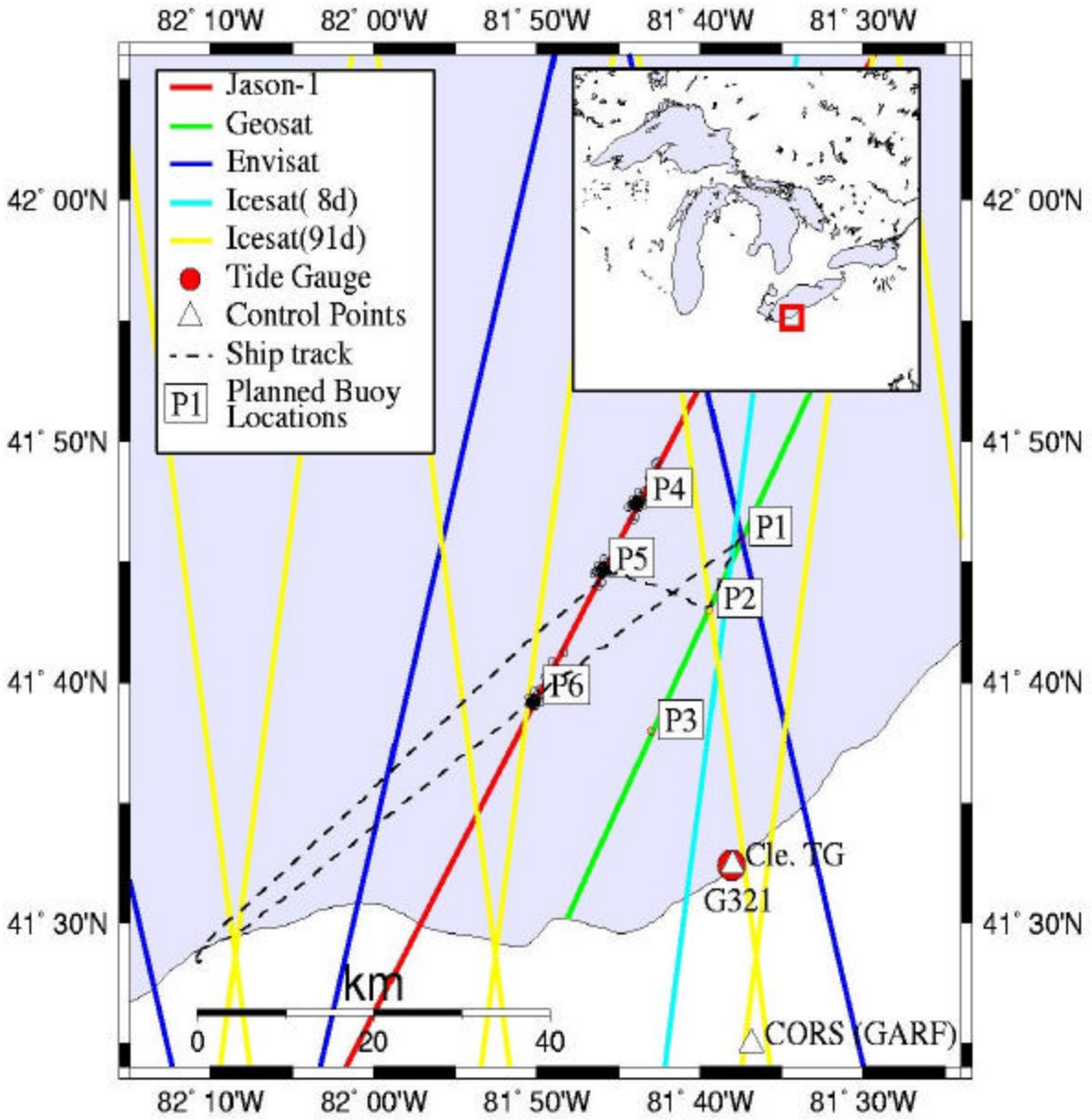

Figure 3.16. The ship track and the planned GPS buoy deployed location in the campaign at Cleveland.

GPS Network for Cleveland Campaign

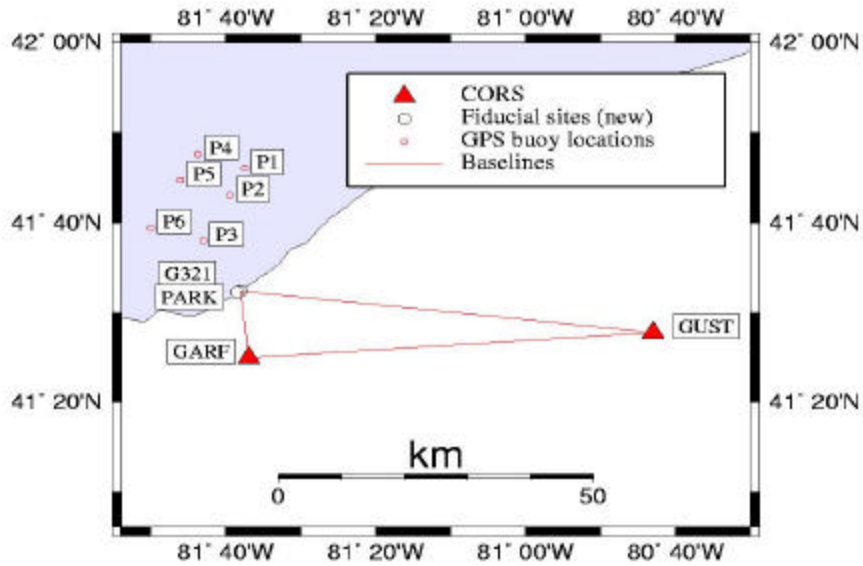

Figure 3.17. The GPS network for the Cleveland Campaign.

	Coordinates	Formal errors
X	695623.691 m	1 mm
Y	-4730265.496 m	5 mm
Z	4207592.042 m	4 mm
Latitude	41.539990deg.	0.14 msec.
Longitude	-81.634156 deg.	0.05 msec.
Ellipsoidal Height	142.314 m	4.6 mm

Table 3.4. The ITRF 2000 coordinates of G321, the main fiducial site for Marblehead Campaign. Its geodetic coordinates are calculated on the GRS 80 Ellipsoid that is adopted by the WGS84 reference frame.

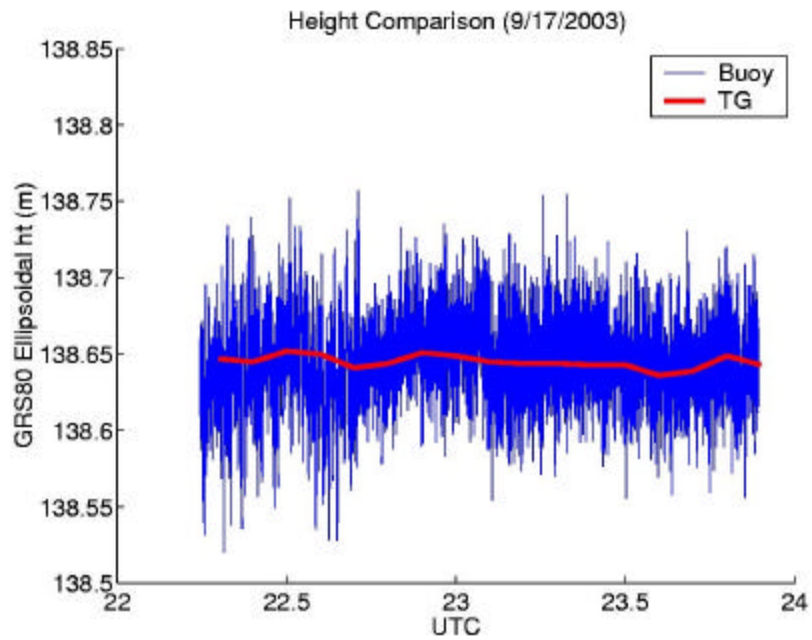

Figure 3.18. The GPS height solution on the GRS Reference Ellipsoid on Sept. 17th, 2003. The tide gauge data were shifted by -35.428 m.

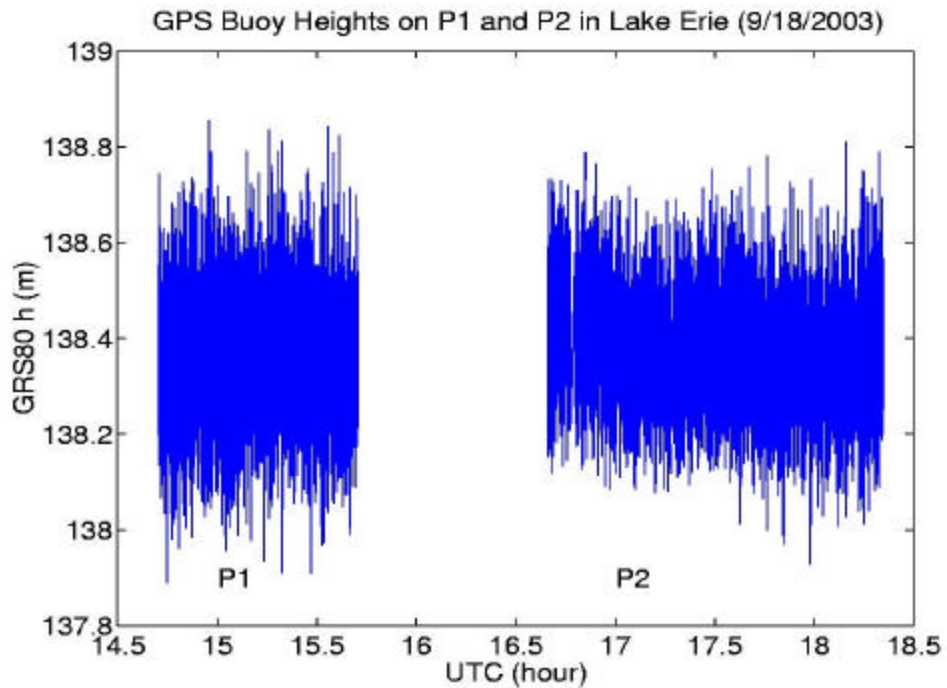

Figure 3.19. The GPS buoy height solution on P1 and P2 in Lake Erie.

The equipment included three Trimble 4000 SSI receivers combined with three Dorne/Margolin Element with Choke Ring antennae. One set of them were installed on the OSU waverider GPS Buoy with a 30-m cable. The other 2 sets were used on the fiducial sites with 2-m fixed height tripods.

The main fiducial site was selected at G321, which is also a NGS GPS control point in the area. Auxiliary fiducial sites AUXI and PARK were selected in the area. PARK was selected about 100 meters west of the Cleveland tide gauge where the buoy was deployed close to the tide gauge on the 17th. G321 and AUXI were planned to be the fiducial sites on the 18th. Figure 3.17 shows the GPS network that consists of the fiducial sites and 2 ODOT (Ohio Department of Transportation) CORS in the vicinity. The ODOT CORS are affiliated to the NGS CORS network which began operating recently. The weighted partial MINOLESS solution of G321 is shown in Table 3.4. Figure 3.18 shows the GPS height solution when the buoy was deployed next to the Cleveland tide gauge (about 100 m off). The local geoid height, the surface separation between NAVD 88 and GRS 80, is estimated as -35.428m. This indicates GRS 80 surface is 35.428m higher than that of NAVD 88. The tide gauge level measurements were shifted by -35.428m in Figure 3.18. Figure 3.19 shows the GPS buoy height solution when the buoy was deployed at P1 and P2 in Lake Erie. This information is prepared for the calibration of Envisat, GFO, and Icesat (91-d orbit). The calibration processes of these altimeters are currently under investigation. The campaign documents can be found in Appendix C.

4. Summary

The three GPS buoy campaigns in the Great Lakes discussed in this report emphasized the field work procedure. These three campaigns have a common goal: to establish a calibration site for altimeters using existing CO-OPS tide gauges. The general procedure is to select the appropriate tide gauge based on the satellite ground tracks. A GPS network is required either to establish the fiducial sites or to verify the site coordinates to its book values if an existing NGS control point was selected as the fiducial site. With only one GPS buoy, its deployment requires two steps: deployment next to the tide gauge to determine local geoid, and deployments in the lake on altimeter nominal footprints for calibration. The predominant error source is the GPS baseline length since it assumes the common errors at both ends of the baseline will be significantly erased by the DGPS technique. As the length of a baseline goes up, this assumption becomes invalid. It is especially apparent on tropospheric range delays at both ends of a baseline. Therefore, the baselines in these past campaigns were less than 30 km, which yield approximately sub-decimeter level accuracy in vertical for one single epoch if the integer ambiguities of phases have resolved correctly. The redundant observations at the same deployed location help to increase accuracy. Thus the GPS buoys were deployed for at least one hour in each location with the ship anchored.

References

- Bettadpur, S., and R. Eanes. 1994. Geographical representation of radial orbit perturbations due to ocean tides: Implications for satellite altimetry. *J. Geophys. Res.* 99, (C12), 24883-94.
- Bisnath, S., D. Dodd, D. Wells, S. Howden, D. Wiesenburg and G. Stone. 2003. Water level recovery with an RTK GPS-equipped buoy. Paper presented in U.S. Hydro 2003 Conference, March 23-27, in Biloxi, Mississippi, USA.
- Born, G.H, M.E. Parke, P. Axelrad, K.L. Gold, J. Johnson, K. W. Key, and D.G. Kubitschek. 1994. Calibration of the TOPEX Altimeter using GPS Buoy. *J. Geophys. Res.*, 99, (C12), 24517-26.
- Centre National d'études Spatiales and National Aeronautics and Space Administration. 2001. *AVISO and PODAAC User Handbook, IGDR and GDR Jason Products*, Edition 1.0. Draft. SMM-MU-M5-OP-13184-CN(AVISO).
- Cheng, K., C. Shum, C. Han, Y. Yi, and D. Martin. 2002. Application of GPS-buoy water level instrument for radar altimeter calibration. In *Gravity, Geoid, and Geodynamics 2000 : GGG2000 IAG International Symposium*, International Association of Geodesy Symposia, Sym. 123. Edited by M.G. Sideris. Springer.
- Cheng, K. 2001. Radar altimeter absolute calibration using GPS water level measurements. *Master Thesis*. The Ohio State University, Columbus, Ohio, USA.
- Haines, B., D. Kubitschek, G. Born, and S. Gill. 2002. Monitoring Jason-1 and TOPEX/POSEIDON from an offshore platform: The Harvest Experiment. Paper presented at Jason-1 Science Working Team Meeting, October, in New Orleans, Louisiana, USA
- Hein, G.W., H. Blomenhofer, H. Landau and E. Taveira. 1992. Measuring sea level changes using GPS in buoys. In *Sea Level Changes: Determination and Effects*, Geophysical Monograph 90, IUGG Vol. 11. Edited by P.L. Woodworth, D.T. Pugh, J.G. DeRonde, R.G. Warrick, and J. Hannah. American Geophysical Union and International Union of Geodesy and Geophysics.

- Hein, G.W., H. Landau, and H. Blomenhofer. 1990. Determination of instantaneous sea surface, wave heights, and ocean currents using satellite observations of the Global Positioning System. *Marine Geodesy* 14:217-24.
- Hess, K. 2001. *Generation of Tidal Datum Fields for Tampa Bay and the New York Bight*, NOAA Technical Report NOS CS 11, National Oceanographic and Atmospheric Administration, USA.
- Jekeli, C. 2002. *Heights, the Geopotential, and Vertical Datums*, Technical Report No. 459, Department of Civil and Environmental Engineering and Geodetic Science, the Ohio State University, Columbus, Ohio, USA.
- Kelecy, T.M., G.H. Born, M.E. Parke, and C. Rocken. 1994. Precise mean sea level measurements using the Global Positioning System. *J. Geophys. Res.*, 99, (C4), 7951-9.
- Key, K, M. Parke, and G. Born. 1998. Mapping the sea surface using GPS buoy. *Marine Geodesy* 21:67-79.
- Kruizinga, G.L. 1997. Validation and applications of satellite radar altimetry. *Ph.D. Dissertation*, the University of Texas, Austin, Texas, USA.
- Li, R., K.W. Bedford, C.K. Shum, J.R. Ramirez, A. Zhang, and K. Di. 2002. Digitalization of coastal management and decision making supported by multi-dimensional geospatial information and analysis. Paper presented at NSF National Conference for Digital Government Research, Los Angeles, CA, USA.
- Liebsch, G., K. Novotny, and R Dietrich. 2002. Comparison of multimission altimetric sea-surface heights with tide gauge observations in the Southern Baltic Sea. *Marine Geodesy* 25:213-34.
- Mader. G. 1999. GPS antenna calibration at the National Geodetic Survey. *GPS Solutions*, 3 (1): 50-8.
- Mader., G.L. 1986. Dynamic Positioning Using Global Positioning System Carrier Phase measurements, *Manuscr. Geod.*, 11, pp. 272-277.
- McCarthy, D. D. 2003. *IERS Conventions*. IERS Technical Note 32. U.S. Naval Observatory.
- Milbert, D. 2002. VDatum Transformation Tool (new Version 1.05), The Geo Community Spatial News, Available online on <http://spatialnews.geocomm.com/features/vdatum/>. (accessed on October 20, 2003).
- Parker, B., D. Milbert, K. Hess and S. Gill. 2003. National VDatum – The implementation of a national vertical datum transformation database. Paper presented in U.S. Hydro 2003

- Conference, March 23-27, in Biloxi, Mississippi, USA.
- Rocken, C, T.M. Kelecy, G.H. Born, L.E. Young, G.H. Purcell Jr., and S.K. Wolf. 1990. Measuring precise sea level from a buoy using the Global Positioning System. *Geophysical Research Letters* 17, (12), 2145-8.
- Schone, T. 2000. *GPS Water Level Measurements*, Final Report SSG2.194. Presented at EGS General Assembly, Apr. 26, in Nice, France.
- Schutz, B.E., G. Kruizinga, D. Kuang, P.A. Abusali, C.K. Shum, R. Gutierrez, S. Nelson, and E. Rodriguez. 1995. Galveston Bay experiment for altimeter calibration. Paper presented at American Geophysical Union Fall Meeting, San Francisco, California, USA.
- Shum, C., Y. Yi, K. Cheng, C. Kuo, A. Braun, S. Calmant, and D. Chambers. 2003. Calibration of Jason-1 altimeter over Lake Erie. *Marine Geodesy* 26:335-54.
- Shum, C. and M. E. Parke. 1999. *Current GPS-buoy sea level research*, Draft, the Ohio State University, Columbus, Ohio, USA.
- Snay, R. 1999. Using the HTDP software to transform spatial coordinates across time and between reference frames. *Surveying and Land Information Systems*. 59 (1):15-25.
- Snow, K. 2002. Application of parameter estimation and hypothesis testing to GPS network adjustment. *Master Thesis*. the Ohio State University, Columbus, Ohio, USA.
- University of California. 2002. *Documentation for the GAMIT GPS Analysis Software*. Release 10.0, Scripps Institution of Oceanography, University of California, San Diego, California, USA.
- Watson, C., R. Coleman, N. White, J. Church, and R. Govind. 2003. Absolute calibration of TOPEX/Poseidon and Jason-1 using GPS buoys in Bass Strait, Australia. Submitted to *Marine Geodesy*.
- Young, L.E., S.C. Wu and T.H. Dixon. 1986. Decimeter GPS positioning for surface element of sea floor geodesy system. *Proc., International Symposium on Marine Positioning*, Reston, Virginia, USA, October 14-17.
- Yi., Y. 2000. *OSU Stackfiles*. Geodetic and GeoInformatic Science Section, Department of Civil and Environmental Engineering and Geodetic Science, the Ohio State University, Columbus, Ohio, USA.

Zilkoski, D. and D'Onofrio, D. 1996. *Geodetic Phase of NOS' San Francisco Bay Demonstration Project*. National Geodetic Survey, National Oceanographic and Atmospheric Administration, USA. Available online on http://www.ngs.noaa.gov/initiatives/HeightMod/Geodetic/sfbay_geodetic.html (accessed on October 10, 2003).

Appendix A. Holland Campaign Documents

Field Work Log

Background

The general purpose of this campaign is to measure the lake level with a special designed GPS buoy in order to compare the lake surface height from the altimeters and the tide gauge data. Two of the crossover points from Topex/Poseidon and GFO in the Lake Michigan near Holland, MI were chosen. The overflight schedule is:

T/P ascending 2300 UTC, March 20, 1999.
T/P descending 1154 UTC, March 22, 1999.
Crossover point: latitude 42°48' 51.12" N, longitude 86°27'24.48" W.

GFO descending 1618 UCT, March 24, 1999.
GFO ascending 0157 UCT, March 25, 1999.

One NOAA benchmark, 7031D was also chosen as the main reference site for the whole campaign. Also a chosen 7031H was also chosen as the auxiliary reference site but has been discarded due to the bad satellite availability. The reason that these two were chosen is because of the availability of reliable knowledge about the relative elevation to the tide gauge. The coordinates for 7031D are:

X: 310880.617 m
Y: -4679087.195 m
Z: 4308925.762 m
Ellipsoidal height: 144.37 m
Normal height: 177.74 m.

One Ashtech Z Surveyor and two Trimble 4700 receivers. One choke ring antenna has been sitting on the buoy. The logging rate is 1 second for GPS receivers with 15-degree cutoff

mask. The conversion of UTC to the local time is subtracting 5 hours from UTC.

Participants

Michael Parke, campaign leader, CEEGS, OSU

C. K. Shum, campaign leader, CEEGS, OSU

B. Burns, captain, Great Lakes Environmental Research Lab., NOAA.

Kevin Cheng, CEEGS, OSU

Doug Martin, National Geodetic Survey, NOAA.

Justin Shum, CEEGS, OSU/video specialist, UT

Hong-Zeng Tseng, CEEGS, OSU

Field Work Log

March 18:

- M. Parke left for Holland

March 19:

- M. Parke setup the buoy and a Choke ring antenna. Other participants arrived at Holland. Check all instruments and charged all batteries.

March 20 (DOY: 079)

- This session was design for the overflight at 6 pm of T/P satellite. It was tentatively scheduled from 2pm to 7pm.
- M. Parke and H. Tseng took the ship to T/P crossover point and C. K. Shum, D. Martin and K. Cheng went to the main reference sites.
- The Ashtech Z Surveyor series receiver was set at 7031D by 1 pm. The antenna height (choke ring) is 2 meters vertically. Another auxiliary reference site named TOPEX was chosen near 7031D, instead of 7031H. It was not a real monument and was arbitrarily chosen for practice only. A Trimble 4700 was used and its antenna height (micro-center antenna) is 1.927 meters (slant distance). It was started by 1:30 pm; unfortunately, the data was only for 15 minutes due to the hardware problem. The Ashtech receiver choked by 5 pm with an uncertainty of the connection between the receiver to the laptop. D. Martin switched logged data to a flash memory card to solve the problem.
- GPS buoy started tracking data from 3 pm and ended by 7 pm with approximately 3 MB data.

March 21 (DOY 080)

- Data downloading and exchange.
- Fix the buoy, changed a new doom.
- Practice Trimble 4700.

March 22 (DOY 081)

- Canceled the original plan to occupy the T/P crossover point at 5:54 am because of weather conditions.
- Set Ashtech at 7031D at 1 pm again (Choke ring, 2 meters vertically) and deployed the buoy in the harbor near the tide gauge.

March 23 (DOY 082)

- Occupied 7031D with Ashtech by 11 am. Choke ring, 2 meters vertically.
- Occupied TOP1TX with Trimble 4700 by 1130 am. Micro-center antenna, 1.526 meters uncorrected slant.
- Deployed buoy at the same place by 1130 am.
- Scouted for a new reference site for GFO crossover point.

March 24 (DOY 083)

- Occupied G317 with Ashtech from 1030 am to 1215 pm. That is NOAA's GPS monument near the airport.
- Occupied PARK with Trimble 4700 from 1040 am to 1230 pm. That is an arbitrarily chosen auxiliary points in a park near the beach. The main reason is to reduce the baseline to GFO cross over point. The approximately distance is off 20 kilometers.
- Deployed GPS buoy at the GFO crossover point. It tangled with anchor by 1030 am. There were still 15 to 20 minutes of good data before that.

Data Sheet: Holland West Tide Gauge

```

AH5303 *****
AH5303 DESIGNATION - 908 7031 J
AH5303 PID - AH5303
AH5303 STATE/COUNTY- MI/OTTAWA
AH5303 USGS QUAD - HOLLAND WEST (1972)
AH5303
AH5303 *CURRENT SURVEY CONTROL
AH5303
AH5303* NAD 83(1997)- 42 45 41.15483(N) 086 11 42.49176(W) ADJUSTED
AH5303* NAVD 88 - 183.3 (meters) 601. (feet) GPS OBS
AH5303
AH5303 X - 311,228.291 (meters) COMP
AH5303 Y - -4,679,759.862 (meters) COMP
AH5303 Z - 4,308,183.055 (meters) COMP
AH5303 LAPLACE CORR- 2.84 (seconds) DEFLEC99
AH5303 ELLIP HEIGHT- 149.74 (meters) (04/28/99) GPS OBS
AH5303 GEOID HEIGHT- -33.51 (meters) GEOID99
AH5303
AH5303 HORZ ORDER - A
AH5303 ELLP ORDER - THIRD CLASS I
AH5303
AH5303.The horizontal coordinates were established by GPS observations
AH5303.and adjusted by the National Geodetic Survey in April 1999.
AH5303
AH5303.The orthometric height was determined by GPS observations and a
AH5303.high-resolution geoid model.
AH5303
AH5303.The X, Y, and Z were computed from the position and the ellipsoidal ht.
AH5303
AH5303.The Laplace correction was computed from DEFLEC99 derived deflections.
AH5303
AH5303.The ellipsoidal height was determined by GPS observations
AH5303.and is referenced to NAD 83.
AH5303
AH5303.The geoid height was determined by GEOID99.
AH5303
AH5303; North East Units Scale Converg.
AH5303;SPC MI S - 141,741.412 3,850,354.620 MT 0.999990919 -1 14 39.6
AH5303;UTM 16 - 4,734,636.833 565,856.498 MT 0.99965336 +0 32 47.3
AH5303
AH5303 SUPERSEDED SURVEY CONTROL
AH5303
AH5303.No superseded survey control is available for this station.
AH5303
AH5303_U.S. NATIONAL GRID SPATIAL ADDRESS: 16TEN6585634637(NAD 83)
AH5303_MARKER: I = METAL ROD
AH5303_SETTING: 59 = STAINLESS STEEL ROD IN SLEEVE (10 FT.+)
AH5303_STAMPING: 7031 J 1997
AH5303_MARK LOGO: NOS
AH5303_PROJECTION: FLUSH
AH5303_MAGNETIC: I = MARKER IS A STEEL ROD
AH5303_STABILITY: B = PROBABLY HOLD POSITION/ELEVATION WELL
AH5303_SATELLITE: THE SITE LOCATION WAS REPORTED AS SUITABLE FOR
AH5303+SATELLITE: SATELLITE OBSERVATIONS - December 03, 1997
AH5303_ROD/PIPE-DEPTH: 9.1 meters
AH5303_SLEEVE-DEPTH : 1 meters
AH5303
AH5303 HISTORY - Date Condition Report By
AH5303 HISTORY - 1997 MONUMENTED NOS
AH5303 HISTORY - 19971203 GOOD NGS
AH5303
AH5303 STATION DESCRIPTION
AH5303
AH5303'DESCRIBED BY NATIONAL GEODETIC SURVEY 1997 (CSM)
AH5303'LOCATED ON THE SOUTH SIDE OF AND NEAR THE WEST END OF LAKE MACATAWA IN
AH5303'THE VILLAGE OF MACATAWA, 0.3 MI (0.5 KM) SOUTH ALONG STATE HIGHWAY 31
AH5303'(RIVER AVENUE FROM THE CITY HALL AND 11TH STREET IN HOLLAND, THEN 1.1
AH5303'MI (1.8 KM) WEST ALONG 17TH STREET, THEN 3.8 MI (6.1 KM)
AH5303'WEST-SOUTHWEST ALONG SOUTH SHORE DRIVE, THEN 0.15 MI (0.24 KM)

```

AH5303'SOUTHEAST ALONG THIRTY SECOND STREET, THEN 0.4 MI (0.6 KM) SOUTH ALONG
AH5303'66TH STREET, THEN 0.05 MI (0.08 KM) EAST ALONG 147TH AVENUE TO THE
AH5303'STATION ON THE RIGHT ACROSS THE AVENUE FROM THE RESIDENCE NUMBER 6591
AH5303'147TH AVENUE. ALSO CAN BE REACHED BY TRAVELING 4.0 MI (6.4 KM) WEST
AH5303'ALONG 147TH AVENUE FROM ITS JUNCTION WITH BUSINESS ROUTE 31 IN
AH5303'HOLLAND. RK IS A STAINLESS STEEL ROD DRIVEN TO REFUSAL ENCASED IN A
AH5303'5-INCH PVC PIPE WITH AN ALUMINUM ACCESS COVER SURROUNDED BY CONCRETE
AH5303'AND FLUSH WITH GROUND LEVEL. IT IS, 316.3 FT (96.4 M) EAST-SOUTHEAST
AH5303'OF THE INTERSECTION OF 66TH STREET AND 147TH AVENUE, 160.0 FT (48.8 M)
AH5303'SOUTHEAST AND ACROSS THE AVENUE FROM THE NORTHWEST CORNER OF HOUSE
AH5303'NUMBER 6591, 149.0 FT (45.4 M) WEST OF A SMALL GROUP (10) OF MAPLES 3
AH5303'TO 5 INCHES IN DIAMETER, 117.6 FT (35.8 M) SOUTHEAST AND ACROSS THE
AH5303'AVENUE FROM THE NORTHEAST CORNER OF HOUSE, 64.0 FT (19.5 M) EAST OF A
AH5303'NAIL AND WASHER IN A LONE 10 INCH DIAMETER PINE TREE, 29.0 FT (8.8 M)
AH5303'SOUTH OF THE CENTERLINE OF 147TH AVENUE, 5.0 FT (1.5 M) NORTH OF THE
AH5303'NORTH EDGE OF A FIELD AND NEAR THE SOUTH SIDE OF A SMALL DITCH ON THE
AH5303'SOUTH SIDE OF THE AVENUE.

Data Sheet: G317 Fiducial Site

```

OL0372 *****
OL0372 FBN          - This is a Federal Base Network Control Station.
OL0372 PACS         - This is a Primary Airport Control Station.
OL0372 DESIGNATION - G 317
OL0372 PID          - OL0372
OL0372 STATE/COUNTY- MI/MUSKEGON
OL0372 USGS QUAD   - MUSKEGON EAST (1980)
OL0372
OL0372                      *CURRENT SURVEY CONTROL
OL0372
OL0372* NAD 83(1994)- 43 09 42.90125(N) 086 13 14.63932(W) ADJUSTED
OL0372* NAVD 88      - 190.565 (meters) 625.21 (feet) ADJUSTED
OL0372
OL0372 X            - 307,139.374 (meters) COMP
OL0372 Y            - 4,649,648.082 (meters) COMP
OL0372 Z            - 4,340,747.329 (meters) COMP
OL0372 LAPLACE CORR- 1.64 (seconds) DEFLEC99
OL0372 ELLIP HEIGHT- 156.84 (meters) (06/11/02) GPS OBS
OL0372 GEOID HEIGHT- -33.77 (meters) GEOID99
OL0372 DYNAMIC HT   - 190.524 (meters) 625.08 (feet) COMP
OL0372 MODELED GRAV- 980,398.8 (mgal) NAVD 88
OL0372 OBS GRAVITY  - 980,400.1 (mgal) GRAV_OBS
OL0372
OL0372 HORZ ORDER  - B
OL0372 VERT ORDER  - FIRST CLASS II
OL0372 ELLP ORDER  - FOURTH CLASS I
OL0372
OL0372.This mark is at Muskegon Airport (MKG)
OL0372
OL0372.The horizontal coordinates were established by GPS observations
OL0372.and adjusted by the National Geodetic Survey in September 1995.
OL0372
OL0372.The orthometric height was determined by differential leveling
OL0372.and adjusted by the National Geodetic Survey in June 1991.
OL0372
OL0372.The X, Y, and Z were computed from the position and the ellipsoidal ht.
OL0372
OL0372.The Laplace correction was computed from DEFLEC99 derived deflections.
OL0372
OL0372.The ellipsoidal height was determined by GPS observations
OL0372.and is referenced to NAD 83.
OL0372
OL0372.The geoid height was determined by GEOID99.
OL0372
OL0372.The dynamic height is computed by dividing the NAVD 88
OL0372.geopotential number by the normal gravity value computed on the
OL0372.Geodetic Reference System of 1980 (GRS 80) ellipsoid at 45
OL0372.degrees latitude (g = 980.6199 gals.).
OL0372
OL0372.The modeled gravity was interpolated from observed gravity values.
OL0372.The observed gravity was obtained from relative gravimeter ties
OL0372.to the IGSN71 gravity network.
OL0372
OL0372;
OL0372;          North      East      Units  Scale  Converg.
OL0372;SPC MI S   - 186,263.115 3,849,239.678 MT 0.99991853 -1 15 42.3
OL0372;UTM 16    - 4,779,090.366 563,349.848 MT 0.99964937 +0 31 59.1
OL0372
OL0372                      SUPERSEDED SURVEY CONTROL
OL0372
OL0372 ELLIP H (09/20/95) 156.84 (m) GP( ) 1 2
OL0372 NAVD 88 (09/20/95) 190.56 (m) 625.2 (f) LEVELING 3
OL0372
OL0372.Superseded values are not recommended for survey control.
OL0372.NGS no longer adjusts projects to the NAD 27 or NGVD 29 datums.
OL0372.See file dsdata.txt to determine how the superseded data were derived.
OL0372
OL0372_U.S. NATIONAL GRID SPATIAL ADDRESS: 16TEN6335079090(NAD 83)
OL0372_MARKER: I = METAL ROD
OL0372_SETTING: 49 = STAINLESS STEEL ROD W/O SLEEVE (10 FT.+)

```

OL0372_STAMPING: G 317 1984
 OL0372_MARK LOGO: NGS
 OL0372_PROJECTION: FLUSH
 OL0372_MAGNETIC: N = NO MAGNETIC MATERIAL
 OL0372_STABILITY: B = PROBABLY HOLD POSITION/ELEVATION WELL
 OL0372_SATELLITE: THE SITE LOCATION WAS REPORTED AS SUITABLE FOR
 OL0372+SATELLITE: SATELLITE OBSERVATIONS - April 26, 2001
 OL0372_ROD/PIPE-DEPTH: 28.0 meters

OL0372	HISTORY	- Date	Condition	Report By
OL0372	HISTORY	- 1984	MONUMENTED	NGS
OL0372	HISTORY	- 19920808	GOOD	USPSQD
OL0372	HISTORY	- 19940523	GOOD	NGS
OL0372	HISTORY	- 19940720	GOOD	USPSQD
OL0372	HISTORY	- 20010426	GOOD	MIDT

OL0372
 OL0372 STATION DESCRIPTION
 OL0372

OL0372'DESCRIBED BY NATIONAL GEODETIC SURVEY 1984
 OL0372'6.2 KM (3.85 MI) SE FROM MUSKEGON HEIGHTS.
 OL0372'0.3 KM (0.2 MI) SOUTH ALONG PECK STREET FROM THE CITY HALL IN MUSKEGON
 OL0372'HEIGHTS, THENCE 3.7 KM (2.3 MI) SOUTHEAST ALONG AIRLINE ROAD, THENCE
 OL0372'0.5 KM (0.35 MI) WEST ALONG AIRPORT ROAD, THENCE 1.6 KM (1.0 MI) SOUTH
 OL0372'ALONG GRAND HAVEN ROAD, AT ELLIS CROSSROAD, 22.79 METERS (74.8 FT)
 OL0372'WEST OF THE CENTERLINE OF GRAND HAVEN ROAD, 24.38 METERS (80.0 FT)
 OL0372'NORTH OF THE CENTER OF ELLIS ROAD, 23.92 METERS (78.5 FT) SOUTH OF THE
 OL0372'CENTER OF A DOUBLE GATE IN THE AIRPORT SECURITY FENCE LINE,
 OL0372'15.84 METERS (52.0 FT) WEST-NORTHWEST OF A FIRE HYDRANT, 1.61 METERS
 OL0372'(5.3 FT) NORTH OF THE CHAIN LINK CORNER FENCE POST, AND 0.27 METERS
 OL0372'(0.9 FT) EAST OF THE CHAIN LINK FENCE. NOTE, DRIVING RATE MET AND ROD
 OL0372'ANCHORD.
 OL0372'THE MARK IS 0.33 METERS SE FROM A WITNESS POST.
 OL0372'THE MARK IS ABOVE LEVEL WITH GRAND HAVEN ROAD.

OL0372
 OL0372 STATION RECOVERY (1992)
 OL0372

OL0372'RECOVERY NOTE BY US POWER SQUADRON 1992 (JEM)
 OL0372'RECOVERED IN GOOD CONDITION.

OL0372
 OL0372 STATION RECOVERY (1994)
 OL0372

OL0372'RECOVERY NOTE BY NATIONAL GEODETIC SURVEY 1994 (CFS)
 OL0372'NOTE--TALL TRIPOD NEEDED TO CLEAR 1.8 M (5.9 FT) HIGH METAL FENCE.
 OL0372'STATION IS LOCATED ABOUT 7 KM (4.35 MI) SOUTH OF MUSKEGON, AT THE
 OL0372'SOUTHEAST CORNER OF THE MUSKEGON COUNTY AIRPORT, OUTSIDE OF THE
 OL0372'PERIMETER FENCE, IN THE NORTHWEST ANGLE OF A ROAD JUNCTION, ON THE
 OL0372'SOUTH EDGE OF SECTION 16, T R N, R 16 W. OWNERSHIP--STATE DEPARTMENT
 OL0372'OF TRANSPORTATION. TO REACH FROM THE OVERPASS AT THE JUNCTION OF U.S.
 OL0372'HIGHWAY 31 AND PONTALUNA ROAD (ABOUT 5 KM (3.10 MI) SOUTH OF THE END
 OL0372'OF INTERSTATE HIGHWAY 96) , GO WEST ON PONTALUNA ROAD FOR 0.83 KM
 OL0372'(0.50 MI) TO A CROSSROAD. TURN RIGHT, NORTH, ON GRAND HAVEN ROAD FOR
 OL0372'3.25 KM (2.00 MI) TO A CROSSROAD (ELLIS ROAD) AND THE STATION ON THE
 OL0372'LEFT. ACCESS COVER IS RECESSED 1 CM BELOW GROUND. STATION IS 13.6 M
 OL0372'(44.6 FT) WEST OF THE EDGE OF GRAND HAVEN ROAD, 19.5 M (64.0 FT) NORTH
 OL0372'OF THE EDGE OF ELLIS ROAD, 1.6 M (5.2 FT) NORTH-NORTHEAST OF A FENCE
 OL0372'CORNER, 0.3 M (1.0 FT) EAST OF THE PERIMETER FENCE, AND 0.3 M (1.0 FT)
 OL0372'SOUTHEAST OF A FIBERGLASS WITNESS POST. ROD IS RECESSED 5 CM BELOW
 OL0372'GROUND.

OL0372
 OL0372 STATION RECOVERY (1994)
 OL0372

OL0372'RECOVERY NOTE BY US POWER SQUADRON 1994
 OL0372'RECOVERED IN GOOD CONDITION.

OL0372
 OL0372 STATION RECOVERY (2001)
 OL0372

OL0372'RECOVERY NOTE BY MICHIGAN DEPARTMENT OF TRANSPORTATION 2001 (KV)
 OL0372'STATION WAS RECOVERED ON 04-03-2001 BY MICHIGAN DEPARTMENT OF
 OL0372'TRANSPORTATION IN GOOD CONDITION. STATION IS GOOD FOR USE WITH
 OL0372'G.P.S.
 OL0372'
 OL0372'TYPED BY RONALD L. RAMSEY, NGS GEODETIC ADVISOR - MICHIGAN.

Appendix B. Marblehead Campaign Documents

Field Work Log

Background

The campaign was on October 20th and 21st, 2001 during a weekend. The general purpose of this campaign is to survey the lake surface gradient from the Marblehead tide gauge to the TP/Jason pass 076 for their absolute calibrations. There was not satellite over flight occurred during the campaign. Three bins along the pass were occupied by the GPS buoy and one location on the way back was also occupied by the buoy. Two NGS GPS control points, Z317 and 3079, were selected as the fiducial sites. Their data sheets, along with the one for the Marblehead tide gauge, are attached in the following pages. The fiducial sites and the Marblehead tide gauge are located within the Marblehead Coast Guard Base, from which we gained the indoor power as well as high-level security during the campaign.

Three Trimble 4000 SSI receivers with three Dorne/Margolin Element with Choke Ring antennae were used. One set of them was used on the buoy and the others were on the fiducial sites.

Participants (alphabetically)

Kevin Cheng, CEEGS, OSU.

Jacob Dunfee, Captain.

Shengjie Ge, CEEGS, OSU.

Doug Martin, National Geodetic Survey, NOAA.

Michael Parke, OSU.

The charter ship, Tug Theresa (a 40' long tow boat), were rented from Boater's Emergency Service, P.O. Box 26, North Shore Boulevard, Marblehead, OH 43440-0026. Toll-free: (877)-798-5194, Local: (419)-798-5194. (<http://www.boateremergency.com/>). The rent is \$1100 since it was off season and the choices were limited.

Field Work Log

All time are local time (EST). EST + 4 hr = UTC.

October 19th (DOY 292, Friday)

19:00 Ge and Cheng left for Marblehead.

22:00 Park and Martin arrived at Marblehead. A meeting was conducted shortly after that.

October 20th (DOY 293, Saturday)

08:00 all, assembly the buoy and testing all equipments.

12:00 setup fiducial sites on Z317 and 3079. Both sites were occupied.

12:10 both sites started to log data in 1 Hz sampling rate.

12:12 deployed GPS buoy next to the tide gauge and started to log data in 1Hz sampling rate.

20:00 pulled the GPS buoy back.

20:00 both fiducial sites kept logging data without the buoy.

20:00 Site 3079 switched to 30 sec sampling rate.

20:30 left the receivers on the fiducial sites running overnight.

October 21st (DOY 294, Sunday)

05:00 Park and Cheng left for the dock to meet the Captain.

05:30 Tug Theresa left the dock.

07:40 Ge and Martin arrived at the Coast Guard Base and switched Site 3079 to 1 Hz rate.

08:44 Park and Cheng deployed the buoy on Bin C.

09:52 pulled back the buoy and traveled to the next location (still for Bin C).

10:23 Park and Cheng deployed the buoy on Bin C. The water was calm and the weather was good.

11:27 pulled back the buoy and traveled to the next location.

12:13 Park and Cheng deployed the buoy on Bin B.

13:16 pulled back the buoy and traveled to the next location.

13:57 Park and Cheng deployed the buoy on Bin A.

15:04 pulled back the buoy and traveled to the next location (still for Bin A).

15:29 Park and Cheng deployed the buoy on Bin A.

16:00 a mild storm came with heavy rain.

16:30 The wave became very calm after the storm. It became foggy and the visibility turned down to 10 m or so.

16:30 pulled back the buoy and traveled to the next location.

17:27 Park and Cheng deployed the buoy on the way back.

18:29 pulled back the buoy and headed back to the dock.

18:40 Ge and Martin shut down both fiducial sites and met Park and Cheng at the dock.

19:00 Cheng paid for the ship cost.

19:10 headed back to Columbus.

Data Sheet: Marblehead Tide Gauge

```

MC0991 *****
MC0991 CBN - This is a Cooperative Base Network Control Station.
MC0991 TIDAL BM - This is a Tidal Bench Mark.
MC0991 DESIGNATION - MARBLEHEAD
MC0991 PID - MC0991
MC0991 STATE/COUNTY- OH/OTTAWA
MC0991 USGS QUAD - KELLEYS ISLAND (1979)
MC0991
MC0991 *CURRENT SURVEY CONTROL
MC0991
MC0991* NAD 83(1995)- 41 32 37.71343(N) 082 43 53.35186(W) ADJUSTED
MC0991* NAVD 88 - 176.273 (meters) 578.32 (feet) ADJUSTED
MC0991
MC0991 X - 604,871.757 (meters) COMP
MC0991 Y - -4,742,439.608 (meters) COMP
MC0991 Z - 4,207,908.561 (meters) COMP
MC0991 LAPLACE CORR- 1.64 (seconds) DEFLEC99
MC0991 ELLIP HEIGHT- 140.82 (meters) (08/20/96) GPS OBS
MC0991 GEOID HEIGHT- -35.43 (meters) GEOID99
MC0991 DYNAMIC HT - 176.202 (meters) 578.09 (feet) COMP
MC0991 MODELED GRAV- 980,217.3 (mgal) NAVD 88
MC0991
MC0991 HORZ ORDER - B
MC0991 VERT ORDER - FIRST CLASS II
MC0991 ELLP ORDER - FOURTH CLASS II
MC0991
MC0991.The horizontal coordinates were established by GPS observations
MC0991.and adjusted by the National Geodetic Survey in August 1996.
MC0991
MC0991.The orthometric height was determined by differential leveling
MC0991.and adjusted by the National Geodetic Survey in January 1997.
MC0991
MC0991.This Tidal Bench Mark is designated as VM 12829
MC0991.by the Center for Operational Oceanographic Products and Services.
MC0991
MC0991.The X, Y, and Z were computed from the position and the ellipsoidal ht.
MC0991
MC0991.The Laplace correction was computed from DEFLEC99 derived deflections.
MC0991
MC0991.The ellipsoidal height was determined by GPS observations
MC0991.and is referenced to NAD 83.
MC0991
MC0991.The geoid height was determined by GEOID99.
MC0991
MC0991.The dynamic height is computed by dividing the NAVD 88
MC0991.geopotential number by the normal gravity value computed on the
MC0991.Geodetic Reference System of 1980 (GRS 80) ellipsoid at 45
MC0991.degrees latitude (g = 980.6199 gals.).
MC0991
MC0991.The modeled gravity was interpolated from observed gravity values.
MC0991
MC0991; North East Units Scale Converg.
MC0991;SPC OH N - 208,478.662 580,685.317 MT 0.99997362 -0 09 07.5
MC0991;UTM 17 - 4,600,575.362 355,580.075 MT 0.99985668 -1 08 54.6
MC0991
MC0991 SUPERSEDED SURVEY CONTROL
MC0991
MC0991 NAD 83(1986)- 41 32 37.72452(N) 082 43 53.37271(W) AD( ) 2
MC0991 NAD 83(1986)- 41 32 37.70599(N) 082 43 53.36004(W) AD( ) 3
MC0991 NAD 27 - 41 32 37.54566(N) 082 43 53.70999(W) AD( ) 3
MC0991 NAVD 88 (06/15/91) 176.281 (m) 578.35 (f) UNKNOWN 1 2
MC0991 NGVD 29 (06/03/92) 176.492 (m) 579.04 (f) ADJUSTED 1 2
MC0991
MC0991.Superseded values are not recommended for survey control.
MC0991.NGS no longer adjusts projects to the NAD 27 or NGVD 29 datums.
MC0991.See file dsdata.txt to determine how the superseded data were derived.
MC0991
MC0991_U.S. NATIONAL GRID SPATIAL ADDRESS: 17TLG5558000575(NAD 83)
MC0991_MARKER: DW = NOS HYDROGRAPHIC SURVEY DISK

```

MC0991_SETTING: 37 = BREAKWALL
 MC0991_STAMPING: AMC MARBLEHEAD 1976
 MC0991_MARK LOGO: NOS
 MC0991_MAGNETIC: N = NO MAGNETIC MATERIAL
 MC0991_STABILITY: C = MAY HOLD, BUT OF TYPE COMMONLY SUBJECT TO
 MC0991+STABILITY: SURFACE MOTION
 MC0991_SATELLITE: THE SITE LOCATION WAS REPORTED AS SUITABLE FOR
 MC0991+SATELLITE: SATELLITE OBSERVATIONS - August 04, 1995

MC0991	HISTORY	- Date	Condition	Report By
MC0991	HISTORY	- 1976	MONUMENTED	NOS
MC0991	HISTORY	- 1980	GOOD	NGS
MC0991	HISTORY	- 19881001	GOOD	OHDNR
MC0991	HISTORY	- 19950804	GOOD	NGS

MC0991
 MC0991 STATION DESCRIPTION
 MC0991

MC0991 DESCRIBED BY NATIONAL OCEAN SERVICE 1976 (RES)
 MC0991 THE STATION IS LOCATED APPROXIMATELY 6.2 MILES NORTH OF
 MC0991 SANDUSKY, OHIO, ON THE PROPERTY OF THE U.S. COAST GUARD STATION
 MC0991 LOCATED IN THE COMMUNITY OF MARBLEHEAD.
 MC0991
 MC0991 TO REACH THE STATION FROM PORT CLINTON, OHIO, PROCEED EAST ON
 MC0991 ROUTE 163 APPROXIMATELY 12 MILES TO MARBLEHEAD AND THE COAST GUARD
 MC0991 STATION. THE STATION IS ON THE WESTERNMOST PIER WITHIN THE
 MC0991 CONFINES OF THE COAST GUARD STATION. IT IS A STANDARD NATIONAL
 MC0991 OCEAN SURVEY DISK STAMPED MARBLEHEAD AMC, 1976 AND IS CEMENTED
 MC0991 FLUSH WITH THE PIER. IT IS 23.5 FEET SOUTH OF THE WHITE
 MC0991 ENTRANCE LIGHT AND 17.5 FEET NW OF A POST SUPPORTING A WATER
 MC0991 LEVEL GAGE.

MC0991 NO AZIMUTH OR REFERENCE MARKS WERE SET.
 MC0991
 MC0991 HEIGHT OF LIGHT ABOVE STATION MARK 1.5 METERS.
 MC0991

MC0991 STATION RECOVERY (1980)
 MC0991

MC0991 RECOVERY NOTE BY NATIONAL GEODETIC SURVEY 1980
 MC0991 2.12 KM NE FROM LAKESIDE.
 MC0991 THE MARK IS ABOVE LEVEL WITH TOP OF BREAKWALL.
 MC0991 1.8 KILOMETERS (1.15 MILES) NORTHEAST ALONG STATE HIGHWAY 163 FROM THE
 MC0991 CROSSING OF THE MARBLEHEAD RAILROAD IN LAKESIDE, THENCE 0.32 KILOMETER
 MC0991 (0.20 MILE) NORTH ALONG FRANCES STREET, ON THE PROPERTY OF THE U.S.
 MC0991 COAST GUARD, SET ATOP THE CONCRETE BREAKWALL NORTH-NORTHWEST OF THE
 MC0991 BOAT HOUSE, 42.7 METERS (140.0 FEET) NORTH-NORTHWEST OF THE NORTHWEST
 MC0991 CORNER OF THE BOAT HOUSE, 14.1 METERS (46.2 FEET) NORTH-NORTHWEST OF
 MC0991 THE METAL PIPE FOR GAGE WELL.

MC0991 STATION RECOVERY (1988)
 MC0991

MC0991 RECOVERY NOTE BY OHIO DEPARTMENT OF NATURAL RESOURCES 1988
 MC0991 THE STATION IS LOCATED AT THE U S COAST GUARD STATION, JUST EAST OF
 MC0991 THE NEUMAN FERRY LANDING ABOUT 2 KM (1.25 MI) EAST OF LAKESIDE, SET
 MC0991 ATOP THE WEST CONCRETE BREAKWALL, 14.2 M (46.6 FT) NORTHWEST OF THE
 MC0991 STEEL PIPE FOR A WATER LEVEL GAGE WELL, 10.3 M (33.8 FT) SOUTH OF THE
 MC0991 NORTH END OF THE BREAKWALL, AND JUST NORTH OF A U S COAST GUARD SIGN.
 MC0991 CAUTION--SUBJECT TO SUBSIDENCE.

MC0991 STATION RECOVERY (1995)
 MC0991

MC0991 RECOVERY NOTE BY NATIONAL GEODETIC SURVEY 1995 (AJL)
 MC0991 RECOVERED IN GOOD CONDITION EXCEPT THAT SCUFF MARKS, PROBABLY FROM
 MC0991 SNOW REMOVAL EQUIPMENT, HAVE OBLITERATED SOME OF THE STAMPING. THE
 MC0991 STATION IS LOCATED ABOUT 10.0 KM (6.20 MI) NORTH OF SANDUSKY, 2.01 KM
 MC0991 (1.25 MI) EAST OF LAKESIDE, ON PROPERTY OF THE US COAST GUARD STATION
 MC0991 IN MARBLEHEAD, JUST EAST OF THE NEUMAN FERRY LANDING, SET ATOP THE
 MC0991 WEST CONCRETE BREAKWALL OF THE COAST GUARD BOAT DOCKING AREA. THE
 MC0991 BREAKWALL IS AN EARTH FILLED STEEL BULKHEAD TOPPED WITH A POURED
 MC0991 CONCRETE APRON INTO WHICH THE MARK IS CEMENTED. THE MARK IS 14.2 M
 MC0991 (46.6 FT) NORTHWEST OF THE STEEL PIPE SUPPORTING A WATER LEVEL GAGE,
 MC0991 10.3 M (33.8 FT) SOUTH OF THE NORTH END OF THE BREAKWALL, AND JUST
 MC0991 NORTH OF A COAST GUARD SIGN.

NGS Visibility Obstruction Diagram for Marblehead Tide Gauge

provided by David Conner.

STATION VISIBILITY DIAGRAM

1/2

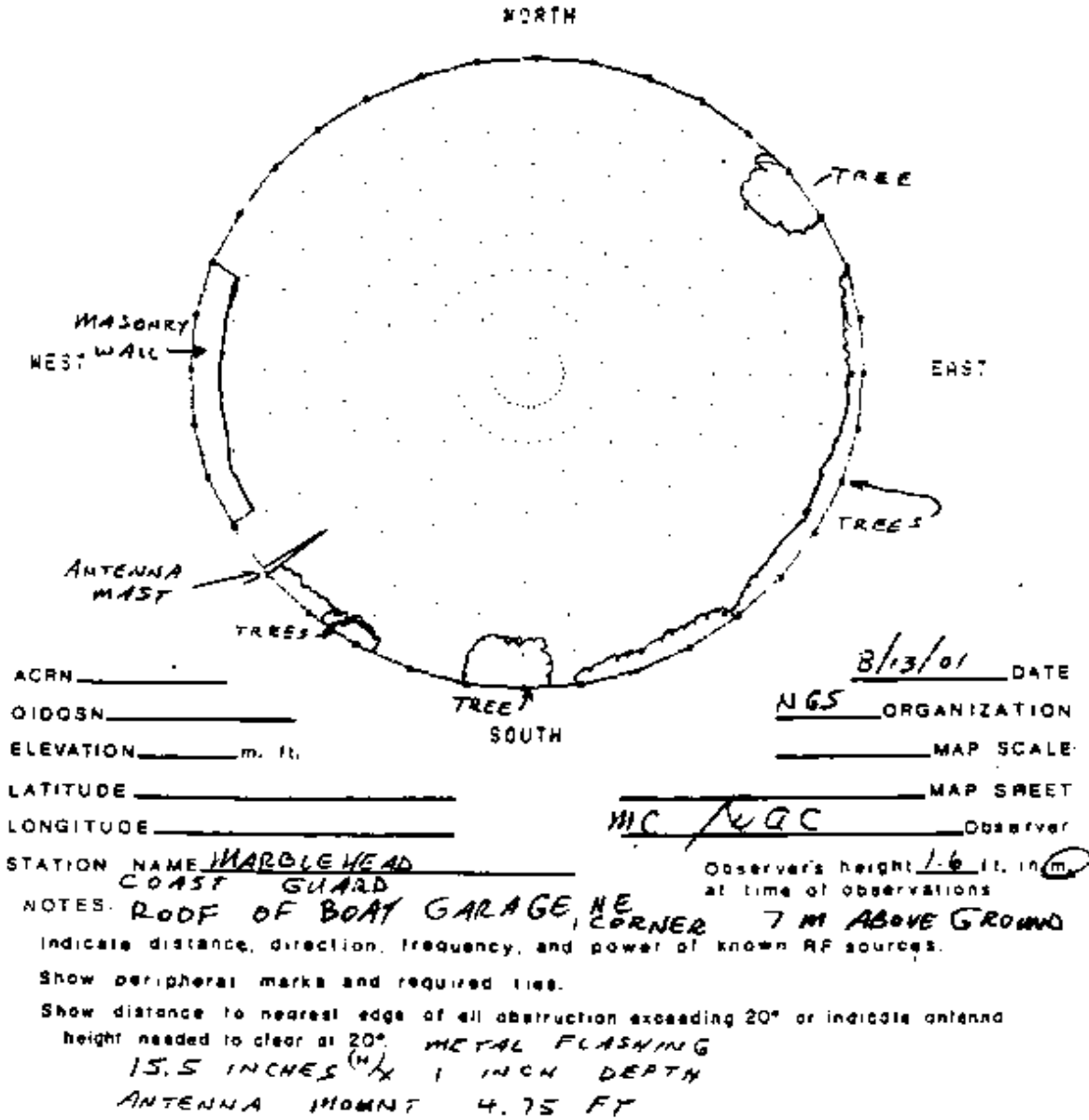

Data Sheet: Z317 Fiducial Site

```

MC0984 *****
MC0984 CBN - This is a Cooperative Base Network Control Station.
MC0984 TIDAL BM - This is a Tidal Bench Mark.
MC0984 DESIGNATION - Z 317
MC0984 PID - MC0984
MC0984 STATE/COUNTY- OH/OTTAWA
MC0984 USGS QUAD - KELLEYS ISLAND (1979)
MC0984
MC0984 *CURRENT SURVEY CONTROL
MC0984
MC0984* NAD 83(1995)- 41 32 34.53873(N) 082 43 54.65255(W) ADJUSTED
MC0984* NAVD 88 - 177.309 (meters) 581.72 (feet) ADJUSTED
MC0984
MC0984 X - 604,850.167 (meters) COMP
MC0984 Y - -4,742,508.621 (meters) COMP
MC0984 Z - 4,207,835.937 (meters) COMP
MC0984 LAPLACE CORR- 1.64 (seconds) DEFLEC99
MC0984 ELLIP HEIGHT- 141.85 (meters) (08/20/96) GPS OBS
MC0984 GEOID HEIGHT- -35.43 (meters) GEOID99
MC0984 DYNAMIC HT - 177.238 (meters) 581.49 (feet) COMP
MC0984 MODELED GRAV- 980,217.2 (mgal) NAVD 88
MC0984
MC0984 HORZ ORDER - B
MC0984 VERT ORDER - FIRST CLASS II
MC0984 ELLP ORDER - FOURTH CLASS II
MC0984
MC0984.The horizontal coordinates were established by GPS observations
MC0984.and adjusted by the National Geodetic Survey in August 1996.
MC0984
MC0984.The orthometric height was determined by differential leveling
MC0984.and adjusted by the National Geodetic Survey in June 1991.
MC0984
MC0984.This Tidal Bench Mark is designated as VM 12827
MC0984.by the Center for Operational Oceanographic Products and Services.
MC0984
MC0984.The X, Y, and Z were computed from the position and the ellipsoidal ht.
MC0984
MC0984.The Laplace correction was computed from DEFLEC99 derived deflections.
MC0984
MC0984.The ellipsoidal height was determined by GPS observations
MC0984.and is referenced to NAD 83.
MC0984
MC0984.The geoid height was determined by GEOID99.
MC0984
MC0984.The dynamic height is computed by dividing the NAVD 88
MC0984.geopotential number by the normal gravity value computed on the
MC0984.Geodetic Reference System of 1980 (GRS 80) ellipsoid at 45
MC0984.degrees latitude (g = 980.6199 gals.).
MC0984
MC0984.The modeled gravity was interpolated from observed gravity values.
MC0984
MC0984;
MC0984;SPC OH N - North East Units Scale Converg.
MC0984;UTM 17 - 4,600,478.056 355,547.975 MT 0.99997349 -0 09 08.3
MC0984
MC0984 SUPERSEDED SURVEY CONTROL
MC0984
MC0984 NAVD 88 (08/20/96) 177.31 (m) 581.7 (f) LEVELING 3
MC0984 NGVD 29 (06/03/92) 177.521 (m) 582.42 (f) ADJUSTED 1 2
MC0984
MC0984.Superseded values are not recommended for survey control.
MC0984.NGS no longer adjusts projects to the NAD 27 or NGVD 29 datums.
MC0984.See file dsdata.txt to determine how the superseded data were derived.
MC0984
MC0984_U.S. NATIONAL GRID SPATIAL ADDRESS: 17TLG5554800478(NAD 83)
MC0984_MARKER: I = METAL ROD
MC0984_SETTING: 49 = STAINLESS STEEL ROD W/O SLEEVE (10 FT.+)
MC0984_STAMPING: Z 317 1980

```

MC0984_MARK LOGO: NGS
 MC0984_PROJECTION: FLUSH
 MC0984_MAGNETIC: 0 = OTHER; SEE DESCRIPTION
 MC0984_STABILITY: A = MOST RELIABLE AND EXPECTED TO HOLD
 MC0984+STABILITY: POSITION/ELEVATION WELL
 MC0984_SATELLITE: THE SITE LOCATION WAS REPORTED AS SUITABLE FOR
 MC0984+SATELLITE: SATELLITE OBSERVATIONS - August 04, 1995
 MC0984_ROD/PIPE-DEPTH: 3.0 meters
 MC0984

MC0984	HISTORY	- Date	Condition	Report By
MC0984	HISTORY	- 1980	MONUMENTED	NGS
MC0984	HISTORY	- 19950804	GOOD	NGS

 MC0984
 MC0984

STATION DESCRIPTION

 MC0984
 MC0984'DESCRIBED BY NATIONAL GEODETIC SURVEY 1980
 MC0984'2.12 KM NE FROM LAKESIDE.
 MC0984'1.8 KILOMETERS (1.1 MILES) NORTHEAST ALONG STATE HIGHWAY 163 FROM THE
 MC0984'CROSSING OF MARBLEHEAD RAILROAD IN LAKESIDE, THENCE 0.32 KILOMETER
 MC0984'(0.20 MILE) NORTH ALONG A PAVED ROAD LEADING TO THE US COAST GUARD
 MC0984'PROPERTY, SET IN THE GRASSY AREA AT THE NORTH END OF THE PARKING LOT
 MC0984'ON THE WEST SIDE OF THE COAST GUARD BUILDING, 63.4 METERS (208.0 FEET)
 MC0984'NORTHWEST OF THE NORTHWEST CORNER OF THE BUILDING, 56.4 METERS (185.0
 MC0984'FEET) NORTH-NORTHWEST OF THE NORTHWEST LEG OF A 3-LEGGED METAL TOWER,
 MC0984'39.6 METERS (130.0 FEET) WEST OF THE CENTER OF THE PAVED ROAD LEADING
 MC0984'DOWN TO THE BOAT HOUSE, 2.8 METERS (9.2 FEET) EAST OF A NORTH-SOUTH
 MC0984'FENCE LINE, 6.55 METERS (21.5 FEET) NORTH OF THE NORTHWEST CORNER OF
 MC0984'THE PAVED PARKING LOT.
 MC0984'NOTE-THIS MARK WAS DRILLED WITH THE DRILL RIG UNTIL ROCK WAS HIT AT
 MC0984'3.0 METERS, THEN THE ROD WAS CEMENTED IN THE DRILL HOLE IN THE ROCK.
 MC0984'THE MARK IS 2.0 METERS E FROM A WITNESS POST.
 MC0984'THE MARK IS 0.6 M BELOW PARKING LOT.
 MC0984

STATION RECOVERY (1995)

 MC0984
 MC0984
 MC0984'RECOVERY NOTE BY NATIONAL GEODETIC SURVEY 1995 (AJL)
 MC0984'RECOVERED IN GOOD CONDITION. SOME REFERENCES IN THE ORIGINAL
 MC0984'DESCRIPTION ARE MISLEADING BECAUSE THE COAST GUARD STATION BUILDING IS
 MC0984'REPLACED WITH A NEW ONE. THE STATION IS LOCATED ABOUT 10.0 KM (6.20
 MC0984'MI) NORTH OF SANDUSKY, 2.01 KM (1.25 MI) EAST OF LAKESIDE, ON PROPERTY
 MC0984'OF THE US COAST GUARD STATION IN MARBLEHEAD, JUST EAST OF THE NEUMAN
 MC0984'FERRY LANDING. THE MARK IS SET IN A GRASSY AREA AT THE WEST SIDE OF
 MC0984'THE COAST GUARD BUILDING, BETWEEN THE ROAD LEADING DOWN TO THE WATER
 MC0984'AND A FENCE, 17.1 M (56.1 FT) NORTHWEST OF THE NORTHWEST CORNER OF THE
 MC0984'COAST GUARD STATION, 12.3 M (40.4 FT) WEST-SOUTHWEST OF BM 3079K 1993
 MC0984'(WHICH IS SET IN THE 1.2 METER-SQUARE BASE OF AN ANTENNA TOWER) , 8.2
 MC0984'M (26.9 FT) NORTH-NORTHEAST OF THE SOUTHEAST CORNER OF A 3.0
 MC0984'METER-HIGH CONCRETE BLOCK BUILDING, 3.5 M (11.5 FT) EAST OF THE
 MC0984'NORTHEAST CORNER OF THE SAME BUILDING, 2.9 M (9.5 FT) EAST OF A FENCE,
 MC0984'AND 2.0 M (6.6 FT) EAST OF A STEEL WITNESS POST.

NGS Visibility Obstruction Diagram for Z317

NATIONAL GEODETIC SURVEY VISIBILITY OBSTRUCTION DIAGRAM

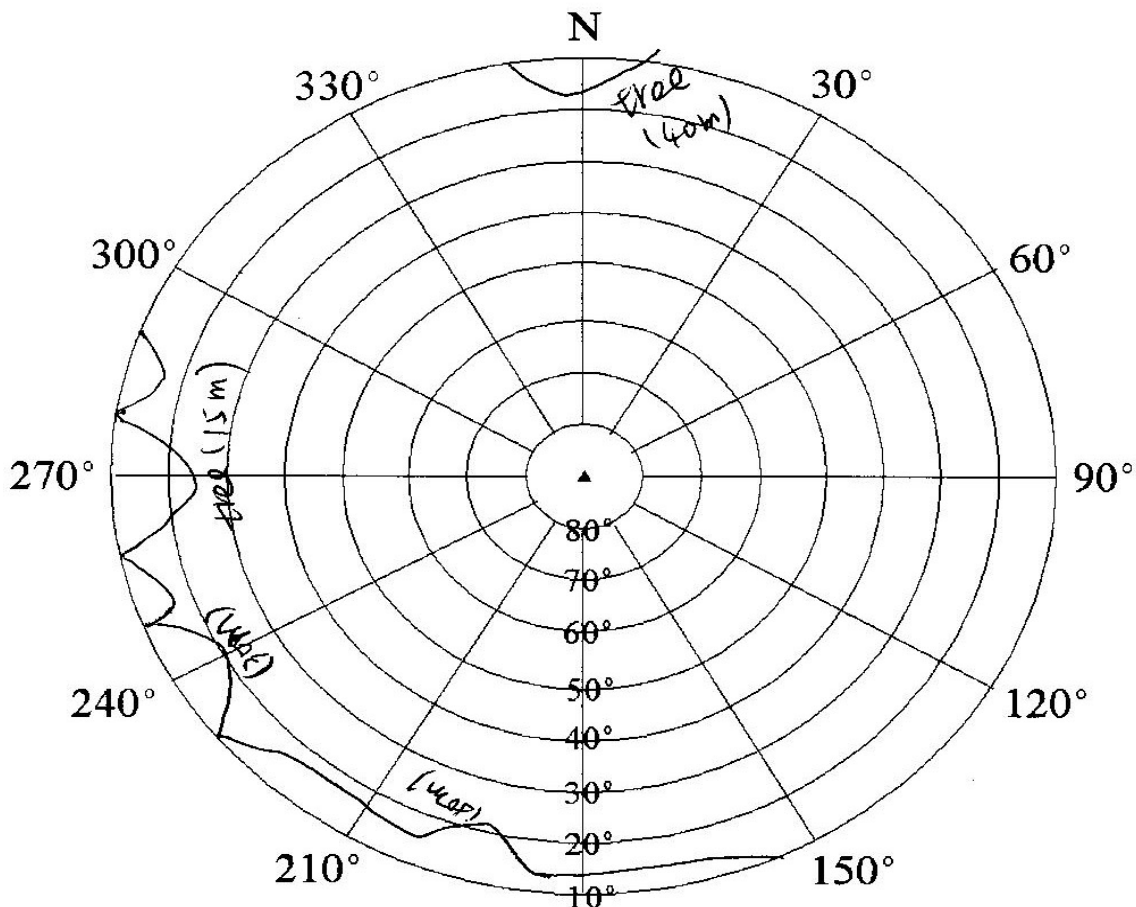

INSTRUCTIONS:

Identify obstructions by azimuth (magnetic) and elevation angle (above horizon) as seen from station mark. Indicate distance and direction to nearby structures and reflective surfaces (potential multipath sources).

4-char ID: G32 | Designation: _____
 PID: _____ Location: near Cleveland tide gauge
 County: _____ Reconnaissance By: _____
 Height above mark, meters: 2.000 Agency/Company: CEEGS, OSU
 Phone: (____) vertical to ARP Date: 9/18/03
 Check if no obstructions above 10 degrees

Appendix C. Cleveland Campaign Documents

Campaign Proposal

Background

This campaign is proposed to be a 3-day campaign collecting GPS buoy data in the area close to NOAA Cleveland water level gauge. The experimental area is shown in Figure 1. A life-saver type of buoy with a Choke Ring GPS antenna attached on top will be deployed to the 6 selected locations with a 30-m cable and rope tethered to the ship. Each point will be occupied with the GPS buoy for about 1-2 hours and the ship is required to be anchored while taking the GPS data. Figure 2 illustrates one picture of the past campaign. The size of the GPS buoy is about 3' diameter.

Proposed locations and their coordinates.

	<i>Latitude</i>	<i>Longitude</i>	<i>Baseline (km)</i>
P1	41° 46' 00" N	81° 37' 30" W	25.2
P2	41° 43' 00" N	81° 39' 30" W	19.8
P3	41° 38' 00" N	81° 43' 00" W	12.5
P4	41° 47' 36" N	81° 43' 46" W	29.2
P5	41° 44' 42" N	81° 46' 00" W	25.3
P6	41° 39' 24" N	81° 50' 02" W	21.1

Proposed schedule

The campaign is proposed on September 17th to 19th. The Jason-1 over flight on P5 is at 10:16 (EST) on September 19th, which needs to be precisely caught at P5.

Day 1 (September 17, Wednesday)

Campaign preparation. The main work includes scout the reference station and tide gauge and a test run of GPS buoy next to the gauge.

Day 2 (September 18, Thursday, projected price: \$650, report to Lora in Port at 7:00 am)

<i>Time</i>	<i>Point to be occupied</i>	<i>Distance to the next Point</i>
08:00 – 10:00	P1	6.2 km
11:00 – 13:00	P2	10.5 km
14:00 – 16:00	P3	

Day 3 (September 19, Friday, projected price \$650, report to Lorain Port at 4:30 am)

<i>Time</i>	<i>Point to be occupied</i>	<i>Distance to the next Point</i>
06:30 – 08:30	P4	6.2 km
09:30 – 11:30	P5 (10:16 Jason-1 over flight)	11.3 km
12:30 – 14:30	P6	N/A

Participants (alphabetically)

Ed Abel, Captain, private charter boat.

Kevin Cheng, CEEGS, OSU.

Yiqun Chen, CEEGS, OSU.

Shengjie Ge, CEEGS, OSU.

Chung-Yen Kuo, CEEGS, OSU.

Harsh Vangani, CEEGS, OSU.

Jeff Reutter at the Ohio Sea Grant and Lake Erie Programs agreed to support the ship coast. David Kelch, an Ohio Sea Grant Extension Agent, helped us to located Captain Abel. Here are their contact information. The size of the boat is 26' x 10'.

Jeff Reutter, 614-292-8949 (work), 614-738-5311 (cell).

David Kelch, 440-326-5851 (work), 440-667-3938 (cell).

Ed Abel, 440-288-9995 (home), capteabel@hotmail.com

Lorain Port: Spitzer, 301 Lakeside Ave., Lorain, Ohio.

GPS Buoy Campaign in Cleveland

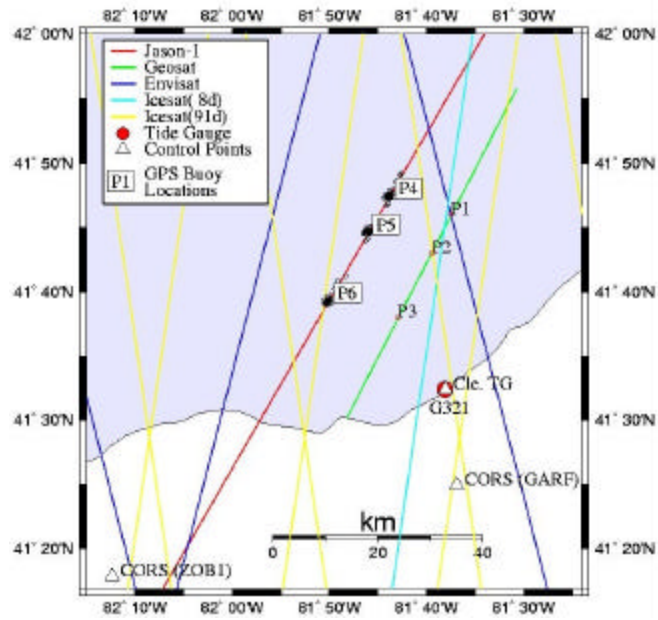

Figure 1(a). Proposed Cleveland GPS buoy campaign.

GPS Buoy Campaign in Cleveland

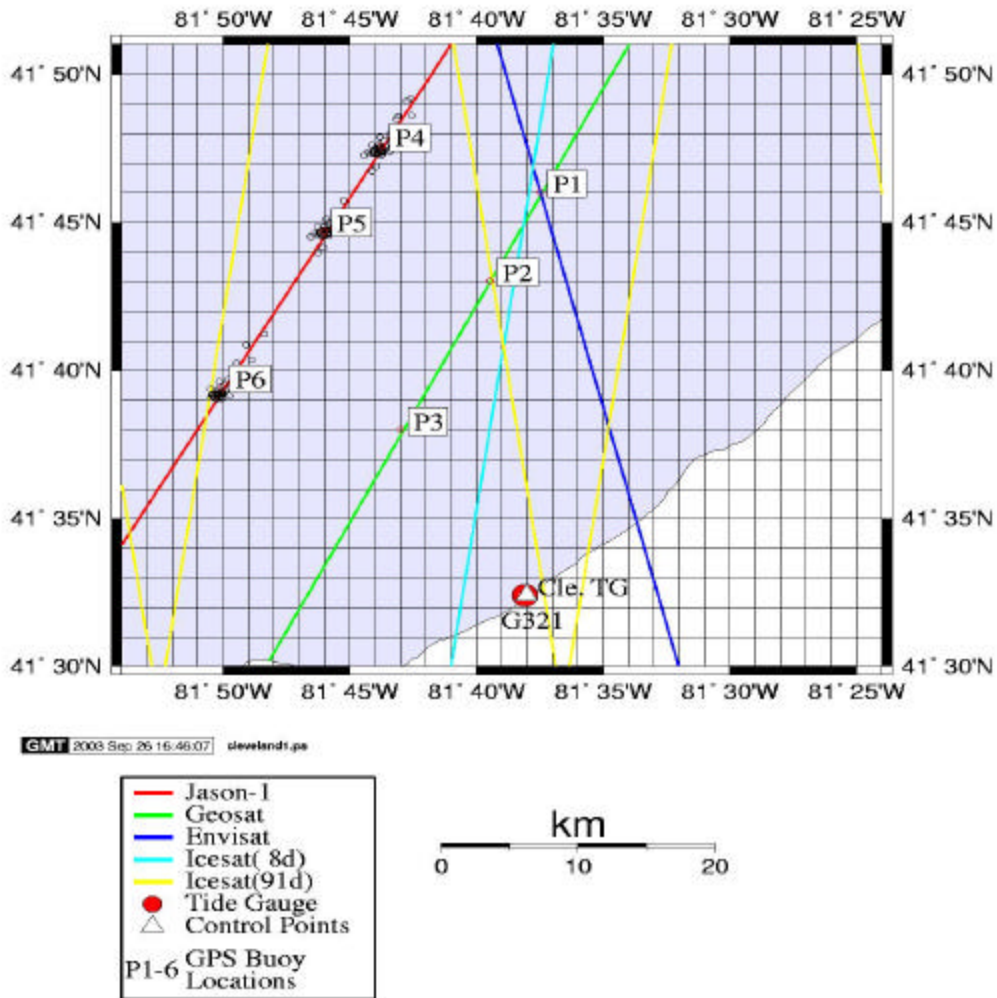

Figure 1(b). Proposed Cleveland GPS buoy campaign and GPS buoy deployed locations.

Field Work Log

All time are local time (EST). EST + 4 hr = UTC.

September 17th (DOY 260, Wednesday)

- 11:00 keeping equipments from HI246 to the vehicle on the back of Hitchcock hall.
- 11:55 leaving from the back of Hitchcock hall
- 12:30 had our lunch
- 14:39 reached hotel Sheraton in Cleveland.
- 15:40 moving to Lake Erie after checking in from the hotel.
- 15:55 reached Lake Erie and setting up things to put the Buoy.
- 16:48 put the buoy in lake, but the position was not ideal as it was very near to the corner and so was not catching the signals.
- 17:05 decided to take out buoy and put in some other place (about 100 westward the tide gauge) where it can be somewhere away from the corner of the lake so that it can catch signals nicely.
- 17:49 succeeded in putting the buoy at correct position so that the buoy is at a good position to receive signals.
- 18:20 Kevin and Yiqun moved to talk to the captain, while Shengjie, Chung-Yen and Harsh were there with the buoy.
- 19:30 It was getting dark so we (Shengjie, Harsh and Chung-Yen) decided to pack up the things and moved back the hotel. Yiqun and Kevin will reach from the hotel after meeting the captain.
- 24:40 After dinner we had our meeting about tomorrow' s plan.

September 18th (DOY 261, Thursday)

Note: This day turned out to be one day before Hurricane Isabel, Class III, visited Lake Erie. It affected the buoy campaign in the afternoon.

- 05:00 Got up in the morning.
- 05:50 Shengjie and Chung-Yen went to lake Erie for the previous day station while Kevin Harsh and Yiqun left for the port.
- 07:05 we (Kevin, Harsh and Yiqun) reached the port and met the captain.
- 07:18 left for the lake. The size of the boat was 26' by 10'. Had a great time, captain was nice and it was nice to see the lake and sunrise early morning from the boat.
- 09:28 reached the first station. We then started to put the buoy in the lake and take the data.

Captain caught big fishes while Yiqun was not well due to sea sickness. Harsh had a nice time with the captain.

11:37 made a move to the next station after packing up the buoy from the lake in the boat.

12:04 reached the 2nd station and started to put the buoy in the lake. Harsh learnt fishing.

14:14 packed up the buoy from lake to boat and made a move for the next station.

14:50 reached the 3rd station, the captain tried to anchor but the weather was getting bad and the waves were about 3-6 feet height. The captain found it hard to anchor.

14:55 We abort the rest of the day and started leaving.

16:57 We reached the port.

19:00 We reached hotel embassy Suite. Shengjie left and four of us were there in the hotel. Yiqun was not well.

21:40 had a meeting deciding about tomorrow's plan.

September 19th (DOY 262, Friday)

Note: The hurricane was very strong when it reached Lake Erie. We could not do anything that we originally planned.

05:30 Kevin got up but the weather was not good as it was raining heavily with strong wind so we decided to observing the weather for another hour.

09:49 We left from the hotel and decided to see the lake.

10:21 We reached the lake but the weather was not good. The tides were high and it was still raining so we had to abort.

13:00 Arrived at Columbus.

Data Sheet: Cleveland Tide Gauge

```

MB1442 *****
MB1442 DESIGNATION - CLEVELAND
MB1442 PID - MB1442
MB1442 STATE/COUNTY- OH/CUYAHOGA
MB1442 USGS QUAD - CLEVELAND NORTH (1994)
MB1442
MB1442 *CURRENT SURVEY CONTROL
MB1442
MB1442* NAD 83(1986)- 41 32 19. (N) 081 37 43. (W) SCALED
MB1442* NAVD 88 - 190.063 (meters) 623.57 (feet) POSTED
MB1442
MB1442 GEOID HEIGHT- -34.36 (meters) GEOID99
MB1442 DYNAMIC HT - 189.990 (meters) 623.33 (feet) COMP
MB1442 MODELED GRAV- 980,227.5 (mgal) NAVD 88
MB1442
MB1442 VERT ORDER - * POSTED, Code NC , SEE BELOW
MB1442
MB1442.The horizontal coordinates were scaled from a topographic map and have
MB1442.an estimated accuracy of +/- 6 seconds.
MB1442
MB1442.The orthometric height was determined by differential leveling
MB1442.and adjusted by the National Geodetic Survey in 1992.
MB1442.No vertical observational check was made to the station.
MB1442.* This is a POSTED BENCH MARK height. Code NC indicates the bench mark
MB1442.was located on a no-check spur therefore a value was not computed.
MB1442
MB1442.The geoid height was determined by GEOID99.
MB1442
MB1442.The dynamic height is computed by dividing the NAVD 88
MB1442.geopotential number by the normal gravity value computed on the
MB1442.Geodetic Reference System of 1980 (GRS 80) ellipsoid at 45
MB1442.degrees latitude (g = 980.6199 gals.).
MB1442
MB1442.The modeled gravity was interpolated from observed gravity values.
MB1442
MB1442; North East Units Estimated Accuracy
MB1442;SPC OH N - 208,240. 672,710. MT (+/- 180 meters Scaled)
MB1442
MB1442 SUPERSEDED SURVEY CONTROL
MB1442
MB1442 NGVD 29 (??/??/92) 190.279 (m) 624.27 (f) ADJ UNCH 1 2
MB1442
MB1442.Superseded values are not recommended for survey control.
MB1442.NGS no longer adjusts projects to the NAD 27 or NGVD 29 datums.
MB1442.See file dsdata.txt to determine how the superseded data were derived.
MB1442
MB1442_U.S. NATIONAL GRID SPATIAL ADDRESS: 17TMF475987(NAD 83)
MB1442_MARKER: DB = BENCH MARK DISK
MB1442_SETTING: 7 = SET IN TOP OF CONCRETE MONUMENT
MB1442_STAMPING: CLEVELAND 1934
MB1442_STABILITY: C = MAY HOLD, BUT OF TYPE COMMONLY SUBJECT TO
MB1442+STABILITY: SURFACE MOTION
MB1442
MB1442 HISTORY - Date Condition Report By
MB1442 HISTORY - 1934 MONUMENTED CGS
MB1442 HISTORY - 1981 MARK NOT FOUND NGS
MB1442 HISTORY - 1987 MARK NOT FOUND USPSQD
MB1442 HISTORY - 19950604 MARK NOT FOUND USPSQD
MB1442
MB1442 STATION DESCRIPTION
MB1442
MB1442'DESCRIBED BY COAST AND GEODETIC SURVEY 1934
MB1442'AT CLEVELAND.
MB1442'AT CLEVELAND, CUYAHOGA COUNTY, ON THE NEW YORK CENTRAL RAILROAD,
MB1442'AT THE EAST EDGE OF GORDAN PARK, 50 YARDS WEST OF A BOARD FENCE,
MB1442'76 FEET NORTH OF THE NORTH RAIL, 27 FEET WEST OF A 3-FOOT OAK
MB1442'TREE, AND 5 FEET HIGHER THAN THE TOP OF THE RAIL. A STANDARD
MB1442'DISK, STAMPED CLEVELAND 1934 AND SET IN THE TOP OF A CONCRETE
MB1442'POST.

```

MB1442
MB1442 STATION RECOVERY (1981)
MB1442
MB1442'RECOVERY NOTE BY NATIONAL GEODETIC SURVEY 1981
MB1442'SEARCHED FOR BUT NOT RECOVERED, THE LOCATION AND AREA HAVE CHANGED,
MB1442'LOCATION IS NOW BELOW THE LEVEL OF THE TRACKS, DESCRIPTION NOW
MB1442'INADEQUATE.
MB1442
MB1442 STATION RECOVERY (1987)
MB1442
MB1442'RECOVERY NOTE BY US POWER SQUADRON 1987 (GHB)
MB1442'MARK NOT FOUND.
MB1442
MB1442 STATION RECOVERY (1995)
MB1442
MB1442'RECOVERY NOTE BY US POWER SQUADRON 1995
MB1442'MARK NOT FOUND.

NGS Visibility Obstruction Diagram for Cleveland Tide Gauge

provided by David Conner.

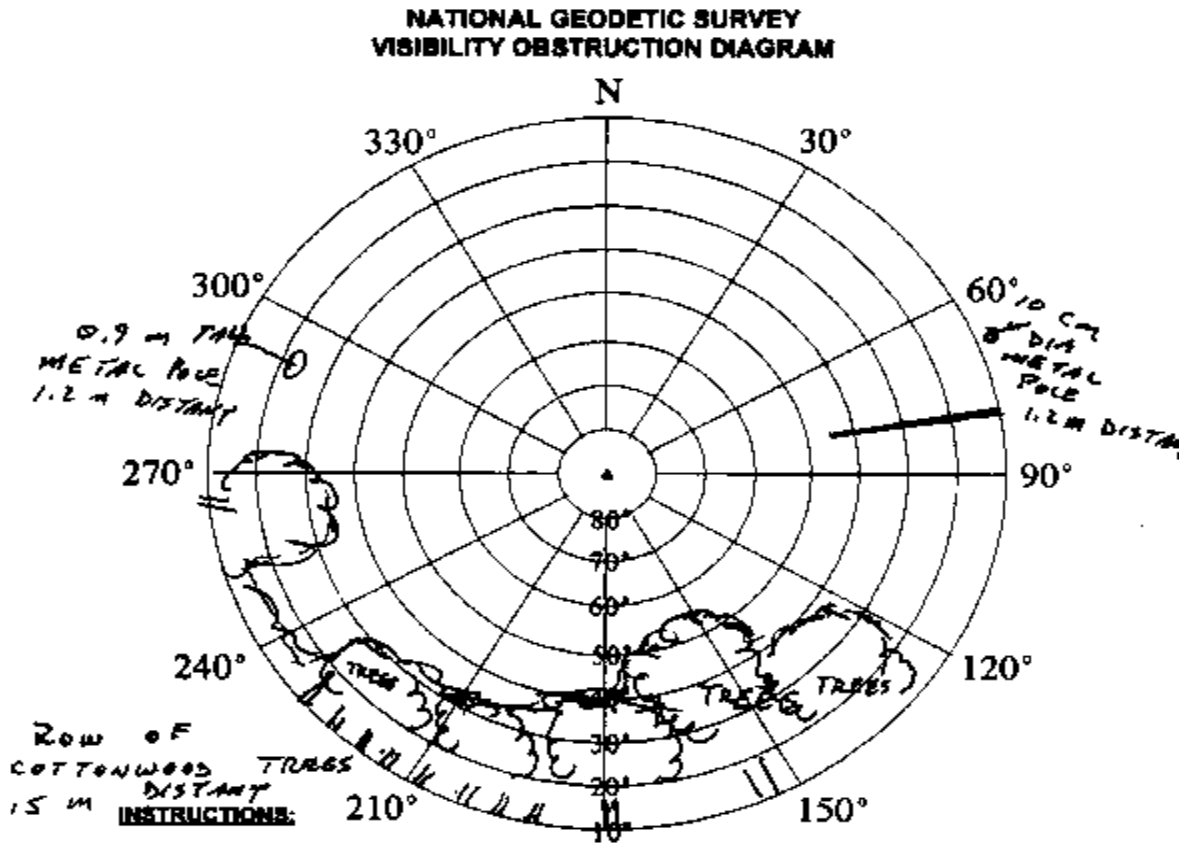

Identify obstructions by azimuth (magnetic) and elevation angle (above horizon) as seen from station mark. Indicate distance and direction to nearby structures and reflective surfaces (potential multipath sources).

Designation: CLEVELAND GAUGE
CLEVELAND LAKEFRONT
Location: STATE PARK

PID: _____

County: CUYAHOGA

Reconnaissance By: DAC

Height above mark: 0.9 Meters
- GAUGE HOUSE ROOFTOP

Agency/Company: NGS Phone: (____) _____

Date: 7/17/01

OBS FROM ROOF OF MASONRY GAUGE HOUSE 8' X 8'

Data Sheet: G321 Fiducial Site

```

MB1563 *****
MB1563 CBN - This is a Cooperative Base Network Control Station.
MB1563 TIDAL BM - This is a Tidal Bench Mark.
MB1563 DESIGNATION - G 321
MB1563 PID - MB1563
MB1563 STATE/COUNTY- OH/CUYAHOGA
MB1563 USGS QUAD - CLEVELAND NORTH (1994)
MB1563
MB1563 *CURRENT SURVEY CONTROL
MB1563
MB1563* NAD 83(1995)- 41 32 23.93345(N) 081 38 02.94417(W) ADJUSTED
MB1563* NAVD 88 - 177.800 (meters) 583.33 (feet) ADJUSTED
MB1563
MB1563 X - 695,624.338 (meters) COMP
MB1563 Y - -4,730,266.882 (meters) COMP
MB1563 Z - 4,207,592.101 (meters) COMP
MB1563 LAPLACE CORR- 1.69 (seconds) DEFLEC99
MB1563 ELLIP HEIGHT- 143.45 (meters) (08/20/96) GPS OBS
MB1563 GEOID HEIGHT- -34.36 (meters) GEOID99
MB1563 DYNAMIC HT - 177.731 (meters) 583.11 (feet) COMP
MB1563 MODELED GRAV- 980,228.1 (mgal) NAVD 88
MB1563
MB1563 HORZ ORDER - B
MB1563 VERT ORDER - FIRST CLASS II
MB1563 ELLP ORDER - FOURTH CLASS II
MB1563
MB1563.The horizontal coordinates were established by GPS observations
MB1563.and adjusted by the National Geodetic Survey in August 1996.
MB1563
MB1563.The orthometric height was determined by differential leveling
MB1563.and adjusted by the National Geodetic Survey in June 1991.
MB1563.WARNING-Repeat measurements at this control monument indicate possible
MB1563.vertical movement.
MB1563
MB1563.This Tidal Bench Mark is designated as VM 12817
MB1563.by the Center for Operational Oceanographic Products and Services.
MB1563
MB1563.The X, Y, and Z were computed from the position and the ellipsoidal ht.
MB1563
MB1563.The Laplace correction was computed from DEFLEC99 derived deflections.
MB1563
MB1563.The ellipsoidal height was determined by GPS observations
MB1563.and is referenced to NAD 83.
MB1563
MB1563.The geoid height was determined by GEOID99.
MB1563
MB1563.The dynamic height is computed by dividing the NAVD 88
MB1563.geopotential number by the normal gravity value computed on the
MB1563.Geodetic Reference System of 1980 (GRS 80) ellipsoid at 45
MB1563.degrees latitude (g = 980.6199 gals.).
MB1563
MB1563.The modeled gravity was interpolated from observed gravity values.
MB1563
MB1563; North East Units Scale Converg.
MB1563;SPC OH N - 208,386.542 672,247.446 MT 0.99997306 +0 34 07.8
MB1563;UTM 17 - 4,598,897.074 447,104.421 MT 0.99963443 -0 25 14.0
MB1563
MB1563 SUPERSEDED SURVEY CONTROL
MB1563
MB1563 ELLIP H (06/30/95) 143.54 (m) GP( ) 1 1
MB1563 NAD 83(1986)- 41 32 23.94224(N) 081 38 02.94631(W) AD( ) 1
MB1563 NAVD 88 (06/30/95) 177.80 (m) 583.3 (f) LEVELING 3
MB1563 NGVD 29 (06/03/92) 178.030 (m) 584.09 (f) ADJUSTED 1 2
MB1563
MB1563.Superseded values are not recommended for survey control.
MB1563.NGS no longer adjusts projects to the NAD 27 or NGVD 29 datums.
MB1563.See file dsdata.txt to determine how the superseded data were derived.
MB1563
MB1563_U.S. NATIONAL GRID SPATIAL ADDRESS: 17TMF4710498897(NAD 83)

```

MB1563_MARKER: F = FLANGE-ENCASED ROD
 MB1563_SETTING: 59 = STAINLESS STEEL ROD IN SLEEVE (10 FT.+)

MB1563_STAMPING: G 321 1981
MB1563_MARK LOGO: NGS
MB1563_PROJECTION: FLUSH
MB1563_MAGNETIC: I = MARKER IS A STEEL ROD
MB1563_STABILITY: A = MOST RELIABLE AND EXPECTED TO HOLD
MB1563+STABILITY: POSITION/ELEVATION WELL
MB1563_SATELLITE: THE SITE LOCATION WAS REPORTED AS SUITABLE FOR
MB1563+SATELLITE: SATELLITE OBSERVATIONS - June 05, 1997
MB1563_ROD/PIPE-DEPTH: 17.1 meters
MB1563_SLEEVE-DEPTH : 6.1 meters

MB1563	HISTORY	- Date	Condition	Report By
MB1563	HISTORY	- 1981	MONUMENTED	NGS
MB1563	HISTORY	- 19891005	GOOD	NGS
MB1563	HISTORY	- 19900326	GOOD	AEROS
MB1563	HISTORY	- 19940731	GOOD	NOS
MB1563	HISTORY	- 19950718	GOOD	NGS
MB1563	HISTORY	- 19970605	GOOD	NOS

MB1563 STATION DESCRIPTION

MB1563'DESCRIBED BY NATIONAL GEODETIC SURVEY 1981
 MB1563'IN CLEVELAND.
 MB1563'THE MARK IS ABOVE LEVEL WITH SIDEWALK.
 MB1563'IN CLEVELAND, IN THE LAKEFRONT STATE PARK BETWEEN THE NORTH END OF
 MB1563'72ND STREET AND LIBERTY BOULEVARD, THE MARK IS DIRECTLY BEHIND THE
 MB1563'WOODEN SIGN FOR THE PARK, 117.34 METERS (385.0 FEET) SOUTH-SOUTHEAST
 MB1563'OF THE NOAA GAGE HOUSE A 7 BY 7-FOOT BRICK BUILDING, 41.14 METERS
 MB1563'(135.0 FEET) SOUTH OF AN ALUMINUM LAMP POST, 28.04 METERS (92.0 FEET)
 MB1563'SOUTHEAST OF THE SOUTHEAST EDGE OF THE SIDEWALK LEADING INTO THE PARK,
 MB1563'13.87 METERS (45.5 FEET) SOUTH OF THE NORTHWEST END OF THE NORTHWEST
 MB1563'ONE OF 10 CONCRETE STOPS OF A SMALL PARKING AREA, 2.43 METERS (8.0
 MB1563'FEET) NORTH OF THE SOUTHEAST LEG OF THE SIGN.

MB1563 STATION RECOVERY (1989)

MB1563'RECOVERY NOTE BY NATIONAL GEODETIC SURVEY 1989
 MB1563'IN CLEVELAND, IN THE LAKEFRONT STATE PARK BETWEEN THE NORTH END OF
 MB1563'72ND STREET AND M. L. KING JR. BOULEVARD, THE MARK IS DIRECTLY
 MB1563'BEHIND THE WOODEN SIGN FOR THE PARK, 117.34 METERS (385.0 FEET)
 MB1563'SOUTH-SOUTHEAST OF THE NOAA GAGE HOUSE (A 7 FOOT SQUARE BRICK
 MB1563'BUILDING), 41.14 METERS (135.0 FEET) SOUTH OF AN ALUMINUM LAMP POST,
 MB1563'28.04 METERS (92.0 FEET) SOUTHEAST OF THE SOUTHEAST EDGE OF THE
 MB1563'SIDEWALK LEADING INTO THE PARK, 13.87 METERS (45.5 FEET) SOUTH OF THE
 MB1563'NORTHWEST END OF THE NORTHWEST ONE OF 10 CONCRETE STOPS OF A SMALL
 MB1563'PARKING AREA, 2.43 METERS (8.0 FEET) NORTH OF THE SOUTHEAST LEG OF
 MB1563'THE SIGN.

MB1563 STATION RECOVERY (1990)

MB1563'RECOVERY NOTE BY AERO SERVICE CORPORATION 1990
 MB1563'RECOVERED IN GOOD CONDITION.

MB1563 STATION RECOVERY (1994)

MB1563'RECOVERY NOTE BY NATIONAL OCEAN SERVICE 1994 (JDR)
 MB1563'RECOVERED AS DESCRIBED.

MB1563 STATION RECOVERY (1995)

MB1563'RECOVERY NOTE BY NATIONAL GEODETIC SURVEY 1995 (AJL)
 MB1563'IN CLEVELAND, IN A LAWN AT LAKEFRONT STATE PARK BETWEEN THE NORTH END
 MB1563'OF 72ND STREET AND M L KING JR BOULEVARD, 117.3 M (384.8 FT) SOUTH OF
 MB1563'THE NOAA GAGE HOUSE (A 2.1 M (6.9 FT) SQUARE BRICK BUILDING) , 61.9 M
 MB1563'(203.1 FT) NORTHWEST OF BM STEPS AT THE NORTHWEST CORNER OF CONCRETE
 MB1563'STAIRS LEADING UPHILL TO A PEDESTRIAN BRIDGE OVER INTERSTATE 90, 53.3
 MB1563'M (174.9 FT) WEST-NORTHWEST OF THE CENTERLINE OF THE PARK ENTRANCE
 MB1563'ROAD, 33.4 M (109.6 FT) EAST OF THE SOUTHEAST CORNER OF A FENCE AROUND
 MB1563'A MARINA, 41.1 M (134.8 FT) SOUTH-SOUTHEAST OF AN ALUMINUM LAMP POST,
 MB1563'AND 28.0 M (91.9 FT) SOUTHEAST OF THE SOUTHEAST EDGE OF THE SIDEWALK

MB1563'LEADING INTO THE PARK.
MB1563
MB1563 STATION RECOVERY (1997)
MB1563
MB1563'RECOVERY NOTE BY NATIONAL OCEAN SERVICE 1997 (CAP)
MB1563'IN CLEVELAND, IN THE LAKEFRONT STATE PARK BETWEEN THE NORTH END OF
MB1563'72ND STREET AND M. L. KING JR. BOULEVARD, THE MARK IS DIRECTLY
MB1563'BEHIND THE WOODEN SIGN FOR THE PARK, 117.34 METERS (384.97 FT)
MB1563'SOUTH-SOUTHEAST OF THE NOAA GAUGE HOUSE (A 7 FOOT (2.1 M) SQUARE BRICK
MB1563'BUILDING), 41.14 METERS (134.97 FT) SOUTH OF AN ALUMINUM LAMP POST,
MB1563'28.04 METERS (91.99 FT) SOUTHEAST OF THE SOUTHEAST EDGE OF THE
MB1563'SIDEWALK LEADING INTO THE PARK, 13.87 METERS (45.51 FT) SOUTH OF THE
MB1563'NORTHWEST END OF THE NORTHWEST ONE OF 10 CONCRETE PARKING STOPS OF A
MB1563'SMALL PARKING AREA, WITH 5-INCH PVC PIPE AND ALUMINUM ACCESS COVER
MB1563'WHICH IS STAMPED G 321 SURROUND BY A MASS OF CONCRETE FLUSH WITH THE
MB1563'GROUND.

NGS Visibility Obstruction Diagram for G321

NATIONAL GEODETIC SURVEY VISIBILITY OBSTRUCTION DIAGRAM

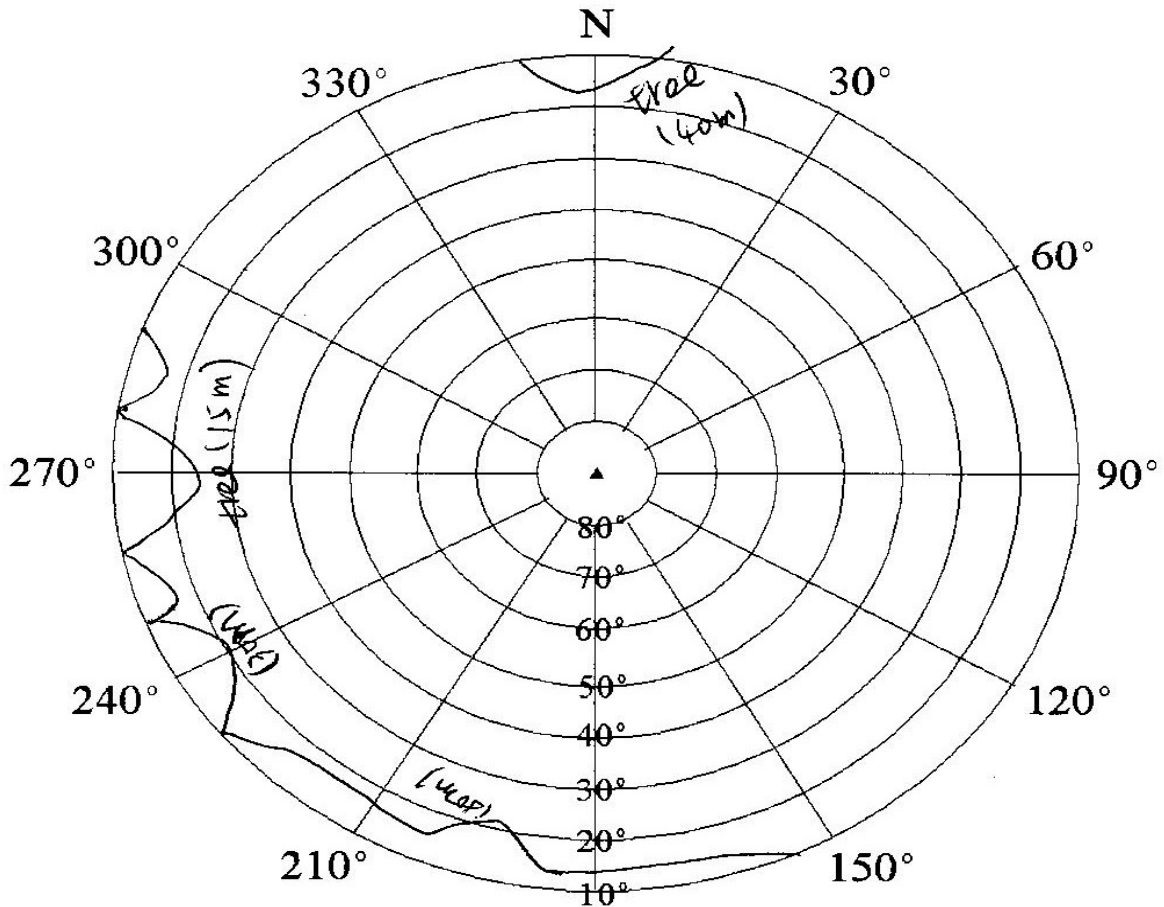

INSTRUCTIONS:

Identify obstructions by azimuth (magnetic) and elevation angle (above horizon) as seen from station mark. Indicate distance and direction to nearby structures and reflective surfaces (potential multipath sources).

4-char ID: G321 Designation: _____

PID: _____ Location: near Cleveland tide gauge

County: _____ Reconnaissance By: _____

Height above mark, meters: 2.000 Agency/Company: CEEGS, OSU

Phone: (____) vertical to ARP Date: 9/18/03

Check if no obstructions above 10 degrees

GPS Station Observation Log for G321

GPS STATION OBSERVATION LOG April 16, 2003	Station Designation: (check applicable: <input type="checkbox"/> FBN <input type="checkbox"/> CBN <input type="checkbox"/> PAC <input type="checkbox"/> SAC <input type="checkbox"/> BM) <div style="text-align: center; font-size: 1.2em;">G321</div>	Station PID, if any: <div style="text-align: center; font-size: 1.2em;">G321</div>	Date (UTC): <div style="text-align: center; font-size: 1.2em;">9/18/2003</div>				
	General Location: <div style="text-align: center; font-size: 1.2em;">Cleveland</div>	Airport ID, if any:	Station 4-Character ID: <div style="text-align: center; font-size: 1.2em;">G321</div>	Day of Year: <div style="text-align: center; font-size: 1.2em;">261</div>			
Project Name: <div style="text-align: center; font-size: 1.2em;">GPS Buoy</div>		Project Number: <div style="text-align: center; font-size: 1.2em;">GPS-</div>	Station Serial # (SSN):	Session ID:(A,B,C etc)			
NAD83 Latitude <div style="font-size: 1.2em;">41° 32' 23.93345</div>	NAD83 Longitude <div style="font-size: 1.2em;">81° 38' 02.94417</div>	NAD83 Ellipsoidal Height <div style="font-size: 1.2em;">143.45 meters</div>	Agency Full Name: <div style="font-size: 1.2em;">CEEGS,</div>				
Observation Session Times (UTC): Sched. Start <u>9:00</u> Stop _____ Actual Start <u>9:09</u> Stop _____		Epoch Interval = <u>1</u> Seconds Elevation Mask = <u>10</u> Degrees	NAVD88 Orthometric Ht. <div style="font-size: 1.2em;">177.80 meters</div>	Operator Full Name: <div style="font-size: 1.2em;">OSU</div>			
Receiver Brand & Model: <div style="font-size: 1.2em;">4000 SSI</div>		Antenna Code*, Brand & Model: <div style="font-size: 1.2em;">D/M Choke Ring</div>		Antenna plumb before session? (Y/N) <input type="checkbox"/> Circle Yes or No Antenna plumb after session? (Y/N) <input type="checkbox"/> Antenna oriented to true North? (Y/N) <input type="checkbox"/> Weather observed at antenna ht. (Y/N) <input type="checkbox"/> explain Antenna ground plane used? (Y/N) <input type="checkbox"/>			
P/N: S/N: Firmware Version: <input type="checkbox"/> CamCorder Battery, <input type="checkbox"/> 12V DC, <input type="checkbox"/> 110V AC, <input type="checkbox"/> Other		P/N: S/N: Cable Length, meters: Vehicle is Parked _____ meters _____ (direction) from antenna.		Antenna radome used? (Y/N) <input type="checkbox"/> if yes, describe. Eccentric occupation (>0.5 mm)? (Y/N) <input type="checkbox"/> Use Any obstructions above 10'? (Y/N) <input type="checkbox"/> Radio interference source nearby (Y/N) <input type="checkbox"/> Vis. form			
Tripod or Antenna Mount: Check one: <input type="checkbox"/> Fixed-Leg Tripod <input type="checkbox"/> Collapsible-leg tripod <input type="checkbox"/> Fixed Mount Brand & Model: <div style="font-size: 1.2em;">2-m fixed height</div> P/N: S/N: Last Adjustment date: _____		** ANTENNA HEIGHT **		Before Session Begins: Meters Feet			
Psychrometer (if used) Brand & Model: P/N: S/N: Last Calibration or check Date: _____		A = Datum point to Top of Tripod (Tripod Height) 2.000		After Session Ends: Meters Feet			
		B = Additional offset to ARP if any (Tribrach/Spacer)					
		H = Antenna Height = A + B = Datum Point to Antenna Reference Point (ARP)					
		Meters = Feet x (0.3048) Height Entered into Receiver = _____ meters.		Note &/or sketch ANY unusual conditions. Be Very Explicit as to where and how Measured!			
Barometer (if used) Brand & Model: S/N:	Weather Data	Weather Codes	Time (UTC)	Dry-Bulb Temp Fahrenheit Celsius	WetBulb Temp Fahrenheit Celsius	Rel. % Humidity	Atm. Pressure inches Hg millibar
	Before						
	Middle						
	After						
Remarks, Comments on Problems, Sketches, Pencil Rubbing, etc: 							
Weather codes are required. Weather data are optional but encouraged. *Antenna code comes from ant_info file furnished by project coordinator.							
Data File Name(s): (Standard NGS Format = <code>ssssdddss.xxx</code>) <small>where ssss=4-Character ID, dddd=Day of Year, s=Session ID, xxx=file dependent extension</small>				Updated Station Description: <input type="checkbox"/> Attached <input type="checkbox"/> Submitted earlier Visibility Obstruction Form: <input type="checkbox"/> Attached <input type="checkbox"/> Submitted earlier Photographs of Station: <input type="checkbox"/> Attached <input type="checkbox"/> Submitted earlier Pencil Rubbing of Mark: <input type="checkbox"/> Attached		LOG CHECKED BY:	
Table of Weather Codes	CODE	PROBLEM	VISIBILITY	TEMPERATURE	CLOUD COVER	WIND	
	0	did not occur	Good, over 15 miles	Normal, 32° F- 80° F	Clear, below 20%	Calm, under 5mph (8km/h)	
	1	did occur	Fair, 7-15 miles	Hot, over 80° F (27 C)	Cloudy, 20% to 70%	Moderate, 5 to 15 mph	
	2	- not used -	Poor, under 7 miles	Cold, below 32° F (0 C)	Overcast, over 70%	Strong, over 15 mph (24km/h)	
Examples: 00000 = No problem, good visibility, normal temp, clear, calm wind 12121 = Problems, poor visibility, hot, overcast, moderate wind							

NGS Visibility Obstruction Diagram for AUX1

NATIONAL GEODETIC SURVEY VISIBILITY OBSTRUCTION DIAGRAM

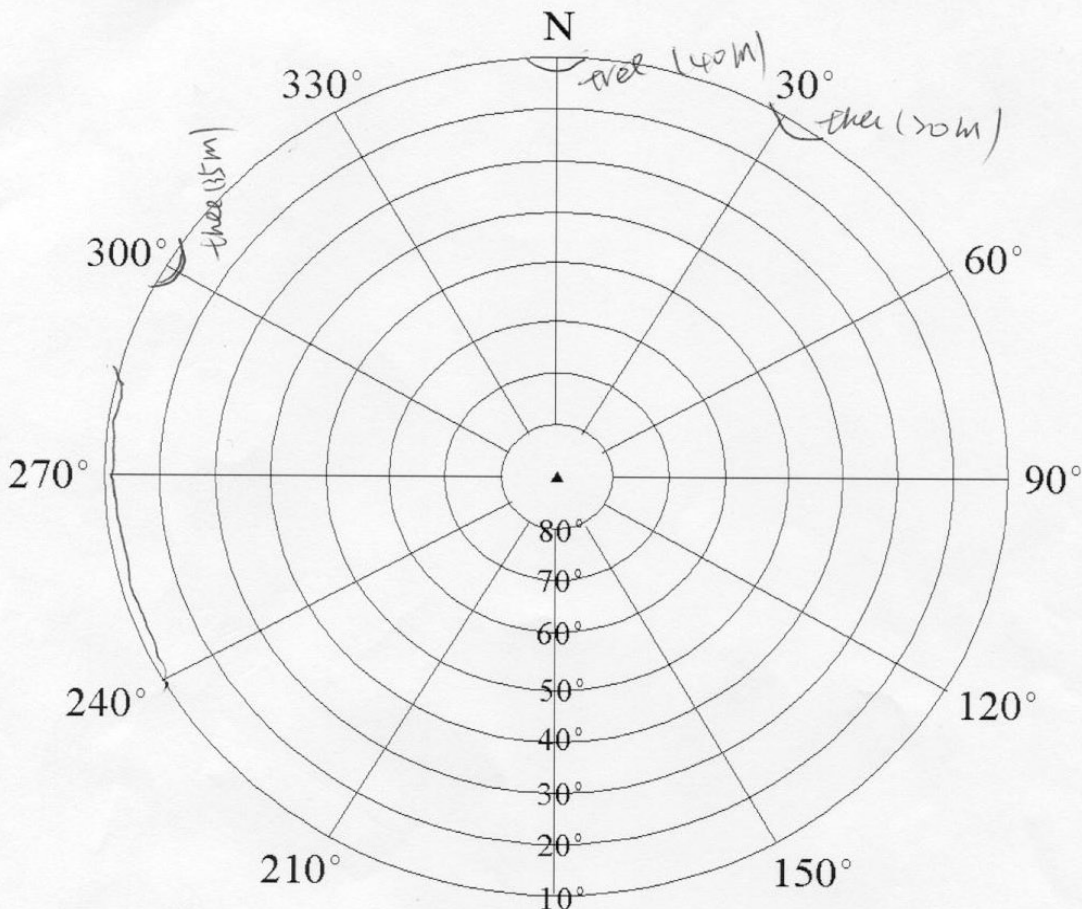

INSTRUCTIONS:

Identify obstructions by azimuth (magnetic) and elevation angle (above horizon) as seen from station mark. Indicate distance and direction to nearby structures and reflective surfaces (potential multipath sources).

4-char ID: AUX1 Designation: _____
 PID: _____ Location: near Cleveland tide gauge
 County: _____ Reconnaissance By: _____
 Height above mark, meters: 2.000 Agency/Company: CEEGS, OSU
 Phone: (____) vertical to ARP Date: 9/18/03
 Check if no obstructions above 10 degrees

GPS Station Observation Log for AUX1

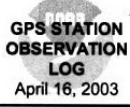
 GPS STATION OBSERVATION LOG April 16, 2003	Station Designation: (check applicable: <input type="checkbox"/> FBN <input type="checkbox"/> CBN <input type="checkbox"/> PAC <input type="checkbox"/> SAC <input type="checkbox"/> BM) AUX1		Station PID, if any: AUX1	Date (UTC): 9/18/2003				
	General Location: Cleveland		Airport ID, if any:	Station 4-Character ID: AUX1	Day of Year: 261			
Project Name: GPS Buoy		Project Number: GPS-		Station Serial # (SSN):	Session ID:(A,B,C etc)			
NAD83 Latitude new point		NAD83 Longitude		NAD83 Ellipsoidal Height meters				
Observation Session Times (UTC): Sched. Start 9:00 Stop		Epoch Interval= 1 Seconds		NAVD88 Orthometric Ht. meters				
Actual Start 9:30 Stop		Elevation Mask = 10 Degrees		GEOID99 Geoid Height meters				
Receiver Brand & Model: 4000 SSI		Antenna Code*, Brand & Model: D/M Choke Ring		Agency Full Name: CEEQS,				
P/N: S/N: Firmware Version:		P/N: S/N: Cable Length, meters:		Operator Full Name: OSU				
<input type="checkbox"/> CamCorder Battery, <input type="checkbox"/> 12V DC, <input type="checkbox"/> 110V AC, <input type="checkbox"/> Other		Vehicle is Parked _____ meters _____ (direction) from antenna.		Phone #: ()				
Antenna plumb before session? (Y/N) Circle Antenna plumb after session? (Y/N) Yes or No Antenna oriented to true North? (Y/N) -if no, Weather observed at antenna ht. (Y/N) explain Antenna ground plane used? (Y/N) *		Antenna radome used? (Y/N) If yes, Eccentric occupation (>0.5 mm)? (Y/N) describe. Any obstructions above 10'? (Y/N) Use Radio interference source nearby (Y/N) Vis. form						
Tripod or Antenna Mount: Check one: <input type="checkbox"/> Fixed-Leg Tripod, <input type="checkbox"/> Collapsible-leg tripod, <input type="checkbox"/> Fixed Mount Brand & Model: P/N: S/N: Last Adjustment date:		** ANTENNA HEIGHT ** A= Datum point to Top of Tripod (Tripod Height) B= Additional offset to ARP if any (Tribrach/Spacer) H= Antenna Height = A + B = Datum Point to Antenna Reference Point (ARP) Meters = Feet x (0.3048) Height Entered into Receiver = _____ meters.		Before Session Begins: Meters Feet After Session Ends: Meters Feet				
Psychrometer (if used) Brand & Model: P/N: S/N: Last Calibration or check Date:		Note &/or sketch ANY unusual conditions. Be Very Explicit as to where and how Measured!						
Barometer (if used) Brand & Model: S/N:		Weather Data	Weather Codes	Time (UTC)	Dry-Bulb Temp Fahrenheit Celsius	WetBulb Temp Fahrenheit Celsius	Rel. % Humidity	Atm. Pressure inches Hg millibar
		Before						
		Middle						
		After						
Remarks, Comments on Problems, Sketches, Pencil Rubbing, etc: 								
Weather codes are required. Weather data are optional but encouraged. *Antenna code comes from ant_info file furnished by project coordinator.								
Data File Name(s): (Standard NGS Format = aaaadddd.xxx) where aaaa=4-Character ID, ddd=Day of Year, s=Session ID, xxx=file dependant extension			Updated Station Description: <input type="checkbox"/> Attached <input type="checkbox"/> Submitted earlier Visibility Obstruction Form: <input type="checkbox"/> Attached <input type="checkbox"/> Submitted earlier Photographs of Station: <input type="checkbox"/> Attached <input type="checkbox"/> Submitted earlier Pencil Rubbing of Mark: <input type="checkbox"/> Attached			LOG CHECKED BY:		
Table of Weather Codes								
	CODE	PROBLEM	VISIBILITY	TEMPERATURE	CLOUD COVER	WIND		
	0	did not occur	Good, over 15 miles	Normal, 32° F - 80° F	Clear, below 20%	Calm, under 5mph (8km/h)		
	1	did occur	Fair, 7-15 miles	Hot, over 80°F (27 C)	Cloudy, 20% to 70%	Moderate, 5 to 15 mph		
	2	- not used -	Poor, under 7 miles	Cold, below 32° F (0 C)	Overcast, over 70%	Strong, over 15 mph (24km/h)		
Examples: 00000 = No problem, good visibility, normal temp, clear, calm wind 12121 = Problems, poor visibility, hot, overcast, moderate wind								