

## NUMERICAL STUDY OF N-HEPTANE FUELLED HCCI UNDER DIFFERENT AIR FUEL RATIO AND INLET AIR TEMPERATURE

H.Hanafi<sup>1,2\*</sup>, M.M.Noor<sup>1,2</sup>, M.M.Rahman<sup>1,2</sup>, K.Kadrigama<sup>1,2</sup>, D. Ramasamy<sup>1,2</sup>,  
C.K.Ihsan<sup>1,2</sup>, M.K. Kamarulzaman<sup>1,2</sup>, Y.Selvaraj<sup>1</sup>

<sup>1</sup>Faculty of Mechanical Engineering, Universiti Malaysia Pahang,  
26600 Pekan, Pahang, Malaysia,  
Phone: +60179834292; Fax: +6094246222

<sup>2</sup>Automotive Engineering Centre, Universiti Malaysia Pahang,  
26600 Pekan, Pahang, Malaysia

\*Email: hasrulazmi.h@gmail.com

### ABSTRACT

This paper examines on numerical modeling of Homogenous Charge Compression Ignition (HCCI) engine model using n-heptane as base fuel. The parameters used in this study is different air to fuel ratio (AFR) (25, 30, 35, 40, 45, 50) and different air inlet temperature (25°C, 50°C, 75°C, 100°C). Performance and emission characteristics of n-heptane were investigated at constant engine speed of 1000 rpm in a HCCI engine model. The effects of inlet air temperature were also examined. The test results showed that brake power, brake mean effective pressure and brake specific fuel consumption decreased when increased AFR and inlet air temperature. Meanwhile, brake thermal efficiency shows an increase when increase when AFR and temperature of the inlet increased. The test results also showed that NO<sub>x</sub>, CO and HC emissions decreased with the increase of inlet air temperature for all AFR value. Overall, this numerical model can be used to predict the performance and emission of the HCCI engine.

**Keywords:** HCCI; n-Heptane; performance; emission

### INTRODUCTION

Recent years, researcher have pushed them in researching the alternative fuel applications in the internal combustion engine industry due to the reason rapid growth in energy demand, limited petroleum reservoir, the pollution from exhaust gases itself and reduction of greenhouse gas effect [1, 2]. Thus, the need for the new advanced combustion modes with broad fuel flexibility continues to rise. Homogeneous charge compression ignition (HCCI) is an advanced fuel-flexible combustion mode which can be which can be used with an extensive variety of octane or cetane fuels. HCCI engines can be considered as hybrid mode as its combine characteristics of both spark-ignition (SI) and compression-ignition (CI) engines. Like SI engines, a premixed fuel-in-air charge is used for cleaner combustion with low soot and particulate matter (PM) emissions. Similar to CI engines, a high operating efficiency is obtained since throttle valves are not needed for power output control and the combustion happens through compression ignition. HCCI mode also can achieve thermal efficiency as high as 50% [3] and emit low emissions, commonly negligible nitrogen oxides (NO<sub>x</sub>) and PM, compared to SI and CI engines respectively [4]. Another major advantages of the HCCI engines is the ability to combust a large variety of fuels ranging from low calorific value fuels such as biomass [5, 6] derived gases to natural gas, alcohols [7], gasoline, and diesel [8]. Furthermore, these fuels also can be combined as blends such as n-butanol/n-heptane, ethanol/n-heptane, and n-butanol/gasoline [9] and [10].

In HCCI engines a homogeneous air–fuel mixture is ignited with a relatively large amount of charge dilution through compression. This results in low-temperature combustion, which afterwards produces low NO<sub>x</sub> and less soot due to less fuel-rich flame regions or localized high-temperature spots inside the cylinder. Moreover, higher thermal efficiencies can be achieved due to the higher compression ratios needed to auto ignite these dilute homogenous air–fuel mixtures. However, the main challenges is that to controlled the combustion phasing of HCCI engines as it governed by chemical kinetics and no specific ignition timing event as in SI or CI engines. Another challenge is the level of Unburned Hydrocarbon (UHC) [11] and CO (carbon monoxide) emissions is relatively high in HCCI [12]. These emissions happen from the charge in the crevice regions and from a thin thermal boundary layer that forms along the in-cylinder surfaces. Other challenges include noise levels which happens due to rapid Heat Release Rates (HRRs) at high loads and limited engine operating range [13].

Numerical models can be categorized into three groups depends on complexity and computational cost: single zone models with chemical kinetics [14], multi-zone models with chemical kinetics [15] and [16], and Computational Fluid Dynamics (CFD) based models with chemical kinetics [17]. Single zone model with chemical kinetics is the simplest among all three where the entire charge mass is treated as a single lumped zone of homogeneous temperature, pressure, and species concentration. Reaction rates and species evolution are solved using chemical kinetics. But these models tend to over-predict HRR and pressure rise rates while under-predicting certain emissions. To solve this problem, multi-zone models are used. In this category, the in-cylinder charge is separated into concentric ring-like or individually lumped zones which are treated as stirred reactors. Compared to single zone, each zone are stratified from one another but is still considered homogeneous in terms of species concentrations and temperature and pressure distributions. This method allows for capturing the species and temperature gradients throughout the cylinder but it will requires more zones if a larger temperature gradient exists across the cylinder.

In order to achieve this combustion process in production engines, it is crucial to construct a more detailed analysis of homogeneous combustion by using multidimensional simulations. This type of simulation requires an accurate description of chemical reaction kinetics, particularly for the description of low-temperature reactions. However, a coupled CFD and detailed chemistry simulation involve substantial memory and CPU. Thus a reduced mechanism is required to simulate the engine cycle for HCCI engine type.

The objective of this work is to study the modeled and study the effect of air fuel ratio (AFR) and different inlet air temperature in HCCI combustion mode fuelled by n-Heptane.

## **NUMERICAL MODEL**

In order to predict the combustion process of the HCCI engine, a numerical model with detailed chemistry was developed to simulate the four-stroke process. Simulations of HCCI combustion using n-Heptane C<sub>7</sub>H<sub>16</sub> have been conducted using a “single-zone” numerical model of the engine. This kind of model treats the combustion chamber as a uniform reactor with uniform temperature, pressure, and composition throughout. Conservation of energy and chemical kinetic relations based on a gas-phase detailed kinetic mechanism for n-Heptane combustion are solved to determine temperature and species histories for the cycle. The chemical mechanism was take from Lawrence Livermore National Laboratory (LNLL)

contains n-Heptane chemistry provided by Mehl et. al [18, 19]. This detailed chemical kinetic mechanism has been developed and validated by comparison to experiments in shock tubes and rapid compression machines.

The model only simulates the closed part of the cycle; intake and exhaust processes are not considered. The single-zone model is a highly idealized representation of the actual processes happened in the combustion chamber. Models exist such as KIVA, that have thousands of zones and thus can capture in more detail of the three-dimensional processes happened in the combustion chamber [20] and [21], such as crevice and boundary layer effects. Still, single-zone models can give insight into the processes occurring in the combustion chamber, particularly processes that happen in the hottest central core gases of the combustion chamber away from the crevice and boundary layers.

Simulations were conducted using the geometric and operating parameters for the engine specified in Table 1.

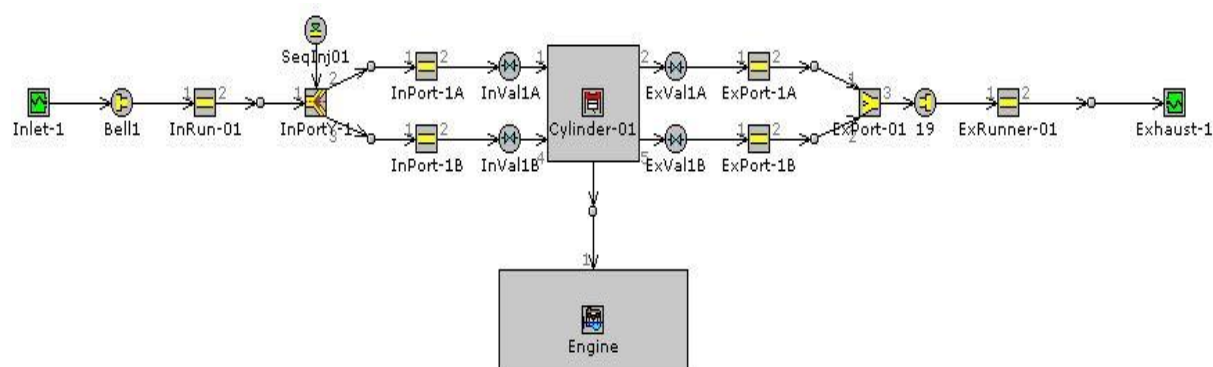

**Figure 1:** HCCI model setup

**Table 1:** Technical specifications of the modeled engine

Engine parameters	Value
Cylinder number	1
Cylinder bore (mm)	80.26
Stroke (mm)	88.90
Swept volume (cc)	540
Compression ratio	13:1
Maximum power output (kW)	15
Maximum engine speed (rpm)	5400

## VALIDATION OF NUMERICAL SIMULATION

The aforementioned numerical simulation with detailed fuel chemistry was first validated against Ref [22]. A single cylinder, four strokes, port injection gasoline HCCI engine was used in their experiments. Air heating system was mounted in the entrance of the intake manifold. Inlet air temperature was also measured using K-type thermocouple placed in the intake manifold and was held constant by closed-loop controller. The coolant and engine oil

temperatures were fixed at 358 K and 348 K respectively in order to prevent incomparability and measurement failures. So, their tests were conducted at steady state operation conditions.

As shown in Figure 2, the cylinder pressure calculated by the model can over-predict with experimental data measured. Moreover, combustion in numerical result takes place a bit faster when compared to the experiment. This may have happened due to the reason that the numerical result is perfectly homogenous, no loss is considered. But this confirms that the chemistry scheme employed can simulate the HCCI combustion and predict the performance and emission of the n-heptane fuel. This confirms that the numerical simulation can be used to calculate the combustion process of HCCI engine if a suitable heat transfer equation is employed.

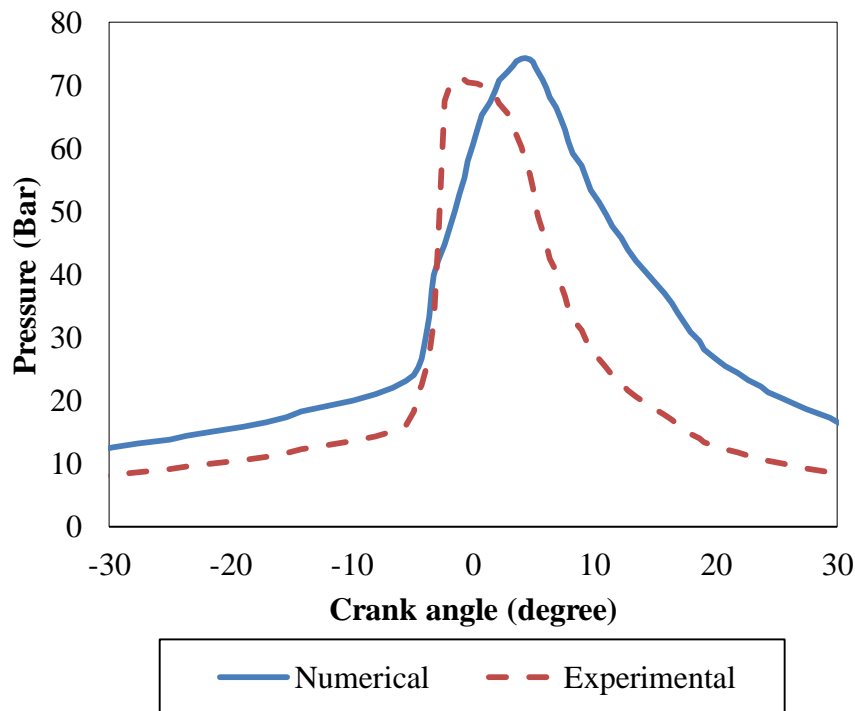

**Figure 2:** Cylinder pressures of n-heptane at different inlet air temperatures ( $n = 1500$  rpm,  $\lambda = 2$ ).

## RESULTS AND DISCUSSION

The simulations were performed at different air-fuel ratios and air inlet temperature. The engine speed was kept constant at 1000 rpm. Inlet air temperature plays an important role on HCCI combustion, because HCCI combustion depends on the chemical kinetics. Charge mixture is compressed until autoignition temperature reached [23]. In this section, performance and emission of each simulation parameter is discussed.

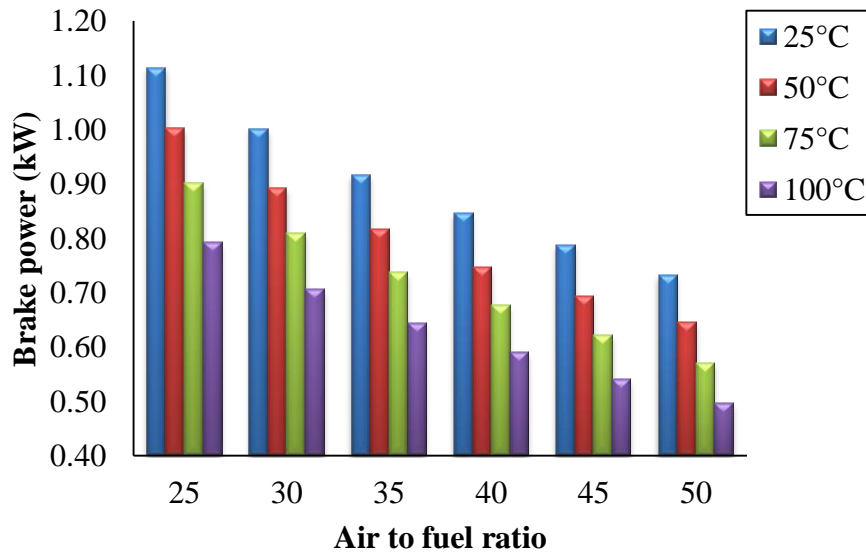

**Figure 3:** Variation of brake power with air to fuel ratio at different air inlet temperature

The brake power developed by the engine on different air fuel ratio starting from 25 to 50 and different air inlet temperature from 25°C to 100°C is presented in Figure 1. As the temperature and AFR increases the BP developed by engine decreased. At maximum temperature i.e. 100°C, the result developed lowest brake power among the others. From the results it is concluded that the higher AFR developed less BP at higher temperature

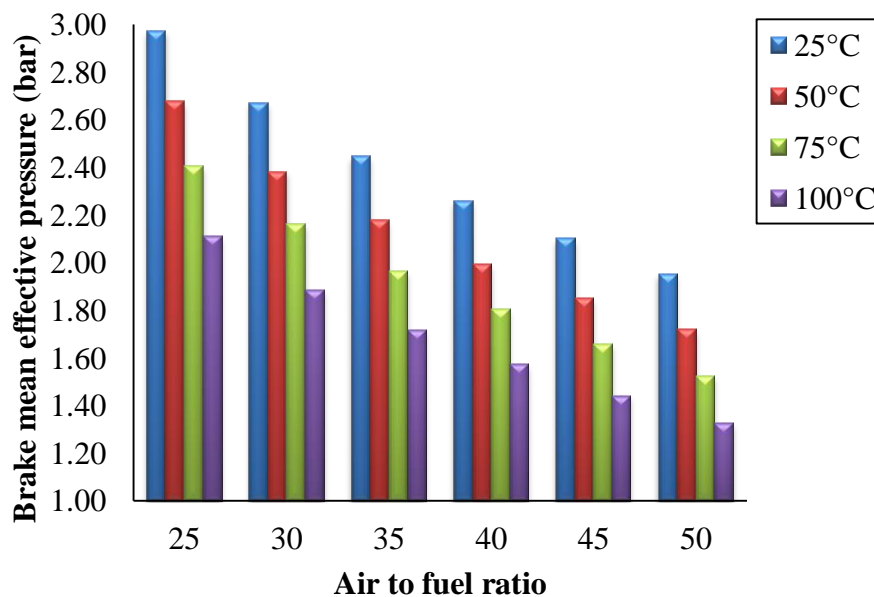

**Figure 4:** Variation of brake mean effective pressure with air to fuel ratio at different air inlet temperature

Brake mean effective pressure (BMEP) is significant performance parameter which signified the averaged cylinder pressure exerted on piston during a cycle. The variation of BMEP with AFR at different inlet air temperatures on HCCI combustion is seen in Figure 4. It is possible to say that BMEP decreases with the increase of inlet air temperature. It also causes the decrease of volumetric efficiency at high inlet air temperatures. Thus, BMEP decreases at high inlet air temperatures as seen in Figure 4. It can be also concluded from Figure 4 that

BMEP decreases with n-heptane due to knocking effect. There was a remarkable difference on BMEP when the AFR increased. Maximum BMEP was obtained with AFR at 25°C inlet air temperature. The reasons of BMEP decrease throughout the simulation those leaner mixtures it causes to drive less energy into the cylinder. Hence, the pressure at the end of combustion increases due to more fuel molecules participation into the chemical reactions.

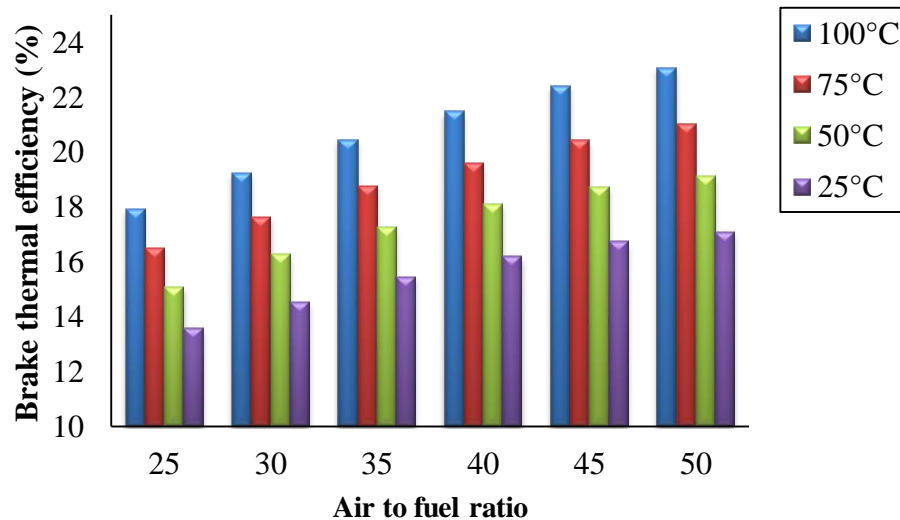

**Figure 5:** Variation of brake thermal efficiency with air to fuel ratio at different air inlet temperature

Brake Thermal Efficiency (BTE) is defined as the conversion performance of the chemical energy of the fuel into mechanical energy in the internal combustion engines. The effects of inlet air temperatures on BTE are shown in Figure 5. BTE increased with the increase of inlet air temperature with n-heptane at different AFR. It can be clearly noticed that autoignition can occur easily at high inlet air temperatures and autoignition conditions enhanced at each point of the combustion chamber, because combustion occurs close to TDC with the increase of inlet air temperature. So, BTE increases. But, when AFR increased BTE result show a decrement result. This due to a reason that less fuel was injected into the engine during simulation. The increase in the BTE with the increase with intake air temperature is probably due to the higher combustion efficiency.

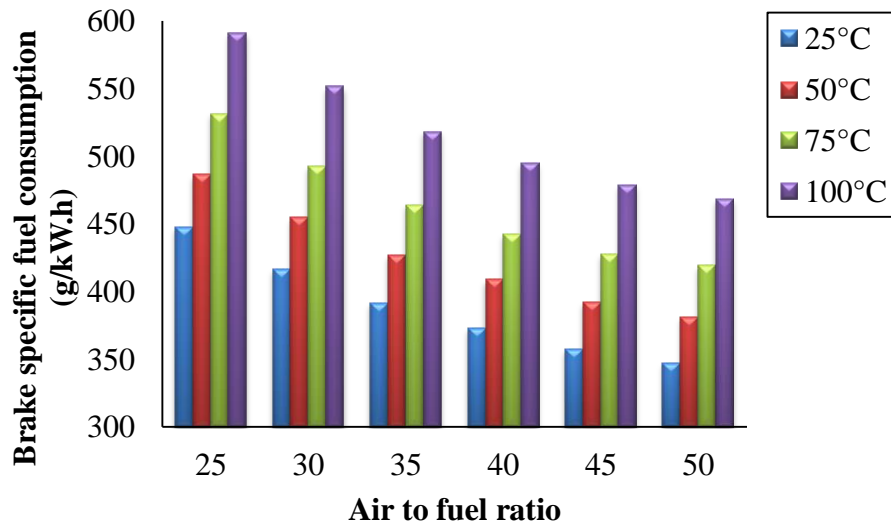

**Figure 6:** Variation of brake specific consumption with air to fuel ratio at different air inlet temperature

Brake specific fuel consumption (BSFC) is a parameter to compare the fuel requirement for producing unit power. Variation of BSFC vs. AFR for all the inlet air temperature is shown in Figure 6. It is clear that heated n-heptane fuel shows low BSFC result. This was due to the fact that higher fuel inlet temperature results in lower viscosity which causes better atomization and subsequently better combustion and results in lower BSFC.

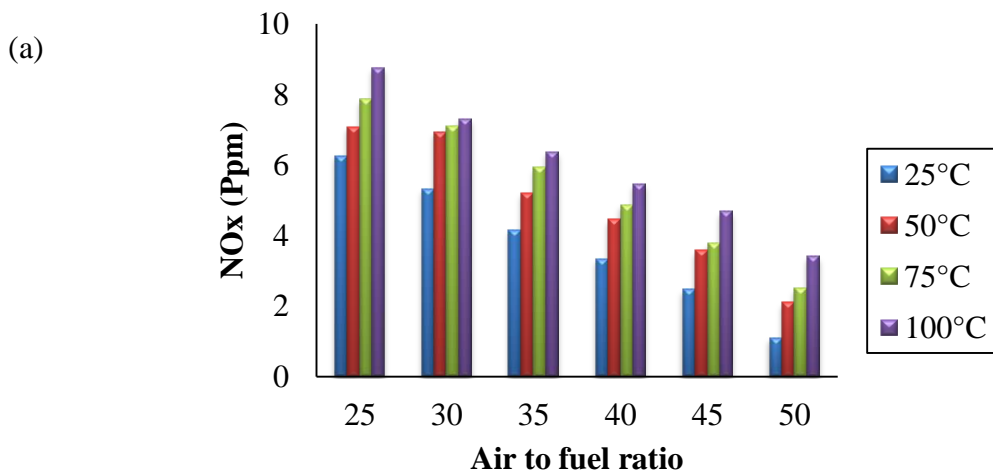

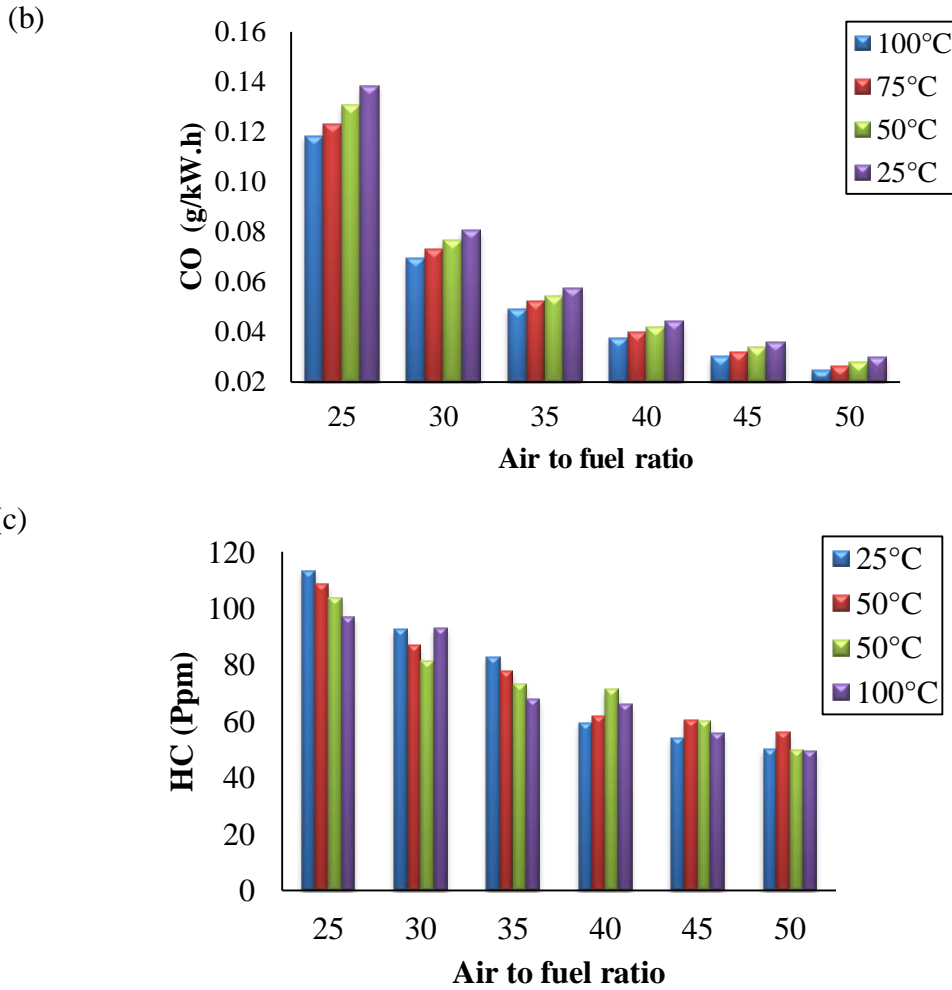

**Figure 7:** Variation of CO, HC and NO<sub>x</sub> with air to fuel ratio at different air inlet temperature

NO<sub>x</sub> can be diminished in HCCI combustion, because HCCI engines operate with leaner homogenous charge mixtures. As NO<sub>x</sub> emissions were emitted at high combustion temperatures, NO formation mechanisms could not happen due to lower end of combustion temperature. This is one of the most important advantages of HCCI combustion. In the simulation, NO emissions were measured almost zero with all AFR at each inlet air temperatures. Lowest NO<sub>x</sub> achieved is at 25°C compared to other temperature as shown in Figure 7 (a). It can also be stated that higher inlet air temperatures increase the tendency of knocking. In HCCI combustion, CO and HC emissions are unfortunately produced because of lower end of combustion temperature and incomplete combustion [24] and [25]. The variation of CO emissions is presented in Figure 7 (b). As seen in Figure 7 (b), minimum CO emissions were produced throughout entire simulation with n-heptane because of higher combustion temperature and faster combustion due to knocking. It can be also concluded from Figure 7(b) that CO emissions decrease with the increase of inlet air temperature, because CO could be oxidized more efficiently due to higher inlet temperatures. So, CO<sub>2</sub> formation is improved and the amount of CO emissions decreased. Maximum CO emissions were measured at 25°C inlet air temperature for all AFR value. Figure 7(c) Fig. 10 shows that HC emissions decrease with the increase of inlet air temperature. HC produce due to the reason that flame escape on cold cylinder surface in the combustion chamber due to insufficient temperature during the combustion. Besides, flame cannot travel through the piston rings and any crevices in the combustion chamber. Hence, autoignition deteriorates and cause incomplete combustion.. The reason of this reduction is that chemical reactions improve and rapid combustion occurs at



high inlet air temperatures. The productions of radicals accelerate with the increase of inlet air temperature and combustion reactions. Moreover, warmer inlet air temperature decreases the cooling effects of homogeneous leaner charge mixture

## CONCLUSIONS

A numerical single zone model of an n-heptane fuelled HCCI engine is studied. A chemical reaction mechanism was used to solve the chemical reactions during combustion. After completion of the model, validation was done against previously published experimental results. The simulation results show good agreement with experimental result and minimum percentage of error is less than 5%.

Overall, the HCCI model able to operate at leaner mixture while providing a positive result. Even though, brake power shows a decrement when air to fuel ratio increased, other performance parameters still show a good increment result such as brake mean effective pressure, brake specific fuel consumption and brake thermal efficiency. For emission, increasing air to fuel ratio, decrease the emission of  $\text{NO}_x$ , CO and HC.

For inlet air temperature effect, increasing inlet air temperature causes the brake specific fuel consumption decrease. Other than that, other performance parameters show a positive result when increasing the inlet air temperature. In term of emission,  $\text{NO}_x$  increase while increasing temperature. Nonetheless HC and CO produce a good emission trend result.

## REFERENCES

- [1] Yao M, Zheng Z, Liu H. Progress and recent trends in homogeneous charge compression ignition (HCCI) engines. *Progress in Energy and Combustion Science*. 2009;35:398-437.
- [2] Reitz RD. Directions in internal combustion engine research. *Combustion and Flame*. 2013;160:1-8.
- [3] Saxena S, Shah N, Bedoya I, Phadke A. Understanding optimal engine operating strategies for gasoline-fueled HCCI engines using crank-angle resolved exergy analysis. *Applied Energy*. 2014;114:155-63.
- [4] Saxena S, Vuilleumier D, Kozarac D, KriECK M, Dibble R, Aceves S. Optimal operating conditions for wet ethanol in a HCCI engine using exhaust gas heat recovery. *Applied energy*. 2014;116:269-77.
- [5] Yamasaki Y, Kanno M, Taura Y, Kaneko S. Study on biomass gas HCCI engine. *SAE Technical Paper*; 2009.
- [6] Haggith DE, Sobiesiak A, Miller LW, Przybyla G. Experimental indicated performance of a HCCI engine fuelled by simulated biomass gas. *SAE Technical Paper*; 2010.
- [7] Maurya RK, Agarwal AK. Experimental study of combustion and emission characteristics of ethanol fuelled port injected homogeneous charge compression ignition (HCCI) combustion engine. *Applied Energy*. 2011;88:1169-80.
- [8] Nathan SS, Mallikarjuna J, Ramesh A. An experimental study of the biogas–diesel HCCI mode of engine operation. *Energy Conversion and Management*. 2010;51:1347-53.
- [9] Saisirirat P, Foucher F, Chanchaona S, Mounaïm-Rousselle C. Spectroscopic measurements of low-temperature heat release for homogeneous combustion compression ignition (HCCI) n-heptane/alcohol mixture combustion. *Energy & Fuels*. 2010;24:5404-9.
- [10] Saisirirat P, Togbé C, Chanchaona S, Foucher F, Mounaim-Rousselle C, Dagaut P. Auto-ignition and combustion characteristics in HCCI and JSR using 1-butanol/n-heptane and ethanol/n-heptane blends. *Proceedings of the Combustion Institute*. 2011;33:3007-14.
- [11] Hairuddin AA, Yusaf T, Wandel AP. A review of hydrogen and natural gas addition in diesel HCCI engines. *Renewable and Sustainable Energy Reviews*. 2014;32:739-61.
- [12] Bendu H, Murugan S. Homogeneous charge compression ignition (HCCI) combustion: Mixture preparation and control strategies in diesel engines. *Renewable and Sustainable Energy Reviews*. 2014;38:732-46.
- [13] Mohanamurugan S, Sendilvelan S. Emission and combustion characteristics of different fuel In A HCCI engine. *International Journal of Automotive and Mechanical Engineering*. 2011;3:279-92.
- [14] Zheng Z, Liu C, Zhang X. Numerical study of effects of reformed exhaust gas recirculation (REGR) on dimethyl ether HCCI combustion. *International Journal of Hydrogen Energy*. 2014;39:8106-17.
- [15] Godiño JAV, García MT, Aguilar FJJ-E, Trujillo EC. Numerical study of HCCI combustion fueled with diesel oil using a multizone model approach. *Energy Conversion and Management*. 2015;89:885-95.
- [16] Neshat E, Saray RK. Effect of different heat transfer models on HCCI engine simulation. *Energy Conversion and Management*. 2014;88:1-14.
- [17] Coskun G, Soyhan HS, Demir U, Turkcan A, Ozsezen AN, Canakci M. Influences of second injection variations on combustion and emissions of an HCCI-DI engine: Experiments and CFD modelling. *Fuel*. 2014;136:287-94.
- [18] Mehl M, Pitz W, Sjöberg M, Dec JE. Detailed kinetic modeling of low-temperature heat release for PRF fuels in an HCCI engine. *SAE Technical Paper*; 2009.

- [19] Mehl M, Pitz WJ, Westbrook CK, Curran HJ. Kinetic modeling of gasoline surrogate components and mixtures under engine conditions. *Proceedings of the Combustion Institute*. 2011;33:193-200.
- [20] Visakhamoorthy S, Tzanetakis T, Haggith D, Sobiesiak A, Wen JZ. Numerical study of a homogeneous charge compression ignition (HCCI) engine fueled with biogas. *Applied Energy*. 2012;92:437-46.
- [21] He K, Androulakis IP, Ierapetritou MG. Numerical investigation of homogeneous charge compression ignition (HCCI) combustion with detailed chemical kinetics using on-the-fly reduction. *Energy & Fuels*. 2011;25:3369-76.
- [22] Uyumaz A. An experimental investigation into combustion and performance characteristics of an HCCI gasoline engine fueled with n-heptane, isopropanol and n-butanol fuel blends at different inlet air temperatures. *Energy Conversion and Management*. 2015;98:199-207.
- [23] Heywood JB. *Internal combustion engine fundamentals*: Mcgraw-hill New York; 1988.
- [24] Bogin Jr G, Chen J-Y, Dibble RW. The effects of intake pressure, fuel concentration, and bias voltage on the detection of ions in a Homogeneous Charge Compression Ignition (HCCI) engine. *Proceedings of the Combustion Institute*. 2009;32:2877-84.
- [25] Guo H, Neill WS. The effect of hydrogen addition on combustion and emission characteristics of an n-heptane fuelled HCCI engine. *International Journal of Hydrogen Energy*. 2013;38:11429-37.