



# ECG and EEG Monitoring using Power Line Communication

Sridhathan C and Fahmi Samsuri

Faculty of Electrical and Electronics Engineering,

University Malaysia Pahang, Pekan Campus, Pahang Darul Makmur, Pekan 26600, Malaysia

Corresponding Email: [csridhathan@yahoo.co.in](mailto:csridhathan@yahoo.co.in), [fahmi@ump.edu.my](mailto:fahmi@ump.edu.my)

**Abstract**— Information and Communication technology (ICT) takes the main role in the economic growth of a country and has many applications such as mobile network, healthcare, navigation system, internet, weather forecasting and home automation. Healthcare devices manufacture incorporate ICT components in their product for remote monitoring and delivering health associated services. Due to this additional telemetry features, cost of the devices are more and all hospital or clinic cannot afford to buy them. Hence in our work, Electrocardiogram (ECG) and Electroencephalogram (EEG) monitoring equipment based on power line communication is developed. This is cost effective and economical equipment which uses existing power cables as communication medium. ECG and EEG signals are measured and digitized for transmission. Power Line Modem (PLM) is used for transmitting and receiving the signals over power line cable. Signals are modulated and demodulated using direct-sequence spread spectrum (DSSS) technology. ECG and EEG signals are affected by power line disturbances at the receiver end. ECG's recurring fixed wave pattern was helpful in studying the noise effect. Noise effect on EEG cannot be determined easily since it does not have fixed wave structures and varies randomly. Finite Impulse Response (FIR) filter with Kaiser Window is designed using MATLAB for filtering noise from ECG signal. When compared with other communication technologies like local area network (LAN), ZigBee, Bluetooth, the establishment cost for healthcare monitor using Power Line Communication (PLC) was less. ECG and EEG signals are successfully transmitted and received using power cables with certain limitations. FIR filter was very effective in ECG noise filtering. It can be concluded that, in future communication using power line cables will slowly replace current technologies and will be used in many health monitoring applications as well.

**Index Terms**— healthcare, PLM, PLC, ECG, EEG, FIR, Kaiser Window

## I. INTRODUCTION

In hospitals, medical equipment like ECG machine, ventilators, infusion pumps, heart beat and blood pressure monitors are placed near the patients who need medical assistance. Medical Intensive Care Unit (MICU) in some hospitals has automated patient monitoring system for their patient. In some cases these automated units are interconnected by networking for central monitoring and medical data storage. Recent year's communication technologies are applied in healthcare for performing surgery and delivering assistance to the patients in the form of tele-surgery, telemedicine, biotelemetry using LAN, Radio Frequency (RF), ZigBee, WAN etc [1, 2, 3]. Table 1 shows a comparative study of PLC with other methods.

Rural and urban sectors are targeted by the medical industries for assisting and delivering medical care. An

DOI: 01.IJCOM.5.1.1527

© Association of Computer Electronics and Electrical Engineers, 2014

TABLE I. COMPARISON OF PLC WITH EXISTING TECHNIQUES

Characteristic of the systems	PLC	Current Limited Medical Monitoring	
		Wired	Wireless
Communication channel	Uses existing power lines	Extra Ethernet / Optical cable	Wireless channel
Carrier Frequency	115Khz	Vary based on its application	
Line of sight issues	No	No	Yes
The Effect of Distance	Yes	No	Yes
Power Consumption	Less	Moderate	High
Current Distance Data Monitoring	1 - 1000m	1m - 10KM	1m- 1Km
Extra power supply	No	Yes	
Reliable and Secure connection	Yes	Yes	
Maximum data packet size (1 Byte = 8 Bits)	256 byte	Vary based on its application	
Bandwidth (baud rate) (rate of data transferred) bits per second	300Kbs	Ethernet: 1 - 100Mbps Optical:Based on distance	Zigbee: 20 - 900 Kbps Bluetooth: 1- 3 Mbps
Speed of signal In the range of 100m	1 - 10 Mbps	Ethernet: 0 - 100 Mbps	Zigbee: 20 - 250Kbps Bluetooth: 2 Mbps

urban sector gets more benefit, since they have the best infrastructure and technology. For establishing these technologies in rural sector requires more investment with slow return rate. Due to large distance, poor transportation and other reasons, the medical facilities are not provided to full extent in rural sector. Power grids are connecting both rural and urban sectors in a larger extent for supplying electricity. Power line communications (PLC) are applied in home automation and networking, Automatic Meter Reading (ARM), street and stage lighting control, voice and data transmissions, high-speed internet service etc.

In smart home system, PLC with other technologies is used for effectively monitoring and controlling electrical appliances. Electrical appliances in home like television, air-conditions, washing machines, refrigerators can be switched ON and OFF as per the requirement of the owner from a remote place. By using, power line based internet service the information from the external world can be obtained at any electrical outlet, thus improving the life style.

In this paper, pre-established power lines are used for telemedicine application so that ECG and EEG signal are monitored. Transmission cum reception of the measured ECG and EEG signals are done by using low voltage power lines. Patient monitoring unit with transmitter is placed near the patient in ICU. A personal computer is interfaced with the receiver unit at the physician's room for displaying the medical information. Based on the received ECG and EEG signal the power line interference and disturbances are analyzed. Characteristics of the power line changes randomly due to attenuation, resonance and loads.

Reliable and accurate analysis of ECG can be done if artefacts and noise are less or filtered. Noise reduction procedures for ECG have been represented in many researchers work. ECG signal filtration is done by a combination of FIR and Kaiser Techniques. This filter has attractive characteristics both in time and frequency domain. Kaiser window have the efficiency and ability in noise removal than other windowing techniques. Designed FIR filter removes baseline wander noise and power line inference of 0.5 and 50Hz. Filtration of ECG is performed prior to analysis for minimizing the false detection rate. In the results, it can be seen that the designed filter removes noise effectively.

PLC is a cost reducing and economical way for communication inside a building with certain constrains like speed, accuracy. Problem in other technologies like establishment cost, power consumption, visible range are less in PLC. Section 1 gives a brief introduction about PLC and comparison with other technologies. Biological parameters and power line technology are described in section 2 and 3. Section 4 outlines System and Hardware Description and section 5 describes about the FIR – Kaiser Window. Result and discussion are in section 6 followed by conclusion.

## II. BIOLOGICAL PARAMETERS

Endogenous and Exogenous signals are used for studying the structure and function of an organ in human being. Signal arising due to natural phenomenon inside the organ like electroencephalogram, electrocardiograms are called as endogenous. Exogenous signal uses artificial sources for studying the internal organs.

### A. Electrocardiogram

Cardiovascular system circulates blood to the entire body with the help of heart and blood vessels like veins and arteries. Heart consists of four chambers, termed as right atrium, left atrium, right ventricle and left ventricle. Sinoatrial (SA) node located at the top of right atrium is termed as the natural pacemaker, since it generates the electrical impulses. Electrical impulses starting from SA node pass through atria wall, atrioventricular node, bundle of his and Purkinje fibers. Contraction of atrium and ventricles are caused by these electrical impulses, thus producing ECG wave. Atria contraction produces 'P' wave and ventricle contraction produces 'QRS' complex. During the ventricular relaxation 'T' wave is obtained. Normal rhythm of heart with the direction of electrical impulses is shown in Figure 1. In Table 2, normal ECG signal with its voltage and time period is given. Due to ageing, smoking, alcohol consumption and work stress number of cardiac related patients and death are increasing. Based on ECG wave, the heart rhythm, heart beat rate and heart disorders like arrhythmia, tachycardia, bradycardia can be detected [4, 5].

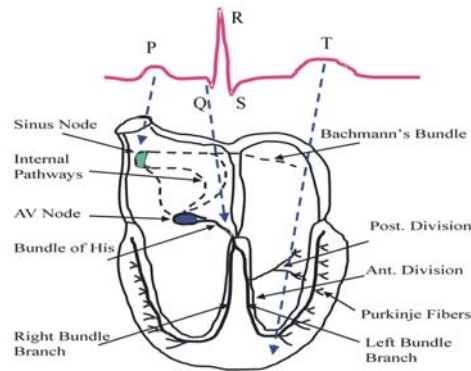

Figure 1. Normal ECG of heart with the direction of electrical impulses [18]

TABLE II. NORMAL ECG WAVE WITH VOLTAGE AND TIME PERIOD



Amplitude		Duration	
Wave	Signal Voltage (mV)	Wave	Time (sec)
P – Depolarization of atria	0.25	P-R Delay of AV node to allow filling of Ventricles	0.12 – 0.20
R – Contraction of ventricles	1.60	Q-S Depolarization of ventricles	0.35 – 0.44
Q – Depolarization of ventricles	0.4	S-T Beginning of ventricle repolarization	0.05 – 0.15
T – Ventricular repolarization	0.1 - 0.5	P- Depolarization of atria	0.11

### B. Electroencephalogram

Brain performs complicated activities like thinking, faces recognition, place recognition, smell, taste, emotion, body balancing, hearing, responding to reflex and hormone secretion by integrating, controlling and performing many signals. It is very difficult and interesting to study the functional behaviour of brain [6, 7]. Electroencephalography is the term used for the electrical signal generated by brain. Needle or scalp electrodes are placed on the patient scalp at different point and EEG is recorded. By analysing EEG wave certain health problems like epilepsy, sleeping disorder, Parkinson's disease, shaking palsy and many more can be detected. In Table 3 below, the EEG waveforms that are generated based on the subject condition with frequency and voltage is given.

Brain is separated into two hemispheres and four lobes coined as frontal, temporal, parietal and occipital. Each lobe is responsible for certain process and functions. Speech, emotional reactions and body movements are controlled by frontal lobe. Recognition of individual face and places are associated with parietal lobe.

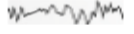
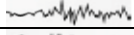
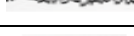
TABLE III. NORMAL EEG SPECTRUM WITH FREQUENCY BAND AND VOLTAGE

Wave		Frequency (Hz)	Voltage ( $\mu$ V)	Subject Condition
Generated	Pattern			
Delta		0.5 – 4	10 mV	Profound Sleep
Theta		4 – 8	Kids – 50, Adult – 10	Light Sleep, Emotional Stress
Alpha		8 – 13	Kids – 75, Adult – 50	Relax, Closed Eye
Beta		13 – 30	10 – 20	Activity, Thinking

Vision and processing of visual information is done in occipital lobe. Talking, hearing and understating others speech is done by temporal lobe. Regions of brain with their function are shown in Figure 2.

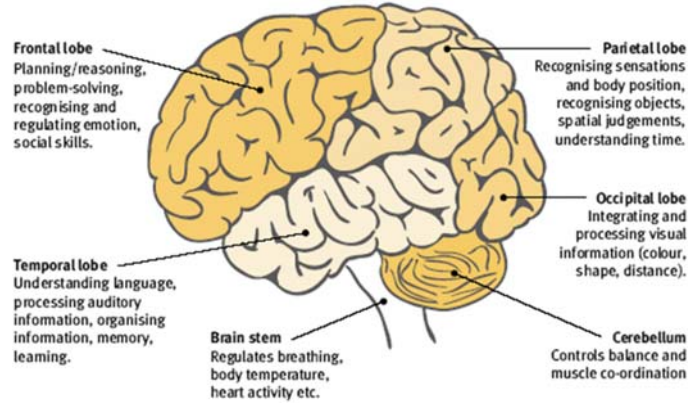

Figure 2. Brain lobes and their functions [19]

### III. POWER LINE COMMUNICATION TECHNOLOGY

Twisted pair or coaxial cables where used in olden days for networking, telephone and home automation. In 1920, power line communication was introduced to detect the faults in power distribution grids and to reduce the power loss. Recently, PLC had a drastic development and made it easy to transmit and receive the information using the power cables in a cost effective way. The power outlets are available in each and every room in all houses for delivering electricity. Hence it proves to be an easy way of communication with drawbacks like noise interference, attenuation due to loads, multipath fading and open circuit [8, 9].

Power plant will be generating power in the term of megawatts and transmit them using the high tension power cable to substations. In substations, they are reduced to few kilowatts for industries. For housing and commercial building they are still reduced and transmitted using low voltage power distribution grids. Power distribution grids with different voltages with communication path for detecting faults are shown in Figure 3. Power line channel is used for high frequency signal communications to reduce the effect of channel impulse, multipath fading, interference of various noises like narrow band noise, Gaussian noise, periodic and non-periodic impulsive noise, background noise as shown in Figure 4 [10, 11, 12 ].

### IV. SYSTEM AND HARDWARE DESCRIPTION

The block diagram of ECG and EEG signal monitoring system using power line communication techniques is shown in Figure 5. Power line modems are used as a platform for communication between the two points. Myocardial activity of the heart can be obtained from ECG signal. Neural activity of the brain is recorded in the form of EEG. Measured ECG and EEG are coded into phase shift keying (PSK) bytes for transmitting over the existing power line cables using Direct Sequence Spread Spectrum techniques (DSSS). Receiver unit coupled with the power line socket decodes the biosignals which are delivered to a personal computer using universal serial bus (USB) port. Visual Basic (VB) software is used for visualization of the biosignals. Position of the electrodes for obtaining ECG and EEG signal is shown in Figure 6. Einthoven's triangle is formed by placing electrode at right arm (RA), left arm (LA) and left leg (LL) for recording ECG. The electrodes placed on the RA and LA is used to measure the potential difference between two points. The

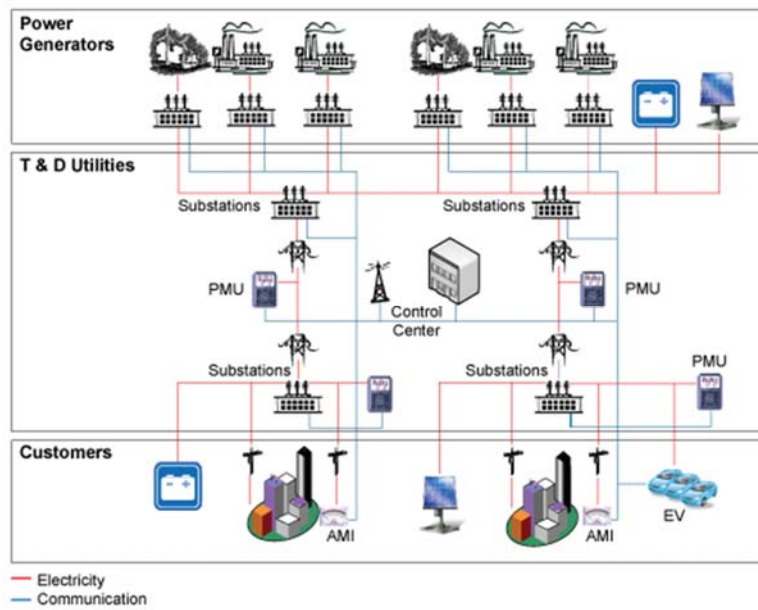

Figure 3. Power Grid and Distribution System [20]

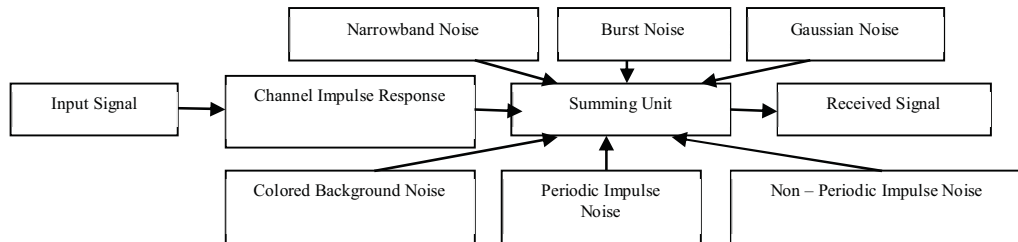

Figure 4. Model of Power Line Channel with channel impulse and additive noises

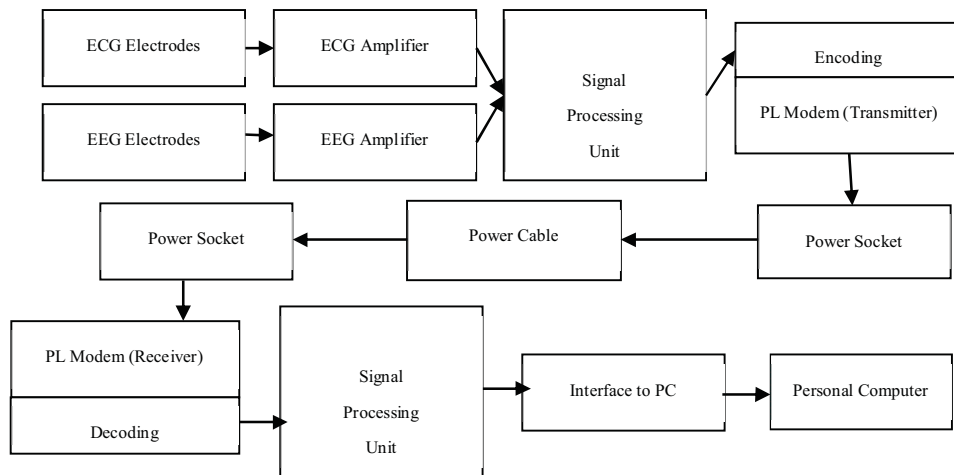

Figure 5. Block diagram of the power line based ECG and EEG monitoring system

electrode placed on LL is a reference electrode or point. EEG is measured by placing the electrodes at prefrontal cortex points FP1 and FP2 with left ear as reference point.

Biosignals are acquired using INA122 instrumentation amplifier as shown in the Figure 7a. It has two operational amplifiers (op-amp) for providing excellent performance during data acquisition. INA122 operates in the voltage range from 2.2V to 36V with quiescent current of 60 $\mu$ A. Electrodes cables from the

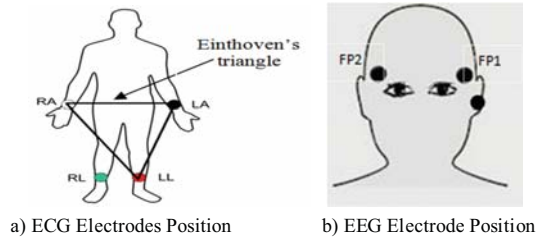

Figure 6. Position of the Electrodes for measuring ECG and EEG signals

RA, LA and LL are connected to the 2, 3 and 4 pin of the amplifier to acquire ECG wave. 2, 3 and 4 pins of the other amplifier are connected to the Fp1, Fp2 and earlobe for obtaining EEG wave. According to data sheet, gain of the amplifier can be varied by changing the value of resistor R1. Gain equation of the amplifier is given below

$$\text{Gain} = 5 + 200 \text{ k}\Omega / R_1 \quad (1)$$

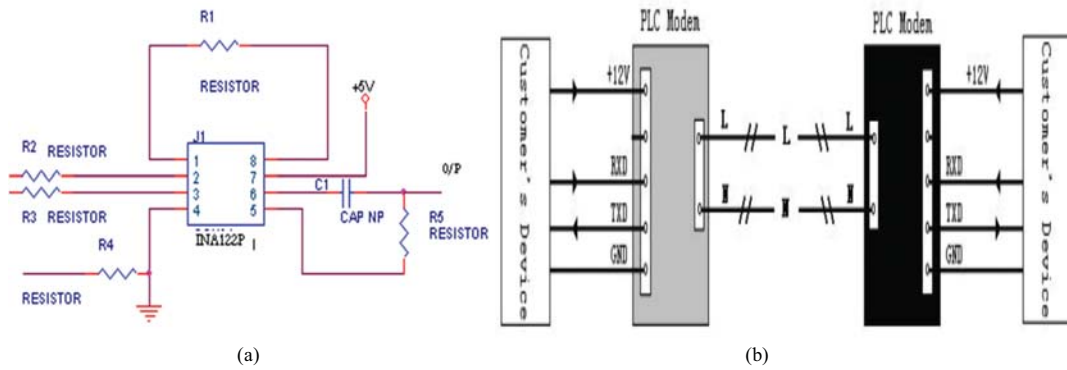

Figure 7. a) Biosignals acquisition circuit using INA122 b) PLM pin connection for device and data communication

Measured ECG and EEG signal are digitalized using the analog to digital convertor ADC0809. These digitized values are fed to the microcontroller using the port 0. Two way communication using PLC is achieved by using modulating carrier signal over the existing power cables. PLC can be categorised into narrowband and broadband. Narrowband is used sensing and communication, whereas broadband is used for internet and home automation [13]. Power line modems (PLM) are used for encoding and decoding the data streams using direct sequence spread spectrum technique (DSSS) with baud rate of 300bps. Pin connection of the PLM with the customer device and communication method is shown in Figure 7b.

PLM transmits the digitized data through the live and neutral cables of a building. Based on the modulation techniques the carrier frequency will be in the range of 50 – 500 kHz. PLM can use any modulation techniques like ASK (amplitude shift keying), FSK (frequency shift keying), PSK (phase shift keying), BPSK (binary phase shift keying) and DSSS (direct-sequence spread spectrum). To reduce the power and narrow band interferences, narrow band data spectrum are converted into broad band data spectrum over the specified bandwidth using spread spectrum technique (SST). For shorter distance, high baud rate like millions bits per sec and for longer distance, baud rate of few hundred bits per sec are used to provide noise immunity. The power line modem used for this work is based on SST with a baud rate of 300 bits per sec at a carrier frequency of 115 kHz. SST signals are decoded at the receiver end and transferred to the personal computer for display. The Block model of prototype used for ECG and EEG signal measuring and transmission is shown in Figure 8. Block diagram of the power line communication Modem is shown in Figure 9.

## V. FIR FILTER AND KAISER WINDOW

Filtering noises from the signal before analysis is an important step in digital signal processing. Digital filters are classified into finite impulse response (FIR) and infinite impulse response (IIR) filters. FIR filter can be easily designed and has good stability hence becomes the primary choice [14, 15]. Noise reduction in ECG is performed by using FIR filters and its effect on a signal can be studied in both time and frequency domains. Frequency based noise removal and analysis is very effective when compared with time domain analysis.



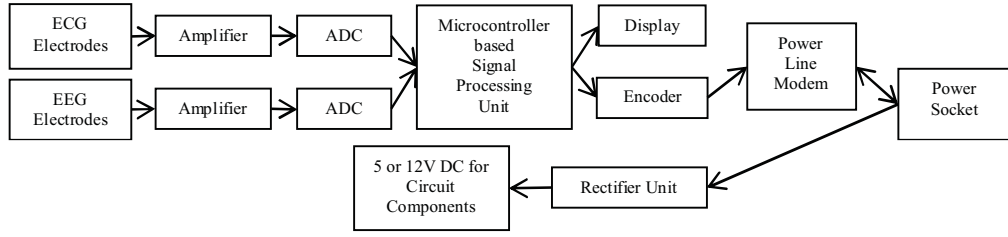

Figure 8. Block representation of Prototype used for measuring ECG and EEG signal

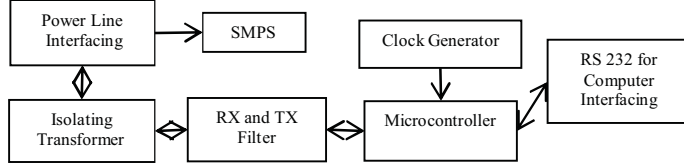

Figure 9. Block representation of Power Line Modem

Hence, frequency domain analysis is preferred and performed on biosignals [16, 17]. Frequency domain filters are designed for noise reduction since particular or range of frequency can be removed. Filters are classified into Notch, band pass and band reject based on their functional characteristics.

#### A. Notch Filter (NF)

Electrical appliances generate 50/60 Hz noise which is termed as power line noise [16, 17]. This noise can be filtered using the notch filter whose basic frequency response and transfer function is given by,

$$H_{\text{notch}}(Z) = \frac{b_0(z - e^{j\theta_0})(z - e^{-j\theta_0})}{(z - re^{j\theta_0})(z - re^{-j\theta_0})} \quad (2)$$

where,

$$r \approx 1 - \frac{\Delta F \pi}{f_s}, b_0 = \frac{|1 - 2r \cos(\theta_0) + r^2|}{2|1 - \cos(\theta_0)|} \quad (3)$$

$b_0$  = filter coefficient;  $z$  = unit delay operator;  $r$  = pole radius;  $\theta_0 = 2\pi F_0 T$ ;  $F_0$  = Notch frequency;  $f_s$  = sampling frequency;  $\Delta F$  = Notch Band

#### B. High Pass Filter (HPF)

Noise in the low frequency range can be removed by implementing a high pass filter. In ECG, signal below 0.5Hz noise are removed as artefacts. Transfer function of an ideal high pass filter is given below,

$$H_{\text{HP}}(\omega) = \begin{cases} 0 & |\omega| < \omega_c \\ 1 & |\omega| > \omega_c \end{cases} \quad (4)$$

where  $\omega_c = 2\pi f_c$  is the filter cut-off frequency

#### C. Low Pass Filter (LPF)

High frequency components that are present in the ECG signals are removed using low pass filter. Ideal low pass filters transfer function is given in equation 7.

$$H_{\text{LP}}(\omega) = \begin{cases} 1 & |\omega| < \omega_c \\ 0 & |\omega| > \omega_c \end{cases} \quad (5)$$

where  $\omega_c = 2\pi f_c$  is the filter cut-off frequency

#### D. Kaiser Window (KW)

The frequency components that are outside the region of concern can be removed by using Kaiser Window. Desirable characteristics can be obtained using Kaiser Window in time and frequency domain. General characteristics function of a Kaiser window is depicted in Figure 10. Kaiser techniques have both time and band limited function [17].

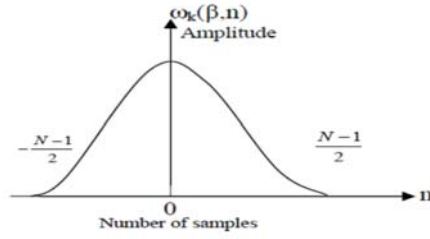

Figure 10. Kaiser Window function

The Kaiser Window function is given by,

$$\omega_k(n) = \begin{cases} \frac{I_0\left[\pi\alpha\sqrt{1-\left(\frac{2n}{N-1}\right)^2}\right]}{I_0(\pi\alpha)} & \text{for } |n| \leq \frac{N-1}{2} \\ 0 & \text{otherwise} \end{cases} \quad (6)$$

$$\omega_k(\beta, n) = \begin{cases} \frac{I_0\left[\beta\left\{1-\left(\frac{2n}{N-1}\right)^2\right\}^{\frac{1}{2}}\right]}{I_0(\beta)} & \text{for } |n| \leq \frac{N-1}{2} \\ 0 & \text{otherwise} \end{cases} \quad (7)$$

where,  $\alpha$  is the adjustable parameter and  $I_0(z)$  is the modified Bessel functions. In some case the factor  $\beta$  is also included in the equation 6 and is modified as given in equation 7.

## VI. RESULT AND DISCUSSION

Acquired ECG and EEG signals are modulated and transmitted with the help of power line modem over the power line cables. Receiver demodulates the signals and ECG, EEG are reconstructed using visual basic (VB) software. In the reconstructed ECG and EEG signal the effect of the power line noises can be seen clearly. The ECG signal recorded at the transmission side is shown in Figure 11a. ECG and EEG signal received using the power line modem and reconstructed using VB is shown in Figure 11b. The closer image of the received ECG is shown in the Figure 11c. When figures 11a and 11c are compared, it can be noticed that noise level was less in the recorded ECG (figure 11a) whereas the ECG signal received after the power line communication was affected more by the power line noises (figure 11c).

Due to load, multipath and resonance effect, characteristic of power line changes often and generates power line noises which overrides the signals and affect them. Here, P-wave and T-wave are highly affected by noises when compared to QRS complex. This is because smaller amplitude components of ECG are affected and interfered by noise more compared to higher amplitude components. Hence encoded signals get altered. ECG has a recurring wave pattern unlike EEG signals which changes randomly according to the patient condition. Hence, EEG cannot be used for studying the effect of noise clearly. The modem was able to transmit the signals up to a distance of 100 – 1000m with a data transfer rate of 300kbps on a single phase power carrier.

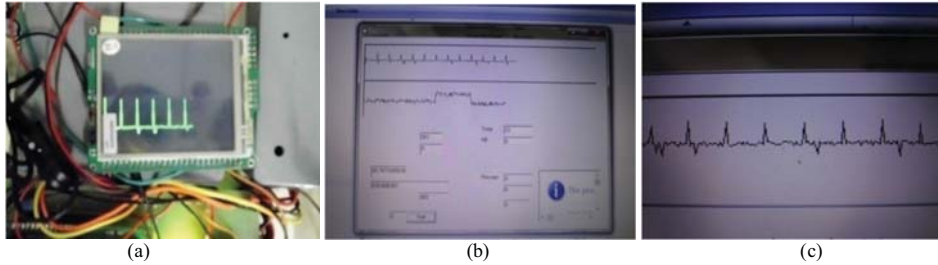

Figure 11. (a) ECG signal obtained at transmission side of the prototype (b) ECG and EEG signal received using PLC (c) Clear view of the received ECG signal



Removing the noises from the ECG is the crucial step, which has to be performed before analysis. FIR filter with Kaiser Window was developed using Matlab environment for removing noise from the signal. The Notch filter was used to remove the 50/60 Hz power line disturbance. Cut off frequency of 0.5 Hz and 100 Hz is used for pass band and stop band filters. These filter combination was used for removing the noise such as power line hum, baseline wander frequency, motion artifacts and electromagnetic interference. In Figures 12 and 13, ECG signals before and after filtration is shown with the removed noise. In upper half is the green coloured ECG signal before filtering and blue colour one is after filtering. The filter reduces the noise to a considerable level.

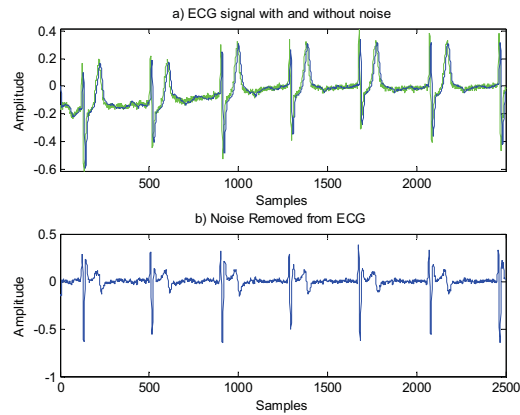

Figure 12. a) ECG signal before and after filtration b) Removed noise

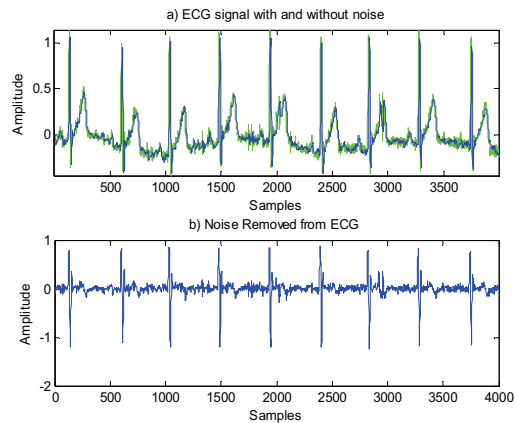

Figure 13. a) ECG signal before and after filtration b) Removed noise

## VII. CONCLUSIONS

Communication using the power line channels provides a larger opportunity for the chronic patients, whose health can be monitored easily in an economical and efficient manner. ECG and EEG signals acquired using the instrumentation amplifiers are transmitted and received over the power cables using power line modems. ECG and EEG signal where affect more by the power line noises during the transmission. Hence noise removal has to be done by using FIR based Kaiser Window. The filter designed was capable of removing 50Hz power line noise and frequencies lesser than 0.5Hz and above 100Hz. The fabricating cost for this prototype was 50 percent less when compared to the existing techniques like Bluetooth, LAN etc. It does not require any new medium for communication. In future, the drawbacks of this current prototype will be reduced and more biosignals will be transmitted for a larger distance with less error rate and more accuracy. FIR filter designed will be modified further so that its efficiency in noise reduction will be more.

## REFERENCES

- [1] Paul Frehill, Desmond Chambers and Cosmin Rotariu, "A Wireless Network Sensor and Server Architecture for Legacy Medical Devices", IEEE International Conference on Telecommunications, St. Petersburg, 16-19 June 2008, 2008 pp1-4.
- [2] Paul Frehill, Desmond Chambers and Cosmin Rotariu, "Using Zigbee to Integrate Medical Devices", Proceedings of the 29th Annual International Conference of the IEEE EMBS, Lyon, France, 23-26 August 2007, pp. 6717-6720
- [3] R. Sukanesh, S. Palanivel Rajan, S. Vijayprasath, S. Janardhana Prabhu and P. Subathra, "GSM-based ECG Tele-aler t System", International Journal of Computer Science and Application, ISSN 0974-0767 Issue 2010, pp.112-116.
- [4] Paul S Addison, "Wavelet transforms and the ECG: a review" Physiological Measurement, Institute of Physics Publishing, 26 (2005), pp. R155–R199
- [5] Cai Ken and Liang Xiaoying, "A Zigbee Based Mesh Network for ECG Monitoring System", in Proc. iCBB, Chengdu, 18-20 June 2010, pp. 1-4.
- [6] Pari Jahankhani, Vassilis Kodogiannis and Kenneth Revett, "EEG Signal Classification Using Wavelet Feature Extraction and Neural Networks" International Symposium on Modern Computing, 2006. JVA '06. IEEE John Vincent Atanasoff 2006, Sofia, 3-6 Oct. 2006, pp120-124.
- [7] R. Dilmaghani, M. Ghavami, K. Cumar, A Dualeh, S. Gomes Da Sousa, R. Salleh Mohd, M. Sekanderzada and H. Koke, "Design and Implementation of a Wireless Multi Channel EEG Recording", 7th International Symposium on Communication Systems Networks and Digital Signal Processing (CSNDSP), Newcastle upon Tyne, 21-23 July 2010, pp741-746
- [8] Muhammad Salman Yousuf and Mustafa El-Shafei, "Power Line Communications: An Overview - Part I", 4th International Conference on Innovations in Information Technology, 2007, Dubai. 18-20 Nov. 2007, pp.218 – 222
- [9] V.C. Gungor and F.C. Lambert, "A survey on communication networks for electric system automation", Computer Networks 50, 2006, pp.877–897.
- [10] J. Michael Silva and Bruce Whitney, "Evaluation of the Potential for Power Line Carrier (PLC) to Interfere with Use of the Nationwide Differential GPS Network", IEEE Transactions on Power Delivery, VOL. 17, NO. 2, April 2002, pp.348-352.
- [11] Manfred Zimmermann and Klaus Dostert, "Analysis and Modeling of Impulsive Noise in Broad-Band Powerline Communications", IEEE Transactions on Electromagnetic Compatibility, vol. 44, no. 1, February 2002, pp. 249 – 258.
- [12] X. Jiang, J. Nguimbis, S. Cheng, H. He, X. Wu, "A novel scheme for low voltage power line communication signal processing" Electrical Power and Energy Systems 25 (2003), pp.269–274.
- [13] Ahmad Usman, Sajjad Haider Shami, "Evolution of communication technologies for smart grid applications", Renewable and Sustainable Energy Reviews, Elsevier, Vol 19(2013), pp. 191-199.
- [14] D.C. Dhubkarya, Aastha Katara and Raj Kumar Thenua, "Simulation of Adaptive Noise Canceller for an ECG signal Analysis", ACEEE International Journal on Signal & Image Processing, Vol. 03, No. 01, Jan 2012, pp.1 – 4.
- [15] Rajib Kar, Durbadal Mandal, Dibbendu Roy, Sakti Prasad Ghoshal, "FIR Filter Design using Particle Swarm Optimization with Constriction Factor and Inertia Weight Approach", ACEEE International Journal on Electrical and Power Engineering, Vol. 02, No. 02, August 2011, pp 1-5.
- [16] Ju-Won Lee and Gun-Ki Lee, "Design of an Adaptive Filter with a Dynamic Structure for ECG Signal Processing", International Journal of Control, Automation, and Systems, vol. 3, no. 1, pp. 137-142, 2005.
- [17] Mbachu C.B, Onoh G. N, Idigo V.E, Ifeagwu E.N, Nnebe S.U "Processing ECG signal with Kaiser Window- based FIR digital filters", International Journal of Engineering Science and Technology, Vol. 3 No. 2011 Page 6775 -83. ISSN : 0975-5462
- [18] "ECG waves and leads" by Meditech Groups, 2012, Web. accessed on 27 February 2014 <<http://www.meditech.cn/meditech-edu/ecg-2.asp>>.
- [19] "Effective workplace communication with employees with acquired brain injury", Commonwealth of Australia, 20 January 2009, Web. accessed on 27 February 2014. <[http://resources.fahcsia.gov.au/ConsumerTrainingSupportProducts/employers/acquired\\_brain\\_injury/sec3.htm](http://resources.fahcsia.gov.au/ConsumerTrainingSupportProducts/employers/acquired_brain_injury/sec3.htm)>
- [20] Ron Wilson, "A Network for the Smart Grid", Altera Corporation, Web accessed on 27 February 2014 <<http://www.altera.com/technology/system-design/articles/2013/network-smart-grid.html>>.