

# EFFECT OF SONICATION FOR IN-SITU STAINLESS STEEL LEAF FILTRATION

Ahmad Ziad Sulaiman<sup>1</sup>, Rosli M.Y<sup>2</sup>, Badhrulhisham A.A<sup>1</sup>, M.Y. Abu Azam<sup>1</sup>

<sup>1</sup>*Department of Chemical Engineering, Faculty of Chemical & Natural Resources Engineering  
University College of Engineering & Technology Malaysia (KUKTEM),  
Locked Bag 12, 25000 Kuantan, Pahang MALAYSIA*

Email: [ziad@kuktem.edu.my](mailto:ziad@kuktem.edu.my), [badhrul@kuktem.edu.my](mailto:badhrul@kuktem.edu.my), [abuazam@kuktem.edu.my](mailto:abuazam@kuktem.edu.my)

Tel : +609-5492384, Fax : +609-5492399

<sup>2</sup>*Department of Chemical Engineering, Faculty of Chemical & Natural Resources Engineering  
Universiti Teknologi Malaysia, 81310 Skudai, Johor, MALAYSIA*

Email: [rosli@fkkksa.utm.my](mailto:rosli@fkkksa.utm.my)

Tel : +607-5505386, Fax : +607-5581463

**ABSTRACT** – The application of ultrasound wave fields in the filtration and separation technology has been identified as a new and clean technology and as alternatively to the classical cleaning processes. Fouling phenomena is a major bottleneck in this separation technology, as expected in the industrial application of such finely porous media. As the filtration process continues, the concentration of solute keeps building up on the filter surface to form a filter cake. This results in a continuous declining of the flux. A number of methods are reported in preventing the fouling phenomena. In this study, the effect of intermittent application of ultrasound wave fields (sonication) on the filtration of Refined Bleached Deodorized (RBD) oil suspension will be presented. The application of ultrasound field is projected to enhance the filtration rate by reducing the thickness of the filter cake formed on the surface of the filtering medium. The main mechanism which is expected to dominate in reducing the thickness of the filter cake is the cavitation phenomenon. In carrying out the study, parameters affecting the performance of the sonicated filtration will be investigated. Among the parameters of concern is the sonication cycle time. An average flux is measured in each experiment as an indication of effectiveness of this method in reducing the filter fouling. In all cases, the application of ultrasound for filtration and separation processes has been successful by reducing the flux declining at different variables.

Keywords: High Intensity Ultrasonic, RBD Oil, Filtration, Pressure Leaf Filter

## 1.0 INTRODUCTION

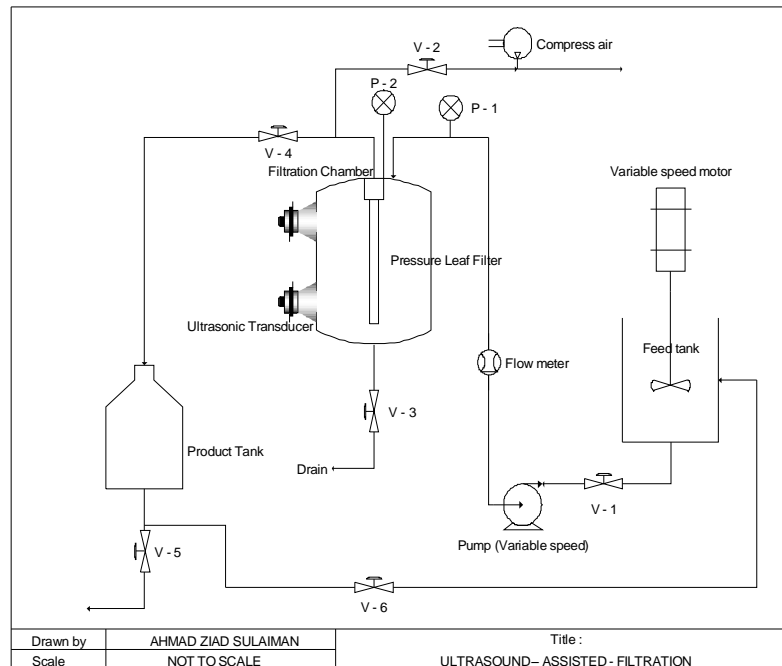
Filtration in the edible/vegetable oil industry is an important unit operation for the separation of bleaching earth from the treated oil. Pressure Leaf Filters are most commonly used for this purpose. During operation, the rate of filtration decreases progressively as a result of filter cake build-up on the surface of the filter medium. The process comes to an end when the whole chamber is filled with solids, normally about 2 ½ hours (for standard size filter) after separating 500 kg of solids from the treated oil. The system requires a regeneration process, which normally takes about 1½ hours. The sequence of filtration and regeneration process is repeated for approximately two to three weeks. Presently, there has not been much work focusing on developing methods to improve the filtration process. Improvement in the rate of filtration, for instance, will reduce the operation time, and hence, increase the productivity. The present method of knocking or vibrating the filter leaf is only applicable after the filtration process is completed, i.e. during the regeneration of the filter medium. Vibrating or knocking the filter leaf during the filtration is not adopted because it may disrupt the whole formation of the filter cake. This is not acceptable since in filtration processes, filter cake is the true medium performing the solid-liquid separation. Realizing the capability of high intensity ultrasound in cleaning processes, the technique was innovated in this invention to increase the rate of filtration of leaf filter. High intensity ultrasound in the solid-liquid suspension would cause the occurrence of cavitation microbubbles in the liquid medium. Thus, intermittent application of ultrasound wave fields within the filtering chamber will increase the rate of filtration by disrupting the concentrated layer near the filter medium, and the cake build-up, and by creating a more porous filter cake. The ultrasound cavitation is relatively gentle in performing the cleaning

and the intermittent application of ultrasound wave fields will reduce the thickness of the filter cake without totally destroying it. The cavitation is created at sites of rarefaction as the liquid fractures or tears because of the negative pressure of the sound wave in the liquid. As the wave fronts pass, the cavitations "bubbles" oscillate under the influence of positive pressure, eventually growing to an unstable size. Finally, the violent collapse of the cavitation "bubbles" results in implosions, which cause shock waves to be radiated from the sites of the collapse. The collapse and implosion of myriad cavitation "bubbles" throughout an ultrasonically activated liquid result in the effect commonly associated with ultrasonics. It has been calculated that temperatures in excess of 10,000°F and pressures in excess of 10,000 psi are generated at the implosion sites of cavitation bubbles (Mason, 1995). Thereby, the mechanical effect of ultrasonic energy can be helpful in displacing particles especially to decrease the thickness of the cake on the filter surface. Indirectly, the reduction of the resistance layer causes an increase in the filtration rate. In carrying out the invention, parameters affecting the performance of the sonicated filtration were successfully investigated. Among the parameters of concern are the filtration cycle time, sonication cycle time and the ultrasonic intensity. An average flux is measured in each experiment as an indication of effectiveness of this method in reducing the filter fouling. Results from the study showed that an increase in filtration rate of up to 80% was achieved with this method.

## 2.0 EXPERIMENTAL

### 2.1 Equipment Design

One lab scale filter leaf module was developed based on the commercial design as illustrated in Figure 1.0. Transducers (40 kHz, 500 W) were supplied by Crest Ultrasonic (M) Sdn. Bhd were attached on each side of the housing wall facing the filter leaf to transmit high intensity wave fields inside the filtering chamber. In the filter chamber, a stainless steel filter leaf was placed at the centre of the chamber, where solids particles were retained on the surface of the filter leaf while the liquid filtrate passed through during the filtration process. Referring to figure 1.0, the filtration process started when the liquid suspension was delivered into the filtering chamber by using a pump. The flowrate of the suspensions entering the filtration module was controlled by a pair of valves.



**Figure 1.0: Schematic Diagram of the experimental setup for ultrasound-assisted filtration**

## 2.2 Design of the Research Work

In order to achieve the objective and the scope of the research, the study was focused on the investigation of the ultrasonic effect on the filtration of bleaching earth suspended in RBD palm oil. In order to observe the ultrasonic effect, baseline or the reference conditions ought to be established. Thus, a series of non-sonicated filtration experiment was conducted to establish the general pattern of the filtration rate as a function of filtration time. Filtration experiment was then conducted with the presence of ultrasonic wave fields, with various settings of ultrasonic parameters. A summary of the operating conditions of the experiment is as shown in Table 1.0.

**Table 1.0: A summary of the operating conditions of the experiments**

Variables		Conditions
1)	Power (W)	500
2)	Frequency (Hz)	40000
3)	Operating Pressure (bar)	4 bar (constant)
4)	Operating Temperature	27 °C
5)	Concentration (g/l)	10
6)	Time Ratio	4S,5S,8S,12S : 8F, 15F, 25F

### 2.2.1 Experimental method to determine the effectiveness of in-situ ultrasonic assisted system in increasing the rate of filtration.

In order to carry out this stage of experiment, parameters affecting the effectiveness of the in-situ ultrasonic cleaning system were varied. Among the important parameters of concern are the ratio of sonicated and un-sonicated filtration time. The behavior of the filtration rate corresponding to the operating conditions, as a function of time, was examined. The degree of flux enhancement was determined by comparing the baseline curve with the curve generated from the ultrasound assisted filtration. The steps in performing the ultrasonic assisted filtration experiment were similar to the ones performed in establishing the baseline curve, except for some additional steps. Firstly, the ultrasonic wave field was supplied intermittently for a specified interval after a specified un-sonicated filtration interval. The combinations of sonicated and un-sonicated filtration intervals investigated in this study are as shown in table 2.0 below:

**Table 2.0: Combinations of sonicated and un-sonicated filtration intervals**

Un-sonicated filtration interval (minute)	Sonicated filtration interval (minute)		
	5	4	8
8			
10			
12			

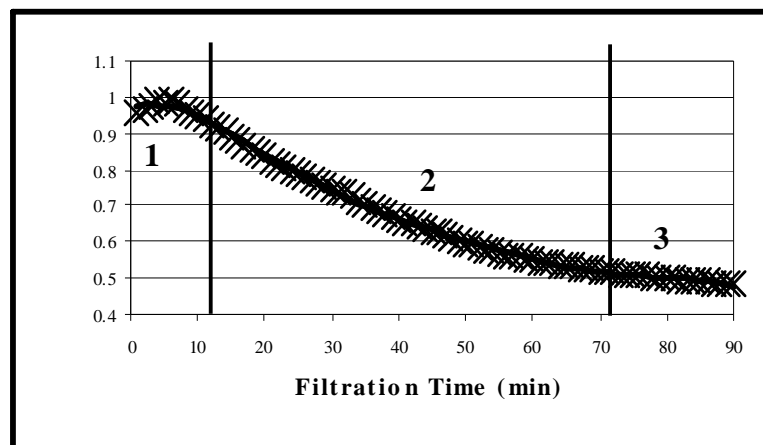
In the filtration process, pre-coating of the filter leaf was required, similar to the common practice adopted in the industries, to ensure a clear filtrate. Based on trial runs in the laboratory and the typical pre-

coating duration in the industries, a ten minute pre-coating time has been adopted throughout this study and was considered sufficient to produce a clear filtrate. Thus, the filtration time started after pre-coating has been achieved.

### 3.0 RESULTS AND DISCUSSION

#### 3.1 Experimental data for *Baseline* determination

Figure 3.0 shows the typical curve of filtrate flux as a function of filtration time in the separation of activated clay from RBD oil using a simulated pressure leaf filter module. For duration of 90 minutes, in general, the curve shows a declining trend throughout the filtration process, indicating the continuous build-up of particulates onto the filtering medium. The first 10 minutes of filtration showed a slow decline of filtrate flux (marked as zone 1 in Figure 3.0). This indicates the stage of steady formation of cake on the surface of filter medium. As the formation of the initial cake layer has been completed, the filtrate flux began to decrease much faster. This is the zone of cake layer formation in which the thickness of the cake progressively thickened as a result of solid depositing on the filter medium following the flow of filtrate passing through the filter (indicated as zone 2 in Figure 3.0). As the filtration process exceeded the 70 minutes filtration time, the constant dropping rate of filtrate flux approached a near constant filtrate flux (zone 3). At this stage, the increase in the cake thickness showed minimal effect on the filtrate flux.



**Figure 3.0: Typical curve of filtrate flux versus filtration time in the filtration of Activated Clay from RBD Oil**

#### 3.2 The effectiveness of in-situ ultrasonication in increasing the rate of filtration.

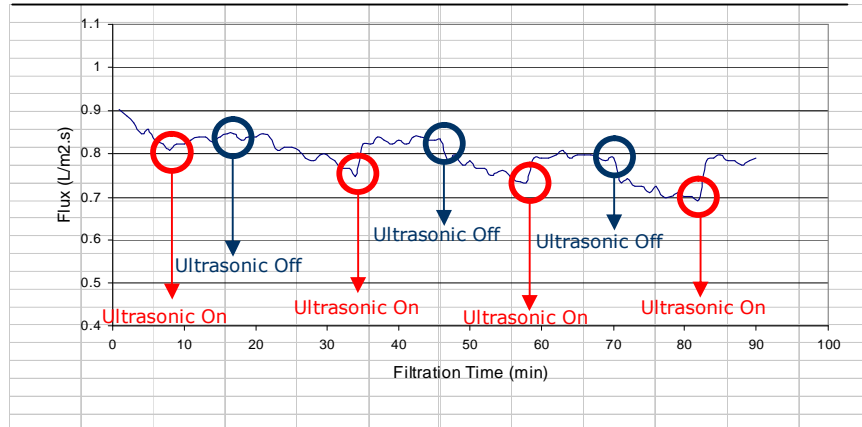
In determining the effectiveness of in-situ ultrasonication in increasing the rate of filtration, several parameters affecting the process were monitored. These include sonication cycle time, filtration cycle time, applied pressure and ultrasound intensity.

#### 3.3 Effect of sonication cycle time.

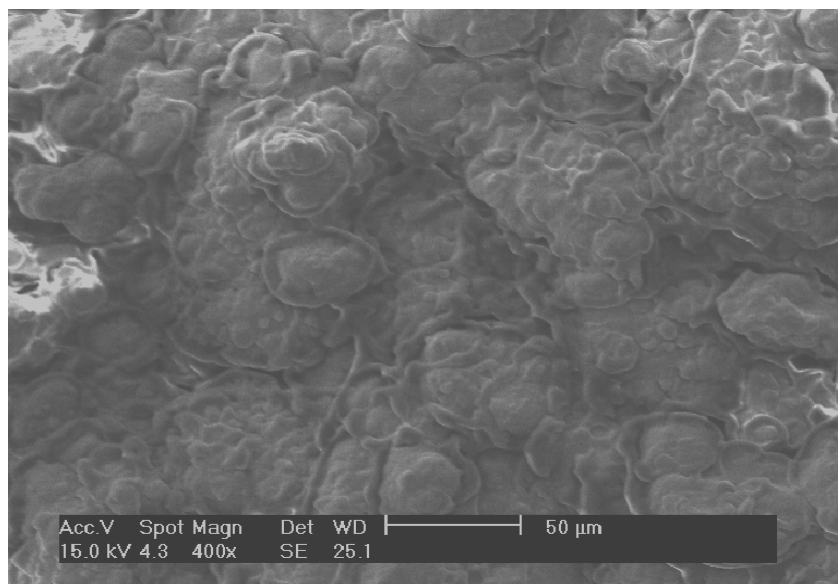
In examining the effect of sonication cycle time on the effectiveness of in-situ ultrasonication in increasing the rate of filtration, experiment was initially conducted to understand the behavior of the filtration as ultrasound field was applied intermittently. Figure 3.1 shows the typical curve obtained as a result of the intermittent ultrasound application. As can be seen in the figure, the rate of filtration progressively dropped as the filtration commenced. This was due to the accumulation of particulates at the filtering surface as the suspension was forced through the filter media. The moment ultrasonic wave field was applied, the filtration rate showed an increasing trend. The increment of the filtration rate was due to

the thinning of the filter cake. The thinning of the filter cake was performed by the cavitation effect of the ultrasound field, as illustrated earlier in chapter two. Another contribution to the increment of filtration rate was the disruption of concentrated layer near the filter cake, by the ultrasound cavitation, which resulted in the reduction of resistance of the filtrate flow. The physical action of the ultrasound field did not totally disrupt the filter cake as minimum layer of filter cake was required in the filtration process. This was concluded from observing the clarity of the filtrate during ultrasound application.

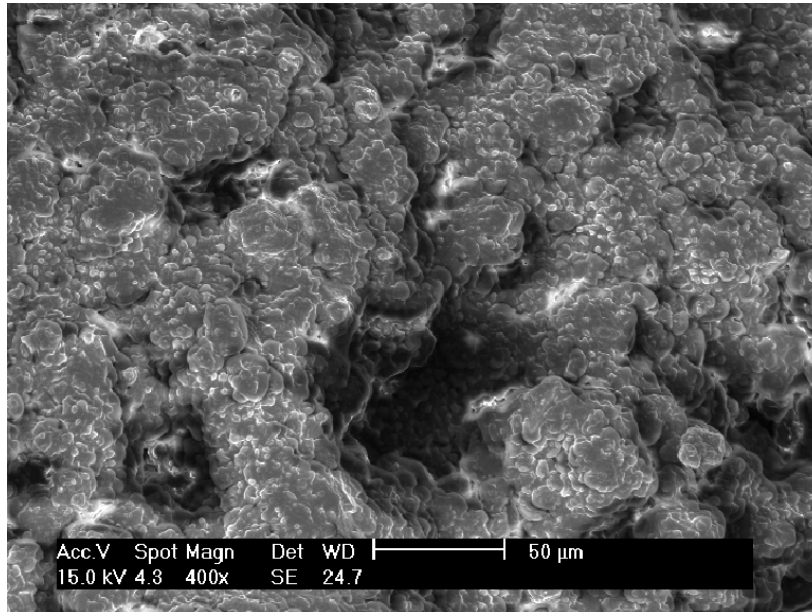
When the ultrasound field was switched off after an interval, the concentrated layer was almost immediately formed and the thickness of the filter cake progressively increased. The implication of these phenomena was reflected in the decreasing trend of the filtration rate. The intermittent application of ultrasound field during the filtration operation was indicated by the saw teeth type of curve showed in figure 3.0. Further analysis of the ultrasound action during the filtration, was performed by analyzing the filter cake under Scanning Electron Microscope (SEM), before and after ultrasound application. Figures 3.2(a) and 3.2(b) show the structure of filter cake before and after ultrasound application, respectively. Figure 3.2(a) indicated a dense structure of filter cake, before application of ultrasound field. In contrast, a more porous structure of filter cake was observed in figure 3.2(b), as a result of the ultrasound cavitation. Thus, it can also be concluded that the increased porosity of the filter cake caused by the cavitation activities was another contributing factor in increasing the filtration rate of the process. In addition, the increased porosity of the filter cake also reduced the impact of the newly formed



**Figure 3.1: Intermittent application of ultrasound field in filtration process**

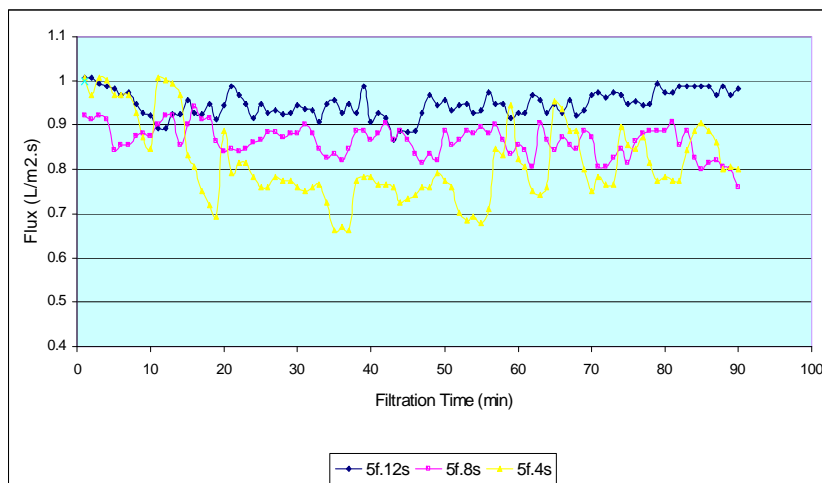


**Figure 3.2 (a): Scanning electron micrograph (x400) of cake structure after 10 minutes filtration (before ultrasonication)**



**Figure 3.2(b): Scanning electron micrograph (x400) of cake structure after Ultrasonication**

filter cake layer during the unsonicated intervals, thereby minimizing the reduction of filtration rate. This is observed in figure 3.1 in which the re-settling of particles after ultrasound application did not show rapid drop in the filtration rate. Upon understanding the ultrasound effect on the filtration process, the study was further conducted to determine the optimum sonication cycle time which gave the best production rate. In order to achieve this, the sonication interval was varied from 4 to 12 minutes, at constant filtration interval of 5 minutes and at applied pressure of 4 bar and ultrasound intensity of  $0.4844 \text{ W/m}^2$ . Figure 3.3 shows the filtrate flux as a function of filtration time when the ultrasound system was switched on and off alternately according to the combination of parameters mentioned above. The figure shows experimental results from sonication interval of 4 minutes, 8 minutes and 12 minutes, at a constant filtration cycle of 5 minutes, respectively. In the first 10 minutes of filtration, no sonication was applied, to ensure a complete formation of initial filter cake layer.



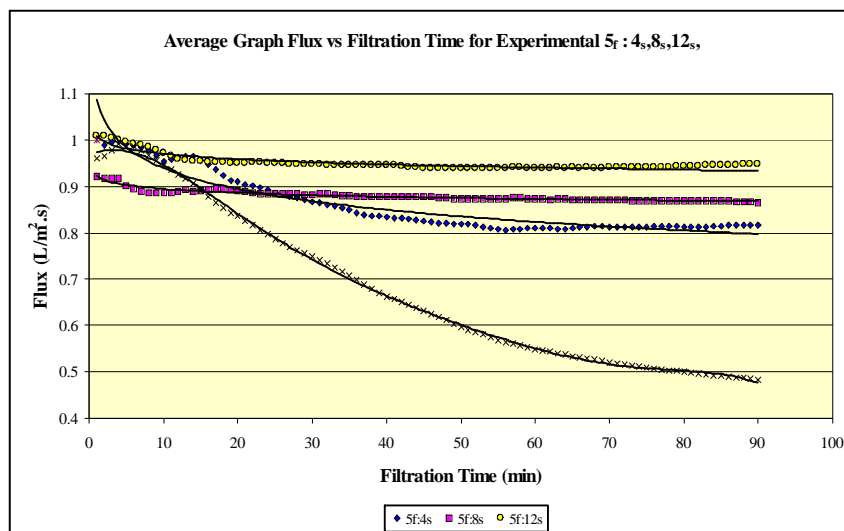
**Figure 3.3: Effect of varying the sonication cycle time.\)**

As can be seen in the figure, saw teeth type of curves were observed in all the combination of parameters. Subscripts ‘f’ and ‘s’ represent the unsonicated and sonicated filtration cycle, respectively. There were differences in term of performance, with sonication

cycle time of 12 minutes showed the highest increment of filtration rate, followed by the 8 minutes and the 4 minutes cycle time, accordingly. However, with the present curves, there was difficulty to further examine and discuss the findings from the experimental results. To overcome the difficulty, an established method of three point average was adopted to treat the experimental data. The method was used to eliminate/minimize fluctuation in the experimental data without altering the overall patent/trend of the curve. The treated data was tabulated in Appendix A and was plotted in Figure 3.4 together with the baseline curve as comparison of performance between the sonicated and unsonicated filtration process. As can be seen in figure 3.4, the plotted curves were smoother, but the overall trend of the curves remained unchanged. In comparison to the baseline curve, all the sonicated experiments showed higher rate of filtration. The general trend observed in the figure was the shortening of filtration time to reach plateau filtration rate as the ultrasonic cycle time was increased. This phenomenon indicated the influence of ultrasound field in arranging the solids particulate during the formation of cake layer. A longer duration of sonication cycle time produced more porous structure of cake layer. Upon switching off the ultrasonic field, further settling of particulates on the formed porous cake structure did not greatly alter the filtration rate, and hence enabling a higher equilibrium filtration rate. Table 3.0 shows a summary of the percent increment of filtration rate in comparison to the unsonicated filtration experiment. The flux increment varied from 63% to 88% as the sonication cycle time was varied from 4 minutes to 12 minutes, respectively. The higher flux increment observed, was consistent with the experimental expectation, since the increased sonication cycle time would result in longer period of particulate dispersion and greater cake thinning. The degree of flux improvement as a result

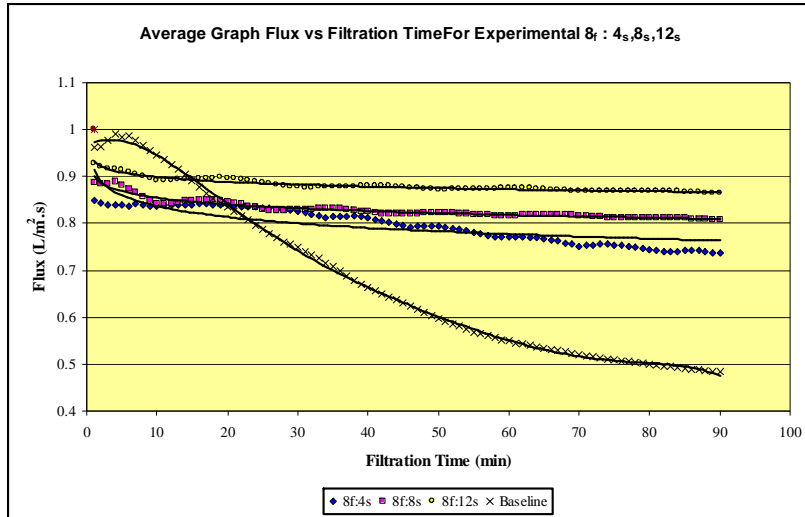
**Table 3.0: Percentage of flux increment as a function of sonication cycle time at 5 minutes filtration cycle time.**

Experiment	5 <sub>f</sub> :4s	5 <sub>f</sub> :8s	5 <sub>f</sub> :12s
Percent Increment	62.55 %	73.54 %	<b>88.47 %</b>



**Figure 3.4: The effect of varying the sonication cycle time on the filtration of activated clay in oil suspension (at filtration cycle time of 5 min)**

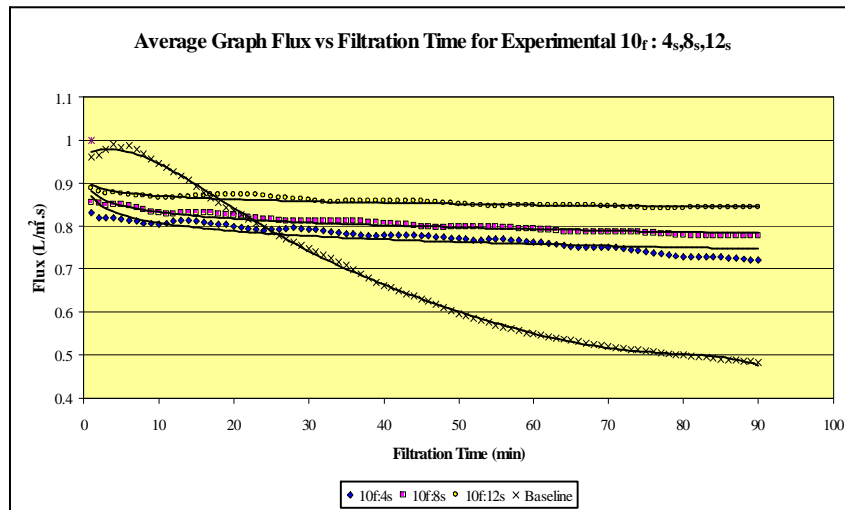
of ultrasound application varies in accordance to the feed solid concentration. The effect of ultrasound was more pronounced at lower solid concentration in comparison to the higher solid concentration. The lower effectiveness of ultrasound at higher solid concentration is due to the higher degree of attenuation of the sound wave fields. Thus, a reduced sound energy is allocated for the cleaning of the filter cake. However, in this study, the solids concentration was not varied and was set at 10 g/l. The decision was in accordance to the common industrial practice in which the concentration does not exceed 10 g/l. The effect of sonication cycle time was further examined by conducting similar set of experiment, but with combination of filtration cycle time of 5 minutes, 8 minutes, 10 minutes and 12 minutes. The experimental flux versus filtration time of each set of experiment was presented in Figure 3.5 to Figure 3.7, while the percent flux improvement was tabulated in Table 3.1 to Table 3.3, respectively



**Figure 3.5: The effect of varying the sonication cycle time on the filtration of activated clay in oil suspension (at filtration cycle time of 8 min).**

**Table 3.1: Percentage of flux increment as a function of sonication cycle time at 8 minutes filtration cycle time.**

Experiment	8f:4s	8f:8s	8f:12s
Percent Increment	49.10 %	62.29 %	73.42 %

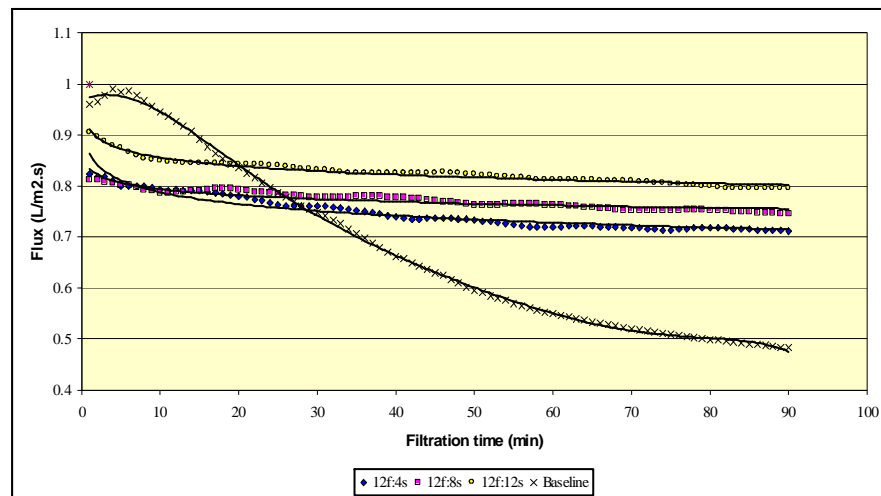


**Figure 3.6: The effect of varying the sonication cycle time on the filtration of activated clay in oil suspension (at filtration cycle time of 10 min).**



**Table 3.2: Percentage of flux increment as a function of sonication cycle time at 10 minutes filtration cycle time.**

Experiment	10f:4s	10f:8s	10f:12s
Percent Increment	46.45 %	55.94 %	<b>68.31 %</b>



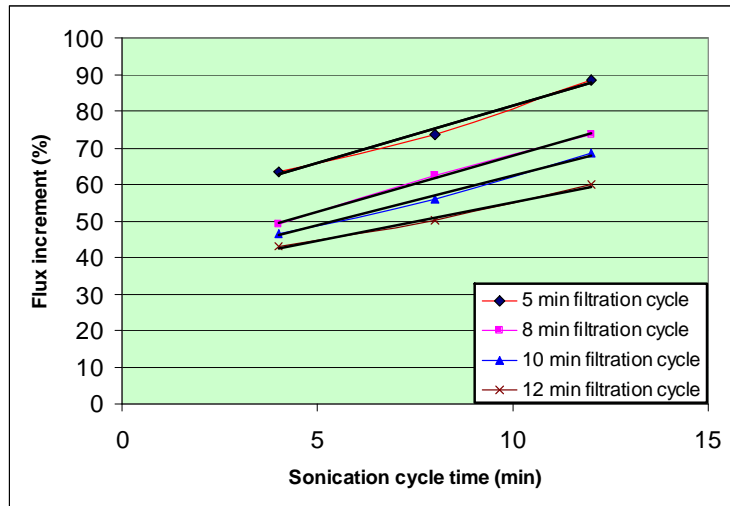
**Figure 3.7: The effect of varying the sonication cycle time on the filtration of activated clay in oil suspension (at filtration cycle time of 12 min).**

**Table 3.3: Percentage of flux increment as a function of sonication cycle time at 12 minutes filtration cycle time.**

Experiment	12 <sub>f</sub> :4 <sub>s</sub>	12 <sub>f</sub> :8 <sub>s</sub>	12 <sub>f</sub> :12 <sub>s</sub>
Percent Increment	42.92 %	50.04 %	<b>59.90 %</b>

As can be seen in the figures, all the results showed consistencies of flux increment as the sonication cycle time was increased. The degree of flux improvement was, on the other hand, inversely proportional to the filtration cycle time. Figure 3.8 shows the summary of the equilibrium flux improvement as a function of sonication cycle time for all the investigated filtration cycle time. Performing least square regression on the data points of all the sets of filtration cycle time, the derived equations showed good correlations, with  $R^2$  values in the range of 0.987 to 0.998 (As shown in Table 3.4). The good correlations observed in all the data sets bring to a conclusion that the data can be represented by a straight line. Thus, it is suggested that within the investigated range of sonication cycle time, the degree of flux improvement is linearly proportional to the sonication cycle time. The slopes of the curves range from 2.1 to 3.1. The slope of the curve is inversely related to the filtration cycle time (i.e. as the filtration cycle time is reduced, the steepness of the slope increases). The highest slope, 3.1, was recorded when the filtration cycle time was set at 5 minutes, and conversely, the lowest slope, 2.1, was recorded when the filtration cycle time was set at 12 minutes. Upon close examination of the curves, it was realized that sonication experiment with shorter filtration cycle time gave higher impact on improving the filtration rate. This phenomenon can be experiential when comparing the degree of flux increment between the two extreme, at filtration cycle time of 5 minutes and 12 minutes. At 12 minutes filtration cycle time, as the sonication cycle time was increased from 4 minutes to 8 minutes (i.e. 4 minutes increment), the percentage of flux improvement was

increased from 42.92% to 50.04% (i.e. 7.12% increment). At 5 minutes filtration cycle time, on the other hand, as the sonication cycle time was increased from 4 minutes to 8 minutes, the percentage of flux improvement was increased from 63.55% to 73.54% (i.e. 9.99% increment). The highest flux improvement achieved in this study was 88.47%, attained at 5 minutes filtration cycle time and 12 minutes sonication cycle time, while the lowest was 42.92%, recorded when the filtration cycle time was set at 12 minutes and sonication cycle time was set at 4 minutes.



**Figure 3.8: Summary of equilibrium flux increment as a function of Sonication Cycle Time for various Filtration Cycle Time.**

**Table 3.4: Least square regression data points of all the sets of filtration cycle time**

Filtration Cycle Time (min)	Equation	R <sup>2</sup> Value
5	$y = 3.115x + 50.267$	$R^2 = 0.9871$
8	$y = 3.04x + 37.283$	$R^2 = 0.9976$
10	$y = 2.7325x + 35.04$	$R^2 = 0.9942$
12	$y = 2.1225x + 33.973$	$R^2 = 0.9914$

#### 4.0 CONCLUSION

From the study, it can be concluded that at low filtration cycle time, the cake developed during the unsonicated cycle was relatively thin, and since the filtration cycle time was short, more frequent ultrasonic cleaning took place. Thus, the thickness of the filter cake was maintained thin and porous throughout the filtration process. As a result, high degree of flux improvement was observed during short filtration cycle time experiment. With similar argument, lower degree of flux improvement observed during long filtration cycle time experiment, since relatively thicker cake covering the filter medium during the filtration.

#### 5.0 ACKNOWLEDGEMENT

We would like to thank Felda Vegetable Oil Product Malaysia for providing the slurry RBD Oil Samples, Crest Ultrasonic (M) Sdn. Bhd for donating the high intensity ultrasonic system. Finally this research is

made possible with the scholarship from the Ministry of Science, Technology and Environment, Malaysia under National Science Fellowship (NSF) program

## 6.0 NOTATION

S = Sonication

F = Filtration

## REFERENCES

- S.Dahnke, K.M.Swamy, F.J. Keil (1999). "A comparative study on the modeling of sound pressure field distributions in a sonoreactor with experimental investigation" *Journal of Ultrasonics Sonochemistry*. Vol. 6. 221-226.
- A.D. Farmer, A.F. Collings, G.J. Jameson (2000). "Effect of ultrasound on surface cleaning of silica particles" *International Journal of Mineral Processing*. Vol. 60.101-113.
- N.A. Tsochatzidis, P. Guiraud, A.M. Wilhelm, H. Delmas. (2001). "Determination of velocity, size and concentration of ultrasonic cavitation bubbles by the phase-Doppler Technique" *Journal of Chemical Engineering Science*. Vol. 56. 1831-1840.
- E. Riera-Franco de Sarabia, *et. Al.* (2000). "Application of high-power ultrasound to enhance fluid/solid particle separation processes". *Journal of Ultrasonics*. Vol. 38. 642-646.
- N.V Dezhkunov. (2002). "Multibubble sonoluminescence intensity dependence on liquid temperature at different ultrasound intensities". *Journal of Ultrasonics Sonochemistry*. Vol. 9 103-106
- S.Dahnke, K.M.Swamy, F.J. Keil (1999). "Modelling of three-dimensional pressure fields in sonochemical reactors with an inhomogeneous density distribution of cavitation bubbles. Comparison of theoretical and experimental results" *Journal of Ultrasonics Sonochemistry*. Vol. 6. 221-226.
- Sukti Majumdar, P. Senthil Kumar, A.B. Pandit. (1998). "Effect of liquid-phase properties on ultrasound intensity and cavitation activity" *Journal of Ultrasonics Sonochemistry*. Vol. 5. 113-118.
- Coulson, J.M. and Richardson, J.F.(1991) "Chemical Engineering, Vol. 2. Fourth Ed., "Particle Technology and Separation Processes", Pergamon Press. 282-335
- F.G. Veldkamp. (1987). "Paper On The Various Filtration Steps In Edible/Vegetable Oil Processing", Symposium Of Oil Processing, Curacao/Na
- Dale Ensminger . (1973). "Ultrasonics-The Low and High Intensity Applications". Marcel Dekker,Inc. New York. 423-427.
- Elliot Goldberg. (1997). "Handbook of Downstream Processing", Lockwood Green Engineers, Inc., New York. 318-334
- Yunus, R.M. (1996). "Ultrasound Fields In Crossflow Microfiltration", Ph. D Thesis, University of Wales Swansea
- Mason, T.J. (1995). "Ultrasonic Intensification of Chemical Processing and Related Operations". Proceeding of The First International Conference on Science, Engineering and Technology of Intensive Processing, 18-20<sup>th</sup> September 1995, Nottingham, UK.
- Geankoplis, C.J. (1995). "Transport Processes and Unit Operations". 3<sup>rd</sup> ed. Singapore: Prentice Hall Simon & Schuster (Asia) Pte. Ltd. 800 – 840

- A. Rushton, A.S. Ward, R.G. Holdich. (1996). "Solid-Liquid Filtration and Separation Technology". 1<sup>st</sup> ed. VCH Publishers, Inc., New York, NY (USA). 33-77
- A. Rushton, A.S. Ward, R.G. Holdich. (1996). "Solid-Liquid Filtration and Separation Technology". 1<sup>st</sup> ed. VCH Publishers, Inc., New York, NY (USA). 397 - 478
- Mason, T.J. (1990). "Sonochemistry: The Uses of Ultrasound in Chemistry". Royal Society of Chemistry, Germany
- Karleskind, A. (1996). "Oils and Fats Manual: A Comprehensive Treatise (Properties-Production-Applications) Volume 2". New Jersey U.S.A : Intercept Ltd. 807 – 893
- Anton Puskar. (1982). "The Use of High Intensity Ultrasonics". New York U.S.A: Elsevier Scientific Publishing Company, Inc. 30 – 55
- Bernardini, E. (1983). "Oil Seeds, Oils and Fats: Oils and Fats Processing Volume II". Rome, Italy: Publishing House Via Failla 63.
- Sa'ari Mustapha, Yahya Sukirman. (1996). "Mathematical Modelling of Coupling Flow and Cake Formation in Filtration Process". Proceedings Volume 1: 7<sup>th</sup> World Filtration Congress Budapest, Hungary. Hungarian Chemical Society.
- Ramlan A. Aziz, Hamdani Saidi *et al.* (1989). "Initial Study on Crude Palm Oil Filtration". One day Seminar on The Latest Development in Filtration Technology, Filtech '89.
- Christopher Dickenson. (1992). "Filters and filtration handbook". 3<sup>rd</sup> ed. Oxford : Elsevier Advanced Technology.