

Wind Power in the UK

A guide to the key issues surrounding onshore wind power development in the UK



Sustainable
Development Commission



Foreword

In my capacity as the immediate past Chairman of RCEP, and Chairman at the time of the RCEP Energy Report, I would like to warmly welcome the SDC's report on wind power in the UK as one that makes a significant contribution to an important area of public debate. All the RCEP's scenarios in its Energy Report envisaged a large role for wind in meeting the challenge of climate change. The RCEP remains convinced of the need for this role, as part of a much broader Climate Change Programme.

I am pleased to note that the SDC report confirms that wind is both the cheapest and one of the most abundant of the UK's renewable resources. At current levels of gas prices, and certainly if credit is given for its carbon-free status in line with current Government estimates of the social cost of carbon, it is already cost-competitive with gas-fired electricity on the best onshore wind sites, and seems likely to be the cheapest of all forms of power generation by 2020 on such sites, even without a carbon credit. In addition, the supposed additional system costs of wind have been much exaggerated in some quarters and it is encouraging to see that this report shows, on the basis of rigorous analysis, that they are in fact very modest.

The RCEP also expects that in the UK wind is likely to substitute for coal-fired generation in the short term and perhaps gas in the medium term. This means that it will reduce carbon emissions substantially.

Another frequent misunderstanding related to wind is the implication of its variability. In fact, with modern meteorology, wind is very predictable over the time scales relevant for balancing the electricity system. Its variability means that it cannot displace fossil plant MW for MW, but at penetrations up to 20% of electricity generation it can displace fossil plant at around 20% of installed wind capacity. The carbon penalty for having to have additional conventional plant on reserve duty to compensate for the variability of wind (which is in any case usually predictable) is very small.

The visual and landscape impacts of wind remain of concern to the RCEP, and to many people who love the UK countryside. This concern must be taken seriously and steps taken not to allow wind farms to spoil sites designated for their beauty. But all forms of power generation have negative environmental impacts, and climate change will have the most serious impacts of all.



Sir Tom Blundell FRS FMedSci

Executive Summary

Wind power development arouses strong opinions. For the general public, a high level of support nationally for wind power can be contrasted with opposition at the local level. This situation presents local planners, councillors, and communities with a difficult task – to assess the needs of the wider environment against local concerns. Information about the complexities of wind power generation – its costs, intermittency issues, effects on the electricity network, noise, ecological and landscape impacts among others – is therefore essential for considered decisions to be made.

The aim of this report is to outline the main issues relating to onshore wind power and comment on their validity from a sustainable development perspective, in line with the principles outlined in the UK's new Framework for Sustainable Development.

Targets

The UK has committed itself to working towards a 60% reduction in CO₂ emissions by 2050, and the development of renewable energy technologies such as wind is a core part of achieving this aim. UK wind resources are more than enough to meet current renewable energy targets – the generation of 10% of UK electricity from renewable sources by 2010, and an aspirational target of 20% by 2020 – and there are no major technical barriers to meeting these targets.

Intermittency

Wind blows at variable speed, variable intensity and sometimes not at all. But this variability is not a problem for the electricity grid. Wind is accurately forecast over the timeframes relevant to network operators and other market participants. Increasing the proportion of wind power in the electricity system does not require greater “back up” capacity, as is often believed, but it does slightly increase the cost. The greater

the proportion of wind on the grid the lower its “capacity value”, and the lower the quantities of conventional technology it displaces. Nevertheless it continues to reduce carbon emissions.

Costs

The generation costs of onshore wind power are around 3.2p/kWh (+/-0.3p/kWh), with offshore at around 5.5p/kWh, compared to a wholesale price for electricity of around 3.0p/kWh. The additional system cost is estimated to be around 0.17p/kWh, when there is 20% wind power on the system. Generation costs are likely to decrease over time as the technology improves, but this will be balanced against increased costs for integrating higher levels of wind generation into the system.

Environmental impacts

As a carbon free source of energy, wind power contributes positively to the UK's effort to reduce our carbon emissions to tackle the threat of climate change. The impact of climate change on the landscape will be radical, and therefore the visual impact of a wind development must be considered in this context. To some, wind turbines are a blot on the landscape whereas to others they are elegant workhorses, but this reaction is highly subjective. However, there are far fewer landscape and environmental impacts associated with wind turbines than with other energy generation technologies, although their development is often in areas that have not had such developments in the past. Wind developments do not have long lasting decommissioning issues, as they can be replaced or removed quickly if necessary.

Wildlife and habitat impacts can be minimised through careful project location, design measures, and appropriate construction techniques. Environmental Impact Assessments must be comprehensive, and thoroughly explore

Executive Summary

all the potential disadvantages so these can be properly mitigated. Not all sites will be appropriate for wind developments, and designated areas should continue to receive a high level of protection.

Community engagement

A key factor in a successful wind development is the involvement of the local community at all stages. This will ensure that the community is involved in exploring ways of mitigating any potential environmental or social impacts – such as overcoming any effects on TV transmission. Communities often perceive noise from turbines to be a potential problem, but the noise from the moving parts has reduced substantially as the technology has advanced, and communities often find that noise is not a problem.

Planning procedure

The planning policy environment and consents procedure need to continue to improve to enable renewable energy development. There will continue to be barriers to some developments because of their impact on radar and aircraft radio navigation systems, but this can be resolved in the pre-planning stage. The UK has some of the strictest policies in place to protect against interference of radar and aviation, and these must be justified.

The Sustainable Development Commission (SDC) hopes that this report will be used to ensure that good practice is followed when new wind power developments are being considered and calls on all stakeholders to play their full part to ensure that the benefits of renewable energy are realised through careful design and consultation.

SUSTAINABLE DEVELOPMENT COMMISSION

MAY 2005



Brandon Clements, Rhona Earnshaw and Phoebe Brown turn on the Isle of Gigha 'Dancing Ladies' providing the 130 strong community with energy and independence.

Contents

1	INTRODUCTION	3	4.7	Alternatives to wind energy	38
1.1	The aim of this report	3	4.8	Projected long-term costs for electricity generation	40
1.2	Considering the big picture – sustainable development	3	4.9	Drawing conclusions	41
1.3	UK perspective	5	5	WIND POWER AND PLANNING	44
1.4	Technical annexes and glossary	5	5.1	Planning process for wind projects	44
2	DELIVERING CLEAN ENERGY: THE ROLE OF WIND	6	5.2	Planning Policy	47
2.1	Climate change and the need for action	6	5.3	Current development plans	48
2.2	Emissions reductions targets	7	6	LANDSCAPE AND ENVIRONMENT	51
2.3	Renewable energy targets	9	6.1	Background	51
2.4	The role of wind power	11	6.2	Landscape change	51
2.5	UK wind resources	13	6.3	Landscape and visual effects	52
2.6	Current and future wind capacity	16	6.4	Visual characteristics of wind farms	54
3	WIND POWER TECHNOLOGY AND NETWORK INTEGRATION	17	6.5	Designated areas	56
3.1	Wind turbine technology	17	6.6	Public perception	56
3.2	Energy balance	18	6.7	Comparing landscape and environmental impacts	57
3.3	UK electricity supply system	19	6.8	Land-take by wind developments	60
3.4	Balancing the system	20	6.9	Achieving a long-term perspective	60
3.5	Capacity and flexibility of wind power	22	7	WILDLIFE AND ECOLOGY	65
3.6	Displacement of fuel use and emissions	25	7.1	Background	65
3.7	Limits on wind capacity	26	7.2	Habitats	65
4	COSTS AND BENEFITS OF WIND	27	7.3	Peat	67
4.1	Background	27	7.4	Water	67
4.2	Calculating generation costs	27	7.5	Birds	68
4.3	Wind power generation costs	29	7.6	Protected mammal species	69
4.4	Comparing wind energy to conventional generation costs	30	7.7	Bats	70
4.5	System costs from wind energy	31	7.8	Good environmental assessment	70
4.6	Cost of UK support mechanisms	37	7.9	The way forward	70

Contents

8	NOISE	72	11	TELECOMMUNICATIONS	106
8.1	Background	72	11.1	Background	106
8.2	How noise is measured	72	11.2	Television	106
8.3	Wind turbine noise	72	11.3	Fixed radio links	107
8.4	Noise reduction	73	11.4	Scanning telemetry systems	107
8.5	Noise levels in the community	74	11.5	A solvable problem	107
8.6	Assessment of noise	74			
8.7	Regulation of noise	75	12	THE PROCESS OF WIND FARM DEVELOPMENT	110
8.8	Noise in perspective	76			
9	WIND POWER AND THE COMMUNITY	79		GLOSSARY OF TERMS	113
9.1	Background	79			
9.2	Public attitudes	79			
9.3	Community concerns	83			
9.4	Economic and community benefits	84			
9.5	Public consultation	85			
9.6	Lessons for success	89			
10	AVIATION AND RADAR	99			
10.1	Background	99			
10.2	Radar	99			
10.3	Aviation	101			
10.4	Seismic stations	102			
10.5	Regulatory process	102			
10.6	International experience	103			
10.7	Mitigation measures	104			
10.8	Balancing priorities	105			

1 Introduction

1.1 The aim of this report

Our report is aimed primarily at those responsible for making decisions about onshore wind power developments, including planning officers, local councillors and local energy and sustainability officers. It is relevant to policy makers at all levels of government – including local authorities, Regional Development Agencies, the Devolved Administrations and UK Government – and can also be used as a good practice guide by the wind and renewable energy industry, environmental organisations, community groups and other stakeholders.

An information booklet has been published to accompany this report to present the key issues in a readily accessible format.

This report purposely concentrates on the onshore sector, where decision making is primarily undertaken at a local level and where debate is strongest. However, many of the issues discussed are relevant to both on and offshore development, and where this is the case no distinction is made. The SDC recognises that there is growing understanding of a number of environmental concerns specific to offshore developments, but believes these would be best dealt with separately, as offshore decisions are made centrally rather than locally.

The SDC has drawn on a wide body of research, supplemented by specially commissioned work and input from key stakeholders. The report also makes use of case study material, internal expertise and access to a variety of government data and analysis. The result is a report which we believe to be comprehensive in its scope and we hope useful to those at the front line on this issue.

The wind power industry in the UK is evolving rapidly. It is hoped that by publishing this report the SDC can contribute to the planning and policy making process at all levels and thereby ensure that good decisions are based on a good understanding of the real issues.

1.2 Considering the big picture – sustainable development

Any decisions the UK takes on the development of wind power and its place in energy policy need to be placed within the context of the Government's overarching policy to pursue and promote sustainable development.

In March 2005, the UK Government and the Devolved Administrations published *One future – different paths*, the UK's shared strategic framework for sustainable development. This was launched in conjunction with the UK Government's new strategy for sustainable development *Securing the Future*.

1 Introduction

A new framework goal sets out the purpose the UK Government and the Devolved Administrations are trying to achieve:¹

The goal of sustainable development is to enable all people throughout the world to satisfy their basic needs and enjoy a better quality of life without compromising the quality of life of future generations.

For the UK Government and the Devolved Administrations, that goal will be pursued in an integrated way through a sustainable, innovative and productive economy that delivers high levels of employment and a just society that promotes social inclusion, sustainable communities and personal well-being. This will be done in ways that protect and enhance the physical and natural environment and use resources and energy as efficiently as possible.

Government must promote a clear understanding of, and commitment to, sustainable development so that all people can contribute to the overall goal through their individual decisions.

Similar objectives will inform all our international endeavours, with the UK actively promoting multilateral and sustainable solutions to today's most pressing environmental, economic and social problems. There is a clear obligation on more prosperous nations both to put their own house in order and to support other countries in the transition towards a more equitable and sustainable world.

A set of five shared principles underpin this purpose and the framework requires that a policy “must respect all five principles” to be considered sustainable:

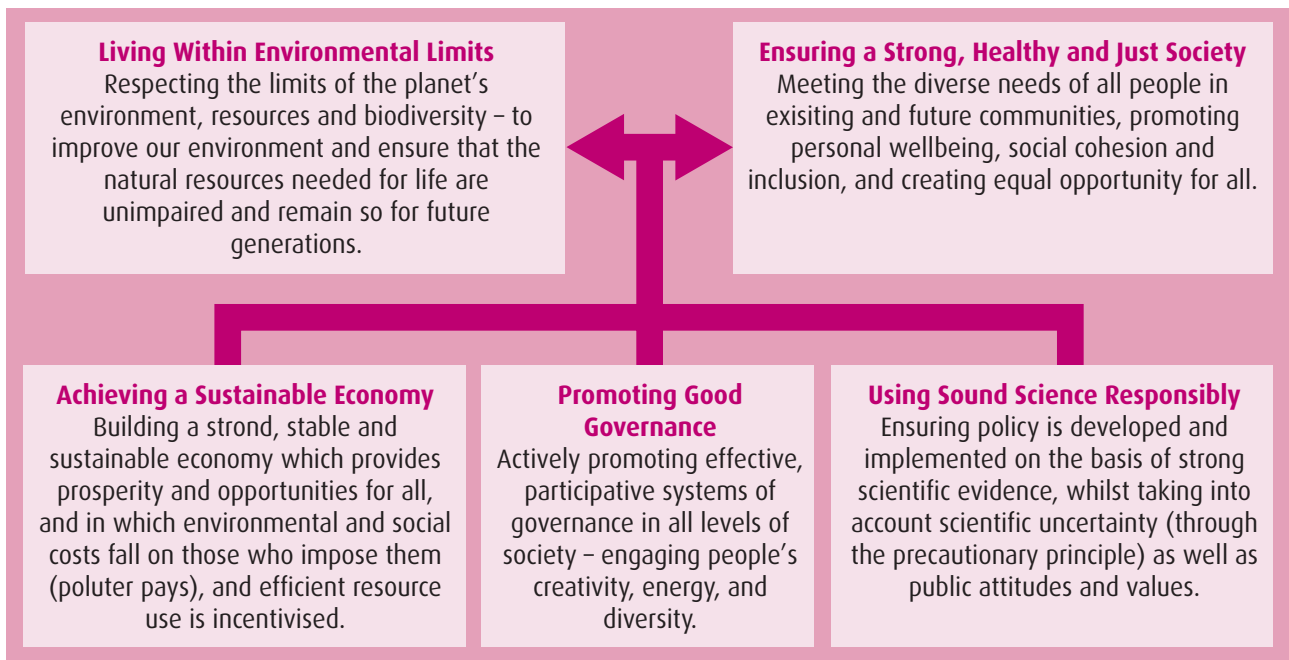

1 Introduction

The framework identifies 'climate change and energy' as one of four priority areas for immediate action, shared across the UK. In particular, the UK Government and Devolved Administrations have committed to "seek to secure a profound change" in the way that we generate and use energy, and in other activities that release these (greenhouse) gases. They have also recognised that they "must set a good example" and have undertaken to "encourage others to follow it".

In applying a sustainable development approach to wind power it is clear that we need to pay particular attention to:

- Accounting for the wider environmental, societal and health implications as well as the economics;
- Ensuring that climate change and security of supply issues are responsibly addressed;
- Basing decisions on strong scientific evidence and ;
- Actively engaging all levels of society in these decisions.

1.3 UK perspective

The SDC is a UK-wide body, reporting to the Prime Minister and the First Ministers of the Devolved Administrations. This report reflects this remit, and covers wind power from a UK perspective. Where national distinctions exist, these are highlighted. However, where no distinction is made, the term 'Government' applies to the UK Government and/or to issues that are not devolved.

1.4 Technical annexes and glossary

At the back of this report there are some technical annexes that give further information on the issues covered in the main chapters. A full glossary is provided at the end of this

document to explain technical issues and terms. A breakdown of the two main electrical units is given below.

Reports on energy issues very often use different units of measurement, which can lead to confusion. Readers should be aware of this when comparing data in this report to other sources of information.

Watt – measure of instantaneous power or capacity:

$1 \text{ GW} = 1,000 \text{ MW} = 1,000,000 \text{ kW} = 1,000,000,000 \text{ W}$

Watt-hour – total energy over time (one watt expended for period of one hour):

$1 \text{ TWh} = 1,000 \text{ GWh} = 1,000,000 \text{ MWh} = 1,000,000,000 \text{ kWh} = 1,000,000,000,000 \text{ Wh}$

2 Delivering clean energy: the role of wind

Summary

- There is now consensus that carbon dioxide emissions are causing climate change, and the harmful effects are widely recognised
- The UK Government and Devolved Administrations have responded to the dangers of climate change by promoting the development of renewable energy sources, including wind power, to reduce emissions of carbon dioxide and other greenhouse gases
- Government policy aims to obtain 10% of the UK's electricity from renewable sources by 2010, with an aspiration to source 20% by 2020
- These targets form part of commitments to reduce the UK's greenhouse gas emissions, with the long-term goal of a 60% reduction in CO₂ emissions by 2050
- The UK has the best and most geographically diverse wind resources in Europe, more than enough to meet current renewable energy targets

2.1 Climate change and the need for action

There is now wide international consensus that human activities over the last two centuries since the start of the industrial revolution have influenced the global climate in a harmful way². This harm will continue to grow, and could dramatically accelerate, unless action is taken to reduce the emissions of greenhouse gases, such as carbon dioxide (CO₂), methane (CH₄) and nitrous oxide (N₂O), by very significant amounts. Greenhouse gases are emitted primarily from the combustion of fossil fuels, intensive agriculture and other industrial processes. They trap solar energy that would normally be radiated back into space, causing average global temperatures to rise. This will affect rainfall patterns and will result in more frequent extreme weather events in the UK and across the globe. Higher temperatures will also lead to melting of the polar ice caps and a rise in the temperature of seawater, causing it to expand; these two effects will cause sea levels to rise.

Detailed scientific information is available in the publications of the Intergovernmental Panel on Climate Change³ (IPCC), the international body set up to research and report on the science of

climate change. The IPCC states that no more than ten of at least 3,000 international climate scientists reject the idea that greenhouse gas emissions are causing the planet to warm. The UK's Chief Scientific Adviser, Sir David King, certainly agrees – in an article in 2004⁴ he stated that:

“In my view, climate change is the most severe problem that we are facing today, more serious even than the threat of terrorism.”

Large areas of the world, including many developing countries, are only a few metres above normal sea level and will suffer catastrophic sea level rises as a consequence of climate change. This could lead to the mass migration of millions of displaced people, putting further pressure on already strained resources.

The geographical position of the UK makes it highly vulnerable to the consequences of climate change. Extreme weather events such as violent storms and increased rainfall are already showing a pattern of change. Low lying, densely populated land in the south and east of the UK,

2 Delivering clean energy: the role of wind

which is already sinking measurably due to long term geological forces, is very vulnerable to any potential rise in sea level.

2.2 Emissions reductions targets

International action to reduce greenhouse gas emissions is embodied in the Kyoto Protocol⁵. The greenhouse gases targeted for reduction are carbon dioxide, methane, nitrous oxide, hydrofluorocarbons, perfluorocarbons, and sulphur hexafluoride. The emission targets are not for the specific gases, but instead for a combination of the six gases weighted by the relative warming effect of each gas, known as their Global Warming Potential; the higher this figure is, the more harmful the gas – see Table 1.

Carbon dioxide emissions come primarily from transport, business, households, and the combustion of fossil fuels in electricity generation – see Figure 1. Although CO₂ has the weakest global warming effect, the sheer scale of emissions from human activities across the world makes this gas the largest contributor to climate change.

The Kyoto Protocol came into force in February 2005. It covers 55% of global greenhouse gas emissions and is a legally binding commitment. The UK's target is to achieve a 12.5% reduction in greenhouse gas emissions from 1990 levels, averaged over the period 2008-2012. This represents the UK's share of a wider European Union (EU) commitment. The Government has also set a national goal of a 20% cut in CO₂ emissions by 2010. This was stated in the 2003 Energy White Paper as the first step in a strategy to achieve 60% cuts in CO₂ by 2050, and as part of the Government's desire to show international leadership on this issue.

The Climate Change Programme announced in 2000ⁱ contains a basket of measures through which the Government intends to meet these targets. UK-wide measures include the Climate Change Levy for business, the Energy Efficiency Commitment for households, a commitment to the EU Emissions Trading Scheme (EUETS), and a raft of other measures to encourage renewable energy and energy efficiency. The Devolved Administrations have separate plans to deal with devolved matters.

Table 1: Concentrations of principal greenhouse gases⁶

	Pre-industrial concentration	Present concentration	Rate of concentration change (1990-1999)	Global Warming Potential	Principal UK sources
Carbon dioxide (CO₂)	288 ppm	372 ppm	+1.5 ppm/yr	1	Fossil fuel combustion (oil, gas, coal)
Methane (CH₄)	848 ppb (0.848 ppm)	1843 ppb (1.843 ppm)	+7.0 ppb/yr	23	Landfills; animal agriculture; losses to the atmosphere of natural gas during production, transportation, and use; coal mining
Nitrous oxide (N₂O)	285 ppb (0.285 ppm)	318 ppb (0.318 ppm)	+0.8 ppb/yr	296	Agricultural soil management; fertilizers; fossil fuel combustion; industrial production of nylon

ⁱ The Climate Change Programme is currently under review and is expected to be updated during 2005.

2 Delivering clean energy: the role of wind

Currently the UK is on course to meet its Kyoto obligations for a 12.5% cut in greenhouse gas emissions during 2008-2012. A large percentage of the reduction achieved since 1990 is due to the commercially-led transition to gas-fired electricity generation. On CO₂, the latest Government projections show that under current measures the UK will only achieve a reduction of 14% by 2010, compared to the 20% target, and more will need to be done if the target is to be achieved. This is because for the last five years CO₂ emissions have stabilised after sustained reductions during the 1990s – see Figure 2. The scale of the task ahead should not be underestimated; the Government expects continued upward pressure on emissions due to more single-person households and continued growth in demand for transport and new appliances. It will therefore be a significant challenge for the UK to restart emissions reductions and achieve its stated goals.

Figure 1: CO₂ emissions by source, 2004⁷

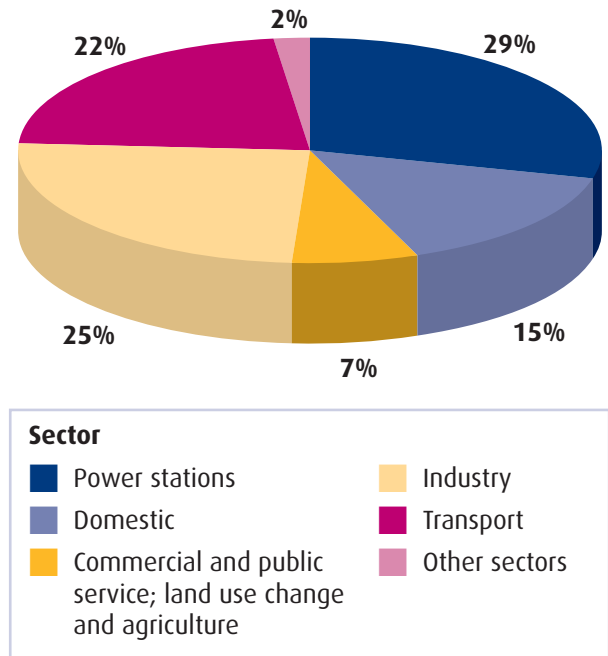
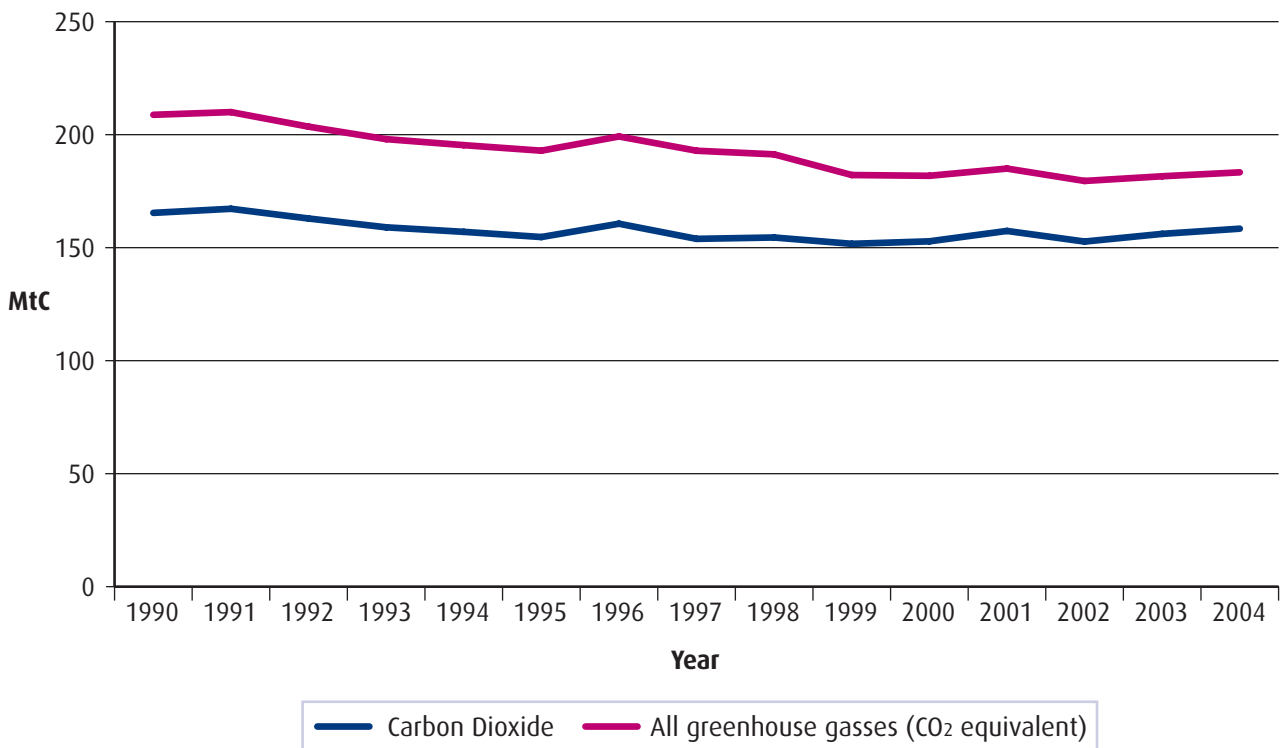

Figure 2: UK CO₂ and greenhouse gas emissions (MtC equivalent), 1990-2003^{7/8}



2 Delivering clean energy: the role of wind

2.3 Renewable energy targets

The drive towards a low carbon economy depends heavily upon the successful stimulation of renewable energy technologies, and these feature strongly in the 2003 Energy White Paper. The principal source of CO₂ is the burning of fossil fuels, including those used for generating electricity - coal, natural gas, and to a far lesser extent oil. The chemical nature of the fuel determines how much CO₂ is produced during the process, with natural gas producing substantially less than coal or oil. Most renewable energy sources do not produce any CO₂, hence the Government's stated intention to increase their use substantially, particularly in electricity generation.

The UK Government has set targets to increase the percentage of renewable electricity generation in total supply. These call for 10% of electricity to come from renewables by 2010, with the aspiration of 20% by 2020. The Devolved Administrations are committed to making an equitable contribution to these targets, and have set their own targets accordingly – these are summarised below. The Government is also relying on the English Regions to put regional policies and targets in place.

The primary mechanism for meeting the renewable energy targets across the UK is a Renewables Obligation on suppliers – this is explained in more detail in Box 1.

It is important to note that electricity represents about a quarter of the UK's consumption of primary energy, and is therefore only part of overall emissions. Transport and non-electric

heating together account for a much larger share of energy consumption and therefore action must also be taken to reduce emissions in these areas as well.

Scotland

The Scottish Executive is committed to making an equitable contribution to the UK Kyoto commitment and is working with the UK Government to meet its targets for reducing emissions. On renewable energy, it has set itself the further goal of generating 18% of Scotland's electricity from renewable sources by 2010 and 40% by 2020. Given the substantial wind resource available in Scotland and its leading competitive position among renewable sources, wind generation will be a major contributor to achieving this target.

Wales

The Welsh Assembly has set a target of 4,000 GWh to be produced from renewable energy sources by 2010, in order to contribute to the UK national target of producing 10% of its electricity from renewablesⁱⁱ.

Northern Ireland

Northern Ireland has an existing target to source 12% of electricity from renewables. However, the recent introduction of a Northern Ireland Renewables Obligation by the Department of Enterprise, Trade and Investment in April 2005 led to a decision to 'decouple' this target from the level of the obligation, which was set at 6.3% by 2012/13. This will increase yearly from a level of around 1.5% in 2003.

ⁱⁱ DTI generating plant statistics do not disaggregate for Wales, so it is not possible to calculate what percentage this is of total generation.

2 Delivering clean energy: the role of wind

English Regions

The Government expects the nine English Regions to play a key part in the delivery of energy policy objectives at the regional level. A number of regions now have their own renewable energy targets for 2010 and beyondⁱⁱⁱ.

Box 1

Renewables Obligation

There are a number of different ways of supporting renewable electricity generation, but after a public consultation between 1999-2000, the Government decided that a Renewables Obligation was their preferred solution for the UK's liberalised electricity market.

The Renewables Obligation (RO) was introduced in April 2002, and covers England and Wales. At the same time, Scotland introduced the Renewables Obligation (Scotland), and Northern Ireland has more recently introduced its own obligation, both with different levels of requirement. As all three Obligations are similar in design, further reference to the RO in this report can be taken as applying to the mechanism in general.

The RO requires electricity suppliers to source an increasing percentage of their electricity from renewable sources. The levels of the Obligation for England and Wales, and for Scotland, are set at 10.4% for 2010/11 and 15.4% for 2015/16. The RO is in place until 2027, giving a clear signal of commitment to investors and developers.

Electricity supply companies can meet their obligation by: presenting Renewable Obligation Certificates (ROCs) to the regulatory authority; by paying a buy-out fund contribution equivalent to £30/MWh (in 2002, rising each year in line with the Retail Prices Index); or a combination of the two. ROCs are issued to renewable generators for each 1 MWh of electricity generated, and are then bought by supply companies.

The RO is 'technology blind', meaning it does not favour one renewable technology over another. The result is that electricity supply companies will tend to choose the most cost-effective generation technologies, and for at least the next five years this will be primarily wind power, biomass and methane recovery (from landfill or coalmines). The Government recognises that this can make it difficult for less commercialised technologies to obtain investment and so it has a series of research & development and capital grant programmes to assist these technologies^{iv}.

ⁱⁱⁱ For example: Greater London Authority, East Midlands Assembly, and South East England Regional Assembly.

^{iv} Further details of these technologies and programmes to assist them can be found on the DTI Renewables website at www.dti.gov.uk/renewables

2 Delivering clean energy: the role of wind

Figure 3: Electricity generation by fuel source in 2004⁷

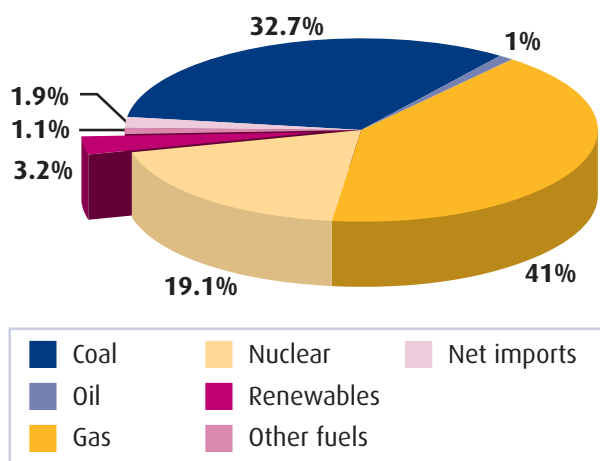

2.4 The role of wind power

Electricity supply and renewables

In 2004 total electricity sales in the UK were around 325,000 GWh¹⁵. This was met primarily by large, centralised power plants fuelled by natural gas, coal and nuclear – see Figure 3 for a breakdown by fuel source. Renewables supplied around 3.2% of total supply in 2004, much of this from large hydroelectric power plants built over the last 50 years and from the combustion of landfill gas. Figure 4 shows how total renewable electricity generation is broken down into different sources for 2003, the most recent year for which figures exist.

The Government has already indicated that there is little scope for further development of large hydropower schemes, due to space and environmental considerations. The renewables targets will therefore have to be met through a combination of other technologies, with the market naturally focussing on those that are most cost competitive. Until 2010, the most popular technologies are likely to be wind power, biomass (used both for co-firing in conventional power plants and in smaller, biomass-only plants), and

methane-recovery. Other technologies, such as tidal, wave, and solar photovoltaics are likely to play a small role, but their contribution in the longer term could be considerable.

Government policy is to encourage the development of a wide range of renewables – a summary of the main technologies available is given in Box 2.

An increasing role for wind power

Onshore wind power is already one of the cheapest forms of renewable energy per kWh, with the potential for even further cost reductions as the technology develops – see Chapter 4. Offshore wind is more expensive, but the industry expects costs to come down over time as experience is gained and the technology is improved. Due to its low cost, current predictions are that electricity supply companies will meet most of their Renewables Obligation to 2010 from wind power. Assuming a wind power utilisation factor, commonly referred to as the ‘capacity factor’, of 30%^v, 9,500 MW (9.5 GW) of installed wind capacity will produce around 25,000 GWh of energy, which when added to the 10,000 GWh that is already generated from renewables, is about 10% of current UK electricity sales and would therefore meet the 2010 target, if electricity consumption remains stable. In reality this target will be met from a variety of renewable energy sources, with on and offshore wind power as major contributors.

No substitute for energy efficiency

Using less energy is one of the cheapest ways of reducing carbon emissions – as discussed in Chapter 4. If the UK were able to cut electricity consumption whilst increasing renewable energy capacity, the effect on emissions would be more substantial, and future renewable energy targets would be easier to meet. The SDC believes that energy efficiency and the development of renewable energy go hand in hand.

^v See Chapter 3 for a discussion of capacity factors.

2 Delivering clean energy: the role of wind

Box 2

Renewable Energy Sources in the UK	
Biomass	Any fuel derived from organic matter, such as wood, oil crops, and agricultural & animal residues. Biomass can also be termed as biofuel, biodiesel, and biogas, and can be used for heat production, electricity generation and fuelling vehicles using a wide variety of conversion technologies. Biomass is renewable only when dedicated crops or forests are used or where replanting occurs. The carbon absorbed during growth will be equal to the emissions during combustion.
Geothermal	Traditionally, geothermal refers to thermal energy from the Earth's core. Heat and electricity can be generated by circulating water deep underground, where it is heated naturally by hot rocks. As an electricity generating option it is geographically specific, with good resources in parts of the US, and in Kenya and the Philippines. The term is increasingly used to cover near-ground energy stores, which can be exploited for low-level heat using a ground source heat pump. This latter option has good potential in the UK, although it does require an electrical input which (with the current electricity mix) will be only partially renewable.
Hydro	Makes use of the energy from moving water, usually by channelling water at high pressure from the top to the bottom of a dam or by making use of river flows to drive an electricity generator. The energy is obtained from the sun, which evaporates water from the sea and deposits it over land, giving it potential energy in the form of height. Although large-scale hydro using dams is still being developed around the world, UK developments will focus on small-scale, 'run of river' projects due to their lower environmental impact and smaller spatial requirement.
Solar photovoltaics (PV)	Solar PV uses high-tech solar cells (usually made from silicon) to produce electricity directly from sunlight. Although currently quite expensive, solar PV costs have fallen dramatically over time and further falls and technological improvements should be possible. Direct sunlight is not necessary and the cells can produce electricity even during cloudy conditions (at a reduced rate). Future applications for solar PV in the UK are likely to centre on building integrated solutions, such as cladding and roofing.
Solar thermal	Solar panels can be fitted to absorb heat from the Sun. This is usually used to heat water, primarily for domestic purposes, although industrial and commercial applications also exist. Solar thermal is exploited extensively in countries such as Cyprus and China, but so far has had limited penetration in the UK. It is now being given more encouragement. A solar thermal collector can provide around 60% of a household's hot water requirement over the year in UK conditions.

2 Delivering clean energy: the role of wind

Box 2 (Continued)

Renewable Energy Sources in the UK	
Tidal	Despite very large resources, tidal energy has not been successfully exploited on a wide scale. Tidal produced electricity is generated by making use of tidal water flows. It can be done by constructing a tidal barrage in an estuary and operating this like a conventional hydro dam – however, the environmental impacts are often prohibitive. Alternatively, turbines can be placed underwater in the tidal stream – these produce power from both in and out flows. Other variations are also possible. Tidal power is gaining increased interest in the UK, with a number of projects at demonstration and testing stage.
Wave	Waves transmit large volumes of energy from windy conditions far out to sea to the shore. Here the energy can be used to generate electricity and a variety of technologies are being developed to do this. The potential of wave energy in the UK is large due to our extensive coastline.
Wind	The subject of this report, wind energy is widely dispersed, although is greatest in high latitude locations. Wind has been used for centuries in windmills of various forms for grinding grain or pumping water. Modern wind turbines are available for both large and small scale electricity generation, and huge technological advances have been seen over the past 20 years.

Figure 4: Makeup of renewable electricity generation in 2003¹⁵

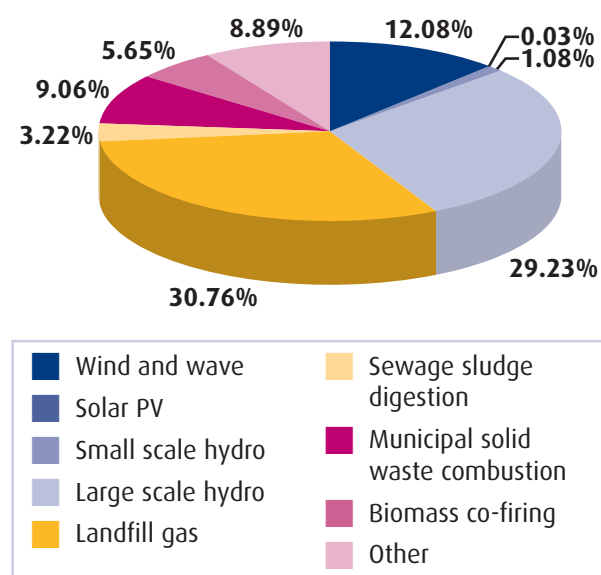

2.5 UK wind resources

The UK has some of the best wind resources in Europe, if not the world, in both onshore and offshore locations. This makes the British Isles a very attractive location for wind developments, as high average wind speeds and good reliability results in more power output and lower costs. Figure 5 shows the onshore European wind resources whilst Figure 6 shows offshore resources.

2 Delivering clean energy: the role of wind

Figure 5: European wind energy resources - onshore⁹

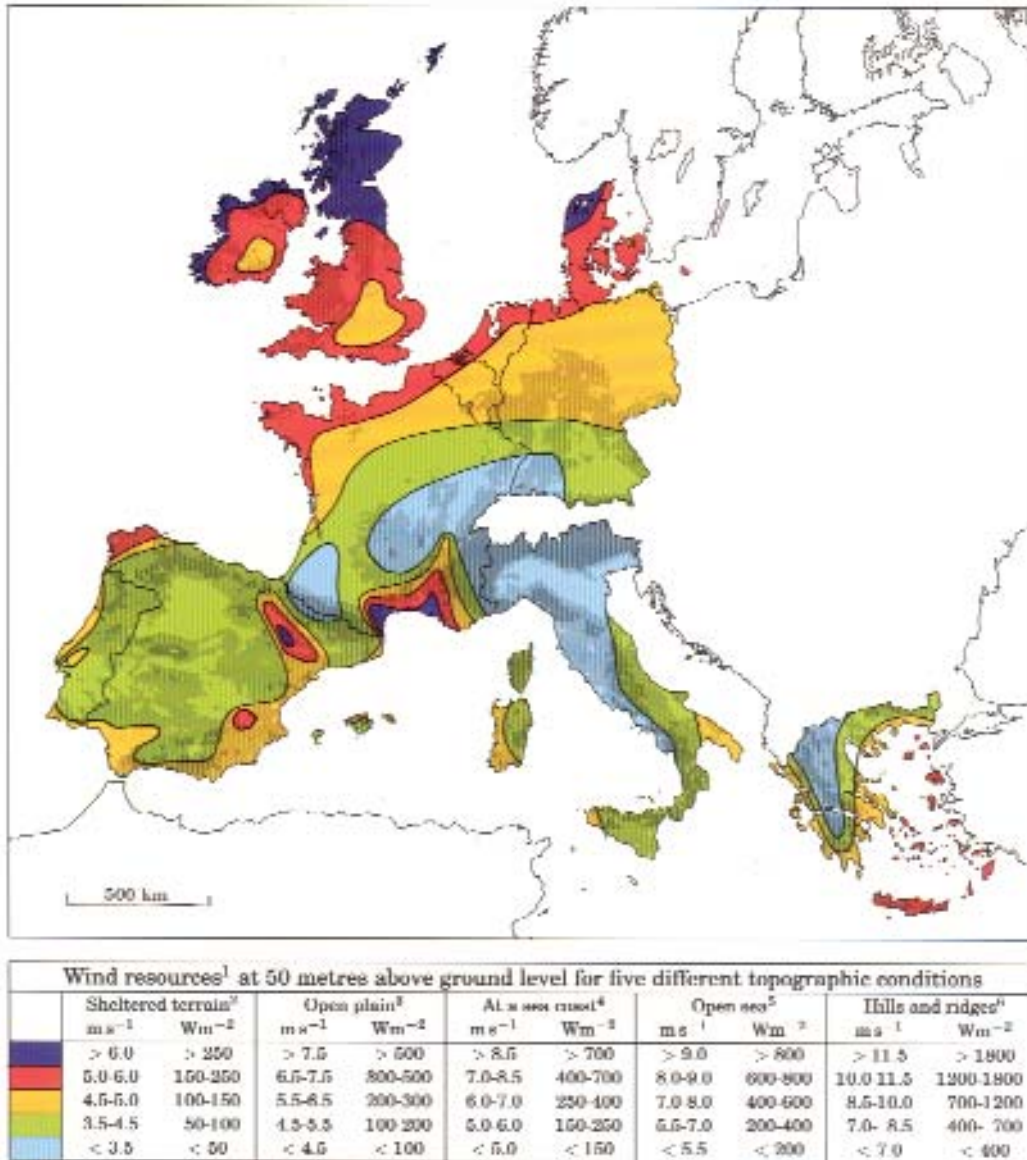

Onshore wind resource

Wind energy resource studies commonly quote a top-level 'theoretical' resource which is progressively reduced by including various constraints such as conservation areas, urban conurbations, low wind speed areas, unsuitable terrain, etc. This leads to the so-called 'technical' resource which is then further constrained by consideration of planning, environmental and

social issues leading to an estimation of the 'practical' resource. Table 2 gives some DTI predictions on the theoretical and practical onshore resource available in the UK¹⁰. Only about 34,000 GWh is needed to reach the 10% target for 2010 from *all* renewables, so there is more than enough onshore wind energy resource alone to achieve that.

2 Delivering clean energy: the role of wind

Table 2: Estimate of UK onshore wind energy resources¹⁰

Theoretical (GWh)	Practical (GWh)
1,000,000	50,000

A study entitled 'Scotland's Renewable Resource 2001' found that onshore wind energy in Scotland is "widespread and is the cheapest of the renewable energy technologies considered", with 11.5 GW of capacity identified as "available" at low cost¹¹. The Scottish Executive calculates that there is enough potential energy from onshore wind power alone to meet Scotland's peak winter demand for electricity twice over.

Figure 6: European wind energy resources - offshore⁹

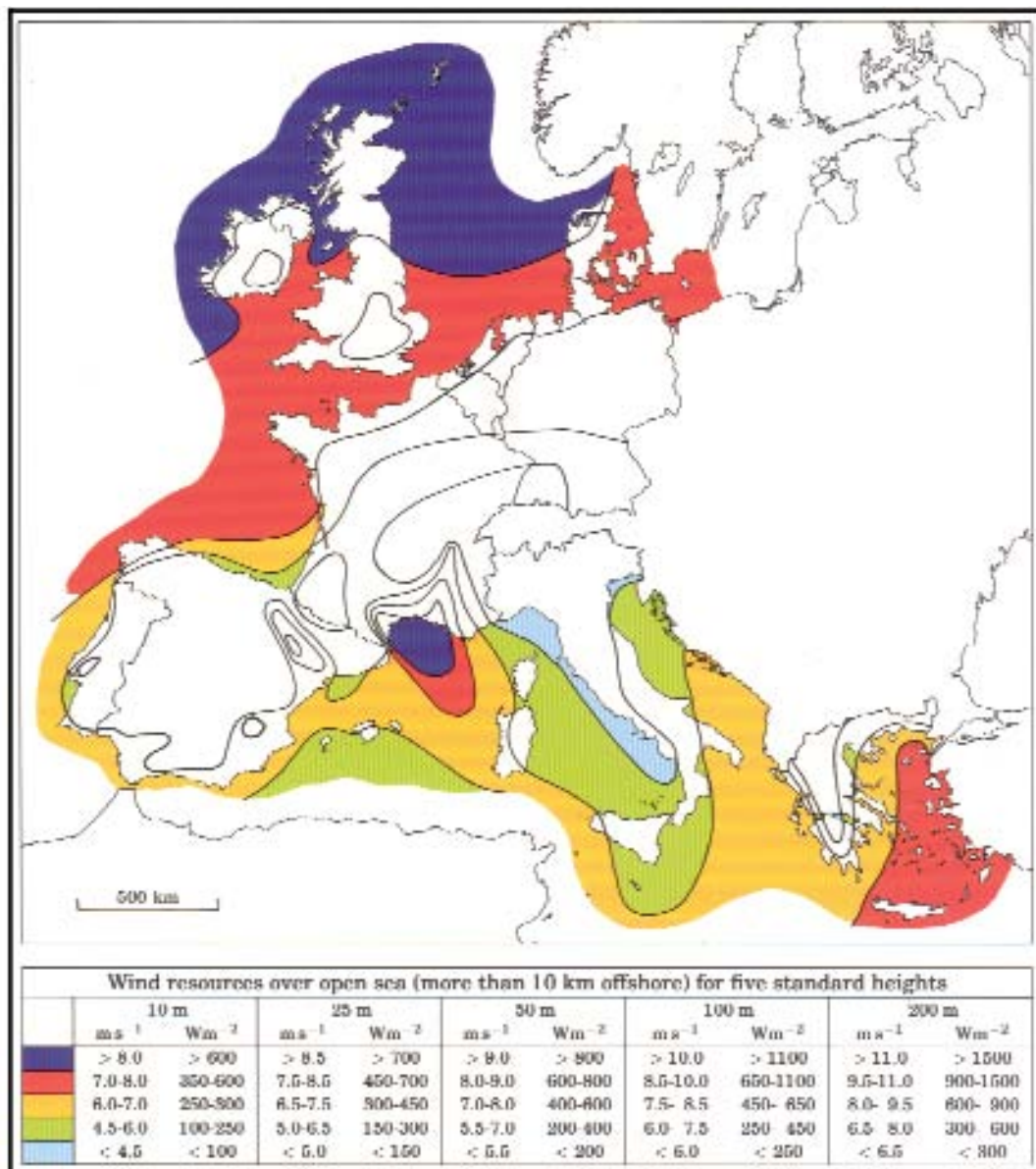

2 Delivering clean energy: the role of wind

Offshore wind resources

The UK's offshore wind energy resource is substantial, estimated at around 100,000 GWh of practical resource¹². The first phase of the Government's bid to release offshore sites for development saw 18 sites awarded leases to develop over 1,000 MW of capacity. The first offshore wind farms in the UK (North Hoyle, Scroby Sands and the Blyth Offshore pilot project) currently contribute 124 MW of offshore generation. These are the first of 12 projects that were granted funding under Round One of the UK Offshore Wind Development programme, the aim of which is to demonstrate offshore technology in the UK and make it commercially viable.

The Department of Trade and Industry (DTI) developed a strategic framework for the offshore wind and marine renewables industries following its 'Future Offshore' consultation in February 2003¹³. It then commissioned a Strategic Environmental Assessment (SEA) of three areas around the UK coast marked for development. Expressions of interest from potential developers of new offshore wind sites under Round 2 led to the letting of sites for 15 projects, with a possible combined capacity of up to 7,200 MW. Many of these projects are currently proceeding to the Environmental Impact Assessment (EIA) stage, and formal planning applications for the most advanced projects are expected to be submitted during 2005-2006. Of the capacity already consented

from Round One, some 500 MW is expected to be commissioned and generating by the end of 2005.

2.6 Current and future wind capacity

It is widely expected, both by Government and industry experts, that wind power will represent the majority of new renewables capacity in 2010 and 2020. There is currently 888 MW of wind energy connected to the grid in the UK, generating around 2,300 GWh of electricity per year¹⁴. During 2005 a further 600 MW is expected to be commissioned, with more in the pipeline – see Table 3.

Recent energy trends show that total electricity generation from renewables in 2003 (the most recent figures available) amounted to 10,600 GWh. There was a 12.5% increase in the installed generating capacity of renewable sources in 2003, mainly as a result of a 39% increase in wind capacity¹⁵. However, the majority of renewables generation in 2003 came from large hydro, waste to energy, and biomass plants – see Figure 4.

Current predictions are that there will be around 8 GW of wind capacity by 2010, made up roughly of 4 GW onshore and 4 GW offshore.

Table 3: Wind capacity status as of January 2005¹⁶

	Built (MW)	Under Construction (MW)	Consented (MW)
Onshore	764	600	1,100
Offshore	124	180	810
Total	888	780	1,910

3 Wind power technology and network integration

Summary

- The energy payback of wind farms has been estimated at 3-10 months
- Wind availability can be forecast to reasonable accuracy in the timeframe relevant to the electricity market
- As the penetration of wind output increases, additional balancing services are required – this is a cost issue rather than a technical constraint
- When wind energy accounts for around 6% of total electricity generation, it displaces conventional plant at around 35% of installed capacity, falling to 20% displacement when wind output reaches 20%
- There is no technical limit to the amount of wind capacity that can be added to an electricity system – the only constraint is one of economics

3.1 Wind turbine technology

Advances in design

Wind energy is one of the most commercially developed and rapidly growing renewable energy technologies in the UK and worldwide. The first UK wind project had ten 400 kW turbines in 1991; just 14 years later turbines of ten times that output are operating. This has involved achievements in engineering design, aerodynamics, advanced materials, control systems and production engineering to grow rotor diameters from 30m to 80m, tower heights from 40m to 100m, and power outputs from 200 kW up to 4 MW (4,000 kW).

Developments continue in many discrete technological areas to ensure that future turbines are more powerful, quieter, need less maintenance, capture more energy, are quicker to build and integrate better into grid operations. As more are built then both the economies of large-scale production and learning-curve effects should enable the wind energy industry, which is very capital intensive, to deliver electricity at lower cost. Further technical details on the components and design of modern wind turbines are provided in Annex A.

Power output

Wind turbines produce power over a wide range of wind speeds. They cut in at between 3 and 4 m/s, reach their rated output at about 13 m/s and are regulated to produce their maximum output through to 25 m/s, when they typically shut down to protect the drive train, gearbox and structure from potential damage – see Figure 7. This maximum speed is equal to 55 mph, which is above gale force 9, defined as when tree branches break. In the UK wind environment a wind turbine will be producing useful power for 70-85% of the year, equating to 6,000-7,500 hours per year.

Capacity factor

The term ‘capacity factor’ refers to the ratio of actual electricity production over what could have been produced by a plant running continuously at full capacity – for wind plant the capacity factor is often quoted over a year. It is similar to the term ‘load factor’, which is more often used when describing the operations of conventional plant.

Wind turbines have a lower capacity factor than conventional power plants because they will not be producing electricity at full output for most of the time. Individual wind turbines situated in the

3 Wind power technology and network integration

UK may have a capacity factor of 20-40%. The exact figure is dependent on location, technology, size, turbine reliability, and the wind conditions during the period of measurement – the capacity factor during the winter is therefore much higher than in the summer. Capacity factors are likely to be higher in the UK than in continental Europe due to our greater wind resources.

There is some disagreement over projected average capacity factors for UK wind farms. A figure of 30-35% is commonly used, but this has been challenged based on the poor performance during 2002 (24.1%) and a number of other years, when wind conditions were lower than average and quoted capacity factors were particularly low¹⁵.

This report explicitly uses the higher figure of 35% in its cost calculations, in line with the assumptions taken by Dale et al¹⁷ in their estimate of the 'system cost' of wind power, see Chapter 4. As their calculations (and a number of others in this report) are based on assumptions for 2020, a higher capacity factor is justifiable because capacity factors are expected to rise over time due to the exploitation of windier sites (in Scotland and Northern Ireland especially), increased offshore development (where wind conditions are more stable – capacity factors of 40% are expected¹³), and improved technology and reliability. A lower capacity factor of 30% is used in Chapter 2 of this report as this figure relates to 2010, by when less of an improvement can be expected.

Design life

The average design life of a wind turbine is about 20 years. After this time, the turbine site could be refitted using the latest technology (often termed as 'repowered') or decommissioned; the latter is sometimes a requirement of a planning decision and a new planning application would be required for refitting to occur. However

repowering is a very practical and economic option and has already been done in the UK.

3.2 Energy balance

Although wind turbines do not produce greenhouse gas emissions when generating electricity, they are responsible for some 'embodied' emissions resulting from the energy used in their manufacture. This is because the current energy mix is primarily fossil fuel based. All electricity generating technologies, including renewables, will require energy during manufacture, construction and operation, so the energy balance issue does not apply just to wind power.

However, the energy balance, or 'payback', of wind power is often mentioned as a factor that limits its effectiveness. There are a number of studies on this subject, although because of the wide variations in assumptions that can be used, care should be taken when comparing different studies. Most studies suggest that wind turbines take between 3 to 10 months to produce the electricity consumed during their life-cycle - from production and installation through to maintenance, and finally decommissioning¹⁸. The House of Lords Science & Technology Select Committee reported a figure of just over one year for onshore wind²². A more recent study by the wind turbine manufacturer, Vestas, calculates life-cycle energy values for two operational wind farms in Denmark (onshore and offshore) using modern 2 MW machines¹⁹. The results put energy payback at just under eight months for onshore turbines, and nine months for offshore machines. The difference is due to the greater amount of construction materials (steel and concrete) needed offshore and the need for more extensive grid connections. If anything, these figures are likely to be lower in the UK due to superior wind resources over Denmark, leading to more energy production and a quicker payback period.

3 Wind power technology and network integration

Figure 7: Typical wind turbine power curve illustrating electrical power generated at key wind speeds²⁰

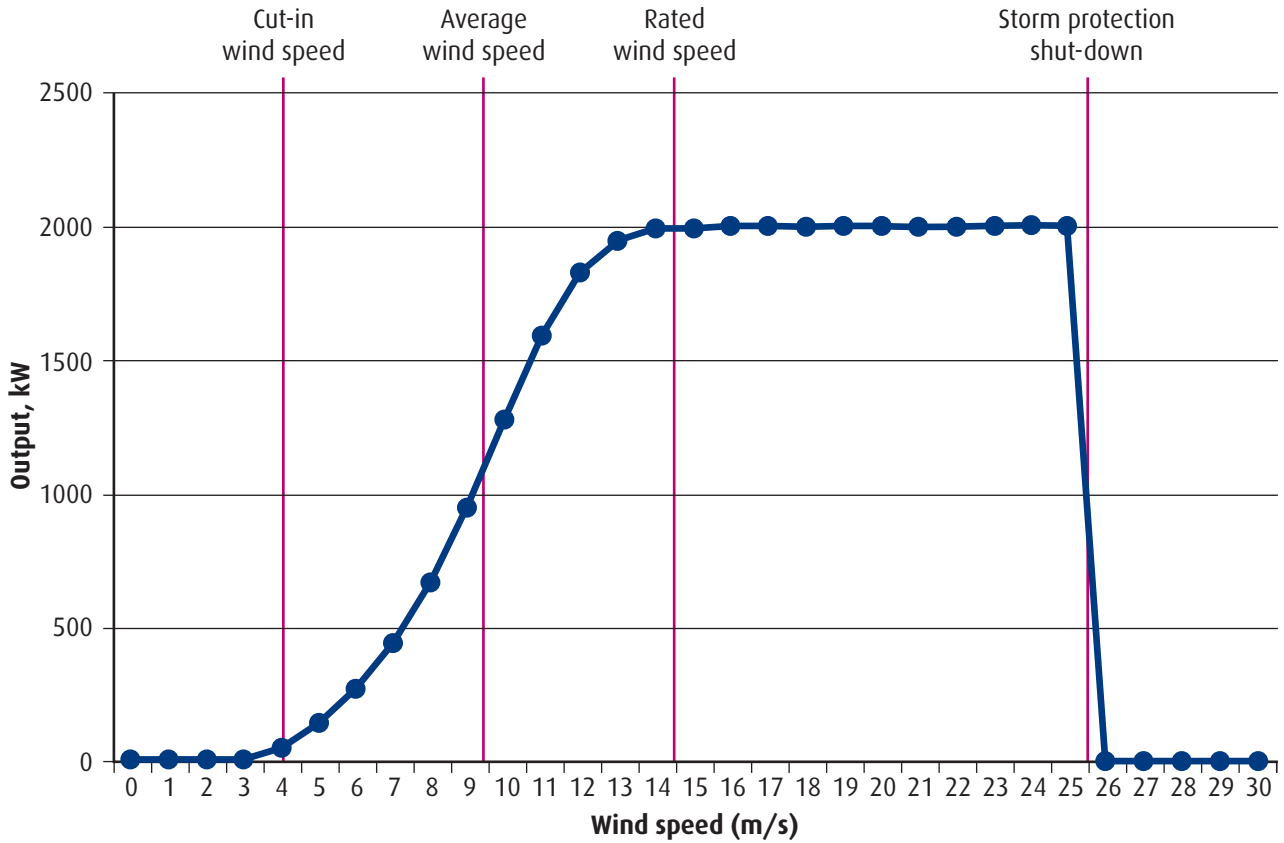

3.3 UK electricity supply system

The UK's electricity supply system is designed to ensure that generation and demand are matched at all times. The system consists of large, centralised generating plants connected directly to the high voltage transmission system which spans the country. This connects to localised distribution networks, which deliver the electricity to the end-user at a lower voltage using a combination of overhead and underground cables.

Great Britain's (GB) electricity system is one of the world's first fully liberalised electricity markets (see Box 3), with generating plants, the national grid system, distribution network and supply companies all privately-owned and operated under the regulation of Ofgem (The

Office of Gas and Electricity Markets). The national grid is run by National Grid Company (NGC; wholly owned subsidiary of National Grid Transco), who are responsible for ensuring the reliability and quality of electricity supply. Strict rules and targets are in place for them to follow and any serious deviation can result in a heavy fine.

Box 3

BETTA (and NETA)

The British Electricity Trading and Transmission Arrangements (BETTA) came into operation in April 2005 to cover the whole GB electricity grid, replacing the New Electricity Trading Arrangements (NETA) that were introduced in March 2001 and covered just England & Wales. Under BETTA (and NETA before it), electricity is traded through bilateral contracts between generators, electricity suppliers and customers across a series of markets operating on a rolling half-hourly basis. National Grid Company (NGC), the system operator of the GB electricity transmission system, operates a balancing mechanism to ensure system security at all times. Generators are out of balance if they cannot provide all the electricity they have been contracted to provide or if they have supplied too much. Suppliers and customers are out of balance if they have consumed too much or too little. Market experience and adjustments since the introduction of NETA have reduced price volatility in the balancing mechanism such that the penalties for generators of less predictable sources of electricity such as wind power are relatively small.

Although the majority of wholesale electricity is traded over long-term contracts between generators and supply companies, NGC must ensure the real-time matching of supply and demand.

The capacity of the GB electricity system is currently around 75.5 GW, with a peak winter demand of 62.7 GW²¹. The minimum load in an average year is roughly 20 GW – this would normally be experienced in the very early hours of a warm summer morning.

The Northern Ireland electricity system is fully connected with the Republic of Ireland system, and has a 500 MW interconnector to Scotland. Total generating capacity in NI (including the interconnector) is currently 2.15 GW, with a peak demand of 1.67 GW.

3.4 Balancing the system

Variable demand

The demand for electricity, or load, changes throughout the day and is dependent on a large number of factors, including the weather

(temperature, wind speed), daylight conditions, the time of day, and TV schedules. On a typical winter day the load increase can reach up to 12,000 MW in two hours over the morning load pickup period as shown in Figure 8. The system also has to deal with more sudden increases in demand, such as those seen during or after TV programmes. In 1990 the end of extra time in the World Cup semi-final between England and Germany resulted in a demand surge of 2,800 MW over a few minutes, the largest ever recorded for a TV programme.

Synchronised tea-making

If the 25 million kettles estimated to exist in the UK were used at once, the 75 GW demand would be equal to the maximum installed capacity on the grid. Any additional demand, from lighting or industry, would overload the system and lead it to fail. This illustrates how the system is designed to rely on aggregate behaviour rather than deal with every remote possibility.

3 Wind power technology and network integration

As well as coping with steep demand changes the electricity system must also be able to deal with sudden losses of supply. This could be a fault at a large power station or the loss of a major transmission line. The system is therefore designed to withstand the loss of the largest operational unit, which currently equals 1,320 MW of capacity (Sizewell B nuclear power plant).

Quality of supply

The electricity system has an inherent level of inertia that is represented through changes in frequency, which is allowed to deviate from the target of 50 Hz by a small margin of 1%. Fluctuations in frequency are a direct measure of the balance between demand and generation in an AC power system and in order to maintain a stable frequency, and therefore quality of supply, the system operator contracts for a number of balancing services.

In the time horizon of less than a minute, frequency is controlled automatically through frequency response services, which are contracted by the system operator. Frequency response is primarily provided by large, central generators (>100 MW) equipped with appropriate governing systems that automatically change active power output in response to a change in system frequency.

In addition, reserve is required for the management of system frequency after a sudden and sustained loss of generation or increase in demand, and is provided by both generating plant and load reductions from some

industrial customers. If system frequency is too low (ie. there is a shortage of generation to meet demand), the operator can call upon allotted reserves, such as conventional plant running at reduced capacity (often called 'spinning reserve'^{vi}) and storage facilities, such as the two pumped storage plants in Wales^{vii}. Load reduction, also a form of reserve, is achieved through demand management. This service is provided by some large industrial customers, who are able to respond to a request to reduce their demand, for which they receive a payment.

In summary, the system operator needs to manage both predictable variations in demand (such as managing morning load pickup) but also deal with unpredictable events such as outages of generators and errors in demand forecasts. Such losses of supply can amount to over 1,000 MW in less than a few seconds, but the system is capable of dealing with this through the use of balancing services, as described above.

^{vi} Spinning reserve is the term used to describe conventional plant which is purposely operated at lower than maximum output in order to provide a quick increase in output at the request of the system operator. Plant operated as spinning reserve is less efficient than when at maximum output, and the generator will usually receive a payment for this service.

^{vii} Pumped storage plants use cheap electricity in off-peak periods to pump water from a lower to a higher reservoir. They can then be called upon during peak periods to release this water back down, providing response output in around 10 seconds. They are a relatively efficient way to provide rapid reserve response.

Figure 8: Typical winter demand, Tuesday 3rd December 2002²¹

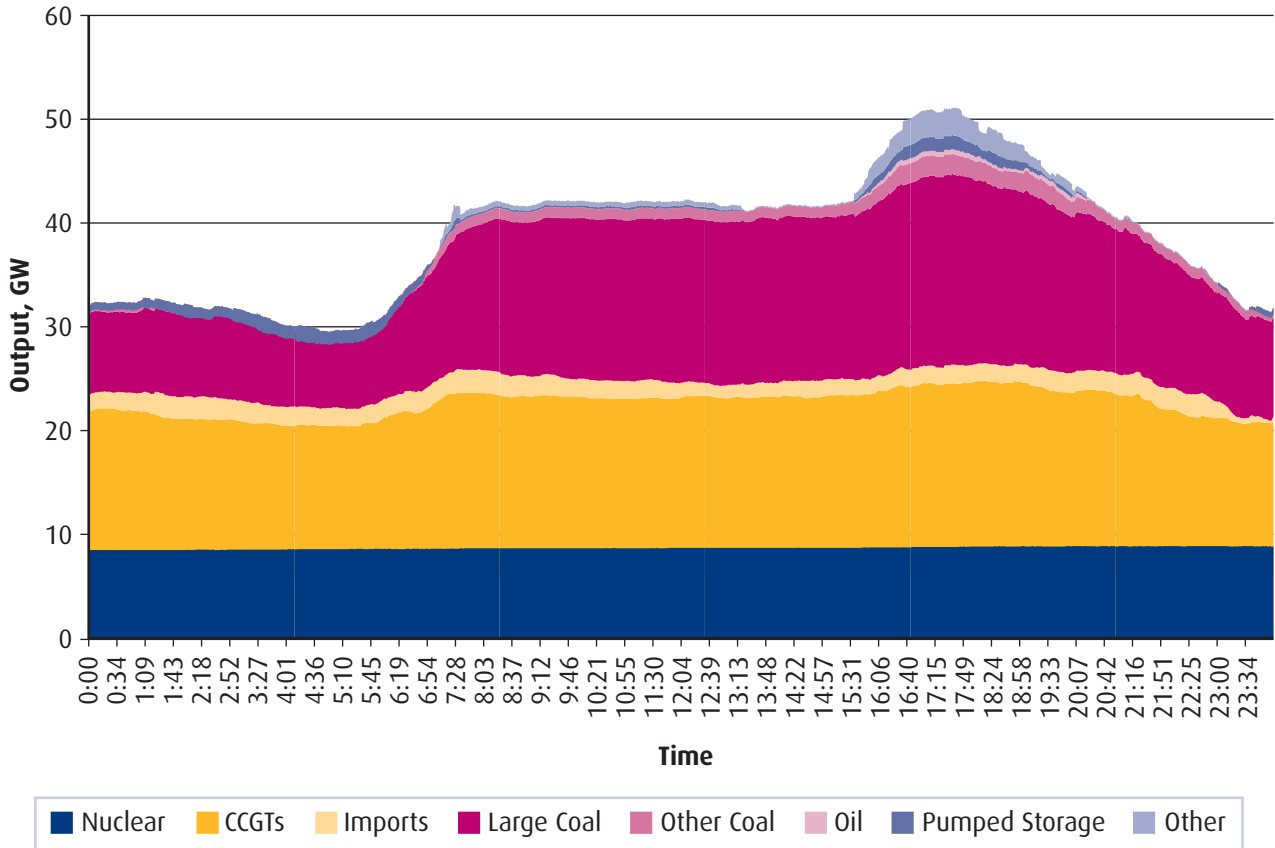

3.5 Capacity and flexibility of wind power

The need for reserves

It is commonly assumed that adding significant wind power capacity to the electricity system will lead to a large expansion in the need for balancing services, particularly reserves. This is due to an implicit assumption that the intermittent output of wind power results in the need for large amounts of reserves devoted entirely to providing standby power for wind output – this is often referred to as ‘backup plant’. Therefore, if the average output of wind plant is 35% of its rated output (its capacity factor), the remaining 65% must be provided as reserve, or backup capacity.

This reasoning is seriously flawed, for three key reasons:

- No generating plant is 100% reliable. Therefore, reserves are required to cover for unexpected outages on all plants.
- The rated capacity of the total installed wind plant is of minor interest to system operators, who make supply security assessments based on estimates of overall statistical probabilities for the complete generating mix. This leads to the concept of ‘capacity values’, described below.
- Wind power is often described as ‘intermittent’, which implies a high level uncertainty as to its actual output, but it can be quite accurately forecast in the appropriate timeframes for balancing electricity supply. A

3 Wind power technology and network integration

more precise term might be 'variable', especially when considering aggregate output, which benefits from the wide distribution of wind turbines across the country.

Instead, system operators assign all generating plant a 'capacity value' (often called 'capacity credit'), which refers to the ability of that plant to contribute firm capacity to the overall system. High availability plant such as combined cycle gas turbine (CCGT) can have a capacity value of up to 90%, meaning 10 GW of gas plant would be treated as providing the system with 9 GW of firm capacity – the remaining 1 GW allows for outages, both scheduled and unscheduled. Existing nuclear plant in the UK has recently shown lower capacity values of 75%, due to a number of problems at individual plants.

No plant has a capacity value of 100%, because there will always be some statistical probability that it will not be available when required. When determining reserve requirements, system operators make an assessment of the needs of the system as a statistical whole rather than considering the needs of each individual plant. This leads to a treatment of wind output that is different than if it were the only generating source available.

Capacity value of wind

Due to the variability of wind power, its capacity value is more limited, as it will not be possible to displace conventional generation capacity on a 'megawatt for megawatt' basis. The capacity value decreases as more wind is installed on the system; at low penetrations it has been put at roughly equal to the capacity factor for wind (30-35%), but at higher penetrations the value decreases. This is because with low penetrations wind output is hardly noticed on the system, but when this increases, the variability of wind becomes more noticeable and its ability to provide firm capacity is reduced. National Grid

Company have stated that 8,000 MW of wind capacity would displace 3,000 MW of conventional plant, with 25,000 MW displacing the need for 5,000 MW. This means that wind power has a capacity value of around 35% at penetrations of around 6%, declining to around 20% at penetrations of 20%. These figures, along with other corroborating evidence, were accepted by the House of Lords Science & Technology Select Committee in their 2004 report into renewable energy²².

It is worth noting that the capacity value of wind is higher in the winter than in the summer, in line with seasonal changes in the capacity factor. This means there is a correlation between the capacity value and times of peak demand.

Lower capacity values have been reported in other countries. For example, a recent report by E.on Netz, one of Germany's network operators, with 44% of that country's wind capacity, quotes an average yearly capacity factor of just over 15%²³. However the UK's greater resource means that capacity factors and the associated capacity values tend to be higher than most other European countries and comparisons can therefore be difficult. In addition, the integrated nature of the GB electricity grid, differing trading rules (eg. gate closure times), and its wide geographical distribution, separates it from some of the other problems faced in Germany.

Wind forecasting and distribution

Wind conditions may not be that easy to predict over the course of days or weeks, but forecasting for the next few hours has become quite accurate. Figure 9 illustrates this by showing a typical 1-hour wind forecast against actual output for one wind farm over a period of a week. The total output of all wind capacity will be less variable, as it will be made up of a large number of wind farms spread throughout

3 Wind power technology and network integration

the country. It therefore follows that greater geographic diversity in wind farm locations is beneficial to the combined output profile of wind power.

The GB electricity supply market operates with a one hour 'gate closure', meaning that contracts to supply electricity have to be agreed one hour in advance. By this time the system operator and other market participants will have a good idea of the likely contribution of wind power within the overall system, and other plant will be scheduled accordingly. Any shortfall in predicted wind output will then be met by the routine use of balancing services.

The accuracy of wind forecasting will continue to improve as more sites are developed and forecasting models are refined.

Accommodating wind power

It should now be clear that accommodating significant amounts of wind capacity on the electricity system is not likely to pose any major operational challenges, and this view has been confirmed by the GB system operator, National Grid Company. It is also the conclusion of a comprehensive report on this issue commissioned by the Carbon Trust and DTI²⁵. At higher wind penetrations, the capacity value of wind is indeed reduced, and this does lead to additional balancing requirements. However, this represents a cost rather than a barrier, as additional reserve requirements will lead to an increase in systems costs – this is explained further in Chapter 4.

On an operational level, wind power has one distinct advantage when compared to large centralised plant. Faults at conventional plant can cause a large instantaneous loss of supply

Figure 9: Wind farm forecast (+ 1 hour) Vs actual output, Ireland 2004 (data provided by Garrad Hassan)²⁴

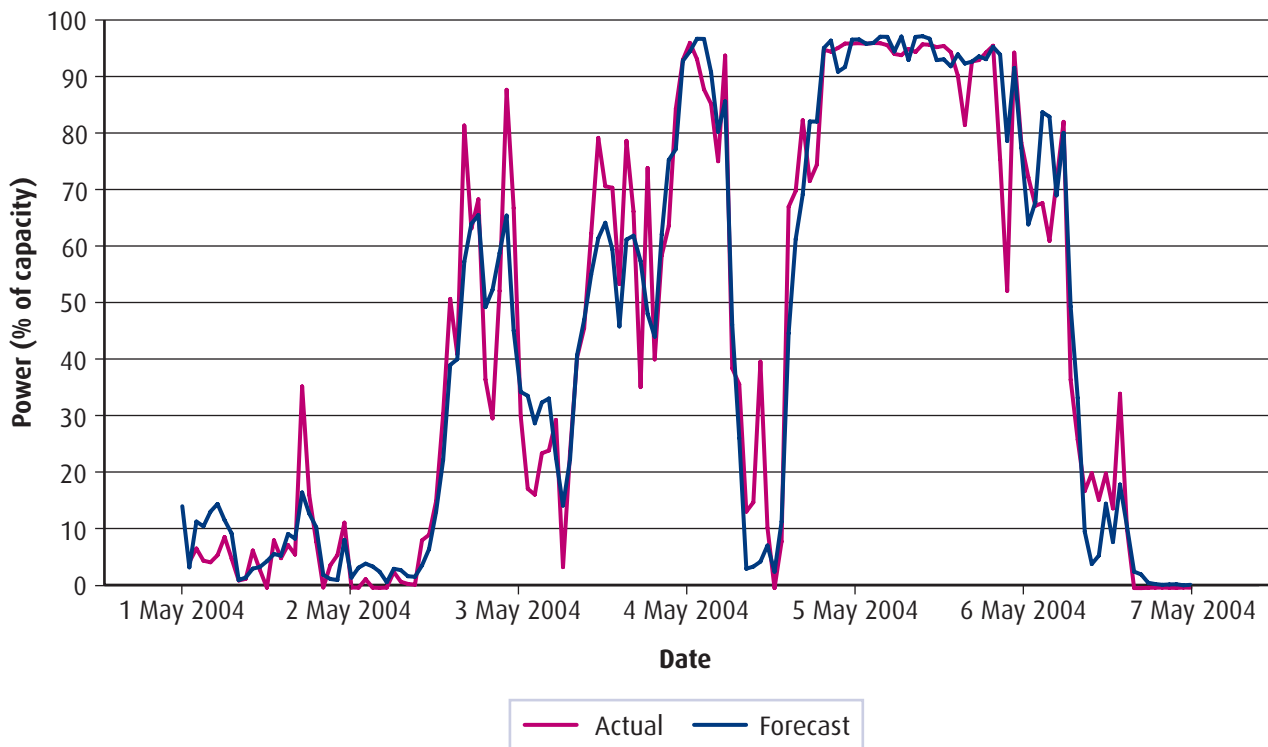

3 Wind power technology and network integration

that must be dealt with using a full range of balancing services. In contrast, combined wind output does not drop from the system in the same way, even under extreme weather conditions (too much, or no wind). Variations in wind output are smoother, making it easier for the system operator to manage changes in supply as they appear within the overall system.

There is often some confusion between the additional reserve capacity needed for wind and the 'plant margin' – the extra capacity that any electricity system needs, over and above the likely peak demand. It is sometimes implied that an extra plant margin is needed to provide the additional reserve capacity to cover for wind, but this is also misleading. Analysis of the effect of integrating 20% wind output shows that although the apparent plant margin is higher, this is simply because the capacity factor of wind plant is lower. In reality, some conventional plant will have been displaced (because of the capacity value of wind), meaning the higher plant margin consists solely of wind plant, because of its lower capacity factor. The additional reserve capacity required to integrate wind energy will therefore be provided by the remaining thermal plant. This issue is explained in more detail in Annex B.

Future reserve options

As already stated, the additional reserve requirements related to the variability of wind could be provided by increasing the use of storage and more emphasis on demand management. These are further explained below:

- **Demand management:** There is scope for a considerable expansion in demand management services, with the possibility of domestic and commercial appliances such as refrigerators being able (with the appropriate technology installed in them) to respond to a drop in frequency by temporarily switching themselves off, without damaging the food inside.
- **Storage:** In the longer term there is the possibility of much greater use of storage, although at present this is seen as an expensive solution. The UK already has several pumped storage plants, but future storage solutions could rely on developing new large-scale 'battery' technologies, or compressed air energy storage.

These options may become more attractive as the percentage of intermittent renewables on the national grid increases and as technologies improve. A large increase in electricity prices would also provide a big incentive, particularly for storage. They both offer low or lower-carbon alternatives to increased use of reserves (which, as shown below, may come from inefficient plant), although in reality all available options will be utilised to some degree.

3.6 Displacement of fuel use and emissions

As nuclear plant currently provides the primary base load of electricity supply, wind generation is likely to displace coal and gas-fired plant. This is illustrated well by Figure 8, which shows how coal generation is the primary load-following (marginal) plant. It is therefore reasonable to assume that wind power output will mainly displace coal, at least in the short to medium term. In the longer term, with greater reliance on gas-fired plant, significant wind penetration, and any increase in the price of gas relative to coal, wind may also begin to displace gas, but this will depend heavily on the actual fuel mix in the future and the extent of demand management and storage options.

It should be noted that the plant displaced by wind, and the plant needed to meet additional reserve requirements are not necessarily the same types of plant. Plant used to provide additional reserve requirements might be the same type as displaced plant, but not necessarily.

3 Wind power technology and network integration

As discussed, some additional reserve may be required by the system operator when wind power penetration becomes significant. Running plants at reduced output is less efficient and so a small amount of additional fuel is used for this purpose. However, the additional fuel requirement will be far less than the total amount of fuel displaced by the wind generated electricity. When wind produces 20% of total output, it is estimated that the emissions savings from wind will be reduced by a little over 1%, meaning that 99% of the emissions from the displaced fuel will be saved¹⁷.

3.7 Limits on wind capacity

The capacity of an electricity system to absorb wind generation is determined more by economics than by absolute technical or practical constraints. As the percentage of wind generating capacity rises, so do the technical and network reinforcement issues that will require resolution. All of these are to some degree influenced by the technologies available at the time, and future technological innovations make the determination of long-term absolute limits unreliable – for example electricity storage developments could make higher wind penetrations possible.

The most obvious practical constraint on wind capacity occurs when peak wind output exceeds the lowest period of demand on the grid system (ie. a windy summer night), allowing for the requirement for some base load plant to continue operating. At this point excess wind capacity will need to be curtailed, and this has an economic cost for wind plant. Technical constraints include the ability of wind plant to respond to system faults, and this is related both to the type of wind turbine technology used and to the dispersal of wind generation on the

network. Improvements in turbine technology and network reinforcement are both possible solutions, again with possible cost implications.

It is generally considered that up to 20% wind capacity penetration is possible on a large electricity network without posing any serious technical or practical problems. Indeed, there is no absolute technical limit to UK wind capacity – instead the issue is an economic one, with higher penetrations leading to increased unit costs. The following statement from National Grid Company confirms this:

“We believe that, if there is a limit to the amount of wind that can be accommodated, that limit is likely to be determined by economic/market considerations.”⁶⁶

Much larger percentages are certainly possible – up to 100% if large-scale storage and greater interconnector capacity is available, possibly combined with wind plant curtailment^{viii} – but the additional cost would substantially increase. In parts of the UK, high local rates of wind penetration will require substantial investment in network upgrades, and economic considerations may currently limit the ability of the local grid to absorb wind capacity.

FURTHER INFORMATION

“Renewables Network Impacts Study” – Carbon Trust / DTI -

[http://www.carbontrust.org.uk/carbontrust/about/publications/Renewables Network Impact Study Final.pdf](http://www.carbontrust.org.uk/carbontrust/about/publications/Renewables%20Network%20Impact%20Study%20Final.pdf)

^{viii} Curtailment would occur when the combined output from wind plant exceeds the load on the system; this is only likely when there is a high penetration of wind power on the system and high winds coincide with a period of low demand.

4 Costs and benefits of wind

Summary

- The generation costs of onshore wind power are around 3.2p/kWh, with offshore at around 5.5p/kWh – this compares to a wholesale price for electricity of around 3.0p/kWh
- The estimated net additional cost (the ‘system cost’) of providing 20% of total output from wind energy in 2020 is 0.17p/kWh based on current gas prices
- If the social cost of carbon is included, the net additional cost of wind power is reduced, and could be zero

4.1 Background

Increasing the use of wind power, and renewables in general, will add some additional costs to the overall cost of electricity. This is because at present wind power is not the cheapest form of power generation, and there are a number of additional system costs that need to be accounted for – for example, balancing and network reinforcement, as described in the previous chapter. Higher costs for carbon-free electricity generation are not limited to renewables; most commentators agree that reducing CO₂ through the greater use of nuclear power or carbon sequestration and storage would also be more costly than new gas-fired plant and would also require some form of public support. The question then is whether the cost of increasing renewable electricity generation is acceptable within the context of the Government’s stated energy policy, and its ultimate goal – to reduce emissions of CO₂. To prepare the UK for the tough challenges ahead, the Government has accepted the need to stimulate investment in environmentally sustainable technologies that are more expensive now, if they have the potential to become competitive over time. Public support mechanisms for renewables are an example of this policy, and should be considered in this context.

There are some variations in different calculations of the costs of meeting the renewable energy targets primarily through

wind power. Many of the estimates of the cost of wind power differ in their basic assumptions, making any comparison very difficult. There is also confusion over what costs are being presented – the unit cost of wind power at the point of delivery, the cost to the system which must incorporate wind power, or simply the cost to the consumer and taxpayer who has to pay for it.

This chapter will explain the background to wind generation costs, before looking at system costs and the cost of public support for renewables. This is followed by an analysis of the alternatives to wind power and how these can be expected to fit in to future electricity supply.

Further details on the components of wind power costs are included in Annex B.

4.2 Calculating generation costs

Attention tends to be focussed on the ‘generation costs’ of renewable technologies for comparison with those of the conventional sources of generation. Generation costs, for all technologies, depend on two sets of parameters:

Technology specific

- The installed cost of the plant, including interest during construction
- Operation and maintenance costs

4 Costs and benefits of wind

- Fuel costs – zero for wind, wave and solar, positive for coal, gas, nuclear and energy crops, negative for ‘energy from waste’
- The efficiency of the plant, in the case of thermal sources of generation and the energy productivity, in the case of wind, wave and solar. The latter is normally expressed in terms of kWh/kW of capacity, or a ‘capacity factor’, which is simply the ratio of the average power to the rated power.

Financial

- Cost of capital, or test discount rate
- Capital repayment period

These financial parameters determine the ‘capital cost’ element of generation costs. As most renewable technologies are capital intensive they are more sensitive to changes in these parameters, as illustrated in Table 4^{ix}. With a 5% discount rate, wind appears to be only 0.3p/kWh more expensive than gas, but with a 10% discount rate, the gap widens to 0.9p/kWh.

Usually, private sector investments will use a higher discount rate than those commissioned by the public sector and this makes financing parameters heavily dependent on national institutional frameworks. In Denmark, for example, the utilities generally use public sector parameters – typically interest rates of 5%, with capital repaid over the life of the plant. In the United States, however, there are no fixed criteria; discount rates are mostly in the range 8-10%, with capital repaid over periods of between 15 and 20 years. As the UK’s energy industry is fully liberalised, higher rates may well apply.

Table 4: The effect of the discount rate on generation costs²⁶

Plant	Test discount rate, %	Gencost p/kWh
CCGT (gas)	5	2.1
	10	2.3
Wind	5	2.4
	10	3.2

The technology specific parameters are, broadly speaking, independent of the location of the plant, although, in the case of wind, there are significant differences between wind speeds – and wind energy productivity – in different geographical locations. Figure 10 shows the effect of different wind speeds on the generation cost of wind power using two indicative installation costs (high and low estimates) for both onshore and offshore developments. As can be seen, a 1 m/s increase in wind speed can reduce generation costs by around 25%.

There is an additional factor, however, that can mask the underlying costs of renewable energy technologies. As most are not yet competitive with the conventional sources of generation, various types of support mechanism have evolved. These mechanisms may or may not promote ‘cost reflectivity’ – ie. they may not accurately reflect the true cost of the renewables they are supporting. The Renewables Obligation is the Government’s current support mechanism, and the public cost of this is likely to be higher than the renewable generation it is supporting, making it a poor guide to the real cost of those renewables. This point is discussed in more detail later.

^{ix} The absolute values for CCGT may now be out of date, due to changes in the price of gas since the report was prepared.

Figure 10: The effect of wind speed on the generation cost of wind power

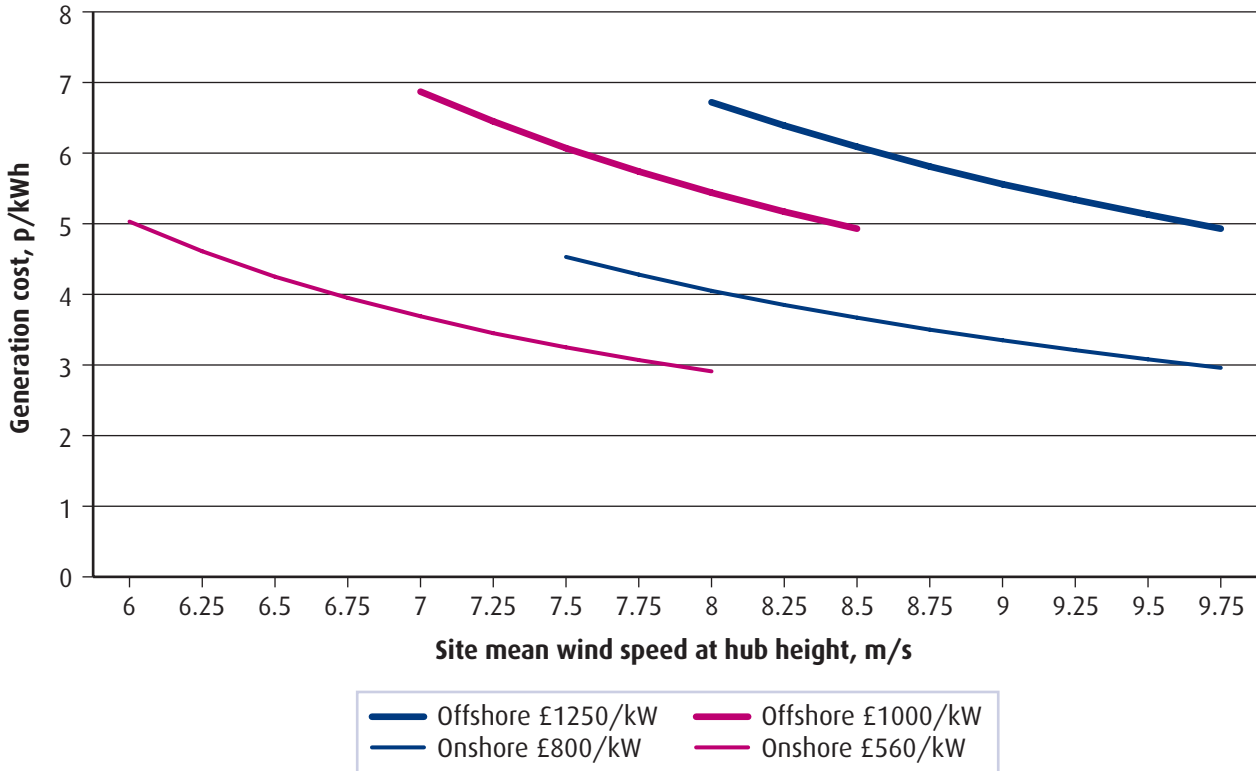

4.3 Wind power generation costs

Present-day wind power generation costs need to be calculated, as the Renewables Obligation masks them. However, its predecessor, the Non-Fossil Fuel Obligation, did offer 15-year contracts, so data from the final bidding rounds is a good guide²⁷. (No allowance has been made for inflation, nor for the steadily reducing costs of the plant; although these two influences will cancel out to some degree). Table 5 includes data from 3 sources considered to use either robust analysis and/or real data, in order of publication date:

- Oxera²⁸: An analysis carried out for the DTI
- WPM: A recent analysis which examined cost data from over 3,300 MW of wind around the world²⁹. Two figures are quoted; for “high” and “low” installed costs.

- IEA³⁰: Recent data from Denmark, which has a wealth of wind energy experience

There is a reasonable degree of consistency between these estimates. The Danish estimates are lowest, in each case, reflecting the use of a low discount rate and long repayment period. Excluding these, the average generation cost from onshore wind in the UK appears to be around 3.2p/kWh (+/-0.3p/kWh), and the generation costs from offshore wind are around 5.5p/kWh.

These prices may be compared with the latest estimates for the wholesale electricity price in the UK market. The average for 2005 is likely to be around 3.0p/kWh³¹. This has risen over the past year, simply because the price of gas has increased, and it tends to reflect the price of baseload generation from gas-fired plant.

4 Costs and benefits of wind

Table 5: Summary of wind generation costs

Source	Capital cost, £/kW	O&M, £/kW	Capacity Factor, %	Tdr %	Life	Gencost, p/kWh	Comments
Onshore							
NFFO5	-	-	-	8 ^x	15	2.9	Average price
Oxera	605-800	15	30	?	20	3.1	
WPM	800	n.q.	36	6	15	3.3	'High' cost, 8.5 m/s site
	550	n.q.	27	6	15	3.0	'Low' cost, 7.2 m/s site
IEA/DK	585	16	27	5	20	2.65	
Offshore							
Oxera	1100-1430	35-42	35	n.q.	20	5.5	
WPM	1200	n.q.	38	6	15	5.7	'High' cost, 8.8 m/s site
	970	n.q.	31	6	15	4.9	'Low' cost, 7.8 m/s site
IEA/DK	1130	36	27	5	20	3.2	

n.q. Not Quoted

Of course, the generation cost of wind farms depends to a large degree on the wind speed available. As this is site specific, costs will vary to some degree, as shown in Figure 10. The generation cost of onshore wind power will tend to face upward pressure as the best sites are developed, although this has to be balanced against improvements in size and design – leading to projections that actual costs will continue to fall (see Section 4.8 below). Three recent studies (ETSU³²; ETSU³³; DTI³⁴) on the subject project only modest upward pressure on costs for the scale of onshore capacity needed to meet current targets.

4.4 Comparing wind energy to conventional generation costs

Although generation costs are used to compare renewable energy and fossil generation, that process is a 'first order' comparison, and is not

precise. A 'level playing field' comparison demands that allowances are made for various factors, some of which add value to renewables, while some subtract.

The key issues are:

- **External costs** are costs attributable to an activity that are not borne by the party involved in that activity. All electricity-generating technologies come with external costs, and those from fossil fuel sources of generation are due to the pollution which arises from their use, and from the impacts of global warming due to their CO₂ emissions. Many economists argue that these costs should be added to the generating costs, and this is the thinking behind proposals for carbon taxation. However, fully internalised carbon taxes could add unacceptable increases to the price of electricity and so most

^x Although developers set their own criteria, the electricity regulator used this rate to test commercial viability

4 Costs and benefits of wind

governments give renewable energy sources a financial boost instead, in the form of support mechanisms. The advent of the EU Emissions Trading Scheme will increase the price of fossil generation, but only by modest amounts – at least initially.

- **Embedded generation benefits**
acknowledge that many renewable energy sources are small-scale and so connect into low voltage distribution networks. This means that losses in the electricity network may be reduced and, possibly, transmission and/or distribution network reinforcements delayed or deferred. The calculation of these benefits is a complex issue and they vary both regionally and locally. However, these benefits may turn to costs if concentrations of renewable energy in remote regions trigger network reinforcements, as is happening in Scotland. In reality, some parts of the UK will experience embedded generation benefits, whilst others will face some network costs – the net effect of these will be passed on to all consumers, regardless of location.
- **Net additional system costs** for variable generation apply especially to wind and wave energy as explained in Chapter 3, and these are discussed below.

4.5 System costs from wind energy

Of great interest to governments and electricity consumers is the likely additional cost, in total, of adding specified amounts of renewable energy to an electricity network. The extra costs that the electricity system might face, termed the ‘system cost’, depends on:

- All the estimated costs of wind power (increased need for balancing services, higher installed cost, and network upgrades)

minus

- The estimated benefits (reduced conventional fuel use, displaced costs of conventional plant – ‘capacity savings’).

The result is then a figure for the net additional cost of electricity from the whole system when a certain percentage of wind generation is added. This will be made up from a number of different costs and benefits falling on different market participants, and therefore estimates of the system cost concentrate on the net overall effect, which will most likely be passed on to consumers.

A number of studies have recently appeared which set out to quantify this net additional cost. These are summarised in Table 6. Care

Table 6: Summary of recent analyses of net additional cost of wind power

Reference	Amount of Wind, %	Relevant date	Extra cost, p/kWh	Comments
Dale et al ³⁵ (UK)	20	2020	0.30	Changes in gas prices mean estimate now out of date; see box and text
Black and Veatch Corp ³⁶ . (Pennsylvania)	10*	2015	0.02	*Includes all renewables; wind accounts for 64% of these
IWEA ³⁷ (Ireland)	41	2020	-0.20	Network costs assumed small; assumes 2% p.a. gas price rise
German Energy Agency ³⁸	From 5 to 15	2015	0.24-0.30	Wind speeds in Germany are lower than in UK, so more capacity needed.

4 Costs and benefits of wind

should be taken when making direct comparisons, as the underlying assumptions differ.

The principal conclusion to be drawn from these results is that the extra system costs associated with accommodating significant amounts of wind energy into an electricity network are very modest. It should be noted that the results from the first study have been superseded by recent changes in the price of natural gas and this point is discussed below. It may also be noted that, despite the lower wind speeds available in

Germany, the additional costs of accommodating an extra 10% of wind energy are also modest.

Box 4 summarises the UK study by Dale et al., a rigorous exercise done using National Grid expertise and data. It evaluated the net additional cost of wind power by assuming it makes up 20% of total UK electricity output by 2020. This percentage is used to provide an extreme scenario, where wind power produces all of the Government's 2020 renewables target; in reality, this is unlikely to be the case, although wind is likely to be the largest contributor.

Box 4: Summary of study by Dale et al.¹⁷ – original results

Extra cost in 2020 of electricity to the consumer if 20% of electricity is sourced from wind, compared to a coal/gas mix

Assumptions:

Electricity demand grows by 17% to 400,000 GWh; peak demand = 70 GW; 26 GW wind capacity displacing 5 GW conventional capacity (capacity credit of 20%); average wind capacity factor of 35% = 20% of sales; 60% of offshore wind directly connected to network; risk of supply interruption in nine winters per century (current standard); 8% discount rate; 15 year life for generating plant.

Cost assumptions in 2020:

Generation plant costs for CCGT : £400/kW, operation costs £20/kW, load factor 85%;

Fuel cost 1.3p/kWh;

Generation plant costs for wind: £455kW onshore, £600kW offshore; operation costs £11/kWh/yr onshore, £20kWh/yr; capacity factor 35%;

Cost of balancing without any wind: £345M/yr

Extra balancing costs for wind : £2.85/MWh of wind

Transmission infrastructure costs: £100/kW or £1.7bn-£3.3bn^{xi};

Wind connection costs: £50/kW or £0.6bn-£1bn;

Transmission connection costs avoided (conventional) – credit of £0 - £300m;

Distribution network reinforcement costs: £40/kW, or £420m.

Total extra cost:

0.3p/kWh sold (or 1.6p/kWh of wind produced) = **5% increase** on current average domestic consumer electricity price (6.0p/kWh).

^{xi} These transmission and connection costs are based on the application of NGC's deterministic investment standards, which assume a wind power contribution on-peak of 60%. This assumption was challenged by Ofgem in their review of transmission network charges in 2004, and NGC are now researching a new approach. However, as transmission costs represent only a small percentage of additional system costs from wind power (see Figure 12), any upward revision is likely to have only a small effect on the final figure.

4 Costs and benefits of wind

Updated analysis

As the price of gas goes up, so the 'fuel saving value' of wind energy also goes up and the net additional cost goes down. The original analysis, above, implicitly used a UK delivered gas price (the 'beach price') of about 19p/therm. One recent analysis suggests 30p/therm is now more appropriate for long-term contracts, at least until 2005/6³⁹. Other estimates go higher. Prices on the US futures markets for gas delivered in 2007 equate to nearer 40p/therm. As it is extremely difficult to quote future gas prices with any certainty, a range of gas prices has been used.

Figure 11 updates the earlier analysis, showing estimates of the extra cost to the electricity consumer of 20% wind energy, for a range of UK gas prices.

It is also instructive to estimate the extra costs with lesser amounts of wind. Department of Trade and Industry (DTI) and British Wind Energy Association (BWEA) modelling suggests that wind might supply 75% of the 2010 target of 10% renewable generation. By 2010, wind prices will not have fallen as far as 2020 projections, and so appropriate assumptions have been made.

The graph shows that the extra cost to the electricity consumer of 7.5% wind by 2010 would be about 0.12p/kWh (with gas at 19p/therm, as in the original analysis). With higher gas prices it would be less: 0.06p/kWh with gas at 30p/therm, or 0.009p/kWh with gas at 40p/therm.

Figure 11: Estimates of the extra cost to the electricity consumer of wind energy, for a range of gas prices⁴⁰

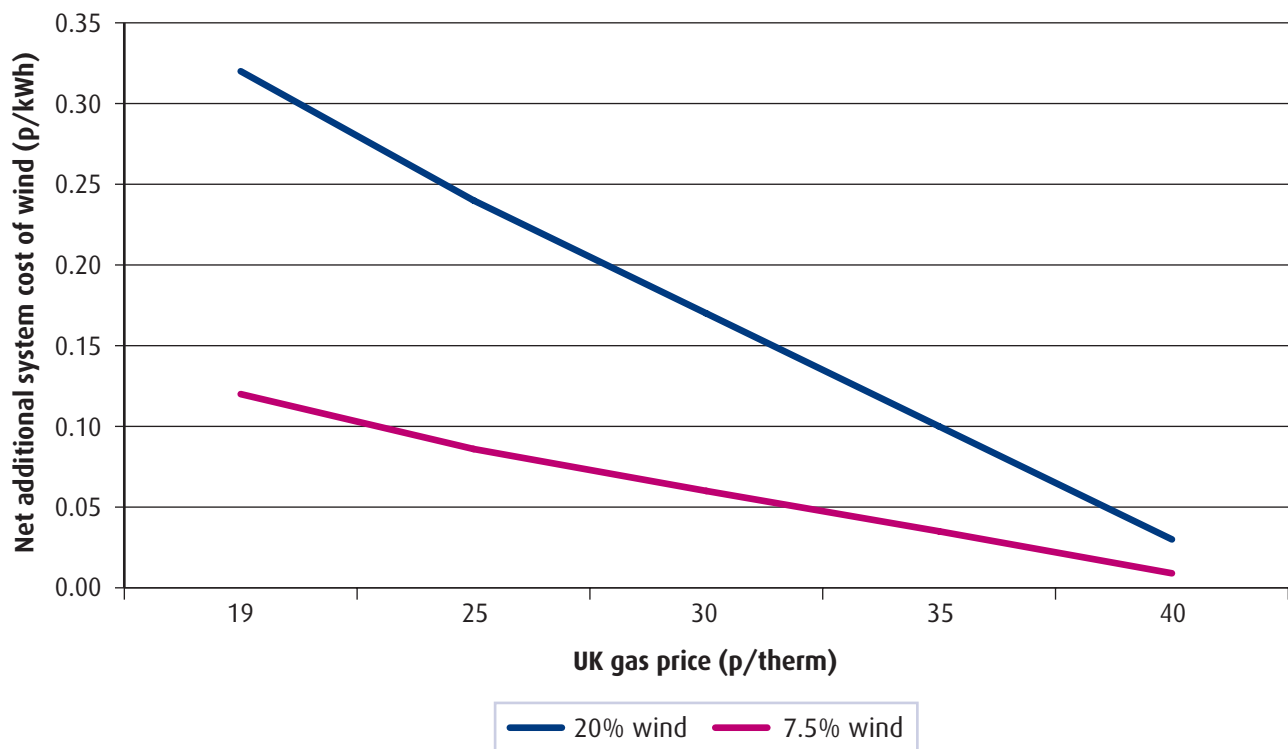

4 Costs and benefits of wind

Similarly, 20% wind by 2020 would add about 0.17p/kWh to electricity prices, with gas at 30p/therm (today's prices), or 0.03p/kWh with gas at 40p/therm. This compares with a net addition of 0.32p/kWh with gas at the original price of 19p/therm.

Figure 12 shows how the 20% wind power scenario compares to the conventional (gas/coal) scenario by breaking down the cost components used in the analysis. This illustrates how additional balancing and infrastructure costs are only a small part of the net additional cost of incorporating 20% wind power.

Further qualifications

It should be noted that the net additional system cost of wind energy derived from this analysis might be slightly pessimistic, for three reasons:

- No allowance is made for the 'cost of carbon' under the EU Emissions Trading Scheme, since it is difficult, while the scheme is in its infancy, to estimate an overall incremental

price for gas generation. This issue is dealt with below.

- It is argued by some that the price of gas should be adjusted for 'market risk'. Generation costs for a gas-fired plant may increase during its life, due to increases in the price of gas. Several studies have attempted to quantify this risk by 'loading' the price of gas, and the additional generation cost is of the order 1p/kWh⁴¹. It should be noted that there is no comparable price uncertainty associated with wind energy generation costs as, once the plant is built, generation costs are more or less determined – apart from unforeseen charges in interest rates, which would affect all generators to some extent.
- The model used by Dale et al reflects 'real life', in as much as the introduction of new, high load factor plant will depress the load factor of all the existing plant as discussed in Annex B. This results in a small increase in the generation costs of the existing plant. The addition of new nuclear, rather than wind, plant to the portfolio would push up

Figure 12: Breakdown of the cost of electricity generation under conventional and 20% wind power scenarios (with gas at 30p/therm)

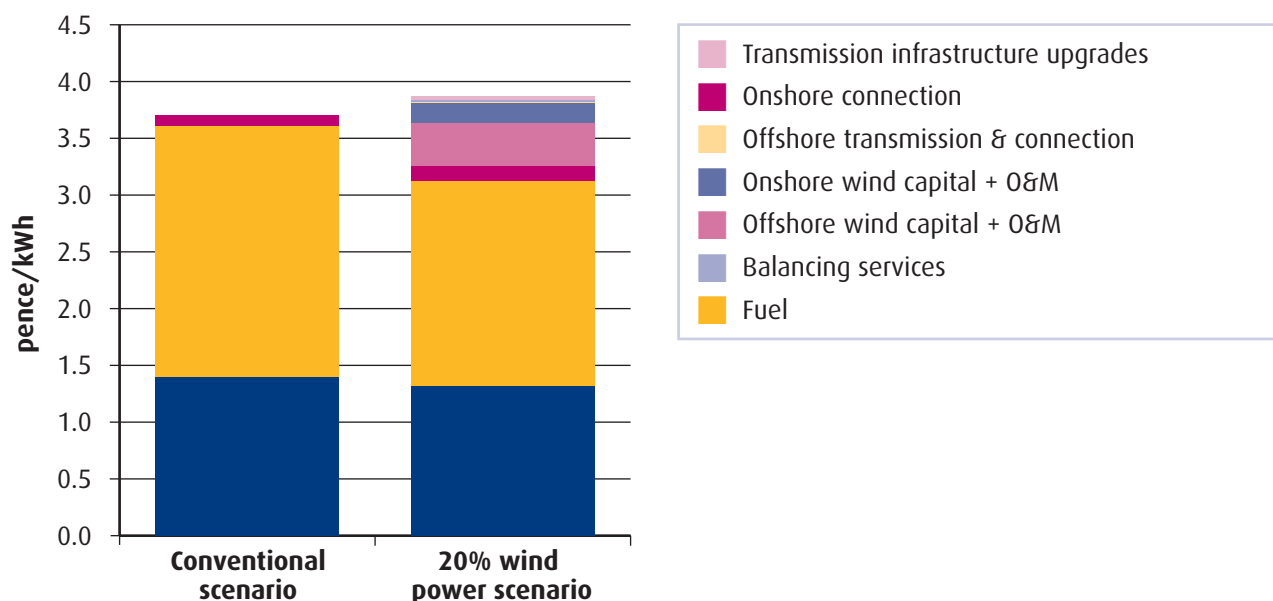

4 Costs and benefits of wind

generation costs by about 0.05p/kWh. Whilst large amounts of new wind energy would push up costs by more than this amount, a 'level playing field' demands that 0.05p/kWh should be deducted from the net additional system costs identified above.

Calculating carbon benefits

As CO₂ is harmful to the global climate, the costs of climate change can and should be attributed to emissions resulting from human activity. It is this principle that is behind calls for carbon taxation, and efforts to create a market for avoided carbon in the form of the EU Emissions Trading Scheme – so that a price is attached to CO₂ emissions.

In 2003 the Government published its assessment of the 'social cost of carbon'⁴² to help give a value to carbon emissions in the absence of full-scale carbon taxation, for when policies are being developed. The value agreed on by Government was a range of £35-140 per tonne of carbon (tC), with a middle value of £70/tC. This translates to £9.55-38 per tonne of CO₂ (tCO₂), with a middle value of around £19/tCO₂. However, the Government also acknowledged that such estimates are hugely varied and that such large-scale harm is difficult and controversial to measure accurately. A revised analysis is expected in the near future.

The social cost of carbon is very different from the market price of carbon, which is operating in the EU Emissions Trading Scheme. The market price in the EUETS is dependent on the allocation of permits by EU Governments and the performance of companies in the scheme, but is currently trading at around £10/tCO₂ and is therefore at the lower end of the Government's range for the social cost of carbon.

As wind energy is a CO₂-free energy source that must compete against fossil fuel alternatives, it

Carbon Vs CO₂

Carbon emissions are often quoted in two ways: in tonnes of carbon dioxide (tCO₂) and in tonnes of carbon (tC). A tonne of CO₂ contains less carbon than a tonne of carbon due to its chemical composition. The conversion formula is:

$$1 \text{ tCO}_2 = 0.273 \text{ tC}$$

or

$$1 \text{ tC} = 3.66 \text{ tCO}_2$$

Therefore, when converting carbon values the same formula must be used:

$$\text{Eg. } \pounds 1 / \text{tCO}_2 = \pounds 3.66 / \text{tC}$$

seems reasonable to try and account for the 'social cost' from CO₂ emitted by conventional power generators and subtract this from the system cost of wind. This is particularly relevant when the system cost calculations above do not take account of the market price of carbon stemming from the EUETS.

To do this one must make some assumptions as to how much carbon wind energy output is displacing. There are large differences between the CO₂ emissions associated with coal (243 tC/GWh) compared to natural gas (97 tC/GWh), with none associated to nuclear power. As already explained, it would be unrealistic to assume that wind energy would displace any nuclear capacity, and it is most likely that it will displace coal in the short to medium term. However, the actual CO₂ displacement in 2020 is hard to estimate and so for the purpose of this report, it has been assumed that wind output will displace the average emissions resulting from gas-fired plant. This figure is likely to be conservative, as in reality some coal-fired generation is likely to exist in 2020. However, it is the figure that the DTI use and is used here so

4 Costs and benefits of wind

Table 7: Impact of the social cost of carbon on the net system cost of wind energy

Social cost of carbon	Total social value of CO ₂ saving	Social value of CO ₂ saving per unit of electricity
£9.50 /tCO ₂ (minimum)	£271m	0.068p/kWh
£19 /tCO ₂ (mid-range)	£540m	0.135p/kWh
£38 /tCO ₂ (maximum)	£1079m	0.270p/kWh

that the carbon benefits of wind power are not overestimated.

Using this figure, and assuming wind energy makes up 20% of total output in 2020 (assumed to be 400,000 GWh – following previous analysis), the CO₂ emissions savings of wind output can be estimated at 28.4 million tonnes of CO₂ per year (or 7.8 MtC). With this figure it is then possible to attach a value to this saving

based on the range of estimates for the social cost of carbon – see Table 7.

If these values are then subtracted from the net additional system costs due to wind energy, this gives a more realistic picture of the net social cost of incorporating wind energy onto the electricity system. Figure 13 summarises the results.

Figure 13: Effect of including the social cost of carbon into estimates for the net system cost of wind energy at 20% of total output

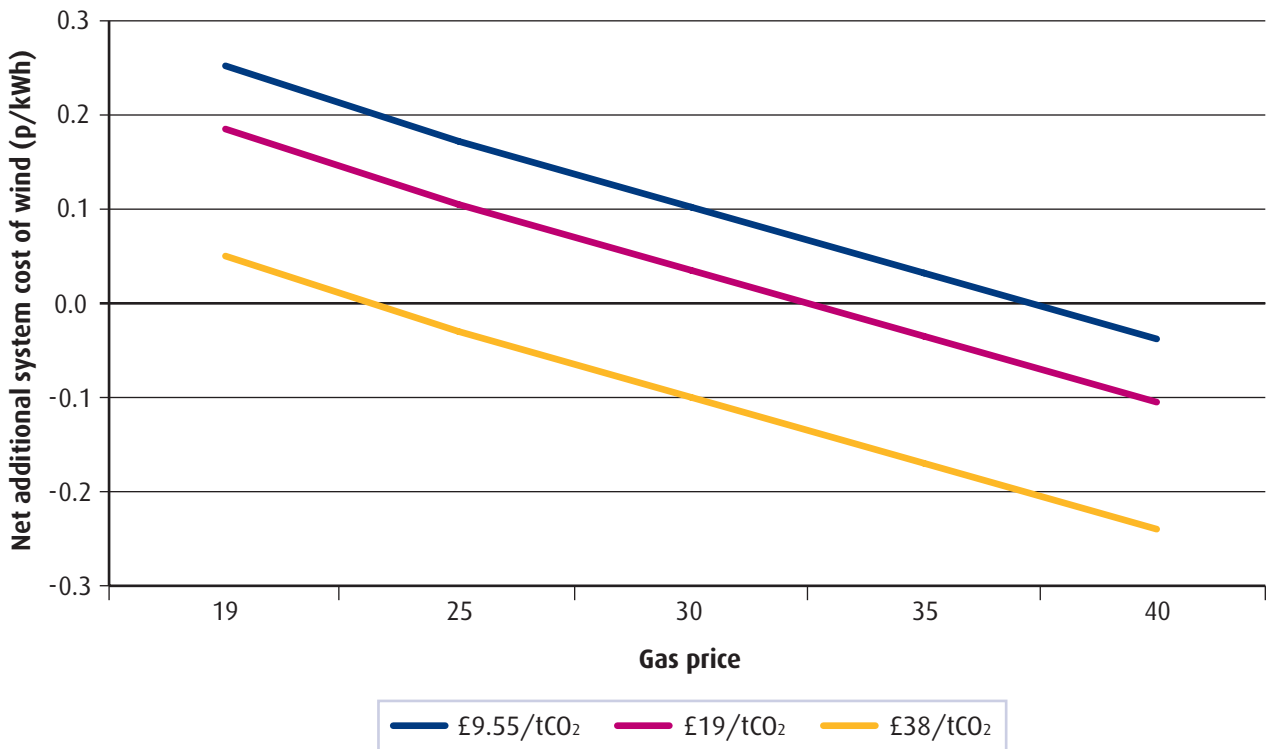

4 Costs and benefits of wind

As this chart shows, accounting for the social cost of carbon reduces the system cost of wind power, making it positive when a high cost of carbon is assumed. Therefore, the social benefit of having 20% wind output might outweigh any costs. Of course, these benefits will not be reflected in the cost of electricity until carbon values are sufficiently internalised in the price of fossil fuels.

4.6 Cost of UK support mechanisms

The primary support mechanism for renewables in the UK is the Renewables Obligation (RO), which was described in Chapter 2. The RO creates a market demand for renewable electricity generation and does not require a Government subsidy – the cost is passed on to the consumer rather than the taxpayer. The RO will primarily assist commercially advanced renewables such as wind, biomass and methane recovery as these lower risk technologies will be most favoured by investors. To support other technologies at the development or pre-commercial stage the DTI funds a number of research & development and capital grant programmes to stimulate investment and innovation.

A recent report by the National Audit Office (NAO)⁴³ expects total public support for all renewables to reach around £700m per annum between 2003 and 2006, two thirds of which will come from the Renewables Obligation, which is paid by consumers through their electricity bills. The remaining third is paid by taxpayers in the form of the DTI's capital grants^{xii} and innovation programmes, and through tax exemptions. The total cost of the RO is expected

to equal around £1bn per annum by 2010, equal to an increase of 5.7% in customers' bills⁴². Although large, this figure is believed to be much less than the historical subsidies given to conventional fossil fuel technologies over the past 60 years, and it avoids the significant 'social cost' that comes with air pollution and carbon dioxide emissions. It also helps create future options to the climate change problem, which although more expensive now may become competitive over time.

It is important to note that the NAO estimates do not correspond to the net additional system costs of wind, as detailed above. The reasons for this are:

- As the NAO points out, the cost of the RO is to a large extent unaffected by the cost of the technologies it is supporting. It is therefore not 'cost reflective'.
- The DTI assessment of the impact of the RO (to which the NAO report refers) does not include network reinforcement costs.
- Some of the other system costs, such as additional balancing services, will not necessarily be borne entirely by renewable energy generators.

On cost reflectivity, the Renewables Obligation Certificate (ROC) price that is passed on to consumers is set more by the lack of availability of renewable capacity and the 'buyout rate'^{xiii} than by the comparative cost of this capacity. In fact, the technology preferences of renewable energy investors can be seen as an indicator of lowest cost – because ROCs have a relatively stable value, these investors will tend to choose the cheapest technology available to maximise

^{xii} Some of this funding will support the development of offshore wind, and can therefore be attributed to the cost of wind energy.

^{xiii} The 'buyout rate' is the price per MWh that electricity supply companies must pay into a central fund if they are unable to provide ROCs up to full value of the electricity they supplied during each period. The buyout fund is then redistributed to those suppliers that met their obligation.

4 Costs and benefits of wind

their profits. Therefore, the NAO expects the RO scheme to be providing wind power generators with subsidies that are above the level needed for project viability. The NAO report recognises that this is unavoidable in the medium term, but does recommend that onshore wind is eventually reassessed and possibly excluded from future RO targets, meaning it would not qualify for ROCs.

The fact that the RO does not cover network reinforcement costs is due to the structure of the UK's electricity system, which separates generators from the companies that operate the distribution and transmission networks. The costs of network reinforcement will therefore fall on the latter, who in turn will pass these on to the consumer through network charges.

A similar situation occurs for the cost of additional balancing services, required for higher penetrations of wind capacity. These costs are unlikely to fall solely to wind energy generators, as they are not easy to determine in real time. They will therefore be picked up by other market participants (as part of the 'Balancing Services Use of System Charges' levied on all users of the system), and will be passed on to consumers.

The Government is in the process of reviewing the Renewables Obligation^{xiv} although the scope of this review excludes major changes to the RO. Any future changes will not affect projects that are already built, approved or planned – this is to avoid damaging investor confidence.

4.7 Alternatives to wind energy

Although the above analysis shows the net additional cost of wind to be relatively small, it is important that the alternatives to wind

energy are also considered. Below is a summary of the main alternatives available and the role they might be expected to play to 2010 and beyond.

Energy efficiency

Although not a fuel in itself, energy efficiency is often the cheapest and most effective way of reducing fossil fuel consumption and emissions from power plants. This is something all sectors – domestic, commercial and industrial – can contribute to, not only by reducing electricity consumption but by reducing use of all fossil fuels, including gas for heating and oil for transport. The benefits of energy efficiency are well known, yet too often opportunities are missed and investments are not made. The Carbon Trust estimates that small and medium enterprises are wasting over £1 billion on energy per year and that many potential investments could be at low or zero cost.

The Government published an Energy Efficiency Action Plan in 2004, which sets out how it intends to achieve cuts of 10 million tonnes of carbon by 2010, which represents around a third of the emissions reductions required⁴⁴. As part of this the Government funds schemes to make information available to the public on what they can do. Websites run by organisations such as the Energy Saving Trust (www.est.org.uk), which focuses on the general public, and the Carbon Trust (www.carbontrust.org.uk) which concentrates on the commercial and public sectors, have a wealth of information on how to save energy or to use it efficiently. Energy suppliers are also required by Government to offer energy saving measures (energy efficient boilers, lamps & appliances, and insulation) to their customers, and this requirement is increasing. However, households need to take

^{xiv} See http://www.dti.gov.uk/renewables/renew_2.2.5.htm for further information.

4 Costs and benefits of wind

up these offers to reduce their energy consumption and undoubtedly both business and the public sector could do much more to reduce their emissions.

Whilst energy efficiency may be cost-effective, action to reduce emissions cannot rely on it alone. The DTI have been quoted as saying, "Renewable energy may be more expensive but its development is essential"⁴⁵. This is because supporting renewable energy and other low carbon technologies now will create future options that enhance the UK's flexibility in mitigating climate change. We should certainly aim to reduce our energy consumption dramatically, but if we also find ways to supply the remaining energy demand in a sustainable way then total emissions reductions will be greater.

Coal

The use of coal is less financially attractive and environmentally acceptable than in the past. The UK has agreed to a series of international treaties to reduce air pollution from coal use, and the EU Large Combustion Plant Directive, which comes into force in 2008, will further constrain emissions of NO_x and SO₂. The high carbon content of coal and the advent of the EU Emissions Trading Scheme in 2005, which places a value on emissions of carbon dioxide, will make the use of coal increasingly unattractive, although in the medium term generators may continue to use coal as it remains cheap and readily available. Carbon capture and sequestration^{xv} or 'clean coal' technologies may offer a way for coal-powered electricity generation to reduce carbon dioxide emissions, but such solutions will come at a cost. A large

percentage of the UK's coal demand is already met from imports and this is likely to continue.

Gas

The DTI projects gas consumption will continue to rise, driven to a large degree by continuing increases in demand from the power sector – by 2010, it is expected that gas will account for between 38% and 52% of total electricity production. In 2004, for the first time, the UK became in net importer of gas, and prices in the world markets rose considerably. Gas is a much cleaner fuel than coal and is less carbon intensive, therefore air pollution and CO₂ emissions are reduced. However, an increasing percentage of gas will need to be imported – by pipeline from Norway, and Russia (passing through mainland Europe), and by sea as liquefied natural gas (LNG) – with implications for energy diversity and fuel security.

Nuclear

Current Government policy on nuclear power was clearly stated in the 2003 Energy White Paper:

*"Current economics make new nuclear build an unattractive option and there are important issues of nuclear waste to be resolved. Against this background, we conclude it is right to concentrate our efforts on energy efficiency and renewables. We do not, therefore, propose to support new nuclear build now."*⁴⁶

^{xv} One possible solution to the continued use of fossil fuels is for the CO₂ to be removed from the fuel, compressed and then stored so that it does not enter the atmosphere. Current storage options include using disused oil wells, injecting into saline aquifers, and pumping CO₂ into the ocean to be absorbed. However carbon sequestration is currently expensive and there are a number of scientific uncertainties outstanding.

4 Costs and benefits of wind

It is the SDC's view that nuclear power has far fewer advantages to offer, in terms of combating climate change, than the combination of energy efficiency, renewables and combined heat and power - as proposed in the Government's own Energy White Paper. Moreover, the Government has stated that an acceptable solution must be found to deal with the existing stockpile of nuclear waste before any new plans for nuclear power are considered. Such a solution is currently not available.

Based on current policies, new nuclear capacity is therefore unlikely for at least another 15 years, given that any decision would need to allow for full public consultation, public inquiries for potential sites, and then the long process of plant construction. Without new-build capacity, nuclear is set to decline as a share of electricity production as plants are taken out of service – by 2010 the 14 plants currently operating will be down to eight, and by 2020 only three are likely to be generating. The newest plant, Sizewell B, is due to close in 2035.

Other renewables

The Government is keen to encourage a wide range of renewables technologies to develop, which will enhance energy diversity and enable further emissions cuts to be made after 2020. At present the most commercially viable and mature renewable technologies are onshore wind power, landfill gas, energy-from-waste, and certain forms of biomass (eg. electricity generation from poultry litter and straw, and co-firing in conventional plant). There are limits to the additional capacity for both landfill gas and energy-from-waste due to site availability and environmental constraints respectively. Therefore, the Government expects electricity suppliers to favour onshore wind and biomass generating plant for meeting their increasing obligation to source renewable electricity up to 2010. Beyond this, other renewables

technologies, such as wave and tidal power, are expected to play an increasing role.

4.8 Projected long-term costs for electricity generation

Another way of looking at the cost of wind is to calculate a projection of the likely future cost. This takes a more long-term view of energy policy, and to a great extent lies behind Government support for renewables.

Table 8 shows a series of projections for a wide range of electricity generating technologies taken from the Government's energy policy review in 2002. This work estimated the costs in pence/kWh for the respective technologies in 2020, presented in today's prices. These projected costs help to show the background behind current energy policy, and the Government's position on renewables in particular. It should be noted that since this table was compiled, generation costs from gas have increased significantly – due to gas price increases. The upper end of the range is now around 3p/kWh for gas CCGT plant.

As this table shows, onshore wind is projected to become the cheapest source of electricity by 2020. This is due to sustained reductions in costs for wind power plant combined with increased costs for fossil fuels, particularly coal and gas. The projections also show that offshore wind, energy crops (a form of biomass) and wave power will all be cost competitive with traditional fuel sources, particularly if CO₂ capture and sequestration is included. The costs for nuclear power are based on a series of projections for new build using plant designs that have not yet been built – this accounts for the 'moderate' level of confidence in the price projections.

4 Costs and benefits of wind

Table 8: Electricity fuel source cost projections for 2020⁴⁷

Technology	Cost in 2020	Confidence in estimate	Cost trends to 2050
Conventional Fuels			
Coal (IGCC ^{xvi})	3.0 – 3.5 p/kWh	Moderate	Decrease
Gas (CCGT)	2.0 – 2.3 p/kWh	High	Limited decrease
Fossil generation with CO ₂ capture & sequestration	3.0 – 4.5 p/kWh	Moderate	Uncertain
Large CHP (gas)	Under 2 p/kWh	High	Limited decrease
Micro CHP (gas)	2.5 – 3.5 p/kWh	Moderate	Sustained decrease
Nuclear	3.0 – 4.0 p/kWh	Moderate	Decrease
Renewables			
Onshore wind	1.5 – 2.5 p/kWh	High	Limited decrease
Offshore wind	2.0 – 3.0 p/kWh	Moderate	Decrease
Energy crops	2.5 – 4.0 p/kWh	Moderate	Decrease
Wave	3 – 6 p/kWh	Low	Uncertain
Solar photovoltaics	10 – 16 p/kWh	High	Sustained decrease

Of course, projections from other studies may offer conflicting views. The aim of presenting this information is to show the background to current UK energy policy – however, a substantial body of research went into these projections, and they are well respected.

4.9 Drawing conclusions

Comparing cost estimations

This section has presented three main sets of information for the cost of wind energy, all of which differ in what they are attempting to show.

Firstly, the generated cost of wind is quite accurately known from a number of studies, and would seem to be around 3.2p/kWh for onshore wind energy and 5.5p/kWh for offshore. This represents a premium over new CCGT gas-fired plant (currently at about 3.0p/kWh), and is the justification for the Government’s support mechanisms, which help to fill the gap and make wind power developments viable. There is good reason to believe that these generation costs will fall over time as ‘learning curve’ effects, innovation and larger-scale production help to reduce plant costs. This is the assumption made in the PIU review, which predicted that onshore wind would be around 1.5-2.5p/kWh by 2020, with offshore at 2.0-3.0p/kWh.

^{xv} IGCC = integrated gasification combined cycle

4 Costs and benefits of wind

Secondly, a number of studies have attempted to estimate the 'system cost' of incorporating 20% wind energy output on the UK grid by 2020. This level of wind capacity represents an extreme scenario, as in reality other renewables will make some contribution. The net system cost is calculated by subtracting all the benefits of wind energy (displaced fuel, avoided plant construction, avoided network reinforcement) from the costs (additional cost of plant, network reinforcement, additional balancing services). This figure is very sensitive to gas price fluctuations, and updated analysis done for this report suggests that with gas prices at their current levels (30p/therm), the net system cost of 20% wind would be around 0.17p/kWh. This represents an increase in electricity prices of around 3.8%. This would be the total cost consumers could expect to pay by 2020 if the true cost of wind generation were accurately reflected in the market. If the carbon benefits of this cost are included, it is substantially reduced, and could be negative (ie. a net benefit to society) if a high social cost of carbon is assumed.

Thirdly, the cost of renewable support mechanisms has been outlined. This analysis relies on a recent report by the National Audit Office, which attempts to determine the cost to consumers and taxpayers of supporting renewable electricity generation. The NAO states that two thirds of this support is in the form of the Renewables Obligation, which provides investors with a financial incentive (in the form of ROCs) to invest in renewables. Consumer support through the RO will cost around £1 billion by 2010, equivalent to a 5.7% increase in the price of electricity. For onshore wind, the value of ROCs is high enough to cover the additional generation costs when compared to the main alternative (gas-fired plant), as outlined above. However, because the Renewables Obligation is not cost reflective, this

support is likely to be in excess of what is needed for onshore wind to be viable at good sites. Most public support mechanisms suffer from this problem, but the important point to note here is that this makes the RO a poor indicator of the cost of wind energy. While generation costs are likely to be lower than the RO implies, other costs (such as network reinforcement and additional balancing services) are outside its scope.

Bringing all these together is not a straightforward process. While we are confident in the estimations of the net additional cost of wind (the 'system cost'), this is unlikely to be the cost that is actually paid by UK consumers. It seems likely that the actual cost will be a combination of public support mechanisms (which will be paid regardless to support all renewables), and the system costs that do not fall within the scope of the Renewables Obligation. The likely cost of the RO in 2020 is unknown, as it is possible it will have been substantially revised by then to take account of the lower cost of wind power. On the other hand, the system cost of wind energy in 2010 is likely to be far lower than in 2020, as Figure 11 shows, and could be close to zero if gas prices are high.

The costs of current policies on encouraging renewables, which are leading to a rapid expansion of wind energy, are well understood, and do not appear to be excessive. The cost of wind power itself, often assumed to be high, seems likely to be lower than the cost of these public support mechanisms, and a calculation of the net system cost does not present any excessive price increases.

Comparing the alternatives

Government support for renewables should be viewed within the context of current energy policy, as outlined in the 2003 Energy White

4 Costs and benefits of wind

Paper. This stresses the need to address climate change, whilst ensuring an adequate level of fuel security. Government thinking was strongly influenced by cost projections such as those in Table 8, which show renewable energy sources decreasing in cost by 2020, and in the case of onshore wind, becoming competitive with conventional plant. Policies that encourage the development of renewables are therefore aimed at stimulating these cost reductions, recognising that this will require public support and subsidy in the medium term.

The SDC does not believe there is a choice to be made between supporting energy efficiency on the one hand, and renewables on the other. Both are needed to enable the UK to achieve its long-term objective of a 60% cut in CO₂ emissions by 2050. Although support for energy efficiency may be more cost effective at present, supporting renewables now increases the choices we will have in the future and for this reason should be encouraged. Compared to fossil fuel or nuclear powered plant, wind power, along with other renewables, offers the only truly sustainable and secure option for electricity generation over the long term. It is for these reasons that it deserves public support.

FURTHER INFORMATION

DTI Renewables website –
www.dti.gov.uk/renewables

5 Wind power and planning

Summary

- Small and medium-sized wind power planning applications are dealt with by local planning authorities
- Large projects are handled directly by the Secretary of State for Trade and Industry or the Scottish Executive
- Planning policies exist for each UK nation to provide guidance for local decision makers on renewable energy developments
- An Environmental Impact Assessment is required for most wind farm developments – this must be comprehensive and fully implemented

This section takes a closer look at the planning system and planning policy for wind energy projects. The planning policy environment and consents procedure are gradually improving – and will need to continue to do so – if the UK is to meet its targets for renewable energy development.

5.1 Planning process for wind projects

All wind developments in the UK have to apply for planning permission and/or consent. For all onshore energy projects in Great Britain over 50 MW in capacity, and those over 1 MW offshore, planning consent is not provided by the local planning authority, but is dealt with directly by the Department of Trade and Industry (DTI) (for England and Wales) or the Scottish Executive (for Scotland) under Section 36 of the Electricity Act 1989^{xvii}. All other projects are dealt with by the local planning authority.

In Northern Ireland, all wind developments require planning permission from the Department of Environment, and under Article 39 of the Electricity (NI) Order 1992, all energy

projects over 10 MW must also obtain consent from the Department of Enterprise, Trade and Investment.

For larger wind power projects (usually those over 5 MW), the wind developer is legally required to produce an independent Environmental Impact Assessment (see Box 5), which should investigate specific concerns such as landscape, noise and wildlife effects. The results of the EIA are published in an Environmental Statement (ES), which is a publicly available document that will be used in the consents process. It is accompanied by a non-technical summary, which should be written in an accessible way and be available free of charge, usually from the developer. Many developers will put this information on their websites, a form of good practice that should be encouraged.

Local planning decisions

For wind power projects under 50 MW, the developer will need to apply for planning permission from the local planning authority (LPA). In England, planning is usually the

^{xvii} The Electricity Act 1989 only applies to the Renewable Energy Zone adjacent to Northern Ireland's territorial waters; it does not cover onshore or territorial water areas.

5 Wind power and planning

responsibility of district councils, except in areas with single-tier unitary authorities, such as some major cities. In Scotland and Wales, planning permission is dealt with by single-tier authorities, and in Northern Ireland the Assembly takes direct control of planning decisions through six regional offices.

In most cases, planning applications will firstly be considered by LPA officials, who will check that proposed wind farm developments are in line with national, regional and local planning policies, before considering the Environmental Statement from the developers (if appropriate) and the responses to the public consultation. They will then make a recommendation to the planning committee, which is composed of local councillors and must make the final decision. If the planning application is rejected the developer may take their case to the relevant appeal body, which has the power to overrule the original decision if it considers that it:

- a) Was a significant departure from national, regional or local planning policy;
- b) Did not fairly assess the balance of national or local environmental, social or economic considerations.

A developer is also entitled to go to appeal following non-determination after the statutory period of eight weeks, or 16 weeks for applications where an EIA has been carried out.

There are three appeal bodies depending on the jurisdiction of the original decision: The Planning Inspectorate (with responsibility for England and Wales), the Scottish Executive Inquiry Reporters Unit, and the Northern Ireland Planning Appeals Commission. These report directly to their respective national governments. The appeal body may request written or informal representation, or it may decide to open a public

inquiry – the latter option is often taken for more controversial or complicated wind farm proposals.

Finally, the Secretary of State with responsibility for local government and planning issues (for projects in England, Wales and Northern Ireland), and the Scottish Executive (for projects in Scotland), have the power to ‘call in’ planning applications for a decision to be taken centrally through a variety of means. For example, schemes may be ‘called in’ if they raise issues of national importance or are a significant departure from the structure plan or national planning policy. In general, this power is used with caution.

National consents process

Onshore wind farm projects over 50 MW in size are automatically dealt with by the Secretary of State for Trade and Industry (in England and Wales) or the Scottish Executive (in Scotland). This process comes under Section 36 of the Electricity Act 1989 and requires the DTI or Scottish Executive to consider all the arguments for and against the proposed development before awarding consent. A local public inquiry may be held. Deemed planning permission will usually be awarded at the same time under Section 90 of the Town and Country Planning Act 1990.

Case Study

Community Support for Wind Power – Swaffham, Norfolk



© Ecotricity

Swaffham 1 proved so popular with the locals that they called for Swaffham 2 to be built despite opposition from the then Principal Planning Officer who is now a wind convert.

Swaffham is one of Norfolk's most attractive market towns, featuring two of the most popular wind turbines in the UK. Over 60,000 local people and visitors have climbed the 300-step spiral staircase inside the Swaffham 1 turbine to reach the unique 65m high viewing platform designed by Foster &

Partners, situated below the hub. There is similar enthusiasm for Swaffham 2 in Sporle Road, Swaffham. Together the two turbines generate enough electricity to supply 75% of Swaffham's total domestic electricity requirements, boosting Norfolk's total wind power by 30%.

"I moved back to Swaffham after being away for 10 years and was delighted to see the generator in the skyline.. much better than cooling towers or chimneys."

Paul Dowden

Swaffham on BBC Norfolk Talk

"I love the wind farms we have in Norfolk, they add to the scenery. I love driving past the Eco-centre at Swaffham. I have to slow down and gawp... I would be very happy to live next to one no problem."

Ron Luton-Brown

Norwich on BBC Norfolk Talk

Case study: Community Support for Wind Power – Swaffham, Norfolk

“The biggest objector to the erection of wind turbines in Norfolk was me. I had never seen one other than in a photograph but I knew that they were wrong for Norfolk. In meetings with Ecotricity I was the one saying ‘No’. However once the application had been submitted and I became aware of the amount of pollution generated by fossil fuels in the production of electricity I became convinced that turbines were an option. I watched the erection of Swaffham 1 and upon its completion I saw a graceful structure which contrary to my earlier views did not detract from the historic character of the town or the surrounding area. Subject to the assessments usual to this type of application, I now support the use of wind energy in Breckland for the production of electricity.”

Greg Britton

Principal Planning Officer of Breckland District Council and former Area Planning Officer

There was overwhelming local support when the installation of Swaffham 1 was mooted back in 1999 by Ecotricity. The District Council received seven letters of official response – three for, three against and one saying it might be acceptable if the colour was right. One person who wasn't in favour was Greg Britton, then Area Planning Officer of Breckland District Council, who was converted to wind energy once he became aware of the amount of pollution generated by fossil fuels in the production of electricity.

The local community was generally enthusiastic. When Ecotricity mailed 100,000 households in Breckland asking residents to say 'Yes' or 'No' to more wind turbines as part of the public consultation on plans for Swaffham 2, around 89% of the 9,000 respondents voted 'Yes'. Only 6.5% said 'No' and some 3.6% were either undecided or left their vote blank. Greg Britton recalls that 26 letters were sent to the planning department over Swaffham 2 – 23 of which were support letters, including three from district councillors. Construction started in the April and Swaffham 2 was completed on 18th July 2003. At the time of building it was the UK's tallest onshore wind turbine.

Now Principal Planning Officer, Greg Britton is looking forward to eight more turbines going up near North Pickenham, a small village four miles South East of Swaffham.



© Ecotricity



© Ecotricity

Lessons and thoughts:

- It is interesting to note that Swaffham 2 received a higher level of support than Swaffham 1 – this indicates that communities can grow to like wind turbines once they have local experience of them.
- Good local engagement can increase levels of public support for wind power, leading to further successful developments in nearby areas.

Key facts:

Swaffham 1

- Ecotricity developed and built the first multi-megawatt 1.5 MW capacity wind turbine at the Ecotech Centre in Swaffham in 1999.
- The first of a new generation of direct drive, variable speed wind turbines has a hub height of 67m, 31m blades, and a rotor diameter of 66m. The turbine rotates at between 10 -22rpm (depending on wind speed).
- The turbine is around 360m from local housing but there have been no noise issues or complaints; a light sensor is installed for shadow flicker.

Swaffham 2

- Construction of the second 1.8 MW turbine was completed on 18th July 2003 at Sporle Road, Swaffham, Norfolk. The hub height is 85m, length of blades 32m, and rotor diameter 70m.
- For further information: www.ecotech.org.uk, www.ecotricity.co.uk

Box 5

Environmental Impact Assessment

The Environmental Impact Assessment procedure ensures that the likely significant environmental effects of development projects and their mitigation measures are identified and taken into account in planning consent procedures. The main product of the EIA procedure is the Environmental Statement (ES), compiled by the developer, which must accompany those planning applications that fall into either Annex I or II of the EIA Directive. The requirement for public involvement means that submission of an Environmental Statement must be advertised and copies made available for public comment. It must also be circulated to relevant statutory consultation bodies. The General Development Procedure Order (1995) sets out the relevant consultees for particular types of development.

Strategic Environmental Assessment

The EC Directive on Strategic Environmental Assessment was transposed in many EU Member States in July 2004 after a gestation period of a decade or so. Its objective is to:

“...provide for a high level of protection of the environment and to contribute to the integration of environmental considerations into the preparation and adoption of plans and programmes with a view to promoting sustainable development, by ensuring that, in accordance with this Directive, an environmental assessment is carried out of certain plans and programmes which are likely to have significant effects on the environment.”

It is an iterative and systematic process, carried out at a strategic level, to identify, predict and report on environmental impacts. It must also identify and give proper consideration to feasible alternative options within plans or programmes. The 2004 SEA Regulations cover certain plans and programmes prepared for town and country planning or land use, agriculture, forestry, fisheries, energy, industry, transport, waste management, water management, telecommunications and tourism. At present, an SEA is not required for proposed wind farm developments onshore. However, in Scotland, the Environment Assessment (Scotland) Bill (which is currently under discussion in the Scottish Parliament) would extend the scope of SEA beyond the terms of the Directive. It aims to ensure that all public sector plans, strategies and programmes are scrutinised for their environmental impact. Although wind farm developments will not automatically be exempt from conducting an SEA, it is unlikely that individual wind farms would qualify.

5.2 Planning policy

Planning policy is devolved to national governments, so England, Scotland, Wales and Northern Ireland have separate policies. Policy in relation to renewable energy has recently been updated by the Office of the Deputy Prime Minister (which has responsibility for England), by the Scottish Executive in Scotland; the Welsh Assembly Government in Wales is due to issue its revised advice shortly. The underlying aim has been to provide clearer guidelines for the consideration of renewable energy projects and to improve the consistency of decisions. This is in line with wider energy policy (as outlined in the 2003 Energy White Paper) and was seen as essential for renewable energy targets to be met.

England

Planning Policy Statement (PPS) 22: Renewable Energy sets out the Government's national planning policies for renewable energy projects in England. It covers national policies in relation to the siting of wind farms generally, and those in close proximity to National Designations – National Parks, Areas of Outstanding Natural Beauty (AONB), Heritage Coasts, Green Belts and other local designations. It advises that in areas with nationally recognised designations or Green Belt status, planning permission for wind farms should only be granted where it can be demonstrated that the objectives of the designation will not be compromised and any significant adverse effects are outweighed by the environmental, social and economic benefits. PPS 22 is published along with a companion guide, which offers practical advice for decision-makers on how projects can be implemented on the ground.

Scotland

National Planning Policy Guideline (NPPG) 6, Renewable Energy Developments sets out the Scottish Executive's national planning policies for renewable energy projects in Scotland and sets

outlined siting considerations for wind farms at the national level. It states that issues to be considered include visual impact, landscape, birds and habitat. In relation to national designations, it advises that renewable energy projects should only be permitted where it can be demonstrated that the objectives of designation and the overall integrity of the area will not be compromised or any significant adverse effects on the qualities for which the area has been designated are clearly outweighed by social and economic benefits of national importance.

Planning Advice Note (PAN) 45 provides advice on good practice on Renewable Energy Technologies in Scotland. In relation to the siting and design of wind farms, PAN 45 reinforces the fact that, given the Scottish Executive commitment to address climate change, it is important for society at large to accept wind farms as a feature of many areas of the Scottish landscape for the foreseeable future. It does, however, emphasise the need to take account of regional and local landscape designations in the siting of wind farms. It stresses a cautious approach in relation to particular landscapes which are rare or valuable, such as National Scenic Areas (NSAs), National Parks and their wider settings. In these locations it is difficult to accommodate wind turbines without detriment to national heritage interests. PAN 45 suggests that areas recovering from past degradation and those not especially valued may be appropriate for wind farm development.

Wales

Technical Advice Note (TAN) 8 was originally published in 1996, and the updated TAN 8 will outline the Welsh Assembly Government's aim to secure the right mix of energy provision whilst minimising the impact on the environment and reducing the overall demand for energy. To meet the Assembly's renewable energy target of 4,000 GWh per annum by 2010,

5 Wind power and planning

the policy aims to achieve 800 MW from strategic onshore wind energy development. The Welsh Assembly Government considers that a few large scale (25 MW+) wind farms could be carefully located to meet the target. The draft TAN 8 identifies seven Strategic Search Areas (SSAs) in Wales which are considered relatively unconstrained. The identification methodology was developed by Assembly consultants using a land use sieve approach and combining this with information about the capacity of the existing and proposed grid network. Local planning authorities are encouraged to undertake more detailed mapping and landscape assessment work to formulate local policies for development of large and small scale wind farms in the SSAs and for smaller wind farms outside the SSAs. Community involvement at early stages in the development of policies and proposals is encouraged. The Welsh Assembly Government is due to issue the revised and agreed TAN 8 by summer 2005.

Northern Ireland

Currently there is no planning policy statement for renewables in Northern Ireland. In August 2004 the Planning Service launched a consultation paper entitled Reforming Planning, which sets out to reform primary planning legislation in Northern Ireland. This could eventually lead to a stated planning policy on the development of renewable energy.

5.3 Current development plans

As most wind developments will go through the local planning system, reliable data can be difficult to obtain. However, Table 9 provides a recent summary of wind power applications that are being dealt with by the local planning system throughout the UK. Data on Section 36 projects can be obtained from the DTI and Scottish Executive^{xviii}.

Table 9: Wind power applications in the UK local planning system⁴⁸

Post consent		Pre Consent	
Under construction	Awaiting construction	Application being considered	Application being prepared
484 MW	686 MW	5,861 MW	4,200 MW

FURTHER INFORMATION

Planning Policy Statement (PPS) 22 – Office of the Deputy Prime Minister - www.odpm.gov.uk/stellent/groups/odpm_planning/documents/pdf/odpm_plan_pdf_030334.pdf

National Planning Policy Guideline (NPPG) 6 – Scottish Executive - www.scotland.gov.uk/library3/planning/nppg/nppg6.pdf

Planning Advice Note (PAN) 45 – Scottish Executive - www.scotland.gov.uk/library/pan/pan45.pdf

Technical Advice Note (TAN) 8 – Welsh Assembly Government - www.wales.gov.uk/subiplanning/content/tans/tan08/tan8_home_e.htm

^{xviii} Please see http://www.dti.gov.uk/energy/leg_and_reg/consents/index.shtml and <http://www.scotland.gov.uk/Topics/Business-Industry/infrastructure/19185/18734> for further information.

6 Landscape and environment

Summary

- The landscape of the British Isles has changed dramatically through human development over the past 5000 years and very few landscapes pre-date this
- Climate change will have a radical impact on our landscape, and wind developments must be viewed in this context
- Landscape and visual impacts are important environmental considerations for wind development applications, yet reaction to these is highly subjective
- Overall there are far fewer landscape and environmental impacts associated with wind turbines when compared to the alternatives – and most of the impacts can be reversed quite quickly
- Wind developments can be in areas that have never had any energy generating technology in the past and are often met with greater resistance

6.1 Background

This chapter looks at landscape, visual and environmental issues related to the siting of wind developments. A sustainable approach demands that the issue of wind power is considered alongside competing alternatives, all of which also have landscape and environmental impacts. There is also a need for the cumulative impact of wind developments on the landscape and environment to be considered, as all energy developments will eventually result in associated impacts as a result of network expansion and upgrades.

With increasing pressures on energy policy and the need to reduce emissions of carbon dioxide, it is hard for any community to be considered exempt from the task of delivering a low carbon future. As climate change presents the most serious threat to UK landscapes, technologies that help limit our contribution to climate change should be encouraged, even where this represents a temporary loss of amenity.

This section provides a synopsis of the different types of wind farms, their landscape and visual characteristics, wind farm design issues and resulting landscape and visual effects which

may cause change to the existing UK landscape. It also looks at the environmental impact of wind developments and the main non-renewable alternatives.

Taking a holistic sustainable development view does not automatically mean a 'green light' for wind developments, as it would require consideration of a wide range of landscape, natural heritage, and environmental issues as well as social and economic ones.

6.2 Landscape change

One definition of landscape is 'an extensive area of scenery'. This does not do full justice to the complexity of the term, which is better described as 'habitat plus mankind and the resulting combination of patterns, perception and process'. The Landscape Institute defines landscape as 'the whole of our external environment, whether within urban or rural areas'. This document should not be regarded as definitive guidance on this subject, which is covered in a number of technical publications and detailed guidance documents.

6 Landscape and environment

The British Isles has a remarkable diversity of landscape. The post-glacial empty wilderness has been transformed over the last 10,000 years into the living landscape of the 21st century. The outline of the British Isles was shaped by the rising sea and its separation from mainland Europe with subsequent colonisation of the land by the forests and the arrival of the first fauna. The encircling seas give the islands a temperate climate and a wealth of marine life. Around 5,000-6,000 years ago, early man initiated the long process of transforming the wilderness into the landscape that is familiar today. Landscapes are not static; they have always been changing and will continue to do so, adapted by human needs and economic activity, and affected by future climate change. They are in a constant state of dynamic equilibrium which cannot be frozen at any one point in time.

Wind projects are just one of the many forms of development that may bring about landscape change in the UK. However it is worth bearing in mind that wind turbines are not permanent structures and once removed the landscape can usually return to its previous condition – although roads may remain for a considerable period of time after a site has been decommissioned. This is provided that wind developments do not lead to land-take by other developments, which should be guarded against in protected or previously undeveloped areas.

6.3 Landscape and visual effects

Landscape effects are changes in landscape fabric, character and quality as a result of development, and differ from visual effects. The latter relate to the appearance of these changes where they can be seen in the landscape and the effect of those changes on people.

It is recognised that landscape and visual impact is one of the key environmental issues in determining wind farm applications, given their typical form, location and function. In a random sample of 50 wind developments which had been refused planning permission^{xix}, 85% of the reasons for refusal were on grounds of landscape and visual impact.

Wind developments have a number of characteristics which cause landscape and visual effects. These characteristics include the turbines, access and site tracks, substation building(s), compound(s), grid connection and anemometer mast(s). The assessment should take account of any proposed mitigation measures, predict their magnitude and assess their significance. Landscape and visual assessments typically include photomontages from a number of viewpoints to illustrate what a wind farm may look like when it is built – see Figure 14.

They may also include Zone of Visual Influence (ZVI) maps which illustrate where a wind farm may be seen from over a given area of landscape.

If a wind farm is designed with sensitivity to the surrounding landscape, then visual impacts can be reduced. Scottish Natural Heritage has developed guidelines to aid in the proper design of wind farms in order to minimise their potential negative impacts on the landscape. The components of the wind farm should be considered relative to the character of landscape in terms of the value of landscape, the experience of landscape, visual composition and the relationship with existing developments.

^{xix} Information provided by BWEA

6 Landscape and environment

Figure 14: Wind farm photomontage





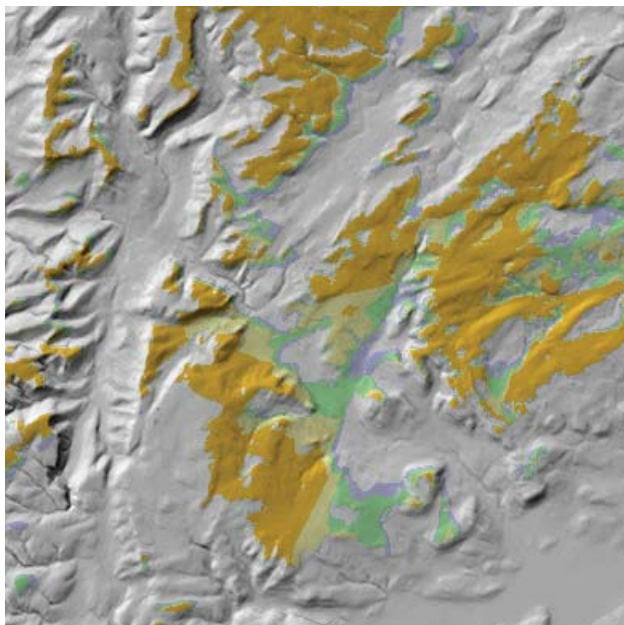

© Enviro

Figure 15: Wind farm Zone of Visual Influence (ZVI) map



Cwm Llwydd - amount of most visible turbine seen

-  No turbines visible
-  Blades, no hubs
-  Hub and upper tower
-  Rotor and lower tower
-  Base (1m) of tower

© Enviro

6.4 Visual characteristics of wind farms

Onshore

The visual characteristics of wind turbines vary with their make and model. Simple and sculptural forms of turbines using three blades generally appear most appropriate, and these are the designs that have become the industry standard.

Onshore wind developments in the UK vary in size from a one turbine to large-scale developments containing over one hundred turbines. The average size of wind developments in the UK is around 10-20 turbines.

Wind developments from the early 1990s, during the early days of the UK wind industry, typically used turbines with a capacity range of 300-400 kW. Over the last 10 years or so turbine technology has evolved, and turbines today can generate up to 3 MW each; a ten-fold improvement in as many years. There are practical limits for onshore sites, as larger turbines and towers become difficult to transport by road. This is likely to put an eventual brake on the upward trend in turbine size.

Today's wind turbines typically have the hub located up to 90m above the ground with turbine blades that sweep a radius of between 40m and 45m, giving the total tip height from the ground to the tip of the vertical rotor, the 'blade tip height', of between 60-120m. The most recently built wind farms typically have turbines with blade tip heights of 100m and above. As a comparison, the height of Big Ben is

100m, the Glasgow Tower 105m, and the London Eye 135m. Future turbine developments may lead to improved performance along with increases in height and rotor diameters. Recent wind farms have fewer, larger machines with bigger blades, operating at lower rotational speeds. Arrays of these larger turbines are less dense because of the increased spacing between the turbines, but this extends their visual influence over a wider overall footprint.

Although the visibility and impact of wind farms increases with larger turbines, it is often difficult to discern relative differences in turbine heights, especially at a distance. It is generally considered better in terms of visual impact for a wind farm to have a lesser number of larger turbines rather than greater numbers of smaller turbines.

Offshore

Offshore wind farms are sited at sea off the mainland coast, either within territorial waters or the newly created Renewable Energy Zone^{xx}. There are less constraints on size for offshore turbines and so larger capacities are being developed – up to 5 MW over the next decade. Typically, they share some of the same visual characteristics as those onshore, but they can also include navigational markings, night-time lighting, offshore substations and onshore grid connections. Use of these markings depends on the variability of the coastal edge, variable visibility with weather conditions and the effects of curvature of the earth.

^{xx} All current offshore wind farms are within territorial waters.

North Hoyle Offshore Wind Farm



Supplied by npower renewables © Anthony Upton 2003

Offshore wind developments tend to have higher turbines and more of them, but their landscape and visual impact is generally less given their distance from the coastline. Nevertheless, the coastal landscape is often unique and offers some of the most highly valued landscape in the UK, so developments can be sensitive.

In the UK, offshore wind projects are currently being built at distances of between 2-10kms from the shore, in relatively shallow water, but new applications will be submitted for sites much further out to sea, including some beyond the UK's territorial waters, in the newly established Renewable Energy Zone. At such distances these wind farms are likely to have

relatively minor visual impacts, but naturally, building and operating offshore turbines is more expensive, and grid connection costs can be higher. This is balanced to some degree by improved performance offshore, but at present there is still a considerable difference in generating costs from onshore wind. Due to Government support, offshore wind energy is expected to be a major contributor to the 2010 targets for renewable electricity generation, and its importance is likely to grow further to 2020 and beyond.

Better design and mitigation

Some landscapes are better able to accommodate wind developments than others, on account of their scale, landform and relief, and ability to limit visibility. Good design of wind farm layouts and their relationship to the form of the landscape can help improve their visual acceptability.

Novar Wind Farm, Highlands



© npower renewables

Siting is generally conditioned by technical, practical and economic reasons such as wind capture, turbulence, access, grid connection, planning and land ownership. These factors will therefore limit the extent to which layout and siting can be adjusted in line with aesthetic considerations.

6 Landscape and environment

A development which is grouped into a tightly clustered array is visually more acceptable if it appears as a single, isolated feature in open, undeveloped land. But in agricultural landscapes, rows of turbines may be visually acceptable where formal field boundaries are an existing feature.

Dun Law Wind Farm, Scottish Borders



© ScottishPower

The overall visual impact of a wind development will principally depend on the area from where it is seen (the extent of visibility) and how it appears within these views (the nature of visibility). It is not necessarily whether it can be seen or not, but how it is seen and how it looks when it is seen. Wind developments will be most acceptable where they look appropriate to the area and create what is perceived as being a positive visual image. However, it is evident that for some, wind turbines are ugly and unsightly structures that are out of place in any rural setting and it is unlikely that design and mitigation measures will be able to change these opinions.

6.5 Designated areas

The UK has many types of designated areas, with National Parks and Areas of Outstanding

Natural Beauty (England, Wales and Northern Ireland only) receiving the highest level of protection, along with a variety of other national and international designations.

The aim of high level designation is to preserve unique and valuable landscapes and areas for the nation's long-term benefit. All the key planning guidance referred to in Chapter 5 recommends that planning permission should not be granted for renewable energy developments in designated areas unless there are strong overriding considerations and no alternative locations. In most cases this is unlikely to apply to commercial-scale wind power proposals^{xxi}, and a strong case can therefore be made for maintaining a high level of protection in areas protected for their landscape and aesthetic value.

6.6 Public perception

Some people view wind turbines as graceful structures that complement the landscape, particularly when compared with the centralised power stations and power lines that have been present across the landscape for many years. Nevertheless, there are also many people who feel that wind turbines represent an industrialisation of the landscape and are unacceptable in rural locations. Anecdotal evidence suggests that wind developments proposed in already industrialised areas receive few visual complaints.

A Scottish Executive study on public attitudes shows that one in four residents living near wind farms (26%) say that they spoil the landscape, with visual impact the primary issue causing people to dislike wind developments⁶¹. But the study also showed that for people living

^{xxi} Small-scale wind turbines and other renewable energy technologies be often be acceptable within designated areas, and there are a number of successful projects. In some cases, such technologies may help to avoid the need for additional grid infrastructure.

Case Study

Industrial Wind Projects – Dagenham, London

Dagenham Diesel Centre (DDC) was opened in November 2003 as the first major building constructed on Ford's 500 acre Essex site for over 30 years. Ford invested £325 million in the state-of-the-art facility in anticipation that around 50% of all cars sold in Europe by 2006 will be diesel-powered.

Looking to demonstrate sustainable energy ideas, Ford consulted with the British Wind Energy Association (BWEA) and were persuaded that as the UK has 40% of the EU's wind resource, there was a good business case for creating London's first wind park as part of the regeneration of Dagenham and to generate 100% cost-effective 'green electricity' to help power the Clean Room Assembly Hall.

Ford chose Ecotricity as project partners. Under the terms of the Merchant Wind Power (MWP) initiative (providing an exclusive source of wind generated electricity for organisations with an environmental agenda), Ecotricity carried out the feasibility studies, environmental assessments and planning applications. This work included consulting with the local communities, the local airport and the RSPB ensuring the plans for the turbines located them at a suitable distance from the Thames to avoid any impact on migratory birds.

The Planning Committees of Havering and Barking & Dagenham Councils granted planning permission. The latest technology and super-quiet E66 Enercon turbines, presently the largest in the UK, were chosen and work was completed with the two turbines installed in April 2004. The process took about three years from original inception to commissioning and the turbines are now an integral part of the Dagenham landscape readily visible from the A13.

The success at Dagenham follows a similar partnership between Ecotricity and Sainsbury's back in 2001. Sainsbury's decided to install a



Ford UK consulted with local communities, the local airport and the RSPB.

600 KW wind turbine at their East Kilbride distribution centre in Scotland, and this was the first such project of its kind based on an industrial site.

"We received no objections to the scheme. I am aware that the response to the Dagenham turbines has been positive and they are seen as a beacon for the regeneration of the Thames Gateway."

Martin Knowles
Principal Planner, London Borough of Havering

"This scheme has made an important contribution towards making London a more sustainable world city and will help us to achieve some of the key targets in my Energy Strategy. I hope it will encourage other large organisations to consider developing similar schemes on their premises."

Ken Livingstone
Mayor of London

"Green power from Ecotricity is fully competitive with our forecast energy prices and there are huge non-financial benefits too; thousands of tonnes of power station emissions are saved by switching our electricity source for the Dagenham Diesel Centre to wind power."

Roger Putnam
Ford of Britain Chairman.



© Ecotricity

Plans for turbines ensured they were located a reasonable distance from the Thames

Lessons and thoughts:

- As a brownfield industrial site, the Dagenham wind park plans raised no objections on landscape, environmental or other grounds from known critics of wind energy. Development on this kind of site represents a huge sustainable development opportunity, where potential conflicts can be minimised.
- Ford offered the various trade union members the chance to visit Swaffham as well as local residents of the two boroughs involved in planning permission. Visiting existing wind farms is probably the best way to appreciate the implications of proposed developments.
- Ford is so pleased with the project that they are looking to develop wind projects at other sites. Other large companies should be encouraged to do the same, particularly where turbines can be situated on developed company land.

Key facts:

- The 85m German produced Enercon 1.8 MW E66 turbines are some of the UK's tallest at 120m with 35m long blades and a rotor diameter of 70m
- The project has a total capacity of 3.6 MW, providing enough power to cover the needs of the Clean Room Assembly Hall..
- To find out more: www.ecotricity.co.uk; www.media.ford.com

6 Landscape and environment

in the immediate vicinity of a wind farm development, only 12% said that the landscape had been spoiled.

Essentially, the debate over whether wind farms are destructive, benign or even positive additions to the UK landscape is highly subjective. The lack of a 'right' or fact-based answer means that this debate is unlikely ever to be resolved, making decisions on individual applications extremely divisive.

However, in order to have an appreciation of the issues involved, it is also important to consider the energy generating alternatives to wind energy, as all of these also have landscape and environmental impacts, many of which are taken for granted.

6.7 Comparing landscape and environmental impacts

The impact that electricity generation has on the landscape and environment depends on the type of fuel and technology that is used to generate it – see Table 10 for a summary. Fossil fuels such as gas and coal, and the uranium required for nuclear fission, all rely on extractive industries for fuel supply. In the case of coal and uranium, this can have a wide and devastating effect on the landscape surrounding the mine site, with the associated infrastructure and waste production contributing to a landscape and environmental impact that can last for years. For UK gas (and oil – although this is a minor contributor to electricity production), extraction is concentrated offshore, and supplies of liquefied natural gas will arrive by sea. However, some onshore infrastructure will still be required to receive, store and distribute the gas and there are a number of environmental issues associated with offshore exploration. And

in other countries, gas and oil are obtained from reserves in onshore locations, where landscape effects will be much more pronounced.

Although many of the landscape and environmental effects of our fuel needs will not be borne in the UK, a sustainable development approach implies that all effects should be considered, wherever they occur in the world. It would not be equitable to suggest that landscape destruction in other countries is justified in order that UK landscapes are preserved.

For combustion, all conventional power plants require a large land area, and their total visual impact would include any pylons that are required to link them to the national grid. The land-take for grid connection would apply equally to wind power, although for smaller development lower voltage pylons are used, and these tend to have a much lower visual impact.

On the environmental side, fossil fuel electricity generation will emit greenhouse gases and other pollutants when combusted, which contribute to climate change and air pollution problems. Coal combustion, with its high sulphur content relative to other fossil fuels, also causes acid rain. This particular problem can be solved by the installation of flue gas de-sulphurisation equipment, but this is costly and many coal plants do not have it fitted. Fossil fuel power plants (especially coal) will often cause ground pollution problems on the land they inhabit, and many conventional plants (including nuclear) will also generate heat pollution^{xxii}, affecting local rivers or the sea. Electricity generated by nuclear fission adds to background levels of radiation and the risks and consequences of serious accidents require rigorous and costly management and operational procedures.

^{xxii} Heat pollution is generated through the cooling needs of conventional power plants, which often use water for this purpose. After this has been cooled to a certain level on-site, warm water is often discharged into rivers or the sea.

6 Landscape and environment

Table 10: Potential environmental impacts from selected electricity generating technologies⁴⁹

Fuel Type	Operation	Potential Environmental Impacts
All sources	Transmission lines	Land use Aesthetics Safety hazard Wildlife (including bird collision)
	Coal	
	Surface mining	Land disturbance Acid mine drainage Silt production Solid waste Habitat disruption Aesthetic impacts Health & safety
	Underground mining	Acid drainage Land subsidence Health & safety Solid waste Coal mine methane emissions
	Processing	Solid waste stockpiles Wastewater Health & safety
	Transportation	Land use Accidents Fuel utilisation
	Conversion	Land use Air pollution Sulphur oxides Nitrogen oxides Particulates Greenhouse gases Carbon dioxide Solid wastes Thermal discharge Aesthetics
Natural Gas	Extraction	Land use (drilling) Brine disposal
	Transportation	Land use (pipelines) Leakage (methane emissions)
	Processing	Air pollution (minor)
	Conversion	Land use Air pollution (relatively minor) Carbon monoxide Nitrogen oxides Greenhouse gases Carbon dioxide

Table 10: (continued) Potential environmental impacts from selected electricity generating technologies⁴⁹

Fuel Type	Operation	Potential Environmental Impacts
Natural Gas (Continued)	Conversion (continued)	Methane Thermal discharge Aesthetics
Nuclear	Mining (Uranium)	Land use (not extensive)
	Milling (separation)	Radioactive wastes Air Water Solid waste
	Enrichment	Minor release of radioactive material
	Conversion	Land use (permanent) Thermal discharge Release of radionuclides (minor) Accident potential Aesthetics
	Reprocessing	Radioactive air emissions
	Radioactive waste disposal	Accident potential (handling, storage) Political instability (long term) Land use
Wind (onshore)	Construction / Siting	Land disturbance (for access, minor) Land use (including access roads) Aviation Radar/telecommunications Aesthetics Wildlife
	Operation	Bird collision Maintenance activities (very minor)
Wind (offshore)	Construction / Siting	Seabed disturbance (construction only) Land use (shipping lanes/on-shore connection) Aesthetics (depends on distance from shore) Aviation Radar/telecommunications Marine life
	Operation	Bird collision Maintenance activities (very minor)

Table 10 does not show the longevity of the landscape or environmental impact that is caused. For fossil fuel and uranium mining, these impacts can be long-lived, as is evident in parts of the UK where coal mining has taken place. On power station sites, the large scale of

the plant and associated infrastructure means that extensive, permanent development usually takes place, and such areas are unlikely to return to their previous condition without comprehensive decommissioning. For nuclear power sites the land-take and associated

6 Landscape and environment

impacts are virtually permanent, as decommissioned sites cannot simply be demolished.

Decommissioning of wind turbines is a relatively straightforward process and in most cases the land can be returned to 'normal' at the end of the turbine's operational life, with access roads and other impacts reversible over time in most cases. In this sense, wind turbines could be seen as temporary structures, and siting decisions now do not necessarily need to become permanent.

6.8 Land-take by wind developments

Despite claims of wholesale destruction of the UK countryside, wind power development is not likely to have the widespread impact that many people imagine. To meet the 20% target for 2020 solely from wind power, the UK would need around 26 GW of wind capacity if electricity supply increases to 400,000 GWh^{xxiii}. If 50% of this is met from onshore wind using an average of 2 MW turbines, this would require around 6,500 turbines. Based on a land-take of around 0.18 ha/MW for the turbines, access roads and substation^{xxiv}, total onshore land-take would equal around 2,340 ha. Based on a total UK land area of 24 million hectares, this is equivalent to around 0.0001% of the total available land. This contrasts with the 3.3 million hectares that is currently classed as 'urban + other' use land. As wind turbines are usually located on hilly land, the space around the turbines is still available for livestock grazing or other activities and is therefore not considered as part of total land-take.

^{xxiii} This figure is based on the assumptions used in the analysis by Dale et al (see Chapter 4). In reality, wind output is only likely to make up part of the 20% renewables target, meaning these estimates are overstated.

^{xxiv} 0.18 ha/MW is based on calculations using data from the proposed Black Law wind farm (143 MW) being developed by ScottishPower.

Figure 16: Wind turbine in front of coal-fired power station, Grevenbroich, Germany.



©Nordex AG

6.9 Achieving a long-term perspective

Out of all the issues surrounding wind power development, landscape and visual impact concerns are the only ones that are primarily subjective. As the effect cannot be measured or calculated and mitigation options are limited, it is unlikely that these issues can ever be resolved to everyone's satisfaction. It therefore seems inevitable that some people will always be objectors to wind farms in rural locations, and as UK wind resources correlate strongly with remote and rural areas, disagreement is unavoidable.

Recent changes to planning guidance across the UK requires local decision-makers to consider national energy policy priorities when deciding on local renewable energy projects, and in many cases it is now unlikely to be enough to reject an application on landscape grounds

6 Landscape and environment

alone. Considering the high level of national, and often local, support for wind power this seems to be a reasonable approach in cases where there is no special landscape designation.

There is a strong case for viewing wind developments as temporary structures, pending longer-term approval on landscape grounds. As full decommissioning is usually possible, lasting objections could potentially be remedied on a case-by-case basis by the eventual removal of the turbines at the end of their working lives. The energy options available will have changed by then, and other technologies may be available. However, it should also be recognised that landscape change has a long history and that what may seem alien now may become accepted over time. Evidence suggests that hostile opinion towards wind farms tend to soften after they are commissioned, and there is

no reason to believe this trend will not be replicated at future developments.

Any concern that UK landscapes will be ruined by wind farm developments needs to be balanced against the widespread harm that climate change itself could cause. Previous chapters have shown that wind power is a practical and viable solution to climate change as part of the much wider societal and economic change that is necessary. The development of onshore wind power will make a major contribution to meeting renewable energy targets and it is not practical to expect offshore wind, which is significantly more expensive, to do this alone.

FURTHER INFORMATION

Countryside Agency - www.countryside.gov.uk

Department of Environment, Food & Rural Affairs - www.defra.gov.uk/wildlife-countryside

Countryside Council for Wales - www.ccw.gov.uk

Campaign to Protect Rural England - www.cpre.org.uk

Campaign for the Protection of Rural Wales - www.cprw.org.uk

Scottish Natural Heritage - www.snh.org.uk

7 Wildlife and ecology

Summary

- The interaction between wind farms and birds, other wildlife and natural habitats is highly site specific
- Wildlife and habitat impacts are best mitigated through careful project location, design measures, and appropriate construction techniques in the first instance
- Developers are required to undertake an Environmental Impact Assessment for all major wind projects, which must be comprehensive and of a high quality
- Not all wind developments will be acceptable, but with careful siting and strategic planning the most sensitive sites can be avoided
- So far, the UK has avoided cases of significant negative impacts on birds from wind developments, and this record must be preserved

7.1 Background

The natural heritage of the British Isles is unique and diverse. Despite centuries of extensive human development and interference, the UK is home to a large number of bird species and contains a wide array of designated sites that represent a significant percentage of the total land area (around 7%⁵⁰). Alarming, climate change will have damaging and wide-ranging effects on wildlife and ecology, with widespread displacement and possible extinctions of sensitive species.

Virtually all organisations involved in nature conservation recognise this threat and are united in their support for measures to help combat it, including renewable energy. However, there is also concern that these measures should not compromise existing conservation efforts and that renewable energy installations in particular should be sited in such a way as to limit their impact on surrounding habitats and affected species. This is consistent with the application of sustainable development principles, which require a holistic approach to such issues that respects natural limits and adopts a precautionary approach where current information is insufficient.

Balancing these concerns is a difficult task, and one that requires a wide spatial overview combined with access to detailed and specific environmental information at the local level. Planners and decision-makers will need to consult widely, and will want to ensure that any Strategic Environmental Assessment and/or Environmental Impact Assessment is of a high standard and has identified the risks posed by the development. Only then can informed decisions be made, and avoidance or mitigation measures discussed, if available.

This chapter looks at the potential effects of wind power developments on wildlife and ecology, concentrating particularly on habitats and birds. More detail is available in Annex E.

7.2 Habitats

The majority of onshore wind developments are based in upland areas, with upland moorland being the most common vegetation type. There has recently been a move by some wind developers to try to site projects largely within commercial forestry plantations in upland areas. For low biodiversity habitat this can be a positive use of land which has already been changed, and has less ecological and nature conservation value. Greater habitat diversity and

reinstatement can be encouraged as part of such development. However, not all forestry plantations are suitable, as they may be key to restoring large, uninterrupted, biodiverse areas of habitat that have been degraded by planting.

Box 6

Birds and Habitats Directives

The Birds Directive was adopted by the European Union in 1979, representing the first directive on nature conservation. It is now the primary tool for delivering against EU obligations under global conventions. The Habitats Directive was adopted in 1992 and together both directives have established a set of standards and norms that are now in common use.

They require Member States to:

- Take measures to conserve all naturally occurring bird species across the EU
- Classify as **Special Protection Areas (SPAs)** the most suitable territories for species listed on Annex I of the Birds Directive and migratory species^{xxv}
- Classify as **Special Areas of Conservation (SACs)** a sufficient area of the habitats set out in Annex I and of the habitats of the species listed in Annex II of the Habitats Directive in order for them to be maintained or restored to favourable conservation status.
- Maintain SPAs and SACs in Favourable Conservation Status.
- Follow the procedure outlined in Article 6 of the Habitats Directive for carrying out appropriate assessments of environmental impacts on SPAs and SACs.

Article 6 is translated into GB law in the Conservation (Natural Habitats, &c.) Regulations 1994^{xxv}. Regulations 48, 49 and 53 set out that:

- If a project is likely to have a significant effect on a SPA/SAC then an Appropriate Assessment has been undertaken of the implications of that project on the site's conservation objectives.
- The decision-maker can only give consent to the project having ascertained that there will not be an adverse effect on the integrity of the site.
- If this cannot be ascertained, then consent for the project can only be given if it can be proved that there are no less damaging alternatives available to meet the project need^{xxvi}, and then that there are imperative reasons of overriding public interest for the project to proceed.
- Should a damaging project be consented after passing these tests, compensatory measures are required to maintain the integrity of the Natura 2000 network (SPAs/SACs).

^{xxv} In Northern Ireland: The Conservation (Nature Habitats, etc.) Regulations (Northern Ireland) 1995

^{xxvi} This includes alternative sites for the project that would be less damaging to the environment, and alternative means to meet the project need (eg: energy efficiency).

7 Wildlife and ecology

The use of brownfield sites for wind developments is likely to be far less controversial in environmental terms, by avoiding some of the ecological and landscape impacts mentioned. There are numerous locations – for example on industrial sites or disused mines and quarries – that present viable opportunities for wind farms. Such sites may also be close to large electricity loads, such as operational factories, or urban areas.

It is difficult to generalise on the significance of specific habitat loss, since it depends on the particular location, habitat types and the past management. The loss of a species poor, common habitat is generally less significant than that of rarer or more diverse types. Habitat loss comes from the turbine bases plus the necessary access tracks, borrow pits^{xxvii} and quarries in wind farm development. Losses caused by connection to the grid depend on the terrain and the method of connection – underground cable, wooden pole line or pylon line. Above ground connection generally causes less habitat damage than underground connection as it can follow existing tracks or low value habitats. However, visual impact is greater from over-ground connections and there may be an associated collision risk for birds. It is therefore essential that the options are assessed on a case-by-case basis.

Not all habitat loss is necessarily permanent if the location is carefully chosen and correct construction methods are used. Habitats can be created or returned above turbine bases and on construction compounds during the life of the wind farm, and, for sites not protected under EU law, the compensation provided for habitat loss can provide benefits for the future management of surrounding habitats. However, even the

provision of various compensation habitats will not always replace what is lost. Sensitive habitats, such as active peatland and ancient woodland, take a long-time to develop and are hard to replicate. For this reason, they are often protected through EU and national designations, and cannot normally be compensated for.

7.3 Peat

Two important issues for upland habitats are the potential effects on the water regime of peat bodies underlying peatland habitats. Peat is a non-renewable fossil fuel and as such should be protected from degradation – serious damage can result in the release of methane, a potent greenhouse gas in itself, which could reduce the carbon savings from the installed wind turbines. It is also a valuable habitat, so issues relating to habitat conservation also need to be considered early in the process.

Wind farms, and in particular access roads, have the potential to alter the hydrology of the peatland, leading to drying and cracking, and potential instability in peat bodies, which can result in the down-slope mass movement of peat, often called a peat slide. The key to avoiding deleterious effects on peat bodies is consideration of the wind farm location, scheme design and environmentally sensitive construction methods. These should be addressed by the EIA where appropriate. Again, conservation bodies can help advise on the appropriateness of proposed developments – see the links at the end of this chapter.

7.4 Water

Indirect habitat loss through pollution and construction disturbance can also occur as a result of careless construction practice. During

^{xxvii} A borrow pit is a traditional name for a small quarry, often in the side of a small hill next to a track from which stone or other construction material is removed to allow the track to be constructed.

Case Study

Consultation, Environmental Assessment and Habitat Improvement – Black Law, Scotland

Over the past five years, ScottishPower and RSPB Scotland have established a new way of working together to integrate habitat enhancement with wind farm development. Together they address diverse and complex challenges arising from the largest consented wind energy site in the UK. The site is being built in two phases and will eventually be home to 64 wind turbines, with a total capacity of 143 MW.



© ScottishPower UK plc.

ScottishPower and RSPB Scotland worked closely on the Habitat Management Plan for 1,440 ha of the 1,850 site. This includes the largest heathland restoration project in Central Scotland.

In 2000, ScottishPower identified sites across Scotland for potential wind energy development and consulted with key stakeholders, including RSPB, who suggested that 10% of those sites offered 'significant ornithological problems'.

The company screened the inappropriate sites out and identified Black Law as a suitable location. Lying half way between Glasgow and Edinburgh, it is a brown field location straddling West Lothian, North and South Lanarkshire.

The site meets Scottish Executive planning policy NPPG6 on renewable energy, has a good wind resource and lies close to the existing grid connections. Its relatively low wildlife interest results from a post-war development history that had left an inauspicious mix of poorly restored and abandoned opencast coal mines, commercial conifer plantation, degraded blanket bog and improved grassland. Preliminary bird surveys showed some species of note but nothing of special significance.



© ScottishPower UK plc.

From this point, project development continued in liaison with all key stakeholders, including Scottish Natural Heritage (SNH), the three Councils, the five different forest owners and the two farms that share the bog, grassland and abandoned opencast mine. The three nearest local communities of Forth, Carluke and Climpy were all involved in public exhibitions during the community consultation phase.

ScottishPower also liaised with RSPB Scotland and others in a broader capacity to establish a Habitat Management Plan for 1,440 ha of the 1850 ha site. Key to the process was the use of outside expertise, such as the contribution from the University of Stirling on river restoration. The Plan was part of the planning conditions attached to consent. RSPB Scotland at all times retained its independent right to object if it deemed it necessary. Consent was granted by the Scottish Ministers on 13th February 2004 and work on the site started the following July with the first phase of 42 turbines due for completion by Autumn 2005.

“Black Law highlights the benefits of finding wind farm sites where there are no conflicts with conservation interests. What has been achieved here is a combination of renewable energy generation, the restoration of abandoned opencast coal mining works and habitat enhancement. Given the wind farm did not present a significant threat to bird life, and following detailed negotiations between ourselves, ScottishPower, the Councils and Scottish Natural Heritage, we have together secured a really positive project that brings significant environmental benefits to the area.”

Stuart Housden
RSPB Scotland Director

“At Black Law wind farm a close working relationship with RSPB Scotland helped enormously in achieving significant benefits for a range of species including black grouse, curlew, lapwing, snipe, otter and water vole. Black Law wind farm demonstrates that wind farms can deliver significant biodiversity gains for a range of threatened habitats and species throughout the wider countryside.”

Alan Mortimer

Head of Renewables Policy, ScottishPower

Lessons and thoughts:

- ScottishPower and RSPB Scotland worked closely on the Habitat Management Plan for 1,440 ha of the site. This includes the largest heathland restoration project in Central Scotland.
- Habitat improvement will be secured through the restoration of 150ha of opencast coal mines, reducing grazing plus drain blocking on the blanket bog, and removal of 458ha of conifer plantation using mulching and whole tree harvesting, to be returned to heathland.
- Under a condition of the planning consent an Ecological Clerk of Works was appointed full time during the construction period. The ECoW provides advice on best practice construction methods and ensures the development does not infringe any conservation law.
- ScottishPower aimed to minimise carbon dioxide emissions from vehicles transporting aggregate for construction by sourcing the stone from the existing opencast coal mine. This proved to be problematic as the stone used broke down as a result of construction traffic. The problem was overcome by immediately adding a capping layer of high grade stone.

Key facts:

- Black Law Wind Farm is on the site of an abandoned opencast coal mine, sheep and cattle grazing farmland and commercial forestry covering around 1850ha, 2km to the northwest of Forth in Lanarkshire, 3km northeast of Carluke and 1.5km from the village of Forth, South Lanarkshire.
- Three different local authorities were involved: West Lothian, South Lanarkshire and North Lanarkshire. Seven different land owners were also involved.
- The project is in two parts: Phase 1 started construction July 2004 and will be completed Autumn 2005 with 42 bonus turbines, 110 metres ground to tip, each with a rated capacity of 2.3MW. Phase 2 will involve a further 22 turbines. Total capacity from the 64 turbines will be 143 MW.
- For further information: www.rspb.org.uk/scotland; www.scottishpower.com/renewables

7 Wildlife and ecology

wind farm planning and construction, watercourses must be carefully protected since pollution of upland streams travels rapidly downstream and affects habitat quality outside the immediate area of the development.

7.5 Birds

The geographic location of the British Isles gives it strategic importance in the survival of internationally important bird populations. Seabirds nest here in their millions in colonies around the coasts. Wildfowl and wading birds have important stop-over locations in the estuaries during their long migrations between their wintering quarters and their Arctic breeding grounds, and three million others spend the winter in Britain and Ireland.

Birds can be affected by wind developments in four key ways:

- Habitat loss or damage (see above)
- Disturbance, leading to displacement or exclusion
- Risk of collision, which can result in mortality
- Barriers to movement, including cumulative impacts

Birds do not, or cannot, always change their behaviour to accommodate wind developments and this puts them at risk from displacement or collision as a result of wind farm developments.

Disturbance

Disturbance from wind farms has been recorded for both feeding and breeding birds. Many birds have been shown to continue their lives unaffected by wind developments and breeding populations of many ground nesting birds have remained the same after onshore wind projects have been constructed.

However, some birds remain averse to wind power structures and maintain safe distances from them, effectively being displaced from feeding or breeding grounds. To reduce such risk, and mitigate or avoid potential harm, assessing the importance of local, site-specific features is an essential requirement of the EIA.

Collision risk

Certain populations, particularly of the larger birds of prey, appear more prone than other groups to fatal collisions with wind turbines. This may be the result of a coincidence of sensitive species, wind turbines and good food sources nearby.

Susceptibility to collision is due to a range of factors including flight and sight conditions, manoeuvrability, flight behaviour/purpose and topography, particular features that concentrate birds, such as migratory bottlenecks, or places where rising winds are important for lift for soaring species.

Most birds either fly around or over wind turbines and of those that fly through, the vast majority negotiate the structures with apparently little difficulty. Almost invariably instances of regular collisions occur where the EIA (or similar) preceding the development of the wind farm has been deficient, where large numbers of turbines are located adjacent to high populations of sensitive species, or where there is either an abundant food resource close to the turbines or where turbines lie on favoured flight paths. In the earlier days of commercial wind power a number of developments were located where significant damage to bird populations was caused by the development. The Tarifa complex in Spain and Altamont Pass in California are two commonly quoted examples, where developers failed to consider the impact on large birds of prey, leading to hundreds of

7 Wildlife and ecology

deaths. Similar mistakes have been made more recently at Navarra in Spain.

However, despite the regularity with which these and other developments are quoted, there is no evidence that these mistakes have been repeated at UK sites. This is due in part to success in avoiding more sensitive sites, therefore continued vigilance is necessary to maintain this position. The onus is on the planning and consents process to ensure that bird assessments (done as part of an EIA) have been thorough before making judgements on wind energy applications, thereby avoiding wind farms in inappropriate locations.

Barriers to movement

There is some concern that wind farms may present a barrier to movement for migrating birds. This is because birds may prefer to fly around wind turbine clusters rather than through or over them. Whilst the effect on birds may not be significant at one site, the cumulative impact could be more serious, where series of wind farms could cause birds to fly a longer route than usual. This would negatively affect their energy balance, and could lead to higher mortality and lower fertility.

It is thought that wind farm design, and consideration of the cumulative impact of projects along or across migratory corridors, could alleviate potential barrier effects on birds. However, more research will be needed before these issues can be fully resolved.

Mitigation measures and further research needs

The findings from bird studies at a number of proposed wind developments have been instrumental in designing solutions to particular issues such as favoured flight paths of birds. This knowledge has led in some cases to the relocation or reduction of wind turbines from

wind development plans. In a number of cases habitat improvements have been commissioned after wind developments have been built to try and compensate for any adverse impacts. Habitat enhancement for UK Biodiversity Action Plan species such as black grouse, for example, should always be considered where wind farm development would potentially affect their habitat. Other innovative schemes are currently in place to improve habitat for species such as the golden eagle, for example on Beinn an Tuirc and Beinn Ghlas.

Although there have now been a number of detailed scientific studies conducted into the impacts of wind developments on birds, most have been undertaken outside the UK. The scientific community needs support in undertaking detailed UK studies, some of which are currently in progress. Developers could provide some real assistance by making the avian studies from their assessments accessible to the scientific community. This could be easily achieved through the use of an internet-based portal. They could also commit to a programme of monitoring before and after construction, and assist the scientific community by providing access to wind farm sites for research purposes. Alternatively, there may be a role for licensing authorities to require developers to undertake monitoring as part of the consents process.

7.6 Protected mammal species

Habitat loss is not likely to be significant for non-avian protected species if adequate environmental survey work is undertaken, and acted upon, when scoping and developing the site. Protected species of mammals such as otter, red squirrel and pine marten are unlikely to come into contact with turbines. Often particular localised issues such as the avoidance of a regularly used mammal path can be fully mitigated by careful micro-siting of an access road or a turbine base. The operational effects

7 Wildlife and ecology

of wind turbines on protected species, with the exception of birds and bats, relate mainly to noise, vibration and movement. These are not thought to affect the ability of animals to hunt or choose a territory.

7.7 Bats

Bats are a species fully protected under UK and EU law. There is no evidence to suggest that wind farms in the UK present a significant source of mortality to bat populations, unless they are sited close to known concentrations of bat activity such as summer roosts, swarming sites, and hibernacula (over-wintering sites). Experience in the US and continental Europe shows that bats can collide with wind turbines and there is some evidence that the levels of mortality are increasing with the increase in size of the turbines. The vast majority of bat fatalities (around 90%) are migratory species during the migration period, rather than 'local' bats on nightly foraging trips. Fatalities are associated with known migration routes. In the UK there are very few migratory species and no known migration routes.

There has been little research in the UK into bats and wind developments. As a precautionary approach it is increasingly important, as wind developments increase in size and number, that all sites are assessed for bat flight activity as part of the planning process so that potential impacts can be avoided and/or reduced through design. Typical onshore wind farm sites are located in areas that generally do not provide good foraging or roosting habitat for bats, although this does not remove the need for proper site surveys and assessments. The 'best practice' approach would be to avoid as much loss of bats' foraging habitat as possible or to replace it locally.

There is no evidence that wind turbines produce ultrasonic sounds that could either attract or repel bats.

7.8 Good environmental assessment

The potential environmental impacts summarised above must be examined at a very early stage in the development process to ensure that inappropriate sites are not proposed. Ideally, spatial strategies for wind farm development, at the SEA level or higher, will help to ensure that low impact locations are selected. For individual developments, the EIA must then be comprehensive and of a high quality, to enable local decision-makers and other stakeholders to identify any problems, and plan mitigation measures where possible.

A thorough EIA can only avoid such problems if they fall within its scope and its key recommendations are acted on. Conservation organisations can help to make objective comments on proposals and are often consulted early on by developers. It is worth noting that most of the major wildlife conservation organisations, including the Royal Society for the Protection of Birds (RSPB), English Nature and Scottish Natural Heritage, are supportive of wind power as a way of mitigating against climate change, which will have serious consequences for birds and other wildlife. However, where evidence suggests that the impacts on wildlife of individual wind farm proposals will be unnecessarily or unacceptably large the same organisations will object to those developments.

7.9 The way forward

This section has shown that there are a number of distinct areas of concern that relate to the siting of wind developments. It is important that developers, communities and other stakeholders identify these issues early on in the process, consult wildlife and conservation groups, and

7 Wildlife and ecology

agree mitigation solutions and habitat improvement schemes where appropriate. The planning system requires that full Environmental Impact Assessments are conducted for all major wind projects so that these impacts can be identified, and avoided, or mitigated through siting, design or habitat improvement where possible. This will be possible only where the EIA is well scoped and of a high quality, and ultimately it is the responsibility of the developer to ensure that this is the case.

The UK has a good record on the quality of wind projects and so far has avoided some of the siting mistakes made at a small number of international sites – a fact recognised by the RSPB⁵¹. There may be scope for licensing authorities to require more stringent mitigation and compensation measures, and a programme

of monitoring, within the financial constraints of the project.

Of course, not all proposed wind power developments will be acceptable, and in some locations there may be grounds for them to be actively discouraged. Spatial strategies, such as the Regional Spatial Strategies in England and the Strategic Search Areas in Wales, offer the opportunity to select the most suitable locations for wind farm development and avoid the most sensitive, and the consideration of renewable energy at this level should be encouraged. Following this, individual wind farm proposals will need to be considered on a case-by-case basis using the best evidence available and with full input from organisations with expertise in this field.

FURTHER INFORMATION

Windfarms and Birds - An analysis of the effects of windfarms on birds, and guidance on environmental assessment criteria and site selection issues – Birdlife International / RSPB - <http://www.abcbirds.org/policy/OffShoreBirdLifeStudy.pdf>

RSPB windfarms information - <http://www.rspb.org.uk/policy/windfarms/index.asp>

English Nature - <http://www.englishnature.gov.uk>

Scottish Natural Heritage - <http://www.snh.org.uk>

Joint Nature Conservation Committee - <http://www.jncc.gov.uk>

Birdlife International - <http://www.birdlife.net>

8 Noise

Summary

- Turbine design has improved substantially as the technology has advanced, with noise from the moving parts progressively reduced
- The public's concern about noise from turbines is often related to perceptions rather than actual experience
- Detailed studies have shown that the very low levels of low frequency noise from wind turbines will not normally cause adverse health effects

8.1 Background

The noise from wind developments has been one of the most intensively studied impacts. Noise levels can be measured and predicted, but (similar to other environmental concerns) public attitudes to noise from wind turbines depend heavily on perception and may therefore be outdated.

As the technology has advanced, wind turbines have generally become quieter, but noise from wind turbines is still frequently raised as a public concern during the planning process for wind farms.

Further detailed information on this issue can be found in Annex D.

8.2 How noise is measured

Noise is defined as any unwanted sound. Whether sound is perceived as such depends heavily on subjective factors as well as on measurable aspects such as how loud the sound is, how long it lasts and the tone of the sound.

Noise is measured in decibels (dB), which is a measure of the sound pressure level – the magnitude of the pressure variations in the air. A change in sound level of 1dB cannot be perceived except under laboratory conditions. An increase of 10dB sounds roughly like a doubling of loudness. Measurements of environmental noise are usually made in dB(A), which includes

a correction to allow for the sensitivity of the human ear. Typical noise levels in the environment are provided in Table 11.

8.3 Wind turbine noise

Mechanical and aerodynamic noise

Virtually everything with moving parts will make some sound, and wind turbines are no exception. The sources of noise emitted from operating wind turbines can be divided into two categories, mechanical and aerodynamic. The primary sources of mechanical noise are the gearbox and the generator. The highest contributor to the total sound power from a turbine is the aerodynamic noise, which is produced by the flow of air over the blades.

The sound from a single wind turbine is usually estimated at between 90 and 100 dB(A) at a specific wind speed. This creates a sound pressure level of 50-60 dB(A) at a distance of 40m from a turbine, which is about the same level as conversational speech. At a house 500m away, the equivalent sound pressure level would be 25-35 dB(A) when the wind is blowing from the turbine towards the house. Ten such wind turbines, all at a distance of 350m would create a noise level of 35-45 dB(A) under the same conditions.

It is perfectly possible to stand underneath a turbine and have a normal conversation without

Case study

Noise Concerns – Fenland, Cambridgeshire



Courtesy Cambs Times



Courtesy Cambs Times

Local Cambridgeshire developers worked on technical design issues to reduce the noise levels of the first wind turbine in the Fens.

When local developer Snowmountain Investments Ltd (now known as Snowmountain Enterprises Ltd) submitted a proposal on 16th August 2000 to erect 10 industrial units, associated access road and a balancing pond at Longhill Road in March, Cambridgeshire, it was a senior planning officer in Fenlands District Council who commented that it might also be a suitable location for the 54,500ha region's first wind turbine. The District Council, which represents a population of 85,600, is an active supporter of sustainable energy initiatives.

The amended application was submitted on 21st November 2000, triggering a two-year planning process involving a series of objections from the Home Office on behalf of HM Prison Whitemoor, which is situated 330m from the wind turbine site. One of their primary concerns was that noise from the proposed turbine would be intolerable and would disturb inmates.

In response, the developers produced evidence that the turbine manufacturers were producing quieter machines and that they were adapting the blades. They also used evidence from an existing site located 40 - 50m from HMP Haverigg in Cumbria, which uses the noisier Vestas V27 turbines without any serious complaints. Planning permission was finally given on 16th October 2002 and the decision signed on 7th April 2003. Construction of the modified turbine started in February 2004 and was commissioned on 1st March 2005. Despite some issues related to early morning shadow flicker (which have been resolved), there have not been any noise complaints, as confirmed below:

“We can confirm that there are no serious noise issues from the wind turbine.”

A spokesperson for HMP Whitemoor



Courtesy Cambs Times

Lessons and thoughts:

- The developers prepared the Environmental Statement with expert help to set out a review of the issues raised and their context to wider national and international commitments
- This project would seem to be a good use of a non-sensitive, semi-industrial site..
- Bat flights paths were a concern. The developers have commissioned a leading UK expert to report on a second phase bat survey between May and October 2005.
- Fenland District Council is pleased to have supported a local developer and is considering applications from Powergen and ScottishPower to erect turbines in Coldham, three miles North of March.

Key facts:

- The site is divided into two areas separated by a road to HMP Whitemoor. The company gave the Home Office the access route in return for free access to each piece of land for industrial and commercial purposes.
- The turbine is on the North of the site in 1.25ha where there had been no proposed use.
- The Environmental Statements included a letter from English Nature concluding that the proposal did not require a full Environmental Statement in view of work undertaken at nearby sites.
- Confronted with noise challenges, the developers were able to show that turbine manufacturers were producing quieter machines than those detailed in the original proposal and submitted this data to the council along with a modified blade design.
- To find out more: www.fenland.gov.uk

8 Noise

raised voices. Meanwhile, sheep and other livestock frequently graze underneath turbines without being driven away by the noise. Wind turbines do not operate below the wind speed referred to as the 'cut-in speed' – this is usually around 4 m/s. Wind data from typical sites in the UK suggests that wind speeds are usually below this for about 20-30% of the time; hence the noise does not happen all the time.

Table 11: Comparative noise levels⁵²

Source / Activity	Indicative noise level dB(A)
Threshold of pain	140
Jet aircraft at 250m	105
Pneumatic drill at 7m	95
Truck at 30mph at 100m	65
Busy general office	60
Car at 40mph at 100m	55
Wind development at 350m	35-45
Quiet bedroom	35
Rural night-time background	20-40
Threshold of hearing	0

Low Frequency Noise

Low frequency noise (20-100 Hz) and infrasound are issues that are frequently raised as concerns associated with wind farm developments. Low frequency noise affecting sleep, such as from ventilation systems or from industrial machinery, is important as a source of environmental concern, especially to those of heightened sensitivity.

Low frequency noise generation is generally confined to turbines whose rotors operate downwind of the support tower – a downwind machine. With the exception of a very few single turbine installations, all current and proposed commercial wind farms in the UK have

turbines with rotors upstream of the tower. These do not usually generate low frequency noise. Infrasound is generally defined as low frequency noise below the normal range of human hearing. A recent review of wind turbine data concludes that infrasound from upwind turbines can be omitted in the evaluation of the environmental effects of wind turbines⁵³.

A review of low frequency noise was completed for Defra in 2003 and concluded that the very low levels of low frequency noise and infrasound which occur from wind turbines will not cause adverse health effects. In order for low frequency noise to lead to stress symptoms, the levels must be above a certain threshold, which is very unlikely to occur for wind turbine noise, especially when the subject is indoors⁵⁴. Typically, except very near the source, people out of doors cannot detect the presence of low frequency noise from a wind turbine over the usual sound of the wind.

Research continues to take place and the DTI have commissioned a study looking into low frequency noise at three wind farms in the UK. Measurements will be taken both inside and outside dwellings and the study is due to report in the first half of 2005.

Impulsive Noise

Although wind turbine sound is not usually considered to be impulsive, the aerodynamic noise generated results in periodic audible swishes, which whilst not impulsive in the same way that hammering or pile driving is, can lead to a 'beating' noise effect. This type of noise generation is generally confined to downwind machines and so is unlikely to be a factor for modern developments.

8.4 Noise reduction

Many things can be done to minimise mechanical turbine noise, either through design

or retrofitting. This can include special finishing of gear teeth, using low speed cooling fans, adding baffles and acoustic insulation to the housing, using vibration isolators and soft mounts for major components, and designing the turbine to prevent noises from being transmitted into the overall structure. Newer machines are already much quieter, and improvements can be expected to advance them further.

Noise and wind turbine operation

Wind turbine generated noise is a function of wind speed and of other aspects of the design of the wind turbine. New turbine designs may have blades that can be pitched (rotated around their long axis). Aerodynamic noise generation is very sensitive to speed of translation at the very tip of the blade. To limit the generation of aerodynamic noise, large modern wind turbines limit the rotor rotation speeds to keep the tip speeds under about 65m/s.

In general, lower rotational speeds and pitch control in upwind rotors as opposed to downwind rotors, lower rotational speeds and pitch control all result in lower noise generation. These factors are all taken into account in the design of modern wind farms in the UK.

Reduction of noise with distance

As distance from the turbine increases, the volume of noise is reduced. Generally, sound decreases at 6dB per doubling of distance. Numerous other factors affect sound propagation in the real world, including absorption by the atmosphere, the reflection and absorption of sound on the ground, the blocking of sound by obstructions and uneven terrain, and by weather effects.

8.5 Noise levels in the community

No landscape is ever completely quiet. The noise from all the different sources in a particular environment is described as ambient noise and this can be a function of such things as local traffic, industrial noises, farm machinery, barking dogs and the interaction of the wind with ground cover, buildings, trees, and power lines. It will vary with time of day, wind speed and direction, and the level of human activity.

Sound emitted from a wind turbine will blend into background noise and decrease in relation to the distance from the tower. Even when wind speed increases, it is difficult to detect any increase in turbine sound above the increase in normal background noise levels caused by the wind. Wind developments may still occasionally be audible when the wind blows because sounds with particular frequencies or in an identifiable pattern may be heard through background noise that is otherwise loud enough to mask those noises; this will of course depend on the distance of the listener. While noise from operating turbines has often been raised as a concern, it has been shown that the noise emitted from wind developments is generally very low. Probably the best way to allay any fears over noise is to visit an operational wind farm.

8.6 Assessment of noise

The response of any individual to noise is very subjective. Whether a noise is objectionable will depend on the type of noise (tonal, broadband, low frequency, or impulsive) and the circumstances and sensitivity of the person who hears it. When planning a wind project, careful consideration is given to any noise which might be heard outside of nearby houses. Inside, the level is likely to be much lower, even with windows open.

There are a number of guidelines that are used to determine acceptable levels of noise such as The World Health Organisation's (WHO) publication 'Guidelines for Community Noise'⁵⁵, The British Standard BS4142, and which offers a well-understood framework for measuring all industrial noise⁵⁶. A report produced for the DTI, "The Assessment and Rating of Noise from Wind Farms", describes a framework for measuring wind farm noise and offers indicative acceptable noise levels for developments⁵⁷.

Because of the importance of background noise in determining the acceptability of the overall noise level, it is crucial to measure the background ambient noise levels for all the wind conditions in which the wind turbine will be operating. Sound propagation is a function of the source sound characteristics (direction and height), distance, air absorption, reflection and absorption and weather effects such as changes of wind speed and temperature with height. There are accepted practices for modelling sound propagation which take all these factors into account and there are a variety of propagation models in current usage.

The onus is on the developer to comply with the noise limits imposed by the planning authority for a permitted wind power site. In the UK, information supplied with the planning application has to indicate whether or not the proposed turbines will meet noise limits.

8.7 Regulation of noise

UK planning control

The noise assessments which accompany planning applications are reviewed by statutory consultees, taking into account the concerns and views of the local community. Such noise assessments are also frequently sent for review by independent noise consultants in order to verify and critically appraise the work. Noise

assessments for wind developments will need to follow the guidance and assessment criteria outlined in BS4142 and in the DTI report (see above).

Operational wind farms

Following the planning process, once wind farms are in operation, then people generally live without noise problems from the development. Councillor Margaret Munn of Ardrossan South Ward in Scotland comments:

"The Ardrossan wind farm has been overwhelmingly accepted by local people – instead of spoiling the landscape we believe it has been enhanced. The turbines are impressive looking, bring a calming effect to the town and contrary to the belief that they would be noisy, we have found them to be silent workhorses."

However, other people have complained about noise from wind developments in the UK. These are well-documented occurrences, with known problems relating to issues such as tonal noise from older wind turbines and with specific malfunctions such as gearbox misalignment and imperfections on the turbine blades. Each of these issues have been subsequently addressed, whether through turbine design improvements (such as the control of tonal noise) or through site specific maintenance (such as the replacement of individual turbine blades during the life of the wind farm).

Solutions to previous noise problems have been integrated into the improved design of the turbines and associated engineering. The location, proximity to human habitation, design of the wind development and maintenance of

the system are all important factors in minimising noise. In addition, sophisticated computer-controlled operating modes can help to minimise noise.

8.8 Noise in perspective

For modern wind farm developments noise concerns need not be a serious issue if the relevant guidance is followed and where there is a reasonable distance between properties and turbines. No landscape is completely quiet, and in most cases increasing aerodynamic noise will be accompanied by increasing background noise from the wind itself. It is worth remembering

that the noise levels at conventional power plants, and in their associated infrastructure and supply needs, are likely to be far higher than those found at wind power sites and although it may not be the same people affected – there will be people that are.

However, developers have a responsibility to ensure that noise assessments are completed to a high standard and mitigation measures put in place where appropriate. The best advice for concerned individuals is to visit an operational, modern wind farm and experience turbine noise in reality.

FURTHER INFORMATION

“The Assessment and Rating of Noise from Wind Farms” – report to the DTI - <http://www.dti.gov.uk/energy/renewables/publications/noiseassessment.shtml>

“Guidelines for Community Noise” – WHO - <http://www.who.int/docstore/peh/noise/guidelines2.html>

Health & Safety Executive noise information - www.hse.gov.uk/noise

9 Wind power and the community

Summary

- The benefits of wind power are shared by the whole nation but it is local communities that are most directly affected by wind farm developments
- Public attitudes to wind farms in the UK are generally positive and are evolving as more of them are built and as realisation of the need for renewable energy sources increases
- The involvement of the local community at all stages in the development of sites is key to the success of the project
- Local communities may have a number of concerns when wind farms are proposed, including impacts on house prices and disturbance during construction; those concerns must be addressed
- There are many benefits to local communities from wind farms through rural regeneration, employment and other income
- Some communities create a local forum in order to ensure useful and fair distribution of the financial benefits

9.1 Background

While wind power can provide renewable energy and environmental benefits on a national and global scale, it is the local community that is most directly affected by these types of development. When local objections arise, development plans can be delayed. Currently there are delayed developments all across the UK, raising the possibility that national renewable energy targets may not be met.

It is therefore essential that communities are fully consulted and involved when planning new wind developments so that their views can be heard. At the same time, it is important that communities listen to the experience gained at previous developments, and are aware of the public perception data that has been collected. This shows that in most cases the impacts of wind developments are far less in reality than previously feared, with the greatest support for wind found amongst those who live closest to the turbines.

9.2 Public attitudes

The threats to everyday life in the UK and elsewhere caused by global warming and climate change are beginning to become topics of popular discussion and public concern. Public attitudes to these threats in the UK and other European countries are evolving all the time. Linked to this, support for wind farms in the UK has been shown to be relatively stable over time.

Table 12 shows a summary of research over the past 13 years into public attitudes towards wind power.

9 Wind power and the community

Table 12: Summary of research conducted into attitudes to wind power

Location	Sponsor/organiser	Date	Support	Against	No Opinion
UK	British Wind Energy Association ^{xxix}	Feb 2005	79%	10%	11%
Britain	Poll by ICM for Greenpeace	Sept. 2004	79%	8%	13%
Scotland	MORI Social Research Institute survey undertaken for Scottish Executive ^{xxx}	2003	82%	2%	-
Porthcawl, Wales	Greenpeace ^{xxxi}	2003	96%	4%	-
National Survey	Ipsos survey undertaken for the British Wind Energy Association ^{xxxii}	June 2003	74%	6%	20%
South West	MORI Social Research Institute survey undertaken for SW Renewable Energy Agency ^{xxxiii}	March–April 2003	84%	4%	12%
Watchfield Oxfordshire	Impact Assessment Unit, School of Planning, Oxford Brookes University	May 2002	84%	12%	4%
Scotland ^{xxxiv}	MORI Social Research Institute survey undertaken for Scottish Renewables Forum	Sept. 2002	95%	2%	3
National Survey	MORI Social Research Institute survey undertaken for Greenpeace	2002	72%	6%	-
Breckland District, Norfolk	Breckland District Council	2002	90% ^{xxxv}	9%	-
Lambrigg Windfarm Cumbria ^{xxxvi}	National Wind Power (NWP)	April 2002	74%	8	18
Scotland	Scottish Executive	2000	67% ^{xxxvii}	11%	21%

^{xxix} BWEA's 'Wind Tracker' - a regular analysis of public opinion to wind energy in the UK. Conducted by NOP, 1000 interviews, representative sample. (Figures are rising 74% in August 2004- 79% in Feb 2005).

^{xxx} The survey was commissioned by the Scottish Executive to conduct survey research among people living close to Scotland's operational wind farms. The full report can be found at: www.scotland.gov.uk/publications

^{xxxi} The poll was conducted by Greenpeace and 650 tourists visiting the towns beaches were interviewed. The vast majority (96%) said they would be just as likely or more likely to return to the resort if the turbines go up. Just 4% said they would be less likely to return. www.greenpeace.org.uk

^{xxxii} The survey was carried out by Ipsos amongst 2,624 UK household bill payers between 6th and 19th June 2003. 74% of respondents were supportive of the Government's ambition to generate 20% of electricity from renewables by 2020, and a similar level of support was demonstrated for increasing the use of wind power in the UK (www.bwea.com).

^{xxxiii} The survey (Public Attitudes Towards Renewable Energy in the South West), conducted across the south west by MORI, asked the question "To what extent, if at all, do you support or oppose the use of wind power in the south west of England?" 54% Strongly supported; 30% tend to support; 12% neither support nor oppose; 3% tend to oppose; 1% strongly oppose and 1% don't know.

^{xxxiv} The survey, conducted in Argyll by MORI, found that 91% of respondents said the presence of wind farms would make no difference to their decision to visit the area again. In fact 4% stated that they would be more likely to return (2% responded "less likely").

^{xxxv} Conducted by Breckland District Council 2002 to inform the development of SPG on Wind Energy. Respondents were asked if the Council should support Wind energy (90.85% Yes, 9.15% No) and when asked what types of renewable energy, 72.75% responded wind turbines.

^{xxxvi} Survey of Residents and visitors to an area near the Lambrigg Wind Farm by National Wind Power.

^{xxxvii} This proportion increased to 73% for those living within 5 km of a windfarm.

Table 12 (continued): Summary of research conducted into attitudes to wind power

Location	Sponsor/organiser	Date	Support	Against	No Opinion
Novar, Scotland	NWP	1998	68%	3%	29%
Lynch Knoll, Glos	Ecotricity, BWEA, Triodos Bank & Stroud DC	1998	67%	7%	14%
Bryn Titli, Wales	NWP (pre-construction) NWP (open day)	1996	68%	14%	19%
		1996	94%	3%	3%
Coal Clough, Lancashire	Liverpool University (dissertation)	1996	96%	4%	-
Trysglwyn, Wales	NWP (open day)	1996	96%	4%	-
Rhyd-y-Groes, Wales	BBC	1994	61%	32%	7%
Taff Ely, Wales	BBC	1994	74%	9%	17%
Kirkby Moor, Cumbria	National Wind Power (NWP)	1994	82%	9%	9%
Llandinam, Wales	CCW BBC	1992/3	83%	3%	14%
		1994	76%	17%	8%
Delabole, Cornwall	Dept. of Trade & Industry (DTI)	1992/3	84%	4%	11%
Cemmaes Wales	DTI	1992/3	86%	1%	13%
Llangwryfon Wales	Countryside Council for Wales (CCW)	1992/3	78%	8%	14%
AVERAGE SUPPORT		1992-2005	80%		
AVERAGE LOCAL SUPPORT			80%		

Despite these surveys it is clear that large-scale developments have attracted vocal protests. The most common complaints concern effects on scenery and landscape, turbine noise, the impact on the local tourist industry, and potential effects on property prices.

One report in particular, "Attitudes and Knowledge of Renewable Energy amongst the General Public – Report of Findings"⁵⁸, has some interesting findings. As a UK-wide report, the results are disaggregated to show the opinion towards wind farms and wind energy in general of different groups:

- **Regional attitudes** – In the UK as a whole less than 2 in 10 people were resistant to the development of a wind farm in their area. People in Northern Ireland were more positive than in any other area of the UK. People in Wales were more resistant than any other area, with over 16% stating that they would be strongly resistant to a wind farm in their area and a further 9% stating that they would be slightly resistant.
- **Knowledge of wind farms** – Resistance to onshore wind farms was related to knowledge, with higher resistance found amongst the less knowledgeable groups. This

9 Wind power and the community

indicates that in general the more people know about wind power the more positive they will be about a proposed development.

- **Age groups** – The age group of people resistant to onshore wind farms is similar to those resistant to renewable energy in general. They were more likely to be younger respondents aged 16-24 (18% resistance) and older respondents aged 45+ (23% resistance) than those aged 25-34 (10% resistance) and 35-44 (15% resistance). There was also a slightly higher resistance amongst those respondents who were retired.
- **Benefits and disadvantages of wind farms** – This report also collated the perceived benefits and objections to wind farms. A summary of these is below:

Figure 17: Perceived benefits of onshore wind farms

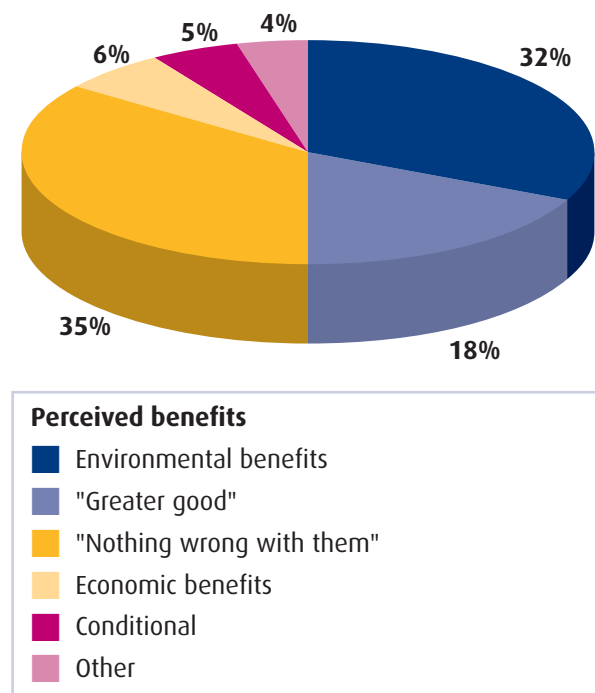

As identified in Figure 17 over half of respondents see wind farms as being necessary for environmental or 'greater good' reasons. But the major objection to wind farms is the visual impact (49%), followed by noise or hum at 12%, and 'not here' responses at 10%.

Figure 18: Objections to onshore wind farms

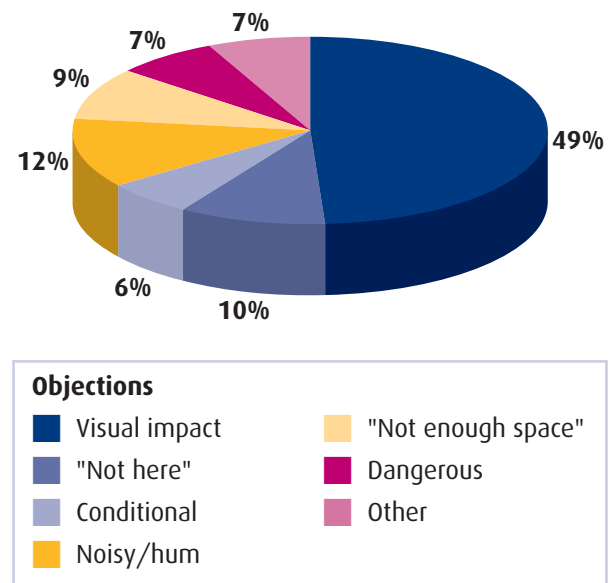

European attitudes

Some other European countries have a wind energy industry that is further developed than the UK's. In a survey carried out across the EU-15 member states in 2002, the opinions of 16,032 people concerning energy and energy technology issues were gathered⁵⁹. This survey revealed that nearly nine out of ten people thought that global warming and climate change were serious problems that required immediate action. As far as energy policy was concerned, protection of the environment and low prices for consumers were the top priorities for EU citizens. The majority of people thought that renewable sources of energy are the least expensive, the best for the environment and the most efficient.

9 Wind power and the community

In Europe – Germany, Spain and Denmark – in that order, have the highest installed wind power capacity. Opinion polls in these countries are not as detailed as those in the UK to date but still give some indication of householder attitude:

Germany

In the German state of Schleswig-Holstein the tourist board undertook a study to assess the impacts of onshore and offshore wind developments on tourism. This study concluded that although visitors to the area are aware of the increasing number of turbines in the landscape they do not influence visitor behaviour.

A 2002 study by the Emnid Research Institute asking “Would you welcome increased use of wind power for climate protection reasons?” elicited a 92% ‘yes’ response from 1,003 people questioned, which implies that even though there are considerably more wind farms in Germany, the majority of people are still in favour of wind energy generation.

Spain

Studies in Spain have showed 85% in favour of the implementation of wind power and 1% against it⁶⁰. Work in Albacete in 2002 for the wind development company EEE showed that 79% considered wind energy to be a benefit, with 1% believing it to be a disbenefit. Between 79% and 91% think that the benefits from wind energy compensate for any negative effects on the environment from installing it.

These studies suggest that Spain is similar to Germany in that although there is considerably more installed capacity than in the UK the majority of people still favour it⁵⁹.

Denmark

A survey conducted by SONAR in 2001 shows that support for wind power is very positive. The question asked was “should Denmark continue to build wind turbines to increase

wind power’s share of the electricity production?” The answer ‘yes’ was given by 68% of people. 18% found the current level satisfactory, 7% thought there were too many and 7% were undecided.

These surveys in countries with many more wind farms indicate that UK public opinion, which is currently averaging 80% in favour of wind power, is unlikely to change dramatically as the public become more familiar with them. However, continued monitoring of this situation is required.

9.3 Community concerns

Many concerns that arise within communities are due to the perceived impacts on individual households, which have been discussed in earlier sections. The Scottish Executive’s study “Public Attitudes to Windfarms” researched the views of local residents about wind developments in their area⁶¹. The following issues were included:

- Visual impact
- Noise from turbines
- Interference with television and radio
- Environmental or ecological effects
- Impact on house prices and other local economic factors
- Disturbance during construction
- Consultation prior to construction

Most of these issues are covered in previous sections of this report, but the impact on house prices and construction disturbance are discussed below.

House prices

Some local communities in the vicinity of proposed wind farms are concerned that house prices will drop if the development proceeds.

9 Wind power and the community

The Royal Institution of Chartered Surveyors (RICS) commented in a study on the housing market in November 2004:

*'The survey shows that 60% of chartered surveyors with experience of house transactions near to wind farms report that they negatively affect house prices, with most saying the biggest impact is at the time of the planning application. A smaller number say that values dip the most as construction starts, and fewer still point to the moment where the plant becomes operational. There is evidence that prices begin to recover after the wind farm has been up and running for two years. This suggests that wind farms become more accepted as communities grow used to them.'*⁶²

This view is backed up by the Scottish Executive study, which suggests that anticipated problems with house prices are not as serious in reality, with only 2% or so of residents reporting this as a problem after the wind project is operating.

Disturbance during construction and operation

Construction activities that may disturb local residents include increased noise and traffic. Both of these issues are normally limited to specified working hours and days, in order to restrict the impact on nearby residents. In addition, the construction period in any given area is usually quite short.

The Scottish Executive study indicated that of residents who lived near to a wind project construction site, only 6% said that there had been problems with additional traffic and 4% said that there was noise or disturbance from traffic during construction.

Disturbances during the operational life of wind developments are usually limited to maintenance activities. These activities would normally involve a maintenance vehicle, and any required maintenance equipment. Most installations have an annual cycle of operational maintenance.

9.4 Economic and community benefits

The net economic benefits associated with the growth of the wind power industry are very difficult to quantify, and such benefits may not always occur close to the site being developed. Jobs will undoubtedly be created by the wind industry, in manufacturing, design, project management, site construction, and operation & maintenance, and in some areas the employment contribution could be substantial. For example, the offshore wind sector is expected to help ease the effect of the decline of the North Sea oil and gas industry on communities in Aberdeen and other port towns. The DTI estimates that up to 35,000 jobs could be created in the renewables sector by 2020, up from around 8,000 currently⁶³, and a large percentage of these are likely to be within the wind power industry.

However, some of the jobs created by the wind power industry will be at the expense of jobs that would otherwise have occurred in other sectors, and any increase in electricity prices may also result in a small negative effect on employment.

Case Study

Community Funds – Tappaghan, Northern Ireland



© Airtricity - Phil McSorley

The cross community Tappaghan Community Fund will benefit from the development of the first wind farm in Northern Ireland.

In March 2005, renewable energy company Airtricity completed its first Northern Ireland wind farm at Tappaghan Mountain in Co Fermanagh. The 13-turbine site is on the border with Co Tyrone and is made up of the town lands of Glenarn, Stranahone and Stranadarriff. This has signalled the beginning of the company's £500m investment programme in NI renewable energy projects.

As part of the development Airtricity has created the Tappaghan Community Fund into which it will pay £260,000 over the lifetime of the project. The local community will benefit directly from this new wind farm as £13,000 will be invested in local community schemes in the area each year.

The community fund model was established with the Corneen Community Fund in 2001. Airtricity donates a fixed percentage of renewable energy income from its local wind farm operation to eight local projects. While generally supporting initiatives sustaining the local environment, other applications are also welcome. For instance, in 2003, grants were awarded to Bawnboy Tidy Towns Committee, Templeport Irish Music Group and Kildallan GFC.

Case study: Community Funds – Tappaghan, Northern Ireland

“This project is a hugely significant development for Fermanagh. It will increase Northern Ireland’s renewable generating capacity by about 20% and will make a valuable contribution towards the target of ensuring that 12% of all electricity consumed is provided from indigenous renewable generation by 2012.”

Barry Gardin
DETI Minister

“The community here at Tappaghan has been very supportive of Airtricity throughout this project and they can be proud of the role they are playing in securing a sustainable energy future for Northern Ireland.”

Mark Ennis
Airtricity Northern Ireland chief executive

Lessons and thoughts:

- The focus on supporting targeted community needs and initiatives is readily replicable as a model for large-scale developers and energy companies in creating effective community engagement. Indeed, community funds have been set up on a number of wind developments throughout the UK.
- Community funds do not replace the need for effective public engagement on new wind farm developments – they should be part of this process by encouraging dialogue between the community and the developers.

Key facts:

- Airtricity submitted its first application in August 2002 to Planning Services in Northern Ireland for the development of the Tappaghan Mountain 250ha open moorland site
- Planning approval was granted in November 2003. The 11-month project started in February 2004 and involves 13 GE Wind 1.5 MW turbines with a hub height of 52.6m and a rotor blade diameter of 70.5m.
- The wind farm at Tappaghan will have a capacity 19.5 MW and will provide enough electricity for 57% of the domestic demand of the population of Fermanagh District Council.
- For more information: www.airtricity.com

Case Study

Community Ownership – Isle of Gigha, Scotland

After many years of decline, the Isle of Gigha's private owners, the Holt family, put it up for sale in August 2001. After a democratic vote the 98 strong population (including six children) decided to launch a bid to buy the island, supported by the local MSP and a number of other bodies. The community set up the Gigha Heritage Trust, which became the new owner of the island on March 15th 2002.

A condition of the grant was to pay back £1 million of the grant to the Scottish Land Fund by March 2004. The Board of Directors of the Gigha Heritage Trust established a five-year development plan to regenerate the island including plans for sustainable housing, the Gigha Hotel, holiday cottages and a wind farm. After a year of feasibility studies, tests and planning assessments, work started in November 2004 with stone for the road and foundations being excavated from the new Gigha Quarry. The second-hand 'Dancing Ladies' named by the community as Faith, Hope and Charity were delivered at the end of November, cleaned up by members of the community, erected, and on 15th December 2004 were switched on.

The Gigha community now generates two thirds of its electricity requirements and is using part of the money generated by the wind farm to contribute to radical energy saving measures in the trust-owned housing stock, 80% of which is below a reasonable standard.



© Islay Studios

Brandon Clements, Rhona Earnshaw and Phoebe Brown turn on the Isle of Gigha 'Dancing Ladies' providing the 130 strong community with energy and independence.

"The wind resource in Scotland is unparalleled and more communities should be able to tap into this. Gigha was able to capitalise on the available wind due to a combination of a unique financial package and the willingness and entrepreneurship of the community themselves."

Dr Eleanor Logan
Chief Executive, Isle of Gigha Heritage Trust

Case study: Community Ownership – Isle of Gigha, Scotland

Lessons and thoughts:

- Community ownership offers a highly inclusive model for wind farm development that can be replicated in many parts of the UK.
- By generating their own electricity and selling their Renewable Obligation Certificates through their electricity supplier, Gigha residents will generate a new source of revenue for the island, whilst providing funds for the replacement of the turbines at the end of their working life.
- The residents are using the net profit from the project to fund energy efficiency improvements, which should in time allow the community to reduce their energy consumption and achieve an even higher contribution from renewable energy without any expansion in generating capacity. Indeed, one day they could become net exporters.

Key facts:

- The Isle of Gigha is the most southerly of the Hebridean islands, three miles west of the Kintyre Peninsula. Population is 130 and rising with 15 children in the school.
- The project used three pre-commissioned (second hand), Vestas V27 wind turbines with a rated capacity of 225 KW. The turbines were originally installed at Windcluster's Haverigg 1 site in Cumbria, which was recently 're-powered' (upgraded).
- Total capital expenditure was £440K, based on a three-way mix of grant funding, debt finance, and equity finance. The project anticipates gross annual income of £150K.
- Further information can be found at: www.gigha.org.uk/windmills
- Several other community projects exist in the UK, see the following links for further information: www.energy4all.co.uk; www.baywind.co.uk; www.reic.co.uk.



© Islay Studios

9 Wind power and the community

If local jobs are created around a wind turbine development, they are likely to be in site-construction as well as operation and maintenance. Wind power developments also have the potential to increase rural incomes through rents on land leased to wind developers.

Wind projects can also bring economic benefits to a community through community benefit payments or the development of a community trust. Community benefit payments are voluntary payments from the developer to the community based on the projected electrical output of the wind farm.

Community trusts or co-operatives enable members to invest their savings in a wind development. The profits of the scheme are then shared amongst those belonging to the trust, usually in the form of regular dividends. One of the most successful examples is the Baywind Energy Co-operative Ltd in Cumbria.

Some developers prefer to help communities in other ways, such as:

- Site conservation and habitat creation for protected flora and fauna
- Improved footpath and site access
- Job creation for site management and conservation initiatives
- Improved TV reception for rural communities
- Educational programmes for local schools
- Grant funding to support local energy efficiency schemes

9.5 Public consultation

What is public consultation?

Public consultation usually occurs during the planning and development of the wind farm as

part of the preparation of the Environmental Statement (from the EIA) and then once a formal application has been made to the relevant planning authority. This would constitute good practice on behalf of the developer.

Legally, the public must be consulted following the submission of a planning application to the local authority for a proposed wind farm development. This is the only stage at which there is a legal obligation for the public to be consulted. The developer would normally place an advertisement in a local paper to advertise the scheme and invite comments. The planning authority of the local council may also advertise the application in the local press or on the council's planning website. Some people may have been contacted prior to this stage if they are neighbours of the scheme or if the Environmental Impact Assessment process indicated that they may be negatively affected by the scheme.

Good practice in public consultation

Good practice in public consultation would involve the public at an early stage. Pre-planning public consultation can yield benefits for both the developer and the public. The developer will gain a valuable insight into the issues of local concern and can plan the development of the scheme to mitigate any negative impacts at an early stage. The public benefits as it gives them time to become informed about the scheme and much more time to prepare a response to the proposal. The consultation process may involve many stakeholders, including the developer, landowners, NGOs, regulatory authorities, local communities, neighbouring property owners and anyone or any organisation that may be affected by the development in either a positive or negative way.

9 Wind power and the community

Local communities could be consulted by the developer, the local planning authority or by an independent third party working on behalf of the developer. A Scottish study published in 2003⁶⁰ asked a number of questions about public consultation, which revealed that very few people can remember being consulted over the development at the planning stage (13%). The most common source of information about the proposed site at that time was the local newspaper (40%) rather than the local council planning office (4%) or the developer (1%). However, few are dissatisfied with the consultation by the developer (11%), with most expressing neutral views. Views are broadly similar with respect to the consultation from the local authority, although even fewer can remember being involved in this.

If there is to be greater dialogue during a planning proposal, communities usually like to see it publicised through their local paper (43%), leaflets through the door (33%) or through public meetings (29%).

Formal consultation

Once planning permission is applied for, the Environmental Statement will be made available to the public for viewing. In addition, developers will often hold information sessions in order to answer any specific questions that the community may have.

As wind farms become more common around the world, their potential impacts will be further researched and documented. Numerous best practice documents exist that developers can use in designing their wind farms to minimise their impact on the local environment and to

benefit the surrounding community. A selection relevant to the UK include:

- British Wind Energy Association (BWEA) (1994). *Best Practice Guidelines for Wind Energy Development*. London^{xxxviii}.
- Carroll, B. and Turpin, T. (2002). *Environmental Impact Assessment Handbook: A practical guide for planners, developers and communities*. Thomas Telford Publishing Ltd., London.
- English Nature et al. (2001). *Wind farm development and nature conservation*. English Nature, Peterborough.
- SNH (2001). *Guidelines on the Environmental Impact of Windfarms and Small Scale Hydroelectric Schemes*, Scottish Natural Heritage, Perth.

Some principles for good public consultation are given in Box 7, followed by wind farm specific guidelines as promoted by the South West Renewable Energy Agency – see Box 8.

^{xxxviii} Currently being updated.

Case Study

Community Engagement – Moel Moelogan, North Wales



Ashden Trust

Moel Moelogan wind farm officially opened on 31st January 2003 as the first 100% community owned project of its kind, run by a collective of three farmers in Conwy County, North Wales. Their aim was to develop wind power while retaining the economic benefit locally.

In 1997, sheep and livestock farmers, Robin Williams with 700 acres, his brother Rheinallt Williams with 600 acres and neighbour Geraint Davies with 430 adjacent acres, faced a decline of up to 75% in their farming incomes following the BSE crisis. The three formed the Cwmni Gwynt Teg cooperative in 1998 to enter the wind energy industry.

Around 1500 people attended an open day when the first turbine was erected in September 2002, and on January 31st 2003 some 500 locals attended a public exhibition of the extension giving a 100% positive response. Objections raised later led to significant changes, including reducing the turbine height from 60 metres to 50 metres and four major changes of position.

The finance model for the project was provided by a £1.7 million loan from Triodos Bank, an Objective One grant of £366,000 from the European Union and a commercial loan of £460,000. Turbine technology had advanced so rapidly between the time of writing the application and receiving planning permission that the farmers realised they only needed two turbines to fulfil their contract with the NFPA. Planning permission for the third turbine was sold to German company, Energie Kontor, to raise equity.

Having gone to the local community for responses to the two operational turbines from January 2003, the collective was granted planning approval on 26th November 2004 for their second wind project Ail Wynt - which translates as 'Second Wind' - for a further nine turbines on the hills near Llanrwst.

Conwy County Borough Council Planning Committee logged all forms of first and second stage consultation process representation for Ail Wynt in November 2004 including letters, pro-forma letters and a petition regarding the second phase. There were 428 letters of support, 85% of these in favour of clean/cheap/safe renewable energy. Of the 234 letters of objection, 63% focused on phase 2 being ugly and damaging the views and landscape. The Committee gathered expert views from the Countryside Council of Wales and Snowdonia National Park Authority to show this would not be significant 'in this particular case'.

"You have to have local consultation. You get planning ups and downs and local opposition groups who will say that the main issue is visual and that turbines are spoiling the countryside. But I think the countryside evolves and has been constantly changed by the people who live and work on the land."

Geraint Davies
Co-founder Cwmni Gwynt Teg cooperative

Case study: Community Engagement – Moel Moelogan, North Wales

“In balancing sustainable energy production against landscape (and other factors) it is appropriate to follow a reasoned and logical approach... it is considered that the Moel Moelogan site provides a less sensitive development site for wind turbines than other potential prospects for a similar scale scheme.”

Conwy County Borough Council Planning Committee conclusion point 60

The cooperative hopes to raise £1 million towards project costs by offering the local community an opportunity to invest in Phase 2 through a bond issue offering an estimated 8% per annum return on capital, with bonus payments in windy years. The remainder of the project costs will be covered by commercial bank loans and the cooperative's own resources. Ail Wynt has committed to donating £50,000 a year to an energy savings grant scheme to help local families and schools save energy and £15,000 a year to two local councils to support other local initiatives.

Cwmni Gwynt Teg won the prestigious Ashden Awards for Sustainable Energy in June 2003. A major factor was being sensitive towards community and environmental issues.



Ashden Trust

Three hill farming families initiated the development of wind energy consulting with and benefiting their local North Wales community.

Lessons and thoughts:

- Coming from within the community, this wind farm development represents one of a number of community ownership models.
- This new source of income can help to support sustainable rural development without displacing traditional rural activities – sheep farming continues alongside the turbines.
- The main opposition was based on landscape change, but the level of objections on both sides shows how subjective an issue this is.

Key facts:

- The two Moel Moelogan turbines are connected to the national grid via a substation at Llanrwst, 4.5km away from the wind farm. A grid connection was constructed by the local power distribution company, Manweb (owned by ScottishPower). The connection cost £690K - almost 25% of the budget.
- Each of Moel Moelogan's turbines is rated at 1.3MW.
- The cooperative has a working relationship with the Royal Society for the Protection of Birds (RSPB) to manage approximately 300 acres of land on their farms to encourage the breeding of endangered species like lapwings and golden plover.
- For further information: www.ailwynt.co.uk, www.ashdenawards.org

9 Wind power and the community

Local authorities are statutorily obliged to consult their communities on development proposals, nevertheless the following guidelines can be helpful:

Box 7: Environment Council's public consultation guidelines

Principles of Effective Public Consultation

The Environment Council recommends that the following principles will help to ensure that public consultation is effective whatever form of engagement with the public is used.

Inclusiveness

All stakeholders should be encouraged to become involved. A particular effort should be made to include the unaffiliated, minorities, the marginalized and the 'silent majority'.

Transparency, Openness and Clarity

All stakeholders should receive all of the information they need. If information is lacking or things are uncertain they should be informed. It should be made clear what stakeholders can or cannot influence by contributing.

Independence

In highly polarised or contentious situations a neutral convenor and independent facilitator should be used to gain the confidence of the stakeholders. It is not possible for a sponsoring organisation, whether the local authority or private company, to facilitate an independent process and any attempt to do so will arouse suspicions about the integrity of the process.

Commitment

Respect for stakeholders is demonstrated by giving the public consultation process the priority and resources that it deserves.

Accessibility

Different ways for people to become involved are important. The UK has a diverse multicultural society and it is essential that people from all parts of the community are able to participate.

Accountability

As soon as possible following the consultation period, participants should be contacted with an account of how and why their contributions have (or have not) influenced the outcome.

Resourcing

A good public consultation requires time and money, a lack of resources can undermine achievements.

Productivity

The aim of public consultation is to improve the outcome for all concerned. How the consultation process will achieve this should be made clear from the beginning to prevent any waste of time and resources.

Box 8: South West Renewable Energy Agency's public consultation guidance

The South West Public Engagement Protocol and Guidance for Wind Energy⁶⁴

This guidance document was commissioned by the South West Renewable Energy Agency and outlines a series of responsibilities aimed at local planning authorities and wind energy developers for promoting more effective public engagement within the development of wind energy projects. The protocol also covers the responsibilities that should be met by stakeholders to ensure the protocol works effectively. It is the only guidance document of its kind in the UK.

Wind energy developers agree to:

- Prepare and apply a coherent engagement plan in discussion with the local planning authority, which will include:
 - *Identification of relevant stakeholders*
 - *Agreed timescales for turning around key phases of the planning process and responding to information requests*
 - *Identification of a clear point of contact that will enable a two way flow of information regarding the project*
 - *Identification of the range of methods appropriate for engaging the relevant stakeholders*
 - *Clarifying the approach to establishing local and wider benefits*
- Promote at an early stage the scope of the consultation, the outline plans for the development, company policy on local benefits and opportunities for public participation
- Identify at an early stage and consult on the potential for local benefits
- Ensure any changes in the engagement plan, in particular changes in timescales, are communicated to other stakeholders in good time
- Ensure participants are kept up to date on progress and feedback is made available on the results of engagement and how it is being used within the development of the project

Local planning authorities agree to:

- Prepare and apply clear planning policy and guidance on wind energy in accordance with national and regional policy and guidance and in consultation with neighbouring local planning authorities
- Support the evolution of the developer's engagement plan by:
 - Establishing a clear point of contact that will enable a two way flow of information regarding the project
 - Agreeing timescales for turning around key phases of the planning process and responding to information requests (any variation from statutory timescales should be clearly justified)
 - Supporting the identification of key stakeholders and the methods appropriate for engaging them
 - Contributing to discussions on the approach to establishing local and wider benefits
- Provide support in communicating with key stakeholders and help in identifying the full range of community views

9 Wind power and the community

Box 8 (continued): South West Renewable Energy Agency's public consultation guidance

- Ensure the sourcing of objective information on disputed areas of debate that is reliable and independent
- Ensure elected members are fully up to date on general issues relating to wind energy technology and the implications for planning
- Provide a high quality flow of information within the authority on proposed developments, including regular briefings for members and other relevant local authority officers

Other key stakeholders will be expected to:

- Enter into constructive dialogue with a view to working towards agreed positions on issues up for negotiation
- Acknowledge developer and/or local planning authority responses to questions and criticisms raised by other stakeholders
- Assist, where possible, in identifying other key stakeholders within the community
- Assist, where appropriate, in identifying the full range of local opinion about the development of local benefits
- Encourage the identification of points of contact that will facilitate a high quality flow of information within the community

9.6 Lessons for success

Previous wind farm developments have shown that success lies with early community consultation, involvement and empowerment. With the introduction of updated planning policies for renewable energy there is increased emphasis on the need for community involvement early on in the process.

Local planning authorities, regional stakeholders and Local Strategic Partnerships should foster community involvement in renewable energy projects and seek to promote knowledge of, and greater acceptance by, the public of prospective renewable energy developments that are appropriately located. Developers of renewable energy projects should engage in active consultation and discussion with local communities at an early stage in the planning process. Communities should be aware of good

practice elsewhere in the UK where beneficial arrangements have been agreed for their community, and where impacts on the local environment have been successfully mitigated.

The involvement of the local community is essential in ensuring that all aspects of public concern are understood and taken into account in the design of the site. Codes of practice with examples of good practice are readily available that give guidance on how to address the various technical and perception issues of public concern. The planning system provides safeguards and opportunities for public participation and for developers to contribute to community welfare through a variety of mechanisms.

10 Aviation and radar

Summary

- Wind turbines can present a hazard to low flying aircraft and may also affect radar and radio navigation systems
- Early consultation with all statutory authorities can help successful siting and mitigation decisions to be made
- Planning systems are in place to regulate the development of tall structures and a pre-application approval system has been established for wind developers
- International experience suggests the UK has some of the strictest policies in place on radar and aviation – these must be justified

10.1 Background

Aviation and radar issues are complex and overlapping, and have long been a major source of complaint for the wind industry. This is because wind turbines can have negative impacts on radar systems and can represent obstructions for low-flying aircraft, and these concerns have resulted in a significant number of planning objections, particularly from the Ministry of Defence (MOD). For their part, the MOD, the Civil Aviation Authority (CAA) and National Air Traffic Services (NATS) have a statutory duty to safeguard certain sites and airspace from radar interference in the interests of national security and for the safe operation of passenger and military aviation – this duty was restated in the 2003 Energy White Paper⁴⁶. Individual airports can also be affected by wind developments.

Planning applications were in the past frequently rejected on the basis of risk to aviation and radar, but the MOD now advises developers on acceptable areas from their perspective well in advance of a formal planning application. Aviation and radar concerns are rarely clear-cut, and solutions can often be found to specific problems where there is a will and where good channels of communication exist. To forward this aim, the DTI established the Wind Energy, Defence and Civil Aviation

Working Group in 2001 to bring together all the stakeholders with the specific objective of improving the understanding of the interaction between wind farms and the aviation community, developing suitable mitigation techniques and improving the pre-planning consultation process. This group published Wind Energy and Aviation Guidelines in 2002 and these will be updated and republished towards the end of 2005.

This section will explain the issues related to aviation and radar including current policy, international experience and possible future developments. Further technical details are available in Annex C.

10.2 Radar

Types of radar

Radar takes two basic forms. Primary surveillance radar (PSR) usually consists of an antenna constantly rotating through 360° round the horizon, sending out pulses of electromagnetic energy, which result in reflections that are displayed on a controller's screen. Secondary surveillance radar (SSR) also sends out pulses from a constantly rotating antenna but in the form of interrogation signals, which trigger responses from transponder equipment in aircraft.

Effects on PSR

The main effect of wind turbines on PSR is due to the rotation of the blades. Since the blades are rotating, they may not produce a radar return on every sweep of the radar, and in multiple-turbine wind developments, the radar may illuminate one turbine on one sweep, then a different one on the next sweep, and so on. This can produce shifting radar returns from within the wind site, sometimes referred to as a 'twinkling' appearance on the radar screen. In most cases, these effects only occur when the wind development is within line of sight of the radar^{xxxix}.

There are three uses for PSR in aviation: for air traffic control (ATC) around airfields, for area or 'en route' ATC, and for military air defence.

ATC around airfields

Most military airfields and commercial airports are equipped with PSR, which is used by controllers to guide aircraft after take-off, to guide incoming aircraft to the runway, and to maintain separation for aircraft operating in the vicinity of the airfield. For these radar systems, a wind development located beneath the departure track, or the final approach track can create particular problems.

For military airfield radars, the MOD requests consultation on projects within 36nm (67km). Whilst controllers may guide aircraft on established tracks, aircrew regularly require to deviate from these tracks due to the nature of the military task. Therefore, an objection is likely for any wind energy project within 36nm which is determined to be visible to the radar. Unlike civil aircraft, military air movements are

not confined to defined routes therefore full view of airspace is required for air traffic control.

En route ATC

Control of aircraft in the en route phase of flight is carried out using a network of long-range radars, located mostly on hilltops stretching from Devon to Shetland and operated by NATS. Most of these aircraft are flying in controlled airspace and have SSR transponders, so in principle these radars are not as vulnerable to the effects on PSR outlined above. However primary radar returns from a wind development located underneath a busy airway may clutter the screen and make it more difficult for controllers to differentiate their traffic from the clutter.

NATS en route radars are a frequent source of objections to wind developments in the UK due to their generally prominent positions and their long range. However, despite the large number of projects receiving initial holding objections, a significant number are subsequently determined to have little or no significance for ATC operations.

Air defence radar

The MOD safeguards seven air defence radar sites around the UK coastline. The air defence radars are at the heart of an air surveillance system which aims to provide unbroken coverage of UK airspace to enable the detection, tracking and identification of all aircraft movements down to the lowest practicable altitude and to deny a clandestine air approach to the UK mainland.

The Government perceives an increased risk of international terrorism and as such air defence

^{xxxix} Certain weather conditions may bend radar energy over the horizon on an irregular basis.

10 Aviation and radar

has assumed a higher priority. Air defence radar policy is under continuous review in the light of emerging research and studies and is steadily moving towards a risk based assessment of individual proposals.

The MOD's current policy is to raise concerns to any proposed wind project within line of sight of an air defence radar head. However, risk assessments are completed on all pre-planning proposals where developers request consultations through Defence Estates. In the instance that the additional risk to air defence operations and training is assessed as manageable, the concerns are removed. MOD policy remains under constant review in light of emerging research and study work – the next formal policy review will be undertaken in July 2005.

Effects on SSR

SSR is much less vulnerable to interference from wind turbines than PSR. The main potential effects are multi-path, where some of the radar energy travels from radar to aircraft (or vice versa) via a reflection off a wind turbine. Studies have found that wind turbine effects on SSR are negligible for a wind development located 5km or more from an SSR station. In the UK, there are statutory consultation requirements for any wind project within 10km of any SSR facilities.

10.3 Aviation

Current plans envisage a rapid, and fundamentally unsustainable^{xi}, increase in aviation over the coming decades, with the potential to increase conflicts between aviation interests and the development of wind energy as new airports are developed and existing ones expanded. The most significant impact of wind turbines on aviation is from radar interference,

but the physical obstruction hazard to aircraft near airports and in military low flying areas has also generated concerns. Radio navigation aids may also be affected.

The UK is party to international agreements which set limits to the height of any constructions within specified distances of airfields, in order to prevent obstacle hazards to aircraft using that airfield. Broadly, wind developments within 10km of airfields are likely to come into conflict with these regulations, while the restrictions are unlikely to apply to projects beyond 15km from an airfield. The CAA are responsible for safeguarding commercial aviation interests.

Wind turbines can present a collision hazard to military aircraft engaged in low flying training, which under normal circumstances would be easily overcome by flying around or over them. However, wind turbines in some locations present an increased hazard to the safety of low flying military aircraft due to airspace and geographical constraints, proximity of other obstructions and weather factors. Low flying training, which is conducted by fast jet aircraft down to 30m above ground level and large fixed wing aircraft down to 45m above ground level, is only permitted in three parts of the UK: part of northern Scotland, south-west Scotland & northern England, and central Wales. Although much of this training is conducted overseas, the MOD considers it essential that the three UK areas are retained to maintain the requisite domestic military capability. In line with current MOD policy, all potential wind farm developments are assessed on a case-by-case basis and it is usually possible to accommodate most proposals with varying degrees of alteration. Developments located on ridges or the higher hilltops (the best sites for wind

^{xi} SDC(2004): Missed Opportunity: Summary Critique of the Air Transport White Paper, London.

10 Aviation and radar

turbines) are more likely to be acceptable because low flying training is concentrated more in the valleys and gently undulating terrain.

The greatest hazard posed by wind turbines to military low flying training is in the vicinity of the Spadeadam Electronic Warfare and Tactics Range (EWTR) on the Cumbria-Northumberland border. Most types of military aircraft conduct tactical flying training in the EWTR that cannot be achieved elsewhere in Europe. For this training to be effective, aircraft need to be able to fly at very low level (ground level in the case of helicopters) with complete freedom to manoeuvre. Moreover, the radar systems used in creating a tactical environment need to be able to operate with minimal interference. The implication is that proposed wind developments in the EWTR area are unlikely to be accepted by the MOD.

10.4 Seismic stations

Although not strictly a radar or aviation issue, seismic monitoring has recently become a significant constraint on wind energy development in the important area of southern Scotland and northern England. This is due to a seismic monitoring station in Scotland which is used to monitor international compliance with the Comprehensive Test Ban Treaty (CTBT), among other activities. There are concerns over the generation of seismic vibration from wind turbines which can mask the seismic signals from nuclear weapons tests.

To address this problem the MOD, in partnership with the BWEA and DTI, commissioned research to look into this issue. They found that wind turbines of current design could interfere with the operation of the station, but a way forward has been agreed by setting a 'noise limit'

(0.336nm rms), which is effectively double the existing noise level at the site. The noise limit extends to 50km around the site, and proposals for wind farm schemes beyond the 50km zone will be assessed against any remaining noise allocation budget. In principle the further a project is away from the seismic recording station the less the potential interference. If future wind turbine designs can be shown to effectively stop the generation of seismic interference then the policy will be reviewed.

10.5 Regulatory process

Defence Estates (responsible for safeguarding at the MOD), the CAA and NATS act as focal points for wind farm developers to consult with defence and civil aviation interests. Defence Estates operates a statutory safeguarding system to ensure that the operators of key civil and military aerodromes, radar stations and navigation facilities have the opportunity to evaluate potential impacts from developments in their vicinity at planning application stage.

Because impacts on aviation and radar are potentially serious enough to prevent approval of a wind project, developers would be taking unacceptable risks with their investment if they did not evaluate these effects well before committing to a planning application. Defence Estates therefore offers a pre-planning assessment service for potential wind developments on behalf of all three organisations, with a helpline number^{xl} for preliminary enquiries. This takes a number of stages:

1. Developers can use a series of high-resolution maps developed by NATS to determine whether their proposed site is likely to be in a problem zone for en-route ATC^{xlii}.

^{xli} Further information is available from the BWEA website at www.bwea.com/aviation

^{xlii} The MOD are currently developing mapping tools for their radar sites.

10 Aviation and radar

2. They can then submit their proposal using a standard proforma to Defence Estates for a more detailed analysis. Their proposal is circulated to a number of relevant agencies^{xliii} and experts by Defence Estates to determine its likely status: 'no concerns', 'possible concerns', or 'serious concerns'.
3. If any issues have been raised, the developer can then ask to discuss possible mitigation measures or technical solutions through Defence Estates.
4. Using the advice obtained, the developer can then decide whether to seek formal planning permission. Defence Estates will use their final assessment as the basis of their recommendation to the planning committee.

Out of the 4,000 pre-planning requests received since 1996, around 2,000 received 'no objections' advice. There are currently plans to speed up this process through the introduction of a web-based pre-planning submission service and Defence Estates aim to reduce the reply period to less than seven weeks.

10.6 International experience

Other countries in Europe have had a generally different experience of the relationship between wind turbines and air traffic control or air defence radar. A report commissioned by the DTI Working Group on Wind Energy, Defence and Civil Aviation Interests in 2002 found that only the German Ministry of Defence had a formal safeguarding consultation zone around its radars similar to the system in the UK, and that *"all other countries have a much more relaxed attitude to the potential impacts of wind turbines on radar-dependant operations and assess proposals on a case-by-case basis."*⁶⁵

In the Netherlands, several wind farms have been built in the vicinity of its busiest civil airport, Amsterdam Schiphol, in the past few years. These include a 14-turbine development in the Amsterdam Western Harbour, 10km north of Schiphol, and under the final approach path to one of its runways, a four-turbine wind farm 15km away at Haarlem, five turbines at Velsen, 20km NW of the airport and ten 100m turbines at Flevoland, 25km east of Schiphol. Although some of these had been erected without following the established consultation process with the Dutch air traffic control authority, LVNL, none of the wind farms subsequently appeared on the airport's radar. LVNL believes this is due to processing originally applied in the radar to eliminate spurious returns from road traffic.

Denmark has the most extensive experience of wind turbines operating within line of sight of radars. In late 2001 the country had more than 1,800 wind turbines located within 30km of air traffic control radars and over 500 within 30km of air defence radars. Many of these turbines are small single units but due to the predominantly flat terrain, radar visibility is generally good. Other than at Copenhagen Kastrup Airport, the Danish experience has been that wind turbines do not adversely impact air traffic and air defence radar operations.

Kastrup has 71 wind turbines within 30km, including eight located only 2km from the airport's SSR and 4km from its main primary radar, and a major 20-turbine offshore wind farm at Middelgrunden, 7-10km north of the airport. The Middelgrunden turbines lie directly under several instrument approach procedures. On commissioning, it was found to generate primary radar clutter and SSR false plots, although in each case the effects were not as

^{xliii} These include CAA, NATs, and Ofcom, who are consulted over possible telecommunications disruption – see following section.

severe as those caused by existing road traffic, chimneys, and buildings around the airport. In relation to the primary radar clutter, the track processing applied in the airport's radar successfully mitigated the effects, while the SSR false plots were dealt with using a proprietary Eurocontrol software tool.

The Dutch and Danish experience illustrates the potential for regulatory policy and air traffic control experience to accommodate wind turbines in proximity to radars. However, the different experience from the UK is explained in part by differences in the structure of airspace and the way in which it is managed. These differences include:

- The UK has more extensive uncontrolled airspace within which wind turbines have a greater potential impact
- The Danish and Dutch ATC authorities routinely control en route traffic using SSR only
- Due to uncertainties about its ability to display non co-operating aircraft, the UK CAA does not permit reliance on the type of track processing software used in Denmark and the Netherlands.

There is also growing experience of co-existence of wind turbines and radar in the USA. At Palm Springs in California, clutter problems on an older generation primary radar which has around one thousand wind turbines within its coverage were addressed by the installation of a new solid-state radar in 2001. The new radar has been able to provide a full radar service to aircraft crossing the wind farm area. However subsequent investigation found that, in practice, the service over the wind farm area was being provided using SSR only. This would not be acceptable to the regulatory authorities in the UK due to the policy that in normal circumstances an aircraft's radar identity must be confirmed and maintained using at least

primary, and, where available, primary and secondary radar. Routine controlling using SSR only is only permitted in certain less busy parts of the upper airspace where procedural separation between aircraft can be applied in the event of radar failure.

10.7 Mitigation measures

A number of mitigation measures are available that could reduce the conflicts between wind developments and aviation/radar concerns:

Operational measures

- Increasing controlled airspace
- Avoiding areas of significant air traffic control interest
- Introduction of Mode S secondary surveillance radar
- Limiting radar service in uncontrolled airspace

Technical measures

- Range-azimuth gate mapping (RAG mapping)
- Temporal threshold processing
- Clutter maps
- Track processing
- Placing antennae at an elevation that raises the radar beam above the wind farm
- A number of technical design improvements, such as radar absorption by turbine blades

Further details on some of these measures can be found in Annex C. The DTI-funded AMS Feasibility Study (due to be published in June 2005) aims to specifically identify and evaluate technical software and hardware mitigation techniques which will then be assessed by the MOD.

10.8 Balancing priorities

In general, many aviation and radar issues can be resolved, firstly by good site scoping, and secondly through a number of technical solutions that are either site-specific or more wide-ranging. The message for developers is that early consultation with the key regulatory stakeholders is essential, and can often avoid problems later on.

Safeguarding institutions also have a role to play in seeking to minimise objections to wind power developments and in trying to find solutions to problems wherever possible. In some cases

there may be issues over who is to pay for any identified measures, such as in the case of additional radar stations, which can be expensive. Such issues should not present a barrier to large or important projects going ahead. Considering the relative flexibility of arrangements in other European countries, the Government should be able to justify all measures currently in place, and should aim to keep abreast of international developments in this field so that good practice and the latest technological solutions can be used.

FURTHER INFORMATION

Wind Energy and Aviation Interests (Guidelines and Proforma) – DTI -
www.dti.gov.uk/renewables/publications/pdfs/windwenergyaviation.pdf

11 Telecommunications

Summary

- Wind turbines can interfere with radio signals and effect TV reception and telecommunications systems
- However, a number of solutions are available to developers to counter any negative effects and these should be identified early so that mitigation measures are included in the consents process

11.1 Background

Telecommunications signals (including TV, radio and data/voice transmission) can be negatively affected by wind turbines. The main issue is the multi-path effect, where there is corruption or distortion of the received signal. Multi-path effect can be caused by any object capable of reflecting radio waves. This may include buildings, towers and other stationary objects.

The effect of wind developments on telecommunications fall into two main categories: effects on broadcast television (and its supporting transmission network), and effects on fixed radio links, mostly at microwave frequencies. Technological trends are changing the telecommunications environment, which benefits wind energy development.

The Office of Communications (Ofcom) has responsibilities for licensing telecommunications systems and protecting radio systems against interference. It also plays an important role in the pre-planning consultation process, providing information on potentially affected telecommunications facilities in the vicinity of proposed wind farm developments.

11.2 Television

Television signals are broadcast from a network of main transmitters around the country, supplemented by additional, lower power, local transmitters in areas where the main signal is of poor quality. Broadcast transmissions are

vulnerable to multi-path effects in the same way as any radio signal, leading to 'ghosting' on the TV picture.

Wind turbine impacts on television reception quality are generally only found where the television subscribers are located in an area where they have a wind farm between them and their nearest TV transmitter. To overcome TV transmission interference the following can be done:

- A more sensitive receiver antenna could be provided for affected householders
- Antennae could be moved to receive from a different source transmitter
- A local community re-broadcast facility could be installed
- Alternative means of transmission, such as satellite or cable, could be used by affected householders

In the future, the switch from analogue to digital terrestrial television may mean that transmission networks become less vulnerable to interference from wind developments. Communities should negotiate with developers early on in the development process to be sure that they do not suffer negative consequences when the wind farm is operational and that appropriate mitigation measures are planned. It should be noted that any large or tall development could interfere with television reception, including the chimneys of local power

11 Telecommunications

plants. Therefore, this problem is not specific to wind power, and solutions are well understood.

11.3 Fixed radio links

Fixed point-to-point radio links are a vital component of the UK's telecommunications infrastructure. They carry trunk telephone services, television signals, mobile phone services, government and defence communications and many private and corporate telephone links over large distances. Most of these are at microwave frequencies, similar to those used by mobile phones. The wind turbine clearance zones around point-to-point microwave links are relatively narrow, although it is not uncommon for an operator to require a clearance zone of as much as 250m on either side of a link whose calculated clearance may be as little as 25m.

11.4 Scanning telemetry systems

The water and power industries use scanning telemetry systems to monitor and control substations, water and sewage works, pipelines and supply networks. These systems work in the UHF

band and, similar to television re-broadcast links, transmit over a wider zone and are therefore more vulnerable to multi-path effects from reflecting objects such as wind turbines. Consequently, the requested clearance zones may be large. Ofcom recommends that consultation be undertaken for any wind project within 1km of a scanning telemetry station.

11.5 A solvable problem

The seriousness of telecommunications issues will usually depend on the type of signal that proposed wind farms will interfere with. In most cases, local interference of TV reception can be solved using relatively low-cost measures for the households affected and these should be identified and planned for in the consents process. However, potential interference of fixed radio links and other key infrastructure is more serious and in some cases will not be easily solved. Early identification of such issues by developers should ensure that proposals only come forward where such problems are minor and can be mitigated.

FURTHER INFORMATION

'The Impact of Large Buildings and Structures (including Wind Farms) on Terrestrial Television Reception' – BBC/Ofcom report -

www.bbc.co.uk/reception/factsheets/pdfs/buildings_factsheet.pdf

Office of Communications (Ofcom) - www.ofcom.org.uk

Case study

TV Signal Interference – Blaen Bowi, Wales

In 1995 Windjen Power Ltd, based in Colwyn Bay, ran a wind energy exhibition at an agricultural show where Mr Guto Jones, owner of Blaen Bowi Farm near Newcastle Emlyn, Carmarthenshire, expressed an interest. The company carried out an analysis of the suitability of his Moelfre Hill site, deemed it suitable and entered into a lease agreement with him for 25 years to erect three 1.3 MW turbines.

Windjen Power Ltd commissioned Crown Castle UK, the primary broadcast transmission company in the UK, to carry out a survey to establish what effect the turbines would have on TV reception. Whilst not 100% conclusive, the survey identified that a repeater would be required on a mast at Llandyfriog. The report also stated that the full effect on TV reception would not become apparent until the wind farm was operational.

A local electrical/aerial engineer was employed to remedy interference issues once the project was operational in July 2002. Some 26 households from surrounding villages did report problems with their TVs. All reports of TV interference up to an 8-10 mile radius were investigated and dealt with as they were received. Rectifying the interference on analogue signals for television took between nine to 12 months. An added bonus is that



© Windjen Power Ltd

With the erection of three turbines, all reports of TV signal interference within a radius of 8–10 miles were resolved. Some families now receive additional Channel 5.

Case study: TV Signal Interference – Blaen Bowi, Wales

some unaffected families now receive Channel 5. The planning authority agreements stated a limit of £5000 that the developer was required to spend on the problem. Windjen has spent £33,000 in resolving TV problems.

The company has recently submitted a planning application to extend Blaen Bowi by a further three 1.3 MW turbines. On the Blaen Bowi wind farm extension planning application, the Environmental Statement includes consultation with the relevant bodies and offers potential solutions.

“Problems of this nature can be quickly resolved given the understanding we have gained. Measures can also be put in place to minimise the TV reception interference after wind farm commissioning.”

D. Jones

Managing Director, Windjen Power Ltd.

Lessons and thoughts:

- Windjen Power Ltd is applying this experience to the Tir Mostyn & Foel Goch wind farm under construction some 8km south west of Denbigh, North Wales that is due for commissioning in August 2005. It will comprise 25 Gamesa turbines with a total capacity of 21.3 MW. Windjen Power Ltd has submitted electromagnetic interference assessment and consultation documents as part of the planning application stating there may be similar interference issues as Blaen Bowi and identifying solutions.
- This case study shows how simple solutions can often be found to problems such as TV interference, and that good consultation with local residents is essential.
- Repeater transmitters are just one of a number of options available to developers. In some cases, the installation of satellite TV at affected households is an alternative option.

Key facts:

- It took six years from locating the Blaen Bowi site to commissioning the turbines. Significant changes were made to optimise the design, taking into consideration visual and landscape considerations.
- By erecting the wind turbines the signal path from Mast 1 to Mast 2 was intersected to some degree, and there were two stages to solving the problem.
- Firstly a relay antenna was placed on an existing Mast 3 allowing the signal from Mast 1 to be sent to Mast 3 and then to Mast 2, bypassing the wind turbines.
- The second stage was to alter the individual household TV aeriels that would have originally received a signal from Mast 1. These aeriels were adjusted to receive the signal from Mast 2. The costs were in two parts, the additional antenna on Mast 3, and the ariel adjustment at individual properties.

12 The process of wind farm development

Assessment Stage

Site selection

Wind power developer looks at potential sites to assess their suitability, taking account of technical, commercial and environmental constraints. Desk-based research will be carried out to see whether sites meet essential criteria, such as:

- Suitable wind resource
- Access to the local electricity distribution system
- Local road access
- Site size and availability (to determine viability)
- Site ownership
- Environmental and radar/aviation considerations

There may also be initial consultation with the local planning authority and statutory consultees to identify potential issues that need to be addressed – the local community may also be approached.

Feasibility

Once a potential site has been identified, the developer will conduct a more detailed feasibility study, including:

- A more detailed technical assessment
- An economic assessment
- An appraisal and scoping exercise
- An assessment of planning constraints (including radar/aviation)
- A technical wind assessment (usually using anemometer masts)

Site visits will be required and the developer will need to agree the scope of the EIA with the relevant authorising body. Consultation with the local community should also take place at this stage if it has not already.

Detailed Assessment

If the proposed site looks to be commercially and environmentally viable, the developer will undertake a detailed assessment, where the exact design and layout of the turbines will be decided. The detailed assessment is likely to include:

- An EIA, if one is required. This will assess, among other things: wildlife and habitat impacts, visual and landscape impacts, and noise
- Detailed community consultation, to help determine appropriate turbine layout and design
- Consultation with the appropriate statutory and non-statutory consultees
- Detailed economic assessment and securing finance for the project

12 The process of wind farm development

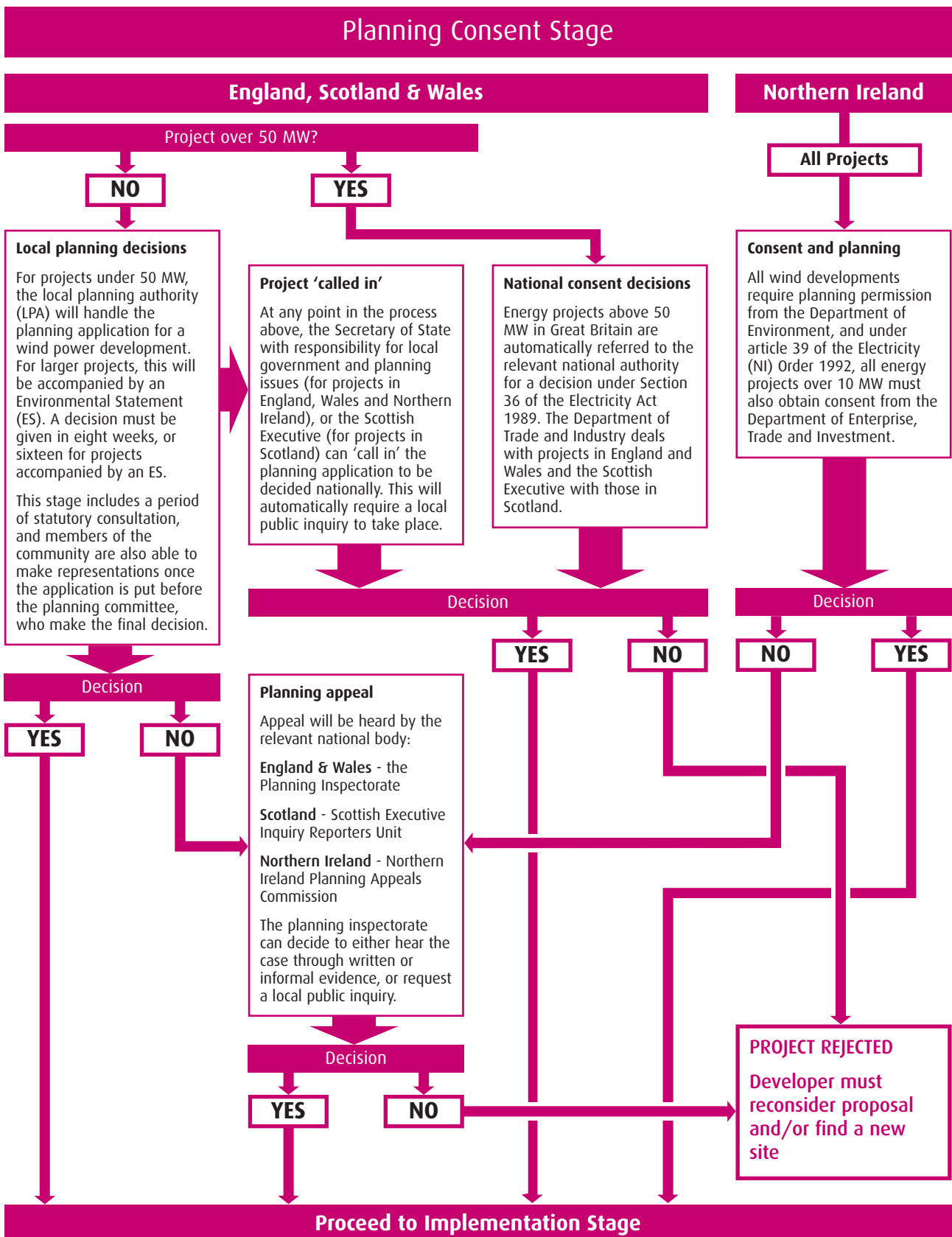

12 The process of wind farm development

Implementation Stage

Construction

Once the project is approved and finance is in place, the developer will hand over responsibility for the site to the lead contractor, who will handle the construction process. The developer will also have to arrange for any work to allow the wind farm to connect to the local distribution or transmission network. If an Environmental Management Plan has been agreed (depending on the nature, size and location of the site), it will be implemented at the earliest opportunity. The construction process generally takes 6-12 months, depending on the size of the project. The local community can be kept informed of progress using an information board system, or an announcement in the local newspaper.

Commissioning

Once construction is complete and grid connections have been made, the wind farm will be ready for commissioning. This will involve 'switching on' the turbines for the first time, allowing wind-generated electricity to flow to the grid for the first time. Developers will often organise a ceremony to celebrate the completion of the project.

Operation & Maintenance

Developers have responsibility for the operation of their wind energy project throughout its lifetime and the public should be notified of any changes of operation. Maintenance activities will need to take place regularly for individual turbines and associated infrastructure to ensure maximum performance.

Decommissioning / Repowering

At the end of their working lives (usually 20 years), the wind turbines will usually be removed and the materials recycled. The site may then be 'repowered', where new turbines are installed in their place, or fully decommissioned. Repowering offers the potential for significant increases in output from existing sites, as the latest technology will be installed. However, in some cases the original planning consent may stipulate that the site is decommissioned. The developer may then choose to apply for planning permission to repower the site, or be forced to decommission it. This would require removal of the foundations and restoration of the site as close as possible to its previous condition.

Glossary of terms

Alternating current (AC) - Flow of electricity that constantly changes direction between positive and negative sides. Electricity produced in the UK moves in current that shifts direction at a rate of 50 times per second (50 Hertz, 50Hz).

Base load - The minimum load experienced by an electric utility system over a given period of time.

Baseload capacity - Generating equipment operated to serve loads 24-hours per day (eg. nuclear power plants).

BETTA - the British Electricity Transmission and Trading Arrangements introduced in April 2005, extending NETA to Scotland.

Capacity - The maximum load a generating unit, generating station, or other electrical apparatus is rated to carry.

Capacity factor - The ratio of the electrical energy produced by a generating unit relative to the electrical energy that could have been produced at continuous full power operation during the same period of time. The Capacity Factor for wind energy in the UK is typically between 20% and 40%.

Capacity value - Sometimes referred to as capacity credit, this is an expression of the percentage of conventional generation that can be displaced by wind generation. The capacity value may be equal to the capacity factor at low levels of wind penetration, but will be lower as penetration increases.

CCGT - Combined cycle gas turbine; modern gas powered electricity generating technology.

Conservation - A foregoing or reduction of electric usage for the purpose of saving natural energy resources and limiting peak demand in order to ultimately reduce the capacity requirements for plant and equipment.

Current (electric) - Flow of electrons in an electric conductor.

Demand (electric) - The rate at which electrical energy is delivered to or by a system. Demand is expressed in kW, kVA, or other suitable units at a given instant or over any designated period of time.

Defra - Department of Environment, Food and Rural Affairs

Distributed generation (embedded generation) - A distributed generation system involves small amounts of generation located on a utility's distribution system for the purpose of meeting local (substation level) peak loads and/or displacing the need to build additional (or upgrade) local distribution lines.

DTI - Department of Trade and Industry

Distribution - The system of wires, switches, and transformers that serve neighbourhoods and businesses; classified as 132,000 volts and below in England and Wales (132kV is considered to be part of the Transmission Network in Scotland). A distribution system reduces the voltage from high-voltage transmission lines (275,000 volts or 400,000 volts) to a level that can be distributed to homes or businesses; 132,000V, 33,000V, 11,000V, 3,300V, 440V.

Distribution system - That part of the electric system that delivers electrical energy to consumers.

DSO, DNO - Distribution System (or Network) Operator.

Embedded generation - see distributed generation

Energy - This is broadly defined as the capability of doing work. In the electricity industry, energy is more narrowly defined as electricity supplied over time, normally expressed in kilowatt-hours.

Energy consumption - The amount of energy consumed in the form in which it is acquired by the user. The term excludes electrical generation and distribution losses.

Glossary of terms

Energy efficiency - Programmes that reduce energy consumption whilst maintaining a given level of output.

Energy mix - the distribution or proportion of different energy sources within the total energy supply.

Energy resources - Everything that could be used by society as a source of energy.

Energy source - A source that provides the power to be converted to electricity e.g. hydro, solar, wind, biomass, fossil fuel, nuclear fuel.

Energy use - Energy consumed during a specified time period for a specific purpose (usually expressed in kWh).

Generation (Electricity) - Process of producing electric energy by transforming other forms of energy.

Generator - Machine used to convert mechanical energy into electrical energy.

Gigawatt (GW) - The unit of electrical power equal to one thousand-million watts, or one thousand megawatts.

Grid - Matrix of an electrical distribution system, the National Grid in the UK.

Installed capacity - The total generating units' capacities in a power plant or on a total utility system. The capacity can be based on the nameplate rating or the declared net (dependable) capacity (DNC).

Intermittent resources - Resources whose output depends on some other factor that cannot be controlled by the utility e.g. wind or sun. Thus, the capacity varies by day and by hour.

Kilowatt (kW) - The electrical unit of power equal to 1,000 watts.

Kilowatt-hour (kWh) - The basic unit of electric energy equal to one kilowatt of power supplied to or taken from an electric circuit for one hour.

Load - The amount of electric power delivered or required at any specified point or points on a system. Load originates primarily at the power consuming equipment of the customer.

Load factor - The ratio of the average load supplied to the peak or maximum load during a designated period. Similar to capacity factor, but more often used when describing conventional plant.

Losses - The general term applied to energy (kWh) and capacity (kW) lost in the operation of an electric system. Losses occur principally as energy transformations from kWh to waste-heat in electrical conductors and apparatus.

Megawatt (MW) - One million watts. A large coal-fired power station in the UK typically has an installed capacity of between 2,000 MW and 4,000 MW

Megawatt-hour (MWh) - One thousand kilowatt-hours or one million-watt hours.

NETA - the New Electricity Trading Arrangements introduced in March 2001 for England and Wales, and governed by the Balancing and Settlement Code (see BSC). Now superseded by BETTA.

Off-peak - Periods of relatively low system demands.

OFGEM - the Office of Gas and Electricity Markets; the energy regulator for the GB gas and electricity sectors.

Outage - Time during which service is unavailable from a generating unit, transmission line, or other facility.

Payback - The length of time it takes for the savings received to cover the cost of implementing the technology.

Peak - Periods of relatively high system demands.

Peak demand - Maximum power used in a given period of time.

Glossary of terms

Phase - One of the characteristics of the electric service supplied or the equipment used. Practically all residential customers have single-phase service at 240 volts. Large commercial and industrial customers typically have three-phase service from 440 volts upwards.

Plant - A facility containing prime movers, electric generators, and other equipment for producing electric energy.

Power - The rate at which energy is transferred.

Power plant - A generating station where electricity is produced.

Production - The act or process of generating electric energy.

Pumped storage - A facility designed to generate electric power during peak load periods with a hydroelectric plant using water pumped into a storage reservoir during off-peak periods.

Regulation - An activity of government to control or direct economic entities by rulemaking and adjudication.

Reliability - Electric system reliability has two components - adequacy and security. Adequacy is the ability of the electric system to supply the aggregate electric demand and energy requirements of the customers at all times, taking into account scheduled and unscheduled outages of system facilities. Security is the ability of the electric system to withstand sudden disturbances such as electric short circuits or unanticipated loss of system facilities.

Renewable energy - the term used to cover those energy flows that occur naturally and repeatedly in the environment, it includes all energy derived from the sun (solar, wind, ocean, and hydro power, plus biomass), and geothermal sources.

Energy that is capable of being renewed by the natural ecological cycle, generally wind, wave, tidal, solar, hydro, biomass.

Renewables Obligation - support mechanism aimed at increasing the percentage of renewable energy generation on the national grid. The Renewables Obligation works by placing an obligation on electricity suppliers to source an increasing percentage of supply from renewables. Separate obligations apply in Scotland and Northern Ireland.

Reserve capacity - Capacity in excess of that required to carry peak load.

ROCs - Renewable Obligation Certificates; the tradable 'currency' of the RO.

Running and quick-start capability - Generally refers to generating units that can be available for load within a 30-minute period.

Scheduled outage - An outage that results when a component is deliberately taken out of service at a selected time, usually for the purposes of construction, maintenance, or testing.

Spinning reserve - Reserve generating capacity running at zero load.

Substation - A facility used for switching and/or changing or regulating the voltage of electricity. Service equipment, line transformer installations, or minor distribution or transmission equipment are not classified as substations.

Supplier - A person or corporation, generator, broker, marketer, aggregator or any other entity, that sells electricity to customers, using the transmission or distribution facilities of an electric distribution company.

System (Electric) - Physically connected generation, transmission, and distribution facilities operating as a single unit.

Terawatt (TW) - One thousand gigawatts

Therm -

Transformer - A device for changing the voltage of alternating current.

Glossary of terms

Transmission - The act or process of transporting electric energy in bulk.

Transmission and distribution (T&D) losses - Losses that result from the heating effect of current as it flows through wires to travel from the generation facility to the customer. Because of losses, the electricity produced by the utility is greater than the electricity that shows up on the customer bills.

Transmission and distribution (T&D) system - An interconnected group of electric transmission lines and associated equipment for the movement or transfer of electrical energy in bulk between points of supply and points at which it is transformed for delivery to the ultimate customers.

Transmission lines - Heavy wires that carry large amounts of electricity over long distances from a generating station to places where electricity is needed. Transmission lines are held high above the ground on tall towers called transmission towers.

Transmission network - the electricity transmission system operating at voltages above 132kV (in England and Wales) and including 132kV in Scotland)

TSO, TNO - (Electricity) Transmission System (or Network) Operator

Upgrade - Replacement or addition of electrical equipment resulting in increased generation or transmission capability.

Utility - A regulated vertically-integrated electricity company. "Transmission utility" refers to the regulated owner/operator of the transmission system only. "Distribution utility" refers to the regulated owner/operator of the distribution system which serves retail customers.

Volt - the unit of electrical potential. It is the electromotive force which, if steadily applied to a circuit having a resistance of one ohm, will produce a current of one ampere.

Volt-amperes - The volt-amperes of an electric circuit; the mathematical product of the volts and amperes. Equals the power in a direct current circuit.

Voltage - Measure of the force of moving electrical energy.

Watt - The electrical unit of power or rate of doing work. One horsepower is equivalent to approximately 746 watts.

Watt-hour - One watt of power expended for one hour.

References

- 1 Defra (2005). *One future - different paths*. Available at: www.sustainable-development.gov.uk/documents/publications/SD%20Framework.pdf
- 2 Intergovernmental Panel on Climate Change (IPCC) (2001). *Climate Change 2001: Synthesis Report*. Available at: http://www.grida.no/climate/ipcc_tar/vol4/english/004.htm
- 3 IPCC (2001). *Climate Change 2001: The Scientific Basis*. Available at: http://www.grida.no/climate/ipcc_tar/vol4/english/076.htm
- 4 King, D. (2004). *Climate Change Science: Adapt, Mitigate or Ignore?* Science, Jan. 9, 2004.
- 5 Kyoto Protocol to the United Nations Framework Convention on Climate Change (1997). Available at: http://unfccc.int/essential_background/kyoto_protocol/items/1678.php
- 6 Carbon Dioxide Information Analysis Center (CDIAC) (2004). Oak Ridge National Laboratory. Available at: <http://cdiac.esd.ornl.gov/home.html>
- 7 DTI (2005). *Energy Trends March 2005*. Available at: http://www.dti.gov.uk/energy/inform/energy_trends/mar_05.pdf
- 8 Defra (2005). *E-Digest Environmental Statistics*. Available at: <http://www.defra.gov.uk/environment/statistics/globalatmos/gagccukem.htm>
- 9 Riso National Laboratory, Denmark. Website available at: <http://www.risoe.dk/>
- 10 DTI (2000). *The UK Wind Resource*. Available at: <http://www.dti.gov.uk/energy/renewables/publications/pdfs/windfs8.pdf>
- 11 Garrad Hassan and Partners Limited (Garrad Hassan) (2001). *Scotland's Renewable Resource 2001 – Executive Summary*. Report completed for Scottish Executive, Glasgow, available at: <http://www.scottish.parliament.uk/enterprise/inquiries/rei/ec04-reis-scotenvlinkfollowup2.pdf>
- 12 DTI (2001). *Offshore Wind Energy*. Available at: <http://www.dti.gov.uk/energy/renewables/publications/pdfs/windfs1.pdf>
- 13 DTI (2002). *Future Offshore consultation document*. Available at: http://www.dti.gov.uk/energy/leg_and_reg/consents/future_offshore/FutureOffshore.pdf
- 14 Figures from BWEA website at: <http://www.bwea.com/map/index.html>
- 15 DTI (2004a). *Digest of UK Energy Statistics 2004*. Published by The Stationery Office. Available at: <http://www.dti.gov.uk/energy/inform/dukes/index.shtml>
- 16 DTI (2005). *2005-6 Review of the Renewables Obligation – preliminary consultation document*. Available at: http://www.dti.gov.uk/renewables/policy_pdfs/renewobligarevreport.pdf
- 17 Dale et al. (2003). *Total cost estimates for large-scale wind scenarios in UK*. Energy Policy 32, pp. 1949-1956.
- 18 Danish Wind Turbine Manufacturers Association (1997). *The Energy Balance of Modern Wind Turbines*. Available from: <http://www.windpower.org/en/tour/env/enpaybk.htm>; citations in *Wind Power Weekly* (1992). Available at: <http://www.awea.org/faq/bal.html>; and Milborrow, D. (1998). *Dispelling the Myths of Energy Payback Time*. Wind Stats Newsletter, Vol. 11, No.2.
- 19 Vestas (2004). *Energy balance information*. Available at: http://www.vestas.com/uk/environment/2005/energy_balance/energy_balance.asp
- 20 Enviro (2005). *Generic wind turbine power curve*.
- 21 NGC (2003). *Seven Year Statement*. Available at: http://www.nationalgrid.com/uk/library/documents/sys_03/default.asp?sNode=SYS&action=&Exp=Y
- 22 House of Lords Science & Technology Select Committee (2004). *Fourth Report: Renewable Energy – Practicalities*. Available at: <http://www.publications.parliament.uk/pa/ld200304/ldselect/ldstech/126/12602.htm>
- 23 E.on Netz (2004). *Wind Report 2004*. Available at: <http://www.eon-netz.com>

References

- 24 Garrad Hassan (2005). Data kindly provided from the GH Forecaster. <http://www.garradhassan.com>
- 25 Carbon Trust / DTI (2004). *Renewables Network Impacts Study*. Available from: <http://www.carbontrust.org.uk/carbontrust/about/publications/Renewables%20Network%20Impact%20Study%20Final.pdf>
- 26 Nuclear Energy Agency/IEA (2005). *UK contribution to: Projected costs of generating electricity, 2005 update*.
- 27 Non-Fossil Purchasing Agency (2005). *Average NFFO Prices*. Available at: <http://www.nfpa.co.uk/index.cfm?pid=33>
- 28 Oxford Economic Research Associates (2004). *Results of renewables market modelling*. Available at: <http://www.dti.gov.uk/renewables/policy/oxeraresults.pdf>
- 29 Milborrow, D. (2005). *Goodbye gas and squaring up to coal*. Windpower Monthly, January 2005.
- 30 IEA/OECD (2005). *Projected costs of generating electricity - 2005 update*. International Energy Agency, Paris.
- 31 Platts (2005). *"Platts price data"*. Power UK, February 2005.
- 32 ETSU (1996). *R-99: A review of the UK onshore wind energy resource*.
- 33 ETSU (1999). *R-122: New and renewable energy: prospects in the UK for the 21st century*.
- 34 DTI (2003). *Modelling carried out for economics paper No 4. - Options for a low carbon future*.
- 35 Dale, L., Milborrow, D., Slark, R. and Strbac, G. (2003). *A shift to wind is not unfeasible*. Power UK, March 2003.
- 36 Black and Veatch Corp (2004). *Economic impact of renewable energy in Pennsylvania*. Available at: http://www.bv.com/energy/eec/studies/PA_RPS_Final_Report.pdf
- 37 Harrison, L, 2004. *Wind economics set to beat gas in Ireland*. Windpower Monthly, December 2004.
- 38 German Energy Agency, 2005. *Planning of the grid integration of wind energy in Germany offshore and onshore up to the year 2020*.
- 39 Oxera, 2004. *Security of supply, energy investment requirements and cost implications*. Report for Centrica
- 40 Milborrow, D. (2005). *Personal correspondence*. (This analysis was carried out under a separate contract to the Carbon Trust and their permission to quote the results is gratefully acknowledged.)
- 41 Awerbuch, S, 2003. *Determining the real cost -- why renewable power is more cost-competitive than previously believed*. Renewable Energy World, March/April 2003.
- 42 HMT/Defra (2002): *Estimating the Social Cost of Carbon Emissions*. Available at: <http://www.hm-treasury.gov.uk/media/209/60/scc.pdf>
- 43 NAO (2005). Department of Trade and Industry: *Renewable Energy*. Available at: http://www.nao.org.uk/publications/nao_reports/04-05/0405210.pdf
- 44 DEFRA (2004). *Energy Efficiency: The Government's Plan For Action*. Available at: <http://www.official-documents.co.uk/document/cm61/6168/6168.pdf>
- 45 DTI spokesperson, as quoted in the Guardian, 11th February 2005. Available at: <http://money.guardian.co.uk/utilities/story/0,11992,1410930,00.html>
- 46 DTI/DEFRA (2003). *Energy White Paper: Our energy future - creating a low carbon economy*. Available at: <http://www.dti.gov.uk/energy/whitepaper/ourenergyfuture.pdf>
- 47 Cabinet Office (2002). *The Energy Review*. Available at: <http://www.number-10.gov.uk/su/energy/TheEnergyReview.PDF>
- 48 Data obtained from RESTATS service provided by Future Energy Solutions for the DTI. Public data available at: www.restats.org.uk
- 49 Jain, R.K. et al. (2002). *Environmental Assessment*. McGraw-Hill, New York.
- 50 Friends of the Earth (2001). *How to Win – saving wildlife sites*. Available at: http://www.foe.co.uk/resource/local/saving_wildlife_sites/getting_started/saving_wildlife_sites_3.pdf

References

- 51 RSPB (2004). *Wind farms and birds, RSPB information sheet*. Available at: http://www.rspb.org.uk/Images/Pages%20from%20Wind%20farms%20and%20birds_tcm5-51248.pdf
- 52 Scottish Executive (2002). *PAN 45: Renewable Energy Technologies*. Edinburgh.
- 53 Jakobsen, J. (2004). *Infrasound Emission from Wind Turbines*. Proceedings from Low Frequency 2004: 11th International meeting on low frequency noise and vibration and its control. Danish Environmental Protection Agency.
- 54 Leventhall (2003). *A review of published research on low frequency noise and its effects*. A report for DEFRA.
- 55 WHO (1999). *Guidelines for Community Noise*. Available at: <http://www.who.int/docstore/peh/noise/guidelines2.html>
- 56 BSI (1997). *BS4142: Method for rating industrial noise affecting mixed residential and industrial areas*.
- 57 ETSU (1996). *ETSU R97: The Assessment & Rating of Noise from Wind Farms*. Available at: <http://www.dti.gov.uk/energy/renewables/publications/noiseassessment.shtml>
- 58 DTI (2003). *Attitudes and Knowledge of Renewable Energy amongst the General Public - Report of Findings*.
- 59 EC (2002). *Energy: Issues, Options and Technologies Science and Society*. The European Opinion Research Group (EORG) for the Directorate-General for Research, EUR 20624.
- 60 EWEA (2003). *Wind Directions (bimonthly magazine)*. September/October 2003.
- 61 Scottish Executive (2003). *Public Attitudes to Windfarms: A survey of Local Residents in Scotland*. Research Study conducted by MORI (Scotland) Social Research Institute. Scottish Executive Social Research. Available at: <http://www.scotland.gov.uk/library5/environment/pawslr.pdf>
- 62 The Royal Institution of Chartered Surveyors (RICS) (2004). *Wind farms hit house prices*. Available at: <http://www.rics.org.uk/Property/Residentialproperty/Residentialpropertymarket/wind+farms+hit+house+prices.htm>
- 63 DTI (2004). *Renewables Supply Chain Gap Analysis*. Available at: <http://www.dti.gov.uk/renewables/publications/pdfs/renewgapreport.pdf>
- 64 South West Renewable Energy Agency (2004). *South West Public Engagement Protocol and Guidance for Wind Energy*. Available at: <http://www.regensw.co.uk/advice/la-windprotocol.asp>
- 65 STASYS Ltd, *Wind Turbines and Aviation Interests - European Experience and Practice*, ETSU W/14/00624/REP, DTI PUB URN No. 03/515, 2002, p.iii
- 66 Enterprise and Culture Committee, Scottish Parliament (2004). *Evidence Received for Renewable Energy in Scotland Inquiry: submission from National Grid Transco*. Available at: <http://www.scottish.parliament.uk/business/committees/enterprise/inquiries/rei/ec04-reis-ngt.htm>

Wind Power in the UK: Annexes

These technical annexes set out background information in much greater detail than the main document. They are meant as a source of technical data and references for readers interested in knowing more about the subject. The data sources are not exhaustive but should provide information that will satisfy most readers' needs.

Annex A

Wind power technology

Rotor blades

Wind turbine rotor blades are either manufactured from glass fibre reinforced polyester resins (small blades) or more typically from pre-impregnated glass reinforced epoxy resin (larger blades) or wood laminates, and comprise aerodynamic shells bonded to a spar. Carbon fibre reinforcement is a common feature on larger blades, adding strength while reducing weight. Studs are embedded in the blade root for attachment to the rotor hub. The commonly used number of rotor blades per turbine is three.

Rotor

The bladed rotor extracts kinetic energy from the wind flowing through it. The power available varies with the cube of the wind speed, i.e. double the wind speed produces eight times the power. The slow speed (13-30rpm) rotor is connected to a gearbox which

increases the rotational speed to drive an electrical generator (1500rpm). The turbulent and gusty nature of wind flow requires the amount of energy extracted by the rotor to be limited in order to protect the gearbox, generator and the wind turbine structure itself from damaging loads. Control is achieved either by aerodynamic stall or by changing the angle (pitch) of the rotor blades. Stall regulated machines effectively run at constant speed, pitch regulated machines can run at variable speed, thereby reducing loads on the drive train.

Gearbox

At the heart of a wind turbine drive train is the gearbox which is designed to increase the low speed, high torque of the rotor to the high speed, low torque of the electrical generator. Gearboxes can be multi-stage helical, planetary, or hybrid designs. Some designs of wind turbine mount the rotor directly to the gearbox, others utilise a separate slow-speed shaft and bearing

Figure 1: Nacelle components in a modern geared wind turbine

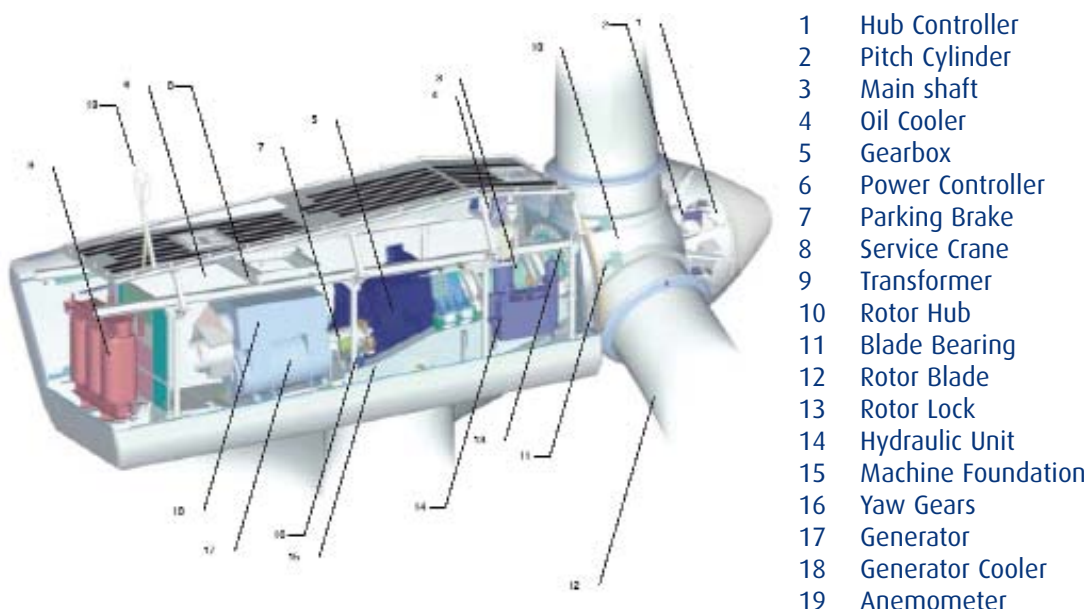

Illustration courtesy of Vestas Wind Systems A/S

Annex A: Wind power technology

arrangement to support the rotor. Other designs dispense with the gearbox altogether and are directly coupled to a large diameter wound-rotor generator running at rotor speed. Direct-drive machines are much quieter than machines with a gearbox as they produce less mechanical or tonal noise.

Generator

Wind turbines with gearboxes can utilise industry standard high speed induction or synchronous generators, the wide choice and availability keeping costs low. Direct-drive machines require bespoke wound-rotor generators. Variable speed operation, with the advantages of low drive train loads, requires the application of power electronics to deal with frequency variations before connection to the fixed frequency grid. The wind industry had benefited from advances in power electronics in terms of power quality, load reduction, and enhanced energy output.

Control systems

The success of modern wind turbine generators owes much to the integration and control of complex dynamic systems. Aerodynamically efficient rotors depend upon pitch control to maintain optimum energy capture through a wide range of wind speeds. There is a yaw system to rotate the nacelle so the rotor always faces the prevailing wind. There is control of the variable speed rotor which is allowed to respond to gusts and load changes to reduce drive train loads. There is control of the output power from the generator in terms of frequency and power quality so that the wind farm's variable output has a benign effect on the electricity grid when synchronised. Wind farms operate fully automatically, entirely unmanned and are monitored remotely, constantly logging data for machinery condition monitoring, technical performance, power generated etc. This is a testament to the high levels of availability

(98%) and reliability, with only 40 hours maintenance required per year. A wind turbine is designed to operate for over 120,000 hours over a 20-year design life.

Transformers

Most wind turbines generate at industry standard 3 phase voltages, typically 460 or 690 volts. Connection to the electricity grid for export of the power is generally made at 33,000 volts (33kV) or even 132kV depending on the total power output of the wind farm. Depending on the wind farm electrical design, voltage transformers may be installed in the nacelle, the tower base, a separate enclosure adjacent to the tower, or the wind farm export substation.

Power quality and power electronics

The advent of variable speed rotors and advances in industrial full-power electronics have been exploited by the wind energy industry to produce machines with high quality electrical output that have a low impact on the grid. The wind energy resources identified on land and offshore and the 15% target for electricity from renewable sources by 2015 can readily be met by wind energy alone with no detrimental impact on the transmission and distribution grid.

Tower

Most wind turbines use tubular steel towers typically tapering from 4.0m diameter at ground level to 2.5m diameter for connection to the nacelle. A modern 2MW machine with a rotor diameter of 80m may utilise a range of tower heights from 60m to 90m depending on annual mean wind speed and site topography. There are an increasing number of developments of one or two wind turbines in semi-urban or industrial landscapes where the annual mean wind speed would not initially attract a

Annex A: Wind power technology

commercial developer but where, with the evolution of high energy capture rotors coupled with increased tower heights, a commercial proposition can be developed. Prefabricated concrete towers with heights in the 100-110m range look set to continue this trend.

FURTHER INFORMATION

“Wind Energy – The Facts” – European Wind Energy Association -
http://www.ewea.org/06projects_events/proj_WEfacts.htm

Annex B

Network integration and costs

Background to generation costs

World wind energy capacity has doubled every three years since 1990. Each doubling was accompanied by a 15% reduction in the price of wind turbines. The price of wind-generated electricity fell more rapidly, as there were also improvements in energy productivity, partly because machines became more reliable, partly due to a trend towards larger machines.

Although the growth in capacity slowed in 2004 – when the annual increase was about 20% – manufacturers continue to innovate and so the downward price trends seem set to continue.

To gain an appreciation of wind turbine and wind-generated electricity prices, it is necessary to examine the prices of wind turbines and of wind farms and their energy productivity. These depend on factors such as location, the size of the machines, and the size of the wind farm. Energy production depends on the site wind speed and has a crucial effect on power prices.

Starting with the wind turbines, Figure 2 tracks list prices from a leading manufacturer from 1990 to 2004.¹ Although list prices are only a guide, and many orders are placed at lower prices, the overall trend – falling from just over €1400/kW in 1990 to €830/kW in 2004 – is strongly downward.

In 1990, the largest size of machine offered by the manufacturer was 150 kW, and it has increased steadily since that time. The sharp drop in prices between 1993 and 1994 reflected an increase in size from 450 kW to 600 kW and the 2004 price (€830/kW, or £570/kW) relates to a 2000 kW machine.

[Note: As much of the source data for Figs 1-3, and Table 1 are in euro, they have not been converted, but generation costs – quoted later – are in UK currency]

Figure 2: Wind turbine list prices (€/kW)

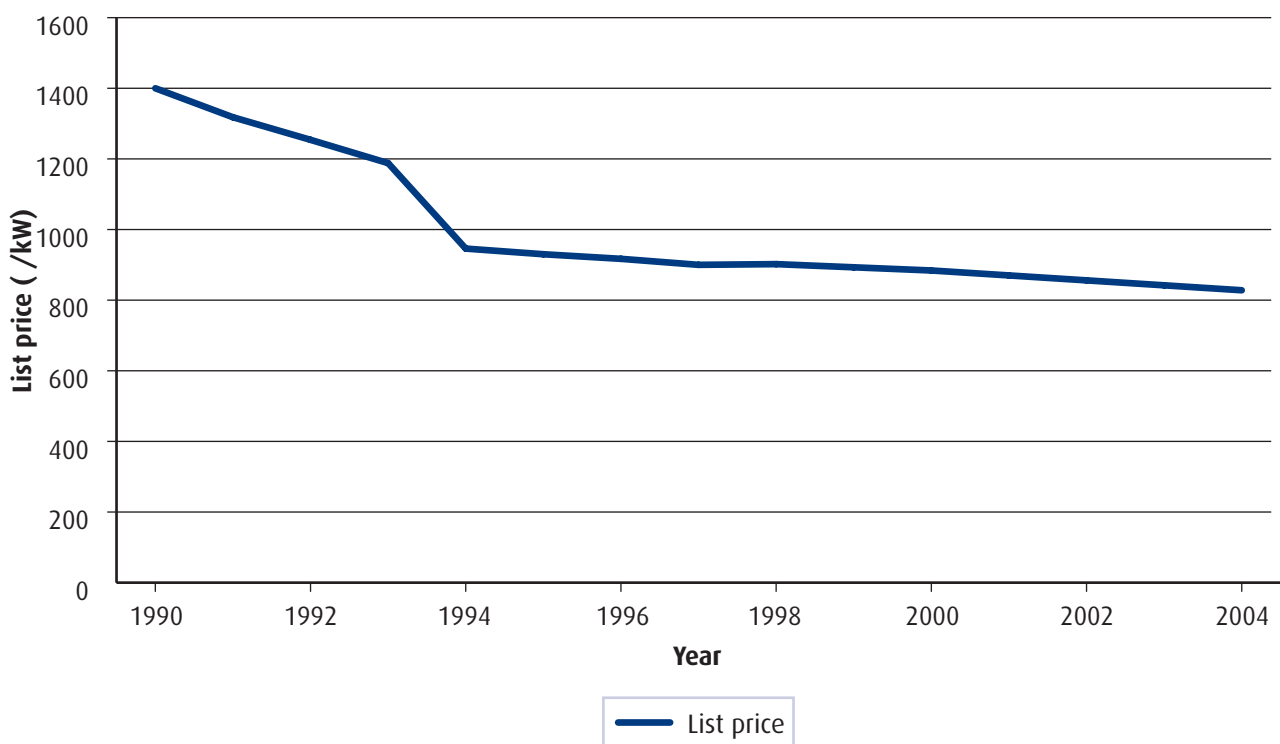

Annex B: Network integration and costs

From 1990 to 2002, world wind energy capacity doubled every three years. Few other energy technologies are growing, or have grown, at such a remarkable rate. In 2003, the growth rate was around 25%, with an extra 8200 MW installed, and a similar quantity was installed in 2004. Total capacity is now nearly 48,000 MW, with around 888 MW installed in the UK.

Whilst cost reductions with increased volume of production are well known in many technologies the 'learning curve' (as it is termed) for wind is well in excess of early expectations. Based on an analysis of the relative amounts of labour and material cost in wind turbines Bergey predicted an 8% reduction of cost per unit doubling of capacity in 1991; what is actually being achieved is nearly double that figure.² The data quoted above is consistent with a 15% learning curve ratio, and other authors have derived similar figures.

The effect of turbine size

The steady decrease in costs has been due, in part, to the move towards larger machines. In 1992 the cheapest machine (per kW) was rated at 300 kW and it is now around 1500 kW. Larger machines tend to be slightly more expensive. When used in wind farms, however, fewer machines realise savings on foundation costs, transport, electrical connections and operational costs, making larger machines potentially more attractive.

The economics for small-scale wind turbines (1-200 kW) are quite different, with the smallest sized machines (1-30 kW) coming out the most expensive per unit of installed capacity. This report does not look at small-scale wind power, but it is important to recognise these differences.

Breakdown of wind farm costs

The total installed cost of a wind farm includes 'balance of plant' costs, such as the cost of

foundations, transport and internal electrical connections. These add between 15 and 30% to the cost of the wind turbines, and there are wide variations which depend on the difficulties of construction and the size of the project. In addition, the cost of the grid connection can often add a substantial sum to the project cost.

A typical cost breakdown for an onshore wind farm is³:

Turbines	72%
Foundations	6%
Electrical connections	2%
Planning	4%
Grid connection	10%
Miscellaneous	6%

Table 1 summarises a number of recent wind farm published prices, drawn from a database of about 30 onshore projects cited in the journal 'Windpower Monthly' in 2004.

There are wide variations, but the average onshore price is €980/kW (range €707-1350/kW). The average offshore price is around €1600/kW (range €1250-1800/kW). The lowest prices, in each case, come from developing world locations, especially China and India.

Operational costs

Operational costs fall with increase of turbine size. Analysis of data from German wind installations shows that total costs fall from around €25/kW/yr at the 250 kW size to around €13/kW/yr at 1500 kW (Figure 3).⁴ These costs include operation and maintenance contracts, insurance and administration. In Britain, operation and maintenance costs also include local authority rates and the rents payable by the plant operators to the landowners – typically around 1.5% of turnover.

Annex B: Network integration and costs

Table 1: Prices of wind farms recently completed or planned

Location	Turbines x rating (MW)	Capacity, (MW)	Cost, (Million)	Cost, €/kW	Reference ⁱ
Canada	20 x 1.5	30	C\$48	1008	September, P.20
Spain	Not quoted	128	€132	1031	July, P.10
Australia	35 x 2.00	70	AS\$130	1077	September, P.16
Ireland	Mixed	72	€80	1111	July, P.8
Jamaica	23 x 0.9	20.7	\$24	870	July, P.27
China	Not quoted	100	\$94.2	707	July, P.28
Scotland	56 x 2.3	129	£90	997	Power UK January 2005
Offshore					
DK, Middlegrunden	20 x 2.0	40	€50	1250	
DK, Horns Rev	80 x 2.0	160	€268	1675	
DK, Nysted	72 x 2.3	166	€230	1389	
UK, North Hoyle	30 x 2.0	60	£74	1790	

Figure 3: Operational cost data

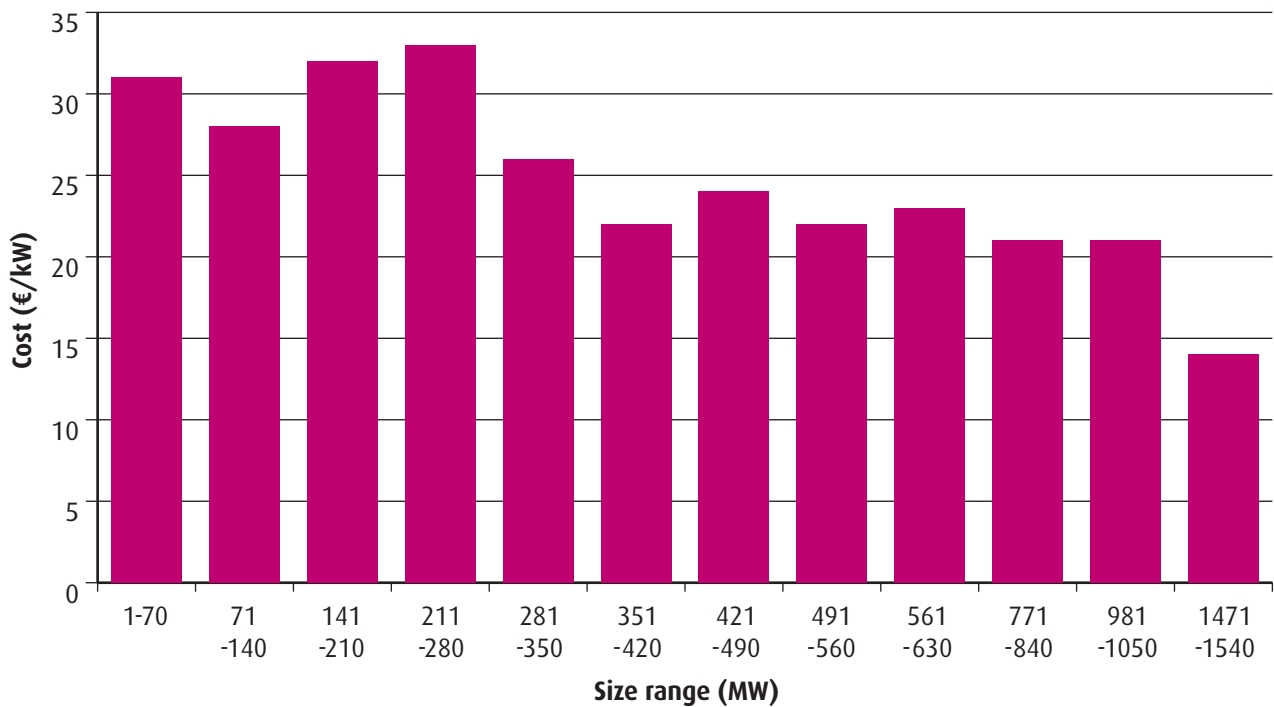

ⁱ Windpower Monthly (2004) except where noted

Energy productivity

Larger turbines means taller turbines – which means they intercept stronger winds. This further enhances their attractions as more energy is being squeezed out of each square metre of rotor area. Winds at 60m are around 4% higher than winds at 45m. This corresponds to around 7% more energy.

To illustrate this point, Figure 4 shows how energy yields vary with size of turbine. The wind speed at 10m is 5.5 m/s in every case, so the larger the turbine, the higher the wind speed seen at hub height. This accounts for the increasing energy productivity.

The calculation uses performance characteristics of actual machines, based on the version with a hub height equal to rotor diameter (or the nearest hub height available).

With higher winds, the use of higher generator ratings can be economically justified, since it

will be operating at rated output for longer periods. This also increases energy productivity. As diameters have increased - from 45 to 60 metres, for example - increased ratings have obtained around 10% more energy out of the airstream.

Differences with offshore wind

One advantage of offshore wind, in many locations – but not necessarily the UK – is that wind speeds are higher, leading to greater energy productivity. In the UK and Greece, however, there are good hilltop sites where higher wind speeds are found. Wind speeds on Scottish hilltop sites range up to 9 m/s, and above, whereas most of the offshore sites now being developed have wind speeds around 8.2 to 8.6 m/s. Offshore wind energy is still at a relatively early stage of development. There are wide variations in contract costs due to the nature of the seabed, the wind regime and the grid connection cost. Wind turbines are more expensive, as they need additional protection

Figure 4: Increases of yield with wind turbine size

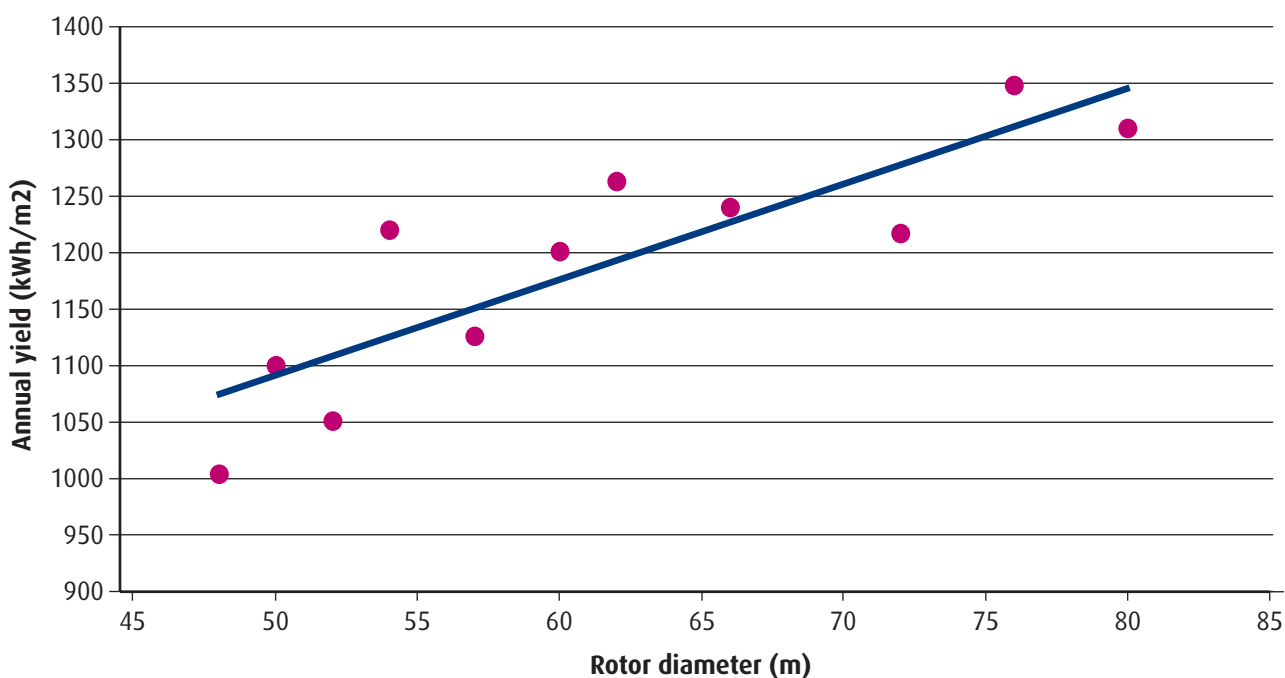

Annex B: Network integration and costs

against the salt spray. This takes various forms, including pressurised nacelles to ensure that electronic equipment is protected. The additional cost of the wind turbines is in the range 10-15%, but the foundations, installation costs and grid connection costs are usually significantly more expensive. The additional costs can almost double the turbine costs, bringing the total installed cost to €1400-1800/kW.

Wind generation costs

Electricity prices for wind energy depend on both technical and institutional factors. The influence of wind speed is easy to take into account, as the capacity factors of most medium and large size wind turbines follow similar trends.

Institutional factors are diverse and lead to wide variations in price. In Denmark, for example, 'public sector' interest rates and repayment periods tend to be used, whereas in the United States and the UK, where all projects are undertaken by the private sector, interest rates are higher and repayment periods shorter.

In the UK the discount rate set by the Treasury for public-sector projects was 6% until 2004. It was replaced by a 'social discount rate' of 3.5%, but the guidelines still demand that account is taken of risk and so a 6% rate may be more appropriate. Rates in the private sector are higher. Figure 6 therefore shows prices for an 8% discount rate and 15-year capital recovery periodⁱ. The 8% discount rate was used by OFFER to test the commercial viability of projects bidding into the Non-Fossil Fuel Obligation, and is probably the minimum likely to be used. It may not be unrealistic. If loan finance can be obtained at 5.5% (real) for 60% of project costs,

a return of 12% real on the equity could be achieved.

Figure 10 (p. 29) shows generation cost estimates for a range of wind speeds and installed costs. The choice of installed costs is based on an analysis of data from over 3300 MW of plant installed or announced in 2004⁵. Sample data are included in Table 1.

The costs used are:

- A low onshore cost of £560/kW- roughly one standard deviation below the mean
- A high onshore cost of £800/kW - roughly one standard deviation above the mean
- A low offshore cost of £1000/kW – corresponding to the early UK farm at Blyth and some Danish wind farms in shallow waters
- A high offshore cost of £1250/kW – corresponding to some of the highest prices in Table 1

As the windy sites – both onshore and offshore – tend to be more expensive to develop, the range of wind speeds corresponding to each cost figure have been restricted accordingly. The graph shows electricity prices, for an onshore project farm at £560/kW declining from around 5p/kWh at 6 m/s to about 2.9p/kWh at 8 m/s. At 8 m/s and £800/kW, the generation cost would be 4p/kWh, and at a very good site (9.75 m/s) the corresponding cost would be 3p/kWh.

Prices for offshore wind at £1000/kW range from 6.9p/kWh at 7 m/s down to 4.9p/kWh at 8.5 m/s. At £1250/kW, prices range from 6.7 m/s at 8 m/s down to 5.2p/kWh at 9.25 m/s.

ⁱⁱ In its document "Future Offshore" the DTI used a 10% discount rate and 20-year life, which gives almost exactly the same annual charge rate.

The effect of market support mechanisms

As wind energy is not yet quite competitive with the conventional sources of electricity generation, various 'market support' mechanisms operate. These compensate the renewable energy sources for having low external costs, as governments tend to shy away from imposing carbon taxes. (Many economists argue that carbon taxes, or cap and trade schemes such as 'domestic tradable quotas', are the desirable long-term solution). The support mechanisms can distort the price of wind energy: prices in Britain under the Non Fossil Fuel Obligation went as low as 2p/kWh but once the Renewables Obligation came into force, prices moved towards 7p/kWh, or above. This simply reflects scarcity in the early days of the Obligation. Similarly, it is argued that 'fixed-price' mechanisms tend to inhibit price reductions. A full discussion of the types of mechanisms and prices paid is included in a recent analysis⁶.

Capacity value

Few renewable energy topics generate more confusion and controversy than that of capacity values (or capacity credits). The British Wind Energy Association has defined the term⁷:

"The reduction, due to the introduction of wind energy conversion systems, in the capacity of conventional plant needed to provide reliable supplies of electricity."

The importance of capacity value is that economic assessments include a 'capacity displacement' term on the 'value' side of the equation. Once the capacity value has been determined, the value of the displaced capacity can be determined from a knowledge of the installed costs of the displaced plant and the relevant financing parameters.

Several studies of the impacts of wind have addressed the issue in more detail and their conclusions are succinctly summarised in a study carried out for the European Commission by the CEGB⁸:

"At low [energy] penetration the firm power that can be assigned to wind energy will vary in direct proportion with the expected output at time of system risk."

In practice, this statement is true for any energy source whether it is renewable or not. 'Firm power' is not the same as 'capacity value', but the two are linked. The reference plant today is usually combined-cycle gas turbine plant (CCGT), with a high availability – around 90% – so 360 MW of firm power corresponds to about 400 MW of CCGT plant.

Several studies have examined this issue and all have concluded that capacity credits at low wind energy penetrations in the UK are roughly equal to the 'winter quarter' capacity factors⁹. These clearly depend on the wind speed at particular sites, but are mostly in the range 36-42%. So 1000 MW of wind plant will displace around 400 MW of thermal plant.

As the amount of wind on a system increases the capacity credit (in fractional terms) declines and Figure 5 shows good agreement from three studies on the way it declines¹⁰. With 20% wind, for example, the capacity credit is about half the capacity factor, so if the latter was 36%, say, the capacity credit would be around 18% of the rated power of the wind plant. In practice, NGT has estimated that 8,000 MW of wind might displace about 3,000 MW of conventional plant and 25,000 MW of wind (20% penetration), would displace about 5,000 MW of such plant¹¹.

Figure 5: Capacity values from three UK studies

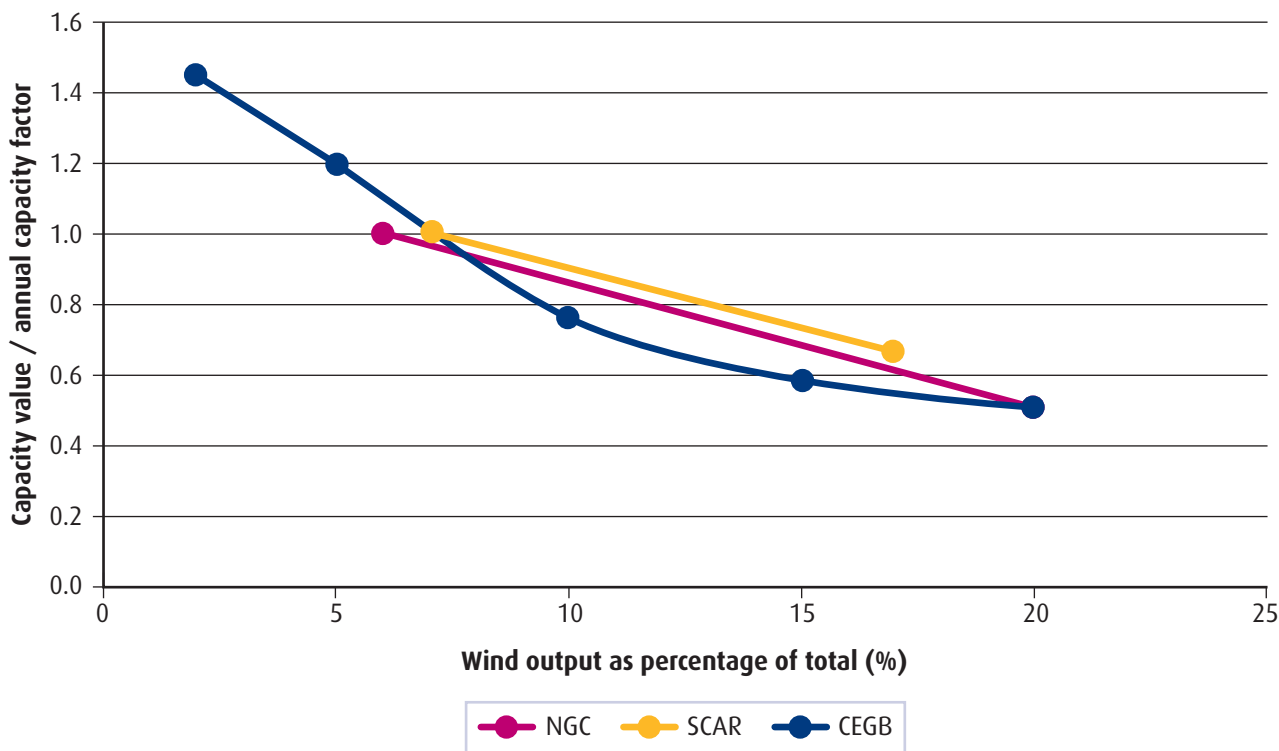

Note: Capacity values are shown divided by capacity factors to normalise the data, as different capacity factor assumptions have been used in each study.

Winter anticyclones

These, it is alleged, frequently becalm the whole country and cause problems for the system operator, due to the absence of any wind power, especially at periods of peak demand. The capacity credit, it is argued, is therefore zero. However, the Environmental Change Institute at the University of Oxford was quite clear when appearing before a House of Lords Select Committee¹²:

"We have looked at that [stationary anticyclones in the middle of winter over the British Isles] occurring in the wind data and the wind data does not show it."

Several authors, including National Wind Power, have also found that peak demand periods actually tend to coincide with above-average wind plant output¹³. The reason for this is that wind output will tend to be correlated to periods of high peak demand, as one of the key factors in determining the load on the electricity system is wind speed. Cold, windy days will lead to increased demand for heating.

Additional balancing costs

These costs also tend to be controversial, but a close examination of the evidence shows that there is actually a very good measure of agreement between several studies. Modest amounts of wind cause few problems (or costs) for system operators, as the extra uncertainty imposed on a system operator by wind energy

Annex B: Network integration and costs

is not equal to the uncertainty of the wind generation, but to the combined uncertainty of wind, demand and thermal generation.

The characteristics of most electricity systems tend to be similar, so estimates of the extra reserve needed to cope with wind energy are also similar. With wind supplying 10% of the electricity, estimates of the additional reserve capacity are in the range 3 to 6% of the rated capacity of wind plant. With 20% wind, the range is approximately 4 to 8%. Estimates of the 'additional costs of intermittency' are mostly close to National Grid's figures: accommodating 10% wind on the UK system would increase balancing costs by £40 million per annum (£2/MWh of wind), and 20% wind would increase those costs by around £200 million per annum (£3/MWh of wind). Estimates from other studies, including work by or for PacifiCorp, the Bonneville Power Authority and the Electric

Power Research Institute yield similar results, shown in Figure 6. With 5% wind, the extra costs are within the range \$1.7-3/MWh, and with 10% wind the range is \$3-5/MWh.

Plant margin and load factors

This is best addressed by looking at how wind capacity fits into the electricity system, using data relevant to the UK network in 2020¹⁴:

Peak demand (in 2020):	70 GW
Installed capacity:	84 GW
Plant margin:	20%
Total generation:	400,000 GWh
System load factor:	54%

When 26 GW of wind is installed on the system it will displace 5 GW of conventional generation (see above), so the installed capacity becomes:

$$\Rightarrow 84 \text{ GW} - 5 \text{ GW} + 26 \text{ GW} = \mathbf{105 \text{ GW}}$$

Figure 6: Estimates of additional balancing costs from six studies

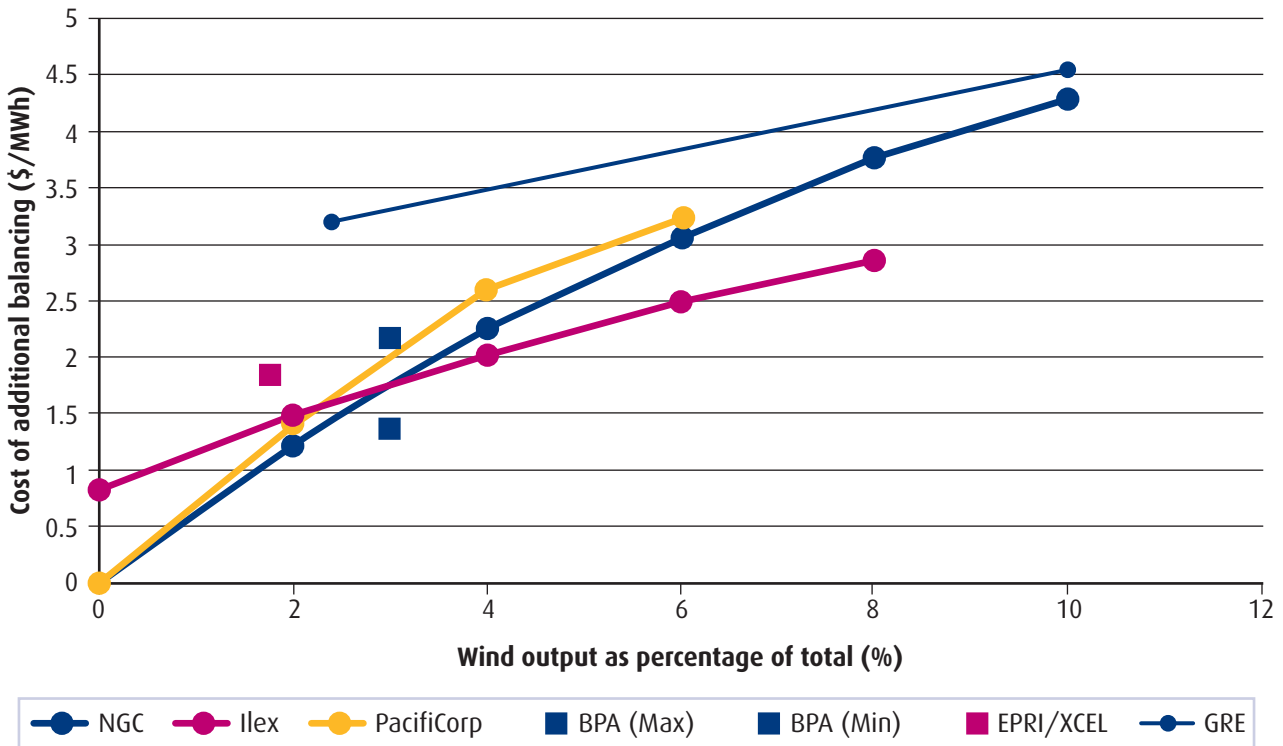

Annex B: Network integration and costs

So, the apparent plant margin is higher, at 50%. However, this arises simply because the load factor (capacity factor) of wind is lower than that of conventional plant and it is therefore debatable whether the apparent margin of 50% is very meaningful. In effect, 5 GW of conventional plant will have been retired (compared against a baseline scenario), so although the 26 GW of wind capacity will not have displaced an equal amount of conventional plant, it will have displaced some, and only a modest amount of additional thermal capacity will be required to cope with the additional variability of wind output. This additional reserve capacity is not the same as additional thermal plant, and is most likely to be provided by a small increase in the remaining plant (that which hasn't been displaced by the capacity value of wind) running in 'reserve mode' or an increase in the use of storage or demand management. In common with many of these issues, this represents a cost to wind rather than a serious constraint.

A side effect of adding 26 GW of wind is that the load factor of the remaining plant is depressed. The overall load factor was 54% before wind capacity was added. When 26 GW of wind capacity is included, the new load factor is calculated as follows:

$$\begin{aligned} & \text{(total generation - wind generation) / ((installed capacity-wind capacity value) x hours in year)} \\ \Rightarrow & (400,000 \text{ GWh} - 77,000 \text{ GWh}) / ((84 \text{ GW} - 5 \text{ GW}) \times 8,760 \text{ hours}) \\ \Rightarrow & 323,000 / 692,040 = \mathbf{47\%} \end{aligned}$$

As the load factor of the remaining conventional plant is now seven percentage points lower, this implies that the generation cost of this plant increases, as the annual capital repayments are spread over less output. This is another 'system cost' that results from adding substantial amounts of wind capacity and is also considered as part of system costs in Chapter 4.

It should be noted, however, that the introduction of any new plant into an electricity network tends to depress the load factor of the existing plant. If, instead of 26 GW of wind, 10 GW of new nuclear capacity were installed (which would generate the same amount of electricity if it operated with a 87.5% load factor), this would displace 8.75 GW of thermal plant. The load factor of the remaining gas plant would then be:

$$\begin{aligned} \Rightarrow & ((400,000 \text{ GWh} - 77,000 \text{ GWh}) / ((84 \text{ GW} - 8.75 \text{ GW}) \times 8,760 \text{ hours}) \\ \Rightarrow & 323,000 / 659,190 = \mathbf{49\%} \end{aligned}$$

Once again, the load factor has been reduced, although by a smaller amount. Strictly speaking therefore, the additional costs of operating a system with wind energy should not include the costs associated with reducing the load factor of the gas plant by 7% (54-47%), but by the additional load factor reduction, compared with the introduction of new conventional plant. With the numbers used above, this corresponds to a 2% reduction. The analysis in Chapter 4 implicitly factors in the additional costs associated with an 7% reduction, and is therefore likely to overestimate this cost element.

It should be emphasised that this additional reduction of the load factor of remaining plant only applies at high wind energy penetrations, when the capacity factor of the wind plant is greater than its

capacity value. At low wind energy penetrations (below about 6%), the capacity value is equal to or greater than the annual average capacity factor. In this case, the extra costs associated with the reduced load factor of the incumbent plant are similar to, or less than, those associated with introducing new thermal plant. No extra system costs are therefore due to wind.

A critique of the E.ON Netz study

A recent report from the German network operator E.ON Netz, 'Wind Year 2003 – an overview', appears to suggest that capacity values are much lower, and additional balancing costs much higher, than the figures quoted above. The report also highlights a low energy productivity of German wind. It claims that the utility needs reserve capacities amounting to 50-60% of the installed wind power capacity, and that the extra balancing costs (for 6% wind) were about €12/MWh of wind – over six times the estimates of Figure 6. On closer inspection, there appear to be several reasons why the numbers are quite different from the 'consensus' data discussed above.

Firstly, low wind speeds in Germany mean that the system operators will experience more fluctuations in wind output than in windier regions. To illustrate this point, assume that the average capacity factor across Germany is 15% and the corresponding capacity factor in Britain is close to its long-term average of about 30%. To generate 8.5 TWh of wind in Germany requires 6250 MW of wind plant, whereas only half that amount of plant would be required in Britain. The power swings from 6250 MW of German wind would therefore be higher than from 3125 MW of wind in Britain.

Secondly, it appears that some of the apparent difficulties the utility has with wind are more to do with administrative procedures and barriers; the network operators tend to operate

independently, so some of the benefits of an integrated network are lost.

Thirdly, plant commitments are made several hours ahead, and the extent to which schedules are revised nearer to 'real time' is not clear. The concept of a 'one hour gate closure', as in Great Britain, or revising a schedule up to one hour before production, appears not to be used.

It may also be noted that the report does not discuss the all-important question of the interaction between variations in consumer demand and variations in wind output.

Future costs

The wind industry has delivered impressive reductions in cost and productivity over the past twenty years. Energy generation prices, as a result, are now close to those of the fossil fuels.

Cost are expected to continue falling for three reasons:

- **Experience:** If wind energy capacity continues to double every three to four years, accompanied each time by a 15% reduction in wind turbine production costs, there will be a 20% reduction in installed costs by 2010. The consensus of the many studies is consistent with this simple analysis, as shown in Table 2.
- **Larger wind turbines:** The trend towards larger wind turbines shows no sign of abating, bringing with it reduced project costs from savings in foundations, transport and electrical connections – even though the wind turbines may be slightly more expensive per kilowatt of rated capacity.
- **Larger wind farms – especially offshore:** The trend towards larger wind farms brings savings in the construction phase, in project management, more efficient utilisation of heavy lifting equipment and, not least, in grid

Annex B: Network integration and costs

connection costs. Increases in project size do not lead to a proportional increase in grid costs, which depend on the length of new lines required and the costs of transformers and switchgear. A number of detailed analyses of future trends in wind energy costs have been carried out recently. Some have based their projections on 'learning curve theory,' looking at the way costs have fallen with increased production; others have looked at the engineering aspects of both wind turbines and wind farms.

Data in Table 2 suggests installed costs onshore will drop by between 11% and 23% by 2010 compared with 2003, giving a range of estimates for onshore installed costs in 2010 between €770-870/kW (£530-600/kW). The corresponding range for 2020 is around £450-620/kW, setting aside the EWEA study, which appears rather low.

Offshore costs are expected to fall somewhat faster as the industry gains more experience in this sector. By 2010, the studies suggest that offshore project costs will be down by 27% to 37%, giving a range of around £700-800/kW. By 2020, they may fall further to around £600-700/kW.

Generation costs are expected to fall a little faster as the larger machines capture higher wind speeds.

Although there is some uncertainty over future costs, it may be noted that the price of electricity from wind plant is effectively fixed once the plant is constructed (setting aside interest rate variations). By contrast, the future prices of fossil fuels are very uncertain and can cause the price of electricity to change after the plant is constructed (unless long-term fuel contracts can be secured, which is unlikely in the present climate). Future prices of gas are extremely uncertain and it is suggested that the premium

Table 2: Estimates of future wind costs

(In the second and third columns, costs are expressed as ratios, so Forum for the Future suggests that 2010 costs onshore will be 77% of 2001 costs.)

Source	2010 cost, 2020 cost (€/kW)	(2010 cost) / (2001 cost)	(2020 cost) / (2001 cost)	Notes
EWEA ¹⁵	451,363			Installed costs onshore
Forum for the Future ¹⁶		0.77	0.70	Installed cost onshore
		0.63	0.58	Installed cost offshore
Report for US DoE ¹⁷	-,443-590		0.69-0.92	Installed costs onshore
UK, PIU ¹⁸			Down to ~0.6	Generation costs onshore
			Down to ~0.4	Generation costs offshore
UK, DTI ¹⁹		0.5-0.7		Generation costs offshore
Garrad Hassan ²⁰		0.89	0.81	Installed cost onshore, ref 2003
		0.73	0.57	Installed cost offshore, ref 2003
Australian study ²¹		0.63	0.55	Generation costs onshore

Annex B: Network integration and costs

needed to "guarantee" fixed gas prices over a 10-year period is around 0.5 USc/kWh. so the emphasis in the short term may well be on coal.²²

The uncertainty over future fossil fuel prices and the continuing downward trend in wind energy prices means that the outlook for wind energy is bright. Wind is already competitive with gas and coal on the higher wind speed sites and this advantage is likely to be strengthened in the future. By 2010 – possibly earlier – the installation of wind energy may well result in lower costs to electricity consumers compared with the continued exploitation of the fossil energy sources.

Fault ride-through considerations

The characteristics of the synchronous generators used in large conventional thermal and hydro units enable the plant to contribute to the provision of system support services (e.g. dynamic voltage and frequency regulation) that are necessary for the stable operation of the system. Wind turbines use different generator technology and, at the moment, do not provide a similar range of support services to the system. At relatively low levels of wind energy penetration this can be tolerated. However, operating the system with large amounts of such plant would pose major challenges in terms of sustaining system integrity.

Hence, the GB Transmission Network Operators have recently set out a proposal that specifies requirements for connecting wind generation equipment to the transmission network. These proposals are described in the Grid Code consultation document.²³ Similar Grid Code modifications have been made in a number of other countries with high penetrations of wind energy^{24/25}.

The main capabilities required of wind farms in the proposed GB Grid Code modifications are:

1. Reactive power capability
2. Active voltage control
3. Restricted maximum ramp rates
4. Operation over an extended frequency range
5. Frequency control capability
6. Power System Stabiliser function
7. Fault ride-through capability

Because of the requirement to provide damping in their mechanical drive trains, wind turbines cannot use directly connected synchronous generators such as are universally used in large conventional power generating units.²⁶ Fixed speed wind turbines use directly connected induction generators while variable speed wind turbines use power electronic converters to connect the fixed frequency of the power system to the variable frequency of the generators. This variable frequency performance is achieved using either the so-called Doubly Fed Induction Generators (DFIG) or generators fed through two fully rated power electronic converters. Traditionally smaller wind turbines (up to around 1 MW) have used fixed speed induction generators with larger wind turbines using DFIG technology. However, in the future there is likely to be an increasing move to fully rated power converters.

The requirements of the new GB Grid Codes cannot be met by fixed speed induction generator wind turbines without additional equipment to provide fast control of reactive power (i.e. Static Var Compensators – SVCs or STATCOMs). It is believed that DFIG and fully rated converter designs can, in principle, meet these requirements but at some additional cost. Following consultation with manufactures, NGC estimated the additional cost of meeting the GB Grid Code requirements as

Annex B: Network integration and costs

being between 1.4%-6% of turbine capital cost. However, such information is commercially confidential and difficult to verify. The proposed Grid Code modifications are still under consideration by Ofgem and so far evidence of compliance by operating wind farms with all the Grid Code provisions has not been published in the open literature.

A particular concern of Transmission Network Operators is the ability of generators to remain stable and connected to the network when faults occur on the transmission network. This is known as fault ride-through capability.

Faults are inevitable on any electrical system and can be due to natural causes (e.g. lightning), equipment failure or third party damage. With relatively low transmission circuit impedances, such fault conditions can cause a large transient voltage depression across wide network areas. Conventional large synchronous generators are expected to trip only if a permanent fault occurs on the circuit to which they are directly connected. Other generators that are connected to adjacent healthy circuits should remain connected and stable after the faulted circuits are disconnected. At present, the GB transmission system is operated to withstand a maximum sudden loss of 1320 MW (i.e. two 660 MW generators).

However, if generation connected to healthy circuits does not remain connected and stable during and after the fault, this generation will be lost in addition to that disconnected by the original fault. Clearly, in this case the power system would be exposed to a loss of generation greater than the current maximum with the consequent danger of the system

frequency dropping too rapidly and load shedding becoming necessary.

A number of studies²⁷ have been carried out to determine the depth of the propagation of voltage depressions for various fault locations and generation scheduling patterns.ⁱⁱⁱ These have then been used to demonstrate the risk to the system of connecting wind turbines which are not adequately robust and which, while connected to healthy circuits, will trip for remote faults.

In summary, if the wind generation to be connected is not able to ride through faults in a similar manner to conventional synchronous plant, the power system would be exposed to a loss of generation greater than the current credible maximum. In this context, the proposed Grid Code update to incorporate wind generation is based on the fundamental requirement that the maximum largest loss of generation should not exceed 1320 MW. This effectively requires that wind generation must remain connected and be able to ride through faults on the transmission network.

Similar fault ride-through requirements are specified in most countries with large numbers of wind turbines including Germany, the world's largest wind turbine market. Unfortunately, the detailed requirements of voltage level and duration of the fault often differ from country to country and there is a clear need for harmonisation, if the operational requirements of the individual power systems allow this. However, given the universal requirement by Transmission System Operators for fault ride-through capability, it is likely that this will be provided as a standard feature of large wind turbines in the future.

ⁱⁱⁱ A factor to be considered is the amount of wind generation connected, as this may have an impact on the actual level of transient voltage at the terminals of the generator due to voltage difference between the fault and the wind farm.

References

- 1 Grevensberg. *Verlag Naturliche Energie*. Windkraft Journal.
- 2 Bergey, K H (1991). *Windfarm strategies: the economies of scale revisited*. Proc Windpower '91, Palm Springs, 24-27 September. American Wind Energy Association.
- 3 European Wind Energy Association (2004). *Wind Energy – the facts*.
- 4 Kassel (2004). *Wind Energy report. Annual evaluation*. ISET.
- 5 Milborrow, D J (2005). *Goodbye gas and squaring up to coal*. Windpower Monthly, 21, No 1, (Jan).
- 6 Harrison, L and Milborrow, D J (2002). *In the absence of a carbon tax*. Windpower Monthly, 18, No 4, (April).
- 7 British Wind Energy Association (1982). *Wind energy for the eighties*. Peter Peregrinus Ltd, Stevenage.
- 8 Holt, JS, Milborrow, DJ and Thorpe, A (1990). *Assessment of the impact of wind energy on the CEGB system. Report for the European Commission*.
- 9 Milborrow, D (1996). *Capacity credits – clarifying the issues*. British Wind Energy Association, 18th Annual Conference, Exeter. Mechanical Engineering Publications Ltd, London.
- 10 Carbon Trust & DTI (2004). *“Renewables Network Impact Study” Annex 4: Intermittency Literature Survey & Roadmap*.
- 11 National Grid Transco (2003). *Evidence to: House of Lords, Science and Technology Committee, 4th report, Session 2003-04. Renewable Energy: Practicalities*. HL paper 126-II.
- 12 Sinden, G (2004). *Oral evidence to: House of Lord Science and Technology Committee. Renewable Energy: Practicalities*. HL paper 126-II.
- 13 Warren, J G, Hannah, P, Hoskin, R E, Lindley, D and Musgrove, P J 1(1995). *Performance of wind farms in complex terrain. Proc 17th BWEA Wind Energy Conf*. Warwick, MEP Ltd.
- 14 Dale et al. (2003). *Total cost estimates for large-scale wind scenarios in UK*. Energy Policy 32, pp. 1949-1956.
- 15 European Wind Energy Association (EWEA) (undated 2001 or 2002). *Wind force 12: A blueprint to achieve 12% of the world's electricity from windpower by 2020*.
- 16 Ekins, P (2001). *The UK's transition to a low-carbon economy*. Forum for the Future.
- 17 Osborn, J et al. (2001). *A sensitivity analysis of the treatment of wind energy in the AEO99 version of NEMS*. University of California/National Renewable Energy Laboratory, LBNL-44070.
- 18 UK Cabinet Office (2002). *Performance and Innovation Unit*. The Energy Review.
- 19 DTI (2002). *Future offshore. A strategic framework for the offshore wind industry*.
- 20 Garrad Hassan and Partners (2003). *OFFSHORE WIND: Economies of scale, engineering resource and load factors*. Dept of Trade and Industry / Carbon Trust.
- 21 Mallon, K and Reardon, J (2004). *Cost Convergence of Wind Power and Conventional Generation in Australia*. Report for the Australian Wind Energy Association by Transition Institute P/L.
- 22 Bolinger, M, Wiser, R and Golove, W (2002). *Quantifying the value that wind power provides as a hedge against volatile natural gas prices*. Proc Windpower 2002. American Wind Energy Association.
- 23 National Grid Company plc, Scottish Hydro-Electric Transmission Ltd, Sp Transmission Ltd (2004). *Background to proposed changes to England & Wales and Scottish Grid Codes Connection Conditions to Incorporate Non-synchronous Generation Technologies*. Supporting Paper for NGC Consultation H/04 and SHETL & SPT consultation SA/2004, 23 June 2004.
- 24 EoN Netz (2003). *Grid Code for extra-high and high voltage*.
- 25 ELTRA (2000). *Specifications for connecting wind farms to the transmissions network*. ELT1999-411a, April 2000.
- 26 Jenkins, N., Allan, R., Crossley, P., Kirschen, K., Strbac, G. (2002). *Embedded Generation*. IEE, London.

References

- 27 National Grid Company plc, Scottish Hydro-Electric Transmission Ltd, Sp Transmission Ltd, *Background to proposed changes to England & Wales and Scottish Grid Codes Connection Conditions to Incorporate Non-synchronous Generation Technologies*, Supporting Paper for: NGC Consultation H/04 and SHETL & SPT consultation SA/2004, 23 June 2004; Integrating Renewables and CHP into the UK Electricity System, Tyndall Centre for Climate Change Research Project TC/IT 1.30; *An Investigation of the Impact of Renewables and CHP on the GB Central Generating System*, X. Wu, N. Jenkins, G. Strbac, The Manchester Centre for Electrical Energy, UMIST, 2003

Annex C

Aviation and communication

Types of radar

Primary surveillance radar (PSR) usually consists of an antenna constantly rotating through 360° round the horizon, sending out pulses of electromagnetic energy that reflect off any object in their path. The reflected energy travels back to the radar antenna where the angle from which the reflection was received and the time taken for the pulse to travel out and back are translated into bearing and range from the radar and displayed on a controller's screen.

Secondary surveillance radar (SSR) sends out pulses from a constantly rotating antenna (often installed on top of a PSR antenna) but in the case of SSR these are interrogation signals that trigger responses from transponder equipment in aircraft. The response includes a four-digit code (set by the pilot) which identifies the aircraft, together with the height of the aircraft. (The height derived by SSR is electrically generated and is not always a true and accurate reflection of the actual height of the aircraft). This information is then displayed on the radar display next to the radar 'blip'. The main differences between PSR and SSR are:

- a) PSR will detect any reflecting object, whereas SSR will only display returns from aircraft with their transponders switched on.
- b) PSR cannot determine the height of an object; in most cases SSR can. The only exception to this is air defence radars, which are 3D, and can determine the height of an object using PSR only.

Effects on PSR

Signal processing is employed in PSR so that objects which are not moving (such as hills, buildings and trees) or are moving at speeds much slower than aircraft (such as ships and

road traffic) are not displayed on the screen. This is called Moving Target Indication (MTI) processing. However wind turbines present a particular problem. They remain in one location, but their blades are turning with tip speeds as high as 150 knots – similar to aircraft speeds. So normal MTI processing cannot eliminate radar returns from wind turbines and the turbines are likely to appear on radar. Controllers have to address:

- Lack of a reliable means of telling whether a primary radar return from the wind farm area is a turbine or an aircraft. This may require the controller to assume the return is an aircraft, and to ensure that the aircraft to which he is providing a service avoid this unknown return.
- The radar returns from the wind turbines may obscure genuine returns from aircraft flying over the wind farm. This could lead to uncertainty that the radar can detect all non-cooperating aircraft in that area.
- The wind turbines may create a radar 'shadow' behind them, within which the radar's ability to detect aircraft may be reduced.

Radar is capable of seeing some way beyond the horizon compared to the visual line of sight. This is because a radar beam refracts, or bends, to some extent towards the earth as it travels through the atmosphere. Radars may be able to detect high-flying aircraft up to 200 nautical miles (370km) away. Objects at lower altitudes, such as wind turbines, may be capable of detection 100km away or more, particularly if the radar and the wind farm are located on prominent hilltops.

There are three uses for primary radar in aviation – each of these has particular requirements and specific issues in terms of the potential impact of wind turbines.

Effects on SSR

Because SSR operates on the basis of transmissions both from the radar to the aircraft and from the aircraft back to the radar, the returned signal is much stronger than in the case of PSR. It is therefore much less vulnerable to interference from wind turbines. Beam distortion, caused by scattering of the signal by the wind turbines and leading to target position errors or false interrogations, is another effect.

Studies in the Netherlands, Ireland and the UK have found that wind turbine effects on SSR are negligible for a wind farm located 5km or more from an SSR station. NATS En Route, which operates SSR at all of its radar stations (repeated) is also notable that the impacts of wind turbines on SSR have been found to be generated by the turbine towers, not the rotating turbine blades. In this respect the impact of wind turbines on SSR is no different in form to that of other tall structures such as chimneys or high buildings.¹

ATC around airfields

Most military airfields and commercial airports are equipped with PSR, which is used by controllers to guide aircraft after take-off, to guide incoming aircraft to the runway, and to maintain separation for aircraft operating in the vicinity of the airfield.

For these radar systems, a wind development located beneath the departure track or the final approach track, or in an area where aircraft are frequently routed (vectored), may create particular problems for controllers. Aircraft vectored across the wind farm area may not be distinguishable from the radar returns produced by the wind turbines. Depending on the level of radar service being provided, aircraft may have to be vectored away from the radar returns produced by the wind turbines.

This can result in aircraft having to fly longer distances, inability to maintain the standard separations between aircraft and, in severe cases, may preclude the provision of a radar service altogether.

These difficulties are most likely to occur when the wind farm is located in uncontrolled airspace, that is, airspace where any aircraft may fly without obtaining permission from or maintaining contact with any ATC agency. This is because in this type of airspace it is more likely that an unknown primary radar return – for example from a wind turbine – could be a real aircraft, and therefore may require radar controllers to vector aircraft around it. Most military airfields and the smaller civil airports and airfields are in uncontrolled airspace.

Airport radars typically provide services out to a range of approximately 40nm (74km) but any impacts from wind farms are likely to be limited to projects within a significantly closer range. Statutory safeguarding arrangements are in place around most commercial airports. Most of these require pre-planning consultation for any wind farm proposal within 30km. However, objections from airport operators may be encountered at greater ranges when the wind farm is in a key area of ATC operational interest. In addition, because responsibility for civil airport safeguarding has been transferred from the central regulatory authority, the CAA, to individual airports, policy and practice on wind farms can vary significantly from one airport to another.

En route ATC

Control of aircraft in the en route phase of flight is carried out by controllers employed by National Air Traffic Services (NATS), based at four centres at Swanwick, West Drayton, Manchester and Prestwick. In addition, en route controllers provide radar services to military aircraft, often

Annex C: Aviation and communication

in uncontrolled airspace, where the impact of unidentified primary radar returns from wind turbines is more significant.

En route radars may be able to detect wind turbines 120km or more away from the radar head. The resulting areas within which wind energy projects may be restricted are very large. Projects in the north of England, southern Scotland and eastern Wales are particularly vulnerable due to the location of three key hilltop radar stations in these areas. NATS has had difficulty in achieving timely handling of the volume of pre-planning notifications of wind farm projects and in late 2004 introduced a new procedure whereby developers are encouraged to consult web-based maps of NATS areas of concern to determine whether a NATS objection is likely. In relation to some en route radar, the maps show areas of interest extending to as much as 100nm (185km) from the radar station.

This may be because the wind farm is located wholly within controlled airspace, or is in an area of relatively low traffic density, or because there is overlapping radar cover from another radar which is not capable of illuminating the wind farm.

Air defence radar

Air defence radars employ both primary (PSR) and secondary surveillance radar (SSR) in the same way as ATC radars, but air defence radars generally have more sophisticated tracking ability and their primary radars are also able to determine the height of a target without SSR information.

Since September 11th 2001 the Ministry of Defence has become more concerned about the impact on the air defence radar system of spurious radar returns from wind turbines and has adopted a policy of raising concerns about any wind farm within line of sight of an air

defence radar head. The air defence authorities require reliable coverage of the low level airspace over both land and sea, so overhead obscuration, induced tracking anomalies and shadow effects are currently of most concern to the air defence community.

However, as experience has been gained, some projects within direct line of sight of the radars have been approved following re-assessment of their specific impact, taking into account any existing wind farms in that sector of the radar's coverage, the importance of the area for air defence, the solidity and reliability of the radar's cover in that area, and whether there is overlapping radar cover from another radar which is not capable of illuminating the wind farm.

Mitigation measures

Operational measures

Increasing controlled airspace can significantly reduce the impact of wind turbines on radar. This is because all aircraft require air traffic control permission to enter controlled airspace. By definition, primary-only radar returns from locations inside controlled airspace where there are no known aircraft can be assumed by controllers not to be aircraft. There may still be concerns, however, about the cumulative impact of multiple wind farms and about the effects of primary radar clutter from wind farms on the ability to track aircraft across the wind farm area. It is also important to note that controlled airspace is not established in order to mitigate the impact of wind farms; it can only be instigated when justified by the levels and types of air traffic. It is typically applied around airports with significant levels of commercial air transport flights.

Avoiding areas of significant air traffic control interest for wind farms within an airport's radar coverage. Typically, avoiding the final approach

Annex C: Aviation and communication

and departure areas for the main runways is essential. In addition, some airports will have air traffic flows biased in particular directions (at airports in Scotland and Northern Ireland, for example, most commercial traffic is to/from the south and south east); wind farms located away from those flight paths will have more chance of avoiding aviation objections.

Introduction of Mode S secondary surveillance radar – a new form of SSR which is being progressively introduced across Europe. The ultimate plan is for all aircraft to be required to carry and operate a Mode S transponder for all flights in all types of UK airspace from 31 March 2008. This proposal is subject to consultation with the UK aviation industry commencing in 2005. Mode S offers the prospect of a significant change in the impact of wind turbines on air traffic radar services. This is because, at present, many aircraft, mainly light aircraft, gliders, microlights and other recreational aviation, fly without a transponder. These aircraft appear as primary-only returns on radar and, due to their small size and construction materials, even their primary radar return may only appear intermittently. Because any primary radar return could be one of these categories of aircraft, controllers providing a service in uncontrolled airspace currently must assume that any primary-only return is an aircraft. If all aircraft from 31 March 2008 must legally be transmitting a Mode S transponder identity, this offers the prospect of a change in regulatory policy on the action to be taken by controllers when they see a primary-only return on their radar screen. If a primary-only return cannot be an aircraft flying legally, these returns could be assumed not to be aircraft. This would bring to an end the need for controllers to vector aircraft around primary radar returns generated by wind turbines. No proposals on changes to the policy on treatment of primary-only radar returns in a mandatory Mode S

environment have yet been put forward by the CAA.

Limiting the radar service in uncontrolled airspace is an option open to controllers providing a service to aircraft in uncontrolled airspace. This is frequently used by controllers when clutter, whether generated by weather, road traffic, wind turbines or other sources, is present on the radar screen. Although a fully-approved and routinely-used procedure, it does constitute a degradation of the radar service offered.

Technical measures

Range-azimuth gate mapping (RAG mapping) is a technique routinely applied in primary radars which identifies particular elements of the radar's coverage within which returns are suppressed. It is often used to eliminate clutter caused by road traffic and buildings. It has potential for use in eliminating wind turbine returns but has the major disadvantage that it also suppresses returns from any aircraft crossing that area, thereby creating a hole in the radar cover and degrading the service provided to pilots.

Temporal threshold processing sets the radar's sensitivity in particular parts of its coverage according to the amplitude of the signal received from that area. This reduces the radar's sensitivity when particular 'cells' are producing high levels of clutter. This process is quite effective in removing shifting clutter returns from the radar screen. However, if a desired target within the area has a weaker return than the clutter, or if it stays within the area for several antenna sweeps (as for example a hovering or slow-moving helicopter might), the clutter threshold will eliminate that genuine target as well as the clutter.

Annex C: Aviation and communication

Clutter maps deal with clutter by storing the location and other characteristics of clutter in a memory circuit, which is then accessed on each sweep to remove that clutter from the signal. Some radars have numerical limits on the number of cells which can be used for clutter mapping or RAG techniques. This may limit the applicability to multiple wind farms.

Track processing analyses radar returns and rejects any consecutive returns which do not conform to pre-set criteria for a moving aircraft. UK radar manufacturer AMS is currently trialling equipment known as ADT which uses a novel approach to track processing which it is hoped will eliminate wind turbine returns and also gain approval from the CAA.

Placing antennae at an elevation that raises the radar beam above the wind farm. In some cases it may be possible to eliminate wind turbine returns from radars where the antenna elevation above the horizontal raises the radar beam above the wind farm. The radar antenna at Belfast Airport, for example, is raised to avoid clutter from local high ground, which has resulted in it avoiding returns from the nearest wind farm. However it is unlikely that raising of an antenna specifically to avoid wind turbine returns would be acceptable in most cases since it would cause reduced coverage of low level airspace.

Optimised antenna design for low elevation sidelobes, **adjusting the tilt** of the transmitted and received beams to minimise the number of unwanted returns in the lowest elevation beam, **changes to signal processing** to reduce the pre and post-compression limiting and **desensitising the background averager** are as yet unproven and yet to be implemented. Ongoing trials and the DTI-funded AMS Feasibility Study which should be published in June 2005 aim to specifically identify and

evaluate technical software and hardware mitigation techniques which will then be assessed by the MOD.

Radio navigation aids

Aeronautical radio navigation aids – beacons to assist aircraft in determining their location – are also potentially vulnerable to interference from wind turbines. Most aeronautical radio navigation aids in the UK are operated by NATS. All NATS technical sites have statutory consultation status for wind farm and other developments in close proximity. For all types of beacon – VOR, NDB, DME – the safeguarding zone for proposed wind energy developments is a 10km radius around the facility.

Although there is some evidence from elsewhere in Europe that safeguarding zones around radio navigation aids are smaller than in the UK, there is no evidence of UK safeguarding policies around these types of facility restricting wind farm development.

Television interference

Broadcast transmissions and the fixed radio links are vulnerable to multi-path effects in the same way as any radio. Television pictures and sound are fed to the transmitters by a network of fixed radio links, the higher capacity ones operating at microwave frequencies (3-30 GHz) while the re-broadcast links (RBLs) from main to local transmitters operate in the lower capacity UHF band (0.3-3 GHz).

Three way split of responsibility

Responsibility for maintaining the quality of television signals across the UK is split geographically between the BBC and what used to be known as the Independent Television Commission (ITC), now integrated into the Office of Communications (Ofcom). Responsibility for the integrity of the supporting network of

Annex C: Aviation and communication

transmission links is correspondingly split between two companies – Crown Castle International (CCI) and NTL.

Because wind farms are usually situated in relatively sparsely populated areas, the numbers of people affected are usually small. There is now extensive experience in the industry of wind farm developers entering into planning agreements to fund studies of TV reception quality and any mitigation required. This can take the form of installation of more sensitive receiver antennae for individual subscribers; moving antennae to receive from a different source transmitter; or installing a local community re-broadcast facility.

The fixed microwave and UHF transmission network can present more widespread issues for wind energy developments. These travel in straight lines between two fixed transmitter/receiver points. Vulnerability to multi-path effects is determined by the frequency of the signal and the length of the link path. The lower the frequency and the longer the link, the more risk there is of multi-path effects. Consequently, long-distance links at UHF frequencies require much larger clearance zones than short microwave links.

In 2002 the Radiocommunications Agency – now part of Ofcom – produced a methodology for calculating the minimum separation distance between a radio link and a wind turbine, using as its basis the concept of the Fresnel Zone². As an example, the Ofcom formula calculates that a 20km long microwave link at 7 GHz would require a clearance of 21 metres between the centre of the link path and any part of a wind turbine at the midpoint of the link, but a smaller clearance towards either end. At 2 GHz, however, the same link would require 39 metres clearance.

As can be seen from the example above, the Ofcom recommended clearances are relatively small, and would permit constructing a wind farm directly in the path of a microwave link if the turbines were placed to avoid the calculated Fresnel Zone.

The consultation process for potential wind farm impacts on television is well-established but because of the split responsibilities between the BBC, two parts of Ofcom, Crown Castle and NTL, it lacks integration. Ofcom licenses most fixed radio links in the UK and this covers some of the television transmission network. However they are not responsible for UHF RBLs. It is therefore necessary to consult all four television bodies plus the fixed link department of Ofcom to obtain an assessment of the likely impact of a wind farm proposal on television. There is also uncertainty derived from differences in policy on the response to consultations. Some of the television consultee organisations will provide preliminary pre-planning assessments which enable developers to assess project risk at an early stage. Others provide no response until after a planning application is submitted.

Ofcom recommendations not always followed

The problem, however, is that the telecommunications industry, including television broadcasters, have not generally taken up the Ofcom recommendations. This is because of a number of uncertainties about the precise effects of wind turbines on radio links, notably:

- The potential for more complex multi-path effects to occur in multiple-turbine wind farms
- A belief that the Ofcom formula is a theoretical minimum and that engineering practice ought to build in a 'buffer' to take account of uncertainties

Annex C: Aviation and communication

- In many cases, lack of precision in the location data for transmitter and receiver sites, leading to large buffer zones around radio links to account for inaccuracy

UHF re-broadcast links

For UHF re-broadcast links (RBLs) carrying the TV signal from main to local transmitters, the problem is of a larger magnitude. Unlike a microwave signal, whose beam is very narrow, the transmitted UHF signal takes the form of a wide cone. The receiver is capable of picking up very low signal strengths at the other end, but because of the wider area over which the signal is transmitted, it is more prone to multi-path effects. The vulnerability is greatest when the reflecting object is close to the receiver end of the link both in distance and in angle.

Experience in the TV industry has been that if the angle between the RBL receiver to transmitter path and the receiver to wind farm path is less than 15°, effects are likely and there are no feasible mitigation measures other than moving the RBL receiver mast to a new location or installing a new microwave link which 'doglegs' around the wind farm. At angles greater than 15° there is some potential for mitigation measures such as installing a more directional receiving antenna at the RBL receiver station. At angles greater than 60° there should be no effects on TV signal quality.³ Industry experience has also found that no effects should be expected when the wind farm is 10km or more away from the RBL receiver.

The difficulty for wind farm developers is that, if a project falls within the 15° zone from an RBL receiver, mitigation is expensive. A new microwave link, or the relocation of the RBL receiver, is likely to cost several hundred thousand pounds, and may delay the project considerably while engineering planning, site selection, land purchases and further impact assessments are carried out.

Potential constraints on wind energy development from television RBLs are also exacerbated by topographical realities. RBLs are most prominent in hilly areas because this is where the main transmitter signal cannot reach subscribers, mostly located in valleys. RBLs therefore frequently cross areas of good wind resource.

Technological trends

Technological trends are changing the telecommunications environment. As the demand for greater and greater telecommunications capacity grows, there is a move away from older systems operating at lower frequencies towards higher frequencies. This benefits wind energy development since higher frequency systems do not require such large obstacle-free zones around their paths. Many communications networks are moving away from fixed terrestrial radio links completely, to other technologies such as satellite and fibre-optic cable. There is also a trend from analogue to digital systems – again a positive trend for wind energy because digital radio is generally more robust in terms of its susceptibility to interference. The developing 3G mobile phone network may generate additional constraints on wind energy projects, but this is not because of the potential impact on signals to/from mobile phones themselves. It is because 3G technology requires more base stations than existing mobile phone systems. This will mean more fixed radio links to/from base stations.

Fixed radio links

Most of these links are at microwave frequencies (3-30 GHz). The Ofcom-recommended wind turbine clearance zones around microwave links are relatively narrow. However most microwave link operators have not taken up the Ofcom recommendations for the same reasons as outlined above.

The consultation process for wind farm developers investigating potential impacts on fixed microwave links is even more fragmented than for the television industry. The first point of contact is Ofcom's fixed links department. However Ofcom's database is not comprehensive. Several significant operators, including BT, the CAA and the MOD, are not covered, and the pace of development by mobile phone companies in particular can mean that many new links take some time to enter the Ofcom database. A response of 'no known links' from Ofcom therefore cannot be taken as definitive and it is necessary to contact all individual operators direct. This is compounded by the complexity of contractual arrangements in the industry. A microwave link may be built by one company, operated by another, to carry services for a third. The locus of responsibility for system integrity and performance is sometimes hard to decipher in these cases.

The existence of a scientifically-determined basis, developed by a government agency, for calculating recommended clearance zones between radio links and wind turbines is a valuable asset for both industries. Industry confidence in its accuracy and dependability will grow as experience of co-existence of radio links and wind farms develops. In the meantime, experience has shown that the willingness of wind power developers to address some of the telecommunications industry uncertainties can ease the process of project approval. Re-surveys to more accurate standards of the transmitter and receiver locations on a microwave link have the potential to reduce the required clearance zone around a link by an order of magnitude.

Scanning telemetry systems

The precise required clearances around the link path for scanning telemetry systems (used primarily by the water and power industries) are unclear and are at the discretion of the telemetry system operator. Some operators have taken Ofcom's consultation trigger distance (1km from a scanning telemetry station) as a required avoidance zone.

The consultation process for scanning telemetry systems is also complex. Ofcom has no remit for and no data on these systems and responsibility for their integrity and performance is held by agency bodies under contract to the system owners. However, these agencies may not hold complete information on the locations of telemetry links and stations. This is compounded by industry reluctance to release such information, apparently on security grounds.

Wind industry experience has shown that willingness to respect confidentiality, combined with the sharing of examples of successful co-existence of wind farms and a variety of telecommunications systems, can ease the process of consultation with telemetry system operators.

FURTHER INFORMATION

In addition to the references cited in the text above, further information is also available from the sources below:

1. A. Knill (2002). Potential Effects of Wind Turbines on Navigational Systems. Available at: <http://www.bwea.com/aviation/Potential-Effects-of-Wind-Turbines-on-Navigational-Systems.pdf>
 2. Summers, E. (2001). The Operational Effects of Wind Farm Developments on ATC Procedures for Glasgow Prestwick International Airport'. Glasgow Prestwick International Airport. Available at: <http://www.bwea.com/aviation/Operational-Effects-of-Wind-Farm-Developments-on-ATC-Procedures-for-Glasgow-Prestwick-International-Airport.pdf>
 3. Summers, E. (2002). Wind Turbines and Aviation Interests - European Experience and Practice. ETSU W/14/00624/REP, DTI PUB URN No. 03/515. Available at: <http://www.bwea.com/aviation/European-Experience-and-Practice.pdf>
 4. DTI/MOD/CAA/BWEA (2002). Wind Energy and Aviation Interests: Interim Guidelines. Available at: <http://www.dti.gov.uk/energy/renewables/publications/pdfs/windwnergyaviation.pdf>
 5. QinetiQ (2003). Wind Farms Impact On Radar Aviation Interests - Final Report. FES W/14/00614/00/REP, DTI PUB URN 03/1294. Available at: <http://www.dti.gov.uk/energy/renewables/publications/W1400614.shtml>
 6. Alenia Marconi Systems Ltd (2003). Feasibility Of Mitigating The Effects Of Windfarms On Primary Radar. ETSU W/14/00623/REP, DTI PUB URN No. 03/976. Available at: <http://www.dti.gov.uk/energy/renewables/publications/w00623.shtml>
-
- 1 Spaven Consulting (2001). *Wind Turbines and Radar: Operational Experience and Mitigation Measures*. Available at: <http://www.bwea.com/aviation/Wind-Turbines-and-Radar-Operational-Experience-and-Mitigation-Measures.pdf>
 - 2 Bacon, D.F. (2002), *A proposed method for establishing an exclusion zone around a terrestrial fixed radio link outside of which a wind turbine will cause negligible degradation of the radio link performance*, Version 1.1, Radiocommunications Agency. Available at: <http://www.ofcom.org.uk/radiocomms/ifi/licensing/classes/fixed/Windfarms/windfarmdavidbacon.pdf>
 - 3 RA/BBC/ITC (1992). *Environmental Impact: Effect of wind farms on UHF television reception*. Engineering Information Bulletin, June 1992.

Annex D

Noise

How noise is measured

Sound is always associated with small scale change in pressure, which produces sensations (i.e. is 'heard') at the human ear. Because of the wide range of sound pressures to which the ear responds, sound pressure is an inconvenient quantity to use in graphs and tables and so noise is measured on a logarithmic scale in decibels (dB). The decibel is a measure of the sound pressure level, i.e. the magnitude of the pressure variations in the air.

A change in sound level of 1 dB cannot be perceived, except under laboratory conditions. Doubling the actual energy of a sound source or doubling the number of identical sound sources corresponds to a 3 dB increase. A 3 dB change in sound level is considered a barely discernible difference, outside the laboratory.

The noise that a machine such as a wind turbine creates is normally expressed in terms of its sound power level. Although this is described in dB(A), it is not a measurement of the noise level but of the power emitted by the machine, which then creates the sound pressure level which can be heard and measured using a sound meter.

Sources of wind turbine noise

Standing next to a wind turbine, it is usually possible to hear a noise often described as a whoosh or a swish as the blades rotate. The whirr of the gearbox and generator may also be audible, depending on the type of turbine.

There are plenty of detailed reviews of the sources and noise generation processes of wind farm noise¹, but in general, the sources of noise emitted from operating wind turbines can be divided into two categories, mechanical and aerodynamic.

Mechanical noise

Mechanical noise is transmitted along the structure of the turbine and is radiated from its surface. The hub, rotor, and tower can all act as loudspeakers, transmitting the mechanical noise and radiating it. Because it is associated with turning machinery, this noise can be heard at a distinct constant frequency, described as 'tonal'.

Aerodynamic noise

The biggest contributor to the total sound power from a turbine is the aerodynamic noise which is produced by the flow of air over the blades. The proportion of noise from each source is typical of modern wind turbines. A large number of complex flow phenomena occur which can generate aerodynamic noise. There is much ongoing research into these phenomena.

Broadband noise is often caused by the interaction of wind turbine blades with atmospheric turbulence, and is also described as the characteristic 'swishing' or 'whooshing' sound of wind turbines. Airfoil noise also includes the noise generated by the air flow right along the surface of the airfoil. This type of noise is typically of a broadband nature, but tonal components may occur due to blunt trailing edges, or flow over slits and holes.

Low frequency noise

Low frequency noise, with frequencies in the range of 20-100 Hz, is mostly associated with 'downwind turbines', with the rotor on the downwind side of the tower. It is caused when the turbine blade encounters localised flow deficiencies due to the flow around a tower. When a rotating blade encounters this, pulses of low frequency noise are generated. Turbines that have their rotors upstream of the tower, except in very rare circumstances, do not generate such pulses since there is nothing blocking the flow upwind of the rotor. When it does occur, because of the low rotational rates

of modern turbine blades, the peak acoustic energy radiated by large wind turbines is in the infrasonic range with a peak in the 8-12 Hz range.

Infrasound is generally defined as low frequency noise below the normal range of human hearing. A recent review of wind turbine data indicates that wind turbines with an upwind motor generate very faint infrasound with a level far below the threshold of perception². This paper concludes that infrasound from upwind turbines can be ignored in the evaluation of the environmental effects of wind turbines.

The levels of infrasound radiated by the largest wind turbines are very low in comparison to other sources of acoustic energy in this frequency range such as sonic booms, shock waves from explosions and large industrial sources. The danger of hearing damage from wind turbine low-frequency emissions is remote to non-existent. It has also been stated that the peak infrasound level from a large wind turbine system is well below the discomfort level associated with low frequency noise³.

Typically, except very near the source, people out of doors cannot detect the presence of low-frequency noise from a wind turbine.

Impulsive/beating noise

The audibility of these periodic audible swishes have recently been linked to stable atmospheric conditions (so are less likely to be heard during the day, during heavy cloud, during strong wind, and in a flat landscape) and also to the possibility of the heightening of these effects due to the partial synchronising of these pulses from several turbines in a wind farm⁴. Turbines that have their rotors upstream of the tower such as those in the UK, except in very rare circumstances, do not generate impulses.

Noise and wind turbine operation

Wind turbines do not operate below the wind speed referred to as the cut-in speed, usually around 3-4 metres per second. Wind data from typical sites in the UK suggests that wind speeds are usually below this for about 20-30% of the time, during which noise is not generated.

Large, variable speed wind turbines often rotate at slower speeds in low winds, increasing in higher winds until the limiting rotor speed is reached. The newest turbine designs include systems to change the rotor speed as the wind changes, and with variable speed control it is possible to programme the turbine sound levels before installation, so the operation of the turbine is micro-managed for the specific characteristics of the chosen location.

Reduction of noise with distance

In order to predict the sound pressure level at a distance from a known sound power level, the method of sound wave propagation must be known. In general, as noise propagates without obstruction from a point source, the sound pressure level decreases. The initial energy in the noise is distributed over a larger and larger area as the distance from the source increases.

Generally, sound attenuates at 6dB per doubling of distance. In all cases, at twice the distance, the area through which the sound energy passes increases by a factor of four and the pressure fluctuations reduce by a factor of two, resulting in a 6dB reduction.

For sound propagation in the real world, one of the key points with these additional attenuation factors is that they are generally dependant on the frequency of the sound⁵. For example, low frequency components of sound will be absorbed less readily by the atmosphere and are less readily blocked by barriers⁶.

As a typical example of sound propagation, depending of the size of the turbine, at one rotor diameter distance from the base of a wind turbine emitting 100 dB(A) the sound level is usually about 55-60 dB(A). At four rotor diameters away it will be 44 dB(A), corresponding to a quiet living room in a house, and at six rotor diameters away it will be approximately 40 dB(A).

Noise reduction methods

Turbines can be designed or retrofitted to minimise mechanical noise. Examples include the helical gearing of gearwheels to reduce the noise level of the gearbox, and mounting the generator, gearing and other components in such a way that vibrations are damped and are not transferred.

Recent improvements in mechanical design of large wind turbines have also resulted in significantly reduced mechanical noise in the form of pure tones. Thus the noise emission from modern wind turbines is dominated by broadband aerodynamic noise⁷. Efforts to reduce aerodynamic noise have included the use of lower tip speed ratios, lower blade angles of attack, upwind turbine designs, variable speed operation and most recently, the use of specially modified blade trailing edges¹. Advanced blade production techniques have included innovations such as reducing sensitivity to roughness on the leading edge of the blade, and maintaining a good geometrical relationship between one airfoil thickness and the next.

Defining an acceptable level of noise

As stated before, the response of a person to noise is very subjective. Because of the wide variation in the levels of individual tolerance for noise, there is no perfect way to measure the subjective effects of noise or of the corresponding reactions or annoyance and

dissatisfaction. For this reason, targets and criteria are usually set to provide broad protection for a community and the amenity of an area.

Standard UK practice is to define a framework which can be used to measure and rate the noise from wind turbines and to provide indicative noise levels thought to offer a reasonable degree of protection to wind farm neighbours and to encourage best practice in turbine design and wind farm siting and layout.

The potential noise impact is usually assessed by predicting the noise which will be produced when the wind is blowing from the turbines towards the houses. This is then compared to the background noise which already exists in the area, without the wind farm operating.

The World Health Organisation's (WHO) publication 'Guidelines for Community Noise' states that general daytime outdoor noise levels of less than 55 dB LAeq are desirable to prevent any serious community annoyance and that internal levels of 30 dB LAeq are desirable to prevent sleep disturbance at night⁸.

National planning policy (PPG 24 'Planning and Noise') and accepted methods for rating likelihood of complaint (BS 4142:1997) are all taken into account in a report produced by the Wind Turbine Noise Working Group⁹, established by the DTI, which recommends ways to assess and rate wind turbine noise.

This states that turbine noise level should be kept to within 5 dB(A) of the average existing evening or night-time background noise level. This is in line with standard practice for assessment of most sources of noise except for transportation and some mineral extraction and construction sites when higher levels are usually permitted. A fixed lower value for these limits of between 35 and 40 dB(A) is also specified when

Annex D: Noise

background noise is very low, namely less than 30 dB(A).

Defining background noise

Because of the importance of the background in determining the acceptability of the noise levels it is crucial to measure the background ambient noise levels for all the wind conditions in which the wind turbine will be operating.

Assessment of background noise levels at potentially sensitive locations requires the measurement of noise levels for a range of wind speeds measured at the proposed site of the wind turbines. This compensates for any difference of wind speeds between the wind turbine site and the sensitive site which may be sheltered from the wind. Assessment of background noise levels is especially important at the cut-in wind speed of the turbines, since the background noise levels are likely to be low in these circumstances.

Defining a source level for wind turbines

Much of the interest in wind turbine noise is focused on the noise anticipated from proposed wind turbine installations, based on the information which is provided by manufacturers. Wind turbines are too big to test for noise levels in a special acoustic test chamber. It is therefore necessary to deduce the noise source power by indirect means. Measurement of the source sound power level is made according to procedures set out in several standards designed to ensure consistent and comparable measurements. These include the IEC 61400-11 standard which is used in Europe. In order to calculate noise levels heard at different distances, the reference sound levels need to be determined. This is the acoustic power being radiated, and is not the actual sound level heard.

Predicting levels at houses

As described previously, sound propagation is a function of many factors. There are accepted practices for modelling sound propagation which take all these factors into account and there is a variety of propagation models in current usage.

The least complex propagation models, which simply address sound wave dispersion and make conservative assumptions about other factors, are primarily used by wind farm developers to help optimise their proposed layouts. In this way, the proposed location of wind turbines which are contributing heavily to combined noise levels at house can be moved. In general, the models which are used assume downwind propagation, i.e. that there is a slight wind blowing from the turbines to the modelled houses.

Prediction methods are constantly revised and reviewed in light of research and experience, looking at issues such as the fact that the source of the noise generation is increasing as turbines increase in height, with consequent impacts on propagation and wind effects.

Compare predicted levels with criteria

In the UK, the current practice controlling wind farm noise is by the application of noise limits at the nearest noise sensitive properties. The emphasis is on developers to demonstrate compliance with these limits prior to the construction of the wind farms. Thus in the UK, planning assessments normally provide an indication of the ability of candidate turbines to meet noise limits since it is not always possible to quote the basic sound power level of new and proposed wind turbines to a relevant degree of accuracy. In this way the onus is on the developer to comply with the noise limits imposed by the planning authority for a permitted wind farm site.

FURTHER INFORMATION

In addition to the references cited in the text above, further information is also available from the sources below:

1. Hubbard, H. and Shepherd, K. (1990). *Wind Turbine Acoustics*. NASA Technical Paper 3057 DOE/NASA/20320-77.
2. IEC (International Electrotechnical Commission). IEC 61400-11: *Wind turbine generator systems – Part 11: Acoustic noise measurement techniques*. Document No. 88/141/CDV.
3. Leventhall (2003). *A review of published research on low frequency noise and its effects*. A report for Defra. Available at: <http://www.defra.gov.uk/environment/noise/lowfrequency/pdf/lowfreqnoise.pdf>
4. National Wind Coordinating Committee(1998). *Permitting of Wind Energy Facilities: A Handbook*. RESOLVE, Washington D. C.
5. Rogers and Manwell (2004). *Wind Turbine Noise Issues – White Paper*. Renewable Energy Research Laboratory, University of Massachusetts.

- 1 Wagner, S., Bareib, R. and Guidati, G. (1996). *Wind Turbine Noise*. Springer, Berlin.
- 2 Jakobsen, J. (2004). *Infrasound Emission from Wind turbines*. Proceedings from Low Frequency 2004, 11th International meeting on low frequency noise and vibration and its control. Information available at: <http://www.multi-science.co.uk/lf2004-pro.htm>
- 3 Shpilrain, E. (2001). *Environmental Aspects of RES Utilization For Distributed Power*. Proceedings from Distributed Power Problems, Opportunities And Challenges. Information available at: http://www.worldenergy.org/wec-geis/news_events/member_news/miec/aspects.asp
- 4 Van de Berg, G. (2004). *Do wind turbines produce significant low frequency sound levels*. Proceedings from Low Frequency 2004, 11th International meeting on low frequency noise and vibration and its control. Information available at: <http://www.multi-science.co.uk/lf2004-pro.htm>
- 5 Beranek, L. and Ver, I. (1992). *Noise and Vibration Control Engineering: Principles and Applications*. Wiley, New York.
- 6 ISO (1996). 9613-2: *Acoustics – attenuation of sound during propagation outdoors*. International Organization for Standardization, Geneva.
- 7 Fégeant, O. (1999). *On the Masking of Wind Turbine Noise by Ambient Noise*. Proceedings from European Wind Energy Conference, Nice, France, March 1-5, 1999.
- 8 WHO (2000). *Guidelines for Community Noise*. World Health Organisation, Geneva. Available at: <http://www.who.int/docstore/peh/noise/guidelines2.html>
- 9 ETSU (1996). *ETSU R97: The Assessment & Rating of Noise from Wind Farms*. Available at: <http://www.dti.gov.uk/energy/renewables/publications/noiseassessment.shtml>

Annex E

Birds and Wildlife

Habitats

The majority of onshore wind farms are based in upland areas, with upland moorland being most common vegetation type. There has recently been a move by renewable energy developers to try to site wind farms largely within commercial forestry plantations in upland areas. From an ecological perspective this is a positive use of land which has already been changed and has less ecological and nature conservation value. Tree cutting around turbines and access tracks and the overall use of the land for this purpose will not usually result in significant habitat change. It is often possible to encourage greater habitat diversity such as forest edge enhancement and habitat regeneration in the surrounding area by removing larger areas of afforestation and enhancing surrounding habitats such as drained bog, as part of such development.

Wind farms planned for and sited on native upland habitats do result in habitat change and loss. Whether this is significant in nature conservation terms really depends on the habitats involved and their relative importance. It is difficult to generalise with such habitat loss, since it depends on the particular location, habitat types and the past management. Overall, a wind farm development that largely resulted in the loss of species-poor rush pasture would have less ecological impact than one which resulted in the loss (direct and indirect) of patterned blanket bog.ⁱ

Habitat loss comes from the turbine bases, plus the necessary access tracks and borrow pitsⁱⁱ/quarries in wind farm development. The

latter is often much more in total area than the amount of land required for turbines. Access tracks to the site and the turbine bases need substantial volumes of stone which tends to be sourced locally, resulting in further habitat loss through opening up areas for stone quarries. Connection of the turbines to a substation and the National Grid can also lead to further habitat loss. The precise impact on habitat of the grid connection depends on the terrain and the method of connection, e.g. underground cable, wooden pole line or pylon line. Generally, above ground connection causes less habitat damage than underground connection, unless underground connections can be routed under existing tracks and roads or in low value habitats. Wind farms are often regarded as temporary structures. In some habitats this is true as they can and will recover fairly rapidly on decommissioning. Not all habitat loss is necessarily permanent and with the correct location and construction methods even the impacts of access tracks can be minimised by allowing for removal when the wind farm is decommissioned. This can achieve longer-term habitat recovery. With careful construction habitats can be created or returned above turbine bases and on construction compounds during the life of the wind farm, and the mitigation provided for habitat loss can provide benefits for the future management of surrounding habitats. This all depends on location and careful 'micro-siting' of the elements involved because even the provision of various compensation habitats will not always replace what is lost. Sensitive habitats that take a long-time to develop such as pristine bogs and ancient semi-natural woodland are hard to replicate. There are also other issues related to

ⁱ Active blanket bog (i.e. blanket bog which still has the peat building species present in sufficient quantity to assume that peat is still being created) is a habitat which is important at a European level and requires formal protection (priority European habitat type).

ⁱⁱ A borrow pit is a traditional name for a small quarry, often in the side of a small hill next to a track that stone is removed from to allow the track to be constructed.

impacts on habitats which need careful consideration during wind farm planning. Two of the most important issues for upland habitats are the potential effects on the water regime of peat bodies underlying peatland habitats and the potential for instability in peat bodies to result in the downslope mass movement of peat, often called a peat slide. The key to avoiding deleterious effects on peat bodies is consideration of the wind farm location, scheme design and environmentally sensitive construction methods.

Indirect habitat loss through pollution and construction disturbance can also occur as a result of careless construction practice. This can happen with wind farm construction as it can with most large-scale construction projects. It is totally preventable with the correct planning controls and environmental supervision. During wind farm planning and construction the protection of watercourses is extremely important since pollution of upland streams travels rapidly downstream and affects habitat quality outside the wind farm. The prevention of such pollution is also particularly important for protected species which may be present in watercourses, some of which – Atlantic salmon, for example – are particularly sensitive to pollution.

Birds

The British Isles as an internationally important refuge for birds

The islands which make up Britain are strongly influenced by the sea. There is over 11,000km of coastline and nowhere is more than 115km from the seaside. Some 120 estuaries drain into the shallow waters of the seas around Britain. The warming effect of the North Atlantic Drift ensures that, for the most part, these estuaries do not freeze in winter.

Britain has an international responsibility for a number of important bird populations associated with our marine and estuarine habitats. Vast colonies of seabirds breed around our coast line, for example 330,000 pairs of Manx Shearwaters breed in Britain and Ireland representing 90% of the world population.¹ Its estuaries support huge numbers of wildfowl and wading birds that either migrate along the east Atlantic flyway or stay throughout their non-breeding season. The British and Irish coastlines are home to some 3 million wading birds in the winter months.² Important numbers of wildfowl include 84% of the world population of Greenland White-fronted Geese that winter in the British Isles and all of the 14,000 Barnacle Geese that breed on the high Arctic island of Spitsbergen and spend their winter in the Solway Firth¹.

The peat and heather moors of Britain are home to internationally important numbers of breeding Dunlin, Golden Plover and Greenshank¹ and the world population of Red Grouse³. Parts of the Scottish Western Isles are the last refuge in Britain of the rare and globally threatened Corncrake¹. The UK's only endemic species, the Scottish Crossbill, is found in a few remnant pockets of the ancient Caledonian pine forest in Scotland⁴.

Climate change and the threat to birdlife

Global warming is already affecting birds in Britain, for example Swallows are now migrating to Britain on average one week earlier than they did 30 years ago⁵. Other species are breeding significantly earlier and it is expected that many will get out of step with the food resources needed to feed their young⁶.

The current accelerated global climate change is the greatest long-term threat to wildlife worldwide⁷. The rapid and significant temperature changes that are occurring today will directly affect the wildlife habitats that are

Annex E: Birds and wildlife

being conserved, by changing the conditions for the plants that they support. This will greatly modify these habitats and the animal communities that live within them.

Prior to human impacts on the world, most wildlife was able to accommodate changes in global temperature because the changes were slow and the wildlife able to migrate to a climate that best suited them. Today such migrations are impossible. In Britain 80% of the countryside is put to agricultural use added to which there are the built environments of cities, industrial sites and road networks all of which provide a barrier to wildlife migration⁸. Professor Sir John Lawton, Chief Executive of the Natural Environment Research Council, described this critical problem of wildlife fragmentation as 'islandisation'. Islandisation within the current context of rapid global warming will inevitably lead to a mass extinction of wildlife⁷.

As the seas warm, water expansion and land ice melts will mean the continued inexorable rise in sea levels. This is causing 'coastal squeeze' where the inter-tidal habitats that support internationally important populations of wildfowl and wading birds are being lost between the rising low water mark and coastal sea defences⁹. It has been calculated that by 2080, if global warming continues at its present rate, the sea level around Britain will have risen between 26 and 86cm¹⁰. The impact on birds that use inter-tidal habitats is self evident. This would, for example, result in an 11% loss of the East Anglian population of breeding Ringed Plover¹¹.

The salt marshes, which form between the strand lines of the mean and spring tides, are particularly vulnerable to coastal squeeze and are home to 86% of the breeding Redshank in England⁹. Between 1986 and 1993, 44% of the

Essex salt marshes had already been lost in this way⁹.

The high mountain tops in Scotland are inhabited by a number of rare breeding birds that are restricted to these zones. Among these specialist birds are Ptarmigan, Dotterel and Snow Bunting. The habitats that support them are temperature sensitive and an annual average rise of just 3°C would destroy them completely¹². Global warming, if left unabated, will render all three species extinct as British breeding birds by the end of this century.

The impact of wind farms on birds

Wind farms cause problems for birds in six ways:

- Birds may have fatal collisions with turbines.
- The land that the development takes up by way of roads, turbine bases and the like removes habitat for birds.
- Some birds simply do not like living within or next to wind farms and are therefore displaced.
- During the construction and decommissioning of wind farms birds may suffer considerable disturbance.
- Wind farms may act as barriers to bird movements where they are unwilling to fly around or over them. Short increases in flight around a wind farm may be inconsequential but the cumulative effect on energy expenditure could be a cause for concern.
- Any of the above in themselves may be tolerable to birds but in combination through deaths and/or displacement and/or disturbance may bring populations under threat.

No one likes to see bird populations harmed but more often than not the impacts from wind farms are actually negligible and in the sense of combating global warming these problems can

Annex E: Birds and wildlife

represent an acceptable trade-off. Clearly there are some areas in which, if wind farms were constructed, such as in the middle of a seabird colony or the breeding territory of an endangered species, then unacceptable impacts on birds would be wrought by wind farm developments.

In order to adequately assess the impacts on birds of proposed wind farms Scottish National Heritage (SNH) has developed a robust and objective guidance system for the assessment of impacts on birds by proposed wind farms – this guidance is currently being revised. In some cases the predicted impacts on birds have been the primary reason for a site being rejected during the planning process¹³.

The purpose of this approach is to allow developers and conservation organisations to be able to work together to:

- Ensure that a wind farm development does not occur in an inappropriate place where important bird populations will be adversely affected.
- Ensure that insignificant bird issues do not inhibit wind farm developments.
- Identify where enhancements can be achieved for birds through appropriate mitigation measures¹³.
- Ensure that adequate baseline information is obtained to minimise uncertainties and enable planning applications to be determined on an informed basis.

The SNH system provides a phased approach to the assessment of risk to birds. The first phase involves an initial desk-based study and on-site assessment which provides the baseline bird data. Occasionally the baseline information is sufficient to demonstrate that there are no

significant negative impacts on birds and no further work is necessary.

Where species of conservation concern are identified as being potentially at risk a programme of bird monitoring and survey work appropriate to the bird interest of the site is developed, forming the second phase of the system. Integral to this is an assessment of the risk of collision of all species of conservation concern with the wind turbines, an assessment of the sensitivity of the site in the context of nature conservation and its magnitude of impact on significant bird populations.

Where an assessment predicts that there is a risk of significant adverse effects then the third phase of the impact assessment explores measures to mitigate the problem such as the relocation of turbines or the options for habitat improvement or creation outside the development envelope. The relevant ornithological chapter in the Environmental Statements that accompany all planning applications for wind farms are drawn up from the results of this programme of systematic study. The Council of Europe through its convention on the conservation of European wildlife, the Bern Convention, has also published guidance on environmental assessment criteria and site selection issues relating to wind farms¹⁴.

Wind farms and bird behaviour

The overriding reason why birds are at risk from wind farms is that they do not, or cannot, always alter their behaviour to accommodate them. For example soaring species, which need rising winds to get off the ground, may be particularly affected by turbines situated on ridges used by these birds for lift, close to their roosts^{15/iii}. It is not known whether habituation occurs over time.

iii The Griffon Vulture is one example, although this species is not found in the UK.

Annex E: Birds and wildlife

Bird behaviour in relation to wind farms can be conveniently divided into two main areas:

- (1) the ways in which flying birds negotiate wind farms and
- (2) their tolerance to wind farm structures whilst feeding, roosting or breeding.

Flying birds

Birds are at risk when attempting to pass through the rotor plane. Natural behaviours and ecological relationships of birds contribute to their inherent sensitivity to wind turbines. Since each bird species exhibits unique suites of behaviours, geographical distributions, and ecological relationships, each also possesses unique sensitivities to wind farms. This sensitivity is estimated by measuring and comparing behaviours that could cause individual species to collide with wind turbines should these behaviours continue unaltered after wind turbines become operational.

Birds try to pass through the rotor plane because they simply cannot see rotating turbine blades or if they see them they either do not recognise them as hazards or are unable to avoid them. In the case of birds of prey it may be because their vision is fixed on the prey that they are pursuing beyond the blades¹⁶. Raptors identify a prey item and continuously observe it until they capture it. If the raptor's target is located behind the rotating blades of a turbine, then the raptor may not see the blades or may see them when it is too late to avoid them. The relative effects of peripheral vision versus fixed focus on prey items remains unknown, as does the degree to which these two factors might interact¹⁷. However, it is important to note that birds other than birds of prey also fatally collide with wind turbines.

The vast majority of bird flights through wind farms result in the individuals successfully

negotiating a route through the wind farm structures, presumably with little difficulty. In studies, collision rates were typically in range of 1 in 1,000-10,000 bird flights through the wind farm¹³. In some cases collision rates are considerably lower, such as at the offshore wind farm at Utgrunden, where over 500,000 eider flights through the wind farm study area have been observed without a single collision being recorded¹⁸. Studies using radar tracking have helped to provide further information on the general ability of birds to avoid collisions. Studies in the Netherlands, for example, showed that nocturnally flying Pochard and Tufted Duck flew regularly through a wind farm under moonlit conditions but flew around the turbines at greater distance from them when it was dark or foggy¹⁹.

Collision rates often need to be interpreted with caution as they can be quoted as averages without an indication of the range of values from which the average has been calculated. There can be substantial variation between different turbines, crucially depending on their location with respect to the main bird flight routes. Nonetheless, there is general consensus that collisions tend to be low frequency events, although the relative impact may be higher for certain species (eg. rare, long-lived birds) than for others.

Bird tolerance to wind farms

It has been shown through various studies that some birds will tolerate wind farm developments and behave very much as before the wind farm was constructed. For example:

- In Orkney there were no differences in the numbers of breeding pairs of ducks, waders, Arctic Skuas, gulls and small birds as a result of the wind farm being developed¹⁹.
- At a site close to the Wadden Sea in the Netherlands there were no effects on

Annex E: Birds and wildlife

breeding Oystercatchers, Lapwings, Black-tailed Godwits or Redshank from the wind farm²⁰.

- In a study at Ovenden Moor wind farm in the Yorkshire Pennines the number of breeding Golden Plover actually increased over a five year period within the wind farm area in contrast to a control site where numbers remained constant.
- At Bryn Titli in mid-Wales, a study showed that Ravens successfully nested within 60m of a wind turbine²¹.

It should be noted that wind farm developments and turbine size so far have been relatively small, and that much larger developments are likely to come forward as the industry matures. This may make it difficult to draw conclusions from these studies for very large projects and more research may be required.

The major potential impact of wind farms on birds is displacement from the development area caused by the removal of habitat, caution shown toward physical structures or the effects of disturbance through human activity or rotor noise or motion. In Denmark, the feeding distribution of wintering Pink-Footed Geese around wind farms was studied in detail²². Birds kept about 100m away from single or rows of turbines, and 200m from clusters of turbines. Other structures in the local landscape such as hedgerows, roads and buildings, had similar effects.

Variable results have been found for other species of goose. On spring staging grounds in Gotland, Barnacle Geese fed as close as 25m to wind turbines²³. A study of the same population on the wintering grounds in Germany, however, found almost no geese feeding within 350m of wind turbines and partial displacement up to 600m. The different distribution of the food

resources at each site may well be an explanation for this variation. That is to say that if birds are hungry and the distribution of available food reserves is in close proximity to wind turbines then birds are less likely to be displaced than if food is more abundant and widespread. It seems that displacement is highly variable and is species and site specific.

There remains a dearth of studies into the displacement effects on birds of the onshore wind farms in upland Britain and the scientific knowledge is therefore scant. There is generally more evidence of displacement of birds around wind farms occurring in coastal habitats. Most of the examples of such disturbance relate to waterfowl, over distances of up to 800m in wintering birds and 300m in the breeding season.

Mitigation and compensation measures

There are a number of ways in which the impacts of wind farm development on birds can be mitigated. There are a range of options which are not always appropriate to all sites but planners are able to review the detail with which developers have considered the mitigation measures for birds within their proposals from knowledge of these options.

Constraints planning

Phase 2 of bird monitoring programmes for proposed wind farm developments takes a minimum of a year and reviews bird activities throughout the site across all seasons to take into account breeding, migrating and wintering birds. Throughout there is an iterative process between the ornithologists undertaking the surveys and the developers. Important elements of those iterations are to review the findings of the studies with the wind farm plans. Careful consideration can then be given to such issues as turbine layout before any planning application is lodged.

Annex E: Birds and wildlife

In many cases it has been discovered that there are preferred bird flight paths through a proposed site. Examples of these include breeding birds moving between the nest and feeding sites,^{iv} wintering wildfowl that are moving between a roost and feeding locations^v and ridges favoured by soaring or hunting birds of prey.^{vi} In other cases important breeding sites that were not previously known about have been found.^{vii} Importantly, these findings by ornithologists have been able to significantly influence the wind farm plans and in some instances turbine locations have been moved or turbines have been completely removed from the overall scheme to avoid these sensitive areas.

Construction mitigation

Environmental responsibilities should be taken very seriously during the construction of wind farms. It is common for developers to employ a site ecologist and on sites where there are bird sensitivities a site ornithologist may be employed to support the site ecologist during the construction process. Such is the case, for example, at Farr and Hadyard wind farm developments in Scotland. This would represent good practice and should be encouraged.

The impacts on birds during the construction phase are most acute during the breeding season and come from the potential disturbance to, and destruction of, nests. In the first instance, development should be timed to avoid the breeding season where possible. In developments that have to go ahead within a

breeding season, ground nesting birds are often dissuaded from attempting to breed by removing the surface vegetation within the 'footprint'²⁴. However, this may be particularly disruptive to certain species, such as breeding waders, which are long-lived and often highly site-faithful. When deemed necessary other physical exclusion techniques are also employed to prevent nest building and breeding attempts and include the use of tapes and flags. During and after construction the number of fences and guy wires should be kept to a minimum, particularly where species of grouse are known to be present as it has been shown that these are one of the major causes of mortality in such birds which fly low, fast and straight with limited manoeuvrability.²⁵

Habitat improvements

While constraints planning can help to mitigate the problems for birds from wind farms, developments may also offer opportunities to compensate or even improve habitats through habitat improvement work outside the development areas. Developers and planners have a responsibility to look at the potential for such options within all wind farm proposals.

The Beinn an Turic wind farm in Argyll and Bute – extensive mitigation plans were put in place to enhance 14,000Ha of upland moorland for breeding birds. Within the plans 500Ha of biologically unproductive Sitka Spruce plantation were felled. The general habitat improvements by far outweighed any habitat lost due to the development itself. It is possible to manipulate

^{iv} A site in Caithness, Scotland, where it was discovered that Red-Throated Divers were commuting from their breeding lochans to feed at sea through a proposed wind farm site.

^v A site in Caithness, Scotland, where it was discovered that a flock of Whooper Swans were commuting through a proposed wind farm site from a roosting loch to day time feeding in fields.

^{vi} A site in the Monadhliath Mountains, Scotland, where it was discovered that Red Kites were using a particular gully to get uplift.

^{vii} A site on Lewis, Scotland, where it was discovered that Eagles were nesting.

Annex E: Birds and wildlife

habitats outside wind farms so that they hold greater numbers of prey species than are actually within the wind farm itself. For example small rodents can easily be encouraged, or discouraged, according to how grassland is managed. Through this manipulation certain birds of prey can be passively relocated away from the hazards of the wind farm development. This aspect of management was thoroughly studied at Altamont Pass in the United States.²⁶

Hadyard Hill in Lanarkshire – plans are being put in place to enhance an area for Black Grouse, a UK Biodiversity Action Plan species. 10Ha of mixed deciduous open woodland are being planted in open grassy moorland, 15Ha of moorland are being converted into wet flush areas by the introduction of simple plastic piling dams and 25Ha of mature commercial pine forest are being felled and restocked to incorporate open areas and edges planted with deciduous trees. Such habitat improvements are becoming more commonplace in wind farm developments and make a positive contribution to the conservation of our wildlife as a whole.

Wind turbine location, placement, design and operation

Careful consideration of the location and layout of wind farms, the design of the associated structures, and regard for turbine operation will significantly mitigate the impacts of wind farms on birds.

Lessons learned from wind farm developments and location

Both in Europe and in the USA it has been generally acknowledged that certain wind farm developments have been badly located and given rise to excessive bird mortality through collisions with wind turbines. At Altamont Pass in California, USA, where the wind resource area has some 1,110 turbines, a minimum of 382

birds were killed between March 1998 and December 2000 through collisions with turbines. A little over half of these casualties (53%) were birds of prey and some species involved, such as Golden Eagles, were of high conservation concern²⁶. An even higher estimate of bird deaths was found at San Gorgonio wind resource area where it was calculated that 6,800 birds were killed annually²⁷. In Europe the Tarifa wind farm complex in the Campo de Gibraltar region of Spain is notable in that it is positioned on an important bird migration route. In addition to deaths of migrating birds there have been a number of resident Griffon Vultures, a rare species in Europe, listed amongst the casualties²⁸.

Studies at Blyth²⁹ and at Zeebrugge Harbours³⁰ both found collision rates higher than one bird per turbine per year, well in excess of the other studies into collision rates at wind farms elsewhere. Data from Zeebrugge also showed very high variability in the observed collision rates for different turbine locations, ranging from 0 to 125 collisions per turbine per year. At both sites the wind farms had been positioned between onshore seabird colonies and their offshore feeding grounds.

These examples serve to remind planners and consultees of their responsibility to thoroughly review the data contained within Environmental Statements. Where they feel that there has been insufficient data gathered upon which to make sound judgements then there should always be an insistence on further studies being undertaken. The overwhelming imperative is to ensure that wind farms that are likely to cause unacceptable impacts on bird populations are not built in the future.

Turbine placement

Wind turbines placed near gullies and those at the end of a string of turbines are more

Annex E: Birds and wildlife

dangerous to birds than others³¹. The inter-tower spacing and the height of turbine towers and rotor diameters might interact to affect species vulnerability to turbine collisions. In addition, the percentage of time that wind turbines operate may also be an important factor in bird collisions.

Painting rotor blades

The as yet untested Hodos rotor blade painting scheme³² may reduce the distance across which motion detection is experienced by birds of prey which would allow them to detect the movement of turbine blades even though they are extremely focused on their quarry. Essentially it involves one blade painted black and two painted white, but achieved cumulatively by precise, evenly distributed painting of black bands on all blades. Whilst if generally applied to wind farms the effect would be aesthetically unacceptable the system, if proved to be effective, could be used judiciously on specifically identified turbines.

Perches

Research in the USA³³ has shown that birds of prey use turbines and other wind farm structures as perches which are thought to increase their risk of collisions. Indeed, where turbines have been out of order significant increases in collisions with adjacent operational turbines were recorded.³⁴ This was thought to be as a result of turbines that had been out of commission for some time being used as perches by birds of prey and flying birds taking action to avoid the perched raptors flew, inadvertently, into the operational turbine next door.

Benign towers

It has been suggested³⁴ that the installation of large poles at the end of turbine lines might act as bird flight diverters. These poles could be placed 5-10m apart and just beyond the rotor

plane of the wind turbine at the end of a string and extend upward to near the high reach of the turbine's blades. The idea is to encourage birds to fly wider around the end of the turbine string, thereby adding distance between the bird's flight path and the operating wind turbines. Poles serving as flight diverters should be installed without guy wires, because guy wires pose collision hazards to flying birds. They should also be designed to prevent perching. Pointed tops might be one design to achieve this.

Turbine cessation

Wind turbines may be especially dangerous to birds during unsettled weather conditions or in periods of poor visibility, such as during fog, rain, darkness, dusk, or dawn³⁵ and perhaps particularly so during migration periods. Through careful study, however, the difficulties precisely affecting a particular population could be ascertained and lead to the judicious shutting down of particularly problematic turbines within a wind farm at any particularly sensitive time of year.

It has been proposed that the precise periods of greatest danger might be ascertained by installing specially designed accelerometers.^{xiii} These devices, properly designed and installed, may be able to detect the precise time of each bird collision. With sufficient data on times and conditions of bird collisions, patterns might emerge that inform managers of higher risk times of the day, or year, when temporary shutdowns of certain wind turbines can substantially lessen bird mortality.

Relocation of selected wind turbines

In all the studies that have investigated bird casualties through turbine strikes, it has been shown that certain wind turbines kill disproportionately more birds because of where those wind turbines are located. Once identified

the careful relocation of such 'killer' turbines would substantially reduce bird mortality.

The need for further research

To date most of the detailed research about how birds behave around wind farms and the impacts they have upon them has been conducted outside Britain. The scientific understanding of the impacts of wind farms on birds is still in its infancy and there is much work still to be done. There is an urgent need for a more standardised approach to the monitoring of adverse wildlife effects both before and after construction. This could form part of the consent conditions for the project, although it will be up to the UK Government and Devolved Administrations to decide whether this is desirable.

The most urgent need for further scientific understanding about birds and wind farms can be summarised in these questions:

- How do the different species of conservation concern behave around wind farms i.e. levels of tolerance or displacement?
- How do different species behave in the vicinity of turbines (notably flight behaviour) and differentially avoid collisions and how is this affected by different environmental conditions such as weather or time of day?
- What are the long term impacts of building wind farms in areas important for the non-breeding elements of populations from where breeding stocks are replenished?
- How is the productivity of birds that remain within wind farms to breed affected? For example rates of post-fledging mortality may well be unsustainably high as may be levels of predation by predators brought in by the prospect of scavenging on collision casualties.
- How are birds affected by the disturbance caused in the construction, operation

(maintenance and repair visits – probably more appropriate to last bullet point) and decommissioning phases of wind farms?

- Do wind farms act as barriers to bird movements?
- What are the cumulative effects of wind farms on bird populations considering the increasing size and height of developments?
- What are the short and long-term displacement impacts on birds from operational wind turbines?
- Effectiveness of mitigation measures

Bats

Bats are fully protected in UK law³. In broad terms wind farms/turbines have the potential to adversely affect bats in the following ways:

- Mortality from collision with the turbines and related structures
- Displacement due to the noise and presence of the wind farm structures
- Direct habitat loss and reduction in habitat quality
- Indirectly through influences that wind turbines and the associated infrastructure may have on bat prey and bat predators

Collision

Experience in the US and continental Europe shows that bats can collide with wind turbines and there is some evidence that the levels of mortality are increasing with the increase in size of the turbines. As with many man-made structures such as electricity pylons and power lines, meteorological masts, buildings etc, wind turbines present a potential collision hazard. However, evidence from the US indicates that wind farms cause bat mortality at a higher level than would be expected by their proportional presence in the environment.

Annex E: Birds and wildlife

The vast majority of bat fatalities are migratory species (ca. 90%) during the migration period, rather than 'local' bats on nightly foraging trips. Fatalities are associated with known migration routes.

In the UK there are very few migratory species and no known 'migration routes' as are thought to be present in the US. Bats do migrate south in the winter in Europe but most seasonal movements of bats in the UK are to and from winter hibernacula, which in some cases can involve northerly movement in the autumn. These are not necessarily linked to seasonal climatic trends.

There are a number of proposed hypotheses to explain why migratory bat species are more susceptible and to explain why wind turbines appear to cause more collision fatalities than might be expected given their still relative scarcity in the landscape. One theory is that bats are attracted to wind turbines as potential stop-over day-time roost sites during nocturnal migrations. Another theory is that migrating bats do not echolocate (a type of natural active SONAR that bats use to detect insect prey and obstacles) and therefore rely on vision alone, increase their risk of colliding with objects.

In the UK there has been less consideration of the collision issue partly because of the fact that wind farms have been active in the US and continental Europe for longer and partly because the evidence from the US indicates that most species in the UK would not be at significant risk. However, there has not been a lot of detailed study to confirm that this is the case for the UK.

In summary, there is no evidence to suggest that wind farms in the UK present a significant source of mortality to bat populations, unless they are sited close to known concentrations of bat activity (e.g. summer roosts, swarming sites,

hibernacula). However, there has not been a lot of attention paid to the issue in the UK and there needs to be further study to confirm this. As a precautionary approach it is increasingly important, as wind farms being to proliferate and increase in size, that all sites are assessed for bat flight activity as part of the planning process so that potential impacts can be avoided and/or reduced through design.

Habitat loss and degradation

As with any development there is the potential for bat habitats to be affected either through construction disturbance or through direct habitat losses from the wind farm structures (or associated tree felling to increase wind yield). Typically, onshore wind farm sites are located in upland areas or in conifer plantations that generally do not provide good foraging or roosting habitat for bats, although it is always important to establish this for a particular site through proper surveys and assessments. If bat roost sites are found within proposed wind farms then the normal practice would be to avoid any disturbance to these areas and site turbines, access tracks, borrow pits and any overhead power lines far enough away so that bats are not affected by them.

Loss of foraging habitat (e.g. woodland and woodland edge, ponds and streams, hedge rows etc) associated with the construction of the turbine bases, access tracks, borrow pits, grid connection etc can also affect bats. Although there is no general legal protection of such habitats, in terms of their use by bats, the 'best practice' approach would be to avoid as much loss of such habitat as possible and where some loss was unavoidable then to compensate for this through habitat enhancement and creation. The design of such mitigation measures requires careful consideration in the overall wind farm design so as to avoid creating attractive habitat for bats near to any turbines.

There has been very little research work carried out on the potential for the physical presence of an operating wind farm to displace bats through disturbance or other means. There is no evidence that wind turbines produce ultrasonic sounds that could either attract or repel bats. However, wind farms could affect aerial insect populations which form the majority of bat prey through changes to insect habitats or the attraction of insects to any artificial lighting associated with the wind farm, thereby indirectly affects bats, either positively or negatively.

In summary, the favoured upland sites for onshore wind farms in the UK generally do not host the best habitat types for bats. In most situations potential adverse effects on bat habitats can be avoided or successfully mitigated, provided that the appropriate survey work is undertaken and that developers recognise the need to consider the issue in the planning and design of the wind farm scheme. Because of the strong legal protection afforded to bat roosts then these sites are normally considered in the planning process. The effects of large-scale wind farm development on bat foraging habitat and habitats that act as links (flyways) or corridors between roost sites and foraging sites can also be important but have not been extensively researched.

Other protected species

The potential for significant adverse effects on protected species^{viii} like otter, badger, wild cat, pine marten, red squirrel etc. relates to the planning and micro-siting of turbines and access tracks. With adequate environmental assessment and design, longer-term disturbance to protected species can be avoided, although

this is likely to be short-term in nature as they are expected to habituate^{ix}. If the 'homes'^{xi} of protected species are not directly disturbed/destroyed during construction work then it is widely accepted in most cases that mitigation can be put in place to prevent any other potentially significant adverse effects such as fragmentation. Mammals (except bats) are not likely to come into direct conflict with the turbines. Habitat loss for wind farm development is not likely to be significant for protected species if adequate environmental survey work is undertaken in planning the site. Often particular localised issues such as the avoidance of a regularly used mammal path can be fully mitigated by careful micro-siting of an access road or a turbine base.

The operational effects of wind turbines on protected species (with the exception of birds and bats) relate mainly to noise and movement. Theoretically, these could affect the hunting and ranging behaviour of protected species. However, such effects are widely considered not to be significant. Species that are regularly present or even those with a much larger territory which includes a wind farm are thought to get used to such changes quite quickly.

^{viii} Protected species legislation is largely included within the Wildlife and Countryside Act, 1981 and amendments, some species are given a higher level of protection at a European level through the Habitats Regulations, 1994.

^{ix} 'Habituation' is the process by which individual animals show a decrease in response to an environmental stimulus over time so that they can distinguish between potentially significant and insignificant events.

^x 'homes' can be underground, in amongst piles of rocks or dense vegetation, or in trees or watercourses.

Annex E: Birds and wildlife

- 1 JNCC (2004). *Special Protection Area qualifying species population estimates*. Available at: <http://www.jncc.gov.uk>.
- 2 Hammond, N., Pearson, B. (1994) *Waders. Hamlyn Bird Behaviour Guide*. Hamlyn.
- 3 Cramp S. & Simmons K.E.L. (1977). (eds) *Handbook of the Birds of Europe the Middle East and North Africa, The Birds of the Western Palearctic*. Oxford University Press.
- 4 Summers, R.W., Piertney, S.B. (2003). *The Scottish Crossbill what we know and what we don't*. British Birds 96: 100-111.
- 5 Phenology data. Available at <http://www.phenology.org.uk>. accessed 12.01.05.
- 6 Crick, H.Q.P., Spark, T.H. (1999). *Climate change related to egg-laying trends*. Nature 399: 423-424.
- 7 RSPB (2004). *Climate change and birds*. RSPB information sheet. Available at: http://www.rspb.org.uk/Images/Climate%20change%20and%20birds_tcm5-56407.pdf
- 8 Meed, J., Knasel, E. (1999). *Farming for Tomorrow*. LBCNC, RSPB.
- 9 Cook, A.S., O'Dowd, B., Durdin, C.J. (1994). *Breeding Redshank on Essex Saltmarshes in 1993*. RSPB unpublished report. Cited in Smart & Gill (2003).
- 10 Hulme, M., Turnpenny, J., Jenkins, G (2002). *Climate Change Scenarios for the United Kingdom: The UKCIP02 Briefing Report*. Tyndall Centre for Climate Change Research, UEA. Cited in Smart & Gill 2003.
- 11 Liley, D. (1999). *Predicting the consequences of human disturbance, predation and sea level rise for ringed plover*. PhD thesis, UEA. Cited in Smart & Gill 2003.
- 12 Brigg, B., Hossell, J (1995). *The Impacts of Global Climate for Biodiversity*. RSPB Conservation Review No. 9.
- 13 Kowallik, C., Barbach-Jaene, J. (2001). *Impact of wind turbines on field utilization by geese in coastal areas of NW Germany*. Vogelkdl. Ber. Niesesachs, 33: 97-102. Cited in Percival 2003.
- 14 Everaert, J., Devos, K., Kuijken, E. (2002). *Windturbines en vogels in Vlaanderen: Voorlopige onderzoeksresultaten en buitenlandse bevindingen Rapport van het Instituut voor Natuurbehoud 2002.03, Brussels*, 76pp. Cited in Langston & Pullen (2003).
- 15 Barrios, L. & Rodriguez, A. (2004). *Behavioural and environmental correlates of soaring-bird mortality at on-shore wind turbines*. Journal of Applied Ecology 41: 72-81.
- 16 Orloff, S., Flannery, A. (1992). *Wind Turbine Effects on Avian Activity, Habitat Use, and Mortality in Altamont Pass and Solano County Wind Resource Area*. Report prepared for the California Energy Commission. Cited in Thelander et al 2003.
- 17 Hodos, W., Potocki, A., Storm, T., Gaffney, M. (2001). *Reduction in Motion Smear to reduce Avian Collision with Wind Turbines*. Proceedings of the National-Wind Power Planning Meeting IV. Carmel, USA, 2000. Cited in Thelander et al 2003.
- 18 Pettersson, J., Stalin, T. (2003). *Influence of offshore windmills on migration birds in southeast coast of Sweden*. Report to GE Wind Energy. Cited in Percival 2003.
- 19 Dirksen, S., Spaans, A.L., Van der Winden, J. (1998). *Nocturnal collision risk with wind turbines in tidal and semi-offshore areas*. In Ratto, C.F., Solari, G. (eds) *Wind Energy and Landscape*. Balkema, Rotterdam, pp 99-108.
- 20 Winkelman, J.E. (1992). *The impact of the Sep wind park near Oosterbierum (Fr.), the Netherlands, on birds. 4: Disturbance*. DLO-Institut voor Bos-en Naluuronderzoek, Arnhem, RIN-rapport 92/5. Cited in Phillips 1994.
- 21 EAS. (1997). *Ovenden Moor Ornithological Monitoring. Report to Yorkshire Windpower, Keighley*: Ecological Advisory Service. Cited in Percival 2000.
- 22 Larsen, J.K. & Madsen, J. (2000). *Effects of wind turbines and other physical elements on field utilization by pink-footed geese (Anser brachyrhynchus): a landscape perspective*. Landscape Ecology 15: 755-764.
- 23 Percival, S.M. (1998). *Birds and wind turbines-managing potential planning issues*. In Powles, (ed) pp 345-350, British Wind Energy Association. Bury St. Edmunds. Cited in Percival 2003.

Annex E: Birds and wildlife

- 24 Jackson, V.S. & Allan R. J. (2000) *Nature reserves and aerodromes-resolving conflicts* Proceedings of the International Birdstrike Committee, 25th Meeting Amsterdam. 1: 339-344.
- 25 Baines, D., Summers, R.W. (1997). *Assessment of bird collision with deer fences in Scottish forests*. Journal of Applied Ecology 34: 941-948.
- 26 Avery, W.L., Springer, P.F., Cassel, J.F. (1997). *Weather Influences on Nocturnal Bird Mortality at a North Dakota Tower*. Wilson Bull, 89: 291-299. Cited in Thelander et al 2003.
- 27 McCrary, M.D., Mckernan, R.L., Schreiber, R.W. (1986). *San Gorgonia wind resource area: Impacts of commercial wind turbine generators on birds, 1985 data*. Report prepared for Southern California Edison Company, 33pp. Cited in Sterner 2002.
- 28 Jaque, L.B., Montes, R.M. (1995). *Effects of wind turbine power plants on the avifauna in the Campo De Gibraltar Region [Spain]*. SEO/BirdLife, 19pp.
- 29 Still, D., Little, b., Lawrence, s. (1995). *The effect of wind turbines on the bird population at Blyth Harbour*. ETSU Report, 34pp. Cited in Percival 2003 and Painter, A., Little, b., Lawrence, s. (1999). *Continuation of bird studies at Blyth Harbour wind farm and the implications for offshore wind farms*. DTI ETSU report no. W/13/00485/00/00. Cited in Percival 2003.
- 30 Everaert, J., Devos, K., Kuijken, E. (2002). *Windturbines en vogels in Vlaanderen: Voorlopige onderzoeksresultaten en buitenlandse bevindingen Rapport van het Instituut voor Natuurbehoud 2002.03, Brussels, 76pp*. Cited in Langston & Pullen 2003.
- 31 Orloff, S., Flannery, A. (1992). *Wind Turbine Effects on Avian Activity, Habitat Use, and Mortality in Altamont Pass and Solano County Wind Resource Area*. Report prepared for the California Energy Commission. Cited in Thelander et al 2003; Orloff, S., Flannery, A. (1996). *A Continued Examination of Avian Mortality in the Altamont Pass Wind resource Area. Report prepared for the California Energy Commission*. Cited in Thelander et al 2003; Hunt, G., (1994). *A Pilot golden Eagle population Project in the Altamont Pass wind resource area, California. Report prepared for the National Renewable Energy Laboratory*. Cited in Thelander et al 2003.
- 32 Hodos, W., Potocki, A., Storm, T., Gaffney, M. (2001). *Reduction in Motion Smear to reduce Avian Collision with Wind Turbines. Proceedings of the National-Wind Power Planning Meeting IV.Carmel, USA, 2000*. Cited in Thelander et al 2003.
- 33 Orloff, S., Flannery, A. (1992). *Wind Turbine Effects on Avian Activity, Habitat Use, and Mortality in Altamont Pass and Solano County Wind Resource Area*. Report prepared for the California Energy Commission. Cited in Thelander et al 2003.
- 34 Thelander, C., Smallwood, K, Ruge, L. (2003). *Bird Risk Behaviours and Fatalities at the Altamont Pass Wind Resource Area*. Available at: <http://www.nrel.gov/docs/fy04osti/33829.pdf>
- 35 Taylor, W.K., Kershner, M.A. (1986). *Migrant Birds killed at a Vehicle Assembly Building (VAB), John F. Kennedy Space Center*. J. Field Ornithol. 57: 142-154. Cited in Thelander et al 2003.; Morrison, M.L. (1996). *Protocols for Evaluation of Existing Wind Developments and Determination of Bird mortality*. Proceedings of the National-Wind Power Planning Meeting II. Palm Springs, USA, 1995. Cited in Thelander et al 2003.





Sustainable
Development Commission

"The most comprehensive study of wind energy in Britain"

Geoffrey Lean, Independent

"A recent report by the government's Sustainable Development Commission was hailed by the industry as a breakthrough because it showed wind power was becoming price competitive with other fuels."

Mark Townsend, Observer

"...the most informative, comprehensive, balanced and readable report on the subject I have ever read"

Prof. Leon Freris, CREST Loughborough University

"Because of the highly charged debate on wind power the report has been peer reviewed, like a scientific paper, to give it greater credibility so it can be used by planners as an authoritative document"

Paul Brown, Guardian

Acknowledgements

Many individuals and organisations assisted us with the compilation of this report and the Commission is extremely grateful to all of them.

The views expressed are those of the Sustainable Development Commission.

Cover image: Niall Olds, Enviro

Published: May 2005 (revised November 2005)

Printed on material that contains a minimum of 100% recycled fibre for uncoated paper and 75% recycled fibre for coated paper.

To order more copies of this report, to order copies of the booklet, *Wind Power, Your Questions Answered*, or to find out more about the work of the Sustainable Development Commission, visit our website at

www.sd-commission.org.uk

