

## Global outlook on energy technology development

**Karlsson, Kenneth Bernard; Petrovic, Stefan; Abad Hernando, Diana**

*Published in:*

Accelerating the clean energy revolution - perspectives on innovation challenges

*Publication date:*

2018

*Document Version*

Publisher's PDF, also known as Version of record

[Link back to DTU Orbit](#)

*Citation (APA):*

Karlsson, K. B., Petrovic, S., & Abad Hernando, D. (2018). Global outlook on energy technology development. In Accelerating the clean energy revolution - perspectives on innovation challenges: DTU International Energy Report 2018 (Chapter 3, pp. 21-27). Technical University of Denmark (DTU).

## DTU Library

Technical Information Center of Denmark

---

### General rights

Copyright and moral rights for the publications made accessible in the public portal are retained by the authors and/or other copyright owners and it is a condition of accessing publications that users recognise and abide by the legal requirements associated with these rights.

- Users may download and print one copy of any publication from the public portal for the purpose of private study or research.
- You may not further distribute the material or use it for any profit-making activity or commercial gain
- You may freely distribute the URL identifying the publication in the public portal

If you believe that this document breaches copyright please contact us providing details, and we will remove access to the work immediately and investigate your claim.

# DTU International Energy Report 2018

Technical University of Denmark



## Accelerating the Clean Energy Revolution - Perspectives on Innovation Challenges

Edited by **Birte Holst Jørgensen** and **Katrine Krogh Andersen**, Technical University of Denmark  
**Elizabeth J. Wilson**, Dartmouth College





DTU International  
Energy Report 2018  
**Accelerating the Clean Energy Revolution  
- Perspectives on Innovation Challenges**

Edited by **Birte Holst Jørgensen** and **Katrine Krogh Andersen**, Technical University of Denmark  
**Elizabeth J. Wilson**, Dartmouth College

Reviewed by **William D'haeseleer**, KU Leuven





# Contents

---

Preface		5
Chapter 1	<b>Key Findings and Recommendations</b>	7
Chapter 2	<b>Executive Summary</b>	13
Chapter 3	<b>Global Outlook on Energy Technology Development</b>	21
Chapter 4	<b>Networked Capabilities for Sustainable Energy Solutions</b>	29
Chapter 5	<b>Smart Grids Innovation Challenge</b>	37
Chapter 6	<b>Off-grid Access to Electricity Innovation Challenge</b>	47
Chapter 7	<b>Carbon Capture Innovation Challenge</b>	55
Chapter 8	<b>Sustainable Bioenergy and Biofuels Innovation Challenge</b>	63
Chapter 9	<b>Power to Fuels and Chemicals Innovation Challenge</b>	73
Chapter 10	<b>Clean Energy Materials Innovation Challenge</b>	81
Chapter 11	<b>District Heating and Cooling Systems Innovation Challenge</b>	89
Chapter 12	<b>Energy Storage Innovation Challenge</b>	99
Abbreviations		111



# Preface

---

The DTU International Energy Report 2018 is DTU's input to Mission Innovation. It comprises leading researchers' perspectives on R&D challenges and needs in respect of the Innovation Challenges and covers the entire spectrum of RD&D, from early-stage research to the demonstration stage. The report also describes the R&D challenges and needs that relate to energy storage, which we regard as of great importance in the transformation to a clean energy system with a large share of variable energy sources.

International collaboration is an integral part of DTU's activities and a prerequisite for its status as an international elite university, a status that is consolidated, and continuously developed, through the work done by researchers, students and the administration. Our objective is for DTU to be among the five leading technical universities in Europe. Our ambition

is to attract the best researchers and research students from both Denmark and abroad, as well as to maintain DTU as an attractive collaboration partner for other leading research environments worldwide.

A strong network of partner universities strengthens DTU's position as an international elite university. DTU is a member of alliances and strategic partnerships with universities from the Nordic countries, Europe and Asia. Furthermore, DTU has a number of close collaborators from different parts of the world, covering most member countries in Mission Innovation.

The DTU energy research community remains involved in national and international research relevant to the Innovation challenges and is ready to engage in further cooperation within Mission Innovation.

DTU International Energy Reports deal with global, regional and national perspectives on current and future energy issues. The individual chapters in the reports are written by DTU researchers in cooperation with leading Danish and international experts.

Each Energy Report is based on internationally recognized scientific material and is fully referenced. Furthermore, the reports are refereed by independent international experts before being edited, produced and published in accordance with the highest international quality standards.

The target readership for the report is DTU colleagues, collaborating partners and customers, funding organizations, institutional investors, ministries and authorities, and international organizations such as the EU, IEA, World Bank, World Energy Council and UN.







Chapter 1

# Key Findings and Recommendations

“Coming together is a beginning, staying together is progress, and working together is success” (Henry Ford, 1863 - 1947)

By **Birte Holst Jørgensen** and **Katrine Krogh Andersen**, Technical University of Denmark  
**Elizabeth J. Wilson**, Dartmouth College



## Recommendations

We need Mission Innovation to unleash the global potential of energy technology development and to provide stimulating and demanding frameworks for international R&D cooperation.

Our key recommendations are as follows:

- *Accelerate Mission Innovation.* MI should maintain its momentum and create a flexible platform for international cooperation that welcomes multiple (and new) actors, facilitates knowledge and information-sharing, and promotes the cost- and task-sharing of RD&D activities. Members should provide the necessary funding for a lean but powerful secretariat, which could be located together with the Clean Energy Ministerial secretariat at the IEA, where it would be able to rely on tested frameworks and a well-established administration.
- *Accelerate Innovation Challenges.* MI must keep up its momentum in the Innovation Challenges and actively support further development both within and across Innovation Challenges. Coalitions of interested countries should support joint projects on selected Innovation Challenges that have already made progress in their strategic research programmes. Opportunities for cooperation with industry and co-financing should be facilitated.
- *Accelerate analytical support.* MI should allocate the necessary funding to monitor the pace of technological progress, its impact and the diversity of the portfolio of mitigation technologies being developed (as also suggested by Myslikova et al. [1] and IEA [2]). Advanced data analytics could support decision-makers in further developing and aligning research activities across institutional and disciplinary boundaries.

## International energy technology cooperation



The innovation and large-scale adoption of clean energy technologies are the keys to decarbonizing the energy sector and critical elements in combatting climate change, complementing other flexible emission-based policies [3; see also 4]. Much is being done both nationally and locally, but international cooperation in energy technology innovation is inevitable given the urgency of the energy and climate challenge [5]. When world leaders came together in Paris in December 2015 to undertake ambitious efforts to combat climate change, twenty countries launched Mission Innovation (MI) to dramatically accelerate global clean energy innovations with the objective of making clean energy widely affordable [6]. As part of the initiative, participating countries committed themselves

to doubling their governments' clean energy research and development (R&D) investments over five years, while encouraging greater levels of private-sector investment in transformative clean energy technologies.

Mission Innovation complements another global initiative, Clean Energy Ministerial (CEM), which was established in 2009 in order to encourage the transition to a global clean energy economy. As illustrated below, the two initiatives cover the whole knowledge chain from research to deployment.

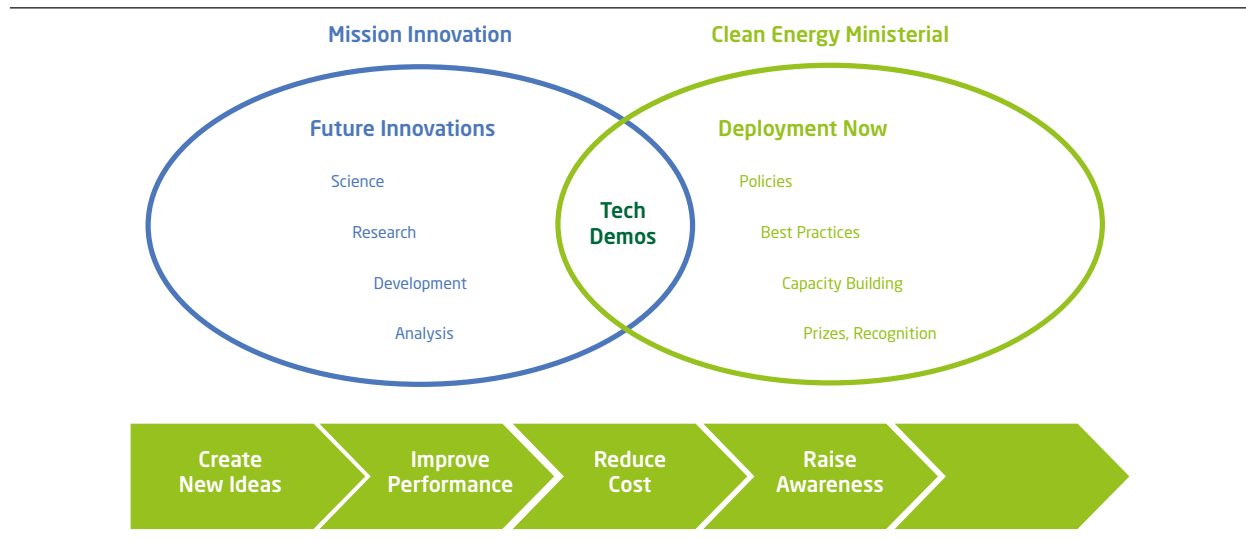

Figure 1. The complementarities of Mission Innovation and Clean Energy Ministerial [7]

The need for international energy R&D cooperation has been highlighted by scholars for some years [8; 9; 10]. The question is not whether to cooperate internationally, but rather how much, with whom, on what and how. In 2015, the “Global Apollo Programme to Combat Climate Change” [11] suggested that countries should commit 0.02% of GDP to the “greatest scientific challenge facing the world”. This would more than double the public research money available for renewable energy, which, with all countries on board, would amount to around \$15 billion USD per year – the same as was spent on the US moon-shot. The Apollo mission had the clear goal of taking man to the moon and bringing him back safely within a concrete timeline. It required huge investments across multiple sectors, solved problems in a bottom-up, cross-disciplinary manner and stimulated risk-taking. But unlike the Apollo project, the global transition to a clean energy system is complex and multi-faceted and can only be a united global effort driven by resource and technological diversity, commercial viability, multiple actors and complementary policies [12; 13; 14].

Mission Innovation may bring about the benefits of international cooperation, such as improving scientific quality, scope and critical mass by linking resources and knowledge across national borders. This means that participating members may both obtain access to the specific missions and attract resources and knowledge regarding these missions [15; 16]. Sharing the costs and risks of expensive research infrastructure falls into the same category, a well-known example being the ITER tokamak facility in southern France. Other broader benefits are related to opening up new markets and attracting new investments. Finally, international scientific cooperation has existed for decades and in different forms, using scientific diplomacy to

strengthen and maintain relations and to confront growing problems on an international scale [17].

International R&D cooperation also has its disadvantages. Managing international R&D cooperation is cumbersome, takes time, has to take into account difficult IPR challenges and must demonstrate a fair return on investments. There are often built-in restrictions on foreign access to national R&D programmes, and international R&D cooperation is vulnerable to changes in financial and political commitments, with the possibility of partners withdrawing or cutting back funding [5; 18].

### The status of Mission Innovation

Today, Mission Innovation is made up of twenty-two countries and the European Commission, accounting for over 80% of global public investment in clean energy research and development, totalling approximately \$15 billion USD per year. It is expected that these resources will accelerate the availability of the advanced technologies that will define a future global energy mix that is clean, affordable and reliable.

Members have also agreed to collaborate on information-sharing, innovation analysis and road-mapping, joint research and capacity-building, and business and investor engagement [19]. As an important first activity, members have identified seven Innovation Challenges on which to focus and to which to commit resources. These are global calls to action and are envisaged as catalysing international cooperation. They cover the entire spectrum of RD&D, from early-stage research needs to projects to demonstrate

technologies. Engagement in an Innovation Challenge is entirely voluntary and is built around a coalition of interested MI members. New Innovation Challenges are envisaged provided there is sufficient interest from MI members. The current seven Innovation Challenges are as follows:

1. Smart Grids Innovation Challenge – to enable future grids that are powered by affordable, reliable, decentralized renewable electricity systems
2. Off-Grid Access to Electricity Innovation Challenge – to develop systems that enable off-grid households and communities to access affordable and reliable renewable electricity
3. Carbon Capture Innovation Challenge – to enable near-zero CO<sub>2</sub> emissions from power plants and carbon-intensive industries
4. Sustainable Biofuels Innovation Challenge – to develop ways to produce, at scale, widely affordable, advanced biofuels for transportation and industrial applications

5. Converting Sunlight Innovation Challenge – to discover affordable ways to convert sunlight into storable solar fuels
6. Clean Energy Materials Innovation Challenge – to accelerate the exploration, discovery and use of new high-performance, low-cost clean energy materials
7. Affordable Heating and Cooling of Buildings Innovation Challenge – to make low-carbon heating and cooling affordable for everyone

The figure below shows which countries are taking the lead in these respects and which are active in each of the Innovation Challenges. There is a broad level of participation, with some countries taking the lead in more than one challenge, namely India, Canada, the US and the European Commission.

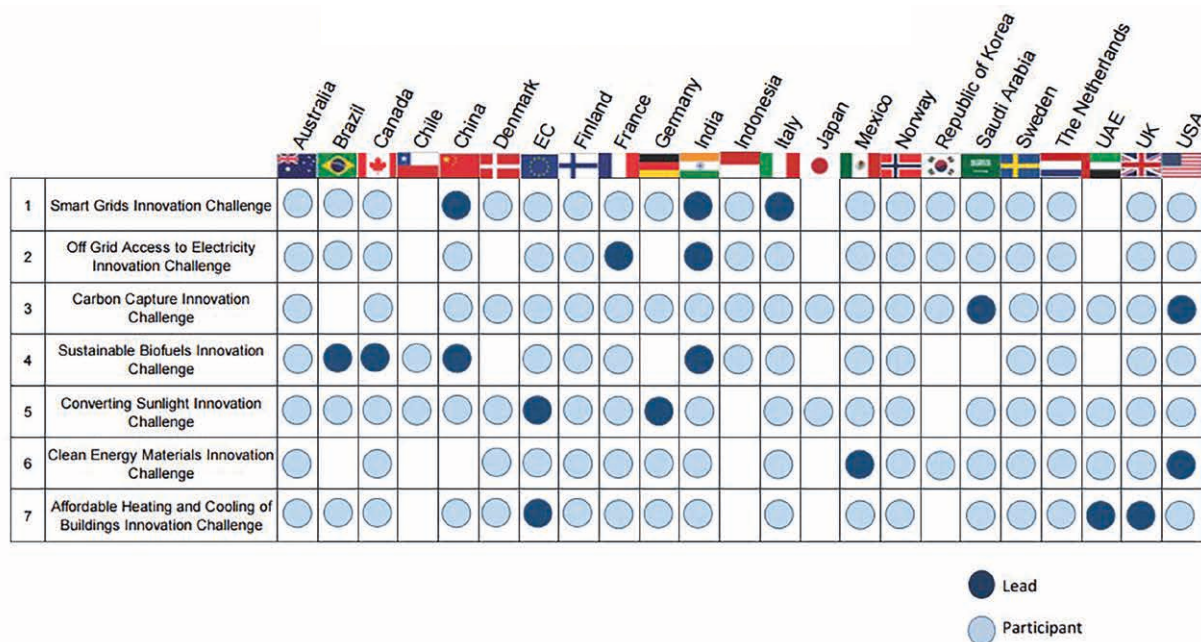

Figure 2. Innovation Challenges and country participation, June 2017.

This global initiative was originally spearheaded by the US. In June 2017, however, President Trump announced the US withdrawal from the Paris agreement and requested cuts to the federal energy R&D budget [20], so that the US is no longer playing a leading role in the initiative, neither politically nor administratively. Instead, the leadership has been passed to the EU Commission, and the virtual secretariat is

now co-ordinated by the UK. Implementation of the Innovation Challenges seems uneven, with some initiatives making steady progress (e.g. Smart Grids and Materials), others more slowly (e.g. Converting sunlight and Biofuels).

Along the way, suggestions have been made to re-frame the initiative so that a more realistic set of goals can be pur-

sued, with less weight being put on the quantitative goal (R&D doubling pledge) and more on qualitative, performance-based goals to accelerate the pace of energy innovation (improve data collection and management, facilitate information-sharing, identify innovation needs, spur collaboration and new institutions, and attract private-sector investment and participation [21; 22]). The problem is that it is unclear whether the US will remain a member of MI and whether the original doubling plans can be achieved without US contributions.

The question remains how to advance international energy R&D cooperation most effectively. Does MI have a (new) role to play, how many resources should be committed, on what and how?

As a construct, Mission Innovation offers the necessary flexibility, allowing both top-down mission-driven commitment and bottom-up engagement driven by the needs of the scientists and individual funders. Firstly, sharing knowledge and information on best practices from around the world may facilitate the adoption of appropriate tools and mechanisms for international cooperation and coordination. Secondly, this can also be used to monitor the pace of technological progress and the diversity of the portfolio of mitigation technologies being developed. Thirdly, Innovation Challenges may develop into knowledge platforms where technology users and producers identify research gaps and opportunities for joint innovation activities, ranging from knowledge-sharing to cost-and task-sharing.

### Accelerating Mission Innovation

The future of MI cooperation may take many forms, but it will be characterized by approaches using variable geometry to work towards an appropriate inclusion of member states, funding agencies and private investors. There is a need for governance models that consider the political will to share knowledge, resources and risks, as well as rewards. Large-scale coordinated investments and efforts like ITER have a very long time scale and may not be optimal here. More appropriate might be a model that seeks collaboration with a specific goal and on a specific activity, but without delegating decisions. A less committed model is cooperation where the rationale is to exploit national strengths and seek coordination wherever they provide added value [23]. Much can be learned from existing models of collaboration and coordination governance. Two major sources for results-oriented, flexible, multilateral collaboration and cooperation stand out:

International technological cooperation has been a key function of the IEA since its establishment in 1975 [24; 25].

Through the Implementing Agreements (now called the Technology Collaboration Programmes (TCP)) a flexible mechanism for both IEA members and partner countries, as well as industry, has enabled innovation to respond to the energy challenge. The 39 TCPs have fostered collaboration in a number of ways, including R&D, proof-of-concept, pilot and demonstration projects, measurements and scientific exchanges. They have been established in response to participants' needs, whereby their structure, funding and other aspects of their research projects vary widely. They share costs and tasks, and participation is based on the equitable sharing of obligations, contributions, rights and benefits. The IEA also collects and publishes national energy R&D expenses, making it an authoritative source on public energy R&D expenditure.

The vast European experience with the multi-level governance of energy technology policy offers lessons learned and best practices for variable geometry approaches. It comes together in the European Strategic Energy Technology Plan (SET-Plan), which since 2006 has been given the mission of accelerating the development and deployment of low-carbon technologies [26]. It promotes research and innovation efforts and facilitates cooperation among EU countries, companies, research institutions and the EU. The SET-Plan comprises the SET-Plan Steering Group, the European Technology and Innovation Platforms, the European Energy Research Alliance and the SET-Plan Information System (SETIS). Other important governance lessons for Mission Innovation are: 1) the commitment of all parties and the strategic alignment of nationally and institutionally rooted goals with international activities; 2) explicit expectation management regarding common or complementary goals and joint principles; 3) alignment of the mode of funding the chosen goals with national regulations; and 4) clear decision-making structures and dissemination frameworks [27].

Since its launch in 2015, the research communities and industries engaged in international cooperation in energy technology have harboured great expectations of Mission Innovation [see, for example, 28 and 29]. During these times of change, Mission Innovation needs to consolidate in order to deliver a concerted international innovation contribution to combatting climate change. The race to accelerate the clean energy revolution must be conducted with committed pledges and activities by all parties, governments, industries and research communities alike.

# References

1. Myslikova, Z., Gallagher, K.S., Zhang, F., Mission Innovation 2.0. Recommendations for the Second Mission Innovation Ministerial in Beijing, China. The Center for International Environment & Resource Policy, Climate Policy Lab, The Fletcher School, Tufts University, May 2017, number 014.
2. IEA, Tracking Clean Energy Progress 2017. Excerpts. Informing Energy Sector Transformations. OECD/IEA 2017. (Available on: <http://www.iea.org/publications/freepublications/publication/Tracking-CleanEnergyProgress2017.pdf>)
3. De Coninck, H., Fischer, C., Newell, R.G., Ueno, T., International technology-oriented agreements to address climate change. In Energy Policy 36 (2008) 335-356.
4. Since 2006, the IEA has regularly published "Energy Technology Perspectives", giving answers to: How much can technology contribute to securing adequate and affordable energy supplies and lower CO<sub>2</sub> emissions? What energy technologies hold the most promise? How long will it take?
5. Gray, J.E., Wonder, E.F., Kratzer, M.B., International Energy Research and Development Cooperation, in Ann. Rev. Energy 1985: 10: 589-611.
6. <http://mission-innovation.net/about/>. Accessed 6 April 2018.
7. Marlay, R., Mission Innovation. Accelerating the Clean energy Revolution. Presentation held at the IEA EGRD workshop 17 May 2016, Paris. (Available at: <https://www.iea.org/media/workshops/2016/egrdspacecooling/19.BobMarlay.pdf>)
8. Stern, N., Stern Review on the Economics of Climate Change, part VI International Collective Action, Chapter 24 Promoting effective international cooperation on technology. [http://webarchive.nationalarchives.gov.uk/20100407181417/http://www.hm-treasury.gov.uk/d/Chapter\\_24\\_Promoting\\_Effective\\_International\\_Technology\\_Co-operation.pdf](http://webarchive.nationalarchives.gov.uk/20100407181417/http://www.hm-treasury.gov.uk/d/Chapter_24_Promoting_Effective_International_Technology_Co-operation.pdf)
9. Weiss, C. and Bonvillian, W.B., Structuring and Energy Technology Revolution, The MIT Press, Cambridge, Massachusetts, 2009.
10. Kempener, R., Bunn, M., Anadon, L.D., Maximizing the Benefit from International Cooperation in energy Innovation. In Anadon et al (eds), Transforming U.S. Energy Innovation. Cambridge University Press, 2014.
11. King, D., Browne, J., Layard, R., O'Donnell, G., Rees, M., Stern, N., Turner, A., A Global Apollo Programme to Combat Climate Change, LSE, 2015. Available on: [http://cep.lse.ac.uk/pubs/download/special/Global\\_Apollo\\_Programme\\_Report.pdf](http://cep.lse.ac.uk/pubs/download/special/Global_Apollo_Programme_Report.pdf)
12. Stine, D.D., The Manhattan Project, the Apollo Program, and Federal Energy Technology R&D Programs: A Comparative Analysis. Congressional Research Service, June 30 2009, 7-5700, RL34645.
13. Foray, D., Mowery, D.C., Nelson, R.R., Public R&D and social challenges: What lessons from mission R&D programs? In Research Policy 41, 2012.
14. Mazzucato, M. Mission-Oriented Innovation Policy: Challenges and Opportunities. Working Paper IPP WP 2017-01, September 2017.
15. Boekholt, P., Edler, J., Cunningham, P., Flanagan, K., Drivers of International collaboration in research. European Commission, 2009.
16. Georghiou, L. Global cooperation in research. In Research Policy 27 (1998) 611-626.
17. See for example Christmann, L., The Inter-American Institute for Global Change Research. In Meeting Global Challenges through Better Governance, International Cooperation in Science, Technology and Innovation. OECD, 2012.
18. Stamm, A., Figueroa, A., Scordato, L., Addressing global challenges through collaboration in science, technology and innovation. In Meeting Global Challenges through Better Governance, International Cooperation in Science, Technology and Innovation. OECD, 2012.
19. <http://mission-innovation.net/wp-content/uploads/2016/06/MI-Enabling-Framework-1-June-2016.pdf>
20. <https://www.reuters.com/article/us-usa-budget-energy/trump-budget-cuts-renewable-energy-office-ups-nuclear-weapons-spending-idUSKBN1FW2MZ>
21. Sanchez, D.L., Sivaram, V. Saving innovative climate and energy research: Four recommendations for Mission Innovation. In Energy Research & Social Science 29 (2017) 123-126.
22. Sanchez, D.L., Sivaram, V. Saving innovative climate and energy research: Four recommendations for Mission Innovation. In Energy Research & Social Science 29 (2017) 123-126
23. Lepori, B., Chassagneaux, Langfeldt, L. Laredo, P., Nedeva, M. Primeri, E. Scordato, L. Reale, E., Institutional logics and actor's strategies in European joint programs, Paper presented at the Science, Technology and Innovation Indicators Conference 2011, Rome, September 2011.
24. Figueroa, A., International Energy Agency Implementing Agreements. In Meeting Global Challenges through Better Governance, International Cooperation in Science, Technology and Innovation. OECD, 2012.
25. IEA, Technology Collaboration Programmes. Highlights and outcomes. OECD, 2016. Available at: <https://webstore.iea.org/technology-collaboration-programmes>
26. Accessed 16 April 2018. <https://ec.europa.eu/energy/en/topics/technology-and-innovation/strategic-energy-technology-plan>.
27. Edler, J. Toward Variable Funding for International Science, in Science Vol. 338 19 October 2012.
28. Inman, M, Sanchez, D.L, Mastrandrea, M.D., Davis, S.J., Fries, K., An unprecedented push for low-carbon energy innovation. Expert perspectives on R&D opportunities for Mission Innovation. 6 June 2016 (Available at: <http://www.nearzero.org/reports/mission-innovation>).
29. <https://energi.di.dk/missioninnovation/pages/forside.aspx>. Accessed 23 April 2018.

Chapter 2

# Executive Summary

By **Birte Holst Jørgensen**, Technical University of Denmark





## International Energy Technology Cooperation

➔ Given the urgency of the energy and climate challenge, the innovation and large-scale adoption of clean energy technologies are the keys to accelerating the clean energy revolution. Cooperation in international energy technology is especially critical if this transformation is to be dramatically accelerated. The question is not whether to cooperate internationally, but rather how much, with whom, on what and how. Therefore, many have welcomed Mission Innovation (MI), a global initiative launched by twenty countries ahead of the Paris agreement in December 2015. The participating countries committed themselves to doubling their governments' clean energy R&D investments over five years and to collaborate on research, capacity-building and the involvement of business. Mission Innovation complements the deployment focus of the Clean Energy Ministerial.

Mission Innovation countries have identified seven Innovation Challenges covering the entire RD&D spectrum on which to focus and to commit resources. Each Innovation Challenge is built around a coalition of interested MI coun-

tries and aims at identifying R&D needs that are not covered by current efforts, promoting opportunities for stakeholders and strengthening collaboration. Since then some initiatives have made more progress than others. Today, Mission Innovation seems to be at a crossroads, with the US reducing its engagement, both politically and administratively.

Nonetheless, Mission Innovation offers the necessary flexibility, allowing for both top-down, mission-driven commitment and bottom-up engagement. New countries have and will become members. The challenge remains how best to support the further consolidation of Mission Innovation. Much can be learned from both previous and ongoing examples of international cooperation in energy technology.

Strong political commitments are needed more than ever to accelerate Mission Innovation and with it international cooperation in energy technology in key Innovation challenges, analytical support and further activities. To support this, a lean, dynamic secretariat is greatly needed and could be located at the IEA alongside the Clean Energy Ministerial.

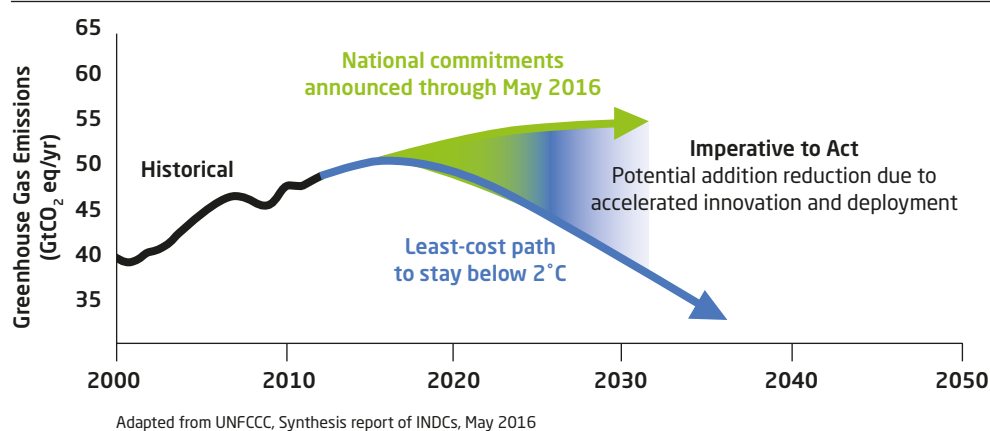

Figure 1. Mission Innovation and national R&D commitments to accelerate innovation and deployment [<http://mission-innovation.net/>]

## Global Outlook on Energy Technology Development

Without major advances in clean energy technology, the Paris agreement to keep global temperatures well below 2 degrees Celsius might lead countries to offer only modest improvements in their future Nationally Determined Contributions (NDC). Even if they fulfil their existing pledges, the globe is likely to warm up by some 2.7 to 3.5 degrees C.

More ambitious policies and actions are needed to keep the global mean temperature increase well below 2 degrees C.

This is explored in various scenarios provided by the IEA. The reference scenario (RTS) presents a major shift away from a business as usual approach, but these efforts will still only limit the temperature increase the 2.7 degrees by 2100. The 2 degrees scenario (2DS) is the central climate-mitigation scenario, one that envisages a highly ambitious and challenging transformation of the global energy system. The newly introduced Beyond 2 degrees scenario (B2DS) explores how far the deployment of technologies that are already available or in the innovation pipeline could take us beyond the 2 degrees C goal in order to achieve net-zero emissions by 2060 and to stay net-zero thereafter.

Some regions need to move faster than others. The EU is expected to have gone net-negative already in 2055. Deep emission cuts can be achieved by using different combinations of supply technologies, improvements to energy efficiency and CCS.

The IEA also tracks the progress of clean energy technologies and assesses whether technologies, savings and emission-reduction measures are on track to achieve the two-degree scenario objectives by 2060. Onshore wind and solar PV, electric vehicles and energy storage are on track towards a transition to sustainable energy. More efforts are needed in offshore wind and hydro-power, while bioenergy, CCS, transport biofuels and renewable heat are not on track at all. Technological progress and disruptive innovations are often linked to the development of materials and new catalysis.

scientific knowledge available across the different disciplines. It also requires new approaches to orchestrate and integrate complex systems into wider socio-economic environments. Therefore, we need to improve our understanding of the capabilities embedded in existing R&D ecosystems. To illustrate this, we have created a network overview of the capabilities of DTU's R&D eco-system in relation to the eight innovation challenges covered in this report. This data-driven analysis provides a glimpse of the complexity of the R&D system. For example, we can observe an increase in R&D collaborations with Asia, which in 2015 exceeded the volume of collaboration with the USA. More generally, we can observe a steady rise in the number and diversity of collaborations.

A mapping of the eight innovation challenges and their relationships shows that the network has a high degree of connectivity both within and between the clusters.

### Networked Capabilities of Sustainable Energy Solutions

Developing new energy technologies requires a systems perspective revealing the connections between the relevant

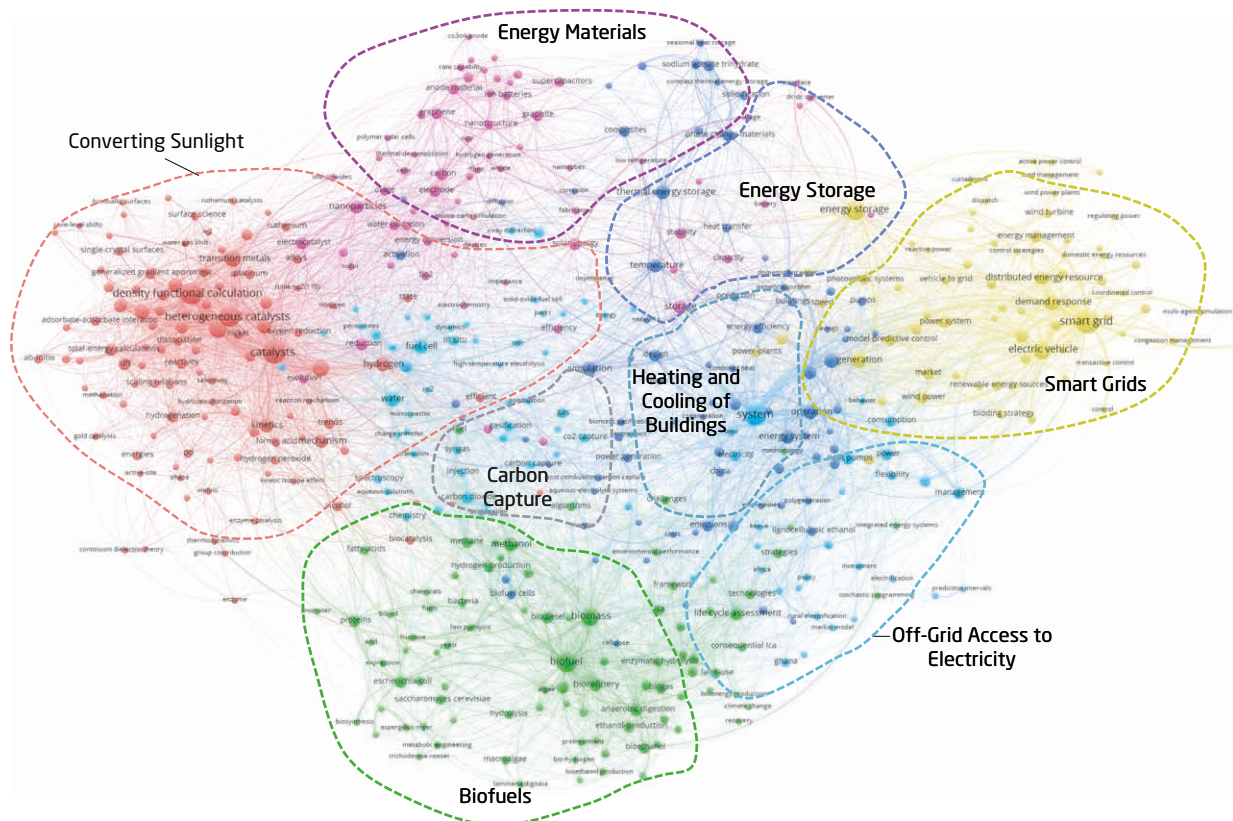

Figure 2. DTU networks associated with Innovation Challenges

The clusters associated with energy storage, heating and cooling, smart grids and off-grid access to electricity are frequently connected to keywords such as systems, integration, behaviour, uncertainty and management. The clusters associated with clean energy materials, converting sunlight, carbon capture and sustainable biofuels are more frequently connected with keywords such as elements and molecules or natural processes, including terms such as graphene, composites, fermentation, catalysts and nanotubes.

## Smart Grids

The smart grids innovation challenge consists in making the electrical grid 'intelligent' through the expansion and/or refurbishment of regional transmission and local distribution grids. The grids of the future must be able to absorb various kinds of strongly fluctuating sources of generation whilst at the same time actively influencing the demand for instantaneous electric power so as to match supply and demand. The key words here are controllability, interoperability and flexibility. Bringing all this together is a major challenge, but there are ample opportunities to do so, hopefully leading to novel solutions and applications. This will require R&D in the following areas:

- *Regional grids.* The large-scale integration of renewable energy sources, including different options for large-scale off-shore wind-power hubs. Further R&D is needed to optimize the operation of regional grids utilizing controllable HVDC connections and to develop novel grid-stabilizing methods in low-inertia systems and new solutions for offshore grids.
- *Distribution grids.* The distribution grid is being transformed from a quasi-passive element in the grid to a system that can be actively operated. Distribution system operations (DSO) need new methods, tools and processes to handle such grids, especially in respect of voltage profiles and congestion management. R&D should also address novel architectures (including DSO markets which allow flexibility to be traded) and aggregation methods to handle demand response.
- *Microgrid.* Microgrids have the ability to provide a high quality of power and to balance it locally by local means. R&D should focus on developing truly consumer-centric solutions, local optimization and energy-sharing based on peer-to-peer methods in energy communities.
- *Cross-cutting.* The development of integrated energy systems brings together a wide range of energy carriers with data systems, water systems and transportation systems. Holistic integrated energy system solutions should be increased. Additionally, big data and analytics, distributed intelligence and other digital solutions should be explored and developed.

## Off-grid Access to Electricity

There are currently 1.1 billion people globally living without access to electricity, 80% of whom live in rural areas, mainly in South Asia and Sub-Saharan Africa. Fortunately, spectacular progress with solar-based off-grid electrification has enabled millions of people to be given access to electricity. This development has been aided by drastically falling solar system prices and new innovative business models by private-sector actors. Also, supportive public initiatives and programmes have facilitated these developments.

There is a consensus that the least-cost option for achieving universal access is to be found in a combination of grid extension, mini-grids and off-grid solutions, and that challenges remain for all three approaches, as follows:

- *Proper planning* is needed in order to delimit the geographical areas for grid extension, mini-grids and off-grid solutions. Governments should take the lead in the planning process and ensure that plans are followed up.
- *A forward-looking, consistent and stable policy and regulatory framework* should be established, including a strong and independent regulatory authority and a level playing field for public and private actors when it comes to having access to subsidies and cross-subsidies.
- *Sufficient financial flows to mini-grid systems* are needed to attract private capital, while still ensuring that tariffs are affordable for the rural poor.
- *Cheaper and higher tiers of energy access* are required for rural households living in dispersed settlements. Government and donor support should be integrated into efforts to reduce the costs for lower income households.
- *Sufficient technical and organisational capacity* should be made available locally to reduce operating and maintenance costs.

## Carbon Capture, Use and Storage

At least a third of global CO<sub>2</sub> emissions can be attributed to point sources with emissions greater than 0.1 Mt CO<sub>2</sub>/yr. Fossil fuels dominate the energy supply today, and even if there is significant growth in renewable energy, they will remain a significant part of the energy mix in the decades to come. Also, heavy industries such as steel, ammonia and cement production will remain large-scale CO<sub>2</sub> emitters. For these reasons, CO<sub>2</sub> capture, utilization and storage are indispensable elements of the clean energy revolution.

*Post-combustion CO<sub>2</sub> capture methods* have been developed over several decades, but further R&D is needed if CO<sub>2</sub> capture, utilization and/or storage are to be implemented on a

large scale. A number of technologies have been matured to the level of pilot scale testing, and a few have been tested in full-scale capture mode at coal- or gas-fired power plants. Detailed modelling of capture processes has simulated and optimized both them and compression processes. Nonetheless, the best processes require close to 10% of the overall power and heat efficiency. The potential for utilization is greatest with enhanced oil recovery or the conversion of CO<sub>2</sub> to chemicals or hydrocarbon fuel.

The different *capture technologies* have different advantages and disadvantages, their applicability depending on the location of the point source. Some new methods, such as metal organic framework absorbents, seem to have a large potential for lower energy costs, but they still need to be developed further.

A *sustainable CCUS value chain* is needed in order for CCUS to be implemented successfully. This requires technological development, as well as the management of environmental performance, risk and economics. In general, the maturation and deployment of CCUS is limited by the lack of proper regulations and the unsatisfactory pricing of CO<sub>2</sub> emissions.

## Sustainable Biofuels

A catalogue of a broad range of biomass and bio-waste conversion technologies for the improved, scalable and cost-effective production of biofuels is available.

In order to improve ethanol yields, further research is needed on the *pretreatment of plant biomass prior to bioprocessing* (physico-chemical pretreatment; enzymatic conversion of cellulose to fermentable sugars; and fermentation of glucose and xylose to ethanol)

*Conversion of biomass by pyrolysis and catalytic hydrolysis* is a matter of converting any lignocellulosic biomass into a liquid bio-oil with a high yield. Bio-oil can be improved by removing oxygen through hydrogenation, after which it can be used as a fuel in the transport sector. Recent research has shown that catalytic hydrolysis improves energy yields in the liquid product more than ethanol from second-generation bio-ethanol processes.

*Gasification of biomass* offers a flexible and efficient platform to convert different types of organic biomass and waste feedstock into, for example, heat, electricity and transport fuels. System performance can be improved by integrating the gasification and pyrolysis of biomass into a number of processes in larger systems. Also, by combining high-temperature electrolysis and thermal gasification with a catalytic converter, it becomes possible to synthesize liquid fuels.

The *enzymatic conversion step* is of significant importance in the processing of cellulosic biomass into fuels. The tech-

nologies involve microbial production, biomass conversion (or degradation) and biorefinery technologies, with new steps for the production of high-value products from side-streams or residues.

*Microbial bioconversion processes* use microbes as catalysts to produce bioenergy and fuels, as well as other products, including biomethane (upgraded biogas), bio-energy (electricity produced in microbial fuel cells) and biofuels (ethanol, biobutanol, biohexanol etc.).

Research efforts in *bioenergy from anaerobic bio-processing* are being directed towards developing more efficient modes of biofuel production from a variety of waste streams. The fermentation of biomass-derived syngas can contribute to increasing the potential of biofuels.

*Advanced biofuels* involve the fungal enzymatic breakdown of biomass and are generated through fungal production. Other systems include advanced biofuels from algae or the use of physical and chemical processes. One major global trend in biomass conversion is that *biorefinery technologies* are being extended so they can convert many new types of biomass. Another trend is the different levels in scaling a biorefinery, from the very big to smaller-scale facilities.

## Converting Sunlight: Power to Fuels and Chemicals

Electrocatalysis is essential to our efforts to discover efficient ways of storing renewable electricity. Being able to store electrical energy as chemical energy would be a most interesting asset in the future energy portfolio, in which conversion back into electricity might be needed. This will also be important in exploring viable alternatives to chemicals produced from fossil-fuel resources.

Although the processes behind electrocatalysis can be powered by renewable energy sources, the catalysts that are currently available are not good enough. Effective catalysts are needed in order to drive electrocatalytic processes, and these are either not good enough or have not yet been identified. For example, nitrogen molecules (N<sub>2</sub>) are bound together very strongly, so it requires a good catalyst before the process can proceed. No such catalyst has yet been found. Regarding the catalysis of water and CO<sub>2</sub>, we are still a long way from a major breakthrough.

A paradigm shift in catalysis research is being pursued. Current research is designed as an interactive loop for the discovery of catalysts. Compared to experimental screening, it is quicker to do computer-aided discovery, thus narrowing down the range of materials of potential interest. This allows the experiments to focus on fewer potentially interesting compounds. And, after characterization and testing, this knowledge is fed back into the screening input,

and a new turn of the cycle takes place. The combination of theoretical and experimental studies has led to the derivation of certain general principles that have improved our understanding of which materials can be used to drive the catalytic process.

One example is the discovery of a new catalyst for fuel cells in which the oxygen reduction reaction caused a large over-potential. Theory and experiment predicted a new class of oxygen reduction catalysts, which, instead of making water, would make hydrogen peroxide. This cannot be used in a fuel cell, but it might be useful for replacing the hydrogen peroxide produced off-site that is used in irrigation systems and for disinfection purposes.

## Clean Energy Materials

The energy transition requires more cost-efficient methods and procedures for the development of the next generation of clean energy materials, i.e. materials that are not only more energy-efficient and cheaper to produce, but also safe and durable, environmentally benign and recyclable, and ultimately reliant on earth-abundant materials to ensure scalability.

However, the traditional, incremental developments of new energy materials are simply not timely enough – rather, the discovery and development of new materials should be accelerated. This was the key message of an international expert working group that outlined the need to establish a *Materials Acceleration Platform* (MAP) with the target of a tenfold increase in the rate of materials discovery.

The cornerstone is *Autonomous Materials Discovery*, that is, “self-sustained” laboratories and production facilities that should possess the autonomous ability to design and synthesize materials, perform and interpret experiments to discover materials, and even predict novel chemical reactions.

The successful application of artificial intelligence (AI)- and machine or deep learning-based techniques has enormous potential. This has been demonstrated in part by, for example, using neural networks in the search for high-performance organic photovoltaic materials.

A so-called Autonomous Research System (ARES) has been developed recently. The AI in an ARES-type system can, for example, extract synthesis conditions directly from the scientific literature, set up and perform atomic-scale computer simulations, and interpret in situ characterization results and data from lab-scale or prototype testing. The models can then be trained to propose suitable synthesis parameters, thus improving the next cycle of computational predictions and materials synthesis.

Many researchers are already playing an important role in

developing key components of the Autonomous Materials Discovery infrastructure. But a coordinated international effort is needed to develop the software and hardware needed to establish a successful Materials Acceleration Platform. Of particular interest is the European Spallation Source and MAX IV, where Autonomous Materials Discovery approaches may be implemented and tested directly.

## District Heating and Cooling Systems

The first district heating plant was built in Denmark in 1903, and today more than 50% of Denmark’s heating demand is covered by district heating, relying on well-established and efficient technologies and practices.

The costs and CO<sub>2</sub> emissions of district heating have been reduced considerably due to temperature reductions in the grids and the more efficient utilization of low-carbon sources, such as solar heating and excess heat from the use of large-scale heat pumps. District heating and cooling systems both have the potential to achieve low-cost decarbonisation of the energy sector through, for example, the low-temperature distribution of district heating, use of excess heat and solar heat, and integration with other parts of the energy sector.

For *low temperature district heating* to be successful, the control of heating systems in buildings must be improved, for example, by reducing the return temperatures from radiators and the forward temperatures for district heating in the grid.

*Heat pumps utilizing ambient heating or cooling and large-scale solar heating* are well known technologies, but significant challenges exist to their large-scale implementation. For large-scale heat pumps, these include improved utilization of excess heat and natural heat sources, new refrigerants, and optimal designs of integrated, multi-stage configurations. For large-scale solar heating, they include improvements to solar collectors, solar collector fields, long-term heat stores and control strategies for heat-storage facilities.

Finally, *better framework conditions* are needed to ensure that barriers are removed and socioeconomically feasible solutions also become economically feasible for the individual consumer. Tapping into the potential benefits of district heating and cooling also requires long-term planning and appropriate regulation, which also facilitates their integration with surrounding energy systems.

## Energy Storage Technologies

Grid stabilization, electric power balancing and fuel for transportation are major challenges in the clean energy system with a high share of fluctuating renewable energy

sources. Flexibility mechanisms can only partly solve these issues, whereas energy storage is becoming increasingly important in providing solutions.

*Flywheels* can deliver frequency stabilization and a short-term auxiliary power service. However, important progress remains in order to bring down costs and improve security.

*Compressed air energy storage* stores electrical energy mechanically. When air is compressed heat is released, causing energy to be lost during the storage operation. R&D efforts should be directed towards improving efficiency by temporarily storing the heat generated during the compression phase and reinjecting it during the expansion phase.

*Rechargeable batteries* are used for various mobile and stationary applications. Li-ion technology has dominated battery sales in recent years, and R&D on Li-ion systems has been going on for a long time. Research has intensified on new battery types (new chemistries), as well as new, cheap organic flow batteries.

The most commonly used electrolyser is the low-temperature (~80 °C) *alkaline electrolysis cell* (AEC). Although AEC electrolysers have been used commercially for decades, more efficient and cost-effective electrolysers should be developed. For low-temperature electrolysers, the hydrogen per volume of electrolyser could be increased by developing zero-gap membranes. Going to higher temperatures and high pressures will improve efficiency, but materials research is needed to achieve long-term stability.

*Polymer exchange membrane electrolyser cells* (PEMEC) were first introduced to overcome some critical issues with alkaline electrolyser cells. PEMECs have great advantages in delivering high-pressure, high-purity hydrogen, but the costs are high, primarily due to the use of Pt and Ru in the electrodes. Research to replace Pt and Ru should be continued.

*Solid oxide electrolysis cells* (SOEC) are already commercially available in the market for CO production, but the costs of hydrogen production from SOEC must be reduced. This will require major improvements in long-term durability and robustness to load variations. Also the manufacturing of cells and stacks should be improved, and the manufacturing steps should be optimized.

*High-temperature thermal energy storage* (600 °C) is a low-cost technology to drive a turbine, which itself can generate electricity. Simple, naturally abundant rocks or firebricks can be used and heated electrically. Once heated, the energy can be stored for long periods, depending on the quality of the insulation. In regions supplied by district heating, this technology is of particular interest because the heat produced by running the turbine can be utilized to supply further heat.

Technological development is ongoing in *latent heat storage*, which is based on phase change materials and is used in connection with solar-thermal power. *Thermo-chemical systems* are still at the research stage and need further development.



Chapter 3

# Global Outlook on Energy Technology Development

By **Kenneth Karlsson**, **Stefan Petrović** and **Diana Abad Hernando**, Department of Management Engineering, Technical University of Denmark





## Introduction

→ The Paris Agreement reached in December 2015 is a global political agreement within the United Nations Framework Convention on Climate Change (UNFCCC). Coming into force in 2020, it deals with issues of mitigation, adaptation and finance relating to greenhouse gas emissions. The aim of the Paris Agreement is to strengthen the global response to the threat of climate change by keeping the global rise in temperature during this century to well below two degrees Celsius above pre-industrial levels and to pursue efforts to limit the temperature increase even further to 1.5 degrees Celsius. All the signatories to the Paris Agreement committed themselves to outlining and communicating their post-2020 plans for reductions in greenhouse gas emissions through “nationally determined contributions” (NDCs), that is, their own self-imposed “promises” or “commitments”. They are also expected to report regularly on their emissions and implementation efforts, as well as to strengthen these efforts in the coming years. To achieve their NDCs, the countries should rely on domestic mitigation options [1].

The NDCs provided for under the Paris Agreement and the officially reported targets to the UN from most countries are not sufficient to achieve greenhouse gas emissions reductions by 2030 that are compatible with the long-term “well below 2°C” ambition. Emissions reductions in the NDCs may, in fact, only add up to one third of the emissions reductions needed to set the world on a least-cost pathway with a 50% to 66% chance of reaching the goal of staying well below 2°C. The Paris Agreement has generated action by both governments and the private sector and has incentivized future action, but that cannot be considered anything more than a very good beginning. To keep the Paris Agreement goals in reach, immediate action is needed in the form of increasing the long-term ambitions of national governments and developing functional and cost-effective technologies [2]. There are still major challenges ahead.

To show how the world can reach certain global climate targets and which clean energy technologies seem to be on track to meet the 2°C Scenario (2DS) targets, the International Energy Agency (IEA) publishes Energy Technology Perspectives (ETP) and Tracking Clean Energy Progress (TCEP) reports. The latest editions of these reports were published in 2017 [3-4], and the present chapter is mainly based on them. We aim to provide an overview of the required development of the future global energy system, arguing for the need to speed up technological development and the implementation of clean energy technologies. Since ETP scenarios are frequently mentioned, they will be introduced in the following paragraphs.

ETP historically published reports based on two scenarios: RTS (Reference Technology Scenario) and 2DS (2 Degrees Scenario). The RTS deals with today’s commitments by national governments to limit emissions and improve energy efficiency, including the NDCs agreed under the Paris Agreement. Therefore, the RTS already represents a major shift from a “business as usual” approach without strong climate policies.<sup>1</sup> These efforts would result in an average temperature increase of 2.7°C by 2100, at which point temperatures would still continue to rise.

The 2DS describes an energy system pathway and a CO<sub>2</sub> emissions trajectory that is consistent with at least a 50% chance of limiting the average global temperature increase to maximum of 2°C by 2100.<sup>2</sup> The 2DS continues to be the ETP’s 2017 central climate mitigation scenario, acknowledging that it envisages a highly ambitious and challenging transformation of the global energy system that relies on a substantially strengthened response compared with today’s efforts.

The newly introduced “Beyond 2 Degrees Scenario” (B2DS) in the IEA’s ETP 2017 explores how far the deployment of technologies that are already available or in the innovation pipeline could take us beyond—read “below”—the 2DS. Technological improvements and their deployment will have to be pushed to their maximum practicable limits across the energy system in order to achieve net zero emissions by 2060 and to stay net zero or below thereafter. Energy sector emissions reach net zero around 2060, supported by significant negative emissions through the deployment of bioenergy with CCS. The B2DS falls within the Paris Agreement’s range of ambition, but it does not aim to define a specific temperature target for “well below 2°C” [3].

## EU and global CO<sub>2</sub> emissions

Two pathways from ETP2017 are presented in the present section. B2DS shows how far known clean-energy technologies could go if pushed to their practical limits, while the RTS is used as a baseline for comparison, reflecting the world’s current ambitions.

The change in EU and global direct CO<sub>2</sub> emissions in the RTS and B2DS scenarios relative to 2014 are presented in Figure 1 [3]. In the RTS, the EU reduces its CO<sub>2</sub> emissions rapidly up to 2025 and then slows down towards 2060. As a result, CO<sub>2</sub> emissions in the EU are more than halved by 2060 relative to 2014. On the other hand, global CO<sub>2</sub> emissions grow modestly until 2045 and stay constant thereafter. In total, this results in about a 16% increase by 2060 relative to 2014. RTS is a scenario which goes far be-

1 The RTS (running to 2060) is roughly commensurate with the New Policy Scenario (NPS)—running to 2040—of the IEA World Energy Outlook.

2 The 2DS (running to 2060) is roughly commensurate with the 450 ppm or Sustainable Development Scenario (SDS)—running to 2040—of the IEA World Energy Outlook.

yond business as usual. It requires significant changes in policy and technologies in the period to 2060, as well as substantial additional cuts in emissions thereafter, yet it still only results in an average temperature increase of 2.7°C by 2100 [3].

In the B2DS scenario, global CO<sub>2</sub> emissions fall dramatically at a constant pace, reaching in 2055 a 95% reduction relative to 2014. In 2060, the world would reach net zero CO<sub>2</sub> emissions. This scenario assumes the utilization of already known technologies without unexpected or unforeseen (disruptive) technological advances, but improvements to and deployments of technologies will have to be pushed to their maximum practicable limits across the energy system based on current expectations and projections.

For the world to attain net zero by 2060, some regions need to move faster than others. In this scenario the EU is expected to have gone net negative already in 2055. The B2DS results are consistent with a 50% chance of limiting average future temperature increases to 1.75°C.

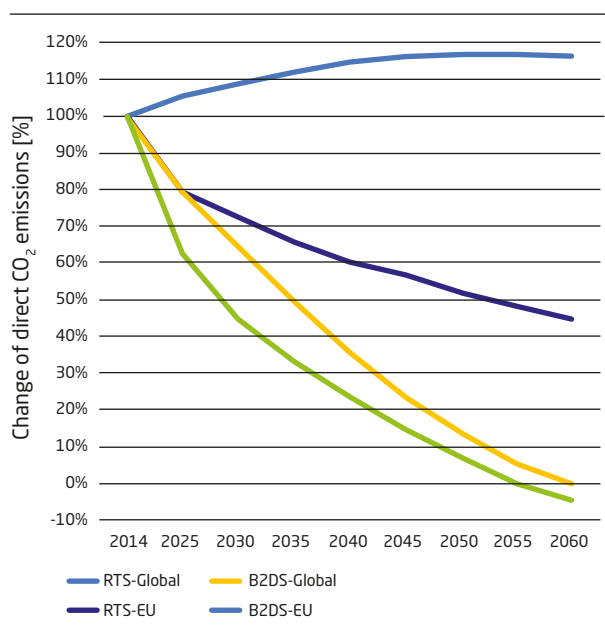

Figure 1. Changes to EU and global direct CO<sub>2</sub> emissions [3]

### Contributions to achieving the “Beyond 2°C” Scenario

The 2DS and the B2DS each set out a rapid decarbonisation pathway in line with international policy aims. To turn the intentions into actual delivery, more ambitious decarbonisation requires much more increased effort and sustained political commitment. The emission reductions in B2DS relative to RTS are presented in Figure 2. As in Figure 1, the

RTS is used as the baseline for comparison while B2DS is presented as ambitious reduction scenario.

Throughout the period analyzed, the difference between 2DS and B2DS originates from different components. End-use energy efficiency improvements, such as heat and electricity savings in households, more efficient vehicles and more efficient industrial processes, are responsible for more than a third of the difference. Additionally, supply from sources of renewable energy becomes very important, especially between 2025 and 2050. Variable renewable energy (VRE) such as wind and solar PV and biomass and waste contribute to the increased use of renewables, being responsible for about a quarter of the overall difference. The contribution from CCS increases steadily from 2025 and grows faster from 2050, ending up being responsible for almost a third of the extra reductions in CO<sub>2</sub> emissions compared to RTS in 2060.

In B2DS, the world reaches carbon neutrality by 2060 and limits future temperature increases to 1.75°C by 2100. This pathway assumes that all available policies are activated throughout the outlook period in every sector worldwide. This will require unprecedented policy action, as well as effort and engagement from all stakeholders.

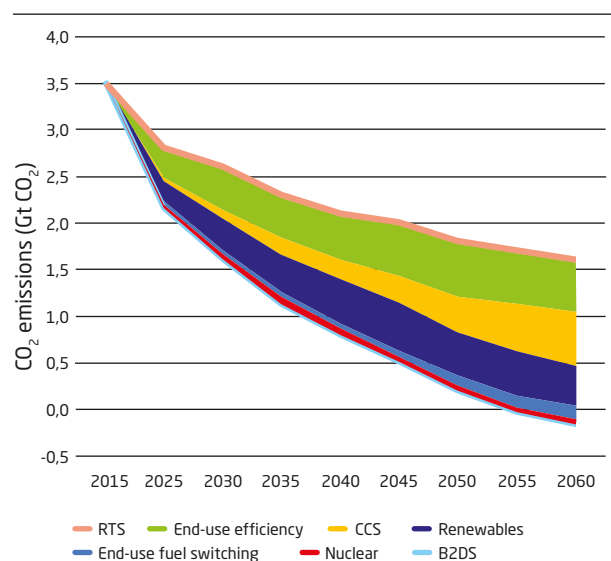

Figure 2. EU emissions reductions (Gt CO<sub>2</sub>) [3]

### Future Energy Mix

#### Primary energy

Deep emission cuts can be achieved using different combinations of supply technologies (renewables and nuclear),

energy efficiency improvements and CCS, as depicted for the EU in Figure 2. Global primary energy supplies in RTS and B2DS are presented in Figure 3.

The most obvious difference between global primary energy supply in RTS and B2DS respectively is its absolute size – in RTS it grows from 569 EJ in 2015 to 843 EJ in 2060, while in B2DS it grows only up to 624 EJ. This difference points to the importance of improvements in energy efficiency.

In RTS, the global use of coal remains constant, while the use of oil grows moderately between 2015 and 2060. In the same period the use of natural gas, which is a less environmentally unfriendly fuel, increases by almost 60%. In B2DS there is a strong fall in coal, oil and natural gas consumption towards 2060 to only 35% of their levels in 2015.

Hydro-power is utilized to its estimated potential in B2DS, but still only covers just above 5% of the global primary energy demand. Hydro-power, especially with storage, can be important for stabilizing and providing flexibility to the electric power grid but it will not be able to provide major quantities of expected primary energy needs in 2060.

The use of other renewables (mainly wind and solar PV) increases by a factor of ten by 2060 relative to 2015 in RTS and twice as much in B2DS. Use of nuclear energy doubles in RTS and triples in B2DS over the fifty-year period. If energy-efficiency measures and renewables fail to contribute in such high amounts as described in B2DS, the need for nuclear energy will be even higher.

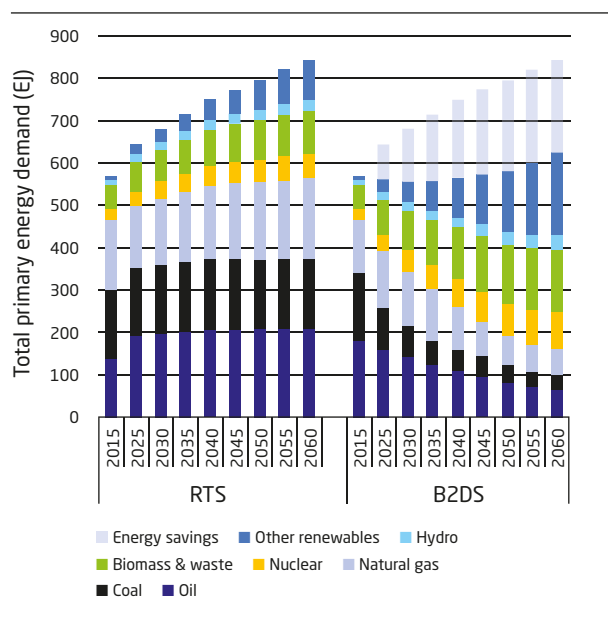

Figure 3. Global primary energy demand in RTS and B2DS [3]

### Electricity production in the B2DS scenario

Significant shares of final energy demand, such as industrial processes, passenger transport, and the heating and cooling of buildings, will be electrified in the future. Therefore, fuel input for electricity production deserves special consideration. Since the production of electricity and district heating is linked in combined heat and power plants, Figure 4 shows fuel input to electricity and district heating generation in B2DS.

Three important messages can be taken from Figure 4. First, fuel input to electricity production in the EU drops between 2014 and 2035 due to the use of more efficient technologies and increases afterwards because of electrification, but it still stays below 2014 levels. In the same period, fuel input to electricity production globally grows by 75% because of reductions in energy poverty in developing countries and rapid economic growth in emerging economies.

Secondly, not all fuels are equally important worldwide. Biomass, wind and nuclear energy are more important in the EU than in the rest of the world. On the other hand, solar CSP and geothermal energy are more important outside the EU. Thirdly, the EU is abandoning the use of fossil fuels much faster than the rest of the world. Figure 4 shows that the EU needs to stop using oil for electricity production by 2025, coal in 2030 and natural gas in 2050. Globally, coal and natural gas remain important due to continued investments in new plants many years ahead. The fossil fuel-based electricity and heat production in B2DS drop from 80% in 2015 to 5-6% in 2060 globally.

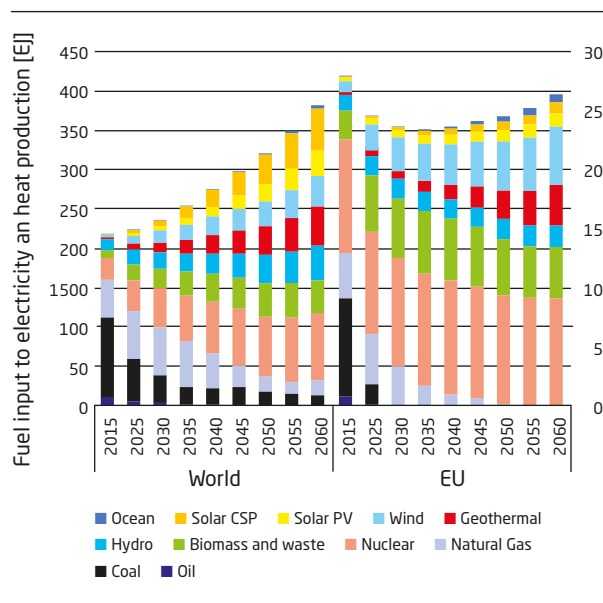

Figure 4. Fuel input to electricity and district heating generation in B2DS [3]

### Tracking Clean Energy Progress

The IEA's Tracking Clean Energy Progress (TCEP) report examines the progress of a variety of clean energy technologies [4]. For each technology, TCEP identifies key measures to scale up and drive development further to achieve a more sustainable and secure global energy system. To benchmark current developments, TCEP uses interim 2025 benchmarks set out in the 2DS, as well as the milestones identified in the IEA Technology Roadmaps. As a result, TCEP assesses whether technologies, energy savings and emission reduction measures are on track to achieve the 2DS objectives by 2060. TCEP uses a traffic light evaluation – green technologies are on track, orange ones need further improvement, and red ones are not on track at all to meet the 2DS targets.

A summary TCEP is presented in Figure 5. Three groups of technologies are on track towards a transition to sustainable energy: mature variable renewables (onshore wind and solar PV), electric vehicles and energy storage. These technologies currently represent a small part of the global energy system, but they are developing rapidly, and their numbers are rapidly increasing, so it can be expected that they will soon become mainstream energy technologies. The “on-track” status of these three technologies depends on

the contribution of the remaining technologies. If “orange” and “red” technologies fail to perform at the expected level, “green” technologies will need to over-perform to compensate. For example, the net annual capacity of nuclear power needs to double to compensate for the planned retirements, while natural gas-fired power plants need to improve efficiency and flexibility to be able to serve as a short-term, lower-carbon alternative to coal. To be fully on track to reach 2DS goals, offshore wind generation needs to triple between 2020 and 2025, while hydropower capacity needs to increase as well. However, newly added offshore wind capacity in 2016 declined by a quarter compared to the previous year, and newly added hydropower capacity declined for the third consecutive year. If these trends continue, “green” technologies will have to perform even better, otherwise the 2DS targets will not be reached.

“Red technologies” such as CCS, biofuels and renewable heating have a large potential and important roles in reaching 2DS goals by 2025, but the potential remains unutilized, i.e. they are currently “not on track”. To reach 2DS goals, CCS facilities need to store over 400 MtCO<sub>2</sub> in 2025, while the production of renewable heat needs to grow from 14 EJ in 2014 to 18.5 EJ in 2025.











On track	Solar PV and onshore wind 	Energy storage 	Electric vehicles 		
Improved, but more effort needed	Offshore wind and hydropower 	Nuclear power 	Natural gas-fired power 		
Not on track	Bioenergy, CSP geothermal 	Carbon capture and storage 	Coal-fired power 	Transport biofuels 	Renewable heat 

Figure 5. Summary of Tracking Clean Energy Progress [4]

## Conclusion

Looking at what is needed to reach a world well below 2°C, and taking into account recent progress in the transition, the importance of Mission Innovation challenges is clearly emphasized.

As outlined in ETP and TCEP, the energy system transition cannot be handled by a single technology or a single region. The effort needs to be global, it needs to be spread over a variety of energy technologies, and it requires several innovation challenges to be successful.

The Smart Grid Innovation Challenge relies on energy storage, on/off grid operations, the integration of large amounts of decentralized renewable power in distribution networks, and the development of technologies at the level of consumers for purposes of demand-side management. Most of the technologies in this challenge are on track (onshore wind, PV, storage, EV's), but for the real smart-grid challenges, i.e., system integration, new market design and regulation, more effort is needed. Chapter 5 focuses on smart grid solutions, and energy storage facilities are treated separately in Chapter 12.

The Off-grid Access to Electricity Innovation Challenge overlaps in its solutions with the Smart Grid challenge, but it has a greater focus on smart small-scale grid management technologies and efficient DC appliances, as well as on local implementation conditions. This innovation challenge is discussed in Chapter 6.

Carbon Capture and Storage, or CCS, is an important solution in a world well below 2°C. Therefore, one critical observation is that this technology is not at all on track. Technological development and investments need to be ramped up dramatically. To go from the RTS scenario to B2DS, CCS technologies are expected to be responsible for one third of the reductions in CO<sub>2</sub> emissions. The more this technology is delayed, the lower the probability of reaching the well below 2°C world. The CCS challenge is analyzed in Chapter 7.

“Production of sustainable biofuels” will be crucial, mainly to supply a growing transportation sector, but also for backup electrical power supplies, heating and industrial processes. Nonetheless, investments globally are not happening at the pace needed, and production prices have to come down. Chapter 8 analyses the role of advanced biofuels and their links with food and material production, while Chapter 9 focuses on converting sunlight into fuels (Power to X).

Technological progress and disruptive innovation are often linked to the development of new materials. The Clean Energy Materials Innovation Challenge is treated in Chapter 10.

TCEP outlined renewable heating as one of the sectors with large unutilized potential which needs to be exploited to reach the 2DS target and beyond. The Affordable Heating and Cooling Innovation Challenge is addressed in Chapter 11.

# References

---

1. United Nations on Climate Change. The Paris Agreement. United Nations Framework Convention on Climate Change (UNFCCC); 2015. Available from: [http://unfccc.int/paris\\_agreement/items/9485.php](http://unfccc.int/paris_agreement/items/9485.php)
2. United Nations Environment. The Emissions Gap Report. United Nations Environment Programme (UNEP); 2017. Available from: <https://www.unenvironment.org/resources/emissions-gap-report>
3. International Energy Agency. Energy Technology Perspectives 2017. Available from: <http://www.iea.org/etp2017/summary/>
4. International Energy Agency. Tracking Clean Energy Progress 2017 (TCEP). Available from: <http://www.iea.org/publications/freepublications/publication/TrackingCleanEnergyProgress2017.pdf>



Chapter 4

# Networked Capabilities for Sustainable Energy Solutions

By **Pedro Parraguez** and **Anja Maier**, Department of Management Engineering,  
Technical University of Denmark





## A network overview of sustainable energy capabilities



The research, development and deployment of large-scale sustainable energy solutions is one of the greatest social challenges of our time. Tackling this challenge requires a systems perspective revealing the connections between the wealth of relevant scientific knowledge available across the natural engineering and social sciences. It also requires new approaches to orchestrate and integrate complex systems into uncertain environments while simultaneously taking regulations, economic concerns and changes in human behaviour into account.

For these reasons, now more than ever we need to leverage and develop further all the potential of R&D ecosystems effectively and efficiently. To do so, we propose to start by understanding the capabilities embedded in existing R&D networks and the connections between the resources and the knowledge that those networks already contain.

To illustrate this with a concrete example, this chapter provides a network overview of the capabilities that are available through DTU's R&D ecosystem to research, develop and deploy clean energy solutions. To provide this overview, this chapter offers a data-driven system analysis of the eight energy challenges covered in this report. These challenges are inspired by Mission Innovation (2017) and consist of "Smart Grids", "Off-Grid Access to Electricity", "Carbon Capture", "Sustainable Biofuels", "Converting Sunlight", "Clean Energy Materials", "Affordable Heating and Cooling of Buildings" and "Energy Storage".

## Challenges and opportunities

Due to the rapid development of highly specialised technologies, mounting environmental challenges and heightened competition, there is increased pressure to develop more sustainable energy solutions [2; 3]. For individual companies acting on their own, it is often impossible to improve, develop and/or deploy new energy solutions. The growing consensus appears to be that sustainable energy solutions require concerted inter-organisational efforts to combine existing resources and capabilities [4–6]. In fact, several industrial practices connected to the inter-organisational development of cleaner and more sustainable production systems have been identified [e.g. 7; 8]. Such multi-stakeholder industrial practices include projects described as industrial symbiosis, circular economy, eco-industrial parks, eco-clusters and sustainable supply chains, as well as other initiatives described as green partnerships and ad-hoc collaborations aimed to support sustainable energy. More generally, outside the cleaner production domain, these types of multi-stakeholder practices can be framed as open innovation projects, joint ventures, alliances, and other forms of inter-organisational collaborative projects [e.g. 9; 10].

Among the many technology sectors connected to the development of more sustainable energy systems are energy efficiency, energy storage, carbon capture, heating and cooling, intelligent energy, smart grids, wind, solar and other renewable energies, and bioenergy [11; 12]. This industrial landscape constitutes a diverse set of evolving interlocked technologies and organisations, which are unfortunately often misrepresented by the currently rigid industrial categorisation schemes and traditional industrial cluster analyses [13–15].

To foster the development of new sustainable energy solutions, numerous national and international innovation networks, cluster organisations, associations and funding programmes have been created. These initiatives are supported by industry, the public sector and non-governmental organisations (NGOs) with the purpose of facilitating information flow, coordination and access to resources [16]. Recent examples of such initiatives include multi-stakeholder partnerships by the United Nations to support fulfilment of the Sustainable Development Goals, the Danish project "Complex Cleantech Solutions" and its successor "CLEAN Solutions", UNIDO's "Global Cleantech Innovation Programme", the European Union's "Climate Knowledge and Innovation Community" (Climate KIC), Innoenergy and the "Sustainable Energy for All" initiative, to name just a few.

Despite the potential envisaged, the resources invested and the broad public and private backing that inter-organisational support initiatives receive, both the companies participating in these projects and the organisations supporting such initiatives report problems related to the challenge of developing inter-organisational projects and identifying capabilities to fill technological gaps in a timely manner [2;17]. Recurrent problems include a limited overview of the industrial landscape of technological capabilities [18; 19], difficulties in finding and assessing collaboration partners based on capability complementarities [20; 21], difficulties in both intra- and inter-organisational cross-disciplinary collaboration [22], and tensions between intellectual property rights and open collaboration [23]. These problems are not always related to the exchange of materials or energy per se, but rather to the exchange of information and non-material resources in the form of knowledge, know-how and technologies [10; 24]. As a consequence, we see an increased need for a more systematic mapping of the capabilities found in R&D ecosystems in order to achieve a better overview of the networks of technologies, knowledge and know-how that are available for solving complex socio-technical problems such as the development and implementation of new sustainable energy solutions.

In this context, R&D ecosystems can be described as sets of research and development organisations embedded in a network and characterised by inter-organisational relations, shared objectives, shared resources and/or exchanges of materials, energy and information. Relations that can lead to

beneficial interactions and inter-dependencies among the participating organisations and their environment [25].

### Mapping DTU's R&D ecosystem of sustainable energy solutions

To better understand the capabilities available to research and develop sustainable energy solutions and to map the relationships between the eight challenges, we have analysed DTU's energy-related solutions through a curated data set of more than 740 ISI publications, sixteen patents, and thirty EU-funded projects ranging from the 5th Framework Programme (FP5) to Horizon 2020. All of these records have at least one participant from DTU and include content relevant to at least one of the eight sustainable energy challenges explored in this report.

The procedure for filtering relevant publications, patents and EU projects consisted in applying a global content filter to each of the three databases (publications, patents, projects), followed by a manual screening of the results to discard false positives. In Boolean form, the keyword-based search used for this study was:

“Smart Grid” OR (“off-grid” AND electric\*) OR “carbon capture” OR “biofuel” OR “convert sunlight” OR “solar energy” OR “energy materials” OR [(heating OR cooling) AND (affordable OR cheap OR sustainable)] OR “energy storage” OR “smart energy” OR (“mini-grid” AND electric\*) OR (“micro-grid” AND electric\*) OR (catalysis AND energy) OR “solar fuels” OR “integrated energy systems” OR “energy system analysis” OR “energy access” OR electrification OR (electricity AND “developing countries”) OR “solar home systems”.

The results of this search, although not exhaustive, provide records from diverse sources and fields large enough to allow a representative overview of content and collaborations over the last twenty years. In total, these records connect DTU with more than 55 countries and 500 organisations. Figure 1 provides a visual summary of the diverse set of regions and organisations that has formed part of DTU's sustainable energy R&D ecosystem since 2005.

The main question explored in Figure 1 is, what have been DTU's collaborations in the area of sustainable energy solutions, and how are they distributed geographically and over time?

In Figure 1, we can observe the growing relevance of collaborations with Asia, which in 2015 exceeded the volume of collaborations with the United States. We can also observe a steady rise in the number and diversity of collaborations, indicating an increasingly complex R&D ecosystem. For example, from 2010 onwards, the primary pool of countries and organisations changes from being mainly associated with developed European countries to a much broader base that includes Asia, southern Europe, the United States and several emerging countries. This trend reflects an expansion in the number of research areas covered, increased ambition levels and the significant increase of R&D investment in this area by both developed and developing countries, a trend that is corroborated by the latest world figures in the “Global Trends in Renewable Energy Investment Report” [26].



DTU's collaborations: Geographical distribution

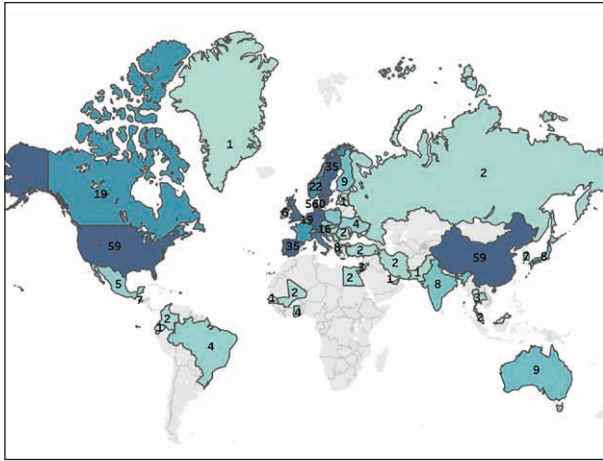

DTU's collaborations: Evolution of records over time

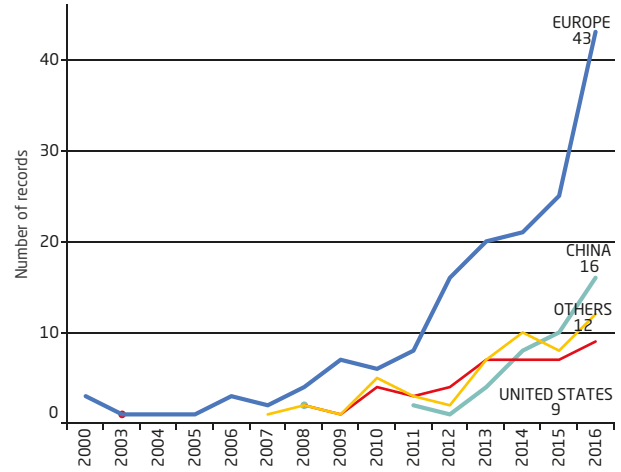

Treemap of DTU's most frequent collaborations by number of records

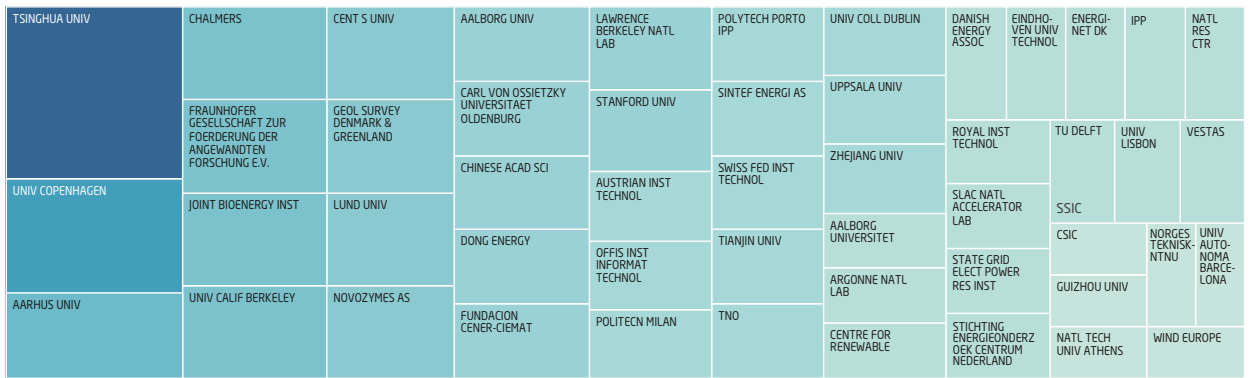
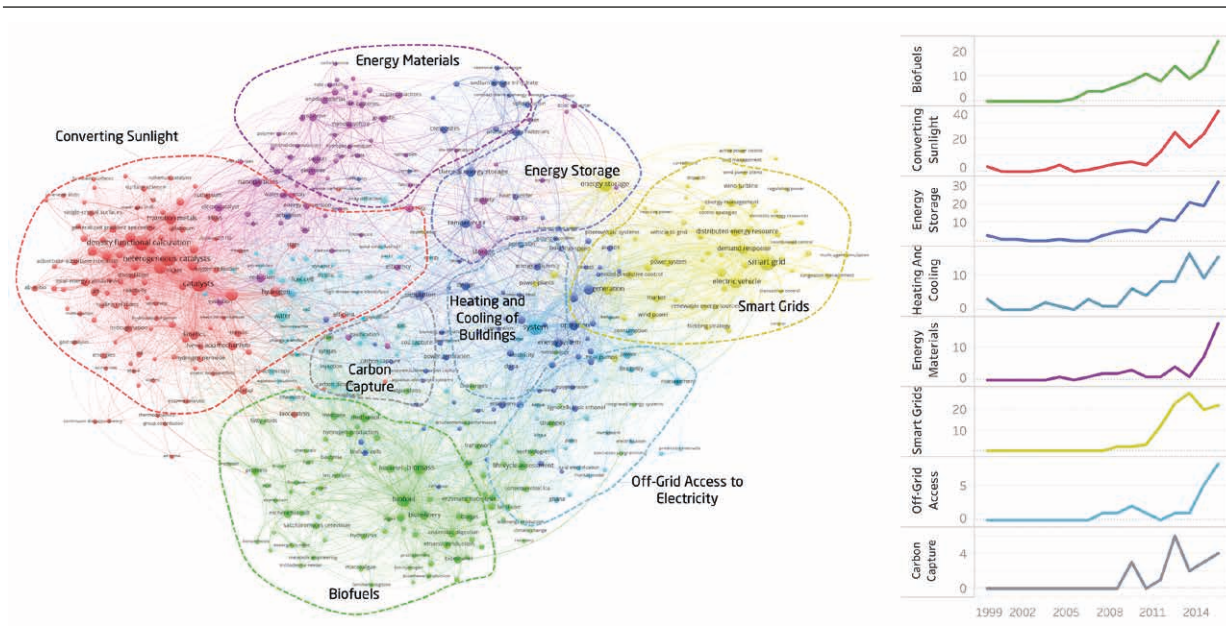

Figure 1. The top left panel shows the geographical distribution of DTU collaborations on the world map. The numbers show the records associated with each region. The top right panel plots the number of records over time per geographical region. The bottom panel shows a tree map with the most frequent collaborations over time. The size represents the number of records connected to each organisation.

### Mapping the eight sustainable energy challenges and their relations

To identify and map the relations between the eight sustainable energy challenges, we performed a content co-occurrence analysis, following the method described by Van Eck and Waltman [27]. In this analysis, DTU’s R&D ecosystem is modelled as a network. The nodes are keywords extracted from the content of each record in our database. In our case, after normalising the keywords, we gathered over 4,000 terms. The edges between the keywords represent co-occurrence relations, of which we reach over 25,000 links. Here, a connection between two keywords exists if they are mentioned together in at least one record. The more frequently two keywords are mentioned together, the stronger the connection between them.

As the whole analysis was performed on the previously filtered database, we know that each record is relevant for at least one of the challenges. In order to identify areas in the network that are primarily associated with one or more of the challenges, we performed a cluster analysis using Waltman, Van Eck, and Noyons’s [28] method to cluster bibliometric networks. Each cluster represents a topic area, where the connections between the keywords are stronger within the cluster to which they are assigned than between other clusters. Having identified the main clusters, a qualitative inspection of the collection of keywords in each cluster allows the clusters to be mapped to each of the eight challenges. As a result, the left panel in Figure 2 shows the relations between the eight challenges as a network, while the right panel plots the main keywords associated with each challenge as an evolution across a fifteen-year timespan.



**Figure 2.** Left panel: network of keywords and co-occurrence relations between those keywords. The size of the nodes represents the frequency of each keyword. The colours show the keyword clusters that are used to identify areas of the network associated with the eight challenges. Right panel: evolution over time of each challenge in terms of the raw frequency of the main keywords associated with the respective challenge.

Through the cluster map in the left panel of Figure 2, we see that there is only one network component with high connectivity within and between the clusters. This can be taken as a sign of the strong topical ties between the eight challenges in DTU's overall R&D ecosystem. We also found that, if we divide the network into two sides, some interesting patterns emerge.

The right side of the network concentrates challenge areas where research and development often interface with policy, human behaviour, regulations and large engineering-system integrations. For example, the clusters on the right side, associated with the challenges of energy storage, heating and cooling, smart grid and off-grid access to electricity, are frequently connected to keywords such as systems, integration, behaviour, uncertainty and management. Another interesting feature of this region is the position that energy storage occupies between smart grids and clean energy materials. This can be explained by the dependencies between different energy storage solutions, the advanced new materials required to make them possible, and the implications of this for the future of the overall energy grid. Such dependencies influence aspects such as the degree to which the energy grid becomes more or less centralised, which in its turn is contingent on the existence of competitive distributed energy storage solutions.

The left of the network concentrates challenge areas where research and development often interface with the natural

sciences, including the life sciences, physics and chemistry. For example, the clusters on the left associated with the challenges of clean energy materials, converting sunlight, carbon capture, and sustainable biofuels, are more frequently connected with keywords that reference elements, molecules or natural processes, including terms such as graphene, composites, fermentation, catalysts and nanotubes. This left side of the overall network can be divided further into an upper and a lower side. The upper side is mostly connected to disciplines such as material science, physics, nanotechnology and photonics. In turn, the lower side is connected to disciplines such as bioengineering, chemical engineering and bio-sciences. For example, within DTU's R&D ecosystem, a large area of research on converting sunlight takes the form of advances in electrocatalysis and photocatalysis that are of interest for sustainable energy conversion and fuel production. In terms of the different clusters and their mapping on to Mission Innovation challenges, energy materials are strongly connected to both energy storage and converting sunlight, making it hard to distinguish a clear unique boundary. This is due to the important enabling role that energy materials play in both challenge areas.

In terms of the evolution over time of the topics associated with each of the eight challenges (right side of Figure 2), we can identify two groups: one group that contains records dating back to 2000, shown in the first five challenges from top to bottom; and a second group that contains the remain-

ing three challenges from top to bottom, where the first records start appearing around 2008. Within each of these two groups, the patterns are relatively similar. With the exception of the heating and cooling of buildings, the first group is mostly connected to the challenges of energy production and storage. In turn, the second group is about the delivery of energy, using more efficient and effective grids, and the challenge of capturing CO<sub>2</sub>, not only to mitigate current emissions, but to reduce the overall accumulated stock of CO<sub>2</sub>. In this way, this temporal progression appears to follow a natural increase in ambitions and R&D investment at DTU.

Beyond the features for each region of the network and their dynamics reported above, it is important to note that the eight challenges are highly interconnected. The differences identified are changes within a spectrum, rather than features that can be easily allocated to independent science fields or technologies. Research areas involved range from fundamental research on new energy materials and studies of metabolic pathways at the cellular level, all the way to the deployment of smart energy grids and the study of decision-support systems to ease the adoption of best energy

practices. Furthermore, we have shown that the eight challenges come together as part of an entire R&D ecosystem that allows sustainable energy to be developed and delivered at scale.

## Conclusion and highlights

The data-driven exploration of DTU's R&D ecosystem for sustainable energy solutions presented in this chapter provides a glimpse into the complex processes and interactions that allow us to research, design and deploy new energy solutions. It highlights the overall connectedness between the eight sustainable innovation challenges and the importance of applying a system perspective in connecting scientific fields and technologies. Furthermore, the socio-technical characteristics of the knowledge and technologies required to move from research to real-world impacts are explicitly visualised. Evidence of this is shown through the integration into one and the same network that covers the spectrum of the natural and engineering sciences, as well as elements of the social sciences.

# References

---

1. Mission Innovation. Mission Innovation Challenges: Progress and Highlights. 2017.
2. OECD. OECD Studies on Environmental Innovation Better Policies to Support Eco-innovation. OECD Publishing; 2011. 304 p.
3. OECD / International Energy Agency. Nordic Energy Technology Perspectives. Paris; 2016.
4. Roscoe S, Cousins PD, Lammig RC. Developing eco-innovations: A three-stage typology of supply networks. *J Clean Prod.* 2016;112:1948-59.
5. Schiller F, Penn AS, Basson L. Analyzing networks in industrial ecology - A review of Social-Material Network Analyses. *J Clean Prod.* 2014;76:1-11.
6. Dovi VG, Friedler F, Huisingh D, Klemeš JJ. Cleaner energy for sustainable future. *J Clean Prod.* 2009;17(10):889-95.
7. Van Bommel HWM. A conceptual framework for analyzing sustainability strategies in industrial supply networks from an innovation perspective. *J Clean Prod.* 2011;19(8):895-904.
8. OECD. Eco-innovation in industry: enabling green growth. Paris: OECD; 2009. 276 p.
9. Gulati R, Gargiulo M. Where Do Interorganizational Networks Come From? *Am J Sociol.* 1999 Mar;104(5):1439-1438.
10. Hagedorn J. Understanding the rationale of strategic technology partnering: interorganizational modes of co-operation and sectorial differences. *Strateg Manag J.* 1993;14(January 1992):371-85.
11. State of Green. State of Green Cleantech Registry [Internet]. 2017 [cited 2017 Feb 22]. Available from: <https://stateofgreen.com/en>
12. Gray M, Caprotti F. Cleantech clusters and the promotion of the low carbon transition: criteria for success and evidence from Copenhagen, Masdar and online platforms. *Carbon Manag.* 2011;2(5):529-38.
13. Salerno M, Lambkin A, Minola T. Key Success Factors in supporting Clean Tech start-ups: A General Framework and an Italian experience. In: Laudon, M and Laird, DL and Romanowicz B, editor. *Clean Technology 2009.* 2009. p. 385-8.
14. Parad M. The Global Cleantech Innovation Index 2014. 2014.
15. Andersen JW, Parraguez P, Maier AM. Net-Sights: Network Insights for Collaborative Sustainable Production – A Practical Guide. Copenhagen; 2016. 52 p.
16. Senge PM, Lichtenstein BB, Kaeufer K, Bradbury H, Carroll JS. Collaborating for systemic change. *MIT Sloan Manag Rev.* 2007;48(2):44-53+92.
17. Waddell S. Societal Change Systems: A Framework to Address Wicked Problems. *J Appl Behav Sci.* 2016 Dec 1;52(4):422-49.
18. Prašnikar J, Lisjak M, Buhovac AR, Štemberger M. Identifying and Exploiting the Inter relationships between Technological and Marketing Capabilities. *Long Range Plann.* 2008;41(5):530-54.
19. Lall S. Technological capabilities and industrialization. *World Dev.* 1992;20(2):165-86.
20. Parraguez P, Maier AM. Network Insights for Partner Selection in Inter-organisational New Product Development Projects. In: Dorian M, Mario S, Neven P, Nenad B, editors. *Proceedings of International Design Conference, DESIGN.* Dubrovnik, Croatia; 2016. p. 1095-104.
21. Büyüközkan G, Arsenyan J, Büyüközkan G, Arsenyanb J. Collaborative product development: a literature overview. *Prod Plan Control.* 2011;(March 2012):37-41.
22. Jeffrey P. Smoothing the Waters: Observations on the Process of Cross-Disciplinary Research Collaboration. *Soc Stud Sci.* 2003;33(4):539-62.
23. Blomqvist K, Hurmelinna P, Seppänen R. Playing the collaboration game right - Balancing trust and contracting. *Technovation.* 2005;25(5):497-504.
24. Mirata M. Experiences from early stages of a national industrial symbiosis programme in the UK: Determinants and coordination challenges. *J Clean Prod.* 2004;12(8-10):967-83.
25. Ruth M, Davidsdottir B. The dynamics of regions and networks in industrial ecosystems. Edward Elgar; 2009. 238 p.
26. UNEP Collaborating Centre for Climate and Sustainable Energy Finance. *Global Trends in Renewable Energy Investment 2017.* 2017.
27. Van Eck NJ, Waltman L. *Visualizing Bibliometric Networks. Measuring Scholarly Impact.* 2014. 285-320 p.
28. Waltman L, Van Eck NJ, Noyons ECM. A unified approach to mapping and clustering of bibliometric networks. *J Informetr.* 2010;4(4):629-35.



Chapter 5

# Smart Grids Innovation Challenge

“to enable future grids that are powered by affordable, reliable, decentralised renewable electricity systems”

By **Jacob Østergaard**, **Tilman Weckesser**, **Daniel Esteban Morales Bondy**, **Per Nørgaard** and **Pierre Pinson**, Department of Electrical Engineering, Technical University of Denmark  
**Luciano Martini**, Ricerca sul Sistema Energetico - RSE SpA  
**Henrik Madsen**, Department of Compute, Technical University of Denmark





## The future grid



The *smart grids innovation challenge* consists in making the electrical grid ‘intelligent’ through the expansion and/or refurbishment of regional transmission and local distribution grids, considering their controllability and flexibility as the main focus. Indeed, the envisaged grids must be able to absorb various kinds of highly fluctuating sources of generation while at the same time trying to actively influence instantaneous electric power demand so as to match supply and demand. The integration of electrical storage would aid significantly in balancing the demand and generation. Clearly, the controllability of smart grids will have to be enabled by modern communication and data management methods. The key words are controllability, interoperability and flexibility. Bringing all this together is a major challenge, but it also presents ample opportunities hopefully leading to novel solutions and applications not envisaged hitherto.

In addition, due to developments in IoT, sensor technologies, and data management capabilities, data from various parts of the energy system are becoming available on a massive scale. The development of energy technologies, combined with the smart use of data through novel computational and analytical methods, makes possible entirely new business models and ways of designing and operating the energy system in the direction of a smarter system based on decarbonization, digitalization and decentralization.

For convenience of discussion, the concept of ‘smart grids innovation’ can be subdivided into the following areas of innovation (the same division is used in the Mission Innovation Challenge #1 Smart Grids):

1. Regional grids (large-scale interconnected high-voltage grids)
2. Distribution grids (local grids connecting customers)
3. Microgrids (locally optimized grids)
4. Cross-cutting innovations

In the following, some of the major trends in development within each of these areas are outlined, and the associated research needs and opportunities are identified.

## Regional grid innovation

### Large-scale renewable energy resource (RES) integration

To enable the large-scale integration of RES (see Figure 1), one of the solutions being considered are long-distance high-voltage (transnational or interstate) ‘regional’ grids. Large amounts of RES are located remotely, often offshore, and thus far away from load centers. Moreover, the power generation of most RES varies and is affected by prediction uncertainties [1]. This gives rise to two major issues for

large-scale RES integration, namely the necessity to balance fluctuations in RES power generation, and long-distance transmission from remote locations to the load centers. Regional grids can potentially solve both issues, or at least help to resolve them [2].

Furthermore, studies have shown that developing regional grids instead of locally reinforcing existing grids is more cost-effective. On the European level, it has been estimated that a regional grid could save 6-8 billion EUR in comparison to solutions where the existing AC networks are locally reinforced [4].

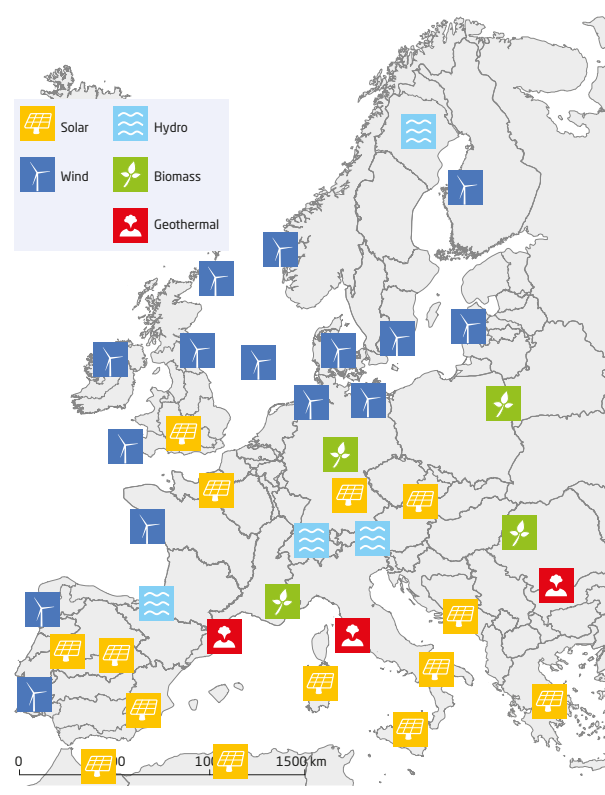

Figure 1: Renewable energy resources in Europe (inspired by [3])

For Europe to fulfill its commitments under the Paris climate agreement (COP21), according to a study [5] approximately 230 GW of offshore wind-power capacity need to be developed. Various long-term scenarios estimate that installed offshore wind-power capacity in the North Sea will reach 70-150 GW by 2040 [6].

To enable such large-scale offshore integration of RES, it has been suggested that offshore wind-power hubs should be developed and built on artificial islands (Figure 2) [7]. It is estimated that one or more wind-power hubs could accommodate up to 70-100 GW of offshore wind power.



Figure 2. North Sea wind-power hub (left) and possible location in the North Sea (right) (figure adopted from [7])

A multi-terminal high-voltage direct-current (HVDC) offshore grid or multiple point-to-point HVDC offshore connections can be used to connect the Wind Power Hubs to the mainland of the surrounding countries, as well as form interconnections between these countries. In such arrangements, the offshore collection grid could be realized by an HVDC or AC grid. Several options are possible.

*Option 1.* The wind-power hub is connected through point-to-point HVDC connections to the mainland, while on the island a collection HVAC grid is used to connect the wind farms. Due to the lack of any synchronous generators in the collection grid, the offshore AC system has zero inertia. In order to realize such a system, new concepts for grid-forming inverters and robust controls for zero-inertia AC systems will have to be developed.

*Option 2.* Instead of operating the offshore AC grid as a zero-inertia system, dedicated components for the provision of inertia could be installed on the island. The required inertia level of such an AC system and which components are most suitable for providing or emulating inertia are issues that still require investigating.

*Option 3.* A multi-terminal HVDC offshore grid can be used to connect the wind-power hubs to the mainland, as well as the different countries to each other. In this arrangement, the offshore collection grid could also be realized by HVDC. In order to realize a multi-terminal HVDC grid, different grid layouts (e.g. radial or meshed) and reliable control strategies will have to be investigated.

### Varying-inertia power systems

Large-scale RES will displace centralized conventional power generation, which provides crucial system services such as frequency and voltage control.

For example, in response to an emergency resulting in an excess of power consumption over generation, the conven-

tional generators release some of their kinetic energy and provide inertia to the system, which limits the rate of change of frequency, allowing control systems to act. Most RES, however, are connected through power electronics and thus do not inherently provide inertia.

The variability of solar radiation and wind will result in greatly altering generation patterns, with varying shares of converter-connected RES and conventional generation. For this reason, system inertia will change in both size and geographical distribution over time. A study of the Nordic Transmission system operator estimates that, in the Nordic synchronous area in 2025, the system kinetic energy could be as low as 80 GWs in low load conditions and as high as 313 GWs in high load conditions [8].

### Need for R&D and innovation

In order to ensure stable and reliable system operation for a wide range of system conditions and generation patterns, new robust approaches to systems control need to be investigated. These will enable RES-based power generation to provide system services such as synthetic inertia or, quite simply, fast frequency control [9][10].

### HVDC and interconnection

In recent years, a growing number of HVDC transmission lines have been installed. HVDC connections can play a key role in the efficient and stable operation of the future system. They offer the unique capability to control active power flows, and the voltage source converter (VSC) type even allows the independent regulation of active and reactive power. Moreover, due to their ability to transfer power over long distances and interconnect asynchronously operated power systems, HVDC links enable the coupling of different electricity markets.

If these opportunities are harnessed efficiently, HVDC links can provide the necessary additional flexibility to guarantee the secure and market-efficient operation of future power

systems. On the European level, it was estimated that an overlay HVDC super grid could save 6-8 billion EUR [4].

**Need for R&D and innovation**

In order to utilize the full potential that HVDC connections offer, new approaches are needed to integrate the capabilities of HVDC links fully into the operation of coupled electricity markets. Also, novel methodologies must be developed for the optimal operation of mixed AC/DC power systems, which coordinate the operation of multiple HVDC links.

**Distribution grid innovation**

The distribution grid is being transformed from a quasi-passive element in the power grid into a system that must be actively operated. This change is a consequence of the installation of fluctuating renewable resources in the distribution grid, as well as electrification of the heat and transport sectors, that is, so-called distributed energy resources (DERs). In addition, local resources for demand start to be actively managed in order to deliver flexibility to the distribution system. Distribution system operators (DSOs) need new methods, tools and processes to handle such an active grid, especially when it comes to voltage profiles and congestion management. The increased digitalization of the power system provides opportunities for the creation of such methods and tools.

**Demand response through aggregation**

Demand response is the control of electric power consumption instantaneously through incentive or control signals. Given that the problems the DSOs face are of a local nature, using local demand response to resolve these issues is ideal. The building and management of the information and communication technology (ICT) infrastructure required for the control of large quantities of small units lies outside the area of expertise and role of the DSO. We must therefore envisage a new role in the power system: the aggregator. It will be the job of the aggregator to represent all units in its portfolio as a single market participant, while ensuring that the needs of the consumers are satisfied [11]. For instance, methods for aggregators to directly control heat pumps for congestion management are being developed and tested. An example of this is the EcoGrid 2.0 project, where two aggregators control a pool of about four hundred houses each, testing both direct control demand response and consumer preference with regard to the energy products provided by the aggregator (e.g. reductions to electricity bills, or prioritizing reductions of customer’s CO<sub>2</sub> emissions). An example of such a test can be seen in Figure 2, where 386 houses with heat pumps responded to a deactivation signal, thus providing about 300 kW of up-regulation. Interestingly, the recovery of energy after the activation is less than the reduction of energy consumption during the activation.

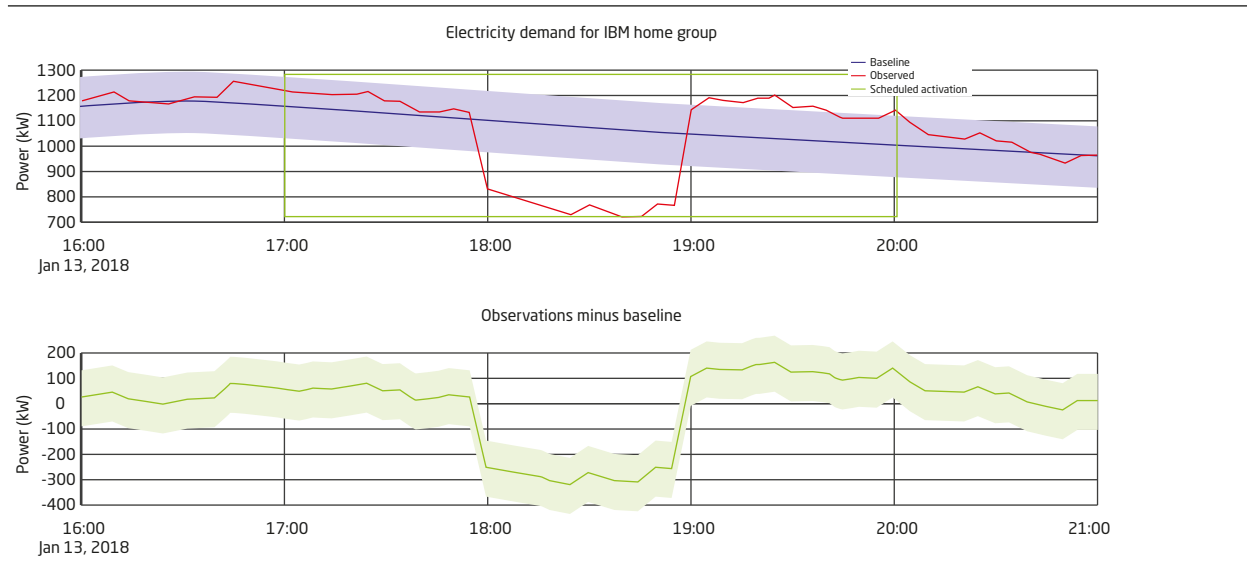

**Figure 3.** An example of an aggregator that provides a demand reduction service (up-regulation) of 300 kW between 18:00 and 19:00. The top figure shows the total power consumption of the aggregated demand, including the response of the activation and its following “kick-back”, as well as the forecasted demand without activation of the demand reduction, the so-called baseline. The bottom graph shows the flexibility provided, that is, the difference of the observed response (measurement) and the baseline.

While demand response aggregation is a topic that academics have worked on extensively in recent years, and several countries have commercial aggregators trading in the energy and ancillary service markets (see, for example, the UK aggregator OpenEnergi or the pilot projects by Nuvve), a standard market framework for aggregators has not yet been widely implemented.

**Enabling trading of flexibility**

Ancillary services for the transmission system are traded in their own markets. If the DSO is to leverage the flexibility provided by demand response, similar markets must be provided where DSO needs and consumer-flexibility can be matched. Concepts based on a so-called flexibility clearing house (a matchmaker between DSO needs and aggregator flexibility) have been designed and tested [11]. Currently, this type of concept is being extended, taking location of flexibility into account and conducting integrated tests with services being traded and enacted. A graphical representation of this can be seen in Figure 4. As it can be seen, it is important to determine how the aggregator will participate in both DSO-oriented flexibility markets and ancillary service markets. Methods of proper coordination with the so-called balance responsible parties (BRP) must be developed.

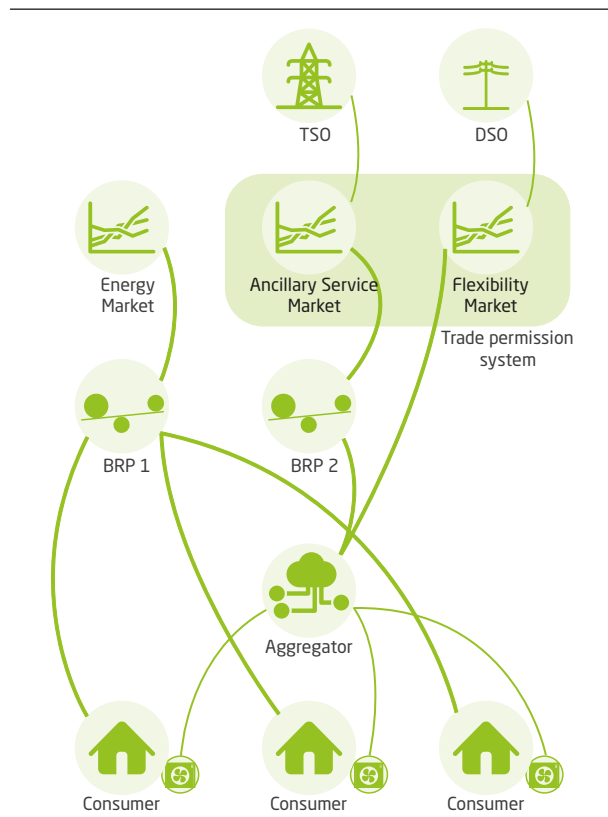

Figure 4. Aggregators will have to be associated to a BRP, either contracting their own (as shown in the figure), or by communicating with the existing BRP of the consumer (BRP1 in the figure).

The specific arrangement presented proposes that the internal measurements of the flexible units that provide services should be accepted for service bid and settlement purposes, thus avoiding the high costs of installing certified behind-the-meter measurement units. Allowing the lower quality measurements to be used will strengthen the aggregators’ business case. Behind-the-meter measurements are needed so that imbalances between forecast consumption and actual consumption can be attributed to specific market actors.

**Need for R&D and innovation**

The future R&D needs include identifying the acceptable quality of the behind-the-meter measurements in order to carry out verification and settlement. In general, the question of how to prequalify and verify service delivery from demand response aggregation has been analyzed in academia, but still needs to be developed into homogenized procedures across Europe.

**TSO-DSO coordination**

The solutions adopted must also provide coordination between ancillary services provided to the TSO (system balancing) and the flexibility offered to the DSO.

Situations will arise where a TSO or BRP activates flexibility at distribution level, thereby causing problems for the DSO. The project “DSOs Role in the Energy Markets” (DREM), together with several Danish DSOs, has identified eight examples of conflict that may occur when DSOs and TSOs gain access to consumer flexibility. These examples vary from conflicts due to direct or indirect demand response acquired by the TSO to those where the DSO actively counteracts ancillary services (contracted by the TSO) in order to protect its own assets.

These examples of conflict will shape the design of a trade permission system, allowing for the coordination between TSO and DSOs (see Figure 4). This system is expected to be the final outcome of DREM and to be adopted by the Danish power system.

Similar issues are being tackled in the Horizon 2020 Smart-Net project, which studies areas with a large amount of wind power and large loads. Smart energy controllers have been installed in around thirty summerhouses with a swimming pool. Through these controllers, voltage issues are mitigated and congestion management is provided to the DSO.

**Services from demand response**

While research and development have taken forward the concept of demand response through aggregators [11-13], demand response is still not fully integrated into the electric power system. In their 2017 report “Explicit Demand Response in Europe”, the Smart Energy Demand Coalition analyzed the barriers that still exist to the adoption of demand response [14]. The analysis was based on four key metrics:

a) access for demand response to markets; b) access to market by service providers; c) product requirements; and d) measurement and verification, payments and penalties. Although the SEDC states that Europe is generally improving its performance in relation to these four key metrics, we believe there are still several challenges that need to be addressed. DTU is tackling these barriers by, for example, proposing changes to product requirements [15]. Additionally, DTU is investigating how non-certified behind-the-meter measurements can be used for purposes of verification and settlement, as well as system state-estimation methods which will allow for a simpler measurement system.

It is also worth mentioning that the regulatory framework in the form of market rules etc. must be aligned with the concept of commercially operating aggregations. Such adjustments of the rules are currently being adopted in multiple countries, and standardized frameworks are being developed.

### Microgrid innovation

In contrast to the centralised power system with large-scale generation units and large-scale power transmission, micro-grid solutions are designed to impart a high degree of self-sufficiency to small, well-defined parts of the grid with weak connections to the rest of the grid, and sometimes even with dynamic boundaries or in complete isolation. In principle a microgrid solution has the ability to provide high power quality and to balance electric power locally by own local means. This is obtained through the smart mobilisation and activation of all the available local energy flexibilities and local system services from all the components that are connected to the grid. Microgrid solutions include a high degree of customer empowerment. All customers must contribute to the proper operation of the microgrid through both power balancing and system services like voltage control and short circuit power.

New means are required for the coordinated and optimised control and operation of microgrids, with new types of actors, markets and business models, including neighbouring energy-sharing and peer-to-peer energy-trading.

Microgrids may be able to operate in true island mode for brief periods, but they are normally connected to other grids, including neighbouring microgrids, exchanging energy and system services whenever appropriate, which produces high value for the microgrid in question, the neighbouring microgrids, and the rest of the grid.

In the ideal situation, the microgrid concept has the potential to become a key building block of the future energy system, providing robust, efficient and reliable energy systems, and significantly replacing the need for dedicated energy transmission. However, this requires a new design of the entire energy system, a new way of organising it so as

to include local engagement and local ownership, and new ways of operating it. The necessary technologies are more or less available, though not yet mature, but the necessary legal and market framework has not been developed. Microgrid solutions should be introduced and demonstrated (e.g. at community levels) under different conditions.

Microgrids can be seen as an extension of community (near) zero-energy concepts, which focus on balancing the community's energy requirements on annual basis, but with the microgrid focusing on optimising the operation of both itself and the entire energy system.

More R&D is needed to evaluate the proper circumstances for the introduction of valuable microgrids so as to identify those locations and situations where they really have added value, rather than just being a fad.



Figure 5. The importance of being able to test microgrid solutions under real or semi-real conditions, as in DTU's SYSLAB experimental research facility (illustration: DTU 2018).

## Cross-cutting innovation

### Energy storage integration

Energy storage has the potential to provide the necessary flexibility in the energy system. In the near term, thermal and electric storage technology is expected to play an important role, while storage of electric energy as hydrogen can do so towards 2050.

The cost of battery storage has fallen dramatically in recent years which, if continued, will lead to the emergence of feasible business models for batteries. Batteries can sup-

ply a number of services to the grid, ranging from energy arbitrage and reserves to deferring grid upgrades and local customer services behind the meter (see Figure 4). Typically, no single service can provide enough value to provide a positive business case, but current research in 'stacked services' enabling the delivery of multiple services by the same installation indicates that positive business models can be provided at current cost levels. Such solutions are currently being demonstrated in the EnergyLab Nordhavn project in Copenhagen [16].

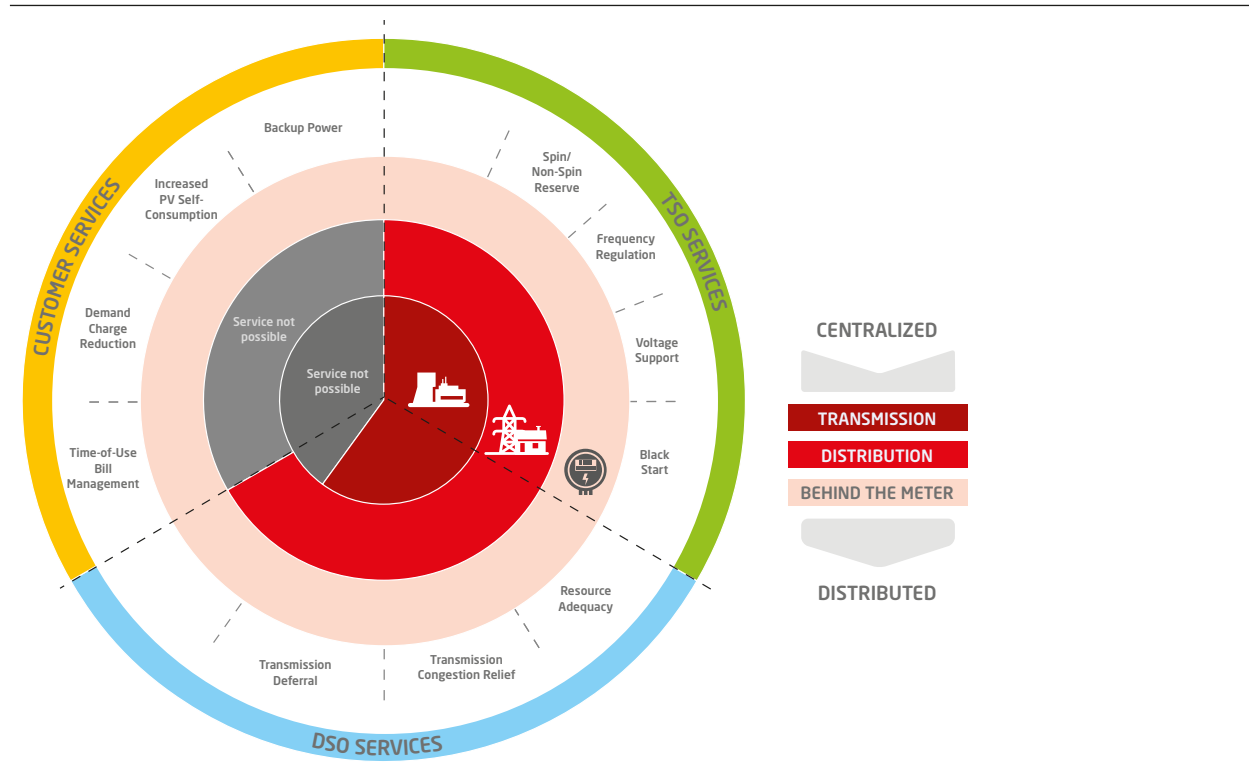

Figure 6. Battery energy storage can provide different services to three stakeholder groups (TSO, DSO and customers) depending on the connection point of the storage unit: in the transmission grid, in the distribution grid, or behind the meter. After [17].

### Integrated energy system

Solutions focusing on the individual aspects of the energy system, such as electric power systems or district heating systems, may overlook the efficiency as well as the potential for cost and emission savings with an integrated approach.

The concept of energy systems integration methodologies brings together the wide range of energy carriers (electricity, thermal systems, gas, fuels) with other infrastructure such as data networks, water systems and transportation systems [18]. The approach facilitates flexibility throughout the entire energy system. The complexity of this holistic

framework, consisting of all the energy-related systems we use today, calls for pioneer research in methods using data intelligence to harness the latent flexibility of integrated energy systems [19].

Big-data analytics and models will play a pivotal role in the intelligent and integrated energy system of the future. Modelling such an integrated energy system is a complicated task, and tailored models are required for operations, forecasting, planning, simulation and market participation. This calls for new modelling techniques that bridge the gap between statistical and physical modelling.

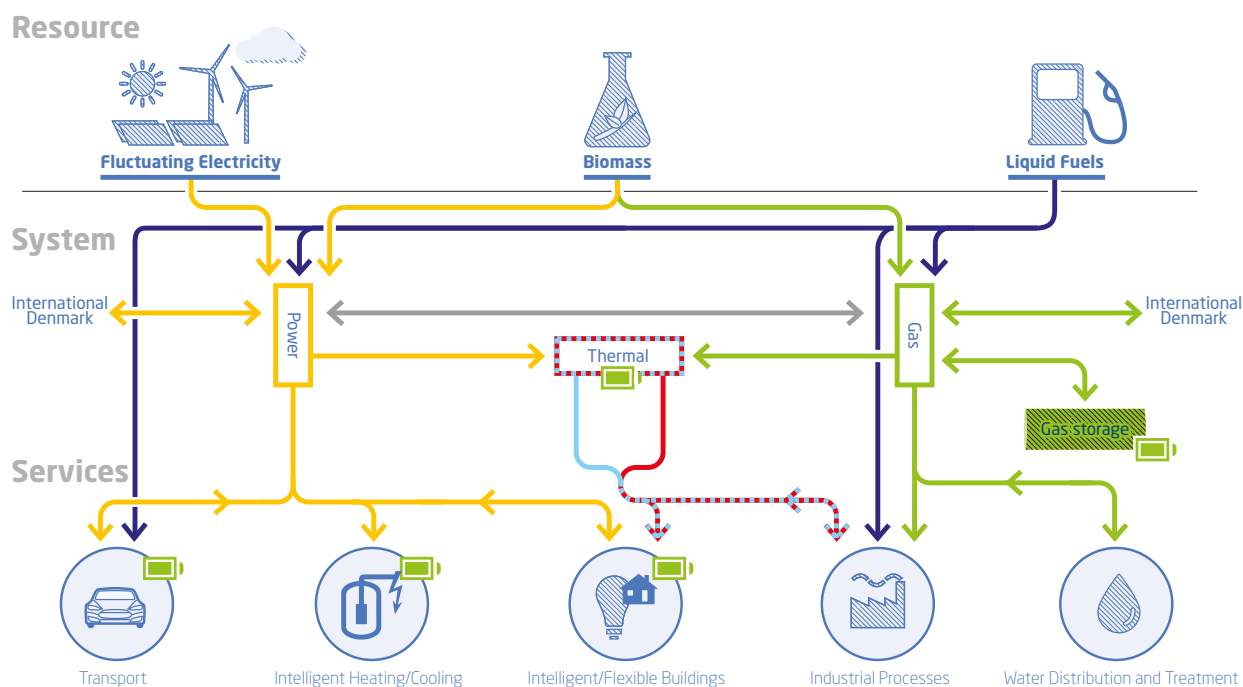

Figure 7. A more integrated energy system, in which big-data analytics and models play an essential role, will enable a more efficient energy system.

### Data, analytics and markets

Data, energy analytics and energy markets will be crucial cross-cutting elements in the development of future smart grids.

Starting with the data itself, actors in electric power systems rapidly entered the digitization world when they found they had to accommodate renewable energy generation, with capacities being distributed over large areas, variable in nature and with limited predictability. This forced them to find ways to monitor renewable energy generating capacities, to obtain additional data (e.g., weather forecasts) to predict power generation in the coming minutes or days, and then increasingly to make further use of monitoring and control capabilities in order to operate power systems with the ever-greater penetration of renewable energy sources.

Eventually, market-based considerations should lead to smart meters being deployed at the residential level, leading to the collection of significantly larger amounts of data. The European Union has committed itself to introducing up to 200 million smart meters for electricity by 2020 with a standard temporal resolution of fifteen minutes. Such smart-meter data opens the door to a number of new business models related to consumer analytics and demand response, though it also presents a number of challenges related to data management and the analytics used to exploit such data, as well

as legal and regulatory issues related to privacy and the ownership of information.

Even in terms of organization, it is still unclear whether data should be kept centrally and channeled through a single platform (as with the DataHub in Denmark), or whether decentralized structures that keep that data at or close to their collection point are to be preferred. Similarly, data can be seen as free and shareable upon agreement, as is traditional in many areas. However, it would make sense to monetize data, as in the Copenhagen city data exchange, although pricing such data in a broader context is an open challenge.

New data streams and opportunities for sensing and actuating in a smart grid (and more generally smart energy) context does not mean that this newly uncovered flexibility can be fully harnessed in an economic manner. This requires the evolution of a market-based coordination framework and a related regulatory framework.

As an example in Denmark, various proposals have been made for the market-based coordination of demand response through national and European projects, yielding a generalized 'balancing-markets- accommodating' demand response [20; 21], as well as a number of approaches to coordination at the transmission and distribution grid levels [19]. These market-based coordination concepts should

be similarly employed to coordinate the gas, heating and electricity systems with price-based and volume-based coordination concepts, both aiming to optimize the flexibility that these other energy systems bring to the electric power system [22].

The increasing amount of generation produced by renewable energy sources (RES) with a volatile and partly unpredictable pattern calls for improved and integrated methods of probabilistic forecasting. The cross-dependencies between, for instance load, wind- and solar-power generation must be accurately described. Furthermore, forecasts must be provided in such a form that they can be used directly in stochastic programming or similar methodologies for decision-making under uncertainty.

## Recommendations

*A new energy reality is emerging.* A number of rapidly developing technologies and major market trends will provoke a new energy reality and transform the whole energy business. Consumer-centric solutions, digitalization and electrification will establish a new main direction for the system. The rapid technological developments behind this transformation include low-cost solar PV, wind power and battery storages, smart building solutions, e-mobility, distributed intelligence and data processing, novel market designs and consumer-centric sharing.

*An immense innovation potential.* The global market potential for new smart grid solutions is immense. When the share of variable renewables increases, new solutions for balancing the system and its secure operation will be needed. Equally important, digitalization will enable new business models and provide new opportunities for completely new actors. Smart grid research and innovation must therefore play a key role in the coming years in developing new understanding and methods unlocking enormous new business potentials.

Several of these innovations will require changes in regulation, including market rules, tariff schemes and energy taxes. The current regulatory framework does not efficiently support the transformation and utilization of the new solutions, including new business models, the role of aggregators, the integration of storage or integrated energy systems. Therefore testing and demonstrating new technology solutions in combination with deviating market rules, tariff schemes and energy taxes should be allowed, thus accelerating the development of new business models, novel digital energy solutions and more integrated smart energy solutions. As this is difficult or even impossible today, regulatory flexibility should be established to allow for such 'real-life' tests in dedicated areas.

*Research and innovation priorities.* Research should be strengthened in a number of areas in the coming years:

- *Regional grids innovation.* Optimization of operation of regional grids utilizing controllable HVDC connections, novel grid-stability methods in low-inertia systems and new solutions for offshore grids.
- *Distribution grids innovation.* Novel architectures including DSO markets which allow trading of flexibility and aggregation methods for demand response should be developed and matured.
- *Microgrid innovation.* Truly consumer-centric solutions, local optimization, and energy-sharing based on peer-to-peer methods in energy communities hold new possibilities for empowering customers.
- *Cross-cutting innovation.* The focus on holistic integrated energy system solutions should be increased. In addition, big data and analytics, distributed intelligence and other digital solutions contain outstanding new possibilities, which should be explored and developed.

*International collaboration and knowledge sharing.* Collaboration is important for the effective development of efficient, robust and widely applicable concepts. The Innovation Challenge Smart Grids is an excellent platform for such international collaboration; however, mechanisms should be designed to support international co-creation through Mission Innovation.



# References

---

1. T. V. Jensen and P. Pinson. "RE-Europe, a large-scale dataset for modeling a highly renewable European electricity system". *Scientific Data*. 2017. 4. Available: [10.1038/sdata.2017.175](https://doi.org/10.1038/sdata.2017.175).
2. D. Van Hertem, M. Ghandhari, "Multi-terminal VSC HVDC for the European supergrid: Obstacles," *Renewable and Sustainable Energy Reviews*, Volume 14, Issue 9, 2010, pp. 31563163, ISSN 1364-0321, <https://doi.org/10.1016/j.rser.2010.07.068>.
3. Desertec: A Visionary Project for Renewable Energies, Available online: <https://www.siemens.com/press/en/presspicture/?press=/en/presspicture/pictures-photonews/2009/pn200912.php>
4. Chatzivasileiadi, S., Krause, T., & Andersson, G. (2013, June). Supergrid or local network reinforcements, and the value of controllability: an analytical approach. In *PowerTech (POWERTECH)*, 2013 IEEE Grenoble (pp. 1-6). IEEE.
5. Müller, M., Haesen, E., Ramaekers, L., Verkaik, N., "Translate COP21 - 2045 outlook and implications for offshore wind in the North Seas", Technical report, Ecofys, July 4, 2017. Online: <https://www.ecofys.com/en/publications/translate-cop21/>
6. North Sea Wind Power Hub consortium, "The Vision", November 17, 2017. Online: <https://northseawindpowerhub.eu/wp-content/uploads/2017/11/Concept-Paper-1-The-Vision.pdf> (last accessed: April 13, 2018).
7. Cooperation European Transmission System Operators to develop North Sea Wind Power Hub, Available online: <https://www.tennet.eu/news/detail/cooperation-european-transmission-system-operators-to-develop-north-sea-wind-power-hub/> (last accessed January 03, 2018)
8. E. Ørum, et al. «Future system inertia.» ENTSOE, Brussels, Tech. Rep. (2015).
9. L. Zeni, A. Rudolph, J. Münster-Swendsen, A. D. Hansen, P. E. Ejnar, "Virtual inertia for variable speed wind turbines". *Wind Energy*. 2013, 16(8). 1225-1239.
10. M. M. N. Rezkalla, A. Zecchino, S. Martinenas, A. Prostejovsky, M. Marinelli, "Comparison between Synthetic Inertia and Fast Frequency Containment Control Based on Single Phase EVs in a Microgrid". *Applied Energy*. 2017.
11. [K. Heussen, D. E. M. Bondy, J. Hu, O. Gehrke and L. H. Hansen, "A clearinghouse concept for distribution-level flexibility services," *IEEE PES ISGT Europe 2013*, Lyngby, 2013, pp. 1-5. DOI: [10.1109/ISGTEurope.2013.6695483](https://doi.org/10.1109/ISGTEurope.2013.6695483)
12. L. Gkatzikis, I. Koutsopoulos and T. Salonidis, "The Role of Aggregators in Smart Grid Demand Response Markets," in *IEEE Journal on Selected Areas in Communications*, vol. 31, no. 7, pp. 1247-1257, July 2013. DOI: [10.1109/JSAC.2013.130708](https://doi.org/10.1109/JSAC.2013.130708).
13. USEF webpage, Available online: <https://www.usef.energy/download-the-framework/a-flexibility-market-design/>
14. SEDC, "Explicit Demand Response In Europe: Mapping the Markets 2017", 2017.
15. D. E. M. Bondy, et al. "Redefining Requirements of Ancillary Services for Technology Agnostic Sources", in *Proceeding of Hawaii International Conference on Systems Sciences 51*, 2018. DOI: <http://hdl.handle.net/10125/50221>
16. EnergyLab Nordhavn project. Available online: [www.energylabnordhavn.dk](http://www.energylabnordhavn.dk).
17. Fitzgerald, Garrett, James Mandel, Jesse Morris, and Hervé Touati. "The Economics of Battery Energy Storage: How multi-use, customer-sited batteries deliver the most services and value to customers and the grid", Rocky Mountain Institute, September 2015.
18. J. Kiviluoma, S. Heinen, H. Qazi, H. Madsen, G. Strbac, C. Kang, N. Zhang, D. Patteeuw, T. Naegler, "Harnessing flexibility from hot and cold: heat storage and hybrid systems can play a major role, *IEEE Power and Energy Magazine*", Vol. 15, pp. 25-33, 2017.
19. H. Madsen, J. Parvizi, R. Halvgaard, L.E. Sokoler, J.B. Jørgensen, L.H. Hansen, K.B. Hilger, "Control of Electricity Loads in Future Electric Energy Systems", in *Handbook of Clean Energy Systems*, Wiley, 2015.
20. EcoGrid 2.0 project. Available online: <http://www.ecogrid.dk/>
21. N. O'Connell, P. Pinson, H. Masen, M. O'Malley, "Economic Dispatch of Demand-side Balancing through Asymmetric Block Offers", *IEEE Transactions on Power Systems*, vol. 31, no. 4, pp. 2999-3007, 2016.
22. G. De Zotti, S. A. Pourmousavi, H. Madsen, N.K. Poulsen, "Ancillary Services 4.0: A Top-to-Bottom Control-Based Approach for Solving Ancillary Service Problems in Smart Grids", Accepted for IEEE Access, 2018.

Chapter 6

# Off-grid Access to Electricity Innovation Challenge

“to develop systems that enable off-grid households and communities to access affordable and reliable renewable electricity”

By **Ivan Nygaard, Ulrich E. Hansen** and **Thomas Hebo Larsen**, UNEP DTU Partnership, Technical University of Denmark  
**Debajit Palit**, The Energy and Resources Institute, TERI, India  
**Charles Muchunku**, Private Consultant, Kenya



## The challenge of universal access to modern energy



There are currently 1.1 billion people globally living without access to electricity, 80% of whom live in rural areas, mainly in South Asia and Sub-Saharan Africa [1]. Hence the challenge of bringing stand-alone off-grid and/or mini-grid solutions to these populations is of paramount importance in fulfilling the United Nations' Sustainable Development Goal (SDG) no. 7, that is, to ensure access to affordable, reliable, sustainable and modern energy for all by 2030. The challenge is substantial since current projections indicate that almost 700 million people would still be without access to electricity in 2030, 90% of them residing in Sub-Saharan Africa [1]. In developing Asia and Latin America a nearly full rate of electrification is expected by 2030, with India being a big success story in having provided more than 500 million people with access to electricity since 2000 [1] its target being to achieve complete electrification by March 2019.

A major challenge in providing the remaining 1.1 billion with access to electricity is the fact that the vast majority lives in rural and remote areas far from the national grid. Furthermore, inhabitants of these areas often have low and irregular incomes, meaning that electrical power load densities in these areas are low. As a result, the combination of low levels of electricity consumption and difficult terrain makes

it costly as well as cumbersome to connect rural populations to the grid in a sustainable fashion. As a result, policy-makers and electrification strategies often give less emphasis to rural electrification than to electrifying urban centres and industrial areas.

Given this situation, the question to be answered is whether it is possible or reasonable to promote clever routes to the provision of access to these rural populations without having to rely on "classical" grid expansion. Possible combinations of novel technologies should be considered and be given an opportunity to prove their worth. It seems that, for these particular situations and geographical circumstances, the focus should rather be on solar-based technologies.

Indeed, access to electrical energy is not a binary between having access to electricity and not having it, as it is the case for utility-supported grid electricity [2]. With the recent diffusion of so-called 'pico solar' products (solar portable lights and solar lanterns with an effect below 10 Wp), solar home systems (SHS), and mini-grids to supplement or be used as alternatives to utility grid electricity, access to electricity should be measured in a graded fashion, i.e., according to the level and quality of the service provided. A systematic way of measuring and verifying access to electricity is provided by the Multi-Tier Framework, which distinguishes between five levels or tiers of energy access as illustrated in Table 1 [3].

**Table 1.** Different levels of electricity access defined by the Multi-Tier Framework [3] ("task lighting" refers to having access to lighting to be able to perform a limited number of important tasks like reading, cooking, etc.).

	TIER 0	TIER 1	TIER 2	TIER 3	TIER 4	TIER 5
Tier criteria		Task lighting AND phone charging	General lighting AND phone charging AND television AND fan (if needed)	Tier 2 AND any medium-power appliances	Tier 3 AND any high-power appliances	Tier 2 AND any very high-power appliances
Annual consumption levels, in kWhs		≥4.5	≥73	≥365	≥1,250	≥3,000
Daily consumption levels, in Whs		≥12	≥200	≥1,000	≥3,425	≥8,219

While many households experience a considerable improvement in being supplied with electric light and the opportunity to charge their mobile phones (tiers 1 & 2), other households might need electricity to run appliances for productive use and income-generating purposes (tiers 3 to 5) [4]. It is unlikely that all countries will be able to reach the highest tiers of access by 2030. Therefore, the Multi-Tier Framework is useful for countries and development agencies in devising policies according to context and funding opportunities, as well as to evaluate progress until the highest tier of access is reached.

## Technological trends

Fortunately, recent years have witnessed spectacular progress with solar-based off-grid electrification that has enabled millions of people to be given access to electricity through either pico solar products, SHS or various types of mini-grid, both AC and DC. This development has been aided by a combination of continuing uncertainty in the price of conventional energy sources<sup>1</sup> and drastically falling solar module prices. This has been the result of the increased efficiency of modules, cost reductions through economies of

<sup>1</sup> The global price of oil has increased steadily from 20-25 USD per barrel in the 1990s, reaching an average level of 100 USD per barrel for the period 2007-2015, after which the price has dropped again to around 60 USD per barrel <https://www.eia.gov/todayinenergy/detail.php?id=34372>

scale and increased competition, especially from Chinese manufacturers. Since 2010, average module prices have fallen by more than 80% and average annual global manufacturing capacity has increased by 30% [5]. Furthermore, the price of solar PV products has not only benefitted from the reduced manufacturing costs of panels, it has also been supported by an overall improvement in the efficiency and performance of complete systems [6; 7].

## Individual systems

Solar technology has reduced costs especially for individual systems, such as solar pico products and SHS, which are mainly used by residents of dispersed settlements, informal settlements and low energy density areas. For these systems, improvements have come from the use of small lithium-ion batteries, energy-efficient lighting alternatives (particularly Light Emitting Diodes or LEDs) and balance of system components (BOS), e.g. inverters, charge controllers, cables and wires. Thus, the price of an SHS offering lamps, a radio and a television dropped from 991 USD in 2009 to 354 USD in 2014 and is expected to decrease by another 50% by 2020 [7]. Pico solar products, which offer a few lights and allow households to charge their mobile phones, have likewise experienced significant falls in price. In 2010 a solar lantern cost around 20 USD, but by 2015 the price had dropped to a little more than 4 USD. Surveys from Kenya, Uganda and Tanzania indicate that households typically spend 36-73 USD for kerosene for lighting over the two-period that a solar lantern normally lasts [8]. Hence, significant savings for households are within reach by switching to solar-powered lighting. As a result, the sales of off-grid solar products has increased rapidly since 2012, reaching almost 31 million units sold cumulatively by the first half of 2017 [9]. Using solar PV-based technology to reach Tiers 1 and 2, which both offer electric light and phone charging, with the addition of a television or a fan respectively, has thus become considerably less costly over the past decade.

## Mini-grids

A mini-grid is a small electricity grid that connects villagers to an electricity-producing unit. It is a major building block in bringing electricity supplies to remote communities,<sup>2</sup> being a least-cost option for the provision of electricity to small towns and villages with adequate load densities wherever local resources make this possible. Mini-grids are reaching higher tiers of energy access that involve the use of medium- and high-power appliances such as refrigerators, water pumps and hair-dryers. Thus, mini-grids can supply sufficient electricity for productive purposes and can sustain income-generating activities in a way that pico solar and

SHSs cannot [11]. Mini-grids are in most cases intended to be connected to the main grid when consumption in the mini-grid reaches a level that makes it economically feasible to link a transmission line to the main grid. To ease future integration with the main grid, it is important for mini-grids to be constructed according to normal grid standards, though this may slightly increase the installation costs.

Electricity generation for mini-grids can come from diesel engines or renewable sources, possibly supplemented by electrical storage. Which technology is the least-cost option depends on the intensity and availability of renewable resources, as well as on the capacity of the mini-grid. As a rule of thumb, hydropower and wind are best suited for larger installations, biogas and thermal gasification for medium-size installations, while biofuels and solar PV are modular, making them feasible for the whole range of installations from small to large [12]. In general, small-scale hydro is a well-proven technology and the least-cost option [13]. In areas with constant and good wind conditions, wind turbines have proved to be a feasible option for larger installations in combination with diesel engines > 50 kW [14]. Small wind power in the size of 2-10 kW has been tested in many countries, but in only a few cases have they proved to be economically feasible compared to diesel-based solutions [15]. Biogas from animal manure and gas from biomass gasification have been tested in many countries. India has hosted a number of programmes for small-scale thermal gasification of biomass to supply mini-grids, but in spite of some isolated success stories, gasification of biomass for mini-grids has proved difficult [16]. Biogas programmes for rural electrification have been implemented in India and recently in a number of countries in Africa (Kenya, Ethiopia, Tanzania, Uganda and Burkina Faso) through a Dutch development programme. While use of gas for cooking has been a success, there are few reports regarding mini-grids supplied by electricity produced from biogas [17]. Mini-grids supplied by electricity from locally produced biofuel from *Jatropha* was tried out in many countries in 2006-2012, but currently very few of these installations are in operation due to the unexpectedly high production costs of *Jatropha* oil [18; 19; 20]. Solar PV has until recently produced electricity at a higher cost than diesel alternatives, but the solar technology is reliable, and in the Indian state of Chhattisgarh, 1,200 solar mini-grids (1-10 kW) have successfully been running for up to fifteen years [21]. Given the fallings cost of solar PV in the last few years, described above, this technology, combined with batteries, is likely to become the least-cost and preferred technology for mini-grids.

A recent major technological advance in the area of mini-grids is the ability to integrate renewable and non-renewable energy technologies with batteries – so-called hybrid mini-grids. This minimizes operating costs, even though invest-

<sup>2</sup> For a typography of mini-grids, see [10]

ment costs increase. The development and diffusion of hybrid mini-grids has to a large extent been driven by the low cost of solar PV, but also combinations of renewable technologies with different generation profiles throughout the day can be used to adapt production profile to load profile and thus reduce battery size. In this regard, successful experiments with solar, wind and gasifier hybrids were conducted in India in mid-2000, and integration of wind and reduction in battery size in PV systems are about to be demonstrated in a project being carried out in Kenya by DTU and a large Danish wind-turbine manufacturer.

To reduce costs and increase reliability, modern hybrid mini-grids have started to use smart grid features (see Chapter 5) to control intermittent production and load, internet-based systems for distant operation and control, and smart metering and mobile-based payment systems for financial management [22]. Experiences from mini-grids can therefore be used as the first steps in introducing smart grid features in existing grids, and in countries with a large number of mini-grids, this can be a test-field for modular networks [23].

While most mini-grids are 240 volt AC grids and therefore in most cases compatible with normal utility networks, a number of DC-based mini-grids still exist at 24 and 48 volts. The advantage of DC mini-grids is that capital expenditure to provide the same level of energy service can be reduced markedly. This makes DC-based micro-grids particularly relevant for low-income households since the connection fee is modest, resulting in a similarly low tariff [24]. In India and Pakistan, DC-based micro-grids are receiving a lot of attention, and very recently the Bureau of Indian Standards has published 48 volt DC standards for micro-grids. The same standards are now being discussed in the International Electrotechnical Commission for adoption as international standards.

Overall, the attractiveness of renewables, in particular solar, as an alternative to the provision of electricity from conventional energy sources has improved drastically over the past decade. Table 2 shows the distribution of solar PV installations across the different market segments from July 2015 to July 2016.

**TABLE 2.** The product-based market segmentation methodology applied in this article (for reference, the corresponding MTF energy access tier is indicated for each segment, as well as sales volumes per segment for July 2015–June 2016 [25]).

Market segment (solar PV capacity)	Service provided	Corresponding Mtf energy access tier	Volume of products sold in sub-Saharan Africa (July 2015–June 2016)
0-1.5 Wp	Single light only	Tier 0	2,178,836 (53%)
1.5-3 Wp	Single light + phone charging	Tier 1—Task lighting AND phone charging	1,161,280 (28%)
3-10 Wp	Multiple lights + phone charging		513,435 (12%)
11-20 Wp	Entry-level stand-alone solar system (3-4 lights, phone charging and low power appliances (e.g., radio, fan))		100,463 (2%)
21-49 Wp	Basic capacity stand-alone solar system (above plus power for TV & extended capacity)	Tier 2—General lighting AND phone charging AND television AND fan (if needed)	64,296 (2%)
50-100 Wp	Medium capacity stand-alone solar system (above but with extended capacity)		64,328 (2%)
100 Wp+	Higher capacity stand-alone solar system (above but with extended capacity)	Tier 2 (Large systems could qualify for Tier 3)	44,163 (1%)

## New business models

While the significant decrease in the price of solar PV technology has been a major driver for the spread of solar products for rural electrification, the process is further supported by the emergence of new and innovative business models by private-sector actors taking advantage of the digital revolution.

In general, four delivery models can be distinguished for individual households: retail, pay-as-you-go (PAYG, to be elaborated below), consumer financing and fee-for-service [25]. The retail model is the conventional approach, where-

by customers simply buy the products off the shelf through existing networks of distributors and retailers. The PAYG approach is a new and innovative model that takes advantage of the widespread use of mobile telephony and the breakthrough of smart metering. The consumer financing model is based on a partnership between a solar PV supplier and a financial institution (e.g. commercial bank, micro-finance institution etc.). The financial institution takes the responsibility for providing consumer finance and collecting repayments, while the supplier is relieved of the cash-flow burden. The fee-for-service model does not transfer ownership of systems to customers; rather, customers pay a fee for usage or recharging products. In general, the retail

and PAYG delivery models have proved efficient in reaching scale in mature markets, whereas the fee-for-service delivery model was mainly used at a time when PV solutions were still very costly, especially in countries such as Morocco and South Africa, where the utilities retained their monopolies [2; 4; 25].

While the vast majority of solar PV products are sold through the retail model, the PAYG model merits further elaboration since its innovative new approach allows suppliers to overcome some of the major challenges associated with bringing electrification to remote and low-income families in developing countries [26]. The PAYG approach avoids the high upfront costs of installing a whole system, as it allows consumers to pay it off gradually via their mobile phones, while smart metering enables suppliers to control the consumption of electricity remotely in cases where a consumer fails to pay. Combined, these innovations overcome the geographical barriers to having to collect payments. The flexibility to pay small amounts is particularly important, as it makes solar products a viable alternative to buying smaller amounts of kerosene or diesel oil for lighting.

Furthermore, after full repayment in 12 to 36 months, households will potentially be able to enjoy free electricity for the remaining lifetime of the system. Having installed pico solar or SHSs allows households to reduce the costs of access to electricity and charging their phones. Moreover, the fact that this solution provides lighting to consumers in the evening when they need it most is another valuable advantage, since rural consumers have been shown to have a high willingness to pay for basic lighting services [27]. However, one shortcoming of the PAYG approach seems to be that it mainly targets households in the 6-40 USD/day income range but does not reach households and consumers at the very bottom of the pyramid, who spend a large part of their income on lighting services [28].

One of the pioneers of the PAYG approach is the Kenyan company M-KOPA, which was founded in 2011 to take advantage of the mobile payment schemes that emerged in Kenya in 2007. M-KOPA sells SHSs to customers by charging a small deposit of roughly 30 USD and subsequently letting customers pay the equivalent of 0.5 USD per day over a period of twelve months to pay off and finally own the system. By 2017, the company had connected more than 500,000 households across Kenya, Tanzania and Uganda to affordable solar power. Several other companies applying more or the less same business model have now entered the market, including Mobisol, Azuri Technologies, Off-Grid Electric, Bboxx, Solar-Now and Simpa [6; 26].

Larger mini-grids for towns situated far from the grid are generally owned and operated by national utilities and dis-

tribution companies. However, since the deregulation of the electricity sector, a variety of publicly supported business models have been experimented with. In Sub-Saharan Africa, since the turn of the century electrification agencies have supported mini-grids under different business models. In Burkina Faso, about 180 mini-grids are owned and operated by village cooperatives, while another fifty are owned and operated by private companies in Mali. In both countries, mini-grids are subsidized, and tariffs are subject to approval by the regulatory authorities.<sup>3</sup>

In India, government agencies run around 2500 mini-grids, and in the last ten years more than 200 have been established by private operators [21]. Recently, also in SSA, new private business models for mini-grids are emerging in competition with the existing organisational arrangements run by the utilities. In Kenya, twenty mini-grids fully financed, owned and operated by private companies have been installed since 2012. By using smart metering and PAYG systems, they have been able to charge cost-reflective tariffs, which are five to ten times higher than regulated tariffs charged by utility grids. This has been possible because consumers find it cheaper than the alternatives, but as with the SHS, there are the same challenges of reaching the poorer segments of the population. Four companies in Kenya are currently following this approach and trying to negotiate access to the same amount of subsidies and cross-subsidies as mini-grids established by the rural electrification authority and the distribution company. One of the Kenyan companies has so far established ten mini-grids. It has up to a hundred systems in the pipeline, and is currently spreading its business to other SSA countries [22; 29].

## Public support

The improved cost competitiveness of solar PV and the emergence of new and innovative business models have been major drivers of the expansion of off-grid solar products and of small private PV-based mini-grids for rural electrification, but this progress would not have been achieved on the current scale without supportive public initiatives and programmes [4; 30].

For off-grid products, public support has been vital in the attempt to counter the large inflow of low-quality counterfeit solar products that are damaging the image of the industry as a whole. One particular initiative established by the World Bank's International Finance Corporation in 2010 under the name of 'Lighting Africa' has been very successful and is currently operating in eleven African countries. The initiative has been scaled up, now being called 'Lighting Global', and new programs have been launched in India, Bangladesh and other Asian countries. The initiative is

<sup>3</sup> For further details, see e.g. [4]

a global certification scheme for pico-scale solar products that aims to increase consumer confidence by ensuring a minimum level of product quality as well as transparent advertising. Furthermore, the initiative collects data that serve as valuable statistical information on the sales of certified products in Africa.

An example of a very successful public programme to support the uptake of solar PV products is the IDCOL Solar Home System Program that has been implemented in Bangladesh since 2003. IDCOL, the state-owned financial institution, implemented the program in collaboration with thirty partner organisations, whose main responsibility was to be locally present to promote and service the SHSs [21]. By May 2017, 4.1 million SHSs had been supplied to rural areas of Bangladesh through a consumer finance model in which the purchase of an SHS is financed by a repayment scheme consisting of 36 equal instalments.

In some countries such as Rwanda, Kenya, Nepal and Myanmar, the use of solar lanterns and SHSs is being incorporated explicitly into national rural electrification strategies. In particular, Kenya's Off-grid Solar Access Program is an example of an innovative public program offering financial incentives in the form of results-based finance and a debt facility for solar off-grid companies currently operating in more densely populated areas to expand operations to off-grid households in underserved counties [31].

Also, mini-grids need considerable amounts of donor finance or cross-subsidies from urban electricity consumers to meet the same tariff level as grid-connected electricity. In a number of countries rural electrification funds are being set up to provide subsidies to reduce the tariffs of private mini-grids and in mini-grids owned and operated by cooperatives. These funds are replenished by funding from international donors and from levies on electricity sold to urban consumers. In some countries, such as Kenya, similar legal frameworks are being introduced, but private companies are still not being given the same amount of subsidies as public entities [32].

## Remaining challenges

Among researchers and practitioners, there is a consensus that the least-cost option for achieving universal access is to be found in a combination of grid extension, mini-grids and off-grid solutions, and that challenges remain for all three approaches. Based on the literature [4; 21] and the authors' own experiences as researchers and consultants, we will conclude this chapter by highlighting the key challenges. These are:

- to ensure proper planning that delimits the geographical areas for grid-extension, mini-grids and off-grid solutions. Such plans have been elaborated in most countries,

often funded by international donors and carried out by researchers and international consultants: see e.g. [32; 33]. Among the challenges in this regard are that plans may overlap with one another, they may be funded by different donors with different perspectives, and the continued planning process may sow confusion over the status and legitimacy of existing and future plans. It is therefore important for governments to take the lead in the planning process and ensure the plans are followed up.

- to establish a forward-looking, consistent and stable policy and regulatory frameworks that define clear roles for private and institutional actors to become involved in rural electrification. This includes the existence of a strong and independent regulatory authority and a level playing field for public and private actors in terms of having access to subsidies and cross-subsidies, which are necessary to reduce tariffs for mini-grids to an affordable level.
- to ensure sufficient financing flows to mini-grid systems. The investment needed for mini-grids can to some extent be sourced through donor funding in the form of grants and loans or through cross-subsidies from high-consumption consumers in electrified areas. But to fill the investment gap, the big challenge is to attract large amounts of private capital, and especially to establish public-private partnerships to build mini-grids, while still ensuring affordable tariffs for the rural poor.
- to provide cheaper and higher tiers of energy access to rural households in dispersed settlements. Up to now the private sector has mostly been able to reach the lower tiers of energy access for the relatively wealthier part of the bottom of the pyramid. There is therefore still a challenge to achieve higher tiers of energy access for all income brackets, and to see how government and donor support can be integrated into these approaches to reduce costs for the lower income brackets.
- to build sufficient technical and organisational capacity to service target areas. Despite the technological breakthroughs described earlier, the remoteness and distributed nature of consumers living in rural areas require that technical and organisational capacity is available locally to reduce operational and maintenance costs.

# References

---

- IEA (2017) *Energy Access Outlook 2017: From Poverty to Prosperity*. International Energy Agency (IEA), Paris, France. [http://www.sun-connect-news.org/fileadmin/DATEIEN/Dateien/New/WEO-2017SpecialReport\\_EnergyAccessOutlook.pdf](http://www.sun-connect-news.org/fileadmin/DATEIEN/Dateien/New/WEO-2017SpecialReport_EnergyAccessOutlook.pdf) [Accessed 21 December 2017].
- Nygaard, I., Dafrallah, T. (2016) *Utility led rural electrification in Morocco: combining grid extension, mini-grids, and solar home systems*. Wiley Interdisciplinary Reviews: Energy and Environment, 5(2): 155-168. DOI: 10.1002/wene.165
- Bhatia, M.; Angelou, N. (2015). Beyond Connections: Energy Access Redefined. ESMAP Technical Report;008/15. World Bank, Washington, DC. © World Bank. <https://www.openknowledge.worldbank.org/handle/10986/24368>
- Christensen, J.M., Mackenzie, G.A., Nygaard, I. & Pedersen, M.B. (2015) *Enhancing Access to Electricity for Clean and Efficient Energy Services in Africa*. UNEP DTU Partnership, Copenhagen, Denmark
- REN21 (2017) *Renewables 2017: Global Status Report*. Paris: REN21 Secretariat
- Alstone, P., Gershenson, D., Turman-Bryant, N., Kammen, D.M., Jacobson, A. (2015) *Off-Grid Power and Connectivity: Pay-As-You-Go financing and digital supply chains for pico-solar*. University of California, Berkeley and Lighting Global.
- Orlandi, I., Tyabji, N., Chase, J. (2016) *Off-grid solar market trends report 2016*. Bloomberg New Energy Finance, World Bank, IFC and Global Off-grid Lighting Association. doi:10.1017/CBO9781107415324.004
- Lighting Africa (2011) *The Off-Grid Lighting Market in Sub-Saharan Africa*. Market Research Synthesis Report. Lighting Africa. <http://light.lbl.gov/library/LA-Mkt-Synthesis.pdf> [Accessed 03.01.2018].
- GOGLA (2017) *Global Off-Grid Solar Market Report: Semi-Annual Sales and Impact Data*. Global Off-Grid Lighting Association & Lighting Global. [http://sun-connect-news.org/fileadmin/DATEIEN/Dateien/New/gogla\\_sales-and-impact-reporth12017\\_def.pdf](http://sun-connect-news.org/fileadmin/DATEIEN/Dateien/New/gogla_sales-and-impact-reporth12017_def.pdf) [Accessed 21 December 2017].
- Pedersen, M.B. (2016) *Deconstructing the concept of renewable energy-based mini-grids for rural electrification in East Africa*. Wiley Interdisciplinary Reviews: Energy and Environment, 5(5): 570-587.
- SE4ALL (2012) *Global Tracking Framework*. Sustainable Energy for All (SE4ALL).
- Kumar A., Mohanty P., Palit, D. and Chaurey, A. (2009) *Approach for standardization of off-grid electrification projects*. Renewable and Sustainable Energy Reviews, 13(8): 1946-1956.
- Kishore, V.V.N., Jagu, D., Nand Gopal, E., (2013). Technology Choices for Off-Grid Electrification, in: Bhattacharyya, S. (ed.), *Rural Electrification Through Decentralised Off-Grid Systems in Developing Countries: Green Energy and Technology*. Springer London, pp. 39-72.
- Nørgård, P., Fonseca, J., (2008). Ultra high wind penetration in simple wind-diesel power systems in Cape Verde. Paper presented at EWEC 2009 conference.
- Kamp, L., Vanheule, L. (2015) *Review of the small wind turbine sector in Kenya: status and bottle necks for growth*. Renewable and Sustainable Energy Reviews, 49: 470-480
- Palit, D., Sovacool, B. K., Cooper, C., Zoppo, D., Eidsness, J., Crafton, M., Johnson, K., Clarke, S. (2013) *The trials and tribulations of the Village Energy Security Programme (VESP) in India*. Energy Policy Energy Policy, 57: 407-413.
- Odarno L, Sawe E, Swai M, Katyega Mjj, Lee A. (2017). Accelerating Mini- Grid Deployment in Sub-Saharan Africa. World Resources Institute and Tatedo. Available from: <https://www.esmap.org/node/140593>
- Nygaard, I., Bolwig, S. (2017) *The rise and fall of foreign private investment in the jatropha biofuel value chain in Ghana*. Environmental Science & Policy, DOI: 10.1016/j.envsci.2017.08.007
- Nygaard, I. (2010) *Institutional options for rural energy access: Exploring the concept of the multifunctional platform in West Africa*. Energy Policy, 38: 1192-1201. DOI: 10.1016/j.enpol.2009.11.009
- Palit, D., Malhotra, R., Mande, S. (2017) *Enhancing viability of biofuel-based decentralized power projects for rural electrification in India*. Environ Dev Sustain 19:263-283. doi: 10.1007/s10668-015-9720-4. <https://link.springer.com/article/10.1007%2Fs10668-015-9720-4>
- GNESD (2014) Renewable energy-based rural electrification: The Mini-Grid Experience from India. New Delhi: Prepared by The Energy and Resources Institute (TERI) for the Global Network on Energy for Sustainable Development (GNESD)
- Pedersen, M.B., Nygaard, I., Wehrmeyer, W. (2017) *Rural electrification through private models: the case of solar-powered mini-grid development in Kenya*. Ph.D. thesis, DTU
- Cronin, T. (2016) Modular concept for RE based rural electrification, WindAc Conference, 31/10/2016, Cape Town: <https://wasaproject.info/docs/AWP2017resources/comp%203/Modular-concept-for-RE-based-rural-electrification.pdf>
- Palit, D., Malhotra, S. (2015) *Energizing rural India using micro grids: the case of solar DC micro-grids in Uttar Pradesh State, India*. Conference: Third International Conference: Micro Perspectives for Decentralized Energy Supply, At Bangalore.
- Muchunku, C., Ulsrud, K., Palit, D., Jonker-Klunne, W. (2018) *Diffusion of Solar PV in East Africa: What can be learned from private sector delivery models?* Wiley Interdisciplinary Reviews. DOI: 10.1002/wene.282
- Rolffs, P., Ockwell, D., Byrne, R. (2015) *Beyond technology and finance: pay-as-you-go sustainable energy access and theories of social change*. Environ. Plan. A 47: 2609-2627. doi:10.1177/0308518X15615368



27. Gill, B., Saluja, S., Palit, D. (2017) *Electricity Pricing and the Willingness to Pay for Electricity in India: Current Understanding and the Way Forward*. New Delhi, The Energy and Resource Institute (TERI). <http://www.teriin.org/files/wtp-report-2017.pdf> [Accessed 05.01.2017].
28. IEA (2014) *Africa Energy Outlook: A Focus on Energy Prospects in Sub-Saharan Africa*. International Energy Agency (IEA), Paris, France. [http://www.iea.org/publications/freepublications/publication/WE02014\\_AfricaEnergyOutlook.pdf](http://www.iea.org/publications/freepublications/publication/WE02014_AfricaEnergyOutlook.pdf) [Accessed 05.01.2018].
29. Pedersen, M. B., Nygaard, I. (2018). System building in the Kenyan electrification regime: The case of private solar mini-grid development. *Energy Research & Social Science*, 42, 211-223.
30. Hansen, U.E., Pedersen, M.B., Nygaard, I. (2015) *Review of solar PV policies, interventions and diffusion in East Africa*. *Renewable Energy and Sustainable Energy Review*, 46: 236-248.
31. World Bank (2017) *Kenya: Off-grid Solar Access Project for Underserved Counties*. The World Bank. <http://documents.worldbank.org/curated/en/212451501293669530/pdf/Kenya-off-grid-PAD-07072017.pdf> [Accessed 03.01.2017].
32. NRECA (2017) *Kenya Electrification Strategy Project: Proposed National Electrification Strategy and Implementation Plan*, NRECA International Ltd.
33. Moner-Girona, M., Bódis, K., Huld, T., Kougias, I., Szabó, S., (2016). Universal access to electricity in Burkina Faso: Scaling-up renewable energy technologies. *Environmental Research Letters*, 11.

Chapter 7

# Carbon Capture Innovation Challenge

"to enable near-zero CO<sub>2</sub> emissions from power plants and carbon intensive industries"

By **Wei Yan, Rasmus Fehrmann, Søren Kegnæs, Jerrik J. Mielby** and **Erling H. Stenby**, Department of Chemistry, Technical University of Denmark  
**Philip L. Fosbøl, Nicolas von Solms** and **Kaj Thomsen**, Department of Chemical and Biochemical Engineering, Technical University of Denmark



## Introduction



At least a third of global CO<sub>2</sub> emissions can be attributed to point sources with emissions larger than 0.1 Mt CO<sub>2</sub>/yr. These sources include power plants burning various fuel types and carbon-intensive industries (cement production, refineries, iron and steel, and production of petrochemicals like ethylene and ammonia). The one thousand largest power plants are responsible for 22% of total global CO<sub>2</sub> emissions from fossil fuels [1], while cement production contributes around 5% of global CO<sub>2</sub> emissions. Fossil fuels dominate the energy supply today, and even with a significant growth in renewable energy over the coming period, they will remain a significant part of the energy mix in twenty to thirty years' time. Even though a lot of electrical energy will be produced from renewable sources in the future, heavy industries such as steel, ammonia, and cement production will remain large-scale CO<sub>2</sub> emitters. For these reasons, CO<sub>2</sub> capture, utilization and storage are indispensable elements in the transition towards the global climate reaching a sustainable state.

In the IEA analysis of the reference 2°C global warming scenario, CO<sub>2</sub> emissions must be reduced drastically over a few decades. In order to achieve this, three main areas must make contributions of approximately equal weight: 1) transitions to renewable energy, 2) increased energy efficiency, and 3) optimization of the current energy mix (e.g. CCUS, replacing coal by natural gas, and nuclear energy). In this scenario the estimated CCUS contribution by 2050 will be ~3.5 Gt/yr, or nearly a hundred times the current CO<sub>2</sub> capture capacity. The challenge is enormous in scale and urgency. CO<sub>2</sub> from these point sources usually has low partial pressures, favoring an efficient and low-cost capture process. Also, the captured CO<sub>2</sub> needs to be disposed of safely and, if possible, utilized to create additional value for the economic viability of the whole CCUS chain.

## Post-combustion CO<sub>2</sub> capture and capture from industry

In order to avoid CO<sub>2</sub> emissions going into the atmosphere, there exists a simple engineering trick that can be applied in the power and industrial sector: emissions from industry go through a stack and end up in the atmosphere. By constructing a large filter before the stack, CO<sub>2</sub> emissions can be reduced by almost 100%. This filter is called a CO<sub>2</sub> capture plant. When the CO<sub>2</sub> is removed from the exhaust gases, it needs to be put somewhere. Currently it is transported in pipelines or by ship before being disposed of (often also referred to as "stored" or "sequestered") underground.

In principle, therefore, removing CO<sub>2</sub> from the exhaust gases sounds simple. The CO<sub>2</sub> capture plant contains two significant units. First, there is an absorption column which cleans out the CO<sub>2</sub> using a liquid solvent. The capture plant also

contains a regeneration unit, a desorber, to take the CO<sub>2</sub> out of the solvent for transport and storage. The solvent itself is then reused in the absorber. However, this rather primitive method is characterized by high energy consumption, resulting in a serious loss of efficiency and hence being costly. The challenges are to make the CCS process more efficient and thus more attractive.

The sections below describe some of the approaches to CO<sub>2</sub> capture that have been studied in detail at DTU. New materials such as Metal Organic Frameworks (MOFs) are currently being looked at in several places, but they have still not been developed to a level of maturity where large-scale pilot testing has taken place.

CO<sub>2</sub> capture from plants usually takes three forms: post-combustion, pre-combustion and oxy-combustion. There are four major separation technologies for CO<sub>2</sub> capture: adsorption, absorption, cryogenic distillation and membrane technology. Our discussion here is limited to absorption in post-combustion CO<sub>2</sub> capture.

## Amines

Amine scrubbing is a well-known technology for gas cleaning that dates back to a patent of 1930 taken out by Bottoms. The first commercial plant was constructed in early 1980. There are many types of amine. One, called mono ethanol amine (MEA), has become industry standard due to its widely successful application over many decades. Today it is often used as a basis for comparison whenever new solvents are benchmarked. There is a good reason for developing new solvents. First of all, the CO<sub>2</sub> capture plant uses energy. Applying a different solvent can significantly lower the energy consumption needed to regenerate the solvent in the reboiler.

Secondly, many companies are often interested in developing their own solvents for the purposes of creating a future business case on its basis. There are basically two types of amines: carbamate (an organic compound derived from carbamic acid or NH<sub>2</sub>COOH), and non-carbamate forming types. Tertiary or sterically hindered amines cannot form carbamate because the CO<sub>2</sub> bond to the nitrogen group in the amine molecule is weak.

MEA is a primary amine: it contains only one side group and forms carbamate. The drawback is a very strong bond in the carbamate molecule which makes it very difficult to get the CO<sub>2</sub> off. Therefore 4 GJ/ton CO<sub>2</sub> are required to regenerate the solvent. The obvious answer is to use only non-carbamate-forming molecules. These require much less energy to regenerate, but there is a noticeable disadvantage: they react very slowly with CO<sub>2</sub>. The consequence is the need for a long contact time between the solvent and CO<sub>2</sub>. The process plant must become unfeasibly big and expensive in order to

accommodate the residence time for these solvents.

MEA is a relatively fast-reacting molecule, but new amine solvents have emerged which react even faster and required less energy. Some of these amines, like piperazine, are often used in combination with non-carbamate solvents in order to have the best of two worlds: fast reaction times and low energy consumption. The most recent development has been to use only piperazine as capture solvents. Energy consumption can be very low, in the order of 2.5 GJ/ton CO<sub>2</sub>, much less than MEA.

### Amino acids

Nonetheless there has been a move away from amine solvents because of the long-term process challenges. The amines tend to decompose during the regeneration process, the degradation products, called nitrosamines, are not particularly healthy to humans, and the solvents tend to corrode the processing equipment, adding cost to the maintenance and operation of the capture plant. For the same reason, in the last decade many new solvents have appeared.

Amino acids possess the positive characteristic of being edible and even healthy. At the same time they are also able to act as CO<sub>2</sub> capture solvents. Taurine has shown itself to be a very promising solvent for CO<sub>2</sub> capture, also being known as an additive in many soda drinks.

Amino acids have a nice story to tell, but the fact is that these solvents also degrade to nitrosamines, and some, like sarcosine, are even more corrosive than MEA. It is therefore quite important to do a significant solvent development and characterization test in order to ensure safe operation.

### Chilled ammonia

Aqueous ammonia solutions were suggested for use as solvents in post-combustion CO<sub>2</sub> capture plants by Gal in 2006. [2] The suggested process was called the chilled ammonia process and included the chilling of solvent and flue gas so that the CO<sub>2</sub> absorption could be performed in the 0–20 °C range, that is, at a sufficiently low temperature to prevent the ammonia from evaporating. Ammonia solutions with up to 28 mass % ammonia were used as solvent. By absorbing CO<sub>2</sub> in this solution, a slurry of ammonium bicarbonate was formed, by heating which CO<sub>2</sub> could be released in pure form. The advantage of using ammonia as a solvent is its

great solubility in water, giving it a very high capacity for CO<sub>2</sub> capture. Another advantage is that ammonia does not undergo thermal or oxidative degradation in the conditions relevant for CO<sub>2</sub> capture.

Difficulties in handling the slurry and the ammonia slip have led to the development of variations of this process that use more dilute solutions of ammonia and do not require so much chilling. Such processes have been shown to be competitive in relation to processes using amine solvents [3]. Recent variations of the ammonia-based post-combustion process include the mixed-salt technology, which uses a solvent consisting of water, ammonia and potassium carbonate [4].

### Enzymes in CO<sub>2</sub> capture

A relatively new technology in the field of carbon capture is the use of enzymes as absorption accelerators [5,6]. The enzyme carbonic anhydrase can be found in almost all living organisms, where it catalyzes CO<sub>2</sub> transport and respiration. In carbon capture technology this enzyme has attracted attention because it has been shown to increase the absorption of solvents that are known to be slow to absorb carbon dioxide, while having a potentially high capacity to do so. Two solvents which have particular promise are N-methyldiethanolamine (MDEA) and potassium carbonate solution, where the addition of 1–2 g/l enzyme was sufficient to increase the uptake of CO<sub>2</sub> by a factor of ten. Working with enzymes in a technical process can therefore provide significant benefits, but it also entails restrictions due to the temperature sensitivity of the enzymes, which start to lose their activity at higher processing temperatures. Solvent regeneration in the desorber is typically carried out at temperatures above 100 °C, which is not suitable for the enzyme. Possible processing solutions to this challenge are the development of more heat-tolerant enzymes, filtration of the enzyme between the absorber and desorber stages, and immobilization of the enzyme in the absorber. All these processing options are areas of active current research.

The DTU absorption column has a packed height of up to 10 m and an internal diameter of 10 cm, with a maximum liquid flow of 10 liter/mi. The column is shown in the photograph below (*Figure 1*).



Figure 1. A view of the DTU absorption column

### Ionic liquid CO<sub>2</sub> absorbers

Ionic liquids (Figure 2) are low melting salts (below 100°C or much lower) consisting typically of a rather large organic cation and an inorganic or organic anion being stable with non-measurable low vapor pressure in an often large temperature range.

Rapidly increasing research and development towards expanding the available number and types of different ILs started around year 2000, since when numerous applications for these new solvents have been proposed. Among these applications, utilizations for CO<sub>2</sub> sequestration have been investigated in the last decade. Also at DTU Chemistry, IL research has taken place since 2000 pioneering their use as solvents for catalysts, biomass conversion and gas separation, including CO<sub>2</sub> capture. Much international research has so far focused on fluorinated ILs, which are attractive for gas scrubbing due to their high thermal stability and low viscosity, though they only exhibit high CO<sub>2</sub> capture capacity at very elevated CO<sub>2</sub> partial pressures.

Furthermore, fluorinated compounds are not attractive for use at large industrial scales, so at DTU we have looked for biologically friendly alternatives and currently have a special focus on amino acid (AA)-derived ionic liquids. Thus,

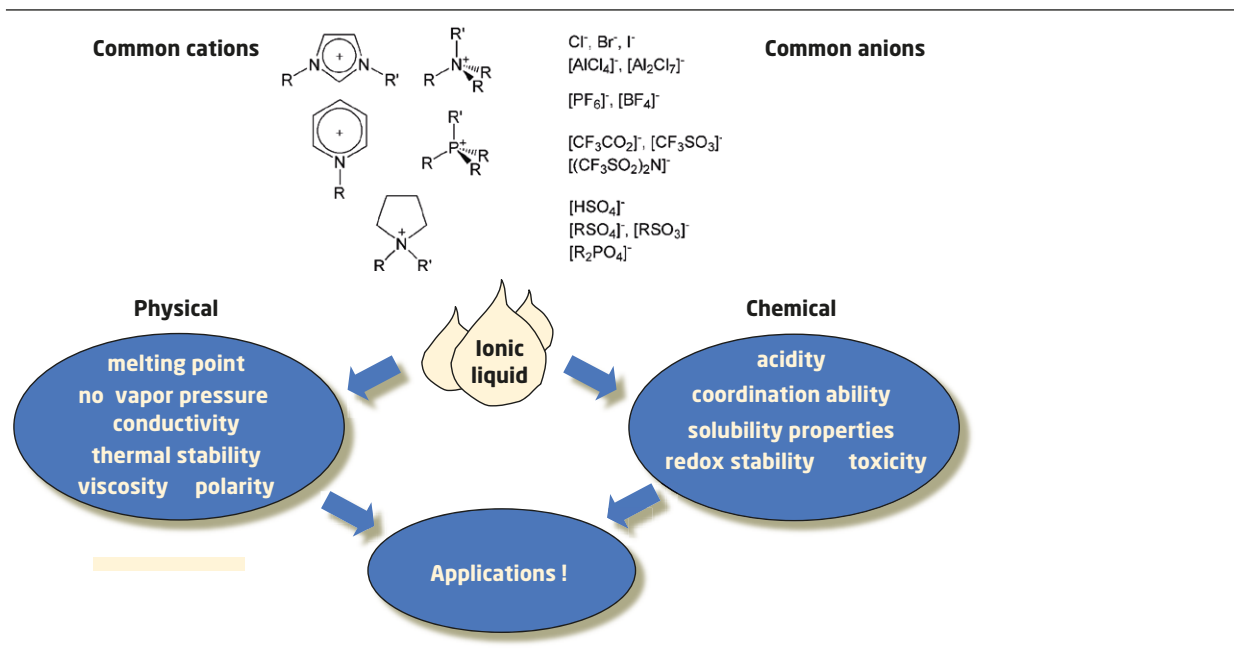

Figure 2. Ionic liquids ion pairs and tunable properties

we have succeeded in synthesizing AA ILs with a high CO<sub>2</sub> binding capacity as cyclic carbamates in a 1:1 reaction stoichiometry to the IL instead of the less attractive 1:2 stoichiometry usually found for ionic liquid amines and the amines mentioned above in aqueous solutions. Furthermore the energy penalty of regenerating AA IL is 50% or less compared to the state-of-the-art amine-based absorbers. In addition, it has been discovered that by impregnating the AA ILs in inert porous supports, the high-mass transport resistance of the viscous AA ILs can be overcome, and apparently solid filters (SILP) with desired gas channel sizes can be extruded in any wanted dimensions. The efficient absorption-desorption temperature range is typically the attractive room temperature 100°C, and since the vapor pressure is not a practical issue a continuous flow operation of the filter is possible. A two-tower arrangement or a rotating filter design are suggested, successful use of the concept for upgrading biogas being achieved in a collaboration with a large Finnish-Swedish company operating in the market. Two patents and several publications document the efforts so far in this direction [7-9].

## CO<sub>2</sub> storage and EOR

Safe sequestration of captured CO<sub>2</sub> is an integral part of CCUS. For large amounts of CO<sub>2</sub> disposal, the most realistic storage places are underground geological structures such as saline aquifers and petroleum reservoirs. While saline aquifers can only be used for storage purposes, injection of CO<sub>2</sub> into petroleum reservoirs can enhance oil and gas production, in addition to sequestering CO<sub>2</sub>. Since Enhanced Oil Recovery (EOR) through CO<sub>2</sub> utilization can generate profits to offset the costs involved in the capture step, this is often considered to be the enabler of large-scale CO<sub>2</sub> sequestration. An additional factor favoring CO<sub>2</sub> storage in petroleum reservoirs is that the geological structures of these reservoirs have usually been better studied than those of unchartered aquifers. This helps control the risk of CO<sub>2</sub> leakage, which is a major concern with underground CO<sub>2</sub> storage.

Although CO<sub>2</sub> EOR is widely used onshore, with many successful examples – e.g. the Weyburn CO<sub>2</sub> EOR/sequestration project – its application in offshore environments is rare due to the high costs of offshore operations. Offshore CO<sub>2</sub> EOR is especially relevant for Europe, most of whose oil production comes from the North Sea. In the Danish sector of the North Sea, the estimated ultimate recovery is <30%, there being great potential for CO<sub>2</sub> EOR as a more economical way of sequestering CO<sub>2</sub>.

DTU has been involved in several CO<sub>2</sub> EOR projects where the focus is to quantify the technical feasibility of offshore CO<sub>2</sub> EOR. These studies show that CO<sub>2</sub> can recover most of the residual oil after flooding by water in laboratory flooding tests [10]. There is no significant weakening of the reservoir rock (chalk) after CO<sub>2</sub> injection [11], and direct diffusion through cap rock specimens seems to be limited [12]. The results support CO<sub>2</sub> EOR, but implementation is still not economically viable due to the lack of affordable captured CO<sub>2</sub>.

The research challenges in offshore CO<sub>2</sub> storage through EOR are diverse. It generally requires a more thorough understanding of the underlying mechanisms to reduce the technical risks and increase the economic viability. Fluid phase behavior at high pressure is essential to both CO<sub>2</sub> EOR and plain CO<sub>2</sub> sequestration. Injected CO<sub>2</sub> can interact with oil and brine and form complex multiple phases, and sometimes even organic deposits. The challenge is the lack of sufficient high pressure data and the accurate modeling of complex multiphase equilibria. To address the challenge, both critical experimental measurements (Figure 3) and theoretical modeling using new advanced thermodynamic models are needed. Fluid-rock interaction is another aspect that is crucial to CO<sub>2</sub> storage, since the injected CO<sub>2</sub> can react with the rock in the presence of water. The interaction can be studied in the laboratory using representative rock samples, but it is challenging to interpret the results for the whole reservoir and estimate the CO<sub>2</sub> effects on rock within the time scale of sequestration. Finally, long-term forecasting of CO<sub>2</sub> EOR and storage relies on simulation. Historically, the reservoir simulation software and the geological sequestration software were developed separately. The sequestration software cannot handle the complex phase equilibrium in CO<sub>2</sub> EOR, while reservoir simulation software usually lacks the reactions between CO<sub>2</sub> containing brine and CO<sub>2</sub> containing minerals. Integration of their capabilities is needed to simulate CO<sub>2</sub> storage through EOR. New algorithms [13] that can handle chemical and phase equilibrium simultaneously can potentially be used to improve the efficiency of the current sequestration simulators.

CO<sub>2</sub> storage through EOR provides a pragmatic route towards large-scale implementation of CO<sub>2</sub> storage. Currently, CO<sub>2</sub> EOR is driven more by its economic benefits and CO<sub>2</sub> storage by environmental concerns. Better integration between the two is expected in both research and implementation.



Figure 3. High pressure unit for fluid phase behavior study at DTU

### CO<sub>2</sub> utilized as chemical raw material

The conversion of renewable energy and biomass into gaseous or liquid hydrocarbon fuels is a promising strategy for using renewable energy and creating renewable transportation fuels. Renewable liquid hydrocarbon fuels are especially useful for shipping, aviation and other heavy transportation, where other known technologies are limited due to their lower energy densities [14]. In principle, such liquid hydrocarbon fuels can be produced from biomass in three steps. In the first step, microorganisms can convert the biomass into biogas (CO<sub>2</sub> and CH<sub>4</sub>) via anaerobic digestion. In the second and third steps, the biogas is converted into syngas (CO and H<sub>2</sub>) through dry reforming and then into liquid fuels through Fischer-Tropsch synthesis. These last two steps are challenging catalytic processes that rely on the development of highly efficient and durable heterogeneous catalysts. Alternatively, renewable H<sub>2</sub> may also be used to convert the CO<sub>2</sub> into CH<sub>4</sub>. This process is called methanation and has recently attracted much interest because the refined bio- or substitute natural gas (bio-SNG) can easily be stored and redistributed via the existing natural gas grid. The production of SNG is a highly exothermic process, which means that the reaction temperature increases drastically when the syngas passes through the catalytic reactor [15]. The main challenge is therefore to manage the heat of the reaction and to develop more active and stable heterogeneous catalysts for the process [16]. Another promising approach in CO<sub>2</sub> utilization is the production of lower olefins such as ethylene or propylene [17]. Today light olefins are mainly produced by cracking fossil derived feedstocks such as naphtha or dehydrogenation of light alkanes from shale gas. In principle light olefins can also be produced from CO<sub>2</sub> through hydrogenation into methanol followed by the so called methanol-to-olefin (MTO) process. The CO<sub>2</sub> derived olefins could

then be used for the production of value-added products such as polyethylene or polypropylene. Although these processes are promising CCUS strategies that could help limit CO<sub>2</sub> emissions, they are still not used on an industrial scale due to the relatively high price of energy compared to the relatively low price of fossil feedstocks. Since CO<sub>2</sub> has high thermodynamic stability, CO<sub>2</sub> conversion into valuable fuels or chemicals requires considerable energy. While hydrogenation makes CO<sub>2</sub> practically significant, the activation energy barriers are still very high. The development of efficient CCUS processes therefore rely on the development of more efficient heterogeneous catalysts.

### Conclusions and global perspectives

CCUS is still a possible method to reduce CO<sub>2</sub> emissions on a significant scale relatively quickly. Converting CO<sub>2</sub> into value-added products not only mitigates CO<sub>2</sub> emissions, it also produces chemicals and fuels that may enhance security of supply, given the strong fluctuation of oil prices. CO<sub>2</sub> conversion of CO<sub>2</sub> is a challenging task because CO<sub>2</sub> is a fully oxidized, thermodynamically stable and inert molecule.

A wide range of post-combustion CO<sub>2</sub> capture methods have been developed through research over several decades. A number of technologies have been matured to the level of pilot scale testing, and a few have been tested in full-scale capture at large point sources such as coal- or gas-fired power plants. Through detailed modelling of the capture processes, process simulation and optimization have been possible, leading to efficient energy integration and reduction in the overall energy penalty for the capture and compression processes. Still, the best processes require close to 10% points of the overall power and heat efficiency, and further research and development are therefore necessary if large-scale implementation of CO<sub>2</sub> capture, utilization and/or storage is to take place. The potential for utilization is greatest within EOR or the conversion of CO<sub>2</sub> to chemicals or hydrocarbon fuel.

The different capture technologies have different advantages and disadvantages, and their applicability depends on the location of the point source. Some new methods, such as metal organic framework absorbents, seem to have a large potential for lower energy costs, but they still need to be developed further.

In order for CCUS to be implemented successfully, the whole value chain has to be covered, i.e. from capture through transport to disposal or utilization. A sustainable CCUS value chain requires technological development, as well as the management of environmental performance, risk and economics. In general, the maturation and deployment of CCUS is limited by the lack of proper regulations and unsatisfactory pricing of CO<sub>2</sub> emissions.

# References

---

1. Turnbull JC, Keller ED, Norris MW, Wiltshire RM Independent evaluation of point source fossil fuel CO<sub>2</sub> emissions to better than 10%. *PNAS* 2016; 113(37): 10287-10291.
2. Gal E. Ultra cleaning combustion gas including the removal of CO<sub>2</sub>. World Intellectual Property. Patent WO 2006022885 (2006)
3. Darde V, Maribo-Mogensen B, van Well WJM, Stenby EH, Thomsen, K. Process simulation of CO<sub>2</sub> capture with aqueous ammonia using the Extended UNIQUAC model. *International Journal of Greenhouse Gas Control* 2012; 10: 74-87.
4. Jayaweera I, Jayaweera P, Elmore R, Bao J, Bhamidi S. Update on mixed-salt technology development for CO<sub>2</sub> capture from post-combustion power stations. *Energy Procedia* 2014; 63: 640-650.
5. Gladis A, Gundersen MT, Fosbøl PL, Woodley JM, von Solms N. Influence of temperature and solvent concentration on the kinetics of the enzyme carbonic anhydrase in carbon capture technology. *Chemical Engineering Journal* 2017; 309: 772-786.
6. Gladis A, Gundersen MT, Neerup R, Fosbøl PL, Woodley JM, von Solms N. CO<sub>2</sub> mass transfer model for carbonic anhydrase-enhanced aqueous MDEA solutions. *Chemical Engineering Journal* 2018; 335: 197-208.
7. Kolding H, Thomassen P., Mossin P, Kegnaes S, Riisager A, Rogez J, et al. Absorption of Flue-Gas Components by Ionic Liquids, *ECS Trans.* 2014; 64: 97-108.
8. Shunmugavel S, Kunov-Kruse AJ, Fehrmann R, Riisager A. Amine-functionalized amino acid-based ionic liquids as efficient and high-capacity absorbents for CO<sub>2</sub>. *ChemSusChem.* 2014; 7(3): 897-902.
9. Ramdin M, De Loos TW, Vlugt TJH. State-of-the-art CO<sub>2</sub> capture with ionic liquids. *Ind. Eng. Chem. Res.* 2012; 51: 8149-8177.
10. Niu B, Yan W, Shapiro AA, Stenby EH. In-situ phase identification and saturation determination in carbon dioxide flooding of water flooded chalk using X-ray computed tomography. Paper SPE 129760 presented at the 17th SPE Improved Oil Recovery Symposium, Oklahoma, USA, 24-28 April, 2010.
11. Alam MM, Hjuler ML, Christensen HF, Fabricius IL. Petrophysical and rock-mechanics effects of CO<sub>2</sub> injection for enhanced oil recovery: chalk from South Arne field, North Sea. *Journal of Petroleum Science and Engineering* 2014; 122: 468-487.
12. Niu B, Yan W. Final Report for DUC EOR Feasibility Study, Part 6: Cap rock Testing. Diffusion Experiments at Reservoir Conditions. Technical University of Denmark, 2012.
13. Tsanas C, Stenby E H, Yan, W. Calculation of multiphase chemical equilibrium by the modified RAND method. *Ind. Eng. Chem. Res.* 2017; 56(41): 11983-11995.
14. Schemme S, Samsun RC, Peters R, Stolten D. Power-to-fuel as a key to sustainable transport systems – An analysis of diesel fuels produced from CO<sub>2</sub> and renewable electricity. *Fuel*, 2017; 205: 198-221.
15. Boll W, Hochgesand G, Higman C, Supp E, Kalteier P, Müller WD, et al. Gas Production, *Ullmann's Encyclopedia of Industrial Chemistry*, 2011.
16. Goodarzi F, Kang L, Wang FR, Joensen F, Kegnaes S, Mielby J. Methanation of CO<sub>2</sub> over zeolite-encapsulated nickel nanoparticles. *ChemCatChem* 2018, 10, 1566 - 1570.
17. Li Z, Wang J, Qu Y, Liu H, Tang C, Miao S, et al. Highly selective conversion of carbon dioxide to lower olefins. *ACS Catal.* 2017; 7: 8544-8548.





Chapter 8

# Sustainable Bioenergy and Biofuels Innovation Challenge

“to develop ways to produce, at scale, widely affordable, advanced biofuels for transportation and industrial applications”

By **Lene Lange, Ioannis Skiadas, Hariklia Gavala, Anker Jensen, Zsuzsa Sárossy, Tobias Pape Thomsen, Kim Dam-Johansen** and **Anne S. Meyer**, Department of Chemical and Biochemical Engineering, Technical University of Denmark  
**Irini Angelidaki**, Department of Environmental Engineering, Technical University of Denmark



## Biomass to bioenergy technologies



New and improved technologies are needed in order to meet the objective of the Mission Innovation on biofuels. In this chapter we provide a catalogue of a selection of the most important biomass and bio-waste conversion technologies targeted at improved, scalable and cost-effective production of biofuels. The technologies span over chemical, physical, and biochemical approaches, and include hydrothermal treatments, pyrolysis, chemical catalysis, gasification, combustion, and bio-processing (enzyme catalysis and microbial conversion). The catalogue includes recent results obtained from DTU research, as well as highlights from global, academic and industrial research. The concept of value-cascading from a biorefinery perspective is considered, and biorefinery technologies and feedstock sources are evaluated.

## Physico-chemical processing of biomass

### Physico-chemical pretreatment of plant biomass prior to bioprocessing

Cellulose-based production of ethanol, also known as cellulosic bioethanol, has received significant attention as a renewable alternative to fossil fuels. The conversion of cellulosic biomass to ethanol involves three main steps: 1) physico-chemical pretreatment; 2) enzymatic conversion of cellulose (and xylan) to fermentable sugars; and 3) fermentation of glucose (C6) and xylose (C5) to ethanol.

The feedstocks for cellulosic ethanol are generally recalcitrant lignocellulosic biomass, such as straw, various types of stalks (e.g. corn stover), and various types of wood. The nature and composition of the feedstocks obviously dictate the specific treatment details, including the choice of enzymes, but in all cases a physico-chemical (hydrothermal or thermochemical) pretreatment is needed prior to the ensuing bio-processing. The purpose of the pretreatment is to make the cellulose amenable to enzymatic attack and in general to enhance the susceptibility of the biomass to enzymatic deconstruction. In the first wave in the development of cellulosic ethanol processes, the focus was on cellulose conversion only. However, now that xylose fermenting yeast has been developed, the pre-treatment also needs to prepare for optimal utilization of the hemicellulose present in the feedstock to maximize the ethanol yields.

The most frequently studied types of pretreatment include hydrothermal pretreatment, with or without the addition of acid. The pretreatment technology may involve direct steam or hot-water treatments in various forms (soaking, spraying), steam explosion, ammonia fiber expansion, or alkaline wet oxidation treatments. Other pretreatment methods such as lime (calcium hydroxide) and organic solvent (“organosolv”) treatments have also been developed and are used widely,

but hydrothermal pretreatment is currently considered the dominant pretreatment technology for industrial cellulosic ethanol production. Hydrothermal pretreatment was also used in, for example, the Inbicon demonstration plant in Denmark and the full-scale Beta Renewables ethanol plant in Italy. Hydrothermal pretreatment is usually carried out by treating the biomass at 180–200°C for 10–20 minutes. The severity of the treatment is a compromise between preparing the cellulose for enzymatic attack and the undesirable production and release of cellulase inhibitors which may retard the enzymatic efficacy. Indeed, it has long been known that the high-temperature treatment generates various furans, as glucose can be converted into 5-(hydroxymethyl)-2-furaldehyde (HMF) and xylose to furan-2-carbaldehyde (furfural) and other compounds. But also phenolics and organic acids, a range of pentose-oligomers (xylo-oligosaccharides), and some short hexose-oligomers may be released due to the hydrothermal treatment [1]. Moreover, research carried out at Ørsted in collaboration with DTU Chemical Engineering has recently established that a vast number of highly potent oligophenolic cellulase inhibitors are generated during hydrothermal pretreatment of wheat straw [2].

It is obviously important to understand the reaction mechanisms and compounds that are formed in order to find ways to prevent their formation or selectively remove them, but the reaction products are also of interest because they may turn out to be useful, valuable biobased chemicals. Hence, the very same compounds that are possible inhibitors of biomass-processing enzymes and microorganisms may also be valuable biobased chemicals. Large-scale lignocellulosic processing therefore also provides a new potential for the industrial-scale synthesis of chemicals. An understanding of the reaction mechanisms and the impact of the reaction conditions during biomass pretreatment on product formation is a prerequisite for designing better biomass-processing strategies. Such knowledge also forms a basis for the development of new biorefinery products from lignocellulosic biomass.

The changes in the biomass materials that take place during processing is also important in relation to optimizing the enzymatic biomass conversion. The physico-chemical pretreatment may, for example, also cause dislocation of components, notably lignin. The influence of the presence of lignin on the enzymatic cellulose conversion is a research subject in its own right [3]. Recently, lignin has moreover received particular attention in relation to valorization, that is, its use in biocomposite materials and binders, and as a starting material for the production of platform chemicals in biorefinery concept processes. Hence, a range of recent research studies have aimed at understanding biomass pretreatment and lignin chemistry in the light of lignin utilization for value-added applications.

The most recent research results obtained at DTU in this area, mostly in research projects conducted in collaboration with industrial companies, include i) new findings unraveling the significance of the physico-chemical surface properties of pretreated biomass for efficient enzymatic processing [3]; ii) use of Fourier transform infrared (FTIR) spectroscopy for fast lignin characterization as a prerequisite for rational lignin valorization [4]; iii) definition of a chemical formula for lignocellulosic biomass ( $C_6H_{8.4}O_{3.5}$ ) [4]; and iv) validation of a new pretreatment severity equation and insight into the fate of mineral elements during the biorefining of lignocellulosic biomass in relation to biomass processing and biorefinery technologies [5].

### Conversion of biomass by pyrolysis and catalytic hydropyrolysis

It is in principle possible to convert any lignocellulosic biomass into a liquid bio-oil with a high yield by fast pyrolysis, where the biomass is rapidly heated to 450-550°C in an inert atmosphere [6; 7]. The process provides significant (6-8 times) densification of the energy content, allowing easy transportation. However, as bio-oil has a high oxygen and water content, its heating value is less than half the heating value of petroleum derivatives such as gasoline/petrol or diesel. Furthermore, due to its high oxygen content, bio-oil is immiscible with fossil oil, being acidic and having a tendency to polymerize during storage. Its use is therefore mainly as a liquid fuel for boilers. The properties of the bio-oil can be significantly improved by removing oxygen through hydrogenation (hydro-deoxygenation (HDO)), after which the resulting product can replace conventional liquid fuels in the transportation sector [8]. Recent research by others and at DTU have shown that the HDO step is most conveniently carried out simultaneously with the biomass pyrolysis [9]. This combined “hydrogen-assisted catalytic biomass pyrolysis” process is called catalytic hydropyrolysis. In hydropyrolysis the energy yield in the liquid product is up to 60 % higher than, for example, the energy yield in ethanol from second-generation bio-ethanol processes. These thermochemical processes may be integrated into an energy system, e.g. on driven by wind capacities, which might provide the required hydrogen through electrolysis (Figure 1). Furthermore, in pilot scale experiments (including at both Aarhus and Aalborg universities), bio-oil produced by hydrothermal liquefaction (HTL) of lignin has been shown to have interesting potential for various end-uses.

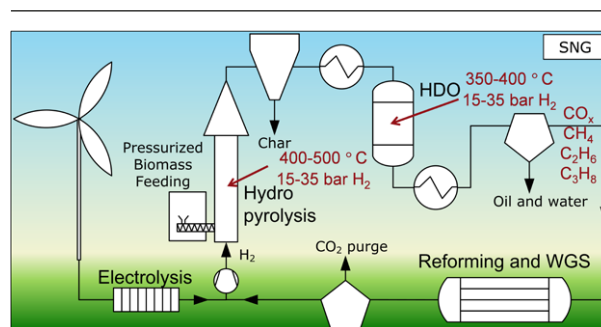

**Figure 1.** Schematic overview of a process for the catalytic hydropyrolysis of biomass to liquid fuel with downstream deep hydrodeoxygenation (HDO). Hydrogen may be derived from water electrolysis using surplus wind (or solar power, or by steam reforming of light pyrolysis gases). When hydrogen comes from wind or solar power, significant co-production of substitute natural gas (SNG) is possible.

### Gasification of biomass followed by synthesis of biofuel

Thermal gasification processes can play an important role in the future energy system because it offers a flexible and efficient platform that can meet a variety of needs. The platform offers options for converting many different types of organic biomass and waste feedstocks into a wide variety of products such as heat, electricity, chemicals, transport fuels and high-value ash and char products. Gasification differs from pyrolysis in having an additional char conversion process in which recalcitrant carbon in the char reacts with a combination of different gasification agents, usually including oxygen, steam and carbon dioxide at elevated temperatures. In this process, the char is converted into a very hot gas consisting predominately of  $CO_2$ ,  $CO$  and  $H_2$ . The gasification step improves the total energy potential in the gas product because the gasification may supply heat for a pyrolysis process in systems that are appropriately integrated.

The main product from the gasification process is a non-condensable gas product which, in addition to  $CO_2$ ,  $CO$ ,  $H_2$  and  $H_2O$ , also may contain a large number of other gaseous hydrocarbons. By-products include smaller quantities of char, ash and condensable compounds (water, tars and oils). The gas product may cover a wide range of calorific values, from 4-7 MJ/m<sup>3</sup> in air-blown gasification to 12-28 MJ/m<sup>3</sup> in oxygen-blown processes. The composition of the gas will vary with the feedstock and design of the gasification process. Gas with a high content of  $CO$  and  $H_2$  and a low tar content—e.g. gas produced from the Two Stage downdraft gasification of wood or sewage sludge—is suitable for many different applications, such as synthesis into green methane, methanol or DME, or conversion in a gas engine or fuel cell [10]. Tar-rich product gas from low-temperature processes

may be suitable for generating bio-oil, and the remaining incondensable gases may be used for the synthesis of fuels or chemicals or heat and power production depending on their composition and calorific value [11].

The residual chars and ashes from gasification still contain carbon. Depending on the feedstock and process design, they may be used as a renewable substitute for industrial products such as fertilizers for agriculture or active carbon for industry and remediation [e.g. 12 and 13].

Gasification and pyrolysis of biomass can be integrated with a number of processes in larger systems or biorefineries to improve overall system performance related to energy efficiency and carbon efficiency, as well as system flexibility in terms of, for example, feedstock or product flexibility (polygeneration). The integration of pyrolysis and/or gasification with

water/steam electrolysis enables the conversion of electricity from renewables to chemical energy bound in the produced fuel, feed or chemical, which is then often referred to as 'storage'. Furthermore, the integration typically enables a doubling of the product output per biomass input because usually a hydrogen deficit limits production, though the hydrogen required can be provided from the electrolysis cells [14].

By combining high-temperature electrolysis and thermal gasification with a catalytic converter, it becomes possible to synthesize methane or liquid fuels, such as methanol. Using the oxygen produced by electrolysis in an oxygen-blown gasification process is highly advantageous, as one avoids diluting the feedstock with nitrogen. The process is depicted in Figure 2.

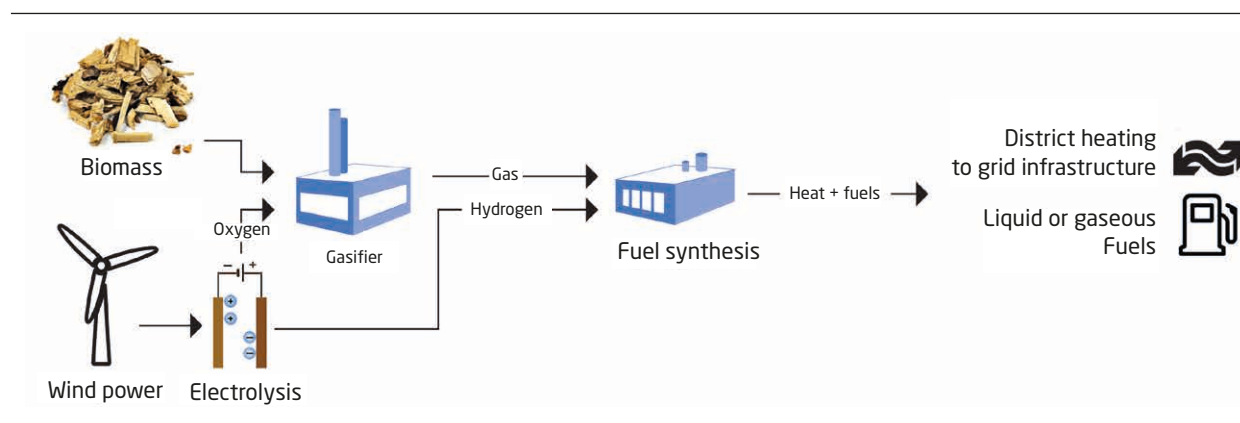

Figure 2. Integration of electrolysis and biomass gasification to produce heat and liquid fuels.

## Bioprocessing technologies for biomass

### The enzymatic conversion step

In the processing of cellulosic biomass into fuels (and other products), the enzymatic conversion step is of crucial significance and has received considerable research attention. Danish industries have a globally leading position in the area of industrial, microbially produced enzymes: Novozymes (<https://www.novozymes.com/en>) and Danisco (now Dupont; <http://www.dupont.com/>). This position implicitly gave Danish public and industrial R&D a head start in developing the core technologies for cellulosic ethanol and biomass conversion, as well as the upcoming bioeconomy. The technologies involve microbial production (by fungi and bacteria, producing enzymes and biorefinery products), biomass conversion (or degradation) and biorefinery technologies involving new steps for the production of various high-value products from side-streams or residues [15].

Given the recently reduced focus on cellulosic ethanol, the conversion of biomass components in order to produce value-added compounds, platform chemicals and “building blocks” or substances for food or feed have received significant attention. Here, enzyme technology and cell factories are particularly suitable due to their reaction selectivity, and development of new products based on designed enzymatic conversions is an important research field of academic and commercial significance. The discovery of new enzymes has recently improved by the availability of sequence databases with sequences of genomes and entire habitats relevant for biomass conversion, and new tools for predicting function of a given protein directly from its gene sequence [15; 16]. Likewise, fast characterization and rational engineering of enzymes have recently advanced due to the availability of novel analytical and molecular biology tools providing new options for development of superior biocatalysts [15].

### Microbial bioconversion processes

By using microbes as catalysts, different types of bioenergy and fuels, as well as several other products, can be produced. A new trend is to utilize waste, including household waste, as raw materials for biogas production, which at the same time reduces the load of the wastes on the environment. The main types of energy carriers produced through the microbial conversion of waste or low-value agroindustrial materials include:

- *Biomethane*. This is “upgraded biogas” from which the CO<sub>2</sub> is removed to increase its calorific value. This upgrading process can be performed microbiologically by the hydrogenotrophic methanogens that bind the CO<sub>2</sub> with hydrogen to produce methane. In that way CO<sub>2</sub> is removed from the biogas, and more CH<sub>4</sub> is produced.
- *Bio-energy* (heat, electricity). Electricity can be produced by combusting biogas in a gas engine. However, electricity could also be produced in microbial fuel cells.
- *Biofuels* (ethanol, biobutanol, biohexanol etc.). Sugars can be converted into biofuels by fermentation using either yeast or bacteria. Newer processes combine fermentation with electrochemistry to convert CO<sub>2</sub> into biofuels and biochemicals.

### Bioenergy from anaerobic bio-processing

The potential for the production of biogas in Denmark is very high – at least ten times higher than what is produced today. Current biogas production in Denmark is based on mixing manure with other (additional), biomass, preferably easily degradable and thus characterized by high methane potential. However, due to the increased demand for biomass feedstock in the bioenergy sector, the availability of these additional biomasses has declined significantly, thus negatively affecting the overall economics of biogas plants. The alternative option is to use lignocellulosic forms of biomass such as manure fibres and agricultural and forest residues, which, however, need to be pretreated in order to be efficiently converted into methane in biogas plants. Existing pretreatment methods are based on high temperatures and pressures and/or the use of harsh chemicals and thus significantly increase the cost of biogas/electricity production. Innovative and low-cost methods for efficient biomass pretreatment for methane production are currently under development [17–20].

In addition to anaerobic digestion, significant research efforts are currently being directed worldwide to developing more efficient biofuel production processes from a variety of waste streams. The fermentation of biomass-derived syngas can contribute to increasing the potential of biofuels (methane and/or alcohols) production as it paves the way for the

conversion of recalcitrant biomasses that are generally not fully exploitable by anaerobic digestion systems. However, there are still several challenges to be addressed in order for this technology (fermentation of syngas) to out-compete first-generation biofuels, but different methodologies are being developed in order to face these important challenges.

### Production of methanol or protein from biogas

The bacterium *Methanococcus capsulatus* can live on methane with ammonia as nitrogen source. The bacteria, oxidize methane to methanol, which then is converted into formaldehyde. Formaldehyde can then be further oxidized to formate and carbon dioxide for energy production or assimilated into new biomass. Based on this idea, the company UniBio produces single-cell bacterial protein-rich animal feed UniProtein® containing 72.9% protein. The methanotrophic bacterium is grown using the patented U-loop technology, adapted to utilizing either natural gas or biogas. Regulatory approval has been achieved for feed for all types of fish and animals [21].

### Integrated biorefineries: the value-cascading principle of biomass conversion

Beyond energy production, the trend is to examine the production of various higher value products to achieve more economically competitive Bioenergy processes based on biomass or waste conversion.

Unlocking the full potential of the biomass (Figure 3) can be achieved by applying the value-cascading approach to biomass conversion: recover the higher value products first (e.g. proteins, human, animal and plant health-relevant smaller molecules, sugar oligos with prebiotics, gut health, effect); and making energy (as well as building blocks for new biobased materials and chemicals) from the remaining fraction of fiber.

The value-cascading biorefinery can pave the way to lowering the price of the biofuel produced, thereby contributing significantly to making biofuel commercially viable, including now, when oil prices are low.

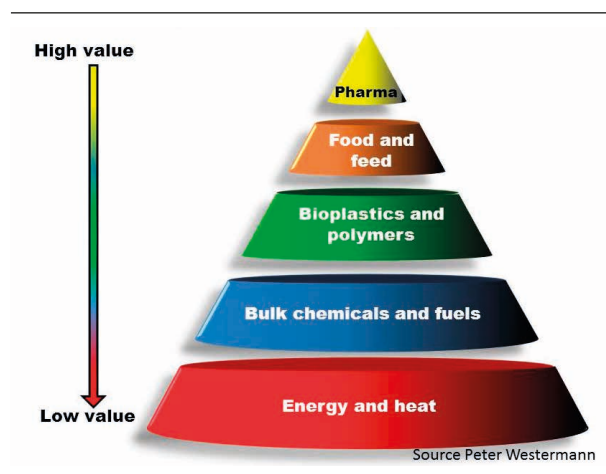

Figure 3. Value-cascading pyramid: Highest value on top, lowest value at the bottom of the pyramid.

Several agro-industrial side streams and crop residues are underutilized today. There is also a need to develop optimized integrated technologies for the valorization of C, N and P from residual solids. Research from DTU describing new value-added processes and simultaneous upgrading options in the area of value-cascading technologies (via biomass and biogas conversion) are listed under (22–32).

#### Biofuels and biorefineries on many types of biomass: beyond wheat straw and cornstover

One of the major global trends in biomass conversion is that biorefinery technologies are extended to be able to convert many new types of biomass. Biorefinery valorization is aimed at unlocking the full potential of the biomass, not only making use of the energy content, but also creating value from the complexity of the biomass. An overview of the many types of biomass used as a basis for bioenergy and other value-added products is given in Figure 4 (terrestrial and aquatic biomass; organic industrial side-streams, wastes and sludge). It can be shown that biomass conversion has developed significantly beyond its initial steps, which focused specifically on making biofuel from straw and stover.

The second major global trend is to aim at many different levels in scaling a biorefinery. Biorefineries making only bioenergy are still very big facilities, as economies have to be reached by scale, the bio-energy profit margin being very low. However, smaller scale biorefineries, with e.g. “end of the pipe” construction, valorizing e.g. protein-rich biomass or the coastal blue biomass biorefinery, can be smaller in size, still be commercially viable and excel in improving resource efficiency. Basically all sizes of biorefineries can also valorize the final residual fractions by making biobased energy.

- The **Yellow Biorefinery** (straw, corn stover, wood)
- The **Green Biorefinery** (fresh green biomass)
- The **Blue Biorefinery** (fish by-catch & cut offs; sea weeds)
- The **Red biorefinery** (slaughterhouse waste)
- The **Grey Biorefinery** (agroindustry side streams)
- The **Brown Biorefinery** (sludge & household waste)
- The **Purple Biorefinery** (CO<sub>2</sub> and Methane used as substrates)

Figure 4. Overview of the many different types of biorefineries, utilizing a broad spectrum of bioresources all with un- or underexploited resources.

In parallel with biomass conversion, technologies are being developed based on the study of nature’s own biomass conversion systems. In particular, gut channels are being studied in detail. The conceptual bridge between designing biorefinery technologies and understanding the metabolism of gut microbiota is formed by currently advanced studies of anaerobic digestion (applied in wastewater treatment and in the production of biogas). The surprisingly convergent enrichment of the microbiota in anaerobic digesters, meaning that most anaerobic digestion plants end up having a highly similar composition of microbes, is now recognized all over the world [33]. These digesters may be considered pools for the discovery of new biomass-converting microbes and enzymes for bioenergy production. Wilkens and co-workers brought the understanding of anaerobic digestion one step further by ranking the types of organisms present in relation to the different types of biomass-converting groups of enzymes (cellulolytic, xylanolytic and amylolytic [34]; see Figure 5).

#### Advanced biofuels, integrated biorefineries, on-site production of enzymes

The terminology used in relation to different types of biofuels is confusing. Currently, there are not only first- and second-generation biofuels, but also third- and fourth-generation biofuels. The European Biofuel Technology Platform has proposed “advanced biofuels” as the term of choice and defined it as: 1) being produced from lignocellulosic feed stock (not from starch, lipid or sugar directly); 2) having low CO<sub>2</sub> emissions or high greenhouse gas reductions; and 3) achieving zero or low indirect impacts on land-use change [35].

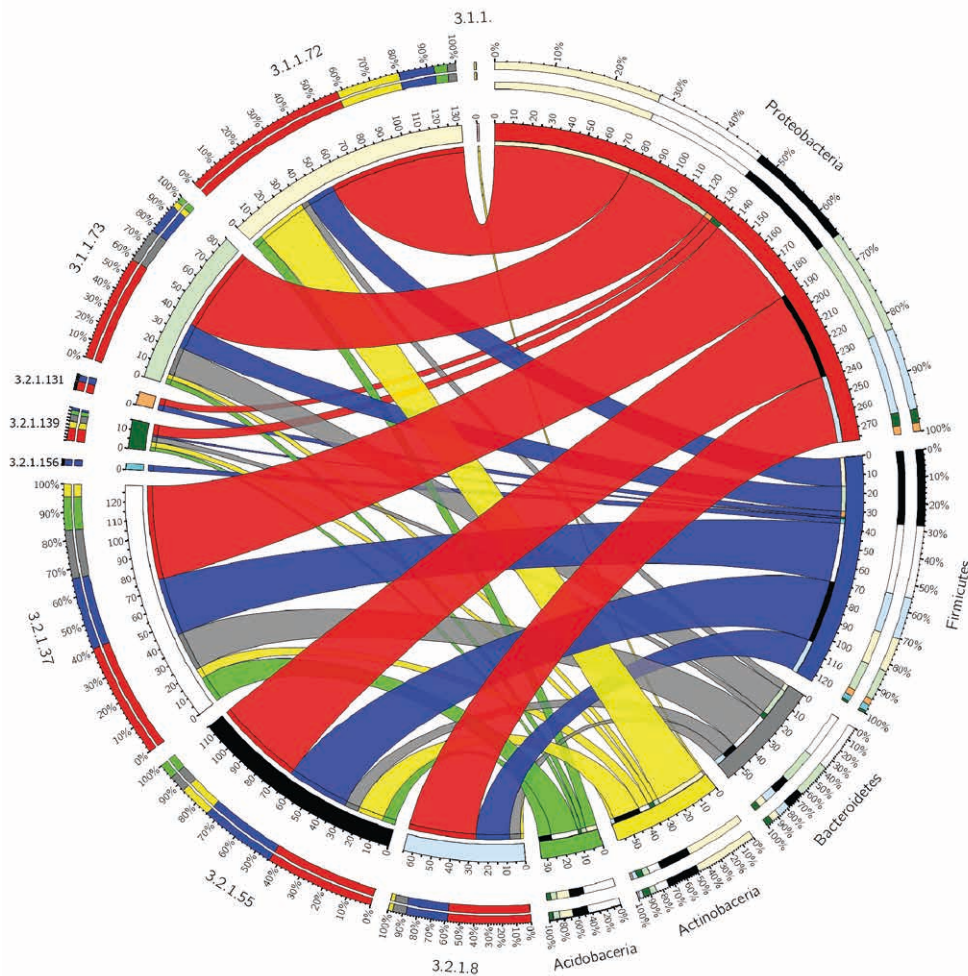

**Figure 5.** The waste-water sludge was recently shown to be a very rich pool of novel enzymes of potential relevance for future improved biomass conversion for bio-based products. The figure shows that the different biomass-converting enzymes (to the left of the circle) produced by the microbiota of the anaerobic waste-water sludge can be connected to the different type of bacteria found in the sludge (to the right). As a result, insight into the role of the different types of microbes in the sludge has been increased.

Most advanced biofuels involve the fungal enzymatic breakdown of biomass and are generated through fungal production. However, alternative systems which do not involve fungi or fungal enzymes are also being developed, including advanced biofuels from algae or the use of physical and chemical processes, e.g. bio-dimethyl ether, bio-synthetic natural gas and bio-oil [36]. Integrated biorefineries [37] are not yet sufficiently cost-effective to be commercially viable. However, improved consolidated efficiencies may be achieved by developing fungal strains that can produce the enzymes needed for biomass conversion and also produce the ethanol.

Alternatively, enzymes may be produced on-site [38] at the site of the biofuel or biorefinery production plant. The required enzymes are, for example, produced on a side stream

of the feed stock, and the entire content of the enzyme-producing seed tank is then added to the main tank to start the enzymatic biomass hydrolysis. However, a number of obstacles, such as intellectual property and technology protection issues, restrictions on use of GMO strains in industrial scale biorefineries and the suboptimized quality of *on-site* enzyme blends, have so far blocked most such development. Nevertheless, on-site solutions can be used when biorefineries are developed in which several higher value products are produced from the feed stock. Another type of technology involves enabling two types of fungi to work in parallel under conditions controlled by changes in pH or another flexible parameter.



## Carbon capture and use of greenhouse gases as substrates

Methane and CO<sub>2</sub> are the major greenhouse gases involved in climate change. An absolutely pivotal development in industry and research, the focus is increasingly on C1 greenhouse gases as the key carbon source to relieve demand for fossil carbon sources [39; 40]. At DTU, several ongoing projects are focusing on the enzymatic reduction of CO<sub>2</sub> to high-in-demand chemicals and fuel compounds such as formate, methanol and formaldehyde. This research has focused and will focus on the discovery and application of key CO<sub>2</sub> converting enzymes, enzyme immobilization technologies, technologies for electron supply and regeneration of reducing equivalents, as well as calculation and optimization of efficiency parameters. Additionally, simultaneous upgrading/value-addition of monomeric sugars (glucose and xylose) during enzymatic CO<sub>2</sub> conversion can be included [41; 42]. The need to convert CO<sub>2</sub> efficiently into industrially relevant compounds is greater than ever. Based on a young but rapidly growing knowledge foundation [43; 44], we believe that enzymatic biocatalysts hold the key to unleashing the potential of the most abundant greenhouse gasses.

## Biofuel seen from the perspective of climate change mitigation and UN development goals

This Innovation Challenge is striving to develop ways to produce, at scale, widely affordable, advanced biofuels for transportation and industrial applications. In recent years, we have become more aware of the need to optimize the way we are using global bio-resources. First, we need to replace not only fossil fuel-based energy with biofuel – in parallel, we must also develop methods for replacing fossil fuel-based chemical building blocks and materials. Furthermore, the observed effects of climate change are challenging food production in many areas of the world. This, together, with a rapidly growing population, makes it of the utmost importance to ensure that global bio-resources are being used much more efficiently than we use them now, when we are throwing away approximately 35% of them. We conclude here that the introduction of bioeconomy-related technologies, upgrading residues, side-streams and wastes can feed many more people and at the same time contribute significantly to the production of biobased fuel, materials and chemicals at commercially viable prices. In this way, technologies can contribute to meeting the UN SDGs (Figure 6) while at the same time contributing to climate change mitigation and to improved resource efficiency overall, as well as, eventually, to more responsible habits of consumption.



Figure 6. The UN sustainable development goals; biofuel is of particular importance for SDG 7, 8, 9, 11, 12 and 13.

# References

---

- Rasmussen H, Sørensen HR, Meyer AS. Formation of degradation compounds from lignocellulosic biomass in the biorefinery: Sugar reaction mechanisms. Vol. 385, Carbohydrate Research. 2014. p. 45-57.
- Rasmussen H, Tanner D, Sørensen HR, Meyer AS. New degradation compounds from lignocellulosic biomass pretreatment: routes for formation of potent oligophenolic enzyme inhibitors. Green Chem [Internet]. 2017;19(2):464-73. Available from: <http://xlink.rsc.org/?DOI=C6GC01809B>
- Djajadi DT, Jensen MM, Oliveira M, Jensen A, Thygesen LG, Pinelo M, et al. Lignin from hydrothermally pretreated grass biomass retards enzymatic cellulose degradation by acting as a physical barrier rather than by inducing nonproductive adsorption of enzymes. Biotechnol Biofuels [Internet]. 2018 Apr;11(1):85. Available from: <https://doi.org/10.1186/s13068-018-1085-0>
- Le DM, Nielsen AD, Sørensen HR, Meyer AS. Characterisation of Authentic Lignin Biorefinery Samples by Fourier Transform Infrared Spectroscopy and Determination of the Chemical Formula for Lignin. Bioenergy Res. 2017;10(4):1025-35.
- Le DM, Sørensen HR, Knudsen NO, Schjoerring JK, Meyer AS. Biorefining of wheat straw: Accounting for the distribution of mineral elements in pretreated biomass by an extended pretreatment-severity equation. Biotechnol Biofuels. 2014;7(1).
- Bridgwater A V. Review of fast pyrolysis of biomass and product upgrading. Biomass and Bioenergy. 2012;38:68-94.
- Trinh TN, Jensen PA, Kim DJ, Knudsen NO, Sørensen HR, Hvilsted S. Comparison of lignin, macroalgae, wood, and straw fast pyrolysis. Energy and Fuels. 2013;27(3):1399-409.
- Mortensen PM, Grunwaldt JD, Jensen PA, Knudsen KG, Jensen AD. A review of catalytic upgrading of bio-oil to engine fuels. Vol. 407, Applied Catalysis A: General. 2011. p. 1-19.
- Marker TL, Felix LG, Linck MB, Roberts MJ. Integrated Hydrolysis and Hydroconversion for the Direct Production of Gasoline and Diesel Fuels or Blending Components from Biomass, Part 1: Proof of Principle Testing. Environ Prog Sustain Energy. 2011;31(2):191-9.
- Ahrenfeldt J, Thomsen TP, Henriksen U, Clausen LR. Biomass gasification cogeneration - A review of state of the art technology and near future perspectives. In: Applied Thermal Engineering. 2013. p. 1407-17.
- Zhou G, Jensen PA, Le DM, Knudsen NO, Jensen AD. Direct upgrading of fast pyrolysis lignin vapor over the HZSM-5 catalyst. Green Chem [Internet]. 2016;18(7):1965-75. Available from: <http://xlink.rsc.org/?DOI=C5GC01976A>
- Thomsen TP, Hauggaard-Nielsen H, Gøbel B, Stoholm P, Ahrenfeldt J, Henriksen UB, et al. Low temperature circulating fluidized bed gasification and co-gasification of municipal sewage sludge. Part 2: Evaluation of ash materials as phosphorus fertilizer. Waste Manag. 2017;66:145-54.
- Maneerung T, Liew J, Dai Y, Kawi S, Chong C, Wang CH. Activated carbon derived from carbon residue from biomass gasification and its application for dye adsorption: Kinetics, isotherms and thermodynamic studies. Bioresour Technol. 2016;200:350-9.
- Clausen LR. Maximizing biofuel production in a thermochemical biorefinery by adding electrolytic hydrogen and by integrating torrefaction with entrained flow gasification. Energy. 2015;85:94-104.
- Lange L, Parmar V, Meyer A. Biocatalysis - Encyclopedia of Sustainable Technologies. In: Abraham M, editor. Reference Module in Earth Systems and Environmental Sciences, from Encyclopedia of Sustainable Technologies, 2017 [Internet]. Oxford: Content Repository Only; 2017. p. 663-73. Available from: <http://www.sciencedirect.com/science/article/pii/B9780124095489102544>
- Busk PK, Pilgaard B, Lezyk MJ, Meyer AS, Lange L. Homology to peptide pattern for annotation of carbohydrate-active enzymes and prediction of function. BMC Bioinformatics [Internet]. 2017;18(1):214. Available from: <http://bmcbioinformatics.biomedcentral.com/articles/10.1186/s12859-017-1625-9>
- Jurado E, Gavala HN, Skiadas I V. Enhancement of methane yield from wheat straw, miscanthus and willow using aqueous ammonia soaking. Environ Technol (United Kingdom). 2013;34(13-14):2069-75.
- Jurado E, Antonopoulou G, Lyberatos G, Gavala HN, Skiadas I V. Continuous anaerobic digestion of swine manure: ADM1-based modelling and effect of addition of swine manure fibers pretreated with aqueous ammonia soaking. Appl Energy. 2016;172:190-8.
- Jurado E, Skiadas I V, Gavala HN. Enhanced methane productivity from manure fibers by aqueous ammonia soaking pretreatment. Appl Energy. 2013;109:104-11.
- Lymperatou A, Gavala HN, Skiadas I V. Optimization of Aqueous Ammonia Soaking of manure fibers by Response Surface Methodology for unlocking the methane potential of swine manure. Bioresour Technol. 2017;244:509-16.
- European Commission. Commission Regulation (EU) No 68/2013 of 16 January 2013 on the Catalogue of feed materials. Off J Eur Union. 2013;(3):1-64.
- Dotsenko G, Lange L. Enzyme Enhanced Protein Recovery from Green Biomass Pulp. Waste and Biomass Valorization. 2017;8(4):1257-64.
- Dotsenko G, Meyer AS, Canibe N, Thygesen A, Nielsen MK, Lange L. Enzymatic production of wheat and ryegrass derived xylooligosaccharides and evaluation of their in vitro effect on pig gut microbiota. Biomass Convers Biorefinery [Internet]. 2017; Available from: <https://doi.org/10.1007/s13399-017-0298-y>
- Morthensen ST, Zeuner B, Meyer AS, Jørgensen H, Pinelo M. Membrane separation of enzyme-converted biomass compounds: Recovery of xylose and production of gluconic acid as a value-added product. Sep Purif Technol. 2018;194:73-80.
- Pierce BC, Agger JW, Zhang Z, Wichmann J, Meyer AS. A comparative study on the activity of fungal lytic polysaccharide monoxygenases for the depolymerization of cellulose in soybean spent flakes. Carbohydr Res [Internet]. 2017;449:85-94. Available from: <http://www.sciencedirect.com/science/article/pii/S000862151730294X>
- Gunnarsson IB, Alvarado-Morales M, Angelidaki I. Utilization of CO<sub>2</sub> fixing bacterium *Actinobacillus succinogenes* 1302 for simultaneous biogas

- upgrading and biosuccinic acid production. *Environ Sci Technol*. 2014;48(20):12464-8.
27. Kuglarz M, Alvarado-Morales M, Karakashev D, Angelidaki I. Integrated production of cellulosic bioethanol and succinic acid from industrial hemp in a biorefinery concept. *Bioresour Technol*. 2016;200:639-47.
  28. D'Este M, Alvarado-Morales M, Angelidaki I. Amino acids production focusing on fermentation technologies - A review. *Biotechnology Advances*. 2017;
  29. D'Este M, Alvarado-Morales M, Ciofalo A, Angelidaki I. Macroalgae *Laminaria digitata* and *Saccharina latissima* as Potential Biomasses for Biogas and Total Phenolics Production: Focusing on Seasonal and Spatial Variations of the Algae. *Energy and Fuels*. 2017;31(7):7166-75.
  30. Jin X, Zhang Y, Li X, Zhao N, Angelidaki I. Microbial Electrolytic Capture, Separation and Regeneration of CO<sub>2</sub> for Biogas Upgrading. *Environ Sci Technol*. 2017;51(16):9371-8.
  31. Bassani I, Kougiaris PG, Treu L, Porté H, Campanaro S, Angelidaki I. Optimization of hydrogen dispersion in thermophilic up-flow reactors for ex situ biogas upgrading. *Bioresour Technol*. 2017;234:310-9.
  32. Zhao N, Angelidaki I, Zhang Y. Electricity generation and microbial community in response to short-term changes in stack connection of self-stacked submersible microbial fuel cell powered by glycerol. *Water Res*. 2017;109:367-74.
  33. Kirkegaard RH, McIlroy SJ, Kristensen JM, Nierychlo M, Karst SM, Dueholm MS. Identifying the abundant and active microorganisms common to full-scale anaerobic digesters. *bioRxiv*. 2016;
  34. Wilkens C, Busk PK, Pilgaard B, Zhang W-J, Nielsen KL, Nielsen PH, et al. Diversity of microbial carbohydrate-active enzymes in Danish anaerobic digesters fed with wastewater treatment sludge. *Biotechnol Biofuels* [Internet]. 2017;10(1):158. Available from: <http://dx.doi.org/10.1186/s13068-017-0840-y>
  35. <http://biofuelstp.eu/>. European Biofuels Technology Platform (EBTP) [Internet]. Available from: <http://biofuelstp.eu/>
  36. Ragauskas AJ, Williams CK, Davison BH, Britovsek G, Cairney J, Eckert CA, et al. The Path Forward for Biofuels and Biomaterials. *Science* (80- ). 2006;311(January):484-9.
  37. Ragauskas AJ, Beckham GT, Bidy MJ, Chandra R, Chen F, Davis MF, et al. Lignin valorization: improving lignin processing in the biorefinery. *Science* [Internet]. 2014;344:1246843. Available from: <http://www.ncbi.nlm.nih.gov/pubmed/24833396>
  38. Bech L, Herbst F, Grell M, Hai Z, Lange L. On-Site Enzyme Production by *Trichoderma asperellum* for the Degradation of Duckweed. *Fungal Genom Biol*. 2015;5:126.
  39. Aresta M, Dibenedetto A, Angelini A. Catalysis for the Valorization of Exhaust Carbon: from CO<sub>2</sub> to Chemicals, Materials, and Fuels. *Technological Use of CO<sub>2</sub>*. *Chem Rev* [Internet]. 2014 Feb 12;114(3):1709-42. Available from: <https://doi.org/10.1021/cr4002758>
  40. Yuan Z, Eden MR, Gani R. Toward the Development and Deployment of Large-Scale Carbon Dioxide Capture and Conversion Processes. *Ind Eng Chem Res* [Internet]. 2016;55(12):3383-419. Available from: <http://pubs.acs.org/doi/abs/10.1021/acs.iecr.5b03277>
  41. Marpani F, Pinelo M, Meyer AS. Enzymatic conversion of CO<sub>2</sub> to CH<sub>3</sub>OH via reverse dehydrogenase cascade biocatalysis: Quantitative comparison of efficiencies of immobilized enzyme systems. *Biochem Eng J* [Internet]. 2017;127:217-28. Available from: <http://dx.doi.org/10.1016/j.bej.2017.08.011>
  42. Luo J, Meyer AS, Mateiu R V., Pinelo M. Cascade catalysis in membranes with enzyme immobilization for multi-enzymatic conversion of CO<sub>2</sub> to methanol. *N Biotechnol* [Internet]. 2015;32(3):319-27. Available from: <http://dx.doi.org/10.1016/j.nbt.2015.02.006>
  43. Shi J, Jiang Y, Jiang Z, Wang X, Wang X, Zhang S, et al. Enzymatic conversion of carbon dioxide. *Chem Soc Rev* [Internet]. 2015;44(17):5981-6000. Available from: <http://xlink.rsc.org/?DOI=C5CS00182>
  44. Sultana S, Chandra Sahoo P, Martha S, Parida K. A review of harvesting clean fuels from enzymatic CO<sub>2</sub> reduction. *RSC Adv* [Internet]. 2016;6(50):44170-94. Available from: <http://xlink.rsc.org/?DOI=C6RA05472B>

Chapter 9

# Power to Fuels and Chemicals Innovation Challenge

“to discover affordable ways to convert sunlight into storable solar fuels”

By **Jakob Kibsgaard**, **Peter C. K. Vesborg** and **Ib Chorkendorff**, Department of Physics, Technical University of Denmark

**Thomas F. Jaramillo** and **Jens K. Nørskov**, SUNCAT Center for Interface Science and Catalysis, Department of Chemical Engineering, Stanford University

**Poul Georg Moses** and **Jens Sehested**, Haldor Topsoe A/S



## Background

→ The key to a sustainable future lies in harvesting energy from the sun. The sun supplies enormous amounts of energy to the earth: the energy from just one hour of solar influx to the earth corresponds to one year of human energy consumption. Nature has developed a method for harvesting solar energy by photosynthesis, providing energy and chemical synthesis routes for plants (and, indirectly, animals). Biomass utilization thus provides one approach to sustainable production, but it cannot cover all our energy consumption needs. In the most optimal places on earth, plants may harvest little more than 1% of the incoming energy, but a more realistic figure would be 0.5% averaged over a year [1]. This is sufficiently efficient to make food for our basic metabolism, but cannot cover our current or projected energy consumption. Biomass has been and will provide an important share of global energy consumption, but it cannot replace the fossil energy resources we are currently using due to competition with food production and the impact on water resources. We must therefore look for much more efficient sources, and here the direct harvesting of solar energy by converting photons into electricity directly (photovoltaic) must be the primary source. Indirectly we can also harvest this energy in the form of wind energy and hydropower.

Thus, when we have made the transformation to relying solely on sustainable energy, it will come in the form of electricity, an excellent form of energy, except it must be used immediately and comes intermittently, whereas we need something that is 100% secure. Although many energy-demanding devices can be electrified and substantial savings can be achieved by doing so, there are areas where this will not be possible. We will still need fuel for long-distance transport, i.e. for aviation, which currently constitutes some 3% of the energy consumption in Europe. Similarly, the fossil resources used in the chemical industry, which account for some 10% of the total energy consumption in Europe, must also be replaced. On top of this seasonal averaging will also be needed through, for example, storage and transport of fuels over long distances in circumstances where power lines may not be the solution. The bottom line is that we need both fuels and chemicals in the future, and it will be essential to develop technology that makes it more efficient to transform electrical energy into chemical energy and back again.

## Opportunities

The most cost-effective way of storing massive amounts of electrical energy today is to use hydropower where water is pumped up in reservoirs. However, as this will not be a generally applicable method for storing energy, other methods will be needed.

Being able to store electrical energy as chemical energy would be a most interesting asset in the future energy portfolio, in which conversion back into electricity might be needed, so that it then also becomes 'dedicated' storage: electricity – fuel – electricity (or power – fuel – power).

One could argue that this is what has really happened to our fossil-fuel resources, which have been storing sunlight energy for millions of years. We need to replace the photosynthesis that took place over millions of years with a more efficient technology of "artificial photosynthesis". The first step in storing electricity as chemical energy could be to split water by electrolysis to produce hydrogen. This is a central part of the overall scheme, as illustrated in Figure 1, taken from one of our recent publications on this subject [2]. Hydrogen could then be burned just as we burn natural gas today or be used in the transport sector in fuel cells, which converts the chemical energy back into electricity with an overall efficiency of roughly 40-60%. – This is significantly lower than batteries, which only have round-trip losses of some 5-15%. This shows why it is so important to increase the efficiency of energy conversion. Taking current technology as a rule of thumb, each conversion step costs roughly 30%, although there are large variations. The hydrogen can also be used, for instance, in steel production, thus replacing the coal used today, which accounts for a substantial part of our industrial CO<sub>2</sub> emissions and ~5% of our global energy consumption [3]. For many purposes, hydrogen would also be an excellent storage medium, especially if it is not intended for use in certain transport sectors or for the transmission of energy between regions.

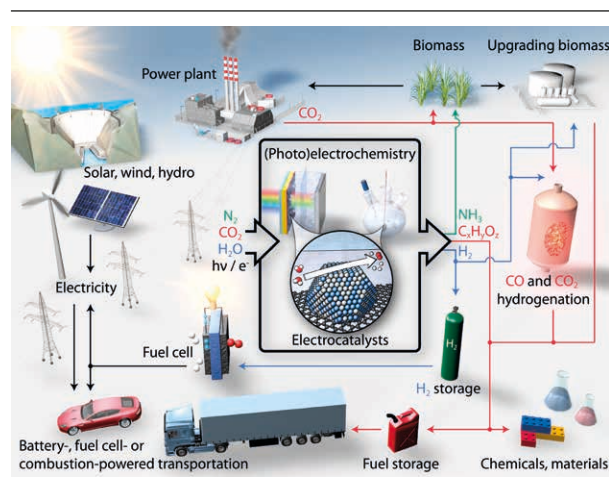

Figure 1. Energy flow chart for a sustainable energy system. Reproduced from [2]

One issue with hydrogen as a fuel is that the combustion energy density per volume is rather low – 2.6 times lower than for methane. Today fuel cell-driven cars use tanks containing 700 bar of hydrogen. These have the advantage that they can be charged within minutes, giving them an advan-

tage over battery-powered cars, but this does not seem to be a solution for aviation, although it has been considered. Thus, here is a need for high-density fuels as we know them today, for which we also have an infrastructure. **Figure 2**, shows chemical energy density per volume and weight of various fuels. In particular, the energy densities of batteries are actually very low.

Nearly all the high-energy density fuels are carbon-based. As sustainable carbon-based fuels must originate from  $\text{CO}_2$ , we must be able to capture and hydrogenate it. Capturing  $\text{CO}_2$  from the atmosphere is an issue since the concentration is only 400 ppm. However, nature does this excellently while producing food or, more generally, biomass. By taking the non-food biomass and burning it in power plants using high-purity oxygen generated by electrolysis, high concentrations of  $\text{CO}_2$  can be produced, making separation more feasible. Concrete production would also be an excellent point source of  $\text{CO}_2$  (it constitutes up to 5% of global  $\text{CO}_2$  emissions, [4] of which roughly half comes from the calcination of limestone). It is predicted that these sources, biomass and point sources, will be able to cover our carbon needs for quite some time. Eventually we may have to extract the  $\text{CO}_2$  from the atmosphere, which will involve substantial additional costs. Having hydrogen and  $\text{CO}_2$  makes it possible to synthesize most of the chemicals we use today, including fuels. Methanol, for instance, is an excellent precursor for making gasoline, polymers and solvents.

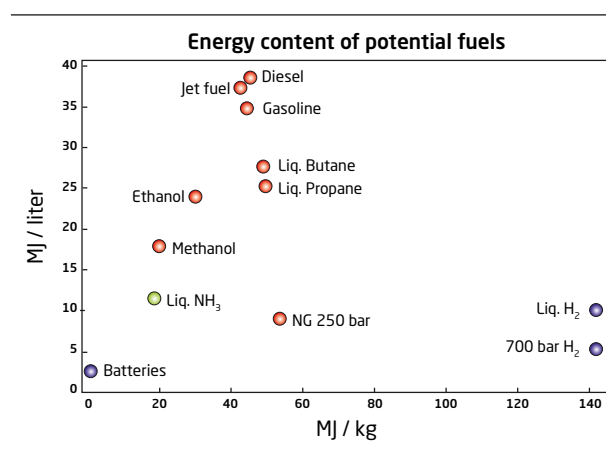

Figure 2. Energy density for a number of important fuels

Making synthetic fuels and chemicals based on energy input from the sun makes more decentralized production possible due to the fact that sustainable energy is decentralized and should be used as such. This is in contrast to the fossil fuel resources, which are more centralized.

If we can produce hydrogen sustainably, we can also make ammonia, since there is plenty of nitrogen in the atmosphere. Today, the process of making ammonia alone con-

sumes 1% of our total energy and is essential since ammonia is not only used as an essential chemical in industry but is also used as fertilizer. It would be impossible to feed the world's population without this essential source of nitrogen. Ammonia today is produced in huge plants at locations where cheap natural gas is available, though with knock-on effects on transport and distribution. Thus it would be of great benefit to produce it close to end use and only when needed, allowing for a more timely dosing in order to avoid subsequent pollution of the environment. Arable land needs ~100 kg/Ha ammonia – with substantial variations depending on soil, plants and location [5] – but assuming we can harvest just 10% of the incoming solar energy and arrive at realistic figures for ammonia production (delocalized production has not been realized as yet), then less than 0.5 % of the area would have to be reserved for this important process – an interesting challenge.

## The Challenge

The demand for more decentralized production matching the incoming energy opens up an interesting new opportunity that to date has remained relatively unexplored: electrochemical production of fuels and chemicals. It is relatively easy to split water to make oxygen and hydrogen, and it can be done in a scalable manner, i.e. it does not need a huge facility like an ammonia plant in order to be economically viable. Hydrogen in smaller amounts is already being produced in this fashion: in acidic electrolysis, water is split on the anode, producing molecular oxygen, while the protons migrate through the electrolyte to the cathode, where they combine to form molecular hydrogen (alkaline electrolysis gives the same result, but is slightly different). However, instead of reducing the protons to molecular hydrogen, these protons can be used to reduce  $\text{CO}_2$  or  $\text{N}_2$  into fuels or chemicals directly on the electrocatalyst. This is indicated on the left of Figure 1 along with the thermal catalysis described above. This is an entire new field of research where the possibilities have only just begun to appear. The approach is somewhat different from the conventional catalysis used in the chemical industry today [6]. In thermal catalysis, the conditions to make a reaction exergonic are created by manipulating the temperature and pressure so that the desired products are produced. In electrochemistry, we have another opportunity, as we can create the desired Gibbs free energy for the products by manipulating the energy of the electrons using the electrical potential. Today hydrogen is mainly made from methane through large-scale production at 30-40 bars and 900-1000 oC. The high temperature is necessary since the reaction  $\text{CH}_4 + 2\text{H}_2\text{O} \rightarrow \text{CO}_2 + 4\text{H}_2$  is strongly endothermic. Similarly, if one were to split water by thermal catalysis  $2\text{H}_2\text{O} \rightarrow \text{O}_2 + 2\text{H}_2$  it would require temperatures that are not compatible with most known materials. Yet, taking a 1.5 V battery you can go home and do this on your kitchen table at room temperature if you are using the right electrocatalysts like platinum for the cathode and iridium oxide for the an-

ode. In principle, it only requires 1.23 V applied to four electrons to split water. However, nothing happens if you only apply 1.23 V because, even with the best catalysts known today, there are considerable barriers for the reaction, so it cannot run reversibly. This is why we need better catalysts. In what follows, we shall try to explain how and why this works and what the limitations are.

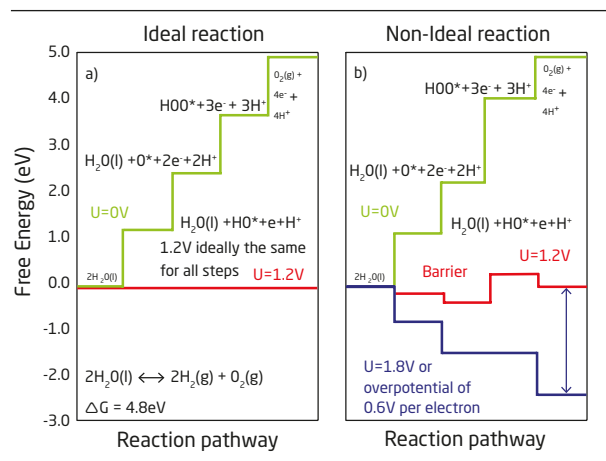

**Figure 3.** Schematic free energy diagram for water splitting. a) displays the ideal case where all intermediates are bond equally strong, while b) shows a more realistic case where an overpotential of 0.6 V occurs due to a too strong bonding of atomic oxygen. Reproduced from ref [6].

The water-splitting reaction can be divided into an anode (oxidation) and a cathode (reduction) reaction according to the two half-reactions (acidic condition):  $2\text{H}_2\text{O} \leftrightarrow 4\text{H}^+ + 4\text{e}^- + \text{O}_2$  and  $4\text{H}^+ + 4\text{e}^- \leftrightarrow 2\text{H}_2$ . The largest bottleneck in splitting water is not the evolution of hydrogen at the cathode, but rather the oxygen evolution reaction (OER) at the anode. In reality, the latter consists of four elementary steps in a catalytic cycle, each involving an electron-proton transfer [7]. This is illustrated in Figure 3a for an ideal catalyst, where the four steps are evenly spaced in energy. The green lines show the case with no applied potential,  $U=0\text{ V}$ , where it is an uphill reaction. By supplying a voltage of 1.2 V for each electron transfer, we obtain the reversible situation (red line), i.e.  $\Delta G=0$ , for all steps, and the process will run spontaneously downhill in free energy at a slightly higher potential  $U > 1.23\text{ V}$ . Unfortunately, it is very challenging to find an electrocatalyst where all the steps are of the same size, as the binding energy of the different intermediates tend to be linearly correlated via the so-called *scaling relations* [8]. A more realistic case (a non-ideal catalyst) is shown in Figure 3b (green line), where the formation of HOO (or O and OH) is associated with a larger energy step than the rest. It is now clearly seen that  $\Delta G$  is not smaller than zero for all steps at the reversible potential of  $U > 1.23\text{ V}$  (red curve); barriers are still present. The process only runs spontaneously when the potential is increased to 1.8 V (blue curve), meaning that the 0.6 V per electron or 33% of the energy is wasted as heat in

the process of making oxygen. This defines the challenge of doing electrocatalysis – finding the optimal catalyst where the steps are equidistant and where there are no other large barriers on top of the potential landscape.

Thus the greater the number of intermediates, the bigger the challenge. This insight has been generated by performing Density Functional Theory (DFT) calculations. Here the potential energy landscape is determined by quantum mechanically calculating the molecule/intermediate interaction with the catalyst. The problem cannot be solved exactly, but approximations are now becoming so good that realistic problems may be solved with reasonable accuracy, at least to the extent that it is possible to compare materials relative to each other. Such investigations reveal that it is very difficult to find a material where the four steps are equidistant, since, as already noted, their reaction energies are strongly correlated through the scaling relations. The oxygen (or OH) bonding energy (the reactivity of the actual catalysts towards oxygen) is called a descriptor, and it is possible to map out the activity for the OER as a function of such descriptors. This is shown in Figure 4, where the OER activity, or rather the overpotential, is shown for different materials. The theoretical overpotential is shown as a function of two descriptors, the free energy of the intermediates OOH and OH, parameters that have been identified as essential in describing the activity, as shown in Figure 4a. Calculated values of these parameters for a number of possible catalysts are included in the plot; all the known data are linearly correlated, and the best are 0.3-0.4 V off the optimum. This provides a likely explanation for the experimental observation that it has been impossible, so far, to find catalysts with overpotentials less than  $\sim 0.3\text{ V}$  (see the benchmarking data in Figure 4b). It seems that we have primarily been optimizing catalysts belonging to a family of materials that follow a scaling relation between the two descriptors. This insight defines future research in this area. We need to be looking for new materials that are capable of breaking the scaling relation (or rather combining different scaling relations) by introducing new sites that can be optimized independently.

If water electrolysis is a challenge, then  $\text{CO}_2$  hydrogenation is even worse, since in this case there are even more steps, each of which has to be optimal in order to produce valuable products at a low energy cost. That is not the only challenge; catalysts that are highly selective must also be chosen, meaning that preferentially only one product is produced, since otherwise substantial energy would be used for subsequent separation. Hori made a substantial contribution to this field in the 1980s by showing that only one metal, namely copper, works optimally in making hydrocarbons and alcohols [9]. It is, however, not particularly useful, since it makes a large range of products with relatively poor selectivity, and basically it only works well for overpotentials above one volt. The difficulties involved are not surprising because making ethanol, for instance, requires eight electrons and thus involves eight different intermediates, which must be

optimized. Silver and gold are very good for converting  $\text{CO}_2$  into CO (this also only requires two electrons), and copper has been able to convert CO into ethanol at much lower overpotentials under alkaline conditions. We have recently found that polycrystalline copper is capable of doing this at a relatively low overpotential  $< 0.4$  V and that it is probably single atomic steps on the surface that are responsible for this (10). Acetaldehyde has been shown to be an important intermediate, and DFT calculations have confirmed these observations. However, acetate and other intermediates are also formed, thus degrading the selectivity.

Figure 5 displays the amount of ethanol and acetaldehyde produced over an oxygen-derived copper surface as a function of charge passed at  $-0.33$  V. Notice how acetaldehyde builds up before ethanol is formed, suggesting that it is an intermediate. It would go beyond the scope to describe all the processes we are currently investigating, but it should be noted that similar issues are also encountered when trying to optimize, for example, fuel-cell catalysts or catalysts for making ammonia electrochemically, the latter being a process where hardly anything is working presently. How are we improving on this situation?

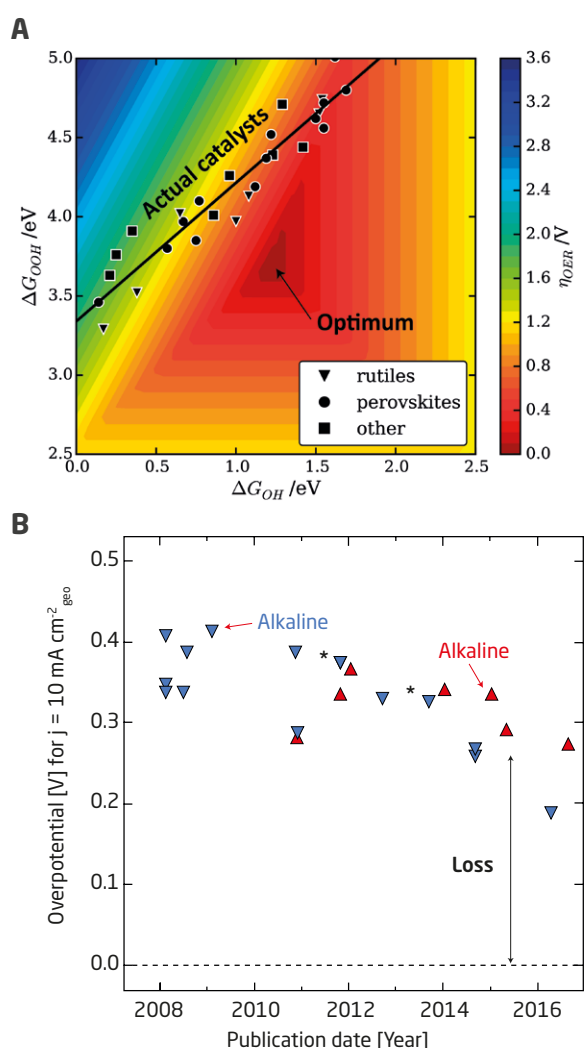

**Figure 4.** a) Contour map of the theoretical overpotential for the oxygen evolution reaction as a function of two descriptors of catalytic activity, the adsorption energies of OH and OOH intermediates. Data for a number of oxide surfaces are included – all follow a scaling relation well off the optimum in activity. b) Chronological trend in overpotential of various OER catalysts in acid and alkali. Data points marked with asterisks are normalized to oxide surface area. Reproduced with permission from [2]

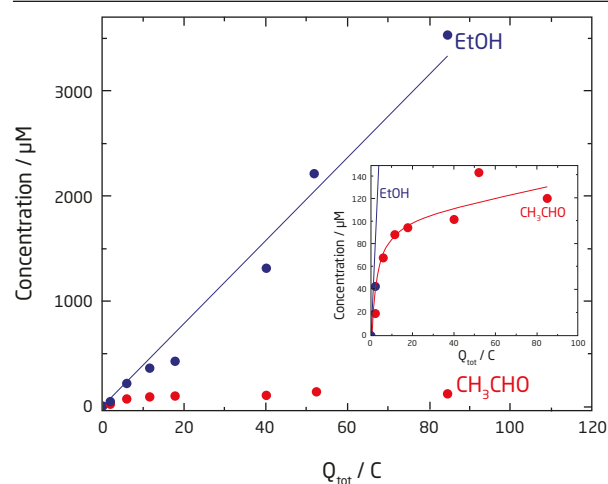

**Figure 5** displays the amount of ethanol and acetaldehyde produced over oxygen-derived copper in a  $0.1\text{M}$  KOH at  $-0.33$  V. Oxygen-derived copper is a copper surface which was first oxidized and then reduced leading to an increased surface area of roughly a factor fifty. Reproduced from [10]. The compound  $\text{CH}_3\text{CHO}$  is acetaldehyde.

## The Approach

As mentioned above, identifying the problem defines the future approach. The challenge is to find new catalyst materials that can break the scaling relation and allow us to reduce the overpotential, while at the same time defining reaction pathways that lead to high selectivity. In the Villum Center for the Science of Sustainable Fuels and Chemicals (a collaborative effort between the Technical University of Denmark, the University of Southern Denmark, Copenhagen University and Stanford University, USA) we utilize a close interaction between experiment and theory in a machinery illustrated in Figure 6. We use an interactive loop process to uncover new catalysts. Compared with experimental screening, it is much quicker to do DFT calculations to narrow down the range of materials of potential interest that are highly active, are selective for the desired product, resistant to corrosion and based on elements that are non-poisonous and abundant. This allows the experiments to focus on fewer potentially



interesting compounds, thus reducing the phase space tremendously. However, when starting to build model systems, it is often realized that more details must be included in the theoretical screening. Examples include new intermediates that could block the surface or a new structure developing on the atomic level that was not taken into account to start with.

Thus, after characterization and testing, this information is fed back to the screening input, and a new turn in the cycle is made, hopefully leading to a new and even better catalyst. All this information is also stored in databases so that the calculations and experiments do not have to be made over and over again.

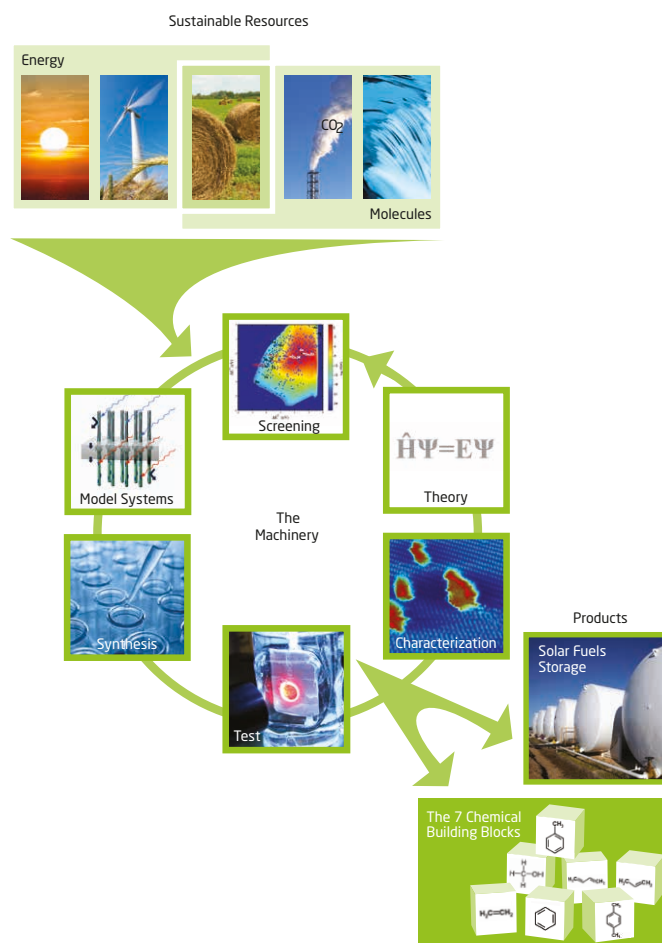

**Figure 6** shows the fundamental idea of the Villum Center for the science of sustainable fuels and chemicals where the machinery is the source of the catalyst discovery, which efficiently shall convert electric energy into chemical energy.

Does this scheme work? To answer this question, we can look back and say “yes”, we have done it before on simpler systems than those described above. Take, for instance, the hydrogen production mentioned above. Here the archetypical electrode for the Hydrogen Evolution Reaction (HER) is platinum, an excellent catalyst for hydrogen production, though its annual production is limited to ~200 ton/year. Pt is very scarce, only being mined in three places on earth, making it as expensive as gold [11]. It is therefore a critical material, and it would be desirable to find a less expensive but also more abundant material [12]. In 2004-5 we screened for such materials and found that MoS<sub>2</sub> had

potential, subsequent experimental testing showed that it worked reasonably well. It was predicted that only the edge of the two-dimensional MoS<sub>2</sub> was the active site [13], and after proving this experimentally [14] the foundation was laid for optimization of this system making as many edge sites as possible. This could be done using the tools of the emerging nano-technology. Later, phosphides, using the same principles, were also shown to be good HER catalysts, and today there are many catalysts with overpotentials of less than 0.1 V, as shown [2] in *Figure 7*. It can clearly be seen here that substantial progress in lowering the overpotential has been made over the past decade (see *Figure 7c*). This is

in sharp contrast to the development of the OER catalysts, as shown [2] in Figure 4b.

The HER is a much simpler reaction than the OER or CO<sub>2</sub> reduction discussed above. Nevertheless, this type of work has already been extended into making a number of new catalysts. One example was the discovery of new catalysts for fuel cells, where the Oxygen Reduction Reaction (ORR) causes a rather large overpotential [15; 16]. A patent family was established that has been developed further in collaboration with the Danish Technology Institute, which is trying to commercialize these catalysts [17]. Theory and experiment also predicted a new class of oxygen reduction catalysts, which, instead of making water, would make hydrogen peroxide [18]. This is a highly undesirable product in a fuel cell, but if one could make appreciable amounts and do it with high selectivity, it could be a most valuable product, especially if it can be produced when needed. This was also patented and today forms the basis for the spin-off

company HPNOW APS, which makes hydrogen peroxide on demand using only electricity and water. This is very useful for replacing the off-site-produced hydrogen peroxide used in irrigation systems and for disinfection purposes. The approach has also been applied to the process of using ammonia as an energy vector by decomposing it into nitrogen and hydrogen, the second of which can then be fed into a fuel cell. This requires extremely clean hydrogen, which has been made possible, leading to the setting up of the spin-off company RenCat APS. We also have enjoyed close collaboration with the leading catalysts company in Denmark, Haldor Topsøe A/S, in investigating the thermal conversion of CO<sub>2</sub> into methanol, an interesting precursor for both chemicals, but certainly also a potential fuel. Here we have laid the foundations for a basic understanding of the process at the atomic level [19; 20]) leading to predictive power for designing better catalysts [21], while at the same time also enabling the discovery of entirely new types of catalysts that potentially could be used in small decentralized systems [22].

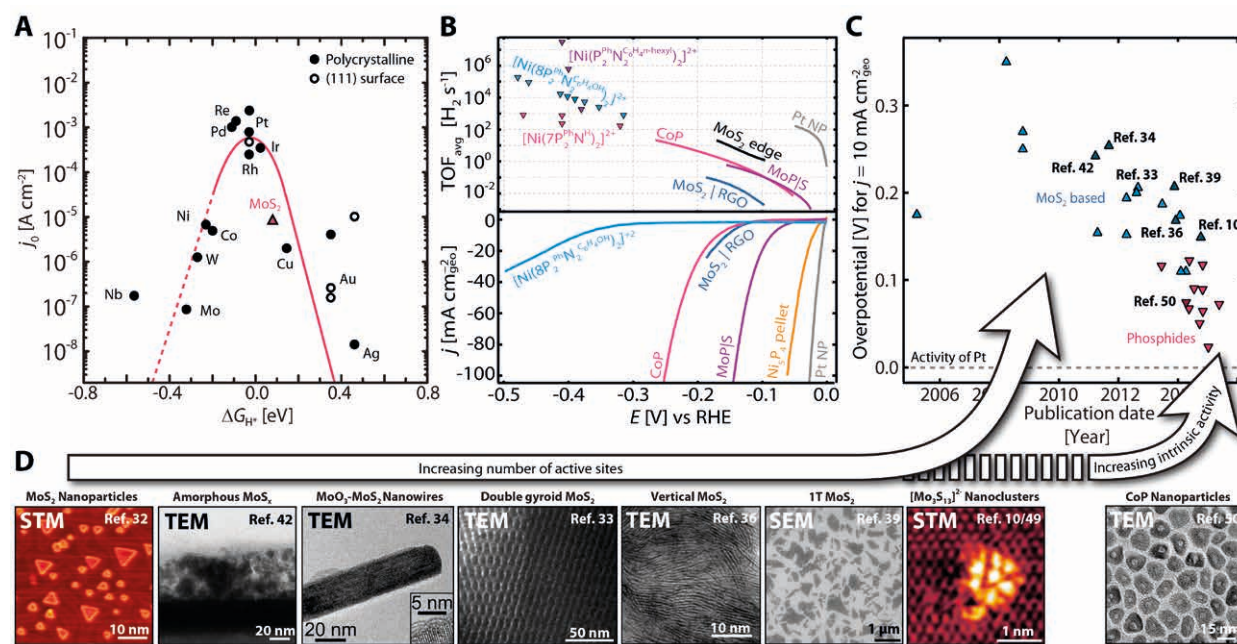

Figure 7 displays (A) HER volcano plot for metals and MoS<sub>2</sub> (B) TOF avg plots with linear sweep voltammograms of various HER catalysts. State-of-the-art Ni-based homogeneous catalysts are also included for comparison. (C) Chronological trend in overpotential of MoS<sub>2</sub>-based and phosphide HER catalysts. (D) Representative microscopy images of HER catalysts. Reproduced from [2]

The examples above show that, although working at a very fundamental level, new insights can be gained that can eventually lead to entirely new processes and products. This is what innovation is all about and is very much in the spirit of the founder of the Technical University of Denmark, H.-C. Ørsted. Doing research and creating fundamental insights are key to solving some of the most pertinent questions humankind is facing. We must discover efficient ways of storing electric energy as chemical energy, just as we must find

means of replacing the chemicals we are producing today from fossil-fuel resources. Here new catalysts are essential.

Imagine that, in the future, we will be capable of increasing the yield of fuel produced on a field from 0.5% (photosynthesis) to 10%: in that case there will be no danger of energy production competing with food production. Or imagine delocalized ammonia production allowing for cleaner and more efficient food production. Keep Dreaming!

# References

- Lewis NS, Nocera DG. Powering the planet: Chemical challenges in solar energy utilization. *Proc Natl Acad Sci U S A*. 2006;103(43):15729-35.
- Seh, Z.W. Kibsgaard, J., Dickens, C.F., Chorkendorff, I., Nørskov, J.K. Jaramillo TF. Combining theory and experiment in electrocatalysis: Insights into materials design. *Science* (80- ). 2017;355:146.
- © OECD/IEA, Agency IE, [www.iea.org](http://www.iea.org). Tracking Clean Energy Progress 2017. 2017.
- Le Quéré, C., Andrew, R. M., Canadell, J. G., Sitch, S., Korsbakken, J. I., Peters, G. P., Manning, A. C., Boden, T. A., Tans, P. P., Houghton, R. A., Keeling, R. F., Alin, S., Andrews, O. D., Anthoni, P., Barbero, L., Bopp, L., Chevallier, F., Chini, L. S. Global Carbon Budget 2016. *Earth Syst Sci Data* [Internet]. 2016;8:605-49. Available from: <http://www.earth-syst-sci-data.net/8/605/2016/>
- Singh A.R., Rohr B.A., Schwalbe J.A., Cargnello M., Chan K., Jaramillo T.F., Chorkendorff I., Nørskov J.K. Electrochemical Ammonia Synthesis - The Selectivity Challenge. *ACS Catal*. 2017;7:706-9.
- Chorkendorff, I., Niematsverdriet, H. Concepts of Modern Catalysis and Kinetics. Third Edit. Wiley-VCH; 2017. 371 p.
- Nørskov JK, Rossmeisl J, Logadottir A, Lindqvist L, Kitchin JR, Bligaard T, et al. Origin of the overpotential for oxygen reduction at a fuel-cell cathode. *J Phys Chem B*. 2004;108(46):17886-92.
- Man IC, Su H-Y, Calle-Vallejo F, Hansen HA, Martínez JI, Inoglu NG, et al. Universality in Oxygen Evolution Electrocatalysis on Oxide Surfaces. *ChemCatChem* [Internet]. 2011;3(7):1159-65. Available from: <http://dx.doi.org/10.1002/cctc.201000397>
- Hori Y. Electrochemical CO<sub>2</sub> Reduction on Metal Electrodes. In: Vayenas CG, White RE, Gamboa-Aldeco ME, editors. *Modern Aspects of Electrochemistry* [Internet]. Springer New York; 2008. p. 89-189. Available from: [http://dx.doi.org/10.1007/978-0-387-49489-0\\_3](http://dx.doi.org/10.1007/978-0-387-49489-0_3)
- E. Bertheussen, A. Verdaguer-Casadevall, D. Ravasio, J. H. Montoya, D. B. Trimarco, C. Roy, S. Meier, J. Wendland, J. K. Nørskov, I. E.L. Stephens IC. Acetaldehyde as an Intermediate in the Electroreduction of Carbon Monoxide to Ethanol on Oxide-Derived Coppe. *Angew Chemie*. 2015;55:1450.
- Laursen AB, Sehested J, Chorkendorff I, Vesborg PCK. Availability of elements for heterogeneous catalysis: Predicting the industrial viability of novel catalysts. *Chinese J Catal*. 2018;39(1).
- Vesborg PCK, Jaramillo TF. Addressing the terawatt challenge: scalability in the supply of chemical elements for renewable energy. *Rsc Adv*. 2012;2(21):7933-47.
- Hinnemann B, Moses PG, Bonde J, Jørgensen KP, Nielsen JH, Hørch S, et al. Biomimetic hydrogen evolution: MoS<sub>2</sub> nanoparticles as catalyst for hydrogen evolution. *J Am Chem Soc*. 2005;127(15):5308-9.
- Jaramillo TF, Jørgensen KP, Bonde J, Nielsen JH, Hørch S, Chorkendorff I. Identification of active edge sites for electrochemical H<sub>2</sub> evolution from MoS<sub>2</sub> nanocatalysts. *Science*. 2007;317(July):100-2.
- Greeley J, Stephens IEL, Bondarenko AS, Johansson TP, Hansen HA, Jaramillo TF, et al. Alloys of platinum and early transition metals as oxygen reduction electrocatalysts. *Nat Chem*. 2009;1(7).
- Escudero-Escribano M, Malacrida P, Hansen MH, Vej-Hansen UG, Velázquez-Palenzuela A, Tripkovic V, et al. Tuning the activity of Pt alloy electrocatalysts by means of the lanthanide contraction. *Science* (80- ). 2016 Apr 1;352(6281):73-6.
- C. Roy, B. P. Knudsen, C. M. Pedersen, A. Velázquez-Palenzuela, L. H. Christensen, C. D. Damsgaard, I. E. L. Stephens and IC (2018). Scalable Synthesis of Carbon Supported Platinum - Rare Earth Alloys for use as Fuel Cell Cathodes. *ACS Catal*. 2018;8:2071-80.
- Siahrostami S, Verdaguer-Casadevall A, Karamad MR, Deiana D, Malacrida P, Wickman B, et al. Enabling direct H<sub>2</sub>O<sub>2</sub> production through rational electrocatalyst design. *Nat Mater*. 2013;12(12):1137-1143.
- Behrens M, Studt F, Kasatkin I, Kuhl S, Havecker M, Abild-Pedersen F, et al. The Active Site of Methanol Synthesis over Cu/ZnO/Al<sub>2</sub>O<sub>3</sub> Industrial Catalysts. *Science* (80- ). 2012;336(6083):893-7.
- Kuld S, Conradsen C, Moses PG, Chorkendorff I, Sehested J. Quantification of Zinc Atoms in a Surface Alloy on Copper in an Industrial-Type Methanol Synthesis Catalyst. *Angew Chemie-International Ed*. 2014;53(23):5941-5.
- Kuld S, Thorhauge M, Falsig H, Elkjær CF, Helveg S, Chorkendorff I, et al. Quantifying the promotion of Cu catalysts by ZnO for methanol synthesis. *Science* (80- ). 2016;352(6288).
- Studt F, Sharafutdinov I, Abild-Pedersen F, Elkjær CF, Hummelshøj JS, Dahl S, et al. Discovery of a Ni-Ga catalyst for carbon dioxide reduction to methanol. *Nat Chem*. 2014;6(4):320-4.

Chapter 10

# Clean Energy Materials Innovation Challenge

“to accelerate the exploration, discovery, and use of new high-performance, low-cost clean energy materials”

By **Tejs Vegge**, Department of Energy Conversion and Storage, Technical University of Denmark  
**Kristian S. Thygesen**, Department of Physics, Technical University of Denmark  
**Alán Aspuru-Guzik**, Department of Chemistry & Chemical Biology, Harvard University



## Introduction

→ The ambition of the ‘Clean Energy Materials Innovation Challenge’ (IC#6) is to identify new approaches to accelerate the development of novel, high-performance, low-cost materials for harvesting, converting and storing clean energy, which will play a crucial role in pursuing the ambitious aims of the Paris Accord. If we continue to rely solely on traditional, incremental developments of new energy materials, it is highly questionable whether it will be practically feasible to reach these goals. Radically new approaches are therefore needed to accelerate the innovation cycle from the fundamental discovery and design of new materials, via synthesis, characterization and testing, to large-scale production and integration.

IC#6 was launched by the members of Mission Innovation (MI) to target the identification and exploration of the most promising research opportunities, which can accelerate the rate of clean energy materials discovery and development by a factor of at least ten. An international IC#6 experts’ working group outlined the need to establish a ‘Materials Acceleration Platform’ (MAP) in a recent White Paper with the subtitle, ‘Accelerating Advanced Energy Materials Discovery by the Integration of High-Throughput Methods with Artificial Intelligence’ [1].

In the MI IC#6 White Paper, the experts identified *Six Grand Goals for a Materials Innovation Revolution*. These must be reached and closely integrated into a MAP for Autonomous Materials Discovery (AMD) (see Figure 1). The key elements of the accelerated Autonomous Materials Discovery (AMD) approach, in order to meet the ambitious target of a tenfold increase in the rate of discovery for clean energy materials:

0. Autonomous Discovery
  1. Artificial Intelligence for Materials
  2. Modular Materials Robotics
  3. Inverse Design
  4. Bridging Length- and Time-Scales
  5. Data Infrastructure and Interchange

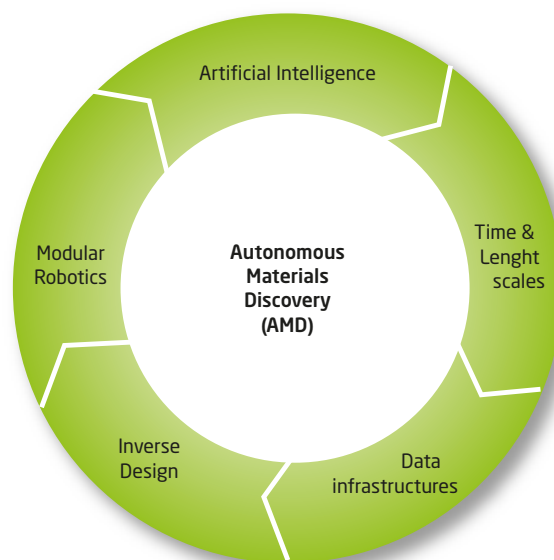

**Figure 1.** The key elements of the accelerated Autonomous Materials Discovery (AMD) approach.

Materials design and discovery represent a fundamental need that crosscuts the entire energy technology portfolio, from energy generation and storage to delivery and end-use. Materials are at the root of every clean energy innovation, including next-generation batteries [2; 3], solar cells [4; 5], photo-catalysts for the production of hydrogen [6], thermal storage, coatings, catalysts for the conversion, capture and catalysts for conversion of CO<sub>2</sub> [7; 8] and nitrogen [9] into sustainable fuels and chemicals. In short, new clean energy materials constitute one of the cornerstones of the global transition to a low-carbon society.

This chapter seeks to outline the potential benefits of developing a MAP/AMD machinery [10], i.e. why this type of machinery is needed, and to identify the potential implications and open research challenges involved in accelerating the development of clean energy materials. Secondly, it aims to identify the current contributions, gaps and outstanding challenges, as well as future opportunities, for DTU researchers and international collaborators.

## Autonomous discovery

Today, advanced materials account for approximately half of the manufacturing costs of clean energy technologies, and the European Energy Materials Industrial Research Initiative (EMIRI) — an industrial platform that is part of the EU Strategic Energy Technology Plan— expects this figure to reach eighty percent in the near future [11]. The global transition towards cleaner energy therefore requires more cost-efficient methods and procedures for the development

of next generation clean energy materials, i.e. materials that are not only more energy efficient and cheaper to produce, but also safe and durable, environmentally benign and recyclable, and ultimately reliant only on earth-abundant materials to ensure scalability.

To reach the proposed level of accelerated materials discovery, “self-sustained” laboratories and production facilities are needed. Such facilities should possess the ability to autonomously design and synthesize materials, perform and interpret experiments to discover clean energy materials, and even predict novel chemical reactions [12]. Creating and deploying autonomous laboratories that can perform this closed-feedback-loop process of materials discovery is the culminating aim of the Six Grand Goals [1].

Successful application of Artificial Intelligence (AI)- and Machine/Deep Learning (ML)-based techniques to accelerate the discovery of next generation clean energy materials has enormous potential. This has already been demonstrated in part using, e.g., neural networks in the search for high-performance organic photovoltaic materials (OPV) [13; 14], but a more generic and versatile machinery spanning different classes of materials and a range of potential applications is needed. The tool ChemOS: *An Orchestration Software to Democratize Autonomous Discovery* [15], recently developed by Prof. Aspuru-Guzik’s group, is an excellent example of this.

A so-called Autonomous Research System (ARES), i.e. an autonomous research robot capable of closed-loop iterative materials production, was recently developed and used by Maruyama et al. to perform a fully autonomous closed-loop production of carbon nanotubes (CNTs) [16]. Here, the objective was for the ARES to learn autonomously to control the growth rate of CNTs using AI and closed-loop feedback over many experimental iterations, whereby an AI planner proposes new experimental growth conditions based on analysis of a database containing prior experiments, iteratively improving its ability to predict growth rates. The AI experimental planner was based on a random forest model with growth conditions exercised through a genetic algorithm.

The AI in an ARES/AMD-type system can, for example, extract synthesis conditions directly from existing scientific literature [17], set up and perform atomic-scale computer simulations at the level of density functional theory (DFT) calculations [18], and interpret *in situ* characterization results and data from lab-scale/prototype testing to establish low-cost ML-based models. The models can then be trained to propose suitable synthesis parameters and autonomously utilize input from *ex / in situ* characterization to improve the next cycle of computational prediction and materials synthesis.

## Artificial intelligence for materials

The IC#6 White Paper finds that “Autonomous research relies on reasoning, decision making and creativity. The particular scale and details of theoretical, computational, synthetic, and characterization evidence in materials research will require the establishment of this new branch of AI. National and international research organizations can facilitate an integrated computer and materials science research effort to develop algorithms that mimic, and then supersede, the intellect and intuition of expert materials scientists” [1].

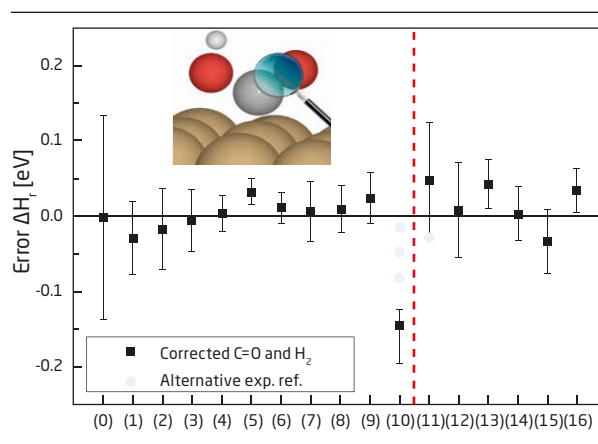

Figure 2. Using a Bayesian error estimation functional (BE-EF-vdW) (23), to identify and correct inherent DFT errors in modeling catalytic reactions [22].

Examples of AI and Machine/Deep Learning surpassing human capabilities are emerging at an ever-increasing rate. Among the most prominent examples are the successes of the AlphaGo [19] and AlphaZero AI programs developed by the Google/Alphabet subsidiary DeepMind. AlphaGo managed to beat the World’s best Go player, Fan Hui, after being trained from gameplay solely through general-purpose supervised and reinforcement learning methods, while AlphaZero beat the World’s best chess program, Stockfish 8, after being provided only with the rules of chess and playing games against itself for less than four hours [20].

Within the discovery of clean energy materials, AI/ML can also provide an efficient platform for the utilization of “bad data” [21], i.e. unsuccessful experiments, non-conclusive observations and data which are traditionally not published or shared, to improve the quality of the surrogate models and thus accelerate the materials discovery process. Using new approaches developed at DTU [22] relying on statistical analysis of a data ensemble from a Bayesian error estimation functional (BEEF) [23], it will also be possible to identify and correct intrinsic and systematic errors in computational approaches used in the design of materials properties, e.g., DFT-based codes for atomic-scale computation-

al materials design. Such self-correction functionalities can be implemented autonomously to improve the accuracy of the computational predictions by online comparison with experimental and computational data, as well as to identify possible experimental outliers (see Figure 2).

### Modular materials robotics

It can be expected that increased communication between synthesis robots and AIs will be an integral part of future research laboratories, possibly revolutionizing how we design and optimize materials and chemical processes [24]. The efficiency of AI-assisted synthesis will depend on the complexity of the energy materials in question. In many areas, for example, molecular synthesis, the materials robotics are to a large extent already in place, but hitherto the AI software and methods have not been able to control the processes at the level needed to achieve full autonomy [25].

Inspiration can be drawn from the fields of pharmaceuticals and biotechnology, where the paradigm of integrating AI and robotics into the discovery process is becoming well established. An excellent example of this is “*The synthesis machine*” developed by Prof. Marty Burke – an automatic device that welds molecular building blocks into a vast array of drug-like compounds, which is expected to revolutionize drug discovery [26; 27].

Similar strategies must be developed for the different classes of clean energy materials to ensure a flexible and scalable synthesis infrastructure. To do this efficiently, modular robotic systems composed of building blocks with standardized properties are needed for the synthesis and characterization.

### Inverse design

Materials innovation by autonomous laboratories can be seeded and accelerated by developing novel materials compositions or structures that can meet the specified requirements. Inverse design enables the automated generation of candidate materials that are specifically designed to meet the specific performance, cost and compatibility requirements of a given clean-energy technology, in principle without imposing *a priori* constraints on the composition and/or structure of the material.

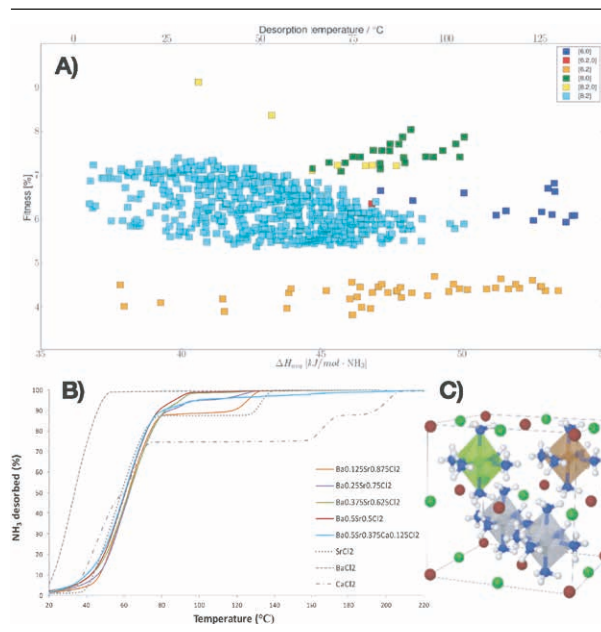

**Figure 3.** A) Predicted ammonia release (wt.%) within a temperature range relevant for automotive DeNO<sub>x</sub> for a class of novel binary and ternary metal halides for ammonia storage. Using genetic algorithms and DFT calculations, it was possible to identify the top 5-10 candidates by calculating only a few percent of >100,000 possible structures. B) Experimental confirmation of the predicted ammonia release conditions. C) The ternary metal halide ammine template crystal structure [28].

A brute force, but often very useful approach is to screen thousands or tens of thousands of clean energy materials using high-throughput DFT calculations – an area where DTU is already world leading [4; 6]. DTU researchers have demonstrated that it is possible to accelerate the rate of discovery of new energy materials by more than the desired factor of ten, e.g., by using genetic algorithms and experimental data to guide the search for materials compositions and structures that can match commercial performance criteria (see Figure 3) [28].

In the future, high-throughput screening strategies must also be complemented by statistical learning methods in order to exploit the vast amounts of information obtained during the screening to adapt and steer the algorithm intelligently towards the most promising candidates. Steps in this direction are now being taken, such as the collaboration between DTU Compute, DTU Physics and DTU Energy, where a combination of deep neural networks and variational autoencoders, initially trained on a database with calculated energies for 5,000 polymers, was successfully used to identify new polymers with energy levels optimized for organic solar cells [29].

## Bridging length and time scales

The range of relevant time- and length-scales, which can potentially govern the properties and performance of new, clean energy materials, is vast (see Figure 4), ranging from the Ångström scale of bonds between atoms via the micrometer properties of individual grains to the meter scale of stationary devices for the conversion and storage of renewable energy.

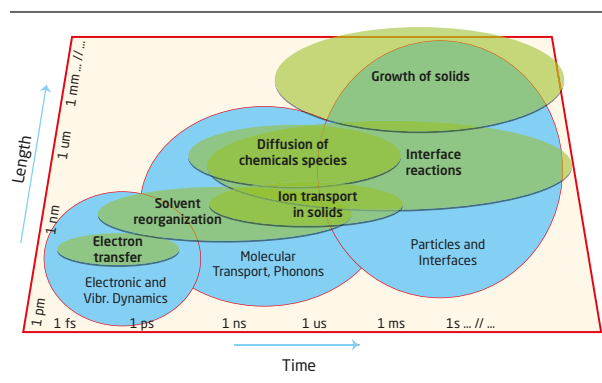

**Figure 4.** The ability to efficiently bridge relevant time- and length scales in the design of new energy materials remains a challenge.

Similarly, electron transfer processes occur on the time scale of femtoseconds, while, for example, solvent reorganization and the making and breaking of chemical bonds can occur on the time scale of picoseconds. Synthesis procedures and characterization experiments generally take place on the scale of seconds or hours, while the stability of the clean energy materials that are produced should be counted in years or even decades. At present, well-developed theories and models exist for describing nearly all time- and length-scales individually, and although successful bridging of scales has been achieved in select areas, such as quantum mechanics / molecular mechanics (QM/MM) [30], more generic methods and approaches for direct bridging or for identifying and passing relevant information between the different time- and length-scale domains have remained elusive, despite many years of research in, for example, multi-scale modelling and characterization [31].

The development of automated bridging tools that span both experimental and computational techniques will be critical in accelerating the design and development of better functional materials and large-scale devices, such as computational modelling and design of materials for wind turbine blades [32]. Improved data standards and software interfac-

es between simulation codes and experimental instruments will be crucial to enable the integration of tools adapted to different scales [1].

Simulation methods can also be made more computationally tractable using AI, such as machine learning surrogate models for computationally more expensive calculations, which can be trained on data from more accurate and computationally expensive methods and then be applied to longer length- and time-scales. Integrated experimental and computational tools will enable a feedback loop between experimental characterization / analysis, computational analysis and prediction across multiple length- and time-scales, which will be facilitated by AI-based tools for decision-making [1].

## Data infrastructure and interchange

Innovation relies on communication and the appropriate representation of both data and the knowledge obtained from it, posing a substantial challenge to the international research community to join forces in establishing, populating and maintaining a shared materials data infrastructure. The resulting product, which embodies an understanding of materials beyond that attainable by a single scientist or team of scientists, will enable and enhance autonomous laboratories. Several international initiatives to create computational materials databases have now been launched, e.g. the Materials Project (<https://www.materialsproject.org>), the Open Quantum Materials Database (OQMD) (<http://oqmd.org>), AFLOW (<http://www.aflowlib.org>) and NOMAD (<https://nomad-coe.eu>), to name but a few.



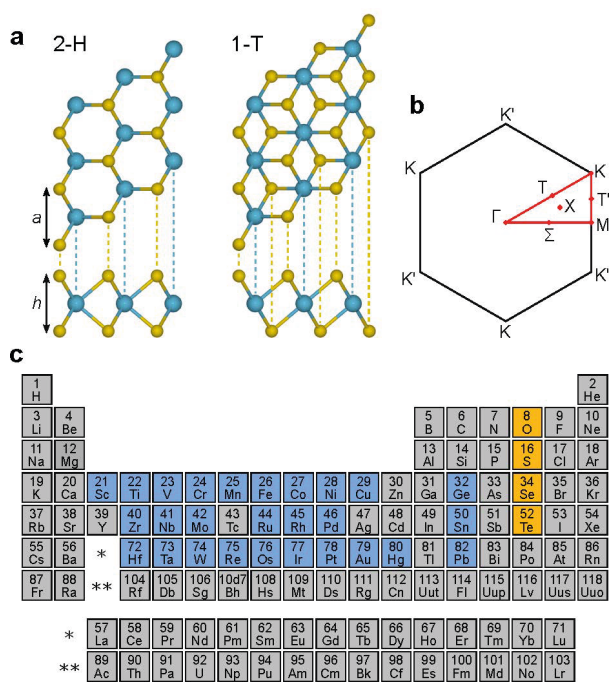

**Figure 5.** A comprehensive database at DTU containing calculated structural and electronic properties of a range of 2D transition metal dichalcogenides (<https://cmr.fysik.dtu.dk/>) [35].

DTU takes part in the EU H2020 Centre of Excellence NOMAD, which is a broad community effort aiming to construct an open Computational Materials Database. At present, NOMAD contains >50 million DFT calculations for different materials and thus constitutes a rich resource for testing and validating intelligent materials discovery methods [33]. DTU researchers are also very active in developing generally applicable software such as ASE (Atomic Simulation Environment) for setting up, manipulating, running, visualizing and analyzing atomistic simulations [34]. Local infrastructure for storing and sharing computed materials data is also available through the open Computational Materials Repository (CMR) [<https://cmr.fysik.dtu.dk/>], for example, a comprehensive 2D computational materials database containing calculated structural and electronic properties of a range of 2D materials (see Figure 5) [35].

Databases like these form an excellent basis for training simple machine learning models for accelerated materials discovery. As an example, Roethlisberger et al. have shown that it is possible to increase the accuracy of the models by using genetic algorithms for the optimization of training set composition from such databases [36], while Wolverton et al. used 435,000 formation energies from the OQMD database to develop an accurate and fast machine learning model with a mean absolute error as low as 80 meV/atom in cross-validation [37].

## Outlook and recommendations

As outlined in the MI IC#6 White Paper, establishing autonomous MAP/AMD facilities would greatly accelerate the rate of discovery of next generation clean energy materials by increasing the rate of experiments performed, harnessing and storing controlled data sets, and seamlessly integrating these with computational predictions and machine learning algorithms, robotics and automation tools. Thus, traditionally independent competence areas such as computer simulations, characterization and synthesis will be integrated by emerging computer science, machine learning, data infrastructure and robotics expertise. Operations will be tightly tied together, enabling researchers to receive and incorporate feedback from adjacent processes rapidly, in order to make both high-level decisions and the necessary adjustments required to optimize the materials design and development process [1]. To ensure the required security and fluidity in the data-sharing process, procedures for the protection of Intellectual Property Rights and citations, e.g. using the Digital Object Identifier (DOI) for datasets, must be standardized.

Many researchers are already playing an important role in developing key components of the necessary AMD infrastructure. In order to take full advantage of this opportunity, universities like DTU should continue to participate actively in the development of the soft- and hardware needed to establish a successful MAP. The emergence of the European Spallation Source (ESS) and MAX IV in Lund (Sweden) offers a unique opportunity for researchers to implement and test AMD/MAP approaches directly and strive to achieve a tenfold acceleration in the design and synthesis of next generation clean energy materials.

Both nationally and internationally, researchers should push for joint investments and coordination among MI member states, including the EU and the US, in order to accelerate the development of the necessary machinery for the accelerated discovery of next generation clean energy materials.

# References

---

- Aspuru-Guzik, Alán; Persson, Kristin; Alexander-Katz, Alfredo; Amador, Carlos; Solis-Ibarra, Diego; Antes, Matt; Mosby, Anna; Aykol, Murat; Chan, Emory; Dwaraknath, Shyam; Montoya, Joseph; Rotenberg, Eli; Gregoire, John; Hatrnick-Simpers, Jason; ...; Vegge, Tejs. Materials Acceleration Platform - Accelerating Advanced Energy Materials Discovery by Integrating High-Throughput Methods with Artificial Intelligence [Internet]. Mexico City; 2018. Available from: <http://mission-innovation.net/wp-content/uploads/2018/01/Mission-Innovation-IC6-Report-Materials-Acceleration-Platform-Jan-2018.pdf>
- Vegge T, Garcia-Lastra JM, Siegel DJ. Lithium-oxygen batteries: At a crossroads? *Curr Opin Electrochem* [Internet]. 2017;6(1):100-7. Available from: <http://www.sciencedirect.com/science/article/pii/S2451910317300923>
- Park H, Kumar N, Melander M, Vegge T, Garcia Lastra JM, Siegel DJ. Adiabatic and Nonadiabatic Charge Transport in Li-S Batteries. *Chem Mater* [Internet]. 2017 Dec 20; Available from: <http://dx.doi.org/10.1021/acs.chemmater.7b04618>
- Ørnsø KB, Jónsson EÖ, Jacobsen KW, Thygesen KS. Importance of the Reorganization Energy Barrier in Computational Design of Porphyrin-Based Solar Cells with Cobalt-Based Redox Mediators. *J Phys Chem C* [Internet]. 2015 Jun 11;119(23):12792-800. Available from: <https://doi.org/10.1021/jp512627e>
- Kuhar K, Crovetto A, Pandey M, Thygesen KS, Seger B, Vesborg PCK, et al. Sulfide perovskites for solar energy conversion applications: computational screening and synthesis of the selected compound LaYS3. *Energy Environ Sci* [Internet]. 2017;10(12):2579-93. Available from: <http://dx.doi.org/10.1039/C7EE02702H>
- Castelli IE, Huser F, Pandey M, Li H, Thygesen KS, Seger B, et al. New Light-Harvesting Materials Using Accurate and Efficient Bandgap Calculations. *Adv ENERGY Mater*. 2015 Jan;5(2).
- Yoo JS, Christensen R, Vegge T, Nørskov JK, Studt F. Theoretical Insight into the Trends that Guide the Electrochemical Reduction of Carbon Dioxide to Formic Acid. *ChemSusChem*. 2016;9(4). Available from: <https://www.doi.org/10.26434/chemrxiv.5952655>
- Bhowmik A, Hansen HA, Vegge T. Electrochemical Reduction of CO<sub>2</sub> on Ir<sub>x</sub>Ru<sub>(1-x)</sub>O<sub>2</sub>(110) Surfaces. *ACS Catal* [Internet]. 2017 Dec 1;7(12):8502-13. Available from: <http://dx.doi.org/10.1021/acscatal.7b02914>
- Abghoui Y, Garden AL, Howalt JG, Vegge T, Skúlason E. Electroreduction of N<sub>2</sub> to Ammonia at Ambient Conditions on Mononitrides of Zr, Nb, Cr, and V: A DFT Guide for Experiments. *ACS Catal*. 2016;6(2).
- Aspuru-Guzik A, Lindh R, Reiher M. The Matter Simulation (R)evolution. 2017; Available from: [https://chemrxiv.org/articles/The\\_Matter\\_Simulation\\_R\\_evolution/5616115](https://chemrxiv.org/articles/The_Matter_Simulation_R_evolution/5616115)
- Stassin F. Energy Materials Industrial Research Initiative (EMIRI) - The role of Materials Research & Innovation for European Growth & Competitiveness.
- Segler MHS, Waller MP. Modelling Chemical Reasoning to Predict and Invent Reactions. *Chem - A Eur J* [Internet]. 2017;23(25):6118-28. Available from: <http://dx.doi.org/10.1002/chem.201604556>
- Pyzer-Knapp EO, Li K, Aspuru-Guzik A. Learning from the Harvard Clean Energy Project: The Use of Neural Networks to Accelerate Materials Discovery. *Adv Funct Mater* [Internet]. 2015;25(41):6495-502. Available from: <http://dx.doi.org/10.1002/adfm.201501919>
- Gómez-Bombarelli R, Wei JN, Duvenaud D, Hernández-Lobato JM, Sánchez-Lengeling B, Sheberla D, et al. Automatic Chemical Design Using a Data-Driven Continuous Representation of Molecules. *ACS Cent Sci* [Internet]. 2018 Jan 12; Available from: <http://dx.doi.org/10.1021/acscentsci.7b00572>
- Roch, Loïc M; Häse, Florian; Kreisbeck, Christoph; Tamayo-Mendoza, Teresa; Yunker, Lars P. E.; Hein, Jason E; Aspuru-Guzik A. ChemOS: An Orchestration Software to Democratize Autonomous Discovery. *ChemRxiv* [Internet]. 2018; Available from: <https://www.doi.org/10.26434/chemrxiv.5952655>
- Nikolaev P, Hooper D, Webber F, Rao R, Decker K, Krein M, et al. Autonomy in materials research: a case study in carbon nanotube growth. *Npj Comput Mater* [Internet]. 2016 Oct 21;2:16031. Available from: <http://dx.doi.org/10.1038/npjcompumats.2016.31>
- Kim E, Huang K, Saunders A, McCallum A, Ceder G, Olivetti E. Materials Synthesis Insights from Scientific Literature via Text Extraction and Machine Learning. *Chem Mater* [Internet]. 2017 Nov 14;29(21):9436-44. Available from: <http://dx.doi.org/10.1021/acs.chemmater.7b03500>
- Lysgaard S, Mýrdal JSG, Hansen HA, Vegge T. A DFT-based genetic algorithm search for AuCu nanoalloy electrocatalysts for CO<sub>2</sub> reduction. *Phys Chem Chem Phys*. 2015;17(42).
- Silver D, Huang A, Maddison CJ, Guez A, Sifre L, van den Driessche G, et al. Mastering the game of Go with deep neural networks and tree search. *Nature* [Internet]. 2016 Jan 27;529:484. Available from: <http://dx.doi.org/10.1038/nature16961>
- Silver, D., Hubert, T., Schrittwieser, J., Antonoglou, I., Lai, M., Guez, A., Lanctot, M., Sifre, L., Kumaran, D., Graepel, T., Lillicrap, T., Simonyan, K., and Hassabis D. Mastering Chess and Shogi by Self-Play with a General Reinforcement Learning Algorithm. *arXiv Prepr* [Internet]. 2017; Available from: <https://arxiv.org/pdf/1712.01815.pdf>
- Raccuglia P, Elbert KC, Adler PDF, Falk C, Wenny MB, Mollo A, et al. Machine-learning-assisted materials discovery using failed experiments. *Nature* [Internet]. 2016 May 4;533:73. Available from: <http://dx.doi.org/10.1038/nature17439>
- Christensen R, Hummelshøj JS, Hansen HA, Vegge T. Reducing Systematic Errors in Oxide Species with Density Functional Theory Calculations. *J Phys Chem C*. 2015;119(31).
- Wellendorff J, Lundgaard KT, Møgelhøj A, Petzold V, Landis DD, Nørskov JK, et al. Density functionals for surface science: Exchange-correlation model development with Bayesian error estimation. *Phys Rev B* [Internet]. 2012 Jun 27;85(23):235149.

- Available from: <https://link.aps.org/doi/10.1103/PhysRevB.85.235149>
- Available from: <http://science.sciencemag.org/content/354/6309/180.abstract>
24. Ley S V, Fitzpatrick DE, Myers RM, Battilocchio C, Ingham RJ. Machine-Assisted Organic Synthesis. *Angew Chemie Int Ed* [Internet]. 2015;54(35):10122–36. Available from: <http://dx.doi.org/10.1002/anie.201501618>
  25. Peplow M. THE ROBO-CHEMIST. *Nature*. 2014 Aug;512(7512):20–2.
  26. Service RF. The synthesis machine. *Science* (80-) [Internet]. 2015 Mar 13;347(6227):1190 LP-1193. Available from: <http://science.sciencemag.org/content/347/6227/1190.abstract>
  27. Service R. Billion-dollar project would synthesize hundreds of thousands of molecules in search of new medicines. *Science*. 2017.
  28. Jensen PB, Bialy A, Blanchard D, Lysgaard S, Reumert AK, Quaade UJ, et al. Accelerated DFT-Based Design of Materials for Ammonia Storage. *Chem Mater*. 2015;27(13).
  29. Jørgensen, P. B.; Mesta, M.; Shil, S.; Garcia-Lastra, J. M.; Jacobsen, K. W.; Thygesen, K. S.; Schmidt MN. Machine learning-based screening of complex molecules for polymer solar cells. submitted. 2018;
  30. Warshel A, Levitt M. Theoretical studies of enzymic reactions: Dielectric, electrostatic and steric stabilization of the carbonium ion in the reaction of lysozyme. *J Mol Biol* [Internet]. 1976;103(2):227–49. Available from: <http://www.sciencedirect.com/science/article/pii/0022283676903119>
  31. Golbraikh A, Fourches D, Sedykh A, Muratov E, Liepina I, Tropsha A. Practical Aspects of Computational Chemistry III. 2014. 187-230 p.
  32. Mikkelsen PL, Mishnaevsky Jr. L. Computational Modelling of Materials for Wind Turbine Blades: Selected DTU Wind Energy Activities. Vol. 10, Materials . 2017.
  33. Thygesen KS, Jacobsen KW. Making the most of materials computations. *Science* (80-) [Internet]. 2016 Oct 14;354(6309):180 LP-181. Available from: <http://science.sciencemag.org/content/354/6309/180.abstract>
  34. Hjorth Larsen A, Jørgen Mortensen J, Blomqvist J, Castelli IE, Christensen R, Duřak M, et al. The atomic simulation environment - A Python library for working with atoms. *J Phys Condens Matter*. 2017;29(27).
  35. Rasmussen FA, Thygesen KS. Computational 2D Materials Database: Electronic Structure of Transition-Metal Dichalcogenides and Oxides. *J Phys Chem C* [Internet]. 2015 Jun 11;119(23):13169–83. Available from: <https://doi.org/10.1021/acs.jpcc.5b02950>
  36. Browning NJ, Ramakrishnan R, von Lilienfeld OA, Roethlisberger U. Genetic Optimization of Training Sets for Improved Machine Learning Models of Molecular Properties. *J Phys Chem Lett* [Internet]. 2017 Apr 6;8(7):1351–9. Available from: <https://doi.org/10.1021/acs.jpcclett.7b00038>
  37. Ward L, Liu R, Krishna A, Hegde VI, Agrawal A, Choudhary A, et al. Including crystal structure attributes in machine learning models of formation energies via Voronoi tessellations. *Phys Rev B* [Internet]. 2017 Jul 14;96(2):24104. Available from: <https://link.aps.org/doi/10.1103/PhysRevB.96.024104>

Chapter 11

# District Heating and Cooling Systems Innovation Challenge

“to make low-carbon heating and cooling affordable for everyone”

---

By **Marie Münster**, Department of Management Engineering, Technical University of Denmark

**Sven Werner**, Halmstad University, Sweden

**Svend Svendsen** and **Simon Furbo**, Department of Civil Engineering, Technical University of Denmark

**Brian Elmegaard**, Department of Mechanical Engineering, Technical University of Denmark



## Introduction

→ The first commercial district heating (DH) systems in the world were built in the 1870-1880s in Lockport, New York. In Denmark, the first district heating plant was a waste incineration plant built in Frederiksberg in 1903. Since then district heating has expanded, mainly in Russia, China and the European Union. Global DH supply currently covers around 8% of the 74 EJ heating demand, a figure that reaches 13% in the EU [1]. In some parts of the world district heating is the most common way of heating buildings, and the district heating technology used today is a mature technology in the sense that it has considerably improved over the years, current thermal networks being able to rely on well-established and efficient technologies and practices. Denmark is one of the frontrunners in this field, with 50% of heating demand being covered by district heating [2]. A heat road map for Europe indicates that similar levels may be economically feasible on a European scale as well [3]. That said, there is still much R&D and innovative work to be done on thermal networks operating at lower temperatures and on integrating further low-carbon energy sources, and on ensuring their effective interaction with other networks.

There has been much less development with respect to district cooling, only around 300 PJ being supplied globally [1]. However, as the global demand for cooling is expected to increase from close to 1000 PJ in 2000 to about 1,4000 PJ in 2050 and more than 36,000 PJ in 2100, the potential is substantial [4]. The district cooling potential in Europe alone is expected to be around 2000 PJ in 2030, with more than 75% of the potential being in the service sector [5].

From the outset, the main reason for building district heating systems was to have a cost-efficient supply of heat taking advantage of the potential for 1) efficient utilization of fuels, e.g. in CHP plants; 2) economies of scale; and 3) using complicated fuels such as waste. Today contemporary environmental problems, including local air quality and global warming, are also driving the development of district heating.

District cooling is similar to district heating, except that cooling is delivered to provide comfortable indoor temperatures on warm summer days. The cooling comes from natural cold resources (such as cold sea or lake waters), absorption chillers fed by excess heat or mechanical chillers with heat recovery. When linked to thermal storage, a heat pump may deliver both heating and cooling. District cooling replaces less efficient local air-conditioning units as well as reduces noise and use of space.

Overall, current technological developments in district heating have three aspects:

- 1) The supply of district heating systems has in Europe become less carbon-intensive through increased use of excess heat and renewable energy sources
- 2) District heating systems have become more efficient through a lowering of temperatures [6]
- 3) Lately, there has been increased focus on integration across energy sectors, most notably through CHP and heat pumps

With regard to the integration of energy sectors, energy system analyses have shown that district heating systems may have an important role to play with respect to the integration of fluctuating renewable energy sources, especially due to cheap thermal storage potential in the district heating systems [7; 8].

Examples of district heating sources of supply are thermal power stations, waste incineration plants and industrial processes. The fundamental idea can be expressed as follows: 'to use local fuel or heat sources that would otherwise be wasted, in order to satisfy local customer demands for heating, by using a heat distribution network of pipes as a local market place' [9]. As a result, district heating systems have contributed to making the fossil fuel-based energy supply more efficient. Since 1990, the 6000+ EU district heating systems have together reduced their carbon dioxide emissions by 35 percent, a higher reduction than in the rest of the EU energy system (see Figure 1).

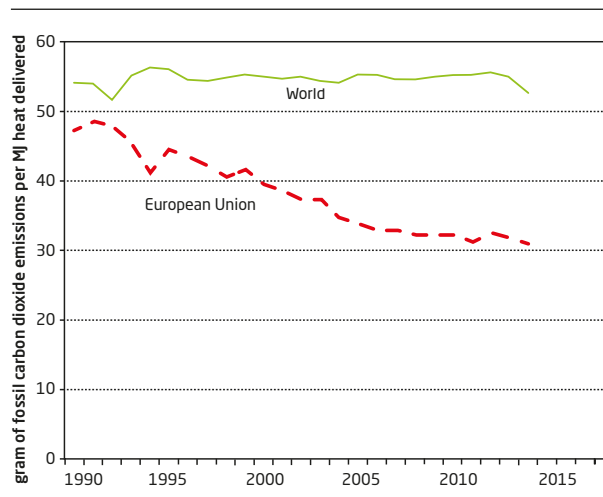

Figure 1. Estimated specific carbon dioxide emissions 1990-2014 from all district heating systems in the world and in the current European Union. [1].

One explanation for these successful reductions in carbon dioxide emissions is that more renewables have been introduced into these heating systems in recent years. Biomass fuels have replaced fossil fuels, geothermal wells provide natural heat and solar collectors have been connected to district heating systems. Temporary surpluses of wind power are absorbed by large electric boilers and heat pumps.

Denmark has actively contributed to this development by:

- Introduction of a national building code requiring low heat demands in new buildings
- Implementation of large solar collector fields in more than a hundred small villages and towns
- Implementation of large seasonal heat storage units to transfer solar heat from sunny summer days to winter heat demand
- Implementation of large electric boilers and heat pumps
- Large national research projects to develop the next, fourth generation of district heating technology using low distribution temperatures. This development will reduce the cost of implementing more renewable and recycled heat in future district heating systems

In Denmark, future scenarios for district heating supply in 2050 could resemble those shown in Figure 2. Except for the Fossile, all future scenarios are 100% renewable (apart from fossil waste). The main difference between the different green scenarios is the amount of biomass imports allowed, with most allowed in the Bio+ scenario and none in the Wind and H<sub>2</sub> scenarios. The results show that around 30% of district heating could be supplied by waste incineration in all scenarios, while up to 30% could be supplied by heat pumps and 20% by biorefineries in the scenarios with low biomass consumption. Solar heating is assumed to supply 7% and industrial excess heat 5% in all scenarios. Similar scenarios might be plausible in other parts of the world, where the role of combustion is also decreasing.

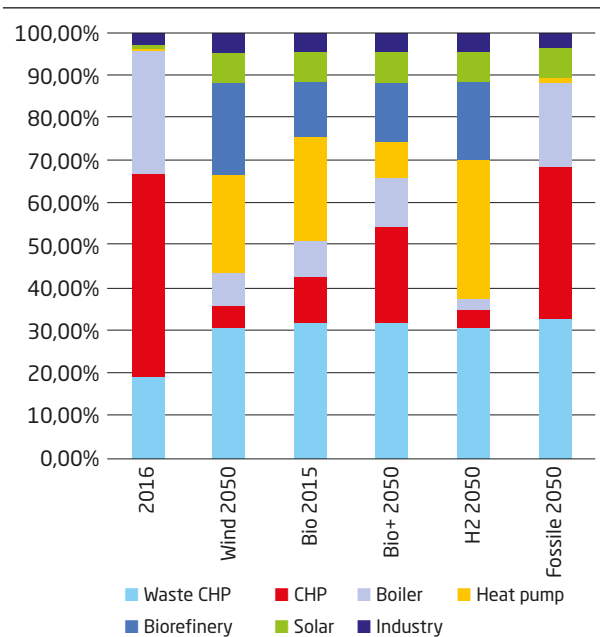

Figure 2. Danish district heating supply in 2016 and in future scenarios for 2050. [2; 10].

In the following sections, the potentials and innovation challenges with regard to low-temperature supply in the building sector and supplying district heating with heat pumps and solar heating are discussed (for more information about heat storage options, see Chapter 12 on storages; also Chapter 8 on bioenergy and Chapter 5 on energy storage integration).

### Low-temperature district heating

Supply and return temperatures in district heating systems in the EU are typically now 80°C and 50°C respectively. The return temperature from existing buildings can be reduced to 30°C through improved control, and the supply temperature may, in most of the year, be reduced to 65°C - 55°C, depending on the type of system used for the production of domestic hot water. For new buildings with very low energy use in low heat-density areas, ultralow temperature district heating may be used that produces supply and return temperatures as low as 30°C and 20°C respectively. They will have to be supplemented with electrical heaters for supplying comfortable domestic hot water at 45°C.

The idea of low-carbon affordable heating systems for buildings by using low temperature district heating is a very promising technology [6], though it still requires dedicated research before large-scale implementation can be considered. The reason for this is that the low-temperature con-

cept envisages making use of different axes: efficient use of *waste heat* (power plants, incineration plants, industrial processes) and *renewable thermal energy* (deep geothermal heat, solar heating plants with seasonal storage), as well as *renewable electrical energy* (heat pumps using wind and solar power). To improve efficiency and reduce the cost of heat from low-carbon sources, it is typically beneficial to make use of lower supply and return temperatures. For example, lowering the return temperature of the district heating system can increase the energy efficiency of the condensation of the moisture in flue gas from the burning of wood chips or waste. In the case of solar heating plants and geothermal heating plants, the efficiencies of these technologies are increased if both the supply and return temperatures of the district heating are reduced. In all cases, the heat loss from the district heating network is reduced when lower temperatures are realized.

Existing district heating systems can be transformed from the present high-temperature, high-carbon systems into low-temperature, low-carbon systems. However, low-temperature district heating systems can also be installed in existing buildings in cities without district heating, thus replacing high carbon energy based individual heating systems. Low-temperature district heating systems can be introduced in all counties with a need for space heating in buildings. However, investigations are needed to find out where this solution offers the cheapest and quickest way of achieving low-carbon heating in buildings.

Low-temperature district heating requires improvements to the control of the heat systems of buildings. There is a very great potential for improvements here with respect to achieving lower supply and return temperatures; by using new smart control concepts, much progress can be made.

Historically, simple systems for heating rooms and domestic hot water have been sized for very large design loads based on design guidelines that use worst-case scenarios. However, the actual heat load in real operations throughout the year is typically much lower than the design load. Therefore, a reduction in operating temperatures is entirely realistic for most of the year. For the few very cold days, the operating temperatures can be raised to the necessary level to provide thermal comfort.

Hence, control of the heating system has to be rethought in order to lower the supply and return temperatures, while maintaining comfort levels for the user.

The recommended process of reducing heating-system operating temperatures is to start by reducing the return temperature and then reduce the supply temperature. [11; 12].

- *Reduced return temperatures* from each radiator can be achieved by using a new type of radiator thermostat with an extra functionality, which limits the return tempera-

ture by using an extra wireless sensor to measure the return temperature from the radiator.

Reduced return temperatures from the central system for heating domestic hot water in large buildings can be realized by using self-learning control systems that produce domestic hot water optimally in a central storage tank according to the typical daily profile for the use of domestic hot water in that particular building.

- *Reduced supply temperatures* for heating systems in the most critical buildings within the district heating system can be achieved by finding and improving the very few critical elements in the existing building and heating system. If, for example, the heat load is extremely high in some rooms because the windows are single glazed or have large air leaks, they should be replaced with new efficient windows. Similarly, if the radiators in some rooms have been dismantled or replaced with smaller radiators, new optimal sized radiators should be installed. Reduction of the supply temperatures needed for central domestic hot-water systems in residential buildings can be achieved by using highly efficient local heat exchangers close to the use of domestic hot water in each flat.

These improvements require technology innovation to improve the control of heating systems in buildings. A new smart thermostatic radiator valve with a temperature sensor on the radiator's return pipe makes it possible to reduce return temperatures from heating systems of buildings and in the district heating system by approximately 20°C, which could make the use of waste heat and renewable heat much more economical. Furthermore, a new concept whereby the district heating companies provide service of the buildings would make it possible for the owners and users of the buildings to obtain help in achieving low temperature operation of the heating systems without technical or economical barriers. These solutions can be realized if innovation is supported. The focus should be on improving existing buildings and district heating grids, as a large effect can be achieved relatively quickly, while new buildings and grids should be planned for optimal solutions with low-temperature operation.

Finally, it should be noted that, even though low-temperature district heating may very well be the best solution for the affordable heating of buildings in cities from a socio-economic viewpoint, particularly with the suggested innovations, it may have to be promoted by, for example, heat planning and regulatory processes.

## Heat pumps

It is expected that our future energy economies will be more electrified, characterized by increased shares of solar power and wind power. For example, Denmark is aiming at abandoning fossil fuels completely in 2050. The expanded use of

heat pumps is one of the significant means that may be adopted for using electricity efficiently and flexibly. Due to the existing, highly developed district heating system, installing heat pumps for this purpose is an appealing option that may be feasible and realizable. The existing Danish district heating networks optimize operations to utilize various energy sources, and they have large amounts of heat capacity, which may be useful in integrating intermittent sources.

The most important advantage of heat pumps is their high levels of energy efficiency, defined by the Coefficient of Performance (COP), that is, the instantaneous ratio of provided heat flow over the electrical power consumed by the compressor. For system assessment purposes, the Seasonal Performance Factor (SPF) is used to evaluate the performance of the system. Existing projects reach a COP of between 3.0 and 5.3 [13], which indicates that the source of the supplied heat is 1 unit of electric power and between 2.0 and 4.3 units stemming from a low-temperature source. Heat pumps are actually thermodynamic refrigeration machines that generate a temperature difference, but with the hot side being considered the valuable output. Accordingly there is a significant overlap between heating and cooling technologies, and district cooling will involve such units if below-ambient temperatures are needed and free cooling is not applicable.

Heat pumps may be installed in individual dwellings as a competitor to district heating. In addition, hybrid solutions, such as integrating temperature booster units, may be used. The technology for large-scale heat pumps is currently not readily available to meet the demands of all district heating systems. The current state-of-the-art technologies require further research and development before the desired potential can be achieved [14]. Among the innovation challenges that must be solved are:

1. *Economics.* Fuel-based district heating is able to produce heat at low prices due to its high efficiency and long investment horizons. This makes it challenging for heat pumps to compete, because the COP will be relatively low due to the high temperature lift currently needed and they require relatively high investment. [15; 16].
2. *Heat source.* Several potential sources exist for heat pumps in district heating depending on the location, both geographically and in the heating system. These include air, seawater, waste water, geothermal heat and excess heat from industry and refrigeration plants, including district cooling [13-17]. The potential for heat pumps in a given location depends on the availability of useful heat sources with a sufficient capacity, as well as cost in terms of the power and investment needed to install them with the unit. The use of existing excess heat as a heat source provides potential benefits, which have been identified for several geographical locations [18-22]. For example, excess heat from existing server parks and refrigeration facilities in industry, trade or district cooling

may be used as heat sources that are available throughout the year, although to varying degrees. Use of these sources will involve heat pumping, and hence power consumption to increase the temperature, but the availability of existing facilities may provide significant feasibility in the quest to identify sufficient heat sources for heat supply by heat pumps.

3. *Refrigerants.* Many options exist in terms of natural and synthetic fluids [23]. The former group includes ammonia, propane, carbon dioxide and water, the latter HFCs and HFOs. Due to the global warming potential of HFCs, their use will be phased out in the coming years [24]. This will limit the choice to either natural fluids, which are cheap and have been used for decades, or the new HFO fluids, which have the benefit of low flammability and low human toxicity. Yet more options can be made available by introducing zeotropic mixtures of these fluids [25].
4. *Technological limitations.* The classic heat pump has at least one compressor and heat exchangers, which all have limitations with regard to their construction and materials. In practical designs, this limits the heating capacity of a single unit, the maximum and minimum temperatures and pressures that are applicable, and the maximum and minimum pressure and temperature lifts. These restrictions require optimal designs of integrated, multi-stage configurations that make it possible to avoid some of the limitations.
5. *Legal, tax and subsidy issues:* The actual economic feasibility of a given solution will depend on the regulations, taxation and subsidy schemes for the given location. Denmark e.g. currently has specific restrictions, which limits the potential for beneficial business cases. New policies and market designs should therefore be developed, which ensures that socioeconomic solutions also are also feasible from a private economic perspective.

For the city of Copenhagen, the heating utility Hofer is developing a number of demonstrations in respect of greater R&D efforts. These involve two 5 MW heat pumps to be installed in the district heating network based on seawater/waste water and geothermal heat sources respectively [15]. Fifteen different heat-pump installations in Europe are described in [13]. These vary in age and efficiency, as well as in capacity, refrigerant and technology. The large variety of solutions and the challenge of selecting the best match for a particular case are to some extent illustrated by these examples.

## Solar heating and large-scale heat storage

The number of solar heating plants and the collector areas for solar heating plants worldwide have increased strongly during the last decade. By the end of 2016, three hundred



solar heating plants for district heating with a total solar collector area of 1,648,383 m<sup>2</sup> were in operation worldwide [28]. Of these systems, 110 with a total solar collector area of 1,317,635 m<sup>2</sup> were in operation in Denmark – that is, 80% of the collectors for solar heating plants providing district heating are in operation in Denmark. Figure 3 shows the development of the total solar collector area of Danish solar heating plants during the last eleven years. Denmark currently hosts the world's largest solar heating plant in Silkeborg. The country has become frontrunner in installing solar heating plants partly because the technology has become competitive with natural gas including a carbon tax, but also because the technology is considered an energy-saving measure, thus competing with the cost of energy-saving technologies to achieve local energy-saving targets.

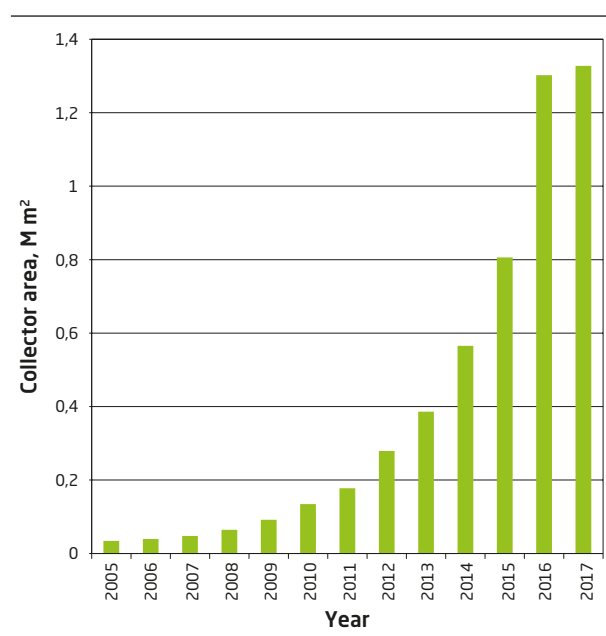

Figure 3. Solar collector area of Danish solar heating plants for district heating.

Most solar heating plants have a solar collector field with a high number of large 12-15 m<sup>2</sup> flat-plate solar collector panels placed on the ground. The collectors are placed in a number of parallel connected rows with up to twenty serial connected collectors. The solar collectors produce heat in sunny periods. The heat can cover a low or high part of the heat demand of the district heating area, either during heat production periods or later, in periods without sunshine. In this case, the heat is first stored in a heat storage.

Solar collectors with one and two covers are used. The efficiency of the solar collector with one cover is higher than the efficiency of the collector with two covers at low temperature levels, while the efficiency of the collector with two covers is higher than the efficiency of the collector with one

cover at high temperature levels. Therefore, collectors with one cover are often placed at the start of the rows, where the temperature is low, and collectors with two covers are placed in the end of the rows, where the temperature is high.

Measurements have shown average yearly thermal performances of Danish solar heating plants in the range of 1480-1667 MJ/m<sup>2</sup> solar collector, corresponding to average yearly utilizations of solar radiation in the range of 37-42% [29]. Investigations show that the life-time of Danish solar collector fields is about thirty years [30].

The suitability of different types of long-term heat storage for solar heating plants has recently been demonstrated. Water pit stores and borehole storage facilities, which make use of water and soil as heat storage material, are promising large-scale heat storage facilities with a potential for low costs and low heat loss [31]. A yearly heat-storage efficiency for a large water pit store in the Dronninglund solar heating plant (used both for short- and long-term heat storage) of 91% has been measured for 2016. Heat storage facilities can also improve the interplay between the solar heating plants and the surrounding energy system by being used not only by the solar collectors, but also by other heat-producing units.

Solar collectors, solar collector fields, long-term heat stores and control strategies for heat storage all have great innovation potential. The solar collectors can be improved by improving the covers, absorbers and ventilation of the collector box to remove moisture. The collector field can be improved by combining different types of collectors: flat plate collectors with one and two covers can be used in the part of the field with low temperature levels, while concentrating tracking collectors can be used in the part of the field with high temperature levels [32]. Water pit storage facilities can meanwhile be improved by means of: better designs of the floating insulating lid, more temperature-resistant liners, better quality check of the water and better designs of inlet/outlet arrangements.

The levelised cost of heat for Danish solar heating plants has decreased strongly during the past decade, due to both the reduced costs of solar collector fields and the increased solar collector areas of the plants. This technology has a high potential for even lower heating costs in most countries in the world, given that Denmark is not a particularly sunny country. Elsewhere the yearly solar radiation on collectors in sunny locations can be up to twice the yearly solar radiation on collectors in Denmark.

District cooling utilizing solar heat is currently not as highly developed as district heating. Furthermore, only relatively few solar cooling plants are in operation compared to solar heating plants for district heating. The efficiency of a thermally driven cooling process increases with increasing temperatures. Therefore, solar collectors with high efficiencies at high temperature levels such as evacuated tubular solar

collectors and concentrating tracking collectors can be used with advantage to match the chiller type [33].

It is expected that district cooling and solar district cooling plants will be used increasingly in the future in locations with a high demand for cooling. However, further research and development are required before economically attractive systems become available.

## Conclusion

In recent years, we have seen great progress in reducing both the costs and the CO<sub>2</sub> emissions of district heating due to temperature reductions in the grids and more efficient utilization of low-carbon sources, such as solar heating and excess heat through the use of large-scale heat pumps. District heating and cooling thus both have great potential to contribute to low-cost decarbonisation of the energy sector globally, if:

1. efficient (low temperature) distribution of district heating is ensured
2. low carbon sources are utilized, such as excess heat, ambient heat/cooling and solar heat
3. the potential synergies of integration with other energy vectors are fully utilized

Technologies for decarbonizing the district heating and cooling sectors show great potential for further improvements in efficiencies and costs. However, further technological innovation potential exist. For low temperature district heating to be successful, the control of heating systems in buildings must be improved. This can happen through two steps:

1. Reducing return temperatures from radiators by using a new type of radiator thermostat with an extra sensor and the functionality to measure the return temperature from the radiator and ensure low return temperatures and better control of systems for hot-water heating in taps.
2. Reducing forward temperature for district heating in the grid by improving critical buildings, due to the combination of high heating demands and the low heat capacity of radiators.

With regard to heat pumps utilizing ambient heat/cooling and large-scale solar heating, the technologies are available, though significant challenges exist for large-scale implementation. For large-scale heat pumps the challenges include improved utilization of excess heat and natural heat sources, new refrigerants, and optimal designs of integrated, multi-stage configurations. For large-scale solar heating they include improvement of solar collectors, solar collector

fields, long-term heat stores and control strategies for heat storage facilities.

Finally, progress in respect of policies, markets and regulation is needed to ensure that barriers are removed and socio-economically feasible solutions also become feasible from a private economic perspective. The large-scale implementation of these technologies will assist in achieving fast cost reductions, as seen with other renewable technologies. However, tapping into the potential benefits of district heating and cooling also requires long-term planning, taking into account the importance of integration with surrounding energy systems. To ensure the optimal efficiency of the integrated sectors, cross-disciplinary studies and cooperation are necessary, since a major barrier to implementation are the high investment costs and limited availability of cheap, risk-averse, long-term financing. Further progress will necessitate close cooperation between the public and private sectors, including close cooperation between research and industry to develop efficient, low-cost, low-maintenance systems.

# References

1. Werner S. International review of district heating and cooling. *Energy* [Internet]. 2017 Oct;137:617-631. Available from: <http://dx.doi.org/10.1016/j.energy.2017.04.045>
2. Danish Energy Agency. Monthly and annual energy statistics, Annual Energy Statistics; 2016. Available from: <https://ens.dk/service/statistik-data-noegletal-og-kort/maanedlig-og-aarlig-energistatistik>
3. Hansen K, Connolly D, Lund H, Drysdale D, Thellufsen J Z. Heat Roadmap Europe: Identifying the balance between saving heat and supplying heat. *Energy*. 2016; 115:1663-1671, DOI: 10.1016/j.energy.2016.06.033.
4. Isaac M, van Vuuren D, Modeling global residential sector energy demand for heating and air conditioning in the context of climate change. *Energy Policy*. 2009; 37(2):507-521. DOI: 10.1016/j.enpol.2008.09.051
5. Renewable Smart Cooling for Urban Europe (Rescue). EU District Cooling Market and Trends. [https://ec.europa.eu/energy/intelligent/projects/sites/iee-projects/files/projects/documents/d2\\_3\\_eu\\_cooling\\_market\\_0.pdf](https://ec.europa.eu/energy/intelligent/projects/sites/iee-projects/files/projects/documents/d2_3_eu_cooling_market_0.pdf)
6. Lund H, Werner S, Wiltshire R, Svendsen S, Thorsen JE, Hvelplund F, Mathiesen BV. 4th Generation District Heating (4GDH): Integrating smart thermal grids into future sustainable energy systems. *Energy*. 2014 Apr;68:1-11.
7. Münster M, Morthorst PE, Larsen HV, Bregnbæk L, Werling J, Lindboe HH, Ravn H. The role of district heating in the future Danish energy system. *Energy* [Internet]. 2012;48(1): 47-55. DOI: 10.1016/j.energy.2012.06.011
8. Bach B, Werling J, Ommen TS, Münster M, Morales González JM, Elmegaard B. Integration of large-scale heat pumps in the district heating systems of Greater Copenhagen. *Energy* [Internet]. 2016;107:321-334. DOI: 10.1016/j.energy.2016.04.029
9. Frederiksen S, Werner S. District heating and cooling. Lund Studentlitteratur; 2013.
10. Danish Energy Agency. Energy scenarios towards 2020, 2035 and 2050 (in Danish). March 2014. ISBN: 978-87-93071-64-3
11. Svendsen S, Østergaard DS, Yang X. Solutions for low temperature heating of rooms and domestic hot water in existing buildings. In: Lund, H., Mathiesen, BV, editors. 3rd International Conference on Smart Energy Systems and 4th Generation District Heating [Internet]. National Museum, Copenhagen: Department of Development and Planning, Aalborg University. 2017 [cited 2017 Sep 12-13]. Session 11. P.151. Available from: [http://vbn.aau.dk/files/262318146/Book\\_of\\_abstracts\\_2017\\_3rd\\_International\\_Conference\\_on\\_Smart\\_Energy\\_Systems\\_and\\_4th.pdf](http://vbn.aau.dk/files/262318146/Book_of_abstracts_2017_3rd_International_Conference_on_Smart_Energy_Systems_and_4th.pdf)
12. Østergaard DS, Svendsen S. Theoretical overview of heating power and necessary heating supply temperatures in typical Danish single-family houses from the 1900s. *Energy and Buildings* [Internet]. 2016 Aug;126:375-383. Available from: <https://doi.org/10.1016/j.enbuild.2016.05.034>
13. European Heat Pump Association AISBL. Large scale heat pumps in Europe [Internet]. Brussels. Available from: <http://www.ehpa.org/technology/best-practices/15-examples-of-successful-industrial-projects/>
14. Elmegaard B, Zühlsdorf B, Reinholdt L, Bantle M. Book of presentations of the International Workshop on High Temperature Heat Pumps. Kgs. Lyngby: Technical University of Denmark (DTU); 2017. 176 p.
15. HOFOR. Final report - Experimental development of electric heat pumps in the Greater Copenhagen DH system - Phase 1 [Internet]. 2016 Jan. Available from: [http://www.hofor.dk/wp-content/uploads/2016/02/svaf\\_final-report\\_2016-02-02.pdf](http://www.hofor.dk/wp-content/uploads/2016/02/svaf_final-report_2016-02-02.pdf)
16. Energistyrelsen. Inspirationskatalog for store varmepumpeprojekter i fjernvarmesystemet. 2014 Nov.
17. Ommen TS, Elmegaard B (Supervisor), Markussen WB (Supervisor). Heat Pumps in CHP Systems : High-efficiency Energy System Utilising Combined Heat and Power and Heat Pumps. DTU Mechanical Engineering; 2015. 316 p. (DCAMM Special Report; No. S187).
18. Broberg S, Backlund S, Karlsson M, Thollander P. Industrial excess heat deliveries to Swedish district heating networks: drop it like it's hot. *Energy Policy* [Internet]. 2012; 51:332-339.
19. Hammond GP, Norman JB. Heat recovery opportunities in UK industry. *Apply Energy* [Internet]. 2014;116:387-397.
20. Persson U, Müller B, Werner S. Heat Roadmap Europe: identifying strategic heat synergy regions. *Energy Policy* [Internet]. 2014;74:663-681.
21. Lund R, Persson U. Mapping of potential heat sources for heat pumps for district heating in Denmark. *Energy* [Internet]. 2016;110:129-138. DOI: 10.1016/j.energy.2015.12.127
22. Bühler F, Petrović S, Karlsson K, Elmegaard B. Industrial excess heat for district heating in Denmark. *Applied Energy* [Internet]. 2017;205:991-1001.
23. Bamigbetan O, Eikevik TM, Nekså P, Bantle M. Review of vapour compression heat pumps for high temperature heating using natural working fluids. *International Journal of Refrigeration*. 2017;80:197-211.
24. Clark E, Wagner S. OZON ACTION FACT SHEET The Kigali Amendment to the Montreal Protocol: HFC Phase-down. 2016

25. Zühlsdorf B, Jensen JK, Cignitti S, Madsen C, Elmegaard B. Improving efficiency of heat pumps by use of zeotropic mixtures for different temperature glides Proceedings of ECOS 2017: 30th International Conference on Efficiency, Cost, Optimization, Simulation and Environmental Impact of Energy Systems. 2017.
26. Bühler F, Holm FM, Huang B, Andreasen JG, Elmegaard B. Mapping of low temperature heat sources in Denmark. In Proceedings of ECOS 2015: 28th International Conference on Efficiency, Cost, Optimization, Simulation and Environmental Impact of Energy Systems. 2015
27. Ommen TS. Heat Pumps in CHP Systems: High-efficiency Energy System Utilising Combined Heat and Power and Heat Pumps. DTU Mechanical Engineering. 2015. (DCAMM Special Report; No. S187).
28. Weiss W, Dür MS, Mauthner F. Solar Heat Worldwide. 2017 edition. SHC (Solar Heating and Cooling) IEA (International Energy Agency); 2017.
29. Furbo S, Dragsted J, Perers B, Andersen E, Bava F, Nielsen KP. Yearly thermal performance of solar heating plants in Denmark - measured and calculated. Solar Energy [Internet]. 2018;159C:186-196.
30. 30. Chen Z, Fan J, Perers B, Furbo S. Levetid for solfangere i solvarmecentraler. DTU Byg-Rapport R-210. 2009.
31. 31. Mangold D, Deschaintre L. Seasonal thermal energy storage. Report on state of the art and necessary further R&D. IEA SHC Programme Task 45; 2015. Available from: <http://task45.iea-shc.org/>
32. 32. Tian Z, Perers B, Furbo S, Fan J. Analyses and validation of a quasi-dynamic model for a solar collector field with flat plate collector and parabolic trough collectors in series for district heating. Energy [Internet]. 2018;142:130-138.
33. 33. Perez-Mora N, Bava F, Andersen M, Bales C, Lennermo G, Nielsen C, Furbo S, Martinez-Moll V. Solar district heating and cooling: A review. International Journal of Energy Research. 2017.



Chapter 12

# Energy Storage Innovation Challenge

By **Allan Schrøder Pedersen** and **Søren Linderoth**, Department of Energy,  
Technical University of Denmark  
**Ruediger-A. Eichel**, Forschungszentrum Jülich



### Why store energy?

→ The energy systems of the future will be dominated by sustainable energy sources primarily based on biomass, wind and solar power. This is the aim of many countries all over the world, and for Denmark the transition from fossil fuels is anticipated to be complete by 2050. However, the fluctuating character of a lot of sustainable energy production implies new challenges to the operation of the energy system since variations in supply and demand are inherently independent of each other and lead to considerable mismatches.

This mismatch problem can be solved by energy storage. Other solutions, often referred to as flexibility options,

among which are smart grid operations, may partly solve the same problem, but comfort and convenience strongly favor energy storage as the solution. In addition, energy for transportation, which accounts for about one third of the final energy demand in Western countries, can only be provided if energy storage forms part of the vehicle technology. Grid stabilization, electric power balancing and fuel for transportation are three major cornerstones of future energy systems and can be secured by energy storage.

Different energy storage technologies are suitable for different applications and services. In the following sections the most relevant technologies will be described briefly, their further development potential will be assessed, and the R&D challenges will be identified.

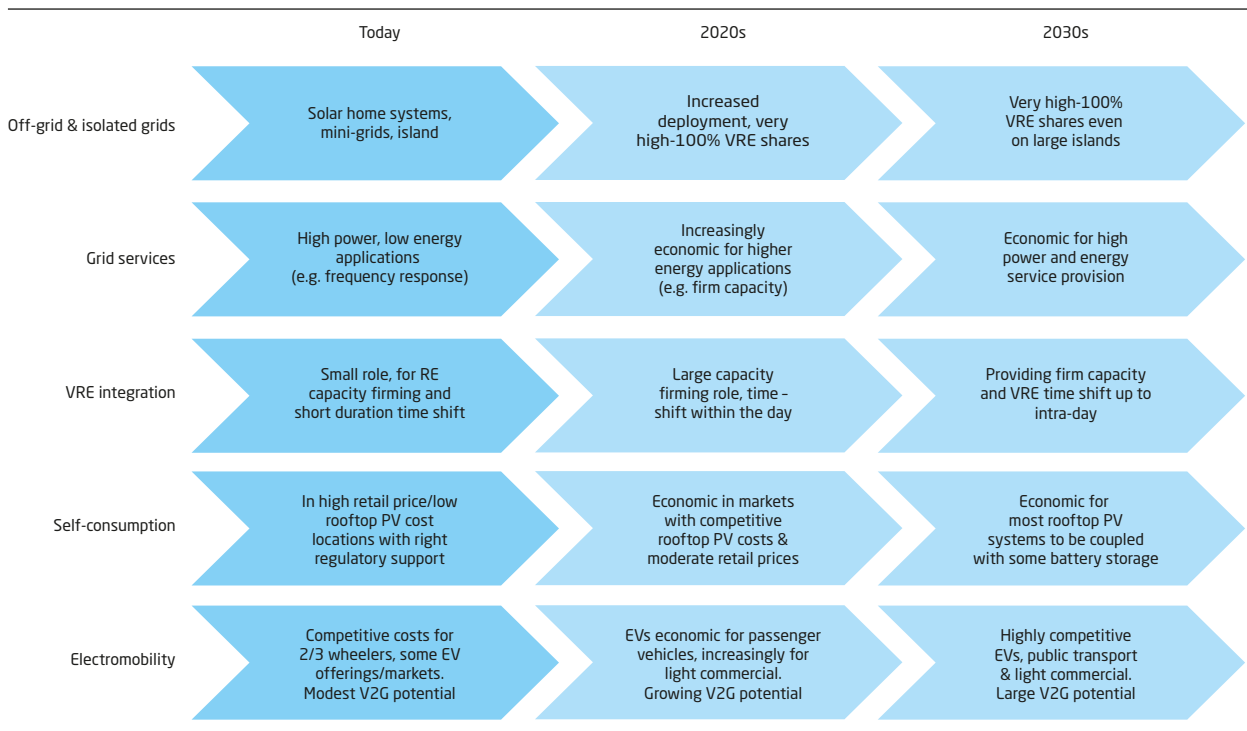

Figure 1. Energy storage needs in the energy transition [1]. The overview concerns electricity grids only, not gas or heating grids.

Electricity must be converted into a storable form of energy when wind- or solar-generated electrical energy needs storing. Basically such conversion turns the electrical energy into *mechanical, thermal or chemical energy*. In principle a very few other possibilities exist (like superconducting magnetic coils), but they are still quite far from real application.

### Electricity converted into mechanical energy

#### Flywheels

Flywheels store electrical energy as kinetic energy by bringing a mass into rotation around an axis. Flywheels are appropriate if fast dynamic energy storage is needed for applications. Two examples are shown in Figure 2.



**Figure 2.** Photo of WattsUp Power's and Amber Kinetics' flywheels. Whereas the latter provides a view into the internal steel rotor, the former utilizes composite materials for the rotor [2].

Flywheels have been used for centuries in steam and combustion engines, whereas development of an independent energy storage potential has been underway only since the 1960s [3]. The world's largest flywheel has been in operation since 1985 [4]. Nonetheless, flywheels are generally considered to be a less mature technology than many batteries, and in addition the cost is not competitive on the commercial market, although it is rapidly catching up, depending partly on the specific application [5].

An important service that flywheels can provide is frequency stabilization and short-term power compensation, as needed in, for example, subways etc. An example showing the response time of a flywheel system can be seen in Figure 3.

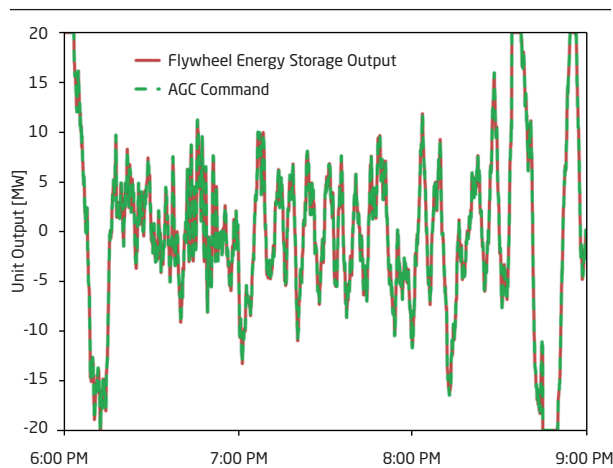

**Figure 3.** The reaction of a flywheel (MW input/output) in response to signals from the automatic generation control. It can be seen that, within the accuracy of the graph (note the axis scaling), the flywheel follows the signals completely. Source: Beacon Power.

A remarkable trend in flywheel prices has been observed in recent years, as shown in Figure 4 below. One major reason for this decrease in prices is that materials and composite wheel production technology have been adopted from the production of wind turbine rotor blades, which have undergone a dramatic development.

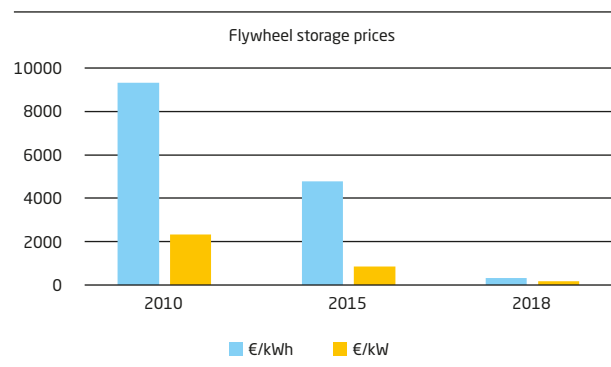

**Figure 4.** Trends in flywheel prices by type of storage and power capacity. Data for 2010 from Beacon Power. Data for 2015 from [6]. Data for 2018 from WattsUp Power based on recent sales.

*Research, development and demonstration requirements.* Important progress still remains to be made in respect of flywheels, as also stated by the European Association for Energy Storage (EASE) [7]:

- Improved and cheaper materials and production techniques for composite flywheels
- The high cost of magnets points to the need for research on new machine concepts with fewer magnets
- Better knowledge and wider experience regarding security cases or frames to reduce the cost of security (safety) during operation
- Demo-plants to demonstrate the convenience of flywheel technology for specific applications

### Compressed Air Energy Storage

Compressed Air Energy Storage (CAES) stores electrical energy mechanically. The input consists of electricity to drive an air compression process. In the basic form of CAES, compressed air is stored directly in pressure tanks or huge underground caverns. When energy requires to be released, the compressed air drives a turbine to generate electricity, thereby bypassing the compressor stage of a typical gas turbine and hence increasing the latter's output considerably.

When air is compressed at a practical speed ( $dp/dt$ , where  $p$  is the pressure), heat is released, causing energy to be lost during the storage operation. However, if the heat can be stored temporarily, the heat can be reinjected during the



expansion process (which is associated with a temperature drop) and thus is not lost. This form of CAES is usually called Adiabatic CAES (A-CAES) because of the lack of heat exchange between the storage system and the external environment. Obviously this has an impact on the overall efficiency (electricity to electricity), as the combustion chambers could be avoided. The Figure 5 below [8] gives a graphic introduction to CAES technology.

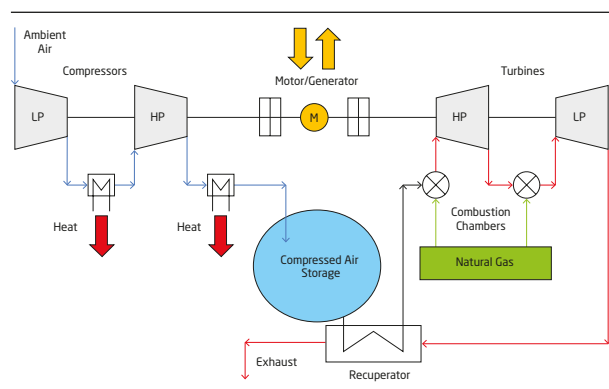

Figure 5. Operating principle of the CAES plant in McIntosh

Table 1 below [9] provides central data for the two facilities that have realized until now. The Huntorf plant (in Germany), commissioned in 1978 to become the world’s first CAES plant, uses 0.8kWh of electricity and 1.6kWh of gas [10] to produce 1kWh of electricity. The McIntosh plant (USA) incorporates a recuperator and uses 0.69kWh of electricity and 1.17kWh of gas [10] to produce 1kWh of electricity.

Type	Simple CAES process, two-stage NG combustors	CAES with recuperator and two-stage NG combustors
Location	Huntorf, Niedersachsen	McIntosh, Alabama
Commissioning	1978	1991
Turbine power	320 MW <sub>el</sub>	110 MW <sub>el</sub>
Generation capacity	~ 1 GWh	2.6 GWh
Thermal round trip efficiency	~ 42%	~ 52%
Specific cost	320 DM/kW <sub>el</sub>	591 \$/kW <sub>el</sub>
Turbine start-up time	> 9 min.	14 min.

Table 1. Data for the Huntorf and the McIntosh traditional CAES plants

In the case of A-CAES, a technology that has not yet been realized in practice, the proposal is to store heat in ceramic materials like rocks or bricks at elevated temperatures (say 600° C).

Research, development and demonstration requirements. Research and development efforts in respect of CAES are directed towards improving the relatively low round cycle efficiency, shown in Table 1, by temporarily storing the heat generated in the compression phase and reinjecting it during the expansion phase [11]. This is expected to improve the power-to-power efficiency to around 70% and bring ACAES into a much more attractive efficiency class. In collaboration with Danish companies, DTU is engaged in R&D on thermal energy storage. The status of this technology is discussed further in the section on thermal energy storage below.

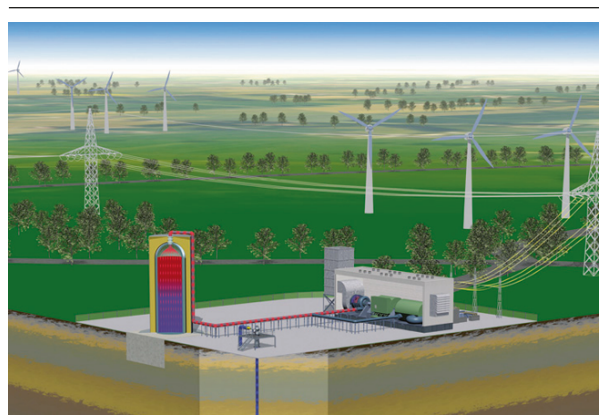

Figure 6. RWE’s vision for an ACAES plant

### Electricity converted into chemical energy

#### Batteries

An electric battery is an electrochemical device with an ion-only conducting electrolyte and two electrodes on each side of the electrolyte. The electrolyte can be liquid or solid. The electrodes are typically solid. When ions move through the electrolyte from one electrode to the other, electrons are allowed to move into the outer circuit, thereby performing work or charging the battery, depending on the direction of the flow. Primary (single-use or ‘disposable’) batteries are used once and discarded. Secondary (rechargeable) batteries can be discharged and recharged multiple times using an applied electric current. Lithium-ion batteries used in vehicles and portable electronics are an example of secondary batteries. The use of secondary, i.e. rechargeable batteries for storing electrical energy will be the focus of this section.

In general batteries have relatively low energy densities. The energy density of batteries is about one to two orders of magnitude lower than for the chemicals (gasoline, diesel) used in today’s road vehicles. Nevertheless, batteries have found numerous and widespread new applications in mobile uses such as in cell phones, laptop PCs and more re-

cently in vehicles as well, in cases where the limited driving distance is sufficient for the owner. The reason for the many applications of batteries is that they are energy efficient (80-90% electricity to electricity depending on use pattern) and extremely practical compared to other solutions. In addi-

tion, battery prices in €/Wh have been reduced strongly in recent years (see Figure 7), partly as a consequence of the dramatically increasing demand for mobile device applications.

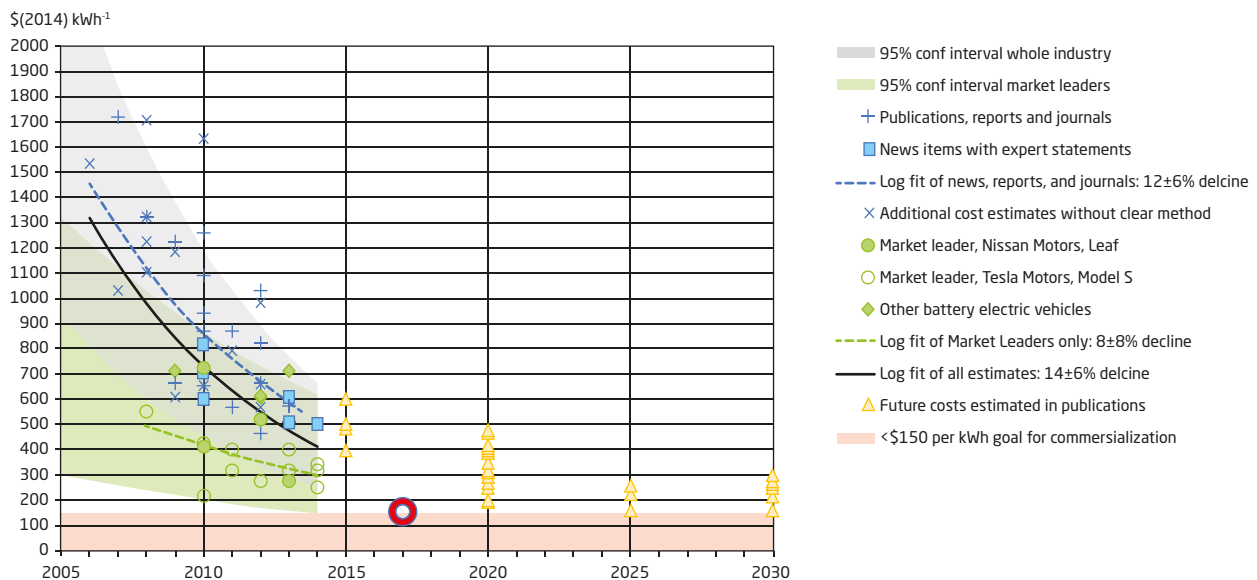

Figure 7. Price development for Li ion batteries for vehicles from [12]. Red circle shows the price of a Chevy Volt battery 2017 (145 \$/kWh).

For stationary applications, large batteries (multi-MW and MWh) are installed in electrical grids in several places worldwide to ensure grid stability in terms of frequency, voltage and power. One example of this is a battery in Los Angeles with a capacity of 100 megawatts, enough to provide 400 megawatt-hours of Li-ion technology battery-based energy storage [13].

There are many different battery types on the market. However, Li-ion technology, in different chemistry versions, has dominated battery sales in recent years, followed by lead-acid and alkaline batteries [14].

### Li-ion technology

Li-ion batteries are used in electronics, electrical vehicles (e.g. Tesla and Nissan), electrical and hybrid ferries, and as stationary energy storage in the multi MW-range. An example is the recent 100 MW/129 MWh Tesla-built storage unit in Australia [15].

### New battery chemistries

R&D on Li-ion systems has been going on intensively for a long time. Some researchers tend to the belief that the technology is approaching the limits of its performance poten-

tial in terms of energy and power density [16]. As a result there has definitely been an intensification of new research into new battery types (new chemistries). Areas in which the DTU is also strongly involved include Na- and Mg-ion technology, Li- and Zn-air, Li-S and Al-S technology, as well as new, cheap organic flow batteries.

*Research, development and demonstration requirements.* The demands batteries are subject to depend on their usage. For mobile applications, high energy densities and safety are of the greatest concern, alongside costs and durability. For large stationary applications, cost, durability and both high energy and fast response to fluctuations are important issues. For mobile applications, solid-state batteries providing higher levels of safety and high energy densities will be an important research and development topic in the coming years, as will cost reductions by replacing Co and to some extent Li with other elements. Recycling and the safe reuse of batteries will also be of importance. For large-scale stationary batteries, low cost, the ability to scale up to high energy content and fast responses will be central.

## Synthetic fuels

### Hydrogen/electrolysis

Electrolysis is a technique whereby chemical reactions are driven by an electrical potential and current. Since the seventeenth century it has been used to separate out certain elements such as zinc, tin and aluminum, and since about 1800 to separate  $H_2$  and  $O_2$  from  $H_2O$ . The water-splitting reaction is as follows:

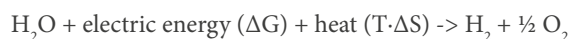

Splitting  $CO_2$  into C or CO and  $O_2$  is also possible and is undertaken industrially. In this section we describe the splitting of water and  $CO_2$ . Supplemented by subsequent chemical reactions, new chemical components can be made, for example,  $H_2$ , CO,  $CH_4$ ,  $CH_3OH$ ,  $NH_3$  and more. These reactions are eased by catalysis.

The key components in an electrolyser cell are the electrolyte and the electrodes. The electrolyte is an ion-only conductor which serves to transfer ions from one electrode to the other. Figure 8 shows the principle of an electrolysis cell.

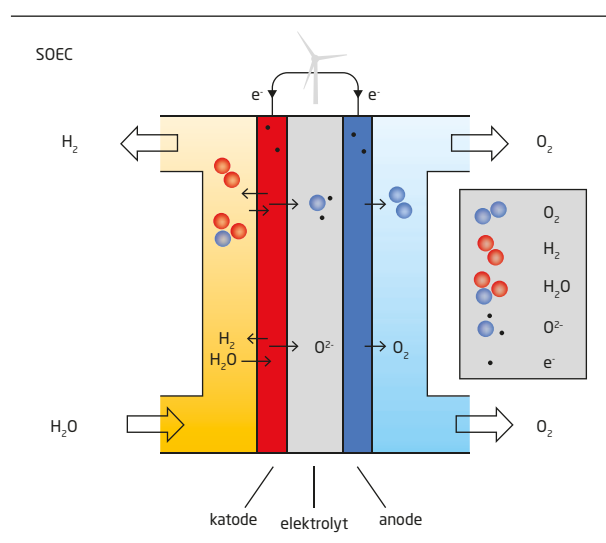

**Figure 8:** Principle of electrolysis, shown for an oxide-conducting electrolyte (O-SOEC)

The electrochemical reactions take place at the electrodes. There are several types of electrolyser cell. The electrolyte may be a liquid or a solid component, and the operating temperatures, depending on the electrolyser cell, may be in the range of about  $20^\circ C$  to  $1000^\circ C$ .

### Alkaline electrolysis cell (AEC)

The most commonly used electrolysers are low-temperature ( $\sim 80^\circ C$ ) alkaline electrolysis cells. Alkaline electrolysers are used in the production of hydrogen for upgrading oil prod-

ucts. Recently, the company NEL announced the delivery of a 100 MW alkaline electrolyser to France.

To achieve an acceptable hydrogen production rate per cell volume, AECs are usually operated at rather high cell voltages (1.7–1.9 V). Although the electrolysis process is endothermic, the losses in the alkaline cells cause heat to be produced as a waste or by-product.

Increasing the operating temperature of the electrolyser speed -up the electrode reactions and, all things being equal, the ion-conduction in the electrolyte, leading to higher production rates for the components being considered and this reducing the overall costs of an electrolyser system. This has led to research into high-temperature (up to about  $250^\circ C$ ) alkaline electrolysis. To retain the water as a liquid, it is operated at high pressure (about 30-40 bar). Thus the product is also delivered at high pressure, and the costs of pressurizing the hydrogen can be reduced.

*Research, development and demonstration requirements.* Although AEC electrolysers have been used commercially for decades, they are still too expensive because the hydrogen can only be produced currently at a high cost. More efficient and cost-effective AEC electrolysers should be developed. For low-temperature (about  $80^\circ C$ ) electrolysers, the hydrogen per volume of electrolyser could be increased by developing zero-gap membranes. Going to higher temperatures and high pressures will improve efficiency. These high-temperature electrolysers are still at low TRL. Materials research is needed to achieve long-term stability. Further RD&D on high-temperature, high-pressure AEC is highly recommended.

### Polymer exchange membrane electrolyser cells (PEMEC)

Polymer exchange membrane electrolyser cells use a proton-conducting solid polymer membrane as the electrolyte. PEM electrolysers were first introduced to overcome some critical issues with alkaline electrolyser cells. PEMEC has shown higher current densities and high pressure operation. Some of these critical issues may now also be resolved through high temperature AEC, as described above.

PEMEC originated in fuel cells (PEMFC). The major advantages of PEM electrolysis are its ability to operate at high current densities, to achieve a low gas crossover rate resulting in very high gas purity, due to its solid structure, and to make possible high-pressure operation. The latter reduces other costs in the compression storage of  $H_2$  in tanks. These advantages can result in reduced operational costs. However, the materials costs of PEMECs are still high, both for the electrolyte and the electrodes used. At present the electrodes still contain precious materials such as Pt and Ru. An important research task is to reduce or replace the amount of these expensive materials in PEMEC.

*Research, development and demonstration requirements.* PEMECs have great advantages in delivering high-pressure, high-purity hydrogen. However, the costs are high, primarily due to the use of Pt and Ru in the electrodes. Research to replace Pt and Ru should be continued.

### Solid oxide electrolysis cells (SOEC)

SOECs operate at high temperatures, typically in the range of 600-1000°C. The electrolyte is a solid O<sub>2</sub>-conducting oxide ceramic component, with electrodes also made of ceramics, sometimes also with, for example, Ni metal in one electrode. All the elements used are non-precious, whence SOEC could become a cheap electrolysis technology. In addition, utilization of the electrical energy can be very high, close to 100% [17]. The reason for this is that for SOEC the “waste” heat is utilized in the “thermal” splitting of the H<sub>2</sub>O. SOEC has another important virtue, namely that it can turn CO<sub>2</sub> into C or CO and O<sub>2</sub>, as well as perform co-electrolysis of both H<sub>2</sub>O and CO<sub>2</sub> to produce CO and H<sub>2</sub>, called syngas, a well-known product in industry for the manufacture of CH components such as methanol and DME etc. In today’s industry, syngas is produced from fossil fuels, but in the future it may be produced by electrolysis, with the CO<sub>2</sub> coming from point sources such as the cement industry, biogas production, power stations and the steel industry etc.

The SOEC described above is the typical SOEC with an O<sub>2</sub>-conducting electrolyte (O-SOEC). However, there also exists an H<sup>+</sup> (proton)-conducting electrolyte SOFC: P-SOFC. The virtue of P-SOFC is that, like PEMEC, the hydrogen produced is of high purity and may also be pressurized. In contrast to PEMEC, the electrodes can be free of Pt and Ru, making them much cheaper than PEMEC. P-SOFC needs to work at high temperatures, presently 500-1000°C, and it is still at low TRL.

*Research, development and demonstration requirements.* O-SOEC is already commercial (HTAS) in the market for CO production. However, the cost of hydrogen production from O-SOEC must be reduced. Here issues like long-term durability, robustness to load variations, the manufacturing of cells and stacks with a larger footprint and the general optimization of manufacturing steps could be pursued. For P-SOEC the manufacture of materials, cells and stacks, improvements durability and demonstrating stacks and systems are all recommended.

### Synthetic fuels besides hydrogen

Hydrogen is the most common and most obvious synthetic fuel to make from renewables using electrolysis. Hydrogen can be stored as a gas (at high pressure) or a liquid or dissolved in hydrides.

Hydrogen also reacts with carbon to make hydrocarbons (e.g. methane, DME, methanol, gasoline etc.) or with nitrogen to make ammonia (NH<sub>3</sub>). Hydrocarbons and ammonia have the advantages over hydrogen that they are easier and

cheaper to store and transport, and that several of them already have widespread infrastructure.

*Hydrocarbons.* The combination of hydrogen with CO<sub>2</sub> is well known, and the Sabatier process is a commercial technology. Co-electrolysis of steam and CO<sub>2</sub> (as described above) to produce syngas (H<sub>2</sub> and CO) is another route that might reduce the overall costs, especially when the process runs at elevated pressures. Solid oxide cells (SOCs) are interesting in this context since they can be operated both as electrolyzers (SOEC) to convert electricity into fuels such as hydrogen or methane, and as fuel cells (SOFC) to convert fuels into electricity. Both productivity and conversion efficiency are improved if the SOC operating pressure is increased from ambient pressure to 10–30 bar [18] [19].

*Ammonia.* NH<sub>3</sub> is a very important product for the productivity of today’s farming, making it possible to feed the billions of inhabitants on mother Earth. The production, storage and distribution of ammonia is therefore well established. The ammonia is produced from N<sub>2</sub> and H<sub>2</sub> by reactions at an iron catalyst, the so-called Haber-Bosch process. There is a famous site of this at the Aswan Dam in Egypt, where hydrogen is produced through alkaline electrolysis and connected to a large ammonia plant. Such units are on a very large scale for reasons of cost. There are interests and research activities in producing NH<sub>3</sub> directly through electrolytic and electro-catalytic processes, leading to the ability to produce and store energy in the form of ammonia locally, and at lower energy costs.

*Research, development and demonstration requirements.* Electrochemical methods to produce NH<sub>3</sub> are recommended. Probably high-temperature, high-pressure electrolysis systems are preferable, e.g. P-SOEC. The development of catalysts in the “NH<sub>3</sub> electrode” that are highly selective to H<sub>2</sub>+N<sub>2</sub> to NH<sub>3</sub> conversion, rather than solely H<sub>2</sub> production, should be one important attempt. The assembly of working cells and stacks should be realized.

## Thermal Energy Storage (TES) and conversion

Thermal energy may be stored principally in three different ways, usually called Sensible TES, TES as latent heat (phase change materials) and Thermo-Chemical Energy Storage.

### Sensible Thermal Energy Storage

Sensible TES (STES) is by far the most common and widely used TES technology. It consists of at least two systems out of thermal equilibrium (at different temperatures) and can be found in domestic hot-water containers, even though users do not always consider their hot-water container to be an energy store. In this domestic case, the hot water reaches temperatures of up to 80-90°C, and therefore the useful work that can be extracted is not very much (naturally, this is also not the aim of storing hot water in households). Many

larger cities have district heating systems employing large hot-water containers (thousands of m<sup>3</sup>) serving as energy stores to manage peaks in the demand or supply of heat. In addition, most households have smaller hot-water containers as well to deal with peak demand. Furthermore, a district heating system itself constitutes a heat storage option, as the temperature (the so-called forward temperature) can be varied within certain limits. The energy storage aspects of district heating systems are treated in Chapter 11 of this document, “Affordable Heating and Cooling Innovation Challenge”.

However, if heat is stored at a high temperature (HT), around 600°C, the potentially extractable useful work is much higher. Such temperatures allow the driving of a steam or ORC turbine, which can generate electricity – a process that has been known and utilized in power plants

for about a century. The technology is interesting in the sustainable energy system, where energy storage is required, because HT-TES is often very cheap. At 600°C simple, naturally abundant rocks or firebricks can be used and heated electrically by wind or solar power. Once heated, the energy can be stored for long periods, depending on the quality of the insulation, which is also very cheap. In regions supplied by district heating, like that found in many large cities, this technology is of particular interest because the heat developed by the turbine process can be utilized to supply heat.

High-temperature TES is currently under development, and at DTU a test facility has been established in collaboration with Danish companies for the study of materials and designs. Figure 6 illustrates the facility. The work was recently presented at the SDEWES conference on the sustainable development of energy [20].

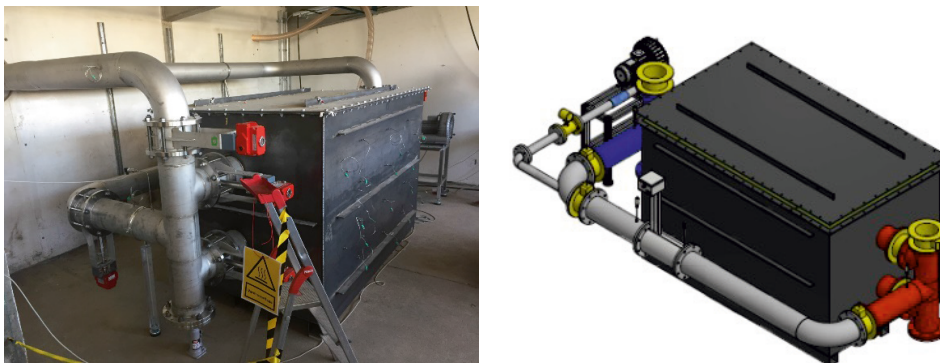

Figure 9. Photo and drawing of test facility for High Temperature Thermal Energy Storage at DTU. The facility contains a 1.5m<sup>3</sup> rock bed.

### Latent Heat Storage

Latent heat storage is based on phase change materials and relies on the fact that heat is involved in phase changes of matter. Heating aluminum through the application of constant (thermal) power starting from room temperature thus follows a curve, as shown in Figure 10 below.

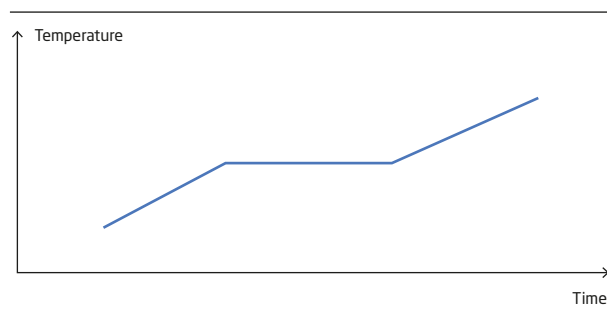

Figure 10. Development of temperature of aluminum upon heating with constant power input

The aluminum is initially heated sensibly to melting point and then kept constant until all the matter has been melted. Additional power simply increases the temperature of the molten aluminum. The interesting aspect of latent heat storage is the constant temperature at which heat is added or extracted (the horizontal part of the heating curve) during the phase transformation. This contrasts with the varying temperature of sensible heat storage. Another attractive aspect of phase change materials is the possibility to utilize sub-cooling effects and controlled release of the latent heat.

Latent heat storage is known to many in the form of small pocket heaters, and the concept has attracted interest over recent years for its use in connection with solar-thermal power. One material studied at DTU is sodium acetate hydrate [21] with a melting temperature of approximately 58°C. This effort has been directed to applications in solar-thermal systems.

Further studies of stable phase change materials, appropriate transition temperatures and control of solid nucleation

are required. In addition, the study and development of improved heat transfer materials and technologies are strongly required for applying these techniques.

### Thermo-Chemical Energy Storage

Chemical reactions are connected with the uptake or release of heat, as illustrated in the following reaction equation:

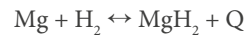

where  $Q$  is the amount of heat released by the formation of magnesium hydride from the elements. The reaction is one of many that can be used for TES following the principles illustrated in Figure 11 below.

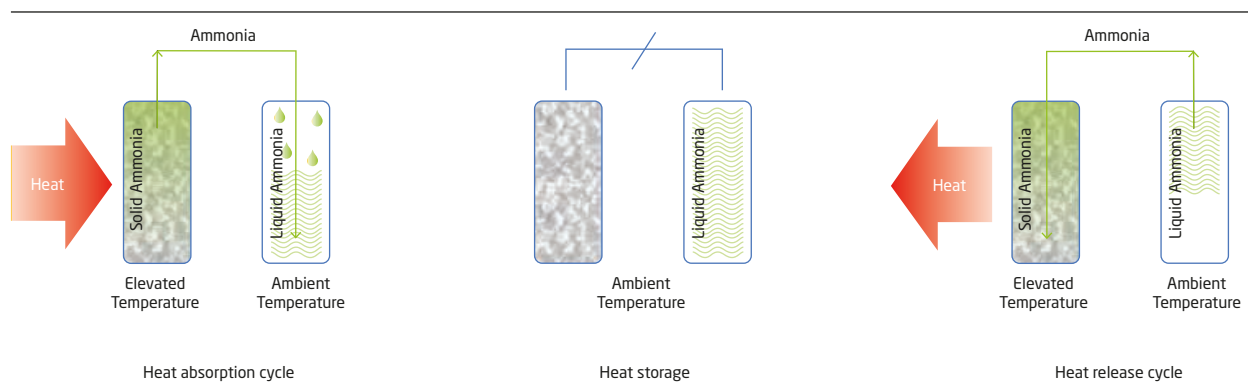

**Figure 11.** Principle of Thermo-Chemical Energy Storage illustrated by a system involving ab- and desorption of ammonia. Starting from the left, heat is added to the ammonia-containing compound, and ammonia is liberated. In the middle, a valve is closed to isolate the ammonia. To the right, the valve has been opened and the ammonia is allowed to react, release heat again and close the cycle. Figure by courtesy of D. Blanchard.

The heat involved in chemical reactions can be considerable. Table 2 shows selected examples of reaction systems and the reaction heats involved, as well as the applicable temperatures.

Chemical system	kJ/mol	Practical temperature °C
$\text{Ca(OH)}_2 \leftrightarrow \text{CaO} + \text{H}_2\text{O}$	100	500
$\text{MgH}_2 \leftrightarrow \text{Mg} + \text{H}_2$	35	400
$\text{MgCl}_2 \cdot 6\text{NH}_3 \leftrightarrow \text{MgCl}_2 + 6\text{NH}_3$	218 [22]	Ambient to 200

**Table 2.** Examples of reaction systems and corresponding molar heats involved

Not many thermo-chemical systems are in use today because they are still at the research stage and need further development. Materials stability and appropriate reaction rates, including rates for thermal power in and out of the systems, are important research topics.

### Conclusions

There exist many possibilities for energy storage, as well as for the simultaneous use of storage technologies at the highest efficiency rates and lowest overall costs. The technologies of choice will depend on the context in which the storage technology is used, and for which application. In Table 3 on the next page, a list of storage technologies is displayed, showing some of their central technical characteristics.



EES technology	Power range (MW)	Discharge time ms-h	Overall efficiency	Power density (W/kg)	Energy density (Wh/kg)	Storage durability	Self-discharge (per day)	Lifetime (yr)	Life cycles (cycles)
PHS	10-5000	1-24 h	0.70-0.82		0.5-1.5	h-months	Negligible	50-60	20000-50000
CAES (underground)	5-400	1-24 h	0.7-0.89		30-60	h-months	Small	20-40	> 13,000
CAES (aboveground)	3-15	2-4 h	0.70-0.90			h-days	Small	20-40	> 13,000
Flywheel	Up to 0.25	ms-15 m	0.93-0.95	1000	5-100	s-min	100 %	15-20	20000-100000
Lead-acid	Up to 20	s-h	0.70-0.90	75-300	30-50	Min-days	0.1-0.3 %	5-15	2000-4500
Na-S	0.05-8	s-h	0.75-0.90	150-230	150-250	s-h	20 %	10-15	2500-4500
NaNiCl <sub>2</sub> (ZEBRA)	50	2-5 h	0.86-0.88	150-200	100-140	s-h	15 %	15	2500-3000
Ni-Cd	Up to 40	s-h	0.60-0.73	50-1000	15-300	Min-days	0.2-0.6 %	10-20	2000-2500
Li-ion	Up to 0.01	m-h	0.85-0.95	50-2000	150-350	Min-days	0.1-0.3 %	5-15	1500-4500
VRFB	0.03-3	s-10 h	0.65-0.85	166	10-35	h-months	Small	5-10	10000-13,000
Zn-Br	0.05-2	s-10 h	0.60-0.70	45	30-85	h-months	Small	5-10	5000-10,000
Fe-Cr	1-100	4-8 h	0.72-0.75					10-15	> 10,000
PSB	15	s-10 h	0.65-0.85			h-months	Small	10-15	2000-2500
SMES	0.1-10	Ms-8 s	0.95-0.98	500-2000	0.5-5	Min-h	10-15 %	15-20	> 100,000
Capacitors	Up to 0.05	Ms-60 m	0.60-0.65	100,000	0.05-5	s-h	40 %	5-8	50,000
SCES	Up to 0.3	Ms-60 m	0.85-0.95	800-23,500	2.5-50	s-h	20-40 %	10-20	> 100,000
Hydrogen (fuel cell)	0.503	s-24 h	0.33-0.42	500	100-100,000	h-months	Negligible	15-20	20,000

Table 3. Technical characteristics of electrical energy storage systems [6]

## Recommendations

All technologies need to be further developed to reach higher efficiencies, lower the cost of production and use and increase durability, while at the same time including life-cycle assessments. Improved batteries for mobile applications, batteries for MW-size stationary storage in connection with, for example, wind and solar parks, and much focus on transforming electricity from renewables into synthetic fuels, such as hydrogen and methanol, are needed. Methane and ammonia are strongly recommended as a way of obtaining safe and cheap energy supplies.

In general, energy storage is increasing strongly in importance, and still more urgent storage needs within the energy system are being identified in respect of the electricity and heating/cooling sectors, as well as in the use of energy for transportation (cf. Figure 1). Such efforts could pave the way for a series of technologies that could support the sustainable energy system and thus accelerate the transition from fossil fuel to non-fossil fuel sources. Denmark already has recognized strongholds in advanced and high-tech industrial and research environments centered on storage and storage-related technologies. Examples are numerous, but cen-

tral topics like heat and cold management, electrochemical processes, catalysis, electronics (including power electronics), electromagnetics, control and synthetic fuels illustrate the potential. Thus, a strong basis exists for increased Danish involvement in developing such energy storage technologies to increase the economic potential and create a strong collection of competencies, including a wide range of large and small private enterprises, as well as several high-ranked universities and leading Danish technological institutes.

# References

---

1. "Electricity Storage and Renewables: Costs and Markets to 2030," International Renewable Energy Agency, Abu Dhabi, 2017.
2. "http://www.elp.com/articles/2016/01/amber-kinetics-signs-flywheel-energy-storage-contract-with-pg-e.html," 2016. [Online]. [Accessed March 2017].
3. Gyuk, I., "Grid Energy Storage," US Department of Energy, 2013.
4. Inage, S.-i., "Prospects of Electricity Storage in Decarbonised Power Grids, IEA Working Paper Series," OECD/IEA, 2009.
5. Kohli, N.K., "Short-Term backup power through flywheel energy storage system. Available on <https://www.slideshare.net/Drnavinkumarkohli/ppt-fly-wheel-navin-kohli> (Accessed March 2017)," 2012.
6. Zakeri, B. and Syri, S., "Electrical energy storage systems: A comparative life cycle cost analysis," *Renewable and Sustainable Energy Reviews*, vol. 42, pp. 569-596, 2015.
7. "Joint EASE/EERA recommendations for a European Energy Storage Technology Development Roadmap towards 2030," EASE and EERA, Brussels, 2013.
8. Karellas, S. and Tzouganatos, N., "Comparison of the performance of compressed-air and hydrogen," vol. 29, 2014.
9. Zunft, Z., Freund, S., and Schlichtenmayer, E.M., "Large Scale Electricity Storage with Adiabatic CAES," Paris, November 2014.
10. Barbour, E., [Online]. Available: <http://energystorage-sense.com/compressed-air-energy-storage/>. [Accessed February 2017].
11. "ADELE – ADIABATIC COMPRESSED-AIR ENERGY STORAGE FOR ELECTRICITY SUPPLY. RWE Brochure," RWE Power AG, Cologne, 2010.
12. Nykvist, B and Nilsson, M., "Rapidly falling costs of battery packs for electric vehicles," *Nature Climate Change*, vol. 5, p. 329-332, 2015.
13. "Fluence," Fluence, [Online]. Available: <http://fluenceenergy.com/energy-storage-solutions/> energy-storage-technology/siestorage-energy-storage/. [Accessed January 2018].
14. "Battery University Website," Battery University, 2016. [Online]. Available: [http://batteryuniversity.com/index.php/learn/article/global\\_battery\\_markets](http://batteryuniversity.com/index.php/learn/article/global_battery_markets). [Accessed January 2018].
15. "BBC News," BBC, December 2017. [Online]. Available: <http://www.bbc.com/news/world-australia-42190358>. [Accessed January 2018].
16. Deign, J., "GTM," 2016. [Online]. Available: <https://www.greentechmedia.com/articles/read/has-lithium-reached-the-point-of-diminishing-returns>. [Accessed January 2018].
17. Ebbesen, S.D., and Jensen, S.H., Hauch, A., Mogenssen, M., "High Temperature Electrolysis in Alkaline Cells, Solid Proton Conducting Cells, and Solid Oxide Cells," *Chemical Reviews*, vol. 114, no. 21, p. 10697-10734, 2014.
18. Jensen, S., Graves, C., Chen, M., Hansen, J. and Sun, X., "Characterization of a Planar Solid Oxide Cell Stack Operated at Elevated Pressure," *Journal of The Electrochemical Society*, 163 (14) F1596-F1604 (2016), vol. 14, no. 163, pp. F1596-F1604, 2016.
19. Jensen, S., Langnickel, H., Hintzen, N., Chen, M., Sun, X., Hauch A. and Bute, G., "PRESSURIZED REVERSIBLE OPERATION OF A 30-CELL SOLID OXIDE CELL STACK USING CARBONACEOUS GASES," in *European Fuel Cell Technology & Applications Conference - Piero Lunghi Conference, Naples, 2017*.
20. Pedersen, A.S., "High-Temperature Thermal Energy Storage for electrification and district heating," in *Proceedings of the 1st LA SDEWES Conference , Rio de Janeiro, 2018 (ISSN 1847-7178)*, Rio de Janeiro, 2018.
21. Dannemand, M., Kong, W., Johansen, J.B. and Furbo, S., "Laboratory test of a cylindrical heat storage module with water and sodium acetate trihydrate," *Energy Procedia* 91 ( 2016 ) 122 – 127, vol. 91, pp. 122-127, 2016.
22. Lespinasse, E. and Spinner, B., "Cold production through coupling of solid-gas reactors I: Performance analysis," *Int. J. Refrig.*, vol. 17, no. 5, pp. 309-322, 1994.
23. "Geological storage in Northern Ireland," Geological Survey of Northern Ireland. [Online].
24. Johnson, P., "ASSESSMENT OF COMPRESSED AIR ENERGY STORAGE SYSTEM (CAES)," Thesis Submitted to the University of Tennessee, University of Tennessee at Chattanooga, Chattanooga, Tennessee, USA, 2014.
25. "Toshiba Leading Innovation," Toshiba. [Online]. [Accessed March 2017].
26. "Fact sheet. Frequency Regulation and Flywheels," Beacon Power, 2010. Archived March 2017. Available on [https://web.archive.org/web/20100331042630/http://www.beaconpower.com/files/Flywheel\\_FR-Fact-Sheet.pdf](https://web.archive.org/web/20100331042630/http://www.beaconpower.com/files/Flywheel_FR-Fact-Sheet.pdf).
27. "http://beaconpower.com," Beacon Power. [Online]. [Accessed March 2017].
28. "European Energy Storage Technology Development Roadmap Update," European Association for Storage of Energy and European Energy Research Alliance, Brussels, 2017.





# Abbreviations

---

<b>ZDS</b>	2 Degrees Scenario	<b>IoT</b>	Internet of Things
<b>AA</b>	Amino acid	<b>LED</b>	Light Emitting Diodes
<b>AAU</b>	Aalborg University	<b>MAP</b>	Materials Accelerator Platform
<b>AC</b>	Alternate current	<b>MEA</b>	Mono ethanol amine
<b>AES</b>	Alcaline electrolysis cell	<b>MI</b>	Mission Innovation
<b>AI</b>	Artificial intelligence	<b>ML</b>	Machine/deep learning
<b>AMD</b>	Autonomous Materials Discovery	<b>MM</b>	Molecular mechanics
<b>ARES</b>	Autonomous Research system	<b>MMP</b>	Minimum miscibility pressure
<b>ASE</b>	Atomic Simulation Environment	<b>MOF</b>	Metal Organic Frameworks
<b>BZDS</b>	Beyond 2 Degrees Scenario	<b>MTO</b>	Methanol-To-Olefin
<b>BOS</b>	Balance of system components	<b>N2</b>	Nitrogen
<b>BRP</b>	Balance responsible parties	<b>NDC</b>	Nationally determined contribution
<b>CAES</b>	Compressed air energy storage	<b>NGO</b>	Non Governmental Organisation
<b>CCS</b>	Carbon Capture and storage	<b>OER</b>	Oxygen evolution reaction
<b>CCUS</b>	Carbon Capture Use and Storage	<b>ORR</b>	Oxygen reduction reaction
<b>CH4</b>	Methane	<b>PAYG</b>	Pay-As-You-Go
<b>CHP</b>	Combined heat and power	<b>PEMEC</b>	Polymer exchange membrane electrolyser cell
<b>CMR</b>	Computational Materials Repository	<b>PEMFC</b>	Polymer exchange membrane fuel cell
<b>CNT</b>	Carbon nanotubes	<b>PGPM</b>	Plant growth promoting material
<b>COP</b>	Coefficient of performance	<b>PJ</b>	Pico joule
<b>COP 21</b>	Conference of Parties 21	<b>PV</b>	Photo voltaic
<b>DER</b>	Distributed energy resources	<b>QM</b>	Quantum mechanics
<b>DFT</b>	Density Functional Theory	<b>R&amp;D</b>	Research and development
<b>DH</b>	District heating	<b>RD&amp;D</b>	Research, development and demonstration
<b>DME</b>	Dimethoxyethane	<b>RES</b>	Renewables
<b>DREM</b>	DSOs role in the Energy Market	<b>RTS</b>	Reference Technology Scenario
<b>DSO</b>	Distributed system operator	<b>SA</b>	Succinic acid
<b>DTU</b>	Technical University of Denmark	<b>SCP</b>	Single cell protein
<b>EMIRI</b>	Energy Materials Industrial Research Initiative	<b>SDG</b>	Sustainable Development Goal
<b>EOR</b>	Enhanced oil recovery	<b>SHS</b>	Solar home system
<b>ETP</b>	Energy Technology Perspectives	<b>SILP</b>	Supported ionic liquid phase
<b>EU</b>	European Union	<b>SNG</b>	Substitute natural gas
<b>EV</b>	Electric vehicle	<b>SNG</b>	Substitute natural gas
<b>GDP</b>	Gross domestic product	<b>SOEC</b>	Solid oxide electrolysis cell
<b>Gt</b>	Giga ton	<b>SSA</b>	Sub Sahara Africa
<b>GW</b>	Giga watt	<b>STES</b>	Sensible Thermal Energy Storage
<b>HER</b>	Hydrogen evolution reaction	<b>TCEP</b>	Tracking clean energy progress
<b>HFC</b>	Hydrofluorocarbon (refrigerant)	<b>TES</b>	Thermal Energy Storage
<b>HFO</b>	Hydrofluoroolefin (refrigerant)	<b>TSO</b>	Transmission system operator
<b>HT</b>	High temperature	<b>TWh</b>	Terawatt hour
<b>HTL</b>	Hydrothermal liquefaction	<b>UN</b>	United Nations
<b>HVDC</b>	High voltage direct current	<b>UNFCCC</b>	United Nations Framework Convention on Climate Change
<b>IEA</b>	International Energy Agency	<b>US</b>	United States of America
<b>IL</b>	Ionic liquid	<b>Yr</b>	Year
<b>INDC</b>	Intended nationally determined contribution		





**DTU International Energy Report 2018**  
**Accelerating the Clean Energy Revolution**  
**- Perspectives on Innovation Challenges**

May 2018

**Edited by**

Birte Holst Jørgensen and Katrine Krogh Andersen, Technical University of Denmark  
Elisabeth J. Wilson, Dartmouth College

**Reviewed by**

William D'haeseleer, KU Leuven

**Design**

Rosendahls a/s

**Print**

Rosendahls a/s

**ISBN** 978-87-93458-57-4

