



# Modelling the Recovery Effect in Batteries and Supercapacitors for Wearable Sensors: Discovering the Existence of Hidden Time Constants

Submitted for consideration for the degree of PhD (posthumous)

**Biomedical Engineering, School of Biological Sciences**

Submitted on behalf of Harneet Arora

Edited by R. Simon Sherratt

**January 2018**

# Preface

Harneet Arora was a wonderful PhD student, full of life, intelligence and promise. After diligently studying for 34 months, Harneet passed away on 30<sup>th</sup> December 2016.

Harneet had been working on an unusual and poorly understood phenomenon termed the battery recovery effect. From her work, she discovered interesting properties of certain types of batteries, whereby when some batteries were left to rest, i.e. little or no current was drawn for a period of time, the battery terminal voltage increased and overall more current is able to be drawn from the battery. This has the clear advantage of extending the use of a battery operated device between charges, perfect for medical wearable devices and aids. Harneet had performed numerous experiments, and characterised novel battery models. Interestingly, she showed the benefit of her work for both batteries and supercapacitors.

At her time of passing, Harneet had published one conference paper, but also had another conference paper accepted at the IEEE International Conference on Consumer Electronics, Las Vegas, January 2017, (to be presented by me as I was going to the conference anyway) showing for the first time that the recovery effect actually existed in supercapacitors. In the same month, my family also deeply suffered the loss of my wife's father. Clearly, I could not travel to Las Vegas to present the paper and perform my other IEEE duties. Kindly, my friend of many years, Dr Dani Díaz-Sánchez (University Carlos III de Madrid) who had also been an academic visitor at Reading presented the paper on our behalf.

I made enquiries with the university Graduate School concerning how we could move forward with requesting a posthumous award of PhD. As Harneet has not yet written her thesis, and the university needed a thesis for examination, after much discussion it was decided that I could submit a "linked thesis" for consideration by the examiners. The linked thesis was to be written by me, but pointed to Harneet's published works and it was the content of the published works that are to be considered by the examiners because the content of those publications are her words, not mine.

Harneet had nearly finished a manuscript for submission to an engineering academic journal on her primary topic of the recovery effect in batteries, proposing for the first time that the recovery effect response contained two discrete dynamics, thus can be modelled by a two-tank system. The manuscript only needed to have the "i's dotted" and the "t's crossed" so I decided to complete the manuscript and attempt to have the paper accepted in a prestigious journal, thus have all of Harneet's work published in order for the linked thesis to point to. After a few rounds of submissions, the manuscript was accepted by the IET Engineering Journal on the 17<sup>th</sup> September 2017 and published on-line 5 days later.

I present this linked thesis with Harneet's three papers in the relevant appendices for consideration of a posthumous PhD for Harneet. When reading the thesis, please refer to the published papers and assess Harneet's work by considering the content of her papers. The purpose of this linked thesis is only to place the published papers in context. Some of the narrative in this linked thesis has been taken from the published papers from this research work.

Respectfully submitted,

R. Simon Sherratt, FIEEE

# Declaration

I confirm that Harneet Arora was a PhD student at the University of Reading who co-wrote **Paper #1**, and wrote as primary author **Paper #2** and **Paper #3**.



R. Simon Sherratt  
Thesis editor.

# Dedication

This thesis is dedicated to the whole Arora family and extended family.

# Acknowledgments

There have been many people who have supported this research.

Firstly, I would like to thank Professor William Harwin for being Harneet's PhD co-supervisor. William never-endingly pushed for Harneet to examine the fundamental physics of the batteries and guided Harneet in dynamic modelling.

IRC-SPHERE (EP/K031910/1) ([www.irc-sphere.ac.uk](http://www.irc-sphere.ac.uk)) is an EPSRC Interdisciplinary Research Collaboration that is managed from the University of Bristol with many partners including Southampton and Reading. SPHERE considers technology that monitors and aids healthcare management of people in their own homes. Harneet joined the SPHERE team in Reading as a PhD student. She often travelled to the SPHERE team in Bristol for meetings. Without the leadership from Professor Ian Craddock, the University of Bristol, SPHERE would simply not exist and I wholeheartedly thank Ian for his support. I also wish to acknowledge the rest of the Reading SPHERE team including Professor William Harwin (Reading lead), Professor William Holderbaum, Dr Balazs Janko (who aided circuit design), Dr Arash Ghamari (who co-authored Harneet's first Reading paper), Dr Rachel King, Dr Emma Villeneuve, Ruth White and Ali Mohamed Ali.

Thank you to Nick Dove, Electronics Technician, for help in construction of the controlled current discharge circuit specifically designed in this research.

Thank you to Dr Dani Díaz-Sánchez (University Carlos III de Madrid) for your support presenting one of Harneet's papers, but also your contributions to SPHERE while you were a visitor in Reading.

Thank you to Paramvir Kaur Pal for supporting Harneet as a friend and fellow researcher.

Lastly, I would like to thank Harneet's husband, Amrinder, and the whole Arora family for their support in allowing us to finalise Harneet's manuscript and support us through the journal paper review process.

Harneet's PhD was funded by the University of Reading Research Endowment Trust Fund. The whole SPHERE team is extremely grateful.

# Table of Contents

Abstract .....	vii
1. Introduction .....	1
1.1 Research Contributions .....	2
1.2 Thesis organisation.....	2
2. Low-power Wireless Communications .....	3
3. Methodology .....	4
4. Modelling the Recovery Effect in Batteries .....	5
5. Recovery Effect in Supercapacitors .....	7
6. Discussion and Reflection.....	8
6.1 Discussion .....	8
6.1.1 Discussion on the effect of the rest time duration .....	8
6.1.2 Discussion on the overall discharge period voltage curve .....	8
6.1.3 Discussion on the voltage curves during the sleep period.....	9
6.1.4 Discussion on the effect on the rise time during sleep cycles .....	9
6.2 Reflection .....	9
7. Conclusion.....	10
Appendix A: Paper #1 .....	11
<p>Ghamari, A., <b>Arora, H.</b>, Sherratt, S. and Harwin, W. (2015) Comparison of low-power wireless communication technologies for wearable health-monitoring applications. In: 2015 International Conference on Computer, Communications, and Control Technology (I4CT), 21-23 April 2015, Imperial Kuching Hotel, Kuching, Sarawak, Malaysia, pp. 1-6, DOI: 10.1109/I4CT.2015.7219525</p>	
Appendix B: Paper #2 .....	18
<p><b>Arora, H.</b>, Sherratt, S., Janko, B. and Harwin, W. (2017) Experimental validation of the recovery effect in batteries for wearable sensors and healthcare devices discovering the existence of hidden time constants. The Journal of Engineering, IET, pre-print available, DOI: 10.1049/joe.2017.0303</p>	
Appendix C: Paper #3 .....	28
<p><b>Arora, H.</b>, Sherratt, R. S., Janko, B. and Harwin, W. (2017) Analysis of recovery effect in supercapacitors for wearable devices. In: IEEE International Conference on Consumer Electronics, 8-10 Jan 2017, Las Vegas, USA, DOI: <a href="https://doi.org/10.1109/ICCE.2017.7889322">10.1109/ICCE.2017.7889322</a></p>	

# Abstract

Wearable devices, including healthcare monitors and aids, are very popular and extremely pervasive. They allow a user to sense physiological parameters and movement, can process sensed data to derive contextualised information, and also communicate with the wider world to allow remote health monitoring and enable health interventions.

The inevitable march of technological invention pushes wearables to have more functionality, process more and sense more. As such, the demands on their power source increases. However, users demand small and lightweight wearable devices which place physical constraints on the power source, thus limiting the available power. To address these two conflicting positions, it seems sensible to consider ways to manage the wearable power source intelligently. It becomes absolutely vital to effectively utilise all the available power for device longevity between charges.

Rechargeable batteries are popular in wearable devices. While rechargeable batteries have good energy density, their charge rate can be limited and they can be relatively heavy. Supercapacitors are likely to also be adopted as power sources for wearable sensors; in particular where the sensor mechanism relies on energy harvesting. A specific advantage of supercapacitors over batteries is their maintained performance over large numbers of discharge cycles and they are relatively light weight.

It is known in the literature that the electrochemical recovery effect can enable the extraction of more power from the battery when implementing idle times in between discharge cycles, and it has been used to develop various power management techniques. However, there is no evidence concerning the actual increase in available power that can be obtained by exploiting the recovery effect. Also, this property cannot be generalised across all battery chemistries since it is an innate phenomenon, relying on the anode/cathode material. Indeed recent developments suggest that recovery effect does not exist at all.

This thesis examines the recovery effect in batteries and presents controlled experiments and results, to verify the presence, and level, of the recovery effect in commonly used battery chemistries that are typically found in wearable sensors and healthcare devices. While the literature analysed the recovery effect using active current and zero discharge current, this work has identified that wearable devices still have a small current drawn from the power source when in idle mode, therefore a novel active and idle discharge circuit was designed to model the recovery effect in the typical operation of wearable devices. The results have revealed that the recovery effect significantly does exist in certain batteries, and a novel contribution from this research has been the identification that the recovery response can be modelled using two different time constants. The time constants reflect the difference in charge carrier movement from the available charge well and the bounded charge well leading to the proposal from this work to model the recovery effect using a two-tank model. This novel finding has important implications for the development of power management techniques that utilise the recovery effect, with application in a large range of battery operated devices. Furthermore, this thesis also has examined the recovery effect in supercapacitors and has for the first time demonstrated that the recovery effect also exists in supercapacitors.

# 1. Introduction

Technology can do wonderful things, there are many exciting subjects to consider and there are many opportunities to improve people's lives. In particular, this can be seen in technology for the healthcare sector.

The challenge of healthcare is not a national issue, it is a global issue. The population over the age of 85 in the UK is predicted to triple by 2035, in the US the population over 65 is estimated to double by 2040, similarly in China the population over 60 is expected to double by 2040 and by the year 2050 Japan will have the oldest population in human history, with an average age of 52 years. While people are living longer, many developed countries are currently confronting an increase in the number of people diagnosed with chronic diseases such as obesity and diabetes. These chronic illnesses are not simply a result of ageing population but are due to inappropriate diet, sedentary lifestyle and insufficient physical activity.

Wearable devices have become pervasive. They can be worn on the ankle, in the shoe, on a belt, on the head, in the ear, around the chest, but primarily on the non-dominant wrist. Such devices can be used to measure physiological parameters, movement and take environmental measurements to derive information concerning a user's health. Unlike other healthcare devices, the narrative around a wrist worn wearable is clear, it is similar to a classical wrist watch but can do more, leaving the hands free for daily activities. However, it is well known that typical wearable sensors need to be charged daily, or even more often, thus damaging the user acceptance of the device. The device no longer monitors behaviour but starts to influence behaviour through the need to monitor remaining charge, and, recharge the device when required. Thus, there is a clear need to create novel solutions to allow wearable devices to last longer and thus become more ubiquitous.

Initially, the research work presented in this thesis considered how to make wearable devices last longer on one battery charge by examining the underlying low-power communication protocols. It was by accident and happenstance that when Harneet was testing a wearable device, its battery terminal disconnected and when it was reconnected, the terminal voltage was significantly higher. This led to investigations concerning what had occurred. After consultations, it was quickly realised that the battery, being disconnected, had recovered over the disconnect time, leading to refocussing this research on the recovery effect. Initial research identified that there were relatively few public domain papers on the recovery effect. The research for low-power devices, and specifically wearables was particularly scant. The primary focus for the recovery effect was in electric vehicles. Indeed, much of the literature was inconclusive, relied on very few experiments, with researchers citing the same few experiments, little qualitative data, and even some researchers claiming the recovery effect did not exist at all. It was the lack of good recovery effect research in the literature that refocused this research into the recovery effect in order to create longer lasting wearable devices.



## 1.1 Research Contributions

This thesis makes the following research contributions:

1. A comparison of low-power wireless communication technologies for wearable health-monitoring applications.
2. Evidence that the recovery effect does indeed exist in Alkaline and Lithium Polymer batteries, but does not exist in Lithium-ion and Nickel-Metal Hydride batteries.
3. A novel battery discharge circuit that, unlike the literature, includes sleep current ( $\mu\text{A}$ ) as well as active current (mA) discharge.
4. Identification that the recovery effect is dynamic, and can be modelled with two differing time-constants in series, leading to the novel proposal to model the recovery effect using a two-tank model.
5. That the recovery effect does exist in supercapacitors.
6. That when implementing idle times to allow for recovery, alkaline batteries can last for 21% longer, Lithium Polymer for 11% longer, and supercapacitors for 20% longer.

From this research, three papers were published and are presented in Appendix A ([Paper #1](#)), Appendix B ([Paper #2](#)), and Appendix C ([Paper #3](#)). These papers will be continually referred to from this linked thesis:

- Paper #1 discusses a comparison of low-power wireless communication technologies for wearable health-monitoring applications.
- Paper #2 presents the experimental validation of the recovery effect in batteries for wearable sensors and healthcare devices, discovering the existence of hidden time constants.
- Paper #3 presents an analysis of the recovery effect in supercapacitors for wearable devices.

## 1.2 Thesis organisation

The rest of this thesis is organised as follows: chapter 2 discusses the role of low-power communications on wearable devices, particularly relating to electrical power; chapter 3 discusses the methodology in the research; chapter 4 discusses the research concerning the recovery effect in batteries; chapter 5 discusses the research concerning the recovery effect in supercapacitors; chapter 6 presents a reflection of the results of the research; finally chapter 7 presents the thesis conclusions.

Unlike most theses, this thesis, being a linked thesis, does not itself present a reference list, but the primary references are presented at the end of each published paper.

## 2. Low-power Wireless Communications

Initially, this research considered that a method to prolong the lifetime of a wearable device, in a healthcare application, would be to consider the wireless communication protocols used to communicate the data from the wearable to a house or residence.

Research was conducted, and [Paper #1 \(Appendix A\)](#) was written with co-author Dr Arash Ghamari. It was published in the digest of an IEEE conference. This paper compared some of the existing and emerging low-power communication protocols that can potentially be employed to support the rapid development and deployment of Body Area Network (BAN) systems. The paper considered Intra Body Communications (IBC) as a low-power enabling technology to allow a receiver and transmitter to communicate over a very short range inside the body. This significantly reduced the power consumption of the sensor nodes present on the body and helped in prolonging their lifetime. While IBC can thus be considered as a promising solution for low power wearable health monitoring systems, it needs multiple sensors on the body and users prefer only to have a single wrist worn wearable. While Zigbee offers in the order of 100m communications and is used in many home control systems, Bluetooth Low Energy (BLE) offers the best power profile for the wearable, assuming that room hubs are available in close proximity to offload sensor data. The paper was a useful research vehicle to focus on electrical power being a critical component in a wearable device.

## 3. Methodology

Initially, this research was concerned with low-power protocols to enable a wearable device to last longer. However, with the accidental realisation of the advantages of the recovery effect, the research was refocused on understanding the recovery effect as a potential method to enable a wearable device to last longer per charge.

A full literature search was performed, which indicated significant deficiencies in the recovery effect literature:

1. Most of the literature kept referring to the same few past experiments, and assumptions were clearly being propagated across papers.
2. It was unclear as to how much extra available charge the recovery effect could offer.
3. It was unclear which batteries could be used with the recovery effect, and which could not.
4. It was unclear as to the time required for a battery to recover.
5. All the previous experiments in the literature implemented the recovery effect by resting the battery with zero current. This was impractical for a wearable device that still draws a sleep, or idle current, when not active. The research examined to what extent this idle current would damage the extra available charge from the recovery process.

The research was conducted to try to answer the questions above, in both batteries and supercapacitors.

## 4. Modelling the Recovery Effect in Batteries

From the literature, and physical measurements, it is known that the recovery effect in batteries can be exploited. It was not, however, clear which batteries exhibited the recovery effect, and to what extent. This section discusses the main concepts, methods and results, from this research work into the recovery effect in batteries.

Research was conducted, and [Paper #2 \(Appendix B\)](#) is the result of this research, published in the open access IET Journal of Engineering. This chapter will refer to this paper.

From the literature, it was found that there are four primary battery chemistries used in wearable devices and small wireless sensors, being Alkaline, Lithium-ion (Li-ion), Li polymer (Li-Po) and Nickel-Metal Hydride (Ni-MH). Suitable devices were procured as detailed in Table 2 of [Paper #2](#).

The batteries were tested using a number of different discharge patterns by varying:

1. The discharge current, between active (mA) and sleep ( $\mu\text{A}$ ). In this research the active discharge current was set at 20 mA and the sleep current to 4  $\mu\text{A}$ .
2. Duty cycling, i.e. the ratio of the sleep time (S) to the active time (A)
3. Random duration of the active time, uniformly distributed.

The duration of the active time was generated randomly (uniform distribution) at each discharge time between the ranges of 10 and 60 s. Each active cycle was followed by a sleep cycle with the duration of the sleep cycle determining the rate of duty cycling. A continuous discharge with sleep time  $S=0$  (i.e. always active so no recovery occurs), and intermittent discharge ratios of  $S = A$  (termed 50%) and  $S=2A$  (termed 67%) were used in this work.

Since the terminal voltage of a battery decays over the discharge period, a constant-current discharge circuit was developed that was able to draw current from non-discharged batteries irrespective of their terminal voltage. A novel design constraint of this system was to switch between active and sleep currents, rather than active and no current, thus emulating the sleep current drain from typical wearable devices. Figure 3 in [Paper #2](#) depicts the circuit diagram of the discharge circuit specifically designed as part of this research. A microprocessor controlled the active (A) to sleep (S) timings. Considering that a typical 100 mAh battery would last 3 years when discharging 4  $\mu\text{A}$  sleep current, then in practice the battery self-discharge will mean a shorter useful life. Therefore, the importance of controlling the exact amount of sleep current was less important. R3 sets the battery current drain when in sleep mode (through (MOSFET) SW1 controlled by microprocessor digital output D.OUT1). To model the current in the active mode,  $V_s$  was used to set the discharge current in the active mode to 20 mA. As most power control circuits in wearable devices use DC/DC converters, their current draw is largely independent of supply voltage. The Darlington BJT, OPAMP1 and R4 form a constant-current drain circuit (through MOSFET SW2 controlled by microprocessor digital output D.OUT2) defining the active discharge period. The current drawn from the battery is closely approximated by  $V_s/R4$ . The battery voltage was buffered and then sampled by an internal analogue-to-digital converter (ADC) to log the battery voltage to a file or off-line analysis. The buffered battery voltage was sampled at 2 kHz enabling the capture of the highly dynamic nature of the terminal voltages under the recovery process. Low-pass filtering of 100 kHz was provided by C1/R2 for electromagnetic compatibility considerations. The gain of the buffer was set by R1 and R2.

In order to avoid generalising battery performance from one battery, the results were obtained by averaging over 5 batteries, with 3 charge/discharge cycles per battery.

The percentage increase in active time, and the percentage increase in total available charge is presented in Table 3 in [Paper #2](#). As can be seen, it was found that the alkaline battery was capable of supplying an additional 21.3% in lifetime, and charge, when exploiting the recovery effect. Likewise, it was found that the Li-Po was capable of supplying an additional 11.7% overall in lifetime and charge, when using the recovery effect. However, no appreciable extra charge was obtained when using the Li-ion or Ni-MH batteries. This result demonstrated that the recovery effect is in fact real and can have a real benefit to real systems, but does depend of the battery chemistry.

Once the results were logged, the experimental measurement results were further analysed to understand the battery behaviour during the sleep cycles, including the voltage rise time. MATLAB curve fitting was used in order to obtain the dynamics of the recovery effect. It was observed that all curves fitted well to a model of two cascaded first-order dynamic responses. Each response has its own gain and time constant. The R-square for these fittings was  $>0.75$ , demonstrating good curve fitting performance. Of question, was to what extent the dynamics changed over the discharge period. Figure 6 in [Paper #2](#) shows the variation in the dynamics during the entire discharge period. It can be seen that though most of the values lie in a similar range, a few cases with high values of time constants for 67% discharge were seen. This slight variation observed can be attributed to the limitations of the fitting algorithm since it tends to find local best-fit values instead of the global. Hence, the median was taken for the time constant values and the results are presented in Table 5 in [Paper #2](#).

After the discovery that the battery terminal voltage under recovery has two time constants, this work considered a model to describe the battery operation under recovery. As a result of this work, a novel two-tank model for the recovery effect in batteries was proposed, as detailed in section 8.3 of [Paper #2](#).

## 5. Recovery Effect in Supercapacitors

Batteries are currently the most commonly used power source in wearable sensors, but batteries are constrained by their energy density and limited charge cycles, making it essential to have an alternative that can overcome these factors and provide longer life span to a wearable.

Supercapacitors are likely to be adopted as power sources for wearable sensors in the future; in particular where the sensor mechanism relies on energy harvesting. A specific advantage of supercapacitors over traditional batteries is their maintained performance over large numbers of discharge cycles. Supercapacitors are electrochemical devices that have high energy and power densities and provide a very large number of charge/discharge cycles, hence can be considered as a lightweight alternative to batteries. Their low internal resistance and high capacitance allow them to be used either as a standalone power source, but they are more likely to be used in conjunction with batteries or energy harvesting circuits to provide an extended lifetime. However, it is still necessary to optimize the energy usage of a supercapacitor to ensure efficient utility.

To determine if supercapacitors have the ability to offer the recovery effect, this research performed experiments to analyse the increase in available energy when implementing sleep times in the same way as analysing batteries.

Research was conducted, and [Paper #3 \(Appendix C\)](#) is the result of this research, published in the digest of an IEEE conference.

In the research, a small button type supercapacitor was used which has a capacitance of 0.1F and rated voltage of 5.5V. The supercapacitor was charged under constant current conditions to 80% of the rated voltage and was then held for 30 minutes to allow the voltage to settle. As in the same procedure used in the battery study, the supercapacitor was drained of current in active (mA) and sleep ( $\mu$ A) periods of various ratios of active to sleep. Table II of [Paper #3](#) shows the increase in available charge when using the recovery effect procedure on supercapacitors. As can be seen, the available charge from a supercapacitor can be increased using idle periods to allow for recovery. This work was the first work to show that the recovery effect does exist in supercapacitors. Interestingly, it was found that an extra 21.6% of charge was made available using the recovery effect, allowing devices to function for longer, and/or require smaller energy harvesting circuits.

Unlike batteries, the time constants were found to be extremely long. For the best charge recovery, an idle time of >10 times the active time is needed.

## 6. Discussion and Reflection

### 6.1 Discussion

#### 6.1.1 Discussion on the effect of the rest time duration

In implementing the recovery effect, a battery or supercapacitor requires to have a rest period, i.e. the current drawn from the device needs to be minimised for a period of time. The duration of rest time plays a critical role in determining the time for which the battery or supercapacitor will be capable of recovering and hence the amount of overall charge, per charge cycle, that it will be able to deliver.

It can be realised from [Paper #3](#), Table 3, that when sleep time equalled the active time (i.e. with 50% duty cycling), only a slight increase in the active time and the charge delivered was observed. When the sleep time was increased to twice that of the active time, ~21% increase was noted for both parameters in case of alkaline batteries, while Li-Po showed a rise of 11%. Li-ion and Ni-MH showed negligible increase in the amount of charge delivered, and hence the active time. In typical sensor systems, allowing for the recovery effect to occur can be implemented from duty cycling the parameters being measured. In the same vein, [Paper #3](#), Table 2 clearly shows an increase in the active time and the charge delivered for supercapacitors.

Whilst the terminal voltage of Li-ion rises during sleep periods, it did not actually recover any charge. Thus it can be inferred that only alkaline and Li-Po batteries have a tendency to recover significant charge during sleep periods and the amount of gain achieved increases with the increase in the duration of the sleep interval, up to two times the active period. Whereas, in supercapacitors, more available charge was achieved when resting the device for up to 10 times the active period. Therefore, supercapacitors will be of benefit to low duty cycle devices, perhaps devices that only operate once per hour, or once per day, energy harvesting in the meantime.

#### 6.1.2 Discussion on the overall discharge period voltage curve

The overall discharge curves for batteries are shown in [Paper #2](#), Figure 4. A typical battery discharge curve generally comprises of an initial quick exponential discharge period, followed by a long sustained normalised duration, before it reaches a knee and subsequently hits the cut-off voltage. Different batteries vary in their discharge shapes due to the difference in the inherent chemical species and their rate of reaction. Alkaline and Ni-MH batteries have a prominent initial exponential period, as compared with Li-ion and Li-Po batteries, which have more of a flatter start. This suggests that the initial voltage variation is higher in alkaline and Ni-MH. The normalised discharge period at the middle of the discharge is very flat for Li-ion, followed by Li polymer, and Ni-MH batteries in contrast to alkaline batteries for which it is continuously decreasing. The knee portion toward the end of the discharge is much more clearly visible in Li-Po, Li-ion and Ni-MH batteries, in comparison with Alkaline.

### 6.1.3 Discussion on the voltage curves during the sleep period

The shape of the battery voltage curve during a sleep interval was useful in understanding the voltage relaxation process. Paper #2, Figure 5, presents the voltage curve for all the batteries tested during sleep cycles from the middle of a discharge cycle. It can be seen that the Ni–MH batteries have flatter curves, i.e. they instantly respond to the step input. However, the other three batteries have significantly visible rise times. The very small time constant of Alkaline batteries allows them to rise quickly from the lower voltage and reach the steady state rapidly. On the other hand, Li-ion and Li-Po batteries have similar discharge curves attributing to the similar range of their time constants.

### 6.1.4 Discussion on the effect on the rise time during sleep cycles

Once the voltage charge/discharge curves were obtained through extensive measurements, and it was realised through modelling that the rise time is formed from two time constants buried in the recovery curves, this research proposed a model of the recovery effect using the two-tank system, modelled as two wells of charge. The first tank, the bounded charge well (BCW) supplies charge to the available charge well (ACW). The ACW is responsible for providing charge to the external load, hence if the ACW is drained, the charge in the BCW is not utilised. If the drain from the ACW is relaxed, then the ACW can be topped up from the BCW, reaching an equilibrium state. The flow of charge that moves across from the BCW to the ACW is proportional to the time constant values. A small time constant indicates the faster movement of charge, whereas a larger value indicates a slow movement, and therefore two time constants from the presence of the two wells. Hence, to achieve a higher utilisation of the battery's chemical material for an increase in the overall charge delivered, smaller time constant values are preferred. Paper #2, Table 5, summarises the time constant values for the batteries tested. It can be seen that Alkaline batteries have the smallest value of fast and slow time constants in comparison with Li-Po and Li-ion which have much higher and a similar range of values. This implies that alkaline batteries have the fastest movement and settlement of the species, thus they require shorter sleep durations to recover the charge delivered, whereas the higher value of time constants in Li-Po suggest slower movement of the species leading to the requirement of comparatively longer sleep intervals to recover charge. Paper #3, Table II shows that supercapacitors have incredibly long time constants compared to batteries.

## 6.2 Reflection

The research presented in the papers discussed, as part of this linked thesis, clearly show that the recovery effect does exist, hopefully, the debates concerning the existence of the recovery effect can be silenced. The research has shown, for the first time, that the recovery effect contains multiple dynamics, and it was proposed that a useful model for the recovery effect is the two-tank model. Furthermore, it has been shown, for the first time, that supercapacitors do exhibit the recovery effect. While supercapacitors do not supply the same level of charge as batteries, supercapacitors can be used in conjunction with energy harvesting circuits to have no-battery, or reduced-battery systems.

On reflection, and as presented in Paper #3, this research has focussed on understanding the recovery effect, by definition in the idle (sleep) periods. What is still not known is an understanding of the maximum duration of the active cycle that can be allowed to occur before a battery should switch to sleep mode, in order for the recovery effect to fully occur. This would prove beneficial for applications/scenarios that cannot afford longer sleep intervals but could accommodate shorter periods. Furthermore, it is still not known if there is any upper bound to the amount of charge recovery that could be obtained from a battery or supercapacitor. This would be helpful in avoiding unnecessary long sleep intervals. In addition, other sizes of a battery should also be analysed to compare the percentage effectiveness of different sizes on the active time and charge delivered.



## 7. Conclusion

The use of wearable devices in the general public has become very much ubiquitous and abundant. Such devices typically have a tiny battery for their power source, however, supercapacitors may also be used. This thesis focussed on extending the device operating time from a single charge, by examining the little understood recovery effect. As opposed to constantly drawing a current from a battery, the recovery effect enables a battery to supply more overall charge, by periodically, requiring a system to enter a sleep state, thus drawing a small idle current and allowing a battery to recover.

The size of literature on the recovery effect was found to be scant and confusing, so it is of no surprise that the recovery effect is often misunderstood, some claim it exists, some claim it does not exist. There were few objective measurements in the literature to draw conclusions on. Which battery types can be used with recovery effect principles was not clear.

The research detailed in this linked thesis has found that the recovery effect does indeed exist and significant increases in battery lifetime (per charge) can be gained, up to 21%. While some batteries can exhibit a recovery, the increase in available charge depends on the battery chemistry. Alkaline and Li-Po batteries show significant recovery whereas Li-ion and Ni-MH show no recovery. It is likely that the confusion surrounding the recovery effect is due to lack of knowledge concerning which batteries can recover, and which cannot.

As part of this research, a novel battery discharge circuit was created to perform measurements on batteries specifically looking for the recovery effect. While in the literature such systems drain batteries with an active current and then zero current, this research identified that wearable devices do still draw an idle current when in sleep mode, therefore batteries in this research were discharged with active (mA) and idle ( $\mu$ A) currents over random time lengths, while maintaining an overall active to sleep ratio.

This thesis analysed the dynamics seen in the battery terminal voltage under recovery and, for the first time, proposes that the recovery effect can be modelled from two time constants. This discovery leads to the proposal in this thesis to model the recovery effect using the two-tank model.

This thesis has also identified that the recovery effect is not just the domain of batteries. For the first time, it is shown that supercapacitors can, too, show benefits from being relaxed. The time constants in supercapacitors are significantly longer than batteries, again up to 22% extra lifetime (per charge) can be gained.

This research work has clear benefits, from its insights, to allow a wearable device to function longer, per charge, and as such the societal impact can be huge. Furthermore, no additional cost or complexity in hardware design is required. In order to benefit from this research, it is required that devices periodically place themselves in sleep-mode, reducing their power, in order to allow the power source to relax and enable recovery to occur. Such processes exist in sensor systems, wireless sensor networks, environmental monitoring and long-term health monitoring, and these are ideal areas for implementing this research.

## Appendix A: Paper #1

Ghamari, A., **Arora, H.**, Sherratt, S. and Harwin, W. (2015) Comparison of low-power wireless communication technologies for wearable health-monitoring applications. In: 2015 International Conference on Computer, Communications, and Control Technology (I4CT), 21-23 April 2015, Imperial Kuching Hotel, Kuching, Sarawak, Malaysia, pp. 1-6.

DOI: [10.1109/I4CT.2015.7219525](https://doi.org/10.1109/I4CT.2015.7219525)

## Appendix B: Paper #2

**Arora, H.**, Sherratt, S., Janko, B. and Harwin, W. (2017) Experimental validation of the recovery effect in batteries for wearable sensors and healthcare devices discovering the existence of hidden time constants. The Journal of Engineering, IET, pre-print available.

DOI: [10.1049/joe.2017.0303](https://doi.org/10.1049/joe.2017.0303)

# Experimental validation of the recovery effect in batteries for wearable sensors and healthcare devices discovering the existence of hidden time constants

Harneet Arora, Robert Simon Sherratt, Balazs Janko, William Harwin

Department of Biomedical Engineering, University of Reading, Reading RG6 6AY, UK  
E-mail: sherratt@ieee.org

Published in *The Journal of Engineering*; Received on 17th July 2017; Accepted on 17th September 2017

**Abstract:** Wearable sensors and healthcare devices use small lightweight batteries to power their operations of monitoring and tracking. It becomes absolutely vital to effectively utilise all the available battery charge for device longevity between charges. The electrochemical recovery effect enables the extraction of more power from the battery when implementing idle times in between use cycles, and has been used to develop various power management techniques. However, there is no evidence concerning the actual increase in available power that can be attained using the recovery effect. Also, this property cannot be generalised on all the battery chemistries since it is an innate phenomenon, relying on the anode/cathode material. Indeed recent developments suggest that recovery effect does not exist at all. Experimental results to verify the presence and level of the recovery effect in commonly used battery chemistries in wearable sensors and healthcare devices are presented. The results have revealed that the recovery effect significantly does exist in certain batteries, and importantly the authors show that it is also comprised of two different time constants. This novel finding has important implications for the development of power management techniques that utilise the recovery effect with application in a large range of battery devices.

## 1 Introduction

Wearable sensor devices have gained wide acceptance in healthcare monitoring and diagnostic applications. These devices allow ubiquitous sensing of the physiological, biochemical and motion-related parameters of the body without any physical assistance from medical professionals. The information collected by the sensors can be relayed to a central hub from where it can be accessed by their individual doctors, carers and family members. However, these devices face a number of challenges which need to be addressed for them to provide an efficient and reliable service. One such key issue is the ultra-low power, long-term wireless connectivity enabling wearables to be able to connect to the central hub at all times and vice versa. The ability to maintain a connection or perform processing largely depends on the amount of energy the device has to expend on this process. The device generally derives power from its battery power source. The amount of power available is constrained by the size and weight of the wearable. As such it is desirable to make optimal use of the available power source so as to prolong the time between required recharge cycles or to replace a non-rechargeable battery [1].

A number of strategies for the effective management of the power available in batteries have been proposed that allow them to last longer than usual. These techniques generally involve enhancement, modification or development of protocols either based on utilising the inherent characteristics of the source or by simply managing the application scenarios. The intuitive phenomenon which has been used so far is the recovery effect. This phenomenon increases the useful power of the source when it is allowed to rest in between discharge cycles [2]. Fig. 1 depicts this concept. It can be realised that the source lasts longer in the case of intermittent discharge in comparison with the continuous discharge. Intermittent discharge is created when the wearable is periodically put to sleep as opposed to being active, thus allowing the battery to self-recover.

The recovery effect has been widely used for modelling battery behaviour and several protocols have also been designed. However, only a limited set of experimental work is available to determine the presence and amount of recovery gain with regard to different battery chemistries. Surprisingly, most of the research to date has been based on the findings of just a small set of

experiments. These experiments were conducted on specific chemistries and size of the batteries, and hence do not generalise to a battery of every size and shape. In contrast to the literature reporting the benefits and utilisation of recovery effect, it has been recently stated that recovery effect is just an illusion and has been wrongly used in all the literature stating its benefit [4]. It has been suggested that the parameters used for identifying and measuring the recovery effect are inappropriate. Much of the literature has not given an indication of the potential charge gain when implementing the recovery effect. As such the existence of the recovery effect has become controversial, yet battery-powered devices are ubiquitous and have a huge growing market, thus extending the required time between charges of battery devices can have a significant impact.

The present paper has been carried out to understand and demonstrate whether the recovery effect is a reality or an illusion. This paper has considered the typical chemistries used in wearable devices and revealed the chemistries that do offer the recovery effect. Furthermore, a novel contribution of this work is that, for the first time, the recovery effect has been shown to be comprised of two time constants: one short and one long. Therefore, battery management systems will need to take both time constants into consideration for maximum battery power extraction. Multiple sets of experiments on commonly used battery chemistries have been conducted offering authentic and reliable results. This work aims to give a perspective toward the parameters that should be used for analysing the recovery effect. A novel battery discharge system with constant-current drain capabilities has been designed for this purpose. Our discharge circuit is the first to test for the recovery effect while still drawing a small sleep current from the battery under test, in order to better model batteries deployed in actual devices. Also, the discharge timings and discharge current values have been chosen such that they can be related to the actual discharge characteristics of typical wearable devices.

This paper has been divided into ten sections. Section 2 describes the battery structure and a chemical description of the recovery effect. Section 3 discusses the battery requirements for intermittent discharge. Section 4 forms the primary literature survey. Section 5 presents the specific motivation for this research. Section 6 details the experimental setup and the scenarios used for the experiments.

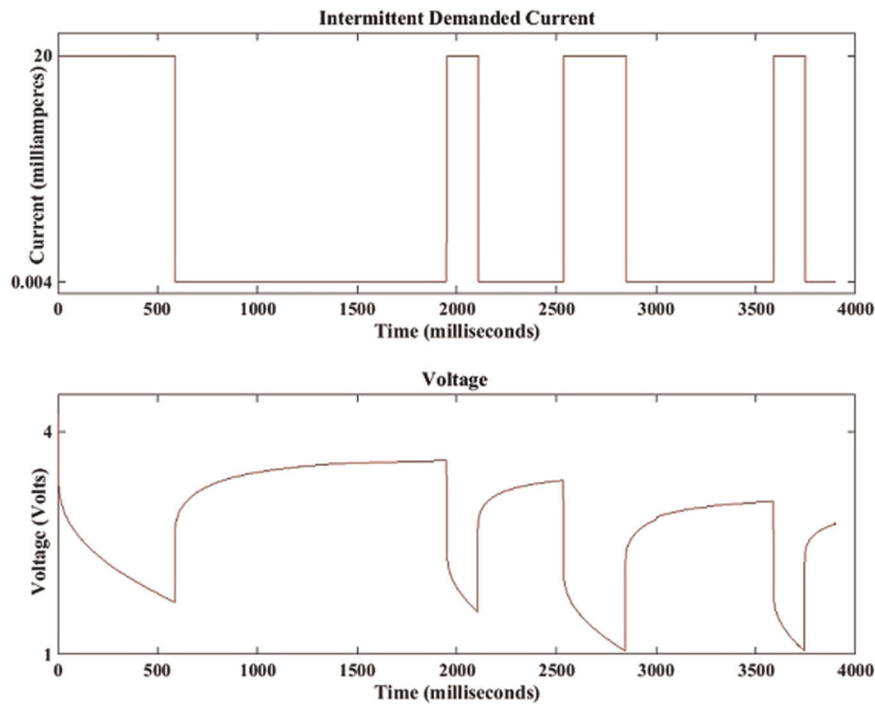

Fig. 1 Concept of recovery effect in the case of intermittent discharge [3]

Section 7 presents the results obtained followed by a discussion in Section 8, conclusions in Section 9 and future work in Section 10.

## 2 Chemical description of the recovery effect

A battery converts the chemical energy stored in electrochemical cells to electrical energy [5]. A cell comprises of an anode and a cathode separated by an electrolyte. When a load is connected to the cell, an oxidation reaction takes place at the anode whereby it loses electrons to the cathode via the external load. These electrons get accepted at the cathode leading to a reduction reaction. In a fully charged state, the electroactive species on both the anode and cathode are homogeneously distributed on the electrode–electrolyte interface [6, 7]. During discharge, the species near the electrode are consumed first and are continuously replaced by others that are further from the electrode. The rate at which this replacement takes place depends on the diffusion constant. If the battery is subjected to long periods of continuous discharge, then the electroactive species at the further end do not get enough time to travel toward the electrode resulting in the battery appearing to have been quickly depleted without all the species actually being consumed. However, if some time is given to the species to travel toward the electrode in between discharges, then additional species can undergo redox reaction and hence allow the battery to last longer [8]. This process of having idle time in between discharges to have more species participating in redox reaction is termed the recovery effect. Since the diffusion rate and the distance to travel toward the electrode play a significant role in the recovery process, it can be realised that batteries with different chemistries, shapes and sizes will show different amounts of recovery. Fig. 1 shows a typical battery recovery effect due to a high-current demand and a sleep current demand of a typical wearable device. As can be seen, when the device is in sleep mode then the battery terminal voltage recovers over time with species movement.

## 3 Battery requirements for intermittent discharge

The recovery process requires a battery to undergo intermittent discharge of high-current values followed by periods of low or no current (termed idle current). As such the battery should not only

be able to withstand high pulses of current but should also provide a high proportion of energy pertaining to low current. Also, the rate of response when the switching between high and low currents happens should be very fast, i.e. the voltage should not take a long time to get to a steady state. In addition to this, the inductive effects at high frequencies should not cause waveform distortion [9].

## 4 Related work

Several experiments have previously been conducted to analyse the effect of intermittent discharge on different battery chemistries. Some of these studies were not aimed at identifying the ability of a battery to recover charge but were rather performed with an intention of analysing a battery's tolerance for high-current pulsed discharge or for understanding the chemical effect that takes place on the material comprising the battery during the rest periods. Table 1 summarises the details of these previous works.

Fuller *et al.* [12] conducted experiments to understand the redistribution of material that takes place when rest times are allowed in between charging and discharging of the cells. An off-the-shelf mobile phone cell battery and a custom-made lithium (Li) foil manganese dioxide cell were analysed for their behaviour. The solution phase concentration and state of charge (SOC) at each electrode along with the cell potential were the parameters considered for analysis. The custom-made cell was put to discharge with a current density of 0.7 mA/cm<sup>2</sup> for 3 h and then relaxed for 1 h with no discharge current. It was observed that when the current was interrupted in order to put the cell to rest, the front of the positive electrode was at lower potential and its back was at higher potential while it was the opposite case for the negative electrode, with its back being at a higher potential and front at a lower potential. This happened due to the sudden disruption of the discharge cycle. The difference in the potential between the front and back of the electrode leads to the flow of active material from the surface of high potential to low potential. The state of the charge of the electrode was a non-uniform function at the beginning of the relaxation period and later transformed into a uniform function. For the mobile phone cell battery, the discharge current of 1.9 A for

**Table 1** Details of previous relevant experimental studies conducted on batteries

Study	Battery chemistry	Off the shelf	Battery capacity/area	Active current/ current density	Active time, s	Sleep time, s	Parameters
[10]	alkaline, NiCd, Ni–MH, Li-ion	yes yes yes yes	1800 mAh 2000 mAh 4500 mAh 1400 mAh	1.5 A	900, 1800	900, 1800	total run time, battery temperature
[11]	lead acid, bipolar cell	no no	5 cm <sup>2</sup> 20 cm <sup>2</sup>	$\geq 10$ A/cm <sup>2</sup>	0.003	0.022	cell potential, current density, power, W/cm <sup>2</sup>
[12]	Li foil cell, Sony Li-ion phone cell	no yes	1 Ah	0.7 mA/cm <sup>2</sup> 1.9 A	10,800, 960	3600 3600	SOC at electrodes, cell potential, solution phase concentration
[9]	TMF lead acid	yes	1.2 Ah	100 A	1	1	total run time
[13]	carbon/LiNiO <sub>2</sub> , graphite/Li <sub>n</sub> NiO <sub>2</sub>	no no	10 cm <sup>2</sup>	10–50 mA/cm <sup>2</sup>	0.01	0.05	cell voltage, number of pulses
[4]	alkaline, Ni–MH, Li-ion	yes yes yes	1200 mAh 730 mAh 400 mAh	40 mW 40 mW 80 mW	50, 5, 0.5	50, 5, 0.5	voltage, power energy, Wh
[14]	Samsung ICR-18650-26F, A123 systems APR-18650-M1A	yes yes	2.6 Ah 1.1 Ah	nominal capacity/20	36,000	12, 7200	discharge capacity, break durations, SOC, discharge time
[15]	LiFePO <sub>4</sub> , LiMn <sub>2</sub> O <sub>4</sub>	no no	5 Ah 6 Ah	0.5, 2 C	varying SOC states	20	diffusion time constant

TMF: thin metal film; Li-ion: lithium-ion; NiCd: nickel cadmium; Ni–MH: nickel-metal Hydride; and H: hours; Wh: watt hours.

16 min followed by a period of no current of 1 h was used. The cell potential in this case first rises instantly as soon as the load was disconnected and then increased gradually with the decrease in concentration over-potential and the relaxation of the concentration gradient.

Other battery studies [9, 11, 13] were aimed at analysing their custom-made batteries for their ability to handle the pulsed discharge with high discharge current. Nelson *et al.* [9] tested a thin metal film (TMF) battery to obtain its discharging and re-charging capabilities including pulsed discharge. The battery was subjected to an active current of 100 A for 1 s followed by a rest period with no current for the same time. An increase of 13.63% in the total run time was observed with pulsed discharge in comparison with the continuous discharge. Lafollette [11] tested batteries under high pulse currents. The current density chosen during the active cycle was at or above 10 A/cm<sup>2</sup>. The discharge period was 3 ms followed by 22 ms rest period. Current density, cell potential and power were parameters used for analysis and it was observed that the behaviours of these batteries were nearly the same under both the continuous and intermittent discharge conditions. Similarly, Lee *et al.* [13] analysed the behaviour of Li nickel dioxide (LiNiO<sub>2</sub>) cathode material under intermittent discharge with a carbon and graphite anode. The carbon/LiNiO<sub>2</sub> cell was pulse discharged at 10 mA/cm<sup>2</sup> for 10 ms followed by a rest period of 50 ms while graphite/LiNiO<sub>2</sub> was discharged with 10–40 mA/cm<sup>2</sup>. Both the cells showed excellent capacity utilisation.

Another set of studies which have been carried out with the aim of analysing their ability to show recovery effect have been previously described [4, 10]. Narayanaswamy *et al.* [4] placed alkaline, Ni–metal hydride (MH) and Li-ion batteries under constant power discharge for 0.5, 5 and 50 s followed by a rest time for the same period. The battery voltage, power and energy were analysed. The authors claimed that the recovery effect does not incur any gain in energy but rather the continuous discharge delivers the same average power compared with intermittent discharge due to the reduced peak power. Castillo *et al.* [10] tested D-sized alkaline, Ni cadmium (Cd), Ni–MH and Li-ion batteries with capacity in the range of 1400–4500 mAh for two rest durations of 15 and 30 min. Their experiments recorded the total run time and battery voltage.

The results showed that alkaline, NiCd and Ni–MH have a tendency to recover charge while there was no effect observed in Li-ion.

Recently, a couple more studies have been conducted to understand the influence of relaxation time on battery parameters [14, 16]. Reichert *et al.* [14] studied commercial Li-ion and found that there was no change in the battery discharge time when incorporating rest times. It was however highlighted that frequent shorter rest periods have a worst effect on ageing in comparison with the fewer but long sleep intervals. Devarakonda and Hu [16] reported research on customised Li-based single cells to explore how diffusion time constant varies with the open-circuit time.

## 5 Motivation

All of the aforementioned studies tested batteries for their behaviour under intermittent discharge but have not clearly analysed the existence of the recovery effect and exactly what, if any, benefits can be achieved when implementing intermittent discharge. Also, in all previous studies in the literature, the sleep current was considered to be zero, whereas in real practical devices, even when the device is put to sleep, there is still some sleep current. Therefore, to analyse the performance of batteries in realistic situations, the sleep current should be taken into consideration. Furthermore, as previously stated by Narayanaswamy *et al.* [4] the intermittent discharge profile of the battery should be compared with the continuous discharge which has the same average power of that of the intermittent discharge. It is claimed that this is a fair comparison between the two profiles instead of comparing the peak power continuous discharge with the intermittent. However, this method does not give an exact understanding of the battery behaviour in real scenarios as the current required by a wearable sensor device to perform its operations remain constant, whereas in constant power discharge the current needs to increase as the voltage decreases from the depleting battery. Also, as there is no supply voltage stabilisation mechanism in many sensor devices, the current used decreases with the decline in voltage [17].

This paper focusses on small batteries and uses current consumption profiles indicative of wearable sensors and healthcare devices. The primary purpose of the battery energy is the exchange of data

**Table 2** Details of the batteries used in this present paper

Battery type	Rechargeable	Open-circuit voltage, V	Cut-off voltage, V	Capacity, mAh	Dimensions ( $L \times W$ ), mm
alkaline	no	1.5	0.9	1500	44.5 × 10.5
Li-ion	no	3.6	0.9	120	24.5 × 5.0
Li polymer	yes	3.7	3.1	110	25.0 × 15.0
Ni–MH	yes	1.2	0.9	1300	50.5 × 14.5

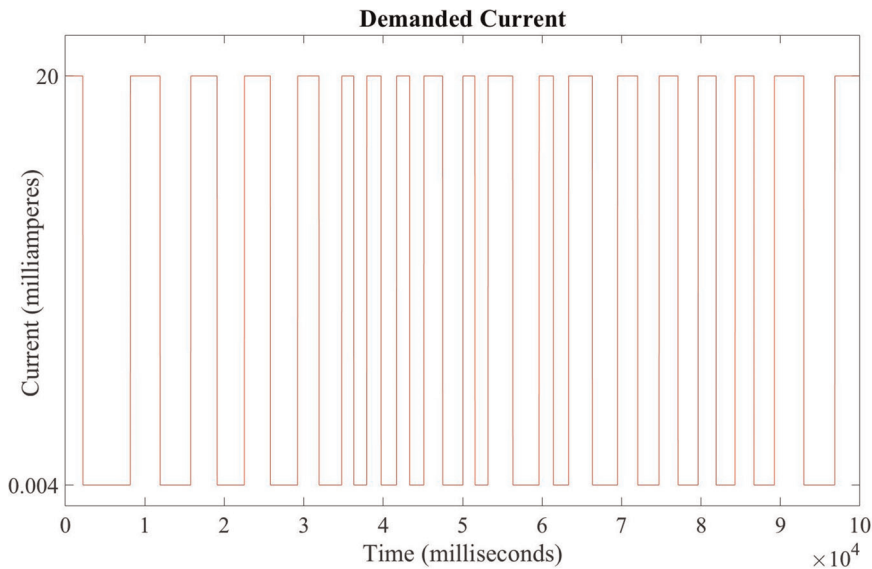
**Fig. 2** Intermittent current demanded during the experiments

with other wireless hubs/routers such as a cell phone or a smart-home infrastructure.

Thus to have a clear understanding of the battery behaviour in actual scenarios, the constant-current discharge has been used for the present paper. To effectively compare the intermittent discharge pattern with the continuous discharge pattern, the increase in the active time and the total charge delivered by the battery in both scenarios have been considered as these parameters give a better realisation of battery performance under different discharge conditions. In addition, the current values chosen for the experiments correspond to the requirements of a typical wearable device. Since no research has yet been carried out with this perspective, this novel paper will prove insightful to future studies that aim to prolong the operating time of a wearable device by managing the energy available in its power source.

## 6 Experimental setup

This section presents the details of the experimental setup used to verify the presence of the recovery effect and amount of recovery that is possible in the scenarios compatible with wearable sensors and healthcare devices using typical chemistries.

In the case of rechargeable batteries (Li polymer and Ni–MH), each battery was fully charged to its own specification. In the case of non-rechargeable batteries (alkaline and Li-ion), each battery was new. Each battery was put to discharge through a constant-current discharge circuit which drains the battery current via specified current values for active and sleep modes. The battery voltage was recorded at a sampling rate of 2 kHz from a randomly varying active/sleep profile as discussed below.

### 6.1 Batteries used

The most commonly used battery chemistries in typical wearable devices have been tested for their behaviour. All of the batteries

are off the shelf and are easily available. The shape, size and weight of the batteries are in alignment with typical requirements of wearable devices. Table 2 presents the relevant details of the batteries used in the experiments.

### 6.2 Discharge pattern

A number of different discharge patterns were created by varying: (i) discharge current (between active and sleep), (ii) rate of duty cycling, i.e. the ratio of sleep time ( $S$ ) to active time ( $A$ ) and (iii) the duration of the active time. The duration of the active time was generated randomly at each discharge time between the ranges of 10 and  $-60$  s. Each active cycle was followed by a sleep cycle with the duration of a sleep cycle determining the rate of duty cycling. A continuous discharge with sleep time  $S=0$  (i.e. always active so no recovery occurs), and intermittent discharges of  $S=A$  (termed 50%) and  $S=2A$  (termed 67%) have been considered for this work. Fig. 2 shows a 100 s snippet of an intermittent current demanded during the experiments.

### 6.3 Constant-current discharge circuit

Since the terminal voltage of a battery decays with discharge, a constant-current discharge circuit was required for this paper that was able to draw current from non-discharged batteries irrespective of their terminal voltage. A novel design constraint of this system was to switch between active and sleep currents, rather than active and no current, as previously discussed in Section 4, thus emulating the sleep current drain from typical wearable devices. Fig. 3 depicts the circuit diagram of the discharge circuit. A micro-processor controls the active/sleep timings, and has an internal analogue-to-digital converter (ADC) for sampling the analogue voltages and logging to a file. As can be seen in Fig. 2, the length of the active time is random, followed with a sleep time that maintains the active/sleep ratio. The discharge circuit was set to discharge 20 mA

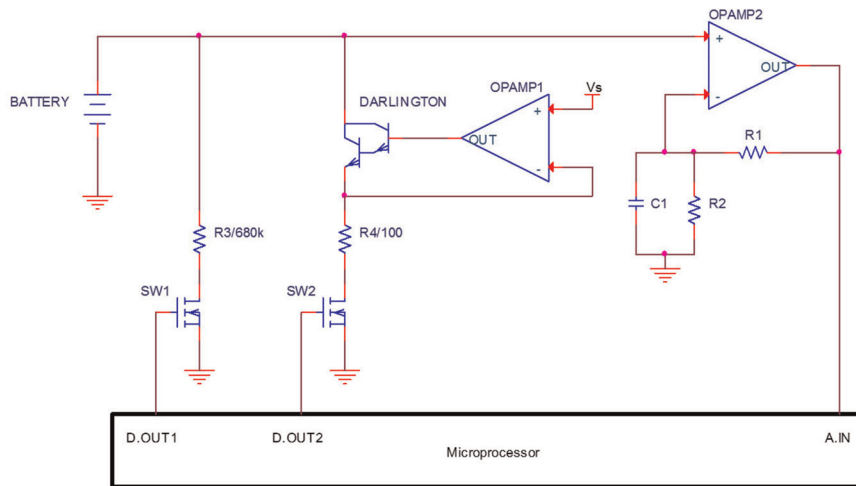

**Fig. 3** Circuit diagram of the constant-current discharge circuit used in the battery discharge measurement system incorporating active and sleep current drains

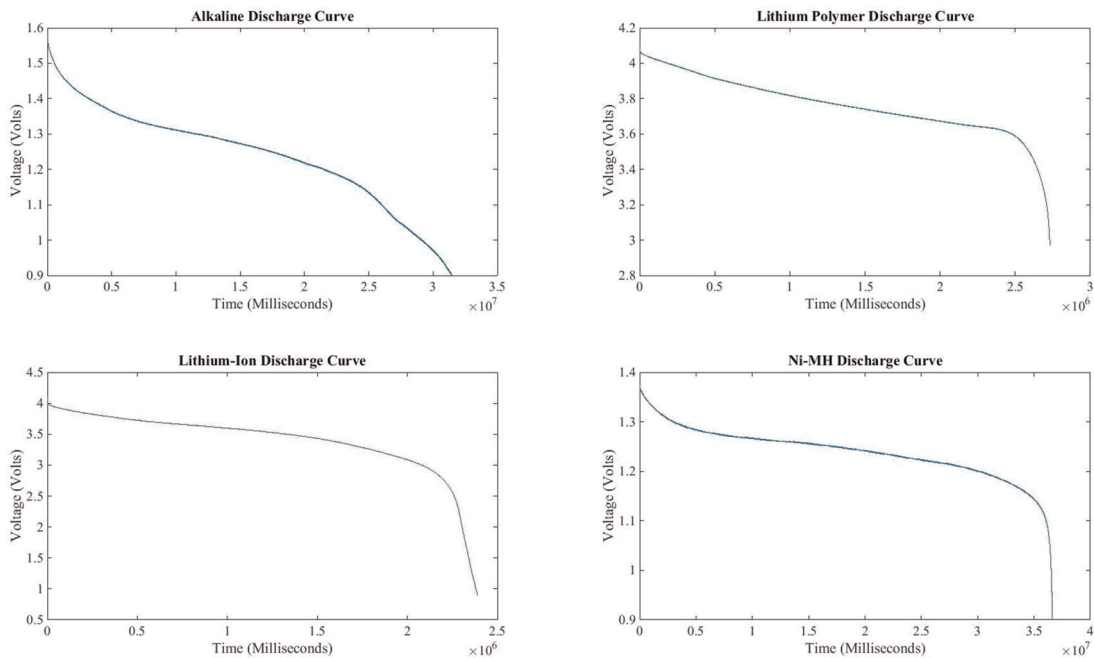

**Fig. 4** Discharge curves of alkaline, Li polymer, Li-ion and Ni-MH batteries obtained from the experimental data

in the active duration and  $4 \mu\text{A}$  in the sleep duration. This broad range of values covers the range of all the typical current requirements of wearable devices and even other sensor devices [18].

Considering that a typical 100 mAh battery would last 3 years when discharging  $4 \mu\text{A}$  sleep current, then practically the battery self-discharge will mean a shorter useful life. Therefore, the importance of controlling the exact amount of sleep current is less important. Resistor R3 sets the battery current drain in sleep mode [through metal-oxide-semiconductor field-effect transistor (MOSFET) SW1 controlled by microprocessor digital output D.OUT1] defining the sleep period discharge.

To model the current in the active mode,  $V_s$  sets the discharge current in the active mode, [1..20] mA. As most power control circuits in wearable devices use DC/DC converters, their current draw is largely independent of supply voltage. The Darlington BJT, OPAMP1 and R4 form a constant-current drain circuit (through MOSFET SW2 controlled by microprocessor digital output D.OUT2) defining the active period discharge. The current drawn from the battery is closely approximated by  $V_s/R4$ . In

practise, a small amount of base current must flow and hence the choice of Darlington transistor with typical  $H_{FE}$  of  $\gg 1000$ . The resulting error is  $< 0.1\%$ .

OPAMP2 forms a high-impedance voltage follower (buffer) to monitor the instantaneous battery voltage, with gain set by  $1 + (R1/R2)$  in order to correctly drive the microprocessor internal ADC pin A.IN. The buffered battery voltage is sampled by the microprocessor at 2 kHz. The high sampling rate allows for capturing the highly dynamic terminal voltages that are of key importance to establish a functional battery model. Low-pass filtering of 100 kHz is provided by C1/R2 for electromagnetic compatibility considerations.

## 7 Results

The results from this set of experiments are as follows. The overall battery discharge curves were considered as shown in Fig. 4 to estimate the total time for which the battery lasts before reaching the cut-off voltage when the battery no longer has enough terminal



voltage to drive the wearable device. Then, for each run, the following parameters were calculated:

- (i) *Total active time*: The total time during which the current demanded and delivered was 20 mA (high-current value).
- (ii) *Total charge delivered*: The overall charge delivered by the battery during both high- and low-current discharge periods as calculated using the Coulomb counting algorithm [19]. According to this method, the total current drawn is integrated over the total functioning time of the battery.

Table 3 shows the percentage increase achieved in the total active time and the charge delivered when batteries were put to

**Table 3** Percentage increase in active time and percentage increase in the total charge delivered by the batteries under two duty cycling rates,  $S=A$  and  $S=2A$

Battery chemistry	Percentage increase in active time		Percentage increase in AC	
	$S=A$	$S=2A$	$S=A$	$S=2A$
alkaline	1.86	<i>21.3</i>	1.88	<i>21.35</i>
Li polymer	8.55	<i>11.68</i>	8.57	<i>11.87</i>
Li-ion	1.41	0.74	1.39	0.67
Ni-MH	-3.93	-2.56	-3.91	-2.55

Results in italic text show where there is a significant improvement in effective discharge time, i.e. recovery effect.

discharge with 50% ( $S=A$ ) and 67% ( $S=2A$ ) duty cycling rate in comparison with when no sleep time was allowed. Also, the mean and standard deviation of these parameters were calculated for multiple runs of each discharge pattern for every battery as detailed in Table 4.

The experimental measurement results were further analysed to understand the battery behaviour during the sleep cycles including the voltage rise time. The recovery response during the sleep cycles were examined and modelled using the curve fitting toolbox in MATLAB. It was observed that all curves fit well to (1), being two cascaded first-order responses. Each response has its own gains,  $a$  and  $c$ , and its own time constants  $b$  and  $d$ , and  $f$  being the average amplitude. The  $R$ -square for these fittings was  $>0.75$ , demonstrating good curve fitting performance. Fig. 5 shows voltage curve fitting during sleep cycles for each battery

$$v_{out} = a(1 - \exp^{-t/b}) + c(1 - \exp^{-t/d}) + f \quad (1)$$

The time constants from each of the fittings for both 50 and 67% discharge pattern were obtained. These values have been represented as histograms in Fig. 6 to show the variation in their values during the entire discharge. It can be seen that though most of the values lie in a similar range, a few cases with high values of time constants for 67% discharge were seen. This slight variation observed can be attributed to the limitations of the fitting algorithm since it tends to find local best-fit values instead of the global. Hence, the median was taken for the time constant values and the results are presented in Table 5.

**Table 4** Mean values for the batteries when subjected to 0, 50 and 67% discharge rates

Battery chemistry	Extracted charge, mAh			Total active time, s		
	0%	50%	67%	0%	50%	67%
alkaline	1397.978	1424.264	1696.549	251630.66	256314.31	305378.92
Li polymer	109.143	118.501	122.19	19645.8	21326.2	21985.42
Li-ion	137.72	139.672	138.741	24790.13	25,136.61	24,958
Ni-MH	1626.56	1625.38	1627.68	292782.04	292507.88	292982.92

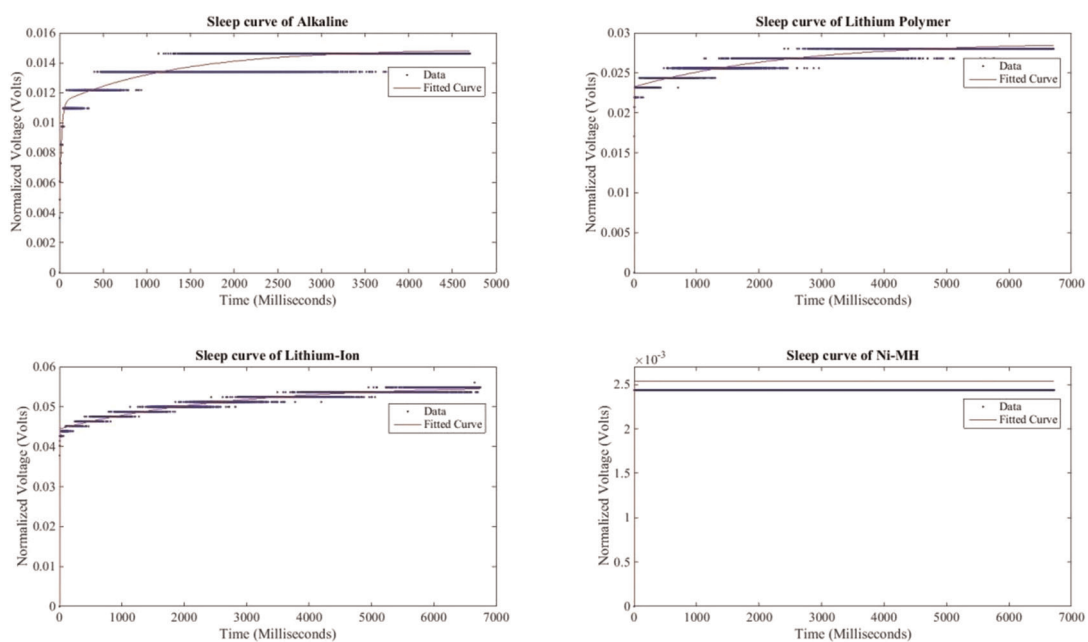

**Fig. 5** Voltage curves during sleep cycle for alkaline, Li polymer, Li-ion and Ni-MH batteries

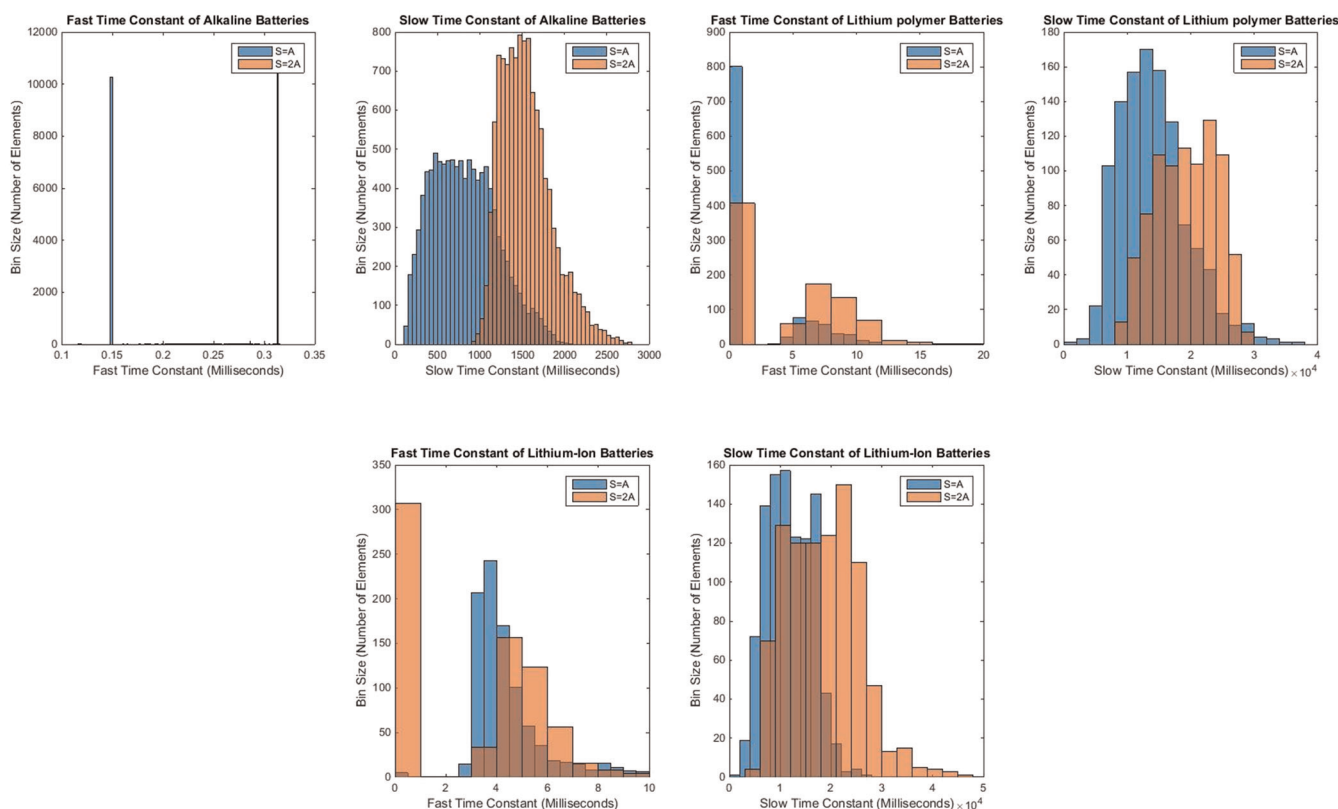

**Fig. 6** Histograms showing the variation in the measured time constants over the full discharge cycle using 50% ( $S = A$ ) and 67% ( $S = 2A$ ) for the alkaline, Li polymer and Li-ion batteries. As can be seen, while the actual time constants of the recovery response do very good over the full discharge period, their response times are within two discrete classifications

**Table 5** Average value of slow and fast time constants for both the discharge patterns for all the batteries

Battery chemistry	Fast time constant, ms		Slow time constant, ms	
	50%	67%	50%	67%
alkaline	0.2154	0.3006	1098.6	1848.1
Li polymer	5.7148	9.744	19,264	18,696
Li-ion	5.08	4.98	14,326	25,559

## 8 Discussion

### 8.1 Effect of the rest time duration

The duration of rest time plays a critical role in determining the time for which the battery will be capable of delivering the demanded active current and hence the amount of charge that it will be able to deliver. It can be realised from Table 3 that when sleep time equals the active time (i.e. with 50% duty cycling) only a slight increase in the active time and the charge delivered is observed. For both alkaline and Li-ion batteries, there is almost 1.8% increase in the observed active time and the charge delivered. Li polymer batteries have shown a rise of 3.4% for both factors. However, a decrease of almost 3.9% has been observed for Ni-MH batteries. When the sleep time was increased to twice that of the active time, ~21% increase was noted for both parameters in case of alkaline batteries, while Li polymer showed a rise of 9%. Li-ion presented >1% increase, whereas Ni-MH showed a decline in both the amount of charge delivered and the active time. Furthermore, whilst the terminal voltage of Li-ion rises during sleep periods, it did not actually recover charge. Thus it can be inferred that only *alkaline* and *Li polymer* batteries have a tendency to

recover significant charge during sleep periods and the amount of gain achieved increases with the increase in the duration of the sleep interval.

### 8.2 Analysis of voltage curves

The voltage curves for the entire discharge and during every sleep cycle of the batteries have been analysed.

**8.2.1 Overall discharge curve:** The overall discharge curves are shown in Fig. 4. A typical battery discharge curve generally comprises of an initial exponential discharge period followed by a long normalised duration before it reaches the knee and subsequently hits the cut-off voltage. Different batteries vary in their discharge shapes due to the difference in the inherent chemical species and their rate of reaction. Alkaline and Ni-MH batteries have a prominent initial exponential period as compared with Li-ion and Li polymer batteries which have more of a flatter start. This suggests that the initial voltage variation is higher in alkaline and Ni-MH. The normalised discharge period at the middle of the discharge is very flat for Li-ion followed by Li polymer and Ni-MH batteries in contrast to alkaline batteries for which it is continuously decreasing. The knee portion toward the end of the discharge is much more clearly visible in Li polymer, Li-ion and Ni-MH batteries in comparison with alkaline.

**8.2.2 Voltage curves during sleep period:** The shape of a voltage curve during a sleep interval is useful in understanding the voltage relaxation process. Fig. 5 presents the voltage curve for all the batteries during sleep cycles from the middle of a discharge cycle. It can be seen that the Ni-MH batteries have flatter curves, i.e. they instantly respond to the step input. However, the other three batteries have significantly visible rise times. The very small time constant of alkaline batteries allows them to rise quickly

from the lower voltage and reach the steady state rapidly. On the other hand, Li-ion and Li polymer batteries have similar shapes attributing to the similar range of time constant values.

### 8.3 Effect on the rise time during sleep cycles

Once the voltage charge/discharge curves were obtained, followed by the realisation of two time constants buried in the recovery curves, research was performed to find a suitable model for the system.

Randles [20] considered electrode reactions, and proposed adding a series tank circuit to the existing battery models that only used a voltage source with a series electrolyte resistance. The tank circuit described the battery dynamics and was formed with the electrode surface capacity in parallel with a series resistance-capacitance circuit modelling the electrode reaction. While it was typical to model the battery discharge with an increasing electrolyte resistance, thus lowering the terminal voltage, Randles' tank circuit was the first to model dynamic electrolyte reaction. However, Randles model was found not to be a good match for the embedded recovery effect of two time constants in this work.

This work found that the battery sleep period satisfies two first-order systems in series (1) and was found to be best modelled by the interactive two-tank system [21]. The kinetic battery model [22] has been used to model the batteries as shown in Fig. 7. The first tank is termed the bounded charge well (BCW) and the second is termed the available CW (ACW). The ACW is responsible for providing charge to the external load, whereas the BCW supplies charge to the ACW. During an active cycle, most of the active species are consumed from the well nearer to the outlet of the ACW. When a sleep period is provided after an active cycle, the active species in the ACW settle toward the well nearer to the outlet, reaching an equilibrium state. During this time there is also a flow of species from the BCW toward the ACW. The number of species that move across and their speed is proportional to the time constant values. A small time constant indicates the faster movement of active species, whereas a larger value indicates a slow movement, and therefore two time constants. Hence, to achieve a higher utilisation of the battery's chemical material for an increase in the overall charge delivered, the smaller time constant values are essential. Equation (1) was used for modelling the voltage curves during sleep cycles and indicated the presence of two time constants. One is a slow time constant which primarily governs the movement of species from the bounded to the ACW, whilst the fast time constant relates to the alignment in the ACW toward the outlet.

Table 5 summarises the time constant values for all three batteries. It can be seen that alkaline batteries have the smallest value of fast and slow time constants in comparison with the other two batteries which have higher and similar range of values. This implies that alkaline batteries have faster movement and settlement

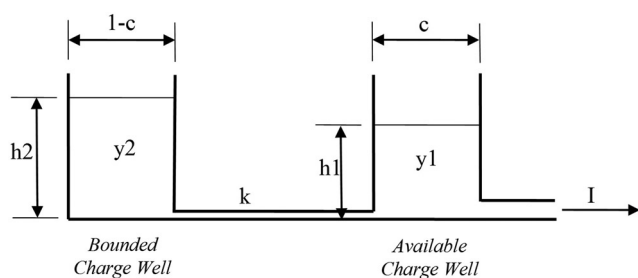

Fig. 7 Battery modelling as two CWs of kinetic battery model [22]. The slow time constant is represented by the left-hand well with a narrow channel to the right-hand well. The fast time constant is represented by the right-hand well supplying the exit channel

of the species, thus they require small sleep durations to recover charge delivered, whereas the higher value of time constants in Li polymer suggest slower movement of the species leading to the requirement of comparatively longer sleep intervals to recover charge.

## 9 Conclusions

This paper has presented experimental results conducted in order to validate the presence of recovery effect in commonly used off-the-shelf batteries in wearable sensors and healthcare devices. Alkaline, Ni-MH, Li-ion and Li polymer batteries were tested for their behaviour under pulsed discharge conditions with duty cycling discharge rates of 50 and 67%. While the literature has investigated the recovery effect using active and off periods of time, the novelty of our results is that when we discharge the batteries to see the recovery effect, we include a small drain current to model the typical sleep current drawn from wearable devices. The total charge delivered and the total active time were analysed for each of these scenarios and compared with the values obtained with the continuous discharge, in order to determine the charge gain that can be achieved from one charge cycle of the rechargeable battery or one use of the non-rechargeable battery. It was observed that alkaline batteries show a significant amount of AC gain and hence active time when subjected to intermittent discharge conditions. Almost 21% rise was observed for both parameters with 67% duty cycling rate. In the case of Li polymer batteries, an increase of 11% was obtained when batteries were allowed to sleep for twice the time they were active while the rise was 8.5% when sleep time was equal to active. On the other hand, a marginal gain of only around 1% was observed for Li-ion batteries in both types of pulsed discharge profiles emphasising that Li-ion batteries do not exhibit the recovery effect. Furthermore, in the case of Ni-MH batteries, instead of observing any gain a drop of 3–4% in the charge delivered over the active time was observed. These findings emphasise that the recovery effect does not depend on the recharge capabilities of a battery but rather it is dependent on its chemical composition.

The novel contribution of this work was to find that the recovery effect discharge curve profiles could be accurately modelled using two time constants. Each recovery curve contained slow and fast time constants. These values represent the rate of movement of active species inside the battery. The smaller values indicate faster movement and hence faster recovery of the charge. Alkaline batteries have the smaller time constant values in comparison with Li polymer batteries and are thus capable of recovering charge much faster and in shorter sleep cycles. To incorporate the two time constants seen from this work, it is proposed that the recovery effect is best modelled using a two-tank model constructed of two first-order systems in series which has good match to the practical batteries tested.

From all these findings, it can be deduced that the recovery effect does indeed exist and owes its existence largely to the active material present. This process leads to significant amounts of gain in the total charge that can be extracted out of the battery when the battery is allowed to relax in discharge, hence making it desirable for use in applications where re-charging and replacement are difficult. This work has increased the AC for battery-powered devices between 11 and 21%. When considering the typical operation time on one charge and the operating current for modern wearable devices, then the time between charging for a wearable device can be extended by several days using these results.

## 10 Future work

The recovery effect needs to be explored further to determine the maximum duration of the active cycle that can be allowed before a battery should switch to sleep mode in order for the recovery effect to fully occur. This would prove beneficial for applications/

scenarios that cannot afford longer sleep intervals but could accommodate shorter ones. Also, it would be interesting to analyse if there is any upper bound to the amount of charge recovery that could be obtained from a battery. This would be helpful in avoiding unnecessary long sleep intervals. In addition, other sizes of a battery should also be analysed to compare the percentage effectiveness of different sizes on the active time and charge delivered.

## 11 Acknowledgments

This work was performed under the SPHERE IRC funded by the UK Engineering and Physical Sciences Research Council (EPSRC), grant EP/K031910/1, and the University of Reading Research Endowment Trust Fund. Sadly, paper author Harneet Arora passed away on the 30th December 2016, just before the final manuscript draft of this paper was completed. The rest of the authors are extremely grateful to the Arora family for permission to submit this work in Harneet's memory.

## 12 References

- [1] Barakah D.M., Ammad-Uddin M.: 'A survey of challenges and applications of wireless body area network (WBAN) and role of a virtual doctor server in existing architecture'. Proc. Third IEEE Int. Conf. Intelligent Systems Modeling and Simulation, Kota Kinabalu, Malaysia, February 2012, pp. 214–219, doi: 10.1109/ISMS.2012.108
- [2] Chiasserini C.F., Rao R.R.: 'Improving battery performance by using traffic shaping techniques', *IEEE J. Sel. Areas Commun.*, 2001, **19**, (7), pp. 1385–1394, doi: 10.1109/49.932705
- [3] Jongerden M.R., Haverkort B.R.: 'Which battery model to use?', *IET Softw.*, 2009, **3**, (6), pp. 445–457, doi: 10.1049/iet-sen.2009.0001
- [4] Narayanaswamy S., Schlueter S., Steinhorst S., *ET AL.*: 'On battery recovery effect in wireless sensor nodes', *ACM Trans. Des. Autom. Electron. Syst.*, 2016, **21**, (4), pp. 1–28, doi: 10.1145/2890501
- [5] Crompton T.R.: 'Battery reference book' (Newnes, 2000, 3rd edn.)
- [6] <http://www.batmax.com/technology-degeneration.php>, accessed January 2017
- [7] [http://chem.libretexts.org/Core/Analytical\\_Chemistry/Electrochemistry/Case\\_Studies/Rechargeable\\_Batteries](http://chem.libretexts.org/Core/Analytical_Chemistry/Electrochemistry/Case_Studies/Rechargeable_Batteries), accessed January 2017
- [8] Rakhmatov D., Vrudhula S.B.K.: 'Time-to-failure estimation for batteries in portable electronic systems'. Proc. IEEE Int. Symp. Low Power Electronics and Design, CA, USA, August 2001, pp. 88–91, doi: 10.1109/LPE.2001.945380
- [9] Nelson R.F., Rinehart R., Varley S.: 'Ultrafast pulse discharge film and recharge battery capabilities of thin-metal film battery technology'. Proc. 11th IEEE Int. Pulsed Power Conf., Baltimore, USA, June–July 1997, pp. 636–641, doi: 10.1109/PPC.1997.679411
- [10] Castillo S., Samala N.K., Manwaring K., *ET AL.*: 'Experimental analysis of batteries under continuous and intermittent operations'. Proc. Int. Conf. Embedded Systems Applications, June 2004, pp. 18–24
- [11] Lafollette R.M.: 'Design and performance of high specific power, pulsed discharge, bipolar lead acid batteries'. Proc. Tenth IEEE Battery Conf. Applications and Advances, CA, USA, January 1995, pp. 43–47, doi: 10.1109/BCAA.1995.398511
- [12] Fuller T.F., Doyle M., Newman J.: 'Relaxation phenomena in lithium-ion-insertion cells', *J. Electrochem. Soc.*, 1994, **141**, (4), pp. 982–990, doi: 10.1149/1.2054868
- [13] Lee Y.S., Sun Y.K., Nahm K.S.: 'Synthesis and characterization of LiNiO<sub>2</sub> cathode material prepared by an adipic acid-assisted sol–gel method for lithium secondary batteries', *Solid State Ion.*, 1999, **118**, (1–2), pp. 159–168, doi: 10.1016/S0167-2738(98)00438-X
- [14] Reichert M., Andre D., Rösmann A., *ET AL.*: 'Influence of relaxation time on the lifetime of commercial lithium-ion cells', *J. Power Sources*, 2013, **239**, pp. 45–53, doi: 10.1016/j.jpowsour.2013.03.053
- [15] Pei L., Wang T., Lu R., *ET AL.*: 'Development of a voltage relaxation model for rapid open-circuit voltage prediction in lithium-ion batteries', *J. Power Sources*, 2014, **253**, pp. 412–418, doi: 10.1016/j.jpowsour.2013.12.083
- [16] Devarakonda L., Hu T.: 'Effects of rest time on discharge response and equivalent circuit model for a lead-acid battery', *J. Power Sources*, 2015, **282**, pp. 19–27, doi: 10.1016/j.jpowsour.2015.02.030
- [17] Mikhaylov K., Tervonen J.: 'Optimization of microcontroller hardware parameters for wireless sensor network node power consumption and lifetime improvement'. Proc. IEEE Int. Congress Ultra Modern Telecommunications and Control Systems and Workshops, Moscow, Russia, October 2010, pp. 1150–1156, doi: 10.1109/ICUMT.2010.5676525
- [18] Milenković A., Otto C., Jovanov E.: 'Wireless sensor networks for personal health monitoring: issues and an implementation', *J. Comput. Commun.*, 2006, **29**, (13–14), pp. 2521–2533, doi: 10.1016/j.comcom.2006.02.011
- [19] Ng K.S., Moo C.S., Chen Y.P., *ET AL.*: 'Enhanced Coulomb counting method for estimating state-of-charge and state-of-health of lithium-ion batteries', *Appl. Energy*, 2009, **86**, (9), pp. 1506–1511, doi: 10.1016/j.apenergy.2008.11.021
- [20] Randles J.E.B.: 'Kinetics of rapid electrode reactions', *Discuss. Faraday Soc.*, 1947, **1**, p. 11, doi: 10.1039/df9470100011
- [21] Coughanowr D.R., LeBlanc S.E.: 'Process systems analysis control' (McGraw-Hill, 1994, 3rd edn)
- [22] Manwell J.F., McGowan J.G.: 'Extension of the kinetic battery model for wind/hybrid power systems'. Proc. Fifth European Wind Energy Association Conf., 1994, pp. 284–289

## Appendix C: Paper #3

**Arora, H.,** Sherratt, R. S., Janko, B. and Harwin, W. (2017) Analysis of recovery effect in supercapacitors for wearable devices. In: IEEE International Conference on Consumer Electronics, 8-10 Jan 2017, Las Vegas, USA.

DOI: [10.1109/ICCE.2017.7889322](https://doi.org/10.1109/ICCE.2017.7889322)