

Title	Adolescence as a vulnerable period for the effects of intrinsic and extrinsic regulators of neurogenesis on cognitive behaviour
Author(s)	O'Leary, James Daniel
Publication date	2017
Original citation	O'Leary, J. D. 2017. Adolescence as a vulnerable period for the effects of intrinsic and extrinsic regulators of neurogenesis on cognitive behaviour. PhD Thesis, University College Cork.
Type of publication	Doctoral thesis
Rights	© 2018, James Daniel O'Leary. http://creativecommons.org/licenses/by-nc-nd/3.0/ 
Embargo information	Not applicable
Item downloaded from	http://hdl.handle.net/10468/6100

Downloaded on 2019-01-07T05:37:08Z



UCC

University College Cork, Ireland
Coláiste na hOllscoile Corcaigh

Ollscoil na hÉireann

THE NATIONAL UNIVERSITY OF IRELAND

Coláiste na hOllscoile, Corcaigh

UNIVERSITY COLLEGE CORK



**Adolescence as a Vulnerable Period for the Effects of Intrinsic
and Extrinsic Regulators of Neurogenesis on Cognitive
Behaviour**

Thesis presented by

JAMES DANIEL O'LEARY

BBSc (La Trobe), PGDipSc (Canterbury), MSc (Canterbury)

Under the supervision of

Dr Yvonne Nolan, Dr Olivia O'Leary and Prof John Cryan

for the degree of

DOCTOR OF PHILOSOPHY

Department of Anatomy and Neuroscience

Head of Department. Prof John Cryan

December 2017

Table of Contents

Declaration.....	8
Acknowledgments.....	9
List of publications arising from this thesis.....	10
List of abbreviations	12
Abstract.....	17
Chapter 1: Introduction and outline of thesis	19
1.1 The hippocampus.....	20
1.1.1 Neuroanatomical structure of the hippocampus.....	20
1.1.2 Adolescence as a sensitive period of neurodevelopment.....	23
1.1.3 Hippocampus and learning and memory.....	25
1.1.4 Behavioural models of hippocampal function	28
1.1.5 The hippocampus and emotion	32
1.2 Adult hippocampal neurogenesis.....	33
1.2.1 Adult hippocampal neurogenesis and cognition	38
1.2.2 Adult hippocampal neurogenesis and pattern separation.....	39
1.2.3 Behavioural models of pattern separation.....	41
1.2.4 Adult hippocampal neurogenesis and spatial learning.....	48
1.2.5 Adult hippocampal neurogenesis and forgetting.....	50
1.2.6 Hippocampal neurogenesis, neurodegenerative and psychiatric disorders.....	51
1.3 Intrinsic and extrinsic regulators of hippocampal neurogenesis.....	53
1.4 Tlx and the hippocampus.....	54
1.4.1 Tlx deletion models.....	54

1.4.2 Tlx and learning and memory	56
1.4.3 Tlx and neurogenesis.....	61
1.5 Exercise and the hippocampus.....	63
1.5.1 Exercise and learning and memory	64
1.5.2 Exercise and hippocampal neurogenesis.....	66
1.5.3 Exercise and neural plasticity.....	68
1.6 Inflammation and the hippocampus.....	72
1.6.1 The pro-inflammatory cytokine interleukin-1 β	73
1.6.2 IL-1 β and learning and memory.....	74
1.6.3 IL-1 β and hippocampal neurogenesis	76
1.7 Stress and the hippocampus	77
1.7.1 Chronic stress and hippocampal-dependent cognition.....	78
1.7.2 Stress and hippocampal neurogenesis	80
1.8 Objectives	82
Chapter 2: The nuclear receptor Tlx regulates motor, cognitive and anxiety-related behaviour during adolescence and adulthood	85
2.1 Abstract.....	86
2.2 Introduction.....	87
2.3 Methods.....	90
2.4 Results.....	98
2.4.1 Nr2e1 ^{-/-} mice have reduced body weight and increased growth rate during adolescence	98
2.4.2 Nr2e1 ^{-/-} mice exhibit increased provoked biting and impaired eye reflex, reaching reflex and piloerection in a primary observation test battery.....	100

2.4.3 Nr2e1 ^{-/-} mice exhibit hyperactivity and deficits in cortico-striatal associated behaviour.....	104
2.4.4 Nr2e1 ^{-/-} mice exhibit deficits in hippocampus-associated cognition	107
2.4.5 Nr2e1 ^{-/-} mice show impaired hippocampal-amygdala dependent cognition	110
2.5 Discussion.....	112
Chapter 3: Differential effects of adolescent and adult-initiated voluntary exercise on context and cued fear conditioning.....	123
3.1 Abstract.....	124
3.2 Introduction.....	125
3.3 Methods.....	128
3.4 Results.....	133
3.4.1 Exercise decreased body weight gain during both adult-initiated and adolescence-initiated exercise.....	133
3.4.2 Running wheel distance	134
3.4.3 The effect of exercise on locomotor activity in the open field test.....	135
3.4.4 Adult-initiated exercise but not adolescence-initiated exercise enhances contextual fear recall in adulthood.....	135
3.4.5 Adult-initiated exercise but not adolescent-initiated exercise enhances cued fear recall in adulthood.....	135
3.4.6 Adolescence-initiated exercise has a greater effect on hippocampal mRNA expression of neural plasticity markers than adult-initiated exercise	137
3.4.7 Adult-initiated exercise selectively enhanced mRNA levels of synaptophysin in the amygdala	140
3.5 Discussion.....	142

Chapter 4: Differential effects of adolescent and adult-initiated exercise on cognition and hippocampal neurogenesis	149
4.1 Abstract	150
4.2 Introduction.....	151
4.3 Methods.....	154
4.4 Results.....	161
4.4.1 Adolescent-initiated exercise preferentially promotes performance in a location discrimination task	161
4.4.2 Adolescent and adult-initiated exercise enhances location discrimination reversal learning.....	161
4.4.3 Adolescent-initiated exercise impaired spontaneous alternation in the Y maze but had no effect on novel object recognition.....	164
4.4.4 Adolescent-initiated exercise preferentially increased hippocampal neural plasticity compared to adult-initiated exercise	166
4.4.5 Positive correlation between neurite length and cognitive flexibility as a result of exercise during adolescence	169
4.5 Discussion.....	171
Chapter 5: Chronic interleukin-1β overexpression in the dorsal hippocampus impairs pattern separation	179
5.1 Abstract	180
5.2 Introduction.....	181
5.3 Methods.....	184
5.4 Results.....	197
5.4.1 Validation of lentiviral-mediated increase in IL-1 β in the dorsal hippocampus	197

5.4.2 IL-1 β impaired pattern separation but not short term spatial working memory or recognition memory	197
5.4.3 IL-1 β selectively impaired hippocampal-dependent cognition in the touchscreen operant chamber	201
5.4.4 IL-1 β does not affect visual discrimination within the touchscreen operant chamber	203
5.4.5 Lentiviral-induced decrease in hippocampal DCX mRNA and morphology of immature neurons.....	204
5.5 Discussion	205
Chapter 6: The effects of chronic unpredictable stress and interleukin-1β overexpression in the dorsal hippocampus on cognition.....	213
6.1 Abstract	214
6.2 Introduction.....	216
6.3 Methods.....	219
6.4 Results.....	226
6.4.1 Chronic unpredictable stress decreases body weight.....	226
6.4.2 Neither chronic unpredictable stress nor IL-1 β affected locomotor activity or anxiety-like behaviour	227
6.4.3 Both chronic unpredictable stress and IL-1 β impaired object memory	227
6.4.4 Chronic unpredictable stress alone impaired spontaneous alternation	229
6.4.5 Chronic unpredictable stress alone impaired contextual fear conditioning	229
6.4.6 Chronic unpredictable stress, IL-1 β and their combination increased depressive-like behaviours	231
6.5 Discussion	233

Chapter 7: General Discussion	239
7.1 Overview and Summary	240
7.2 Limitations of knockout models of Tlx	244
7.3 Adolescence as a vulnerable period?	246
7.4 Extrinsic regulators of neurogenesis: Neuroinflammatory conditions	249
7.5 Behavioural models of pattern separation: Where are we going?	252
7.6 Recommendations for future work	253
7.7 Concluding remarks	255
Appendix A: A low-cost touchscreen operant chamber using a Raspberry Pi microcomputer	257
A.1 Abstract	258
A.2 Introduction	259
A.3 Methods	264
A.4 Results	267
A.5 Discussion	269
Appendix B: Chronic unpredictable stress increases anhedonia and anxiety-like behaviour	279
B.1 Introduction	280
B.2 Methods	281
B.3 Results	284
B.4 Discussion	285
Appendix C: Published manuscripts	287
References	319

DECLARATION

All work presented in this thesis is original and my own and has not been submitted in whole or in part for another degree at any other university, except where specified.

James Daniel O'Leary

December 2017

AUTHOR CONTRIBUTION

The author conducted all the work in this thesis independently with the exception of the following contributions.

Chapter 2. Danka Kozareva helped conduct behavioural testing of Nr2e1 mice.

Chapter 3. Dr Alan Hoban helped perform and interpret PCR mRNA analysis.

Chapter 4. Dr Alan Hoban and Ms. Ashely Murphy imaged, counted and performed dendritic branch analysis of DCX-positive cells.

Chapter 5. Dr Cara Hueston performed stereotaxic surgery and behavioural testing, Dr Alan Hoban and Ms Lauren Pawley performed dendritic branch analysis of DCX-positive cells.

Chapter 6. Dr Cara Hueston assisted with stereotaxic surgery and performed the serum corticosterone immunoassay.

ACKNOWLEDGEMENTS

I would like to thank my supervisors Drs Yvonne Nolan and Olivia O’Leary and Prof John Cryan for giving me the opportunity to carry out this PhD as well as their support, guidance and enthusiasm, even for raspberry pi related work, throughout the course of this project. This work was funded by Science Foundation Ireland (SFI) under Grant Number SFI/IA/1537 awarded to Dr Yvonne Nolan and Prof John Cryan. I am thankful to Prof. Elizabeth Simpson, University of British Columbia for kindly providing us with the initial breeding stock of Nr2e1 mice. Financial support for living expenses was provided by a student stipend. This greatly helped offset the costs of living abroad in Ireland during this study. Thank you, Yvonne and John. All experiments were conducted in accordance with the European Directive 2010/63/EU, and under an authorization issued by the Health Products Regulatory Authority Ireland and approved by the Animal Ethics Committee of University College Cork (AE19130/1019). I am grateful to both Dr Cara Hueston and Dr Alan Hoban for their support and helpful advice throughout this project. Thank you, Cara and Alan. I would also like to thank Pat Fitzgerald, Tara Foley and Dr Gerry Moloney for their technical assistance and advice over the last few years. I am grateful for the technical assistance and advice from the Biological Services Unit staff, Noelle Sexton, Jason Radford, Brian Foley and Aine Dorgan. I would also like to thank fellow PhD Students, Erin Dolan, Ciaran O Leime, Danka Kozareva, Ken Howick and Shauna Wallace for their support and encouragement as well as for the many coffee runs, chats and nights out, which were always a lot of fun! I would also like to thank Brian Foley and Thorsten Becker for all the engaging conversations over the years, although they significantly added to my time in the lab each day!

Finally, I would like to thank my Dad, Mum and Sister Joanna, who provided invaluable support while studying overseas, without their help, this endeavor, would not have been possible. Lastly to my friend Michael Lawes, who provided much support and encouragement, the much needed skype breaks whilst studying helped to make the distance between Australia and Ireland feel not so distant. Thank you.

PUBLICATIONS ARISING FROM THIS WORK

Chapters 2 to 6 and Appendices A and B were prepared ready for submission to various scientific journals, some of which have already been published. Chapters 1 and 7 introduce and close this thesis study, respectively, for which components have been presented at various conferences.

Submitted

[O'Leary J.D.](#), Hoban E.A., Cryan J.F., O'Leary O.F.⁺ & Nolan Y.M.⁺ (2017).

Differential effects of adolescent and adult-initiated voluntary exercise on context and cued fear conditioning. *Neuropharmacology* ⁺Equal contribution.

[O'Leary J.D.](#), Hoban E.A., Murphy A., O'Leary O.F., Cryan J.F., & Nolan Y.M.

(2017). Differential effects of exercise during adolescence and adulthood on cognition and plasticity. *Hippocampus*.

Refereed journals

[O'Leary J.D.](#), O'Leary O.F., Cryan J.F. & Nolan Y.M. (2018). A low-cost touchscreen operant chamber using a raspberry pi. *Behavioural Research Methods* (<https://doi.org/10.3758/s13428-018-1030-y>).

[O'Leary, J.D.](#), O'Leary, O. F., Cryan, J.F. & Nolan, Y.M. (2016). Regulation of behaviour by the nuclear receptor Tlx. *Genes Brain and Behavior* (doi:10.1111/gbb.12357).

[O'Leary, J.D.](#)⁺, Kozareva, D.A⁺, Hueston, C.M., O'Leary, O.F., Cryan, J.F. & Nolan, Y.M. (2016). The nuclear receptor Tlx regulates motor, cognitive and anxiety-related behaviours during adolescence and adulthood. *Behavioral Brain Research* **306**, 36-47. ⁺Equal contribution.

Conference proceedings

O'Leary J.D., Hoban E.A., Brouwers C., Sullivan A.M., O'Leary O.F., Cryan J.F., & Nolan Y.M (2017). Differential effects of exercise during adolescence and adulthood on cognition and plasticity. The Society for Neuroscience Washington DC, USA. November 2017.

O'Leary J.D., Hoban E.A., O'Leary O.F., Cryan J.F., & Nolan Y.M (2017). Differential effects of exercise during adolescence and adulthood on cognition and plasticity. EBBS Biennial Meeting, Barcelona, Spain, September 2017.

O'Leary J.D., Brouwers C., Brosens N., O'Leary O.F., Cryan J.F., Sullivan A.M & Nolan Y.M (2016). Impact of voluntary exercise during adolescence on cognitive performance in a touchscreen operant chamber during adulthood. The Society for Neuroscience San Diego, USA. November 2016.

O'Leary J.D., Kozareva D.A., Hueston C.M., O'Leary O.F., Cryan J.F. & Nolan Y.M (2016) The nuclear receptor Tlx regulates motor, cognitive and anxiety-related behaviours during adolescence and adulthood. Eurogenesis Bordeaux, France July 2016.

O'Leary J.D., Kozareva D.A., Hueston C.M., O'Leary O.F., Cryan J.F. & Nolan Y.M (2015) The nuclear receptor Tlx regulates motor, cognitive and anxiety-related behaviours during adolescence and adulthood. EBPS Biennial Meeting, Verona, Italy, September, 2015.

O'Leary J.D., Hueston C.M., Kozareva D.A., O'Leary O.F., Cryan J.F. & Nolan Y.M (2014) Role of the nuclear receptor Tlx in cognition during adolescence and adulthood. Young Neuroscientist Symposium, Dublin, September, 2014.

Hueston C.M., Amels B.R., O'Leary J.D., Ryan S.M., Cryan J.F. & Nolan Y.M (2013) Lentiviral overexpression of interleukin-1 beta in the hippocampus induces cognitive deficits: Selective reversal by voluntary exercise throughout adolescence. 21st Annual PNIRS Meeting, Philadelphia, USA, May 2013.

ABBREVIATIONS

AEEC	Animal Experimentation Ethics Committee
AP	Antero-posterior
APP	Amyloid precursor protein
ANOVA	Analysis of variance
BDNF	Brain-derived neurotrophic factor
bFGF	Basic fibroblast growth factor
BMP	Bone morphogenetic protein
BrdU	5'-Bromo-2-deoxyuridine
CA	cornu ammonis
CA1	cornu ammonis region 1
CA2	cornu ammonis region 2
CA3	cornu ammonis region 3
cAMP	Cyclic adenosine monophosphate
CANTAB	Cambridge Neuropsychological Test Automated Battery
cDNA	Complementary deoxyribonucleic acid
CNS	Central nervous system
CORT	Corticosterone
CREB	cAMP-response-element binding protein
CUS	Chronic unpredictable stress
DAPI	4',6-diamidino-2-phenylindole
dB	Decibel
DC	Direct current
DCX	Doublecortin
DG	Dentate Gyrus
DV	Dorso-ventral
EC	Entorhinal cortex
FGF-2	Fibroblast Growth Factor
GCL	Granular Cell Layer
GABA	γ -aminobutyric acid

GFAP	Glial fibrillary acidic protein
GPIO	General purpose input output
GUI	Graphical user interface
h	Hour
HDAC	Histone deacetylases
HET	Heterozygous
HPA	Hypothalamic-pituitary-adrenal
HPC	Hippocampus
IDLE	Integrated Development and Learning Environment
IGF-I	Insulin-like growth factor-I
IL-1 β	Interleukin-1 β
IL-1RA	Interleukin-1 receptor antagonist
IPC	Intermediate progenitor cell
i.p.	Intraperitoneal
ITI	Inter-trial interval
KCC2	Potassium-chloride transporter member 5
kHz	Kilohertz
KO	Knockout
LED	Light emitting diode
LSD1	Lysine-specific demethylase 1
LPS	Lipopolysaccharide
LTP	Long term potentiation
LV	Lateral ventricle
M	Mean
mA	Milliamp
MAPK	Mitogen activated protein kinase
MF	Mossy fibers
mg	Milligrams
Min	Minutes
miR	Micro RNA
ml	Milliliter

mm	Millimeter
mRNA	Messenger ribonucleic acid
MWM	Morris water maze
NGF	Nerve growth factor
NPC	Neural precursor cell
Nr2e1	Nuclear receptor Subfamily 2 Group E Member 1
NSC	Neural stem cell
NF- κ B	Nuclear factor kappa B
PAL	Pairwise associative learning
PCR	Polymerase chain reaction
PBS	Phosphate-buffered saline
PFA	Paraformaldehyde
PFC	Prefrontal cortex
PND	Post-natal day
PSA-NCAM	Polysialylated neural cell adhesion molecule
PSD-95	Postsynaptic density protein 95
qRT-PCR	Quantitative reverse transcriptase PCR
RGL	Radial glia-like cells
RNA	Ribonucleic acid
RNAse	Ribonuclease
RPM	Revolutions per minute
SD	Standard deviation
SEM	Standard error of the mean
SGZ	Subgranular zone
SVZ	Subventricular zone
TLX	Talless
TNF- α	Tumour necrosis factor- α
TUNL	Trial Unique not matching to location
μ g	Microgram
μ m	Microns
μ l	Microlitre

VEGF

Vascular endothelial growth factor

WT

Wild type

ABSTRACT

Postnatal hippocampal neurogenesis is the birth of new neurons within the dentate gyrus that occurs throughout the lifespan. In adulthood, these new neurons have been shown to be necessary for cognitive tasks such as spatial and contextual memory. It is well established that adult hippocampal neurogenesis can be modulated by a number of intrinsic and extrinsic factors, such as intracellular signalling molecules, exercise, inflammation and stress. Moreover, levels of adult hippocampal neurogenesis do not remain constant throughout life. Indeed, levels of hippocampal neurogenesis and integration of new neurons within the dentate gyrus are up to four times higher during adolescence than during adulthood. The first aim of this thesis (addressed in Chapter 2) was to explore the extent and involvement of TrkA in motor, cognitive and anxiety-related behaviour. A spontaneous deletion of TrkA, a key intrinsic regulator of neurogenesis, was demonstrated to impair motor, cognitive and anxiety-related behaviours during adolescence and adulthood. The second aim of this thesis (addressed in Chapters 3 and 4) was to investigate the impact of adolescent-initiated exercise on hippocampal plasticity and contextual and cued fear conditioning as well as pattern separation in adulthood. It was demonstrated that adult-initiated exercise enhanced both contextual and cued fear conditioning, while conversely, exercise that began in adolescence did not affect performance in these tasks and these differential effects were accompanied by differential expression of plasticity-related genes in the hippocampus in adulthood. Moreover, adult and adolescent-initiated exercise enhanced cognitive flexibility and dendritic complexity of immature neurons in the dentate gyrus. The third aim of this thesis (addressed in Chapter 5) was to examine the impact of

chronically elevated IL-1 β on adult hippocampal neurogenesis and pattern separation. It was shown that chronic lentiviral-mediated overexpression of IL-1 β within the dorsal hippocampus impaired neurogenesis and performance in its associated cognition, while sparing neurogenesis independent cognition. Finally, the fourth aim of this thesis (addressed in Chapter 6) was to explore the impact of chronic IL-1 β , chronic unpredictable stress exposure, or a combination of an initial chronic IL-1 β insult was examined following exposure to chronic unpredictable stress on learning and memory and depressive-like behaviours. It was shown that exposure to chronically elevated IL-1 β and chronic stress independently impair certain types of learning and memory and increased depressive-like behaviour. However, exposure to a sequential ‘two-hit’ of chronically elevated hippocampal IL-1 β and chronic stress did not produce an exacerbated phenotype.

In summary (Chapter 7), disruption of intrinsic regulators of neurogenesis, such as Tlx, or exposure to extrinsic factors, such as exercise or adverse stimuli, like inflammation and stress, and the consequent effect on cognition may provide insight into why adolescence is a vital period for correct conditioning of hippocampal function in later life.

CHAPTER 1

Introduction

*Part of this introduction relating to the regulation of behavior by the nuclear receptor
TLX has been published*

[O'Leary, J.D.](#), O'Leary, O. F., Cryan, J.F. & Nolan, Y.M. (2016). Regulation of
behaviour by the nuclear receptor TLX. *Genes Brain and Behavior*
(doi:10.1111/gbb.12357).

1.1 The hippocampus

1.1.1 Neuroanatomical structure of the hippocampus

The hippocampal formation is a structure within the medial temporal lobe that is involved in episodic memory and spatial navigation (Bannerman et al., 2004, O'Keefe, 1976). Despite notable differences across species, similarities and generalizations can be drawn regarding its structure and function (Strange et al., 2014). The hippocampal formation is comprised of three major regions, the *cornu ammonis* (CA), the dentate gyrus (DG) and the subiculum (Nolte, 2002). The *cornu ammonis* is subdivided into the CA1, CA2 and CA3 subregions. Each of the CA1, CA2 and CA3 consist of a polymorphic layer which contains basal dendrites and axon collaterals of pyramidal neurons (Nolte, 2002). The pyramidal cell layer is comprised of the pyramidal neuronal cell bodies, the principal excitatory neurons of the hippocampus. The *stratum radiatum* contains the dendrites of the pyramidal cells and recurrent axon collaterals of the pyramidal cells, and the molecular layer contains the distal dendrites of the pyramidal cells and incoming axons of the perforant pathway from the entorhinal cortex (EC) (Neves et al., 2008). The DG is comprised primarily of granular neurons and can be divided into three main layers; the first is the molecule layer, which contains the dendrites of the granular cells and incoming axons from the perforant pathway. The second is the granular cell layer (GCL), containing the cell bodies of the granule cells which are glutamate containing excitatory neurons as well as the subgranular zone (SGZ). The SGZ is of special importance as adult neurogenesis takes place here

(discussed in greater detail below). The third layer is the *stratum multiforme*, a polymorphic layer which contains axons of granular cells and the inhibitory γ -aminobutyric acid (GABA)-ergic interneurons (Nolte, 2002).

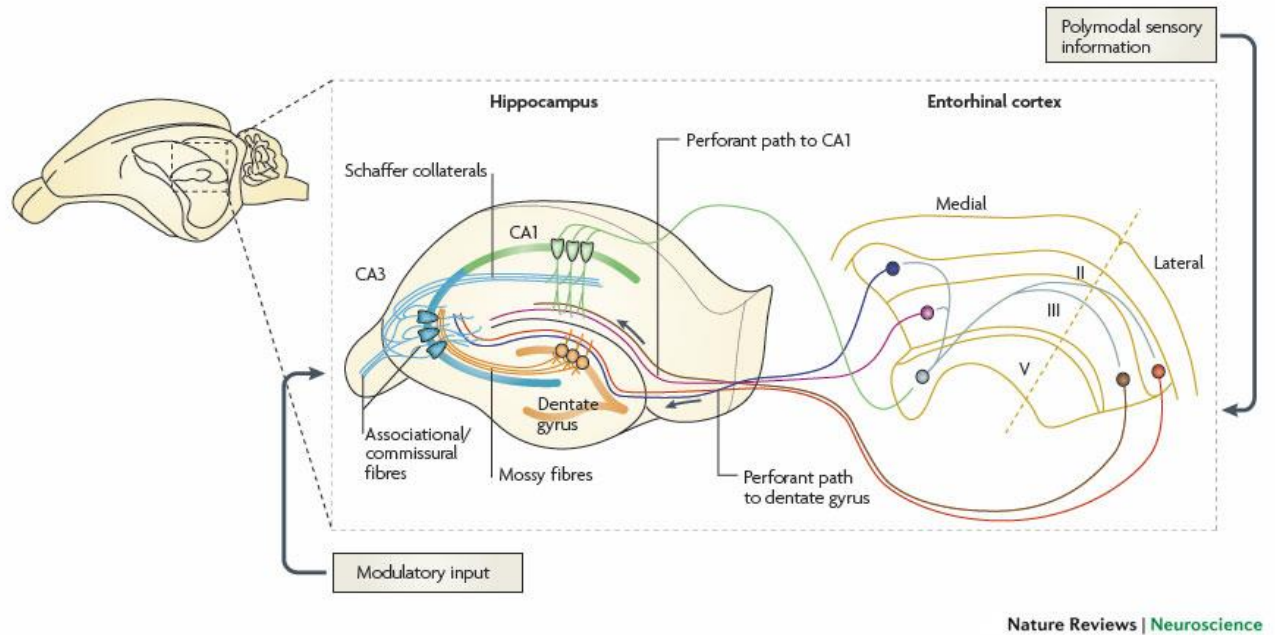

Figure 1.1: Neural circuitry of the rodent hippocampus. Neurons from the entorhinal cortex (EC) layer II forms connections with the (DG) and CA3 through the perforant pathway. CA3 neurons receive connections from the DG mossy fibers. Neurons within the CA3 project to CA1 pyramidal cells through Schaffer collaterals. EC layer III neurons project to the CA1. CA1 neurons project to the subiculum, which sends hippocampal output back to the EC. Adapted from Neves et al. (2008).

Polymodal sensory information arrives in the hippocampus from the EC through the perforant pathways which provide both direct and indirect input to the CA1 pyramidal neurons (Figure 1.1) (Kandel, 2000, Lie et al., 2004). Through the indirect pathway, axons from layer II of the EC make excitatory synapses with the granule cells of the DG, via the perforant path (Figure 1.1) (Neves et al., 2008). The granule cells of the

DG then project through the mossy fiber pathway to make excitatory synapses with the pyramidal cells within the CA3 and hilar interneurons of the hippocampus (Neves et al., 2008, Lie et al., 2004). The CA3 cells project through the Schaffer collateral pathway to CA1 pyramidal cells (Neves et al., 2008, Rebola et al., 2017). The CA1 is a major output node of the hippocampus and has been suggested to play a role in novelty detection and input comparison (Treves and Rolls, 1994, Kaifosh and Losonczy, 2016). More recently, CA1 pyramidal cells have been proposed to play a key role in parallel information processing in the hippocampus (Soltesz and Losonczy, 2018). Alternatively, neurons from layer III of the EC connect directly through the perforant path, making excitatory synapses on the distal dendrites of CA1 pyramidal neurons (Kandel, 2000). This special tri-synaptic circuitry of the hippocampus has been suggested to underlie its unique functionality in cognitive processes (Tonegawa and McHugh, 2008).

The input and output connections of the dorsal hippocampus and ventral hippocampus are anatomically distinct (Swanson and Cowan, 1977, Nolte, 2002, Kandel, 2000). Increasingly more ventral and medial bands of the EC are connected to increasingly more ventral levels of the hippocampus (Strange et al., 2014). A dorsolateral band of the EC is preferentially connected to the dorsal hippocampus. Specifically, the pre- limbic, perirhinal and postrhinal cortices project to the dorsal hippocampus, while the infralimbic, piriform as well as the pre and para-subiculum project to the ventral hippocampus (Strange et al., 2014). There is also a greater density of place fields within the dorsal hippocampus compared to the ventral hippocampus (Jung et al., 1994). The

dorsal hippocampus projects to the EC, nucleus accumbens core, retrosplenial cortex and septum (Kandel, 2000), whereas the ventral hippocampus projects to the medial prefrontal cortex, nucleus accumbens shell and basolateral amygdala as well as the ventral basolateral and basomedial nucleus of the amygdala (Strange et al., 2014). Importantly, the differences in connectivity of the dorsal and ventral hippocampus with cortical and subcortical structures along the dorsoventral axis of the hippocampus are gradual and not absolute, suggesting that functional differences may also exhibit a gradient-like organization (Strange et al., 2014).

1.1.2 Adolescence as a sensitive period of neurodevelopment

Adolescence represents a time of transition from childhood to adulthood, during which significant lifestyle changes occur along with an increase in independence from caregivers (Arnett, 2000), and it is believed to be a critical period for the programming of future adult behaviours (Sawyer et al., 2012). In humans, the onset of the biological changes associated with puberty has often been considered to signal the onset of adolescence (Spear, 2000, Arain et al., 2013). Although the timing overlaps between these two developmental stages, adolescence is separate from the more temporally restricted phase of puberty, which refers to the attainment of sexual maturation (Casey et al., 2008b). There are no definite markers for the adolescent period, however, in humans it is considered to be from ages 12 to 18 years, and in mice and rats from post-natal day (PND) 21–60 (Spear, 2000). In mammals, adolescence is a critical period for maturation of the hippocampal circuitry (Sousa et al., 1998, Bayer, 1982) and heightened neural plasticity (He and Crews, 2007). Dentate gyrus neurons undergo substantial

structural remodeling during adolescence (Koshibu et al., 2004, Lenroot and Giedd, 2006). In adolescent rats (PND 28) there is an approximately 35-40% linear increase in the total number of granule cells in the DG of compared to adult (120 PND) rats, while the volume of a single granule cell nucleus in the DG decreases with age (Bayer, 1982). Indicating that older rats have a larger DG with small neurons. The morphology of granular neurons within the lower blade of the DG also change during the adolescent period (Zehr et al., 2008). Specifically, the dendrites in the lower infrapyramidal blade undergo pruning close to the cell body and an increase in distal dendritic spine densities (Zehr et al., 2008). Moreover, gonadal steroid hormones, which dramatically increase during the adolescent period have been shown to alter neuronal structure in the hippocampus (Lenroot and Giedd, 2006). The spine synaptic density in the CA1 subfield have been reported to be affected by the presence of circulating testosterone (Leranth et al., 2003). Similarly, estradiol has also been shown to increase dendritic spine density in hippocampal neurons (Murphy et al., 1998, Frankfurt and Luine, 2015). Levels of hippocampal neurogenesis, that is, the production, differentiation and integration of new neurons within the subgranular zone of the GCL of the DG is up to four times higher during adolescence than during adulthood in rats and mice (He and Crews, 2007, Curlik et al., 2014). Therefore, as the hippocampus generates significantly more cells during the adolescent period, it is possible that the adolescent brain is especially sensitive to environmental factors and experiences (Curlik et al., 2014). This enhanced response may have significant consequences for the functional integrity of the hippocampus. Thus, given the neural, hormonal and behavioural changes that occurs during adolescences, this development period may be a critical

window during which alternations in hippocampal function may result in organizational changes lasting throughout adulthood (Fuhrmann et al., 2015, Schneider, 2013, Curlik et al., 2014, Blakemore and Choudhury, 2006, Spear, 2004). However, whether changes in hippocampal plasticity during this sensitive period of maturation can alter behaviour in adulthood is yet to be fully explored.

1.1.3 Hippocampus and learning and memory

Memory refers to the storage of learned information and is crucial for adaptive behaviour (Dudai and Morris, 2013). The process of memory formation has three key stages. Firstly, information undergoes encoding, which is the initial processing of information to an internal representation of the environment which can be stored within the brain. Secondly, memory storage refers to the creation of a permanent record of the encoded information through a process of consolidation. Thirdly, retrieval or recall, is the process of accessing the previously encoded and stored information (Koehl and Abrous, 2011). Memory can be divided into short-term and long-term memory (Cowan, 2008). Short-term memory has a limited capacity and lasts only for a period of a few seconds to minutes, while long-term memory has a potentially unlimited capacity and duration (Deco and Rolls, 2005, Cowan, 2008). The hippocampus has been strongly associated with long-term storage of information. Particularly, declarative memory which encompasses both episodic and semantic memories.

The hippocampus is crucial for these learning and memory processes, playing a key role in the initial encoding of multimodal information and consolidation of newly

formed memories to other neocortical regions for long-term storage (Andersen, 2007, Damasio, 2008). The first link between the hippocampus and memory came from anecdotal evidence in the 1950's from Henry Molaison, whose medial temporal lobe was bilaterally removed to treat intractable epilepsy. This treatment led to severe anterograde and partial retrograde amnesia, which resulted in the inability to form new memories, while previous memories of events prior to the removal of the medial temporal lobe were retained (Scoville and Milner, 1957). The memory impairment of Henry Molaison provided some of the first evidence for the role for the hippocampus in memory formation and the transfer of memories from the hippocampus to other cortical regions over time.

It is now well established that the hippocampus is crucial for learning and memory process (Squire, 1992). Specifically, it is responsible for the formation and retrieval of declarative memories (Eichenbaum, 2004, Tulving and Markowitsch, 1998). Declarative memory, which consists of memories that can be consciously recalled such as knowledge of events and experiences requires the rapid formation of associations between specific events and experiences (Eichenbaum, 2000). The subregions of the hippocampus, CA1, CA3 and the DG have been implicated in the rapid acquisition of contextual memories with the DG acting as a pattern separator of incoming information (Lee and Kesner, 2004). Declarative memory can further be subdivided into episodic and semantic memories. Episodic memory is comprised of one's experiences and specific events and are typically referred to as the 'what', 'where' and 'when' information in relation to events (Tulving and Markowitsch, 1998, Tulving, 2002).

Semantic memory is comprised of our accumulated knowledge such as facts (McClelland et al., 1995). The hippocampus is involved in some but not all types of memory and while there is debate over the specific nature of hippocampal-dependent and independent memory, it is well established that lesions or disruption of the hippocampus affects several forms of memory, such as; episodic memory and spatial as well as contextual memory (Fanselow and Dong, 2010, Squire et al., 2004), whereas, non-declarative memory is unaffected by hippocampal disruption (Deng et al., 2010). In addition, the hippocampus has also been shown to play a role in spatial navigation (O'Keefe, 1976). Specific neurons within the CA1 and CA3 subregions have been shown to be activated when an animal moves through a specific area of its environment (O'Keefe, 1976, Smith and Mizumori, 2006). These cells have been referred to as place cells and help to form a cognitive map of the environment (O'Keefe and Nadel, 1978, O'Keefe, 1976, O'Keefe, 1979).

There is a growing consensus that there is at least two distinct functional domains of the hippocampus (Fanselow and Dong, 2010). Selective lesion studies have shown that the hippocampus is functionally subdivided along the septotemporal axis into a dorsal and ventral region, associated with distinct behaviours (Bannerman et al., 2004). Moreover, recent neuroanatomical studies have suggested that the hippocampus may be further divided into an additional third intermediate region, with overlapping characteristics of both the dorsal and ventral regions (Fanselow and Dong, 2010). The process of learning and memory is generally associated with the dorsal hippocampus, while the ventral hippocampus is associated with emotional behaviour, particularly fear learning and anxiety-related behaviours (Bannerman et al., 2004). Therefore it has

been suggested that the dorsal and ventral regions of the hippocampus are involved in different functions (Moser and Moser, 1998, Fanselow and Dong, 2010). Evidence for a differential role of the dorsal and ventral hippocampus has come from lesion studies that have demonstrated that lesions of the dorsal hippocampus impaired spatial learning within the Morris water maze in rats (Moser et al., 1993, Moser et al., 1995b), as well as spatial working memory in both T maze and water maze (Bannerman et al., 2002). Previous studies have shown that lesions of the ventral hippocampus impair contextual fear conditioning in rats (Richmond et al., 1999, Bannerman et al., 2003). Moreover, Bannerman et al. (2003) reported that lesions of the ventral hippocampus did not affect spatial learning within the Morris water maze or T maze in rats. Indeed, the rodents behaviour following a ventral hippocampal lesion mimicked that of a benzodiazepine-induced decrease in anxiety-like behaviours (Bannerman et al., 2003). Together, these studies highlight that the dorsal hippocampus is preferentially involved in spatial learning and memory, while the ventral hippocampus is associated with anxiety-related behaviours (Bannerman et al., 2004).

1.1.4 Behavioural models of hippocampal function

Several behavioural models have been developed to assess hippocampal function, these include measures of spatial and contextual memory, such as the Morris water maze, Barnes maze, contextual fear conditioning and touchscreen operant conditioning (Figure 1.2). The Morris water maze, has become a standard behaviour test of hippocampal-dependent learning and memory in rats and mice. It is comprised of a spatial navigation task in which the animal must find a hidden platform in a water maze

(Morris, 1984). The escape from the platform is the positive reinforced as the rodent is highly motivated to escape a water environment (Crawley, 2007). Performance in the Morris water maze has been shown to be sensitive to hippocampal disruption. The testing procedures consist of an initial training phase, where rodents learn to swim towards a visible platform. Followed by a hidden platform task and a subsequent probe trial. There are many different protocols for the Morris water maze that help to evaluate different aspects of memory that may be dependent or independent of the hippocampus. For example, during the hidden platform task, distal cues in the room can be removed and the location signaled by a single cue proximal to the platform, in this way cued learning, a hippocampal independent process, can be assessed. Moreover, several hidden platform trials can be completed with the location of the platform alternating, which would allow for the assessment of reversal learning, a measure of cognitive flexibility which is mediated by the prefrontal cortex. Furthermore, remote memory can also be evaluated by adding or extending probe trials by several weeks from initial training. A dry-land alternative to the Morris water maze is the Barnes maze. In the Barnes maze paradigm the rodent explores a brightly lit open field with holes around its perimeter, with one of the holes leads to an escape tunnel (Barnes, 1979). Like the Morris water maze, the escape from the aversive brightly lit open field is the positive reinforcement (Barnes, 1979, Crawley, 2007). Hippocampal independent processes can also be assessed in the Barnes maze by adaption of the protocol. The location of the escape tunnel can be alternated on subsequent testing trials, which would allow for the investigation of behavioural flexibility. Spatial learning has also been assessed in a variety of maze configurations, such as the Y-maze, T-maze and radial arm maze

(Figure 1.2D-F). Spontaneous alternation is the tendency of rodents to alternate non-reinforced choices of the Y-maze, T-maze or radial arm maze (Hughes, 2004). In this task, the animal must remember which arm it has entered on a previous occasion in order to correctly alternate its subsequent choice. This task has been suggested to be a measure of spatial working memory, and sensitive to hippocampal disruption (Gerlai, 1998). The Y-maze, T-maze or radial arm maze can also be used to assess hippocampal-independent behaviour, such as reversal learning. Under these procedures, the animal is first trained to obtain a food reward from one the maze's baited arms. Following subsequent training the animal learns to alternate their entry into a maze arm based on the location of the previously baited arm.

Contextual fear conditioning is another hippocampal-dependent task which assesses contextual memory. In this paradigm, the ability of the rodent to associate an aversive shock to a particular context is assessed (Figure 1.2G) (Fanselow, 1980). The rodent is placed inside a chamber and a mild electric shock is administered, upon re-entry into the same chamber the rodent having learnt the association between the contextual environment and shock will display freezing behaviour, in expectation of the aversive stimuli (Fanselow, 1980, Crawley, 2007). This task has been extensively shown to assess hippocampal-dependent processes (Fanselow and Dong, 2010). However, variations in the paradigm can also be used to assess associative and non-associative learning, such as habituation or sensitization to a shock-paired stimulus as well as the extinction of conditioned stimulus response. Object recognition is a task that has been widely used as a measure of short-term and long-term memory and has been shown to be

a entorhinal-hippocampal dependent task (Figure 1.2C) (Crawley, 2007, Dere et al., 2007). In a modified version of this task, rodents are presented with two identical objects in a testing arena, following which one object-location is moved. Upon a second exposure to testing arena, the rodent will display a preference in exploring the object that has been displaced (Dere et al., 2007). In more recent years, a novel touchscreen operant task has been developed to assess location discrimination (Figure 1.2I) (Oomen et al., 2013, Oomen et al., 2015). In this paradigm, the rodent is trained to nose-poke the correct location on a touchscreen to receive a food reward. Previous studies have demonstrated that performance in this task is affected by changes in adult hippocampal neurogenesis (Clelland et al., 2009, Creer et al., 2010).

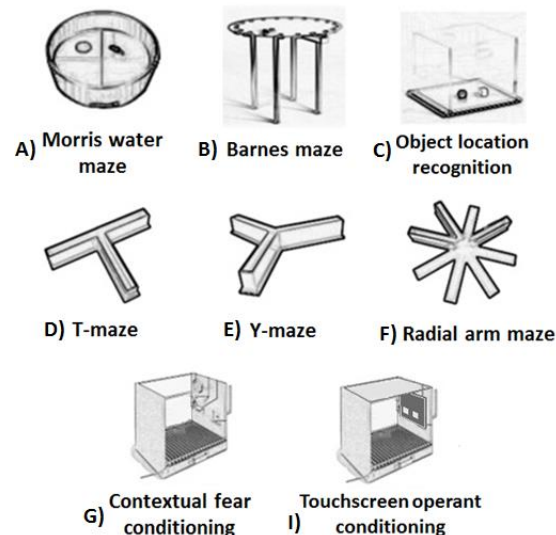

Figure 1.2: Animal behavioural tests for assessing learning and memory. A) Morris water maze, in this task rodents learn to navigate to a hidden platform. B) Barnes maze, rodents learn to navigate to an escape box. C) Object location recognition measures a rodent's preference for novelty. D and E) T-maze and Y-maze, rodents are trained to retrieve a food reward from the correct maze arm. F) Radial arm maze, rodents are trained to retrieve a food reward from the correct maze arm. G) Contextual fear conditioning, rodents learn to associate a fear response to the context of the chamber. I) Touchscreen operant conditioning, rodents are trained to nose-poke the correct location on a screen for a food reward. Adapted from Sharma et al. (2010).

1.1.5 The hippocampus and emotion

The involvement of the hippocampus in emotion has been well established, with both lesions and neuroanatomical studies demonstrating a role of the ventral hippocampus in fear learning and anxiety-related behaviours (Bannerman et al., 2004, Fanselow and Dong, 2010). Indeed, the hippocampus, in conjunction with the amygdala and ventromedial prefrontal cortex have shown to be critical for the acquisition and retrieval of fear learning (Hartley and Phelps, 2010). Specifically, the hippocampal projections to the ventromedial prefrontal cortex and amygdala have been shown to mediate context specific freezing behaviour. More recently, Huff et al. (2013) demonstrated that optogenetic excitation of the basolateral amygdala enhanced retention in an inhibitory avoidance task. Similarly, optogenetic inhibition of the basolateral amygdala impaired performance in this task (Huff et al., 2013). Moreover, Huff et al. (2016) further demonstrated that optogenetic excitation of the ventral hippocampal-basolateral amygdala pathway enhanced retention of foot-shock training, while optogenetic inhibition impaired performance. Taken together, these findings implicate the hippocampal-basolateral amygdala circuitry in the consolidation of fear memory (Huff et al., 2016, Huff et al., 2013).

The hippocampus has also been implicated in emotion through its regulatory role of the hypothalamic–pituitary–adrenal axis (HPA) (Dedovic et al., 2009, Jacobson and Sapolsky, 1991). The HPA-axis, a major mediator of the endocrine-stress response has been shown to be impaired following lesions of the hippocampus (Dedovic et al., 2009,

Jacobson and Sapolsky, 1991). Thus, another potential pathway in which the hippocampus regulates emotion may be through its inhibitory role of the HPA-axis. Furthermore, the dysregulation of the hippocampus has been implicated in the aetiology of mood and affective disorders such as depression, bipolar and anxiety-related disorders (Revest et al., 2009, Belzung et al., 2015, Campbell et al., 2004). Indeed, disruptions in pattern separation may underlie the over generalization of fear responses to emotional stimuli which is a hallmark of anxiety disorders (Kheirbek and Hen, 2014, Kheirbek et al., 2012). This over generalization of memory may be driven by disruption of hippocampal processes, which subsequently leads to impairment in the resolution and interference between similar memories (Besnard and Sahay, 2016). The addition of new neurons within the hippocampus has been suggested as a potential mechanism of action of antidepressant drugs (Boldrini et al., 2012, Boldrini et al., 2009, Malberg et al., 2000, O'Leary and Cryan, 2014, O'Leary et al., 2013, Santarelli et al., 2003). However, further work is needed to fully elucidate the role of the hippocampus and emotional regulation and the aetiology of affective disorders.

1.2 Adult hippocampal neurogenesis

Altman and colleagues were the first to demonstrate that new neurons were formed within the adult brain, in a process referred to as adult neurogenesis (Altman and Das, 1965, Altman, 1962). This landmark discovery questioned the long-held dogma that no new neurons were created within the CNS after birth (Colucci-D'Amato et al., 2006, Gage, 2000). However, it took several decades before this concept was accepted by

the wider scientific community (Gage, 2002). It is now widely accepted that neurogenesis occurs within the adult brain, namely the subventricular zone (SVZ) of the lateral ventricles and the subgranular zone (SGZ) of the DGs in several species including rats and mice (Goncalves et al., 2016), guinea-pigs (Altman and Das, 1967), marmoset monkeys (Gould et al., 1998) and tree shrews (Gould et al., 1997a) as well as humans (Eriksson et al., 1998, Ernst and Frisé, 2015). Evidence now also suggests that adult neurogenesis occurs within the rodent hypothalamus, where it has been proposed to contribute to homeostatic functions such as energy balance and food intake (Kokoeva *et al.*, 2005, Sousa-Ferreira *et al.*, 2014). It has also been observed within the striatum in humans and has been suggested to contribute to the generation of new striatal interneurons (Bergmann *et al.*, 2015, Eriksson *et al.*, 1998, Gage, 2000, Sousa-Ferreira *et al.*, 2014). While the functional significance of new adult striatal neurons is yet to be fully understood, it is possible that they contribute to motor and cognitive functions such as behavioural flexibility (Ernst & Frisé 2015). Dysregulation of adult striatal neurogenesis has also been implicated in the pathophysiology of Huntington's disease, suggesting a possible role in neurodegenerative disorders (Curtis *et al.*, 2003). However, most research to date on adult neurogenesis has focused on hippocampal neurogenesis. During adult hippocampal neurogenesis the newly generated cells pass through several developmental stages as they migrate away from the SGZ and intergrade into the GCL of the DG, (Figure 1.3) (Gage, 2000, van Praag et al., 2002, Goncalves et al., 2016). The neurogenic niche of the subgranular zone is comprised of radial glia-like cells (RGL) which generate the proliferating intermediate progenitor cells (IPCs). These new born cells are characterized by expression of intermediate

filament proteins glial fibrillary acidic protein (GFAP), nestin or Ki67. The progenitor cells in turn give rise to neuroblasts which differentiate into immature neurons, that are characterized by expression of doublecortin (DCX) or polysialylated neural cell adhesion molecule (PSA-NCAM). As the newly differentiated neurons mature, they are characterized by the expression of neuron-specific nuclear protein (NeuN) (Bischofberger, 2007). The new neurons integrate into the existing GCL of the DG, establishing synaptic connections with CA3 region of the hippocampus and the EC (Braun and Jessberger, 2014).

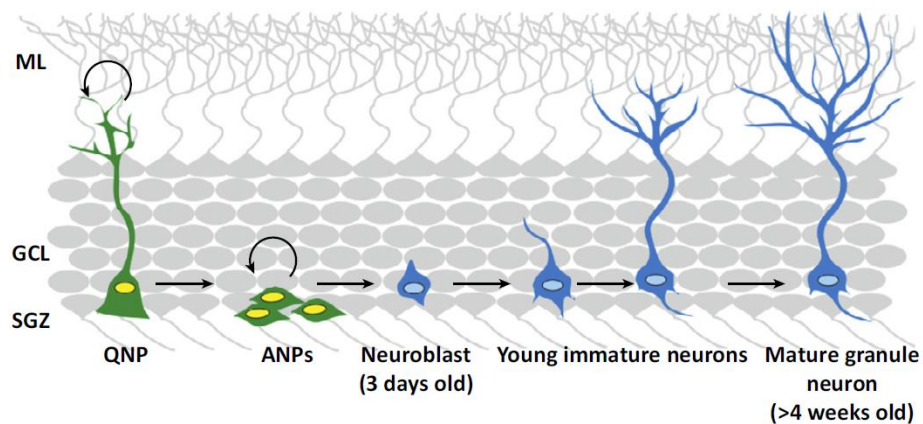

Figure 1.3: Progenitor cell development. New cells pass through several developmental stages while migrating away from the subgranular zone and integrate into the GCL of the DG. Adapted from (O'Leary and Cryan, 2014). Quiescent neural progenitor (QNP), Amplifying neural progenitor (ANP) Subgranular zone (SGZ), Granular cell layer (GCL) and Molecular layer (ML).

During maturation the young immature neurons (approximately 3-4 weeks old) exhibit distinct physiological differences from the mature granule cell population, with immature neurons exhibiting a heightened excitability (Aimone et al., 2011, Bonaguidi et al., 2012). In immature neurons, GABA regulates cell proliferation and neurite

outgrowth through an excitatory, depolarizing activation, due to the high intracellular concentration of chloride (Watanabe and Fukuda, 2015, Sernagor et al., 2010).

During maturation, GABA initially elicits an excitatory response in newborn neurons, but as the cell matures and becomes integrated into the existing hippocampal circuitry, GABA exhibits an inhibitory effect (Bischofberger, 2007). The shift in excitability is due to a change in the expression of chloride transporters that control chloride homeostasis. Specifically, the Na^+ - K^+ - 2Cl^- co-transporter (NKCC1), which increases the intracellular concentration of chloride, is predominantly expressed in immature neurons, which causes a GABA-mediated-excitatory action (Watanabe and Fukuda, 2015, Sernagor et al., 2010). As the new neuron matures, the NKCC1 transporter is downregulated and an upregulation of the potassium-chloride transporter member 5 (KCC2) occurs. This results in low intracellular concentration of chloride ions, which shifts the GABA-mediated excitation to inhibition (Sernagor et al., 2010). Thus, adult-born cells initially exhibit an excitatory response to GABAergic synaptic transmission, but as the cells mature, expression of KCC2 increases, and approximately 3 weeks after cell proliferation the transition from an excitatory to an inhibitory role of GABA occurs, with glutamate eliciting an excitatory effect (Figure 1.4) (Goncalves et al., 2016). These differences in excitability have been suggested to indicate functionally distinct roles between the young (immature) and mature neurons within the hippocampus (Aimone et al., 2011, Bonaguidi et al., 2012). GABA-CREB signalling has been shown to regulate the maturation and survival of newly born neurons (Jagasia et al., 2009, Ge et al., 2007). Specifically, CREB is activated in new granule neurons during maturation and a loss of CREB leads to an impairment in dendritic development

and neuronal integration (Jagasia et al., 2009). In rodents it takes several weeks for adult newborn cells to mature and functionally integrate into the existing hippocampal circuitry, whereas in macaque monkeys it takes approximately 6 months (van Praag et al., 2002, Kempermann et al., 2003, Kohler et al., 2011). In humans, the newborn neurons are thought to mature similar as macaque monkeys, however further work is needed to support this theory (Bergmann et al., 2015, Eriksson et al., 1998).

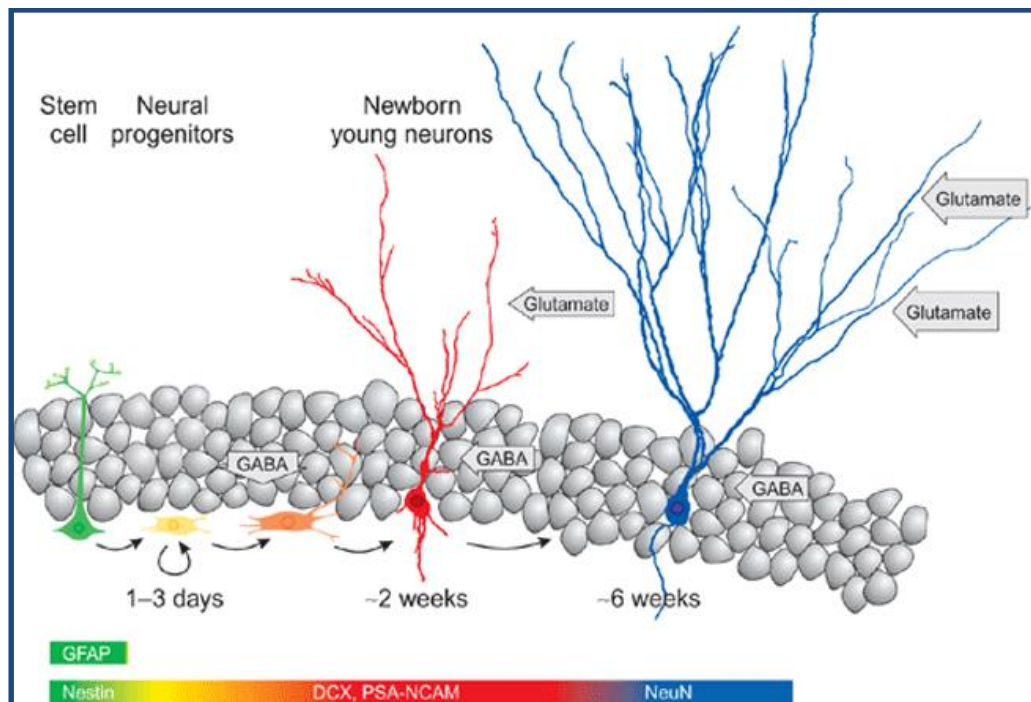

Figure 1.4: Adult hippocampal neurogenesis. New born cells within the SGZ are characterized by expression of intermediate filament proteins glial fibrillary acidic protein (GFAP) and nestin. The new born cells differentiate into neurons, characterized by expression of doublecortin (DCX) or polysialylated neural cell adhesion molecule (PSA-NCAM) or into glial cells. Mature neurons are characterized by expression of neuron-specific nuclear protein (NeuN). Initially GABA is excitatory to newborn neurons, once the cell is integrated, GABA becomes inhibitory. Adapted from Bischofberger (2007).

1.2.1 Adult hippocampal neurogenesis and cognition

The addition of new neurons into the existing hippocampal neurocircuitry has been suggested to play a key role in learning and memory. Spatial learning in the Morris water maze and trace eye-blink conditioning, a hippocampal-dependent processes, have also been shown to rescue new born neurogenesis within the adult hippocampus (Shors et al., 2012, Gould et al., 1999a, Gould et al., 1999c, Dupret et al., 2007). In particular, Curlik et al. (2013) demonstrated that learning rescues newly born neurons from death, by integration of new born cells into existing hippocampal circuitry in rats. Importantly, the learning had to be challenging in order to promote cell survival (Curlik and Shors, 2011). While there are some discrepancies in the literature, for the most part adult hippocampal neurogenesis has been linked to cognitive function in tasks which require spatial memory, contextual memory, and pattern separation, that is the ability to form distinct representations of similar inputs (Clelland et al., 2009, Rola et al., 2004, Raber et al., 2004, Saxe et al., 2006c, Snyder et al., 2005b, Aimone et al., 2011, Dupret and Abrous, 2010). Hippocampal neurogenesis has also been implicated in memory consolidation and forgetting (Kitamura and Inokuchi, 2014b, Akers et al., 2014, Frankland et al., 2013). Impairments in hippocampal neurogenesis has also been suggested as a potential mechanisms which underlies the cognitive decline associated with the neuropathology of neurodegenerative diseases, such as Alzheimer's and Parkinson's disease as well as stress-related disorders such as depression and anxiety (Crews *et al.*, 2010, Marlatt & Lucassen, 2010, Winner & Winkler, 2015).

1.2.2 Adult hippocampal neurogenesis and pattern separation

The ability to discriminate between similar experiences is a critical feature of episodic memory (Tulving and Markowitsch, 1998). In order to form new memories of these similar experiences, a process that encodes the memory in a discrete non-overlapping fashion is required. Without such a process, memory recall would suffer high interference from similarly encoded memories (Kent et al., 2016). The process of discriminating between similar memories has been termed pattern separation. Pattern separation was first proposed as a key function of the DG, as convergent evidence from computational, physiological and behavioural studies indicated that the unique tri-synaptic circuitry of the hippocampus positioned the DG for the disambiguation of incoming neural inputs from the EC (Marr, 1971, Knierim and Neunuebel, 2016, Myers and Scharfman, 2011, Myers and Scharfman, 2009, McHugh et al., 2007, Yassa and Stark, 2011).

More recently, pattern separation has been linked to hippocampal neurogenesis (Aimone et al., 2011, Sahay et al., 2011c, Revest et al., 2009, Besnard and Sahay, 2016, McHugh et al., 2007, Tronel et al., 2012). Young neurons that are approximately 2 weeks old begin to receive GABAergic input and start expressing glutamatergic receptors (Ge et al., 2006). After four weeks of age, the young neurons begin to establish synaptic connections from glutamatergic neurons within the EC, similar to existing mature granule cells (Toni et al., 2007). However, despite similar levels of glutamatergic input, GABAergic input to the young neurons is relatively low compared

to mature granule cells (Lacar et al., 2014). This difference in excitation/inhibition balance causes a period of heightened excitability of the immature neurons, where long-term potentiation is more readily induced within the young neurons compared to mature neurons (Schmidt-Hieber et al., 2004, Wang et al., 2000, Snyder et al., 2001). This suggests that young maturing neurons may contribute to memory formation function through regulation of excitation-inhibition balance of the DG (Park et al., 2015). Indeed, Marin-Burgin et al. (2012) demonstrated that young neurons are more likely to respond to two separate neural inputs than their mature counterparts, and thus requires a weaker input (medial perforant pathway activation) to trigger an action potential. Marin-Burgin et al. (2012) showed that weak afferent activity recruits few mature granule cells but activates a large number of the immature neurons. For example, a stimulus that activates approximately 5% of mature granule cells will activate approximately 30% of the immature granule cell population. These differences in activation thresholds are dictated by an enhanced excitation/inhibition balance in immature granule cells which is not present in mature neurons (Marin-Burgin et al., 2012). Therefore, immature granule cells exhibit a low activation threshold that switches with time as the cell matures, toward a higher activation threshold. This finding suggests that activity patterns entering the DG can undergo differential decoding by a heterogeneous population of granules cells which were born at different times (Marin-Burgin et al., 2012). Thus, newborn neurons have a developmental period during which they exhibit unique physiological characteristics, separate from the mature granule cell population and this heterogeneity may underlie the ability of the DG to function as a pattern separator of incoming information. Moreover, it has

been demonstrated that this period of heightened excitability is a transient developmental stage where young granule cells are initially hyper-sensitive to a narrow input and secondly, where older mature granule cells respond to a wide range of input signals (Brunner et al., 2014). In addition, (Brunner et al., 2014) the shift from a narrow input specificity to a wide input range is not predicted by the chronological age of the cell, and thus, it has been proposed that this change in input sensitivity may be experience dependent (Brunner et al., 2014). Furthermore, adult derived mature granule cells are almost indistinguishable from the existing hippocampal neural circuitry, suggesting that these young neurons have a unique contribution to hippocampal function during this maturation period. However, once the cell matures it functions in a similar fashion as the pre-existing mature granule cell population (Laplagne et al., 2006, Aimone et al., 2011). Taken together, these data suggest that new neurons are a potential mechanism by which the DG encodes similar but non-identical environmental inputs through distinct cellular populations within the hippocampal circuitry (Deng et al., 2013).

1.2.3 Behavioural models of pattern separation

In recent years, novel cognitive tests have been developed to tease apart the relationship between hippocampal neurogenesis and pattern separation (Bekinschtein et al., 2013a, Oomen et al., 2013, Sahay et al., 2011b). Four main behavioural models have been developed and are commonly used in assessing pattern separation. These include; fear conditioning paradigms, object-location recognition and radial arm maze based tasks as well as touchscreen-operant based tests (Figure 1.5). The latter allows for increased

translation with human neuropsychological assessments as well as the testing of multiple types of cognitive tasks utilizing the same behavioural platform (Oomen et al., 2013, Horner et al., 2013, Bekinschtein et al., 2013a, McHugh et al., 2007). The underlying concept of these pattern separation tasks is to present an animal with two similar but different stimuli that the animal must discriminate or “separate” in order to exhibit the correct behavioural response. The role of adult hippocampal neurogenesis in pattern separation has come from *in vivo* studies investigating loss/gain function following changes in neurogenesis. The majority of these studies have focused on neurogenesis ablation, using a variety of techniques, such as antimetabolic drugs, low-dose focal irradiation and permanent or temporary genetic manipulations (Sahay et al., 2011a, Niibori et al., 2012, Tronel et al., 2012).

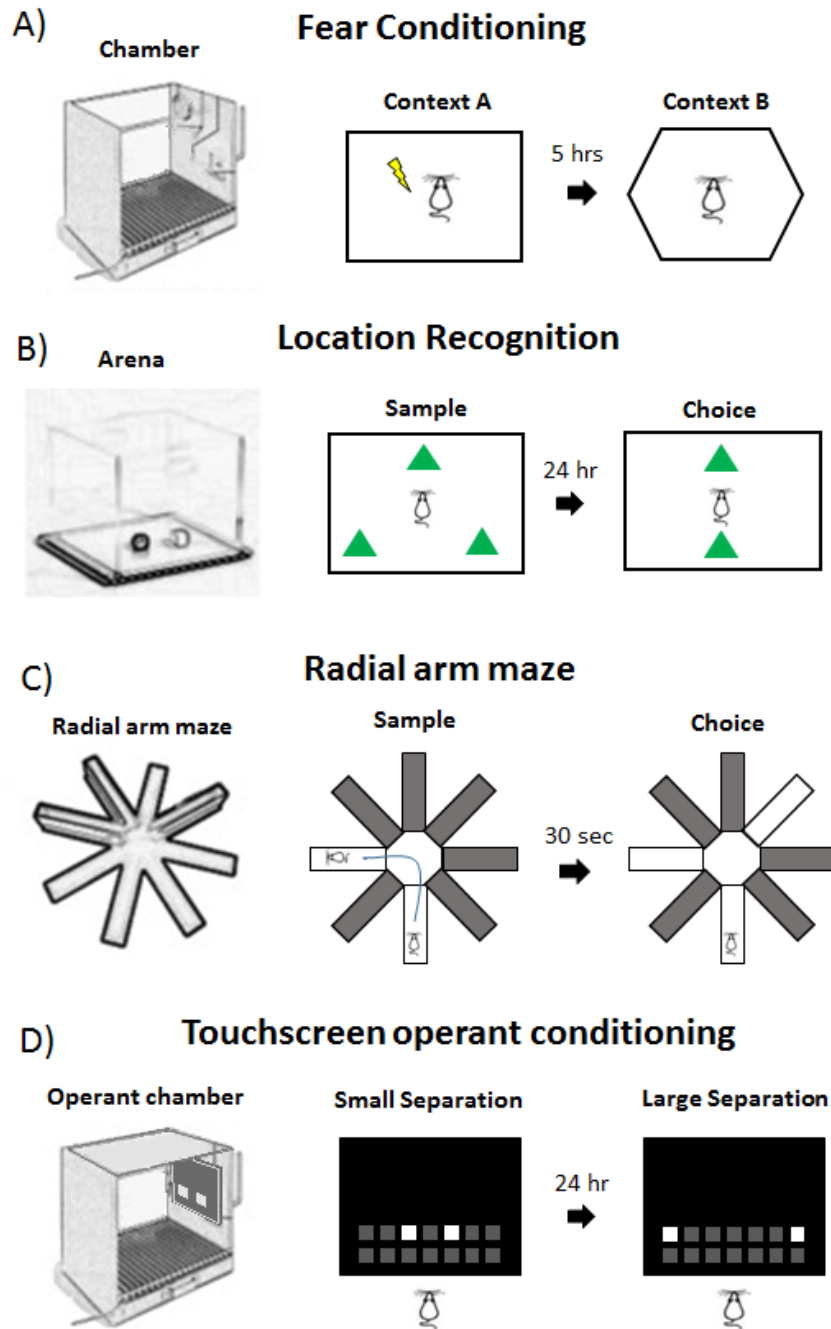

Figure 1.5: Behavioural models of pattern separation. Illustration of the different pattern separation behavioural models. Fear conditioning paradigm (A). Object-location paradigm (B). Radial arm maze paradigm (C). Touchscreen operant paradigm (D).

1.2.3.1 Fear conditioning paradigm of pattern separation

In the fear conditioning paradigm of pattern separation, the animal learns to associate a particular context with an aversive electric shock. The animal undergoes several exposures to a fear conditioning chamber with an aversive electric shock (Context A) as well as a second “shock free” chamber with different contextual cues (Context B) (Kheirbek et al., 2012). Over several exposures, the animal learns to anticipate a shock in Context A (indicated by increased freezing behaviour) and no shock in Context B (indicated by reduced freeze behaviour) (Figure 1.5A) (Sahay et al., 2011b, Kheirbek et al., 2012, Tronel et al., 2012). Freeze behaviour is a complete immobility except for breathing and is a common response to a fearful or aversive stimuli where escape is impossible (LeDoux, 1998). The contextual overlap between Context A and B can be manipulated by varying the similarity of the contextual cues within the fear conditioning chambers (i.e. chamber lighting, scent, visual cues). Animals with intact hippocampal neurogenesis readily learn to discriminate the contextual environment in which the shock is administered (Context A) compared to a neutral environment (Context B), whereas animals with impaired neurogenesis overgeneralize the conditioned response to both conditioned (Context A) and neutral context (Context B) and are therefore unable perform a contextual discrimination or “pattern separate” (Kheirbek et al., 2012, Tronel et al., 2012, Saxe et al., 2006c, Sahay et al., 2011b).

1.2.3.2 Object-location paradigm of pattern separation

Object-location based models of pattern separation employ modified spontaneous location recognition tasks. These tasks are similar to the traditional novel object location recognition tasks that employ a sample phase, in which the animal is initially presented with 3 identical objects in an arena with various spatial cues and is allowed to explore the objects (thereby encoding information regarding the object's features and its position in space) (Kent et al., 2015, Bekinschtein et al., 2013a, Bekinschtein et al., 2014, Crawley, 1999). Following the sample phase and inter trial delay (to allow for the encoding of object-location information), the animal is exposed to a test phase in which one object has been removed and other object has been displaced (placed in a new location) (Figure 1.5B). The animal, having a natural preference for novelty, will tend to explore the now displaced object (Antunes and Biala, 2012). The contextual overlap between the sample phase and test phase can be manipulated by reducing or increasing the distance of the displaced object. For example, a small object displacement will create a high contextual overlap between the sample and test phase (i.e. difficult to notice a difference) whereas a large object displacement will create a low contextual overlap between the sample and test phase (i.e. easy to notice a difference) (Bekinschtein et al., 2013a, Bekinschtein et al., 2014). Therefore, animals with intact hippocampal neurogenesis are able to discriminate between a small displaced object which has high contextual overlap, as indicated by a preference in exploration for the displaced object, while rats with ablated neurogenesis fail to discriminate between the small displaced object and the unmoved object, as indicated by an equal amount of time spent exploring both the displaced object and familiar

object (Bekinschtein et al., 2013a, Bekinschtein et al., 2014). Within this paradigm, pattern separation is measured during the small displacement (i.e. high contextual overlap). Therefore, when there is a large object displacement (i.e. low contextual overlap), animals with either intact or impaired hippocampal neurogenesis perform equally well.

1.2.3.3 Radial arm maze paradigm of pattern separation

The delay non-matching to place task in the radial arm maze, was first developed by (Marigetto et al., 1993). In this task the animal is initially trained to retrieve a food reward from a baited arm (Marigetto et al., 1993). The animal is then exposed to a sample phase in which only one arm is open. Upon reward collection the animal is given an inter-trial interval and a second arm is baited. During the choice phase, the previously baited arm remains empty and the new arm contains the food reward. The animal must correctly retrieve the reward from the newly baited arm, and entry into the previously rewarded arm results in a failure (Figure 1.5C). The radial arm maze model of pattern separation utilizes a modified version of this task (Clelland et al., 2009). In this paradigm, pattern separation is assessed by manipulating the spatial separation between the sample arm and choice arm to create conditions of either high or low contextual overlap. For example, a choice arm which is located next to the sample arm exhibits high contextual overlap (i.e. high spatial interference) whereas, a choice arm located opposite (180 degree) the sample arm exhibits low contextual overlap (i.e. low spatial interference) (Clelland et al., 2009). Therefore, animals with intact hippocampal

neurogenesis are able to correctly retrieve the food reward when the choice arm is in close proximity to an empty sample arm, while animals with impaired hippocampal neurogenesis incorrectly return to the unabated sample arm (Clelland et al., 2009). Furthermore, during the low contextual overlap conditions, that is, when the choice arm is furthest (180 degree) from the sample arm, animals with either intact or impaired hippocampal neurogenesis perform equally well.

1.2.3.4 Touchscreen operant paradigm of pattern separation

Touchscreen based paradigms utilizes the touchscreen operant chamber where animals are trained to nose-poke an image on a touch sensitive screen to receive a food reward (McTighe et al., 2009, Talpos et al., 2010). In this paradigm, pattern separation is assessed by a two-choice spatial discrimination task where the animal is presented with two identical images (white squares). One is reinforced with a food reward and the other is punished with a timeout. The inter-stimulus distance between the correct and incorrect image is either reduced so there is only a small separation between the two images (i.e. high contextual overlap), or a large separation between the two images (i.e. low contextual overlap). Over several trials animals are presented with the “large separation” (large inter-stimulus distance, 5 cm) and a “small separation” (small inter-stimulus distance, 1 cm) (Figure 1.5D). Again, animals with intact neurogenesis are able to perform the task when there is a small inter-stimulus distance i.e. high spatial interference while, animals with impaired neurogenesis are unable to respond to the correct image. Additionally, it is possible that while this task requires spatial learning,

it may also be mediated by the prefrontal cortex, as the animal is required to respond to the correct reward location, and then alternate their response based on the previously learnt reward location (Oomen et al., 2013). Therefore, requiring the rat to retrieve spatial-context appropriate memories and suppress competing spatial-context inappropriate memories (i.e. the previously correct reward location, which is now incorrect), a process that has been linked to the prefrontal cortex (Kehagia et al., 2010). The number of times in which an animal can alternate their response (i.e. re-learn the previous reward-location contingency) may serve as an indication of reversal learning and a measure of cognitive flexibility.

1.2.4 Adult hippocampal neurogenesis and spatial learning

The role of the hippocampus in spatial memory has been well established. Specific neurons within the CA1 and CA3 subregions have been shown to be activated when an animal moves through a specific area of its environment (O'Keefe, 1976, Smith and Mizumori, 2006). These cells have been referred to as place cells and help to form a spatial map of the environment (O'Keefe and Nadel, 1978). Moreover, lesions of the dorsal hippocampus have led to impairments in spatial memory (Moser et al., 1993, Moser et al., 1995a, Fanselow and Dong, 2010). However, the involvement of hippocampal neurogenesis in spatial learning remains to be fully elucidated. Previous studies have reported contradictory findings on the role of hippocampal neurogenesis in spatial learning, with either disruption of adult hippocampal neurogenesis corresponding to impairments in spatial learning (Dupret et al., 2008, Garthe et al.,

2009, Garthe et al., 2014, Jessberger et al., 2009, Snyder et al., 2005b) or no effect in spatial learning (Groves et al., 2013). Findings from a meta-analysis on spatial learning and neurogenesis revealed no consensus in findings on neurogenesis and spatial learning, highlighting the controversy within the literature (Groves et al., 2013). It has been suggested that the relationship between stress/ glucocorticoids and hippocampal behaviour may explain the heterogeneity observed within the literature (Groves et al., 2013). Specifically, the different testing environments and subsequent stress levels of the animals may explain the variance in findings. Integrating data on the interaction between stress and adult hippocampal neurogenesis may be important in order to fully understand the role of these new cells in spatial learning. Moreover, disruption of hippocampal neurogenesis also did not affect less complex spatial learning (Dupret et al., 2008). Thus, differences in the specific behavioural paradigms between studies may also account for the differences in findings. Furthermore, many other experimental parameters such as the method used to disrupt hippocampal neurogenesis (radiation, genetic or pharmacological) (Dupret et al., 2007, Garthe et al., 2009, Saxe et al., 2006b, Snyder et al., 2005b), the duration of treatment before behavioural testing, the experimental animals (species, strain or sex), the behavioural paradigms, (including; intra-trial interval (ITI), number of trials, length of trials) may affect the behavioural outcomes. Therefore, a systematic standardization of the protocols employed would enable better comparison between studies.

Therefore, adult hippocampal neurogenesis may not contribute to hippocampal learning in general but only to highly specific aspects of learning, such as pattern separation, as adult hippocampal neurogenesis appears to be relevant for specific

aspects of the Morris water maze task, such as retention and platform reversal-learning (Garthe et al., 2014). The differences in methodologies between studies may help to explain the differences in results as the contribution of these new neurons to cognitive process may only be detectable when the behavioural task is sufficiently demanding, that is when there is a high contextual overlap between inputs (Garthe and Kempermann, 2013). In addition, it has been suggested that the ablation of hippocampal neurogenesis will only impair information processing within the hippocampus in situations where the processing load is high (Dupret et al., 2007). Thus, disruption of hippocampal neurogenesis will not always result in a detectable performance reduction.

1.2.5 Adult hippocampal neurogenesis and forgetting

The addition of new neurons to the hippocampus has also been suggested to play a role in the forgetting of acquired memories (Akers et al., 2014). Acquired memory is initially dependent upon the hippocampus during encoding and memory consolidation. However, the process by which newly formed memories become progressively independent from the hippocampus is unclear. It has been suggested that this decay or clearance of the memory trace from the hippocampus may enable this area to continuously encode and store new information (Kitamura and Inokuchi, 2014a, McClelland et al., 1995). The addition of new neurons then may act to erase the previous memory trace in the hippocampus (Kitamura and Inokuchi, 2014a). New born neurons have been shown to modulate the period of hippocampal dependency of a fear memory (Kitamura et al., 2009). More specifically, a decrease in hippocampal

neurogenesis resulted in a prolonged period where the newly formed fear memory was susceptible to hippocampal disruption (Kitamura et al., 2009). Inversely, an increase in hippocampal neurogenesis has been shown to increase the decay rate of the hippocampal dependency of a fear memory (Kitamura et al., 2009). Impairments in hippocampal neurogenesis during adolescence have been shown to negatively affect spatial learning within the Morris water maze, while impaired neurogenesis in adulthood did not affect spatial learning, suggesting that disruption of neurogenesis may alter hippocampal development whereas during adulthood and aging, pre-existing neurons may compensate for the lack of new hippocampal neurons (Martinez-Canabal et al., 2013). Neurogenesis has also been implicated in infantile amnesia (Guskjolen et al., 2017).

1.2.6 Adult hippocampal neurogenesis, neurodegenerative and psychiatric disorders

While some discrepancies are evident in the literature, impairments in hippocampal neurogenesis have been implicated in the neuropathology of neurodegenerative diseases such as Alzheimer's and Parkinson's disease (Wesnes et al., 2014, Ormerod et al., 2013, Crews et al., 2010, Marlatt and Lucassen, 2010, Winner and Winkler, 2015) as well as in ageing itself (Kuhn et al., 1996b, Spalding et al., 2013). The rate of hippocampal neurogenesis has been shown to decline with age in rodents (Kuhn et al., 1996a) and non-human primates (Leuner et al., 2007, Gould et al., 1999b). Specifically, the proliferation rate of NSCs in the DG is reduced by as much as 80% in aged rats (Jin et al., 2003). Alzheimer's disease is characterized by progressive

neurodegeneration and increased levels of the hyperphosphorylated tau and amyloid- β protein, which aggregates to form plaques and neurofibrillary tangles within the basal forebrain, cortex, hippocampus and amygdala (Selkoe, 2001). Furthermore, the hippocampus has been identified as one of the first regions affected by the emergence of the tau and amyloid- β plaques and neurofibrillary tangles (Hardy and Selkoe, 2002). In addition, Crews et al. (2010) demonstrated that the number of newly born neurons within the hippocampus was decreased in the *post-mortem* brains of patients previously diagnosed with Alzheimer's disease. Moreover, hippocampal neurogenesis has been shown to be altered in several transgenic mouse models of Alzheimer's disease. In the amyloid precursor protein (APP) transgenic mouse model of Alzheimer's disease, proliferation within the DG has been shown to be decreased (Haughey et al., 2002, Donovan et al., 2006), while, other studies have reported an increase in proliferation and neuronal differentiation within the DG of APP23 transgenic mice (Mirochnic et al., 2009), as well as in postmortem DG tissue of patients previously diagnosed with Alzheimer's disease (Jin et al., 2004). Parkinson's disease is characterized by progressive neurodegeneration of nigral dopaminergic neurons resulting in the depletion of striatal dopamine. Cell proliferation within the hippocampus has been shown to be reduced in postmortem brains of individuals with Parkinson's disease (Hoglinger et al., 2004). Moreover, cell proliferation within the hippocampus is reduced following dopamine depletion as well as in the 6-hydroxydopamine mouse model of Parkinson's disease (Hoglinger et al., 2004). Given that neural precursor cells (NPC) express dopamine receptors, it is possible that cognitive dysfunction associated

with Parkinson's disease may be mediated through disruption of hippocampal neurogenesis resulting from dopaminergic degeneration.

1.3 Intrinsic and extrinsic regulators of hippocampal neurogenesis

A large number of intrinsic regulators of hippocampal neurogenesis, such as Tlx, Wnt, Notch, nuclear factor kappa B alpha (NF- κ B), mitogen activated protein kinase (MAPK) have been shown to play a key role in the regulation of hippocampal neurogenesis (O'Léime et al., 2017, Mu et al., 2010, Aimone et al., 2014). Moreover, several intrinsic regulators of inflammation have also been shown to play a key role in hippocampal neurogenesis. Specifically, the pro-inflammatory cytokine IL-1 β has been shown to negatively affect NPC's through down regulation of the nuclear receptor Tlx (Ryan et al., 2013). These intrinsic factors regulate gene expression within NPCs in order to control proliferation, differentiation and maturation into neuronal or glial cells (Mu et al., 2010). In addition, several extrinsic factors, such as environmental enrichment and exercise, as well as certain types of learning have been shown to beneficially modulate hippocampal neurogenesis and its associated cognitive processes (Lucassen et al., 2010). Learning itself has been shown to promote cell survival and provide a buffer against the negative effects of stress on cognition (Gould et al., 1999a). Conversely, other extrinsic factors such as stress have been shown to negatively impact hippocampal neurogenesis and disruption hippocampal and neurogenesis-associated learning and memory (Ryan and Nolan, 2016a). Understanding the role of intrinsic

and extrinsic regulators of hippocampal neurogenesis may help in the development of novel therapeutic treatments.

1.4 Tlx and the hippocampus

1.4.1 Tlx deletion models

The orphan nuclear receptor Nr2e1 (also known as Tlx or Tailless) is a key intrinsic regulator of embryonic and adult neurogenesis, with expression localized within the neurogenic niche of the forebrain and retina throughout development and adulthood (Islam and Zhang, 2015, Monaghan et al., 1995, Shi et al., 2004). In an effort to understand the role of Tlx in neurogenesis and cognitive processes such as learning and memory, several different Tlx deletion models have been developed in mice (Monaghan et al., 1997, Shi et al., 2004, Young et al., 2002, Yu et al., 2000, Zhang et al., 2008b). Each of these models differs in the method of genetic disruption: (1) a spontaneous deletion of all nine exons occurring within the Tlx gene (referred to as “fierce” (*frc*)) (Young et al., 2002), (2) targeted deletion of Tlx by homologous recombination disruption of exons two and three (Monaghan et al., 1997) and exons three, four and five (Yu et al., 2000) (referred to as *Tlx-hr*), and (3) a floxed conditional deletion of Tlx by flanking exon 2 with two loxP sites (referred to as *Tlx-Cre-lox*; infection of a Cre-expressing virus results in deletion of the second Tlx allele) (Zhang et al., 2008b). The developmental period in which genetic disruption occurs also varies across studies in that it ranges from embryonic (spontaneous deletion and *Tlx-hr mice*) (Monaghan et al., 1997, Shi et al., 2004, Young et al., 2002, Yu et al., 2000) to

conditional disruption in adulthood (*Tlx-Cre-lox*) (Zhang et al., 2008b). Furthermore, the genetic background of these mouse models varies. The spontaneous deletion model has been investigated in B16129F1, C57BL/6J and 129P3/JEm mice (O'Leary et al., 2016a, Wong et al., 2010, Young et al., 2002, Monaghan et al., 1997, Roy et al., 2004), whereas the targeted deletion of *Tlx* by homologous recombination model has only been investigated within B16129F2 mice (Monaghan et al., 1997, Roy et al., 2004). Similarly, the floxed conditional deletion model has only been established with C57BL/6J mice (Zhang et al., 2008b). The background strain is known to affect the behavioural phenotype observed in knockout and transgenic mice as well as mutation-phenotype interaction and is therefore an important factor to consider when comparing findings from studies using mice bred on different genetic backgrounds (Jacobson and Cryan, 2007, Silva et al., 1997). For example, mice bred on a 129B6F1 background have been reported to outperform C57BL/6J mice in spatial learning paradigms (Wehner and Silva, 1996), while C57BL/6J mice have been shown to be hyperactive compared to 129 and hybrid 129BL/6J mice (Võikar et al., 2001). Sex-genetic-background interactions have also been shown to affect behavioural phenotype. For example, Võikar et al. (2001) reported that male hybrid 129BL/6J exhibited higher anxiety-like behaviour within the elevated plus maze compared to female counterparts. Thus, methodological differences in the generation of these models should be considered when making direct comparisons between different studies assessing the behavioural effects of *Tlx* manipulation. Nonetheless, disruption in *Tlx* expression results in a number of neuroanatomical and behavioural abnormalities across all deletion models of *Tlx*.

1.4.2 *Tlx* and learning and memory

The role of *Tlx* in cognitive processes such as learning and memory has been investigated in several different animal models of *Tlx* deletion. *Tlx* is expressed within the developing forebrain and the disruption of *Tlx* expression during this time results in the malformation of the amygdala, hippocampus and septum and poor performance across several learning paradigms dependent upon these malformed regions. The Morris water maze is a hippocampus-dependent spatial learning and memory task, and the hippocampus has been shown to be reduced within both B16129F1-*frc* and B16129F2-*Tlx-hr* mice (Morris, 1984). However, B16129F2-*Tlx-hr* mice show normal spatial learning acquisition within the Morris water maze despite their reduced hippocampal volume (Drill, 2009, Belz et al., 2007). Although, despite normal acquisition, behavioural flexibility within the Morris water maze was impaired (Drill, 2009). Furthermore, B16129F2-*Tlx-hr* mice also show no deficits in spontaneous alternation within the radial arm maze, another hippocampal-dependent task (Drill, 2009). This evidence suggests that malformations derived from early life *Tlx* disruption are not sufficient to impair performance on this hippocampal-dependent task, but do affect prefrontal-hippocampal-dependent behavioural flexibility. However, when *Tlx* function is impaired specifically during adulthood *Tlx* has also been shown to play a role in hippocampal-dependent cognitive processes through its regulatory effect on adult hippocampal neurogenesis. C57BL/6J-*Tlx-Cre-lox* mice exhibit impaired acquisition and short term recall measured 24 hours later, while long term recall was spared. This impairment was correlated with a decrease in hippocampal neurogenesis (Murai et al., 2014, Zhang et al., 2008a). While *Tlx* has been shown to

affect spatial learning, a neurogenesis-associated process, limited research on the role of *Tlx* in other neurogenesis-dependent tasks such as pattern separation has been carried out. It should be noted that pattern separation is regarded as a cognitive process which is most likely to be dependent on hippocampal neurogenesis (Aimone et al., 2011, Clelland et al., 2009, Creer et al., 2010, Sahay et al., 2011a, Sahay et al., 2011c). While adult C57BL/6J-*Tlx-Cre-lox* mice exhibit reduced adult hippocampal neurogenesis and impaired spatial learning within the Morris water maze (Zhang et al., 2008b), further investigation is still necessary to draw definitive conclusions on the role of *Tlx* in behaviour, and how mechanisms such as hippocampal neurogenesis might drive the behavioural effect resulting from *Tlx* disruption. It should also be noted that controversy remains regarding the role of adult hippocampal neurogenesis in spatial learning (Arruda-Carvalho et al., 2011, Clelland et al., 2009, Saxe et al., 2006b, Snyder et al., 2005b, Wojtowicz et al., 2008, Drapeau et al., 2003, Nada et al., 2013). Although, several studies have characterized the expression and the functional role of *Tlx* within the brain during embryonic and early postnatal development (Islam and Zhang, 2015, Monaghan et al., 1995, Roy et al., 2002, Wong et al., 2010, Roy et al., 2004), the functional role of *Tlx* during adolescence remains largely unexplored. In particular, it is not yet clear whether there are critical periods during postnatal life when *Tlx* might play a more dominant role in cognition, and whether such effects are sex-dependent. Thus, one aim of this thesis was to explore the extent and involvement of *Tlx* in learning and memory as well as hippocampal-independent functions during adolescence and adulthood in both male and female mice, see Chapter 2.

Differences in anxiety phenotypes have been reported in the spontaneous deletion model across different genetic backgrounds (*C57BL/6J-*frc** and *Bl6129F1-*frc**). *C57BL/6J-*frc** and *Bl6129F1-*frc** mice display an anxiolytic phenotype independent of sex, but dependent on strain within the elevated plus maze (Young et al., 2002). Specifically, adult male and female *C57BL/6J-*frc** mice exhibit reduced anxiety-like behaviour in the elevated plus maze, while male and female *Bl6129F1-*frc** mice showed similar levels of exploration to wild-type control mice (Young et al., 2002). In addition, *Bl6129F2-*Tlx-hr** mice also exhibit reduced anxiety-like behaviour within the elevated plus maze (Roy et al., 2002). Further investigations utilizing the adult conditional *C57BL/6J-*Tlx-Cre-lox** mice would help to establish a role for *Tlx* in anxiety-like behaviours and determine whether the anxiolytic phenotype is due to neurodevelopmental abnormalities or *Tlx* impairment in the adult brain. It is possible that reduced adult hippocampal neurogenesis may play a role in anxiety, however the contribution of new neurons in anxiety is still debated within the literature and a consensus has not been reached (Petrik et al., 2012). Moreover, the mechanisms underlying the sex-specific effects are currently unclear but there is a growing body of literature focusing on sex-dependent effects of adult hippocampal neurogenesis in stress and anxiety-related behaviours (Loi et al., 2014, Mahmoud et al., 2016). Taken together, early life disruption of *Tlx* produces an anxiolytic phenotype which may be explained by abnormal development of key limbic system structures, such as the hippocampus and amygdala, areas known to play a role in anxiety-related behaviours while the contribution of *Tlx* to anxiety-related behaviours in adulthood requires further investigation.

The most striking behavioural phenotype displayed by both male and female C57BL/6J-*frc* and Bl6129F1-*frc* mice is increased aggression (Abrahams et al., 2005, Young et al., 2002). Moreover, male C57BL/6J-*frc* mice are more aggressive compared to Bl6129F1-*frc* counterparts in both home cage and neutral arena encounters (Young et al., 2002). Female C57BL/6J-*frc* and Bl6129F1-*frc* mice also exhibit elevated aggression within a resident-intruder paradigm as well as reduced maternal behaviour resulting in the premature death of pups (Young et al., 2002). Conversely, heterozygous C57BL/6J-*frc* and Bl6129F1-*frc* mice display typical maternal behaviour and as such, heterozygous C57BL/6J-*frc* and Bl6129F1-*frc* mice have been used to breed experimental animals. Thus, controlling for potential effects of impaired maternal behaviour on the pups. Abrahams et al. (2005) utilized Bl6129F1-*frc* mice to develop a transgenic mouse line carrying the human nuclear receptor 2E1, and interestingly, these transgenic mice displayed similar levels of aggression compared to controls, suggesting the aggressive phenotype was rescued (Abrahams et al., 2005). These data indicate that similar mechanisms involving Tlx may underlie abnormalities in aggression in humans. However, currently no studies have been carried out investigating the role of Tlx in aggression in humans.

Similarly to the spontaneous deletion model, Bl6129F2-*Tlx-hr* mice exhibit a hyper-aggressive phenotype, displaying a greater number of attacks towards non-estrus females than control wild type littermates (Roy et al., 2002). Furthermore, the serotonin_{2A/C} receptor has been shown to mediate the aggressive phenotype of male Bl6129F2-*Tlx-hr* mice within the resident intruder paradigm (Juarez et al., 2013). While Juarez et al. (2013) observed less heterozygous mice engaged in aggression

(36%), those that did, displayed a similar aggressive phenotype (latency and duration of attacks) compared to B16129F2-*Tlx-hr* littermates (Juarez et al., 2013). Taken together, these data suggest that *Tlx* plays a role in aggression. These effects seem to be a result of neurodevelopmental deficits as elevated aggression is not observed in adult C57BL/6J-*Tlx-Cre-lox* mice (Zhang et al., 2008b) thus suggesting that the reported aggressive phenotype is a function of disruption to relevant neural circuits involved in emotional regulation during development/early life.

Hyperactivity has been observed in male B16129F1-*frc* mice (Wong et al., 2010). However, despite the similar developmental time frame of genetic disruption (early life) as well as similar neuroanatomical and emotional behavioural abnormalities, hyperactivity was not observed in B16129F2-*Tlx-hr* mice (Roy et al., 2002). This may be due to the fact that the striatum remains structurally intact in the B16129F2-*Tlx-hr* mice, resulting in normal locomotor activity (Drill, 2009). These findings suggest that disruption of motor activity may be a unique characteristic of the spontaneous deletion of *Tlx*. Furthermore, these effects on motor function may be a result of neurodevelopmental deficits as adult C57BL6/J-*Tlx-Cre-lox* mice do not exhibit a hyperactive phenotype, but motor performance on the rotarod has yet to be tested within these mice (Zhang et al., 2008b). Investigations into motor function (i.e. rotarod performance) following early life and adult disruption of *Tlx* is needed to further establish a role of *Tlx* in motor performance and corticostriatal pathways.

1.4.3 Tlx and neurogenesis

Tlx is a key intrinsic regulator of embryonic and adult neurogenesis (Islam and Zhang, 2015, Monaghan et al., 1995, Shi et al., 2004). Tlx has been shown to regulate neural stem cell (NSC) maintenance through complexing with histone deacetylases (HDACs) and recruitment of lysine-specific demethylase 1 (LSD1) and to regulate repression of several cell cycle genes including p21, Wnt7na, cyclinD1, p27Kip1 and Pten (Shi et al., 2004, Sun et al., 2007, Yokoyama et al., 2008, Sun et al., 2010, O'Léime et al., 2017). Furthermore, microRNA MiR-9 and MiR-219 have been shown to affect the post transcriptional regulation of Tlx expression (Murai et al., 2016, Zhao et al., 2009). Upregulation of miR-219 and a corresponding downregulation of Tlx has been shown in NSCs taken from patients with schizophrenia, suggesting a possible role of Tlx in neurodevelopment disorders such as schizophrenia (Murai et al., 2016). Expression of Tlx is localized within the neurogenic niche of the forebrain and retina throughout development and adulthood (Islam and Zhang, 2015, Monaghan et al., 1995, Shi et al., 2004). The temporal pattern of Tlx expression begins at embryonic day 8 (E8) peaking at E13.5 and decreasing by E16 (Drill, 2009, Monaghan et al., 1995). Expression begins to increase again postnatally continuing into adulthood (Monaghan et al., 1995, Shi et al., 2004). Tlx mRNA and protein is expressed within the lateral ganglionic eminence of the telencephalon as well as the developing amygdala, striatum, hippocampus and septum (Drill, 2009). Moreover, Tlx has been shown to regulate the timing of neurogenesis in the cortex during development, regulate the timing of postnatal astrogenesis through modulation of bone morphogenetic protein BMP-SMAD signalling (Qin et al., 2014), and to play a role in retinal development through

the regulation of the Pax 2 gene, Müller glia, S-cones, and glycinergic amacrine cell differentiation (Corso-Diaz and Simpson, 2015, Yu et al., 2000). Thus, Tlx plays a crucial role in neural and retinal development through its role in controlling cell cycle progression and exit of NSCs from quiescence (Corso-Diaz and Simpson, 2015, Li et al., 2008, Miyawaki et al., 2004, Roy et al., 2004, Roy et al., 2002, Shi et al., 2004, Yu et al., 2000).

Given the role of Tlx in embryonic neurogenesis and subsequent neural and retinal development, Tlx may play a possible role in neurodevelopment disorders. Indeed, early life deletion of Tlx causes neuroanatomical abnormalities such as decreased hippocampal volume, structural changes within the prefrontal cortex and amygdala as well as enlarged ventricles (Young et al., 2002). The neuroanatomical abnormalities observed in Tlx knockout mice are similar to those seen in patients with depression (decreased hippocampal volume) (Campbell et al., 2004, Videbech and Ravnkilde, 2004), as well as with bipolar disorder (structural and or volumetric changes within the prefrontal cortex, hippocampus and amygdala) (Andreazza and Young, 2014a, Strakowski et al., 2012a), and schizophrenia (enlarged ventricles and reduced hippocampal volume) (Ross et al., 2006). Disruption of Tlx expression also causes malformation of the lateral and basolateral amygdala, brain regions involved in the regulation of anxiety (Stenman et al., 2003, Tasan et al., 2010). Moreover, genetic variation at the Nr2e1 locus in humans has been linked to increased susceptibility to developing bipolar disorder (Kumar et al., 2008).

1.5 Exercise and the hippocampus

A growing body of evidence suggests that exercise in adulthood has a significant effect on the brain and behaviour (Voss et al., 2013, Gomez-Pinilla and Hillman, 2013), and may also protect against the cognitive decline associated with ageing and neurodegenerative disorders (Ryan and Kelly, 2016, Ryan and Nolan, 2016a, Brown et al., 2013). The development of animal models of exercise has helped to elucidate the molecular mechanisms underlying exercise-induced changes in cognition (Voss et al., 2013). In rodents, both short-term (1-2weeks) and prolonged (> 4 weeks) exercise paradigms, using either voluntary running wheel or forced treadmill exercise have been investigated (Kelly, 2015). Indeed, voluntary wheel running activity is a well adopted exercise paradigm of experience-based change in synaptic plasticity that simulates aspects of voluntary human behavior (Molteni et al., 2002). The voluntary wheel running paradigm promotes *ad libitum* exercise and therefore running, speed, distance and duration vary between animals, which is thought to closely model human exercise regimes, whereas, in forced treadmill exercise paradigms, the running time, speed and distance are fixed experimental parameters (Voss et al., 2013). Moreover, the forced treadmill running has also been shown to produce physiological adaptations indicative of chronic stress, which may alter exercise derived changes in behaviour (Moraska et al., 2000). However, for the most part, studies investigating the effects of chronic running wheel or treadmill exercise have shown enhanced hippocampal-dependent cognition and these enhancements are associated with significant changes in the neurocircuitry involved in learning and memory, particularly the hippocampus (Brockett et al., 2015, Creer et al., 2010). Thus exercise may be a simple non-

pharmacological means to maintain brain function and promote plasticity as well as a therapeutic treatment for psychiatric disorders in which hippocampal function is altered.

1.5.1 Exercise and learning and memory

Prolonged running wheel and treadmill exercise (seven to twelve weeks) in adulthood has been shown to enhance hippocampal-dependent cognition, such as spatial learning in the Morris water maze in adult and aged rats (Anderson et al., 2000, Ang et al., 2006, Albeck et al., 2006) and mice (Rhodes et al., 2003, van Praag et al., 2005). Contextual fear conditioning, another hippocampal-dependent task, has also been shown to be enhanced following prolonged (four, six or eight weeks) wheel running exercise in adult rats (Baruch et al., 2004, Burghardt et al., 2006, Greenwood et al., 2009) and mice (Kohman et al., 2012, Clark et al., 2008, Dubreucq et al., 2011). In addition, pattern separation has been shown to be enhanced following prolonged (ten weeks) running wheel exercise in adult and aged mice using both the touchscreen operant chamber (Creer et al., 2010) and fear conditioning paradigms (Wu et al., 2015). Likewise, prolonged (six weeks) forced treadmill exercise has been shown to increase pattern separation assessed using the radial arm maze in mice (So et al., 2017). Long-term potentiation (LTP), a physiological model of learning and memory in the DG (Bliss and Collingridge, 1993), has been shown to be increased following exercise (Vivar et al., 2013, van Praag et al., 1999a). Specifically, field recordings in acute hippocampal slices of mice exposed to eight weeks of voluntary wheel running exercise showed an

increase in LTP in the DG compared to sedentary controls (Vivar et al., 2013, van Praag et al., 1999a). Similarly, *in vivo* recordings within the DG exhibited enhanced LTP following one week exposure to voluntary wheel running (Farmer et al., 2004) or forced treadmill exercise (O'Callaghan et al., 2007). However, exercise does not appear to promote all types of hippocampal-dependent cognition, as previous studies have reported contradictory findings in both spatial working memory and novel object recognition. Voluntary wheel running exercise for six to seven weeks was demonstrated to improve spatial working memory in the radial arm maze in rats (Anderson et al., 2000, Gram et al., 2016, Alomari et al., 2016), whereas, spatial working memory in the T-maze was reportedly unaffected following one week of forced exercise in rats (Acevedo-Triana et al., 2017). In addition, novel object recognition, a hippocampal and perirhinal cortex-dependent processes has shown differential effects of exercise on performance. Previous studies have reported contradictory findings of exercise on object recognition, with some studies demonstrating enhanced performance following either voluntary or forced exercise (one to four weeks) (O'Callaghan et al., 2007, Griffin et al., 2009, Bolz et al., 2015, Hopkins and Bucci, 2010), and others reporting no effect of wheel running exercise (two to four weeks) on recognition memory (Brockett et al., 2015, Bolz et al., 2015). Thus, further work is needed to fully elucidate the effects of exercise on certain types of hippocampal-dependent cognition. It has been well established that exercise conveys pro-cognitive effects in the aging brain (Ryan and Kelly, 2016, Ryan and Nolan, 2016b). Indeed, both voluntary and forced running during middle and later age have been shown to improve performance in hippocampus-dependent memory tasks in

rats (Albeck et al., 2006, Adlard et al., 2005), mice (van Praag et al., 2005, Gibbons et al., 2014) as well as humans (Duzel et al., 2016, Erickson et al., 2011, Intlekofer and Cotman, 2013). However, how exercise interventions that begin earlier in life such as, adolescent or young adult affect aged-related hippocampal-dependent impairments is yet to be fully explored.

1.5.2 Exercise and hippocampal neurogenesis

The survival rate of newly born neurons in the hippocampus has been shown to be increased by exposure to a more complex environment, suggesting that adult hippocampal neurogenesis may be regulated by experiences (Gould et al., 1999a, Kempermann et al., 1998). Specifically, Kempermann et al. (1998) demonstrated that exposure to enriched environments enhanced the survival rate of newly formed neurons. Under environmentally enriched conditions there is increased opportunity for learning, socialization, and physical activity (van Praag et al., 2000). Indeed, physical activity has been shown to be a critical component of the effects of environmental enrichment on hippocampal neurogenesis (Kobilo et al., 2011, van Praag et al., 2000). Furthermore, both short term (one week) (van Praag et al., 1999a) and prolonged (twelve weeks) (Creer et al., 2010) running wheel exercise in adulthood has been shown to be a potent stimulator of hippocampal neurogenesis. Indeed, it is hypothesized that the beneficial effects of exercise on hippocampal-dependent cognition is due, in part, to its pro-neurogenic capacity (Clark et al., 2008, Ji et al., 2014). Interestingly, the pro-neurogenic effects of exercise appear to be restricted to the hippocampus, as adult neurogenesis within the olfactory bulb has been shown to be unaffected following

running (Brown et al., 2003). Voluntary wheel running has been shown to increase proliferation and cell survival within the hippocampus (van Praag et al., 1999b). Furthermore, both prolonged (five weeks) voluntary wheel running and forced treadmill exercise have been shown to combat the age-related decline in hippocampal neurogenesis, with enhances in the proliferation and survival of neuronal progenitor cells within the DG of aged mice (van Praag et al., 2005, Wu et al., 2008, Kronenberg et al., 2006). Moreover, the exercise induced increase in cell proliferation occurs without altering apoptosis in the DG (Kim et al., 2002). Furthermore, while short term exercise has been shown to increase cell proliferation, exercise induced increase in immature neurons, as measured by doublecortin (DCX), a marker of immature neurons, only occur following 14 days of exercise (Patten et al., 2013). These data suggest that later cellular developmental stages, such as neuronal differentiation require greater periods of exercise to impact. Indeed, the duration of exercise has been suggested to be an important factor in the pro-neurogenic capacity of exercise. Lucassen et al. (2010) suggested that short periods of exercise (a few days) convey positive effects on hippocampal neurogenesis whereas prolonged periods (several weeks) exerts a negative impact on hippocampus neurogenesis effects (Lucassen et al., 2010, Naylor et al., 2005, Droste et al., 2003). To date, the majority of studies investigating the impact of exercise on hippocampal neurogenesis has been reported in adulthood. Thus, how exercise affects hippocampus neurogenesis during different developmental periods, when basal levels of cell proliferation and survival are altered is yet to be fully understood.

1.5.3 Exercise and neural plasticity

Running has been shown to induce morphological changes. Short-term (one week) running wheel exercise has been shown to reorganize of the circuitry of new born neurons in the hippocampus in mice (Sah et al., 2017). Sah et al. (2017) demonstrated that one week of exercise increased arborization of immature adult born granule cells. Specifically, the cell body and total dendrite length were significantly larger in running animals compared to controls. In addition, the number of dendrite branch points, a measure used to quantify the complexity of a neuron, was greater in mice that had undergone exercise compared to sedentary controls (Sah et al., 2017). Likewise, running wheel exercise for two weeks increased the dendritic length and the number of dendritic spines of granule neurons in the DG in rats (Eadie et al., 2005). Moreover, Dostes et al. (2016) demonstrated that the effect of exercise on neuronal morphology was activity-dependent, with mice given unlimited (24 hour) access to a running wheel for three weeks exhibiting a greater increase in dendritic complexity compared to mice with limited (3 hour) running wheel access also for three weeks. Moreover, prolonged running wheel exercise (twelve weeks) has been shown to increase the dendritic spine density not only in granule neurons of the DG, but also in the CA1 pyramidal neurons, and in layer III of the entorhinal cortex in rats (Stranahan et al., 2007, Siette et al., 2013). In the CA1 region, exercise induced changes were accompanied by changes in dendritic arborization and alternations in the morphology of individual spines. Specifically, running animals had longer dendritic spines on pyramidal neurons in the CA1 (Stranahan et al., 2007). These findings suggest that exercise accelerates new neuron maturation by increasing their dendritic complexity and spine density but does

not result in overall changes by the time the neurons are one month old (Eadie et al., 2005, Stranahan et al., 2007, Vaynman et al., 2004, Dostes et al., 2016). In addition, exercise has also been shown to increase hippocampal mRNA and protein expression of PSD-95, and synaptophysin markers of synaptic plasticity (Vaynman et al., 2006). Furthermore, previous work has shown that BDNF within the DG can alter cellular and dendritic morphology of granule neurons in the DG and pyramidal neurons in the CA1 (Tyler and Pozzo-Miller, 2003, Tolwani et al., 2002, McAllister et al., 1997). Thus, exercise induces morphological changes in neurons may be mediated by neurotrophic factors, such as BDNF. Exercise that begins in earlier life (PND 29) and continues into late adolescence (PND 49) has been shown to have a similar effect on neuronal morphology to exercise that begins later in life, with increases in cell density within the hippocampus (CA1, CA3 and DG) as well as preferentially enhancing synaptophysin protein levels within the ventral hippocampus in rats (Hescham et al., 2009). However, whether there are differences in the functional outcome of early exercise onset and hippocampal neuronal morphology is yet to be fully explored.

Trophic factors associated with progenitor cell survival and differentiation (Gage, 2012), alterations in synaptic strength (Schuman, 1999), as well as learning and memory (Fischer et al., 1987), are elevated after several days of exercise (Neeper et al., 1995, Gomez-Pinilla et al., 1997). Brain derived neurotrophic factor (BDNF) plays a key role in the regulation of hippocampal neurogenesis through promotion of cell survival of newly differentiated neurons (Foltran and Diaz, 2016). Both intra-hippocampal infusion of BDNF in rats (Scharfman et al., 2005) and chronic peripheral

administration of BDNF in mice (Schmidt and Duman, 2010), has been shown to increase the number and survival of newborn neurons in the DG. Exposure to voluntary wheel-running in adulthood for one week increases levels of BDNF mRNA and protein within the hippocampus (Neeper et al., 1995, Neeper et al., 1996, Cotman and Berchtold, 2002, Berchtold et al., 2001, Uysal et al., 2015). Specifically, hippocampal BDNF levels were increased in both young mice (Rhodes et al., 2003) and aged mice following one or six months of voluntary wheel running exercise (Marlatt et al., 2012). Additionally, exercise that begins earlier in life (PND 21) and continues into adulthood (PND 60) has also been shown to increase hippocampal levels of BDNF (Gomes da Silva et al., 2012). Acute wheel running exercise (6 h) in mice has been shown to increase BDNF mRNA expression within the hippocampus and this exercise-induced increase was mediated by cAMP-response-element binding protein (CREB), a transcription factor involved in the maintenance of synaptic plasticity and cell survival (Chen and Russo-Neustadt, 2009). Fibroblast Growth Factor (FGF-2) promotes proliferation and differentiation of hippocampal NPCs in rats and mice (Palmer et al., 1999, Yoshimura et al., 2001), and has also been shown to be elevated following one week of voluntary running-wheel exercise in rats (Gomez-Pinilla et al., 1997, Gomez-Pinilla et al., 1998).

Insulin-like growth factor-I (IGF-I) is a growth-promoting peptide hormone that is expressed in the developing hippocampus. It has been shown to promote proliferation and neuronal differentiation of progenitor cells resulting in increased neurogenesis in the adult rat hippocampus (Cameron et al., 1998). Acute forced treadmill exercise for

one hour has been demonstrated to increase uptake of circulating IGF-1 in rats (Carro et al., 2000, Annenkov, 2009). Additionally, peripheral infusion of IGF-1 has been shown to enhance hippocampal neurogenesis in rats (Åberg et al., 2000). Moreover, IGF-1 has been reported to increase hippocampal BDNF gene expression therefore IGF-1 may be an important mediator of exercise-induced increases in hippocampal neurogenesis through action upon BDNF signalling (Carro et al., 2000, Trejo et al., 2008).

Nerve growth factor (NGF) is known to increase the survival of adult newly born neurons (Frielingsdorf et al., 2007). Furthermore, NGF mRNA expression has been reported to be increased within the hippocampus following one week of running wheel exercise (Neeper et al., 1996). Basic fibroblast growth factor (bFGF) has also been shown to increase proliferation of NPCs during development (Tropepe et al., 1999). In addition, one week of running wheel exercise has been shown to increase FGF-2 mRNA expression within the hippocampus (Gomez-Pinilla et al., 1997).

Vascular endothelial growth factor (VEGF) regulates hippocampal neurogenesis, through the VEGF receptor (Flk-1) which is expressed on hippocampal NPCs (Yang et al., 2003). Disruption of *Vegf* gene expression impairs cell proliferation and differentiation of new born neurons within the hippocampus (Sun et al., 2006). VEGF has also been demonstrated to regulate the exercise-induced effects on hippocampal neurogenesis (Fabel et al., 2003). Given the VEGF receptor (Flk-1) is expressed on

hippocampal NPCs, exercise-induced changes in VEGF may act directly upon hippocampal NPCs (Yang et al., 2003). Moreover, blockage of VEGF signalling by an VEGF antagonist prevented the exercise-induced increase in the number of immature neurons in the DG of mice following one week of running wheel access (Fabel et al., 2003). Although neurotrophic factors, including NGF (Neeper et al., 1996) and FGF-2 (Gomez-Pinilla et al., 1997), have been reportedly increased in the hippocampus following voluntary running wheel exercise in rats, this upregulation appears to be transient and less robust compared to that of BDNF, suggesting that BDNF may be a candidate for mediating the long-term benefits of exercise on hippocampal functioning. Taken together, these findings suggest that the effect of exercise on dendritic complexity within the hippocampus may in part be mediated by BDNF.

1.6 Inflammation and the hippocampus

There is a growing consensus that the increasing impact of age and stress-related inflammatory insults on daily living positions neuroinflammation as a significant protagonist of neurodegeneration and associated cognitive disorders (Amor et al., 2010, Green and Nolan, 2014, Ryan and Nolan, 2016b). The hippocampus is particularly vulnerable to neuronal degeneration and the consequent cognitive dysfunction associated with ageing, neurodegenerative and psychiatric disorders (Conrad, 2008, Bartsch and Wulff, 2015). A common pathological feature of these neurodegenerative and psychiatric disorders, as well as in normal ageing, is neuroinflammation, which has been consistently shown to negatively affect hippocampal-dependent processes (Amor

et al., 2010, Barrientos et al., 2015, Green and Nolan, 2014, Nolan et al., 2013, Ryan and Nolan, 2016b). Understanding the contribution of neuroinflammation to hippocampal disruption may help to understand the cognitive decline associated with ageing and neurodegenerative disorders.

1.6.1 The pro-inflammatory cytokine interleukin-1 β

The pro-inflammatory cytokine Interleukin-1 (IL-1) is produced primarily by macrophages and monocytes as well as by glia and neurons within the brain (Srinivasan et al., 2004, Palomo et al., 2015, Rothwell and Luheshi, 2000). IL-1 is produced in two forms, IL-1 α and IL-1 β , whose signalling is mediated by the IL-1 receptor type I (Palomo et al., 2015). Furthermore, IL-1 β is a major mediator of neuroinflammation and is highly expressed within the hippocampus (Ban et al., 1991, Parnet et al., 1994). It has been shown that hippocampal neurons express the IL-1R1 and respond to IL-1 β through its cognate receptor IL-1R1 to impair LTP (Lynch, 2015). IL-1R1 is also expressed on hippocampal NPCs, thus making NPCs vulnerable to inflammatory insults (Green and Nolan, 2012b). The primary source of inflammatory cytokines in the brain is glia and both microglia and astrocytes can be stimulated to produce IL-1 β , TNF α and IL-6 (Minogue et al., 2012, Cowley et al., 2012). Sustained microglial activation in response to chronic stress, infection, toxins or age is responsible for prolonged release of the prototypic cytokine IL-1 β from microglia, which influences the normal function of neurons (Lull and Block, 2010).

1.6.2 IL-1 β and learning and memory

Evidence indicates that IL-1 β is required for hippocampal-dependent learning and memory under quiescent conditions. Schneider et al. (1998) demonstrated that IL-1 β mRNA expression in the CA1 and DG was substantially increased during long term potentiation (LTP), a process underlying hippocampal learning and memory, in rats. However, under chronic inflammatory conditions such as those reported in ageing and neurodegenerative disorders, IL-1 β has a detrimental effect on memory processes (Goshen et al., 2007, Hauss-Wegrzyniak et al., 2002, Kohman and Rhodes, 2013, Lynch et al., 2010). Particularly, impaired interleukin-1 signalling is associated with deficits in hippocampal memory processes and neural plasticity (Avital et al., 2003). Furthermore, acute elevations in hippocampal IL-1 β has been shown to inhibit long-term potentiation (LTP) within the DG and CA3 region of the hippocampus of both rats and mice (Katsuki et al., 1990, Cunningham et al., 1996, Lynch, 2015). Impairments in hippocampal-dependent cognition have primarily been observed in studies investigating the effects of acute IL-1 β exposure. Acute intracerebroventricular administration of recombinant IL-1 β protein (Oitzl et al., 1993), as well as prolonged overexpression of IL-1 β in transgenic mice has been reported to impair spatial learning in the Morris water maze in Wistar rats (Moore et al., 2009, Hein et al., 2010). Previous work has shown impaired spatial working memory in the radial arm maze following acute intra-hippocampal administration of IL-1 β recombinant protein in Wistar rats (Matsumoto et al., 2004). Similarly, acute intra-hippocampal administration of IL-1 β has also been shown to impair other hippocampal-dependent tasks such as contextual fear recall in Wistar rats (Gonzalez et al., 2009). Lipopolysaccharide (LPS) has been

shown to induce an acute elevation of IL-1 β and to impair both spatial and contextual memory in rats (Gibertini et al., 1995, Goshen et al., 2007, Barrientos et al., 2002). However, the impact of prolonged increases in IL-1 β on hippocampal neurogenesis-dependent cognitive function is yet to be fully explored.

Chronic neuroinflammation is associated with neurodegenerative disorders (Amor et al., 2010). Indeed, pro-inflammatory cytokine expression is elevated in neurodegenerative disorders (Shaftel et al., 2008, Freeman and Ting, 2016). Specifically, increased levels of IL-1 β protein has been shown in postmortem tissue of the striatum and *substantia nigra* of patients previously diagnosed with Parkinson's disease (Tansey and Goldberg, 2010), as well as in brain tissue and plasma of patients previously diagnosed with Alzheimer's disease (Swardfager et al., 2010, Meraz-Ríos et al., 2013). Moreover, accumulating evidence suggests that IL-1 β might contribute to the development or even cause Alzheimer's disease. In particular, IL-1 β can induce APP- β mRNA expression in endothelial cells (Meraz-Ríos et al., 2013), which suggests that IL-1 β increasing in AD patients could be linked to A β formation. Although it is well established that acute neuroinflammation reduces adult hippocampal neurogenesis, the role of chronic neuroinflammation, which may be more representative of ongoing processes in CNS disorders, remains relatively unknown.

1.6.3 IL-1 β and hippocampal neurogenesis

NPCs have been shown to express the type 1 IL-1 receptor (IL-1R1), suggesting that IL-1 β may act directly upon NPCs (Green et al., 2012). Acute IL-1 β exposure has also been shown to negatively impact upon hippocampal neurogenesis, both *in vitro* (Green and Nolan, 2012b, Ryan et al., 2013, Zunszain et al., 2012) and *in vivo* (Vallières et al., 2002, McPherson et al., 2011, Wu et al., 2013). Furthermore, chronic administration (four weeks) of IL-1 β into the dorsal hippocampus via osmotic mini-pumps has been shown to decrease the number of DCX-positive cells in the DG in mice (Goshen et al., 2008). Similarly, transgenic overexpression of IL-1 β has also been shown to reduce DCX-positive cells in the DG in mice (Wu et al., 2012). Similarly, acute intracerebroventricular administration of IL-1 β also decreases cell proliferation, in the DG in rats (Koo and Duman, 2008). Moreover, IL-1 β is known to disrupt brain-derived-neurotrophic-factor (BDNF) signalling, a major mediator of neurogenesis (Tong et al., 2008, Tong et al., 2012, Ryan et al., 2013, Green and Nolan, 2012b). Therefore, it is possible that IL-1 β may affect hippocampal neurogenesis through both direct action on NPCs through the IL-1R1 signalling and indirectly through disruption of BDNF signalling. Taken together, these findings suggest impairments in hippocampal neurogenesis by inflammation may be mediated through pro-inflammatory cytokines, such as IL-1 β , which alter neuronal differentiation and integration, subsequently affecting hippocampal-dependent processes (Yirmiya and Goshen, 2011, Mathieu et al., 2010). Understanding the basis of inflammatory-induced changes in hippocampal neurogenesis will provide us with valuable information on the

functional importance of new neurons, and the potential use of adult neurogenesis for repair and regeneration of hippocampal function.

1.7 Stress and the hippocampus

Chronic stress is a risk factor for the development of psychiatric disorders such as depression, anxiety disorders, and post-traumatic stress disorder (Hammen, 2005, de Kloet et al., 2005, de Kloet et al., 2016, Lucassen et al., 2013). Interestingly, these stress-related psychiatric disorders are also characterized by impairments in various aspects of cognitive functioning. Indeed, chronic stress has profound effects on the brain and behaviour, influencing a wide range of cognitive processes in both rodents and humans, such as spatial learning (Conrad, 2010, Schwabe et al., 2007), working memory (Kim and Diamond, 2002, Schoofs et al., 2008) as well as cognitive flexibility and decision making (Dias-Ferreira et al., 2009, Lee and Goto, 2015). Stress-induced impairment in cognitive function in rodents is often associated with significant changes in the underlying neurocircuitry of learning and memory, particularly the hippocampus (Figure 1.6) (McEwen, 2007). The effects of stress on cognition have been suggested to be mediated at least in part through changes in hippocampal neuronal morphology, such as impaired synaptic plasticity (Kim and Diamond, 2002), and reduced proliferation and survival of adult born hippocampal neurons (Egeland et al., 2015, Gould and Tanapat, 1999, Mirescu and Gould, 2006).

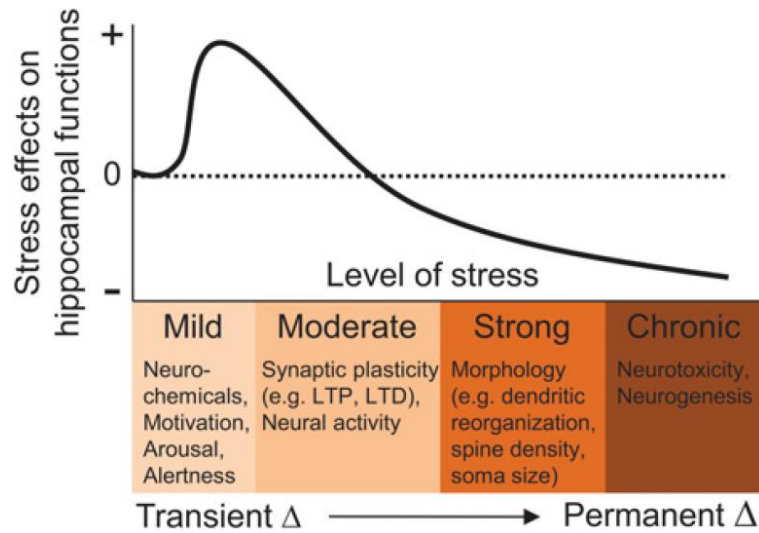

Figure 1.6: Biological effects of stress on the hippocampus. As the severity (intensity, duration) of stress increases, alterations in neurochemicals, synaptic plasticity, neural activity, morphology, and neurogenesis occur in the hippocampus that can influence hippocampal cognitive processes. Adapted from Kim et al. (2015c).

Understanding the impact of chronic stress on hippocampal-dependent cognitive processes may help to understand the aetiology of psychiatric disorders such as depression and anxiety-related disorders, and the development of affective therapeutic treatments.

1.7.1 Chronic stress and hippocampal-dependent cognition

The chronic unpredictable stress (CUS) paradigm has been widely used as an behavioural model to investigate the impact of prolonged stress on the brain and behaviour, it consists of the random, intermittent, and unpredictable exposure to a variety of stressors over the course of several weeks (Monteiro et al., 2015). Although other behavioural models of chronic stress have been developed, such as physical restraint stress and foot shock, the intermittent and unpredictability of the CUS

paradigm has been suggested to closely model the “everyday life stress” experienced by humans (Monteiro et al., 2015, Crawley, 2007). To date, stress-induced impairments in cognitive function in rodents have been reported to be associated with significant changes in the underlying neurocircuitry of learning and memory, particularly the hippocampus (McEwen, 2007). The high density of glucocorticoid and IL-1R1 receptors within this area are implicated in the effects of stress and inflammation on hippocampal-dependent cognition (Conrad, 2008, Mirescu and Gould, 2006, Farrar et al., 1987). In response to both acute and chronic stress, neurons undergo morphological changes, including dendritic atrophy and spine reduction, which have a negative impact on hippocampal-dependent cognitive processes (de Kloet et al., 2005). Previous reports that have shown that chronic restraint stress induces impairment in location memory in rats (Beck and Luine, 2002, Bowman et al., 2003). Similarly, spatial learning in the Morris water maze, another hippocampal-dependent task, has also been shown to be impaired following both chronic restraint stress (Kitraki et al., 2004) and chronic unpredictable stress (McFadden et al., 2011) in rats. These behavioural impairments were correlated with a decrease in glucocorticoid receptor immunoreactivity within the CA1 area and the DG as well as a reduction in new born neurons within the hippocampus (Kitraki et al., 2004, Gould and Tanapat, 1999). Furthermore, chronic restraint stress has been shown to induce impairments in object location memory, another hippocampal-dependent task, in rats (Beck and Luine, 2002, Bowman et al., 2003). Previous studies have reported contradictory findings of stress effects on object recognition, with some studies demonstrating stress-induced impairments following chronic restraint stress in rats (Luine, 2002, Bowman et al.,

2003), and others reporting no effect of chronic restraint stress in rats (Bowman et al., 2003, Bowman et al., 2006). Likewise, performance in spatial working memory, a task requiring an intact hippocampus and prefrontal cortex has resulted in conflicting behavioural outcomes. Pothion et al. (2004) reported that spontaneous alternation in the Y-maze was unaffected following chronic mild stress in mice, whereas, chronic restraint stress has been shown to impair spatial working memory in the Y-maze in rats (Conrad et al., 1996, Wright and Conrad, 2005). The reason for the differences in findings is unclear and future work is needed to fully elucidate the impact of chronic stress of hippocampal dependent cognition.

1.7.2 Stress and hippocampal neurogenesis

Stress has been shown to have a negative effect on hippocampal neurogenesis (Egeland et al., 2015, Gould and Tanapat, 1999). The effects of stress on cognition have been suggested to be mediated at least in part through changes in hippocampal neuronal morphology, such as impaired synaptic plasticity (Kim and Diamond, 2002), and reduced proliferation and survival of adult born hippocampal neurons (Egeland et al., 2015, Gould and Tanapat, 1999, Mirescu and Gould, 2006). While the specific mechanistic links between stress and cognition are not fully known, a variety of stress regimes have been developed which demonstrate this antineurogenic effect. Both, Koo and Duman (2008) and Dias-Ferreira et al. (2009) demonstrated that acute and chronic unpredictable stress decreased cell proliferation within the hippocampus in rats. Similarly, chronic mild stress has also been shown to decrease the number of proliferating cells and newly born neurons in the DG of mice (Goshen et al., 2008).

Moreover, psychosocial stress elicited by the exposure of rats to the odor of a natural predator, such as a fox odor, has been demonstrated to reduce cell proliferation within the hippocampus in rats (Tanapat et al., 2001). Psychological stress is a major contributing factor of depression (Anacker and Pariante, 2012), and repeated exposure to psychological stress impairs cell proliferation, cell survival and decreases the growth of new neurons in the hippocampus in rats (Magariños et al., 1997), and tree shrew (Gould et al., 1997b), coupled with an increase in depressive-like behaviours (Monteiro et al., 2015). Furthermore, in the learned helplessness model of depression, inescapable stress has been shown to decrease hippocampal neurogenesis in rats (Malberg and Duman, 2003). Administration of fluoxetine, a selective serotonin reuptake inhibitor, reportedly blocked the stress induced downregulation of cell proliferation (Malberg and Duman, 2003). These findings suggest that stress-induced effects on depressive and cognitive processes, may in part be mediated through hippocampal neurogenesis (Levone et al., 2015).

1.8 Objectives

Adult hippocampal neurogenesis is modulated by a number of intrinsic and extrinsic factors. Tlx is crucial in maintaining NPCs within the neurogenic niche and IL-1 β has been shown to regulate neurogenesis through changes in Tlx expression. Therefore, the goal of this thesis was to investigate the role of intrinsic regulators of hippocampal neurogenesis, such as Tlx and IL-1 β as well as extrinsic regulators, such as exercise and stress on learning and memory during adolescence and adulthood.

AIM 1: The first aim of this thesis, addressed in chapter 2 was to explore the extent of an early life disruption of Tlx on motor, cognitive and anxiety-related behaviour during adolescence and adulthood in both males and females by using mice with a spontaneous deletion of Tlx (Nr2e1^{-/-} mice).

AIM 2: The second aim of this thesis, addressed in chapters 3 and 4 was to determine the impact of adolescent-initiated exercise on pattern separation and contextual and cued fear conditioning and the potential role of plasticity to mediate these behavioural changes.

AIM 3: The third aim of this thesis, addressed in chapter 5 was to examine the impact of chronic lentiviral overexpression of IL-1 β within the dorsal hippocampus on

hippocampal neurogenesis and pattern separation using both touchscreen and object-location paradigms.

AIM 4: The fourth aim of this thesis, addressed in chapter 6 was to examine the impact of chronic unpredictable stress and chronic lentiviral overexpression of IL-1 β within the dorsal hippocampus on memory and depressive-like behaviour.

CHAPTER 2

The Nuclear Receptor Tlx Regulates Motor, Cognitive and Anxiety-Related Behaviours during Adolescence and Adulthood

This work has been published

O'Leary, J.D⁺, Kozareva, D.A⁺, Hueston, C.M., O'Leary, O.F., Cryan, J.F. & Nolan, Y.M. (2016). The nuclear receptor Tlx regulates motor, cognitive and anxiety-related behaviours during adolescence and adulthood. *Behavioral Brain Research* **306**, 36-47. ⁺ Equal contribution.

2.1 Abstract

The nuclear receptor Tlx is a key regulator of embryonic and adult hippocampal neurogenesis and has been genetically linked to bipolar disorder. Mice lacking Tlx (*Nr2e1*^{-/-}) display deficits in adult hippocampal neurogenesis and behavioural abnormalities. However, whether Tlx regulates behaviour during adolescence or in a sex-dependent manner remains unexplored. Therefore, the role of Tlx was investigated in a series of behavioural tasks in adolescent male and female mice with a spontaneous deletion of Tlx (*Nr2e1*^{-/-} mice). Testing commenced at adolescence (postnatal day 28) and continued until adulthood (postnatal day 67). Adolescent male and female *Nr2e1*^{-/-} mice were hyperactive in an open field, an effect that persisted in adulthood. Male but not female *Nr2e1*^{-/-} mice exhibited reduced thigmotaxis during adolescence and adulthood. Impairments in rotarod motor performance developed in male and female *Nr2e1*^{-/-} mice at the onset of adulthood. Spontaneous alternation in the Y-maze, a hippocampus-dependent task, was impaired in adolescent but not adult male and female *Nr2e1*^{-/-} mice. Contextual fear conditioning was impaired in adolescent male *Nr2e1*^{-/-} mice only, but both male and female adolescent *Nr2e1*^{-/-} mice showed impaired cued fear conditioning, a hippocampal-amygdala dependent cognitive process. These deficits persisted into adulthood in males but not females. In conclusion, deletion of Tlx impairs motor, cognitive and anxiety-related behaviours during adolescence and adulthood in male and female mice with most effects occurring during adolescence rather than adulthood independent of housing conditions. This suggests that Tlx has functions beyond regulation of adult hippocampal neurogenesis, and may be an important target in understanding neurobiological disorders.

2.2 Introduction

The orphan nuclear receptor Tlx, encoded by the gene *Nr2e1*, is a key regulator of embryonic and adult neurogenesis, with expression localized within the neurogenic niche of the forebrain and retina (Islam and Zhang, 2015, Monaghan et al., 1995, Shi et al., 2004). Tlx has been shown to be crucial for neural and retinal development (Li et al., 2008, Miyawaki et al., 2004). Mice lacking Tlx display hypoplasia of the retina, cerebrum and olfactory bulbs as well as malformation of the limbic system, specifically the DG within the hippocampus (Miyawaki et al., 2004, Monaghan et al., 1997, Roy et al., 2002, Young et al., 2002, Yu et al., 2000). Moreover, deletion of Tlx has been shown to impair adult neurogenesis, synaptic plasticity and to negatively affect dendritic structure within the DG of adult mice (Christie et al., 2006). Thus, alterations in Tlx expression are likely to affect hippocampus-dependent behaviour.

Several different mouse models have been developed to target Tlx *in vivo*, such as targeted disruption by homologous recombination (Roy et al., 2002, Shi et al., 2004), spontaneous deletion (Young et al., 2002) and conditional deletion (Zhang et al., 2008b) (collectively referred to here as *Nr2e1*^{-/-}). Differences between these models make it difficult to draw comparisons. However, similarities are seen across models as mice with impairments in Tlx function have shown a number of behavioural abnormalities. The most striking behavioural phenotype of mice with a spontaneous deletion is aggression, which is regulated by the prefrontal cortex and limbic system

(Rosell and Siever, 2015). This circuitry has previously been shown to be defective in *Nr2e1*^{-/-} mice with both a targeted disruption of Tlx by homologous recombination and spontaneous deletion (Monaghan et al., 1997, Young et al., 2002). Hyperactivity has also been documented in mice with a spontaneous deletion of Tlx from as early as postnatal day (P) 18 (Wong et al., 2010). Furthermore, impairments in spatial learning have been observed in adult mice with a conditional deletion of Tlx, while contextual and cued fear memory were unaffected (Zhang et al., 2008b). Conversely, it has been shown that following a targeted disruption of Tlx by homologous recombination, mice exhibited poor contextual and cued fear recall, despite normal fear acquisition, in addition to reduced anxiety-like behaviour within the elevated plus maze (Roy et al., 2002). The reasons for the discrepancies across studies in adult mice are unclear but may be a function of the different methods used to reduce or inhibit Tlx expression, and/or when Tlx disruption occurs, such as early life or adulthood (Roy et al., 2002, Zhang et al., 2006). When the Tlx transgene was overexpressed using lentivirus-mediated means or in transgenic mice, an increase in adult hippocampal neurogenesis and enhanced performance in the Morris water maze as well as prepulse inhibition was observed (Murai et al., 2014). This work suggests a role for Tlx in learning and memory through its regulatory effect on adult hippocampal neurogenesis.

The mammalian brain continues to develop after birth, throughout childhood and into adulthood (Sisk and Foster, 2004, Spear, 2004). The adolescent period, which occurs in mice in postnatal weeks 3-8 (Laviola et al., 2003), is a critical developmental window when crucial neural circuits are established via a period of synaptic re-modelling

(Andersen, 2003, Blakemore and Choudhury, 2006) and is a key period for susceptibility to stress and the emergence of neurobiological disorders such as schizophrenia, depression and anxiety (Fuhrmann et al., 2015, Giedd et al., 2008, Green and Nolan, 2014, O'Connor and Cryan, 2014, Spear, 2007). Interestingly, linkage analysis studies of patients with bipolar disorder have reported susceptibility loci on chromosomes where *Nr2e1* is expressed (Kumar et al., 2008) thus suggesting a potential link between Tlx and mood disorders. Several studies have characterized the expression and the functional role of Tlx within the brain during embryonic and early postnatal development (Islam and Zhang, 2015, Monaghan et al., 1995, Roy et al., 2004, Roy et al., 2002, Wong et al., 2010). However, the functional role of Tlx during adolescence remains largely unexplored. In particular, it is not yet clear whether there are critical periods during postnatal life when Tlx might play a more dominant role in cognition, and whether such effects are sex-dependent. Thus, the aim of this study was to explore the extent and involvement of Tlx in hippocampus dependent cognition as well as hippocampus-independent functions during adolescence and adulthood in both male and female mice.

2.3 Methods

2.3.1 Experimental design

Behavioural analysis was carried out in male and female mice with a spontaneous deletion of the *Tlx* gene (*Nr2e1^{-/-}*), heterozygous (*Nr2e1^{+/-}*) and wild type littermates. In order, to capture potential deficits that may manifest during the adolescent developmental period, behavioural testing commenced at P28 and continued into adulthood until P67. Sensorimotor tests and motor performance tests on the rotarod were conducted each week. Open field tests, spontaneous alternation in the Y-maze, and contextual and cued fear conditioning were conducted during adolescence (P28-35), and again in adulthood (P56-67; see Figure 2.1 for experimental design). *Nr2e1^{-/-}* mice display impaired eye sight, therefore the behavioural tasks employed were chosen to minimize the dependency on visuospatial learning as much as possible (Brown and Wong, 2007, Dember and Roberts, 1958, Morgan et al., 2008).

2.3.2 Animals

The animals used in the present study were all first generation offspring on a hybrid B6129 background resulting from mating male heterozygote (*Nr2e1^{+/-}*) mice on a 129S1/SvImJ background with female heterozygote (*Nr2e1^{+/-}*) mice on a C57BL/6J background. They were kindly provided by Prof. Elizabeth Simpson, University of British Columbia and were generated as previously described (Wong et al., 2010). These mice exhibit a spontaneous deletion of the entire *Nr2e1* allele, including all nine

exons. However, the deletion of the *Tlx* gene does not affect the transcription of neighbouring genes (Kumar et al., 2004). The impact of maternal care was controlled for as all animals were first generation littermate offspring resulting from mating male heterozygote (*Nr2e1^{+/-}*) mice with female heterozygote (*Nr2e1^{+/-}*) mice. All pups were weaned at P21. Due to the aggression that has been previously described in this strain male *Nr2e1^{-/-}* mice were singly housed after weaning (Young et al., 2002). Male wild type and heterozygous littermates and all female mice were grouped housed in standard housing conditions (temperature 21°C and relative humidity 55%). All mice had food and water available *ad libitum*. All experiments were conducted in accordance with the European Directive 2010/63/EU, and under an authorization issued by the Health Products Regulatory Authority Ireland and approved by the Animal Ethics Committee of University College Cork.

2.3.3 *Body weight, growth rate and primary observation tests*

Animals were weighed and growth rate calculated each week [(present weight – past weight)/ past weight x100]. Sensorimotor tests were conducted to identify any gross impairment which may have affected behavioural testing. The primary observation scores and sensorimotor testing were adapted from the Irwin behavioural screen (Crawley, 2007, Cryan et al., 2003, Irwin, 1968). This included measures of general health and physical appearance as well as sensorimotor reflexes, piloerection, palpebral closure, salivation, tremors, gait, trunk curl, pinna reflex, whisker reflex, reaching reflex, eye reflex, righting reflex, toe pinch, and provoked biting as a measure of

aggression. Observations were recorded each week (P30, P37, P44, P51 and P58) and a score was assigned as indicated in Table 2.1.

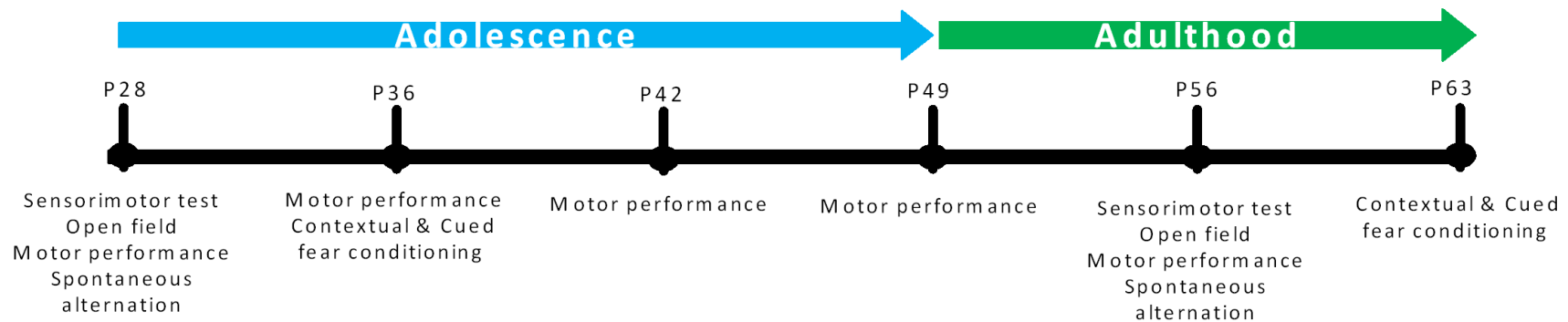

Figure 2.1: Experimental design. *Nr2e1*^{-/-}, *Nr2e1*^{+/-} and wild type mice were tested during adolescent development (postnatal day 28-49) and adulthood (postnatal day 56-67).

Table 2.1: Primary Observation of Nr2e1^{-/-} mice.

Physical Characteristics				Sensorimotor Reflexes			
Presence of Whiskers	Score	Appearance of Fur	Score	Gait	Score	Trunk Curl	Score
None	0	Ungroomed and disheveled	0	Normal	0	Absent	0
A few	1	Somewhat disheveled	1	Fluid but abnormal	1	Present	1
Most, but not a full set	2	Well-groomed (normal)	2	Limited movement only	2		
A full set	3			Incapacity	3	Eye Reflex	
		Wounds				Present	0
Piloerection		None	0	Reaching Reflex		Absent	1
None	0	Signs of previous wound	1	None	0		
Most hairs on end	1	Slight wounds present	2	Upon nose contact	1	Whisker Reflex	
		Moderate wounds present	3	Upon vibrissae contact	2	Present	0
Respiration		Extensive wounds present	4	Before vibrissae contact	3	Absent	1
Gasping, irregular	0			Early vigorous extension	4		
Slow, shallow	1	Salivation				Toe Pinch	
Normal	2	None	0	Provoked Biting		None	0
Hyperventilation	3	Slight margin of sub-maxillary area	1	Absent	0	Slight withdrawal	1
		Wet zone entire sub-maxillary area	2	Present	1	Moderate withdrawal, not brisk	2
Patches of Fur missing on Face						Brisk, rapid withdrawal	3
None	0	Patches of Fur missing on body		Pinna Reflex		Very brisk, repeated extension and flexion	4
Some	1	None	0	None	0		
Extensive	2	Some	1	Active retraction, moderately brisk flick	1		
		Extensive	2	Hyperactive, repetitive flick	2		
Palpebral Closure				Righting Reflex		Tremor	
Eyes wide open	0	Skin Color		No impairment	0	None	0
Eyes 1/2 closed	1	Blanched	0	Number of sec required to right	1 to 10	Mild	1
Eyes closed	2	Pink	1			Marked	2
		Bright, deep red, flushed	2				

2.3.4 Locomotor activity and Thigmotaxis in the open field

Spontaneous exploratory locomotor activity and thigmotaxis in the open field were used as a general measure of motor function and anxiety-related behaviours, respectively (Crawley, 2007). Animals were placed within a rectangular open field (32 x 40 cm; made in house) for 10 minutes. Locomotor activity is a simple measure of the distance the animal travels within the open field during the test, where large distances indicate hyperactivity. Thigmotaxis refers to the tendency of rodents to stay close to the walls of a maze during exploration (Choleris et al., 2001, Crawley, 2007). The behavioural test measures anxiogenesis induced by exposure to a novel environment as rodents tend to avoid open spaces and stay close to borders of maze arenas. Both locomotor activity and thigmotaxis were analysed using specialized software (Ethovision XT, Noldus Information Technology, USA).

2.3.5 Motor performance in the Rotarod

Performance on the accelerating rotarod is a well-established measure of motor performance (Crawley, 2007) and was assessed in this paradigm using a protocol adapted from Menalled et al. (2009). The mice were placed on the rotarod apparatus (Ugo Basile, Italy) for five minutes and tested on an accelerating protocol (4 RPM to 40 RPM over five minutes, averaging 7.2 RPM acceleration). The latency for each mouse to fall was recorded. The mice were tested during three trials a day for three consecutive days (total nine trials), with the best score recorded. The test was repeated at weekly intervals beginning P28, P35, P42, P49 and P56, respectively. A reduced

latency to fall indicates impairment in motor performance and suggests a dysfunction within the cortical-striatal circuit which regulates motor behaviour.

2.3.6 Spontaneous alternation in the Y maze

Spontaneous alternation behaviour is the tendency of rodents to alternate their exploration of maze arms (such as those of the Y maze) and is used as a measure of hippocampal-dependent working memory as previously described (Hughes, 2004). The Y maze consisted of three arms 120° from each other (16 cm x 6.5 cm; made in house). The protocol was adapted from Senechal et al. (2007) (Senechal et al., 2007). Each animal was placed into the first arm of the maze facing the wall, and allowed to explore the maze for five minutes. The number and order of arm entries were recorded. An arm entry was defined as all four paws entering into the arm (four paw criteria). An alternation was determined as the number of consecutive entries into the three maze arms. Alternations were then divided by the total number of entries during the five minute test period.

2.3.7 Contextual and cued fear conditioning

Contextual fear conditioning was used to assess hippocampal-dependent learning, while cued fear conditioning was employed to probe amygdala-dependent cognitive processes as previously described (Maren, 2001, Pattwell et al., 2011). During acquisition, animals were first placed into the fear conditioning chamber (Med Associates, 30.5 cm x 24.1 cm x 21.0 cm) which was scented with a lemon and ginger

tea bag (Twinings™). Animals were allowed to explore the chamber for two minutes during an acclimation period and then received three shock and tone pairs (30 s tone; 5 kHz; 70 dB; 1 s foot shock; 0.65 mA DC current) separated by 30 second intervals. Animals were placed back in their home cage one minute after the final shock. Contextual fear memory was assessed 24 hours later by placing the animals back into the same chamber, but in the absence of tone and shock. Freezing behaviour (sec) was measured during the last 3.5 minutes of the total 5.5 minute protocol using specialized software (Video freeze, Med Associates, USA).

Cued fear conditioning was measured 24 hours after the contextual test in the same chambers. To measure cued fear learning, animals were placed into a novel context (white floor; black wall insert at 60°; and almond scent 1%) with presentation of the tone but no foot shock. Animals were allowed two minutes to acclimatize followed by three tone presentations (30 s; 5 kHz; 70 dB). Freezing behaviour during the 30 second tone presentations was recorded (Video freeze, Med Associates, USA). Contextual and cued fear conditioning was assessed during adolescence and adulthood with mice reconditioned to the tone and context in adulthood. Prior to reconditioning in adulthood, mice were placed back into the initial shock chamber to assess contextual fear memory retention. Twenty-four hours later mice were placed in the same chamber as the cued fear conditioning chamber in order to assess cued fear memory recall retention.

2.3.8 Statistical analysis

All data were analysed using SPSS statistical software (SPSS, Chicago, IL). Data from body weight, rotarod motor performance, and cued fear conditioning were analysed by repeated measures ANOVA with Bonferroni post hoc test. Data from open field, spontaneous alternation and contextual fear conditioning were analysed by one-way ANOVA, with Fisher's LSD post hoc analysis. Nonparametric data from sensorimotor tests were analysed by the Kruskal–Wallis one-way ANOVA. An alpha level of 0.05 was used as criterion for statistical significance. Parametric data are presented as mean \pm SEM. Nonparametric data are presented as percentage (%) displaying normal response.

2.4 Results

2.4.1 *Nr2e1*^{-/-} mice have reduced body weight and increased growth rate during adolescence

Male and female mice gained weight throughout development (Figure 2.2A and B). The Mauchly's test indicated that in the male cohort the assumptions of sphericity had been violated, (χ^2 (9) = 51.29, $p < 0.01$). Therefore, the degrees of freedom were corrected using Greenhouse-Geisser estimates of sphericity as the epsilon was less than 0.75 ($\epsilon = 0.595$). The results show that all male mice gain body weight with age (F (2.38, 83.32) = 421.39, $p < 0.01$; Figure 2.2A). Female mice also showed a similar result, with all genotypes gaining weight with age (F (4, 136) = 253.83, $p < 0.01$; Figure

2.2B). There was a significant effect of genotype on body weight throughout adolescence and adulthood, in both male ($F(2, 35) = 17.74, p < 0.01$) and female ($F(2, 34) = 20.35, p < 0.01$) mice, with $Nr2e1^{-/-}$ mice remaining significantly lighter than their wild type and heterozygous littermates (Bonferroni post hoc comparison, $p < 0.01$). There was also a significant interaction between age and genotype in male ($F(4.76, 83.32) = 4.40, p < 0.01$) and female ($F(8, 136) = 3.21, p < 0.01$) mice, indicating that $Nr2e1^{-/-}$ mice do not gain weight similarly to their wild type and $Nr2e1^{+/-}$ littermates.

Male and female mice show a reduction in the rate of growth as they approach adulthood (Figure 2.2C and D). Interestingly, $Nr2e1^{-/-}$ mice appear to have a higher rate of growth during early adolescence (P35) compared to wild type and $Nr2e1^{+/-}$ littermates in both males ($F(2, 35) = 18.69, p < 0.01$) and females ($F(2, 34) = 24.66, p < 0.01$). Furthermore, this increased growth rate appears to normalize at the onset of adulthood (P49-56). These results indicate that while $Nr2e1^{-/-}$ mice gain body weight at a greater rate throughout development, body weight remains reduced compared to wild type and heterozygous littermates. This finding is stable across sex and is independent of housing conditions.

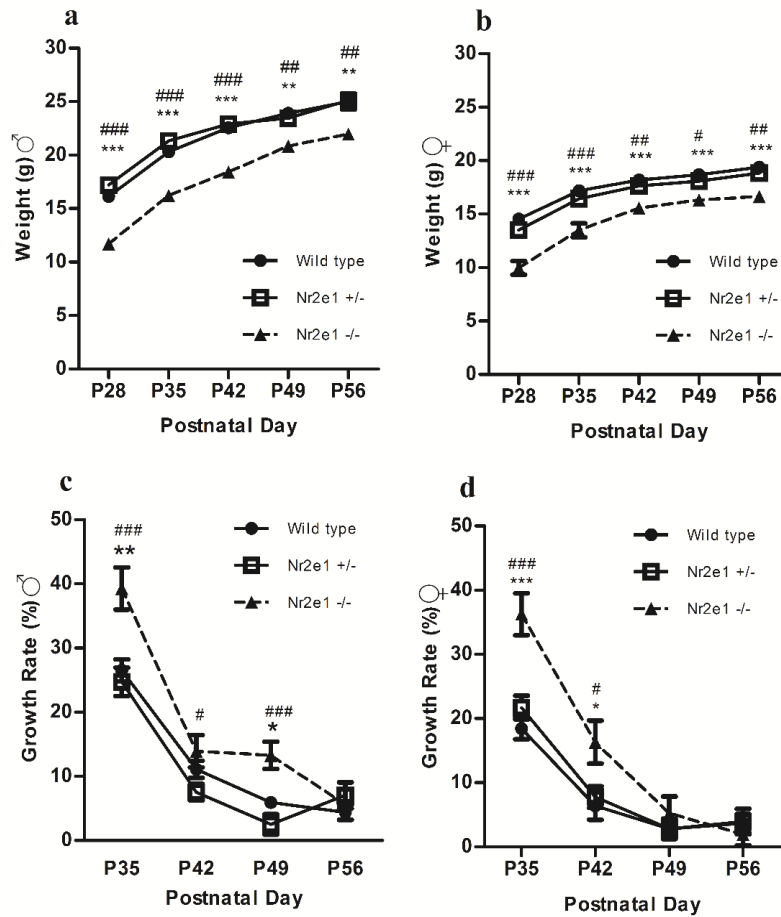

Figure 2.2: Body weight as a function of genotype, sex and age. Body weight of male (a) and female (b) mice; growth rate of male (c) and female (d) mice. *** $p < 0.0001$, ** $p < 0.001$, * $p < 0.05$, Nr2e1^{-/-} compared to wild type mice. ### $p < 0.0001$, ## $p < 0.001$, # $p < 0.05$, Nr2e1^{-/-} compared to Nr2e1^{+/-} mice; ANOVA with post hoc Bonferroni analysis. All results are expressed as mean \pm SEM. Sample size per sex: wild type ($n = 13-14$), Nr2e1^{+/-} ($n = 16$), Nr2e1^{-/-} ($n = 8$).

2.4.2 Nr2e1^{-/-} mice exhibit increased provoked biting and impaired eye reflex, reaching reflex and piloerection in a primary observation test battery

The results of the primary observation tests are summarised in Tables 2 and 3. There was no significant difference across genotype, sex or age in animal appearance (presence of whiskers, appearance of fur, and patches of fur missing, skin colour),

respiration, tremors, salivation, gait, trunk curl, pinna reflex, whisker reflex, toe pinch reflex or righting reflex. However, both male and female *Nr2e1*^{-/-} mice showed an increase in provoked biting during adolescence (male, $p < 0.05$ and female, $p < 0.05$; Table 2.2). This increase in provoked biting continued in adulthood (Table 2.3) but did not reach statistical significance (male, $p = 0.14$ and female, $p = 0.13$). Male *Nr2e1*^{-/-} mice also exhibited impaired eye reflex during adolescence ($p < 0.05$; Table 2.2). However, this wasn't observed during adulthood ($p > 0.05$; Table 3). In addition, adolescent male *Nr2e1*^{-/-} mice showed a trend towards impaired reaching reflex ($p = 0.057$; Table 2.2). This pattern continued during adulthood in male mice but did not reach statistical significance (males $p = 0.12$; females $p > 0.05$; Table 2.3). Further, adult male *Nr2e1*^{-/-} mice exhibited an increase in piloerection ($p < 0.01$) and an increase in palpebral closure ($p < 0.05$; Table 2.3).

Table 2.2: Primary Observation of Nr2e1^{-/-} mice in adolescent mice. * p<0.05, Nr2e1^{-/-} compared to wild type mice. Kruskal–Wallis one-way ANOVA. Wild type (n = 13-14), Nr2e1^{+/-} (n = 16), Nr2e1^{-/-} (n = 8).

Physical Characteristics	Male			Physical Characteristics	Female		
	Wild type	Nr2e1 ^{+/-}	Nr2e1 ^{-/-}		Wild type	Nr2e1 ^{+/-}	Nr2e1 ^{-/-}
Presence of Whiskers (%)	100	100	100	Presence of Whiskers (%)	100	100	100
Well-groomed fur (%)	100	100	100	Well-groomed fur (%)	100	100	100
Piloerection (%)	0	0	0	Piloerection (%)	0	0	0
Missing fur on Face (%)	21.4	13.3	0	Missing fur on Face (%)	0	12.5	12.5
Missing fur on body (%)	0	0	12.5	Missing fur on body (%)	7.6	18.7	12.5
Palpebral Closure (%)	0	0	0	Palpebral Closure (%)	0	0	0
Wounds (%)	0	6.25	0	Wounds (%)	0	6.2	0
Respiration	Normal	Normal	Normal	Respiration	Normal	Normal	Normal
Tremor (%)	0	0	0	Tremor (%)	0	0	0
Skin Color	Normal	Normal	Normal	Skin Color	Normal	Normal	Normal
Salivation (%)	0	0	0	Salivation (%)	0	0	0
Sensorimotor Reflexes (% displaying normal response)				Sensorimotor Reflexes (% displaying normal response)			
Gait	100	100	100	Gait	100	100	100
Trunk Curl	100	100	100	Trunk Curl	92.3	93.7	100
Reaching Reflex	71.4	100	62.5	Reaching Reflex	92.3	87.5	62.5
Pinna Reflex	85.7	87.5	75	Pinna Reflex	100	75	87.5
Eye Reflex	85.7	100	62.5*	Eye Reflex	90.09	66.67	100
Whisker Reflex	85.7	92.85	75	Whisker Reflex	100	80	100
Toe Pinch	78.5	81.25	62.25	Toe Pinch	100	81.25	100
Righting Reflex (% impaired)	0	0	0	Righting Reflex (% impaired)	0	0	0
Provoked Biting (%)	38.4	31.2	87.5*	Provoked Biting (%)	30.7	37.5	77.8*

Table 2.3: Primary Observation of *Nr2e1*^{-/-} mice in adult mice. ***p <0.0001, ** p <0.001, * p<0.05, *Nr2e1*^{-/-} compared to wild type mice. Kruskal–Wallis one-way ANOVA. Wild type (n = 13), *Nr2e1*^{+/-} (n = 16), *Nr2e1*^{-/-} (n = 8).

Physical Characteristics	Male			Physical Characteristics	Female		
	Wild type	<i>Nr2e1</i> ^{+/-}	<i>Nr2e1</i> ^{-/-}		Wild type	<i>Nr2e1</i> ^{+/-}	<i>Nr2e1</i> ^{-/-}
Presence of Whiskers (%)	100	100	100	Presence of Whiskers (%)	84.6	81.2	87.5
Well-groomed fur (%)	76.9	75	62.5	Well-groomed fur (%)	100	93.7	100
Piloerection (%)	0	0	62.5***	Piloerection (%)	0	0	0
Missing fur on Face (%)	0	0	0	Missing fur on Face (%)	0	0	0
Missing fur on body (%)	0	0	0	Missing fur on body (%)	0	0	0
Palpebral Closure (%)	0	0	25*	Palpebral Closure (%)	0	0	12.5
Wounds (%)	7.7	12.5	37.5	Wounds (%)	0	0	12.5
Respiration	Normal	Normal	Normal	Respiration	Normal	Normal	Normal
Tremor (%)	0	0	0	Tremor (%)	0	0	0
Skin Color	100	100	100	Skin Color	100	100	100
Salivation (%)	7.7	0	33.33	Salivation (%)	0	13.3	0
Sensorimotor Reflexes (% displaying normal response)				Sensorimotor Reflexes (% displaying normal response)			
Gait	100	100	100	Gait	100	100	100
Trunk Curl	100	100	100	Trunk Curl	84.6	93.7	100
Reaching Reflex	92.3	62.5	50	Reaching Reflex	92.3	87.5	62.5
Pinna Reflex	76.9	75	75	Pinna Reflex	100	62.5	87.5
Eye Reflex	92.3	81.25	100	Eye Reflex	100	86.66	83.33
Whisker Reflex	84.61	87.5	100	Whisker Reflex	77.77	86.66	100
Toe Pinch	100	93.7	100	Toe Pinch	92.3	93.7	100
Righting Reflex (% impaired)	0	0	0	Righting Reflex (% impaired)	0	0	0
Provoked Biting (%)	46.1	50	87.5	Provoked Biting (%)	46.1	31.2	75

2.4.3 Nr2e1^{-/-} mice exhibit hyperactivity and deficits in cortico-striatal associated behaviour

2.4.3.1 Locomotor activity in the open field

Testing in the open field revealed that male (Figure 2.3A) and female (Figure 2.3B) *Nr2e1^{-/-}* mice were hyperactive during adolescence (male $F(2, 37) = 25.21, p < 0.01$, female $F(2, 36) = 18.05, p < 0.01$), independent of housing conditions. Hyperactivity continued into adulthood in both male ($F(2, 37) = 37.79, p < 0.01$) and female ($F(2, 36) = 19.77, p < 0.01$) *Nr2e1^{-/-}* mice (Figure 2.3C and D, respectively). Furthermore, hyperactivity appeared to be more pronounced during adulthood in both male and female *Nr2e1^{-/-}* mice with an approximately threefold increase in distance travelled compared to wild types (Figure 2.3C and D).

2.4.3.2 Thigmotaxis in the open field

Adolescent male *Nr2e1^{-/-}* mice exhibited a significant increase in exploration of the centre of the open field ($F(2, 37) = 3.90, p < 0.05$) indicating a reduction in thigmotaxis behaviour (Figure 2.3E). This observation continued into adulthood ($F(2, 37) = 6.37, p < 0.01$; Figure 2.3G). All female mice showed similar thigmotaxis behaviour throughout adolescence ($F(2, 36) = 0.46, p > 0.05$) and adulthood ($F(2, 36) = 1.39, p > 0.05$; Figures 2.3F and H, respectively).

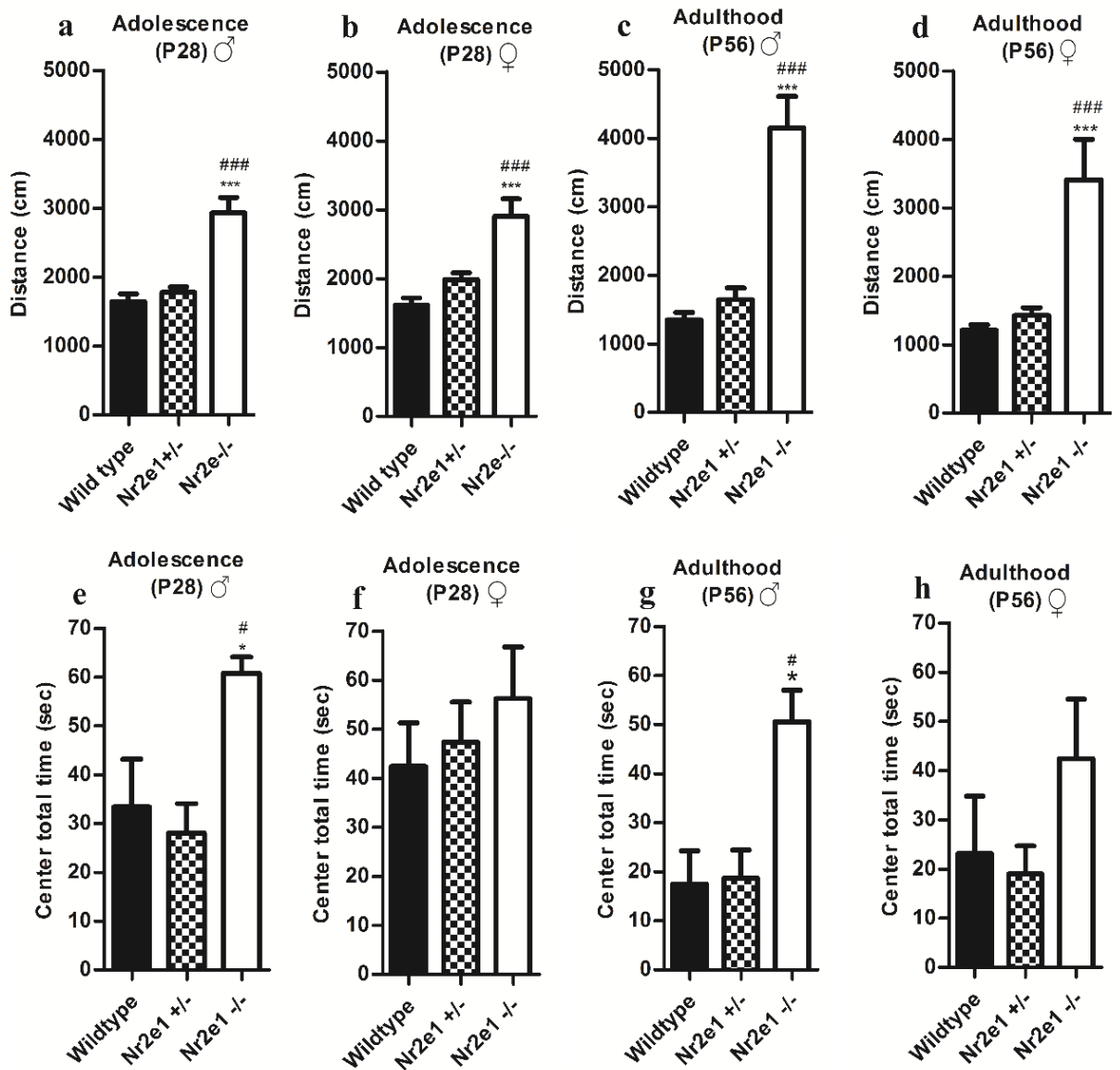

Figure 2.3: Locomotor activity and thigmotaxis in an open field as a function of genotype. Locomotor activity in adolescent male (A) and female (B) mice, and in adult male (C) and female (D) mice. Exploration of arena centre in adolescent male (e) and female (F) mice, and in adult male (G) and female (H) mice. *** $p < 0.0001$, ** $p < 0.001$, * $p < 0.05$, Nr2e1^{-/-} compared to wild type mice. ### $p < 0.0001$, ## $p < 0.001$, # $p < 0.05$, Nr2e1^{-/-} compared to Nr2e1^{+/-} mice; ANOVA with post hoc Bonferroni analysis. All results are expressed in mean \pm SEM. Sample size per sex: wild type ($n = 13-14$), Nr2e1^{+/-} ($n = 16$), Nr2e1^{-/-} ($n = 8$).

2.4.3.3 Motor performance on the Rotarod

The Mauchly's test indicated the assumptions of sphericity had been violated in both male ($\chi^2(9) = 27.64, p < 0.01$), and female ($\chi^2(9) = 18.77, p < 0.027$) mice. Therefore, the degrees of freedom were corrected using Greenhouse-Geisser estimates of sphericity for males as the epsilon was less than 0.75; ($\epsilon = 0.74$), and the Huynh-Feidt estimates of sphericity for females as the epsilon was greater than 0.75, ($\epsilon = 0.949$). With this correction testing on the rotarod revealed that impairments in motor performance developed at the onset of adulthood (P42; Figure 2.4A and B), in both male ($F(2.69, 103.603) = 4.54, p < 0.01$) and female ($F(3.795, 129.026) = 9.36, p < 0.01$) *Nr2e1^{-/-}* mice, independent of housing conditions. There was a significant effect of genotype on motor performance, in both male ($F(2, 35) = 6.88, p < 0.01$; Figure 2.4A) and female ($F(2, 34) = 7.59, p < 0.01$; Figure 2.4B) *Nr2e1^{-/-}* mice. There was also a significant interaction between age and genotype in male ($F(5.92, 103.603) = 3.344, p < 0.01$) and female ($F(7.59, 109.202) = 2.97, p < 0.01$) mice. Bonferroni post hoc comparison revealed that impairments in motor performance developed in both male and female *Nr2e1^{-/-}* mice at the onset of adulthood (Figure 2.4A and B). This indicates that motor performance does not remain stable throughout development for *Nr2e1^{-/-}* mice.

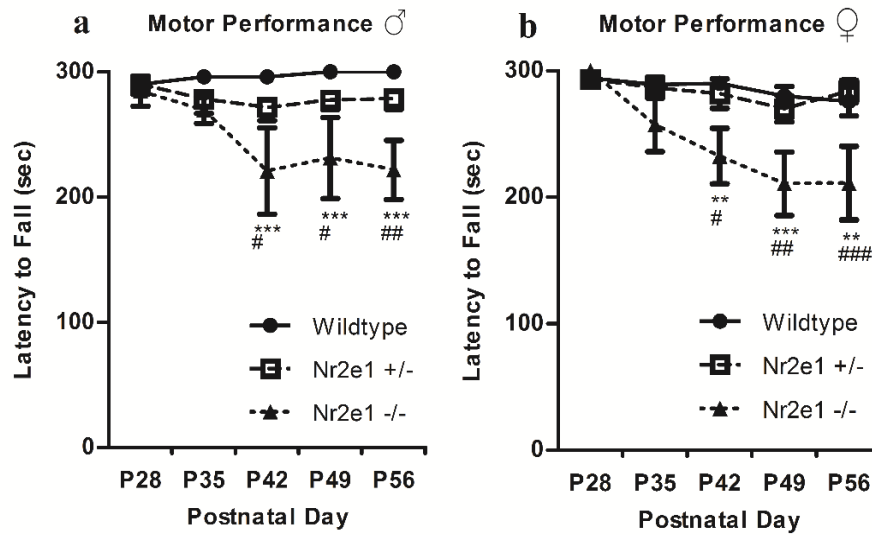

Figure 2.4: Motor performance in a Rota-rod latency to fall paradigm as a function of genotype. Motor performance on the Rotarod in male (A) and female (B) mice. *** $p < 0.0001$, ** $p < 0.001$, * $p < 0.05$, $Nr2e1^{-/-}$ compared to wild type mice. #### $p < 0.0001$, ## $p < 0.001$, # $p < 0.05$, $Nr2e1^{-/-}$ compared to $Nr2e1^{+/-}$ mice; ANOVA with post hoc Bonferroni analysis. All results are expressed in mean \pm SEM. Sample size per sex: wild type ($n = 13-14$), $Nr2e1^{+/-}$ ($n = 16$), $Nr2e1^{-/-}$ ($n = 8$).

2.4.4 $Nr2e1^{-/-}$ mice exhibit deficits in hippocampus-associated cognition

2.4.4.1 Spontaneous alternation in the Y maze

In the spontaneous alternation test of working memory, male and female $Nr2e1^{-/-}$ mice showed impaired spontaneous alternation during adolescence compared to $Nr2e1^{+/-}$ and wild type mice, (male $F(2, 37) = 4.60$, $p < 0.01$ and female $F(2, 36) = 3.97$, $p < 0.05$; Figure 2.5a and b). However, this effect did not persist into adulthood (Figure 2.5C and D). A significant effect was observed in spontaneous alternation in adult male mice ($F(2, 37) = 7.31$, $p < 0.01$; Figure 2.5C). Post hoc comparison using the Fisher's LSD test revealed this was due to an increase in $Nr2e1^{+/-}$ performance compared to

wild type, ($p < 0.01$) and *Nr2e1*^{-/-} mice, ($p < 0.01$). Female mice exhibited no overall difference in spontaneous alternation during adulthood ($F(2, 36) = 1.80, p > 0.05$; Figure 2.5D).

2.4.4.2 Contextual fear conditioning

Male *Nr2e1*^{-/-} mice showed impaired freezing behaviour during adolescence compared to *Nr2e1*^{+/-} and wild type mice ($F(2, 36) = 8.82, p < 0.01$; Figure 2.5E). Adolescent female *Nr2e1*^{-/-} mice showed a trend for reduced contextual freezing but this did not reach statistical significance ($F(2, 34) = 2.46, p = 0.10$; Figure 2.5F). Contextual freezing during adulthood did not differ across sex or genotype (male $F(2, 36) = 2.34, p > 0.05$; Figure 2.5G); female ($F(2, 28) = 0.47, p > 0.05$; Figure 2.5H).

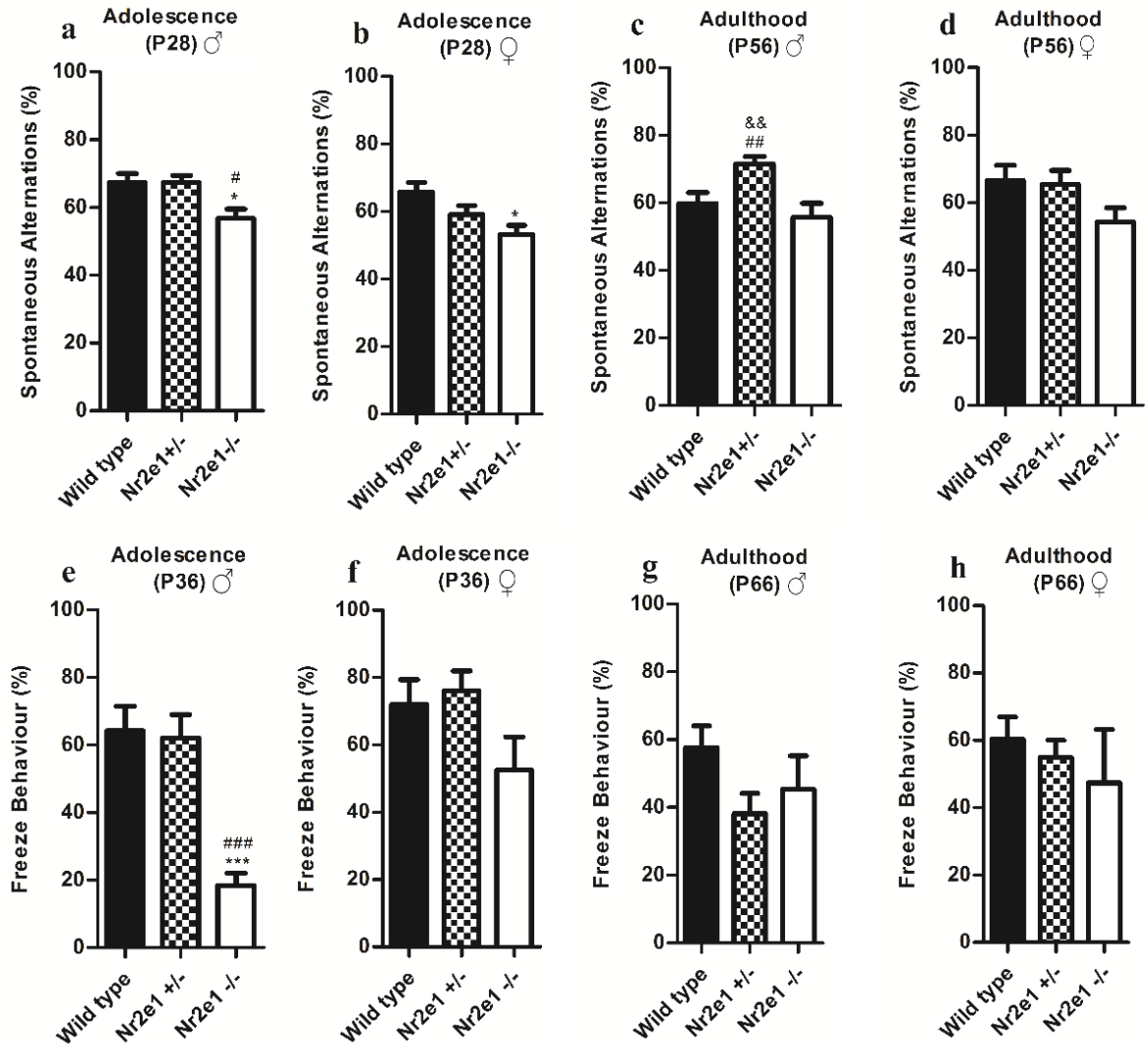

Figure 2.5: Spontaneous alternation (%) in the Y-maze and contextual fear conditioning as a function of genotype during adolescence (P28-36) and adulthood (P56-66). Spontaneous alternation in adolescent male (A) and female (B) mice, and in adult male (C) and female (D) mice. Contextual freeze behaviour in adolescent male (E) and female (F) mice, and in adult male (G) and female (H) mice. *** $p < 0.0001$, ** $p < 0.001$, * $p < 0.05$, Nr2e1^{-/-} compared to wild type mice. ### $p < 0.0001$, ## $p < 0.001$, # $p < 0.05$, Nr2e1^{-/-} compared to Nr2e1^{+/-} mice; && $p < 0.001$, Nr2e1^{+/-} compared to wild type mice; ANOVA with post hoc Fisher's LSD test. All results are expressed as mean \pm SEM. Sample size per sex: wild type ($n = 8-14$), Nr2e1^{+/-} ($n = 15-16$), Nr2e1^{-/-} ($n = 6-8$).

2.4.5 *Nr2e1*^{-/-} mice show impaired hippocampal-amygdala dependent cognition

2.4.5.1 Cued fear conditioning

Both male and female *Nr2e1*^{-/-} mice showed impaired cued fear recall during adolescence (male $F(2, 34) = 3.62, p < 0.05$ and female $F(2, 32) = 10.17, p < 0.01$; Figures 2.6A and D). In adulthood, only male *Nr2e1*^{-/-} mice exhibited impaired cued fear recall ($F(2, 34) = 14.31, p < 0.01$; Figure 2.6B). Interestingly, male *Nr2e1*^{+/-} mice also exhibited impaired cued fear recall during adulthood, but not during adolescence. However, no impairment was observed in female *Nr2e1*^{+/-} or *Nr2e1*^{-/-} mice during adulthood ($F(2, 26) = 0.96, p > 0.05$; Figure 2.6E).

To measure the retention of the cued fear memory that was acquired during adolescence, we first measured freezing behaviour in response to the cue but prior to the re-introduction of the unconditioned stimulus at P62 (Figures 2.6C and F). In this cued fear memory retention test both male and female adult (P62) *Nr2e1*^{-/-} mice exhibited poor retention of the fear memory that was acquired in adolescence (male $F(2, 34) = 19.95, p < 0.01$ and female $F(2, 29) = 17.0, p < 0.01$).

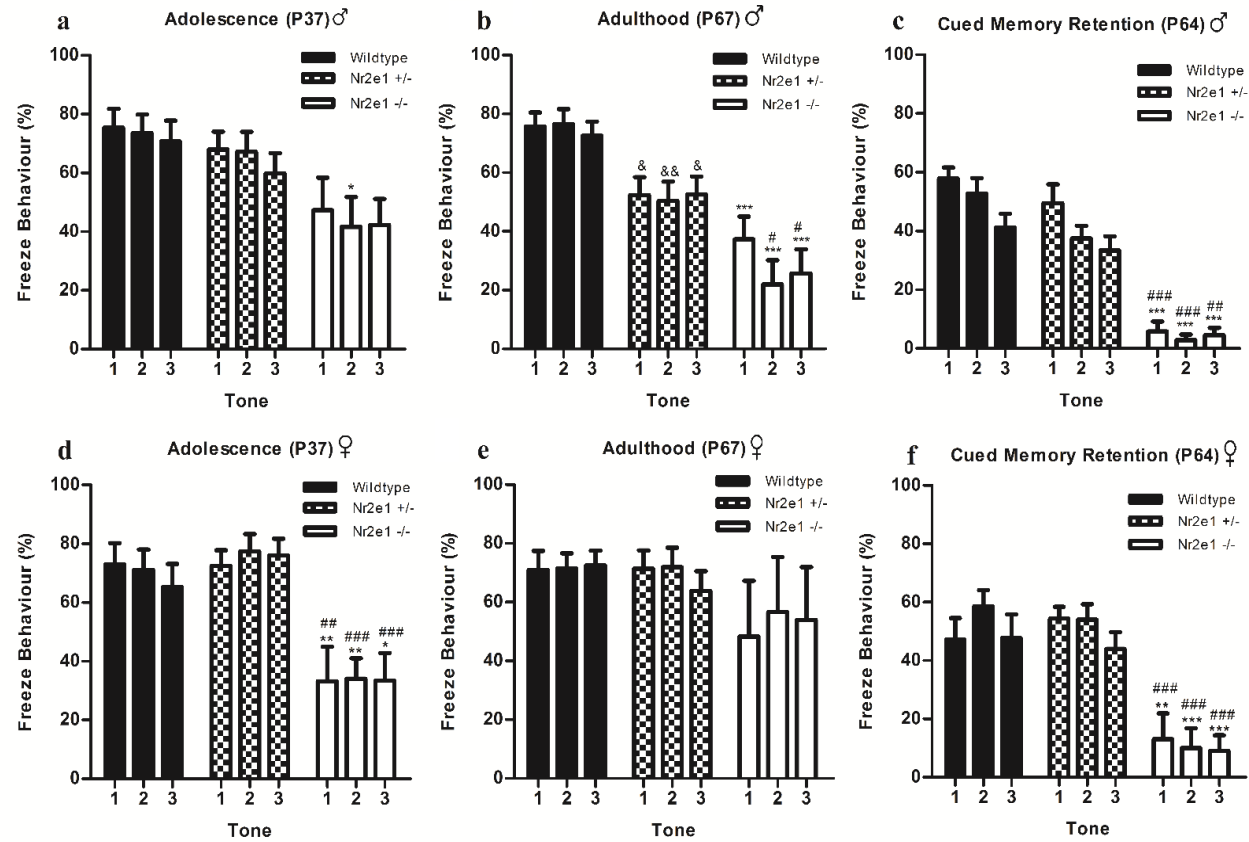

Figure 2.6: Cued fear conditioning as a function of genotype during adolescence (P37) and adulthood (P67). Cued fear conditioning in adolescent male (A) and female (D) mice, and in adult male (C) and female (F) mice. Cued fear memory retention test in male (B) and female (E) mice. *** $p < 0.0001$, ** $p < 0.001$, * $p < 0.05$ $Nr2e1^{-/-}$ compared to wild type mice. ### $p < 0.0001$, ## $p < 0.001$, # $p < 0.05$ $Nr2e1^{-/-}$ compared to $Nr2e1^{+/-}$ mice; & $p < 0.05$ $Nr2e1^{+/-}$ compared to wild type mice; ANOVA with post hoc Bonferroni analysis. All results are expressed as mean \pm SEM. Sample size per sex: wild type ($n = 8-14$), $Nr2e1^{+/-}$ ($n = 13-16$), $Nr2e1^{-/-}$ ($n = 6-8$).

2.5 Discussion

This study demonstrated that Tlx has a role to play in motor, cognitive and anxiety-related behaviour during adolescence and adulthood independent of sex or housing conditions, with most impact during adolescence. Both adolescent male and female *Nr2e1*^{-/-} mice showed deficits in spatial working memory as measured by spontaneous alternation in the Y maze. Further, adolescent male but not female *Nr2e1*^{-/-} mice showed deficits in hippocampal function as measured by contextual fear conditioning but these effects in hippocampus-dependent memory tasks did not persist into adulthood. Previous studies have reported contradictory findings regarding the involvement of Tlx in hippocampus-associated cognition in adult mice. Similar to the present study, it has been shown that normal fear acquisition and contextual fear conditioning occurs in adult male *Nr2e1*^{-/-} mice (Zhang et al., 2008b). Impaired associative fear memory in contextual fear conditioning in adult male mice with a targeted disruption of Tlx has also been reported (Roy et al., 2002). The present study is to our knowledge the first report of impaired spatial working memory in adolescent male and female *Nr2e1*^{-/-} mice with a spontaneous deletion; however, this deficit did not persist into adulthood. This is in contrast to the previously reported impairments in spatial working memory in Tlx deficit mice albeit using the Morris water maze and in mice with a conditional deletion in adulthood (Zhang et al., 2008b), rather than a spontaneous deletion. The reasons for the discrepancies across studies in adult mice are unclear but may be a function of the different methods used to reduce or inhibit Tlx expression, or the time at which the Tlx disruption occurs. Zhang et al. (2008) generated a conditional deletion of Tlx in adult mice localized to the forebrain and

olfactory bulbs, whereas Roy et al. (2002) generated a transgenic strain with a targeted disruption of *Tlx* (Roy et al., 2002, Zhang et al., 2008b). In the mice used in the present study, the *Tlx* deletion occurs from birth via a spontaneous deletion of all nine exons of the gene. It is important to consider that germline mutation models such as the *Nr2e1*^{-/-} mice used in the current study and by others (where *Tlx* disruption occurs in early life) may impact upon developmental processes (Shi et al., 2004, Wong et al., 2010, Young et al., 2002) that could thus contribute to the behavioural phenotype. Indeed, early life appears to be a sensitive period to *Tlx* disruption as indicated by greater neuroanatomical and behavioural impairments in mice with an early life deletion of *Tlx* compared to mice with an adult knockdown (Shi et al., 2004, Wong et al., 2010, Young et al., 2002, Zhang et al., 2008b). Thus, the method of interference on *Tlx* expression may affect the level of impairment observed, and in turn might at least partially explain the inconsistent findings. Taken together, while there is evidence that *Tlx* plays a role in hippocampus-dependent cognition, adolescence may be the more susceptible period to disruption of spatial working memory and hippocampal processes from *Tlx* deletion.

During adolescence, both male and female *Nr2e1*^{-/-} mice exhibited impaired cued fear conditioning, a hippocampal-amygdala dependent cognitive process (Maren, 2001). Interestingly, these deficits persist and are more pronounced in adult male *Nr2e1*^{-/-} mice. On the other hand, the cued fear memory impairments observed in adolescent female *Nr2e1*^{-/-} mice did not persist into adulthood. While *Nr2e1*^{-/-} mice exhibit some delay in cued fear acquisition, freezing behaviour reaches levels exhibited by wild type

control mice by the end of the training period (data not shown) and so these impairments are not due to deficits in acquisition. Interestingly, we report the novel finding that male but not female *Nr2e1*^{+/-} mice also exhibited impaired cued fear conditioning during adulthood. Previous studies have reported contradictory findings on cued fear conditioning in male *Nr2e1*^{-/-} mice, with either normal (Zhang et al., 2008b) or impaired (Roy et al., 2002) cued fear conditioning in male mice being reported. Unlike the present study however, the effects in female mice were not investigated in these earlier studies (Roy et al., 2002, Zhang et al., 2008b). The reasons underlying the discrepancies in adult male *Nr2e1*^{-/-} mice cued fear conditioning are not clear but may again be a function of the methods used to reduce or inhibit *Tlx* expression or possibly the experimental variables in the cued fear conditioning test. The fear conditioning training protocol employed by Roy et al. (2002) consisted of one training session (2 x 30 s; tone 80 dB; 2 kHz; followed by 2 s shock 0.75 mA) whereas the protocol used by Zhang et al. (2008) consisted of three training sessions (1 x tone 20 s; 80 dB; 2 kHz; followed by 1 s shock 0.70 mA). In the current study the fear conditioning training consisted of one training session (3 x tone 30 s; 70 dB; 5 kHz; followed by 1 s foot shock 0.65 mA DC current). It is possible that the additional training sessions employed by Zhang et al. (2008) facilitated fear association and improved learning compared to the one training session implemented by Roy et al. (2002) and in the current study. Furthermore, in the present study the same animals were tested during adolescence and in adulthood. It is therefore important to consider the potential effects of fear conditioning training during the adolescent period and its potential impact on fear conditioning in adulthood when drawing conclusions with

previous studies. In addition, single housing has been shown to impair contextual and cued fear conditioning (Voikar et al., 2005). Given that aggression within male *Nr2e1*^{-/-} mice necessitated being single housed compared to group housed female *Nr2e1*^{-/-} mice, it is not possible to delineate whether the sex-dependent effects on contextual and cued fear conditioning are due to *Tlx* deletion or housing conditioning *per se*. Nevertheless, since the amygdala plays a key role in cued fear conditions, these studies suggest that *Tlx* may also be important in regulating the functions of brain structures beyond the hippocampus, particularly during adolescence.

Deletion of *Tlx* resulted in a sex-dependent effect on thigmotaxis in the open field. Adolescent and adult male but not female *Nr2e1*^{-/-} mice exhibited a significant reduction in thigmotaxis thus suggesting reduced anxiety-like behaviour. In support, previous studies have reported that adult male *Nr2e1*^{-/-} mice with a targeted disruption of the *Tlx* locus are less anxious within the elevated plus maze (Roy et al., 2002). It has also been previously shown that adult male *Nr2e1*^{-/-} mice (with a spontaneous deletion of *Tlx*) display an anxiolytic phenotype independent of sex, but dependent on strain within the elevated plus maze (Young et al., 2002). Indeed, adult male and female *Nr2e1*^{-/-} mice on a C57BL/6J background exhibited reduced anxiety-like behaviour in the elevated plus maze, while *Nr2e1*^{-/-} mice on a B6129F1 background showed similar exploration to control mice (Young et al., 2002). It is important to note that in the latter study, wild type and heterozygous animals were grouped and constituted the control group, while in the present study differences in cued fear memory were observed in adult male *Nr2e1*^{+/-} mice compared to wild type mice. Thus,

when data from *Nr2e1*^{+/-} mice is pooled with that from wild type mice, subtle changes in the limbic system circuitry of *Nr2e1*^{+/-} mice may not be picked up. The amygdala plays a key role in both anxiety behaviour and cued fear conditioning (Davidson, 2002, Maren, 2001). Thus, together with the findings in cued fear conditioning, the reduction in thigmotaxis further supports the hypothesis that Tlx can regulate neurobiological processing in brain areas beyond the hippocampus.

Hyperactivity was observed in both male and female *Nr2e1*^{-/-} mice during adolescence and adulthood. This is in agreement with previous studies using the same strain, where hyperactivity was reported as early as P18 as well as in adulthood (Wong et al., 2010, Young et al., 2002). The findings presented here, in conjunction with previous reports suggest that in the absence of Tlx, the resulting neuroanatomical disruption causes a sex-independent hyperactivity that occurs in adolescence and persists into adulthood. *Nr2e1*^{-/-} mice exhibited a progressive decline in motor performance on the accelerating rotarod at the onset of adulthood. This novel finding suggests that deletion of Tlx causes disruption of cortico-cerebellar/striatal cognitive processing. However, this disruption does not manifest as behavioural impairment until the onset of adulthood, suggesting that Tlx involvement is age-dependent. The impairment in motor performance on the rotarod does not seem to be related to the hyperactive phenotype as both adolescent male and female *Nr2e1*^{-/-} mice are hyperactive, yet impairments in rotarod performance only emerge towards the onset of adulthood.

Previous studies using *Nr2e1*^{-/-} mice with a spontaneous deletion have reported that mice are physically smaller throughout development and adulthood (Wong et al., 2010,

Young et al., 2002). Similarly, we report that both male and female *Nr2e1*^{-/-} mice exhibit reduced body weight. In addition, we also report that despite smaller body weights, *Nr2e1*^{-/-} mice exhibit an enhanced growth rate during adolescence. Reduced body weight has also been observed in transgenic mice with a targeted disruption of *Tlx*, where deviation in postnatal weight gain appears at a similar time point (~P23) to that reported here and previously (Monaghan et al., 1997, Wong et al., 2010). Specifically, Young et al. (2002) have previously reported the body weight of male and female *Nr2e1*^{-/-} mice from embryonic day 12.5 through to adulthood (P70) and show that a deviation in body weight between wildtype and *Nr2e1*^{-/-} mice occurs at approximately P21. However, when a conditional deletion is implemented in adulthood, body weight is not affected (Zhang et al., 2008b). Interestingly, the point of deviation in growth (~P21) coincides with the initiation of hyperactivity (~P18) (Wong et al., 2010). Wong et al. 2010 suggested failure to gain weight at a similar rate to control littermates may be due to the hyperactive phenotype of these mice as they observed no difference in milk consumption of pre-wean *Nr2e1*^{-/-} mice (P0, P7 and P18). This suggests failure to gain weight at a similar rate was not due to a difference in food consumption (Wong et al., 2010). Although in the present study *Nr2e1*^{-/-} mice exhibit a greater growth rate than wild type and *Nr2e1*^{+/-} littermates (Wong et al., 2010). It is likely that hyperactivity stems from underlying neuroanatomical abnormalities resulting from germline deletion of *Tlx*. However, food intake and metabolism studies have yet to be conducted in adulthood which may help delineate the effect of *Tlx* deletion on body weight gain.

Sensorimotor observations of wild type, *Nr2e1*^{+/-} and *Nr2e1*^{-/-} mice have been previously reported in early postnatal life and adulthood (Young et al., 2002). However sensorimotor performance during the adolescent period had yet to be fully described and any sex-dependent effect had yet to be characterized. Here, we show that both male and female adolescent *Nr2e1*^{-/-} mice exhibit increased provoked biting (an indication of aggression) which is a well-documented phenotype of this strain (Young et al., 2002). However, while biting was increased in both male and female *Nr2e1*^{-/-} mice in adulthood, it did not reach statistical significance (male, $p = 0.14$ and female, $p = 0.13$). Nevertheless, previous studies have reported high aggression in adult male and female *Nr2e1*^{-/-} mice (Abrahams et al., 2005, Young et al., 2002). Defective limbic system functionality in *Nr2e1*^{-/-} mice is thought to play a role in the aggressive phenotype (Monaghan et al., 1997, Young et al., 2002). We also observed impaired eye reflex in male adolescent *Nr2e1*^{-/-} mice. Mice lacking *Tlx* display hypoplasia of the retina resulting in impaired vision (Miyawaki et al., 2004, Young et al., 2002). While previous studies have shown that this impairment is independent of sex, here female *Nr2e1*^{-/-} mice showed a similar response to wild types. It is unclear why this impairment was observed in a sex-dependent manner. Finally, male adult *Nr2e1*^{-/-} mice display impaired piloerection and palpebral closure, while adult female *Nr2e1*^{-/-} mice show similar primary sensorimotor observations compared to wild type and *Nr2e1*^{+/-} littermates. Together, it seems that the sensorimotor impairments (provoked biting, eye reflex, piloerection and palpebral closure) resulting from the *Tlx* deletion are somewhat dependent on sex and age.

A potential limitation to the behavioural studies within this strain of *Nr2e1*^{-/-} mice is the potential confound of visual impairment (Corso-Diaz and Simpson, 2015, Young et al., 2002). Thus, it might be suggested that the anxiolytic phenotype observed within the open field in male *Nr2e1*^{-/-} mice could reflect vision impairments. Specifically, mice with reduced vision may unintentionally explore the center of the arena because they are unaware it is an exposed area of the maze. However, impaired vision has been shown in both sexes (Young et al., 2002). Therefore, a lack of a similar anxiolytic phenotype in female mice suggests that this behavioural phenotype is a result of neural abnormalities other than visual abnormalities. Moreover, spontaneous alternation and rotarod performance has previously been shown to be unaffected by visual performance (Dember and Roberts, 1958, Morgan et al., 2008) and thus unlikely to be affected by visual impairments in the present study. A second limitation of this study stems from the requirement to single house male knockout mice due to their aggressive phenotype (Young et al., 2002). However, previous studies have shown that spontaneous alternation and motor performance on the rotarod are unaffected by housing conditions in C57BL/6 mice (Voikar et al., 2005). Furthermore, previous studies have shown that singly housed *Nr2e1*^{-/-} mice exhibit reduced body weight and increased hyperactivity compared to single housed wild type littermates (Voikar et al., 2005). Thus, suggesting that social isolation does not account for the reduced body weight and hyperactivity of *Nr2e1*^{-/-} mice observed within this study. Notwithstanding that social isolation may impact upon fear conditioning, overall the evidence suggests that the impairments in motor, cognitive and anxiety-related behaviours assessed here are likely a function of *Tlx* deletion rather than housing conditions.

Given the well-established role of Tlx as a transcriptional repressor of downstream target genes, it is important to consider the molecular mechanisms which may underpin the discrepancies in behaviour between wildtype and Tlx-deficient mice in the current study and indeed the developmental time points at which these changes emerge. Tlx has been shown to recruit the epigenetic modulators lysine-specific histone demethylase 1 (LSD1) and histone deacetylases (HDAC) 3 and 5 to regulate gene expression (Sun et al., 2010, Sun et al., 2007). In turn, expression of an array of genes has been shown to be regulated by Tlx and of particular interest are p21 and Pten as they are involved in adult hippocampal neurogenesis (Amiri et al., 2012, Pechnick et al., 2008). Indeed Pten has been shown to have a role in hippocampal-dependent contextual fear conditioning in mice (Lugo et al., 2013). Because adolescence is a significant developmental period for the remodelling of hippocampal connectivity and networking including neurogenesis, Tlx-regulated genes such as p21 and pten may have important roles to play in mediating the associated behavioural changes at this time. Future studies will help elucidate this theory.

A number of studies have shown that deletion of Tlx causes neuroanatomical abnormalities similar to those observed in bipolar disorder and schizophrenia, such as enlarged ventricles and reduced volume of the hippocampus, cerebral cortex and amygdala, as well as impaired neurogenesis (Andreazza and Young, 2014b, Ross et al., 2006, Strakowski et al., 2012b). Moreover, genetic variation at the *Nr2e1* locus in humans has been linked to susceptibility of developing bipolar disorder (Kumar et al., 2008). Furthermore, the behavioural abnormalities of *Nr2e1* mice are similar to those

observed in bipolar disorder i.e., aggression, hyperactivity and impaired learning (Ballester et al., 2012, Latalova, 2009, Vohringer et al., 2013, Najt et al., 2007). Interestingly, these disorders manifest primarily during the adolescent period, and this aligns with the behavioural observations in the adolescent Tlx deficient mice in the current study (Giedd et al., 2008). Thus, the observed impairment in limbic system structure and function may indicate a potential role of Tlx in mood disorders. In conclusion, we show that deletion of Tlx results in impairment in motor, cognitive and anxiety-related behaviours during adolescence and adulthood in both male and female mice with the majority of effects occurring during adolescence rather than adulthood. We also show that there is a progressive decline in motor performance of *Nr2e1*^{-/-} mice in adulthood thus indicating cortico-cerebellar/striatal dysfunction in these mice. This novel finding together with alterations in amygdala-dependent behaviour suggests a function for Tlx beyond its regulation of adult neurogenesis in the hippocampus. Adolescence is a critical period for postnatal brain maturation and thus susceptibility to emotional and cognitive-related disorders. Given that the role of Tlx in the regulation of cognitive and anxiety-related behaviour is most apparent during adolescence, Tlx is poised to be a key target in understanding the emergence of neurobiological disorders at the onset of adolescence and early adulthood.

CHAPTER 3

Differential Effects of Adolescent and Adult-initiated Voluntary Exercise on Contextual and Cued Fear Conditioning

This work has been submitted to the journal Neuropharmacology

[O’Leary J.D.](#), Hoban E.A., Cryan J.F., O’Leary O.F.⁺ & Nolan Y.M.⁺ (2017).

Differential effects of adolescent and adult-initiated voluntary exercise on hippocampal and amygdala-dependent fear conditioning. ⁺Equal contribution.

3.1 Abstract

Adolescence is a critical period for postnatal brain maturation and a sensitive time for increased susceptibility to developing emotional and cognitive-related disorders. Exercise during adulthood has been shown to increase hippocampal plasticity and enhance cognition. However, the impact of exercise initiated in adolescence, on brain and behaviour in adulthood is not yet fully explored or understood. The aim of this study was to compare the impact of voluntary exercise that was initiated either during adolescence or early adulthood on cognitive performance in hippocampal and amygdala-dependent fear conditioning tasks in adulthood. Adult (eight weeks old) and adolescent (four weeks old) male Sprague Dawley rats had access to a running wheel (exercise) or were left undisturbed (sedentary control) for seven weeks. Adult-initiated exercise enhanced both contextual and cued fear conditioning, while conversely, exercise that began in adolescence did not affect performance in these tasks and these differential effects were accompanied by differential expression of plasticity-related genes in the hippocampus and amygdala in adulthood. Specifically, adolescent-initiated exercise increased the expression of many plasticity related genes in the hippocampus including, *BDNF*, *synaptophysin*, *Creb*, *PSD-95*, *Arc*, *TLX* and *DCX*, while adult-initiated exercise did not affect hippocampal plasticity related genes. Together our data shows that exercise initiated during adolescence has a differential effect on hippocampal and amygdala-dependent behavior and neuronal plasticity compared to when exercise was initiated in adulthood. These findings reinforce adolescence as a period during which environmental influences have distinct impact on neuronal plasticity and cognition.

3.2 Introduction

Adolescence is a critical period for the maturation of the hippocampal circuitry (Sousa et al., 1998, Bayer, 1982, Park et al., 2017a) and heightened neural plasticity (He and Crews, 2007). In parallel, adolescence has been identified as a key period of increased susceptibility to developing emotional and cognitive-related disorders (Fuhrmann et al., 2015, Schneider, 2013, Hueston et al., 2017, Kim et al., 2017). Thus, adolescence may be a critical period during which environmentally-induced alterations in hippocampal function may result in organizational effects which persist into adulthood thus having long-term impacts on hippocampal-dependent cognition (Fuhrmann et al., 2015, Schneider, 2013, Curlik et al., 2014, Blakemore and Choudhury, 2006, Spear, 2004). The amygdala, which is involved in attributing the emotional significance of environmental cues (Maren and Quirk, 2004, Adolphs, 2010, Bissiere et al., 2008, Hoban et al., 2017), also continues to develop throughout adolescence, with an initial increase in region volume (Uematsu et al., 2012, Payne et al., 2010, Park et al., 2017b) and subsequent dendritic pruning (Zehr et al., 2006), as well as an increase in the density of the fibers connecting the amygdala, hippocampus and prefrontal cortex which continues into adulthood (Cunningham et al., 2002, Casey et al., 2008a). These cellular changes are thought to underlie the changes in emotional processing that emerge during the adolescent period (Scherf et al., 2013, Park et al., 2017b, Ganella and Kim, 2014). Furthermore, as the amygdala is extensively interconnected with both cortical and subcortical regions including the hippocampus, it is possible that subtle changes in the amygdala during the adolescent period may cause wide spread

functional changes which persist into adulthood (Scherf et al., 2013, Pessoa, 2008, Ganella and Kim, 2014, Kim, 2016) which are also thought to be influenced by environmental experiences during adolescence such as, environmental enrichment, social interaction and exercise (Hueston et al., 2017).

A growing body of evidence suggests that environmental enrichment and exercise in adulthood has significant effects on the brain and behaviour (for reviews, see (Voss et al., 2013, Gomez-Pinilla and Hillman, 2013, Kelly, 2015, Nithianantharajah and Hannan, 2006)), but there is little information on the long-term impact of exercise during adolescence on the adult brain (Hueston et al., 2017). Under environmentally enriched conditions there is increased opportunity for learning, socialization, and physical activity (van Praag et al., 2000, Nithianantharajah and Hannan, 2006). Indeed, physical activity has been shown to be a critical component of the effects of environmental enrichment on the hippocampus, a key structure involved in learning and memory (Kobilo et al., 2011, van Praag et al., 2000). Moreover, there is evidence to suggest that exercise may protect against the cognitive decline associated with ageing and neurodegenerative disorders (Ryan and Kelly, 2016, Ryan and Nolan, 2016a, Brown et al., 2013).

For the most part, animal studies have revealed that exposure of adult rodents to a running wheel or a treadmill results in enhanced hippocampal-dependent cognition, such as spatial learning and contextual fear conditioning (Baruch et al., 2004, Kohman et al., 2012, van Praag et al., 2005, Griffin et al., 2009, Short et al., 2017). Moreover,

exercise during adulthood enhances neural plasticity in the hippocampus through increases in synaptic plasticity (Patten et al., 2013, Farmer et al., 2004, Vivar et al., 2013), dendritic spine density (Eadie et al., 2005, Stranahan et al., 2007, Dostes et al., 2016), upregulation of immediate early genes (Simon et al., 2006), as well as transcription factors (Chen and Russo-Neustadt, 2009) and neurotrophic factors such as brain-derived neurotrophic factor (BDNF) and vascular endothelial growth factor (VEGF) (Adlard et al., 2004, Marlatt et al., 2012). Treadmill exercise has also been shown to improve amygdala-associated cued fear conditioning in adult rats (Lin et al., 2012, Liu et al., 2009), coupled with an increase in BDNF in the amygdala (Lin et al., 2012, Greenwood et al., 2009). The majority of studies to date have focused on the effects of exercise in adulthood, when the hippocampal and amygdala-mediated neural circuitry of learning and memory is physiologically mature. However, the impact of exercise during key developmental periods when these structures are still undergoing maturation and are therefore more susceptible to environmental conditions, is yet to be fully explored. Thus, the aim of this study was to compare the impact of voluntary exercise that was initiated during adolescence or adulthood on plasticity and cognitive performance in hippocampal and amygdala-dependent fear conditioning tasks in adulthood.

3.3 Methods

3.3.1 Animals and experimental Design

Adult (8 weeks old) and adolescent (4 weeks old) male Sprague Dawley rats were obtained from Envigo Laboratories (The Netherlands). All rats were pair housed in standard housing conditions (45 x 28 x 20cm) or in cages with access to a running wheel (45 x 28 x 25cm), with temperature $22 \pm 1^\circ\text{C}$, relative humidity 50% and a 12:12 hour light-dark cycle (lights on: 0730h) and had *ad libitum* access to food and water. All experiments were conducted in accordance with the European Directive 2010/63/EU, and under an authorization issued by the Health Products Regulatory Authority Ireland and approved by the Animal Ethics Committee of University College Cork (AE19130/1019).

The experimental design is shown in Figure 3.1. The two independent cohorts of rats; adolescent (N = 20) and adult (N = 21) were pair-housed in either standard housing or with continuous access to a running wheel (Techni plast, UK) for four weeks prior to behavioural testing by contextual and cued fear conditioning and in the open field. Due to the limited time window of experimenting with adolescent animals, each cohort underwent the experiment sequentially rather than concurrently. Three control rats that were sedentary during adolescence and three rats that underwent exercise during adolescence did not acquire a fear response and were removed from the study. Running or sedentary conditions were maintained for the duration of the experiment which lasted a total of seven weeks. Running distance (km) was recorded daily and body

weights were recorded weekly. Twenty-four hours after the completion of behavioural testing, rats were culled via un-anaesthetized decapitation and the brains were placed into a brain matrix. Coronal slices were made and the whole hippocampus (dorsal and ventral) and amygdala from both the left and right hemispheres were rapidly dissected with tweezers according to relevant anatomical coordinates (Figure 3.2). Samples were snap frozen on dry ice before storage at -80°C (Figure 3.2) for mRNA analysis of neural plasticity markers BDNF, Creb, TLX, DCX, synaptophysin, PSD-95 and Arc; Table 1).

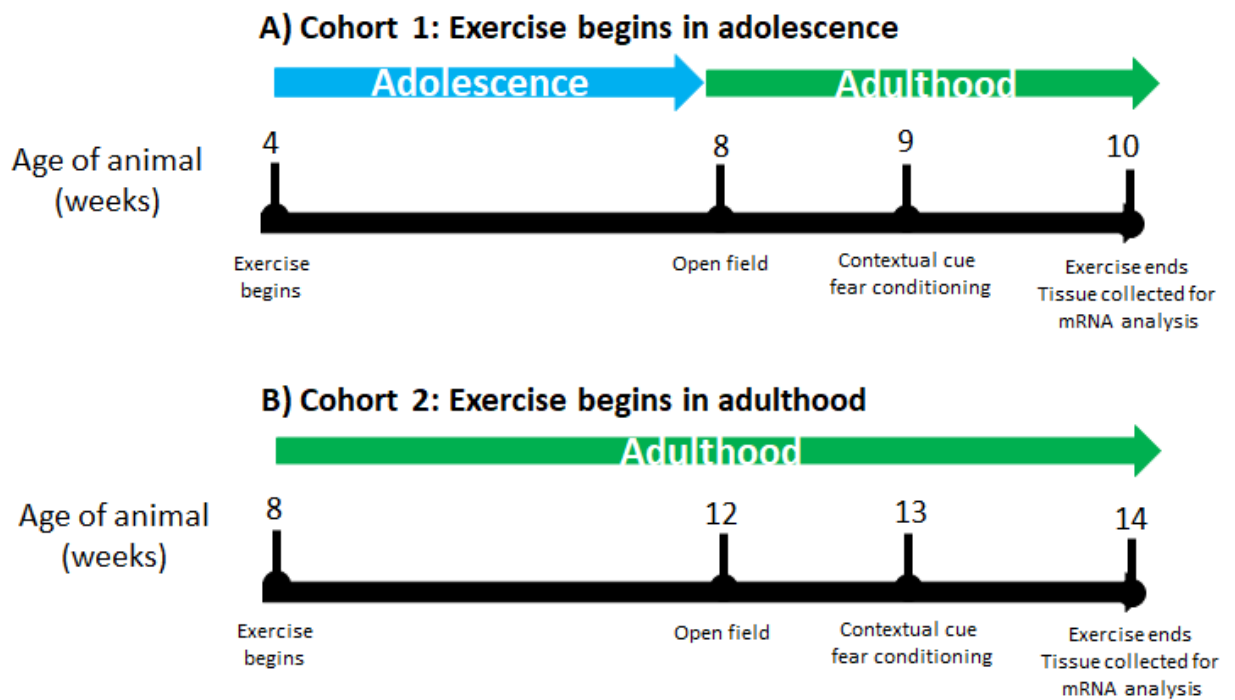

Figure 3.1: Experimental timeline. Outline of the experimental timeline for rats undergoing exercise initiated in adulthood (8 weeks of age) (A) or adolescence (4 weeks of age) (B). All rats were pair housed in standard housing (control) or with continuous access to a running wheel (exercise). Exercise began at either four weeks or eight weeks of age and continued throughout testing, for a total of seven weeks. Behavioural testing commenced after four weeks of exercise and tissue was collected for mRNA analysis of markers for neural plasticity.

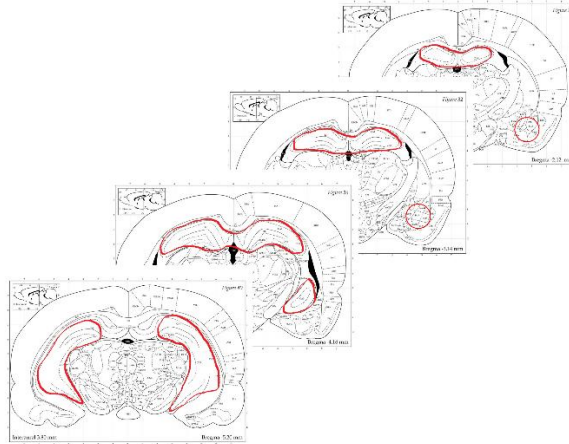

Figure 3.2: Diagram of hippocampal and amygdala dissection. Rat brain atlas with anatomical coordinates (Palkovits, 1983) of the hippocampus and amygdala highlighted to show regions dissected for analysis of markers of plasticity.

3.3.2 Open field test

Spontaneous exploratory locomotor activity in the open field was used as a general measure of motor function (Choleris et al., 2001). Rats were placed in an open field arena (90 cm diameter) under bright lighting conditions for 10 minutes (400 lux). Distance travelled and time in the center of the arena were recorded and calculated using Ethovision software (Noldus). The arena was cleaned with a 50% ethanol solution between each animal to remove odour cues.

3.3.3 Contextual and cued fear conditioning

Contextual fear conditioning was used to assess hippocampal-dependent learning, while cued fear conditioning was employed to probe amygdala-dependent cognitive processes as previously described (Pattwell et al., 2011, Maren, 2001). During

acquisition, rats were placed into the fear conditioning chamber (Med Associates, 30.5 cm x 24.1 cm x 21.0 cm) with the floor comprised of steel bars which delivered a mild electric shock and was scented with a lemon and ginger tea bag (Twinings™). Rats were allowed to explore the chamber for two minutes during an acclimation period and then received three shock and tone pairs (30 s tone; 5 kHz; 70 dB; 1 s foot shock; 0.65 mA DC current) separated by 30 second intervals. Rats were placed back in their home cage one minute after the final shock. Contextual fear memory was assessed 24 hours later by placing the rats back into the same chamber, but in the absence of tone and shock. Time spent freezing (s) was measured during the last 3.5 minutes of the total 5.5-minute protocol using specialized software (Video freeze, Med Associates, USA).

Cued fear conditioning was measured 24 hours after the contextual test in the same chambers. To measure cued fear learning, rats were placed into a novel chamber (white floor mat; black wall insert at 60°; and scented with a 1% almond solution) with presentation of the tone but no foot shock. Rats were allowed two minutes to acclimatize followed by three tone presentations (30 s; 5 kHz; 70 dB). Time spent freezing (s) during the 30 second tone presentations was recorded (Video freeze, Med Associates, USA).

3.3.4 RNA extraction & qRT-PCR

Total RNA was extracted using the mirVana™ miRNA isolation kit (Ambion/life technologies) and DNase treated (Turbo DNA-free, Ambion/life technologies) according to the manufacturers recommendations (8-10 rats per group). A Nanodrop 2000 (Thermo Scientific) was used to determine RNA concentration. All qRT-PCR experiments were performed using KiCqStart® SYBR® Green qPCR ReadyMix™ with ROX™ (Sigma). cDNA was then synthesised using the high capacity cDNA reverse transcription kit (Applied Biosystems) and diluted to 10 ng/μl. For individual genes (*BDNF*, *synaptophysin*, *Creb*, *PSD-95*, *Arc*, *TLX* and *DCX*; Table 3.1), three technical replicates were carried out for each biological sample on the Applied Biosystems StepOnePlus Real-Time PCR System and the average of the closest two results analysed using the $\Delta\Delta C_t$ – method (Livak and Schmittgen, 2001).

Table 3.1: List of PCR Primers.

Gene	Forward Sequence (5'→3')	Reverse Sequence (5'→3')
BDNF	GACCAAGTGTAATCCCATGGGTTA	GTTCCAGTGCCTTTTGTCTATGC
Synaptophysin	CCCTTCAGGCTGCACCAA	TTGGTAGTGCCCCCTTTGAC
Creb	CCGCCAGCATGCCTTC	TGCAGCCCAATGACCAAA
PSD-95	ACGCCGAAGAGTCAGAGAAA	ACTGTTGGACCGAGTGAACC
Arc	TGGCTATCCCCTATTTTCACC	AAGATGGTGTGGGCCAGAT
TLX	GCTTTCTTCACAGCGGTAC	GCAGACACAGCGGTCAACT
DCX	ATCTCTACCCCACAAGCCCT	ATCTCTACCCCACAAGCCCT
HPRT1	GCGAAAGTGGAAAAGCCAAGT	GCCACATCAACAGGACTCTGTAG

3.3.5 Statistical analyses

All data were analyzed primarily by 2 x 2 Between Subjects Factorial ANOVA and simple main effects as appropriate using SPSS statistical software (SPSS, Chicago, IL). Analysis of behavioural data was performed on n=7 for the adolescent cohort and n=10-11 for the adult cohort. With regard to analysis of q-PCR data, tissue samples that failed to show a standard amplification curve were removed from analysis. Therefore, statistical analysis of qPCR data from rats after adolescent-initiated exercise was carried out on n = 6-7 (hippocampus) and n = 5-7 (amygdala), and after adult-initiated exercise on n = 7-9 (hippocampus) and on n = 9-10 (amygdala). An α -level of 0.05 was used as criterion for rejection of the null hypothesis. Data are presented as mean plus standard errors of the mean (SEM).

3.4 Results

3.4.1 Exercise decreased body weight gain during adolescent-initiated exercise

There was no significant main effect of exercise [$F(1, 19) = 2.65, p > 0.05$; Figure 3.3A] on body weight when exercise was initiated in adulthood. However, there was a significant interaction between exercise and time when exercise was initiated in adulthood [$F(6,19) = 2.72, p < 0.05$]. Exercise that began during adolescence reduced body weight gain [$F(1, 12) = 15.13, p < 0.01$; Figure 3.3B]. There was also a significant interaction between exercise and time when exercise was initiated in adulthood [$F(6, 12) = 11.61, p < 0.01$].

3.4.2 Running wheel distance

Over the course of the seven-week exercise paradigm, all rats increased the amount of running [F (6, 72) = 138.3, $p < 0.001$; Figure 3.3C], with rats that began exercise in adulthood running an average of 3.96 km per day and rats that began exercise in adolescence running an average of 3.43 km per day. There was also a significant interaction between time and age [F (6, 72) = 9.17, $p < 0.001$; Figure 3.3C] as well as a main effect of age [F (1, 12) = 11.42, $p < 0.01$; Figure 3.3C], whereby adolescent rats initially ran a shorter distance per week compared to their adult counterparts. Simple main effects at individual time-points revealed that this effect was apparent at weeks two [F (1, 12) = 42.18, $p < 0.001$, three [F (1, 12) = 24.46, $p < 0.001$] and seven [F (1, 12) = 24.38, $p < 0.001$] of the exercise regime, but reached a steady state level in both groups after four weeks.

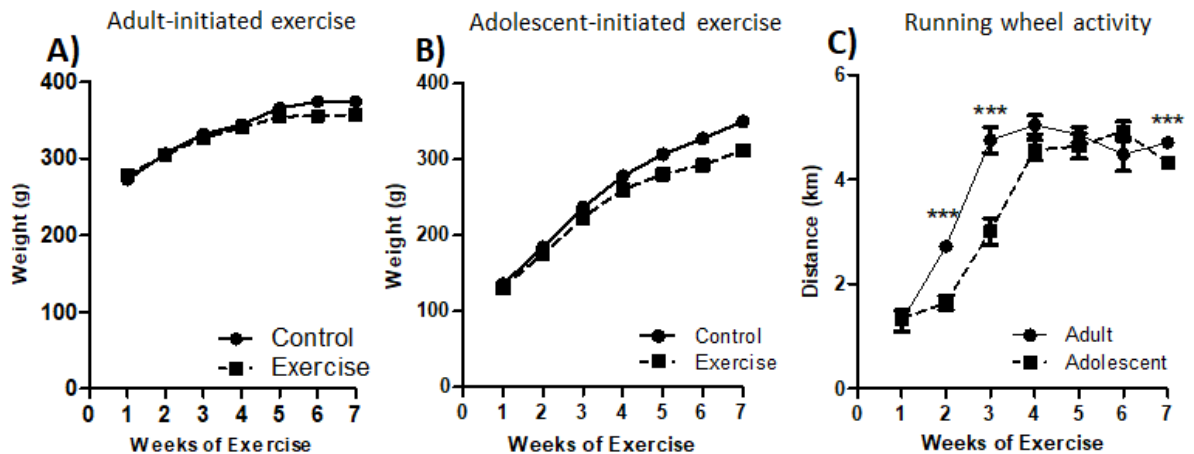

Figure 3.3: Body weight and Running distance. Body weight of rats after exercise was initiated in adulthood ($n = 10-11$) (A) or adolescence ($n = 7$) (B). Running wheel activity (km) for both adult and adolescent-initiated exercise (C). Control compared to Exercise; Repeated measures ANOVA with simple main effects (***) $p < 0.001$). Data are presented as means \pm SEM.

3.4.3 Age but not exercise-related changes in locomotor activity in the open field test

Locomotor activity in the open field was unaffected by exercise [$F(1, 31) = 3.93$, $p > 0.05$; Figure 3.4A]. Conversely, there was a significant main effect of age [$F(1, 31) = 31.47$, $p < 0.001$; Figure 3.4A] on distanced travelled; animals that had exercise initiated during adolescence and their sedentary control counterparts exhibited increased activity compared to adult cohorts.

3.4.4 Adult-initiated exercise but not adolescence-initiated exercise enhanced contextual fear recall in adulthood

There was no main effect of exercise [$F(1, 31) = 0.009$, $p > 0.05$] or age [$F(1, 31) = 2.87$, $p > 0.05$; Figure 3.4B] on contextual fear conditioning. However, there was a significant interaction between age and exercise [$F(1, 31) = 9.38$, $p < 0.01$; Figure 3.4B]. Simple main effects revealed that contextual fear recall was enhanced in rats when exercise began in adulthood [$F(1, 31) = 6.23$, $p < 0.05$; Figure 3.4B]. Conversely, contextual fear recall was unaffected in rats that began exercise in adolescence [$F(1, 31) = 3.67$, $p > 0.05$; Figure 3.4B].

3.4.5 Adult-initiated exercise but not adolescence-initiated exercise enhanced cued fear recall in adulthood

There was no main effect of exercise [$F(1, 31) = 0.11$, $p > 0.05$; Figure 3.4C] on cued fear conditioning. However, there was a main effect of age [$F(1, 31) = 8.34$, $p > 0.01$; Figure 3.4C] as well as a significant interaction between age and exercise [$F(1, 31) = 6.46$, $p < 0.05$]. Simple main effects revealed that exercise initiated in adulthood

increased cued recall [$F(1, 31) = 5.15, p < 0.05$; Figure 3.4C], while exercise initiated in adolescence had no effect [$F(1, 31) = 2.03, p > 0.05$]. Baseline freezing was unaffected by exercise [$F(1, 31) = 1.84, p > 0.05$; Figure 3.3D and E]. However, there was a main effect of age on baseline freezing during fear acquisition [$F(1, 31) = 10.49, p < 0.01$].

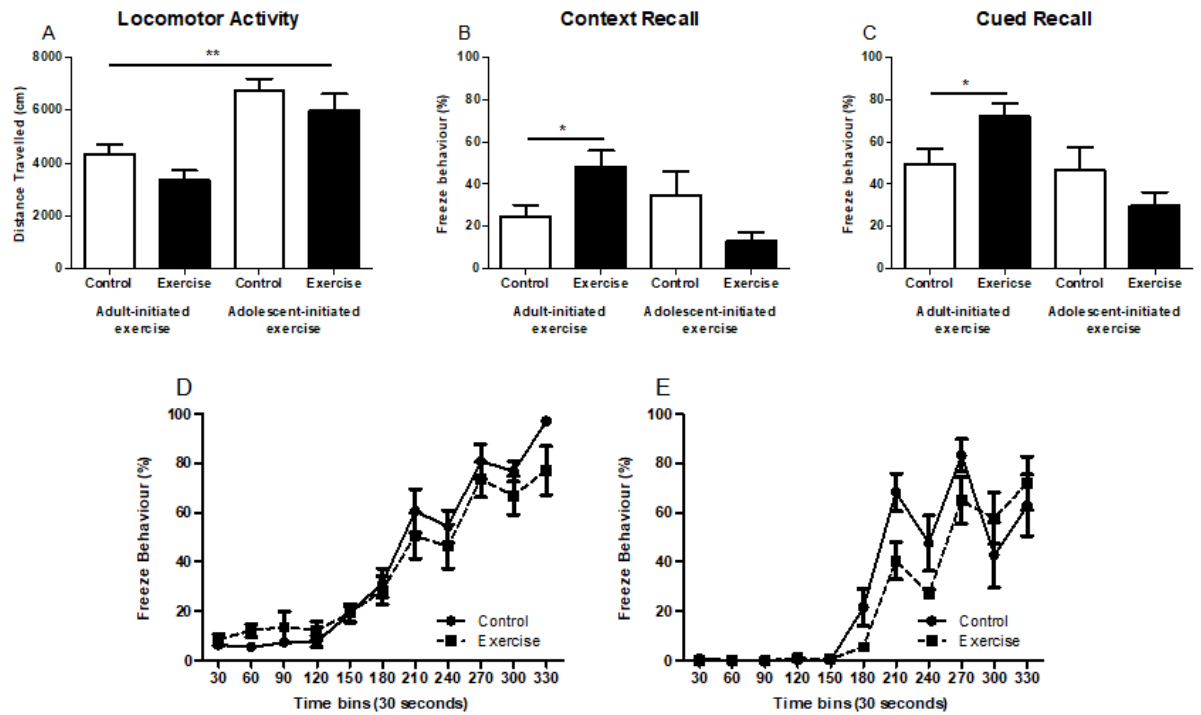

Figure 3.4: Differential effects of adult-initiated exercise and adolescence-initiated exercise on context and cued fear recall. Locomotor activity in the open field of rats after exercise was initiated in adulthood or adolescence (A). Contextual fear recall of rats after exercise was initiated in adulthood or adolescence (B). Cued fear recall of rats after exercise was initiated in adulthood or adolescence (C). Baseline freezing of rats after exercise was initiated in adulthood (D) or adolescence (E). Bar graphs indicate average for adult cohort ($n = 10-11$) and adolescent cohort ($n = 7$). Control compared to Exercise; 2 x 2 Factorial ANOVA with simple main effects ($*p < 0.05$, $**p < 0.001$). Data are presented as means \pm SEM.

3.4.6 Adolescence-initiated exercise had a greater effect on hippocampal mRNA expression of neural plasticity markers than adult-initiated exercise

Exercise had a significant main effect on hippocampal BDNF mRNA expression [F (1, 24) = 20.90, $p < 0.01$; Figure 3.5A]. There was also a significant interaction between age and exercise [F (1, 24) = 6.17, $p < 0.05$]; exercise beginning in adolescence increased BDNF expression in the hippocampus [F (1, 24) = 21.78, $p < 0.01$], while adult-initiated exercise had no effect [F (1, 24) = 2.54, $p > 0.05$]. Exercise also had a significant main effect on hippocampal Creb mRNA expression, a transcription factor downstream of BDNF [F (1, 27) = 64.26, $p < 0.001$; Figure 3.5B]. Moreover, there was a significant main effect of age [F (1, 27) = 66.41, $p < 0.001$; Figure 3.5B] as well as a significant interaction between age and exercise [F (1, 27) = 81.29, $p < 0.001$]; exercise beginning in adolescence increased Creb mRNA expression in the hippocampus [F (1, 27) = 132.47, $p < 0.001$; Figure 3.5B], while adult-initiated exercise had no effect [F (1, 27) = .55, $p > 0.05$ Figure 3.5B]. Exercise had a significant main effect on hippocampal mRNA expression of synaptophysin [F (1, 25) = 33.56, $p < 0.001$; Figure 3.5C], which exists in presynaptic vesicles. There was also a significant main effect of age [F (1, 25) = 7.80, $p < 0.01$; Figure 3.5C] as well as a significant interaction between age and exercise [F (1, 25) = 10.75, $p < 0.01$], where exercise beginning in adolescence increased synaptophysin mRNA expression in the hippocampus [F (1, 25) = 39.87, $p < 0.001$; Figure 3.5C], while adult-initiated exercise had no effect [F (1, 25) = 3.26, $p > 0.05$; Figure 3.5C].

Exercise had a significant main effect on hippocampal PSD-95 mRNA expression [F (1, 24) = 34.69, $p < 0.001$ Figure 3.5D], a regulator of postsynaptic function. Likewise, there was a significant main effect of age [F (1, 24) = 29.76, $p < 0.001$ Figure 3.5D] as well as a significant interaction between age and exercise [F (1, 24) = 36.69, $p < 0.001$], where exercise beginning in adolescence increased PSD-95 mRNA expression in the hippocampus [F (1, 24) = 71.50, $p < 0.001$ Figure 3.5D], while adult-initiated exercise had no effect [F (1, 24) = .02, $p > 0.05$ Figure 3.5D]. Exercise alone did not affect hippocampal Arc mRNA expression [F (1, 27) = 2.40, $p > 0.05$; Figure 3.5E], an immediate-early gene involved in the induction and maintenance of some forms of neuronal plasticity. Moreover, there was also no main effect of age [F (1, 27) = 4.04, $p > 0.05$; Figure 3.5E]. However, there was a significant interaction between age and exercise [F (1, 27) = 8.22, $p < 0.01$], where exercise beginning in adolescence increased Arc mRNA expression in the hippocampus [F (1, 27) = 8.38, $p < 0.01$; Figure 3.5E], while adult-initiated exercise had no effect [F (1, 27) = 1.03, $p > 0.05$; Figure 3.5E]. Exercise had a significant main effect on TLX, a key regulator of neurogenesis [F (1, 25) = 9.37, $p < 0.01$; Figure 3.5F]. There was also a significant main effect of age [F (1, 25) = 16.85, $p < 0.001$; Figure 3.5F], as well as a significant interaction between age and exercise on TLX expression [F (1, 25) = 26.29, $p < 0.001$], where exercise initiated in adolescence increased hippocampal TLX expression [F (1, 25) = 32.48, $p < 0.001$; Figure 3.5F], while adult-initiated exercise had no effect [F (1, 25) = 2.20, $p > 0.05$; Figure 3.5F].

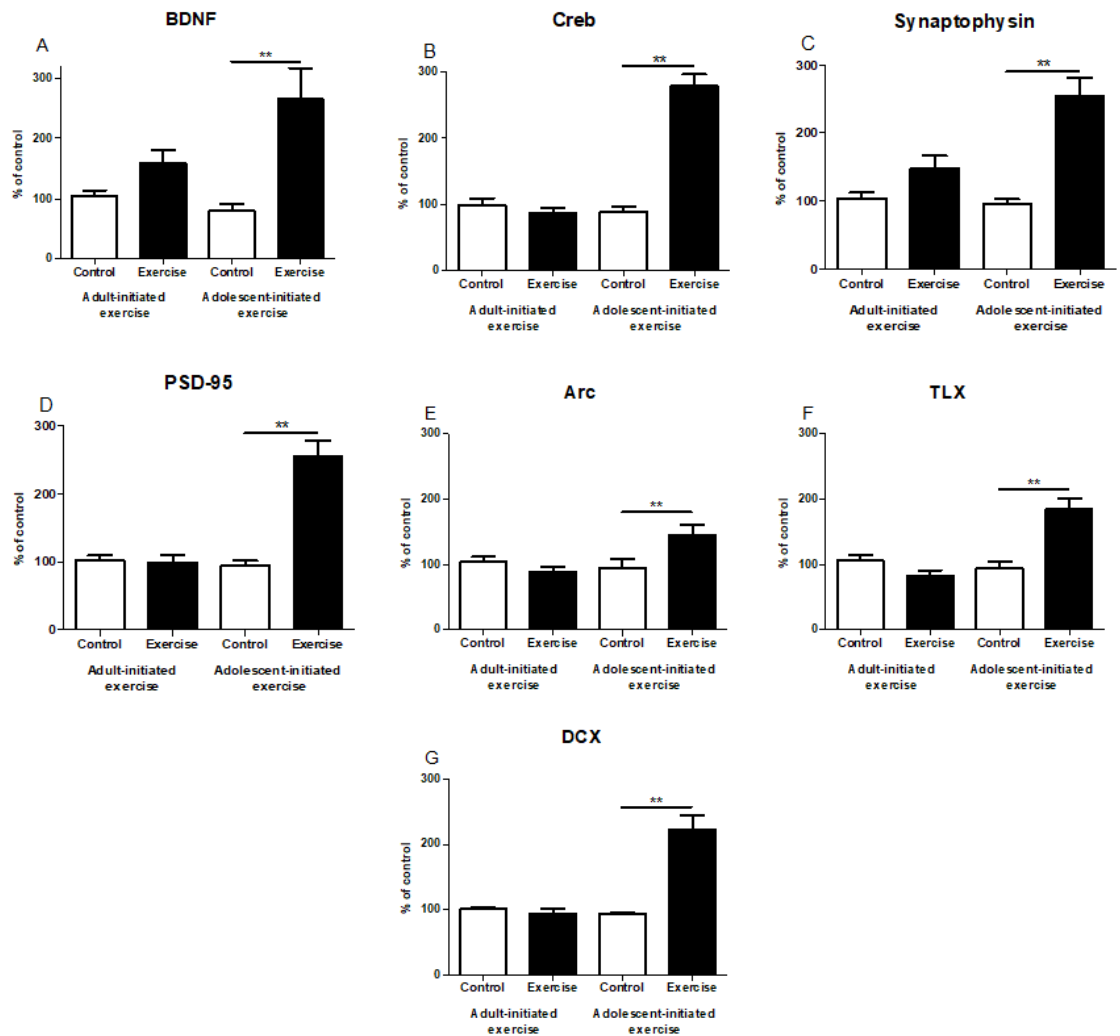

Figure 3.5: Differential effects of adult-initiated exercise and adolescence-initiated exercise on hippocampal mRNA expression of neural plasticity genes. mRNA expression of plasticity genes, brain-derived neurotrophic factor (BDNF) (A), cAMP response element binding protein (Creb) (B), synaptophysin (C), synapse-associated protein 90 (PSD-95) (D), activity-regulated cytoskeleton-associated protein (Arc) (E), TLX (Nuclear Receptor Subfamily 2 Group E Member 1) (F) and doublecortin (DCX) (G) in the hippocampus of rats following adult or adolescent initiated exercise. Bar graphs indicate average values in hippocampal tissue from adolescent-initiated exercise ($n = 6-7$) and adult-initiated exercise ($n = 7-9$) after HPRT1 normalization relative to control levels Control compared to Exercise; 2 x 2 factorial ANOVA with simple main effects ($*p < 0.05$). Data are presented as means + SEM.

Exercise had a significant main effect on DCX, a marker of immature neurons [F (1, 25) = 26.98, $p < 0.001$; Figure 3.5G]. Similarly, there was a significant main effect of age [F (1, 25) = 25.45, $p < 0.001$; Figure 3.5G] as well as a significant interaction between age and exercise [F (1, 25) = 32.61, $p < 0.001$], where exercise beginning in adolescence increased DCX mRNA expression in the hippocampus [F (1, 25) = 57.61, $p < 0.001$; Figure 3.5G], while adult-initiated exercise had no effect [F (1, 25) = .13, $p > 0.05$; Figure 3.5G].

3.4.7 Adult-initiated exercise selectively enhanced mRNA levels of synaptophysin in the amygdala

There was a main effect of exercise [F (1, 29) = 5.06, $p < 0.05$; Figure 3.6A] on synaptophysin mRNA expression in the amygdala. A priori t-test indicated exercise beginning in adulthood significantly increased synaptophysin expression [t (17) = 2.29, $p < 0.05$]. However, there was no main effect of age [F (1, 29) = .97, $p > 0.05$; Figure 3.6A], nor interaction between age and exercise [F (1, 29) = .31, $p > 0.05$]. Conversely, there was no main effect of exercise [F (1, 29) = 2.14, $p > 0.05$; Figure 3.6B] or age [F (1, 29) = 2.41, $p > 0.05$; Figure 3.6B], nor interaction effect [F (1, 29) = 1.96, $p > 0.05$] on BDNF mRNA expression in the amygdala. Likewise, there was no main effect of exercise [F (1, 29) = .82, $p > 0.05$; Figure 3.6C], or age [F (1, 29) = .57, $p > 0.05$; Figure 3.6C], nor interaction between age and exercise on amygdala Creb mRNA expression [F (1, 29) = .17, $p > 0.05$]. There was also no significant effect of exercise [F (1, 29) = 2.15, $p > 0.05$; Figure 3.6D], or age [F (1, 29) = 1.05, $p > 0.05$];

Figure 3.6D], nor interaction between age and exercise on amygdala PSD-95 mRNA levels [F (1,29) = .45, $p > 0.05$]. Moreover, there was no main effect of exercise [F (1, 27) = .75, $p > 0.05$; Figure 3.6E], or age [F (1, 27) = .26, $p > 0.05$; Figure 3.6E], nor interaction between age and exercise on amygdala Arc mRNA expression [F (1, 27) = .00, $p > 0.05$].

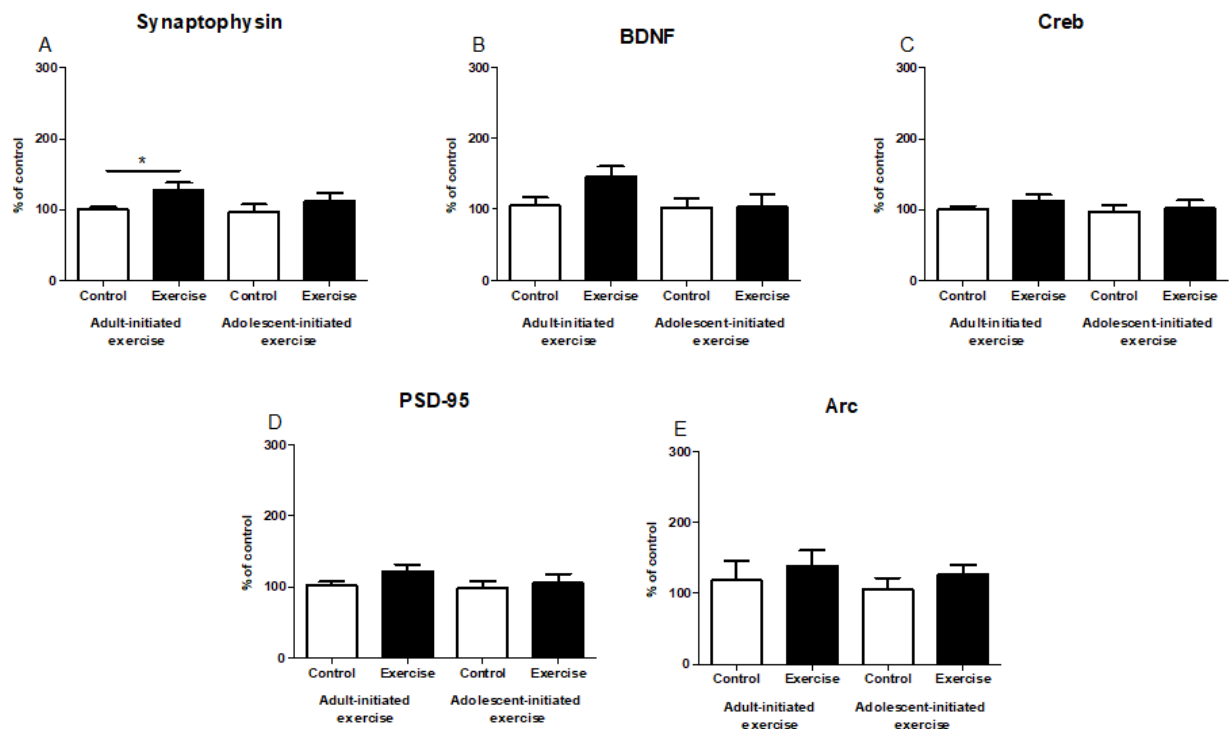

Figure 3.6: Adult-initiated exercise selectively enhanced Synaptophysin mRNA expression in the amygdala. mRNA expression of plasticity genes, synaptophysin (A), brain-derived neurotrophic factor (BDNF) (B), cAMP response element binding protein (Creb) (C), synapse-associated protein 90 (PSD-95) (D), activity-regulated cytoskeleton-associated protein (Arc) (E) in the amygdala of rats following adult or adolescent initiated exercise. Bar graphs indicate average values for adolescent-initiated exercise ($n = 5-7$) and adult-initiated exercise ($n = 9-10$) after HPRT1 normalization relative to control levels. Control compared to Exercise; 2 x 2 factorial ANOVA with simple main effects ($*p < 0.05$). Data are presented as means + SEM.

3.5 Discussion

This study revealed that a repeated voluntary exercise regimen initiated in adulthood enhanced both contextual and cued fear recall, whereas adolescent-initiated exercise failed to show a similar enhancement. On the other hand, adolescence-initiated exercise induced an increase in mRNA expression of neural plasticity markers in the hippocampus while adult-initiated exercise did not. Conversely, adult-initiated exercise selectively enhanced synaptophysin mRNA expression in the amygdala, while amygdala plasticity was unaffected by exercise beginning in adolescence.

Our finding that adult-initiated exercise enhanced contextual fear conditioning is in agreement with previously published studies. Indeed, prolonged (four, six or eight weeks) running wheel exercise during adulthood has previously been shown to enhance contextual fear recall in adult rats (Baruch et al., 2004, Burghardt et al., 2006, Greenwood et al., 2009) and mice (Kohman et al., 2012, Clark et al., 2008, Dubreucq et al., 2011). These findings also support other studies which have investigated the effects of several weeks of exercise on other hippocampal-dependent tasks. Specifically, prolonged (four and twelve weeks) weeks of either running wheel or treadmill exercise enhanced spatial learning in the Morris water maze in adult and aged rats (Adlard et al., 2004, Albeck et al., 2006, Ang et al., 2006) as well as mice (Rhodes et al., 2003, van Praag et al., 2005).

In contrast, to these findings on adult-initiated exercise, we found that when exercise was initiated in adolescence it did not affect contextual fear conditioning. To the best

of our knowledge, this is the first study to investigate the impact of adolescent-initiated exercise on contextual fear conditioning in adulthood, however others have investigated the impact exercise beginning in adolescence on other hippocampal-dependent cognitive tasks. Indeed, prolonged (six weeks) running wheel (Uysal et al., 2015), and (six or eight weeks) treadmill exercise (Uysal et al., 2005, Uysal et al., 2015, Gomes da Silva et al., 2012), initiated during the adolescent period (three to four weeks of age), enhanced spatial learning in the Morris water maze in rats. Additionally, exposure to environmental enrichment, a process that has similar pro-cognitive and pro-neurogenic effects as exercise, initiated during adolescent development (five weeks of age) and continuing for eight weeks into adulthood, similar to our exercise regime, has also been shown to enhance spatial learning in the Morris water maze in mice (Williams et al., 2001). In the present study, the rats that were exposed to exercise during adolescence continued to run through adulthood thus this may have inadvertently masked potential behavioural changes from this earlier life exposure. This limitation may be overcome in future studies by examining the impact of limiting exercise to the adolescent period only. Furthermore, this could be expanded to include multiple cohorts with different ages of exercise onset, for example with exercise beginning at four weeks of age through to 14 weeks. In addition, despite both cohorts of rats being tested in adulthood, there was a main effect of the age at which exercise began on baseline freezing. It is possible that the increased locomotor activity that was observed in the cohort of rats that began exercise during adolescence (both control and exercise) may have confounded freezing behaviour in the fear conditioning task thus making it difficult to draw definitive conclusions. Therefore, further work is needed

to fully elucidate the effects of exercise on hippocampal maturation processes during key development periods, such as adolescence.

In an effort to elucidate the neurobiology underlying exercise induced changes in contextual fear conditioning, we investigated the impact of seven weeks of running wheel exercise on plasticity-related genes in the hippocampus in adulthood. We found that adult-initiated exercise did not affect mRNA expression of plasticity related markers in the adult hippocampus, whereas adolescent-onset exercise increased mRNA expression of an array of neural plasticity markers in the hippocampus, such as BDNF, Creb, synaptophysin, PSD-95, Arc and the neurogenesis-related genes TLX and DCX in the adult hippocampus. Growth and transcription factors such as BDNF and Creb as well as hippocampal neurogenesis have previously been shown to play a key role in fear conditioning (Kim et al., 2013, Liu et al., 2004, Saxe et al., 2006a). Moreover, immediate early genes, such as Arc have also been shown to be required for contextual fear conditioning (Czerniawski et al., 2011). Previous studies that have shown similar adult-initiated exercise-induced behavioural enhancements were associated with an increase in hippocampal *BDNF* mRNA expression (Greenwood et al., 2009). In addition, prolonged (four weeks) running wheel exercise increased both VEGF and BDNF protein levels within the hippocampus in adult rats (Adlard et al., 2004, Uysal et al., 2015) as well as short-term (one week) running wheel exercise (Neeper et al., 1996, Neeper et al., 1995), and short-term (one week) treadmill exercise in rats (O'Callaghan et al., 2007). Moreover, prolonged (three and eight weeks) running wheel exercise in adulthood has also been shown to increase dendritic complexity and spine

density in the rat (Stranahan et al., 2007) and mouse (Dostes et al., 2016) hippocampus. Although we did not assess protein nor morphological changes within the hippocampus in the present study, it is possible that the improved contextual fear recall in adult rats is mediated by an exercise-induced change in proteins that regulate neuronal morphology.

Similarly, prolonged (six weeks) running wheel and (eight weeks) treadmill exercise initiated in adolescence (three and four weeks of age) has also been shown to increase BDNF protein levels in adult rats (Uysal et al., 2015, Uysal et al., 2005). Moreover, four to six weeks of running wheel (Hopkins et al., 2011) or treadmill exercise (Gomes da Silva et al., 2012, Uysal et al., 2015) initiated during the adolescent period (three to four weeks of age), has been shown to increase hippocampal BDNF and VEGF protein levels as well as TrkB expression, a downstream target of BDNF (Uysal et al., 2015, Hopkins et al., 2011, Gomes da Silva et al., 2012). Furthermore, the behavioural enhancements following adolescent environmental enrichment were also correlated with an increase in cAMP response element binding protein (CREB) within the hippocampus, a downstream target of BDNF (Williams et al., 2001). Furthermore, disruption of BDNF-TrkB signalling abolishes adult-initiated exercise-induced morphological changes in the hippocampus (Liu et al., 2009). Thus exercise-induced changes in neural plasticity may be driven by upregulation of hippocampal BDNF signalling, which in turn promotes hippocampal-dependent cognition. On the other hand, however, although we found that adolescent-initiated exercise increased *BDNF* expression, it did not translate to an increase in cognitive function. Thus suggesting a

dissociation between exercise-induced changes in *BDNF* and enhanced behavioural performance. Endogenous *BDNF* in the hippocampus (Heldt et al., 2007) and amygdala (Kirtley and Thomas, 2010) have been shown to be necessary for fear extinction. Therefore, it is possible that exercise induced changes in *BDNF* within the hippocampus may have altered fear extinction, which was not assessed in the present study. Interestingly, this dissociation is in line with a previous study that reported an adult-initiated exercise-induced increase in hippocampal *BDNF* protein levels while displaying no change in spatial learning, a hippocampal-dependent process (O'Callaghan et al., 2007). Together, these data suggest that prolonged voluntary exercise in adulthood but not adolescence enhances contextual recall, a hippocampal-dependent cognitive processes, possibly through upregulation of neurotrophic factors.

The results in the current study demonstrated that amygdala-dependent cued fear recall, was enhanced in rats that began exercise in adulthood, while exercise that was initiated in adolescence did not affect cued fear recall in adulthood. Contradictory findings have been reported regarding the effects of adult exercise on cued fear conditioning. Prolonged (four or eight weeks) running wheel exercise did not affect cued fear recall in adult rats (Burghardt et al., 2006, Baruch et al., 2004) or mice (Kohman et al., 2012) whereas prolonged (nine weeks) treadmill exercise improved cued fear recall in an APP/PS1 transgenic mouse model of Alzheimer's disease (Lin et al., 2015). Habituation and sensitization to a previously conditioned stimulus, such as a tone has been shown to determine the expression and extinction of the conditioned fear response (Kamprath and Wotjak, 2004; Seo et al., 2016). Thus, the changes in cued, as well as

contextual fear conditioning observed here may also reflect changes in non-associative learning in adulthood. The neural circuitry of fear learning continues to undergo maturation during the adolescent period (Pattwell et al., 2013, Scherf et al., 2013, Pessoa, 2008, Kim, 2016, Kim et al., 2017), thus we hypothesized that exercise-induced changes in plasticity in the basolateral amygdala during this time may have impacted upon the maturation of key neural circuits involved in emotional processing which persisted into adulthood. However, we did not observe any changes on cued fear recall in adulthood or on plasticity markers in the adult amygdala as a result of voluntary exercise initiated during adolescence. Previous studies have demonstrated that four weeks of treadmill exercise initiated in adolescence (five weeks of age) improved cued fear recall, while voluntary running wheel exercise (four weeks) during the same developmental period did not affect cued fear recall in adult rats (Lin et al., 2012). Taken together with our current results, these findings suggest that any beneficial effect of exercise during adolescence on cued fear recall may be mediated through the type of exercise employed (Lin et al., 2012, Liu et al., 2009).

In an effort to determine the neurobiology underlying exercise-induced changes in cued fear conditioning, we investigated the impact of seven weeks of running wheel exercise on plasticity-related genes in the amygdala in adulthood. Adult-initiated exercise selectively enhanced mRNA levels of pre-synaptic synaptophysin in the amygdala. This finding supports a previous study which showed a similar increase in synaptic proteins such as synaptosomal-associated protein 25 (SNAP-25) and TrkB in the amygdala of rats following four weeks of treadmill exercise in adulthood (Liu et al.,

2009). Different different types of exercise, such as four weeks of running wheel or treadmill exercise has also been shown to induce differential effects on BDNF protein levels in the amygdala following adolescent-initiated exercise (Lin et al., 2012). Specifically, forced treadmill exercise beginning in adolescence and continuing into adulthood increased TrkB protein levels and dendritic arborization and spine density in the basolateral amygdala, whereas the same duration of running wheel exercise also beginning in adolescence did not affect neural plasticity in the amygdala in adulthood (Lin et al., 2012). BDNF and TrkB are important regulators of neuronal development and though we did not observe changes in amygdala BDNF mRNA following adult or adolescent-onset exercise, it is possible that exercise-induced changes in these key neurotrophic factors at the protein level or indeed the morphology of neurons during the critical development period may alter the maturation processes of amygdala circuitry which in turn effect amygdala-dependent processes in later life.

In conclusion, adult-initiated exercise enhanced both contextual and cued fear conditioning. Conversely, exercise that began in adolescence did not affect contextual or cued fear conditioning, despite an enhancement of several hippocampal neural plasticity markers. Together these data show that adolescence is a critical period for brain maturation with experience shaping plasticity and cognitive processes in later life and highlight the importance of understanding the development of neural systems associated with the emergent behaviors of adolescence.

CHAPTER 4

Differential Effects of Adolescent and Adult-initiated Exercise on Cognition and Hippocampal Neuroplasticity

This work has been submitted to the journal Hippocampus

O'Leary J.D., Hoban E.A., Murphy A., O'Leary O.F., Cryan J.F., & Nolan Y.M.
(2017). Differential effects of exercise during adolescence and adulthood on
cognition and plasticity.

4.1 Abstract

Adolescence is a critical period for postnatal brain maturation and thus a time when environmental influences may affect cognitive processes in later life. Exercise during adulthood has been shown to increase hippocampal neurogenesis and enhance cognition. However, the impact of exercise initiated in adolescence, on the brain and behavior in adulthood is not fully understood. The aim of this study was to compare the impact of voluntary exercise that is initiated during adolescence or early adulthood on cognitive performance in hippocampal-dependent and independent processes using both object-based and touchscreen operant paradigms. Adult (8 week) and adolescent (4 week) male Sprague Dawley rats had access to a running wheel (exercise) or were left undisturbed (sedentary control) for four weeks. Results from touchscreen-based tasks showed that reversal learning was enhanced by both adult and adolescent-initiated exercise, while only exercise that began in adolescence induced a subtle but transient increase in performance on a location discrimination task. Spontaneous alternation in the Y-maze was impaired following adolescent onset exercise, while object memory was unaffected by either adult or adolescent-initiated exercise. Adolescent-initiated exercise increased the number of hippocampal DCX cells, an indicator of neurogenesis, and also promoted the complexity of neurites on DCX cells, a key process for synaptic integration, to a greater degree than adult-initiated exercise. Together the data here show that exercise during the adolescent period compared to adulthood differentially affects cognitive processes and the development of new hippocampal neurons in later life.

4.2 Introduction

The positive effects of exercise on learning and memory is well established for reviews, see Voss et al. (2013) and Gomez-Pinilla and Hillman (2013). Specifically, voluntary exercise in adulthood has been shown to enhance hippocampal-dependent cognition, such as spatial learning (van Praag et al., 2005, Anderson et al., 2000) and contextual fear conditioning (Baruch et al., 2004, Kohman et al., 2012) in both rats and mice. Moreover, other forms of learning, such as cognitive flexibility, a prefrontal cortex-mediated processes is also increased following exercise in adult rats and mice (Brockett et al., 2015). Exercise-induced enhancement in cognitive function is often associated with significant changes in the neurocircuitry involved in learning and memory, such as the hippocampus and prefrontal cortex (Brockett et al., 2015, Creer et al., 2010). In particular, exercise in adulthood has been shown to be a potent stimulator of hippocampal neurogenesis, a form of structural plasticity that occurs in the dentate gyrus (DG) of the hippocampus (van Praag et al., 1999a). Indeed, it is hypothesized that the beneficial effects of exercise on hippocampal-dependent cognition is due, in part, to its pro-neurogenic capacity (Clark et al., 2008, Ji et al., 2014). Adult hippocampal neurogenesis has been shown to be necessary for cognitive processes such as spatial memory and contextual memory, as well as the ability to discriminate between similar memories (Frankland et al., 2013, Saxe et al., 2006c, Snyder et al., 2005a, Rola et al., 2004). This process of pattern separation encodes memories in a discrete non-overlapping fashion, and without such a process, memory recall would suffer high interference from similarly encoded memories (Kent et al., 2016). Pattern

separation has been repeatedly associated with hippocampal neurogenesis (Aimone et al., 2011, Sahay et al., 2011c, Revest et al., 2009, Besnard and Sahay, 2016). Indeed, several weeks of running wheel exercise in adult mice has been shown to enhance pattern separation through upregulation of hippocampal neurogenesis (Creer et al., 2010). In recent years, novel cognitive tests have been developed to tease apart the relationship between hippocampal neurogenesis and cognitive function. One such approach has been the development of touchscreen-based tests which allow for increased translation of pre-clinical research findings, and thus help to bridge the species divide, Appendix A (Oomen et al., 2013, Horner et al., 2013). The majority of studies to date, using both object and touchscreen-based approaches to assess cognitive function, have focused on the effects of exercise in adulthood, when the neural circuitry underling learning and memory is physiologically mature. However, the impact of exercise on cognitive processes during key developmental periods when the hippocampus and prefrontal cortex are still undergoing maturation is yet to be fully explored (Hueston et al., 2017).

Adolescence is a sensitive period for maturation of the hippocampal circuitry, during which time an increase in the number of granule cells and dendritic arbors occurs, as well as increased synaptic pruning and an overall increase in the volume of the hippocampal layers (Sousa et al., 1998, Bayer, 1982, Hueston et al., 2017, Fuhrmann et al., 2015, Schneider, 2013). In order for these new neurons to process information, extensive neurite arborization occurs so that neurons are capable of receiving and integrating complex synaptic inputs. Thus, adolescence may be a critical period during

which alterations in hippocampal function may result in organizational effects which last throughout adulthood (Fuhrmann et al., 2015, Schneider, 2013, Curlik et al., 2014, Blakemore and Choudhury, 2006, Spear, 2004). The prefrontal cortex also undergoes significant maturation during the adolescent period which continues into early adulthood, with increases in synaptic pruning and myelination (Spear, 2013, Casey et al., 2008b, Giedd et al., 1999, Blakemore and Choudhury, 2006). These developmental processes allow for the strengthening and fine tuning of connections between the hippocampus and prefrontal cortex and are thought to underlie the emergence of cognitive functions which typically develop in adolescence, such as response inhibition and cognitive flexibility (Selemon, 2013, Spear, 2013). We propose that exercise during adolescence may capitalize on the peak in neural plasticity during this period. Thus, the aim of this study was to determine the impact of voluntary exercise initiated at adolescence on hippocampal neurogenesis, neurite arborization and cognitive performance in hippocampal neurogenesis-dependent and independent tasks in adulthood.

4.3 Methods

4.3.1 Animals and experimental design

Adult (8 week) and adolescent (4 week) male Sprague Dawley rats were obtained from Envigo Laboratories (The Netherlands). All rats were paired housed in standard housing conditions (temperature $22 \pm 1^\circ\text{C}$, relative humidity 50%) with a 12:12 hour light-dark cycle (0730-1930) and had *ad libitum* access to food and water. All experiments were conducted in accordance with the European Directive 2010/63/EU, and under an authorization issued by the Health Products Regulatory Authority Ireland and approved by the Animal Ethics Committee of University College Cork (AE19130/1019). Two independent cohorts of rats (adult and adolescent) were pair housed in either standard housing (control group $n = 10$ for each cohort) or with continuous access to a running wheel (Techni plast, UK) (exercise group $n = 10$ for each cohort) for four weeks prior to behavioural testing and for the duration of the study (Figure 4.1). Voluntary running wheel activity is a well-adopted exercise paradigm of experience-based change in synaptic plasticity that simulates aspects of voluntary human behaviour (Molteni et al., 2002). Access to running wheels was maintained for the experiment and running distance (km) was recorded daily. All rats with access to running wheels ran an average of 2.5 (km) per day for the duration of the study. Rats were assessed by the following behavioural tests: spontaneous alternation in the Y-maze, novel object recognition using object-based tasks, and location discrimination and reversal learning using touchscreen operant-based tasks. Rats were sacrificed three weeks after completion of the behavioural tasks and brain tissue was collected for

immunohistological analysis of hippocampal neurogenesis and neurite arborization (Figure 4.1).

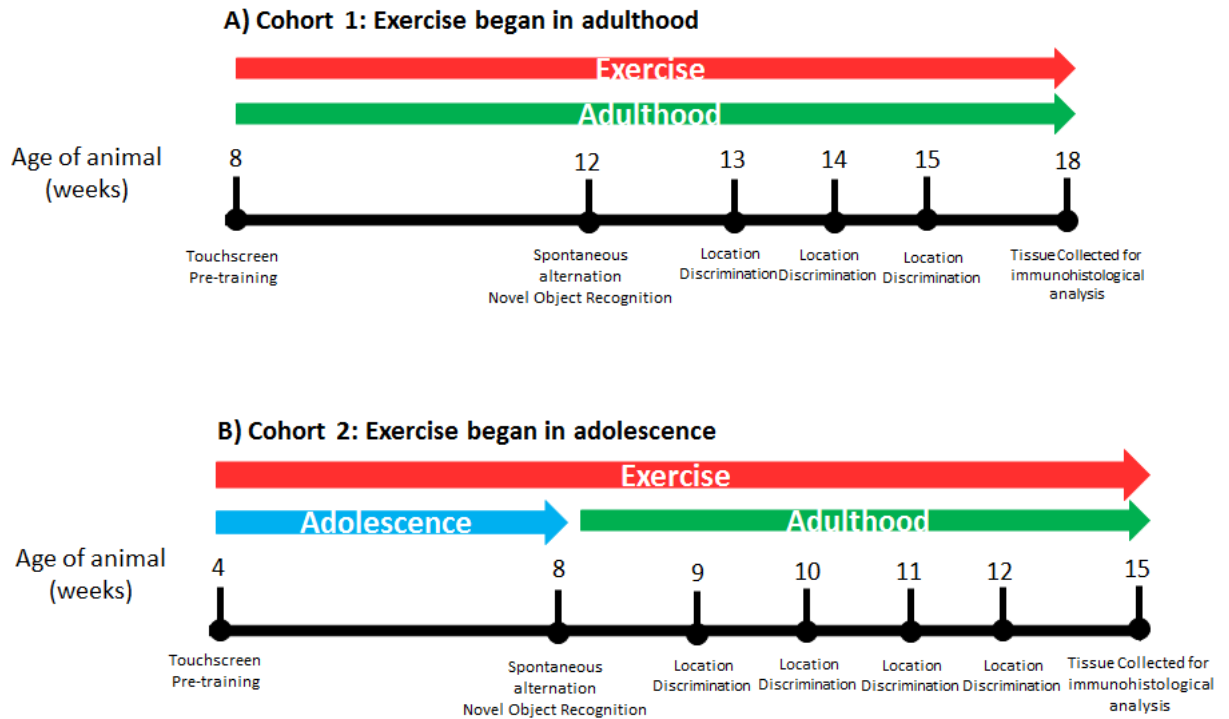

Figure 4.1: Experimental timeline. Outline of the experimental timeline for rats undergoing exercise during adulthood (A) or adolescence (B). All rats were pair housed in standard housing (control) or with continuous access to a running wheel (exercise). Exercise began at either 8 or 4 weeks of age and continued throughout testing. Behavioural testing commenced after 4 weeks of exercise and tissue was collected for immunohistological analysis of neurogenesis and neurite complexity.

4.3.2 Touchscreen pre-training

Touchscreen chambers consisting of a rectangular operant box with grid flooring, overhead light, a touchscreen, and food hopper were used (Med Associates, USA). Following three days of food restriction (90% of free feeding weight), rats were trained

to use the touchscreens in 5 stage's as previously described (Horner et al., 2013). Briefly, in stage 1, rats were habituated to the touchscreen chambers and food pellets for 30 min each day for two days. During stage 2, a relationship between the visual stimuli (images of white squares), Figure 4.2A, D) and a food reward was introduced. Stimuli were presented on the touchscreen for 30 seconds, following which a pellet reward was delivered. Each displayed image and reward collection pair was referred to as a trial. The inter trial interval for stage 2 and all subsequent stages was 20s. If the image was touched by the rat, a three pellet reward was delivered to encourage future responses to the displayed image. Once the rat had completed 60 trials within 60 minutes the animal advanced to the next training stage. During stage 3, visual stimuli were presented on the touchscreen until a response was made, upon which a reward was presented. Again, once the rat had completed 60 trials within 60 minutes the animal advanced to the next training stage. Stage 4 was similar to stage 3 with the addition of a trial initiation step where rats had to initiate the onset of each trial with a nose-poke into the reward delivery magazine. Again, once the rat had completed 60 trials within 60 minutes the animal advanced to the next training stage. During stage 5, a penalty (5 second time-out period with house light on) was introduced for touches to an area of the touchscreen that was not displaying the image, thus shaping the animals' response to the visual stimuli only. In stage 5, criterion was 100 trials with \geq 80% correct on two consecutive sessions in 60 minutes.

4.3.3 Location discrimination training

Location discrimination was assessed as described by Oomen et al. (2013). Rats were initially trained on an intermediate separation, consisting of two response image locations with an intermediate inter-stimulus distance (5cm); one image location was reinforced (CS+) and the other was punished (CS-). Rats were required to obtain 7 correct trials out of 8. The reinforced location was then reversed and the animal was again required to learn the new reward contingency (7 correct trials out of 8); this was referred to as a reversal. The intermediate separation was continued until the animal was able to attain the initial location-reward contingency, as well as the subsequent reversal within one session (60 minutes) in three out of four consecutive sessions. Upon successful completion of training, rats advanced to the location discrimination task.

4.3.4 Touchscreen location discrimination testing

Following successful completion of the intermediate training, rats proceeded to the location discrimination test. The location discrimination test consisted of a large separation (large inter-stimulus distance, 8cm) and a small separation (small inter-stimulus distance, 1cm). The trial structure of these sessions were identical to the intermediate trials as described above; rats were allowed unlimited trials in 60 minutes to complete as many reversals as possible (7 correct trials out of 8). Rats were exposed to 2 sessions of each separation (large or small, Figure 4.2A and D) per block, with each rat completing 3 blocks of trials (i.e. 6 sessions in total for each large and small separation). Both the starting separation (small or large) and reward location (left or right) were counterbalanced between groups. The number of trials to complete the first

reversal was recorded, as well as the total number of reversals completed within the 60-minute session.

4.3.5 Spontaneous alternation in the Y maze

Spontaneous alternation behaviour is the tendency of rodents to alternate their exploration of maze arms (such as those of the Y maze) and is used as a measure of hippocampal-dependent working memory (Hughes, 2004). The Y maze consisted of three arms 120° from each other (40 x 10 x 20 cm; made in house). The protocol was adapted from Senechal et al. (2007). Each animal was placed into the first arm of the maze facing the wall, and allowed to explore the maze for five minutes. The number and order of arm entries were recorded. An arm entry was defined as all four paws entering into the arm (four paw criteria). An alternation was determined as the number of consecutive entries into the three maze arms. Alternations were then divided by the total number of entries during the five-minute test period. The percentage of alternations was calculated as $\% = \text{Alternations}/(\text{Entries}-2)$.

4.3.6 Novel object recognition

Novel object recognition, a hippocampal-perirhinal cortex dependent task, was assessed as described by Bevins and Besheer (2006). On day 1 the rats were habituated to the testing arena (rectangle arena) for a 10-minute exploration period. On day 2, two identical objects were positioned on adjacent corners approximately 5 cm from each wall of the arena and each animal was introduced for a 10-minute exploration period. Rats were then placed directly back into their home cages. After a three-hour inter-

trial interval, one familiar object was replaced with a novel object, and each animal was introduced for a five-minute exploration period. Object exploration was defined when the animal's nose came within a 2 cm radius of the object. The testing arena and objects were cleaned with a 50% alcohol solution. Video recordings were made to allow for manual scoring of object exploration. Object discrimination was calculated as the time spent exploring the novel object divided by the total time spent exploring both objects.

4.3.7 Tissue processing and immunohistochemistry

On completion of the behavioural testing, rats were deeply anaesthetised with sodium pentobarbital and then transcardially perfused with 4% paraformaldehyde. Brains were post-fixed for 24 hours in 4% paraformaldehyde, transferred to 30% sucrose until full penetration of cryoprotectant occurred, snap frozen in liquid nitrogen and stored at -80°C. Coronal sections through the DG were collected onto slides at 40 µm thickness in a 1:6 series.

Non-specific antibody binding was blocked using 10% normal donkey serum (NDS) in a solution of PBS with 0.3% Triton-X100 and tissue sections were incubated with goat anti-DCX (DCX, Goat Polyclonal, Santa Cruz sc-8066, 1:100). Sections were then incubated with a secondary antibody (biotinylated rabbit anti-goat) and DCX-positive cells were visualised with a solution of 3,3'-diaminobenzidine (DAB). A cresyl violet counterstain was applied, and sections were washed, mounted, and coverslipped with DPX mounting media.

4.3.8 Image analysis

Images across a 1:6 series through the DG were obtained using an Olympus BX 53 Upright Microscope (BioSciences Imaging Centre, Department of Anatomy and Neuroscience, UCC). The total number of positively labelled cells were counted and expressed as cells per section of the DG. DCX-positive neurons from adult-initiated exercise (n = 4) and adolescent-initiated exercise (n = 4) were selected based on their having minimal overlap with neurites of adjacent neurons, thus there were 40-50 neurons analysed per group. Neurons were imaged at 100X magnification on an Olympus BX40 microscope and each was traced using *Camera Lucida* (Wollaston, 1807). The tracings were scanned onto a personal computer and total neurite length was measured by a blinded observer using Neuron J software (Meijering et al., 2004). The extent of neurite branching was determined by counting the number of neurite branch points and the number of processes per DCX-positive cell.

4.3.9 Statistical analyses

All data were analysed using SPSS statistical software (SPSS, Chicago, IL). Behavioural data (n = 8-10), neurite complexity (n = 4) and the number of DCX-positive cells (n = 3-4) were graphed as means +SEM. Data were analysed by Student's t-test or repeated measures ANOVA as described below. An alpha level of 0.05 was used as criterion for statistical significance, and probability levels quoted for non-significance. Standard errors of the mean (SEM) were used with all graphical output.

4.4 Results

4.4.1 Adolescent-initiated exercise preferentially promoted performance in a location discrimination task

No effect of exercise during adulthood was observed in both the large and small separation condition of the location discrimination task [F (1, 36) = 0.50, $p > 0.05$; Figure 4.2B], [F (1, 36) = 0.76, $p > 0.05$; Figure 4.2E], respectively. Similarly, there was no effect of exercise during adolescence on location discrimination in the large separation task [F (1, 38) = 0.71, $p > 0.05$; Figure 4.2C]. While there was no overall effect of exercise during adolescence on small separation task [F (1, 38) = 1.71, $p > 0.05$; Figure 4.2F], when t-tests at each of the 3 trial blocks were performed, there was a non-significant trend for adolescent exercise to increase performance in the second trial block [t (38) = 1.84, $p = 0.07$; Figure 4.2F].

4.4.2 Adolescent and adult-initiated exercise enhanced location discrimination reversal learning

There was a significant effect of adult-initiated exercise on reversal learning in the large separation condition, [F (1, 36) = 14.52, $p < 0.001$; Figure 4.3B]. Pairwise comparison indicated that rats beginning exercise in adulthood outperformed sedentary control adult rats in reversal learning in the large separation discrimination task during trial block 2 ($p < 0.001$) and 3 ($p < 0.001$), (Figure 4.3B). Likewise, in the small separation condition, there was a significant effect of adult exercise on reversal learning [F (1, 36) = 5.97, $p < 0.05$; Figure 4.3E]. Pairwise comparison indicated that rats beginning

exercise in adulthood outperformed sedentary control adult rats in reversal learning in the small separation discrimination task during trial block 3 ($p < 0.01$), (Figure 4.3E). In the large separation condition, there was a non-significant trend of adolescent-initiated exercise to enhance reversal learning [$F(1, 38) = 2.31, p = 0.13$; Figure 4.3C]. A pairwise comparison indicated that adolescent-initiated exercise outperformed sedentary control counterparts in reversal learning in the large separation discrimination task during trial block 3 ($p < 0.01$), (Figure 4.3C). Likewise, in the small separation condition, there was a significant effect of adolescent exercise on reversal learning [$F(1, 38) = 17.39, p < 0.0001$; Figure 4.3F]. A pairwise comparison indicated that rats beginning exercise in adolescence outperformed sedentary control counterparts in reversal learning in the small separation discrimination task during trial block 1 ($p < 0.05$) trial block 2 ($p < 0.001$), and trial block 3 ($p < 0.01$) (Figure 4.3F).

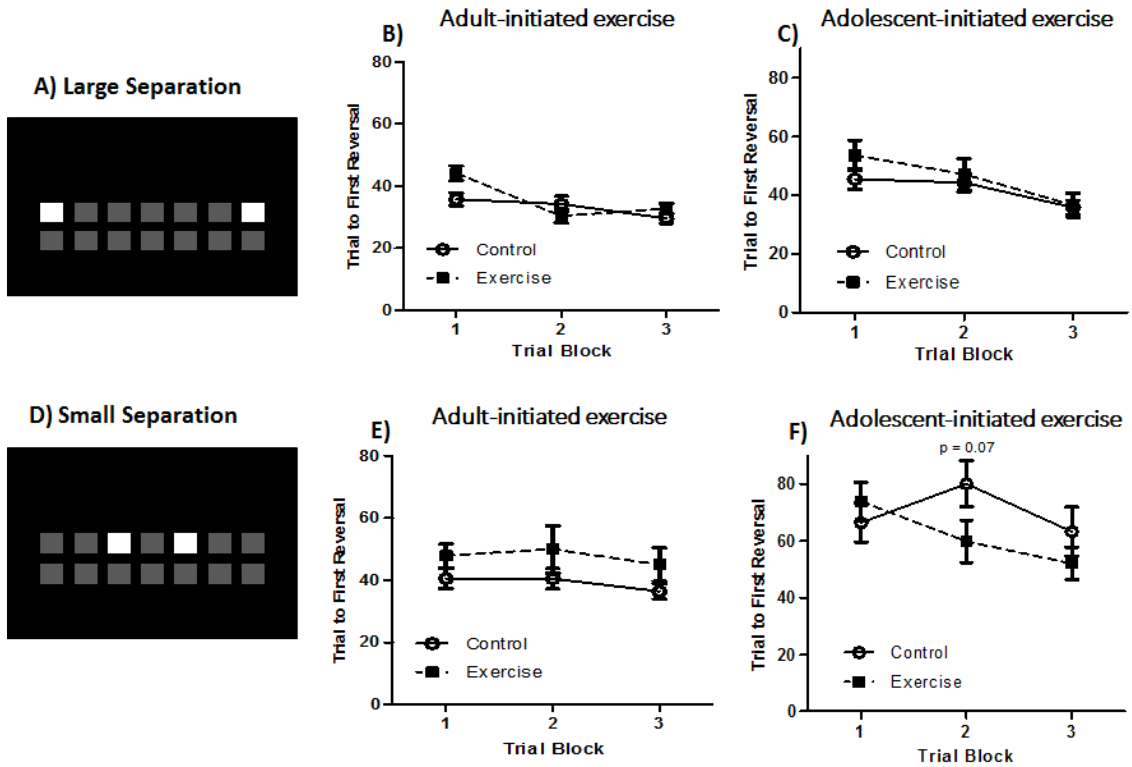

Figure 4.2: Exercise during adolescence preferentially promotes performance in a location discrimination task. Representative image of large separation location discrimination screen (A). Trials to first reversal of the large location discrimination condition after exercise was initiated in adulthood (B) or during adolescence (C). Representative image of small separation location discrimination screen (D). Trials to first reversal of the small location discrimination condition after exercise was initiated in adulthood (E) or during adolescence (F). Data are graphed as means \pm SEM ($n=8-10$).

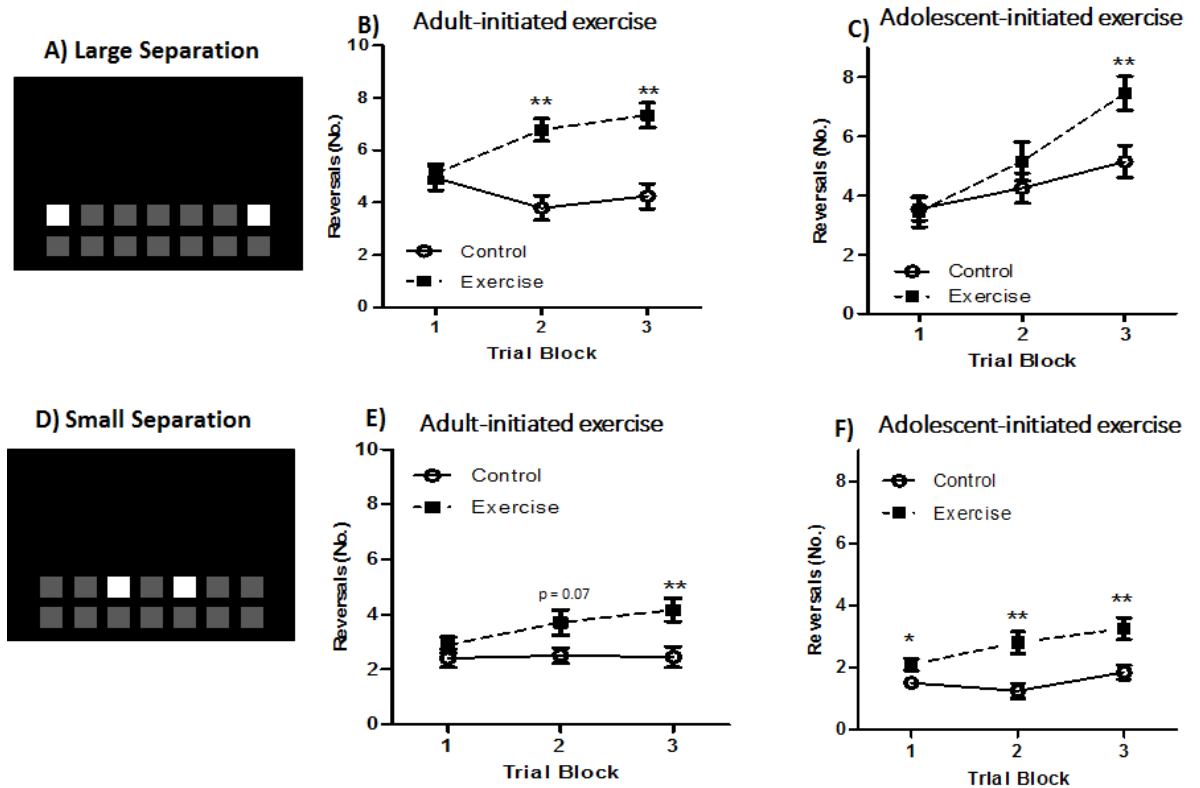

Figure 4.3: Exercise during both adolescence and adulthood enhances location discrimination reversal learning. Representative image of large separation location discrimination screen (A). Reversal learning in the large location discrimination condition after exercise was initiated in adulthood (B) or during adolescence (C). Representative image of small separation location discrimination screen (D). Reversal learning in the small location discrimination condition after exercise was initiated in adulthood (E) or during adolescence (F). (* $p < 0.05$, ** $p < 0.01$). Data are graphed as means \pm SEM ($n = 8-10$).

4.4.3 Adolescent-initiated exercise impaired spontaneous alternation in the Y maze but had no effect on novel object recognition

Exercise initiated during adulthood had no effect on spontaneous alternation in the Y-maze, a test of working memory [$t(18) = 0.97$, $p < 0.05$; Figure 4.4A]. However, rats

that began exercise in adolescence showed impaired spontaneous alternation compared to sedentary control rats [t (18) = 3.07, p < 0.01; Figure 4.4B].

The novel object recognition memory test, a measure of short-term memory, was unaffected by exercise which began either in adulthood [t (16) = 0.14, p < 0.05; Figure 4.4C] or adolescence [t (18) = 0.34 p < 0.05; Figure 4.4D].

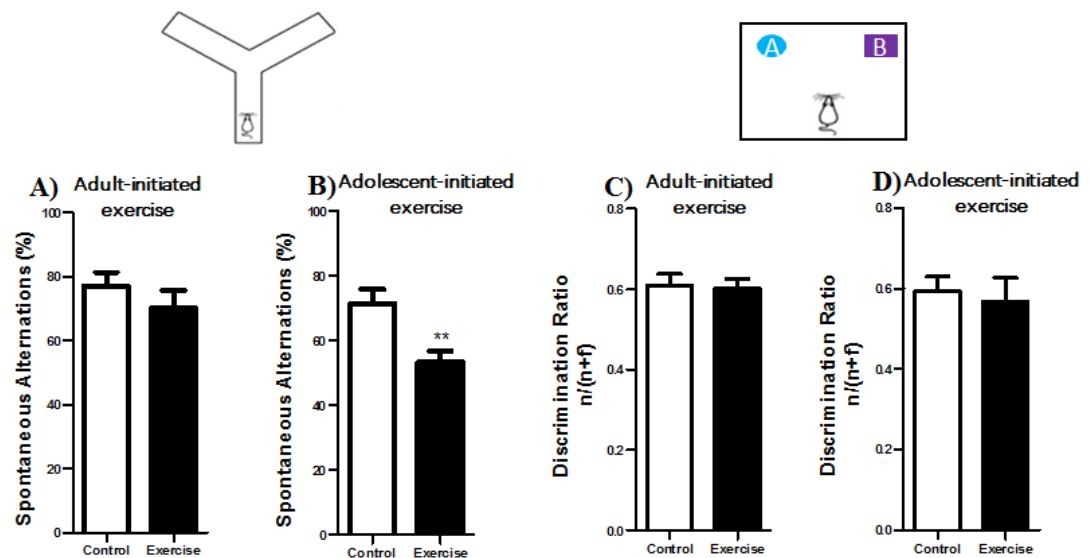

Figure 4.4: Exercise that began in adolescence impairs spontaneous alternation but has no effect on novel object recognition. Spontaneous alternation of rats after exercise was initiated in adulthood (A) or during adolescence (B). Novel object recognition of rats after exercise was initiated in adulthood (C) or during adolescence (D). (**p<0.01). Data are graphed as means +SEM (n=10).

4.4.4 Adolescent-initiated exercise preferentially increased hippocampal neurogenesis compared to adult-initiated exercise

There was no change in the number of DCX-positive cells in the DG as a result of exercise initiated during adulthood [t (6) = 1.13, $p > 0.05$; Figure 4.5A, C and E]. However, adolescent-initiated exercise induced a significant increase in the number of DCX-positive cells in the DG [t (4) = 2.87, $p < 0.05$; Figure 4.5B, D and F].

Exercise beginning in adulthood induced a significant increase in the neurite length of DCX-positive cells [t (6) = 4.99, $p < 0.001$; Figure 4.6A], as well as in the number of neurite branch points [t (6) = 3.33, $p < 0.05$; Figure 4.6B], and the number of neurites per DCX-positive cell [t (6) = 4.89, $p < 0.01$; Figure 4.6C]. Similarly, adolescent-initiated exercise also increased the neurite length [t (6) = 5.59, $p < 0.01$; Figure 4.6F], the number of neurite branch points [t (6) = 4.73, $p < 0.01$; Figure 4.6G] and the number of neurites per DCX-positive cell [t (6) = 4.87, $p < 0.01$; Figure 4.6H]. However, the degree of change induced by adolescent-initiated exercise was much greater; a 0.8-fold increase in neurite length (compared to 0.2-fold increase as a result of adult exercise), a 1.2-fold increase in the number of neurite branch points (0.4-fold in adult exercise) and a 1-fold increase in the number of neurites per DCX-positive cell (0.4-fold in adult exercise). When the complexity of neurites on DCX-positive cells were directly compared between animals that began exercise in adulthood or adolescence, there was no significant difference in neurite length [t (6) = 1.38, $p > 0.05$; Figure 4.6K]. However, there was a significant increase in the number of neurite branch points [t (6)

= 2.64, $p < 0.05$; Figure 4.6L] and the number of neurites per DCX-positive cell [$t(6)$ = 2.96, $p < 0.05$; Figure 4.6M] following adolescent-initiated exercise.

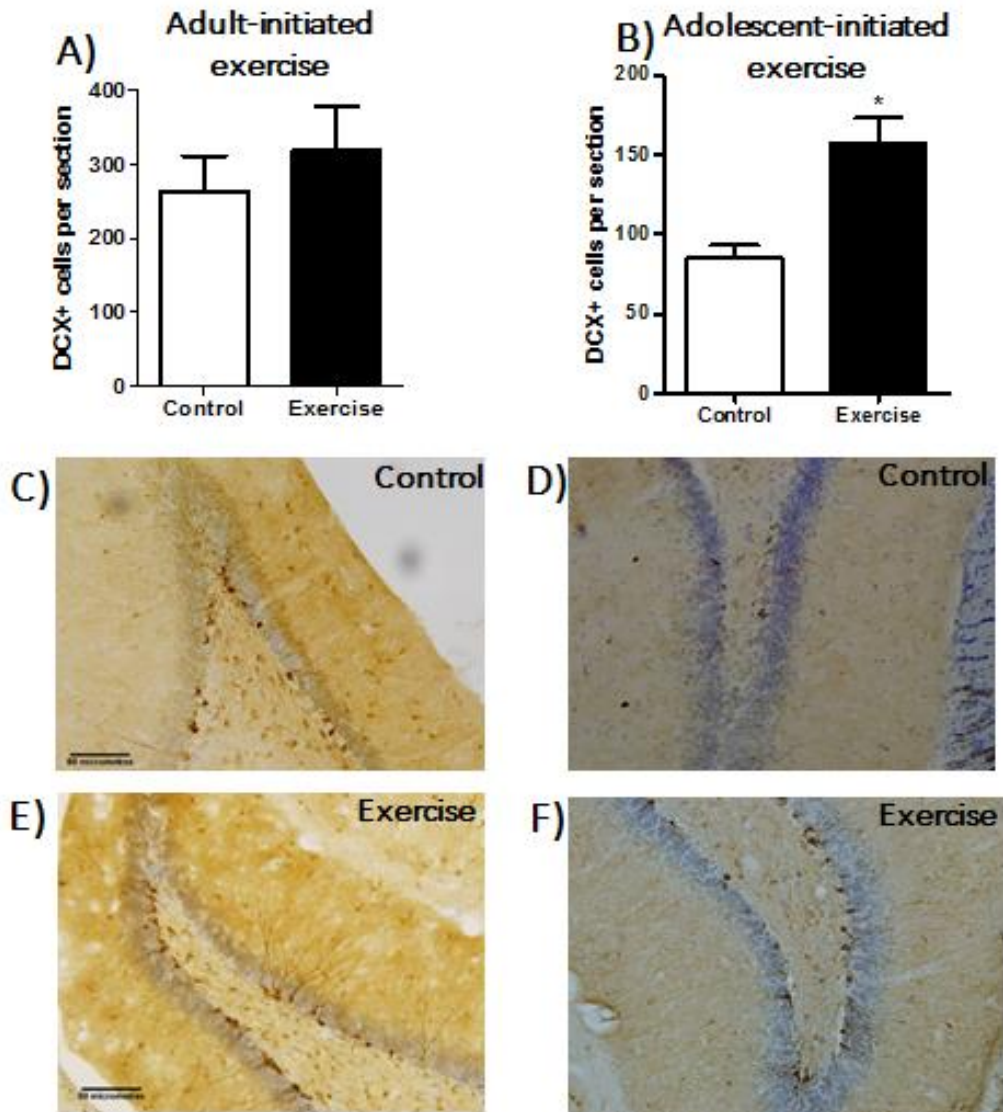

Figure 4.5: Exercise that began in adolescence but not adulthood increased hippocampal neurogenesis. DCX+ cells in the DG of rats after exercise was initiated in adulthood (A) or during adolescence (B). Representative image of DCX+ cells in the DG of adult sedentary control (C), adolescent sedentary control (D) rats, and in the DG of rats after exercise was initiated in adulthood (E) or during adolescence (F). (* $p < 0.05$). Data are graphed as means +SEM ($n=3-4$).

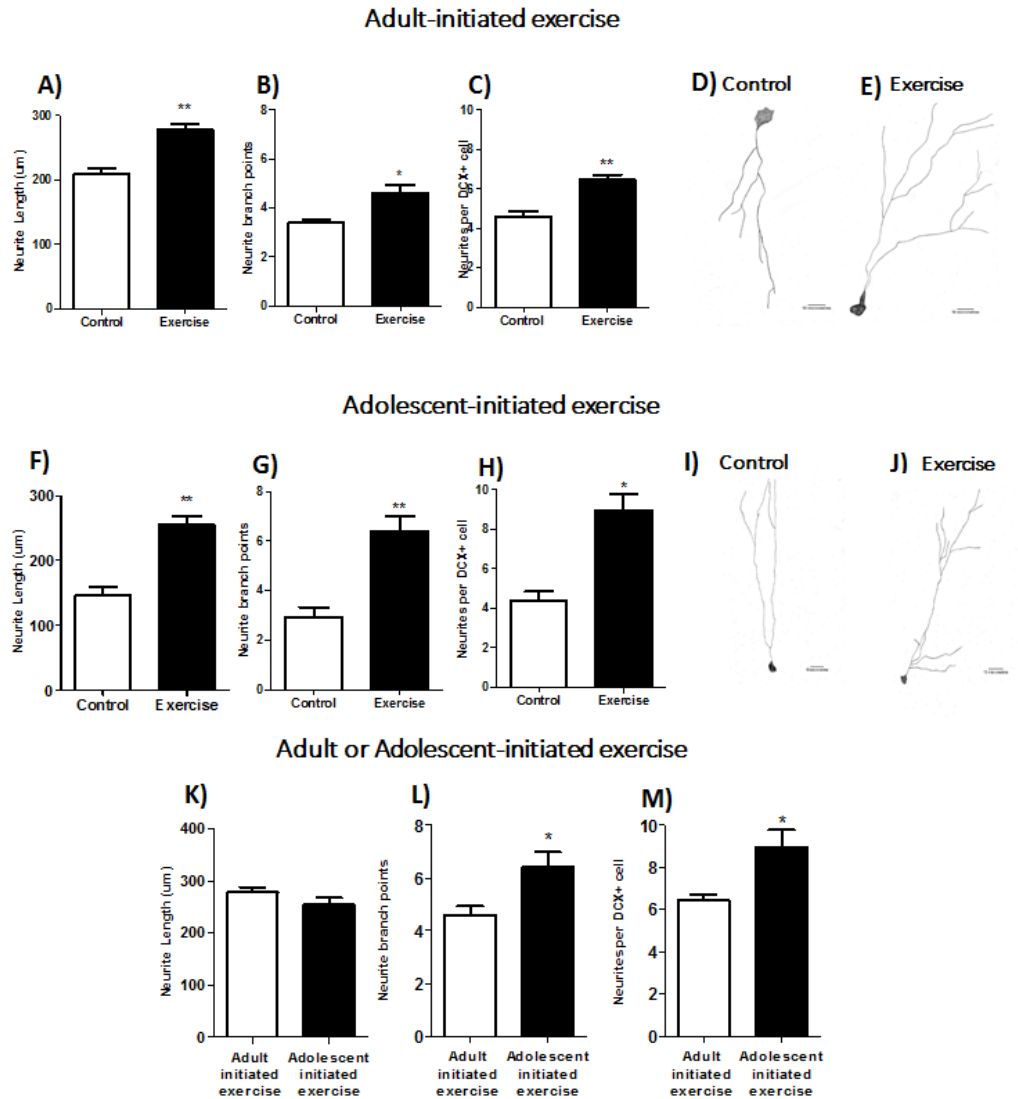

Figure 4.6: Adolescent-initiated exercise increased neurite complexity of hippocampal DCX-positive cells to a greater degree than adult-initiated exercise. Neurite length of DCX+ cells in the DG of rats after exercise was initiated in adulthood (A) or during adolescence (D). Number of neurite branch points on DCX+ cells in the DG of rats after exercise was initiated in adulthood (B) or during adolescence (E). Number of neurites per DCX+ cell of rats after exercise was initiated in adulthood (C) or during adolescence (F). Representative image of the DCX+ cells in the DG of adult sedentary control (G), adolescent sedentary control (I) rats, and in the DG of rats after exercise was initiated in adulthood (H) or during adolescence (J). Comparison of neurite length (K), neurite branch points (L) on DCX+ cells, and the number of neurites per DCX+ cells (M) in the DG of rats after exercise was initiated in adulthood or adolescence (* $p < 0.05$, ** $p < 0.01$, *** $p < 0.001$). Data are graphed as means + SEM ($n = 4$).

4.4.5 Positive correlation between neurite length and cognitive flexibility as a result of exercise during adolescence

There was a significant positive correlation between the neurite length of DCX-positive cells and performance in reversal learning during the small separation condition in rats that began exercise in adolescence [$r = 0.775$, $n = 8$, $p < 0.05$; Figure 4.7C]. This was not observed in rats that began exercise in adulthood [$r = 0.524$, $n = 8$, $p > 0.05$; Figure 4.7A]. No correlation was observed between neurite length and reversal learning performance in the large separation condition; adult-initiated exercise [$r = 0.527$, $n = 8$, $p > 0.05$; Figure 4.7B] and adolescent-initiated exercise, [$r = 0.353$, $n = 8$, $p > 0.05$; Figure 4.7D].

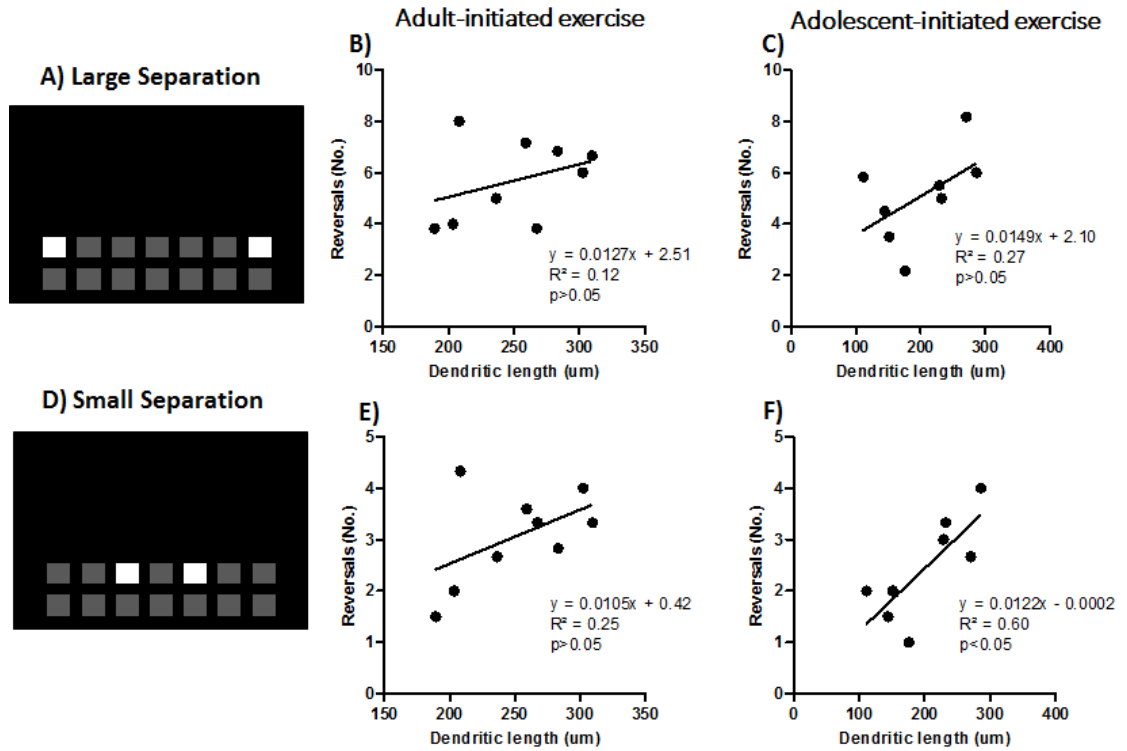

Figure 4.7: Correlation of neurite length of DCX-positive cells and cognitive flexibility. Correlation of reversal learning in the small separation condition with neurite length after exercise was initiated in adulthood (A) or adolescence (C). Correlation of reversal learning in the large separation condition with neurite length after exercise was initiated in adulthood (B) or adolescence (D). Data are graphed as means ($n=8$).

4.5 Discussion

This study revealed a differential effect of adolescent and adult-initiated exercise on cognition and neurogenesis in adulthood. Exercise that began in adolescence had a subtle effect on pattern separation, whereas both adult and adolescent-initiated exercise enhanced reversal learning in the touchscreen location discrimination task. Moreover, both adult and adolescent-initiated exercise increased the complexity of neurites on new born neurons in the DG, although exercise beginning in adolescence induced a greater fold increase in neurite complexity compared to exercise beginning later in life. Moreover, only adolescent-initiated exercise increased the number of these immature neurons in the DG.

The touchscreen location discrimination task was used to measure pattern separation. Performance in location discrimination during the small separation condition (i.e. when the images are close together and therefore have high contextual overlap) has been suggested to be a measure of pattern separation and to be sensitive to changes in hippocampal neurogenesis (Oomen et al., 2013, Creer et al., 2010, Clelland et al., 2009). The results of the current study indicated that exercise initiated in adulthood did not affect location discrimination during either the small or large separation conditions. Similarly, there was no difference in performance following exercise that began in adolescence in the large separation condition. However, there was a non-significant trend of enhanced performance during the small separation condition following adolescent-initiated exercise, although this mild effect was transient as both

exercise and control animals performed similarly in the final training block. Most work to date on exercise-induced effects on pattern separation has been reported from experiments using adult or aged rodents. Prolonged (ten weeks) of voluntary exercise enhanced performance during the small separation condition (i.e. when the images are close together and therefore have high contextual overlap) in the touchscreen operant chamber in aged mice (Creer et al., 2010). Likewise, voluntary exercise has been shown to increase pattern separation using a fear conditioning paradigm (in which contextual overlap varied between fear conditioning chambers) in aged (17 months old) mice (Wu et al., 2015). Studies using adult rodents have shown that forced treadmill exercise for six weeks increased pattern separation assessed in the radial arm maze (where conditions of either high or low spatial and contextual overlap were created between the sample arm and the choice arm) (So et al., 2017). However, our results from the touchscreen operant chamber reveal that exercise during adulthood did not affect pattern separation. The difference in results we report may be due to methodological, species or age differences. Creer et al. (2010) initially trained the aged mice to use the touchscreen before the exercise regime began, while in the present study exercise began at the same time as touchscreen training. Moreover, it is possible that the exercise-induced increase in performance is more readily observed in an aged animal compared to healthy adult. Although exercise did not affect performance during touchscreen training in this study (data not shown), it is possible that transient exercise-induced changes in hippocampal functioning were lost after several weeks of operant training and once rats had reached criteria for location discrimination testing. Furthermore, there may be a ceiling effect in discrimination performance where

optimal learning by healthy rats leaves no capacity for exercise-induced enhancements (Griffin et al., 2009). Increasing the task difficulty (i.e. reducing the inter-stimulus distance) may help to overcome potential ceiling effects and improve task sensitivity to subtle and transient enhancements in performance of rats. To date, no reports have been published on adolescent-initiated exercise on pattern separation despite the heightened plasticity that occurs in the hippocampus during this period of the lifespan. Interestingly, the subtle yet non-significant effect following adolescent-onset exercise that we observed in the current study was coupled with an increase in the number of immature neurons and the complexity of their neurites. Indeed, performance in the small separation condition of the touchscreen location discrimination task has previously been associated with increased survival of hippocampal new born neurons, albeit in aged mice (Creer et al., 2010).

Adult and adolescent-initiated exercise enhanced reversal learning, a hippocampal prefrontal cortex-mediated behaviour, which was assessed using the touchscreen location discrimination task and measured by the number of times the rat could switch between reward locations (i.e. reversals). Previous work has shown that running wheel exercise (two weeks) during adulthood in rats facilitated performance in an attentional set-shifting task, a measure of cognitive flexibility (Brockett et al., 2015). However, despite the dominant role of the prefrontal cortex in adolescent brain development and behaviour, to date no data have been reported to show the impact of adolescent-initiated exercise on prefrontal cortex-mediated cognitive flexibility. Exercise-induced enhancement of cognitive flexibility has previously been linked with structural changes

in the hippocampus and prefrontal cortex in adulthood. Specifically, two weeks of running wheel exercise increased the spine density and spine length of neurons in the medial prefrontal cortex as well as inducing an increase in protein levels of the synaptic plasticity markers synaptophysin and PSD-95 in the orbitofrontal cortex of adult rats (Brockett et al., 2015). Moreover, cognitive flexibility may also be modulated by exercise-induced increases in hippocampal plasticity which in turn alters hippocampal-medial prefrontal cortex projections and thus influences executive function processes, such as cognitive flexibility (Garthe et al., 2009, Burghardt et al., 2012).

Spontaneous alternation in the Y-maze, a hippocampal-dependant spatial working memory task (Hughes, 2004), was unaffected by adult-initiated exercise, while adolescent-initiated exercise impaired spontaneous alternation behaviour. Previous studies have reported contradictory findings of exercise on working memory. Prolonged (seven weeks) running wheel exercise has been shown to improve spatial working memory in the radial arm maze in rats (Anderson et al., 2000, Alomari et al., 2016), whereas, spatial working memory in the T-maze has been shown to be unaffected following one week of forced exercise in rats (Acevedo-Triana et al., 2017). The differences may also be due to the specific behavioural tasks used to measure spatial working memory i.e. spontaneous behavior versus training/reward directed behavior. Thus, exercise may enhance spatial working memory when the task is sufficiently challenging, such as in the radial arm maze where a correct response requires several days of training compared to one-time spontaneous exploration in the Y-maze. Moreover, exercise beginning earlier in life may not convey a global

enactment of cognitive processes and in fact may negatively affect certain spontaneous behaviors in later life.

Novel object recognition, a hippocampal and entorhinal cortex-dependent processes, was unaffected by exercise that began in adulthood or adolescence. Findings from previous studies investigating the effects of exercise on object recognition have been varied. Studies have demonstrated an enhancement of object discrimination following either one week of forced exercise in adult rats (Griffin et al., 2009) or three and four weeks of running wheel exercise in adult rats (Hopkins and Bucci, 2010, Bolz et al., 2015), whereas, two or three weeks of running wheel exercise had no effect on object recognition in adult rats (Brockett et al., 2015) or adult mice (Bolz et al., 2015). This may be due to the fact that differences in the inter-trial interval between the sample and test phase have been shown to differentially recruit the hippocampus or perirhinal/entorhinal cortex processes during object recognition (Cohen and Stackman, 2015, Hammond et al., 2004). Thus, tasks with a longer inter-trial interval (e.g. 24h) such as reported by (Griffin et al., 2009, Hopkins and Bucci, 2010, Bolz et al., 2015) detected an exercise-induced enhancement in discrimination, while tasks with a shorter inter-trial interval (a few hours), such as employed in the current study and by others (Brockett et al., 2015, Bolz et al., 2015) did not detect an exercise-induced effect. Indeed, Bolz et al. (2015) demonstrated that three weeks of voluntary exercise enhanced object discrimination following a 24 hour inter-trial interval, but did not impact object discrimination after a 1.5 hour inter-trial interval in adult rats.

Exercise that began in either adulthood or adolescence increased the dendritic complexity of immature neurons (DCX-positive cells). This is line with previous work showing that voluntary running wheel exercise for two months (Stranahan et al., 2007) and two to three weeks (Eadie et al., 2005) increased the dendritic length and the number of dendritic spines of granule neurons in the DG of adult rats. Interestingly, a recent report has demonstrated that as little as one week of running wheel exercise can induce an increase the arborization of immature adult born granule cells as measured by total dendritic length and the number of dendritic branch points in new granule cells in the hippocampus of adult mice resulting in a reorganization of the circuitry of one-week-old adult-born hippocampal neurons (Sah et al., 2017). However, behavioural correlates were not assessed in this study and so it would be interesting to investigate the relationship between exercise-induced dendritic arborization of new hippocampal neurons and the emergence of any potential cognitive changes in terms of duration of exercise. Dostes et al. (2016) has reported that the effect of exercise on neuronal morphology is activity-dependent in that mice given unlimited (24 hour) access to a running wheel for three weeks showed a greater increase in dendritic complexity in the hippocampus compared to mice with limited (3 hour) running wheel access. Another factor to be considered in exercise-induced changes in cognition as a function of neurite complexity of new neurons is the age at which exercise is initiated. This is borne out in the results of the present study which reveal that exercise initiated in adolescence had a greater fold increase in complexity of neurites on new neurons compared to exercise that began in adulthood. Moreover, there was a positive correlation between the neurite length of new neurons and performance in reversal learning during the small

separation condition in rats that began exercise in adolescence which was not observed in rats that began exercise in adulthood.

We observed that exercise that began during adolescence increased the number of immature neurons in the DG in adulthood while exercise initiated during adulthood did not. This is surprising as previous reports have demonstrated the pro-neurogenic effect of exercise during adulthood (van Praag et al., 1999). However, most studies on exercise during adulthood have used animals that were singly housed in order to ensure sole access to running wheels by the rodents. It is possible that the housing conditions in the current study (pair housing) may have provided an enriched environment resulting in elevated baseline levels of neurogenic cells which was not possible to enhance by exercise in adult rats, but only by exercise during adolescence. Indeed, a recent report demonstrated that voluntary exercise by pair-housed mice during adolescence increased the survival of new neurons in the DG (Kozareva et al., 2018). However, this line of enquiry requires further investigation.

In conclusion, adolescent-initiated exercise resulted in a differential effect on hippocampal-dependent and independent cognition, neurogenesis and neurite arborisation in adulthood compared to exercise initiated during adulthood. Thus, environmental influences such as exercise during this critical period of brain development, may have long lasting effects on cognitive processes in later life.

CHAPTER 5

Chronic Interleukin-1 β in the Dorsal Hippocampus Impairs Pattern Separation

This work is being prepared for publication

Hueston, C.M⁺., [O'Leary J.D⁺](#)., Hoban, A.E., Pawley, L.C., Cryan J.F., O'Leary O.F.
& Nolan Y.M. (2017). Chronic interleukin-1 β in the dorsal hippocampus impairs
pattern separation. ⁺ Equal contribution.

5.1 Abstract

Understanding the long term consequences of chronic inflammation in the hippocampus may help to develop therapeutic targets for the treatment of cognitive disorders related to stress, ageing and neurodegeneration. The hippocampus is particularly vulnerable to increases in the pro-inflammatory cytokine interleukin-1 β (IL-1 β), a mediator of neuroinflammation, with elevated levels implicated in the aetiology of neurodegenerative disorders such as Alzheimer's and Parkinson's. Acute increases in hippocampal IL-1 β have been shown to impair cognition and reduce adult hippocampal neurogenesis, the birth of new neurons. However, the impact of prolonged increases in IL-1 β , as evident in clinical conditions, on cognition has not been fully explored. The current studies utilized a lentiviral approach to induce long-term overexpression of IL-1 β in the dorsal hippocampus of adult male Sprague Dawley rats. Following three weeks of viral integration, pattern separation, a process involving hippocampal neurogenesis, was impaired in IL-1 β treated rats in both object-location and touchscreen operant paradigms. This was coupled with decreased dendritic complexity of immature neurons in the hippocampus. Conversely, tasks involving the hippocampus, but not sensitive to disruption of hippocampal neurogenesis, including spontaneous alternation, novel object and location recognition were unaffected. Touchscreen operant visual discrimination, a cognitive task involving the prefrontal cortex, was largely unaffected by IL-1 β overexpression. In conclusion, our findings suggest that chronically elevated IL-1 β in the hippocampus selectively impairs pattern separation. Inflammatory-mediated disruption of adult neurogenesis may contribute to the cognitive decline associated with neurodegenerative and stress-related disorders.

5.2 Introduction

There is a growing consensus that the increasing impact of age and stress-related inflammatory insults on daily living positions neuroinflammation as a significant protagonist of neurodegeneration and associated cognitive disorders (Amor et al., 2010, Ryan and Nolan, 2016b). The hippocampus is particularly vulnerable to neuronal degeneration and the consequent cognitive dysfunction associated with ageing, neurodegenerative and psychiatric disorders (Bartsch and Wulff, 2015). The pro-inflammatory cytokine interleukin-1 β (IL-1 β), a major mediator of neuroinflammation, and its cognate receptor are expressed at high levels within the hippocampus (Ban et al., 1991, Parnet et al., 1994). While evidence indicates that IL-1 β is required for hippocampal-dependent cognition under quiescent conditions, it is well established that IL-1 β has a detrimental effect on memory processes under chronic inflammatory conditions such as those associated with neurodegenerative disorders (Goshen et al., 2007, Kohman and Rhodes, 2013, Lynch et al., 2010). Furthermore, acute IL-1 β treatment inhibits long-term potentiation (LTP) in the hippocampus (Lynch, 2015), and impairs both spatial and contextual memory (Gibertini et al., 1995, Goshen et al., 2007, Barrientos et al., 2002). Acute IL-1 β exposure also negatively impacts upon hippocampal neurogenesis, the birth of new neurons, both *in vitro* (Green and Nolan, 2012b, Ryan et al., 2013, Zunszain et al., 2012) and *in vivo* (Goshen et al., 2008, McPherson et al., 2011). Together, these findings suggest that IL-1 β may mediate inflammation induced changes in cognition by affecting hippocampal-dependent

processes associated with hippocampal neurogenesis (Yirmiya and Goshen, 2011, O'Leime et al., 2017, Hueston et al., 2017). However, the impact of prolonged increases in IL-1 β on hippocampal neurogenesis-dependent cognitive function is yet to be fully explored.

Adult hippocampal neurogenesis has been shown to be necessary for cognitive tasks which require spatial memory and contextual memory and has also been implicated in anxiety and forgetting (Frankland et al., 2013, Saxe et al., 2006c, Snyder et al., 2005a, Revest et al., 2009, Clelland et al., 2009). An important aspect of learning and memory is the ability to encode newly formed memories in a discrete non-overlapping fashion so as to reduce interference between similarly encoded memories (Tulving and Markowitsch, 1998). The process of discriminating between similar contextual memories has been referred to as pattern separation and has been repeatedly associated with hippocampal neurogenesis (Aimone et al., 2011, Sahay et al., 2011c). In recent years, novel cognitive tests have been developed to tease apart the relationship between hippocampal neurogenesis and cognitive function, including touchscreen-based tests which allow for testing multiple types of cognitive tasks utilizing the same platform as well as increasing the translational power of pre-clinical research findings, Appendix A (Oomen et al., 2013, Horner et al., 2013, Bekinschtein et al., 2013b).

As current evidence points to inflammation as a protagonist of both cognitive dysfunction and adult hippocampal neurogenesis, the hypothesis of the current study was that chronically elevated hippocampal IL-1 β impairs location discrimination

through disruption of adult hippocampal neurogenesis in both touchscreen-based and non-touchscreen behavioural paradigms. Understanding the basis of inflammatory-induced changes in hippocampal neurogenesis-associated cognition will provide us with valuable information on the functional importance of new neurons, and the potential use of adult neurogenesis for repair and regeneration of hippocampal function.

5.3 Methods

5.3.1 Animals and experimental design

Adult male Sprague-Dawley rats obtained from Harlan UK (325-350 grams) were pair housed in a colony maintained at $22 \pm 1^\circ\text{C}$, with a 12:12 hour light-dark cycle (lights on 0630-1830). All animal procedures were performed under licenses issued by the Health Products Regulatory Authority (HPRA, Ireland), in accordance with the European Communities Council Directive (2010/63/EU) and approved by the Animal Experimentation Ethics Committee (AEEC) of University College Cork. Two independent cohorts of animals were injected with either a lentivirus overexpressing mCherry-tagged IL-1 β or mCherry alone (control) into the dorsal hippocampus. The first cohort (control (n = 10), IL-1 β (n = 10); Figure 5.1A) underwent non-touchscreen based behavioural testing. Hippocampal tissue from this cohort was used to assess DCX and IL-1 β mRNA and protein expression as well as validate viral spread by mCherry and IL-1 β immunohistochemistry. The second cohort of rats (control (n = 10), IL-1 β (n = 10); Figure 5.1B) underwent touchscreen based behavioural testing. Immunohistochemistry for DCX, IL-1 β and mCherry was carried out on hippocampal tissue from this cohort. All rats had *ad libitum* access to food and water except the cohort of rats that underwent touchscreen testing in which case they were food restricted to 90-95% body weight for the duration of testing.

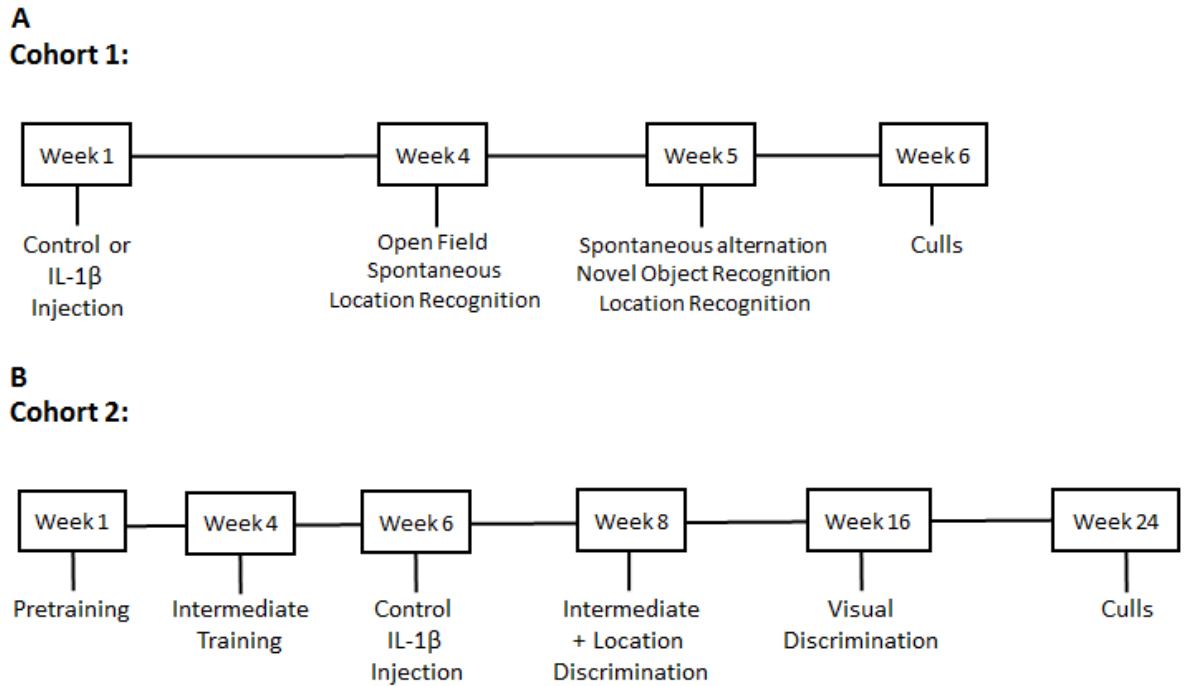

Figure 5.1: Experimental design. Outline of the experimental timeline for animals undergoing non-touchscreen behavioural tasks, Cohort 1; Control ($n = 10$), IL-1 β ($n = 10$) (A), or touchscreen-based tasks, Cohort 2; Control ($n = 10$), IL-1 β ($n = 10$) (B).

5.3.2 Virus preparation

Production of plasmids and lentiviruses to overexpress mouse IL-1 β and the fluorophore mCherry or a control virus expressing mCherry only was carried out by Genecopoeia (GeneCopoeia, MD, USA). Briefly, lentiviral particles containing either mCherry or mCherry-tagged IL-1 β plasmids were generated by following a standardised protocol using highly purified plasmids and EndoFectin LentiTM and TitreBoostTM reagents. The lentiviral transfer vector was co-transfected into 293Ta cells with Lenti-PacTM FIV packaging mix. The lentivirus particles were then purified and stored at -80°C until use.

5.3.3 Stereotaxic surgery and Lentiviral injection

Rats were anaesthetised with isoflurane and placed into a Kopf stereotaxic frame. Lentivirus for the mCherry-tagged overexpression of IL-1 β (3 μ L: 5.62 x 10³ transfecting units) or mCherry control (3 μ L: 5.13 x 10³ transfecting units) on an FIV backbone and under a CMV promotor (Genecopeia, USA) was injected into the dorsal hippocampus using the coordinates AP: -3.5 mm, ML: \pm 2.4 mm, DV: -3.8 mm relative to Bregma (Barrientos et al., 2002) at a rate of 1 μ L/min followed by a 5 min diffusion. Rats were injected with carprofen and 5% glucose (s.c.) prior to anaesthetic recovery. All rats were allowed to recover for 1 week with *ad libitum* access to food and water.

5.3.4 Behavioural tasks

5.3.4.1 Modified spontaneous location recognition test

The modified spontaneous location recognition test, is a modified version of the standard novel location recognition task in which animals undergo two consecutive location discrimination tests where the inter-stimulus distance between the novel and familiar locations have been varied so as to create a state of either high or low contextual overlap. Previous studies have demonstrated that performance during conditions of high contextual overlap require intact hippocampal neurogenesis (Bekinschtein et al., 2014). The task was conducted in the open field arena, covered with bedding under dim light conditions (20 lux) as described previously (Kent et al., 2015, Bekinschtein et al., 2013b). The testing room had three proximal spatial cues and distal standard furniture. Rats were habituated to the arena for 10 minutes per day

for 5 consecutive days before testing. During the acquisition phase, three identical objects were placed 15 cm from the edge of the open field, and 30 cm from the center of the arena, and rats were allowed to explore for 10 minutes. In the large separation condition, the three objects (O1, O2, and O3) were separated by 120° angles (Figure 5.3A). In the small separation condition, two of the objects were separated by a 50° angle (O2, O3), and the third was placed at an equal distance between the two (O1; Figure 5.3B). The test phase was conducted 24 hours following acquisition. During this phase, two of the previously used objects were placed in the arena. One (O4) was placed in the same position as O1, while a second (O5) was placed halfway between the acquisition locations of O2 and O3 (Figure 5.3A, B) and rats were allowed to explore for 5 minutes. Both the objects used and order of testing were counterbalanced within and between groups. Time spent with the objects was recorded, and a discrimination index of object recognition was calculated as $DI = (\text{seconds with O5} - \text{seconds with O4}) / (\text{seconds with O4} + \text{seconds with O5})$.

5.3.4.2 Spontaneous alternation test

Spontaneous alternation behaviour is the tendency of rodents to alternate their exploration of maze arms (such as those of the Y maze) and is used as a measure of hippocampal-dependent working memory (Hughes, 2004). The Y maze consisted of three arms 120° from each other (40 x 10 x 20 cm; made in house). The protocol was adapted from Senechal et al. (2007). Each animal was placed into the first arm of the maze facing the wall, and allowed to explore the maze for five minutes. The number

and order of arm entries were recorded. An arm entry was defined as all four paws entering into the arm (four paw criteria). An alternation was determined as the number of consecutive entries into the three maze arms. Alternations were then divided by the total number of entries during the five-minute test period. The percentage of alternations was calculated as $\% = \text{Alternations}/(\text{Entries}-2)$.

5.3.4.3 Object recognition and location test

The object recognition test, a hippocampal-perirhinal cortex-dependent task and the location discrimination test, a hippocampal-dependent task was as carried out as described by (Bevins and Besheer, 2006). Rats were first habituated to an empty chamber (40.5cm L x 36.5cm W x 28.0cm H) under dim light (20 lux) for 10 minutes. Twenty-four hours later, rats were exposed to 2 identical objects (either ceramic mugs or glass bottles) for 10 minutes, followed by a 3-hour inter-trial interval. After the delay, recognition memory was tested with a 5-minute exposure to one novel object (Figure 5.3D). The next day, rats were exposed to two novel objects for 10 minutes that were placed in the same position as on the previous day. Following a 1-hour inter-trial interval, rats were placed back into the arena, with one object in a novel location (Figure 5.3E). All behaviours were recorded, and videos were scored to determine the amount of time the rats spent attending to the novel vs. familiar objects and locations. Objects and locations were counterbalanced between groups. Time spent with the objects was recorded, and a discrimination ratio of object recognition was calculated as $DR = \text{seconds with novel}/(\text{seconds with novel} + \text{seconds with familiar})$.

5.3.4.4 Open field test

Spontaneous exploratory locomotor activity and thigmotaxis in the open field were used as a general measure of motor function and anxiety-related behaviours, respectively (Choleris et al., 2001). Rats were placed in an open field arena (90 cm diameter) under bright lighting conditions (400 lux) for 10 minutes. Distance travelled and time in the center of the arena were recorded and calculated using Ethovision software (Noldus). The arena (and all arenas, apparatus, and objects in subsequent tasks) were cleaned with a 70% ethanol solution between exposures of each animal to the arena to remove odour cues.

5.3.4.5 Touchscreen pre-training

Touchscreen chambers consisting of a rectangular operant box with grid flooring, overhead light, a touchscreen, and food hopper were used (Med Associates, USA). Following three days of food restriction (90% of free feeding weight), rats were trained to use the touchscreens in 5 stages as previously described (Horner et al., 2013). Briefly, in stage 1, rats were habituated to the touchscreen chambers and food pellets for 30 min each day for two days. During stage 2, a relationship between the visual stimuli (images of white squares), see Figure 5.2A, D) and a food reward was introduced. Stimuli were presented on the touchscreen for 30 seconds, following which a pellet reward was delivered. Each displayed image and reward collection pair was referred to as a trial. The inter trial interval for stage 2 and all subsequent stages was 20s. If the image was touched by the rat, a three pellet reward was delivered to

encourage future responses to the displayed image. Once the rat had completed 60 trials within 60 mins the animal advanced to the next training stage. During stage 3, visual stimuli were presented on the touchscreen until a response was made, upon which a reward was presented. Again, once the rat had completed 60 trials within 60 mins the animal advanced to the next training stage. Stage 4 was similar to stage 3 with the addition of a trial initiation step where rats had to initiate the onset of each trial with a nose-poke into the reward delivery magazine. Again, once the rat had completed 60 trials within 60 mins the animal advanced to the next training stage. During stage 5, a penalty (5 second time-out period with house light on) was introduced for touches to an area of the touchscreen that was not displaying the image, thus shaping the animals response to only the visual stimuli. In stage 5, criterion was 100 trials with $\geq 80\%$ correct on two consecutive sessions in 60 minutes.

5.3.4.6 Location discrimination training and testing

The touchscreen location discrimination task is a hippocampal-dependent task in which the animal undergo two consecutive location discrimination tests where the inter-stimulus distance between the reinforced (CS+) and punished (CS-) locations are varied so as to create a state of either high or low contextual overlap. Previous studies have demonstrated that performance in location discrimination during conditions of high contextual overlap is sensitive to changes in hippocampal neurogenesis (Creer et al., 2010, Clelland et al., 2009). Location discrimination was assessed as described by Oomen et al. (2013). Rats were initially trained on an intermediate separation,

consisting of two response image locations with an intermediate inter-stimulus distance (5cm), one image location was reinforced (CS+) and the other was punished (CS-) (Figure 5.3A). Rats were required to obtain 7 correct trials out of 8. The reinforced location was then reversed and the animal was again required to learn the new reward contingency (7 correct trials out of 8), this was referred to as a reversal. The intermediate separation was continued until the animal was able to attain the initial location-reward contingency, as well as the subsequent reversal within one session (60mins) in three out of four consecutive sessions. Upon successful completion of training, rats were allowed free access to food for 2 days before undergoing surgery for injection of a lentivirus overexpressing IL-1 β and the fluorophore mCherry, or a control virus expressing mCherry only bilaterally into the dorsal hippocampus.

Following surgery, rats were allowed to recover for 1 week before re-introducing food restriction. After 1 week of food restriction, rats were re-tested on the intermediate separation to ensure similar basal performance between groups. Following this, rats proceeded to the location discrimination testing. The location discrimination testing consisted of a large separation (large inter-stimulus distance, 8 cm) and a small separation (small inter-stimulus distance, 1 cm). The trial structure of these sessions were identical to the intermediate trials as described above; rats were allowed unlimited trials in 60 minutes to complete as many reversals as possible (7 correct trials out of 8). Rats were exposed to 2 sessions of each separation (large or small, see Figure 5.3C and F) per block, with each rat completing 3 blocks of trials (i.e. 6 sessions in total for each large and small separation). Both the starting separation (small or large) and reward

location (left or right) were counterbalanced between groups. The number of trials to complete the first reversal was recorded, as well as the total number of reversals completed within the 60-minute session.

5.3.4.7 Visual discrimination and reversal testing

Visual discrimination and reversal learning is a measure of executive function and has been shown to be sensitive to prefrontal cortex manipulation (Kim et al., 2015a, Mar et al., 2013). Following location discrimination testing, rats were tested on visual discrimination as previously described (Horner et al., 2013). Rats were presented with two images (CS- Spider and CS+ Plane, Figure 5.4A). One image was always reinforced with a food pellet, regardless of image location. The reinforced image and locations were counterbalanced across rats to reduce any positioning-response bias. Briefly, rats were allowed 60 minutes to complete 100 trials of visual discrimination. In order to discriminate, the rat must correctly touch the reinforced image. If the incorrect image was touched, the rat received correction trials until the correct image was touched. These correction trials did not count towards the 100 trials allowed per session. Criteria to completion was 2 consecutive sessions of at least 80% correct of the 100 trials per session. Once visual discrimination criterion was reached, rats were switched to reversal testing, where the opposite image was now correct. The same criteria were used for reversal testing as for visual discrimination for a maximum of 8 weeks.

5.3.5 Tissue analysis

5.3.5.1 q-PCR

Rats were culled via un-anaesthetized decapitation, the hippocampal tissue was dissected out and processed according to the GenElute kit directions (Sigma). Briefly, total cellular RNA was homogenized into lysis solution using 1mm glass beads (Thistle Scientific) in a MagnaLyser system (Roche). Homogenised sample was filtered through a binding column to remove non-RNA. Equal volume of 70% ethanol was added to the filtrate and purified through columns, which were then washed with buffer. Purified mRNA was eluted into elution solution, and a further DNase wipeout step was conducted using DNase1 (Sigma). Total RNA yield and purity were determined using the Nanodrop System (Thermo Scientific). Synthesis of cDNA was performed on 0.1–1.0µg of normalized total RNA from each sample using ReadyScript cDNA synthesis mix (Sigma). Probed cDNA amplification was performed in a 20µL reaction consisting of 10µl KiCqStart qPCR ReadyMix with ROX (Sigma), 0.1µL of primer (final concentration 250nM), 1µL cDNA template, and 8.8µL RNase-free water and captured in real-time using the StepOne Plus system (Applied Biosystems). Relative IL-1β (primer sequences: Forward- AAAGAAGAAGATGGAAAAGCGGTT; Reverse- GGGAAGTGTGCAGACTCAAATC) and DCX (primer sequences: Forward - ATCTCTACACCCACAAGCCCT; Reverse- ATCTCTACACCCACAAGCCCT) gene expression was adjusted to β-Actin (Forward- GCGAGTACAACCTTCTTGCAGCTC; Reverse- TGGCATGAGGGAGCGCGTAA) and quantified using the 2–ΔΔCT method.

5.3.5.2 Western Blot

Total protein was extracted from hippocampal tissue using commercially available RIPA Lysis and Extraction Buffer (Thermo Fisher Scientific, 89901) in combination with Complete™ Mini EDTA-Free Protease Inhibitors (Roche, 04693159001) in a 1:1 ratio with dH₂O (400ul of RIPA buffer per sample was used). Separation using SDS-polyacrylamide gel electrophoresis was carried out on each sample. Proteins were electrochemically transferred to a nitrocellulose membrane as previously described (Green and Nolan, 2012, Nolan et al., 2005). The nitrocellulose membrane was then incubated with a mouse primary antibody for the detection of viral delivery of IL-1 β (R&D systems, goat anti-mouse IL-1 β polyclonal, 1:500) and loading control, β -actin (Sigma, mouse polyclonal, 1:1000). Membranes were incubated with HRP tagged secondary antibody (1:10,000 dilution). Proteins were visualized using exposure film and ECL detection kit (GE healthcare). Quantification of the immunoblot bands was carried out using densitometry on ImageJ software. Intensity readings for each band were expressed as arbitrary units relative to controls.

5.3.5.3 Immunohistochemistry

Rats were euthanized with an i.p. injection of Sleep-Away (1.0mL/kg) and transcardially perfused using a 0.9% phosphate buffered saline (PBS) solution followed by 4.0% paraformaldehyde in PBS. Brains were removed and post-fixed in 4% formaldehyde in PBS overnight, then transferred to a 30% sucrose solution. Coronal sections through the dorsal DG were cut at 40 μ m onto slides in a 1:12 series. For

analysis of viral spread, sections were blocked in 10% normal donkey serum (Sigma) and incubated with Dapi (Sigma) to stain nuclei. Viral spread was imaged using the autofluorescence of the mCherry tagged virus. For representative images of IL-1 β , sections were blocked in 10% normal donkey serum (Sigma) and incubated with rat anti-IL-1 β (1:100; R&D Systems) followed by Alexa-Fluor 488 (Invitrogen) to label endogenous IL-1 β and Dapi (Sigma) to stain nuclei.

For analysis of newly born neurons, sections were blocked in 10% normal donkey serum (Sigma) and incubated with goat anti-DCX (Santa Cruz sc-8066). Sections were then incubated in the appropriate AlexaFluor (AF488) secondary antibody and then with Dapi (1:5000; Sigma) to stain nuclei. Lastly, sections were washed, mounted, and coverslipped with anti-fade mounting media (Dako). Images were obtained using an Olympus FV1000 scanning laser confocal system (BioSciences Imaging Centre, Department of Anatomy and Neuroscience, UCC). For DCX, Z-stack images (step size 1 μ m) were collected with a 20X objective, and cells expressing DCX were counted within 4 grid counting frames of 60x60 pixels per image. Data are expressed as the number of DCX+ cells per mm³ of DG.

5.3.5.4 Neuronal morphology

For analysis of neurite length and complexity, hippocampal sections (1:12 series) were incubated with primary antibody goat anti-DCX (Santa Cruz sc-8066) followed by biotinylated horseradish peroxidase (HRP) streptavidin ABC complex. DCX-positive neurons were selected from control and IL-1 β -treated rats based on their having

minimal overlap with neurites of adjacent neurons. Ten randomly selected neurons were sampled per animal thus there were 30-40 neurons analysed per group (Dolce et al., 2016). Neurons were imaged at 100x magnification on the Olympus BX40 microscope and each was traced using *Camera Lucida*. The traced images were then scanned and analyzed using Neuron J. Total neurite length and the length of primary and secondary neurites were measured in pixels by a blinded observer and converted to μm^2 using a scaled micrometer and Image J software. The extent of neurite branching was determined by counting the number of neurite branch points.

5.3.6 Statistical analysis

Analysis of behavioural data ($n = 10$) were conducted in Statistica 7 (Statsoft; Tulsa, OK) using t-test or repeated measures ANOVA designs as appropriate. Two animals were removed from the open field analysis as tracking software was unable to reliably track these animals. Therefore, open field distance and exploration data ($n = 8$) were analyzed Statistica 7 (Statsoft; Tulsa, OK). An α -level of 0.05 was used as criterion for rejection of the null hypothesis. Fisher's LSD test was used for post-hoc analyses. Analysis of q-PCR ($n = 6-8$), IL-1 β protein expression ($n = 4-5$) and DCX-positive cells and morphology ($n = 5$) were conducted in Statistica 7 (Statsoft; Tulsa, OK) using t-test. Data are expressed as mean \pm SEM.

5.4 Results

5.4.1 Validation of lentiviral-mediated increase in IL-1 β in the dorsal hippocampus

The injection coordinates were verified by observation of mCherry autofluorescence in the dorsal DG (Figure 5.2A, B, E and F). Additionally, the production of IL-1 β by the lentivirus was verified by both PCR, where an increase in IL-1 β mRNA ([t (13) = -2.99, $p < 0.05$], Figure 5.2C) was found; and by Western Blot, as an increase in IL-1 β protein expression approached significance ([t (7) = 2.25, $p = 0.06$]; Figure 5.2D) in IL-1 β -injected animals compared to controls.

5.4.2 IL-1 β impaired pattern separation but not short term spatial working memory or recognition memory

During the acquisition phase, rats spent equivalent times exploring the three objects regardless of treatment ([F (2, 36) = 0.61, $p = 0.55$]; data not shown). When the rats were tested on the large separation, both groups were able to differentiate the novel from familiar location ([t (18) = -0.67, $p = 0.51$]; Figure 5.3A). However, in the small separation condition, the IL-1 β -treated animals showed a significant decrease in performance [t (17) = 2.11, $p < 0.05$], such that they could no longer differentiate between the objects (Figure 5.3B).

IL-1 β did not affect the percentage of alternations made in the Y-Maze ([t (18) = -1.36, p = 0.19]; Figure 5.3C) or the number of entries made into the different arms ([t (18) = -0.65, p = 0.52]; data not shown).

Performance in the both the novel object recognition task [t (18) = 0.77, p = 0.45] and novel object location task [t (18) = -0.68, p = 0.50] was not affected by IL-1 β (Figure 5.3D, E).

Distance travelled in the open field ([t (16) = 1.10, p = 0.29]; Figure 5.3F) was unaffected by IL-1 β . Time in the center of the arena was also analysed as a measure of anxiety-like behaviour, and no difference was found between the control and IL-1 β -treated rats ([t (16) = -1.19, p = 0.25]; Figure 5.3G). There was also no difference in the number of entries to the center of the arena ([t (16) = -0.93, p = 0.37], data not shown) between control rats and IL-1 β -treated rats.

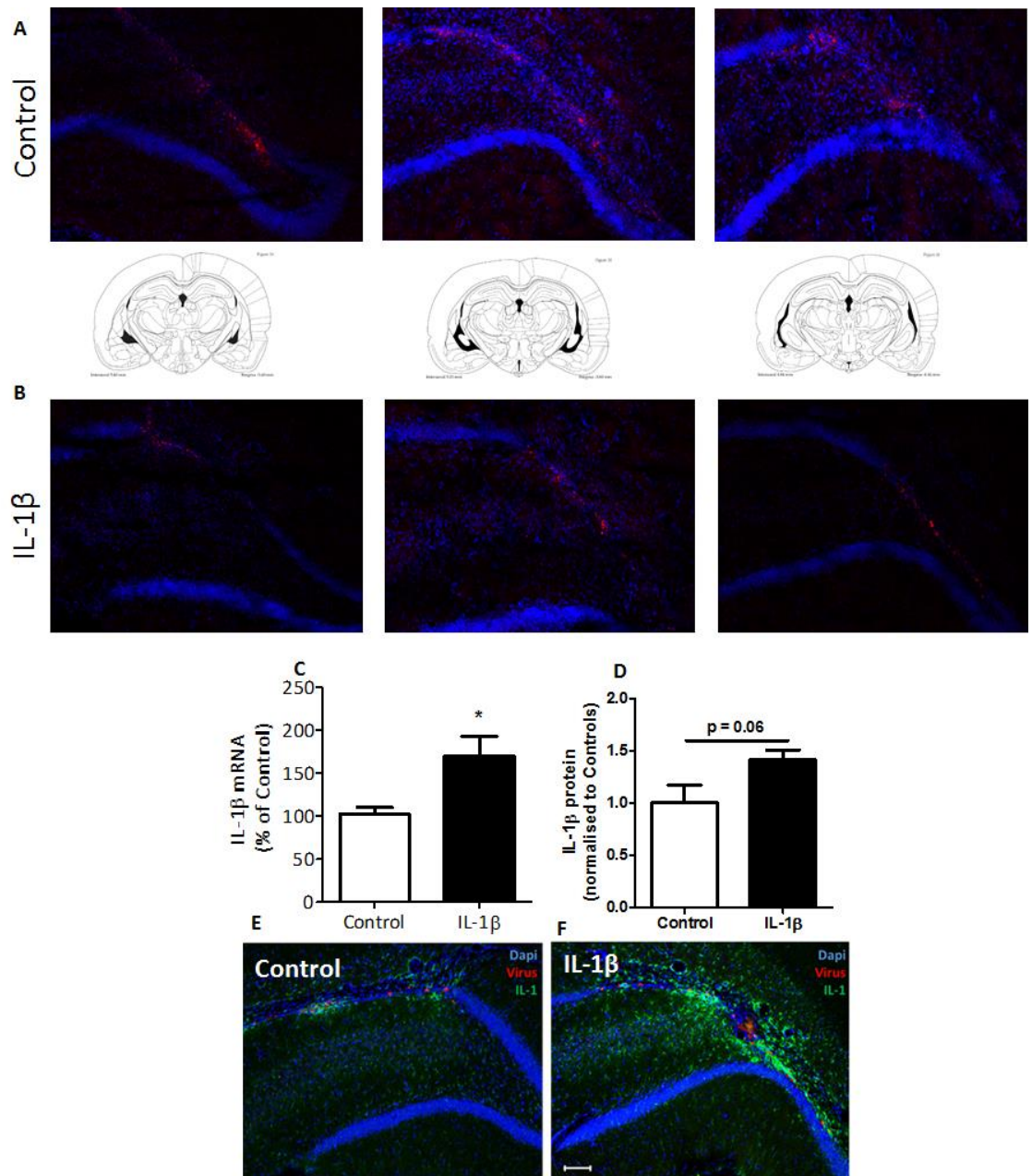

Figure 5.2: Lentivirus-mediated IL-1 β expression. Representative image of mCherry autofluorescence through the dorsal hippocampus of rats injected with a lentivirus overexpressing mCherry (control) (A) or mCherry and IL-1 β (B). IL-1 β mRNA ($n = 6-8$) (C) and protein ($n = 4-5$) (D) expression in the hippocampus. Representative image of mCherry (red) and IL-1 β (green) immunopositive protein expression in the dorsal hippocampus of control (E) and IL-1 β -injected (F) rats. * $p < 0.05$. Data are graphed as means + SEM. Scale bar = 100 μ m.

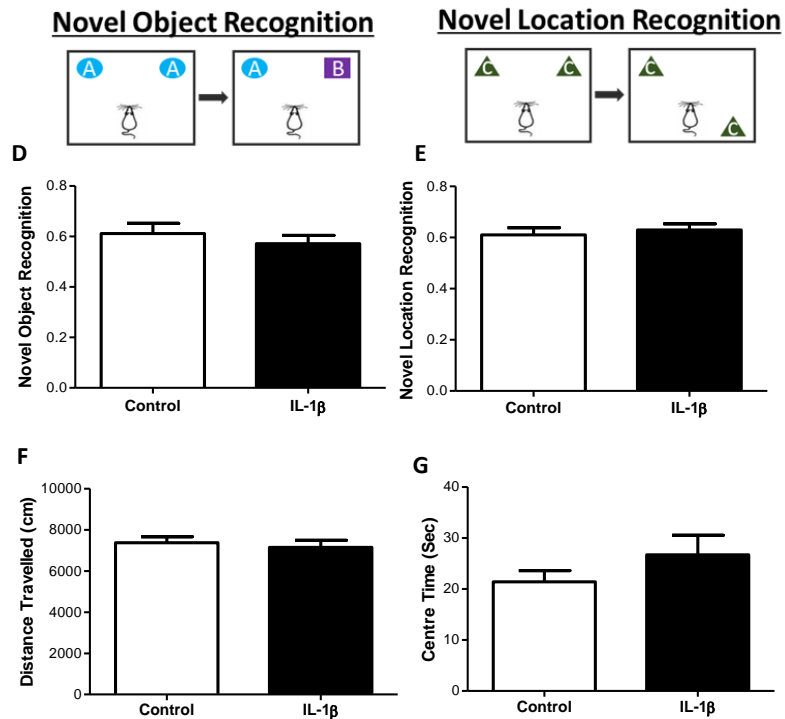
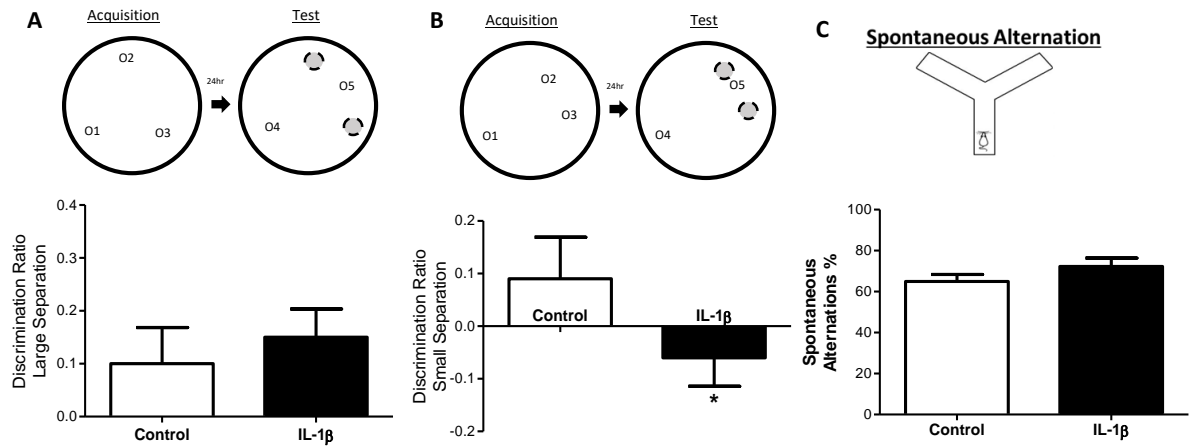

Figure 5.3: IL-1β impaired pattern separation but not short term spatial working memory or recognition memory. Pattern separation in the large (A) and small (B) separation conditions. Percentage of spontaneous alternation in the Y-maze (C). Discrimination ratio for novel object recognition (D) and novel location recognition (E). Distance travelled (F) and time spent in the centre (G) of the open field. Graphs indicate average values for $n = 10$, $*p < 0.05$. Data are graphed as means + SEM.

5.4.3 IL-1 β selectively impaired hippocampal-dependent cognition in the touchscreen operant chamber

5.4.3.1 Post-surgical baseline intermediate location discrimination

All animals displayed an improved performance on the intermediate test across the 4 training sessions [F (3, 54) = 3.44, $p < 0.05$]. However, no effect of IL-1 β [F (1, 18) = 0.48, $p = 0.50$] or interaction effect [F (3, 54) = 0.82, $p = 0.49$] was observed (Figure 5.4B).

5.4.3.2 Location discrimination testing

In the large separation, while the rats had a decreased number of trials to reversal across time [F (2, 36) = 18.14, $p < 0.001$], no effect of IL-1 β [F (1, 18) = 0.20, $p = 0.66$] or interaction [F (2, 36) = 0.22, $p = 0.81$] was observed (Figure 5.4D). In the small separation, rats performed better across session blocks [F (2, 36) = 11.22, $p < 0.001$], and while there was no interaction effect [F (2, 36) = 1.90, $p = 0.16$], a trend for an effect of IL-1 β [F (1, 18) = 3.31, $p = 0.086$] was observed. When t-tests between IL-1 β -treated and control animals in the small separation at each of the three blocks were performed, there was a significant decrease in performance within the second trial block ([t (18) = 3.47, $p < 0.01$]; Figure 5.4G). When the total number of reversals during each block was examined, there was an increase in performance over time in both the large ([F (2, 36) = 80.13, $p < 0.001$]; Figure 5.4E) and small ([F (2, 36) = 66.03, $p < 0.001$]; Figure 5.4H) separations. However, no effect of IL-1 β (large: [F (1, 18) = 0.28, $p = 0.61$]; small: [F (1, 18) = 1.17, $p = 0.29$]) or interaction effect (large: [F

(2, 36) = 1.56, $p = 0.22$]; small: [F (2, 36) = 0.94, $p = 0.40$]) was found in either separation.

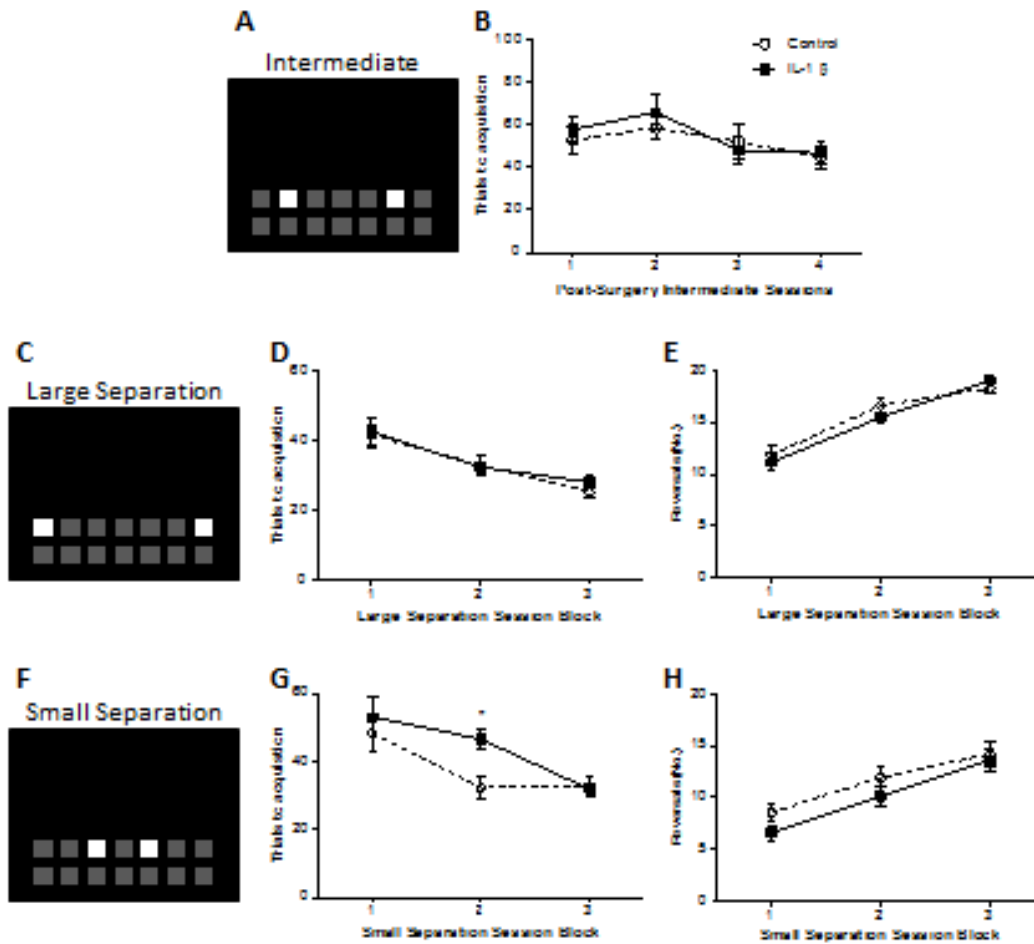

Figure 5.4: IL-1 β selectively impaired hippocampal-dependent cognition in the touchscreen operant chamber. Representative image (A) and trials to acquisition (B) during intermediate location discrimination training. Representative image (C) and trials to acquisition (D) and number of reversals completed (E) in the large separation location discrimination condition. Representative image (F) and trials to acquisition (G) and number of reversals completed (H) in the small separation location discrimination condition. Graphs indicate average values for $n = 10$, $*p < 0.05$. Data are graphed as means \pm SEM.

5.4.4 IL-1 β did not affect visual discrimination within the touchscreen operant chamber

For visual discrimination, no difference in the number of sessions to criteria was found due to IL-1 β overexpression ([$t(13) = 1.27, p = 0.23$]; Figure 5.5B). Not all animals were able to reach criteria on the visual discrimination task (8 control, 7 IL-1 β), however, no difference in the proportion of animals reaching criteria was found between groups using the log-rank (Mantel-Cox) test ([$\chi^2 = 0.64, p = 0.42$]; Figure 5.5C). For the visual discrimination reversal task, not enough animals were able to reach criteria to allow analysis of differences of sessions to criteria (7 control, 2 IL-1 β). However, a difference in the proportion of animals reaching criteria was found [$\chi^2 = 5.26, p < 0.05$], with IL-1 β resulting in an increased number of animals failing to reach criteria (Figure 5.5D).

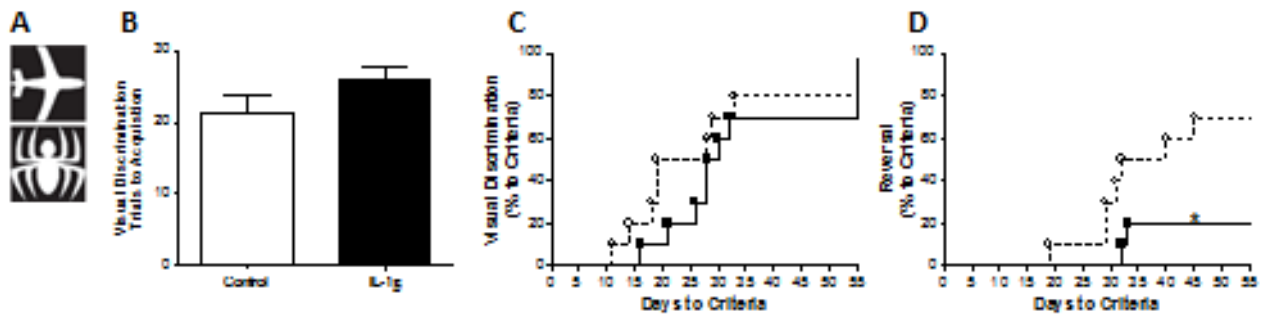

Figure 5.5: IL-1 β did not affect visual discrimination within the touchscreen operant chamber. Representative image of visual discrimination stimuli (A). Trials to acquisition of the visual discrimination task (B). Survival curve of the proportion of rats that reached learning criteria for the visual discrimination task (C). Survival curve of the proportion of rats that reached learning criteria for the visual discrimination reversal task (D). Graphs indicate average values for $n = 10$, $*p < 0.05$. Data graphed as means + SEM.

5.4.5 Lentiviral-induced decrease in hippocampal DCX mRNA and morphology of immature neurons

IL-1 β decreased DCX mRNA expression, a marker of immature neurons, in the hippocampus ([t (10) = 2.98, p < 0.05]; Figure 5.6A) but did not affect the number of DCX-positive cells ([t (4) = 0.26, p > 0.05]; Figure 5.6B). However, IL-1 β reduced the complexity of neurites on DCX-positive cells as indicated by a significant decrease in the total neurite length of DCX-positive cells ([t (4) = 2.96, p < 0.05]) and specifically, a decrease in the length of secondary neurites ([t (4) = 3.59, p < 0.05]; Figure 5.6C). There was also a non-significant trend towards a decrease in the number of neurite branch points ([t (4) = 2.33, p = 0.08]; Figure 5.6D).

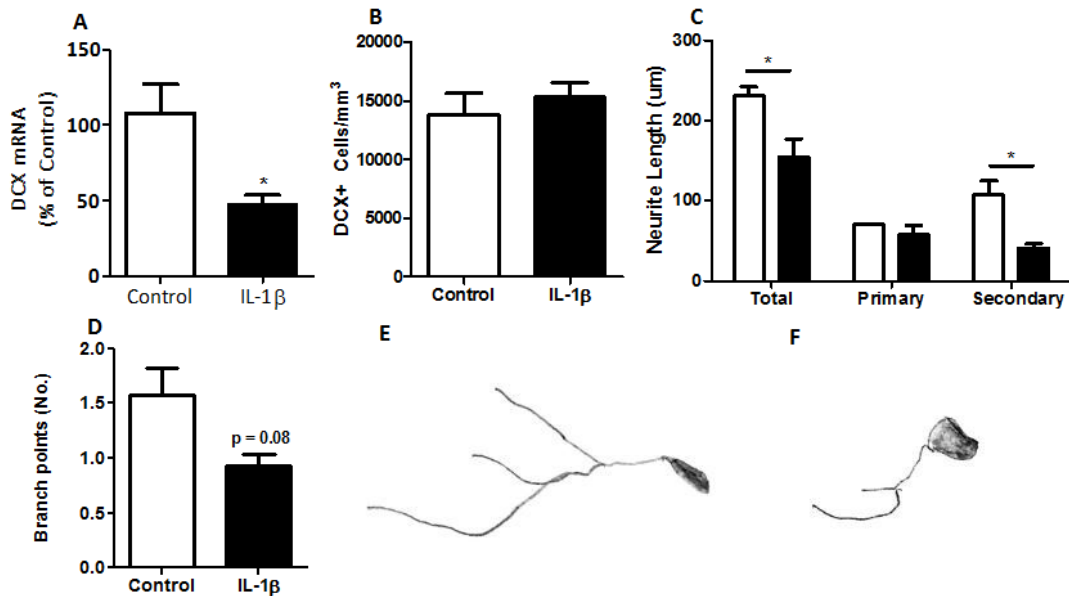

Figure 5.6: IL-1 β decreased hippocampal DCX expression and morphology of DCX. DCX mRNA expression in the hippocampus (n = 6-8) (A). DCX-positive cells (B) Neurite length (C) and number of neurite branch points (D) on DCX-positive cells (n = 5). Representative image of the DCX+ cells in the DG of control (E) and IL-1 β -treated (F) rats. *p < 0.05. Data are graphed as means + SEM.

5.5 Discussion

Understanding the role of inflammation on brain processes underlying cognitive behaviour is an important approach to developing novel treatment strategies for age-related disorders. This study investigated the effects of lentiviral overexpression of IL-1 β on hippocampal-dependent and independent cognition using both touchscreen and non-touchscreen behaviour paradigms. The results indicated that chronic IL-1 β exposure impaired performance in the modified spontaneous location recognition task, a means of assessing pattern separation. Specifically, task performance was impaired by IL-1 β when there was a small inter-stimulus distance between the novel and familiar locations and therefore high contextual overlap, while performance was unaffected when there was a large inter-stimulus distance between locations and thus low contextual overlap. Discrimination between memories of high contextual overlap has been referred to as pattern separation, and discrimination during the small inter-stimulus conditions (i.e. when there is high contextual overlap) has been shown to be sensitive to disruption of adult hippocampal neurogenesis (Bekinschtein et al., 2014). In support, we found that chronic IL-1 β overexpression decreased DCX mRNA and impaired the morphological development of DCX-positive cells which was coupled with impaired performance in the spontaneous location recognition task. The impairment was not caused by IL-1 β -induced sickness behavior, as locomotor activity and exploration in the open field were unaffected. It is important to note that mild food restriction has been shown to enhance exploration in spontaneous tasks and impact hippocampal neurogenesis (Lee et al., 2000). Thus, as rats tested in the modified spontaneous location recognition test had *ad libitum* access to food this may have

contributed to the relatively low discrimination ratio in the current study compared to previously reported findings (Kent et al., 2015, Bekinschtein et al., 2014).

The touchscreen location discrimination task similarly varies the inter-stimulus distance between reward locations creating both high and low contextual overlap conditions and thus has been proposed to measure pattern separation processes (Oomen et al., 2013). Performance in the touchscreen location discrimination task during high contextual overlap has been shown to be sensitive to changes in hippocampal neurogenesis (Oomen et al., 2013, Creer et al., 2010, Clelland et al., 2009, McTighe et al., 2009, Yassa and Stark, 2011). The results from the current study indicated a subtle and transient impairment in performance by IL-1 β overexpression when there was a small inter-stimulus distance between the displayed images (i.e. high contextual overlap), whereas performance was unaffected by IL-1 β when there was a large inter-stimulus distance between the images (i.e. low contextual overlap). However, the effect was not long lasting as control and IL-1 β -treated animals performed at similar levels by the end of the training (Session Block 3). Moreover, the mild impairment in location discrimination may be due to the relatively short period of time between lentiviral injection and location discrimination testing (4 weeks). Increasing the time between lentiviral injection and testing may help to facilitate viral integration and convey a greater disruption to hippocampal-dependent processes such as pattern separation. In a previous study, rodents that underwent focal radiation of the hippocampus exhibited an impairment in performance during the small separation condition and this impairment was correlated with a decrease in the number of DCX-

positive cells in the DG (Clelland et al., 2009). Our finding that IL-1 β overexpression decreases the complexity of neurites on immature neurons which is indicative of impaired synaptic integration may have played a role in the IL-1 β -induced impairments in tasks assessing pattern separation observed here. Together, these data highlight the notion that disruption to pattern separation by an overexpression of IL-1 β may be mediated through its effects on hippocampal neurogenesis.

Impairments in hippocampal-dependent cognition have primarily been observed in studies investigating the effects of acute IL-1 β exposure. Specifically, acute intracerebroventricular administration of recombinant IL-1 β protein has been reported to impair spatial learning in the Morris water maze in Wistar rats (Oitzl et al., 1993). Similarly, acute intra-hippocampal administration of IL-1 β has been shown to impair contextual fear recall in Wistar rats (Gonzalez et al., 2009). Previous studies have also reported impairments in other hippocampal-dependent tasks such as contextual fear recall and spatial memory within the Morris water maze following a prolonged overexpression of IL-1 β in transgenic mice (Moore et al., 2009, Hein et al., 2010). However, to our knowledge this is the first study to show that a targeted chronic increase in IL-1 β in the hippocampus induced an impairment in both touchscreen operant and object-based pattern separation paradigms.

Interestingly, we report that novel location recognition was unaffected by IL-1 β . While novel location recognition has been shown to be hippocampal-dependent (Antunes and Biala, 2012, Bevins and Besheer, 2006), it is possible that the increased concentration

of IL-1 β induced by lentiviral overexpression was not high enough to induce changes in some types of hippocampal-dependent cognition, such as novel location recognition. Conversely, cognitive processes such as pattern separation may be more sensitive to long-term low grade increases in IL-1 β .

Chronic IL-1 β overexpression in the dorsal hippocampus also did not affect performance in novel object recognition by rats. Previous reports have suggested that the perirhinal cortex is involved in distinguishing familiarity, which is the main component of the novel object recognition task (Balderas et al., 2008), whereas the hippocampus is required for contextual and spatial memories, but not necessarily required for discrimination of familiarity (Winters et al., 2004). As novel object recognition is assessed by the rodent's ability to distinguish a novel object from a familiar object, the impaired function of the hippocampus induced by chronic IL-1 β may not be sufficient to affect novel object recognition performance which relies upon both the perirhinal cortex and hippocampus (Dere et al., 2007). Similarly, spontaneous alternation in the Y-maze was unaffected by IL-1 β in this study. Previous work has shown impaired spatial working memory in the radial arm maze following acute intra-hippocampal administration of IL-1 β recombinant protein in Wistar rats (Matsumoto et al., 2004). However, the difference in results may stem from methodological differences in assessing spatial working memory. Here, spatial working memory was measured by spontaneous alternation in the Y-maze, a task which relies on the natural tendency of rodents to alternate in the exploration of non-reinforced maze arms (Hughes, 2004). Alternatively, in a study by Matsumoto et al. (2004), spatial working

memory was assessed in the radial arm maze, a paradigm which employs greater training and motivation to seek out a food reward and therefore might be more sensitive to hippocampal disruptions. Moreover, the notion that IL-1 β selectively impairs subtypes of hippocampal-dependent cognition is further supported by findings that have shown hippocampal-independent tasks such as cued fear conditioning and non-spatial learning in the Morris water maze are spared following two weeks of overexpression of IL-1 β in transgenic mice (Hein et al., 2010, Moore et al., 2009). Taken together, these data suggest that chronic IL-1 β in the hippocampus selectively affected certain aspects of hippocampal-dependent cognitive function, specifically pattern separation, which may be an indication of the sensitivity of pattern separation tasks to measure subtle changes in hippocampal function, possibly relating to adult hippocampal neurogenesis. The hippocampus is functionally subdivided along the septotemporal axis into a dorsal and ventral region, which are associated with distinct behaviours (Moser and Moser, 1998, Fanselow and Dong, 2010). The process of spatial memory is generally associated with the dorsal hippocampus, while the ventral hippocampus is associated with emotional behaviour, particularly cued fear learning and anxiety-related behaviours (Bannerman et al., 2004). Indeed, the data presented here confirmed lentiviral-mediated overexpression of IL-1 β in the dorsal hippocampus, however, it is possible the virus also spread into the ventral hippocampus. Therefore, future work may investigate the impact of chronically elevated IL-1 β along the septotemporal axis of the hippocampus and its distinct impact on ventral hippocampal-dependent processes such as emotional regulation.

We reported that there were no statistically significant difference in visual discrimination and reversal learning following chronic IL-1 β overexpression. Visual discrimination and reversal learning are measures of executive function such as cognitive flexibility, decision making and attention and have been shown to be sensitive to prefrontal cortex manipulation (Mar et al., 2013). Our results suggest that disruption of the hippocampus by chronic IL-1 β may not be sufficient to impair prefrontal cortex-mediated executive functions, such as cognitive flexibility or decision making. However, there was a significantly greater number of IL-1 β -treated animals that were unable to complete the visual discrimination reversal learning task suggesting that IL-1 β negatively impacted upon acquisition of the task. Although other studies have not directly investigated the effects of IL-1 β overexpression on visual discrimination and reversal learning using the touchscreen operant paradigm, previous studies using the amyloid precursor protein (APP) transgenic mice, (a model of Alzheimer's disease pathology that have increased levels of hippocampal IL-1 β (Howlett and Richardson, 2009, Piipponiemi et al., 2017)), show similar acquisition of visual discrimination, but impaired reversal learning compared to wildtype controls (Piipponiemi et al., 2017). However, it is important to note that APP transgenic mice exhibit far more complex pathology than just increased levels of hippocampal IL-1 β (Howlett and Richardson, 2009).

Chronic IL-1 β overexpression significantly reduced hippocampal mRNA expression of DCX, a marker for immature neurons. This finding is in line with previous work that reported chronic administration (4 weeks) of IL-1 β into the dorsal hippocampus via

osmotic mini-pumps decreased the number of DCX-positive cells (Goshen et al., 2008). Similarly, transgenic overexpression of IL-1 β in the hippocampus has been shown to reduce DCX-positive cells (Wu et al., 2012). While our current findings do not demonstrate an IL-1 β -induced decrease in the number of DCX-positive cells, we show that chronic IL-1 β overexpression impaired the complexity of neurites on DCX-positive cells, a key process for synaptic integration. This finding is in line with previous work that chronic administration of LPS via osmotic mini pump reduced the dendritic length and postsynaptic cluster density of immature neurons in the DG (Llorens-Martin et al., 2014). In addition, acute IL-1 β treatment has been shown to inhibit LTP in the hippocampus, a measure of synaptic plasticity (Lynch, 2015). Together, these data suggest that chronic IL-1 β may affect hippocampal-dependent processing through disruption of synaptic integration of new born neurons rather than by affecting the numbers of new neurons. These effects may in part be mediated through IL-1 type 1 receptor (IL-1R1) signalling. NPCs have been shown to express IL-1R1, suggesting that IL-1 β may act directly upon these stem-like cells (Green et al., 2012, Ryan et al., 2013). These findings suggest that impairments in hippocampal neurogenesis by inflammation may be mediated through IL-1 β , which alters neuronal differentiation and integration, and which subsequently affects hippocampal-dependent processes.

In summary, our data demonstrate that lentiviral-induced chronic elevation of hippocampal IL-1 β selectively impairs performance in object-based and touchscreen based behaviour paradigms that assess pattern separation, coupled with an IL-1 β -

induced decrease in neurogenesis. Disruption of adult neurogenesis through IL-1 β may contribute to the cognitive dysfunction associated with neurodegenerative and stress-related disorders, as well as with ageing, each of which display heightened inflammatory states characterized by increased IL-1 β expression (Bartsch and Wulff, 2015, Amor et al., 2010).

CHAPTER 6

The Effects of Chronic Unpredictable Stress and Interleukin-1 β Overexpression in the Dorsal Hippocampus on Cognition

6.1 Abstract

A major contributing factor to the development of stress related psychiatric disorders is exposure to multiple adverse events, whereby exposure to some initial adverse stimuli, such as inflammation or stress, compromises the ability to adapt to a second adverse event. The hippocampus is particularly vulnerable to adverse stimuli, such as chronic unpredictable stress and inflammation. The pro-inflammatory cytokines, interleukin-1 β (IL-1 β), has been proposed as a central regulator of the stress response. However, the impact of prolonged increases in IL-1 β , followed by a secondary insult of chronic stress on cognitive function is yet to be fully explored. Therefore, the aim of this study was to examine the impact of chronic IL-1 β , chronic unpredictable stress exposure, or a combination of an initial chronic IL-1 β insult followed by exposure to chronic unpredictable stress on learning and memory and depressive-like behaviours. Here, we used a lentiviral approach to induce long-term gene overexpression of IL-1 β in the dorsal hippocampus of adult male Sprague Dawley rats. Three weeks after virus injection rats were either exposed to chronic unpredictable stress or left undisturbed for an additional three weeks. The results indicated that object memory was impaired by IL-1 β overexpression or chronic unpredictable stress as well as the combination of the two treatments, whereas only chronic unpredictable stress exposure impaired spontaneous alternation in the Y-maze. Chronic unpredictable stress, but not IL-1 β nor the combination of the two treatments affected contextual fear recall, while cued fear recall was unaffected by IL-1 β or stress. IL-1 β , chronic unpredictable stress and their combination also increased depressive-like behaviours in the forced swim test, while corticosterone levels were unaffected. In conclusion, our findings suggest that

exposure to chronically elevated IL-1 β and chronic stress independently impair certain types of learning and memory and increase depressive-like behaviour. However, exposure to a sequential ‘two-hit’ of chronically elevated hippocampal IL-1 β and chronic stress does not produce an exacerbated phenotype.

6.2 Introduction

In our aging global population, the cognitive decline associated with neurodegenerative and psychiatric disorders represents a major healthcare problem (Shao et al., 2017). There is a growing consensus that the increasing impact of stress-related inflammatory insults on daily living positions neuroinflammation as a promising therapeutic target for treatment of neurodegeneration and associated cognitive disorders (Amor et al., 2010, Ryan and Nolan, 2016b). It has been suggested that exposure to multiple stressful events is a major contributing factor to the development of stress related psychiatric conditions such as depression, anxiety disorders, and post-traumatic stress disorder (Hammen, 2005, de Kloet et al., 2005, de Kloet et al., 2016, Lucassen et al., 2013). Exposure to multiple stressful events, termed the ‘two-hit’ hypothesis, proposes that susceptible neurons under stress devote their compensatory potential to adapt to the current stressful stimuli, such as inflammation, and thereby lose their capacity to adapt to a second stressful stimuli in the future (Zhu et al., 2004, Zhu et al., 2007). Thus pathological conditions, such as impaired cognition, emerge due to a compromised ability to adapt to an adverse environment.

The hippocampus is particularly vulnerable to stress and inflammation. The pro-inflammatory cytokine interleukin-1 β (IL-1 β) is a major mediator of neuroinflammation and its cognate receptor IL-1R1 is highly expressed within the hippocampus (Ban et al., 1991, Parnet et al., 1994). Under chronic neuroinflammatory

conditions such as those associated with neurodegenerative disorders, IL-1 β has been shown to have a detrimental effect on learning and memory in rodent models (Goshen et al., 2007, Kohman and Rhodes, 2013, Lynch et al., 2010). Indeed, acute IL-1 β inhibits hippocampal-dependent learning such as spatial learning and contextual fear conditioning (Gibertini et al., 1995, Goshen et al., 2007, Barrientos et al., 2002).

Similarly, chronic stress in humans has been shown to have profound effects on learning and memory such as spatial learning (Schwabe et al., 2007), working memory (Schoofs et al., 2008) as well as cognitive flexibility and decision making (Liston et al., 2009). The chronic unpredictable stress (CUS) paradigm has been widely used as an behavioural model to investigate the impact of prolonged stress and consists of the random, intermittent, and unpredictable exposure to a variety of stressors over the course of several weeks (Monteiro et al., 2015). Although other behavioural models of chronic stress have been developed, such as physical restraint stress and foot sock, the intermittent and unpredictability of the CUS paradigm has been suggested to closely model the daily stress experienced by humans (Monteiro et al., 2015, Crawley, 2007). To date, stress-induced impairment in cognitive function in rodents have been reported to be associated with significant changes in the underlying neurocircuitry of learning and memory, particularly the hippocampus (McEwen, 2007). Despite this, the mechanisms underlying the behavioural effects of stress remain to be fully explored (Goshen and Yirmiya, 2009). One possible mechanism is that excessive pro-inflammatory cytokines, particularly IL-1 β , may contribute to the actions of stress (Koo and Duman, 2008, Goshen and Yirmiya, 2009). Rodents exposed to acute restraint

stress has been shown to increase IL-1 β in several brain areas, including the hippocampus (Nguyen et al., 1998, Vichaya et al., 2011). Moreover, administration of an interleukin-1 receptor antagonist (IL-1RA) into the hypothalamus (Shintani et al., 1995) or hippocampus (Koo and Duman, 2008) produces stress-like behaviour effects, anhedonia and activation of the hypothalamic-pituitary-adrenal (HPA) axis as well as impairment in hippocampal-dependent contextual fear conditioning (Pugh et al., 1999). Together, these findings suggest that IL-1 β and chronic stress may mediate inflammation-induced changes in cognition through disruption of hippocampal-dependent processes (Yirmiya and Goshen, 2011, O'Leime et al., 2017, Hueston et al., 2017). However, whether the impact of a 'two hit' paradigm, combining an initial insult of chronically elevated hippocampal IL-1 β and a second insult of exposure to a chronic stress has a collectively greater impact on hippocampal-dependent and independent cognitive function is yet to be fully explored. Therefore, given the role of stress and IL-1 β as independent risk factors of cognitive dysfunction, the aim of the current study was to determine whether a prior insult of chronically elevated hippocampal IL-1 β would exacerbate chronic unpredictable stress-induced changes in hippocampal-dependent and independent cognitive processes.

6.3 Methods

6.3.1 Animals and experimental design

Adult male Sprague-Dawley rats obtained from Harlan UK (325-350 grams) were pair housed in a colony maintained at $22 \pm 1^\circ\text{C}$, with a 12:12 hour light-dark cycle (lights on 0630-1830). All animal procedures were performed under licenses issued by the Health Products Regulatory Authority (HPRA, Ireland), in accordance with the European Communities Council Directive (2010/63/EU) and approved by the Animal Experimentation Ethics Committee (AEEC) of University College Cork. Four independent cohorts of animals were injected with either a lentivirus overexpressing mCherry (control) or IL-1 β tagged to mCherry. The first cohort (mCherry control (n = 10)) and second cohort (IL-1 β (n = 10)) underwent behavioural testing six weeks after surgery. The third cohort (mCherry control (n = 10) and fourth cohort (IL-1 β (n = 10)) underwent three weeks of chronic unpredictable stress prior to behavioural testing and the stress regime continued during testing for a total of six weeks (Figure 6.1). All rats had *ad libitum* access to food and water except the cohort of rats that underwent chronic unpredictable stress, in which stressed animals were periodically food deprived overnight during the stress regime (Table 6.1). All rats were weighted daily.

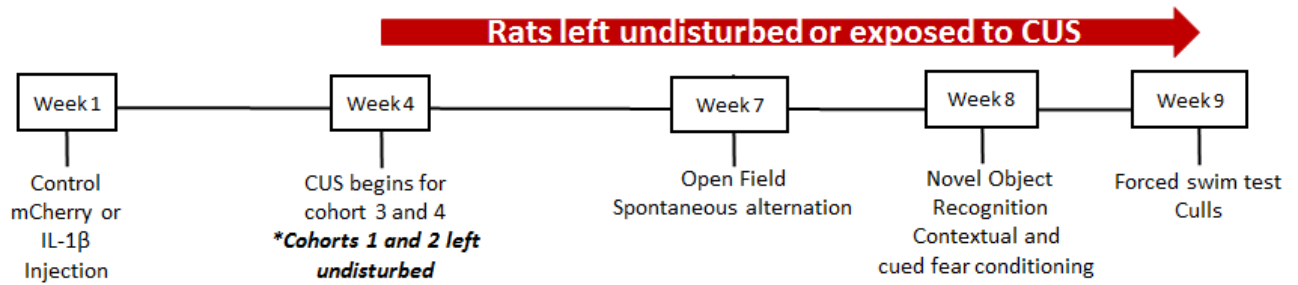

Figure 6.1: Experimental timeline. Rats were injected with a lentivirus for the overexpression of IL-1 β or mCherry control. Cohorts 1 (control $n = 10$) and 2 (IL-1 β $n = 10$) were left undisturbed for six weeks following viral injection. Three weeks after viral injection, cohorts 3 (control $n = 10$) and 4 (IL-1 β $n = 10$) were exposed to CUS for an additional three weeks. Six weeks after the initial viral injection behavioural testing commenced. CUS continued during testing for a total of eight weeks.

6.3.2 Stereotaxic surgery and Lentiviral injection

Rats were anaesthetised with isoflurane and placed into a stereotaxic frame. An FIV backbone lentivirus for the overexpression of IL-1 β tagged to mCherry (3 μ L: 5.62×10^3 transfecting units) or mCherry (3 μ L: 5.13×10^3 transfecting units) under a CMV promotor (Genecopeia, USA) was injected into the dorsal hippocampus using the coordinates AP: -3.5 mm, ML: ± 2.4 mm, DV: -3.8 mm relative to Bregma (Palkovits, 1983) at a rate of 1 μ L/min followed by a 5 minute diffusion. Rats were injected with carprofen and 5% glucose (s.c.) prior to anaesthetic recovery.

6.3.3 Chronic unpredictable stress

The chronic unpredictable stress (CUS) procedure used a variety of stressors for 42 days to maximize unpredictability (Table 6.1) and previously established in Appendix B. Rats were exposed to one stressor during the light cycle; (lights off, cage rocker, physical restraint, isolation, cage tilt, strobe light or white noise) as well as one stressor during the dark cycle; (lights on, wet bedding, overcrowding, food deprivation or isolation) each day. Stressors were randomized such that no stressor was repeated on a consecutive days (Table 6.1). Control animals were left undisturbed for six weeks.

Table 6.1: Experimental schedule for CUS procedure.

Stressor	Duration	Day
Lights on	Overnight	1,7,23,27,33
Light off	3 h	2,6,11,14,19,22
Cage rocker	1 h	3,7,12,15,17,25,29
Wet Bedding	Overnight	3,10,17,22,26,31,40
Restraint	1 h	4,9,13,16,18,22,33,39
Overcrowding	Overnight	6,12,16,21,25,30,34
Food deprivation	Overnight	5,8,14,18,27,32
Isolation	Overnight	11,20,24,29,34
Isolation	3 h	5,8,19,24,26,41
Cage tilt	Overnight	2,9,28,32,35
Strobe Light	Overnight	4,13,20,24,30,37
White noise (Radio)	4 h	1,10,15,21,28,31,36

6.3.4 Open field test

Spontaneous exploratory locomotor activity and exploration of arena center in the open field were used as a general measure of motor function and anxiety-related behaviours, respectively (Choleris et al., 2001). Rats were placed in an open field arena (90 cm diameter) under bright lighting conditions (400 lux) for 10 minutes. Distance travelled and time in the center of the arena were recorded and calculated using Ethovision software (Noldus). The arena (and all arenas, apparatus, and objects in subsequent tasks) were cleaned with a 70% ethanol solution between exposures of each animal to the arena to remove odour cues.

6.3.5 Novel object recognition

Novel object recognition, a perirhinal cortex dependent task, was assessed as described by Bevins and Besheer (2006). On day 1, rats were habituated to the testing arena (rectangle arena) for a 10-minute exploration period. On day 2, two identical objects (Duplo® blocks) were positioned on adjacent corners approximately 5 cm from each wall of the arena and each animal was introduced for a 10-minute exploration period. Rats were then placed directly back into their home cages. After a 3-hour inter-trial interval, one familiar object was replaced with a novel object, and the time spent exploring the novel object was recorded over a 5-minute exploration period. Object exploration was defined as when the animal's nose came within a 2 cm radius of the object. The testing arena and objects were cleaned with a 50% alcohol solution. Object

discrimination was calculated as the time spent exploring the novel object divided by the total time spent exploring both objects.

6.3.6 Spontaneous alternation in the Y maze

Spontaneous alternation behaviour is the tendency of rodents to alternate their exploration of maze arms (such as those of the Y maze) and is used as a measure of hippocampal-dependent working memory (Hughes, 2004). The Y maze consisted of three arms 120° from each other (40 x 10 x 20 cm; made in house) and the protocol used was adapted from Senechal et al. (2007). Each animal was placed into the first arm of the maze facing the wall, and allowed to explore the maze for five minutes. The number and order of arm entries were recorded. An arm entry was defined as all four paws entering into the arm (four paw criteria). An alternation was determined as the number of consecutive entries into the three maze arms. Alternations were then divided by the total number of entries during the five-minute test period. The percentage of alternations was calculated as $\% = \text{Alternations} / (\text{Total Entries} - 2)$.

6.3.7 Contextual and cued fear conditioning

Contextual fear conditioning was used to assess hippocampal-dependent learning, while cued fear conditioning was employed to probe amygdala-dependent cognitive processes as previously described (Pattwell et al., 2011, Maren, 2001). During the acquisition phase, rats were placed into the fear conditioning chamber (Med Associates, 30.5 cm x 24.1 cm x 21.0 cm with steel bar floors and scented with a lemon and ginger

tea bag (Twinings™)). Rats were allowed to explore the chamber for two minutes during an acclimation period and then received three shock and tone pairs (30 s tone; 5 kHz; 70 dB; 1 s foot shock; 0.8 mA DC current) separated by 30 second intervals. Rats were placed back in their home cage one minute after the final shock. Contextual fear memory was assessed 24 hours later by placing the rats back into the same chamber, but in the absence of the tone and shock. Time spent freezing was measured during the last 3.5 minutes of the total 5.5-minute protocol using specialized software (Video freeze, Med Associates, USA).

Cued fear conditioning was measured 24 hours after the contextual test. To measure cued fear learning, rats were placed into a novel context (white floor; black wall insert at 60°; and almond scent 1%) with the presentation of the tone but no foot shock. Rats were allowed two minutes to acclimatize followed by three 30 second tone presentations (30 s; 5 kHz; 70 dB). Time spent freezing during the 30 second tone presentations was recorded (Video freeze, Med Associates, USA).

6.3.8 Forced swim test (FST)

The FST is a measure of antidepressant-like behaviour. The task was carried out as previously described (Slattery and Cryan, 2012). A preswim (15 min) was conducted first, 24 hours prior to the test swim. On test day, all rats were introduced again to the Plexiglas cylinder (46cm tall x 21cm in diameter) filled with water (24°C) to a depth of 30cm. Test sessions (5 minutes) were recorded by video camera. Rats were removed from their home cage and placed into the tank. After 5 min, animals were removed

from the tank, dried and replaced back into their home cage. The tank was then emptied, and fresh water was replaced into the tank between each animal. The parameters of interest were the length of time immobile, swimming and climbing. The predominant behaviours (immobile, swimming or climbing) were scored every 5 seconds within the 5 minute time frame (Slattery and Cryan, 2012). Climbing was defined by the rat presenting its forepaws along the edge of the cylinder in an upwards movement. Any horizontal movement was classified as swimming. Finally, immobility was defined as no additional movement required for the animal to maintain its head above water. Latency to first immobile display was also measured.

6.3.9 Serum corticosterone immunoassay

On the first day of the FST, tail blood samples were obtained from each individual animal at four different time points. Specifically, blood was taken immediately before the FST and at 30 min, 45 min and 90 min following the swim stress. Approximately 200 µl of blood was collected in tubes containing EDTA to avoid coagulation. The tubes were centrifuged at 3500 x g at room temperature for 15 minutes. Plasma was removed and stored at -80c. Measurement of corticosterone levels was carried out using a commercially available ELISA kit (Corticosterone ELIA Kit, ADI-900-097, Enzo Life Sciences) according to the manufacturer's protocol. Absorbance was read at 405nm using a plate reader (Synergy HT, BioTek Instruments, Inc.).

6.3.10 Tissue

Rats were euthanized with an i.p. injection of Sleep-Away (1.0mL/kg) and transcardially perfused using a 0.9% phosphate buffered saline (PBS) solution followed by 4.0% paraformaldehyde in PBS. Brains were removed and post-fixed in 4% formaldehyde in PBS overnight, then transferred to a 30% sucrose solution. Coronal sections from the brains were cut at 40 μ m onto slides in a 1:12 series and stored at -80°C for future analysis.

6.3.11 Statistical analysis

All data were analysed using SPSS statistical software (SPSS, Chicago, IL). Data were analysed primarily by Student's t-test or two-way repeated measures ANOVA with Bonferroni post-hoc test. An alpha level of 0.05 was used as criterion for statistical significance. Data are presented as mean plus standard errors of the mean (SEM).

6.4 Results

6.4.1 Chronic unpredictable stress decrease body weight

All animals gained weight throughout testing (Figure 6.2A). The results indicated that there was no main effect of IL-1 β on body weight [F (1, 36) = 0.152, p > 0.05]. However, there was a significant main effect of CUS on body weight [F (1, 36) = 18.34, p < 0.001], with rats exposed to CUS or the combine CUS and IL-1 β overexpression exhibiting a reduction in body weight compared to control at experimental week 4, (p

< 0.01) week 5 ($p < 0.001$), week 6 ($p < 0.001$), week 7 ($p < 0.01$), week 8 ($p < 0.05$) and week 9 ($p < 0.05$) (Pairwise comparison; Figure 6.2A).

6.4.2 Neither CUS nor IL-1 β treatment affected locomotor activity or anxiety-like behaviour

Distanced travelled in the open field, a measure of hyperactivity was unaffected in either IL-1 β overexpression [$F(1, 36) = 0.97, p > 0.05$] or CUS [$F(1, 36) = 0.12, p > 0.05$] (Figure 6.2B). Time in the center of the arena was also analysed as a measure of anxiety-like behaviour, and was no significant main effect of either IL-1 β overexpression or CUS [$F(1, 36) = 0.42, p > 0.05$] [$F(1, 36) = 0.007, p > 0.05$] (Figure 6.2C).

6.4.3 Both CUS and IL-1 β treatment impaired object memory

The results indicated that there was a non-significant main effect of IL-1 β overexpression [$F(1, 34) = 1.92, p = 0.17$] and CUS [$F(1, 34) = 2.45, p = 0.12$] on object recognition. There was also a non-significant interaction between CUS and IL-1 β overexpression [$F(1, 34) = 4.00, p = 0.053$]. When t-tests between control and IL-1 β overexpression and CUS animals in object recognition were performed, there was a significant decrease in performance within the IL-1 β -treated animals [$t(17) = 3.53, p < 0.01$], CUS [$t(17) = 3.30, p < 0.01$], and the combined CUS and IL-1 β -treated animals ([$t(18) = 2.25, p < 0.05$]; Figure 6.3A).

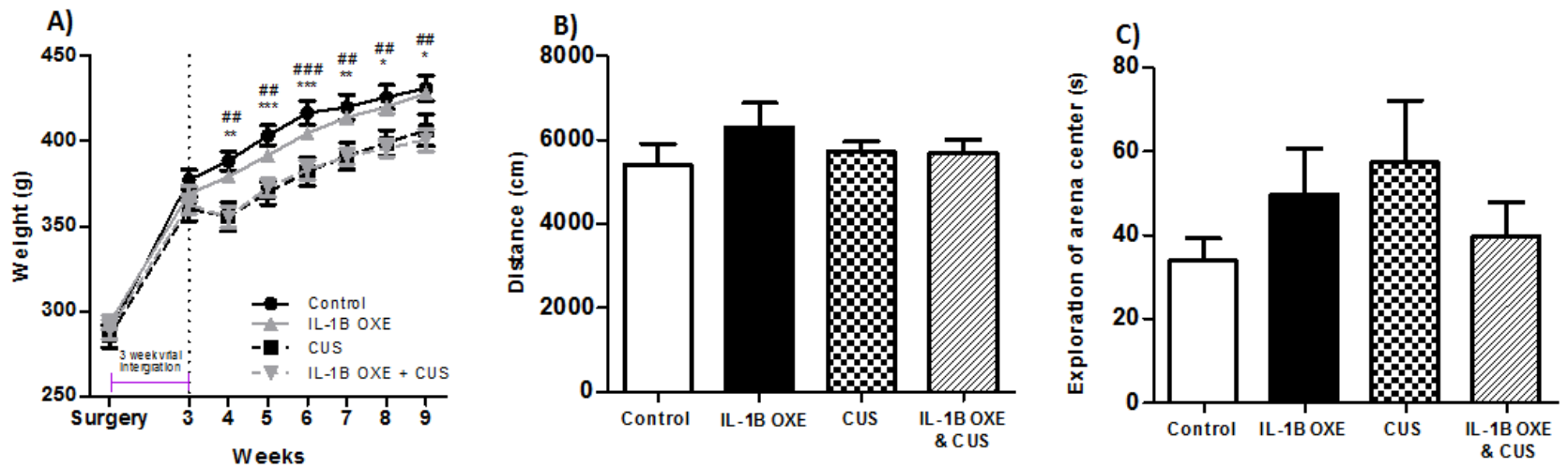

Figure 6.2: Body weight, locomotor activity and anxiety-like behaviour. Body weight (A). Distance travelled in the open field (B). Time spent exploring the center of the open field (C). Line graph and bar graphs indicates average values for $n = 10$. Two-way ANOVA with pairwise comparison $*p < 0.05$; $**p < 0.01$, $***p < 0.001$, control & CUS compared to control; $\#p < 0.05$; $\#\#p < 0.01$, $\#\#\#p < 0.001$, IL-1 β & CUS compared to control. Data presented as means \pm SEM.

6.4.4 CUS alone impaired spontaneous alternation in the Y maze

The results indicated that there was a significant main effect of CUS [$F(1, 34) = 6.08$, $p < 0.05$], and IL-1 β [$F(1, 34) = 7.11$, $p < 0.05$] on spontaneous alternation in the Y maze, with animal exposed to CUS only animals exhibiting impaired spontaneous alternation ($p < 0.05$) Bonferroni posthoc comparison. There was also a non-significant trend for an interaction between CUS and IL-1 β on spontaneous alternation ($[F(1, 34) = 3.17$, $p = 0.08]$; Figure 6.3B).

6.4.5 CUS, but not IL-1 β nor the combination of CUS IL-1 β affected contextual fear conditioning

There was a non-significant trend of CUS on contextual fear recall, [$F(1, 36) = 3.40$, $p = 0.07$]. However, there was no main effect of IL-1 β ($[F(1, 36) = 0.45$, $p > 0.05]$; Figure 3C). In addition, the results indicated that there was no main effect of CUS [$F(1, 36) = 1.07$, $p > 0.05$] or IL-1 β [$F(1, 36) = 0.71$, $p > 0.05$] on cued fear conditioning (Figure 6.3D).

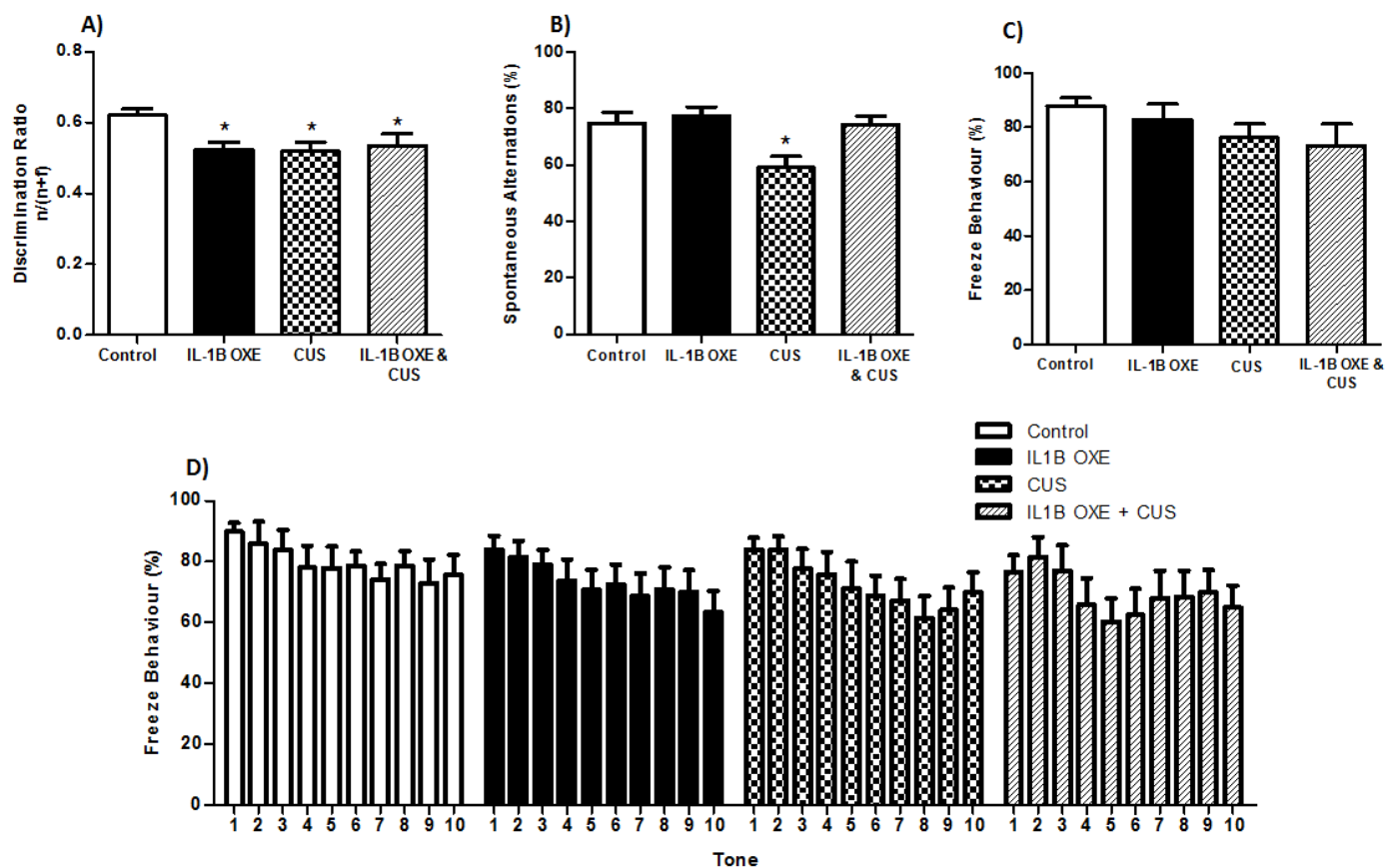

Figure 6.3: Chronic stress and IL-1 β effects on hippocampal-dependent and independent cognition. Novel object recognition (A). Spontaneous alternation (B). Contextual fear recall (C) Cued fear recall (D). Bar graphs indicates average values for $n = 10$, (A) Student's t test $*p < 0.05$, compared to control. (B, C and D) Two-way ANOVA with pairwise comparison $*p < 0.05$ compared to control. Data presented as means \pm SEM.

6.4.6 CUS, IL-1 β and their combination increased depressive-like behaviour

The results indicated that there was a non-significant main effect of IL-1 β [F (1, 36) = 3.97, $p = 0.054$] and CUS [F (1, 36) = 3.33, $p = 0.07$] on the latency to immobility. There was also a significant interaction between IL-1 β and CUS on the latency to immobility [F (1, 36) = 5.4, $p < 0.05$]. When t-tests between control and IL-1 β and CUS animals in latency to first immobile event were performed, there was a significant decrease in latency to first immobile by animals treated with IL-1 β [t (18) = 2.57, $p < 0.05$] or exposed to CUS [t (18) = 2.35, $p < 0.05$], or the combined CUS and IL-1 β -treated animals ([t (18) = 2.14, $p < 0.05$] Figure 6.4A). However, there was no main effect of IL-1 β [F (1, 36) = 0.79, $p > 0.05$] or CUS [F (1, 36) = 2.57, $p > 0.05$] on the amount of immobility, nor was there an effect of IL-1 β [F (1, 36) = 0.06, $p > 0.05$] or CUS [F (1, 36) = 2.73, $p > 0.05$] on climbing or swimming behaviour in the forced swim test [F (1, 36) = 1.83, $p > 0.05$], [F (1, 36) = 0.64, $p > 0.05$], IL-1 β and CUS respectively (Figure 6.4B). There was no main effect of IL-1 β [F (1, 35) = 0.53, $p > 0.05$] or CUS [F (1, 35) = 2.62, $p > 0.05$] on plasma corticosterone response following the forced swim stress (Figure 6.4C).

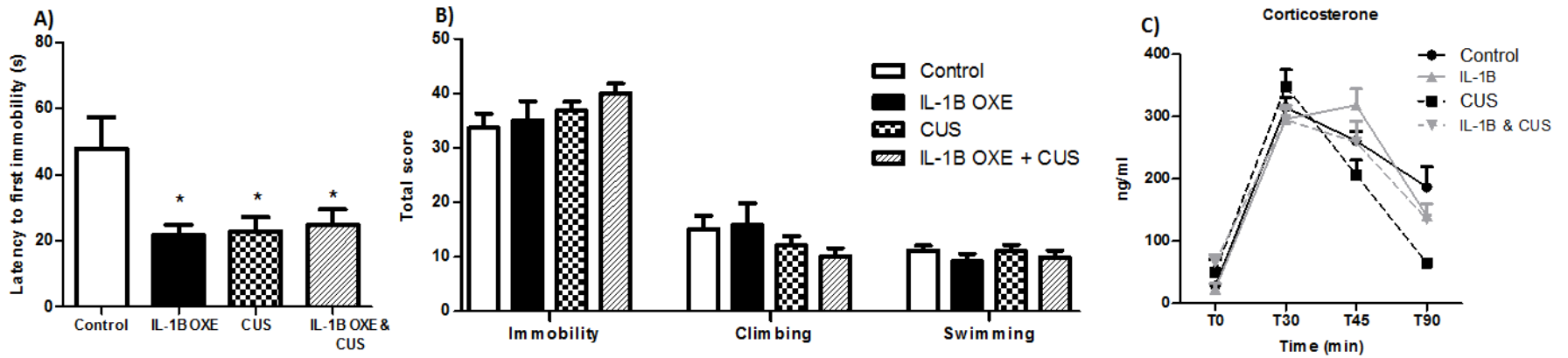

Figure 6.4: Chronic stress and IL-1 β effects on depressive-like behaviours and corticosterone response to swim stress. Latency to first immobile phase (A). Forced swim test behaviours, immobility, climbing and swimming (B). Corticosterone response to swim stress (C). Bar graphs and line graph indicates average values for $n = 10$, * $p < 0.05$, Student's t test compared to control. Data presented as means \pm SEM.

6.5 Discussion

This study investigated the effects of exposure to chronic IL-1 β in the dorsal hippocampus, CUS or a combination of both IL-1 β and CUS on a battery of behavioural tasks. The data showed that exposure to chronically elevated IL-1 β or CUS affected hippocampal associated cognition, but for the most part, rats exposed to a combination of both chronic IL-1 β and CUS did not display an exaggerated behavioural phenotype.

Novel object recognition, a hippocampal-perirhinal cortex-dependent behaviour, was impaired in rats exposed to chronically elevated IL-1 β . It is important to note that we previously reported that overexpression of IL-1 β in the dorsal hippocampus did not affect object memory (O'Leary et al., unpublished; Chapter 5). It is possible that this difference is due to the duration of viral integration. In the previous chapter (Chapter 5), object recognition testing commenced four weeks after of administration of the lentivirus. This increased interval might have resulted in comparatively higher levels of IL-1 β expression, thus resulting in increased disruption of hippocampal dependent processes. However, this hypothesis has yet to be directly tested. Exposure to CUS and chronic IL-1 β combined with CUS were also impaired in object recognition. Previous studies have reported contradictory findings of chronic stress effects on object recognition, with some studies demonstrating impaired object memory following three weeks of chronic restraint stress, an alternative stress protocol to CUS where animals are repeatedly physically restrained, in rats (Luine, 2002, Bowman et al., 2003), and others reporting no effect in object memory following four weeks of chronic restraint

stress in rats (Bowman et al., 2003, Bowman et al., 2006). The differences in findings may be due to differences in the methods used to assess object memory. Specifically, differences in the inter-trial interval between the sample and test phase have been shown to differentially recruit the hippocampus or perirhinal cortex during object recognition (Cohen and Stackman, 2015, Hammond et al., 2004). Thus, as chronic stress has a profound effect on the hippocampus, studies in which the inter-trial interval lasts several hours, where object recall is dependent upon the hippocampus is sensitive to stress induced-disruption. Likewise, studies with a longer inter-trial interval, lasting less than an hour, where object recall is dependent upon the perirhinal cortex, recognition performance is unaffected to stress-induced hippocampal disruption. Indeed, Bowman et al. (2003) reported that three weeks of chronic restraint stress in rats did not impair object memory following either a 10 minute or 1 hour inter-trial interval, but did observe an impairment following a 4 hour inter-trial interval (similar to our protocol of a 3 hour inter-trial interval). Taken together, these findings suggest that the level of hippocampal involvement in object recognition memory may mediate the impact of stress and inflammation induced disruption in cognition.

Spontaneous alternation in the Y-maze, a hippocampal-dependent spatial working memory task was impaired in rats exposed to CUS. Previous work has shown that three weeks of chronic restraint stress impaired spatial working memory in the Y-maze in Sprague Dawley rats (Conrad et al., 1996, Wright and Conrad, 2005). However, it has also been reported, that CUS did not alter spontaneous alternation in the Y-maze in mice (Pothion et al., 2004). In contrast, to the effects of CUS, IL-1 β had no effect on

spontaneous alternation. Likewise, the combination of CUS and IL-1 β did not affect performance in the Y-maze. This is in contrast to previous studies that have shown performance in the radial arm maze, a measure of spatial working memory, to be impaired following acute intra-hippocampal administration of IL-1 β recombinant protein (100ng) in Wistar rats (Matsumoto et al., 2004). It is possible that the difference in findings may stem from the method used to assess spatial working memory. In the present study, spatial working memory was measured by spontaneous alternation in the y-maze, a task which relies on the natural tendency of rodents to alternate in the exploration of non-reinforced maze arms (Hughes, 2004). The radial arm maze is a paradigm which employs greater training and motivation to seek out a food reward and therefore might be more sensitive to hippocampal disruptions.

In the assessment of contextual fear recall, a hippocampal-dependent process, rats exposed to CUS displayed a non-significant trend towards impaired recall. There are conflicting reports on the effects of chronic stress on contextual fear recall in rats. Previous studies have shown that three weeks of chronic restraint stress enhanced contextual fear recall in rats (Conrad et al., 1999, Sandi et al., 2001), while other have shown that similar stress regimes (three weeks of chronic restraint stress) resulted in an impairment of contextual fear recall in rats (Baran et al., 2009). Thus further studies examining the effects of stress-induced changes in contextual fear conditioning are required. Furthermore, we did not observe impairments in contextual fear conditioning following IL-1 β overexpression or the combination of CUS and IL-1 β . In contrast, Hein et al. (2010) similarly reported impaired contextual fear conditioning following

two weeks of IL-1 β overexpression in the hippocampus in transgenic mice (Hein et al., 2010). In this mouse model, mice carry a dormant human IL-1 β excisional activation transgene, when activated by a Cre-expressing virus, astrocytes local to the injection site express human IL-1 β , which in turn binds to the murine IL-1 β receptor (Hein et al., 2010, Shaftel et al., 2007). In contrast the in the present study, IL-1 β is overexpressed using a lentivirus overexpressing mouse IL-1 β tagged with mCherry, with behavioural testing commencing 6 weeks following. In addition, other studies have investigating the impact of acute IL-1 β exposure on contextual fear conditioning. Acute intra-hippocampal administration of IL-1 β (5ng/0.25 μ l) has been shown to impair contextual fear recall in Wistar rats (Gonzalez et al., 2009). Differences between our findings and those of previous studies may be related to the intensity of the foot shock administered. Indeed, studies by Baran et al. (2009) and Gonzalez et al. (2009) reported an impairment in context fear recall employed a foot shock of 0.4 mA and 0.5 mA respectively, whereas in the present study a foot shock of 0.8 mA was employed. Thus the severity of the foot shock and therefore salience of the fear memory, may have confounded task performance, causing a ceiling effect and an inability to detect subtle changes in contextual fear learning. Cued fear conditioning, an amygdala-dependent cognitive processes was unaffected by IL-1 β . These findings are in line with previous studies that have shown that cued fear recall was unaffected following two weeks of overexpression of IL-1 β in transgenic mice (Hein et al., 2010). Likewise, exposure to CUS did not affect cued fear recall. Previous studies by (Baran et al., 2009) demonstrated that chronic restraint stress did not affect cued fear recall in male Sprague Dawley rats (Baran et al., 2009). Likewise, there was no effect of IL-1 β or a

combination of CUS and CUS IL-1 β on cued fear conditioning. Taken together these data suggest that IL-1 β overexpression in the dorsal hippocampus and CUS selectively impair certain types of hippocampal-dependent tasks, while amygdala-dependent cognitive processes, such as cued fear conditioning were unaffected.

Since CUS is commonly used to induce depressive-like phenotype, we also examined the impact of CUS and IL-1 β on depressive-like behaviours in the forced swim test. The results indicated that rats exposed to CUS displayed an increase in depressive-like behaviour in the forced swim test, as measured by a reduced latency to immobility. These results are in line with previous findings that demonstrated that four weeks (Dalla et al., 2005) and nine weeks of CUS in rats (Dalla et al., 2002, Dalla et al., 2011) and two weeks of restraint stress in mice (Norman et al., 2010) increased depressive-like behaviours, such as increase immobility and decreased time spent swimming, in the forced swim test in mice. Similarly, other stressors such as restraint stress and acute foot shock have also been shown to increase immobility in the forced swim test (Weiss et al., 1981, Zebrowska-Lupina et al., 1990), as well as social defeat in mice (Hebert et al., 1998). Likewise, we observed that chronic IL-1 β and a combination of CUS and IL-1 β reduced the latency to immobility. Previous studies have shown that intraperitoneal administration of recombinant mouse IL-1 β (1 and 5 μ g) increased depressive-like behaviour in the forced swim test, as indicated by an increase in immobility (Dunn and Swiergiel, 2005). Taken together these data suggest that both chronic stress and overexpression of IL-1 β in the dorsal hippocampus affect depressive-like behaviour. However, despite a reduction in the latency to immobility,

we did not observe an effect of CUS or IL-1 β on the amount of immobility, swimming or climbing behaviour. This finding suggests that the observed increase in depressive-like behaviour in the present study was subtle. Indeed, this notion of a subtle depressive behavioural phenotype is supported by the lack of a robust effect in corticosterone response following the forced swim test. We report that exposure to CUS did not alter plasma corticosterone levels following the forced swim test. In fact, exposure to CUS appeared to attenuate the corticosterone levels. This is in contrast to previous work that has shown that four weeks of CUS in rats (Dalla et al., 2005) and two weeks of restraint stress in mice (Norman et al., 2010) increased corticosterone following the forced swim test.

Taken together, these data suggest that exposure to IL-1 β or CUS affected certain types of learning and memory, such as object memory and spontaneous alternation in the Y-maze as well as increasing depressive-like behaviours, although these effects were subtle. Interestingly, exposure to a combination of CUS and IL-1 β overexpression did not result in an exacerbated behavioural phenotype. However, as the present study reported limited effects in depressive-like behaviours, coupled with a lack of HPA activation, as indicated by an unaltered corticosterone response following the forced swim test, caution is needed in extrapolating findings. Thus, further work is needed to explore the impact of a combined treatment of CUS and IL-1 β on the brain and behaviour.

CHAPTER 7

General Discussion

7.1 Overview and summary

The mammalian brain continues to develop after birth, throughout childhood and into adulthood (Sisk and Foster, 2004, Spear, 2004). The adolescent period is a critical developmental window when crucial neural circuits are established via a period of synaptic re-modelling (Andersen, 2003, Blakemore and Choudhury, 2006). Indeed, levels of hippocampal neurogenesis and integration of new neurons within the DG are significantly increased during adolescence than during adulthood (Curlik et al., 2014, He and Crews, 2007). It is well established that adult hippocampal neurogenesis can be modulated by a number of intrinsic and extrinsic factors, such as intracellular signalling molecules, exercise, inflammation and stress (Hueston et al., 2017, O'Léime et al., 2017). Deciphering how changes to the central nervous system at this time affects structure, function and behavioural outputs is important to better understand any long-lasting effects. To advance our understanding of such mechanisms this thesis is focused on three topics of investigation.

The first examined the regulation of behaviour by the nuclear receptor Tlx in $Nr2e1^{-/-}$ mice, which was examined in Chapter 2 and summarized in Table 7.1. This was achieved through examining the involvement of Tlx in motor, cognitive and anxiety-related behaviour during adolescence and adulthood in both male and female mice. The findings presented in Chapter 2 demonstrated that the deletion of Tlx induced

hyperactivity as well as impairments in contextual and cued fear conditioning as well as anxiety-related behaviour (Table 7.1). These changes in behaviour occurred independent of sex or housing conditions, with the greatest impact occurring during adolescence.

The second topic of this thesis reported on the effects of adolescent-initiated exercise on pattern separation and contextual and cued fear conditioning and the potential role of plasticity to mediate these behavioural changes (Chapters 3 and 4 and Appendix C; summarized in Table 7.1). Adult-initiated exercise enhanced both contextual and cued fear conditioning, while conversely, exercise that began in adolescence did not affect performance in these tasks and these different effects were accompanied by differential expression of plasticity-related genes in the amygdala and the hippocampus in adulthood. Furthermore, it was demonstrated that adolescent-initiated exercise had a subtle effect on pattern separation, in a touchscreen location task, when assessed in adulthood, whereas both adult and adolescent-initiated exercise enhanced reversal learning in a touchscreen location task. Moreover, both adult and adolescent-initiated exercise increased the dendritic complexity of new born neurons in the DG, but, only adolescent-initiated exercise increased the number of these immature neurons (Table 7.1).

The third area of study explored the effects of chronic IL-1 β in the dorsal hippocampus on pattern separation and hippocampal neurogenesis (Chapter 5; summarized in Table

7.1). It was shown that pattern separation was impaired in chronic IL-1 β -treated rats in both object-location and touchscreen operant paradigms (Table 7.1). On the other hand, tasks involving the hippocampus, but not sensitive to disruption of hippocampal neurogenesis including spontaneous alternation, novel object and location recognition as well as visual discrimination were unaffected. Additionally, assessment of chronic IL-1 β in the hippocampus followed by exposure to chronic unpredictable stress on memory and depressive-like behaviour (Chapter 6; summarized in Table 7.1) revealed that this combination of chronic insults impaired learning and memory and increased depressive-like behaviour (Table 7.1).

In summary, the disruption of intrinsic regulators of hippocampal neurogenesis, such as Tlx and IL-1 β or the exposure to extrinsic factors such as exercise or stress which are known to impact upon cognitive function through neurogenic mechanisms, may provide insight into why adolescence is a critical period for conditioning of hippocampal function in later life.

Table 7.1: Summary of findings.

Regulation of behaviour by Tlx	Finding	Method	Brain region
Hyperactivity	↑	Open field	Cortical striatal
Anxiety-like behaviour	↓	Open field	Amygdala
Context recall	↓	Fear conditioning	Dorsal hippocampal
Cued recall	↓	Fear conditioning	Amygdala/ventral hippocampus
Motor performance	↓	Rotarod	Cortical striatal
Adult exercise			
Context recall	↑	Fear conditioning	Dorsal hippocampal
Cued recall	↑	Fear conditioning	Amygdala/ventral hippocampus
Cognitive flexibility	↑	Touchscreen reversal learning	Prefrontal cortex, hippocampus
Hippocampal plasticity (mRNA)	Unchanged	qPCR	Hippocampus
Hippocampal plasticity (Neurogenesis)	Unchanged	Histology	Dentate gyrus
Hippocampal plasticity (morphology)	↑	Dendritic complexity of DCX-positive cells	Dentate gyrus
Adolescent exercise			
Context recall	Unchanged	Fear conditioning	Dorsal hippocampal
Cued recall	Unchanged	Fear conditioning	Amygdala/ventral hippocampus
Cognitive flexibility	↑	Touchscreen reversal learning	Prefrontal cortex, hippocampus
Hippocampal plasticity (mRNA)	↑	qPCR	Hippocampus
Hippocampal plasticity (Neurogenesis)	↑	Histology	Dentate gyrus
Hippocampal plasticity (morphology)	↑	Dendritic complexity of DCX-positive cells	Dentate gyrus
IL-1β and memory			
Pattern separation	↓	Touchscreen location discrimination	Dentate gyrus, hippocampal neurogenesis
Hippocampal plasticity (morphology)	↓	Dendritic complexity of DCX-positive cells	Dentate gyrus
Stress and IL-1β			
Depressive-like behaviour	↑	Forced swim test	Amygdala, Hippocampus, prefrontal cortex
Object memory	↓	Object recognition	perirhinal cortex, hippocampus
Context recall	Unchanged	Fear conditioning	Dorsal hippocampal
Cued recall	Unchanged	Fear conditioning	Amygdala/ventral hippocampus

7.2 Limitations of knockout models of Tlx

There has been extensive work characterizing the impact of early life deletion of Tlx on behaviour (Young et al., 2002, Roy et al., 2002, O'Leary et al., 2016a, O'Leary et al., 2016b). However, a limitation with a spontaneous deletion model of Tlx is the need to single house the *Nr2e1*^{-/-} male mice, given their severe aggression (Young et al., 2002). Indeed, single housing of rodents has been shown to impair learning and memory (Voikar et al., 2005). Therefore, in the studies reported here (Chapter 2), it was not possible to delineate whether the sex-dependent effects on contextual and cued fear conditioning are due to Tlx deletion or housing conditions *per se*. Future studies should include a single housed female *Nr2e1*^{-/-} cohort in order to avoid this confounding impact of housing on behaviour. Furthermore, future studies should also consider employing alternative approaches to Tlx disruption, such as a viral vector-mediated gene knockdown. Viral vector-mediated gene disruption would overcome some of the limitations of a spontaneous deletion of Tlx. Viral vectors can cross the cellular membrane unimpeded, infect post-mitotic cells and can transfer genetic material into target cells (Deglon and Hantraye, 2005). The implementation of a lentiviral approach would enable disruption of Tlx during adolescence without disruption of early life developmental processes, such as in the case of the spontaneous deletion model used in Chapter 2. It would also ensure that disruption of Tlx is localized to the hippocampal neurogenic niche. This would help to further elucidate the role of Tlx during critical development periods, thus representing an advantageous approach promising for future research into the role of Tlx in brain and behaviour. Indeed, a conditional overexpression of Tlx model using lentiviral mediated technology has been developed.

It was shown that overexpression of Tlx leads to an increase in adult hippocampal neurogenesis and performance within the Morris water maze as well as rescuing Tlx-deficits of knockout mice (Murai et al., 2014). Future studies could also investigate the role of Tlx during early life by conditional disruption during adolescent versus adulthood. Conditional disruption of Tlx in adulthood would enable unimpeded neurodevelopment during early life, and in turn could help overcome the limitations of the spontaneous deletion model. For example, a floxed deletion model by Cre-Lox recombination has been developed (Zhang et al., 2008b) and enabled the conditional disruption of Tlx. This spared developmental processes that are affected by other early life deletion models like the spontaneous deletion.

Finally, the newly developed clustered, regularly interspaced, short palindromic repeat (CRISPR) technology has become a widely adopted method for developing genetic knockout models (Cong et al., 2013). CRISPR overcomes many of the caveats associated with the current genetic models such as enhanced gene targeting, reduction in the number of animals needed to generate and maintain a genetic line as well as the ability to edit multiple genes within a single animal. This gives CRISPR the potential to become the standard approach in the generation of genetic models and genome editing experimentation. The utilization of CRISPR can be expected to dominate future studies investigating the regulation of behaviour of genes like Tlx.

7.3 Adolescence as a critical period?

Adolescence has been shown to be a critical period for postnatal brain maturation and thus a time when environmental influences may affect important cognitive processes in later life (Fuhrmann et al., 2015). It was shown that exercise during adulthood increased hippocampal plasticity and enhance hippocampal-dependent cognition, whereas adolescent-initiated exercise did not affect hippocampal-dependent behaviour. It is possible, that the adolescent period is a critical period to disrupting brain maturation leading to impairments in cognitive processes, such as learning and memory, similar to what was observed in the Tlx deletion models (Fuhrmann et al., 2015, Andersen, 2003). It may however not be a sensitive period for enhancement of cognitive processes involving the hippocampus, such as pattern separation and contextual fear conditioning. Given that the DG undergoes substantial structural remodeling during adolescence, with increases in dendritic complexity, cell proliferation and survival, further increases in this neural plasticity may not convey any functional advantages (i.e. improved performance in behavioural tasks) (Koshibu et al., 2004, Lenroot and Giedd, 2006, Curlik et al., 2014). Indeed, here it was shown that exercise beginning in adolescence did not improve contextual fear conditioning or pattern separation in the touchscreen operant chamber, despite increases in hippocampal plasticity. Thus, it is possible that as the baseline level of hippocampal plasticity is already substantially elevated and that a ceiling-effect prevents any further improvement by environmental, pharmacological or genetic factors. This could be assessed experimentally by investigating the impact of similar amounts of exercise in the aged animal. It has previously been shown that hippocampal plasticity reduces with

age. Specifically, decreases in neurogenesis, dendritic complexity and synaptic dendritic complexity in the aged hippocampus have been widely reported (Bartsch and Wulff, 2015). Therefore, in this “aged” state, extrinsic factors such as exercise may more readily improve cognitive performance, compared to a younger more plastic brain. It is important to note the differences in connectivity of the dorsal and ventral hippocampus with cortical and subcortical structures along the dorsoventral axis of the hippocampus, which suggests a functional separation. However, the analysis of mRNA plasticity markers in chapter 3 was conducted on the total hippocampal tissue i.e. both dorsal and ventral hippocampus. Similarly, the number of DCX-positive neurons and their dendritic complexity analyzed in chapter 4 was assessed in the total hippocampus. Therefore, it is not possible to fully delineate the potential differential effects of extrinsic factors such as exercise beginning in adulthood or earlier in life on dorsal or ventral regions of the hippocampus.

Other brain regions, such as the prefrontal cortex, also undergo significant maturation during early life, particularly in adolescence, and maturation continues during early adulthood. Increases in dendritic arborization, synaptic pruning and myelination have been widely observed (Spear, 2013, Casey et al., 2008b, Giedd et al., 1999, Blakemore and Choudhury, 2006). These developmental processes allow for the strengthening and fine tuning of connections between the prefrontal cortex and subcortical regions, and are thought to underlie the emergence of cognitive functions which typically develop in adolescence, such as response inhibition and cognitive flexibility (Selemon, 2013, Spear, 2013). In Chapters 3 and 4 exercise was initiated during the adolescent

period, thus it is possible that exercise may have also induced changes within the prefrontal cortex. Indeed, reversal learning, a prefrontal cortex mediated task was increased following adolescent exercise (Table 7.1). However, prefrontal cortex pathology was not investigated. Exercise-induced changes in prefrontal cortex maturation may have a profound effect on cognition in adulthood, compared to exercise-induced changes in the hippocampus (which was examined in Chapter 3 and 4). Thus the developing prefrontal cortex may be more susceptible to extrinsic factors, such as exercise. Indeed, early life experience has been shown to shape the development of the prefrontal cortex (Kolb et al., 2012). Thus future work could investigate the potential impact of early exercise on the prefrontal cortex and its associated cognitive function. Specifically, further work is needed to investigate the impact of adolescent-initiated exercise on cognitive flexibility and dendritic complexity in the prefrontal cortex following exercise beginning in adolescence.

Other extrinsic factors such as diet have also been shown to impact brain maturation (Hueston et al., 2017). Diet is one of the most easily modifiable lifestyle factors that is known to alter cognitive and behavioural performance, including neurogenesis (Stangl and Thuret, 2009, Murphy et al., 2014). Indeed, evidence now points to the importance of adolescent diet for general well-being, including brain health (O'Connor and Cryan, 2014). Changes in the human diet over the past 50 years have been suggested to be putting the adolescent brain in a more vulnerable state. 'Western' diets high in processed foods, fats and sugars result in many problems including obesity, diabetes and cognitive and emotional disorders (Kanoski and Davidson, 2011). Furthermore, diet composition has been shown to influence the gut microbiome (Singh et al., 2017).

Indeed, there is a growing appreciation for the importance of bacteria in shaping brain development and behaviour (Cryan and Dinan, 2012, Grenham et al., 2011). Disruption of the gut-microbiota during early life negatively affects cognition in adulthood (Dinan et al., 2018). In particular, it has been shown that disruption of the gut-microbiota during adolescence impaired object recognition and increased anxiety-like behaviour in adult mice (Desbonnet et al., 2015). Future work could investigate the relationship between diet, exercise and the microbiota on brain maturation, particularly during key developmental periods, such as adolescence. This would help to build a clearer picture of the potential beneficial impact of extrinsic factors, such as diet and exercise, on developing structures connected with the hippocampus and perhaps the regulation through the microbiota could enhance our understanding of the adolescent period when behaviour and cognitive processes are shaped for later life.

7.4 Extrinsic and intrinsic regulators of neurogenesis: Neuroinflammatory conditions

The impact of exercise in adulthood on learning and memory examined in Chapter 3 and 4 showed that exercise enhanced hippocampal-dependent cognition. The impact of a lentiviral-mediated chronic IL-1 β in the dorsal hippocampus of adult rats on neurogenesis and its associated function of pattern separation was examined in Chapter 5. It was shown that pattern separation was impaired in IL-1 β treated rats in both object-location and touchscreen operant paradigms. A lentiviral-mediated overexpression of IL-1 β is a useful technique to produce long-term changes in gene

expression, however it is not possible to directly compare the specific dose of IL-1 β relative to previous studies that administered intra-hippocampal IL-1 β protein. Future work could overcome this limitation by directly comparing hippocampal IL-1 β protein levels following lentiviral-mediated overexpression with alternative intra-hippocampal and intracerebroventricular administered as well intraperitoneal administered of LPS, a common methodology used to incite inflammation in the brain. This would enable a comparative measure between different techniques helping to harmonize the field of IL-1 β -induced behavioural changes. More work could also be expanded to examine the impact of chronic IL-1 β on neuronal morphology of immature neurons, such as the dendritic complexity and the potential of other extrinsic and intrinsic factors on IL-1 β -induced impairments in the morphology of new neurons. Here it was shown that exercise enhanced the complexity of neurites on new neurons in the DG (Chapter 4). While, conversely chronic IL-1 β impaired neurite length of DCX-positive neurons (Chapter 5). These two lines of enquiry could be combined to investigate the potential of exercise to recover IL-1 β -induced impairment in hippocampal plasticity and cognitive processes, such as learning and memory. Indeed, previous work has suggested that exercise may protect against the cognitive decline associated with ageing and neurodegenerative disorders (Ryan and Kelly, 2016, Ryan and Nolan, 2016a, Brown et al., 2013).

One potential therapeutic target in mediating the effects of IL-1 β -induced impairment in cognitive processes is Tlx. Tlx has been shown to mediate the effects of IL-1 β -induced reduction in cell proliferation (Ryan et al., 2013, Green and Nolan, 2012a,

Green and Nolan, 2012b). Acute exposure of IL-1 β protein has also been demonstrated to reduced Tlx expression and impair cell proliferation *in vitro* (Ryan et al., 2013). Moreover, increases in Tlx expression has been shown to protect against the negative effects of IL-1 β on hippocampal NPCs (Ó'Léime et al., 2017). However, it is unknown whether an enhancement in Tlx signalling is able to protect against the negative neurogenic effects of IL-1 β on cognitive processes, such as pattern separation. In Chapter 2 the role of Tlx in cognitive and anxiety like behaviour was investigated. This work could also be expanded and combined with the IL-1 β overexpression studies in Chapter 5 in order to investigate the ability to Tlx to rescue IL-1 β induced behavioural deficits *in vivo*. Thus, future experiments could examine the involvement of Tlx in IL-1 β -induced changes in adult hippocampal neurogenesis, which may help to identify a mechanistic insight into disorders in which neuroinflammation causes alterations in neurogenesis. Furthermore, given the propensity of stress (both acute and chronic) to elevate hippocampal IL-1 β protein, Tlx-IL-1 β signalling may also yield valuable insight into a mechanism by which stress affects memory. Finally, the impact of chronic IL-1 β in the hippocampus during key developmental periods, such as adolescence is an avenue for future research.

7.5 Behavioural models of pattern separation: Where are we going?

In recent years, novel cognitive tests have been developed to tease apart the relationship between hippocampal neurogenesis and cognition (Bekinschtein et al., 2013a, Oomen et al., 2013, Sahay et al., 2011b, Tronel et al., 2012). In particular, pattern separation has become a common behavioural paradigm in assessing functional changes in adult hippocampal neurogenesis. As discussed earlier, several behavioural models have been developed to examine pattern separation. These include; fear conditioning paradigms, object-location recognition and radial arm maze based tasks as well as touchscreen-operant based tests. The latter allows for increased translation with human neuropsychological assessments as well as the testing of multiple types of cognitive tasks utilizing the same behavioural platform (Oomen et al., 2013, Horner et al., 2013, Bekinschtein et al., 2013a, McHugh et al., 2007). However, a limitation of these approaches is the need for extensive training of experimental animals and often require food restriction. Indeed, food restriction has been shown to alter hippocampal neurogenesis (Kitamura et al., 2006, Lee et al., 2002a, Lee et al., 2000, Lee et al., 2002b), which may confound such task performance. Furthermore, the extended training may also impact upon learning paradigms as experimental animals undergo extensive training prior to cognitive testing and the impact of prolonged instrumental training on hippocampal neurogenesis has not be fully explored. In addition, this prolonged training also limits the examination of behaviour during earlier developmental periods, such as adolescence. These limitations could be overcome by

the development of a one-trial pattern separation task. The underlying concept of pattern separation is to present an animal with two similar but distinct stimuli that the animal must discriminate or “separate” in order to exhibit the correct behavioural response. Therefore, a one-trial cued fear conditioning task could be developed, whereby a high pitch tone is paired with a foot shock, thus when the animal is exposed to a novel context, varying the frequency of the conditioned tone to be either similar (high pitch) or different (low pitch) to the original conditioned stimulus. Additional experiments could be devised in order to test this hypothesis.

7.6 Recommendations for future work

7.6.1 Regulation of behaviour by Tlx

The work in Chapter 2 demonstrated a role of Tlx to regulate motor, cognitive and anxiety-related behaviour. In order to advance our understanding of the role of Tlx in behaviour, new experiments are needed to determine if social isolation is inhibitory to the effects of a spontaneous deletion of Tlx on cognitive processes. This could be achieved by studies employing both male and female single-house Nr2e1^{-/-} and wildtype control mice and assessing a series of behaviour, such as those reported in Chapter 2. In addition, investigations are needed into the impact of a lentiviral-mediated knockdown of Tlx in the DG of rats during the adolescent period and the subsequent performance on neurogenesis associated cognition, such as pattern separation. Finally, the potential of exercise to protect against lentiviral-mediated knockdown of Tlx-induced impairment in cognition could be explored in rats. These

experiments will help gain insight into the mechanisms of by which behaviour in adulthood is shaped by experiences in adolescence.

7.6.2 Exercise during adolescence

The work in Chapters 3 and 4 investigated the impact of exercise beginning earlier in life, when the brain is still undergoing maturation and high levels of plasticity are maintained. It was shown that exercise initiated in adolescence enhanced hippocampal plasticity, however this effect did not translate into improved learning and memory in later life. Further work is needed to fully elucidate the impact of exercise during key developmental periods, such as adolescence on brain maturation of behaviour. New experiments could investigate the impact of shorter periods of exercise, such as one week, during adolescence and test cognition later in life. Additionally, the impact of adolescent exercise on the neuronal morphology could be expanded to include other brain regions. Specifically, exercise-induced changes in the morphology of pyramidal neurons in the prefrontal cortex and basolateral amygdala in adulthood could be examined.

7.6.3 IL-1 β and memory

Understanding the mechanisms by which IL-1 β disrupts cognition is vital in the development of therapeutics for the treatment of inflammatory-related disorders, such as Alzheimer's and Parkinson's disease. The work in Chapter 5 examined the impact of chronic IL-1 β in the dorsal hippocampus on learning and memory. The findings showed that pattern separation and hippocampal neurogenesis were impaired following

lentiviral-mediated overexpression of IL-1 β in the dorsal hippocampus. Given the functional separation along the septo-temporal axis of the hippocampus, one potential avenue for future experiments is to compare the effects of chronically elevated IL-1 β in the dorsal and ventral hippocampus on the neuronal morphology of new born neurons in both the dorsal and ventral hippocampus. These studies will help build an understanding of the mechanism by which exposure to IL-1 β impairs learning and memory.

7.7 Concluding remarks

In conclusion, the work presented here demonstrated a role of both intrinsic and extrinsic regulators of hippocampal neurogenesis during adolescence and adulthood on cognition and plasticity. Furthermore, it was shown that chronically elevated IL-1 β within the hippocampus, a major mediator of neuroinflammation, leads to disruption of adult neurogenesis through which may contribute to the cognitive decline associated with inflammation and neurodegenerative disorders. Future research into the mechanisms underlying the susceptibility of the adolescent hippocampus to disruption of intrinsic regulators neurogenesis, such as Tlx, or exposure to extrinsic factors, such as exercise or adverse stimuli, like stress and inflammation, and the consequent effect on cognition may provide insight into why adolescence may be a vital period for correct conditioning of future hippocampal function.

APPENDIX A

A Low-cost Touchscreen Operant Chamber Using a Raspberry Pi™

This work has been published

[O'Leary J.D.](#), O'Leary O.F., Cryan J.F. & Nolan Y.M. (2018). A low-cost touchscreen operant chamber using a raspberry pi microcomputer. Behavioural Research Methods (doi: 10.3758/s13428-018-1030-y).

A.1 Abstract

The development of a touchscreen platform for rodent testing has allowed the advancement of new methods for cognitive testing that have been back translated from clinical assessment tools to pre-clinical animal models. This platform for cognitive assessment in animals is comparable to human neuropsychological tests such as those employed by the Cambridge Neuropsychological Test Automated Battery and thus has several advantages compared to standard maze apparatuses typically employed in rodent behavioural testing, such as the Morris water maze. These include improved translation of pre-clinical models as well as high-throughput and automation of animal testing. However, these systems are relatively expensive, which can impede progress for researchers with limited resources. Here we describe a low-cost touchscreen operant chamber based on the single board computer, Raspberry Pi™, which is capable of performing similar tasks to that of the current state-of-the-art systems. This system provides an affordable alternative for cognitive testing in a touchscreen operant paradigm for researchers with limited funding.

A.2 Introduction

Operant-based behavioural tasks are standard techniques used in experimental psychology in which a rodent learns to press a lever or turn a wheel to receive an appetitive or aversive response (Crawley, 2007, Skinner, 1938). Standard operant paradigms, such as fixed ratio (where a reward is delivered every n th lever press) or variable ratio (where a reward is delivered after a pseudo-random number of lever presses) have been used to investigate addiction, impulsivity and motivation (Halladay et al., 2017, Salamone and Correa, 2002, Perry et al., 2005). These operant-based tasks have been further developed over the years, particularly with the implementation of a computer touchscreen in place of the levers. Touchscreen operant chambers have been used in a variety of species, such as rodents, (McTighe et al., 2009), birds (Cook, 1992), dogs (Range et al., 2008) as well as reptiles (Mueller-Paul et al., 2014). The development of a touchscreen platform for behavioural testing has allowed the advancement of new methods for cognitive assessment in pre-clinical models (Bartko et al., 2011, Bussey et al., 2012, Horner et al., 2013, Nithianantharajah et al., 2015). These methodologies are comparable to the human neuropsychological tests employed by the Cambridge Neuropsychological Test Automated Battery (CANTAB), such as the Pairwise Associative Learning (PAL) task and Trial Unique Non-matching to Location (TUNL) task (Bartko et al., 2011, Bussey et al., 2012, Kim et al., 2015b, Mar et al., 2013, Nithianantharajah et al., 2015, Talpos et al., 2009). Just as patients in the clinic use an iPad/computer to respond to visual and audio cues during neurocognitive

assessment, rodents can view a computer touchscreen and respond in a similar fashion (nose pokes compared to finger touches) during behavioural testing in an operant chamber. Very often the rodent tasks have similar or identical visual stimuli to those of the stimuli used for testing in the clinic. In this platform the rodent is presented with an image on the computer screen and depending on the task paradigm is trained to respond to either the specific image or location of the image via nose pokes on the touch sensitive computer screen. A correct response elicits a food reward while an incorrect response triggers a timeout. Through repeated trials the rodent's performance can be assessed and the underlying neurobiology required for the task can be studied. Currently, there are several tasks available that assess different aspects of cognitive function and associated neurophysiology, such as Visual discrimination and reversal learning, 5-Choice Serial Reaction Time task and Continuous Performance Test (rCPT), which measure executive function such as, cognitive flexibility, decision making and attention, and have been shown to be sensitive to prefrontal cortex manipulation in rats and mice (Kim et al., 2015a, Mar et al., 2013). In addition, the location discrimination and TUNL tasks, which measure spatial learning have been shown to be dependent on adult hippocampal neurogenesis and an intact hippocampal formation in rats and mice (Oomen et al., 2013, Talpos et al., 2010, Creer et al., 2010, McTighe et al., 2009, Clelland et al., 2009). Similarly, the PAL task has also been shown to be sensitive to glutamatergic inactivation of the hippocampus in rats (Talpos et al., 2009). Furthermore, impaired performance in the PAL task has been shown in patients with schizophrenia (Wood, 2002). In addition, PAL performance has been

identified as a predicative measure of Alzheimer's disease pathology (Swainson et al., 2001).

The touchscreen operant platform for behavioural assessment in animals has several advantages compared to the standard maze apparatus commonly employed in rodent behavioural testing, such as the Morris water maze or radial arm maze. Firstly, it enables the design of tasks that better represent human neuropsychological tests thus it is highly translatable. For example, audio-visual stimuli as well as the task paradigm itself, such as the PAL task, can be set up so that they are identical to those used in tasks for humans (Talpos et al., 2009). Secondly, the touchscreen operant platform can be used to conduct behavioural assessments as part of a test battery. While this is also the case for tasks using standard maze apparatus, like the Morris water maze or radial arm maze, the touchscreen platform enables a consistent environment and behavioural response/reward system, thereby reducing any potential confounds from employing different maze equipment and paradigms. Thirdly, the platform is automated thus a number of chambers can be used simultaneously for behavioural assessments. This increases the throughput of experimental animals as well as reducing the burden of labour on the experimenter. While the touchscreen system has advantages over standard maze paradigms, the current systems can cost upwards of 25,000 EUR for a four-chamber system. This can be prohibitively expensive for researchers with limited resources, such is often the case for early-career scientists or those in the developing world. Thus, due to the relatively low cost of the necessary components, the option to build a touchscreen chamber in-house is an attractive and viable option. Indeed, several groups have already reported on building low cost operant chambers. Steurer et al.

(2012) demonstrated a low-cost touchscreen operant chamber which could be used by a variety of species, such as pigeons, tortoise and dogs. This system was significantly cheaper than commercial alternatives, at approximately 3,000 EUR. Moreover, work by Pineño (2014) further reduced the price point of an in-house system, by building a low cost touchscreen operant chamber using a touch sensitive iPod and an Arduino microcontroller. This group was the first to demonstrate a low-cost touchscreen operant chamber using off the shelf electronics for a fraction of the cost of commercially available alternatives, at only a few hundred euros. Although the system is innovative, it is limited in its ability to facilitate the running of similar tasks to that of the current state-of-the-art systems such as the Bussey-Saksida chambers given the small touchscreen display, although the addition of an iPad with a larger screen may help to overcome this limitation (Pineño, 2014). It is worth pointing out that the original aim of this study was to showcase a proof of concept that off-the-shelf components could be used to build a low-cost alternative and thus lay the foundation for future work. Since then, Devarakonda et al. (2016) built a Rodent Operant Bucket (ROBucket), a standard operant chamber based on the Arduino microcontroller. The system was comprised of two nose poke sensors and a liquid delivery system capable of both fixed ratio and progressive ratio training that can be used to train mice to nose poke a receptacle for a sucrose solution (Devarakonda et al., 2016). Moreover, Rizzi et al. (2016) built a low cost rodent nose-poke chamber using the Arduino microcontroller. Their system was comprised of four nose-poke modules that detected and counted head entries. Rizzi et al. (2016) successfully trained mice to prefer the nose-poke module, which would trigger an optogenetic stimulation of dopaminergic neurons within the

ventral tegmental area. While both Devarakonda et al. (2016) and Rizzi et al. (2016) demonstrate low cost alternatives, these systems are designed as standard operant chambers and therefore do not allow for similar translatable tasks available within a touchscreen operant platform. Here, we build on previous work by Pineño (2014), Devarakonda et al. (2016) and Rizzi et al. (2016) by combining the single board computer Raspberry Pi™ and a 7 inch Raspberry Pi™ touchscreen with an Arduino microcontroller to demonstrate a low cost touchscreen operant chamber capable of performing a number of similar tasks to that of the current state-of-the-art systems, such as auto-shaping animals to nose-poke for a food response, as well as more complex paradigms such as visual discrimination and PAL or TUNL tasks.

The Raspberry Pi™ is a single board computer, roughly the size of a credit card. Despite its size and inexpensive price (approx. €30 EUR) the Pi runs a full computer operating system and is capable of performing the same tasks as those of a typical desktop PC e.g. word processing and web browsing. In addition, the Raspberry Pi™ has several general purpose input output (GPIO) pins. GPIO pins are generic pins on an integrated circuit whose function can be programmed by the user. For example, they can be programmed to receive specific input (i.e. reading a temperature sensor) or deliver a certain output (i.e. moving a servo motor). In addition, the Raspberry Pi™ touchscreen is a fully integrated touch sensitive display that runs natively on the Raspberry Pi™. The combination of a full PC operating system, touch sensitive display, easy hardware integration through the GPIO pins and inexpensive price makes the Raspberry Pi™ a very powerful platform for electronic projects and is therefore an

ideal basis for a touchscreen operant chamber. This paper describes a low-cost touchscreen operant chamber based on the Raspberry Pi™, a single board computer system.

A.3 Methods

A.3.1 Hardware

The main components of the touchscreen operant chamber were a Raspberry Pi 2 (Raspberry Pi foundation, UK), a 7" touchscreen display for the Raspberry Pi (Raspberry Pi foundation, UK) and an Arduino Uno microcontroller (Arduino, Italy) (Figure A1a and b). All components were purchased from Adafruit Industries, USA. The touchscreen display was connected to the Raspberry Pi™ and mounted within a Perspex box (35.6 x 23.4 x 22.8 cm), which was housed within a sound attenuating box (63.5 x 43.2 x 42.2 cm) (Med Associates, USA). On the opposite side of the Perspex box was a food magazine, which was comprised of a food hopper connected to a pellet delivery chute, made from a PVC pipe. A servo motor within the hopper would dispense a 45 mg pellet, which would fall into the delivery chute (PVC pipe) and into the collection receptacle after each correct response (Figure A1a and b). The food hopper was controlled by a servo motor attached to the Raspberry Pi™ (Figure A2). An LED light within the collection receptacle signalled a reward and an infrared (IR) beam detected the collection of the food pellet. The IR beam/sensor was connected to the Arduino Uno, which was in turn connected to the Raspberry Pi™ via USB (Figure A2). A Piezo buzzer within the Perspex box was also used to signal the delivery of the

food pellet and was controlled by the Raspberry Pi™ (Figure A2). For a detailed list of components and associated price at time of publication see Table A1. The commercially available Med Associates touchscreen operant chamber (consisting of a rectangular operant box with grid flooring, overhead light, a touchscreen, and food hopper; Med Associates, USA) was used for comparison.

A.3.2 Software

A program to control the main functionality of the touchscreen chamber was written in Python (version 3.1.1), a high-level programming language utilizing the pygame library (<https://www.pygame.org/news>) that ran on the Raspberry Pi™ (Figure A3). Briefly, the program displayed two images (two white squares) on the screen. Once either image was touched (e.g. nose-poked by the rat), the program moved the attached servo motor, located within the food hopper, which in turn dispensed a food pellet. Simultaneously, a tone was played through a buzzer and an LED light within the food receptacle was turned on to signal reward delivery. An infrared beam (IR) within the food receptacle detected the collection of the food reward. The next trial then began and the same process was repeated. A second program was written in the Arduino sketch, which signaled an IR beam break detection in the food collection receptacle. The code for the Arduino sketch was adapted from Adafruit.com example code (<https://learn.adafruit.com/ir-breakbeam-sensors/overview>). Each correct response was written to a text file and saved to the Raspberry Pi™. These data were used to determine the animal's performance during each session.

A.3.3 Experimental design

Two male Sprague-dawley rats (10 weeks, bred in house) were used to validate the Raspberry Pi™ touchscreen system. An additional group consisting of three male Sprague-Dawley rats (8 weeks) were obtained from Envigo Laboratories (The Netherlands) and trained in the standard Med Associates touchscreen operant chamber for comparison in training performance. Rats were group housed in standard housing conditions (temperature 22°C, relative humidity 50%) on a 12 h light/dark cycle (0730-1930). Water and rat chow were available *ad libitum* prior to food restriction. Rats were food restricted to 90% of free feeding weight so as increase motivation to seek out a food reward within the touchscreen operant paradigm. All experiments were conducted in accordance with the European Directive 2010/63/EU, and under an authorization issued by the Health Products Regulatory Authority Ireland and approved by the Animal Ethics Committee of University College Cork.

A.3.4 Behavioural auto-shaping protocol

Rats were food deprived with body weight maintained at 90% of free feeding weight during operant training so as to increase motivation to seek out a food reward. The auto-shaping protocol was adapted from Horner et al. (2013) and was comprised of 3 stages that served to shape the animals to touch the touchscreen for a food reward. Stage 1 involved habituation to the testing chambers for 30 minutes for 2 consecutive days, with 10 pellets dispensed within the food magazine. Criteria for the animal to progress to the next stage of training was that all pellets were consumed within the 30-minute session. The food magazine light was illuminated during food delivery and was

switched off upon food collection. The house light was off and no images were displayed on the screen. Stage 2 involved associating the displayed image with a food reward. Two images (white squares) were presented simultaneously for 30 seconds in two locations (left and right), separated by 5cm. If no touch occurred after 30 seconds a food pellet was dispensed and the food magazine was illuminated and a tone (1 s, 3 kHz) was sounded. If the image was touched by the animal, a reward (1 x 45mg food pellet) was dispensed immediately and concurrently with the tone (1 s, 3 kHz), and the food magazine light was switched on. Upon reward collection, the magazine light was switched off and an intertrial interval (ITI) began (5 s), following which a new trial began. The session ended after 30 trials or 30 minutes, whichever came first. The criteria for the animals to progress to the next training stage was to complete 30 trials in 30 minutes. Stage 3 involved associating the image touch with a food reward. The protocol was the same as for stage 2 except that the animal must touch the displayed image to receive a reward. The session ended after 100 trials or 60 minutes. The criteria for the animals to complete the final stage of training was to complete 60 trials in 60 minutes for at least two consecutive days.

A.4 Results

A.4.1 Auto-shaping task

A.4.1.1 Stage 1: Habituation

During stage 1, two rats were habituated to the Raspberry Pi™ chamber environment over two days. During these two habituation days, both rats ate the ten food pellets

within the food receptacle and both were therefore advanced to the next stage of training. An additional three rats were similarly habituated to the Med Associates operant chamber. Likewise, the rats ate all ten food pellets within the food receptacle during the two habituation days and were thus advanced to the next stage of training.

A.4.1.2 Stage 2: Image/reward pairing

During stage 2, image off-set was paired with the food reward. Initially, both rats in the Raspberry Pi™ chamber only completed approx. ten trials per session (Figure A4a and b). However, after 5 days of training, both rats completed 30 trials within 30 minutes (Figure A4a and b). Therefore, both rats were advanced to the next stage of training. Rats trained in the Med Associates chamber out performed rats using the Raspberry Pi™ system by completing 100 trials in one 60-minute training session (Figure A4c-e) and they were advanced to the next stage of training after one session.

A.4.1.3 Stage 3: Touch response

During stage 3, the rats were required to touch the image for a food reward. Initially, performance by rat 1 in the Raspberry Pi™ chamber was quite low in that only 3-4 trials were completed within the 60-minute session. However, after 5 days of training rat 1 completed 63 trials and 73 trials respectively, on two consecutive days within the 60-minute session (Figure A4f). Similarly, the performance of rat 2 in the Raspberry Pi™ chamber was initially inconsistent with completion of only 6 trials on the first day followed by 62 trials on day 2 and then only 17 trials on day 3. However, after 5 days of training, rat 2 completed 112 trials on two consecutive days within the 60-minute session (Figure A4g). During stage 3, rats in the Med Associates chambers quickly reached learning criteria. Specifically, rat 3 performed quite low on the first day of training, however this performance quickly improved, completing 96 and 100 trials on training day 2 and 3, respectively (Figure A4h). Similarly, rats 4 and 5 completed 67

and 81 trials on day 1, and 98 and 100 trials on training day 2, respectively (Figure A4i and j). We directly compared the performance of rats during stage 3 in both systems and show that rats trained in the Raspberry Pi™ system were slower to reach the learning criteria compared to rats trained in the Med Associates system (Figure A5). However, all rats reached a similar level of performance by days 4 and 5 (Figure A5) indicating that all rats learnt to touch the image for a food response regardless of the touchscreen operant chamber system used.

A.5 Discussion

Here we describe a low-cost touchscreen operant chamber based on the Raspberry Pi™, a single board computer system. Specifically, two rats were successfully trained to nose poke two white squares in a low-cost touchscreen operant chamber and their performance was compared to rats trained in a standard Med Associates touchscreen operant chamber. Both rats trained in the low-cost Raspberry Pi™ system reached the learning criteria of 60 trials within 60 minutes on two consecutive days within 10 days. For comparison with a commercially available system, three rats were trained in the standard Med Associates touchscreen operant chamber. Rats trained in the Med Associates chamber reached the learning criteria of 60 trials within 60 minutes on two consecutive days within 4 days of testing. Previous studies have shown similar levels of performance and training acquisition as reported here in the Raspberry Pi™ system. Specifically, Horner et al. (2013), Mar et al. (2013) and Oomen et al. (2013) reported that learning criteria was reached within 5 days, and Sbisa et al. (2017) reported

successful training after 13 days. Although we observed a slower acquisition rate of rats trained in the Raspberry PiTM system, it may be due to the design of the reward collection receptacle itself (a piece of PVC pipe). For example, in the Raspberry PiTM system, delivery of the food pellet may land in the front or back of the delivery chute (PVC pipe), leading to slight inconsistencies in the reward placement and subsequently affecting task acquisition. This limitation will be overcome by further optimization of the collection receptacle. Nevertheless, our data demonstrates that the current system is a potential viable low-cost alternative to the current state-of-the-art systems.

Notwithstanding, there are a number of improvements and alterations that could be applied to our system to advance its development. For example, the acquisition rate of the animals could be improved by the use of “screen masks” that aid the animal’s response to specific active windows of the touchscreen screen where an image is presented. Screen masks physically cover the touchscreen except for the response windows where the image is presented. Therefore, encouraging the rodent’s attention and nose-pokes to the specific area of the screen that will elicit a food reward. This would help to shape the animal’s response and improve task acquisition. Furthermore, the Perspex rectangular box described here could easily be changed to a trapezoid box, which has been suggested to help focus attention of the experimental animal towards the touchscreen thereby improving task acquisition. We report an overall cost of the touchscreen chamber of approximately €160 EUR, which is almost half the previous estimate of 300 USD reported by Pineño (2014). This price could be further reduced by elimination of the Arduino microcontroller. Here we used the Arduino to control the

IR beam to detect reward collection. It could be removed and the IR sensor controlled by the Raspberry Pi™ to reduce the overall cost of the hardware by approx. €20 EUR.

It should be noted that a limitation of the low-cost approach is that each program has to be programmed individually, which requires both time and programming knowledge. Moreover, the current system runs a .py file from within the python IDLE (Integrated Development and Learning Environment) and therefore requires some programming knowledge to operate once it is set up. This limitation could be overcome by the development of a graphical user interface (GUI). A GUI would allow for a better end-user experience, similar to that of the current top-end systems such as the Med Associates system used in the current study. The GUI could also facilitate other functionality such as data analysis and task building for future behavioural assessment. Although the development of a GUI would require significant work, it would enable adoption of low cost alternative systems by less technologically savvy researchers. Indeed, Pineño (2014) developed a GUI that allowed the wireless pairing of the iPod touch within the operant chamber with a second iOS device, such as an iPhone or iPad, for graphing and monitoring the animal's behaviour during the experimental session. In the short term, the program presented here could also be improved by better data handling capabilities, similar to that described by Pineño (2014). Currently, the program simply records a '1' to a text file after every correct response and the numbers are summed at the end of the program to generate a basic performance score. This could be improved by including response latencies, reward collection latencies, screen

touches during the ITI for measures of preservation, as well as a heat map of screen touches throughout the session to aid detection of location bias for individual animals.

In summary, our work has advanced previous work by Pineño (2014), Devarakonda et al. (2016) and Rizzi et al. (2016) by combining the Raspberry Pi™ and a 7 inch touchscreen display with an Arduino microcontroller to create a low cost touchscreen operant chamber capable of performing tasks such as the auto-shaping task and other more complex paradigms like the PAL or TUNL which are available in the Med Associates and other state-of-the-art commercially available systems. This low-cost alternative system will provide researchers who have limited funding with a viable option to carry out cognitive testing in a touchscreen operant platform. While the chamber described here is a prototype and requires some knowledge of programming and electronics by the user in order to operate it, it demonstrates that low cost systems are capable of conducting similar behavioural tasks to those of the high-end commercially available systems.

Table A1: List of components of the Raspberry Pi™ chamber.

Part	Price* (EUR)
Raspberry Pi 2 Model B ARMv7	€35.00
7" touchscreen display for the Raspberry Pi	€70.00
Arduino Uno microcontroller	€20.00
Buzzer: (Local electronics store)	€1.00
Pack of White LEDs	€5.00
IR Break Beam Sensor 5mm LEDs	€6.00
Continuous Rotation Servo FeeTech FS5103R	€10.00
Perspex box	€5.00
PVC pipe for Food magazine	€3.00
Pack of Assorted electrical wire	€3.00
Total	€158.00

Note: *Price of components at time of writing

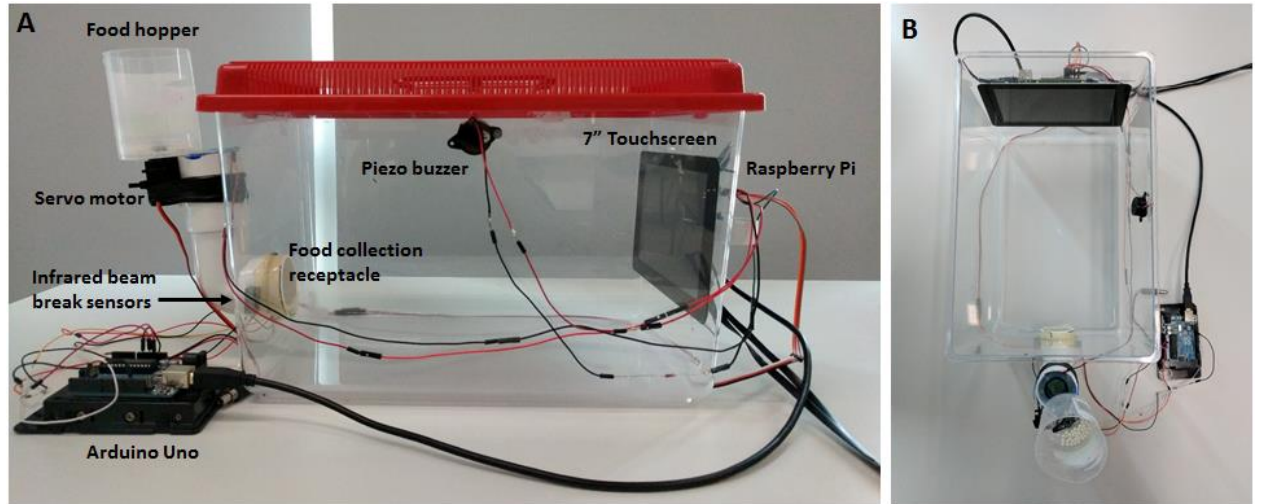

Figure A1: Raspberry PiTM touchscreen operant chamber. The Raspberry PiTM and touchscreen were mounted to a Perspex box with a food magazine and collection receptacle equipped opposite to the display (a). Top down view of the Raspberry PiTM chamber (b). The touchscreen chamber was placed inside a sound attenuating box.

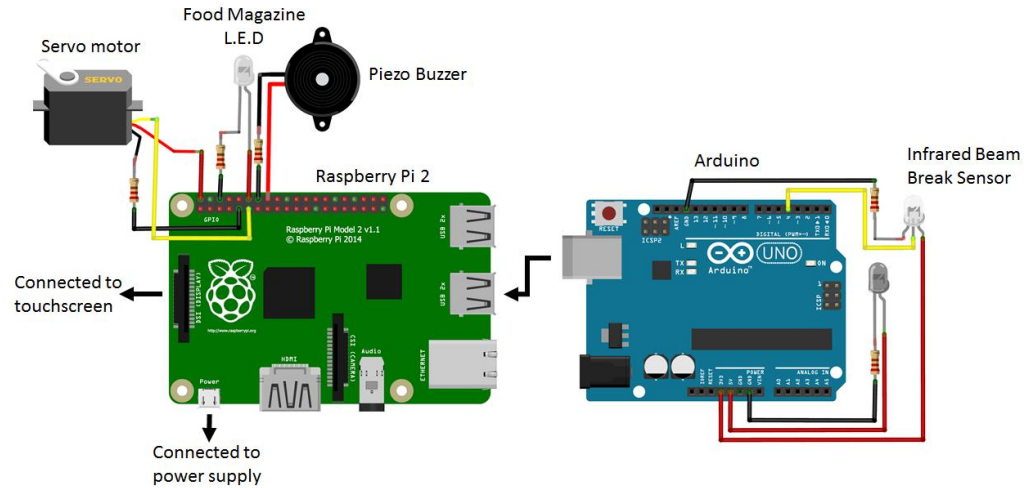

Figure A2: Wiring diagram of the Raspberry Pi™ and Arduino. The servo motor was connected to the Raspberry Pi™ 5V pin, GND pin and GPIO pin 17. The food magazine LED was connected to the GPIO pin 18 and GND pin. The Piezo buzzer was connected to the GPIO pin 23 and GND pin. The Arduino was connected to the Raspberry Pi™ via a USB. The Infrared beam break sensor was connected to the 5V pin, 3.3V pin, GND pin and GPIO pin 4 of the Arduino.

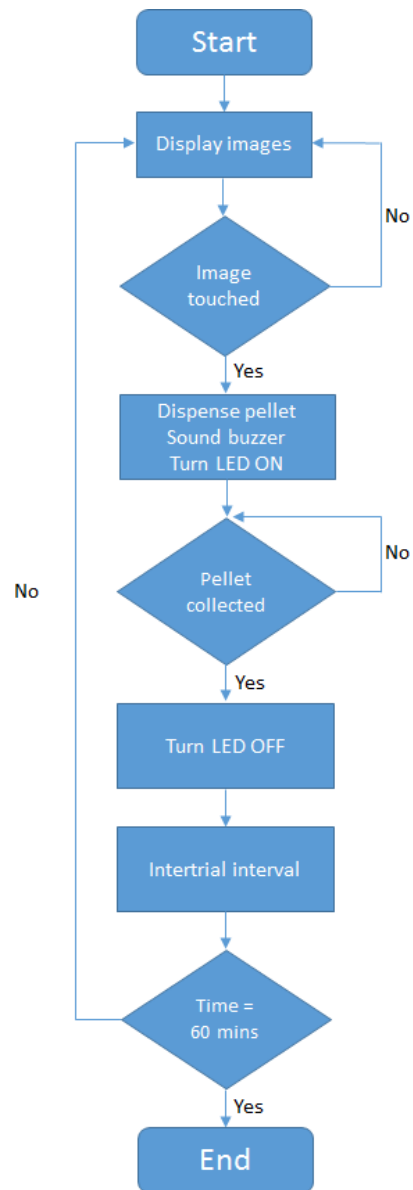
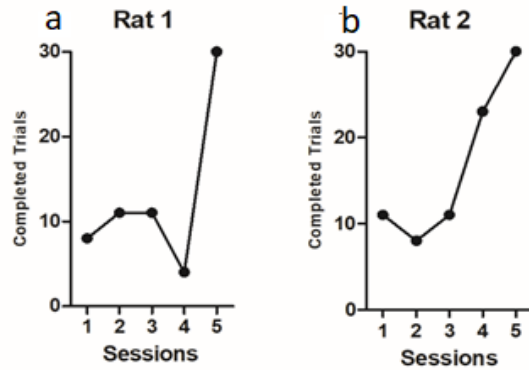
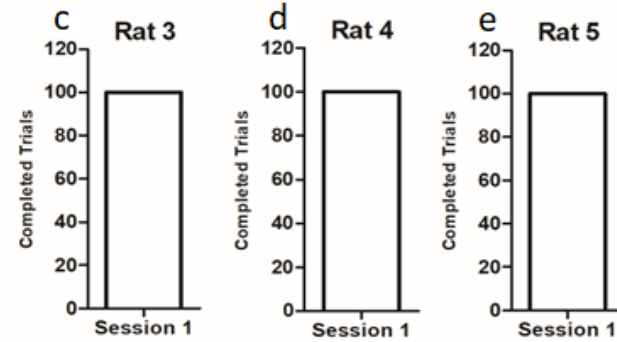

Figure A3: Flowchart of the auto-shaping program. The program to run the touchscreen chamber was comprised of a basic loop function where images were displayed on the screen and if touched triggered a “correct response” condition. This in turn activated a servo motor that dispensed a food pellet as well as playing a tone and turning an LED light on. The program looped for 60 minutes.

Raspberry Pi Chamber Stage 2



Med associates chamber Stage 2



Stage 3

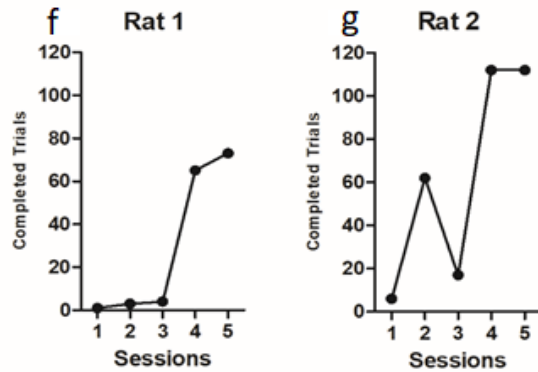

Stage 3

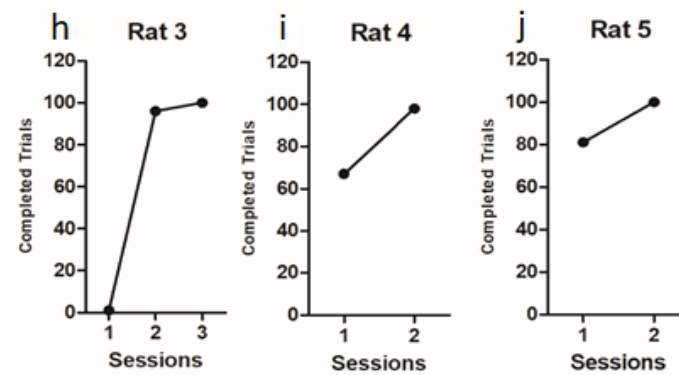

Figure A4: Auto shaping. Completed trials during stage 2 in the Raspberry PiTM system (a and b) and in the Med Associates system (c-e). Completed trials during stage 3 in the Raspberry PiTM system (f and g) and in the Med Associates system (h-i).

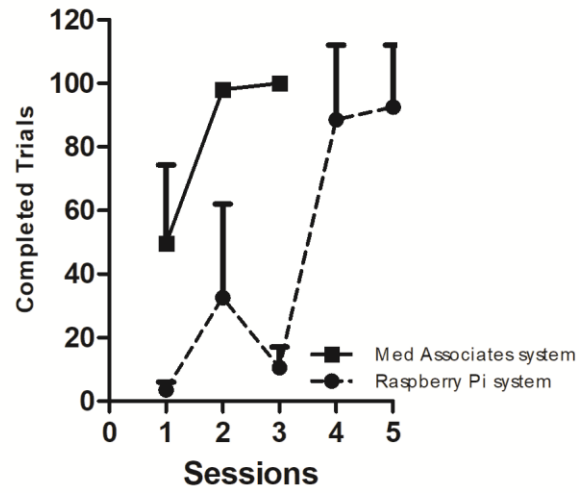

Figure A5: Comparison of training performance. Completed trials during stage 3 of rats trained in the Raspberry PiTM or Med Associates system.

APPENDIX B

Chronic Unpredictable Stress Increases Anhedonia and Anxiety-like Behaviour

B.1 Introduction

It is well established that chronic stress is a risk factor for the development of psychiatric disorders such as depression, anxiety, and post-traumatic stress disorder (Hammen, 2005, de Kloet et al., 2005, de Kloet et al., 2016, Lucassen et al., 2013). Interestingly, these stress-related psychiatric disorders are also characterized by impairments in various aspects of cognitive functioning. Moreover, exposure to chronic stress has profound effects on the brain and behaviour, influencing a wide range of cognitive processes. The chronic unpredictable stress protocol has been widely used to study the impact of stress exposure in several behavioural models and consists in the random, intermittent, and unpredictable exposure to a variety of stressors during several weeks, and has been suggested to closely model the stress of everyday in humans. Here we sort to validate that our chronic unpredictable stress protocol in adult Sprague Dawley rats prior to the extensive behavioural testing conducted in Chapter 6. Following three weeks of chronic unpredictable stress, anhedonic-like behaviour was increased as measured by a reduction in sucrose preference. Moreover, chronic unpredictable stress also decreased the time spent exploring the center of the open field, an indication of increased anxiety-like behaviour. Together, these data were used as validation of the stress protocol as a method to investigate the impact of chronic unpredictable stress on hippocampal-dependent and independent cognition as reported in Chapter 6.

B.2 Methods

B.2.1 Animals and experimental design

Adult male Sprague Dawley rats (300g) were obtained from Envigo Laboratories (The Netherlands). All rats were paired housed in standard housing conditions (temperature 22°C, relative humidity 50%) on a 12 h light/dark cycle (0730-1930) and had *ad libitum* access to food and water. All experiments were conducted in accordance with the European Directive 2010/63/EU, and under an authorization issued by the Health Products Regulatory Authority Ireland and approved by the Animal Ethics Committee of University College Cork.

Rats were divided into a control (n = 10) and stress group (n = 10) group (Figure B1). The stress group underwent chronic unpredictable stress (CUS) for three weeks prior to behavioural testing and the stress regime continued during testing for a total of 6 weeks. Rats in the control group were housed under standard conditions in a separate room with body weight recorded daily.

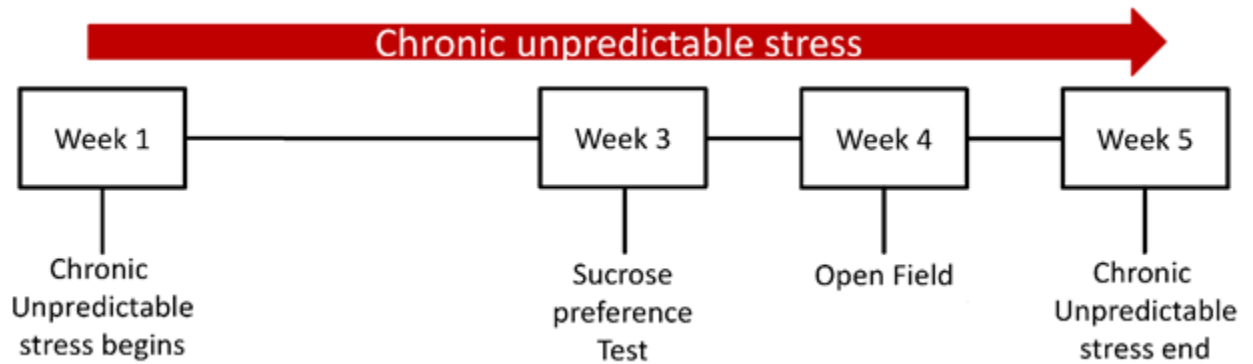

Figure B1: Experimental design. Rats underwent a chronic unpredictable stress regime for 3 weeks prior to behavioural testing and continuously through testing; Control ($n = 10$) and Stress ($n = 10$).

B.2.2 Chronic unpredictable stress

The chronic unpredictable stress (CUS) procedure used a variety of stressors for 33 days to maximize unpredictability (Table B1). Rats were exposed to one stressor during the light cycle; (lights off, cage rocker, physical restraint, isolation, cage tilt, strobe light or white noise) as well as one stressor during the dark cycle; (lights on, wet bedding, overcrowding, food deprivation or isolation) each day. Stressors were randomized such that no stressor was repeated on a consecutive days (Table B1).

B.2.3 Sucrose preference test

Prior to the initiation of CUS, rats were singly housed and habituated to a 1% sucrose solution for 24 h. On days 0 and 21, water bottles were removed from the cages for 4 hours after which rats were presented with two bottles containing either 1% sucrose or tap water. After one hour, the bottles were removed and rats were returned to the pair housed conditions. Sucrose preference was calculated as the percentage of sucrose

solution consumed relative to the total amount of liquid consumed. The bottle order (left or right placement in the cage) was counter-balanced across groups. The sucrose preference test was conducted from 1900-2000 h as rodents' greatest water consumption occurs during the first hour of the dark cycle (Koo and Duman, 2008).

B.2.4 Locomotor activity and anxiety-like behaviour in the Open Field

Spontaneous exploratory locomotor activity and thigmotaxis in the open field were used as a general measure of motor function and anxiety-related behaviours, respectively (Crawley, 2007). Rats were placed in a circular open field arena (90 cm diameter) under bright lighting conditions for 10 minutes. Behaviours were recorded, and distance travelled, and time in the centre of the arena (50% of arena area) were calculated using Ethovision software (Noldus Information Technology, USA). The arena was cleaned with a 50% ethanol solution between exposure of each animal to the arena to remove odour cues.

B.2.5 Statistical analyses

All data were analyzed using SPSS statistical software (SPSS, Chicago, IL). All data were checked for assumptions of normality using histograms, normality plots as well as formal tests (kolmogorov-smirnov and Shapiro-Wilk tests). Assumptions of equality of variance were checked using Levene's test and box plots. Data from sucrose preference and behavioural tests were compared using Independent Samples t-test. Data from body weight was analyzed by ANOVA with repeated measures. An alpha

level of 0.05 was used as criterion for statistical significance. Parametric data are presented as mean +SEM.

Table B1: Experimental schedule for CUS procedure.

Stressor	Duration	Day
Lights on	Overnight	1,7,23,27,33
Light off	3 h	2,6,11,14,19,22
Cage rocker	1 h	3,7,12,15,17,25,29
Wet Bedding	Overnight	3,10,17,22,26,31
Restraint	1 h	4,9,13,16,18,22,33
Overcrowding	Overnight	6,12,16,21,25,30
Food deprivation	Overnight	5,8,14,18,27,32
Isolation	Overnight	11,20,24,29
Isolation	3 h	5,8,19,24,26
Cage tilt	Overnight	2,9,28,32,
Strobe Light	Overnight	4,13,20,24,30
White noise (Radio)	4 h	1,10,15,21,28,31

B.3 Results

B.3.1 Body weight gain and sucrose preference

Both control and stressed rats gained weight, [F (4, 72) = 195, p <0.0001]. Although there was no main effect of CUS on body weight gain [F (1, 54) = 1.35, p >0.05]; Figure 2A. Furthermore, sucrose preference, a measure of anhedonia was decreased as a result of 21 days of CUS exposure; [t (16) = 2.54, p < 0.05]; Figure B2B.

B.3.2 Locomotor activity and anxiety-like behaviour in the Open Field

There was no significant difference in locomotor activity between control and stressed rats; [$t(17) = 2.07, p > 0.05$]; Figure B2C. CUS decreased exploration of the center of the open field compared to control; [$t(17) = 2.70, p < 0.05$]; Figure B2D.

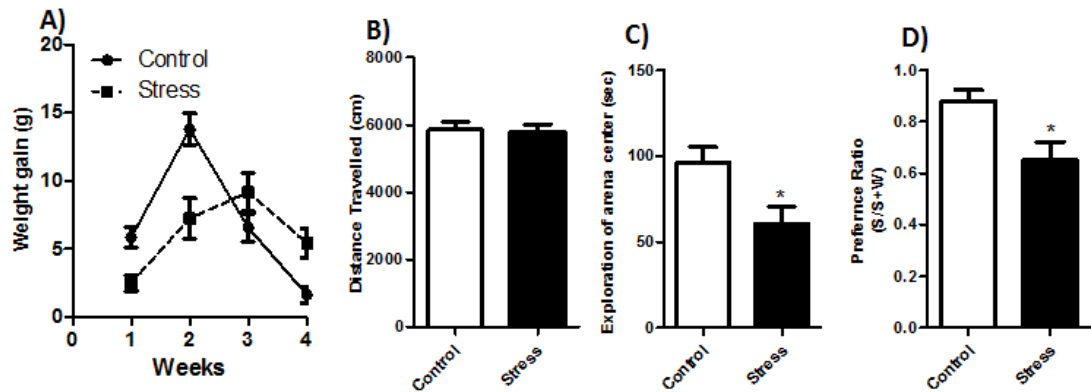

Figure B2: Chronic unpredictable stress increases anhedonia and anxiety-like behaviour. Weight gain (A). Locomotor activity in the open field (B). Exploration of arena center in the open field (C). Sucrose preference test (D). Bar graphs indicates average values in $n = 10$ (* $p < 0.05$). Data presented as mean +SEM.

B.4 Discussion

This study interrogated the effects of CUS on anhedonia and anxiety-like behaviour in adult Sprague Dawley rats. We report that chronic stress induced anhedonia and anxiety-like behavior in the open field. Sucrose preference was impaired following 3 weeks of CUS. This finding is in line with previous studies that have shown that CUS and chronic restraint stress reduced sucrose preference in both rats (Bessa et al., 2013, Chiba et al., 2012, D'Aquila et al., 1994) and mice (Pothion et al., 2004, Willner et al.,

1992, Strekalova et al., 2004, Goshen et al., 2008). We also report that rats exposed to CUS spent less time exploring the center of the open field, a measure of anxiety-like behaviour (Crawley, 2007, Choleris et al., 2001), supporting previous studies showing that both CUS and chronic restraint stress increased anxiety-like behaviour within a variety of behavioural paradigms such as the open field (Zhu et al., 2014, Bowman et al., 2006), light dark box (Mineur et al., 2006), and evaluated plus maze (Zhu et al., 2014, Chiba et al., 2012) in both rats and mice. In conclusion, these validate the CUS protocol as a method to investigate the impact of chronic unpredictable stress on hippocampal-dependent and independent cognition as reported in Chapter 6.

APPENDIX C

Published Manuscripts



A low-cost touchscreen operant chamber using a Raspberry Pi™

James D. O'Leary¹ · Olivia F. O'Leary^{1,2} · John F. Cryan^{1,2} · Yvonne M. Nolan^{1,2}

© Psychonomic Society, Inc. 2018

Abstract

The development of a touchscreen platform for rodent testing has allowed new methods for cognitive testing that have been back-translated from clinical assessment tools to preclinical animal models. This platform for cognitive assessment in animals is comparable to human neuropsychological tests such as those employed by the Cambridge Neuropsychological Test Automated Battery, and thus has several advantages compared to the standard maze apparatuses typically employed in rodent behavioral testing, such as the Morris water maze. These include improved translation of preclinical models, as well as high throughput and the automation of animal testing. However, these systems are relatively expensive, which can impede progress for researchers with limited resources. Here we describe a low-cost touchscreen operant chamber based on the single-board computer, Raspberry Pi™, which is capable of performing tasks similar to those supported by current state-of-the-art systems. This system provides an affordable alternative for cognitive testing in a touchscreen operant paradigm for researchers with limited funding.

Keywords Cognition · Touchscreen operant chamber · Operant behavior · Raspberry Pi · Arduino · Automation

Operant-based behavioral tasks are standard techniques used in experimental psychology in which a rodent learns to press a lever or turn a wheel to receive an appetitive or aversive response (Crawley, 2007; Skinner, 1938). Standard operant paradigms, such as fixed-ratio (in which a reward is delivered every *n*th lever press) or variable-ratio (in which a reward is delivered after a pseudorandom number of lever presses) training, have been used to investigate addiction, impulsivity, and motivation (Halladay, Kocharian, & Holmes, 2017; Perry, Larson, German, Madden, & Carroll, 2005; Salamone & Correa, 2002). These operant-based tasks have been further developed over the years, particularly through the implementation of a computer touchscreen in place of levers. Touchscreen operant chambers have been used in a variety of species including rodents (McTighe, Mar, Romberg, Bussey, & Saksida, 2009), birds (Cook, 1992), dogs (Range, Aust, Steurer, & Huber, 2008), and reptiles (Mueller-Paul et al., 2014). The development of a touchscreen platform for behavioral testing has allowed new methods for cognitive

assessment in preclinical models (Bartko, Vendrell, Saksida, & Bussey, 2011; Bussey et al., 2012; Horner et al., 2013; Nithianantharajah et al., 2015). These methodologies are comparable to the human neuropsychological tests employed by the Cambridge Neuropsychological Test Automated Battery, such as the pairwise associative learning (PAL) task and the trial-unique nonmatching to location (TUNL) task (Bartko et al., 2011; Bussey et al., 2012; Kim, Romberg, et al., 2015b; Mar et al., 2013; Nithianantharajah et al., 2015; Talpos, Winters, Dias, Saksida, & Bussey, 2009). Just as patients in the clinic use an iPad/computer to respond to visual and audio cues during neurocognitive assessment, rodents can view a computer touchscreen and respond in a similar fashion (via nose pokes rather than finger touches) during behavioral testing in an operant chamber. Very often the rodent tasks have visual stimuli similar or identical to the stimuli used for testing in the clinic. Using this platform, the rodent is presented with an image on the computer screen and, depending on the task paradigm, is trained to respond to either the specific image or location of the image via nose pokes on the touch-sensitive computer screen. A correct response elicits a food reward, whereas an incorrect response triggers a timeout. Through repeated trials the rodent's performance can be assessed and the underlying neurobiology required for the task can be studied. Currently, several tasks are available that assess different aspects of cognitive function and associated neurophysiology, such as visual

✉ Yvonne M. Nolan
y.nolan@ucc.ie

¹ Department of Anatomy and Neuroscience, University College Cork, Cork, Ireland

² APC Microbiome Institute, University College Cork, Cork, Ireland

discrimination and reversal learning, the five-choice serial reaction time task, and the continuous performance test, which all measure executive functions, such as cognitive flexibility, decision making, and attention, and have been shown to be sensitive to prefrontal cortex manipulation in rats and mice (Kim, Hvoslef-Eide, et al., 2015a; Mar et al., 2013). In addition, the location discrimination and TUNL tasks, which measure spatial learning, have been shown to be dependent on adult hippocampal neurogenesis and an intact hippocampal formation in rats and mice (Clelland et al., 2009; Creer, Romberg, Saksida, van Praag, & Bussey, 2010; McTighe et al., 2009; Oomen et al., 2013; Talpos, McTighe, Dias, Saksida, & Bussey, 2010). Similarly, the PAL task has been shown to be sensitive to glutamatergic inactivation of the hippocampus in rats (Talpos et al., 2009). Furthermore, impaired performance in the PAL task has been shown in patients with schizophrenia (Wood et al., 2002), and PAL performance has been identified as a predicative measure of Alzheimer's disease pathology (Swainson et al., 2001).

The touchscreen operant platform for behavioral assessment in animals has several advantages relative to the standard maze apparatus commonly employed in rodent behavioral testing, such as the Morris water maze or radial arm maze. First, it enables the design of tasks that better represent human neuropsychological tests thus it is highly translatable. For example, audiovisual stimuli as well as the task paradigm itself, such as the PAL task, can be set up so that they are identical to those used in tasks for humans (Talpos et al., 2009). Second, the touchscreen operant platform can be used to conduct behavioral assessments as part of a test battery. Although this is also the case for tasks using standard maze apparatuses, such as the Morris water maze or radial arm maze, the touchscreen platform enables a consistent environment and behavioral response/reward system, thereby reducing any potential confounds from employing different maze equipment and paradigms. Third, the platform is automated thus a number of chambers can be used simultaneously for behavioral assessments. This increases the throughput of experimental animals and reduces the burden of labor on the experimenter. Although the touchscreen system has advantages over standard maze paradigms, current systems can cost upward of €25,000 for a four-chamber system. This can be prohibitively expensive for researchers with limited resources, as is often the case for early-career scientists or those in the developing world. Thus, due to the relatively low cost of the components, the option of building a touchscreen chamber in-house is both attractive and viable. Indeed, several groups have already reported building low-cost operant chambers. Steurer, Aust, and Huber (2012) demonstrated a low-cost touchscreen operant chamber that could be used by a variety of species, such as pigeons, tortoise and dogs. This system was significantly cheaper than commercial alternatives, at approximately €3,000. Moreover, work by Pineño (2014) further reduced the price point of an in-house system, by building a low-cost

touchscreen operant chamber using a touch-sensitive iPod and an Arduino microcontroller. This group was the first to demonstrate a low-cost touchscreen operant chamber using off-the-shelf electronics for a fraction of the cost of commercially available alternatives, at only a few hundred euros. Although the system is innovative, it is limited in its ability to facilitate the running of similar tasks to that of the current state-of-the-art systems, such as the Bussey–Saksida chambers given the small touchscreen display, although the addition of an iPad with a larger screen may help to overcome this limitation (Pineño, 2014). It is worth pointing out that the original aim of this study was to showcase a proof of concept that off-the-shelf components could be used to build a low-cost alternative, and thus lay the foundation for future work. Since then, Devarakonda, Nguyen, and Kravitz (2016) built a Rodent Operant Bucket (ROBucket), a standard operant chamber based on the Arduino microcontroller. The system consisted of two nose-poke sensors and a liquid delivery system capable of both fixed-ratio and progressive-ratio training that can be used to train mice to nose poke a receptacle for a sucrose solution (Devarakonda et al., 2016). Moreover, Rizzi, Lodge, and Tan (2016) built a low-cost rodent nose-poke chamber using the Arduino microcontroller. Their system was composed of four nose-poke modules that detected and counted head entries. Rizzi et al. successfully trained mice to prefer the nose-poke module, which would trigger an optogenetic stimulation of dopaminergic neurons within the ventral tegmental area. Although both Devarakonda et al. and Rizzi et al. demonstrated low-cost alternatives, these systems are designed as standard operant chambers and therefore do not allow for the similar translatable tasks available within a touchscreen operant platform. Here, we build on the previous work by Pineño, Devarakonda et al., and Rizzi et al. by combining the single-board Raspberry Pi™ computer and 7-in. Raspberry Pi touchscreen with an Arduino microcontroller. We demonstrate that this low-cost touchscreen operant chamber is capable of supporting a number of tasks similar to those enabled by current state-of-the-art systems, such as autoshaping animals to nose-poke for a food response, as well as more complex paradigms such as visual discrimination and the PAL and TUNL tasks.

The Raspberry Pi is a single-board computer, roughly the size of a credit card. Despite its size and inexpensive price (approx. €30), the Pi runs a full computer operating system and is capable of supporting the same tasks as a typical desktop PC—for instance, word processing and web browsing. In addition, the Raspberry Pi has several general purpose input-output (GPIO) pins. GPIO pins are generic pins on an integrated circuit whose function can be programmed by the user. For example, they can be programmed to receive specific input (i.e., reading a temperature sensor) or deliver a certain output (i.e., moving a servo motor). In addition, the Raspberry Pi touchscreen is a fully integrated touch-sensitive display that

runs natively on the Raspberry Pi. The combination of a full PC operating system, touch-sensitive display, easy hardware integration through the GPIO pins, and inexpensive price makes the Raspberry Pi a very powerful platform for electronic projects, and therefore an ideal basis for a touchscreen operant chamber. This article describes a low-cost touchscreen operant chamber based on the Raspberry Pi, a single-board computer system.

Materials and method

Hardware

The main components of the touchscreen operant chamber were a Raspberry Pi 2 (Raspberry Pi Foundation, UK), a 7-in. touchscreen display for the Raspberry Pi (Raspberry Pi Foundation, UK), and an Arduino Uno microcontroller (Arduino, Italy) (Figs. 1a and b). All components were purchased from Adafruit Industries, USA. The touchscreen display was connected to the Raspberry Pi and mounted within a Perspex box (35.6 × 23.4 × 22.8 cm), which was housed within a sound-attenuating box (63.5 × 43.2 × 42.2 cm) (Med Associates, USA). On the opposite side of the Perspex box was a food magazine, which consisted of a food hopper connected to a pellet delivery chute, made from a PVC pipe. A servo motor within the hopper dispenses a 45-mg pellet, which falls down the delivery chute and into the collection receptacle after each correct response (Figs. 1a and b). The food hopper was controlled by a servomotor attached to the Raspberry Pi (Fig. 2). An LED light within the collection receptacle signaled a reward,

and an infrared (IR) beam detected the collection of the food pellet. The IR beam/sensor was connected to the Arduino Uno, which was in turn connected to the Raspberry Pi via a USB port (Fig. 2). A Piezo buzzer within the Perspex box was used to signal the delivery of the food pellet and was also controlled by the Raspberry Pi (Fig. 2). For a detailed list of the components and their associated prices at the time of publication, see Table 1. The commercially available Med Associates touchscreen operant chamber (consisting of a rectangular operant box with grid flooring, overhead light, touchscreen, and food hopper; Med Associates, USA) was used for comparison.

Software

A program to control the main functionality of the touchscreen chamber was written in Python (version 3.1.1), a high-level programming language utilizing the pygame library (<https://www.pygame.org/news>), which ran on the Raspberry Pi (Fig. 3). Briefly, the program displayed two images (two white squares) on the screen. Once either image was touched (e.g. nose-poked by the rat), the program moved the attached servomotor, located within the food hopper, which in turn dispensed a food pellet. Simultaneously, a tone was played through a buzzer, and an LED light within the food receptacle was turned on to signal reward delivery. An infrared (IR) beam within the food receptacle detected collection of the food reward. The next trial then began, and the same process was repeated. A second program was written in the Arduino sketch, which signaled an IR beam-break detection in the food collection receptacle. The code for the Arduino sketch was adapted from Adafruit.com example code (<https://learn.adafruit.com/ir-breakbeam-sensors/>

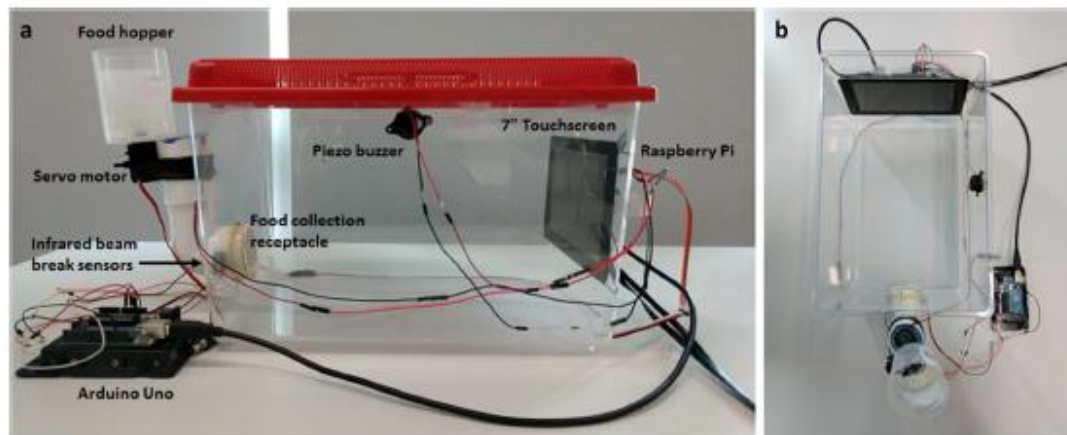

Fig. 1 Raspberry Pi touchscreen operant chamber. The Raspberry Pi and touchscreen were mounted to a Perspex box, with a food magazine and collection receptacle equipped opposite to the display (a). Top-down view

of the Raspberry Pi chamber (b). The touchscreen chamber was placed inside a sound-attenuating box.

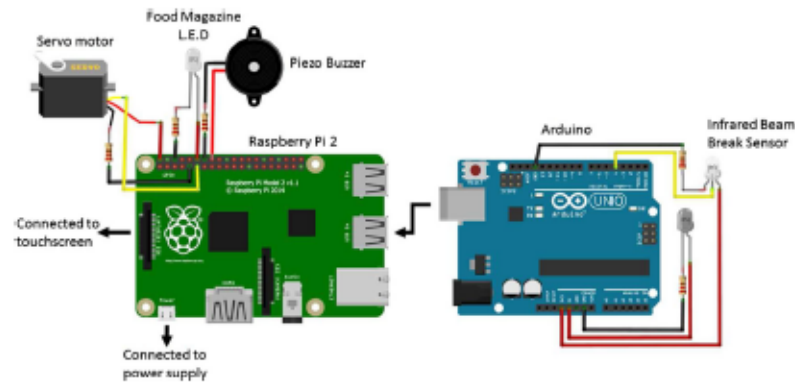

Fig 2 Wiring diagram of the Raspberry Pi and Arduino: The servomotor was connected to the Raspberry Pi 5-V pin, GND pin, and GPIO Pin 17. The food magazine LED was connected to the GPIO Pin 18 and GND pin. The Piezo buzzer was connected to the GPIO Pin 23 and GND pin.

The Arduino was connected to the Raspberry Pi via a USB port. The infrared beam-break sensor was connected to the 5-V pin, 3.3-V pin, GND pin, and GPIO Pin 4 of the Arduino

overview). Each correct response was written to a text file and saved to the Raspberry Pi. These data were used to determine the animal's performance during each session.

Experimental design

Two male Sprague-Dawley rats (ten weeks old, bred in-house) were used to validate the Raspberry Pi touchscreen system. An additional group consisting of three male Sprague-Dawley rats (eight weeks old) was obtained from Envigo Laboratories (The Netherlands) and trained in the standard Med Associates touchscreen operant chamber for comparison in training performance. The rats were group-housed in standard housing conditions (temperature 22 °C, relative humidity 50%) on a 12-h light/dark cycle (0730–1930). Water and rat chow were available ad libitum prior to food restriction. Rats were food

restricted to 90% of their free-feeding weight so as to increase their motivation to seek out a food reward within the touchscreen operant paradigm. All experiments were conducted in accordance with the European Directive 2010/63/EU, and under an authorization issued by the Health Products Regulatory Authority Ireland and approved by the Animal Ethics Committee of University College Cork.

Behavioral autoshaping protocol

Rats were food-deprived, with body weight maintained at 90% of their free-feeding weight during operant training so as to increase their motivation to seek out a food reward. The autoshaping protocol was adapted from Horner et al. (2013) and was composed of three stages that served to shape the animals to touch the touchscreen for a food reward. Stage 1 involved habituation to the testing chambers for 30 min for two consecutive days, with ten pellets dispensed within the food magazine. Criteria for the animal to progress to the next stage of training was that all pellets were consumed within the 30-min session. The food magazine light was illuminated during food delivery and was switched off upon food collection. The house light was off, and no images were displayed on the screen. Stage 2 involved associating the displayed image with a food reward. Two images (white squares) were presented simultaneously for 30 s in two locations (left and right), separated by 5 cm. If no touch had occurred after 30 s, a food pellet was dispensed, and the food magazine was illuminated and a tone (1 s, 3 kHz) was sounded. If the image was touched by the animal, a reward (1 × 45 mg food pellet) was dispensed immediately and concurrently with the tone (1 s, 3 kHz), and the food magazine light was switched on. Upon reward collection, the magazine light was switched off and an intertrial interval (ITI) began (5 s), following which a new trial began.

Table 1 List of components of the Raspberry Pi chamber

Part	Price* (EUR)
Raspberry Pi 2 Model B ARMv7	€35.00
7-in. touchscreen display for the Raspberry Pi	€70.00
Arduino Uno microcontroller	€20.00
Buzzer (Local electronics store)	€1.00
Pack of white LEDs	€5.00
IR break-beam sensor 5-mm LEDs	€6.00
Continuous Rotation Servo FeeTech FS5103R	€10.00
Perspex box	€5.00
PVC pipe for food magazine	€3.00
Pack of assorted electrical wire	€3.00
Total	€158.00

* Price of components at time of writing

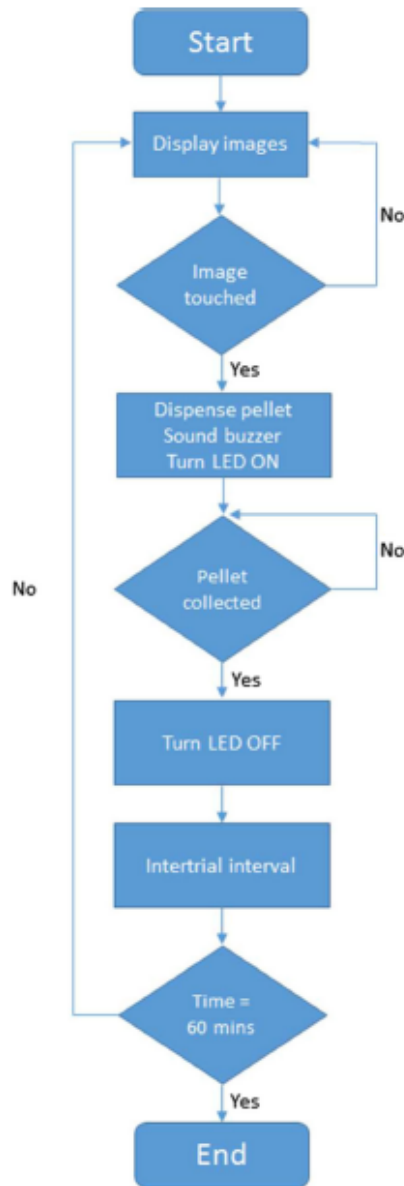

Fig. 3 Flowchart of the autoshaping program: The program to run the touchscreen chamber consisted of a basic loop function in which images were displayed on the screen and, if touched, triggered a “correct response” condition. This in turn activated a servo motor that dispensed a food pellet as well as playing a tone and turning an LED light on. The program looped for 60 minutes

The session ended after 30 trials or 30 min, whichever came first. The criteria for the animals to progress to the next

training stage was to complete 30 trials in 30 min. Stage 3 involved associating the image touch with a food reward. The protocol was the same as for Stage 2, except that the animal had to touch the displayed image to receive a reward. The session ended after 100 trials or 60 min. The criteria for the animals to complete the final stage of training was to complete 60 trials in 60 min for at least two consecutive days.

Results

Autoshaping task

Stage 1: Habituation During Stage 1, two rats were habituated to the Raspberry Pi chamber environment over two days. During these two habituation days, both rats ate the ten food pellets within the food receptacle, and both were therefore advanced to the next stage of training. An additional three rats were similarly habituated to the Med Associates operant chamber. Likewise, the rats ate all ten food pellets within the food receptacle during the two habituation days and were thus advanced to the next stage of training.

Stage 2: Image/reward pairing During Stage 2, image offset was paired with the food reward. Initially, both rats in the Raspberry Pi chamber only completed approximately ten trials per session (Figs. 4a and b). However, after five days of training, both rats completed 30 trials within 30 min (Figs. 4a and b). Therefore, both rats were advanced to the next stage of training. The rats trained in the Med Associates chamber outperformed the rats using the Raspberry Pi system by completing 100 trials in one 60-min training session (Figs. 4c–e), so they were advanced to the next stage of training after one session.

Stage 3: Touch response During Stage 3, the rats were required to touch the image for a food reward. Initially, performance by Rat 1 in the Raspberry Pi chamber was quite low, in that only three or four trials were completed within the 60-min session. However, after five days of training Rat 1 had completed 63 trials and 73 trials, respectively, on two consecutive days within the 60-min session (Fig. 4f). Similarly, the performance of Rat 2 in the Raspberry Pi chamber was initially inconsistent with training, with only six trials completed on the first day, followed by 62 trials on Day 2 but then only 17 trials on Day 3. However, after five days of training, Rat 2 completed 112 trials on two consecutive days within the 60-min session (Fig. 4g). During Stage 3, the rats in the Med Associates chambers quickly reached the learning criteria. Specifically, Rat 3’s performance was quite low on the first day of training; however, this performance quickly improved, resulting in the completion of 96 and 100 trials on Training Days 2 and 3, respectively (Fig. 4h). Similarly, Rats 4 and 5

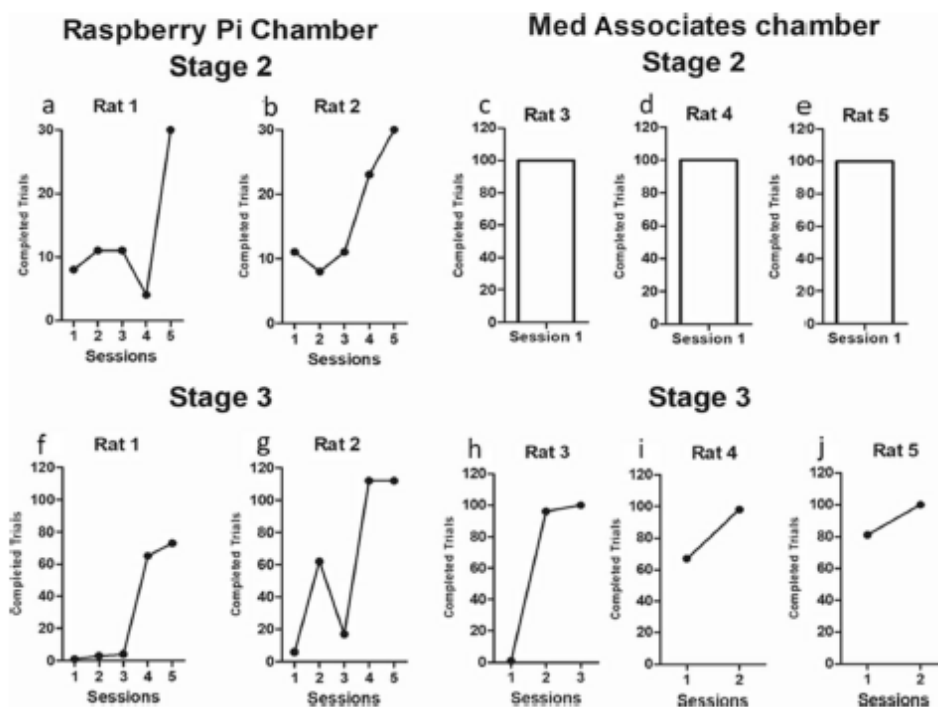

Fig. 4 Autoshaping. Completed trials during Stage 2 in the Raspberry Pi system (a and b) and in the Med Associates system (c–e). Completed trials during Stage 3 in the Raspberry Pi system (f and g) and in the Med Associates system (h–j)

completed 67 and 81 trials on Day 1, and 98 and 100 trials on Training Day 2, respectively (Figs. 4i and j). We directly compared the performance of the rats during Stage 3 in both systems, to show that the rats trained in the Raspberry Pi system were slower to reach the learning criteria than the rats trained in the Med Associates system (Fig. 5). However, all rats had reached a similar level of performance by Days 4 and 5 (Fig. 5), indicating that all rats had learned to touch the image for a

food response, regardless of the touchscreen operant chamber system used.

Discussion

Here we describe a low-cost touchscreen operant chamber based on the Raspberry Pi, a single board computer system. Specifically, two rats were successfully trained to nose poke two white squares in a low-cost touchscreen operant chamber and their performance was compared to rats trained in a standard Med Associates touchscreen operant chamber. Both rats trained in the low-cost Raspberry Pi system reached the learning criteria of 60 trials within 60 min on two consecutive days within ten days. For comparison with a commercially available system, three rats were trained in the standard Med Associates touchscreen operant chamber. Rats trained in the Med Associates chamber reached the learning criteria of 60 trials within 60 min on two consecutive days within four days of testing. Previous studies have shown similar levels of performance and training acquisition as reported here in the Raspberry Pi system. Specifically, Horner et al. (2013), Mar et al. (2013), and Oomen et al. (2013) reported that learning criteria was reached within five days, and Sbisa, Gogos, and

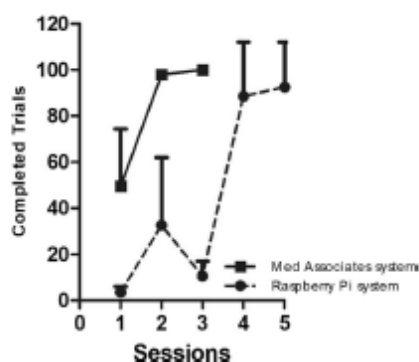

Fig. 5 Comparison of training performance: Completed trials during Stage 3 for rats trained in the Raspberry Pi or the Med Associates system

van den Buuse (2017) reported successful training after 13 days. Although we observed a slower acquisition rate of rats trained in the Raspberry Pi system, it may be due to the design of the reward collection receptacle itself (a piece of PVC pipe). For example, in the Raspberry Pi system, delivery of the food pellet may land in the front or back of the delivery chute (PVC pipe), leading to slight inconsistencies in the reward placement and subsequently affecting task acquisition. This limitation will be overcome by further optimization of the collection receptacle. Nevertheless, our data demonstrate that the present system is a potential viable, low-cost alternative to the current state-of-the-art systems.

Notwithstanding, a number of improvements and alterations could be applied to our system to advance its development. For example, the acquisition rate of the animals could be improved by the use of “screen masks” that aid the animal’s response to specific active windows of the touchscreen where an image is presented. Screen masks physically cover the touchscreen except for the response windows where the image is presented, therefore encouraging the rodent’s attention and nose-pokes to the specific area of the screen that will elicit a food reward. This would help shape the animal’s response and improve task acquisition. Furthermore, the Perspex rectangular box described here could easily be changed to a trapezoid box, which has been suggested as a means to help focus the attention of an experimental animal toward the touchscreen, thereby improving task acquisition. We report an overall cost of the touchscreen chamber of approximately €160, which, as of the date the manuscript was submitted, was substantially less than the previous estimate of USD300 reported by Pineño (2014). This price could be further reduced by elimination of the Arduino microcontroller. Here we used the Arduino to control the IR beam in order to detect reward collection. The Arduino could be removed and the IR sensor controlled by the Raspberry Pi, thus reducing the overall cost of the hardware by approximately €20.

It should be noted that a limitation of the low-cost approach is that each program has to be programmed individually, which requires both time and programming knowledge. Moreover, the present system runs a .py file from within the python IDLE (Integrated Development and Learning Environment), and therefore requires some programming knowledge to operate once it is set up. This limitation could be overcome by the development of a graphical user interface (GUI). A GUI would allow for a better end-user experience, similar to that of the current top-end systems, such as the Med Associates system used in the present study. The GUI could also facilitate other functionality, such as data analysis and task building for future behavioral assessment. Although the development of a GUI would require significant work, it would also enable the adoption of low-cost alternative systems by less technologically savvy researchers. Indeed, Pineño (2014) developed a GUI that allowed the wireless pairing of

the iPod touch within the operant chamber with a second iOS device, such as an iPhone or iPad, for graphing and monitoring the animal’s behavior during the experimental session. In the short term, the program presented here could also be improved by better data-handling capabilities, similar to those described by Pineño. Currently, the program simply records a “1” to a text file after every correct response, and the numbers are summed at the end of the program to generate a basic performance score. This could be improved by including response latencies, reward collection latencies, and screen touches during the ITI as measures of preservation, as well as a heat map of screen touches throughout the session to aid detection of location bias for individual animals.

In summary, our work has advanced previous work by Pineño (2014), Devarakonda et al. (2016), and Rizzi et al. (2016) by combining the Raspberry Pi and a 7-in. touchscreen display with an Arduino microcontroller to create a low-cost touchscreen operant chamber capable of performing tasks such as the autoshaping task and other more complex paradigms, such as the PAL or TUNL, that are available in the Med Associates and other state-of-the-art commercially available systems. This low-cost alternative system will provide researchers who have limited funding with a viable option to carry out cognitive testing in a touchscreen operant platform. Although the chamber described here is a prototype and requires some knowledge of programming and electronics by the user in order to operate it, it demonstrates that low-cost systems are capable of conducting similar behavioral tasks to those of the high-end commercially available systems.

Author note This work was funded by Science Foundation Ireland (SFI) under Grant Number SFI/IA/1537. The authors declare no conflict of interest.

References

- Bartko, S. J., Vendrell, I., Saksida, L. M., & Bussey, T. J. (2011). A computer-automated touchscreen paired-associates learning (PAL) task for mice: Impairments following administration of scopolamine or dicyclomine and improvements following donepezil. *Psychopharmacology*, *214*, 537–548. <https://doi.org/10.1007/s00213-010-2050-1>
- Bussey, T. J., Holmes, A., Lyon, L., Mar, A. C., McAllister, K. A., Nithisantharajah, J., ... Saksida, L. M. (2012). New translational assays for preclinical modelling of cognition in schizophrenia: The touchscreen testing method for mice and rats. *Neuropharmacology*, *62*, 1191–1203. <https://doi.org/10.1016/j.neuropharm.2011.04.011>
- Clelland, C. D., Choi, M., Romberg, C., Clemenson, G. D., Jr., Fragniere, A., Tytes, P., ... Bussey, T. J. (2009). A functional role for adult hippocampal neurogenesis in spatial pattern separation. *Science*, *325*, 210–213. <https://doi.org/10.1126/science.1173215>
- Cook, R. G. (1992). Acquisition and transfer of visual texture discriminations by pigeons. *Journal of Experimental Psychology: Animal*

- Behavior Processes*, 18, 341–353. <https://doi.org/10.1037/0097-7403.18.4.341>
- Crawley, J. (2007). What's wrong with my mouse: Behavioral phenotyping of transgenic and knockout mice (2nd). Hoboken: Wiley.
- Creer, D. J., Romberg, C., Saksida, L. M., van Pnag, H., & Bussey, T. J. (2010). Running enhances spatial pattern separation in mice. *Proceedings of the National Academy of Sciences*, 107, 2367–2372. <https://doi.org/10.1073/pnas.0911725107>
- Devarakonda, K., Nguyen, K. P., & Kravitz, A. V. (2016). ROBUCKET: A low cost operant chamber based on the Arduino microcontroller. *Behavior Research Methods*, 48, 503–509. <https://doi.org/10.3758/s13428-015-0603-2>
- Halladay, L. R., Kocharian, A., & Holmes, A. (2017). Mouse strain differences in punished ethanol self-administration. *Alcohol*, 58, 83–92. <https://doi.org/10.1016/j.alcohol.2016.05.008>
- Homer, A. E., Heath, C. J., Hvoslef-Eide, M., Kent, B. A., Kim, C. H., Nilsson, S. R., ... Bussey, T. J. (2013). The touchscreen operant platform for testing learning and memory in rats and mice. *Nature Protocols*, 8, 1961–1984. <https://doi.org/10.1038/nprot.2013.122>
- Kim, C. H., Hvoslef-Eide, M., Nilsson, S. R., Johnson, M. R., Herbert, B. R., Robbins, T. W., ... Mar, A. C. (2015a). The continuous performance test (cPT) for mice: A novel operant touchscreen test of attentional function. *Psychopharmacology*, 232, 3947–3966. <https://doi.org/10.1007/s00213-015-4081-0>
- Kim, C. H., Romberg, C., Hvoslef-Eide, M., Oomen, C. A., Mar, A. C., Heath, C. J., ... Saksida, L. M. (2015b). Trial-unique, delayed nonmatching-to-location (TUNL) touchscreen testing for mice: sensitivity to dorsal hippocampal dysfunction. *Psychopharmacology*, 232, 3935–3945. <https://doi.org/10.1007/s00213-015-4017-8>
- Mar, A. C., Homer, A. E., Nilsson, S. R., Alsio, J., Kent, B. A., Kim, C. H., ... Bussey, T. J. (2013). The touchscreen operant platform for assessing executive function in rats and mice. *Nature Protocols*, 8, 1985–2005. <https://doi.org/10.1038/nprot.2013.123>
- McTighe, S. M., Mar, A. C., Romberg, C., Bussey, T. J., & Saksida, L. M. (2009). A new touchscreen test of pattern separation: effect of hippocampal lesions. *NeuroReport*, 20, 881–885. <https://doi.org/10.1097/WNR.0b013e318172e5eb2>
- Mueller-Paul, J., Wilkinson, A., Aust, U., Steurer, M., Hall, G., & Huber, L. (2014). Touchscreen performance and knowledge transfer in the red-footed tortoise (*Chelonia mydas carbonaria*). *Behavioral Processes*, 106, 187–192. <https://doi.org/10.1016/j.beproc.2014.06.003>
- Nithianantharajah, J., McKechnie, A. G., Stewart, T. J., Johnstone, M., Blackwood, D. H., St. Clair, D., ... Saksida, L. M. (2015). Bridging the translational divide: identical cognitive touchscreen testing in mice and humans carrying mutations in a disease-relevant homologous gene. *Scientific Reports*, 5, 14613. <https://doi.org/10.1038/srep14613>
- Oomen, C. A., Hvoslef-Eide, M., Heath, C. J., Mar, A. C., Homer, A. E., Bussey, T. J., & Saksida, L. M. (2013). The touchscreen operant platform for testing working memory and pattern separation in rats and mice. *Nature Protocols*, 8, 2006–2021. <https://doi.org/10.1038/nprot.2013.124>
- Perry, J. L., Larson, E. B., German, J. P., Madden, G. J., & Carroll, M. E. (2005). Impulsivity (delay discounting) as a predictor of acquisition of IV cocaine self-administration in female rats. *Psychopharmacology*, 178, 193–201. <https://doi.org/10.1007/s00213-004-1994-4>
- Pineño, O. (2014). ArduPod Box: A low-cost and open-source Skinner box using an iPod Touch and an Arduino microcontroller. *Behavior Research Methods*, 46, 196–205. <https://doi.org/10.3758/s13428-013-0367-5>
- Range, F., Aust, U., Steurer, M., & Huber, L. (2008). Visual categorization of natural stimuli by domestic dogs. *Animal Cognition*, 11, 339–347.
- Rizzi, G., Lodge, M. E., & Tan, K. R. (2016). Design and construction of a low-cost nose poke system for rodents. *MethodsX*, 3, 326–332. <https://doi.org/10.1016/j.mex.2016.04.002>
- Salamone, J. D., & Correa, M. (2002). Motivational views of reinforcement: Implications for understanding the behavioral functions of nucleus accumbens dopamine. *Behavioural Brain Research*, 137, 3–25. [https://doi.org/10.1016/S0166-4328\(02\)00282-6](https://doi.org/10.1016/S0166-4328(02)00282-6)
- Sbita, A. M., Gogos, A., & van den Bussche, M. (2017). Spatial working memory in the touchscreen operant platform is disrupted in female rats by ovariectomy but not estrous cycle. *Neurobiology of Learning and Memory*, 144, 147–154. <https://doi.org/10.1016/j.nlm.2017.07.010>
- Skinner, B. F. (1938). The behaviour of organisms: An experimental analysis. New York: Appleton-Century.
- Steurer, M. M., Aust, U., & Huber, L. (2012). The Vienna comparative cognition technology (VCCT): An innovative operant conditioning system for various species and experimental procedures. *Behavior Research Methods*, 44, 909–918. <https://doi.org/10.3758/s13428-012-0198-9>
- Swanson, R., Hodges, J. R., Galton, C. J., Semple, J., Michael, A., Dunn, B. D., ... Sahakian, B. J. (2001). Early detection and differential diagnosis of Alzheimer's disease and depression with neuropsychological tasks. *Dementia and Geriatric Cognitive Disorders*, 12, 265–280. <https://doi.org/10.1159/000051269>
- Talpos, J. C., McTighe, S. M., Dias, R., Saksida, L. M., & Bussey, T. J. (2010). Trial-unique, delayed nonmatching-to-location (TUNL): A novel, highly hippocampus-dependent automated touchscreen test of location memory and pattern separation. *Neurobiology of Learning and Memory*, 94, 341–352. <https://doi.org/10.1016/j.nlm.2010.07.006>
- Talpos, J. C., Winters, B. D., Dias, R., Saksida, L. M., & Bussey, T. J. (2009). A novel touchscreen-automated paired-associate learning (PAL) task sensitive to pharmacological manipulation of the hippocampus: a translational rodent model of cognitive impairments in neurodegenerative disease. *Psychopharmacology*, 205, 157–168. <https://doi.org/10.1007/s00213-009-1526-3>
- Wood, S. J., Proffitt, T., Mahony, K., Smith, D. J., Buchanan, J.-A., Brewer, W., ... Pantelis, C. (2002). Visuospatial memory and learning in first-episode schizophreniform psychosis and established schizophrenia: a functional correlate of hippocampal pathology? *Psychological Medicine*, 32, 429–438. <https://doi.org/10.1017/S0033291702005275>

Review

Regulation of behaviour by the nuclear receptor TLX

J. D. O'Leary[†], O. F. O'Leary^{†,‡}, J. F. Cryan^{†,‡} and Y. M. Nolan^{†,*}

[†]Department of Anatomy and Neuroscience, and [‡]APC Microbiome Institute, University College Cork, Cork, Ireland
^{*}Corresponding author: Y. M. Nolan, Department of Anatomy and Neuroscience, University College Cork, Cork, Ireland. E-mail: y.nolan@ucc.ie

The orphan nuclear receptor *Tlx* (Nr2e1) is a key regulator of both embryonic and adult hippocampal neurogenesis. Several different mouse models have been developed which target *Tlx* *in vivo* including spontaneous deletion models (from birth) and targeted and conditional knockouts. Although some conflicting findings have been reported, for the most part studies have demonstrated that *Tlx* is important in regulating processes that underlie neurogenesis, spatial learning, anxiety-like behaviour and interestingly, aggression. More recent data have demonstrated that disrupting *Tlx* during early life induces hyperactivity and that *Tlx* plays a role in emotional regulation. Moreover, there are sex- and age-related differences in some behaviours in *Tlx* knockout mice during adolescence and adulthood. Here, we discuss the role of *Tlx* in motor-, cognitive-, aggressive- and anxiety-related behaviours during adolescence and adulthood. We examine current evidence which provides insight into *Tlx* during neurodevelopment, and offer our thoughts on the function of *Tlx* in brain and behaviour. We further hypothesize that *Tlx* is a key target in understanding the emergence of neurobiological disorders during adolescence and early adulthood.

Keywords: Adolescence, aggression, anxiety, behaviour, cognition, hippocampus, neurogenesis, Nr2e1, *Tlx*

Received 24 May 2016, revised 15 September 2016 and 21 October 2016, accepted for publication 25 October 2016

Nuclear receptors are members of a superfamily of transcription factors that regulate a variety of developmental and physiological processes (Germain *et al.* 2006) and have been the subject of therapeutic strategies for an array of disorders including brain disorders. Specifically, nuclear receptors such as the glucocorticoid receptor, Nurr1, peroxisome proliferator-activated receptors, liver X receptor (LXR) and the orphan nuclear receptor subfamily 2 group E member 1 (Nr2e1 or *Tlx*) have been implicated in the aetiology and treatment of several neurological disorders such as depression,

bipolar disorder as well as in Alzheimer's and Parkinson's diseases (Anacker *et al.* 2011; Holsboer 2000; Kumar *et al.* 2008; Mandrekar-Colucci & Landreth 2011; Nolan *et al.* 2013). Recent attention has focused on the role of some nuclear receptors (e.g. Nr2e1 and REV-ERB α) in regulating neurogenesis (Islam & Zhang 2015; Li *et al.* 2012; Qu & Shi 2009; Schnell *et al.* 2014; Shi *et al.* 2004; Wang & Xiong 2016; Wang *et al.* 2013). In an effort to further understand the role of *Tlx* in neural development and behaviour, several different *Tlx* deletion models have been developed in mice (Monaghan *et al.* 1997; Shi *et al.* 2004; Young *et al.* 2002; Yu *et al.* 2000; Zhang *et al.* 2008). Each of these models differ in the method of genetic disruption (Fig. 1): (1) a spontaneous deletion of all nine exons occurring within the *Tlx* gene [referred to as 'fierce' (*frcl*) (Young *et al.* 2002)]; (2) targeted deletion of *Tlx* by homologous recombination disruption of exons 2 and 3 (Monaghan *et al.* 1997) and exons 3, 4 and 5 (Yu *et al.* 2000) (referred to as *Tlx-hr*); and (3) a floxed conditional deletion of *Tlx* by flanking exon 2 with two loxP sites (referred to as *Tlx-Cre-lox*; infection of a Cre-expressing virus results in deletion of the second *Tlx* allele) (Zhang *et al.* 2008). The developmental period in which genetic disruption occurs also varies across studies in that it ranges from embryonic (spontaneous deletion and *Tlx-hr*) (Monaghan *et al.* 1997; Shi *et al.* 2004; Young *et al.* 2002; Yu *et al.* 2000) to conditional disruption in adulthood (*Tlx-Cre-lox*) (Zhang *et al.* 2008). Furthermore, *Tlx-*frcl** mice exhibit deletion of all nine exons of the *Tlx* gene, while *Tlx-hr* and *Tlx-Cre-lox* mice exhibit only partial deletions (exons 2–3, exons 3–5 or exon 2, respectively), although Monaghan *et al.* (1997) reported that some residual 3' RNA (exon 5) remained following *Tlx* deletion but that the *Tlx* gene was still disrupted. Thus, the transcriptional consequences of partial deletions are an avenue for future investigations. For example, it is possible that the resultant transcription from a partial deletion of *Tlx* compared to a complete deletion of *Tlx* may explain the neuroanatomical and phenotypic differences observed across deletion models. Likewise, the genetic backgrounds of these mouse models may impact upon the neuroanatomical changes observed (summarized in Table 1). The spontaneous deletion model has been investigated in Bl6129F1, C57BL/6J and 129P3/JEms mice (O'Leary *et al.* 2016; Wong *et al.* 2010; Young *et al.* 2002), whereas the targeted deletion of *Tlx* by homologous recombination model has only been investigated in Bl6129F2 mice (Monaghan *et al.* 1997; Roy *et al.* 2004). Similarly, the floxed conditional deletion model has only been established with C57BL/6J mice (Zhang *et al.* 2008). The background strain is known to affect the behavioural phenotype observed in knockout and transgenic

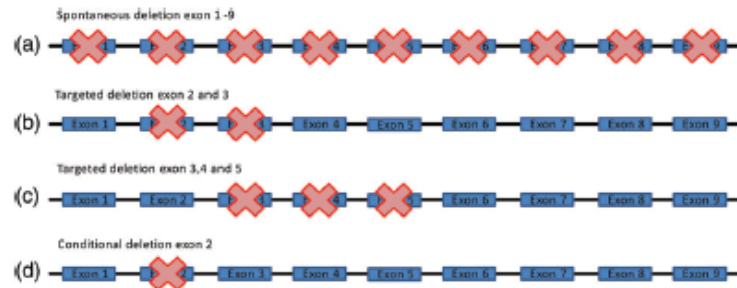

Figure 1: Illustration of the different exons targeted for each *Tlx* deletion model. (a) Spontaneous deletion of exons 1–9 (*frc* mice) (Young *et al.* 2002). (b) Targeted deletion of exons 2 and 3 by homologous recombination (*Tlx-hr* mice) (Monaghan *et al.* 1997). (c) Targeted deletion of exons 3, 4 and 5 by homologous recombination (*Tlx-hr* mice) (Yu *et al.* 2000). (d) Floxed conditional deletion of exon 2 (*Tlx-Cre-lox*) (Zhang *et al.* 2008).

Table 1: Summary of neuroanatomical changes across strain backgrounds in *Tlx* deletion models

Neuroanatomical changes	Background strain				
	Spontaneous deletion			Homologous recombination deletion	Cre-lox deletion
	C57BL/6J	129P3/JEMs	B16129F1	B16129F2	C57BL/6J
Brain volume	↓	↓	↓	↓	√
Hydrocephalus	↑	×	×	×	×
Ventricle sizes	↑	×	×	×	×
Hypoplasia of cerebrum	↑	↑	↑	×	×
Hypoplasia of olfactory lobes	↑	↑	↑	↑	×
Hippocampal volume	↓	↓	↓	↓	√
Adult hippocampal neurogenesis	↓	↓	↓	↓	↓
Plasticity (dentate gyrus)	No data	No data	↓	No data	No data

Data derived from (Christie *et al.* 2006; Kumar *et al.* 2004; Li *et al.* 2012, 2008; Monaghan *et al.* 1997; Roy *et al.* 2002; Shi *et al.* 2004; Wong *et al.* 2010; Young *et al.* 2002; Yu *et al.* 2000; Zhang *et al.* 2008; Zhao *et al.* 2009).
 ↑, increase; ↓, decrease; ×, not observed; √, normal observation.

mice as well as mutation–phenotype interactions, and is therefore an important factor to consider when comparing findings from studies using mice bred on different genetic backgrounds (Jacobson & Cryan 2007; Silva *et al.* 1997; Sittig *et al.* 2016). For example, mice bred on a 129B6F1 background have been reported to outperform C57BL/6J mice in spatial learning paradigms (Wehner & Silva 1996), while C57BL/6J mice have been shown to be hyperactive compared to 129 and hybrid 129BL/6J mice (Vöikar *et al.* 2001). Sex–genetic background interactions have also been shown to affect behavioural phenotype. For example, Vöikar *et al.* (2001) reported that male hybrid 129BL/6J mice exhibited higher anxiety-like behaviour within the elevated plus maze compared to female counterparts. Thus, methodological differences in the generation of these models should be considered when making direct comparisons between different studies assessing the behavioural effects of *Tlx* manipulation. Nonetheless, disruption in *Tlx* expression results in a number of neuroanatomical and behavioural abnormalities across all deletion models of *Tlx*. This article reviews the evidence for a role of *Tlx*

in neuroanatomical development, aggression, cognition, neurogenesis, anxiety-related behaviours and motor performance (summarized in Table 2). Particular emphasis is placed on identifying the differences and similarities in neuroanatomical and behavioural findings observed across several genetic knockdown models. These considerations may help to reconcile the seemingly inconsistent findings of the role of *Tlx* among several studies. We also outline future directions and pressing questions that need to be addressed in order to understand how the various effects of *Tlx* disruption fit together.

Tlx and neuroanatomical development

Tlx and neurogenesis

Accumulating evidence supports a role for *Tlx* in neurogenesis, the birth of new neurons, in both the developing and adult brain. *Tlx* (*Nr2e1*) is a key regulator of embryonic and adult neurogenesis, with expression localized within the neurogenic niche of the forebrain and retina throughout

Table 2: Summary of neuroanatomical, cognitive, motor and anxiety impairments in *Tlx* knockout mice

Developmental period of disruption	Germline		Adulthood
	Spontaneous deletion	Homologous recombination deletion	Cre-lox deletion
Phenotype			
Body weight	↓	↓	√
Vision	↓	↓	√
Pain sensitivity	√	√	No data
Aggression			
Resident intruder attacks (home cage)	↑	↑	×
Aggressive encounters (neutral arena)	↑	No data	No data
Aggressive encounters (mating female)	↑	↑	No data
Biting towards handling	↑	No data	No data
Neuroanatomical and cellular			
Adult hippocampal neurogenesis	↓	↓	↓
Plasticity (dentate gyrus)	↓	No data	No data
Enlarged ventricles	↑	×	×
Hypoplasia of cerebrum	↑	↑	×
Hypoplasia of olfactory lobes	↑	↑	×
Hippocampal volume	↓	↓	√
Cognition			
Spatial learning (MWM)	No data	√	↓
Contextual fear conditioning	↓	↓	√
Spontaneous alternation	↓	√	No data
Passive avoidance	↓	No data	No data
Motor function			
Locomotor activity	↑	√	√
Motor performance	↓	No data	No data
Anxiety			
Elevated plus maze	↓	↓	No data
Open field (thigmotaxis)	↓	√	No data
Cued fear conditioning	↓	↓	√
Acoustic startle reactivity	↓	No data	No data

Data derived from (Christie *et al.* 2006; Juarez *et al.* 2013; Kumar *et al.* 2004; Li *et al.* 2008, 2012; Monaghan *et al.* 1997; O'Leary *et al.* 2016; Roy *et al.* 2002; Shi *et al.* 2004; Wong *et al.* 2010; Young *et al.* 2002; Yu *et al.* 2000; Zhang *et al.* 2008; Zhao *et al.* 2009).

↑, increase; ↓, decrease; ×, not observed; √, normal observation.

development and adulthood (Islam & Zhang 2015; Monaghan *et al.* 1995; Shi *et al.* 2004). The temporal pattern of *Tlx* expression begins at embryonic day 8 (E8) peaks at E13.5 and decreases by E16 (Drill 2009; Monaghan *et al.* 1995). Expression begins to increase again postnatally and continues into adulthood (Monaghan *et al.* 1995; Shi *et al.* 2004). *Tlx* mRNA and protein is expressed within the lateral ganglionic eminence of the telencephalon as well as the developing amygdala, striatum, hippocampus and septum (Drill 2009). Moreover, *Tlx* has been shown to regulate the timing of neurogenesis in the cortex during development, regulate the timing of postnatal astrogenesis through modulation of bone morphogenetic protein BMP-SMAD signalling (Qin *et al.* 2014), and play a role in retinal development through the regulation of the Pax 2 gene, Müller glia, S-cones and glycinergic amacrine cell differentiation (Curso-Diaz & Simpson 2015; Yu *et al.* 2000).

Tlx has also been shown to regulate neural stem cell maintenance through complexing with histone deacetylases and recruitment of lysine-specific demethylase 1 and to regulate repression of several cell cycle genes including p21, Wnt7a, cyclinD1, p27Kip1 and Pten (Shi *et al.* 2004;

Sun *et al.* 2007, 2010; Yokoyama *et al.* 2008). Furthermore, microRNAs such as miR-9 and miR-219 have been shown to affect the post-transcriptional regulation of *Tlx* expression (Murai *et al.* 2016; Zhao *et al.* 2009). Murai *et al.* (2016) identified an upregulation of miR-219 and a corresponding down-regulation of *Tlx* in neural stem cells taken from patients with schizophrenia, which suggests a possible role of *Tlx* in neurodevelopment disorders such as schizophrenia. Thus, *Tlx* is crucial for neural and retinal development through its role in controlling cell cycle progression and exit of neural stem cells from quiescence (Curso-Diaz & Simpson 2015; Li *et al.* 2008; Miyawaki *et al.* 2004; Roy *et al.* 2004, 2002; Shi *et al.* 2004; Yu *et al.* 2000).

Given the role of *Tlx* in neural and retinal development, and in embryonic neurogenesis, *Tlx* may play a possible role in neurodevelopment disorders. Indeed, early-life deletion of *Tlx* causes neuroanatomical abnormalities such as decreased hippocampal volume, structural changes within the prefrontal cortex and amygdala, as well as enlarged ventricles (Young *et al.* 2002). The neuroanatomical abnormalities observed in *Tlx* knockout mice are similar to those seen in patients with depression (decreased hippocampal volume) (Campbell

et al. 2004; Videbech & Ravnkilde 2004), bipolar disorder (structural and/or volumetric changes within the prefrontal cortex, hippocampus and amygdala) (Andreazza & Young 2014; Strakowski et al. 2012) and schizophrenia (enlarged ventricles and reduced hippocampal volume) (Ross et al. 2006). Disruption of *Tlx* expression also causes malformation of the lateral and basolateral amygdala, brain regions involved in the regulation of anxiety (Stenman et al. 2003; Tasan et al. 2010). Moreover, genetic variation at the *Nr2e1* locus in humans has been linked to increased susceptibility to developing bipolar disorder (Kumar et al. 2008).

It has been established that neurogenesis occurs within the adult brain, namely the subventricular zone of the lateral ventricles and the subgranular zone of the dentate gyrus (DG). Evidence now suggests that adult neurogenesis occurs in the rodent hypothalamus, where it has been proposed to contribute to homeostatic functions such as energy balance and food intake (Kokoeva et al. 2005; Sousa-Ferreira et al. 2014). Adult neurogenesis has also been shown within the striatum in humans and has been suggested to contribute to the generation of new striatal interneurons (Bergmann et al. 2015; Eriksson et al. 1998; Gage 2000; Sousa-Ferreira et al. 2014). While the functional significance of new adult striatal neurons is yet to be fully understood, it is possible that they contribute to motor and cognitive functions such as behavioural flexibility (Ernst & Frisén 2015). Dysregulation of adult striatal neurogenesis has also been implicated in the pathophysiology of Huntington's disease, suggesting a possible role in neurodegenerative disorders (Curtis et al. 2003). However, most research to date on a role for adult neurogenesis and behaviour has focused on hippocampal neurogenesis. Adult hippocampal neurogenesis has been associated with specific hippocampal-dependent cognitive processes such as spatial learning, memory consolidation and forgetting (Aimone et al. 2011; Akers et al. 2014; Clelland et al. 2009; Kitamura & Inokuchi 2014; Nakashiba et al. 2012; Oomen et al. 2014; Snyder et al. 2005). Conditional disruption of *Tlx* in adulthood has been shown to result in impairments in hippocampal neurogenesis and spatial learning (Zhang et al. 2008), while disruption of *Tlx* during embryonic development causes widespread neuroanatomical and behavioural abnormalities. While some discrepancies are evident in the literature, impairment in hippocampal neurogenesis has been implicated in the neuropathology of neurodegenerative diseases such as Alzheimer's and Parkinson's diseases (Crews et al. 2010; Marlatt & Lucassen 2010; Winner & Winkler 2015) as well as in ageing itself (Kuhn et al. 1996; Spalding et al. 2013). Adult hippocampal neurogenesis has also been implicated in the behavioural response to stress, suggesting a possible role in stress resilience (Levone et al. 2015; O'Leary et al. 2014; Snyder et al. 2011). Furthermore, dysregulation of adult neurogenesis has been associated with psychiatric disorders including anxiety (Revest et al. 2009), schizophrenia (Reif et al. 2007; Toro & Deakin 2007) and has been implicated in the mechanism of action of antidepressant drugs (Boldrini et al. 2012, 2009; Malberg et al. 2000; O'Leary & Cryan 2014; O'Leary et al. 2013; Santarelli et al. 2003). A common pathological feature of these neurodegenerative and psychiatric disorders, as well as in normal ageing is neuroinflammation, which has also been consistently shown

to negatively affect adult hippocampal neurogenesis (Amor et al. 2010; Barrientos et al. 2015; Green & Nolan 2014; Nolan et al. 2013; Ryan & Nolan 2016). Interestingly, it has recently been shown that the proinflammatory cytokine interleukin-1 β negatively affects both embryonic and adult hippocampal neurogenesis in parallel with a downregulation of hippocampal expression of *Tlx* (Green & Nolan 2012; Ryan et al. 2013).

Effects of spontaneous early-life deletion of *Tlx* on neuroanatomical development

The majority of studies that have investigated the role of *Tlx* in behavioural and cognitive processes have been conducted using a spontaneous deletion model of *Tlx* (*Nr2e1-*frc**) developed by Prof. Elizabeth Simpson, University of British Columbia (Abrahams et al. 2005; O'Leary et al. 2016; Wong et al. 2010; Young et al. 2002). In this model, genetic disruption occurs from a germline spontaneous deletion of all nine exons of the *Nr2e1* allele and does not appear to affect the transcription of neighbouring genes (Kumar et al. 2004). The mutation conforms to Mendelian inheritance and as such 25% of off-spring has neither *Nr2e1* alleles (knock-out), a further 25% of off-spring has both *Nr2e1* alleles (wild type) and the remaining 50% of off-spring has only one *Nr2e1* allele (heterozygous) (Young et al. 2002). The spontaneous deletion has been investigated on a variety of genetic backgrounds (C57BL/6J, 129P3/JEms and Bl6129F1) and similar neuroanatomical abnormalities have been observed across strains (Young et al. 2002). Specifically, hypoplasia of the retina, cerebrum and olfactory bulbs as well as malformation of the limbic system, predominantly in the DG of the hippocampus, has been reported (Young et al. 2002). On the other hand, enlarged ventricles and hydrocephalus have been observed in the C57BL/6J-*frc* mice only (Young et al. 2002), thus suggesting a strain-gene interaction. Furthermore, spontaneous deletion of *Tlx* resulted in impaired adult neurogenesis, synaptic plasticity as well as deformation of the dendritic structure within the DG of adult male Bl6129F1-*frc* mice (Christie et al. 2006; Wong et al. 2010). C57BL/6J-*frc*, 129P3/JEms-*frc* and Bl6129F1-*frc* mice are also physically smaller throughout development and during adulthood (O'Leary et al. 2016; Wong et al. 2010; Young et al. 2002). As mice with a spontaneous deletion are devoid of the *Tlx* gene from conception, it is not possible to decipher if the impairments observed during adulthood are a result of abnormal development and malformed neural circuitry stemming from a lack of *Tlx* during key developmental periods or from processes that require *Tlx* expression in adulthood. Thus, future studies should employ models with a conditional deletion so as to characterize the effects of *Tlx* disruption at different developmental stages (i.e. postnatal, adolescence and adulthood).

Effects of conditional early-life deletion of *Tlx* on neuroanatomical development

Another early-life deletion model involves targeted disruption of *Tlx* by homologous recombination (*Tlx-hr*) (Belz et al. 2007; Monaghan et al. 1997, 1995; Roy et al. 2004, 2002;

Shi *et al.* 2004). Mice in this model were generated by breeding chimaeric male mice derived from 129/J ES cell clones within C57BL/6J female mice, and the resulting heterozygous F1 mice were bred to produce homozygous *Tlx* knockout F2 mice (Bl6129F2-*Tlx-hr*) (Monaghan *et al.* 1997). Deletion of *Tlx* within the Bl6129F2-*Tlx-hr* mice was driven by either calcium/calmodulin-dependent protein kinase type II alpha chain (CaMKII α) or homeobox protein Emx1 (Emx1) Cre-lox recombination resulting in *Tlx* knockdown within the neurogenic area of the developing brain but not the eye (Belz *et al.* 2007; Drill 2009). This approach allowed the investigation of early-life effects of *Tlx* disruption without affecting retinal development and subsequent performance in behavioural paradigms dependent upon intact vision. Bl6129F2-*Tlx-hr* mice exhibit similar neuroanatomical abnormalities as observed in those with the spontaneous deletion (Monaghan *et al.* 1997; Young *et al.* 2002). Bl6129F2-*Tlx-hr* present with a reduced volume of rhinencephalic and limbic structures, including the olfactory bulbs, DG, cortico-medial amygdala and entorhinal cortex, reduced hippocampal neurogenesis in adulthood as well as abnormal proliferation and neural differentiation during development (Li *et al.* 2008; Monaghan *et al.* 1997; Roy *et al.* 2002, 2004; Shi *et al.* 2004), while the striatum and hypothalamus are a similar size to that of control mice. Although neurogenesis has not been investigated within the hypothalamus of adult Bl6129F2-*Tlx-hr* mice, given that the structural integrity of this region is relatively unaltered, it is possible that *Tlx* disruption does not impair adult hypothalamic neurogenesis. Yu *et al.* (2000) developed a similar knockout strain by targeted homologous recombination on a 129 background. They observed similar neuroanatomical abnormalities, retinal and optic nerve degeneration as well as defects in the rhinencephalic and limbic structures. Similar to the spontaneous deletion model, targeted disruption of *Tlx* by homologous recombination occurs in early life, and therefore the neuroanatomical abnormalities observed may result from neurodevelopmental deficits in the animals. However, this deletion model does overcome limitations of retinal impairment; *Tlx* disruption is driven by either CaMKII α or Emx1 Cre-lox recombination, an enzyme and protein that are only expressed within the brain, thus sparing *Tlx* expression within the eye and maintaining vision. Future studies could implement this knockdown model at key developmental time points.

Effects of conditional disruption of *Tlx* in adulthood

A conditional deletion of *Tlx* has also been developed in adult male mice by Cre-lox recombination on a C57BL/6J background (C57BL/6J-*Tlx-Cre-lox*), thus allowing the assessment of the effect of *Tlx* knockdown specifically in adulthood (Zhang *et al.* 2008). The mice exhibit one allele of *Tlx* replaced with a lacZ marker and the other *Tlx* allele is flanked by loxP sites. Infection with a Cre-expressing virus resulted in a specific deletion of the second *Tlx* allele, causing an 80% reduction in proliferating cells within the hippocampus (Zhang *et al.* 2008). *Tlx* knockdown occurs upon infection and can therefore be induced during adulthood (or another developmental time period), allowing for unimpeded developmental processes. Therefore, major neuroanatomical

abnormalities evident in the aforementioned mouse models (i.e. enlarged ventricles and reduced hippocampal volume) are not observed in this conditional deletion model. In addition, neural morphology is similar to control mice, except for a significant reduction in hippocampal neurogenesis (Zhang *et al.* 2008).

The role of *Tlx* in behaviour

The role of *Tlx* in aggression

The most striking behavioural phenotype displayed by both male and female C57BL/6J-*frc* and Bl6129F1-*frc* mice is increased aggression (Abrahams *et al.* 2005; Young *et al.* 2002). Moreover, male C57BL/6J-*frc* mice are more aggressive compared to Bl6129F1-*frc* counterparts in both home cage and neutral arena encounters (Young *et al.* 2002). Female C57BL/6J-*frc* and Bl6129F1-*frc* mice also exhibit elevated aggression within a resident-intruder paradigm as well as reduced maternal behaviour resulting in the premature death of pups (Young *et al.* 2002). Conversely, heterozygous C57BL/6J-*frc* and Bl6129F1-*frc* mice display typical maternal behaviour and as such heterozygous C57BL/6J-*frc* and Bl6129F1-*frc* mice have been used to breed experimental animals, thus controlling for potential effects of impaired maternal behaviour on the pups. Abrahams *et al.* (2005) utilized Bl6129F1-*frc* mice to develop a transgenic mouse line carrying the human nuclear receptor 2E1, and interestingly, these transgenic mice displayed similar levels of aggression compared to controls, suggesting that the aggressive phenotype was rescued (Abrahams *et al.* 2005). These data indicate that similar mechanisms involving *Tlx* may underlie abnormalities in aggression in humans. However, while no studies to date have investigated the role of *Tlx* in aggression in humans, variations in the *NR2E1* human gene have been associated with a higher susceptibility for bipolar disorder as well as for schizophrenia and aggression (Kumar *et al.* 2008), suggesting a possible role of *Tlx* in human psychiatric disorders.

Similarly to the spontaneous deletion model, Bl6129F2-*Tlx-hr* mice exhibit a hyper-aggressive phenotype, displaying a greater number of attacks towards non-estrus females than control wild-type littermates (Roy *et al.* 2002). Furthermore, the serotonin_{2AC} receptor has been shown to mediate the aggressive phenotype of male Bl6129F2-*Tlx-hr* mice in the resident intruder paradigm (Juarez *et al.* 2013). While Juarez *et al.* (2013) observed that fewer heterozygous mice engaged in aggression (36%), those that did displayed a similar aggressive phenotype (latency and duration of attacks) compared to Bl6129F2-*Tlx-hr* littermates (Juarez *et al.* 2013). Conversely, an aggressive phenotype has not been observed in heterozygous mice with a spontaneous deletion. O'Leary *et al.* (2016) observed no increase in aggression as measured by provoked biting within the heterozygous Bl6129F1-*frc* mice. Taken together, these data suggest that *Tlx* plays a role in aggression through disruption of relevant neural circuits involved in emotional regulation. While it is possible that an aggressive phenotype is a result of neurodevelopmental deficits due to a lack of *Tlx* during early life, *Tlx* deletion during adulthood cannot be ruled out as a cause of aggressive behaviour. However,

aggression in animals with a disruption of *Tlx* in adulthood (such as in C57BL/6J-*Tlx-Cre-lox* mice or by utilizing lentiviral in adult animals) has not yet been reported.

The role of *Tlx* in cognition

Given the role of *Tlx* in neural precursor cell maintenance and its importance for neural development as well as in adult neurogenesis, it is not surprising that several laboratories have investigated its potential role in cognition. *Tlx* is expressed within the developing forebrain and the disruption of *Tlx* expression during this time results in the malformation of the amygdala, hippocampus and septum, and poor performance across several learning paradigms dependent upon these malformed regions. The Morris water maze is a hippocampus-dependent spatial learning and memory task, (Morris 1984). Bl6129F2-*Tlx-hr* mice show normal spatial learning acquisition in the Morris water maze despite their reduced hippocampal volume (Belz et al. 2007; Drill 2009). However, despite normal acquisition, behavioural flexibility in the Morris water maze by Bl6129F2-*Tlx-hr* mice was impaired (Drill 2009). This evidence suggests that malformations derived from early-life *Tlx* disruption are not sufficient to impair performance on this hippocampal-dependent task, but do affect prefrontal-hippocampal-dependent behavioural flexibility. Although performance in the Morris water maze has not been investigated in the spontaneous deletion mode (Bl6129F1-*frc*), adolescent male and female Bl6129F1-*frc* mice have shown deficits in spatial working memory as measured by spontaneous alternation in the Y maze (O'Leary et al. 2016). Conversely, Bl6129F2-*Tlx-hr* mice show no deficits in spontaneous alternation within the radial arm maze (Drill 2009). Given that Bl6129F2-*Tlx-hr* mice do not have *Tlx* deletion in the retina, while the Bl6129F1-*frc* mice do, deficits in performance by the Bl6129F1-*frc* mice may be an artefact of poor eyesight rather than due to impaired hippocampal functioning. Passive avoidance has also been shown to be impaired in adult Bl6129F1-*frc* mice compared to wild-type littermates (Wong et al. 2010). Further, adolescent male but not female Bl6129F1-*frc* mice showed deficits in hippocampal function as indicated by impaired contextual fear recall but these effects did not persist into adulthood (O'Leary et al. 2016). Moreover, adult male Bl6129F2-*Tlx-hr* mice exhibited poor contextual fear recall despite normal fear acquisition, similar to Bl6129F1-*frc* mice (O'Leary et al. 2016). However, male C57BL/6J-*Tlx-Cre-lox* mice exhibit normal contextual and cued fear conditioning in adulthood (Zhang et al. 2008). Interestingly, O'Leary et al. (2016) observed no deficits in spatial working memory or contextual and cued fear recall within the heterozygous Bl6129F1-*frc* mice, which suggests that 50% expression of *Tlx* is sufficient to maintain normal cognitive processes. These data thus suggest that disrupting *Tlx* early during neurodevelopment affects hippocampus-dependent learning and memory including spatial working memory during adolescence and contextual fear recall during adulthood. However, when *Tlx* function is impaired specifically during adulthood, effects were limited to spatial learning and short-term recall. Nevertheless, it is important to keep in mind that only contextual and cued fear recall and spatial learning within the Morris water maze were

examined in the conditional knockouts, and a more extensive investigation of cognitive function in these mice is warranted before firm conclusions can be drawn.

Tlx has also been shown to play a role in hippocampal-dependent cognitive processes through its regulatory effect on adult hippocampal neurogenesis. C57BL/6J-*Tlx-Cre-lox* mice exhibit impaired acquisition and short-term recall measured 24 h later, while long-term recall was spared. This impairment was correlated with a decrease in hippocampal neurogenesis (Murai et al. 2014; Zhang et al. 2008). While *Tlx* has been shown to affect spatial learning, a neurogenesis-associated process, limited research on the role of *Tlx* in other neurogenesis-dependent tasks such as pattern separation has been carried out. It should be noted that pattern separation is regarded as a cognitive process which is most likely to be dependent on hippocampal neurogenesis (Aimone et al. 2011; Clelland et al. 2009; Creer et al. 2010; Sahay et al. 2011a,2011b). Collectively, the data suggest that *Tlx* plays a role in hippocampal-associated cognition. It also seems that disruption of *Tlx* during early life is a critical time period that can consequently affect behaviour during adolescence and adulthood. While adult C57BL/6J-*Tlx-Cre-lox* mice exhibit reduced adult hippocampal neurogenesis and impaired spatial learning in the Morris water maze (Zhang et al. 2008), further investigation is still necessary to draw definitive conclusions on the role of *Tlx* in behaviour, and how mechanisms such as hippocampal neurogenesis might drive the behavioural effect resulting from *Tlx* disruption. It should be noted however that controversy remains regarding the role of adult hippocampal neurogenesis in spatial learning (Arruda-Carvalho et al. 2011; Ben Abdallah et al. 2013; Clelland et al. 2009; Drapeau et al. 2003; Saxe et al. 2006; Snyder et al. 2005; Wojtowicz et al. 2008).

The role of *Tlx* in anxiety-related behaviour

Differences in anxiety phenotypes have been reported in the spontaneous deletion model across different genetic backgrounds (C57BL/6J-*frc*, 129P3/JEms-*frc* and Bl6129F1-*frc*). Young et al. (2002) showed that C57BL/6J-*frc* and Bl6129F1-*frc* mice display an anxiolytic phenotype independent of sex, but dependent on strain within the elevated plus maze. Specifically, adult male and female C57BL/6J-*frc* mice exhibit reduced anxiety-like behaviour in the elevated plus maze, while male and female Bl6129F1-*frc* mice showed similar levels of exploration to control mice (Young et al. 2002). In the open field test, male Bl6129F1-*frc* mice displayed decreased anxiety-like behaviour during adolescence and adulthood as indicated by reductions in thigmotaxis. However, this effect was sex-specific as it was not observed in adolescent or adult female Bl6129F1-*frc* mice (O'Leary et al. 2016). Interestingly, O'Leary et al. (2016) observed no deficits in thigmotaxis behaviour in the open field by the heterozygous Bl6129F1-*frc* mice, suggesting that 50% expression of *Tlx* is sufficient for typical anxiety-like behaviour. In the same study, male and female adolescent Bl6129F1-*frc* mice also exhibited impaired cued fear recall (a process that involves the amygdala) and these deficits persisted and were more pronounced in adult

male Bl6129F1-*frc* mice but did not persist into adulthood in female Bl6129F1-*frc* mice. While adolescent and adult male and female Bl6129F1-*frc* mice show some delay in fear acquisition, freezing behaviour reached levels similar to those exhibited by wild-type control mice, thus suggesting that these impairments in cued fear recall are not due to deficits in acquisition (O'Leary *et al.* 2016). Thus, *Tlx* may play a role in anxiety in a sex-dependent manner and particularly when tested during adulthood. In addition, Bl6129F2-*Tlx-hr* mice also exhibit reduced anxiety-like behaviour in the elevated plus maze (Roy *et al.* 2002). Further investigations utilizing the adult conditional C57BL6/J-*Tlx-Cre-lox* mice would help to establish a role for *Tlx* in anxiety-like behaviours and determine whether the anxiolytic phenotype is due to neurodevelopmental abnormalities or *Tlx* impairment in the adult brain. It is possible that reduced adult hippocampal neurogenesis may play a role in anxiety. However, the contribution of new neurons in anxiety is still debated within the literature and a consensus has not been reached (Petric *et al.* 2012). Moreover, the mechanisms underlying the sex-specific effects are currently unclear but there is a growing body of literature focusing on sex-dependent effects of adult hippocampal neurogenesis in stress- and anxiety-related behaviours (Loi *et al.* 2014; Mahmoud *et al.* 2016). Taken together, early-life disruption of *Tlx* produces an anxiolytic phenotype that may be explained by abnormal development of key limbic system structures such as the hippocampus and amygdala, areas known to play a role in anxiety-related behaviours, while the contribution of *Tlx* to anxiety-related behaviours in adulthood requires further investigation.

The role of *Tlx* in motor performance

Hyperactivity has been consistently observed in both male and female Bl6129F1-*frc* mice (O'Leary *et al.* 2016; Wong *et al.* 2010). However, despite the similar developmental time frame of genetic disruption (early life) as well as similar neuroanatomical and emotional behavioural abnormalities, hyperactivity was not observed in Bl6129F2-*Tlx-hr* mice (Roy *et al.* 2002). This may be due to the fact that the striatum remains structurally intact in the Bl6129F2-*Tlx-hr* mice, resulting in normal locomotor activity (Drill 2009). Adult male and female Bl6129F1-*frc* mice show a progressive decline in motor performance on the accelerating rotarod which occurs at the onset of adulthood (O'Leary *et al.* 2016). This impairment does not seem to be related to the hyperactive phenotype, however, as adolescent male and female Bl6129F1-*frc* mice display no impairments in motor performance despite both sexes exhibiting a hyperactive phenotype (O'Leary *et al.* 2016). Interestingly, there were no deficits in motor performance on the rotarod by the heterozygous Bl6129F1-*frc* mice (O'Leary *et al.* 2016). These findings suggest that disruption of motor activity may be a unique characteristic of the spontaneous deletion of *Tlx*. The deficits in rotarod performance also indicate that *Tlx* may be important in corticostriatal pathways. Furthermore, these effects on motor function may be a result of neurodevelopmental deficits as adult C57BL6/J-*Tlx-Cre-lox* mice do not exhibit a hyperactive phenotype. However, motor performance on the rotarod has yet to be tested in these mice (Zhang *et al.* 2008). Investigation

into the motor function (i.e. rotarod performance) of adult mice with a conditional deletion of *Tlx* is needed to establish a role of *Tlx* in motor performance and corticostriatal pathways.

Limitations of current *Tlx* mouse models

A potential limitation to the behavioural studies in mice with an early-life disruption of *Tlx* is the potential confound of visual impairments (Corso-Diaz & Simpson 2015; Young *et al.* 2002; Yu *et al.* 2000). Both Bl6129F1-*frc* and Bl6129F2-*Tlx-hr* mice display atrophy of the retina and impaired eyesight as a consequence. Therefore, behavioural tasks employed in mice with an early-life disruption of *Tlx* should avoid or minimize tasks that rely upon visuospatial learning. While it has been suggested that spontaneous alternation, rotarod motor performance and cued fear conditioning paradigm do not heavily rely upon visuospatial learning (Brown & Wong 2007; Dember & Roberts 1958; Morgan *et al.* 2008), visual impairment is a potential confound for findings from the open field test and contextual fear conditioning paradigm (Cook *et al.* 2001). Another limitation of this knockout model is the aggressive phenotype (Young *et al.* 2002). Male C57BL6/J-*frc* and Bl6129F1-*frc* mice must be singly housed to avoid violent attacks against cage mates. Therefore, tasks such as social recognition, social defeat and social transmission of food preference cannot be performed and thus limits the characterization of the knockout strain. Furthermore, individual housing is a potential confound as social isolation has previously been shown to influence the behavioural phenotype of mice (Voikar *et al.* 2005). In conclusion, the spontaneous deletion model enables investigation of the role of *Tlx* in development as knockout mice are devoid of the *Tlx* gene from conception. However, due to this, it is not possible to decipher if the impairments observed during adulthood are a result of abnormal development and malformed neural circuitry stemming from a lack of *Tlx* during key developmental periods, or from processes that require *Tlx* expression in adulthood. It is also possible that a lack of *Tlx* during early life could promote molecular compensatory mechanisms during key development periods, which further complicates the mechanistic association between *Tlx* disruption and developmental impairments. Similarly, the targeted disruption of *Tlx* by homologous recombination model enables investigation of the role of *Tlx* in development as Bl6129F2-*Tlx-hr* mice are devoid of the *Tlx* gene from conception, similar to the spontaneous deletion model described earlier. The limitation of these two models is overcome by a floxed conditional deletion of *Tlx* model (C57BL6/J-*Tlx-Cre-lox*) whereby typical developmental processes are maintained, except during the period of genetic disruption. Use of this mouse model would allow for investigation of the role of *Tlx* in neurogenesis and behaviour throughout different developmental time points. Another advantage is the reduced off-target side effects, such as retinal malformation, which is a major constraint in the behavioural testing of C57BL6/J-*frc* and Bl6129F1-*frc* mice. However, behaviour has only thus far been examined in adult C57BL6/J-*Tlx-Cre-lox* mice. This conditional deletion model by Zhang *et al.* (2008) gives rise to a deletion of the

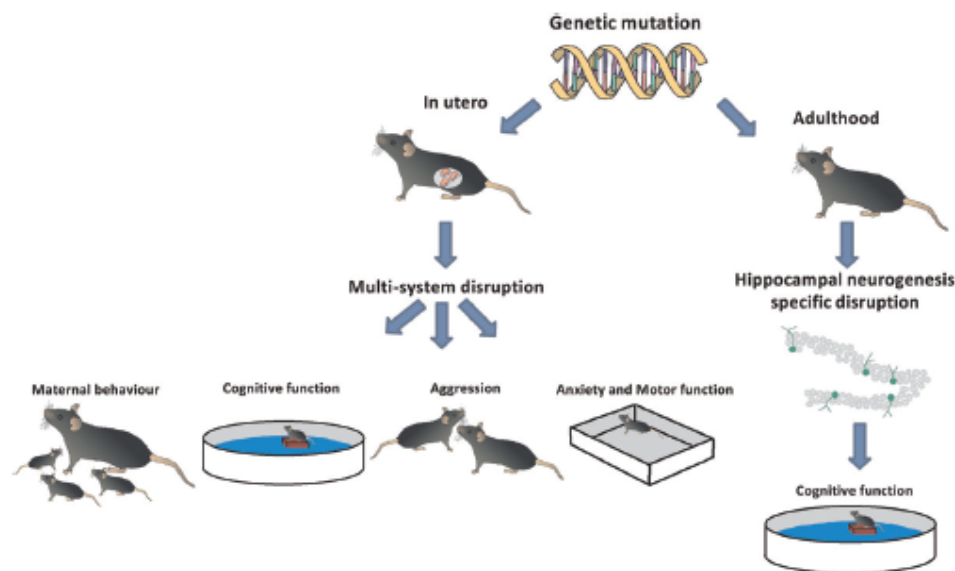

Figure 2: Illustration of the age-dependent effects of *Tlx* disruption: Disruption of *Tlx* during early life results in neuroanatomical and behavioural abnormalities. Conditional knockdown of *Tlx* in adulthood results in specific impairment in hippocampal neurogenesis and its associated cognition.

second *Tlx* allele and a resultant 80% reduction in proliferating cells in the adult hippocampus, while preserving the neuroarchitecture of other regions. Thus, it would be a useful model to consolidate the link between *Tlx*, adult hippocampal neurogenesis and behaviour and to further investigate the association between *Tlx*, hippocampal neurogenesis and behaviour at specific time points during the life span.

It is important to consider that germline mutation models may impact upon developmental processes (Wong *et al.* 2010; Young *et al.* 2002). For example, *Tlx* disruption in early life may result in greater *Tlx*-associated impairment in adulthood compared to deletion models where disruption does not occur until adulthood (Fig. 2). Indeed, early life appears to be a period which is more sensitive to *Tlx* disruption as indicated by greater neuroanatomical and behavioural impairments in mice with an early-life deletion compared to mice with an adult knockdown (Wong *et al.* 2010; Young *et al.* 2002; Zhang *et al.* 2008). Thus, the method of interference on *Tlx* expression may affect the level of impairment observed and in turn might at least partially explain inconsistent findings. Nevertheless, impaired adult hippocampal neurogenesis was consistent across all models. It is also important to consider the genetic background of a strain when comparing genetic models as the strain background has been shown to affect behavioural phenotypes as well as mutation–phenotype interaction (Jacobson & Cryan 2007; Silva *et al.* 1997). Indeed, a mutation–phenotype interaction has been observed within C57BL/6J-*frc* mice who display a higher instance of hydrocephalus, enlarged ventricles and serve aggression compared to Bl6129F1-*frc* mice (Young

et al. 2002). This finding suggests that the C57BL/6J strain may be sensitive to a mutation–phenotype interaction of with the *Tlx* gene. Moreover, disruption of *Tlx* by homologous recombination and adult floxed conditional knockdown have each only been investigated on one background, Bl6129F2 and C57BL/6J, respectively. It is therefore important to be cautious when comparing findings across the different *Tlx* deletion models.

Concluding remarks and future directions

The current evidence suggests that *Tlx* plays a role in aggression-, cognition- and anxiety-related behaviours as well as motor performance during adolescence and adulthood, although there are some discrepancies across studies. The reasons for these discrepancies are unclear but may be a function of the different methods used to reduce or inhibit *Tlx* expression, or the time at which the *Tlx* disruption occurs (early life vs. adulthood). Given that the majority of evidence for the role of *Tlx* in behaviour and cognition comes from studies of mice with an embryonic deletion, future studies will need to investigate a range of cognitive domains within the adult deletion model, such as anxiety and aggression. This will help to elucidate the role of *Tlx* within the adult brain vs. development and will help to eliminate confounds of neurodevelopmental abnormalities. Moreover, the specific role of *Tlx* in other cognitive tasks, such as the ability to discriminate between similar contextual memories, i.e. pattern separation as well as memory consolidation and erasure (cognitive

processes strongly linked to adult hippocampal neurogenesis), is yet to be explored and is a potential avenue for future research (Aimone *et al.* 2011; Barak & Ben Hamida 2012; Clelland *et al.* 2009; Creer *et al.* 2010; Frankland *et al.* 2013; Kitamura & Inokuchi 2014; Sahay *et al.* 2011a, 2011b).

Because early life appears to be a sensitive period to *Tlx* disruption, future studies could investigate the role of *Tlx* during early life by conditional disruption during adolescent vs. adulthood. In effect, conditional disruption of *Tlx* in adulthood would enable unimpeded neurodevelopment during early life, and in turn would help overcome the limitations of the spontaneous deletion model. An alternative approach to the deletion of *Tlx* by Cre-Lox recombination is the use of region-specific lentiviral-mediated knockdown of *Tlx*. Lentiviral-mediated knockdown would allow for the specific disruption of *Tlx* not only in selected brain regions (such as the DG) but also at specific developmental time points, such as early postnatal age or adolescence. This approach would help to overcome many of the caveats produced by the current germline deletion models.

Finally, evidence of alterations in amygdala-dependent behaviour (i.e. cued fear conditioning and emotional regulation) suggests a function for *Tlx* beyond its regulation of adult neurogenesis in the hippocampus. Adolescence is a critical period for postnatal brain maturation and thus susceptibility to and a vulnerable time for the potential to develop emotional- and cognitive-related disorders (Andersen 2003; Blakemore & Choudhury 2006; Green & Nolan 2014; O'Connor & Cryan 2014). Given that the role of *Tlx* in the regulation of cognitive- and anxiety-related behaviour is most apparent during adolescence, *Tlx* is poised to be a key target in understanding the emergence of neurobiological disorders at the onset of adolescence and early adulthood.

References

- Abrahams, B.S., Kwok, M.C., Trinh, E., Budaghzadeh, S., Hossain, S.M. & Simpson, E.M. (2005) Pathological aggression in 'fierce' mice corrected by human nuclear receptor 2E1. *J Neurosci* **25**, 6263–6270.
- Aimone, J.B., Deng, W. & Gage, F.H. (2011) Resolving new memories: a critical look at the dentate gyrus, adult neurogenesis, and pattern separation. *Neuron* **70**, 589–596.
- Akers, K.G., Martinez-Canabal, A., Restivo, L., Yiu, A.P., De Cristofaro, A., Hsiang, H.-L., Wheeler, A.L., Guskjolen, A., Niibori, Y., Shoji, H., Ohira, K., Richards, B.A., Miyakawa, T., Josselyn, S.A. & Frankland, P.W. (2014) Hippocampal neurogenesis regulates forgetting during adulthood and infancy. *Science* **344**, 598–602.
- Amor, S., Puentes, F., Baker, D. & van der Valk, P. (2010) Inflammation in neurodegenerative diseases. *Immunology* **129**, 154–169.
- Anacker, C., Zunszain, P.A., Carvalho, L.A. & Pariante, C.M. (2011) The glucocorticoid receptor: pivot of depression and of antidepressant treatment? *Psychoneuroendocrinology* **36**, 415–425.
- Andersen, S.L. (2003) Trajectories of brain development: point of vulnerability or window of opportunity? *Neurosci Biobehav Rev* **27**, 3–18.
- Andreazza, A.C. & Young, L.T. (2014) The neurobiology of bipolar disorder: identifying targets for specific agents and synergies for combination treatment. *Int J Neuropsychopharmacol* **17**, 1039–1052.
- Arruda-Carvalho, M., Sakaguchi, M., Akers, K.G., Josselyn, S.A. & Frankland, P.W. (2011) Posttraining ablation of adult-generated neurons degrades previously acquired memories. *J Neurosci* **31**, 15113–15127.
- Barak, S. & Ben Hamida, S. (2012) Memory erasure, enhanced extinction and disrupted reconsolidation. *J Neurosci* **32**, 2250–2251.
- Barrientos, R.M., Kitt, M.M., Watkins, L.R. & Maier, S.F. (2015) Neuroinflammation in the normal aging hippocampus. *Neuroscience* **309**, 84–99.
- Belz, T., Liu, H.K., Bock, D., Takacs, A., Vogt, M., Wintermantel, T., Brandwein, C., Gass, P., Greiner, E. & Schutz, G. (2007) Inactivation of the gene for the nuclear receptor tailless in the brain preserving its function in the eye. *Eur J Neurosci* **26**, 2222–2227.
- Ben Abdallah, N.M., Filipkowski, R.K., Pruschy, M., Jaholkowski, P., Winkler, J., Kaczmarek, L. & Lipp, H.P. (2013) Impaired long-term memory retention: common denominator for acutely or genetically reduced hippocampal neurogenesis in adult mice. *Behav Brain Res* **252**, 275–286.
- Bergmann, O., Spalding, K.L. & Frisen, J. (2015) Adult neurogenesis in humans. *Cold Spring Harb Perspect Biol* **7**, 1–12.
- Blakemore, S.J. & Choudhury, S. (2006) Development of the adolescent brain: implications for executive function and social cognition. *J Child Psychol Psychiatry* **47**, 296–312.
- Boldrini, M., Underwood, M.D., Hen, R., Rosoklija, G.B., Dwork, A.J., John Mann, J. & Arango, V. (2009) Antidepressants increase neural progenitor cells in the human hippocampus. *Neuropsychopharmacology* **34**, 2376–2389.
- Boldrini, M., Hen, R., Underwood, M.D., Rosoklija, G.B., Dwork, A.J., Mann, J.J. & Arango, V. (2012) Hippocampal angiogenesis and progenitor cell proliferation are increased with antidepressant use in major depression. *Biol Psychiatry* **72**, 562–571.
- Brown, R.E. & Wong, A.A. (2007) The influence of visual ability on learning and memory performance in 13 strains of mice. *Learn Mem* **14**, 134–144.
- Campbell, S., Marriott, M., Nahmias, C. & MacQueen, G.M. (2004) Lower hippocampal volume in patients suffering from depression: a meta-analysis. *Am J Psychiatry* **161**, 598–607.
- Christie, R., Li, W., Redila, V.A., Booth, H., Wong, B.K.Y., Eadie, B.D., Ernst, C. & Simpson, E.M. (2006) Deletion of the nuclear receptor nr2e1 impairs synaptic plasticity and dendritic structure in the mouse dentate gyrus. *Neuroscience* **137**, 1031–1037.
- Clelland, C.D., Choi, M., Romberg, C., Clemanson, G.D.Jr., Fragniere, A., Tyers, P., Jessberger, S., Saksida, L.M., Barker, R.A., Gage, F.H. & Bussey, T.J. (2009) A functional role for adult hippocampal neurogenesis in spatial pattern separation. *Science* **325**, 210–213.
- Cook, M.N., Williams, R.W. & Flaherty, L. (2001) Anxiety-related behaviors in the elevated zero-maze are affected by genetic factors and retinal degeneration. *Behav Neurosci* **115**, 468–476.
- Corso-Diaz, X. & Simpson, E.M. (2015) Nr2e1 regulates retinal lamination and the development of Muller glia, S-cones, and glycinergic amacrine cells during retinogenesis. *Mol Brain* **8**, 1–21.
- Creer, D.J., Romberg, C., Saksida, L.M., van Praag, H. & Bussey, T.J. (2010) Running enhances spatial pattern separation in mice. *Proc Natl Acad Sci USA* **107**, 2367–2372.
- Crews, L., Adame, A., Patrick, C., Delaney, A., Pham, E., Rockenstein, E., Hansen, L. & Masliah, E. (2010) Increased BMP6 levels in the brains of Alzheimer's disease patients and APP transgenic mice are accompanied by impaired neurogenesis. *J Neurosci* **30**, 12252–12262.
- Curtis, M.A., Penney, E.B., Pearson, A.G., van Roon-Mom, W.M.C., Butterworth, N.J., Dragunow, M., Connor, B. & Faull, R.L.M. (2003) Increased cell proliferation and neurogenesis in the adult human Huntington's disease brain. *Proc Natl Acad Sci USA* **100**, 9023–9027.
- Dember, W.N. & Roberts, W.W. (1958) Alternation behavior in peripherally-blinded rats. *Percept Mot Skills* **8**, 91–94.
- Drapeau, E., Mayo, W., Auroousseau, C., Le Moal, M., Piazza, P.V. & Abrous, D.N. (2003) Spatial memory performances of aged rats in the water maze predict levels of hippocampal neurogenesis. *Proc Natl Acad Sci USA* **100**, 14385–14390.
- Drill, E.A. (2008) *Deciphering the role of tlx in dorsal neural progenitors and its contribution to brain structure and behavior*. Unpublished doctoral dissertation, University of Pittsburgh, Pittsburgh, PA.

- Eriksson, P.S., Perfilieva, E., Bjork-Eriksson, T., Alborn, A.M., Nordborg, C., Peterson, D.A. & Gage, F.H. (1998) Neurogenesis in the adult human hippocampus. *Nat Med* **4**, 1313–1317.
- Ernst, A. & Frisen, J. (2015) Adult neurogenesis in humans – common and unique traits in mammals. *PLoS Biol* **13**, 1–12.
- Frankland, P.W., Kohler, S. & Josselyn, S.A. (2013) Hippocampal neurogenesis and forgetting. *Trends Neurosci* **36**, 497–503.
- Gage, F.H. (2000) Mammalian neural stem cells. *Science* **287**, 1433–1438.
- Germain, P., Staels, B., Dacquet, C., Spedding, M. & Laudet, V. (2006) Overview of nomenclature of nuclear receptors. *Pharmacol Rev* **58**, 685–704.
- Green, H.F. & Nolan, Y.M. (2012) GSK-3 mediates the release of IL-1 β , TNF- α and IL-10 from cortical glia. *Neurochem Int* **61**, 666–671.
- Green, H.F. & Nolan, Y.M. (2014) Inflammation and the developing brain: consequences for hippocampal neurogenesis and behavior. *Neurosci Biobehav Rev* **40**, 20–34.
- Holsboer, F. (2000) The corticosteroid receptor hypothesis of depression. *Neuropsychopharmacology* **23**, 477–501.
- Islam, M.M. & Zhang, C.L. (2015) TLX: a master regulator for neural stem cell maintenance and neurogenesis. *Biochim Biophys Acta* **1849**, 210–216.
- Jacobson, L.H. & Cryan, J.F. (2007) Feeling strained? Influence of genetic background on depression-related behavior in mice: a review. *Behav Genet* **37**, 171–213.
- Juarez, P., Valdovinos, M.G., May, M.E., Lloyd, B.P., Couppis, M.H. & Kennedy, C.H. (2013) Serotonin(2)A/C receptors mediate the aggressive phenotype of TLX gene knockout mice. *Behav Brain Res* **256**, 354–361.
- Kitamura, T. & Inokuchi, K. (2014) Role of adult neurogenesis in hippocampal-cortical memory consolidation. *Mol Brain* **7**, 1–8.
- Kokoeva, M.V., Yin, H. & Flier, J.S. (2005) Neurogenesis in the hypothalamus of adult mice: potential role in energy balance. *Science* **310**, 679–683.
- Kuhn, H.G., Dickinson-Anson, H. & Gage, F.H. (1996) Neurogenesis in the dentate gyrus of the adult rat: age-related decrease of neuronal progenitor proliferation. *J Neurosci* **16**, 2027–2033.
- Kumar, R.A., Chan, K.L., Wong, A.H., Little, K.O., Rajcan-Separovic, E., Abrahams, B.S. & Simpson, E.M. (2004) Unexpected embryonic stem (ES) cell mutations represent a concern in gene targeting: lessons from "fierce" mice. *Genesis* **38**, 51–57.
- Kumar, R.A., McGhee, K.A., Leach, S., Bonaguro, R., Maclean, A., Aguirre-Hernandez, R., Abrahams, B.S., Cocco, E.F., Hodgins, S., Turecki, G., Condon, A., Muir, W.J., Brooks-Wilson, A.R., Blackwood, D.H. & Simpson, E.M. (2008) Initial association of NR2E1 with bipolar disorder and identification of candidate mutations in bipolar disorder, schizophrenia, and aggression through resequencing. *Am J Med Genet B Neuropsychiatr Genet* **147b**, 880–889.
- Levone, B.R., Cryan, J.F. & O'Leary, O.F. (2015) Role of adult hippocampal neurogenesis in stress resilience. *Neurobiol Stress* **1**, 147–155.
- Li, W., Sun, G., Yang, S., Qu, Q., Nakashima, K. & Shi, Y. (2008) Nuclear receptor TLX regulates cell cycle progression in neural stem cells of the developing brain. *Mol Endocrinol* **22**, 56–64.
- Li, S., Sun, G., Murai, K., Ye, P. & Shi, Y. (2012) Characterization of TLX expression in neural stem cells and progenitor cells in adult brains. *PLoS One* **7**, 1–8.
- Loj, M., Koricka, S., Lucassen, P.J. & Joels, M. (2014) Age- and sex-dependent effects of early life stress on hippocampal neurogenesis. *Front Endocrinol* **5**, 1–11.
- Mahmoud, R., Wainwright, S.R. & Galea, L.A. (2016) Sex hormones and adult hippocampal neurogenesis: regulation, implications, and potential mechanisms. *Front Neuroendocrinol* **41**, 129–152.
- Malberg, J.E., Eisch, A.J., Nestler, E.J. & Duman, R.S. (2000) Chronic antidepressant treatment increases neurogenesis in adult rat hippocampus. *J Neurosci* **20**, 9104–9110.
- Mandrekar-Colucci, S. & Landreth, G.E. (2011) Nuclear receptors as therapeutic targets for Alzheimer's disease. *Expert Opin Ther Targets* **15**, 1085–1097.
- Marlatt, M.W. & Lucassen, P.J. (2010) Neurogenesis and Alzheimer's disease: biology and pathophysiology in mice and men. *Curr Alzheimer Res* **7**, 113–125.
- Miyawaki, T., Honda, Y., Uemura, A., Tanabe, Y., Dezawa, M., Yu, R.T. & Tanabe, T. (2004) Tlx, an orphan nuclear receptor, regulates cell numbers and astrocyte development in the developing retina. *J Neurosci* **24**, 8124–8134.
- Monaghan, A.P., Grau, E., Bock, D. & Schutz, G. (1995) The mouse homolog of the orphan nuclear receptor *tailless* is expressed in the developing forebrain. *Development* **121**, 839–853.
- Monaghan, A.P., Bock, D., Gass, P., Schwager, A., Wolfer, D.P., Lipp, H.P. & Schutz, G. (1997) Defective limbic systemin micelacking the *tailless* gene. *Nature* **390**, 515–517.
- Morgan, D., Munireddy, S., Alamed, J., DeLeon, J., Diamond, D.M., Bickford, P., Hutton, M., Lewis, J., McGowan, E. & Gordon, M.N. (2008) Apparent behavioral benefits of tau overexpression in P301L tau transgenic mice. *J Alzheimers Dis* **15**, 605–614.
- Morris, R. (1984) Developments of a water-maze procedure for studying spatial learning in the rat. *J Neurosci Methods* **11**, 47–60.
- Murai, K., Qu, Q., Sun, G., Ye, P., Li, W., Asuelime, G., Sun, E., Tsai, G.E. & Shi, Y. (2014) Nuclear receptor TLX stimulates hippocampal neurogenesis and enhances learning and memory in a transgenic mouse model. *Proc Natl Acad Sci USA* **111**, 9115–9120.
- Murai, K., Sun, G., Ye, P., Tian, E., Yang, S., Cui, Q., Sun, G., Trinh, D., Sun, O., Hong, T., Wen, Z., Kalkum, M., Riggs, A.D., Song, H., Ming, G.-J. & Shi, Y. (2016) The TLX-miR-219 cascade regulates neural stem cell proliferation in neurodevelopment and schizophrenia iPSC model. *Nat Commun* **7**, 1–15.
- Nakashiba, T., Cushman, J.D., Pelkey, K.A., Renaudineau, S., Buhl, D.L., McHugh, T.J., Rodriguez Barrera, V., Chittajallu, R., Iwamoto, K.S., McBain, C.J., Fanselow, M.S. & Tonegawa, S. (2012) Young dentate granule cells mediate pattern separation, whereas old granule cells facilitate pattern completion. *Cell* **149**, 188–201.
- Nolan, Y.M., Sullivan, A.M. & Toulouse, A. (2013) Parkinson's disease in the nuclear age of neuroinflammation. *Trends Mol Med* **19**, 187–196.
- O'Connor, R.M. & Cryan, J.F. (2014) Adolescent brain vulnerability and psychopathology through the generations: role of diet and dopamine. *Biol Psychiatry* **75**, 4–6.
- O'Leary, O.F. & Cryan, J.F. (2014) A ventral view on antidepressant action: roles for adult hippocampal neurogenesis along the dorsoventral axis. *Trends Pharmacol Sci* **35**, 675–687.
- O'Leary, O.F., Zandy, S., Dinan, T.G. & Cryan, J.F. (2013) Lithium augmentation of the effects of desipramine in a mouse model of treatment-resistant depression: a role for hippocampal cell proliferation. *Neuroscience* **228**, 36–46.
- O'Leary, O.F., Felice, D., Galimberti, S., Savignac, H.M., Bravo, J.A., Crowley, T., El Yacoubi, M., Vaugeois, J.M., Gassmann, M., Bettler, B., Dinan, T.G. & Cryan, J.F. (2014) GABAB(1) receptor subunit isoforms differentially regulate stress resilience. *Proc Natl Acad Sci USA* **111**, 15232–15237.
- O'Leary, J.D., Kozareva, D.A., Hueston, C.M., O'Leary, O.F., Cryan, J.F. & Nolan, Y.M. (2016) The nuclear receptor Tlx regulates motor, cognitive and anxiety-related behaviours during adolescence and adulthood. *Behav Brain Res* **306**, 36–47.
- Oomen, C.A., Bekinschtein, P., Kent, B.A., Saksida, L.M. & Bussey, T.J. (2014) Adult hippocampal neurogenesis and its role in cognition. *Wiley Interdiscip Rev Cogn Sci* **5**, 573–587.
- Petrik, D., Lagace, D.C. & Eisch, A.J. (2012) The neurogenesis hypothesis of affective and anxiety disorders: are we mistaking the scaffolding for the building? *Neuropharmacology* **62**, 21–34.
- Qin, S., Niu, W., Iqbal, N., Smith, D.K. & Zhang, C.L. (2014) Orphan nuclear receptor TLX regulates astrogenesis by modulating BMP signaling. *Front Neurosci* **8**, 1–10.
- Qu, Q. & Shi, Y. (2009) Neural stem cells in the developing and adult brains. *J Cell Physiol* **221**, 5–9.
- Reif, A., Schmitt, A., Fritzen, S. & Lesch, K.-P. (2007) Neurogenesis and schizophrenia: dividing neurons in a divided mind? *Eur Arch Psychiatry Clin Neurosci* **257**, 290–299.

- Revest, J.M., Dupret, D., Koehl, M., Funk-Reiter, C., Grosjean, N., Piazza, P.V. & Abrous, D.N. (2009) Adult hippocampal neurogenesis is involved in anxiety-related behaviors. *Mol Psychiatry* **14**, 959–967.
- Ross, C.A., Margolis, R.L., Reading, S.A.J., Pletnikov, M. & Coyle, J.T. (2006) Neurobiology of schizophrenia. *Neuron* **52**, 139–153.
- Roy, K., Thiels, E. & Monaghan, A.P. (2002) Loss of the tailless gene affects forebrain development and emotional behavior. *Physiol Behav* **77**, 595–600.
- Roy, K., Kuznicki, K., Monaghan, A.P., Wu, Q., Sun, E., Bock, D., Schutz, G. & Vranich, N. (2004) The Tlx gene regulates the timing of neurogenesis in the cortex. *J Neurosci* **38**, 8333–8345.
- Ryan, S.M. & Nolan, Y.M. (2016) Neuroinflammation negatively affects adult hippocampal neurogenesis and cognition: can exercise compensate? *Neurosci Biobehav Rev* **61**, 121–131.
- Ryan, S.M., O'Keefe, G.W., O'Connor, C., Keeshan, K. & Nolan, Y.M. (2013) Negative regulation of TLX by IL-1 β correlates with an inhibition of adult hippocampal neural precursor cell proliferation. *Brain Behav Immun* **33**, 7–13.
- Sahay, A., Scobie, K.N., Hill, A.S., O'Carroll, C.M., Kheirbek, M.A., Burghardt, N.S., Fenton, A.A., Dranovsky, A. & Hen, R. (2011a) Increasing adult hippocampal neurogenesis is sufficient to improve pattern separation. *Nature* **472**, 466–470.
- Sahay, A., Wilson, D.A. & Hen, R. (2011b) Pattern separation: a common function for new neurons in hippocampus and olfactory bulb. *Neuron* **70**, 582–588.
- Santarelli, L., Saxe, M., Gross, C., Surget, A., Battaglia, F., Dulawa, S., Weisstaub, N., Lee, J., Duman, R., Arancio, O., Belzung, C. & Hen, R. (2003) Requirement of hippocampal neurogenesis for the behavioral effects of antidepressants. *Science* **301**, 805–809.
- Saxe, M.D., Battaglia, F., Wang, J.W., Malleret, G., David, D.J., Monkton, J.E., Garcia, A.D., Sofroniew, M.V., Kandel, E.R., Santarelli, L., Hen, R. & Drew, M.R. (2006) Ablation of hippocampal neurogenesis impairs contextual fear conditioning and synaptic plasticity in the dentate gyrus. *Proc Natl Acad Sci USA* **103**, 17501–17506.
- Schnell, A., Chappuis, S., Schmutz, I., Brai, E., Ripperger, J.A., Schaad, O., Weitz, H., Descombes, P., Alberi, L. & Albrecht, U. (2014) The nuclear receptor REV-ERB α regulates *Fabp7* and modulates adult hippocampal neurogenesis. *PLoS One* **9**, 1–14.
- Shi, Y., Chidung Lie, D., Taupin, P., Nakashima, K., Ray, J., Yu, R.T., Gage, F.H. & Evans, R.M. (2004) Expression and function of orphan nuclear receptor TLX in adult neural stem cells. *Nature* **427**, 78–83.
- Silva, A.J., Simpson, E.M., Takahashi, J.S. et al. (1997) Mutant mice and neuroscience: recommendations concerning genetic background. *Neuron* **19**, 755–759.
- Sittig, Laura J., Carbonetto, P., Engel, Kyle A., Krauss, Kathleen S., Barrios-Camacho, Camila M. & Palmer, Abraham A. (2016) Genetic background limits generalizability of genotype-phenotype relationships. *Neuron* **91**, 1253–1259.
- Snyder, J.S., Hong, N.S., McDonald, R.J. & Wojtowicz, J.M. (2005) A role for adult neurogenesis in spatial long-term memory. *Neuroscience* **130**, 843–852.
- Snyder, J.S., Soumier, A., Brewer, M., Pickel, J. & Cameron, H.A. (2011) Adult hippocampal neurogenesis buffers stress responses and depressive behaviour. *Nature* **476**, 458–461.
- Sousa-Ferreira, L., de Almeida, L.P. & Cavadas, C. (2014) Role of hypothalamic neurogenesis in feeding regulation. *Trends Endocrinol Metab* **25**, 80–88.
- Spalding, K.L., Bergmann, O., Alkass, K., Bernard, S., Salehpour, M., Huttner, H.B., Bostrom, E., Westerlund, I., Vial, C., Buchholz, B.A., Possnert, G., Mash, D.C., Druid, H. & Frisen, J. (2013) Dynamics of hippocampal neurogenesis in adult humans. *Cell* **153**, 1219–1227.
- Stenman, J., Yu, R.T., Evans, R.M. & Campbell, K. (2003) Tlx and Pax6 co-operate genetically to establish the pallio-subpallial boundary in the embryonic mouse telencephalon. *Development* **130**, 1113–1122.
- Strakowski, S.M., Adler, C.M., Almeida, J., Altshuler, L.L., Blumberg, H.P., Chang, K.D., DeBello, M.P., Frangou, S., McIntosh, A., Phillips, M.L., Sussman, J.E. & Townsend, J.D. (2012) The functional neuroanatomy of bipolar disorder: a consensus model. *Bipolar Disord* **14**, 313–325.
- Sun, G., Yu, R.T., Evans, R.M. & Shi, Y. (2007) Orphan nuclear receptor TLX recruits histone deacetylases to repress transcription and regulate neural stem cell proliferation. *Proc Natl Acad Sci USA* **104**, 15282–15287.
- Sun, G., Alzayady, K., Stewart, R., Ye, P., Yang, S., Li, W. & Shi, Y. (2010) Histone demethylase LSD1 regulates neural stem cell proliferation. *Mol Cell Biol* **30**, 1997–2005.
- Tasan, R.O., Nguyen, N.K., Weger, S., Sartori, S.B., Singewald, N., Heilbronn, R., Herzog, H. & Sperk, G. (2010) The central and basolateral amygdala are critical sites of neuropeptide YY2 receptor-mediated regulation of anxiety and depression. *J Neurosci* **30**, 6282–6290.
- Toro, C.T. & Deakin, J.F.W. (2007) Adult neurogenesis and schizophrenia: a window on abnormal early brain development? *Schizophr Res* **90**, 1–14.
- Videbech, P. & Ravnkilde, B. (2004) Hippocampal volume and depression: a meta-analysis of MRI studies. *Am J Psychiatry* **161**, 1957–1966.
- Voikar, V., Koks, S., Vasar, E. & Rauvala, H. (2001) Strain and gender differences in the behavior of mouse lines commonly used in transgenic studies. *Physiol Behav* **72**, 271–281.
- Voikar, V., Polus, A., Vasar, E. & Rauvala, H. (2005) Long-term individual housing in C57BL/6J and DBA/2 mice: assessment of behavioral consequences. *Genes Brain Behav* **4**, 240–252.
- Wang, T. & Xiong, J.-Q. (2016) The orphan nuclear receptor TLX/NR2E1 in neural stem cells and diseases. *Neurosci Bull* **32**, 108–114.
- Wang, Y., Liu, H.K. & Schutz, G. (2013) Role of the nuclear receptor Tailless in adult neural stem cells. *Mech Dev* **130**, 388–390.
- Wehner, J.M. & Silva, A. (1996) Importance of strain differences in evaluations of learning and memory processes in null mutants. *Dev Dis Res Rev* **2**, 243–248.
- Winner, B. & Winkler, J. (2015) Adult neurogenesis in neurodegenerative diseases. *Cold Spring Harb Perspect Biol* **7**, 1–14.
- Wojtowicz, J.M., Askew, M.L. & Winocur, G. (2008) The effects of running and of inhibiting adult neurogenesis on learning and memory in rats. *Eur J Neurosci* **27**, 1494–1502.
- Wong, B.K.Y., Hossain, S.M., Trinh, E., Ottmann, G.A., Budaghzadeh, S., Zheng, Q.Y. & Simpson, E.M. (2010) Hyperactivity, startle reactivity and cell-proliferation deficits are resistant to chronic lithium treatment in adult *Nr2e1*(frc/frc) mice. *Genes Brain Behav* **9**, 681–694.
- Yokoyama, A., Takezawa, S., Schule, R., Kitagawa, H. & Kato, S. (2008) Transrepressive function of TLX requires the histone demethylase LSD1. *Mol Cell Biol* **28**, 3995–4003.
- Young, K.A., Berry, M.L., Mahaffey, C.L., Saionz, J.R., Hawes, N.L., Chang, B., Zheng, Q.Y., Smith, R.S., Bronson, R.T., Nelson, R.J. & Simpson, E.M. (2002) Fierce: a new mouse deletion of *Nr2e1*; violent behaviour and ocular abnormalities are background-dependent. *Behav Brain Res* **132**, 145–158.
- Yu, R.T., Chiang, M.Y., Tanabe, T., Kobayashi, M., Yasuda, K., Evans, R.M. & Umehara, K. (2000) The orphan nuclear receptor Tlx regulates Pax2 and is essential for vision. *Proc Natl Acad Sci USA* **97**, 2621–2625.
- Zhang, C.L., Zou, Y., He, W., Gage, F.H. & Evans, R.M. (2008) A role for adult TLX-positive neural stem cells in learning and behaviour. *Nature* **451**, 1004–1007.
- Zhao, C., Sun, G., Li, S. & Shi, Y. (2009) A feedback regulatory loop involving microRNA-9 and nuclear receptor TLX in neural stem cell fate determination. *Nat Struct Mol Biol* **16**, 365–371.

Acknowledgments

This work was funded by Science Foundation Ireland (SFI) under grant number SFI/IA/1537. The authors declare no conflict of interest.

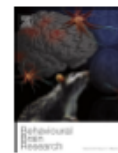

Research report

The nuclear receptor Trx regulates motor, cognitive and anxiety-related behaviours during adolescence and adulthood



James D. O'Leary^{a,1}, Danka A. Kozareva^{a,1}, Cara M. Hueston^a, Olivia F. O'Leary^{a,b}, John F. Cryan^{a,b}, Yvonne M. Nolan^{a,*}

^a Department of Anatomy and Neuroscience, University College Cork, Ireland

^b APC, Microbiome Institute, University College Cork, Ireland

HIGHLIGHTS

- The nuclear receptor Trx regulates motor, cognitive and anxiety-related behaviours during adolescence and adulthood.
- The role of Trx in spatial working memory is most apparent in adolescence.
- Regulation of anxiety-related behaviour by Trx is sex-dependent.
- The effects of Trx deletion on hyperactivity are sex-independent.
- Regulation of cortical-striatal behaviour by Trx is age-dependent.

ARTICLE INFO

Article history:

Received 6 November 2015

Received in revised form 4 March 2016

Accepted 8 March 2016

Available online 9 March 2016

Keywords:

Trx

Nr2e1

Adolescence

Cognition

Anxiety

Neurogenesis

ABSTRACT

The nuclear receptor Trx is a key regulator of embryonic and adult hippocampal neurogenesis and has been genetically linked to bipolar disorder. Mice lacking Trx (*Nr2e1*^{-/-}) display deficits in adult hippocampal neurogenesis and behavioural abnormalities. However, whether Trx regulates behaviour during adolescence or in a sex-dependent manner remains unexplored. Therefore, we investigated the role of Trx in a series of behavioural tasks in adolescent male and female mice with a spontaneous deletion of Trx (*Nr2e1*^{-/-} mice). Testing commenced at adolescence (postnatal day 28) and continued until adulthood (postnatal day 67). Adolescent male and female *Nr2e1*^{-/-} mice were hyperactive in an open field, an effect that persisted in adulthood. Male but not female *Nr2e1*^{-/-} mice exhibited reduced thigmotaxis during adolescence and adulthood. Impairments in rotarod motor performance developed in male and female *Nr2e1*^{-/-} mice at the onset of adulthood. Spontaneous alternation in the Y-maze, a hippocampus-dependent task, was impaired in adolescent but not adult male and female *Nr2e1*^{-/-} mice. Contextual fear conditioning was impaired in adolescent male *Nr2e1*^{-/-} mice only, but both male and female adolescent *Nr2e1*^{-/-} mice showed impaired cued fear conditioning, a hippocampal-amygdala dependent cognitive process. These deficits persisted into adulthood in males but not females. In conclusion, deletion of Trx impairs motor, cognitive and anxiety-related behaviours during adolescence and adulthood in male and female mice with most effects occurring during adolescence rather than adulthood, independent of housing conditions. This suggests that Trx has functions beyond regulation of adult hippocampal neurogenesis, and may be an important target in understanding neurobiological disorders.

© 2016 Elsevier B.V. All rights reserved.

1. Introduction

The orphan nuclear receptor Trx, encoded by the gene *Nr2e1*, is a key regulator of embryonic and adult neurogenesis, with expression localized within the neurogenic niche of the forebrain and

retina [1–3]. Trx has been shown to be crucial for neural and retinal development [4,5]. Mice lacking Trx display hypoplasia of the retina, cerebrum and olfactory bulbs as well as malformation of the limbic system, specifically the dentate gyrus within the hippocampus [5–9]. Moreover, deletion of Trx has been shown to impair adult neurogenesis, synaptic plasticity and to negatively affect dendritic structure within the dentate gyrus of adult mice [10]. Thus, alterations in Trx expression are likely to affect hippocampus-dependent behaviour.

* Corresponding author.

E-mail address: y.nolan@ucc.ie (Y.M. Nolan).

¹ Equal contribution.

Several different mouse models have been developed to target *Tlx* *in vivo*, such as targeted disruption by homologous recombination [3,7], spontaneous deletion [8] and conditional deletion [11] (collectively referred to here as *Nr2e1*^{-/-}). Differences between these models make it difficult to draw comparisons. However, similarities are seen across models as mice with impairments in *Tlx* function have shown a number of behavioural abnormalities. The most striking behavioural phenotype of mice with a spontaneous deletion is aggression, which is regulated by the prefrontal cortex and limbic system [12]. This circuitry has previously been shown to be defective in *Nr2e1*^{-/-} mice with both a targeted disruption of *Tlx* by homologous recombination and spontaneous deletion [6,8]. Hyperactivity has also been documented in mice with a spontaneous deletion of *Tlx* from as early as postnatal day (P) 18 [13]. Furthermore, impairments in spatial learning have been observed in adult mice with a conditional deletion of *Tlx*, while contextual and cued fear memory were unaffected [11]. Conversely, it has been shown that following a targeted disruption of *Tlx* by homologous recombination, mice exhibited poor contextual and cued fear recall, despite normal fear acquisition, in addition to reduced anxiety-like behaviour within the elevated plus maze [7]. The reasons for the discrepancies across studies in adult mice are unclear but may be a function of the different methods used to reduce or inhibit *Tlx* expression, and/or when *Tlx* disruption occurs, such as early life or adulthood [7,14]. When the *Tlx* transgene was overexpressed using lentivirus-mediated means or in transgenic mice, an increase in adult hippocampal neurogenesis and enhanced performance in the Morris water maze as well as prepulse inhibition was observed [15]. This work suggests a role for *Tlx* in learning and memory through its regulatory effect on adult hippocampal neurogenesis.

The mammalian brain continues to develop after birth, throughout childhood and into adulthood [16,17]. The adolescent period, which occurs in mice in postnatal weeks 3–8 [18], is a critical developmental window when crucial neural circuits are established via a period of synaptic re-modelling [19,20] and is a key period for susceptibility to stress and the emergence of neurobiological disorders such as schizophrenia, depression and anxiety [21,22][21–25]. Interestingly, linkage analysis studies of patients with bipolar disorder have reported susceptibility loci on chromosomes where *Nr2e1* is expressed [26] thus suggesting a potential link between *Tlx* and mood disorders. Several studies have characterized the expression and the functional role of *Tlx* within the brain during embryonic and early postnatal development [1,2,7,13,27]. However, the functional role of *Tlx* during adolescence remains largely unexplored. In particular, it is not yet clear whether there are critical periods during postnatal life when *Tlx* might play a more dominant role in cognition, and whether such effects are sex-dependent. Thus, the aim of this study was to explore the extent and involvement of *Tlx* in hippocampus-dependent cognition as well as hippocampus-independent functions during adolescence and adulthood in both male and female mice.

2. Materials and method

2.1. Experimental design

Behavioural analysis was carried out in male and female mice with a spontaneous deletion of the *Tlx* gene (*Nr2e1*^{-/-}), heterozygous (*Nr2e1*^{+/-}) and wild type littermates. In order to capture potential deficits that may manifest during the adolescent developmental period, behavioural testing commenced at P28 and continued into adulthood until P67. Sensorimotor tests and motor performance tests on the rotarod were conducted each week. Open field tests, spontaneous alternation in the Y-maze, and contextual and cued fear conditioning were conducted during adolescence

(P28–35), and again in adulthood (P56–67; see Fig. 1 for experimental design). *Nr2e1*^{-/-} mice display impaired eye sight, therefore the behavioural tasks employed were chosen to minimize the dependency on visuospatial learning as much as possible [28–30].

2.2. Animals

The animals used in the present study were all first generation offspring on a hybrid B6129 background resulting from mating male heterozygote (*Nr2e1*^{+/-}) mice on a 129S1/SvImJ background with female heterozygote (*Nr2e1*^{+/-}) mice on a C57Bl/6J background. They were kindly provided by Prof. Elizabeth Simpson, University of British Columbia and were generated as previously described [13]. These mice exhibit a spontaneous deletion of the entire *Nr2e1* allele, including all nine exons. However, the deletion of the *Tlx* gene does not affect the transcription of neighbouring genes [31]. The impact of maternal care was controlled for as all animals were first generation littermate offspring resulting from mating male heterozygote (*Nr2e1*^{+/-}) mice with female heterozygote (*Nr2e1*^{+/-}) mice. All pups were weaned at P21. Due to the aggression that has been previously described in this strain, male *Nr2e1*^{-/-} mice were singly housed after weaning [8]. Male wild type and heterozygous littermates and all female mice were grouped housed in standard housing conditions (temperature 21 °C and relative humidity 55%). All mice had food and water available *ad libitum*. All experiments were conducted in accordance with the European Directive 2010/63/EU, and under an authorization issued by the Health Products Regulatory Authority Ireland and approved by the Animal Ethics Committee of University College Cork.

2.3. Body weight, growth rate and primary observation tests

Animals were weighed and growth rate calculated each week [(present weight – past weight)/past weight x100]. Sensorimotor tests were conducted to identify any gross impairment which may have affected behavioural testing. The primary observation scores and sensorimotor testing were adapted from the Irwin behavioural screen [32–34]. This included measures of general health and physical appearance as well as sensorimotor reflexes, piloerection, palpebral closure, salivation, tremors, gait, trunk curl, pinna reflex, whisker reflex, reaching reflex, eye reflex, righting reflex, toe pinch, and provoked biting as a measure of aggression. Observations were recorded each week (P30, P37, P44, P51 and P58) and a score was assigned as indicated in Table 1.

2.4. Locomotor activity and thigmotaxis in the open field

Spontaneous exploratory locomotor activity and thigmotaxis in the open field were used as a general measure of motor function and anxiety-related behaviours, respectively [32]. Animals were placed within a rectangular open field (32 x 40 cm; made in house) for 10 min. Locomotor activity is a simple measure of the distance the animal travels within the open field during the test, where large distances indicate hyperactivity. Thigmotaxis refers to the tendency of rodents to stay close to the walls of a maze during exploration [32,35]. The behavioural test measures anxiogenesis induced by exposure to a novel environment as rodents tend to avoid open spaces and stay close to borders of maze arenas. Both locomotor activity and thigmotaxis were analysed using specialized software (Ethovision XT, Noldus Information Technology, USA).

2.5. Motor performance in the rotarod

Performance on the accelerating rotarod is a well-established measure of motor performance [32] and was assessed in this

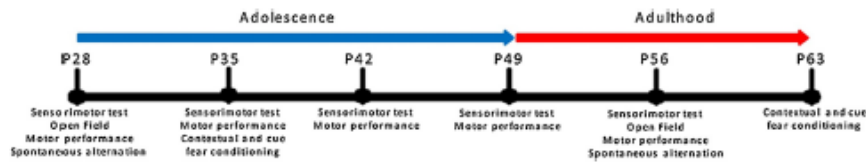

Fig. 1. Experimental design. *Nr2e1^{-/-}*, *Nr2e1^{+/-}* and wild type mice were tested during adolescent development (postnatal day 28–49) and adulthood (postnatal day 56–67).

Table 1
Primary observation of *Nr2e1^{-/-}* mice.

Physical Characteristics		Sensorimotor Reflexes	
Presence of Whiskers	Score	Appearance of Fur	Score
None	0	Ungroomed and disheveled	0
A few	1	Somewhat disheveled	1
Most, but not a full set	2	Well-groomed (normal)	2
A full set	3		
Piloerection		Wounds	
None	0	None	0
Most hairs on end	1	Signs of previous wound	1
		Slight wounds present	2
Respiration		Moderate wounds present	3
Gaspings, irregular	0	Extensive wounds present	4
Slow, shallow	1	Salivation	
Normal	2	None	0
Hyperventilation	3	Slight margin of sub-maxillary area	1
		Wet zone entire sub-maxillary area	2
Patches of Fur missing on Face		Patches of Fur missing on body	
None	0	None	0
Some	1	Some	1
Extensive	2	Extensive	2
Palpebral Closure		Skin Color	
Eyes wide open	0	Blanched	0
Eyes 1/2 closed	1	Pink	1
Eyes closed	2	Bright, deep red, flushed	2
		Gait	
		Normal	0
		Fluid but abnormal	1
		Limited movement only	2
		Incapacity	3
		Reaching Reflex	
		None	0
		Upon nose contact	1
		Upon vibrissae contact	2
		Before vibrissae contact	3
		Early vigorous extension	4
		Provoked Biting	
		Absent	0
		Present	1
		Pinna Reflex	
		None	0
		Active retraction, moderately brisk flick	1
		Hyperactive, repetitive flick	2
		Righting Reflex	
		No impairment	0
		Number of sec required to right	1 to 10
		Marked	2
		Trunk Curl	
		Absent	0
		Present	1
		Eye Reflex	
		Present	0
		Absent	1
		Whisker Reflex	
		Present	0
		Absent	1
		Toe Pinch	
		None	0
		Slight withdrawal	1
		Moderate withdrawal, not brisk	2
		Brisk, rapid withdrawal	3
		Very brisk, repeated extension and flexion	4
		Tremor	
		None	0
		Mild	1
		Marked	2

paradigm using a protocol adapted from Menalled, El-Khodori [36]. The mice were placed on the rotarod apparatus (Ugo Basile, Italy) for five minutes and tested on an accelerating protocol (4 RPM to 40 RPM over five minutes, averaging 7.2 RPM acceleration). The latency for each mouse to fall was recorded. The mice were tested during three trials a day for three consecutive days (total nine trials), with the best score recorded. The test was repeated at weekly intervals beginning P28, P35, P42, P49 and P56, respectively. A reduced latency to fall indicates impairment in motor performance and suggests a dysfunction within the cortical-striatal circuit which regulates motor behaviour.

2.6. Spontaneous alternation in the Y maze

Spontaneous alternation behaviour is the tendency of rodents to alternate their exploration of maze arms (such as those of the Y maze) and is used as a measure of hippocampal-dependent working memory as previously described [37]. The Y maze consisted of three arms 120° from each other (16 cm × 6.5 cm; made in house). The protocol was adapted from Senechal et al. [38]. Each animal was placed into the first arm of the maze facing the wall, and allowed to explore the maze for five minutes. The number and order of arm entries were recorded. An arm entry was defined as all four paws entering into the arm (four paw criteria). An alternation was determined as the number of consecutive entries into the three maze arms. Alternations were then divided by the total number of entries during the five minute test period.

2.7. Contextual and cued fear conditioning

Contextual fear conditioning was used to assess hippocampal-dependent learning, while cued fear conditioning was employed to probe amygdala-dependent cognitive processes as previously described [39,40]. During acquisition, animals were first placed into the fear conditioning chamber (Med Associates, 30.5 cm × 24.1 cm × 21.0 cm) which was scented with a lemon and ginger tea bag (Twinings™). Animals were allowed to explore the chamber for two minutes during an acclimation period and then received three shock and tone pairs (30 s tone; 5 kHz; 70 dB; 1 s foot shock; 0.65 mA DC current) separated by 30 s intervals. Animals were placed back in their home cage one minute after the final shock. Contextual fear memory was assessed 24 h later by placing the animals back into the same chamber, but in the absence of tone and shock. Freezing behaviour (sec) was measured during the last 3.5 min of the total 5.5 min protocol using specialized software (Video freeze, Med Associates, USA).

Cued fear conditioning was measured 24 h after the contextual test in the same chambers. To measure cued fear learning, animals were placed into a novel context (white floor; black wall insert at 60°; and almond scent 1%) with presentation of the tone but no foot shock. Animals were allowed two minutes to acclimatize followed by three tone presentations (30 s; 5 kHz; 70 dB). Freezing behaviour during the 30 s tone presentations was recorded (Video freeze, Med Associates, USA). Contextual and cued fear conditioning was assessed during adolescence and adulthood with mice reconditioned to the tone and context in adulthood. Prior to reconditioning

in adulthood, mice were placed back into the initial shock chamber to assess contextual fear memory retention. Twenty four hours later mice were placed in the same chamber as the cued fear conditioning chamber in order to assess cued fear memory recall retention.

2.8. Statistical analysis

All data were analysed using SPSS statistical software (SPSS, Chicago, IL). Data from body weight, rotarod motor performance, and cued fear conditioning were analysed by repeated measures ANOVA with Bonferroni post hoc test. Data from open field, spontaneous alternation and contextual fear conditioning were analysed by one-way ANOVA, with Fisher's LSD post hoc analysis. Non-parametric data from sensorimotor tests were analysed by the Kruskal–Wallis one-way ANOVA. An alpha level of 0.05 was used as criterion for statistical significance. Parametric data are presented as mean \pm SEM. Nonparametric data are presented as percentage (%) displaying normal response.

3. Results

3.1. *Nr2e1*^{-/-} mice have reduced body weight and increased growth rate during adolescence

Male and female mice gained weight throughout development (Fig. 2a and b). The Mauchly's test indicated that in the male cohort the assumptions of sphericity had been violated ($\chi^2(9) = 51.29$, $p < 0.01$). Therefore the degrees of freedom were corrected using Greenhouse–Geisser estimates of sphericity as the epsilon was less than 0.75 ($\epsilon = 0.595$). The results show that all male mice gain body weight with age ($F(2, 38, 83.32) = 421.39$, $p < 0.01$; Fig. 2a). Female mice also showed a similar result, with all genotypes gaining weight with age ($F(4, 136) = 253.83$, $p < 0.01$; Fig. 2b). There was a significant effect of genotype on body weight throughout adolescence and adulthood, in both male ($F(2, 35) = 17.74$, $p < 0.01$) and female ($F(2, 34) = 20.35$, $p < 0.01$) mice, with *Nr2e1*^{-/-} mice remaining significantly lighter than their wild type and heterozygous littermates (Bonferroni post hoc comparison, $p < 0.01$). There was also a significant interaction between age and genotype in male ($F(4, 76, 83.32) = 4.40$, $p < 0.01$) and female ($F(8, 136) = 3.21$, $p < 0.01$) mice, indicating that *Nr2e1*^{-/-} mice do not gain weight similarly to their wild type and *Nr2e1*^{+/-} littermates.

Male and female mice show a reduction in the rate of growth as they approach adulthood (Fig. 2c and d). Interestingly, *Nr2e1*^{-/-} mice appear to have a higher rate of growth during early adolescence (P35) compared to wild type and *Nr2e1*^{+/-} littermates in both males ($F(2, 35) = 18.69$, $p < 0.01$) and females ($F(2, 34) = 24.66$, $p < 0.01$). Furthermore, this increased growth rate appears to normalize at the onset of adulthood (P49–56). These results indicate that while *Nr2e1*^{-/-} mice gain body weight at a greater rate throughout development, body weight remains reduced compared to wild type and heterozygous littermates. This finding is stable across sex and is independent of housing conditions.

3.2. *Nr2e1*^{-/-} mice exhibit increased provoked biting and impaired eye reflex, reaching reflex and piloerection in a primary observation test battery

The results of the primary observation tests are summarised in Tables 2 and 3. There was no significant difference across genotype, sex or age in animal appearance (presence of whiskers, appearance of fur, and patches of fur missing, skin colour), respiration, tremors, salivation, gait, trunk curl, pinna reflex, whisker reflex, toe pinch reflex or righting reflex. However, both male and female *Nr2e1*^{-/-} mice showed an increase in provoked biting during adolescence (male, $p < 0.05$ and female, $p < 0.05$; Table 2). This increase

in provoked biting continued in adulthood (Table 3) but did not reach statistical significance (male, $p = 0.14$ and female, $p = 0.13$). Male *Nr2e1*^{-/-} mice also exhibited impaired eye reflex during adolescence ($p < 0.05$; Table 2). However, this was not observed during adulthood ($p > 0.05$; Table 3). In addition, adolescent male *Nr2e1*^{-/-} mice showed a trend towards impaired reaching reflex ($p = 0.057$; Table 2). This pattern continued during adulthood in male mice but did not reach statistical significance (males $p = 0.12$; females $p > 0.05$; Table 3). Further, adult male *Nr2e1*^{-/-} mice exhibited an increase in piloerection ($p < 0.01$) and an increase in palpebral closure ($p < 0.05$; Table 3).

3.3. *Nr2e1*^{-/-} mice exhibit hyperactivity and deficits in cortico-striatal associated behaviour

3.3.1. Locomotor activity in the open field

Testing in the open field revealed that male (Fig. 3a) and female (Fig. 3b) *Nr2e1*^{-/-} mice were hyperactive during adolescence (male $F(2, 37) = 25.21$, $p < 0.01$, female $F(2, 36) = 18.05$, $p < 0.01$), independent of housing conditions. Hyperactivity continued into adulthood in both male ($F(2, 37) = 37.79$, $p < 0.01$) and female ($F(2, 36) = 19.77$, $p < 0.01$) *Nr2e1*^{-/-} mice (Fig. 3c and d, respectively). Furthermore, hyperactivity appeared to be more pronounced during adulthood in both male and female *Nr2e1*^{-/-} mice with an approximately three-fold increase in distance travelled compared to wild types (Fig. 3c and d).

3.3.2. Thigmotaxis in the open field

Adolescent male *Nr2e1*^{-/-} mice exhibited a significant increase in exploration of the centre of the open field ($F(2, 37) = 3.90$, $p < 0.05$) indicating a reduction in thigmotaxis behaviour (Fig. 3e). This observation continued into adulthood ($F(2, 37) = 6.37$, $p < 0.01$; Fig. 3g). All female mice showed similar thigmotaxis behaviour throughout adolescence ($F(2, 36) = 0.46$, $p > 0.05$) and adulthood ($F(2, 36) = 1.39$, $p > 0.05$; Fig. 3f and h, respectively).

3.3.3. Motor performance on the rotarod

The Mauchly's test indicated the assumptions of sphericity had been violated in both male ($\chi^2(9) = 27.64$, $p < 0.01$) and female ($\chi^2(9) = 18.77$, $p < 0.027$) mice. Therefore, the degrees of freedom were corrected using Greenhouse–Geisser estimates of sphericity for males, as the epsilon was less than 0.75 ($\epsilon = 0.74$), and the Huynh–Feidt estimates of sphericity for females, as the epsilon was greater than 0.75 ($\epsilon = 0.949$). With this correction, testing on the rotarod revealed that impairments in motor performance developed at the onset of adulthood (P42; Fig. 4a and b) in both male ($F(2, 69, 103.603) = 4.54$, $p < 0.01$) and female ($F(3, 795, 129.026) = 9.36$, $p < 0.01$) *Nr2e1*^{-/-} mice, independent of housing conditions. There was a significant effect of genotype on motor performance, in both male ($F(2, 35) = 6.88$, $p < 0.01$; Fig. 4a) and female ($F(2, 34) = 7.59$, $p < 0.01$; Fig. 4b) *Nr2e1*^{-/-} mice. There was also a significant interaction between age and genotype in male ($F(5, 92, 103.603) = 3.344$, $p < 0.01$) and female ($F(7, 59, 109.202) = 2.97$, $p < 0.01$) mice. Bonferroni post hoc comparison revealed that impairments in motor performance developed in both male and female *Nr2e1*^{-/-} mice at the onset of adulthood (Fig. 4a and b). This indicates that motor performance does not remain stable throughout development for *Nr2e1*^{-/-} mice.

3.4. *Nr2e1*^{-/-} mice exhibit deficits in hippocampus-associated cognition

3.4.1. Spontaneous alternation in the Y maze

In the spontaneous alternation test of working memory, male and female *Nr2e1*^{-/-} mice showed impaired spontaneous alternation during adolescence compared to *Nr2e1*^{+/-} and wild type mice

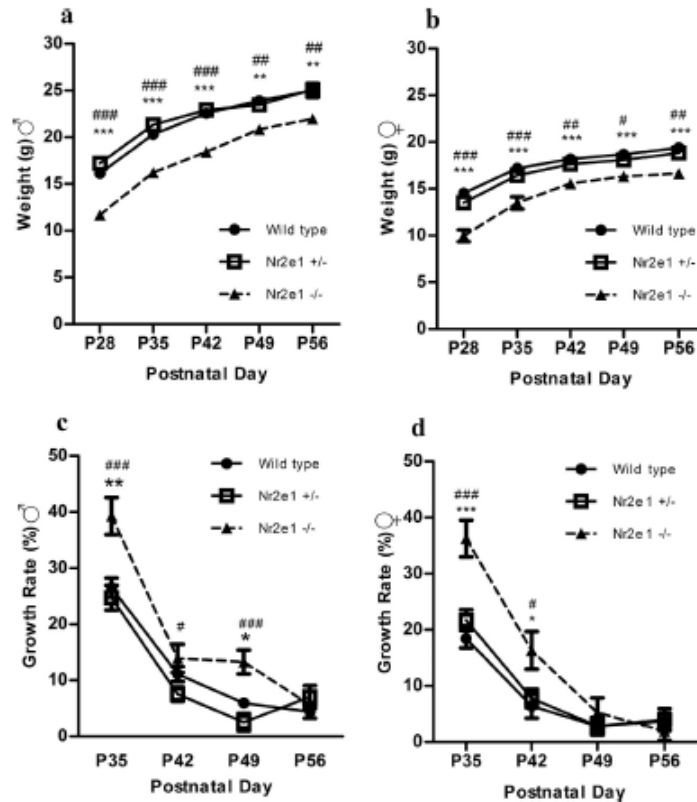

Fig. 2. Body weight as a function of genotype, sex and age. Body weight of male (a) and female (b) mice; growth rate of male (c) and female (d) mice. *** $p < 0.0001$, ** $p < 0.001$, * $p < 0.05$, Nr2e1^{-/-} compared to wild type mice. ### $p < 0.0001$, ## $p < 0.001$, # $p < 0.05$, Nr2e1^{-/-} compared to Nr2e1^{+/-} mice; ANOVA with post hoc Bonferroni analysis. All results are expressed as mean \pm SEM. Sample size per sex: wild type ($n = 13$ – 14), Nr2e1^{+/-} ($n = 16$), Nr2e1^{-/-} ($n = 8$).

Table 2
Primary Observation in adolescent mice.

Male				Female			
Physical Characteristics	Wild type	Nr2e1 ^{+/-}	Nr2e1 ^{-/-}	Physical Characteristics	Wild type	Nr2e1 ^{+/-}	Nr2e1 ^{-/-}
Presence of Whiskers (%)	100	100	100	Presence of Whiskers (%)	100	100	100
Well-groomed fur (%)	100	100	100	Well-groomed fur (%)	100	100	100
Piloerection (%)	0	0	0	Piloerection (%)	0	0	0
Missing fur on Face (%)	21.4	13.3	0	Missing fur on Face (%)	0	12.5	12.5
Missing fur on body (%)	0	0	12.5	Missing fur on body (%)	7.6	18.7	12.5
Palpebral Closure (%)	0	0	0	Palpebral Closure (%)	0	0	0
Wounds (%)	0	6.25	0	Wounds (%)	0	6.2	0
Respiration	Normal	Normal	Normal	Respiration	Normal	Normal	Normal
Tremor (%)	0	0	0	Tremor (%)	0	0	0
Skin Color	Normal	Normal	Normal	Skin Color	Normal	Normal	Normal
Salivation (%)	0	0	0	Salivation (%)	0	0	0
Sensorimotor Reflexes (% displaying normal response)				Sensorimotor Reflexes (% displaying normal response)			
Gait	100	100	100	Gait	100	100	100
Trunk Curl	100	100	100	Trunk Curl	92.3	93.7	100
Reaching Reflex	71.4	100	62.5	Reaching Reflex	92.3	87.5	62.5
Pinna Reflex	85.7	87.5	75	Pinna Reflex	100	75	87.5
Eye Reflex	85.7	100	62.5	Eye Reflex	90.09	66.67	100
Whisker Reflex	85.7	92.85	75	Whisker Reflex	100	80	100
Toe Pinch	78.5	81.25	62.25	Toe Pinch	100	81.25	100
Righting Reflex (% impaired)	0	0	0	Righting Reflex (% impaired)	0	0	0
Provoked Biting (%)	38.4	31.2	87.5	Provoked Biting (%)	30.7	37.5	77.8

Nr2e1^{-/-} compared to wild type mice. Kruskal–Wallis one-way ANOVA. Sample size per sex: wild type ($n = 13$ – 14), Nr2e1^{+/-} ($n = 16$), Nr2e1^{-/-} ($n = 8$).

* $p < 0.05$.

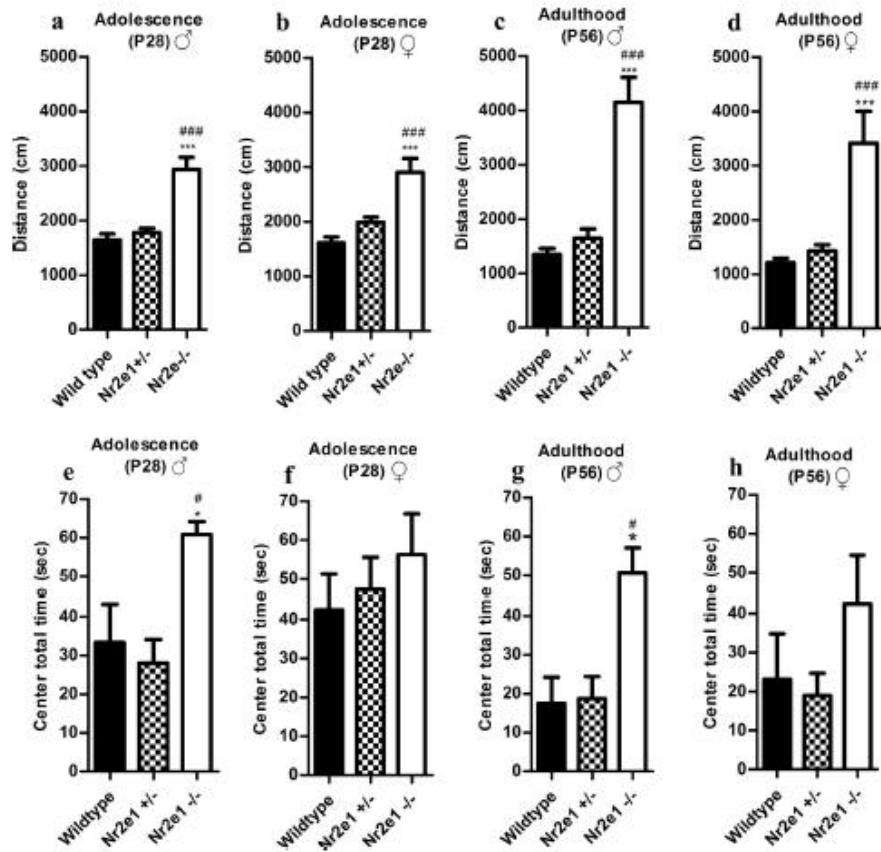

Fig. 3. Locomotor activity and thigmotaxis in an open field as a function of genotype. Locomotor activity in adolescent male (a) and female (b) mice, and in adult male (c) and female (d) mice. Exploration of arena centre in adolescent male (e) and female (f) mice, and in adult male (g) and female (h) mice. *** $p < 0.0001$, ** $p < 0.001$, * $p < 0.05$, $Nr2e1^{-/-}$ compared to wild type mice. *** $p < 0.0001$, ** $p < 0.001$, * $p < 0.05$, $Nr2e1^{-/-}$ compared to $Nr2e1^{+/-}$ mice; ANOVA with post hoc Bonferroni analysis. All results are expressed in mean \pm SEM. Sample size per sex: wild type (n=13–14), $Nr2e1^{+/-}$ (n=16), $Nr2e1^{-/-}$ (n=8).

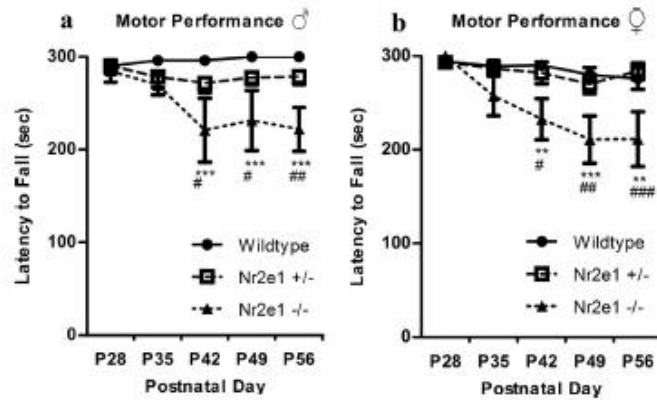

Fig. 4. Motor performance in a Rota-rod latency to fall paradigm as a function of genotype. Motor performance on the Rotarod in male (a) and female (b) mice. *** $p < 0.0001$, ** $p < 0.001$, * $p < 0.05$, $Nr2e1^{-/-}$ compared to wild type mice. *** $p < 0.0001$, ** $p < 0.001$, * $p < 0.05$, $Nr2e1^{-/-}$ compared to $Nr2e1^{+/-}$ mice; ANOVA with post hoc Bonferroni analysis. All results are expressed in mean \pm SEM. Sample size per sex: wild type (n=13–14), $Nr2e1^{+/-}$ (n=16), $Nr2e1^{-/-}$ (n=8).

Table 3
Primary observation in adult mice.

Male				Female			
Physical Characteristics	Wild type	Nr2e1 ^{+/-}	Nr2e1 ^{-/-}	Physical Characteristics	Wild type	Nr2e1 ^{+/-}	Nr2e1 ^{-/-}
Presence of Whiskers (%)	100	100	100	Presence of Whiskers (%)	84.6	81.2	87.5
Well-groomed fur (%)	76.9	75	62.5	Well-groomed fur (%)	100	93.7	100
Piloerection (%)	0	0	62.5**	Piloerection (%)	0	0	0
Missing fur on Face (%)	0	0	0	Missing fur on Face (%)	0	0	0
Missing fur on body (%)	0	0	0	Missing fur on body (%)	0	0	0
Palpebral Closure (%)	0	0	25*	Palpebral Closure (%)	0	0	12.5
Wounds (%)	7.7	12.5	37.5	Wounds (%)	0	0	12.5
Respiration	Normal	Normal	Normal	Respiration	Normal	Normal	Normal
Tremor (%)	0	0	0	Tremor (%)	0	0	0
Skin Color	100	100	100	Skin Color	100	100	100
Salivation (%)	7.7	0	33.33	Salivation (%)	0	13.3	0
Sensorimotor Reflexes (% displaying normal response)				Sensorimotor Reflexes (% displaying normal response)			
Gait	100	100	100	Gait	100	100	100
Trunk Curl	100	100	100	Trunk Curl	84.6	93.7	100
Reaching Reflex	92.3	62.5	50	Reaching Reflex	92.3	87.5	62.5
Pinna Reflex	76.9	75	75	Pinna Reflex	100	62.5	87.5
Eye Reflex	92.3	81.25	100	Eye Reflex	100	86.66	83.33
Whisker Reflex	84.61	87.5	100	Whisker Reflex	77.77	86.66	100
Toe Pinch	100	93.7	100	Toe Pinch	92.3	93.7	100
Righting Reflex (% impaired)	0	0	0	Righting Reflex (% impaired)	0	0	0
Provoked Biting (%)	46.1	50	87.5	Provoked Biting (%)	46.1	31.2	75

Nr2e1^{-/-} compared to wild type mice. Kruskal–Wallis one-way ANOVA. Sample size per sex: wild type (n=13), Nr2e1^{+/-} (n=16), Nr2e1^{-/-} (n=8).

* p<0.05.

** p<0.0001.

(male $F(2, 37)=4.60$, $p<0.01$ and female $F(2, 36)=3.97$, $p<0.05$; Fig. 5a and b). However, this effect did not persist into adulthood (Fig. 5c and d). A significant effect was observed in spontaneous alternation in adult male mice ($F(2, 37)=7.31$, $p<0.01$; Fig. 5c). Post hoc comparison using the Fisher's LSD test revealed this was due to an increase in Nr2e1^{+/-} performance compared to wild type ($p<0.01$) and Nr2e1^{-/-} mice ($p<0.01$). Female mice exhibited no overall difference in spontaneous alternation during adulthood ($F(2, 36)=1.80$, $p>0.05$; Fig. 5d).

3.4.2. Contextual fear conditioning

Male Nr2e1^{-/-} mice showed impaired freezing behaviour during adolescence compared to Nr2e1^{+/-} and wild type mice ($F(2, 36)=8.82$, $p<0.01$; Fig. 5e). Adolescent female Nr2e1^{-/-} mice showed a trend for reduced contextual freezing but this did not reach statistical significance ($F(2, 34)=2.46$, $p=0.10$; Fig. 5f). Contextual freezing during adulthood did not differ across sex or genotype (male $F(2, 36)=2.34$, $p>0.05$; Fig. 5g); female ($F(2, 28)=0.47$, $p>0.05$; Fig. 5h).

3.5. Nr2e1^{-/-} mice show impaired hippocampal-amygdala dependent cognition

3.5.1. Cued fear conditioning

Both male and female Nr2e1^{-/-} mice showed impaired cued fear recall during adolescence (male $F(2, 34)=3.62$, $p<0.05$ and female $F(2, 32)=10.17$, $p<0.01$; Fig. 6a and d). In adulthood, only male Nr2e1^{-/-} mice exhibited impaired cued fear recall ($F(2, 34)=14.31$, $p<0.01$; Fig. 6b). Interestingly, male Nr2e1^{+/-} mice also exhibited impaired cued fear recall during adulthood, but not during adolescence. However, no impairment was observed in female Nr2e1^{+/-} or Nr2e1^{-/-} mice during adulthood ($F(2, 26)=0.96$, $p>0.05$; Fig. 6e).

To measure the retention of the cued fear memory that was acquired during adolescence, we first measured freezing behaviour in response to the cue but prior to the re-introduction of the unconditioned stimulus at P62 (Fig. 6c and f). In this cued fear memory retention test both male and female adult (P62) Nr2e1^{-/-} mice exhibited poor retention of the fear memory that was acquired

in adolescence (male $F(2, 34)=19.95$, $p<0.01$ and female $F(2, 29)=17.0$, $p<0.01$).

4. Discussion

This study demonstrated that Tlx has a role to play in motor, cognitive and anxiety-related behaviour during adolescence and adulthood independent of sex or housing conditions, with most impact during adolescence. Both adolescent male and female Nr2e1^{-/-} mice showed deficits in spatial working memory as measured by spontaneous alternation in the Y maze. Further, adolescent male but not female Nr2e1^{-/-} mice showed deficits in hippocampal function as measured by contextual fear conditioning but these effects in hippocampus-dependent memory tasks did not persist into adulthood. Previous studies have reported contradictory findings regarding the involvement of Tlx in hippocampus-associated cognition in adult mice. Similar to the present study, it has been shown that normal fear acquisition and contextual fear conditioning occurs in adult male Nr2e1^{-/-} mice [11]. Impaired associative fear memory in contextual fear conditioning in adult male mice with a targeted disruption of Tlx has also been reported [7]. The present study is to our knowledge the first report of impaired spatial working memory in adolescent male and female Nr2e1^{-/-} mice with a spontaneous deletion; however, this deficit did not persist into adulthood. This is in contrast to the previously reported impairments in spatial working memory in Tlx deficit mice albeit using the Morris water maze and in mice with a conditional deletion in adulthood [11], rather than a spontaneous deletion. The reasons for the discrepancies across studies in adult mice are unclear but may be a function of the different methods used to reduce or inhibit Tlx expression, or the time at which the Tlx disruption occurs. Zhang et al. generated a conditional deletion of Tlx in adult mice localized to the forebrain and olfactory bulbs, whereas Roy et al. generated a transgenic strain with a targeted disruption of Tlx [7,11]. In the mice used in the present study, the Tlx deletion occurs from birth via a spontaneous deletion of all nine exons of the gene. It is important to consider that germline mutation models such as the Nr2e1^{-/-} mice used in the current study and by others (where Tlx disrupts

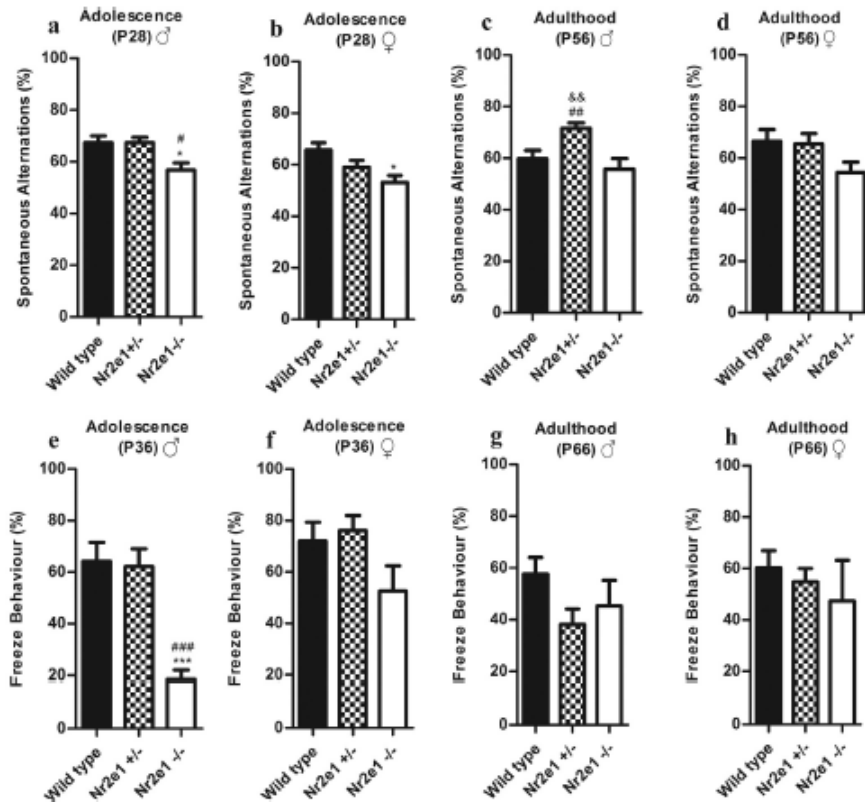

Fig. 5. Spontaneous alternation (%) in the Y-maze and contextual fear conditioning as a function of genotype during adolescence (P28–36) and adulthood (P56–66). Spontaneous alternation in adolescent male (a) and female (b) mice, and in adult male (c) and female (d) mice. Contextual freeze behaviour in adolescent male (e) and female (f) mice, and in adult male (g) and female (h) mice. *** $p < 0.0001$, ** $p < 0.001$, * $p < 0.05$, $Nr2e1^{-/-}$ compared to $Nr2e1^{+/+}$ mice; ## $p < 0.001$, $Nr2e1^{+/+}$ compared to wild type mice; ANOVA with post hoc Fisher's LSD test. All results are expressed as mean \pm SEM. Sample size per sex: wild type ($n = 8–14$), $Nr2e1^{+/+}$ ($n = 15–16$), $Nr2e1^{-/-}$ ($n = 6–8$).

tion occurs in early life) may impact upon developmental processes [3,8,13] that could thus contribute to the behavioural phenotype. Indeed, early life appears to be a sensitive period to Tlx disruption as indicated by greater neuroanatomical and behavioural impairments in mice with an early life deletion of Tlx compared to mice with an adult knockdown [3,8,11,13]. Thus, the method of interference on Tlx expression may affect the level of impairment observed, and in turn might at least partially explain the inconsistent findings. Taken together, while there is evidence that Tlx plays a role in hippocampus-dependent cognition, adolescence may be the more susceptible period to disruption of spatial working memory and hippocampal processes from Tlx deletion.

During adolescence, both male and female $Nr2e1^{-/-}$ mice exhibited impaired cued fear conditioning, a hippocampal-amygdala dependent cognitive process [39]. Interestingly, these deficits persist and are more pronounced in adult male $Nr2e1^{-/-}$ mice. On the other hand, the cued fear memory impairments observed in adolescent female $Nr2e1^{-/-}$ mice did not persist into adulthood. While $Nr2e1^{-/-}$ mice exhibit some delay in cued fear acquisition, freezing behaviour reaches levels exhibited by wild type control mice by the end of the training period (data not shown) and so these impairments are not due to deficits in acquisition. Interestingly,

we report the novel finding that male but not female $Nr2e1^{-/-}$ mice also exhibited impaired cued fear conditioning during adulthood. Previous studies have reported contradictory findings on cued fear conditioning in male $Nr2e1^{-/-}$ mice, with either normal [11] or impaired [7] cued fear conditioning in male mice being reported. Unlike the present study however, the effects in female mice were not investigated in these earlier studies [7,11]. The reasons underlying the discrepancies in adult male $Nr2e1^{-/-}$ mice cued fear conditioning are not clear but may again be a function of the methods used to reduce or inhibit Tlx expression or possibly the experimental variables in the cued fear conditioning test. The fear conditioning training protocol employed by Roy et al. consisted of one training session (2×30 s; tone 80 dB; 2 kHz; followed by 2 s shock 0.75 mA) whereas the protocol used by Zhang et al. consisted of three training sessions ($1 \times$ tone 20 s; 80 dB; 2 kHz; followed by 1 s shock 0.70 mA). In the current study the fear conditioning training consisted of one training session ($3 \times$ tone 30 s; 70 dB; 5 kHz; followed by 1 s foot shock 0.65 mA DC current). It is possible that the additional training sessions employed by Zhang et al. facilitated fear association and improved learning compared to the one training session implemented by Roy et al. and in the current study. Furthermore, in the present study the same animals

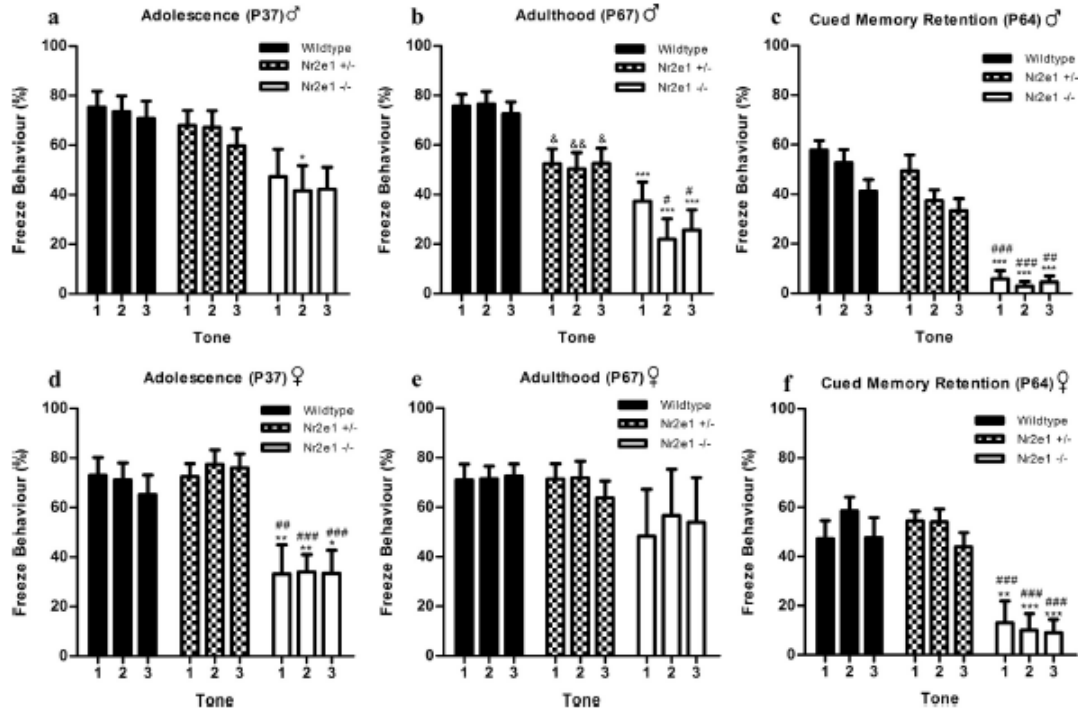

Fig. 6. Cued fear conditioning as a function of genotype during adolescence (P37) and adulthood (P67). Cued fear conditioning in adolescent male (a) and female (d) mice, and in adult male (c) and female (f) mice. Cued fear memory retention test in male (b) and female (e) mice. *** $p < 0.0001$, ** $p < 0.001$, * $p < 0.05$ $Nr2e1^{-/-}$ compared to wild type mice. ### $p < 0.0001$, ## $p < 0.001$, # $p < 0.05$ $Nr2e1^{-/-}$ compared to $Nr2e1^{+/-}$ mice; * $p < 0.05$ $Nr2e1^{+/-}$ compared to wild type mice; ANOVA with post hoc Bonferroni analysis. All results are expressed as mean \pm SEM. Sample size per sex: wild type ($n = 8-14$), $Nr2e1^{+/-}$ ($n = 13-16$), $Nr2e1^{-/-}$ ($n = 6-8$).

were tested during adolescence and in adulthood. It is therefore important to consider the potential effects of fear conditioning training during the adolescent period and its potential impact on fear conditioning in adulthood when drawing conclusions with previous studies. In addition, single housing has been shown to impair contextual and cued fear conditioning [41]. Given that aggression within male $Nr2e1^{-/-}$ mice necessitated being single housed compared to group housed female $Nr2e1^{-/-}$ mice, it is not possible to delineate whether the sex-dependent effects on contextual and cued fear conditioning are due to *Tlx* deletion or housing conditioning *per se*. Nevertheless, since the amygdala plays a key role in cued fear conditions, these studies suggest that *Tlx* may also be important in regulating the functions of brain structures beyond the hippocampus, particularly during adolescence.

Deletion of *Tlx* resulted in a sex-dependent effect on thigmotaxis in the open field. Adolescent and adult male but not female $Nr2e1^{-/-}$ mice exhibited a significant reduction in thigmotaxis thus suggesting reduced anxiety-like behaviour. In support, previous studies have reported that adult male $Nr2e1^{-/-}$ mice with a targeted disruption of the *Tlx* locus are less anxious within the elevated plus maze [7]. It has also been previously shown that adult male $Nr2e1^{-/-}$ mice (with a spontaneous deletion of *Tlx*) display an anxiolytic phenotype independent of sex, but dependent on strain within the elevated plus maze [8]. Indeed, adult male and female $Nr2e1^{-/-}$ mice on a C57BL/6J background exhibited reduced anxiety-like behaviour in the elevated plus maze, while $Nr2e1^{-/-}$ mice on a B6129F1 background showed similar exploration to con-

trol mice [8]. It is important to note that in the latter study, wild type and heterozygous animals were grouped and constituted the control group, while in the present study differences in cued fear memory were observed in adult male $Nr2e1^{+/-}$ mice compared to wild type mice. Thus, when data from $Nr2e1^{+/-}$ mice is pooled with that from wild type mice, subtle changes in the limbic system circuitry of $Nr2e1^{+/-}$ mice may not be picked up. The amygdala plays a key role in both anxiety behaviour and cued fear conditioning [39,42]. Thus, together with the findings in cued fear conditioning, the reduction in thigmotaxis further supports the hypothesis that *Tlx* can regulate neurobiological processing in brain areas beyond the hippocampus.

Hyperactivity was observed in both male and female $Nr2e1^{-/-}$ mice during adolescence and adulthood. This is in agreement with previous studies using the same strain, where hyperactivity was reported as early as P18 as well as in adulthood [8,13]. The findings presented here, in conjunction with previous reports suggest that in the absence of *Tlx*, the resulting neuroanatomical disruption causes a sex-independent hyperactivity that occurs in adolescence and persists into adulthood. $Nr2e1^{-/-}$ mice exhibited a progressive decline in motor performance on the accelerating rotarod at the onset of adulthood. This novel finding suggests that deletion of *Tlx* causes disruption of cortico-cerebellar/striatal cognitive processing. However, this disruption does not manifest as behavioural impairment until the onset of adulthood, suggesting that *Tlx* involvement is age-dependent. The impairment in motor performance on the rotarod does not seem to be

related to the hyperactive phenotype as both adolescent male and female *Nr2e1*^{-/-} mice are hyperactive, yet impairments in rotarod performance only emerge towards the onset of adulthood.

Previous studies using *Nr2e1*^{-/-} mice with a spontaneous deletion have reported that mice are physically smaller throughout development and adulthood [8,13]. Similarly, we report that both male and female *Nr2e1*^{-/-} mice exhibit reduced body weight. In addition, we also report that despite smaller body weights, *Nr2e1*^{-/-} mice exhibit an enhanced growth rate during adolescence. Reduced body weight has also been observed in transgenic mice with a targeted disruption of *Tlx*, where deviation in postnatal weight gain appears at a similar time point (~P23) to that reported here and previously [6,13]. Specifically, Young et al. have previously reported the body weight of male and female *Nr2e1*^{-/-} mice from embryonic day 12.5 through to adulthood (P70) and show that a deviation in body weight between wildtype and *Nr2e1*^{-/-} mice occurs at approximately P21. However, when a conditional deletion is implemented in adulthood, body weight is not affected [11]. Interestingly, the point of deviation in growth (~P21) coincides with the initiation of hyperactivity (~P18) [13]. Wong et al. suggested failure to gain weight at a similar rate to control littermates may be due to the hyperactive phenotype of these mice as they observed no difference in milk consumption of pre-wean *Nr2e1*^{-/-} mice (P0, P7 and P18). This suggests failure to gain weight at a similar rate was not due to a difference in food consumption [13]. Although in the present study *Nr2e1*^{-/-} mice exhibit a greater growth rate than wild type and *Nr2e1*^{+/-} littermates [13]. It is likely that hyperactivity stems from underlying neuroanatomical abnormalities resulting from germline deletion of *Tlx*. However, food intake and metabolism studies have yet to be conducted in adulthood which may help delineate the effect of *Tlx* deletion on body weight gain.

Sensorimotor observations of wild type, *Nr2e1*^{+/-} and *Nr2e1*^{-/-} mice have been previously reported in early postnatal life and adulthood [8]. However sensorimotor performance during the adolescent period had yet to be fully described and any sex-dependent effect had yet to be characterized. Here, we show that both male and female adolescent *Nr2e1*^{-/-} mice exhibit increased provoked biting (an indication of aggression) which is a well-documented phenotype of this strain [8]. However, while biting was increased in both male and female *Nr2e1*^{-/-} mice in adulthood, it did not reach statistical significance (male, $p=0.14$ and female, $p=0.13$). Nevertheless, previous studies have reported high aggression in adult male and female *Nr2e1*^{-/-} mice [8,43]. Defective limbic system functionality in *Nr2e1*^{-/-} mice is thought to play a role in the aggressive phenotype [6,8]. We also observed impaired eye reflex in male adolescent *Nr2e1*^{-/-} mice. Mice lacking *Tlx* display hypoplasia of the retina resulting in impaired vision [5,8]. While previous studies have shown that this impairment is independent of sex, here female *Nr2e1*^{-/-} mice showed a similar response to wild types. It is unclear why this impairment was observed in a sex-dependent manner. Finally, male adult *Nr2e1*^{-/-} mice display impaired piloerection and palpebral closure, while adult female *Nr2e1*^{-/-} mice show similar primary sensorimotor observations compared to wild type and *Nr2e1*^{+/-} littermates. Together, it seems that the sensorimotor impairments (provoked biting, eye reflex, piloerection and palpebral closure) resulting from the *Tlx* deletion are somewhat dependent on sex and age.

A potential limitation to the behavioural studies within this strain of *Nr2e1*^{-/-} mice is the potential confound of visual impairment [8,44]. Thus, it might be suggested that the anxiolytic phenotype observed within the open field in male *Nr2e1*^{-/-} mice could reflect vision impairments. Specifically, mice with reduced vision may unintentionally explore the centre of the arena because they are unaware it is an exposed area of the maze. However,

impaired vision has been shown in both sexes [8]. Therefore a lack of a similar anxiolytic phenotype in female mice suggests that this behavioural phenotype is a result of neural abnormalities other than visual abnormalities. Moreover, spontaneous alternation and rotarod performance has previously been shown to be unaffected by visual performance [29,30] and are thus unlikely to be affected by visual impairments in the present study. A second limitation of this study stems from the requirement to single house male knockout mice due to their aggressive phenotype [8]. However, previous studies have shown that spontaneous alternation and motor performance on the rotarod are unaffected by housing conditions in C57BL/6 mice [41]. Furthermore, previous studies have shown that singly housed *Nr2e1*^{-/-} mice exhibit reduced body weight and increased hyperactivity compared to single housed wild type littermates [41] thus suggesting that social isolation does not account for the reduced body weight and hyperactivity of *Nr2e1*^{-/-} mice observed within this study. Notwithstanding that social isolation may impact upon fear conditioning, overall the evidence suggests that the impairments in motor, cognitive and anxiety-related behaviours assessed here are likely a function of *Tlx* deletion rather than housing conditions.

Given the well-established role of *Tlx* as a transcriptional repressor of downstream target genes, it is important to consider the molecular mechanisms which may underpin the discrepancies in behaviour between wildtype and *Tlx*-deficient mice in the current study, and indeed the developmental time points at which these changes emerge. *TLX* has been shown to recruit the epigenetic modulators lysine-specific histone demethylase 1 (*LSD1*) and histone deacetylases (*HDAC*) 3 and 5 to regulate gene expression [45,46]. In turn, expression of an array of genes has been shown to be regulated by *Tlx* and of particular interest are *p21* and *Pten* as they are involved in adult hippocampal neurogenesis [47,48]. Indeed *Pten* has been shown to have a role in hippocampal-dependent contextual fear conditioning in mice [49]. Because adolescence is a significant developmental period for the remodelling of hippocampal connectivity and networking including neurogenesis, *Tlx*-regulated genes such as *p21* and *pten* may have important roles to play in mediating the associated behavioural changes at this time. Future studies will help elucidate this theory.

A number of studies have shown that deletion of *Tlx* causes neuroanatomical abnormalities similar to those observed in bipolar disorder and schizophrenia, such as enlarged ventricles and reduced volume of the hippocampus, cerebral cortex and amygdala, as well as impaired neurogenesis [50–52]. Moreover, genetic variation at the *Nr2e1* locus in humans has been linked to susceptibility of developing bipolar disorder [26]. Furthermore, the behavioural abnormalities of *Nr2e1* mice are similar to those observed in bipolar disorder i.e., aggression, hyperactivity and impaired learning [53–56]. Interestingly, these disorders manifest primarily during the adolescent period, and this aligns with the behavioural observations in the adolescent *Tlx* deficient mice in the current study [22]. Thus the observed impairment in limbic system structure and function may indicate a potential role of *Tlx* in mood disorders. In conclusion, we show that deletion of *Tlx* results in impairment in motor, cognitive and anxiety-related behaviours during adolescence and adulthood in both male and female mice with the majority of effects occurring during adolescence rather than adulthood. We also show that there is a progressive decline in motor performance of *Nr2e1*^{-/-} mice in adulthood thus indicating cortico-cerebellar/striatal dysfunction in these mice. This novel finding together with alterations in amygdala-dependent behaviour suggests a function for *Tlx* beyond its regulation of adult neurogenesis in the hippocampus. Adolescence is a critical period for postnatal brain maturation and thus susceptibility to emotional and cognitive-related disorders. Given

that the role of Tlx in the regulation of cognitive and anxiety-related behaviour is most apparent during adolescence, Tlx is poised to be a key target in understanding the emergence of neurobiological disorders at the onset of adolescence and early adulthood.

Conflict of interest

The authors declare no conflict of interest.

Acknowledgements

This work was funded by Science Foundation Ireland (SFI) under Grant Number SFI/1A/1537. We thank Prof. Elizabeth Simpson, University of British Columbia for kindly providing us with Nr2e1 mice.

References

- M.M. Islam, C.L. Zhang, TLX: A master regulator for neural stem cell maintenance and neurogenesis, *Biochim. Biophys. Acta* 1849 (2015) 210–216.
- A.P. Monaghan, E. Grau, D. Bock, G. Schutz, The mouse homolog of the orphan nuclear receptor tailless is expressed in the developing forebrain, *Development* 121 (1995) 839–853.
- Y. Shi, D. Chichung Lie, P. Taupin, K. Nakashima, J. Ray, R.T. Yu, et al., Expression and function of orphan nuclear receptor TLX in adult neural stem cells, *Nature* 427 (2004) 78–83.
- W. Li, G. Sun, S. Yang, Q. Qu, K. Nakashima, Y. Shi, Nuclear receptor TLX regulates cell cycle progression in neural stem cells of the developing brain, *Mol. Endocrinol.* 22 (2008) 56–64.
- T. Miyawaki, Y. Honda, A. Uemura, Y. Tanabe, M. Dezawa, R.T. Yu, et al., Tlx, an orphan nuclear receptor, regulates cell numbers and astrocyte development in the developing retina, *J. Neurosci.* 24 (2004) 8124–8134.
- A.P. Monaghan, D. Bock, P. Gass, A. Schwager, D.P. Wolfer, H.P. Lipp, et al., Defective limbic systemin micelacking the tailless gene, *Nature* 390 (1997) 515–517.
- K. Roy, E. Thiels, A.P. Monaghan, Loss of the tailless gene affects forebrain development and emotional behavior, *Physiol. Behav.* (2002) 595–600.
- K.A. Young, M.L. Berry, C.L. Mahaffey, J.R. Saionz, N.L. Hawes, B. Chang, et al., Fierce: a new mouse deletion of Nr2e1; violent behaviour and ocular abnormalities are background-dependent, *Behav. Brain Res.* 132 (2002) 145–158.
- R.T. Yu, M.Y. Chiang, T. Tanabe, M. Kobayashi, K. Yasuda, R.M. Evans, et al., The orphan nuclear receptor Tlx regulates Pax2 and is essential for vision, *Proc. Natl. Acad. Sci. U. S. A.* 97 (2000) 2621–2625.
- R. Christie, W. Li, V.A. Redila, H. Booth, B.K.Y. Wong, B.D. Eadie, et al., Deletion of the nuclear receptor nr2e1 impairs synaptic plasticity and dendritic structure in the mouse dentate gyrus, *Neuroscience* 103 (2006) 1–7.
- C.L. Zhang, Y. Zou, W. He, F.H. Gage, R.M. Evans, A role for adult TLX-positive neural stem cells in learning and behaviour, *Nature* 451 (2008) 1004–1007.
- D.R. Rossell, L.J. Szever, The neurobiology of aggression and violence, *CNS Spectr.* (2015) 1–26.
- B.K.Y. Wong, S.M. Hossain, E. Trinh, G.A. Ottmann, S. Budaghzadeh, Q.Y. Zheng, et al., Hyperactivity, startle reactivity and cell-proliferation deficits are resistant to chronic lithium treatment in adult Nr2e1(frc/frc) mice, *Genes Brain Behav.* 9 (2010) 681–694.
- C.L. Zhang, Y. Zou, R.T. Yu, F.H. Gage, R.M. Evans, Nuclear receptor TLX prevents retinal dystrophy and recruits the corepressor atrophin1, *Genes Dev.* 20 (2006) 1308–1320.
- K. Murai, Q. Qu, G. Sun, P. Ye, W. Li, G. Asuelime, et al., Nuclear receptor TLX stimulates hippocampal neurogenesis and enhances learning and memory in a transgenic mouse model, *Proc. Natl. Acad. Sci. U. S. A.* 111 (2014) 9115–9120.
- C.L. Sisk, D.L. Foster, The neural basis of puberty and adolescence, *Nat. Neurosci.* 7 (2004) 1040–1047.
- L.P. Spear, Adolescent brain development and animal models, *Ann. N. Y. Acad. Sci.* 1021 (2004) 23–26.
- G. Laviola, S. Macnise, Morley-Fletcher, W. Adriani, Risk-taking behavior in adolescent mice: psychobiological determinants and early epigenetic influence, *Neurosci. Biobehav. Rev.* 27 (2003) 19–31.
- S.L. Andersen, Trajectories of brain development: point of vulnerability or window of opportunity, *Neurosci. Biobehav. Rev.* 27 (2003) 3–18.
- S.J. Blakemore, S. Choudhury, Development of the adolescent brain: implications for executive function and social cognition, *J. Child Psychol. Psychiatry* 47 (2006) 296–312.
- D. Fuhrmann, L.J. Knoll, S.J. Blakemore, Adolescence as a sensitive period of brain development, *Trends Cognit. Sci.* (2015).
- J.N. Giedd, M. Keshavan, T. Paus, Why do many psychiatric disorders emerge during adolescence, *Nat. Rev. Neurosci.* 9 (2008) 947–957.
- H.F. Green, Y.M. Nolan, Inflammation and the developing brain: consequences for hippocampal neurogenesis and behavior, *Neurosci. Biobehav. Rev.* 40 (2014) 20–34.
- R.M. O'Connor, J.F. Cryan, Adolescent brain vulnerability and psychopathology through the generations: role of diet and dopamine, *Biol. Psychiatry* 75 (2014) 4–6.
- L.P. Spear, Assessment of adolescent neurotoxicity: rationale and methodological considerations, *Neurotoxicol. Teratol.* 29 (2007) 1–9.
- R.A. Kumar, K.A. McGhee, S. Leach, R. Bonaguro, A. Maclean, R. Aguirre-Hernandez, et al., Initial association of NR2E1 with bipolar disorder and identification of candidate mutations in bipolar disorder, schizophrenia, and aggression through resequencing, *Am. J. Med. Genet. B Neuropsychiatr. Genet.* 147b (2008) 880–889.
- K. Roy, K. Kuznicki, A.P. Monaghan, Q. Wu, E. Sun, D. Bock, et al., The Tlx gene regulates the timing of neurogenesis in the cortex, *J. Neurosci.* 24 (2004) 8333–8345.
- R.E. Brown, A.A. Wong, The influence of visual ability on learning and memory performance in 13 strains of mice, *Learn. Mem.* 14 (2007) 134–144.
- W.N. Dember, W.W. Roberts, Alternation behavior in peripherally-blinded rats, *Percept. Mot. Skills* 8 (1958) 91–94.
- D. Morgan, S. Munireddy, J. Alamed, J. DeLeon, D.M. Diamond, P. Bickford, et al., Apparent behavioral benefits of tau overexpression in P301L tau transgenic mice, *J. Alzheimer's Dis. JAD* 15 (2008) 605–614.
- R.A. Kumar, K.L. Chan, A.H. Wong, K.Q. Little, E. Rajcan-Separovic, B.S. Abrahams, et al., Unexpected embryonic stem (ES) cell mutations represent a concern in gene targeting: lessons from fierce mice, *Genesis* 38 (2004) 51–57.
- J. Crawley, *What's Wrong With My Mouse: Behavioral Phenotyping of Transgenic and Knockout Mice*, 2 ed., Hoboken, New Jersey, John Wiley & Sons, 2007.
- J.F. Cryan, P.H. Kelly, H.C. Neijt, G. Sansig, P.J. Flor, H. van Der Putten, Antidepressant and anxiolytic-like effects in mice lacking the group III metabotropic glutamate receptor mGluR7, *Eur. J. Neurosci.* 17 (2003) 2409–2417.
- S. Irwin, Comprehensive observational assessment: Ia a systematic, quantitative procedure for assessing the behavioral and physiologic state of the mouse, *Psychopharmacologia* 13 (1968) 222–257.
- E. Choleris, A.W. Thomas, M. Kavaliers, F.S. Prato, A detailed ethological analysis of the mouse open field test: effects of diazepam, chlordiazepoxide and an extremely low frequency pulsed magnetic field, *Neurosci. Biobehav. Rev.* 25 (2001) 235–260.
- L. Menalled, B.F. El-Khodori, M. Patry, M. Suarez-Farinas, S.J. Orenstein, B. Zahasky, et al., Systematic behavioral evaluation of Huntington's disease transgenic and knock-in mouse models, *Neurobiol. Dis.* 35 (2009) 319–336.
- R.N. Hughes, The value of spontaneous alternation behavior (SAB) as a test of retention in pharmacological investigations of memory, *Neurosci. Biobehav. Rev.* 28 (2004) 497–505.
- Y. Senechal, P.H. Kelly, J.F. Cryan, F. Natt, K.K. Dev, Amyloid precursor protein knockdown by siRNA impairs spontaneous alternation in adult mice, *J. Neurochem.* 102 (2007) 1928–1940.
- S. Maren, Neurobiology of Pavlovian fear conditioning, *Annu. Rev. Neurosci.* 24 (2001) 897–931.
- S.S. Pattwell, K.G. Batha, B.J. Casey, I. Ninane, F.S. Lee, Selective early-acquired fear memories undergo temporary suppression during adolescence, *PNAS* 108 (2011) 1182–1187.
- V. Voikar, A. Polus, E. Vasar, H. Rauvala, Long-term individual housing in C57Bl/6J and DBA/2 mice: assessment of behavioral consequences, *Genes Brain Behav.* 4 (2005) 240–252.
- R.J. Davidson, Anxiety and affective style: role of prefrontal cortex and amygdala, *Biol. Psychiatry* 51 (2002) 68–80.
- B.S. Abrahams, M.C. Kwok, E. Trinh, S. Budaghzadeh, S.M. Hossain, E.M. Simpson, Pathological aggression in fierce mice corrected by human nuclear receptor 2E1, *J. Neurosci.* 25 (2005) 6263–6270.
- X. Corso-Diaz, E.M. Simpson, Nr2e1 regulates retinal lamination and the development of Muller glia, S-cones, and glycinergic amacrine cells during retinogenesis, *Mol. Brain* 8 (2015) 37.
- G. Sun, K. Alzayady, R. Stewart, P. Ye, S. Yang, W. Li, et al., Histone demethylase LSD1 regulates neural stem cell proliferation, *Mol. Cell. Biol.* 30 (2010) 1997–2005.
- G. Sun, R.T. Yu, R.M. Evans, Y. Shi, Orphan nuclear receptor TLX recruits histone deacetylases to repress transcription and regulate neural stem cell proliferation, *Proc. Natl. Acad. Sci. U. S. A.* 104 (2007) 15282–15287.
- A. Amiri, W. Cho, J. Zhou, S.G. Birnbaum, C.M. Sinton, R.M. McKay, et al., Pten deletion in adult hippocampal neural stem/progenitor cells causes cellular abnormalities and alters neurogenesis, *J. Neurosci.* 32 (2012) 5880–5890.
- R.N. Pechnick, S. Zonis, K. Wawrowsky, J. Pourmorady, V. Chesnokova, p21Cip1 restricts neuronal proliferation in the subgranular zone of the dentate gyrus of the hippocampus, *Proc. Natl. Acad. Sci. U. S. A.* 105 (2008) 1358–1363.
- J.N. Lugo, G.D. Smith, J.B. Morrison, J. White, Deletion of PTEN produces deficits in conditioned fear and increases fragile X mental retardation protein, *Learn. Mem.* 20 (2013) 670–673.
- A.C. Andrezza, L.T. Young, The neurobiology of bipolar disorder: identifying targets for specific agents and synergies for combination treatment, *Int. J. Neuropsychopharmacol.* 17 (2014) 1039–1052.

- [51] C.A. Ross, R.L. Margolis, S.A.J. Reading, M. Pletnikov, J.T. Coyle, Neurobiology of schizophrenia, *Neuron* 52 (2006) 139–153.
- [52] S.M. Strakowski, C.M. Adler, J. Almeida, L.L. Altschuler, H.P. Blumberg, K.D. Chang, et al., The functional neuroanatomy of bipolar disorder: a consensus model, *Bipolar Disord.* 14 (2012) 313–325.
- [53] J. Ballester, T. Goldstein, B. Goldstein, M. Obreja, D. Axelson, K. Monk, et al., Is bipolar disorder specifically associated with aggression, *Bipolar Disord.* 14 (2012) 283–290.
- [54] K. Latalova, Bipolar disorder and aggression, *Int. J. Clin. Pract.* 63 (2009) 889–899.
- [55] P.A. Vohringer, S.A. Barroilhet, A. Amerio, M.L. Reale, K. Alvear, D. Vergne, et al., Cognitive impairment in bipolar disorder and schizophrenia: a systematic review, *Front Psychiatry.* 4 (2013) 87.
- [56] P. Najt, J. Perez, M. Sanches, M.A. Peluso, D. Glahn, J.C. Soares, Impulsivity and bipolar disorder, *Eur. Neuropsychopharmacol.* 17 (2007) 313–320.

References

- ÅBERG, M. A. I., ÅBERG, N. D., HEDBÄCKER, H., OSCARSSON, J. & ERIKSSON, P. S. 2000. Peripheral Infusion of IGF-I Selectively Induces Neurogenesis in the Adult Rat Hippocampus. *J. Neurosci.*, 20, 2896-2903.
- ABRAHAMS, B. S., KWOK, M. C., TRINH, E., BUDAGHZADEH, S., HOSSAIN, S. M. & SIMPSON, E. M. 2005. Pathological aggression in "fierce" mice corrected by human nuclear receptor 2E1. *J. Neurosci.*, 25, 6263-70.
- ACEVEDO-TRIANA, C. A., ROJAS, M. J. & CARDENAS, P. F. 2017. Running wheel training does not change neurogenesis levels or alter working memory tasks in adult rats. *PeerJ*, 5, e2976.
- ADLARD, P. A., PERREAU, V. M. & COTMAN, C. W. 2005. The exercise-induced expression of BDNF within the hippocampus varies across life-span. *Neurobiol. Aging*, 26, 511-20.
- ADLARD, P. A., PERREAU, V. M., ENGESSER-CESAR, C. & COTMAN, C. W. 2004. The timecourse of induction of brain-derived neurotrophic factor mRNA and protein in the rat hippocampus following voluntary exercise. *Neurosci. Lett.*, 363, 43-48.
- ADOLPHS, R. 2010. What does the amygdala contribute to social cognition? *Ann. N. Y. Acad. Sci.*, 1191, 42-61.
- AIMONE, J. B., DENG, W. & GAGE, F. H. 2011. Resolving New Memories: A Critical Look at the Dentate Gyrus, Adult Neurogenesis, and Pattern Separation. *Neuron*, 70, 589-596.
- AIMONE, J. B., LI, Y., LEE, S. W., CLEMENSON, G. D., DENG, W. & GAGE, F. H. 2014. Regulation and function of adult neurogenesis: from genes to cognition. *Physiol. Rev.*, 94, 991-1026.
- AKERS, K. G., MARTINEZ-CANABAL, A., RESTIVO, L., YIU, A. P., DE CRISTOFARO, A., HSIANG, H.-L., WHEELER, A. L., GUSKJOLEN, A., NIIBORI, Y., SHOJI, H., OHIRA, K., RICHARDS, B. A., MIYAKAWA, T., JOSSELYN, S. A. & FRANKLAND, P. W. 2014. Hippocampal Neurogenesis Regulates Forgetting During Adulthood and Infancy. *Science*, 344, 598-602.
- ALBECK, D. S., SANO, K., PREWITT, G. E. & DALTON, L. 2006. Mild forced treadmill exercise enhances spatial learning in the aged rat. *Behav. Brain Res.*, 168, 345-8.
- ALOMARI, M. A., KHABOUR, O. F., ALZOUBI, K. H. & ALZUBI, M. A. 2016. Combining restricted diet with forced or voluntary exercises improves hippocampal BDNF and cognitive function in rats. *Int. J. Neurosci.*, 126, 366-73.
- ALTMAN, J. 1962. Are new neurons formed in the brains of adult mammals? *Science*, 135, 1127-8.
- ALTMAN, J. & DAS, G. D. 1965. Autoradiographic and histological evidence of postnatal hippocampal neurogenesis in rats. *J. Comp. Neurol.*, 124, 319-35.
- ALTMAN, J. & DAS, G. D. 1967. Postnatal neurogenesis in the guinea-pig. *Nature*, 214, 1098-1101.
- AMIRI, A., CHO, W., ZHOU, J., BIRNBAUM, S. G., SINTON, C. M., MCKAY, R. M. & PARADA, L. F. 2012. Pten deletion in adult hippocampal neural stem/progenitor cells causes cellular abnormalities and alters neurogenesis. *J. Neurosci.*, 32, 5880-90.
- AMOR, S., PUENTES, F., BAKER, D. & VAN DER VALK, P. 2010. Inflammation in neurodegenerative diseases. *Immunology*, 129, 154-169.
- ANDERSEN, P. 2007. *The hippocampus book*, Oxford University Press.
- ANDERSEN, S. L. 2003. Trajectories of brain development: point of vulnerability or window of opportunity? *Neurosci. Biobehav. Rev.*, 27, 3-18.

- ANDERSON, B. J., RAPP, D. N., BAEK, D. H., MCCLOSKEY, D. P., COBURN-LITVAK, P. S. & ROBINSON, J. K. 2000. Exercise influences spatial learning in the radial arm maze. *Physiol. Behav.*, 70, 425-429.
- ANDREAZZA, A. C. & YOUNG, L. T. 2014a. The neurobiology of bipolar disorder: identifying targets for specific agents and synergies for combination treatment. *Int. J. Neuropsychopharmacol.*, 17, 1039-52.
- ANDREAZZA, A. C. & YOUNG, L. T. 2014b. The neurobiology of bipolar disorder: identifying targets for specific agents and synergies for combination treatment. *Int. J. Neuropsychopharmacol.*, 17, 1039-1052.
- ANG, E.-T., DAWE, G. S., WONG, P. T. H., MOOCHHALA, S. & NG, Y.-K. 2006. Alterations in spatial learning and memory after forced exercise. *Brain Res.*, 1113, 186-193.
- ANNENKOV, A. 2009. The Insulin-Like Growth Factor (IGF) Receptor Type 1 (IGF1R) as an Essential Component of the Signalling Network Regulating Neurogenesis. *Mol. Neurobiol.*, 40, 195-215.
- ANTUNES, M. & BIALA, G. 2012. The novel object recognition memory: neurobiology, test procedure, and its modifications. *Cogn. Process*, 13, 93-110.
- ARAIN, M., HAQUE, M., JOHAL, L., MATHUR, P., NEL, W., RAIS, A., SANDHU, R. & SHARMA, S. 2013. Maturation of the adolescent brain. *Neuropsychiatric Disease and Treatment*, 9, 449-461.
- ARNETT, J. J. 2000. Emerging adulthood: A theory of development from the late teens through the twenties. *Am. Psychol.*, 55, 469.
- ARRUDA-CARVALHO, M., SAKAGUCHI, M., AKERS, K. G., JOSSELYN, S. A. & FRANKLAND, P. W. 2011. Posttraining ablation of adult-generated neurons degrades previously acquired memories. *J. Neurosci.*, 31, 15113-15127.
- AVITAL, A., GOSHEN, I., KAMSLER, A., SEGAL, M., IVERFELDT, K., RICHTER-LEVIN, G. & YIRMIYA, R. 2003. Impaired interleukin-1 signaling is associated with deficits in hippocampal memory processes and neural plasticity. *Hippocampus*, 13, 826-34.
- BALDERAS, I., RODRIGUEZ-ORTIZ, C. J., SALGADO-TONDA, P., CHAVEZ-HURTADO, J., MCGAUGH, J. L. & BERMUDEZ-RATTONI, F. 2008. The consolidation of object and context recognition memory involve different regions of the temporal lobe. *Learn. Mem.*, 15, 618-624.
- BALLESTER, J., GOLDSTEIN, T., GOLDSTEIN, B., OBREJA, M., AXELSON, D., MONK, K., HICKEY, M., IYENGAR, S., FARCHIONE, T., KUPFER, D. J., BRENT, D. & BIRMAHER, B. 2012. Is bipolar disorder specifically associated with aggression? *Bipolar Disord.*, 14, 283-90.
- BAN, E., MILON, G., PRUDHOMME, N., FILLION, G. & HAOUR, F. 1991. Receptors for interleukin-1 (α and β) in mouse brain: Mapping and neuronal localization in hippocampus. *Neuroscience*, 43, 21-30.
- BANNERMAN, D. M., DEACON, R. M., OFFEN, S., FRISWELL, J., GRUBB, M. & RAWLINS, J. N. 2002. Double dissociation of function within the hippocampus: spatial memory and hyponeophagia. *Behav Neurosci*, 116, 884-901.
- BANNERMAN, D. M., GRUBB, M., DEACON, R. M. J., YEE, B. K., FELDON, J. & RAWLINS, J. N. P. 2003. Ventral hippocampal lesions affect anxiety but not spatial learning. *Behav. Brain Res.*, 139, 197-213.
- BANNERMAN, D. M., RAWLINS, J. N., MCHUGH, S. B., DEACON, R. M., YEE, B. K., BAST, T., ZHANG, W. N., POTHUIZEN, H. H. & FELDON, J. 2004. Regional dissociations within the hippocampus--memory and anxiety. *Neurosci. Biobehav. Rev.*, 28, 273-83.

- BARAN, S. E., ARMSTRONG, C. E., NIREN, D. C., HANNA, J. J. & CONRAD, C. D. 2009. Chronic stress and sex differences on the recall of fear conditioning and extinction. *Neurobiol. Learn. Mem.*, 91, 323-332.
- BARNES, C. A. 1979. Memory deficits associated with senescence: a neurophysiological and behavioral study in the rat. *J Comp Physiol Psychol*, 93, 74-104.
- BARRIENTOS, R. M., HIGGINS, E. A., SPRUNGER, D. B., WATKINS, L. R., RUDY, J. W. & MAIER, S. F. 2002. Memory for context is impaired by a post context exposure injection of interleukin-1 beta into dorsal hippocampus. *Behav. Brain Res.*, 134, 291-298.
- BARRIENTOS, R. M., KITT, M. M., WATKINS, L. R. & MAIER, S. F. 2015. Neuroinflammation in the normal aging hippocampus. *Neuroscience*, 309, 84-99.
- BARTKO, S. J., VENDRELL, I., SAKSIDA, L. M. & BUSSEY, T. J. 2011. A computer-automated touchscreen paired-associates learning (PAL) task for mice: impairments following administration of scopolamine or dicyclomine and improvements following donepezil. *Psychopharmacology*, 214, 537-48.
- BARTSCH, T. & WULFF, P. 2015. The hippocampus in aging and disease: From plasticity to vulnerability. *Neuroscience*, 309, 777-780.
- BARUCH, D. E., SWAIN, R. A. & HELMSTETTER, F. J. 2004. Effects of exercise on Pavlovian fear conditioning. *Behav. Neurosci.*, 118, 1123.
- BAYER, S. A. 1982. Changes in the total number of dentate granule cells in juvenile and adult rats: a correlated volumetric and 3H-thymidine autoradiographic study. *Exp. Brain Res.*, 46, 315-23.
- BECK, K. D. & LUINE, V. N. 2002. Sex differences in behavioral and neurochemical profiles after chronic stress: Role of housing conditions. *Physiol. Behav.*, 75, 661-673.
- BEKINSCHTEIN, P., KENT, B. A., OOMEN, C. A., CLEMENSON, G. D., GAGE, F. H., SAKSIDA, L. M. & BUSSEY, T. J. 2013a. BDNF in the dentate gyrus is required for consolidation of "pattern-separated" memories. *Cell Rep.*, 5, 759-68.
- BEKINSCHTEIN, P., KENT, BRIANNE A., OOMEN, CHARLOTTE A., CLEMENSON, GREGORY D., GAGE, FRED H., SAKSIDA, LISA M. & BUSSEY, TIMOTHY J. 2013b. BDNF in the Dentate Gyrus Is Required for Consolidation of "Pattern-Separated" Memories. *Cell Reports*, 5, 759-768.
- BEKINSCHTEIN, P., KENT, B. A., OOMEN, C. A., CLEMENSON, G. D., GAGE, F. H., SAKSIDA, L. M. & BUSSEY, T. J. 2014. Brain-derived neurotrophic factor interacts with adult-born immature cells in the dentate gyrus during consolidation of overlapping memories. *Hippocampus*, 24, 905-11.
- BELZ, T., LIU, H. K., BOCK, D., TAKACS, A., VOGT, M., WINTERMANTEL, T., BRANDWEIN, C., GASS, P., GREINER, E. & SCHÜTZ, G. 2007. Inactivation of the gene for the nuclear receptor *tailless* in the brain preserving its function in the eye. *Eur. J. Neurosci.*, 26, 2222-2227.
- BELZUNG, C., WILLNER, P. & PHILIPPOT, P. 2015. Depression: from psychopathology to pathophysiology. *Curr Opin Neurobiol*, 30, 24-30.
- BERCHTOLD, N. C., KESSLAK, J. P., PIKE, C. J., ADLARD, P. A. & COTMAN, C. W. 2001. Estrogen and exercise interact to regulate brain-derived neurotrophic factor mRNA and protein expression in the hippocampus. *Eur. J. Neurosci.*, 14, 1992-2002.
- BERGMANN, O., SPALDING, K. L. & FRISEN, J. 2015. Adult Neurogenesis in Humans. *Cold Spring Harb. Perspect. Biol.*, 7.
- BESNARD, A. & SAHAY, A. 2016. Adult Hippocampal Neurogenesis, Fear Generalization, and Stress. *Neuropsychopharmacology*, 41, 24-44.

- BESSA, J. M., MORAIS, M., MARQUES, F., PINTO, L., PALHA, J. A., ALMEIDA, O. F. & SOUSA, N. 2013. Stress-induced anhedonia is associated with hypertrophy of medium spiny neurons of the nucleus accumbens. *Transl. Psychiatry*, 3, e266.
- BEVINS, R. A. & BESHEER, J. 2006. Object recognition in rats and mice: a one-trial non-matching-to-sample learning task to study 'recognition memory'. *Nat. Protoc.*, 1, 1306-11.
- BISCHOFBERGER, J. 2007. Young and excitable: new neurons in memory networks. *Nat. Neurosci.*, 10, 273-275.
- BISSIERE, S., PLACHTA, N., HOYER, D., MCALLISTER, K. H., OLPE, H. R., GRACE, A. A. & CRYAN, J. F. 2008. The rostral anterior cingulate cortex modulates the efficiency of amygdala-dependent fear learning. *Biol. Psychiatry*, 63, 821-31.
- BLAKEMORE, S. J. & CHOUDHURY, S. 2006. Development of the adolescent brain: implications for executive function and social cognition. *J. Child Psychol. Psychiatry*, 47, 296-312.
- BLISS, T. V. & COLLINGRIDGE, G. L. 1993. A synaptic model of memory: long-term potentiation in the hippocampus. *Nature*, 361, 31-9.
- BOLDRINI, M., HEN, R., UNDERWOOD, M. D., ROSOKLIJA, G. B., DWORK, A. J., MANN, J. J. & ARANGO, V. 2012. Hippocampal angiogenesis and progenitor cell proliferation are increased with antidepressant use in major depression. *Biol. Psychiatry*, 72, 562-71.
- BOLDRINI, M., UNDERWOOD, M. D., HEN, R., ROSOKLIJA, G. B., DWORK, A. J., JOHN MANN, J. & ARANGO, V. 2009. Antidepressants increase neural progenitor cells in the human hippocampus. *Neuropsychopharmacology*, 34, 2376-89.
- BOLZ, L., HEIGELE, S. & BISCHOFBERGER, J. 2015. Running improves pattern separation during novel object recognition. *Brain Plasticity*, 1, 129-141.
- BONAGUIDI, M. A., SONG, J., MING, G. L. & SONG, H. 2012. A unifying hypothesis on mammalian neural stem cell properties in the adult hippocampus. *Curr Opin Neurobiol*, 22, 754-61.
- BOWMAN, R. E., BECK, K. D. & LUINE, V. N. 2003. Chronic stress effects on memory: sex differences in performance and monoaminergic activity. *Horm. Behav.*, 43, 48-59.
- BOWMAN, R. E., MACLUSKY, N. J., DIAZ, S. E., ZRULL, M. C. & LUINE, V. N. 2006. Aged rats: Sex differences and responses to chronic stress. *Brain Res.*, 1126, 156-166.
- BRAUN, S. M. & JESSBERGER, S. 2014. Adult neurogenesis: mechanisms and functional significance. *Development*, 141, 1983-6.
- BROCKETT, A. T., LAMARCA, E. A. & GOULD, E. 2015. Physical exercise enhances cognitive flexibility as well as astrocytic and synaptic markers in the medial prefrontal cortex. *PLoS One*, 10, e0124859.
- BROWN, B. M., PEIFFER, J. J. & MARTINS, R. N. 2013. Multiple effects of physical activity on molecular and cognitive signs of brain aging: can exercise slow neurodegeneration and delay Alzheimer's disease? *Mol. Psychiatry*, 18, 864-74.
- BROWN, J., COOPER-KUHN, C. M., KEMPERMANN, G., VAN PRAAG, H., WINKLER, J., GAGE, F. H. & KUHN, H. G. 2003. Enriched environment and physical activity stimulate hippocampal but not olfactory bulb neurogenesis. *Eur. J. Neurosci.*, 17, 2042-2046.
- BROWN, R. E. & WONG, A. A. 2007. The influence of visual ability on learning and memory performance in 13 strains of mice. *Learn. Mem.*, 14, 134-144.
- BRUNNER, J., NEUBRANDT, M., VAN-WEERT, S., ANDRASI, T., KLEINE BORGMANN, F. B., JESSBERGER, S. & SZABADICS, J. 2014. Adult-born granule cells mature through two functionally distinct states. *eLife*, 3, e03104.
- BURGHARDT, N. S., PARK, E. H., HEN, R. & FENTON, A. A. 2012. Adult-born hippocampal neurons promote cognitive flexibility in mice. *Hippocampus*, 22, 1795-808.

- BURGHARDT, P. R., PASUMARTHI, R. K., WILSON, M. A. & FADEL, J. 2006. Alterations in fear conditioning and amygdalar activation following chronic wheel running in rats. *Pharmacol. Biochem. Behav.*, 84, 306-312.
- BUSSEY, T. J., HOLMES, A., LYON, L., MAR, A. C., MCALLISTER, K. A., NITHIANANTHARAJAH, J., OOMEN, C. A. & SAKSIDA, L. M. 2012. New translational assays for preclinical modelling of cognition in schizophrenia: the touchscreen testing method for mice and rats. *Neuropharmacology*, 62, 1191-203.
- CAMERON, H. A., HAZEL, T. G. & MCKAY, R. D. 1998. Regulation of neurogenesis by growth factors and neurotransmitters. *J. Neurobiol.*, 36, 287-306.
- CAMPBELL, S., MARRIOTT, M., NAHMIAS, C. & MACQUEEN, G. M. 2004. Lower hippocampal volume in patients suffering from depression: a meta-analysis. *Am. J. Psychiatry*, 161, 598-607.
- CARRO, E., NUNEZ, A., BUSIGUINA, S. & TORRES-ALEMAN, I. 2000. Circulating insulin-like growth factor I mediates effects of exercise on the brain. *J. Neurosci.*, 20, 2926-33.
- CASEY, B., JONES, R. M. & HARE, T. A. 2008a. The adolescent brain. *Ann. N. Y. Acad. Sci.*, 1124, 111-126.
- CASEY, B. J., GETZ, S. & GALVAN, A. 2008b. The adolescent brain. *Dev. Rev.*, 28, 62-77.
- CHEN, M. J. & RUSSO-NEUSTADT, A. A. 2009. Running exercise-induced up-regulation of hippocampal brain-derived neurotrophic factor is CREB-dependent. *Hippocampus*, 19, 962-72.
- CHIBA, S., NUMAKAWA, T., NINOMIYA, M., RICHARDS, M. C., WAKABAYASHI, C. & KUNUGI, H. 2012. Chronic restraint stress causes anxiety- and depression-like behaviors, downregulates glucocorticoid receptor expression, and attenuates glutamate release induced by brain-derived neurotrophic factor in the prefrontal cortex. *Prog. Neuropsychopharmacol. Biol. Psychiatry*, 39, 112-119.
- CHOLERIS, E., THOMAS, A. W., KAVALIERS, M. & PRATO, F. S. 2001. A detailed ethological analysis of the mouse open field test: effects of diazepam, chlordiazepoxide and an extremely low frequency pulsed magnetic field. *Neurosci. Biobehav. Rev.*, 25, 235-260.
- CHRISTIE, R., LI, W., REDILA, V. A., BOOTH, H., WONG, B. K. Y., EADIE, B. D., ERNST, C. & SIMPSON, E. M. 2006. Deletion of the nuclear receptor nr2e1 impairs synaptic plasticity and dendritic structure in the mouse dentate gyrus. *Neuroscience*, 137, 1031-1037.
- CLARK, P. J., BRZEZINSKA, W. J., THOMAS, M. W., RYZHENKO, N. A., TOSHKOV, S. A. & RHODES, J. S. 2008. Intact neurogenesis is required for benefits of exercise on spatial memory but not motor performance or contextual fear conditioning in C57BL/6J mice. *Neuroscience*, 155, 1048-58.
- CLELLAND, C. D., CHOI, M., ROMBERG, C., CLEMENSON, G. D., JR., FRAGNIERE, A., TYERS, P., JESSBERGER, S., SAKSIDA, L. M., BARKER, R. A., GAGE, F. H. & BUSSEY, T. J. 2009. A functional role for adult hippocampal neurogenesis in spatial pattern separation. *Science*, 325, 210-3.
- COHEN, S. J. & STACKMAN, R. W., JR. 2015. Assessing rodent hippocampal involvement in the novel object recognition task. A review. *Behav. Brain Res.*, 285, 105-17.
- COLUCCI-D'AMATO, L., BONAVIDA, V. & DI PORZIO, U. 2006. The end of the central dogma of neurobiology: stem cells and neurogenesis in adult CNS. *Neurol. Sci.*, 27, 266-70.
- CONG, L., RAN, F. A., COX, D., LIN, S., BARRETTO, R., HABIB, N., HSU, P. D., WU, X., JIANG, W., MARRAFFINI, L. A. & ZHANG, F. 2013. Multiplex Genome Engineering Using CRISPR/Cas Systems. *Science*, 339, 819-823.

- CONRAD, C. D. 2008. Chronic Stress-Induced Hippocampal Vulnerability: The Glucocorticoid Vulnerability Hypothesis. *Rev. Neuroscience*, 19, 395-411.
- CONRAD, C. D. 2010. A critical review of chronic stress effects on spatial learning and memory. *Prog. Neuropsychopharmacol. Biol. Psychiatry*, 34, 742-55.
- CONRAD, C. D., GALEA, L. A. M., KURODA, Y. & MCEWEN, B. S. 1996. Chronic stress impairs rat spatial memory on the Y maze, and this effect is blocked by tianeptine treatment. *Behav. Neurosci.*, 110, 1321.
- CONRAD, C. D., LEDOUX, J. E., MAGARINOS, A. M. & MCEWEN, B. S. 1999. Repeated restraint stress facilitates fear conditioning independently of causing hippocampal CA3 dendritic atrophy. *Behav. Neurosci.*, 113, 902-13.
- COOK, R. G. 1992. Acquisition and transfer of visual texture discriminations by pigeons. *Exp. Psychol. Anim. Behav. Process*, 18, 341.
- CORSO-DIAZ, X. & SIMPSON, E. M. 2015. Nr2e1 regulates retinal lamination and the development of Muller glia, S-cones, and glycinergic amacrine cells during retinogenesis. *Mol. Brain*, 8, 37.
- COTMAN, C. W. & BERCHTOLD, N. C. 2002. Exercise: a behavioral intervention to enhance brain health and plasticity. *Trends in Neurosci.*, 25, 295-301.
- COWAN, N. 2008. What are the differences between long-term, short-term, and working memory? *Progress in brain research*, 169, 323-338.
- COWLEY, T. R., O'SULLIVAN, J., BLAU, C., DEIGHAN, B. F., JONES, R., KERSEKENS, C., RICHARDSON, J. C., VIRLEY, D., UPTON, N. & LYNCH, M. A. 2012. Rosiglitazone attenuates the age-related changes in astrocytosis and the deficit in LTP. *Neurobiol. Aging*, 33, 162-175.
- CRAWLEY, J. 2007. *What's Wrong With My Mouse: Behavioral Phenotyping of Transgenic and Knockout Mice*, Hoboken, New Jersey, John Wiley & Sons.
- CRAWLEY, J. N. 1999. Behavioral phenotyping of transgenic and knockout mice: experimental design and evaluation of general health, sensory functions, motor abilities, and specific behavioral tests. *Brain Res.*, 835, 18-26.
- CREER, D. J., ROMBERG, C., SAKSIDA, L. M., VAN PRAAG, H. & BUSSEY, T. J. 2010. Running enhances spatial pattern separation in mice. *Proc. Natl. Acad. Sci. U.S.A.*, 107, 2367-72.
- CREWS, L., ADAME, A., PATRICK, C., DELANEY, A., PHAM, E., ROCKENSTEIN, E., HANSEN, L. & MASLIAH, E. 2010. Increased BMP6 levels in the brains of Alzheimer's disease patients and APP transgenic mice are accompanied by impaired neurogenesis. *J. Neurosci.*, 30, 12252-62.
- CRYAN, J. F. & DINAN, T. G. 2012. Mind-altering microorganisms: the impact of the gut microbiota on brain and behaviour. *Nature Reviews Neuroscience*, 13, 701.
- CRYAN, J. F., KELLY, P. H., NEIJT, H. C., SANSIG, G., FLOR, P. J. & VAN DER PUTTEN, H. 2003. Antidepressant and anxiolytic-like effects in mice lacking the group III metabotropic glutamate receptor mGluR7. *Eur. J. Neurosci.*, 17, 2409-17.
- CUNNINGHAM, A. J., MURRAY, C. A., O'NEILL, L. A. J., LYNCH, M. A. & O'CONNOR, J. J. 1996. Interleukin-1 β (IL-1 β) and tumour necrosis factor (TNF) inhibit long-term potentiation in the rat dentate gyrus in vitro. *Neurosci. Lett.*, 203, 17-20.
- CUNNINGHAM, M. G., BHATTACHARYYA, S. & BENES, F. M. 2002. Amygdalo-cortical sprouting continues into early adulthood: Implications for the development of normal and abnormal function during adolescence. *J. Comp. Neurol.*, 453, 116-130.
- CURLIK, D. M., 2ND, DIFEO, G. & SHORS, T. J. 2014. Preparing for adulthood: thousands upon thousands of new cells are born in the hippocampus during puberty, and most survive with effortful learning. *Front. Neurosci.*, 8, 70.

- CURLIK, D. M., 2ND, MAENG, L. Y., AGARWAL, P. R. & SHORS, T. J. 2013. Physical skill training increases the number of surviving new cells in the adult hippocampus. *PLoS One*, 8, e55850.
- CURLIK, D. M., 2ND & SHORS, T. J. 2011. Learning increases the survival of newborn neurons provided that learning is difficult to achieve and successful. *J. Cogn. Neurosci.*, 23, 2159-70.
- CZERNIAWSKI, J., REE, F., CHIA, C., RAMAMOORTHY, K., KUMATA, Y. & OTTO, T. A. 2011. The importance of having Arc: expression of the immediate-early gene Arc is required for hippocampus-dependent fear conditioning and blocked by NMDA receptor antagonism. *J Neurosci*, 31, 11200-7.
- D'AQUILA, P. S., BRAIN, P. & WILLNER, P. 1994. Effects of chronic mild stress on performance in behavioural tests relevant to anxiety and depression. *Physiol. Behav.*, 56, 861-867.
- DALLA, C., ANTONIOU, K., DROSSOPOULOU, G., XAGORARIS, M., KOKRAS, N., SFIKAKIS, A. & PAPADOPOULOU-DAIFOTI, Z. 2005. Chronic mild stress impact: are females more vulnerable? *Neuroscience*, 135, 703-14.
- DALLA, C., PITYCHOUTIS, P., KOKRAS, N. & PAPADOPOULOU-DAIFOTI, Z. 2011. *Sex Differences in Response to Stress and Expression of Depressive-Like Behaviours in the Rat*.
- DALLA, C., XAGORARIS, M., DASKAS, S., ANTONIOU, K., SFIKAKIS, A. & PAPADOPOULOU-DAIFOTI, Z. 2002. Combination of chronic mild stress and forced swim test in male and female rats: Behavioral and neurochemical effects. *Eur. Neuropsychopharmacol.*, 12, 249.
- DAMASIO, A. R. 2008. The brain binds entities and events by multiregional activation from convergence zones. *Brain*, 1.
- DAVIDSON, R. J. 2002. Anxiety and affective style: role of prefrontal cortex and amygdala. *Biol. Psychiatry*, 51, 68-80.
- DE KLOET, E. R., JOELS, M. & HOLSBOER, F. 2005. Stress and the brain: from adaptation to disease. *Nat. Rev. Neurosci.*, 6, 463-475.
- DE KLOET, E. R., OTTE, C., KUMSTA, R., KOK, L., HILLEGERS, M. H., HASSELMANN, H., KLIEGEL, D. & JOELS, M. 2016. Stress and depression a crucial role of the mineralocorticoid receptor. *J. Neuroendocrinol.*, 28.
- DECO, G. & ROLLS, E. T. 2005. Attention, short-term memory, and action selection: a unifying theory. *Progress in neurobiology*, 76, 236-256.
- DEDOVIC, K., DUCHESNE, A., ANDREWS, J., ENGERT, V. & PRUESSNER, J. C. 2009. The brain and the stress axis: the neural correlates of cortisol regulation in response to stress. *Neuroimage*, 47, 864-71.
- DEGLON, N. & HANTRAYE, P. 2005. Viral vectors as tools to model and treat neurodegenerative disorders. *J Gene Med*, 7, 530-9.
- DEMBER, W. N. & ROBERTS, W. W. 1958. Alternation behavior in peripherally-blinded rats. *Percept Mot Skills*, 8, 91-94.
- DENG, W., AIMONE, J. B. & GAGE, F. H. 2010. New neurons and new memories: how does adult hippocampal neurogenesis affect learning and memory? *Nat Rev Neurosci*, 11, 339-50.
- DENG, W., MAYFORD, M. & GAGE, F. H. 2013. Selection of distinct populations of dentate granule cells in response to inputs as a mechanism for pattern separation in mice. *eLife*, 2.
- DERE, E., HUSTON, J. P. & DE SOUZA SILVA, M. A. 2007. The pharmacology, neuroanatomy and neurogenetics of one-trial object recognition in rodents. *Neurosci. Biobehav. Rev.*, 31, 673-704.

- DESBONNET, L., CLARKE, G., TRAPLIN, A., O'SULLIVAN, O., CRISPIE, F., MOLONEY, R. D., COTTER, P. D., DINAN, T. G. & CRYAN, J. F. 2015. Gut microbiota depletion from early adolescence in mice: Implications for brain and behaviour. *Brain, Behavior, and Immunity*, 48, 165-173.
- DEVARAKONDA, K., NGUYEN, K. P. & KRAVITZ, A. V. 2016. ROBucket: A low cost operant chamber based on the Arduino microcontroller. *Behav. Res. Methods*, 48, 503-509.
- DIAS-FERREIRA, E., SOUSA, J. C., MELO, I., MORGADO, P., MESQUITA, A. R., CERQUEIRA, J. J., COSTA, R. M. & SOUSA, N. 2009. Chronic stress causes frontostriatal reorganization and affects decision-making. *Science*, 325, 621-5.
- DINAN, T. G., CRYAN, J. F. & STANTON, C. 2018. Gut Microbes and Brain Development Have Black Box Connectivity. *Biological Psychiatry*, 83, 97-99.
- DONOVAN, M. H., YAZDANI, U., NORRIS, R. D., GAMES, D., GERMAN, D. C. & EISCH, A. J. 2006. Decreased adult hippocampal neurogenesis in the PDAPP mouse model of Alzheimer's disease. *J Comp Neurol*, 495, 70-83.
- DOSTES, S., DUBREUCQ, S., LADEVEZE, E., MARSICANO, G., ABROUS, D. N., CHAOULOFF, F. & KOEHL, M. 2016. Running per se stimulates the dendritic arbor of newborn dentate granule cells in mouse hippocampus in a duration-dependent manner. *Hippocampus*, 26, 282-8.
- DRAPEAU, E., MAYO, W., AUROUSSEAU, C., LE MOAL, M., PIAZZA, P.-V. & ABROUS, D. N. 2003. Spatial memory performances of aged rats in the water maze predict levels of hippocampal neurogenesis. *Proc. Natl. Acad. Sci. U.S.A.*, 100, 14385-14390.
- DRILL, E. A. 2009. *Deciphering the role of *tlx* in dorsal neural progenitors and its contribution to brain structure and behavior*. PhD PhD, University of Pittsburgh.
- DROSTE, S. K., GESING, A., ULBRICHT, S., MULLER, M. B., LINTHORST, A. C. & REUL, J. M. 2003. Effects of long-term voluntary exercise on the mouse hypothalamic-pituitary-adrenocortical axis. *Endocrinology*, 144, 3012-23.
- DUBREUCQ, S., MARSICANO, G. & CHAOULOFF, F. 2011. Emotional consequences of wheel running in mice: Which is the appropriate control? *Hippocampus*, 21, 239-242.
- DUDAI, Y. & MORRIS, R. G. 2013. Memorable trends. *Neuron*, 80, 742-750.
- DUNN, A. J. & SWIERGIEL, A. H. 2005. Effects of interleukin-1 and endotoxin in the forced swim and tail suspension tests in mice. *Pharmacol. Biochem. Behav.*, 81, 688-693.
- DUPRET, D. & ABROUS, D. N. 2010. A new chapter in the field of memory: hippocampal neurogenesis. *Eur. J. Neurosci.*, 204, 113-29.
- DUPRET, D., FABRE, A., DOBROSSY, M. D., PANATIER, A., RODRIGUEZ, J. J., LAMARQUE, S., LEMAIRE, V., OLIET, S. H., PIAZZA, P. V. & ABROUS, D. N. 2007. Spatial learning depends on both the addition and removal of new hippocampal neurons. *PLoS Biol*, 5, e214.
- DUPRET, D., REVEST, J. M., KOEHL, M., ICHAS, F., DE GIORGI, F., COSTET, P., ABROUS, D. N. & PIAZZA, P. V. 2008. Spatial relational memory requires hippocampal adult neurogenesis. *PLoS ONE*, 3, e1959.
- DUZEL, E., VAN PRAAG, H. & SENDTNER, M. 2016. Can physical exercise in old age improve memory and hippocampal function? *Brain*, 139, 662-673.
- EADIE, B. D., REDILA, V. A. & CHRISTIE, B. R. 2005. Voluntary exercise alters the cytoarchitecture of the adult dentate gyrus by increasing cellular proliferation, dendritic complexity, and spine density. *J Comp Neurol*, 486, 39-47.
- EGELAND, M., ZUNSZAIN, P. A. & PARIANTE, C. M. 2015. Molecular mechanisms in the regulation of adult neurogenesis during stress. *Nat. Rev. Neurosci.*, 16, 189-200.

- EICHENBAUM, H. 2000. A cortical-hippocampal system for declarative memory. *Nat Rev Neurosci*, 1, 41-50.
- EICHENBAUM, H. 2004. Hippocampus: cognitive processes and neural representations that underlie declarative memory. *Neuron*, 44, 109-120.
- ERICKSON, K. I., VOSS, M. W., PRAKASH, R. S., BASAK, C., SZABO, A., CHADDOCK, L., KIM, J. S., HEO, S., ALVES, H. & WHITE, S. M. 2011. Exercise training increases size of hippocampus and improves memory. *Proc. Natl. Acad. Sci. U.S.A*, 108, 3017-3022.
- ERIKSSON, P. S., PERFILIEVA, E., BJORK-ERIKSSON, T., ALBORN, A.-M., NORDBORG, C., PETERSON, D. A. & GAGE, F. H. 1998. Neurogenesis in the adult human hippocampus. *Nat Med*, 4, 1313-1317.
- ERNST, A. & FRISÉN, J. 2015. Adult Neurogenesis in Humans- Common and Unique Traits in Mammals. *PLoS Biology*, 13, e1002045.
- FABEL, K., FABEL, K., TAM, B., KAUFER, D., BAIKER, A., SIMMONS, N., KUO, C. J. & PALMER, T. D. 2003. VEGF is necessary for exercise-induced adult hippocampal neurogenesis. *Eur. J. Neurosci.*, 18, 2803-2812.
- FANSELOW, M. S. 1980. Conditional and unconditional components of post-shock freezing. *Integrative Physiological and Behavioral Science*, 15, 177-182.
- FANSELOW, M. S. & DONG, H.-W. 2010. Are the Dorsal and Ventral Hippocampus Functionally Distinct Structures? *Neuron*, 65, 7-19.
- FARMER, J., ZHAO, X., VAN PRAAG, H., WODTKE, K., GAGE, F. H. & CHRISTIE, B. R. 2004. Effects of voluntary exercise on synaptic plasticity and gene expression in the dentate gyrus of adult male Sprague-Dawley rats in vivo. *Neuroscience*, 124, 71-9.
- FARRAR, W. L., KILIAN, P. L., RUFF, M. R., HILL, J. M. & PERT, C. B. 1987. Visualization and characterization of interleukin 1 receptors in brain. *J Immunol*, 139, 459-63.
- FISCHER, W., WICTORIN, K., BJÖRKLUND, A., WILLIAMS, L., VARON, S. & GAGE, F. 1987. Amelioration of cholinergic neuron atrophy and spatial memory impairment in aged rats by nerve growth factor. *Nature*, 329, 65-68.
- FOLTRAN, R. B. & DIAZ, S. L. 2016. BDNF isoforms: a round trip ticket between neurogenesis and serotonin? *J Neurochem*, 138, 204-21.
- FRANKFURT, M. & LUINE, V. 2015. The evolving role of dendritic spines and memory: interaction(s) with estradiol. *Hormones and behavior*, 74, 28-36.
- FRANKLAND, P. W., KÖHLER, S. & JOSSELYN, S. A. 2013. Hippocampal neurogenesis and forgetting. *Trends Neurosci.*, 36, 497-503.
- FREEMAN, L. C. & TING, J. P. Y. 2016. The pathogenic role of the inflammasome in neurodegenerative diseases. *J. Neurochem.*, 136, 29-38.
- FRIELINGSORF, H., SIMPSON, D. R., THAL, L. J. & PIZZO, D. P. 2007. Nerve growth factor promotes survival of new neurons in the adult hippocampus. *Neurobiol Dis*, 26, 47-55.
- FUHRMANN, D., KNOLL, L. J. & BLAKEMORE, S. J. 2015. Adolescence as a Sensitive Period of Brain Development. *Trends Cogn Sci*, 19, 558-566.
- GAGE, F. 2012. *Isolation, characterization and utilization of CNS stem cells*, Res. Perspect. Neurosci. , Springer Science & Business Media.
- GAGE, F. H. 2000. Mammalian neural stem cells. *Science*, 287, 1433-8.
- GAGE, F. H. 2002. Neurogenesis in the adult brain. *J Neurosci*, 22, 612-3.
- GANELLA, D. E. & KIM, J. H. 2014. Developmental rodent models of fear and anxiety: from neurobiology to pharmacology. *Br J Pharmacol*, 171, 4556-74.
- GARTHE, A., BEHR, J. & KEMPERMANN, G. 2009. Adult-generated hippocampal neurons allow the flexible use of spatially precise learning strategies. *PLoS One*, 4, e5464.

- GARTHE, A., HUANG, Z., KACZMAREK, L., FILIPKOWSKI, R. K. & KEMPERMANN, G. 2014. Not all water mazes are created equal: cyclin D2 knockout mice with constitutively suppressed adult hippocampal neurogenesis do show specific spatial learning deficits. *Genes Brain Behav*, 13, 357-64.
- GARTHE, A. & KEMPERMANN, G. 2013. An old test for new neurons: refining the Morris water maze to study the functional relevance of adult hippocampal neurogenesis. *Front. Neurosci.*, 7, 63.
- GE, S., GOH, E. L. K., SAILOR, K. A., KITABATAKE, Y., MING, G.-L. & SONG, H. 2006. GABA regulates synaptic integration of newly generated neurons in the adult brain. *Nature*, 439, 589-593.
- GE, S., PRADHAN, D. A., MING, G. L. & SONG, H. 2007. GABA sets the tempo for activity-dependent adult neurogenesis. *Trends Neurosci*, 30, 1-8.
- GERLAI, R. 1998. A new continuous alternation task in T-maze detects hippocampal dysfunction in mice. A strain comparison and lesion study. *Behav Brain Res*, 95, 91-101.
- GIBBONS, T. E., PENCE, B. D., PETR, G., OSSYRA, J. M., MACH, H. C., BHATTACHARYA, T. K., PEREZ, S., MARTIN, S. A., MCCUSKER, R. H. & KELLEY, K. W. 2014. Voluntary wheel running, but not a diet containing (-)-Epigallocatechin-3-gallate and β -Alanine, improves learning, memory and hippocampal neurogenesis in aged mice. *Behav. Brain Res.*, 272, 131-140.
- GIBERTINI, M., NEWTON, C., FRIEDMAN, H. & KLEIN, T. W. 1995. Spatial learning impairment in mice infected with *Legionella pneumophila* or administered exogenous interleukin-1-beta. *Brain Behav. Immun.*, 9, 113-28.
- GIEDD, J. N., BLUMENTHAL, J., JEFFRIES, N. O., CASTELLANOS, F. X., LIU, H., ZIJDENBOS, A., PAUS, T., EVANS, A. C. & RAPOPORT, J. L. 1999. Brain development during childhood and adolescence: a longitudinal MRI study. *Nat Neurosci*, 2, 861-863.
- GIEDD, J. N., KESHAVAN, M. & PAUS, T. 2008. Why do many psychiatric disorders emerge during adolescence? *Nature Rev. Neurosci.*, 9, 947-957.
- GOMES DA SILVA, S., UNSAIN, N., MASCO, D. H., TOSCANO-SILVA, M., DE AMORIM, H. A., SILVA ARAUJO, B. H., SIMOES, P. S., NAFFAH-MAZZACORATTI MDA, G., MORTARA, R. A., SCORZA, F. A., CAVALHEIRO, E. A. & ARIDA, R. M. 2012. Early exercise promotes positive hippocampal plasticity and improves spatial memory in the adult life of rats. *Hippocampus*, 22, 347-58.
- GOMEZ-PINILLA, F., DAO, L. & SO, V. 1997. Physical exercise induces FGF-2 and its mRNA in the hippocampus. *Brain Res*, 764, 1-8.
- GOMEZ-PINILLA, F. & HILLMAN, C. 2013. The influence of exercise on cognitive abilities. *Compr Physiol*, 3, 403-28.
- GOMEZ-PINILLA, F., SO, V. & KESSLAK, J. P. 1998. Spatial learning and physical activity contribute to the induction of fibroblast growth factor: neural substrates for increased cognition associated with exercise. *Neuroscience*, 85, 53-61.
- GONCALVES, J. T., SCHAFFER, S. T. & GAGE, F. H. 2016. Adult Neurogenesis in the Hippocampus: From Stem Cells to Behavior. *Cell*, 167, 897-914.
- GONZALEZ, P. V., SCHIOTH, H. B., LASAGA, M. & SCIMONELLI, T. N. 2009. Memory impairment induced by IL-1beta is reversed by alpha-MSH through central melanocortin-4 receptors. *Brain Behav. Immun.*, 23, 817-22.
- GOSHEN, I., KREISEL, T., BEN-MENACHEM-ZIDON, O., LICHT, T., WEIDENFELD, J., BEN-HUR, T. & YIRMIYA, R. 2008. Brain interleukin-1 mediates chronic stress-induced depression in

- mice via adrenocortical activation and hippocampal neurogenesis suppression. *Mol. Psychiatry*, 13, 717-28.
- GOSHEN, I., KREISEL, T., OUNALLAH-SAAD, H., RENBAUM, P., ZALZSTEIN, Y., BEN-HUR, T., LEVY-LAHAD, E. & YIRMIYA, R. 2007. A dual role for interleukin-1 in hippocampal-dependent memory processes. *Psychoneuroendocrinology*, 32, 1106-15.
- GOSHEN, I. & YIRMIYA, R. 2009. Interleukin-1 (IL-1): A central regulator of stress responses. *Front. Neuroendocrinol.*, 30, 30-45.
- GOULD, E., BEYLIN, A., TANAPAT, P., REEVES, A. & SHORS, T. J. 1999a. Learning enhances adult neurogenesis in the hippocampal formation. *Nat Neurosci*, 2, 260-5.
- GOULD, E., MCEWEN, B. S., TANAPAT, P., GALEA, L. A. & FUCHS, E. 1997a. Neurogenesis in the dentate gyrus of the adult tree shrew is regulated by psychosocial stress and NMDA receptor activation. *J. Neurosci.*, 17, 2492-2498.
- GOULD, E., MCEWEN, B. S., TANAPAT, P., GALEA, L. A. & FUCHS, E. 1997b. Neurogenesis in the dentate gyrus of the adult tree shrew is regulated by psychosocial stress and NMDA receptor activation. *J. Neurosci.*, 17, 2492-8.
- GOULD, E., REEVES, A. J., FALLAH, M., TANAPAT, P., GROSS, C. G. & FUCHS, E. 1999b. Hippocampal neurogenesis in adult Old World primates. *Proc. Natl. Acad. Sci. U.S.A.*, 96, 5263-5267.
- GOULD, E. & TANAPAT, P. 1999. Stress and hippocampal neurogenesis. *Biol. Psychiatry*, 46, 1472-1479.
- GOULD, E., TANAPAT, P., HASTINGS, N. B. & SHORS, T. J. 1999c. Neurogenesis in adulthood: a possible role in learning. *Trends Cogn Sci*, 3, 186-192.
- GOULD, E., TANAPAT, P., MCEWEN, B. S., FLÜGGE, G. & FUCHS, E. 1998. Proliferation of granule cell precursors in the dentate gyrus of adult monkeys is diminished by stress. *Proc. Natl. Acad. Sci. U.S.A.*, 95, 3168-3171.
- GRAM, M. G., WOGENSEN, E., MOSEHOLM, K., MOGENSEN, J. & MALA, H. 2016. Exercise-induced improvement in cognitive performance after fimbria-fornix transection depends on the timing of exercise administration. *Brain Res Bull*, 125, 117-26.
- GREEN, H. F. & NOLAN, Y. M. 2012a. GSK-3 mediates the release of IL-1beta, TNF-alpha and IL-10 from cortical glia. *Neurochem Int*, 61, 666-71.
- GREEN, H. F. & NOLAN, Y. M. 2012b. Unlocking mechanisms in interleukin-1beta-induced changes in hippocampal neurogenesis--a role for GSK-3beta and TLX. *Transl. Psychiatry*, 2, e194.
- GREEN, H. F. & NOLAN, Y. M. 2014. Inflammation and the developing brain: Consequences for hippocampal neurogenesis and behavior. *Neurosci. Biobehav. Rev.*, 40, 20-34.
- GREEN, H. F., TREACY, E., KEOHANE, A. K., SULLIVAN, A. M., O'KEEFFE, G. W. & NOLAN, Y. M. 2012. A role for interleukin-1 β in determining the lineage fate of embryonic rat hippocampal neural precursor cells. *Mol. Cell. Neurosci.*, 49, 311-321.
- GREENWOOD, B. N., STRONG, P. V., FOLEY, T. E. & FLESHNER, M. 2009. A behavioral analysis of the impact of voluntary physical activity on hippocampus-dependent contextual conditioning. *Hippocampus*, 19, 988-1001.
- GRENHAM, S., CLARKE, G., CRYAN, J. F. & DINAN, T. G. 2011. Brain-Gut-Microbe Communication in Health and Disease. *Frontiers in Physiology*, 2, 94.
- GRIFFIN, E. W., BECHARA, R. G., BIRCH, A. M. & KELLY, A. M. 2009. Exercise enhances hippocampal-dependent learning in the rat: evidence for a BDNF-related mechanism. *Hippocampus*, 19, 973-80.

- GROVES, J. O., LESLIE, I., HUANG, G. J., MCHUGH, S. B., TAYLOR, A., MOTT, R., MUNAFO, M., BANNERMAN, D. M. & FLINT, J. 2013. Ablating adult neurogenesis in the rat has no effect on spatial processing: evidence from a novel pharmacogenetic model. *PLoS Genet*, 9, e1003718.
- GUSKJOLEN, A., JOSSELYN, S. A. & FRANKLAND, P. W. 2017. Age-dependent changes in spatial memory retention and flexibility in mice. *Neurobiol Learn Mem*, 143, 59-66.
- HALLADAY, L. R., KOCHARIAN, A. & HOLMES, A. 2017. Mouse strain differences in punished ethanol self-administration. *Alcohol*, 58, 83-92.
- HAMMEN, C. 2005. Stress and depression. *Annu. Rev. Clin. Psychol.*, 1, 293-319.
- HAMMOND, R. S., TULL, L. E. & STACKMAN, R. W. 2004. On the delay-dependent involvement of the hippocampus in object recognition memory. *Neurobiol. Learn Mem.*, 82, 26-34.
- HARDY, J. & SELKOE, D. J. 2002. The amyloid hypothesis of Alzheimer's disease: progress and problems on the road to therapeutics. *Science*, 297, 353-6.
- HARTLEY, C. A. & PHELPS, E. A. 2010. Changing fear: the neurocircuitry of emotion regulation. *Neuropsychopharmacology*, 35, 136-46.
- HAUGHEY, N. J., NATH, A., CHAN, S. L., BORCHARD, A. C., RAO, M. S. & MATTSON, M. P. 2002. Disruption of neurogenesis by amyloid beta-peptide, and perturbed neural progenitor cell homeostasis, in models of Alzheimer's disease. *J Neurochem*, 83, 1509-24.
- HAUSS-WEGRZYNIAK, B., LYNCH, M. A., VRANIYAK, P. D. & WENK, G. L. 2002. Chronic Brain Inflammation Results in Cell Loss in the Entorhinal Cortex and Impaired LTP in Perforant Path-Granule Cell Synapses. *Exp. Neurol.*, 176, 336-341.
- HE, J. & CREWS, F. T. 2007. Neurogenesis decreases during brain maturation from adolescence to adulthood. *Pharmacol Biochem Behav*, 86, 327-33.
- HEBERT, M., EVENSON, A., LUMLEY, L. & MEYERHOFF, J. 1998. Effects of acute social defeat on activity in the forced swim test: Parametric studies in DBA/2 mice using a novel measurement device. *Aggress. Behav.*, 24, 257-269.
- HEIN, A. M., STASKO, M. R., MATOUSEK, S. B., SCOTT-MCKEAN, J. J., MAIER, S. F., OLSCHOWKA, J. A., COSTA, A. C. & O'BANION, M. K. 2010. Sustained hippocampal IL-1beta overexpression impairs contextual and spatial memory in transgenic mice. *Brain Behav. Immun.*, 24, 243-53.
- HELDT, S., STANEK, L., CHHATWAL, J. & RESSLER, K. 2007. Hippocampus-specific deletion of BDNF in adult mice impairs spatial memory and extinction of aversive memories. *Mol. Psychiatry*, 12, 656-670.
- HESCHAM, S., GRACE, L., KELLAWAY, L. A., BUGARITH, K. & RUSSELL, V. A. 2009. Effect of exercise on synaptophysin and calcium/calmodulin-dependent protein kinase levels in prefrontal cortex and hippocampus of a rat model of developmental stress. *Metab. Brain Dis.*, 24, 701.
- HOBAN, A. E., STILLING, R. M., MOLONEY, G., SHANAHAN, F., DINAN, T. G., CLARKE, G. & CRYAN, J. F. 2017. The microbiome regulates amygdala-dependent fear recall. *Mol Psychiatry*, In Press.
- HOGLINGER, G. U., RIZK, P., MURIEL, M. P., DUYCKAERTS, C., OERTEL, W. H., CAILLE, I. & HIRSCH, E. C. 2004. Dopamine depletion impairs precursor cell proliferation in Parkinson disease. *Nat Neurosci*, 7, 726-35.
- HOPKINS, M. E. & BUCCI, D. J. 2010. BDNF expression in perirhinal cortex is associated with exercise-induced improvement in object recognition memory. *Neurobiol Learn Mem*, 94, 278-284.

- HOPKINS, M. E., NITECKI, R. & BUCCI, D. J. 2011. Physical exercise during adolescence versus adulthood: differential effects on object recognition memory and brain-derived neurotrophic factor levels. *Neuroscience*, 194, 84-94.
- HORNER, A. E., HEATH, C. J., HVOSLEF-EIDE, M., KENT, B. A., KIM, C. H., NILSSON, S. R., ALSIO, J., OOMEN, C. A., HOLMES, A., SAKSIDA, L. M. & BUSSEY, T. J. 2013. The touchscreen operant platform for testing learning and memory in rats and mice. *Nat. Protoc.*, 8, 1961-84.
- HOWLETT, D. R. & RICHARDSON, J. C. 2009. The pathology of APP transgenic mice: a model of Alzheimer's disease or simply overexpression of APP? *Histol. Histopathol.*, 24, 83-100.
- HUESTON, C. M., CRYAN, J. F. & NOLAN, Y. M. 2017. Stress and adolescent hippocampal neurogenesis: diet and exercise as cognitive modulators. *Transl. Psychiatry*, 7, e1081.
- HUFF, M. L., EMMONS, E. B., NARAYANAN, N. S. & LALUMIERE, R. T. 2016. Basolateral amygdala projections to ventral hippocampus modulate the consolidation of footshock, but not contextual, learning in rats. *Learn Mem*, 23, 51-60.
- HUFF, M. L., MILLER, R. L., DEISSEROTH, K., MOORMAN, D. E. & LALUMIERE, R. T. 2013. Posttraining optogenetic manipulations of basolateral amygdala activity modulate consolidation of inhibitory avoidance memory in rats. *Proc Natl Acad Sci U S A*, 110, 3597-602.
- HUGHES, R. N. 2004. The value of spontaneous alternation behavior (SAB) as a test of retention in pharmacological investigations of memory. *Neurosci. Biobehav. Rev.*, 28, 497-505.
- INTLEKOFER, K. A. & COTMAN, C. W. 2013. Exercise counteracts declining hippocampal function in aging and Alzheimer's disease. *Neurobiol. Dis.*, 57, 47-55.
- IRWIN, S. 1968. Comprehensive observational assessment: Ia. A systematic, quantitative procedure for assessing the behavioral and physiologic state of the mouse. *Psychopharmacologia*, 13, 222-57.
- ISLAM, M. M. & ZHANG, C. L. 2015. TLX: A master regulator for neural stem cell maintenance and neurogenesis. *Biochim Biophys Acta*, 1849, 210-216.
- JACOBSON, L. & SAPOLSKY, R. 1991. The role of the hippocampus in feedback regulation of the hypothalamic-pituitary-adrenocortical axis. *Endocr Rev*, 12, 118-34.
- JACOBSON, L. H. & CRYAN, J. F. 2007. Feeling strained? Influence of genetic background on depression-related behavior in mice: a review. *Behav Genet*, 37, 171-213.
- JAGASIA, R., STEIB, K., ENGLBERGER, E., HEROLD, S., FAUS-KESSLER, T., SAXE, M., GAGE, F. H., SONG, H. & LIE, D. C. 2009. GABA-CREB signalling regulates maturation and survival of newly generated neurons in the adult hippocampus. *The Journal of neuroscience : the official journal of the Society for Neuroscience*, 29, 7966-7977.
- JESSBERGER, S., CLARK, R. E., BROADBENT, N. J., CLEMENSON, G. D., JR., CONSIGLIO, A., LIE, D. C., SQUIRE, L. R. & GAGE, F. H. 2009. Dentate gyrus-specific knockdown of adult neurogenesis impairs spatial and object recognition memory in adult rats. *Learn Mem*, 16, 147-54.
- Ji, J. F., Ji, S. J., SUN, R., LI, K., ZHANG, Y., ZHANG, L. Y. & TIAN, Y. 2014. Forced running exercise attenuates hippocampal neurogenesis impairment and the neurocognitive deficits induced by whole-brain irradiation via the BDNF-mediated pathway. *Biochem Biophys Res Commun*, 443, 646-51.
- JIN, K., PEEL, A. L., MAO, X. O., XIE, L., COTTRELL, B. A., HENSHALL, D. C. & GREENBERG, D. A. 2004. Increased hippocampal neurogenesis in Alzheimer's disease. *Proc. Natl. Acad. Sci. U.S.A.*, 101, 343-7.

- JIN, K., SUN, Y., XIE, L., BATTEUR, S., MAO, X. O., SMELICK, C., LOGVINOVA, A. & GREENBERG, D. A. 2003. Neurogenesis and aging: FGF-2 and HB-EGF restore neurogenesis in hippocampus and subventricular zone of aged mice. *Aging cell*, 2, 175-183.
- JUAREZ, P., VALDOVINOS, M. G., MAY, M. E., LLOYD, B. P., COUPPIS, M. H. & KENNEDY, C. H. 2013. Serotonin(2)A/C receptors mediate the aggressive phenotype of TLX gene knockout mice. *Behav Brain Res*, 256, 354-61.
- JUNG, M. W., WIENER, S. I. & MCNAUGHTON, B. L. 1994. Comparison of spatial firing characteristics of units in dorsal and ventral hippocampus of the rat. *J. Neurosci.*, 14, 7347-7356.
- KAIFOSH, P. & LOSONCZY, A. 2016. Mnemonic functions for nonlinear dendritic integration in hippocampal pyramidal circuits. *Neuron*, 90, 622-634.
- KANDEL, E. R., SCHWARTZ, J. H. 1., & JESSELL, T. M. 2000. *Principles of neural science* New York, McGraw-Hill, Health Professions Division.
- KANOSKI, S. E. & DAVIDSON, T. L. 2011. Western diet consumption and cognitive impairment: links to hippocampal dysfunction and obesity. *Physiol Behav*, 103, 59-68.
- KATSUKI, H., NAKAI, S., HIRAI, Y., AKAJI, K.-I., KISO, Y. & SATOH, M. 1990. Interleukin-1 β inhibits long-term potentiation in the CA3 region of mouse hippocampal slices. *Eur. J. Pharmacol.*, 181, 323-326.
- KEHAGIA, A. A., MURRAY, G. K. & ROBBINS, T. W. 2010. Learning and cognitive flexibility: frontostriatal function and monoaminergic modulation. *Curr. Opin. Neurol.*, 20, 199-204.
- KELLY, A. M. 2015. Non-pharmacological Approaches to Cognitive Enhancement. *Handb Exp Pharmacol*, 228, 417-39.
- KEMPERMANN, G., GAST, D., KRONENBERG, G., YAMAGUCHI, M. & GAGE, F. H. 2003. Early determination and long-term persistence of adult-generated new neurons in the hippocampus of mice. *Development*, 130, 391-9.
- KEMPERMANN, G., KUHN, H. G. & GAGE, F. H. 1998. Experience-induced neurogenesis in the senescent dentate gyrus. *J. Neurosci.*, 18, 3206-3212.
- KENT, B. A., BEYNON, A. L., HORNSBY, A. K., BEKINSCHTEIN, P., BUSSEY, T. J., DAVIES, J. S. & SAKSIDA, L. M. 2015. The orexigenic hormone acyl-ghrelin increases adult hippocampal neurogenesis and enhances pattern separation. *Psychoneuroendocrinology*, 51, 431-9.
- KENT, B. A., HVOSLEF-EIDE, M., SAKSIDA, L. M. & BUSSEY, T. J. 2016. The representational-hierarchical view of pattern separation: Not just hippocampus, not just space, not just memory? *Neurobiol Learn Mem*, 129, 99-106.
- KHEIRBEK, M. A. & HEN, R. 2014. Add neurons, subtract anxiety. *Sci Am*, 311, 62-7.
- KHEIRBEK, M. A., KLEMENHAGEN, K. C., SAHAY, A. & HEN, R. 2012. Neurogenesis and generalization: a new approach to stratify and treat anxiety disorders. *Nat Neurosci*, 15, 1613-20.
- KIM, C. H., HVOSLEF-EIDE, M., NILSSON, S. R., JOHNSON, M. R., HERBERT, B. R., ROBBINS, T. W., SAKSIDA, L. M., BUSSEY, T. J. & MAR, A. C. 2015a. The continuous performance test (rCPT) for mice: a novel operant touchscreen test of attentional function. *Psychopharmacology*, 232, 3947-66.
- KIM, C. H., ROMBERG, C., HVOSLEF-EIDE, M., OOMEN, C. A., MAR, A. C., HEATH, C. J., BERTHIAUME, A. A., BUSSEY, T. J. & SAKSIDA, L. M. 2015b. Trial-unique, delayed nonmatching-to-location (TUNL) touchscreen testing for mice: sensitivity to dorsal hippocampal dysfunction. *Psychopharmacology*, 232, 3935-45.
- KIM, E. J., PELLMAN, B. & KIM, J. J. 2015c. Stress effects on the hippocampus: a critical review. *Learn. Mem.*, 22, 411-416.

- KIM, J., KWON, J.-T., KIM, H.-S. & HAN, J.-H. 2013. CREB and neuronal selection for memory trace. *Frontiers in Neural Circuits*, 7, 44.
- KIM, J. H. 2016. Youth is not wasted on the young: Commentary on a BBR themed issue on developmental regulation of memory in anxiety and addiction. *Behav Brain Res*, 298, 1-3.
- KIM, J. H., PERRY, C. J., GANELLA, D. E. & MADSEN, H. B. 2017. Postnatal development of neurotransmitter systems and their relevance to extinction of conditioned fear. *Neurobiol Learn Mem*, 138, 252-270.
- KIM, J. J. & DIAMOND, D. M. 2002. The stressed hippocampus, synaptic plasticity and lost memories. *Nat Rev Neurosci*, 3, 453-62.
- KIM, S.-H., KIM, H.-B., JANG, M.-H., LIM, B.-V., KIM, Y.-J., KIM, Y.-P., KIM, S.-S., KIM, E.-H. & KIM, C.-J. 2002. Treadmill exercise increases cell proliferation without altering of apoptosis in dentate gyrus of Sprague-Dawley rats. *Life Sciences*, 71, 1331-1340.
- KIRTLEY, A. & THOMAS, K. L. 2010. The exclusive induction of extinction is gated by BDNF. *Learn. Mem.*, 17, 612-619.
- KITAMURA, T. & INOKUCHI, K. 2014a. Role of adult neurogenesis in hippocampal-cortical memory consolidation. *Mol Brain*, 7, 1-8.
- KITAMURA, T. & INOKUCHI, K. 2014b. Role of adult neurogenesis in hippocampal-cortical memory consolidation. *Mol. Brain*, 7, 1-8.
- KITAMURA, T., MISHINA, M. & SUGIYAMA, H. 2006. Dietary restriction increases hippocampal neurogenesis by molecular mechanisms independent of NMDA receptors. *Neurosci Lett*, 393.
- KITAMURA, T., SAITOH, Y., TAKASHIMA, N., MURAYAMA, A., NIIBORI, Y., AGETA, H., SEKIGUCHI, M., SUGIYAMA, H. & INOKUCHI, K. 2009. Adult neurogenesis modulates the hippocampus-dependent period of associative fear memory. *Cell*, 139, 814-27.
- KITRAKI, E., KREMMYDA, O., YOULATOS, D., ALEXIS, M. N. & KITTAS, C. 2004. Gender-dependent alterations in corticosteroid receptor status and spatial performance following 21 days of restraint stress. *Neuroscience*, 125, 47-55.
- KNIERIM, J. J. & NEUNUEBEL, J. P. 2016. Tracking the flow of hippocampal computation: Pattern separation, pattern completion, and attractor dynamics. *Neurobiol Learn Mem*, 129, 38-49.
- KOBILO, T., LIU, Q. R., GANDHI, K., MUGHAL, M., SHAHAM, Y. & VAN PRAAG, H. 2011. Running is the neurogenic and neurotrophic stimulus in environmental enrichment. *Learn Mem*, 18, 605-9.
- KOEHL, M. & ABROUS, D. N. 2011. A new chapter in the field of memory: adult hippocampal neurogenesis. *Eur J Neurosci*, 33, 1101-14.
- KOHLER, S. J., WILLIAMS, N. I., STANTON, G. B., CAMERON, J. L. & GREENOUGH, W. T. 2011. Maturation time of new granule cells in the dentate gyrus of adult macaque monkeys exceeds six months. *Proc. Natl. Acad. Sci. U.S.A.*, 108, 10326-31.
- KOHRMAN, R. A., CLARK, P. J., DEYOUNG, E. K., BHATTACHARYA, T. K., VENGHAUS, C. E. & RHODES, J. S. 2012. Voluntary wheel running enhances contextual but not trace fear conditioning. *Behav Brain Res*, 226, 1-7.
- KOHRMAN, R. A. & RHODES, J. S. 2013. Neurogenesis, inflammation and behavior. *Brain Behav. Immun.*, 27, 22-32.
- KOLB, B., MYCHASIUK, R., MUHAMMAD, A., LI, Y., FROST, D. O. & GIBB, R. 2012. Experience and the developing prefrontal cortex. *Proceedings of the National Academy of Sciences of the United States of America*, 109, 17186-17193.

- KOO, J. W. & DUMAN, R. S. 2008. IL-1beta is an essential mediator of the antineurogenic and anhedonic effects of stress. *Proc. Natl. Acad. Sci. U.S.A.*, 105, 751-6.
- KOSHIBU, K., LEVITT, P. & AHRENS, E. T. 2004. Sex-specific, postpuberty changes in mouse brain structures revealed by three-dimensional magnetic resonance microscopy. *Neuroimage*, 22, 1636-45.
- KOZAREVA, D. A., O'LEARY, O. F., CRYAN, J. F. & NOLAN, Y. M. 2018. Deletion of TLX and social isolation impairs exercise-induced neurogenesis in the adolescent hippocampus. *Hippocampus*, 28, 3-11.
- KRONENBERG, G., BICK-SANDER, A., BUNK, E., WOLF, C., EHNINGER, D. & KEMPERMANN, G. 2006. Physical exercise prevents age-related decline in precursor cell activity in the mouse dentate gyrus. *Neurobiol Aging*, 27, 1505-13.
- KUHN, H. G., DICKINSON-ANSON, H. & GAGE, F. H. 1996a. Neurogenesis in the dentate gyrus of the adult rat: age-related decrease of neuronal progenitor proliferation. *J Neurosci*, 16, 2027-2033.
- KUHN, H. G., DICKINSON-ANSON, H. & GAGE, F. H. 1996b. Neurogenesis in the dentate gyrus of the adult rat: age-related decrease of neuronal progenitor proliferation. *J Neurosci*, 16, 2027-33.
- KUMAR, R. A., CHAN, K. L., WONG, A. H., LITTLE, K. Q., RAJCAN-SEPAROVIC, E., ABRAHAMS, B. S. & SIMPSON, E. M. 2004. Unexpected embryonic stem (ES) cell mutations represent a concern in gene targeting: lessons from "fierce" mice. *Genesis*, 38, 51-7.
- KUMAR, R. A., MCGHEE, K. A., LEACH, S., BONAGURO, R., MACLEAN, A., AGUIRRE-HERNANDEZ, R., ABRAHAMS, B. S., COCCARO, E. F., HODGINS, S., TURECKI, G., CONDON, A., MUIR, W. J., BROOKS-WILSON, A. R., BLACKWOOD, D. H. & SIMPSON, E. M. 2008. Initial association of NR2E1 with bipolar disorder and identification of candidate mutations in bipolar disorder, schizophrenia, and aggression through resequencing. *Am J Med Genet B Neuropsychiatr Genet.*, 147b, 880-9.
- LACAR, B., PARYLAK, S. L., VADODARIA, K. C., SARKAR, A. & GAGE, F. H. 2014. Increasing the resolution of the adult neurogenesis picture. *F1000Prime Rep*, 6, 8.
- LAPLAGNE, D. A., ESPOSITO, M. S., PIATTI, V. C., MORGENSTERN, N. A., ZHAO, C., VAN PRAAG, H., GAGE, F. H. & SCHINDER, A. F. 2006. Functional convergence of neurons generated in the developing and adult hippocampus. *PLoS Biol*, 4, e409.
- LATALOVA, K. 2009. Bipolar disorder and aggression. *Int J Clin Pract*, 63, 889-99.
- LAVIOLA, G., MACRÌ, S., MORLEY-FLETCHER, S. & ADRIANI, W. 2003. Risk-taking behavior in adolescent mice: psychobiological determinants and early epigenetic influence. *Neurosci. Biobehav. Rev.*, 27, 19-31.
- LEDOUX, J. 1998. Fear and the brain: where have we been, and where are we going? *Biol. psychiatry*, 44, 1229-1238.
- LEE, I. & KESNER, R. P. 2004. Differential contributions of dorsal hippocampal subregions to memory acquisition and retrieval in contextual fear-conditioning. *Hippocampus*, 14, 301-310.
- LEE, J., DUAN, W., LONG, J. M., INGRAM, D. K. & MATTSON, M. P. 2000. Dietary restriction increases the number of newly generated neural cells, and induces BDNF expression, in the dentate gyrus of rats. *J Mol Neurosci*, 15, 99-108.
- LEE, J., DUAN, W. & MATTSON, M. P. 2002a. Evidence that brain-derived neurotrophic factor is required for basal neurogenesis and mediates, in part, the enhancement of neurogenesis by dietary restriction in the hippocampus of adult mice. *J Neurochem*, 82, 1367-75.

- LEE, J., SEROOGY, K. B. & MATTSON, M. P. 2002b. Dietary restriction enhances neurotrophin expression and neurogenesis in the hippocampus of adult mice. *Journal of neurochemistry*, 80, 539-547.
- LEE, Y. A. & GOTO, Y. 2015. Chronic stress effects on working memory: association with prefrontal cortical tyrosine hydroxylase. *Behav. Brain Res.*, 286, 122-7.
- LENROOT, R. K. & GIEDD, J. N. 2006. Brain development in children and adolescents: insights from anatomical magnetic resonance imaging. *Neuroscience & biobehavioral reviews*, 30, 718-729.
- LERANTH, C., PETNEHAZY, O. & MACLUSKY, N. J. 2003. Gonadal hormones affect spine synaptic density in the CA1 hippocampal subfield of male rats. *Journal of Neuroscience*, 23, 1588-1592.
- LEUNER, B., KOZOROVITSKIY, Y., GROSS, C. G. & GOULD, E. 2007. Diminished adult neurogenesis in the marmoset brain precedes old age. *Proc. Natl. Acad. Sci. U.S.A.*, 104, 17169-17173.
- LEVONE, B. R., CRYAN, J. F. & O'LEARY, O. F. 2015. Role of adult hippocampal neurogenesis in stress resilience. *Neurobiol Stress*, 1, 147-155.
- LI, W., SUN, G., YANG, S., QU, Q., NAKASHIMA, K. & SHI, Y. 2008. Nuclear Receptor TLX Regulates Cell Cycle Progression in Neural Stem Cells of the Developing Brain. *Mol Endocrinol*, 22, 56-64.
- LIE, D. C., SONG, H., COLAMARINO, S. A., MING, G. L. & GAGE, F. H. 2004. Neurogenesis in the adult brain: new strategies for central nervous system diseases. *Annu Rev Pharmacol Toxicol*, 44, 399-421.
- LIN, T.-W., CHEN, S.-J., HUANG, T.-Y., CHANG, C.-Y., CHUANG, J.-I., WU, F.-S., KUO, Y.-M. & JEN, C. J. 2012. Different types of exercise induce differential effects on neuronal adaptations and memory performance. *Neurobiol Learn Mem*, 97, 140-147.
- LIN, T. W., SHIH, Y. H., CHEN, S. J., LIEN, C. H., CHANG, C. Y., HUANG, T. Y., CHEN, S. H., JEN, C. J. & KUO, Y. M. 2015. Running exercise delays neurodegeneration in amygdala and hippocampus of Alzheimer's disease (APP/PS1) transgenic mice. *Neurobiol Learn Mem*, 118, 189-97.
- LISTON, C., MCEWEN, B. S. & CASEY, B. J. 2009. Psychosocial stress reversibly disrupts prefrontal processing and attentional control. *Proc. Natl. Acad. Sci. U.S.A.*, 106, 912-917.
- LIU, I. Y., LYONS, W. E., MAMOUNAS, L. A. & THOMPSON, R. F. 2004. Brain-derived neurotrophic factor plays a critical role in contextual fear conditioning. *Journal of Neuroscience*, 24, 7958-7963.
- LIU, Y. F., CHEN, H. I., WU, C. L., KUO, Y. M., YU, L., HUANG, A. M., WU, F. S., CHUANG, J. I. & JEN, C. J. 2009. Differential effects of treadmill running and wheel running on spatial or aversive learning and memory: roles of amygdalar brain-derived neurotrophic factor and synaptotagmin I. *J. Physiol.*, 587, 3221-3231.
- LIVAK, K. J. & SCHMITTGEN, T. D. 2001. Analysis of relative gene expression data using real-time quantitative PCR and the 2(-Delta Delta C(T)) Method. *Methods*, 25, 402-8.
- LLORENS-MARTIN, M., JURADO-ARJONA, J., FUSTER-MATANZO, A., HERNANDEZ, F., RABANO, A. & AVILA, J. 2014. Peripherally triggered and GSK-3beta-driven brain inflammation differentially skew adult hippocampal neurogenesis, behavioral pattern separation and microglial activation in response to ibuprofen. *Transl Psychiatry*, 4, e463.
- LOI, M., KORICKA, S., LUCASSEN, P. J. & JOELS, M. 2014. Age- and sex-dependent effects of early life stress on hippocampal neurogenesis. *Front Endocrinol*, 5, 13.
- LUCASSEN, P. J., FITZSIMONS, C. P., KOROSI, A., JOELS, M., BELZUNG, C. & ABROUS, D. N. 2013. Stressing new neurons into depression? *Mol. Psychiatry*, 18, 396-7.

- LUCASSEN, P. J., MEERLO, P., NAYLOR, A. S., VAN DAM, A. M., DAYER, A. G., FUCHS, E., OOMEN, C. A. & CZECH, B. 2010. Regulation of adult neurogenesis by stress, sleep disruption, exercise and inflammation: Implications for depression and antidepressant action. *Eur Neuropsychopharmacol*, 20, 1-17.
- LUGO, J. N., SMITH, G. D., MORRISON, J. B. & WHITE, J. 2013. Deletion of PTEN produces deficits in conditioned fear and increases fragile X mental retardation protein. *Learn Mem*, 20, 670-3.
- LUINE, V. 2002. Sex differences in chronic stress effects on memory in rats. *Stress*, 5, 205-16.
- LULL, M. E. & BLOCK, M. L. 2010. Microglial activation and chronic neurodegeneration. *Neurotherapeutics*, 7, 354-365.
- LYNCH, A. M., MURPHY, K. J., DEIGHAN, B. F., O'REILLY, J.-A., GUN'KO, Y. K., COWLEY, T. R., GONZALEZ-REYES, R. E. & LYNCH, M. A. 2010. The Impact of Glial Activation in the Aging Brain. *Aging Dis.*, 1, 262-278.
- LYNCH, M. A. 2015. Neuroinflammatory changes negatively impact on LTP: A focus on IL-1 β . *Brain Res.*, 1621, 197-204.
- MAGARIÑOS, A. M., VERDUGO, J. M. G. & MCEWEN, B. S. 1997. Chronic stress alters synaptic terminal structure in hippocampus. *Proc. Natl. Acad. Sci. U.S.A.*, 94, 14002-14008.
- MAHMOUD, R., WAINWRIGHT, S. R. & GALEA, L. A. M. 2016. Sex hormones and adult hippocampal neurogenesis: Regulation, implications, and potential mechanisms. *Front Neuroendocrinol*, 41, 129-152.
- MALBERG, J. E. & DUMAN, R. S. 2003. Cell Proliferation in Adult Hippocampus is Decreased by Inescapable Stress: Reversal by Fluoxetine Treatment. *Neuropsychopharmacology*, 28, 1562.
- MALBERG, J. E., EISCH, A. J., NESTLER, E. J. & DUMAN, R. S. 2000. Chronic antidepressant treatment increases neurogenesis in adult rat hippocampus. *J Neurosci*, 20, 9104-10.
- MAR, A. C., HORNER, A. E., NILSSON, S. R., ALSIO, J., KENT, B. A., KIM, C. H., HOLMES, A., SAKSIDA, L. M. & BUSSEY, T. J. 2013. The touchscreen operant platform for assessing executive function in rats and mice. *Nat. Protoc.*, 8, 1985-2005.
- MAREN, S. 2001. Neurobiology of Pavlovian fear conditioning. *Annu Rev Neurosci*, 24, 897-931.
- MAREN, S. & QUIRK, G. J. 2004. Neuronal signalling of fear memory. *Nat Rev Neurosci*, 5, 844-52.
- MARIGHETTO, A., MICHEAU, J. & JAFFARD, R. 1993. Relationships between testing-induced alterations of hippocampal cholinergic activity and memory performance on two spatial tasks in mice. *Behavioural Brain Research*, 56, 133-144.
- MARIN-BURGIN, A., MONGIAT, L. A., PARDI, M. B. & SCHINDER, A. F. 2012. Unique processing during a period of high excitation/inhibition balance in adult-born neurons. *Science*, 335, 1238-42.
- MARLATT, M. & LUCASSEN, P. 2010. Neurogenesis and Alzheimers Disease: Biology and Pathophysiology in Mice and Men. *Curr Alzheimer Res*, 7, 113-125.
- MARLATT, M. W., POTTER, M. C., LUCASSEN, P. J. & VAN PRAAG, H. 2012. Running throughout middle-age improves memory function, hippocampal neurogenesis, and BDNF levels in female C57BL/6J mice. *Dev Neurobiol*, 72, 943-52.
- MARR, D. 1971. Simple memory: a theory for archicortex. *Philos Trans R Soc Lond B Biol Sci*, 262, 59-128.
- MARTINEZ-CANABAL, A., AKERS, K. G., JOSSELYN, S. A. & FRANKLAND, P. W. 2013. Age-dependent effects of hippocampal neurogenesis suppression on spatial learning. *Hippocampus*, 23, 66-74.

- MATHIEU, P., BATTISTA, D., DEPINO, A., ROCA, V., GRACIARENA, M. & PITOSI, F. 2010. The more you have, the less you get: the functional role of inflammation on neuronal differentiation of endogenous and transplanted neural stem cells in the adult brain. *J. Neurochem.*, 112, 1368-1385.
- MATSUMOTO, Y., YAMAGUCHI, T., WATANABE, S. & YAMAMOTO, T. 2004. Involvement of arachidonic acid cascade in working memory impairment induced by interleukin-1 beta. *Neuropharmacology*, 46, 1195-1200.
- MCALLISTER, A. K., KATZ, L. C. & LO, D. C. 1997. Opposing Roles for Endogenous BDNF and NT-3 in Regulating Cortical Dendritic Growth. *Neuron*, 18, 767-778.
- MCCLELLAND, J. L., MCNAUGHTON, B. L. & O'REILLY, R. C. 1995. Why there are complementary learning systems in the hippocampus and neocortex: insights from the successes and failures of connectionist models of learning and memory. *Psychol Rev*, 102, 419-57.
- MCEWEN, B. S. 2007. Physiology and neurobiology of stress and adaptation: central role of the brain. *Physiol. Rev.*, 87, 873-904.
- MCFADDEN, L. M., PARIS, J. J., MITZELFELT, M. S., MCDONOUGH, S., FRYE, C. A. & MATUSZEWICH, L. 2011. Sex-dependent effects of chronic unpredictable stress in the water maze. *Physiol. Behav.*, 102, 266-75.
- MCHUGH, T. J., JONES, M. W., QUINN, J. J., BALTHASAR, N., COPPARI, R., ELMQUIST, J. K., LOWELL, B. B., FANSELOW, M. S., WILSON, M. A. & TONEGAWA, S. 2007. Dentate gyrus NMDA receptors mediate rapid pattern separation in the hippocampal network. *Science*, 317, 94-9.
- MCPHERSON, C. A., AOYAMA, M. & HARRY, G. J. 2011. Interleukin (IL)-1 and IL-6 regulation of neural progenitor cell proliferation with hippocampal injury: Differential regulatory pathways in the subgranular zone (SGZ) of the adolescent and mature mouse brain. *Brain Behav. Immun.*, 25, 850-862.
- MCTIGHE, S. M., MAR, A. C., ROMBERG, C., BUSSEY, T. J. & SAKSIDA, L. M. 2009. A new touchscreen test of pattern separation: effect of hippocampal lesions. *Neuroreport*, 20, 881-5.
- MEIJERING, E., JACOB, M., SARRIA, J. C., STEINER, P., HIRLING, H. & UNSER, M. 2004. Design and validation of a tool for neurite tracing and analysis in fluorescence microscopy images. *Cytometry A*, 58, 167-76.
- MENALLED, L., EL-KHODOR, B. F., PATRY, M., SUAREZ-FARINAS, M., ORENSTEIN, S. J., ZAHASKY, B., LEAHY, C., WHEELER, V., YANG, X. W., MACDONALD, M., MORTON, A. J., BATES, G., LEEDS, J., PARK, L., HOWLAND, D., SIGNER, E., TOBIN, A. & BRUNNER, D. 2009. Systematic behavioral evaluation of Huntington's disease transgenic and knock-in mouse models. *Neurobiol Dis*, 35, 319-36.
- MERAZ-RÍOS, M. A., TORAL-RIOS, D., FRANCO-BOCANEGRA, D., VILLEDA-HERNÁNDEZ, J. & CAMPOS-PEÑA, V. 2013. Inflammatory process in Alzheimer's Disease. *Front Integr Neurosci*, 7, 59.
- MINEUR, Y. S., BELZUNG, C. & CRUSIO, W. E. 2006. Effects of unpredictable chronic mild stress on anxiety and depression-like behavior in mice. *Behav. Brain Res.*, 175, 43-50.
- MINOGUE, A. M., BARRETT, J. P. & LYNCH, M. A. 2012. LPS-induced release of IL-6 from glia modulates production of IL-1 β in a JAK2-dependent manner. *J. Neuroinflammation*, 9, 126.
- MIRESCU, C. & GOULD, E. 2006. Stress and adult neurogenesis. *Hippocampus*, 16, 233-8.
- MIROCHNIC, S., WOLF, S., STAUFENBIEL, M. & KEMPERMANN, G. 2009. Age effects on the regulation of adult hippocampal neurogenesis by physical activity and environmental

- enrichment in the APP23 mouse model of Alzheimer disease. *Hippocampus*, 19, 1008-18.
- MIYAWAKI, T., HONDA, Y., UEMURA, A., TANABE, Y., DEZAWA, M., YU, R. T. & TANABE, T. 2004. Tlx, an Orphan Nuclear Receptor, Regulates Cell Numbers and Astrocyte Development in the Developing Retina. *J Neurosci*, 24, 8124–8134.
- MOLTENI, R., YING, Z. & GOMEZ-PINILLA, F. 2002. Differential effects of acute and chronic exercise on plasticity-related genes in the rat hippocampus revealed by microarray. *Eur J Neurosci*, 16, 1107-16.
- MONAGHAN, A. P., BOCK, D., GASS, P., SCHWAGER, A., WOLFER, D. P., LIPP, H. P. & SCHUTZ, G. 1997. Defective limbic systemin micelacking the tailless gene. *Nature*, 390, 515-517.
- MONAGHAN, A. P., GRAU, E., BOCK, D. & SCHUTZ, G. 1995. The mouse homolog of the orphan nuclear receptor tailless is expressed in the developing forebrain. *Development*, 121, 839-53.
- MONTEIRO, S., ROQUE, S., DE SÁ-CALÇADA, D., SOUSA, N., CORREIA-NEVES, M. & CERQUEIRA, J. J. 2015. An Efficient Chronic Unpredictable Stress Protocol to Induce Stress-Related Responses in C57BL/6 Mice. *Front. Psychiatry*, 6, 6.
- MOORE, A. H., WU, M., SHAFTEL, S. S., GRAHAM, K. A. & O'BANION, M. K. 2009. Sustained expression of interleukin-1beta in mouse hippocampus impairs spatial memory. *Neuroscience*, 164, 1484-95.
- MORASKA, A., DEAK, T., SPENCER, R. L., ROTH, D. & FLESHNER, M. 2000. Treadmill running produces both positive and negative physiological adaptations in Sprague-Dawley rats. *Am J Physiol Regul Integr Comp Physiol*, 279, R1321-9.
- MORGAN, D., MUNIREDDY, S., ALAMED, J., DELEON, J., DIAMOND, D. M., BICKFORD, P., HUTTON, M., LEWIS, J., MCGOWAN, E. & GORDON, M. N. 2008. Apparent Behavioral Benefits of Tau Overexpression in P301L Tau Transgenic Mice. *J Alzheimers Dis*, 15, 605-614.
- MORRIS, R. 1984. Developments of a water-maze procedure for studying spatial learning in the rat. *J Neurosci Methods*, 11, 47-60.
- MOSER, E., MOSER, M. B. & ANDERSEN, P. 1993. Spatial learning impairment parallels the magnitude of dorsal hippocampal lesions, but is hardly present following ventral lesions. *J Neurosci*, 13, 3916-25.
- MOSER, M. B. & MOSER, E. I. 1998. Functional differentiation in the hippocampus. *Hippocampus*, 8, 608-619.
- MOSER, M. B., MOSER, E. I., FORREST, E., ANDERSEN, P. & MORRIS, R. G. 1995a. Spatial learning with a minislab in the dorsal hippocampus. *Proc. Natl. Acad. Sci. U.S.A.*, 92, 9697-701.
- MOSER, M. B., MOSER, E. I., FORREST, E., ANDERSEN, P. & MORRIS, R. G. 1995b. Spatial learning with a minislab in the dorsal hippocampus. *Proc. Natl. Acad. Sci. U.S.A.*, 92, 9697-9701.
- MU, Y., LEE, S. W. & GAGE, F. H. 2010. Signaling in adult neurogenesis. *Curr Opin Neurobiol*, 20, 416-23.
- MUELLER-PAUL, J., WILKINSON, A., AUST, U., STEURER, M., HALL, G. & HUBER, L. 2014. Touchscreen performance and knowledge transfer in the red-footed tortoise (*Chelonoidis carbonaria*). *Behav. Process*, 106, 187-192.
- MURAI, K., QU, Q., SUN, G., YE, P., LI, W., ASUELIME, G., SUN, E., TSAI, G. E. & SHI, Y. 2014. Nuclear receptor TLX stimulates hippocampal neurogenesis and enhances learning and memory in a transgenic mouse model. *Proc. Natl. Acad. Sci. U.S.A.*, 111, 9115-20.
- MURAI, K., SUN, G., YE, P., TIAN, E., YANG, S., CUI, Q., SUN, G., TRINH, D., SUN, O., HONG, T., WEN, Z., KALKUM, M., RIGGS, A. D., SONG, H., MING, G.-L. & SHI, Y. 2016. The TLX-miR-

- 219 cascade regulates neural stem cell proliferation in neurodevelopment and schizophrenia iPSC model. *Nat Commun*, 7.
- MURPHY, D. D., COLE, N. B., GREENBERGER, V. & SEGAL, M. 1998. Estradiol increases dendritic spine density by reducing GABA neurotransmission in hippocampal neurons. *J Neurosci*, 18, 2550-9.
- MURPHY, T., DIAS, G. P. & THURET, S. 2014. Effects of diet on brain plasticity in animal and human studies: mind the gap. *Neural plasticity*, 2014.
- MYERS, C. E. & SCHARFMAN, H. E. 2009. A role for hilar cells in pattern separation in the dentate gyrus: a computational approach. *Hippocampus*, 19, 321-37.
- MYERS, C. E. & SCHARFMAN, H. E. 2011. Pattern separation in the dentate gyrus: a role for the CA3 backprojection. *Hippocampus*, 21, 1190-215.
- NADA, M.-B., FILIPKOWSKI, R. K., PRUSCHY, M., JAHOLKOWSKI, P., WINKLER, J., KACZMAREK, L. & LIPP, H.-P. 2013. Impaired long-term memory retention: common denominator for acutely or genetically reduced hippocampal neurogenesis in adult mice. *Behav. Brain Res.*, 252, 275-286.
- NAJT, P., PEREZ, J., SANCHES, M., PELUSO, M. A., GLAHN, D. & SOARES, J. C. 2007. Impulsivity and bipolar disorder. *Eur Neuropsychopharmacol*, 17, 313-20.
- NAYLOR, A. S., PERSSON, A. I., ERIKSSON, P. S., JONSDOTTIR, I. H. & THORLIN, T. 2005. Extended voluntary running inhibits exercise-induced adult hippocampal progenitor proliferation in the spontaneously hypertensive rat. *J Neurophysiol*, 93, 2406-14.
- NEEPER, S. A., GOMEZ-PINILLA, F., CHOI, J. & COTMAN, C. 1995. Exercise and brain neurotrophins. *Nature*, 373, 109.
- NEEPER, S. A., GOMEZ-PINILLA, F., CHOI, J. & COTMAN, C. W. 1996. Physical activity increases mRNA for brain-derived neurotrophic factor and nerve growth factor in rat brain. *Brain Res*, 726, 49-56.
- NEVES, G., COOKE, S. F. & BLISS, T. V. P. 2008. Synaptic plasticity, memory and the hippocampus: a neural network approach to causality. *Nat. Rev. Neurosci.*, 9, 65-75.
- NGUYEN, K. T., DEAK, T., OWENS, S. M., KOHNO, T., FLESHNER, M., WATKINS, L. R. & MAIER, S. F. 1998. Exposure to acute stress induces brain interleukin-1beta protein in the rat. *J Neurosci*, 18, 2239-46.
- NIIBORI, Y., YU, T. S., EPP, J. R., AKERS, K. G., JOSSELYN, S. A. & FRANKLAND, P. W. 2012. Suppression of adult neurogenesis impairs population coding of similar contexts in hippocampal CA3 region. *Nat Commun*, 3, 1253.
- NITHIANANTHARAJAH, J. & HANNAN, A. J. 2006. Enriched environments, experience-dependent plasticity and disorders of the nervous system. *Nature Rev Neurosci*, 7, 697.
- NITHIANANTHARAJAH, J., MCKECHANIE, A. G., STEWART, T. J., JOHNSTONE, M., BLACKWOOD, D. H., ST CLAIR, D., GRANT, S. G., BUSSEY, T. J. & SAKSIDA, L. M. 2015. Bridging the translational divide: identical cognitive touchscreen testing in mice and humans carrying mutations in a disease-relevant homologous gene. *Sci Rep*, 5, 14613.
- NOLAN, Y. M., SULLIVAN, A. M. & TOULOUSE, A. 2013. Parkinson's disease in the nuclear age of neuroinflammation. *Trends Mol Med*, 19, 187-96.
- NOLTE, J. 2002. *The Human Brain: An Introduction to Its Functional Anatomy*, Mosby.
- NORMAN, G. J., KARELINA, K., ZHANG, N., WALTON, J. C., MORRIS, J. S. & DEVRIES, A. C. 2010. Stress and IL-1 β contribute to the development of depressive-like behavior following peripheral nerve injury. *Mol. psychiatry*, 15, 404-414.

- O'CALLAGHAN, R. M., OHLE, R. & KELLY, A. M. 2007. The effects of forced exercise on hippocampal plasticity in the rat: A comparison of LTP, spatial- and non-spatial learning. *Behav Brain Res*, 176, 362-6.
- O'CONNOR, R. M. & CRYAN, J. F. 2014. Adolescent brain vulnerability and psychopathology through the generations: role of diet and dopamine. *Biol Psychiatry*, 75, 4-6.
- O'KEEFE, J. 1976. Place units in the hippocampus of the freely moving rat. *Exp. Neurol*, 51, 78-109.
- O'KEEFE, J. 1979. A review of the hippocampal place cells. *Prog Neurobiol*, 13, 419-39.
- O'KEEFE, J. & NADEL, L. 1978. *The Hippocampus as a Cognitive Map*, Oxford., Clarendon Press.
- O'LEARY, J. D., KOZAREVA, D. A., HUESTON, C. M., O'LEARY, O. F., CRYAN, J. F. & NOLAN, Y. M. 2016a. The nuclear receptor Tlx regulates motor, cognitive and anxiety-related behaviours during adolescence and adulthood. *Behav Brain Res*, 306, 36-47.
- O'LEARY, J. D., O'LEARY, O. F., CRYAN, J. F. & NOLAN, Y. M. 2016b. Regulation of behaviour by the nuclear receptor TLX. *Genes Brain Behav*.
- O'LEARY, O. F. & CRYAN, J. F. 2014. A ventral view on antidepressant action: roles for adult hippocampal neurogenesis along the dorsoventral axis. *Trends Pharmacol Sci*, 35, 675-87.
- O'LEARY, O. F., ZANDY, S., DINAN, T. G. & CRYAN, J. F. 2013. Lithium augmentation of the effects of desipramine in a mouse model of treatment-resistant depression: a role for hippocampal cell proliferation. *Neuroscience*, 228, 36-46.
- O'LEÍME, C. S., CRYAN, J. F. & NOLAN, Y. M. 2017. Nuclear Deterrents: Intrinsic Regulators of IL-1 β -induced Effects on Hippocampal Neurogenesis. *Brain Behav. Immun.*, 66, 394-412.
- Ó'LEÍME, C. S., KOZAREVA, D. A., HOBAN, A. E., LONG-SMITH, C. M., CRYAN, J. F. & NOLAN, Y. M. 2017. TLX is an intrinsic regulator of the negative effects of IL-1 β on proliferating hippocampal neural progenitor cells. *The FASEB Journal*.
- OITZL, M. S., VAN OERS, H., SCHÖBITZ, B. & RON DE KLOET, E. 1993. Interleukin-1 β , but not interleukin-6, impairs spatial navigation learning. *Brain Res.*, 613, 160-163.
- OOMEN, C. A., HVOSLEF-EIDE, M., HEATH, C. J., MAR, A. C., HORNER, A. E., BUSSEY, T. J. & SAKSIDA, L. M. 2013. The touchscreen operant platform for testing working memory and pattern separation in rats and mice. *Nat. Protoc.*, 8, 2006-21.
- OOMEN, C. A., HVOSLEF-EIDE, M., KOFINK, D., PREUSSER, F., MAR, A. C., SAKSIDA, L. M. & BUSSEY, T. J. 2015. A novel 2- and 3-choice touchscreen-based continuous trial-unique nonmatching-to-location task (cTUNL) sensitive to functional differences between dentate gyrus and CA3 subregions of the hippocampus. *Psychopharmacology (Berl)*, 232, 3921-33.
- ORMEROD, B. K., HANFT, S. J., ASOKAN, A., HADITSCH, U., LEE, S. W. & PALMER, T. D. 2013. PPAR γ activation prevents impairments in spatial memory and neurogenesis following transient illness. *Brain Behav Immun*, 29, 28-38.
- PALKOVITS, M. 1983. The rat brain in stereotaxic coordinates. *Neuropeptides*, 3, 319.
- PALMER, T. D., MARKAKIS, E. A., WILLHOITE, A. R., SAFAR, F. & GAGE, F. H. 1999. Fibroblast growth factor-2 activates a latent neurogenic program in neural stem cells from diverse regions of the adult CNS. *J Neurosci*, 19, 8487-97.
- PALOMO, J., DIETRICH, D., MARTIN, P., PALMER, G. & GABAY, C. 2015. The interleukin (IL)-1 cytokine family--Balance between agonists and antagonists in inflammatory diseases. *Cytokine*, 76, 25-37.
- PARK, C. H. J., GANELLA, D. E. & KIM, J. H. 2017a. A dissociation between renewal and contextual fear conditioning in juvenile rats. *Dev Psychobiol*, 59, 515-522.

- PARK, C. H. J., GANELLA, D. E. & KIM, J. H. 2017b. Juvenile female rats, but not male rats, show renewal, reinstatement, and spontaneous recovery following extinction of conditioned fear. *Learn Mem*, 24, 630-636.
- PARK, E. H., BURGHARDT, N. S., DVORAK, D., HEN, R. & FENTON, A. A. 2015. Experience-Dependent Regulation of Dentate Gyrus Excitability by Adult-Born Granule Cells. *J Neurosci*, 35, 11656-66.
- PARNET, P., AMINDARI, S., WU, C., BRUNKE-REESE, D., GOUJON, E., WEYHENMEYER, J. A., DANTZER, R. & KELLEY, K. W. 1994. Expression of type I and type II interleukin-1 receptors in mouse brain. *Mol. Brain Res.*, 27, 63-70.
- PATTEN, A. R., SICKMANN, H., HRYCIW, B. N., KUCHARSKY, T., PARTON, R., KERNICK, A. & CHRISTIE, B. R. 2013. Long-term exercise is needed to enhance synaptic plasticity in the hippocampus. *Learn Mem*, 20, 642-7.
- PATTWELL, S. S., BATHA, K. G., CASEY, B. J., NINANE, I. & LEE, F. S. 2011. Selective early-acquired fear memories undergo temporary suppression during adolescence. *Proc. Natl. Acad. Sci. U.S.A.*, 108, 1182-1187.
- PATTWELL, S. S., LEE, F. S. & CASEY, B. J. 2013. Fear learning and memory across adolescent development Hormones and Behavior Special Issue: Puberty and Adolescence. *Horm. Behav*, 64, 380-389.
- PAYNE, C., MACHADO, C. J., BLIWISE, N. G. & BACHEVALIER, J. 2010. Maturation of the Hippocampal Formation and Amygdala in Macaca mulatta: A Volumetric Magnetic Resonance Imaging Study. *Hippocampus*, 20, 922-935.
- PECHNICK, R. N., ZONIS, S., WAWROWSKY, K., POURMORADY, J. & CHESNOKOVA, V. 2008. p21Cip1 restricts neuronal proliferation in the subgranular zone of the dentate gyrus of the hippocampus. *Proc. Natl. Acad. Sci. U.S.A.*, 105, 1358-63.
- PERRY, J. L., LARSON, E. B., GERMAN, J. P., MADDEN, G. J. & CARROLL, M. E. 2005. Impulsivity (delay discounting) as a predictor of acquisition of IV cocaine self-administration in female rats. *Psychopharmacology*, 178, 193-201.
- PESSOA, L. 2008. On the relationship between emotion and cognition. *Nature Rev Neurosci*, 9, 148.
- PETRIK, D., LAGACE, D. C. & EISCH, A. J. 2012. The neurogenesis hypothesis of affective and anxiety disorders: are we mistaking the scaffolding for the building? *Neuropharmacology*, 62, 21-34.
- PIPONNIEMI, T. O., BRAGGE, T., VAUHKONEN, E. E., VARTIAINEN, P., PUOLIVÄLI, J. T., SWEENEY, P. J. & KOPANITSA, M. V. 2017. Acquisition and reversal of visual discrimination learning in APPSwDI/Nos2^{-/-} (CVN) mice. *Neurosci. Lett.*, 650, 126-133.
- PINEÑO, O. 2014. ArduiPod Box: A low-cost and open-source Skinner box using an iPod Touch and an Arduino microcontroller. *Behav Res Methods*, 46, 196-205.
- POTHION, S., BIZOT, J.-C., TROVERO, F. & BELZUNG, C. 2004. Strain differences in sucrose preference and in the consequences of unpredictable chronic mild stress. *Behav. Brain Res.*, 155, 135-146.
- PUGH, C. R., NGUYEN, K. T., GONYEA, J. L., FLESHNER, M., WATKINS, L. R., MAIER, S. F. & RUDY, J. W. 1999. Role of interleukin-1 beta in impairment of contextual fear conditioning caused by social isolation. *Behav. Brain Res.*, 106, 109-118.
- QIN, S., NIU, W., IQBAL, N., SMITH, D. K. & ZHANG, C. L. 2014. Orphan nuclear receptor TLX regulates astrogenesis by modulating BMP signaling. *Front Neurosci*, 8, 1-10.

- RABER, J., ROLA, R., LEFEVOUR, A., MORHARDT, D., CURLEY, J., MIZUMATSU, S., VANDENBERG, S. R. & FIKE, J. R. 2004. Radiation-Induced Cognitive Impairments are Associated with Changes in Indicators of Hippocampal Neurogenesis. *Radiation Res.*, 162, 39-47.
- RANGE, F., AUST, U., STEURER, M. & HUBER, L. 2008. Visual categorization of natural stimuli by domestic dogs. *Animal Cognition*, 11, 339-347.
- REBOLA, N., CARTA, M. & MULLE, C. 2017. Operation and plasticity of hippocampal CA3 circuits: implications for memory encoding. *Nat Rev Neurosci*, 18, 208-220.
- REVEST, J. M., DUPRET, D., KOEHL, M., FUNK-REITER, C., GROSJEAN, N., PIAZZA, P. V. & ABROUS, D. N. 2009. Adult hippocampal neurogenesis is involved in anxiety-related behaviors. *Mol. Psychiatry*, 14, 959-967.
- RHODES, J. S., VAN PRAAG, H., JEFFREY, S., GIRARD, I., MITCHELL, G. S., GARLAND, T., JR. & GAGE, F. H. 2003. Exercise increases hippocampal neurogenesis to high levels but does not improve spatial learning in mice bred for increased voluntary wheel running. *Behav Neurosci*, 117, 1006-16.
- RICHMOND, M., YEE, B., POUZET, B., VEENMAN, L., RAWLINS, J., FELDON, J. & BANNERMAN, D. 1999. Dissociating context and space within the hippocampus: effects of complete, dorsal, and ventral excitotoxic hippocampal lesions on conditioned freezing and spatial learning. *Behav Neurosci*, 113, 1189.
- RIZZI, G., LODGE, M. E. & TAN, K. R. 2016. Design and construction of a low-cost nose poke system for rodents. *MethodsX*, 3, 326-332.
- ROLA, R., RABER, J., RIZK, A., OTSUKA, S., VANDENBERG, S. R., MORHARDT, D. R. & FIKE, J. R. 2004. Radiation-induced impairment of hippocampal neurogenesis is associated with cognitive deficits in young mice. *Exp. Neurol.*, 188, 316-30.
- ROSELL, D. R. & SIEVER, L. J. 2015. The neurobiology of aggression and violence. *CNS Spectr*, 165, 429-42.
- ROSS, C. A., MARGOLIS, R. L., READING, S. A. J., PLETNIKOV, M. & COYLE, J. T. 2006. Neurobiology of Schizophrenia. *Neuron*, 52, 139-153.
- ROTHWELL, N. J. & LUHESHI, G. N. 2000. Interleukin 1 in the brain: biology, pathology and therapeutic target. *Trends Neurosci*, 23, 618-25.
- ROY, K., KUZNICKI, K., MONAGHAN, A. P., WU, Q., SUN, E., BOCK, D., SCHUTZ, G. & VRANICH, N. 2004. The *Tlx* gene regulates the timing of neurogenesis in the cortex. *J Neurosci*, 38, 8333– 8345.
- ROY, K., THIELS, E. & MONAGHAN, A. P. 2002. Loss of the *tailless* gene affects forebrain development and emotional behavior. *Physiol Behav*, 77, 595–600.
- RYAN, S. M. & KELLY, A. M. 2016. Exercise as a pro-cognitive, pro-neurogenic and anti-inflammatory intervention in transgenic mouse models of Alzheimer's disease. *Ageing Res Rev*, 27, 77-92.
- RYAN, S. M. & NOLAN, Y. M. 2016a. Neuroinflammation negatively affects adult hippocampal neurogenesis and cognition: can exercise compensate? *Neurosci Biobehav Rev*, 61, 121-31.
- RYAN, S. M. & NOLAN, Y. M. 2016b. Neuroinflammation negatively affects adult hippocampal neurogenesis and cognition: can exercise compensate? *Neurosci. Biobehav. Rev.*, 61, 121-31.
- RYAN, S. M., O'KEEFFE, G. W., O'CONNOR, C., KEESHAN, K. & NOLAN, Y. M. 2013. Negative regulation of *TLX* by *IL-1beta* correlates with an inhibition of adult hippocampal neural precursor cell proliferation. *Brain Behav. Immun.*, 33, 7-13.

- SAH, N., PETERSON, B. D., LUBEJKO, S. T., VIVAR, C. & VAN PRAAG, H. 2017. Running reorganizes the circuitry of one-week-old adult-born hippocampal neurons. *Scientific Reports*, 7, 10903.
- SAHAY, A., SCOBIE, K. N., HILL, A. S., O'CARROLL, C. M., KHEIRBEK, M. A., BURGHARDT, N. S., FENTON, A. A., DRANOVSKY, A. & HEN, R. 2011a. Increasing adult hippocampal neurogenesis is sufficient to improve pattern separation. *Nature*, 472, 466-470.
- SAHAY, A., SCOBIE, K. N., HILL, A. S., O'CARROLL, C. M., KHEIRBEK, M. A., BURGHARDT, N. S., FENTON, A. A., DRANOVSKY, A. & HEN, R. 2011b. Increasing adult hippocampal neurogenesis is sufficient to improve pattern separation. *Nature*, 472, 466-70.
- SAHAY, A., WILSON, DONALD A. & HEN, R. 2011c. Pattern Separation: A Common Function for New Neurons in Hippocampus and Olfactory Bulb. *Neuron*, 70, 582-588.
- SALAMONE, J. D. & CORREA, M. 2002. Motivational views of reinforcement: implications for understanding the behavioral functions of nucleus accumbens dopamine. *Behav Brain Res*, 137, 3-25.
- SANDI, C., MERINO, J. J., CORDERO, M. I., TOUYAROT, K. & VENERO, C. 2001. Effects of chronic stress on contextual fear conditioning and the hippocampal expression of the neural cell adhesion molecule, its polysialylation, and L1. *Neuroscience*, 102, 329-339.
- SANTARELLI, L., SAXE, M., GROSS, C., SURGET, A., BATTAGLIA, F., DULAWA, S., WEISSTAUB, N., LEE, J., DUMAN, R., ARANCIO, O., BELZUNG, C. & HEN, R. 2003. Requirement of hippocampal neurogenesis for the behavioral effects of antidepressants. *Science*, 301, 805-9.
- SAWYER, S. M., AFIFI, R. A., BEARINGER, L. H., BLAKEMORE, S.-J., DICK, B., EZEH, A. C. & PATTON, G. C. 2012. Adolescence: a foundation for future health. *The Lancet*, 379, 1630-1640.
- SAXE, M. D., BATTAGLIA, F., WANG, J.-W., MALLERET, G., DAVID, D. J., MONCKTON, J. E., GARCIA, A. D. R., SOFRONIEW, M. V., KANDEL, E. R. & SANTARELLI, L. 2006a. Ablation of hippocampal neurogenesis impairs contextual fear conditioning and synaptic plasticity in the dentate gyrus. *Proceedings of the National Academy of Sciences*, 103, 17501-17506.
- SAXE, M. D., BATTAGLIA, F., WANG, J. W., MALLERET, G., DAVID, D. J., MONCKTON, J. E., GARCIA, A. D., SOFRONIEW, M. V., KANDEL, E. R., SANTARELLI, L., HEN, R. & DREW, M. R. 2006b. Ablation of hippocampal neurogenesis impairs contextual fear conditioning and synaptic plasticity in the dentate gyrus. *Proc. Natl. Acad. Sci. U.S.A.*, 103.
- SAXE, M. D., BATTAGLIA, F., WANG, J. W., MALLERET, G., DAVID, D. J., MONCKTON, J. E., GARCIA, A. D., SOFRONIEW, M. V., KANDEL, E. R., SANTARELLI, L., HEN, R. & DREW, M. R. 2006c. Ablation of hippocampal neurogenesis impairs contextual fear conditioning and synaptic plasticity in the dentate gyrus. *Proc. Natl. Acad. Sci. U.S.A.*, 103, 17501-6.
- SBISA, A. M., GOGOS, A. & VAN DEN BUUSE, M. 2017. Spatial working memory in the touchscreen operant platform is disrupted in female rats by ovariectomy but not estrous cycle. *Neurobiol Learn Mem*, 144, 147-154.
- SCHARFMAN, H., GOODMAN, J., MACLEOD, A., PHANI, S., ANTONELLI, C. & CROLL, S. 2005. Increased neurogenesis and the ectopic granule cells after intrahippocampal BDNF infusion in adult rats. *Exp Neurol*, 192, 348-56.
- SCHERF, K. S., SMYTH, J. M. & DELGADO, M. R. 2013. The amygdala: An agent of change in adolescent neural networks. *Horm. Behav*, 64, 298-313.
- SCHMIDT-HIEBER, C., JONAS, P. & BISCHOFBERGER, J. 2004. Enhanced synaptic plasticity in newly generated granule cells of the adult hippocampus. *Nature*, 429, 184-7.

- SCHMIDT, H. D. & DUMAN, R. S. 2010. Peripheral BDNF produces antidepressant-like effects in cellular and behavioral models. *Neuropsychopharmacology*, 35, 2378.
- SCHNEIDER, H., PITOSI, F., BALSCHUN, D., WAGNER, A., DEL REY, A. & BESEDOVSKY, H. O. 1998. A neuromodulatory role of interleukin-1beta in the hippocampus. *Proc. Natl. Acad. Sci. U.S.A.*, 95, 7778-83.
- SCHNEIDER, M. 2013. Adolescence as a vulnerable period to alter rodent behavior. *Cell Tissue Res*, 354, 99-106.
- SCHOOF, D., PREUß, D. & WOLF, O. T. 2008. Psychosocial stress induces working memory impairments in an n-back paradigm. *Psychoneuroendocrinology*, 33, 643-653.
- SCHUMAN, E. M. 1999. Neurotrophin regulation of synaptic transmission. *Curr Opin Neurobiol*, 9, 105-109.
- SCHWABE, L., OITZL, M. S., PHILIPPSEN, C., RICHTER, S., BOHRINGER, A., WIPPICH, W. & SCHACHINGER, H. 2007. Stress modulates the use of spatial versus stimulus-response learning strategies in humans. *Learn. Mem.*, 14, 109-116.
- SCOVILLE, W. B. & MILNER, B. 1957. Loss of recent memory after bilateral hippocampal lesions. *J. Neurol. Neurosurg. Psychiatry*, 20, 11-21.
- SELEMON, L. D. 2013. A role for synaptic plasticity in the adolescent development of executive function. *Transl. Psychiatry*, 3, e238.
- SELKOE, D. J. 2001. Alzheimer's disease: genes, proteins, and therapy. *Physiol Rev*, 81, 741-66.
- SENECHAL, Y., KELLY, P. H., CRYAN, J. F., NATT, F. & DEV, K. K. 2007. Amyloid precursor protein knockdown by siRNA impairs spontaneous alternation in adult mice. *J. Neurochem.*, 102, 1928-40.
- SERNAGOR, E., CHABROL, F., BONY, G. & CANCEDDA, L. 2010. GABAergic Control of Neurite Outgrowth and Remodeling During Development and Adult Neurogenesis: General Rules and Differences in Diverse Systems. *Front Cell Neurosci.*, 4, 11.
- SHAFTEL, S. S., GRIFFIN, W. S. T. & O'BANION, M. K. 2008. The role of interleukin-1 in neuroinflammation and Alzheimer disease: an evolving perspective. *J. Neuroinflammation*, 5, 7.
- SHAFTEL, S. S., KYRKANIDES, S., OLSCHOWKA, J. A., MILLER, J. N., JOHNSON, R. E. & O'BANION, M. K. 2007. Sustained hippocampal IL-1 beta overexpression mediates chronic neuroinflammation and ameliorates Alzheimer plaque pathology. *J Clin Invest*, 117, 1595-604.
- SHAO, W., PENG, D. & WANG, X. 2017. Genetics of Alzheimer's disease: From pathogenesis to clinical usage. *J Clin Neurosci*, 45, 1-8.
- SHARMA, S., RAKOCZY, S. & BROWN-BORG, H. 2010. Assessment of spatial memory in mice. *Life Sciences*, 87, 521-536.
- SHI, Y., CHICHUNG LIE, D., TAUPIN, P., NAKASHIMA, K., RAY, J., YU, R. T., GAGE, F. H. & EVANS, R. M. 2004. Expression and function of orphan nuclear receptor TLX in adult neural stem cells. *Nature*, 427, 78-83.
- SHINTANI, F., NAKAKI, T., KANBA, S., SATO, K., YAGI, G., SHIOZAWA, M., AISO, S., KATO, R. & ASAI, M. 1995. Involvement of interleukin-1 in immobilization stress-induced increase in plasma adrenocorticotrophic hormone and in release of hypothalamic monoamines in the rat. *J Neurosci*, 15, 1961.
- SHORS, T. J., ANDERSON, M. L., CURLIK, D. M., 2ND & NOKIA, M. S. 2012. Use it or lose it: how neurogenesis keeps the brain fit for learning. *Behav Brain Res*, 227, 450-8.
- SHORT, A. K., YESHURUN, S., POWELL, R., PERREAU, V. M., FOX, A., KIM, J. H., PANG, T. Y. & HANNAN, A. J. 2017. Exercise alters mouse sperm small noncoding RNAs and induces a

- transgenerational modification of male offspring conditioned fear and anxiety. *Transl Psychiatry*, 7, e1114.
- SIETTE, J., WESTBROOK, R. F., COTMAN, C., SIDHU, K., ZHU, W., SACHDEV, P. & VALENZUELA, M. J. 2013. Age-Specific Effects of Voluntary Exercise on Memory and the Older Brain. *Biol. Psychiatry*, 73, 435-442.
- SILVA, A. J., SIMPSON, E. M., TAKAHASHI, J. S., LIPP, H.-P., NAKANISHI, S., WEHNER, J. M., GIESE, K. P., TULLY, T., ABEL, T., CHAPMAN, P. F., FOX, K., GRANT, S., ITOHARA, S., LATHE, R., MAYFORD, M., MCNAMARA, J. O., MORRIS, R. J., PICCIOTTO, M., RODER, J., SHIN, H.-S., SLESINGER, P. A., STORM, D. R., STRYKER, M. P., TONEGAWA, S., WANG, Y. & WOLFER, D. P. 1997. Mutant Mice and Neuroscience: Recommendations Concerning Genetic Background. *Neuron*, 19, 755-759.
- SIMON, P., FEHRENBACH, E. & NIESS, A. M. 2006. Regulation of immediate early gene expression by exercise: short cuts for the adaptation of immune function. *Exerc Immunol Rev*, 12, 112-31.
- SINGH, R. K., CHANG, H.-W., YAN, D., LEE, K. M., UCMAK, D., WONG, K., ABROUK, M., FARAHNIK, B., NAKAMURA, M., ZHU, T. H., BHUTANI, T. & LIAO, W. 2017. Influence of diet on the gut microbiome and implications for human health. *Journal of Translational Medicine*, 15, 73.
- SISK, C. L. & FOSTER, D. L. 2004. The neural basis of puberty and adolescence. *Nat Neurosci*, 7, 1040-7.
- SKINNER, B. F. 1938. *The behaviour of organisms: An experimental analysis*, New York, Appleton-Century Company Inc.
- SLATTERY, D. A. & CRYAN, J. F. 2012. Using the rat forced swim test to assess antidepressant-like activity in rodents. *Nat Protoc*, 7, 1009-14.
- SMITH, D. M. & MIZUMORI, S. J. 2006. Hippocampal place cells, context, and episodic memory. *Hippocampus*, 16, 716-29.
- SNYDER, J. S., HONG, N. S., MCDONALD, R. J. & WOJTOWICZ, J. M. 2005a. A role for adult neurogenesis in spatial long-term memory. *Neuroscience*, 130, 843-852.
- SNYDER, J. S., HONG, N. S., MCDONALD, R. J. & WOJTOWICZ, J. M. 2005b. A role for adult neurogenesis in spatial long-term memory. *Neuroscience*, 130, 843-52.
- SNYDER, J. S., KEE, N. & WOJTOWICZ, J. M. 2001. Effects of adult neurogenesis on synaptic plasticity in the rat dentate gyrus. *J Neurophysiol*, 85, 2423-31.
- SO, J. H., HUANG, C., GE, M., CAI, G., ZHANG, L., LU, Y. & MU, Y. 2017. Intense Exercise Promotes Adult Hippocampal Neurogenesis But Not Spatial Discrimination. *Front Cell Neurosci*, 11, 13.
- SOLTESZ, I. & LOSONCZY, A. 2018. CA1 pyramidal cell diversity enabling parallel information processing in the hippocampus. *Nature Neuroscience*, 21, 484-493.
- SOUSA, N., MADEIRA, M. D. & PAULA-BARBOSA, M. M. 1998. Effects of corticosterone treatment and rehabilitation on the hippocampal formation of neonatal and adult rats. An unbiased stereological study. *Brain Res*, 794, 199-210.
- SPALDING, K. L., BERGMANN, O., ALKASS, K., BERNARD, S., SALEHPOUR, M., HUTTNER, H. B., BOSTROM, E., WESTERLUND, I., VIAL, C., BUCHHOLZ, B. A., POSSNERT, G., MASH, D. C., DRUID, H. & FRISÉN, J. 2013. Dynamics of hippocampal neurogenesis in adult humans. *Cell*, 153.
- SPEAR, L. P. 2000. The adolescent brain and age-related behavioral manifestations. *Neurosci Biobehav Rev*, 24, 417-63.

- SPEAR, L. P. 2004. Adolescent Brain Development and Animal Models. *Ann. N. Y. Acad. Sci.*, 1021, 23-26.
- SPEAR, L. P. 2007. Assessment of adolescent neurotoxicity: rationale and methodological considerations. *Neurotoxicol Teratol*, 29, 1-9.
- SPEAR, L. P. 2013. Adolescent Neurodevelopment. *J AdolescHealth*, 52, S7-S13.
- SQUIRE, L. R. 1992. Memory and the hippocampus: a synthesis from findings with rats, monkeys, and humans. *Psychol Rev*, 99, 195-231.
- SQUIRE, L. R., STARK, C. E. & CLARK, R. E. 2004. The medial temporal lobe. *Annu Rev Neurosci*, 27, 279-306.
- SRINIVASAN, D., YEN, J.-H., JOSEPH, D. J. & FRIEDMAN, W. 2004. Cell type-specific interleukin-1 β signaling in the CNS. *J. Neurosci*, 24, 6482-6488.
- STANGL, D. & THURET, S. 2009. Impact of diet on adult hippocampal neurogenesis. *Genes & Nutrition*, 4, 271-282.
- STENMAN, J., YU, R. T., EVANS, R. M. & CAMPBELL, K. 2003. Tlx and Pax6 co-operate genetically to establish the pallio-subpallial boundary in the embryonic mouse telencephalon. *Development*, 130, 1113-1122.
- STEURER, M. M., AUST, U. & HUBER, L. 2012. The Vienna comparative cognition technology (VCCT): an innovative operant conditioning system for various species and experimental procedures. *Behav. Res. Methods*, 44, 909-918.
- STRAKOWSKI, S. M., ADLER, C. M., ALMEIDA, J., ALTSHULER, L. L., BLUMBERG, H. P., CHANG, K. D., DELBELLO, M. P., FRANGO, S., MCINTOSH, A., PHILLIPS, M. L., SUSSMAN, J. E. & TOWNSEND, J. D. 2012a. The functional neuroanatomy of bipolar disorder: a consensus model. *Bipolar Disord*, 14, 313-25.
- STRAKOWSKI, S. M., ADLER, C. M., ALMEIDA, J., ALTSHULER, L. L., BLUMBERG, H. P., CHANG, K. D., DELBELLO, M. P., FRANGO, S., MCINTOSH, A., PHILLIPS, M. L., SUSSMAN, J. E. & TOWNSEND, J. D. 2012b. The functional neuroanatomy of bipolar disorder: a consensus model. *Bipolar Disord.*, 14, 313-25.
- STRANAHAN, A. M., KHALIL, D. & GOULD, E. 2007. Running Induces Widespread Structural Alterations in the Hippocampus and Entorhinal Cortex. *Hippocampus*, 17, 1017-1022.
- STRANGE, B. A., WITTER, M. P., LEIN, E. S. & MOSER, E. I. 2014. Functional organization of the hippocampal longitudinal axis. *Nat Rev Neurosci*, 15, 655-669.
- STREKALOVA, T., SPANAGEL, R., BARTSCH, D., HENN, F. A. & GASS, P. 2004. Stress-Induced Anhedonia in Mice is Associated with Deficits in Forced Swimming and Exploration. *Neuropsychopharmacology*, 29, 2007-2017.
- SUN, G., ALZAYADY, K., STEWART, R., YE, P., YANG, S., LI, W. & SHI, Y. 2010. Histone demethylase LSD1 regulates neural stem cell proliferation. *Mol Cell Biol*, 30, 1997-2005.
- SUN, G., YU, R. T., EVANS, R. M. & SHI, Y. 2007. Orphan nuclear receptor TLX recruits histone deacetylases to repress transcription and regulate neural stem cell proliferation. *Proc. Natl. Acad. Sci. U.S.A.*, 104, 15282-7.
- SUN, Y., JIN, K., CHILDS, J. T., XIE, L., MAO, X. O. & GREENBERG, D. A. 2006. Vascular endothelial growth factor-B (VEGFB) stimulates neurogenesis: evidence from knockout mice and growth factor administration. *Dev Biol*, 289, 329-35.
- SWAINSON, R., HODGES, J. R., GALTON, C. J., SEMPLE, J., MICHAEL, A., DUNN, B. D., IDDON, J. L., ROBBINS, T. W. & SAHAKIAN, B. J. 2001. Early detection and differential diagnosis of Alzheimer's disease and depression with neuropsychological tasks. *Dement Geriatr Cogn Disord*, 12, 265-80.

- SWANSON, L. W. & COWAN, W. M. 1977. An autoradiographic study of the organization of the efferent connections of the hippocampal formation in the rat. *J Comp Neurol*, 172, 49-84.
- SWARDFAGER, W., LANCTOT, K., ROTHENBURG, L., WONG, A., CAPPELL, J. & HERRMANN, N. 2010. A meta-analysis of cytokines in Alzheimer's disease. *Biol Psychiatry*, 68, 930-41.
- TALPOS, J. C., MCTIGHE, S. M., DIAS, R., SAKSIDA, L. M. & BUSSEY, T. J. 2010. Trial-unique, delayed nonmatching-to-location (TUNL): a novel, highly hippocampus-dependent automated touchscreen test of location memory and pattern separation. *Neurobiol Learn Mem*, 94, 341-52.
- TALPOS, J. C., WINTERS, B. D., DIAS, R., SAKSIDA, L. M. & BUSSEY, T. J. 2009. A novel touchscreen-automated paired-associate learning (PAL) task sensitive to pharmacological manipulation of the hippocampus: a translational rodent model of cognitive impairments in neurodegenerative disease. *Psychopharmacology*, 205, 157-68.
- TANAPAT, P., B. HASTINGS, N., A. RYDEL, T., GALEA, L. & GOULD, E. 2001. Exposure to fox odor inhibits cell proliferation in the hippocampus of adult rats via an adrenal hormone-dependent mechanism. 437, 496-504.
- TANSEY, M. G. & GOLDBERG, M. S. 2010. Neuroinflammation in Parkinson's disease: its role in neuronal death and implications for therapeutic intervention. *Neurobiol Dis*, 37, 510-8.
- TASAN, R. O., NGUYEN, N. K., WEGER, S., SARTORI, S. B., SINGEWALD, N., HEILBRONN, R., HERZOG, H. & SPERK, G. 2010. The central and basolateral amygdala are critical sites of neuropeptide Y/Y2 receptor-mediated regulation of anxiety and depression. *J Neurosci*, 30, 6282-90.
- TOLWANI, R. J., BUCKMASTER, P. S., VARMA, S., COSGAYA, J. M., WU, Y., SURJ, C. & SHOOTER, E. M. 2002. BDNF overexpression increases dendrite complexity in hippocampal dentate gyrus. *Neuroscience*, 114, 795-805.
- TONEGAWA, S. & MCHUGH, T. J. 2008. The ins and outs of hippocampal circuits. *Neuron*, 57, 175-7.
- TONG, L., BALAZS, R., SOIAMPORNKUL, R., THANGNIPON, W. & COTMAN, C. W. 2008. Interleukin-1 beta impairs brain derived neurotrophic factor-induced signal transduction. *Neurobiol. Aging*, 29, 1380-93.
- TONG, L., PRIETO, G. A., KRAMÁR, E. A., SMITH, E. D., CRIBBS, D. H., LYNCH, G. & COTMAN, C. W. 2012. BDNF-dependent synaptic plasticity is suppressed by IL-1 β via p38 MAPK. *J. Neurosci.*, 32, 17714-17724.
- TONI, N., TENG, E. M., BUSHONG, E. A., AIMONE, J. B., ZHAO, C., CONSIGLIO, A., VAN PRAAG, H., MARTONE, M. E., ELLISMAN, M. H. & GAGE, F. H. 2007. Synapse formation on neurons born in the adult hippocampus. *Nat Neurosci*, 10, 727.
- TREJO, J. L., LLORENS-MARTÍN, M. V. & TORRES-ALEMÁN, I. 2008. The effects of exercise on spatial learning and anxiety-like behavior are mediated by an IGF-I-dependent mechanism related to hippocampal neurogenesis. *Mol Cell Neurosci*, 37, 402-411.
- TREVES, A. & ROLLS, E. T. 1994. Computational analysis of the role of the hippocampus in memory. *Hippocampus*, 4, 374-391.
- TRONEL, S., BELNOUE, L., GROSJEAN, N., REVEST, J. M., PIAZZA, P. V., KOEHL, M. & ABROUS, D. N. 2012. Adult-born neurons are necessary for extended contextual discrimination. *Hippocampus*, 22, 292-8.
- TROPEPE, V., SIBILIA, M., CIRUNA, B. G., ROSSANT, J., WAGNER, E. F. & VAN DER KOOY, D. 1999. Distinct neural stem cells proliferate in response to EGF and FGF in the developing mouse telencephalon. *Dev Biol*, 208, 166-88.

- TULVING, E. 2002. Episodic memory: from mind to brain. *Annu Rev Psychol*, 53, 1-25.
- TULVING, E. & MARKOWITSCH, H. J. 1998. Episodic and declarative memory: role of the hippocampus. *Hippocampus*, 8, 198-204.
- TYLER, W. J. & POZZO-MILLER, L. 2003. Miniature synaptic transmission and BDNF modulate dendritic spine growth and form in rat CA1 neurones. *J Physiol*, 553, 497-509.
- UEMATSU, A., MATSUI, M., TANAKA, C., TAKAHASHI, T., NOGUCHI, K., SUZUKI, M. & NISHIJO, H. 2012. Developmental trajectories of amygdala and hippocampus from infancy to early adulthood in healthy individuals. *PLoS one*, 7, e46970.
- UYVAL, N., KIRAY, M., SISMAN, A., CAMSARI, U., GENCOGLU, C., BAYKARA, B., CETINKAYA, C. & AKSU, I. 2015. Effects of voluntary and involuntary exercise on cognitive functions, and VEGF and BDNF levels in adolescent rats. *Biotech. Histochem*, 90, 55-68.
- UYVAL, N., TUGYAN, K., KAYATEKIN, B. M., ACIKGOZ, O., BAGRIYANIK, H. A., GONENC, S., OZDEMIR, D., AKSU, I., TOPCU, A. & SEMIN, I. 2005. The effects of regular aerobic exercise in adolescent period on hippocampal neuron density, apoptosis and spatial memory. *Neurosci Lett*, 383, 241-245.
- VALLIÈRES, L., CAMPBELL, I. L., GAGE, F. H. & SAWCHENKO, P. E. 2002. Reduced Hippocampal Neurogenesis in Adult Transgenic Mice with Chronic Astrocytic Production of Interleukin-6. *J. Neurosci.*, 22, 486-492.
- VAN PRAAG, H., CHRISTIE, B. R., SEJNOWSKI, T. J. & GAGE, F. H. 1999a. Running enhances neurogenesis, learning, and long-term potentiation in mice. *Proc. Natl. Acad. Sci. U.S.A.*, 96, 13427-31.
- VAN PRAAG, H., KEMPERMANN, G. & GAGE, F. H. 1999b. Running increases cell proliferation and neurogenesis in the adult mouse dentate gyrus. *Nat Neurosci*, 2, 266-70.
- VAN PRAAG, H., KEMPERMANN, G. & GAGE, F. H. 2000. Neural consequences of environmental enrichment. *Nat Rev Neurosci*, 1, 191-8.
- VAN PRAAG, H., SCHINDER, A. F., CHRISTIE, B. R., TONI, N., PALMER, T. D. & GAGE, F. H. 2002. Functional neurogenesis in the adult hippocampus. *Nature*, 415, 1030-4.
- VAN PRAAG, H., SHUBERT, T., ZHAO, C. & GAGE, F. H. 2005. Exercise enhances learning and hippocampal neurogenesis in aged mice. *J Neurosci*, 25, 8680-5.
- VAYNMAN, S., YING, Z. & GOMEZ-PINILLA, F. 2004. Hippocampal BDNF mediates the efficacy of exercise on synaptic plasticity and cognition. *Eur J Neurosci*, 20, 2580-90.
- VAYNMAN, S. S., YING, Z., YIN, D. & GOMEZ-PINILLA, F. 2006. Exercise differentially regulates synaptic proteins associated to the function of BDNF. *Brain Research*, 1070, 124-130.
- VICHAYA, E. G., YOUNG, E. E., FRAZIER, M. A., COOK, J. L., WELSH, C. J. & MEAGHER, M. W. 2011. Social Disruption Induced Priming of CNS Inflammatory Response to Theiler's Virus is Dependent upon Stress Induced IL-6 Release. *J. Neuroimmunol*, 239, 44-52.
- VIDEBECH, P. & RAVNKILDE, B. 2004. Hippocampal volume and depression: a meta-analysis of MRI studies. *Am J Psychiatry*, 161, 1957-66.
- VIVAR, C., POTTER, M. C. & VAN PRAAG, H. 2013. All About Running: Synaptic Plasticity, Growth Factors and Adult Hippocampal Neurogenesis. *Curr Top Behav Neurosci.*, 15, 189-210.
- VOHRINGER, P. A., BARROILHET, S. A., AMERIO, A., REALE, M. L., ALVEAR, K., VERGNE, D. & GHAEMI, S. N. 2013. Cognitive impairment in bipolar disorder and schizophrenia: a systematic review. *Front Psychiatry*, 4, 87.
- VÖIKAR, V., KÖKS, S., VASAR, E. & RAUVALA, H. 2001. Strain and gender differences in the behavior of mouse lines commonly used in transgenic studies. *Physiol Behav*, 72, 271-281.

- VOIKAR, V., POLUS, A., VASAR, E. & RAUVALA, H. 2005. Long-term individual housing in C57BL/6J and DBA/2 mice: assessment of behavioral consequences. *Genes Brain Behav*, 4, 240-52.
- VOSS, M. W., VIVAR, C., KRAMER, A. F. & VAN PRAAG, H. 2013. Bridging animal and human models of exercise-induced brain plasticity. *Trends Cogn Sci*, 17, 525-44.
- WANG, S., SCOTT, B. W. & WOJTOWICZ, J. M. 2000. Heterogenous properties of dentate granule neurons in the adult rat. *J Neurobiol*, 42, 248-57.
- WATANABE, M. & FUKUDA, A. 2015. Development and regulation of chloride homeostasis in the central nervous system. *Front Cell Neurosci.*, 9, 371.
- WEHNER, J. M. & SILVA, A. 1996. Importance of strain differences in evaluations of learning and memory processes in null mutants. *Dev Dis Res Rev*, 2, 243-248.
- WEISS, J. M., GOODMAN, P. A., LOSITO, B. G., CORRIGAN, S., CHARRY, J. M. & BAILEY, W. H. 1981. Behavioral depression produced by an uncontrollable stressor: Relationship to norepinephrine, dopamine, and serotonin levels in various regions of rat brain. *Brain Res Rev.*, 3, 167-205.
- WESNES, K. A., ANNAS, P., BASUN, H., EDGAR, C. & BLENNOW, K. 2014. Performance on a pattern separation task by Alzheimer's patients shows possible links between disrupted dentate gyrus activity and apolipoprotein E in4 status and cerebrospinal fluid amyloid-beta42 levels. *Alzheimers Res Ther*, 6, 20.
- WILLIAMS, B. M., LUO, Y., WARD, C., REDD, K., GIBSON, R., KUCZAJ, S. A. & MCCOY, J. G. 2001. Environmental enrichment: effects on spatial memory and hippocampal CREB immunoreactivity. *Physiol Behav*, 73, 649-58.
- WILLNER, P., MUSCAT, R. & PAPP, M. 1992. Chronic mild stress-induced anhedonia: A realistic animal model of depression. *Neurosci. Biobehav. Rev.*, 16, 525-534.
- WINNER, B. & WINKLER, J. 2015. Adult neurogenesis in neurodegenerative diseases. *Cold Spring Harb Perspect Biol*, 7, a021287.
- WINTERS, B. D., FORWOOD, S. E., COWELL, R. A., SAKSIDA, L. M. & BUSSEY, T. J. 2004. Double dissociation between the effects of peri-postrhinal cortex and hippocampal lesions on tests of object recognition and spatial memory: heterogeneity of function within the temporal lobe. *J. Neurosci.*, 24, 5901-8.
- WOJTOWICZ, J. M., ASKEW, M. L. & WINOCUR, G. 2008. The effects of running and of inhibiting adult neurogenesis on learning and memory in rats. *Eur. J. Neurosci.*, 27, 1494-1502.
- WOLLASTON, W. H. 1807. LVIII. Description of the camera lucida. *The Philosophical Magazine*, 27, 343-347.
- WONG, B. K. Y., HOSSAIN, S. M., TRINH, E., OTTMANN, G. A., BUDAGHZADEH, S., ZHENG, Q. Y. & SIMPSON, E. M. 2010. Hyperactivity, startle reactivity and cell-proliferation deficits are resistant to chronic lithium treatment in adult Nr2e1(frc/frc) mice. *Genes Brain Behav*, 9, 681-94.
- WOOD, S. J., PROFFITT, T., MAHONY, K., SMITH, D. J., BUCHANAN, J.-A., BREWER, W., STUART, G. W., VELAKOULIS, D., MCGORRY, P. D. AND PANTELIS, C. 2002. Visuospatial memory and learning in first-episode schizophreniform psychosis and established schizophrenia: a functional correlate of hippocampal pathology? *Psychol. Med*, 32, 429-438.
- WRIGHT, R. L. & CONRAD, C. D. 2005. Chronic stress leaves novelty-seeking behavior intact while impairing spatial recognition memory in the Y-maze. *Stress*, 8, 151-4.
- WU, C. W., CHANG, Y. T., YU, L., CHEN, H. I., JEN, C. J., WU, S. Y., LO, C. P. & KUO, Y. M. 2008. Exercise enhances the proliferation of neural stem cells and neurite growth and survival of neuronal progenitor cells in dentate gyrus of middle-aged mice. *J Appl Physiol*, 105, 1585-94.

- WU, M. D., HEIN, A. M., MORAVAN, M. J., SHAFTEL, S. S., OLSCHOWKA, J. A. & O'BANION, M. K. 2012. Adult murine hippocampal neurogenesis is inhibited by sustained IL-1 β and not rescued by voluntary running. *Brain Behav. Immun.*, 26, 292-300.
- WU, M. D., MONTGOMERY, S. L., RIVERA-ESCALERA, F., OLSCHOWKA, J. A. & O'BANION, M. K. 2013. Sustained IL-1 β expression impairs adult hippocampal neurogenesis independent of IL-1 signaling in nestin+ neural precursor cells. *Brain Behav. Immun.*, 32, 9-18.
- WU, M. V., LUNA, V. M. & HEN, R. 2015. Running rescues a fear-based contextual discrimination deficit in aged mice. *Front Syst Neurosci*, 9, 114.
- YANG, S. Z., ZHANG, L. M., HUANG, Y. L. & SUN, F. Y. 2003. Distribution of Flk-1 and Flt-1 receptors in neonatal and adult rat brains. *Anat Rec A Discov Mol Cell Evol Biol*, 274, 851-6.
- YASSA, M. A. & STARK, C. E. 2011. Pattern separation in the hippocampus. *Trends Neurosci.*, 34, 515-25.
- YIRMIYA, R. & GOSHEN, I. 2011. Immune modulation of learning, memory, neural plasticity and neurogenesis. *Brain Behav. Immun.*, 25, 181-213.
- YOKOYAMA, A., TAKEZAWA, S., SCHULE, R., KITAGAWA, H. & KATO, S. 2008. Transrepressive function of TLX requires the histone demethylase LSD1. *Mol Cell Biol*, 28, 3995-4003.
- YOSHIMURA, S., TAKAGI, Y., HARADA, J., TERAMOTO, T., THOMAS, S. S., WAEBER, C., BAKOWSKA, J. C., BREAKEFIELD, X. O. & MOSKOWITZ, M. A. 2001. FGF-2 regulation of neurogenesis in adult hippocampus after brain injury. *Proc. Natl. Acad. Sci. U.S.A.*, 98, 5874-5879.
- YOUNG, K. A., BERRY, M. L., MAHAFFEY, C. L., SAIONZ, J. R., HAWES, N. L., CHANG, B., ZHENG, Q. Y., SMITH, R. S., BRONSON, R. T., NELSON, R. J. & SIMPSON, E. M. 2002. Fierce: a new mouse deletion of Nr2e1; violent behaviour and ocular abnormalities are background-dependent. *Behav Brain Res*, 132, 145-58.
- YU, R. T., CHIANG, M. Y., TANABE, T., KOBAYASHI, M., YASUDA, K., EVANS, R. M. & UMESONO, K. 2000. The orphan nuclear receptor Tlx regulates Pax2 and is essential for vision. *Proc. Natl. Acad. Sci. U.S.A.*, 97, 2621-5.
- ZEBROWSKA-LUPINA, I., STELMASIAK, M. & POROWSKA, A. 1990. Stress-induced depression of basal motility: effects of antidepressant drugs. *Pol. J. Pharmacol. Pharm.*, 42, 97-104.
- ZEHR, J. L., NICHOLS, L. R., SCHULZ, K. M. & SISK, C. L. 2008. Adolescent development of neuron structure in dentate gyrus granule cells of male Syrian hamsters. *Dev Neurobiol*, 68, 1517-26.
- ZEHR, J. L., TODD, B. J., SCHULZ, K. M., MCCARTHY, M. M. & SISK, C. L. 2006. Dendritic pruning of the medial amygdala during pubertal development of the male Syrian hamster. *Dev. Neurobiol*, 66, 578-590.
- ZHANG, C. L., ZOU, Y., HE, W., GAGE, F. H. & EVANS, R. M. 2008a. A role for adult TLX-positive neural stem cells in learning and behaviour. *Nature*, 451, 1004.
- ZHANG, C. L., ZOU, Y., HE, W., GAGE, F. H. & EVANS, R. M. 2008b. A role for adult TLX-positive neural stem cells in learning and behaviour. *Nature*, 451, 1004-7.
- ZHANG, C. L., ZOU, Y., YU, R. T., GAGE, F. H. & EVANS, R. M. 2006. Nuclear receptor TLX prevents retinal dystrophy and recruits the corepressor atrophin1. *Genes Dev*, 20, 1308-20.
- ZHAO, C., SUN, G., LI, S. & SHI, Y. 2009. A feedback regulatory loop involving microRNA-9 and nuclear receptor TLX in neural stem cell fate determination. *Nat Struct Mol Biol.*, 16, 365-71.

- ZHU, S., WANG, J., ZHANG, Y., LI, V., KONG, J., HE, J. & LI, X.-M. 2014. Unpredictable chronic mild stress induces anxiety and depression-like behaviors and inactivates AMP-activated protein kinase in mice. *Brain Res.*, 1576, 81-90.
- ZHU, X., LEE, H. G., PERRY, G. & SMITH, M. A. 2007. Alzheimer disease, the two-hit hypothesis: an update. *Biochim Biophys Acta*, 1772, 494-502.
- ZHU, X., RAINA, A. K., PERRY, G. & SMITH, M. A. 2004. Alzheimer's disease: the two-hit hypothesis. *Lancet Neurol*, 3, 219-226.
- ZUNSZAIN, P. A., ANACKER, C., CATTANEO, A., CHOUDHURY, S., MUSAELYAN, K., MYINT, A. M., THURET, S., PRICE, J. & PARIANTE, C. M. 2012. Interleukin-1 β : A New Regulator of the Kynurenine Pathway Affecting Human Hippocampal Neurogenesis. *Neuropsychopharmacology*, 37, 939-949.