

Contract Report 2000-05

**Atmospheric Dispersion Study of Deicing Salt  
Applied to Roads:  
First Progress Report**

by

**Allen L. Williams, Gary J. Stensland, Cathy R. Peters, and Jim Osborne**

**Prepared for the  
Illinois Department of Transportation  
Illinois State Toll Highway Authority**

**April 2000**



Illinois State Water Survey  
Atmospheric Environment Section  
Champaign, Illinois

A Division of the Illinois Department of Natural Resources

# **Atmospheric Dispersion Study of Deicing Salt Applied to Roads: First Progress Report**

Allen L. Williams, Professional Scientist  
Gary J. Stensland, Principal Professional Scientist  
Cathy R. Peters, Associate Supportive Scientist  
Jim Osborne, Assistant Supportive Scientist

**Illinois Department of Natural Resources  
Illinois State Water Survey  
2204 Griffith Drive  
Champaign, Illinois 61820-7495**

**Prepared for  
Illinois Department of Transportation  
Illinois State Toll Highway Authority**

## Executive Summary

This report describes the status of an initial effort to understand and describe the atmospheric transport of road salt in the form of sodium chloride (NaCl) applied to highways as a deicing material. The study area is a proposed 20.1 kilometer or km (12.5 mile) tollway that is planned to extend Interstate 355 (I-355) located west of Chicago, Illinois, to connect Interstate 55 (I-55) and Interstate 80 (I-80) southwest of Chicago near Lemont, Illinois. Prior to construction, which has not yet begun, the focus of the effort has been to establish background levels of the road salt aerosol, to construct permanent sites along the proposed route corridor from which to better monitor and measure road salt aerosol properties, and to identify important parameters for use in constructing a computer model to describe the salt emission and deposition. The present status of the proposed project is that construction plans have been delayed at least until approval of a supplement to the environmental impact statement.

Results from chemical analysis of aerosol and snow samples are reported that show progress toward characterizing the road salt aerosol with respect to its size, mechanisms of emission, range of atmospheric transport, and mechanisms of deposition. Analysis of the preliminary data suggest:

- A large portion of the salt aerosol that becomes aerosolized is emitted after the road surface has been cleared of snow and ice.
- Approximately 90 percent of the airborne road salt is contained in aerosol particles of diameter larger than 2.5 micrometers ( $\mu\text{m}$ ) or  $10^{-4}$  inches.
- The salt deposition pattern near a treated roadway as determined by snow samples decreases consistently with distance from the road. Average deposition values for a single snow event are found here to yield an aerial deposition of 0.06 grams per square meter (0.6 pounds per acre) at 500 meters (1,640 feet) from the road. The corresponding value for the total deposition per length of roadway is 85 grams per meter or g/m (300 pounds per mile or lb/mi).

Five permanent sampling sites are almost completed and will provide a flexible monitoring capability to better quantify the road salt emission, transport, and deposition. Road salt emissions in aerosol samples collected at the locations of two of the permanent sites are reported here. The sites are located 0.6 km (0.4 mi) and 1.0 km (0.6 mi) southeast of I-55 in the prevailing downwind direction, but could also be affected by salt emission from a secondary road in the vicinity. A comparison of the aerosol measurements at the two sampling sites during periods when salt was applied shows that the site nearer to the sources consistently had higher levels of NaCl. Most of the NaCl was found in particles with diameter larger than  $10 \mu\text{m}$  ( $4 \times 10^{-4}$  inches).

## Table of Contents

	<i>Page</i>
INTRODUCTION.....	1
ACKNOWLEDGMENTS.....	2
SITE DESCRIPTION, CHEMICAL ANALYSIS, AND SAMPLE COLLECTION....	3
SAMPLING SITES.....	3
CHEMICAL ANALYSIS.....	6
DATA MANAGEMENT.....	8
SAMPLE COLLECTION AND INTERPRETATION OF RESULTS.....	8
AEROSOL SAMPLING.....	8
SNOW SAMPLING.....	12
I-55 Snow Samples.....	14
Windsor Road Snow Samples.....	17
Deposition Estimate.....	18
Deposition Uncertainty.....	19
Comparison to Results of Morton Arboretum Study.....	19
DISCUSSION OF RESULTS.....	20
FUTURE RESEARCH.....	23

# **Atmospheric Dispersion Study of Deicing Salt Applied to Roads: First Progress Report**

## **Introduction**

This report describes initial results of the project “Atmospheric Dispersion of Deicing Salt Applied to Roads” performed by the Illinois State Water Survey and supported by the Illinois Department of Transportation and the Illinois State Toll Highway Authority. The study addresses the emission, atmospheric transport, and deposition of deicing salt. The deicing material used almost exclusively in Illinois is sodium chloride (NaCl) or common table salt. Much of the road salt applied during deicing operations is pushed to the roadside by highway clearing operations and by vehicular traffic. A portion can be incorporated into the salt spray raised by vehicles. The larger spray drops fall out near the road, but some of the smaller droplets, or the residue they leave behind upon evaporation, may become aerosols capable of longer range transport. Salt aerosols can also be produced by vehicular traffic from dried salt deposits on the road surface. An overall goal of this effort is to develop a model of the salt aerosol emission and deposition for general application. The goal of this investigation is to determine the dominant road salt emission and deposition mechanisms.

The study area is in the counties of DuPage, Cook, and Will in northeastern Illinois, where a 20.1 kilometer (km) or 12.5 mile (mi) long multi-lane divided tollroad has been proposed for construction. The new route would extend Interstate 355 (I-355) southward to link Interstate 55 (I-55) and Interstate 80 (I-80) as shown in figure 1a. A distinctive feature of the proposed route is a bridge approximately 1.6 km (one mile) long and 30.5 meters (m) or 100 ft high crossing the Keepataw Forest Preserve in the Des Plaines River valley near the village of Lemont. The present status of the proposed road construction project is that construction plans have been delayed at least until approval of a supplement to the environmental impact statement.

This report includes descriptions of five sampling sites constructed to establish the background salt aerosol concentrations prior to road construction and to monitor salt aerosol concentrations during and after construction. The wind-directed sampling strategy to be used in future monitoring is also described. Preliminary data are reported for aerosol sampling (nonwind-directed) that was started at the inception of the study in February 1996 and includes measurements during two winter periods. Results are also reported for measurements of the salt concentration in snow samples taken following snowstorms at distances up to 500 m (1,640 ft) on both sides of I-55. Results are also reported for snow samples taken adjacent to a road in Urbana, Illinois, which represented a case when significant salt emission and deposition occurred long after the snow event.

## **Acknowledgments**

This work is supported by the Illinois Department of Transportation, Bureau of Design and Environment, and the Illinois State Toll Highway Authority through contract number IDOT P-30-020-95 ADS. We would like to acknowledge the project manager, Mr. Walt Zyznieuski, of the Bureau of Design and Environment for his many contributions to the project.

Disclaimer: The contents of this report reflect the views of the authors who are responsible for the facts and accuracy of the data presented herein. The contents do not necessarily reflect the official views or policies of the Illinois Department of Transportation, the Illinois State Toll Highway Authority, or the Illinois State Water Survey.

## Site Description, Chemical Analysis, and Sample Collection

### Sampling Sites

Aerosol samplers have been operated continuously at two sites since the study began. These two sites are located on Citizens Utility Company of Illinois property. As plans for the study evolved, three additional locations were selected as permanent sites for aerosol monitoring. Figure 1b shows the five site locations. Sites 1 and 2 are along the historic Illinois and Michigan Canal 50 m (160 ft) and 328 m (1,080 ft) east, respectively, of the proposed bridge location. These sites are on land made available by the village of Lemont. Sites 3 and 5 are the two Citizens Utility sites. Site 4 is located within the Woodridge Forest Preserve of the Forest Preserve District of DuPage County. All five sites, on which substantial structures have been constructed similar to that shown in figure 2, were provided at no cost through

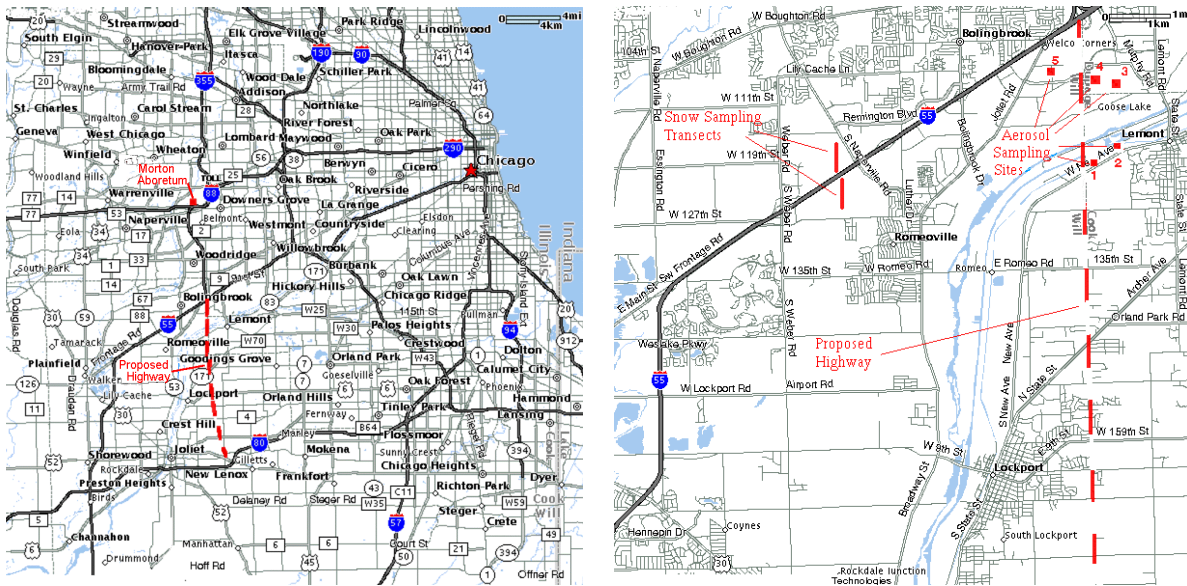

Figure 1a (left) and Figure 1b (right). Location of the proposed highway southwest of Chicago extending I-355 south of Woodridge to I-80 at New Lenox. Figure 1b is a detailed view of Figure 1a showing locations of the instrumented aerosol sampling sites in the Des Plaines River valley near Lemont and north of the river between Lemont and Bolingbrook. The transects in figure 1b north and south of I-55 in northwest Romeoville indicate where snow samples analyzed in this report were collected (adapted from 1999 MapQuest.com Inc; © 1999 Navigation Technologies).





agreement between the University of Illinois and each of the cited organizations. As an additional courtesy, Citizens Utility provides electricity to sites 3 and 5, thereby avoiding the necessity of installing separate electrical utility poles. All the monitoring sites are similar in construction, and figure 2 shows a photograph of site 4.

The primary strategy for site location is to sample at multiple distances from the new road in the prevailing downwind direction. This strategy was implemented at two different locations: below the proposed bridge and along a segment of the new route where the roadway would not be elevated from the surrounding terrain. A factor in favor of locating sampling sites 1 and 2 below the bridge is that the dominant mechanism of salt emission from the bridge could differ from that over a level surface, because droplets thrown from the bridge by vehicular traffic have longer evaporation times. Sampling sites 3 and 4 are located about 287 m and 50 m (942 ft and 160 ft), respectively, in the prevailing downwind direction of the proposed road in an area where the road is not elevated, and site 5 is 338 m (1,110 ft) west of the proposed route. The main consideration for including site 5 is to account for the impact of emissions from I-55 and Joliet Road (see figure 1b) on measurements at sites 3 and 4. The aerosol sampling design at the permanent sites is based on the idea of “wind-directed” sampling in which given samples are collected only when the wind is from a certain direction. In this way, the strength and composition of the aerosol emitted from the new road can be identified distinct from the complicating influence of similar sources in the area.



Figure 2. Site 4 with construction typical of all aerosol sampling sites.

Each site has a 2.4 m (8 ft) high chain link fence 6.1 m (20 ft) on a side to provide a measure of security. A 6.1 m (20 ft) high tower at each site is equipped with instrumentation and a data logger to measure and record wind speed and wind direction. Inlets for the wind-directed aerosol sampling are located at the top of the tower adjacent to where wind speed and direction are measured. A cedar deck at the base of each tower provides a platform for ground-based instruments that include rain/snow samplers and nonwind-directed aerosol sampling. The data logger coding can be changed remotely, providing the opportunity to conduct various specialized experiments. The rain/snow samplers include a moisture sensor to open the wet-side only precipitation collection container during precipitation events, and these data are input to the data logger. The signal from the moisture sensor can be used to coordinate sampling decisions based on whether precipitation is occurring. Electricity and phone service are installed at each site, and modem access to the data loggers allows remote access and control.

## Chemical Analysis

The chemical analysis is performed by ion chromatography. Snow samples are collected in the field in plastic freezer bags. Prior to analysis the collected snow is melted and water aliquots for analysis are taken directly from the freezer bags. The extraction procedure for aerosol samples is to extract the filter in 10 milliliters (ml) or 0.6 cubic inches ( $\text{in}^3$ ) of de-ionized water for a period of 48 hours.

About 3 ml ( $0.2 \text{ in}^3$ ) of extract is used during routine analysis, and the balance of the extract is stored in case further analysis is required. The sample from the anion injection loop is passed onto a Dionex AS4A column for which the flow and elutriate concentrations have been optimized to separate chloride (Cl), nitrate ( $\text{NO}_3$ ), and sulfate ( $\text{SO}_4$ ) anions. Likewise, the contents of the cation injection loop are passed onto a Dionex CS12A column for analysis of the cations sodium (Na), potassium (K), and calcium (Ca). The values obtained from the analysis are in units of milligrams of each element or component measured per liter of the injected solution (mg/l) which is equivalent to  $6 \times 10^{-7}$  ounces per cubic inch ( $\text{oz}/\text{in}^3$ ). The instrument detection limit is obtained by repeatedly analyzing samples containing the lowest concentration that can be measured to determine within a 99 percent confidence interval whether a given concentration differs from zero. The anion instrument detection limits are 0.0098 mg/l ( $5.66 \times 10^{-9} \text{ oz}/\text{in}^3$ ) for Cl, 0.037 mg/l ( $2.14 \times 10^{-8} \text{ oz}/\text{in}^3$ ) for  $\text{NO}_3$ , and 0.048 mg/l ( $2.77 \times 10^{-8} \text{ oz}/\text{in}^3$ ) for  $\text{SO}_4$  based on repeated injections at a concentration of 0.1 mg/l ( $5.78 \times 10^{-8} \text{ oz}/\text{in}^3$ ). The corresponding values for the cations are 0.028 mg/l ( $1.62 \times 10^{-8} \text{ oz}/\text{in}^3$ ) for Na, 0.043 mg/l ( $2.49 \times 10^{-8} \text{ oz}/\text{in}^3$ ) for K, and 0.037 mg/l ( $2.14 \times 10^{-8} \text{ oz}/\text{in}^3$ ) for Ca based on injected concentrations of 0.200 mg/l ( $1.16 \times 10^{-7} \text{ oz}/\text{in}^3$ ).

A set of measurements that indicates the accuracy of the analytical results is the correspondence of Na and Cl. They are measured on different chromatographic columns, and they commonly cause analytical problems. For example, Na can sometimes leach from glassware during sample handling. Figure 3 plots the concentration of Na in moles per liter (moles/l) versus

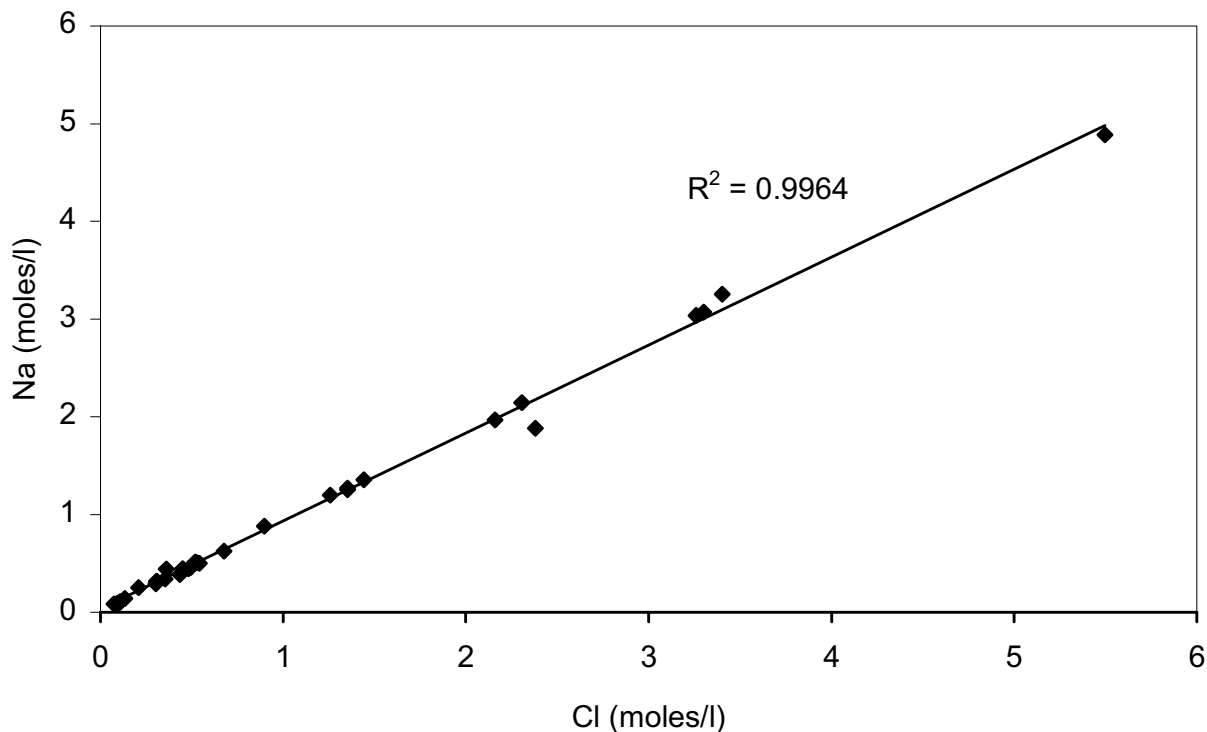

Figure 3. Molar concentration of sodium (Na) to chloride (Cl) in I-55 snow samples shows a one-to-one relationship for the ions, as is true for sodium chloride (NaCl).

that of Cl for the snow samples collected along I-55. If Na and Cl are present as salt (NaCl), there should be a one-to-one correspondence between the molar concentrations. The regression of Na to Cl in the plot shows a high correlation and a molar ratio (Na/Cl) of 0.97, indicating that the Na and Cl measured originate from salt.

Several quality assurance/quality control procedures are in place to identify problem areas and to quantify measurement errors. These include the analysis of field and procedure blanks, checks of the de-ionized water used for mixing elutriates and extraction of the samples, blind analysis of samples with known concentrations, a rigid procedure to assure that the analysis is under control at all times, systematic checks of instrument flow rates, verification that the meteorological data are accurate, duplicate aerosol sampling, and various system blanks. The use of the data at this point is qualitative to the extent that the emphasis is on identifying the relevant processes of salt emission and deposition to serve as guidance for further refinement of the sampling techniques, and in preparation for constructing a descriptive model. The present analysis has concentrated more on winter situations when the salt concentrations are assumed to be higher.

## Data Management

The data management tasks are organized around building a central Microsoft Access database that includes information from the field work and the laboratory analysis. Data can be easily transferred between Access and Microsoft Excel as needed. The Excel file format is compatible with that of the chromatographic software used to control the chromatograph and to calculate the chemical concentrations. More sophisticated statistical analysis will be performed using a statistical software package that is compatible with Excel for file transfer. The computer platform for constructing the salt deposition model is not yet clearly defined, but it will likely include scientific programming in Visual Basic. Both Access and Excel recognize Visual Basic coding, which will aid the process of data transfer for model development and testing.

Field data are collected on forms designed to standardize the field procedures to assure that pertinent data are recorded, while keeping the amount of field notation reasonably small. The field form includes sample identification numbers, start and end times and dates for sample collection, sample flow calibration data, and flow settings. The field data are entered into an Access form that is identical to the field form. Filter tare weights and loaded filter weights are recorded and entered in another Access table. Finally, the results of chemical analysis, which are transferred from the chromatographic software to Excel, are transferred into Access. The total database is then constructed in Access, which facilitates queries and other aspects of data handling. Often the results of Access queries are transferred to Excel for further analysis.

## Sample Collection and Interpretation of Results

### Aerosol Sampling

Nonwind-directed aerosol sampling has been conducted almost continuously since the study began. Two sampling instruments used are a high volume aerosol sampler (hivol) and a dichotomous aerosol sampler (dichot), both commonly used for collecting different aerosol size fractions. The hivol collects essentially all particles with diameter below approximately 40 micrometers ( $\mu\text{m}$ ) or  $1.6 \times 10^{-3}$  inches (in), which are referred to as total suspended particulate (TSP). The flow rate of the hivol is 850 liters per minute or lpm (30 cubic feet per minute or cfm), and the samples are collected on glass fiber filters. The dichot collects particles in two size ranges. As the aerosol enters at a flow rate of 16.7 lpm (0.59 cfm), all particles larger than 10  $\mu\text{m}$  ( $3.9 \times 10^{-4}$  in) are removed from the airstream in the first stage of separation. The remaining particles are then separated into two size classes by a virtual impactor with a cutpoint of 2.5  $\mu\text{m}$  ( $9.8 \times 10^{-5}$  in). The particle size class corresponding to particles of diameter  $d < 2.5 \mu\text{m}$  ( $9.8 \times 10^{-5}$  in) are designated as the “fine” particles, and the particle size class corresponding to  $2.5 \mu\text{m} < d <$

10  $\mu\text{m}$  ( $9.8 \times 10^{-5}$  in  $< d < 3.9 \times 10^{-4}$  in) are designated as “coarse” particles. Both types of particles are collected on separate 37 millimeter (2.5 in) diameter Teflon filters.

The wind-directed sampling arrangement for collecting fine and coarse aerosols at five permanent sites uses a dichotomous sampler with the standard components for the 10  $\mu\text{m}$  ( $3.9 \times 10^{-4}$  in) and 2.5  $\mu\text{m}$  ( $9.8 \times 10^{-5}$  in) cutoffs, but with a modified filter holder and connective tubing. A dichot inlet with the 10  $\mu\text{m}$  ( $3.9 \times 10^{-4}$  in) separation stage is mounted at the top of the tower. A tube the same diameter as used for the dichot particle flow extends down the tower and connects to the dichot body that includes the 2.5  $\mu\text{m}$  ( $9.8 \times 10^{-5}$  in) dichotomous virtual impactor. After the aerosol stream is separated in the virtual impactor, the fine and coarse aerosol streams are then passed into a filter pack rather than through a single filter. Figure 4 shows a sketch of the filter pack arrangement. The data logger monitors the wind direction and calculates the consecutive 15-minute average wind directions. When the 15-minute averaged wind direction is from a specified range of directions, and optionally when other criteria are matched, such as whether precipitation is occurring, the data logger sends a signal to open one of the electric valves V1-V4 to collect the sample on the corresponding filter. An identical filter pack arrangement is used on both the coarse and fine aerosol streams.

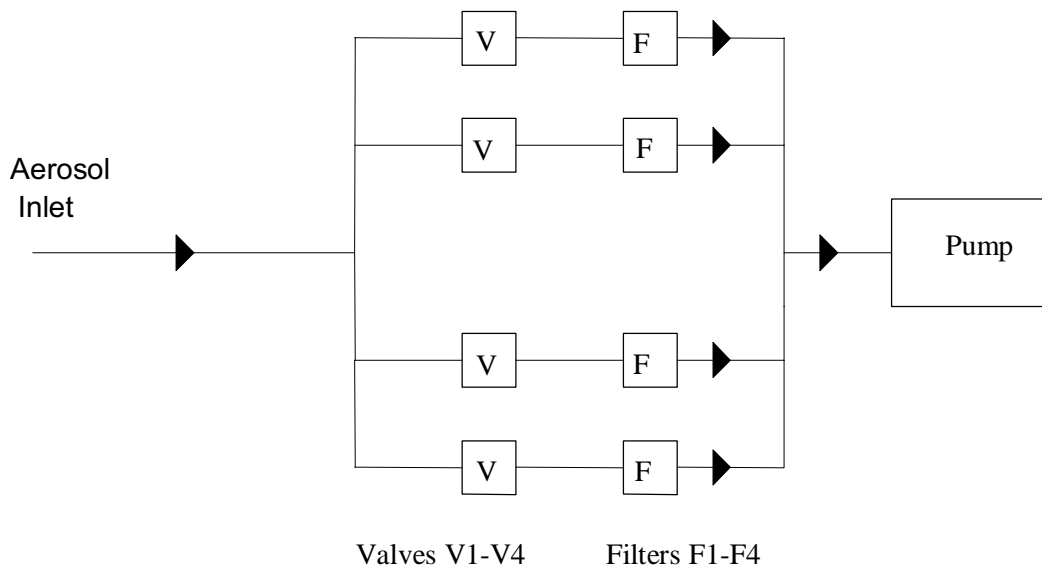

Figure 4. Sketch of filter pack arrangement for wind-directed dichot sampling.

The hivol is not used in the wind-directed arrangement, but rather a “hivol surrogate” device collects aerosols in the approximate large particle size range. A TSP inlet designed for flow rates of approximately 16 lpm (0.59 cfm) is used. The aerosol enters the inlet at the top of the tower and passes through a pipe to the base of the tower and into a manifold. The manifold is designed to remove snowflakes and raindrops that may enter the system. The airstream then passes into the appropriate filter of a filter pack depending on the wind direction, and other pre-set criteria, as with the wind-directed dichot device. The filter used for the hivol surrogate is a Nuclepore membrane with 8 :m ( $3.1 \times 10^{-4}$  in) pore size. Particles larger than 8 :m ( $3.1 \times 10^{-4}$  in) are collected on the filter, and those smaller than 8 :m ( $3.1 \times 10^{-4}$  in) are not collected but pass on through the filter holes.

For the present analysis it is convenient to work with a derived particle size class defined as “large” particles, which are in the range  $10 \text{ :m} < d < 40 \text{ :m}$  ( $3.9 \times 10^{-4} \text{ in} < \mathbf{d} < 1.6 \times 10^{-3} \text{ in}$ ). The respective large particle concentrations are then found by subtracting the coarse and fine particle concentrations from the TSP concentrations. Tables 1 and 2 show the ambient mass concentrations and the mass concentrations of different ions for each of the particle size classes at sites 3 and 5, respectively, on January 14, 17, and 28, 1997. Table 3 provides averages for the two sites. Most of the NaCl is contained in the large particle size fraction.

**Table 1. Total Aerosol Mass Concentration and Sodium, Chloride, Calcium, and Sulfate Ion Mass Concentrations ( $\mu\text{g}/\text{m}^3$ ) Measured in Aerosol Samples at Site 3 after Snow Events on 1/14/97, 1/17/97, and 1/28/97.**

<i>Variables</i>	<i>Chloride</i>	<i>Sulfate</i>	<i>Sodium</i>	<i>Calcium</i>	<i>Mass</i>
<i>TSP (<math>\mu\text{g}/\text{m}^3</math>)</i>	1.76	5.05	1.32	0.62	40.15
<i>Large (<math>\mu\text{g}/\text{m}^3</math>)</i>	1.24	1.46	0.59	0.18	7.71
<i>Coarse (<math>\mu\text{g}/\text{m}^3</math>)</i>	0.44	0.76	0.59	0.36	12.12
<i>Fine (<math>\mu\text{g}/\text{m}^3</math>)</i>	0.08	2.83	0.14	0.08	20.32
<i>% Large</i>	70.52	28.97	44.53	28.57	19.19
<i>% Coarse</i>	24.94	15.04	44.83	58.44	30.19
<i>% Fine</i>	4.54	56.00	10.64	12.99	50.62

**Note:** The variables % Large, % Coarse, and % Fine represent the portion of the corresponding size fraction as a percent of the TSP mass fraction.

**Table 2. Total Aerosol Mass Concentration and Sodium, Chloride, Calcium, and Sulfate Ion Mass Concentrations ( $\mu\text{g}/\text{m}^3$ ) Measured in Aerosol Samples at Site 5 after Snow Events on 1/14/97, 1/17/97, and 1/28/97.**

<i>Variables</i>	<i>Chloride</i>	<i>Sulfate</i>	<i>Sodium</i>	<i>Calcium</i>	<i>Mass</i>
<i>TSP (<math>\mu\text{g}/\text{m}^3</math>)</i>	2.41	5.26	1.50	0.67	38.02
<i>Large (<math>\mu\text{g}/\text{m}^3</math>)</i>	1.58	1.00	0.36	0.18	-2.45
<i>Coarse (<math>\mu\text{g}/\text{m}^3</math>)</i>	0.72	0.78	0.96	0.41	14.35
<i>Fine (<math>\mu\text{g}/\text{m}^3</math>)</i>	0.11	3.48	0.18	0.08	26.12
<i>% Large</i>	65.53	19.07	23.90	26.32	-6.43
<i>% Coarse</i>	29.90	14.82	64.09	61.65	37.74
<i>% Fine</i>	4.57	66.11	12.02	12.03	68.69

**Note:** The variables % Large, % Coarse, and % Fine represent the portion of the corresponding size fraction as a percent of the TSP mass fraction.

Figure 5 shows NaCl levels found in TSP samples for a single date in October 1996 and several other dates in January 1997. In most instances, corresponding samples at site 3 and at site 5 are shown. Likewise, figure 6 shows data for Cl over the first two winter periods for the dichot coarse and fine samples at site 3. Each of the peaks in the TSP and coarse dichot curves in figures 5 and 6 corresponds to periods when road salt was applied. When the salt concentration is high the values at site 5 are systematically higher than at site 3. At lower concentrations, when no salt application occurred, the site 5 values are the same or only slightly higher than those at site 3. This is consistent with a NaCl source at I-55 and at Joliet Road. The fine particle size class

**Table 3. Average of Measurements at Site 3 and Site 5.**

<i>Variables</i>	<i>Chloride</i>	<i>Sulfate</i>	<i>Sodium</i>	<i>Calcium</i>	<i>Mass</i>
<i>TSP (<math>\mu\text{g}/\text{m}^3</math>)</i>	2.09	5.16	1.41	0.64	39.08
<i>Large (<math>\mu\text{g}/\text{m}^3</math>)</i>	1.41	1.23	0.47	0.18	2.63
<i>Coarse (<math>\mu\text{g}/\text{m}^3</math>)</i>	0.58	0.77	0.78	0.39	13.24
<i>Fine (<math>\mu\text{g}/\text{m}^3</math>)</i>	0.10	3.16	0.16	0.08	23.22
<i>% Large</i>	68.03	24.02	34.21	27.44	6.38
<i>% Coarse</i>	27.42	14.93	54.46	60.05	33.96
<i>% Fine</i>	4.55	61.05	11.33	12.51	59.65

**Note:** The variables % Large, % Coarse, and % Fine represent the portion of the corresponding size fraction as a percent of the TSP mass fraction.

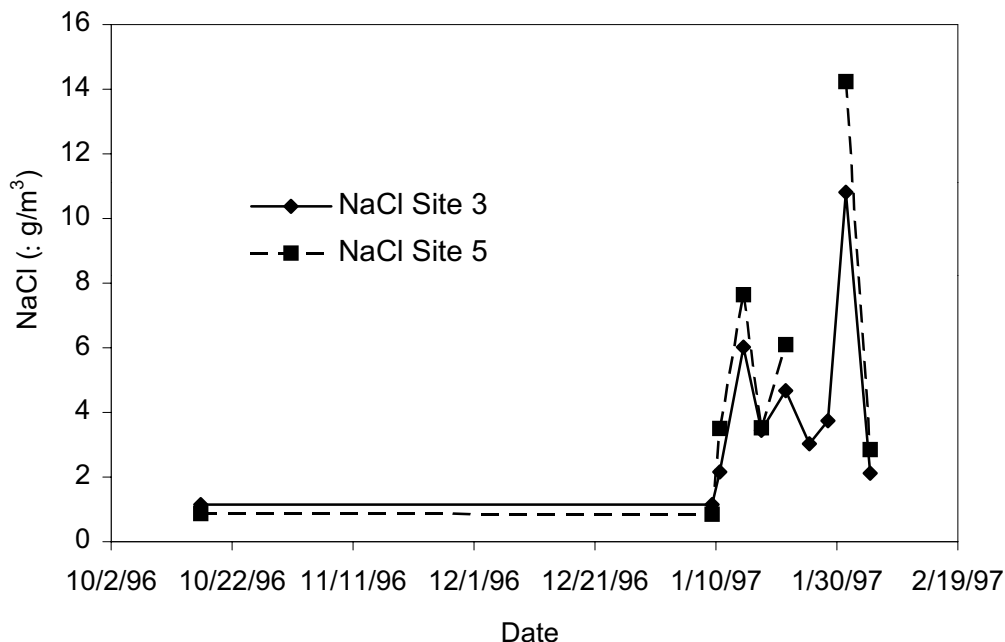

Figure 5. Plot of sodium chloride (NaCl) concentration of TSP samples versus time for samples collected at Sites 3 and 5. Peaks correspond to snow events.

shows much less response from salting events as shown by figure 6. In addition, the strong molar correspondence between Na and Cl, found for snow samples and for the coarse dichot data, does not hold for the fine particulate samples. It appears that most of the Na and Cl in the fine particle sizes are not present as NaCl, and that particles originating from the roadway do not significantly contribute to the fine particle mass.

### Snow Sampling

In order to quantify the levels of road salt deposition, various snow samples were collected, and the results are reported below. In each case, samples were collected as a function of distance from the road on which deicing material had been applied. A polyethylene scoop of dimensions approximately 10 centimeters (cm) or 3.9 in by 10 cm (3.9 in) was used to collect the samples. The sampling procedure was to collect the sample throughout the snow depth taking care not to disturb soil below the snow and to collect enough snow to yield approximately 10 ml (0.6 in<sup>3</sup>) of water for chemical analysis. Results from snow samples collected near I-55 and near



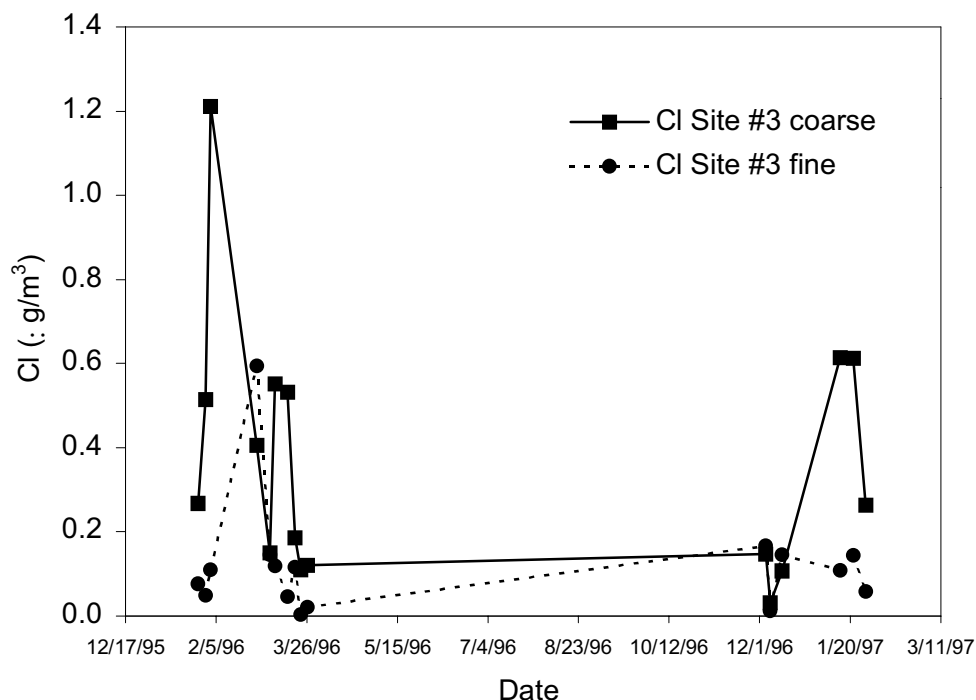

Figure 6. Plot of chloride (Cl) ( $\text{g/m}^3$ ) in dichot samples versus time for both coarse and fine aerosol particles at Site 3. Peaks in the coarse samples correspond to snow events.

Windsor Road in Urbana, Illinois showed that salt concentrations in the snow decrease uniformly as a function of distance from the road.

The road salt material deposited in the snow beyond a distance  $D$  of about 50 m (160 ft) from the road has a distinctly different composition than road salt material nearer the road. Table 4 shows the ratios of Cl to  $\text{SO}_4$ , K, and Ca in the snow near I-55 at  $D \leq 50$  m ( $D \leq 160$  ft) and at  $D > 50$  m ( $D > 160$  ft). Each of the ratios is considerably higher for the samples taken in the region near the road. Beyond about 50 m (160 ft) the ratios remain constant. We do not yet know why the snow deposits have differing composition, but suspect multiple emission mechanisms that produce slightly different particle compositions are at work for particles deposited within the first 50 m (160 ft) of the road. Because the primary concern for this study is to analyze long-range transport, deposition within the first 50 m (160 ft) of the road, which appears much more complex, will be treated in a later report.

**Table 4. Mean and Standard Deviation (S.D.) of Ratios of Chloride (Cl) to Sulfate (SO<sub>4</sub>), Potassium (K), and Calcium (Ca) for Snow Samples South of I-55.**

Distance from Road	Number of Samples	Cl/SO <sub>4</sub>		Cl/K		Cl/Ca	
		Mean	S.D.	Mean	S.D.	Mean	S.D.
≤ 50 m	4	66	12	150	39	103	22
> 50 m	16	17	5	74	20	26	10

### *I-55 Snow Samples*

Snow samples along I-55 were collected on January 14, 17, and 28, 1997, following three different snow events. The samples were taken at mile marker 264 about 8 km (5 mi) southwest of the eventual intersection of I-55 and the new road. Figure 1b shows the sampling transects. The lines in figure 7 are numerical fits to the data for each case, shown as an aid to viewing the data. The distance is reported as perpendicular distance from the roadway, and samples were collected from the edge of the road out to about 500 m (1,640 ft) from the roadway. Units are in grams of NaCl per square meter (g/m<sup>2</sup>). The analytical measurements yield the concentration of NaCl in the water from the melted snow. Deposition in units of mass NaCl per unit area is obtained by multiplying the concentration in each case by the water equivalent for the corresponding snow amount. Meteorological data, including snow amounts, are taken from the National Climate Data Center of the National Oceanic and Atmospheric Administration for nearby O'Hare Airport and correspond to the observed snow amounts at the sampling areas.

Figure 8 presents averages of the data for all three cases considered, both north and south of I-55. The regression formulas shown in the figure correspond to units of gm/m<sup>2</sup> and the deposition in units of pounds per acre (lb/acre) are plotted on the secondary axis. The average data can be empirically fitted to high correlation by a simple power distribution for both the north and south directions as shown in the figure. The "best-fit" equation and its correlation coefficient squared or R<sup>2</sup> value are shown in figure 8 for both curves. In each case the deposition to the south of I-55 is higher than to the north. Weather conditions for each case are discussed in some detail to provide a perspective as to why the deposition is higher south of the road. As might be expected, wind direction is a very important factor influencing the deposition pattern.

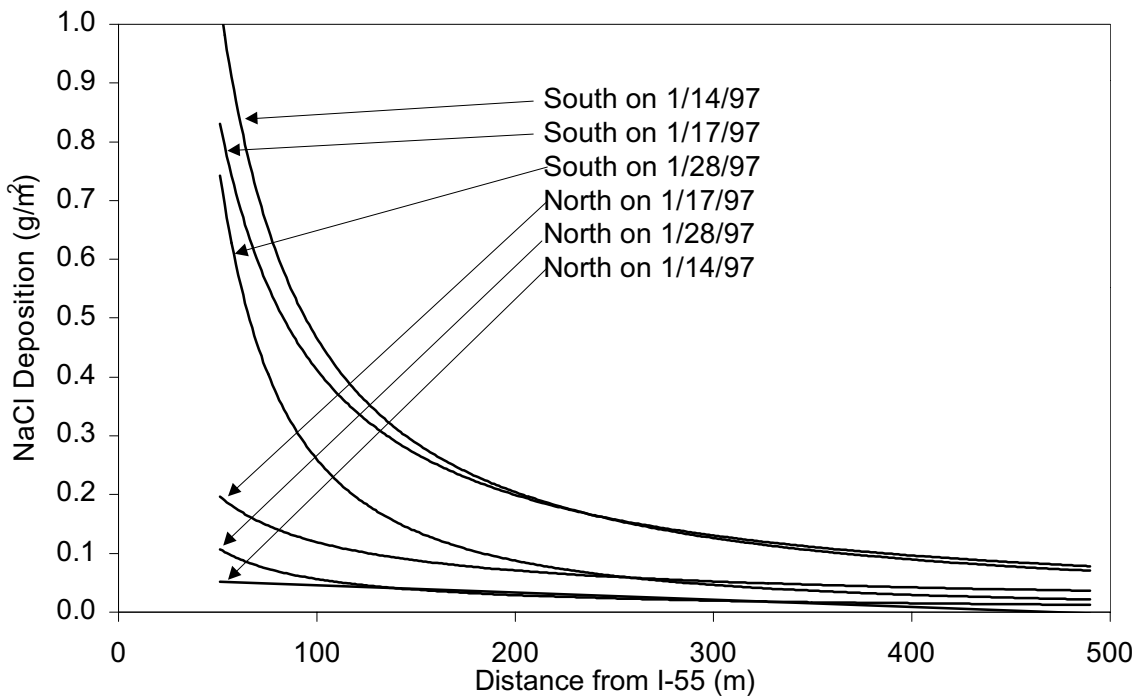

Figure 7. Plot of sodium chloride (NaCl) deposition in snow versus distance north and south of I-55 at mile marker 264 for snow samples collected on January 14, January 17, and January 28, 1997.

The samples for January 14 followed a 3.6 cm (1.4 inch) snow event between 5 a.m. and 5 p.m. on January 9. The temperature was  $-2.8$  degrees Celsius ( $^{\circ}\text{C}$ ) or 27 degrees Fahrenheit ( $^{\circ}\text{F}$ ), and the wind was from the north at 14.5 kilometers per hour (km/hr) or 9 miles per hour (mph), but shifted to the west later that evening. It remained cold with average daily temperatures between  $-9.4$   $^{\circ}\text{C}$  and  $-19$   $^{\circ}\text{C}$  (15  $^{\circ}\text{F}$  and  $-2$   $^{\circ}\text{F}$ ) and westerly winds with averages ranging between 11.3 and 24.1 km/hr (7 and 15 mph) that persisted until the samples were collected the evening of January 14. Deposition north of I-55 in this case is shown in the lowest curve in figure 7, while the deposition south of the road corresponds to the curve with the highest deposition values. Of the three cases considered, the January 14 samples have the most distinct separation. There were no southerly winds so concentrations north of the road are very low. As I-55 has a southwest to northeast orientation in the area sampled rather than being strictly east to west, a westerly wind would tend to carry material south of the road. Clearly, the deposition in the downwind direction from the road is much higher than in the upwind direction.

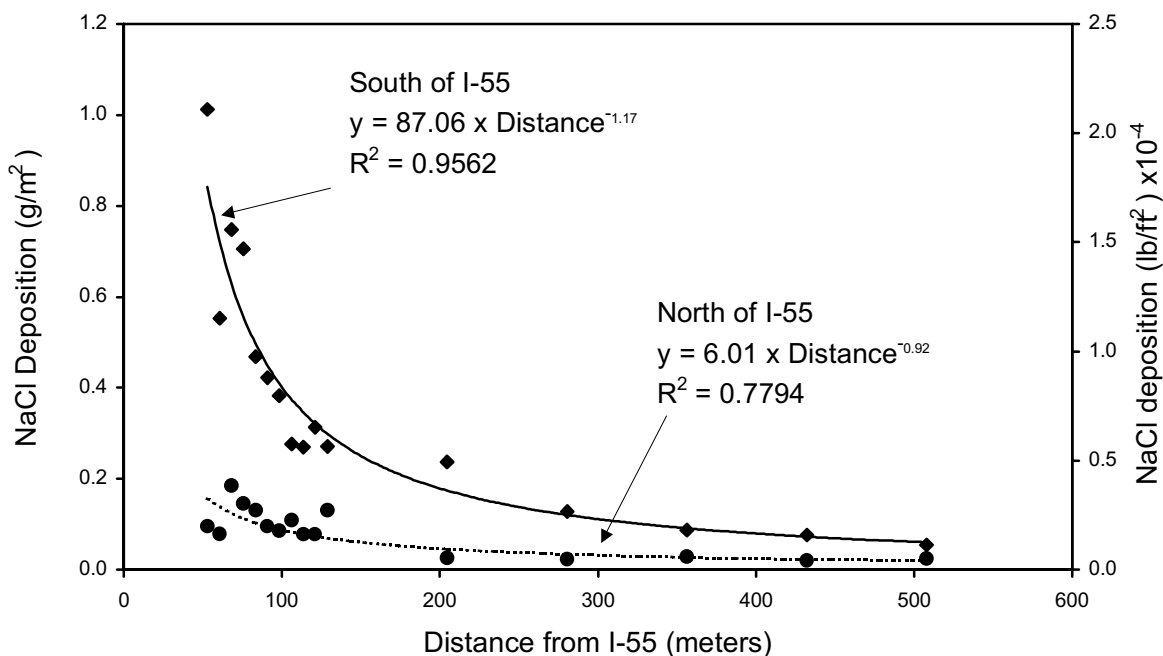

Figure 8. Average of snow deposition amounts shown in figure 7 for samples collected north and south of I-55. Regressions are valid in the approximate range  $50 \text{ m} < D < 500 \text{ m}$ .

Samples were collected on January 17 after a 6.1 cm (2.4 inch) snowstorm between 7 a.m. and 7 p.m. on January 15, with an average daily temperature of  $-6.7 \text{ }^\circ\text{C}$  ( $20 \text{ }^\circ\text{F}$ ). In this case, the winds were approximately 14.5 km/hr (9 mph) and shifted from southerly to westerly while it was snowing. The average daily temperature dropped to  $-2.8 \text{ }^\circ\text{C}$  ( $27 \text{ }^\circ\text{F}$ ) on January 16 with northwesterly winds at 30.6 km/hr (19 mph), and to  $-19.4 \text{ }^\circ\text{C}$  ( $-3 \text{ }^\circ\text{F}$ ) on January 17 when the winds were westerly at 22.5 km/hr (14 mph). The deposition to the north of I-55 for this instance is the highest of the three cases shown in figure 7. Data for deposition south of I-55 in this case are represented by the intermediate of the three curves of the figure. Here, again, the difference is striking between the deposition to the north and south of the roadway. There could have been a contribution due to wet emission from the road surface both north and south of the road since the wind was from both directions while it was snowing. There was little opportunity for dry emission to the north, since the winds were northerly from the time the snow ended until sampling two days later. This indicates that the wet emission may not be a dominant process.

The two remaining curves of figure 7, the lowest of the three to the south and the intermediate of the three to the north, represent samples collected on January 28 from a snow event between 9 a.m. and 6 p.m. on January 26. The snow accumulation was 2.54 cm (1 inch) with  $-9.4 \text{ }^\circ\text{C}$  ( $15 \text{ }^\circ\text{F}$ ) temperatures and southeast winds at 12.9 km/hr (8 mph). The wind

remained from the southeast all night, shifted to the northwest at about 9 a.m. on January 27, and remained from west-northwest at about 16.1 km/hr (10 mph) until samples were collected on January 28. The temperature was  $-8.3\text{ }^{\circ}\text{C}$  ( $17\text{ }^{\circ}\text{F}$ ) on January 27 and dropped to  $-16.7\text{ }^{\circ}\text{C}$  ( $2\text{ }^{\circ}\text{F}$ ) on January 28 when the samples were collected. Since it only snowed 2.54 cm the road would have been easily cleared, and the wind did not shift toward the south until about 14 hours after the snow had stopped. Thus road should have been dry during the whole time that aerosol was deposited to the south. There was ample opportunity for wet emission to carry NaCl aerosol northward by southerly winds during the snow event if significant emission had occurred while the road was wet, but the corresponding NaCl concentrations were very low. This provides fairly strong evidence that dry emission dominates wet emission.

### *Windsor Road Snow Samples*

On January 31, 1996, and later on February 5, snow samples were collected on both sides of Windsor Road, an undivided 4-lane highway in Urbana, Illinois that has a 72 km/hr (45 mph) speed limit. This case provided an opportunity to further draw distinction between salt emission during and after the snow event. Following a 2.54 cm (1 inch) of snow early on January 31 the temperature became frigid, with the result that the snow stayed on the ground all week, and it did not snow between the two dates sampled. Figure 9 shows the Cl mass concentrations in the snow as a function of distance both north and south of the road for two different snow sampling days. The prevailing wind was from the north during the snow and until the first set of samples was collected. The salt concentrations are much higher toward the south than toward the north for the one-day samples. During the next four days the wind was predominantly from the north and west while the temperature remained cold, only reaching a high of  $-9.4\text{ }^{\circ}\text{C}$  ( $15.1\text{ }^{\circ}\text{F}$ ) on February 1. As shown in figure 9 by the February 5 samples, concentrations to the north of the road about doubled over this period. On February 5 the winds changed to southerly and the temperature increased to  $-2.8\text{ }^{\circ}\text{C}$  ( $27.0\text{ }^{\circ}\text{F}$ ). The resulting deposition to the north of the road as shown in figure 9 increased by about a factor of 10 to become almost as high as that to the south. This quite clearly shows that salt emission from the dry road surface is a significant process.

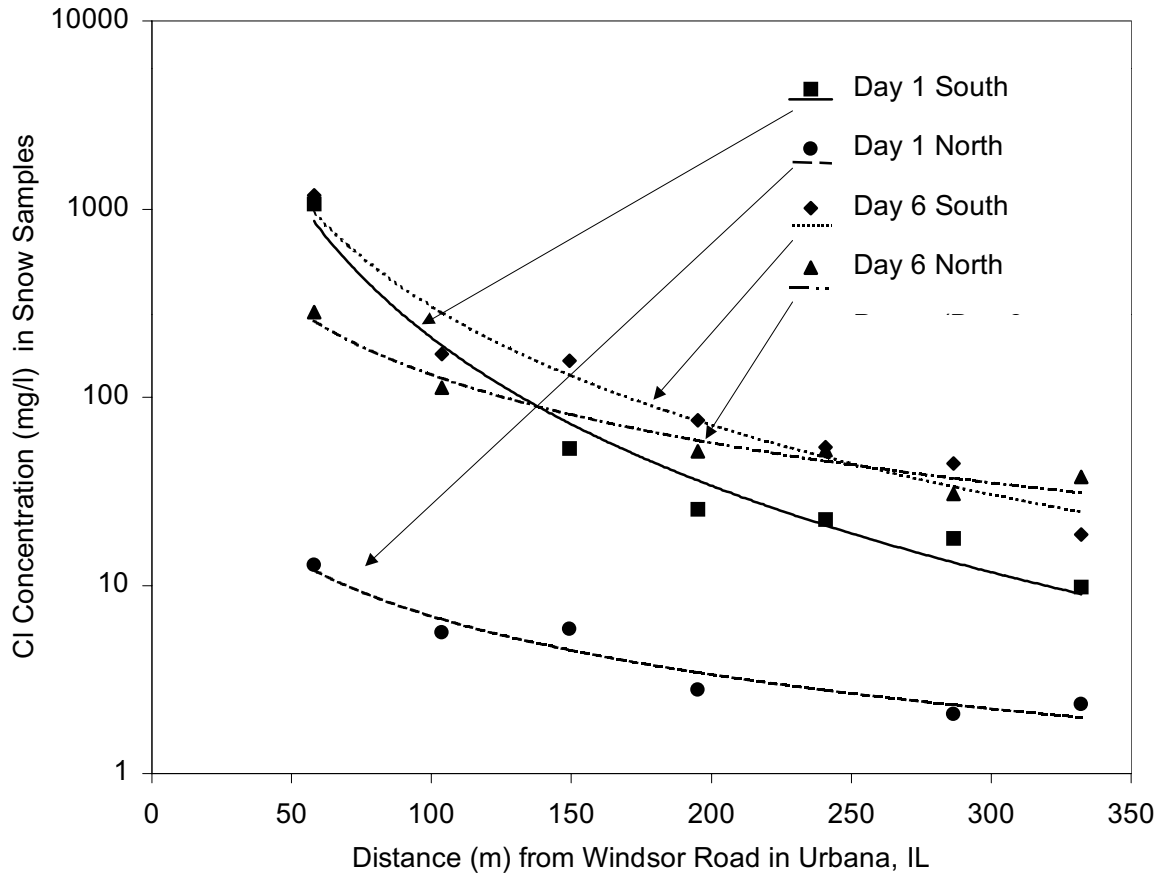

Figure 9. Plot of Cl (mg/l) versus distance from Windsor Road in Urbana. Samples were collected 1 day after the 2.54 cm snow event and again after 6 days. The 6-day deposition north of the road is from dry deposition, because it did not snow between the two sampling dates.

### Deposition Estimate

The deposition per length of road can be estimated from the snow sample data simply by integrating the curves in figure 8 over an interval from the closest distance of 50 m (160 ft) out to any arbitrary distance less than 500 m (1,600 ft), which is the limit of the range of reported measurements. Carrying out the calculation between these limits yields a total deposition of 85 grams per meter (g/m) or 300 pounds per mile (lb/mi) south of the road, and a corresponding total of 21 g/m (73 lb/mi) north of the road. In these examples more than four times as much salt

was deposited to the south as compared to north of the road. For comparison to the amount of salt applied, typical salt applications are in the range of 300 lb/mi per highway lane (IDOT, 1994). There can be several road salt applications throughout the course of a snowstorm. According to the deposition model given in figure 8, about half the deposition south of the road occurs between 50 and 177 m (160 ft and 581 ft) and half between 177 and 500 m (581 ft and 1,600 ft). This suggests that the aerosol can be transported a considerable distance. Since it disperses while in transport, the aerial deposition actually becomes quite small. Even at 50 m (160 ft), it is only  $0.9 \text{ g/m}^2$  (8.1 lb/acre), drops to  $0.14 \text{ g/m}^2$  (1.2 lb/acre) at 250 m (820 ft), and is  $0.06 \text{ g/m}^2$  (0.6 lb/acre) at 500 m (1,640 ft). At 1.6 km (1 mile) south of the road the deposition is  $0.016 \text{ g/m}^2$  (0.14 lb/acre) if the formula for deposition south of the road in figure 8 is extended to that range.

### *Deposition Uncertainty*

The above analysis of the weather conditions associated with the different snow sampling cases shows the wind direction plays an important role in determining the NaCl deposition patterns, and, therefore, the uncertainty in wind direction makes an important contribution to the uncertainty in the current estimates of the NaCl deposition. This contribution to the uncertainty can be estimated by examining the variation in the deposition among the three snow sample cases. The uncertainty comes to 64 percent upon integrating each of the three curves shown in figure 7 for deposition south of I-55 between 50 and 500 m (260 ft and 1,640 ft) upon taking twice the standard deviation between cases as a measure of the uncertainty.

An aspect that has not been included in the uncertainty estimate is that the emission source may be temperature dependent. Our hypothesis is that dry emission occurs because the brine solution from the melted snow dries and leaves a solid film on the roadway surface that is gradually broken and ejected into the air by vehicular traffic. An important parameter would be the thickness of the dry salt film. If snow maintenance is accomplished according to IDOT guidelines (IDOT, 1994), the concentration of brine solution on the road would be controlled to achieve a certain degree of freezing point depression. For example, the air temperature during the snow event on January 9 (samples collected on January 14) was  $-2.8 \text{ }^\circ\text{C}$  ( $27 \text{ }^\circ\text{F}$ ). If the road temperature was also at this temperature it would be necessary to lower the freezing point by  $2.8 \text{ }^\circ\text{C}$  ( $5 \text{ }^\circ\text{F}$ ) to prevent pavement freezing. According to the eutectic curve for NaCl (IDOT, 1997; Kirchner, 1992) this would require a 5 percent by weight NaCl solution. However, for the January 26 snow event, when the air temperature was  $-9.4 \text{ }^\circ\text{C}$  ( $15.1 \text{ }^\circ\text{F}$ ), it would take a 15 percent NaCl solution to prevent freezing of the pavement. At the colder temperature, where there should be three times as much salt in solution, the dried salt layer film would be thicker, perhaps creating a stronger dry emission source.

### *Comparison to Results of Morton Arboretum Study*

The only data, of which we are aware, that provide a direct comparison with the above results are the work of Kelsey and Hootman (1992) from their study of the salt deposition at the Morton Arboretum in Lisle, Illinois, which is reviewed by Huff and Paulson (1993). The Morton Arboretum at Lisle is located about 20 km northeast of the present study area, lying to the north and west of where I-88 and I-355 come together northwest of Downers Grove (see figure 1a). The Kelsey and Hootman experiments consisted of bucket sampling for salt deposition on the Arboretum grounds just to the north of I-88 and I-355, which combine to form 12 lanes as they pass the southern boundary of the Arboretum. The climatology of both study areas should be the same, so one would expect the salt deposition north of the two interstates to be much lower than to the south, based on the results of the present study.

Huff and Paulson (1993) cite a seasonal salt deposition value of 3,570 g/m or 2.4 pounds per foot (lb/ft) along the highway from the Kelsey and Hootman data, where all 12 lanes were considered to contribute to the deposition, and measurements were taken from 14.9 m (49 ft) out to 1,018 m (3,340 ft) from the roadway. In order to compare the present results and those of Kelsey and Hootman, the expression given in figure 8 corresponding to deposition north of I-55 is used and is extended to the range of from 14.9 m to 1,018 m from the roadway, which is, strictly, beyond the range where the correlation was established. Also, the present results are increased by the factor 3 to account for twelve rather than four lanes. For the three cases studied here, the average snow depth is 4 cm (1.6 inches); so for the annual average snow amount of 101.6 cm (40 inches), we estimate the annual deposition amount from the present measurements as being larger by the factor (40/1.6). Our calculation of the annual deposition at the Arboretum consequently becomes 2,114  $\nabla$  1,353 g/m (1.4  $\nabla$  1.0 lb/ft), which includes a 64 percent uncertainty as discussed above. Our estimated deposition range is thus 761 g/m to 3,467 g/m (0.5 lb/ft to 2.3 lb/ft), which is comparable to the 3,570 g/m (2.4 lb/ft) found from the Kelsey and Hootman data. According to our results indicating that the deposition to the south of I-55 is about 4 times higher than to the north, it follows that most of the salt aerosol emitted from I-88 and I-355 does not deposit on the Arboretum grounds.

### **Discussion of Results**

A model describing the salt emission, transport, and deposition from treated roads should consider all the important mechanisms. The above reported snow sampling cases suggest that a large part of the salt emission in the form of aerosols capable of atmospheric transport beyond 50 m (160 ft) occurs after the snow event, suggesting that dry emission is important. Two possible dry emission processes are apparent. Salt dried in a film on the roadway could be aerosolized by vehicular traffic. Salt trucks also might be the source of substantial aerosol emission as the salt is spread on the highway. Since most of the NaCl is in the large particle size class where the individual particles are comparable in size to droplets in a cloud, the aerosol salt plume would be brightly visible, like a cloud, if the particle number concentrations are high enough. Typical



cloud droplet concentrations are from 100 to 1000 per cubic centimeter ( $\text{cm}^{-3}$ ) or  $1.64 \times 10^3$  to  $1.64 \times 10^4$  per cubic inch ( $\text{in}^{-3}$ ). If the emission is of the order 1 gm/cm (355 lb/mi) of road length as indicated above, and if this material is aerosolized in a plume of  $10 \mu\text{m}$  ( $3.9 \times 10^{-4}$  in) diameter particles extending 6 m (20 ft) across the roadway and also 6 m (20 ft) above the roadway, then the aerosol number concentration would be  $2,337/\text{cm}^3$  ( $3.84 \times 10^4/\text{in}^3$ ). Since a salt truck applies salt to treat a road only a few times before and during the snow event, the amount of salt aerosolized per pass would necessarily be a significant fraction of the total emitted. This implies that if the truck itself is a major source, the associated aerosol concentration would be several hundred per cubic centimeter and would produce a visible plume. Since no such plume is observed from a truck applying salt to a roadway, this rules out the truck itself as a source significant enough to produce the observed deposition.

It is useful to consider a similar scenario to determine if erosion of dried salt from the highway surface is reasonable. A salt film  $10 \mu\text{m}$  ( $3.9 \times 10^{-4}$  in) thick formed on a 6 m (20 ft) wide road represents 1.3 gm/cm (461 lb/mi) along the roadway, which is comparable to the observed deposition of  $\sim 1$  g/cm ( $\sim 355$  lb/mi). If that amount of NaCl is aerosolized into  $10 \mu\text{m}$  ( $3.9 \times 10^{-4}$  in) diameter particles in a volume of dimensions 1 cm (0.4 in) along the road, 6 m (20 ft) across the road, and 6 m (20 ft) above the road, the number concentration would again be  $2,337/\text{cm}^3$  ( $3.84 \times 10^4/\text{in}^3$ ). Even if a single passing vehicle were able to aerosolize as much as 1 percent of the total mass, the particle concentration would only be on the order of  $20/\text{cm}^3$  ( $328/\text{in}^3$ ). Since the salt film would be eroded by the passage of hundreds of vehicles, the  $10 \mu\text{m}$  ( $3.9 \times 10^{-4}$  in) thick salt film could be aerosolized without a visible plume being developed, so the process cannot be ruled out based on the fact that no visible plume is observed.

Deposition of the road salt aerosol must be either dry deposition or wet deposition (precipitation scavenging). Precipitation scavenging is ordinarily classified according to whether it is in-cloud scavenging (rainout) or below cloud scavenging (washout) (Stensland and dePena, 1975; Williams, 1974). Since rainout involves the interaction of particles with rain clouds, the corresponding size of the rainout deposition patterns would be on the order of the scale of clouds and would not fall off sharply as a function of distance from the road as does the salt deposition shown in figures 7-9. Therefore rainout cannot be the dominant deposition mechanism. Washout refers to the collection and deposition of aerosol particles by falling rain or snow. The washout efficiency depends on the rain or snow rate, and the size of the aerosol particles being scavenged. Aerosol particles larger than  $10 \mu\text{m}$  ( $3.9 \times 10^{-4}$  in) have high washout efficiencies, and the process is especially efficient for snow because the shape of snowflakes enhances their ability to intercept aerosol particles. Dry deposition of particles that are predominantly larger than a diameter of  $10 \mu\text{m}$  ( $3.9 \times 10^{-4}$  in) is basically determined by the terminal fall velocity of the aerosol particles, which varies approximately as the square of the aerosol size. The deposition patterns observed show features consistent with both washout and dry deposition.

Even though washout is an efficient removal mechanism, it must be raining or snowing for washout to occur. There may not be significant aerosol emission while precipitation is occurring if the spray from the wet road surface is not an important aerosol source. The emission

of dried salt on the road would not occur while it is raining or snowing. The Windsor Road and I-55 snow sampling results suggest that emission occurred primarily after the pavement had time to dry. These arguments lead to the proposition that emission of dry salt from the road, followed by its dry deposition downwind of the road, are the dominant processes.

Further checks can be made from the present data to test the consistency of the dry emission/dry deposition hypothesis. Salt aerosol concentrations were determined at the aerosol sampling sites, as recorded in table 3, so an estimate of dry deposition can be made. Since snow samples were also collected at aerosol sampling sites, as reported in table 5, the dry deposition estimate can be compared with the actual deposition. Suppose the ambient concentration of Cl in large particles is  $1.4 \mu\text{g}/\text{m}^3$ , which is the average concentration for sites 3 and 5 given in table 3. From this particulate concentration and reasonable assumptions about the dry deposition parameters, an estimate of the resulting Cl concentration in the snow can be made. If  $c$  is the air concentration of Cl,  $v$  is the dry deposition velocity, and  $t$  is the sampling time, the mass deposited per unit area is  $c v t$ . Assuming the snow is 2.54 cm (1 in) deep, which is an equivalent water depth of 0.254 cm (0.1 in), this dry deposition amount should translate to a snow concentration of  $c v t / 0.254$ . We can set  $t = 4$  days which was the duration of the aerosol sampling for each filter. If the dry deposition velocity is taken as the terminal velocity of NaCl spheres, which is a strong function of particle diameter (Twomey, 1977), the calculated snow concentration of Cl is 1.25 mg/l ( $7.23 \times 10^{-7}$  oz/in<sup>3</sup>) assuming particle diameters of 10  $\mu\text{m}$  ( $3.9 \times 10^{-4}$  in). For 20  $\mu\text{m}$  ( $7.9 \times 10^{-4}$  in) diameter particles the deposition becomes 5.02 mg/l which is much closer to the measured value of 6.76 mg/l ( $2.90 \times 10^{-6}$  oz/in<sup>3</sup>) given in table 5 for the average amount of Cl deposited in the snow at sites 3 and 5. This indicates that the process of dry deposition is consistent with the measured results, and that the particle diameters are in the 20  $\mu\text{m}$  ( $7.9 \times 10^{-4}$  in) range.

**Table 5. Average Concentrations of Chloride (Cl), Sulfate (SO<sub>4</sub>), Sodium (Na), and Calcium (Ca) in Multiple Snow Samples Taken at Sites after Snow Events on 1/14/97, 1/17/97, and 1/28/97.**

<i>Sample Description</i>	<i>Cl (mg/l)</i>	<i>SO<sub>4</sub> (mg/l)</i>	<i>Na (mg/l)</i>	<i>Ca (mg/l)</i>
<i>Site 3</i>	4.09	1.58	2.53	1.29
<i>Site 5</i>	9.42	1.82	5.67	1.63
<i>Average</i>	6.76	1.70	4.10	1.46

If salt particles are emitted at the roadway, an interesting question is whether their dry deposition could produce the deposition patterns shown in figures 6 and 7. Key uncertainties are the specification of the dry deposition velocity, the initial height of the salt aerosol plume, and the wind speed. Suppose the deposition velocity is taken as 2.6 cm/sec (1 in/sec) corresponding to the terminal velocity of a 20  $\mu\text{m}$  ( $7.9 \times 10^{-4}$  in) diameter NaCl sphere falling in air under gravity. If the particle source is associated with vehicular action, the salt plume might be visualized as being similar to the dust plume produced by a vehicle traveling on a dirt or graveled road. Although the emission occurs at the roadway surface, the initial shape and particularly the height of the plume are determined by the air flow around the vehicle caused by its speed and the prevailing wind. The height of the vehicle should represent a lower limit to the plume height, and it is quite conceivable that the plume can be several times the vehicle height. An approximation of the distance the particles would be transported downwind can be made by assuming they travel horizontally at the prevailing wind speed as they fall from their initial height to the ground. At an initial plume height of 3 m (9.8 ft) and a wind speed of 4 km/hr (5 mph), the transport distance is 260 m (853 ft), and at an initial height of 6 m (20 ft) and a wind speed of 32 km/hr (40 mph), the transport distance is 2,060 m (6,760 ft or 1.28 mi). Improvements to the calculation could be made by taking atmospheric diffusion into account. The particle size distribution is also very important, because the terminal velocity varies as the square of the particle diameter. Thus, for the same wind speed and injection height, a particle half as large would travel four times as far, and the salt aerosol is bound to have a size distribution varying over a range of sizes. Despite the uncertainties, the approximation does indicate that the road salt aerosol in the observed large particle size class could produce the salt deposition patterns shown in figures 7 and 8.

A final point in assessing the plausibility of the dry emission/dry deposition hypothesis concerns the shape of the curves in figure 9 describing the variation of the salt deposition with distance from the road for the Windsor Road experiments. In particular, comparing the curves for day 1 south of the road to those for day 6 north of the road, it is seen that the initial emissions fall off more steeply than at later times. If dry deposition is the dominant deposition mechanism, this behavior is consistent with a shift of the particle size distribution to smaller sizes, which persist in the atmosphere longer. After the road initially dries following salt application, the thickness of the salt film would apparently be greatest, and it would decrease with time as it becomes eroded by vehicular traffic, so the process of dry emission of the eroded film followed by dry deposition of the particles is consistent with observed shift in the deposition pattern to longer distances at later times.

### **Future Research**

The analysis presented here provides a basis for focusing efforts and resources to improve the road salt study. The particle size range of most importance has been identified. Based on evidence from aerosol and snow sampling, the hypothesis presented is that the most important emission process is erosion of dried salt material from the roadway followed by dry deposition of the aerosolized salt material. This hypothesis must be tested, and the basic emission and

deposition processes identified before a numerical model can be constructed. The composition differences in the deposited material will be critically investigated by additional snow sampling near and far from the road, and by analysis of the composition of the bulk road salt material. More sophisticated statistical analyses will be performed to specify with statistical certainty whether the salt spray and the aerosol deposited far from the road are different. If the composition of the particles does change with distance from the road source, it could be a marker for specifying the relative magnitude of different emission mechanisms.

The question of dry versus wet deposition can be investigated in several ways. A wet/dry raingage that automatically covers the sample after precipitation has ended can be used to exclude dry deposition from snow samples. If dry deposition is the dominant process, such snow samples should be low in NaCl. The same instrument also collects deposition to a bucket exposed only when there is no precipitation. This sample should contain most of the NaCl if dry deposition is the dominant process. In the wind-directed sampling protocol, wet deposition, dry deposition, and aerosol samples can be obtained when the wind is from the direction of a suspected source. This is especially important in helping to directly determine the extent to which road salt at a given location is affected by different sources. For example, the emission from city streets, as seen from data at the sampling sites when the wind is from the direction of a town, can possibly be inferred from the data. Coupled with a wind-directed capability, the system shows promise of quantifying the magnitude of the different salt sources in the area.

Since the aerosol sampling capability at the permanent sites is designed to evaluate the emissions from the proposed new road, which it is now clear will not be constructed within the time frame of the study, the objective of evaluating emissions from the proposed new highway cannot be realized. The presently reported aerosol results indicate that the site nearer to I-55 has consistently higher aerosol concentrations than a similar site located farther downwind of I-55. There are also secondary roads in the area and the wind-directed sampling capability will be used in the winter of 1999/2000 to try to distinguish the relative road salt contributions from secondary roads close to the sampling sites compared to the more distant interstate highway.

## References

- Huff, L. and J. Paulson. 1993. *Technical Memorandum on Salt Spray Effects on FAP 340*. Illinois Department of Transportation, Springfield, IL.
- IDOT. 1994. *Snow and Ice Control Manual Districts 2 Through 9*, Illinois Department of Transportation, Division of Highways, Bureau of Operations, Springfield, IL.
- IDOT. 1997. *Guidelines for Liquid Chemical Application for Snow and Ice Control*. Illinois Department of Transportation, Division of Highways, Bureau of Operations, Springfield, IL.
- Kelsey, P. and R. Hootman. 1992. Deicing Salt Dispersion and Effects on Vegetation along Highways. Case Study: Deicing Salt Deposition on the Morton Arboretum. In F.M. D'Itri (ed.), *Chemical Deicers and the Environment*, Lewis Publishers, Chelsea, MI, pp. 253-282.
- Kirchner, H. 1992. Comparative Study of Chemical Deicers: Undercutting and Disbondment. In F.M. D'Itri (ed.), *Chemical Deicers and the Environment*, Lewis Publishers, Chelsea, MI, pp. 495-518.
- Stensland, G. and R. dePena. 1975. A Model of Below-Cloud Precipitation Scavenging of NaCl. *J. Geophysical Res.* **80**: 3410-3418.
- Twomey, S. 1977. *Atmospheric Aerosols*. Elsevier, New York.
- Williams, A. 1974. Analysis of In-Cloud Scavenging Efficiencies, In R.G Semonin and R.W. Beadle (eds.), *Precipitation Scavenging*, CONF-741003, National Technical Information Service, U.S. Department of Commerce, Springfield, Virginia, pp. 258-275.