



## Plecas, Milana and Kockar, Ivana (2015) Shinnel Glen hydro scheme analysis. [Report] ,

This version is available at <https://strathprints.strath.ac.uk/63983/>

**Strathprints** is designed to allow users to access the research output of the University of Strathclyde. Unless otherwise explicitly stated on the manuscript, Copyright © and Moral Rights for the papers on this site are retained by the individual authors and/or other copyright owners. Please check the manuscript for details of any other licences that may have been applied. You may not engage in further distribution of the material for any profitmaking activities or any commercial gain. You may freely distribute both the url (<https://strathprints.strath.ac.uk/>) and the content of this paper for research or private study, educational, or not-for-profit purposes without prior permission or charge.

Any correspondence concerning this service should be sent to the Strathprints administrator: [strathprints@strath.ac.uk](mailto:strathprints@strath.ac.uk)

# Shinnel Glen hydro scheme analysis

Report produced by University of Strathclyde for the Accelerating Renewables Connection Project

Authors:

Milana Plecas: [milana.plecas@strath.ac.uk](mailto:milana.plecas@strath.ac.uk)

Ivana Kockar: [ivana.kockar@strath.ac.uk](mailto:ivana.kockar@strath.ac.uk)

Date of Issue: 21<sup>th</sup> October 2015

# Contents

1	Introduction.....	2
2	Overview of PowerFactory Modelling.....	3
2.1	Modelling of 11kV side.....	3
2.2	Modelling of LV side.....	5
2.3	Modelling of the existing and potential generators.....	6
3	Input data.....	7
4	Methodology, analysis and results.....	8
4.1	First case study.....	8
4.2	Second case study.....	10
4.3	Third case study.....	12
5	Conclusions.....	13
	Appendix 1: Summary of scripts developed during modelling.....	14
	A1.1. Script: TimeStepWithMultipleGen.....	14
	A1.2. Script: DG_capacityWithMultipleGen.....	16
	A1.3. Script: LoadFlow.....	18
	A1.4. Script: checkLineLoading.....	19

# 1 Introduction

This interim report outlines details of work carried out by the University of Strathclyde to analyse potentials of a community hydro project in Shinnel Glen area. The report is produced as part of the Accelerating Renewable Connections (ARC) project for Scottish Power Energy Networks.

Although this area has existing hydropower generation schemes and significant potential for further growth, the connection of further community, small and medium scale renewable generation is limited by a very low demand and the existing infrastructure of the distribution network. Current and potential hydropower schemes are shown in Figure 1. There are 4 existing schemes with overall capacity of 39kW and 14 potential schemes with overall capacity of 334kW.

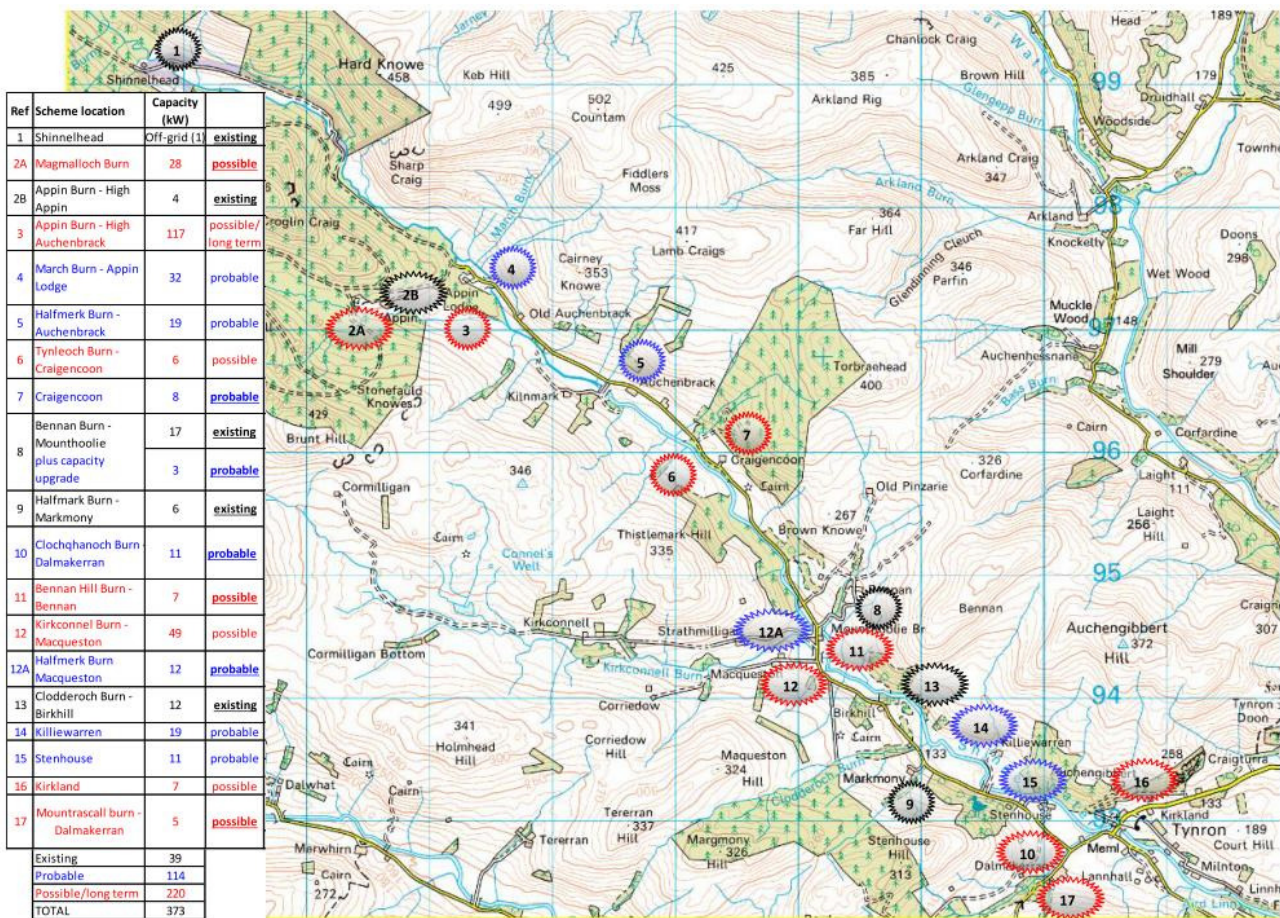

Figure 1: Shinnel Glen current and potential hydropower scheme map

All of above schemes are connected to the LV side of Feeder 12 which is fed from Penpont primary station. As shown in Figure 1, almost all of the potential schemes are proposed to be connected to the end of this feeder, which is a 2 wire, single-phase line. Such new Distributed Generation (DG) connection could have a significant impact on the voltage levels in the area, and may create significant number of instances of LV overvoltage excursions.

The main goal of this report is to provide details of the modelling and analysis carried out to investigate the potential of new DG connections to this already voltage constrained feeder.

## 2 Overview of PowerFactory Modelling

In order to study various DG scenarios, Strathclyde has developed a simplified PowerFactory (PF) model of Penpont Feeder 12, with existing and potential hydro schemes based on SPEN's geographic information system (GIS) database and a provided map of Shinnel Glen hydropower schemes. The model is a simplification of the real feeder, and it has been matched as closely as possible to the information available on the design of the feeder from SPEN's GIS database.

### 2.1 Modelling of 11kV side

Although there are a number of secondary substations (S/S), it was possible to simplify the problem by aggregation of some of these substations into one. The final model of the investigated Shinnel Glen network is shown in Figure 2, and includes the following:

1. Penpont 11kV primary busbar with a connected external grid acting as the swing bus (right end of the feeder)
2. Eight 11kV secondary substations connected to the 3-phase 11kV line (red circuited busbars) with balanced three-phase 11kV loads.
3. Six 11kV secondary substations connected to the 1-phase 11kV line which is in our model presented as 3-phase line which is explained below (green circuited busbars)

Based on the available data, network parameters were calculated as:

- 3-phase line of the feeder from Penpont primary up to Stenhouse Noja secondary substations (S/S) is mainly modelled as SCA 50mm 11kV overhead line (OHL) (dashed line) with a short cable section modelled as Aluminum 185mm Coral (solid line).
- A single-phase line in Shinnel Glen area, from Stenhouse Noja S/S up to the end of the feeder, is, per SPEN's suggestions<sup>1</sup>, also modelled as a 3-phase SCA OHL because of the issues with modelling single-phase line in PowerFactory. Therefore, all loads and generators connected to this part of the feeder are connected only to phase A<sup>2</sup>, as there was a single-phase line.

---

<sup>1</sup> Based on a conversation with Andrew Park and Ken Sharp on the 5<sup>th</sup> of October 2015. They suggested to make a single-phase line 3-phase as there has always been an issue with modelling of single-phase lines in PowerFactory.

<sup>2</sup> Based on a conversation with Andrew Park on the 25<sup>th</sup> of September 2015.

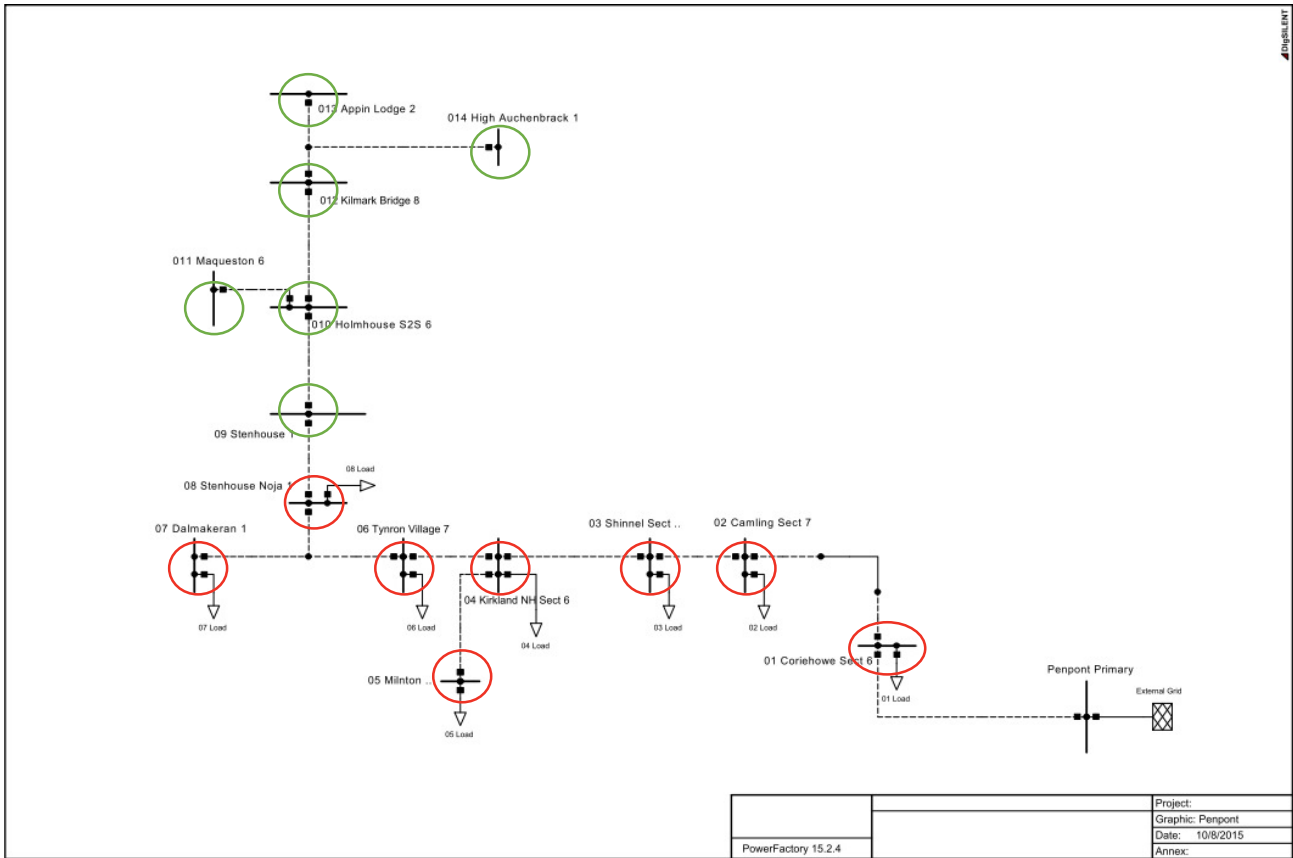

Figure 2: PowerFactory model of Feeder 12 fed from Penpont substation

In order to illustrate aggregation of some of the substations, as mentioned above, for the purpose of modelling and naming within the scripts, all modelled secondary substations are named in the following pattern: reference number of S/S, name and a number of aggregated S/S. Table 1 summarizes all secondary substation names with associated loads.

Number	PowerFactory 11kV station name	11kV load name
	Penpont Primary	N/A
1.	01 Coriehowe Sect 6	01 Load
2.	02 Camling Sect 7	02 Load
3.	03 Shinnel Sect 7	03 Load
4.	04 Kirkland NH Sect 6	04 Load
5.	05 Milnton 8	05 Load
6.	06 Tynron Village 7	06 Load
7.	07 Dalmakeran 1	07 Load
8.	08 Stenhouse Noja 1	08 Load
9.	09 Stenhouse 1	N/A
10.	010 Holmhouse S2S 6	N/A
11.	011 Maqueston 6	N/A
12.	012 Kilmark Bridge 8	N/A
13.	013 High Auchenbrack 1	N/A
14.	014 Appin Lodge 2	N/A

Table 1: Summary of secondary substation names and their 11kV loads

## 2.2 Modelling of LV side

Each secondary substation that has existing or potential hydro scheme is extended to include an 11kV/433V transformer, LV busbar and LV load (red circled areas), as shown in Figure 3. All LV loads connected to the LV busbars after Stenhouse Noja S/S are connected to phase A of each LV busbar, as explained in Section 2.1.

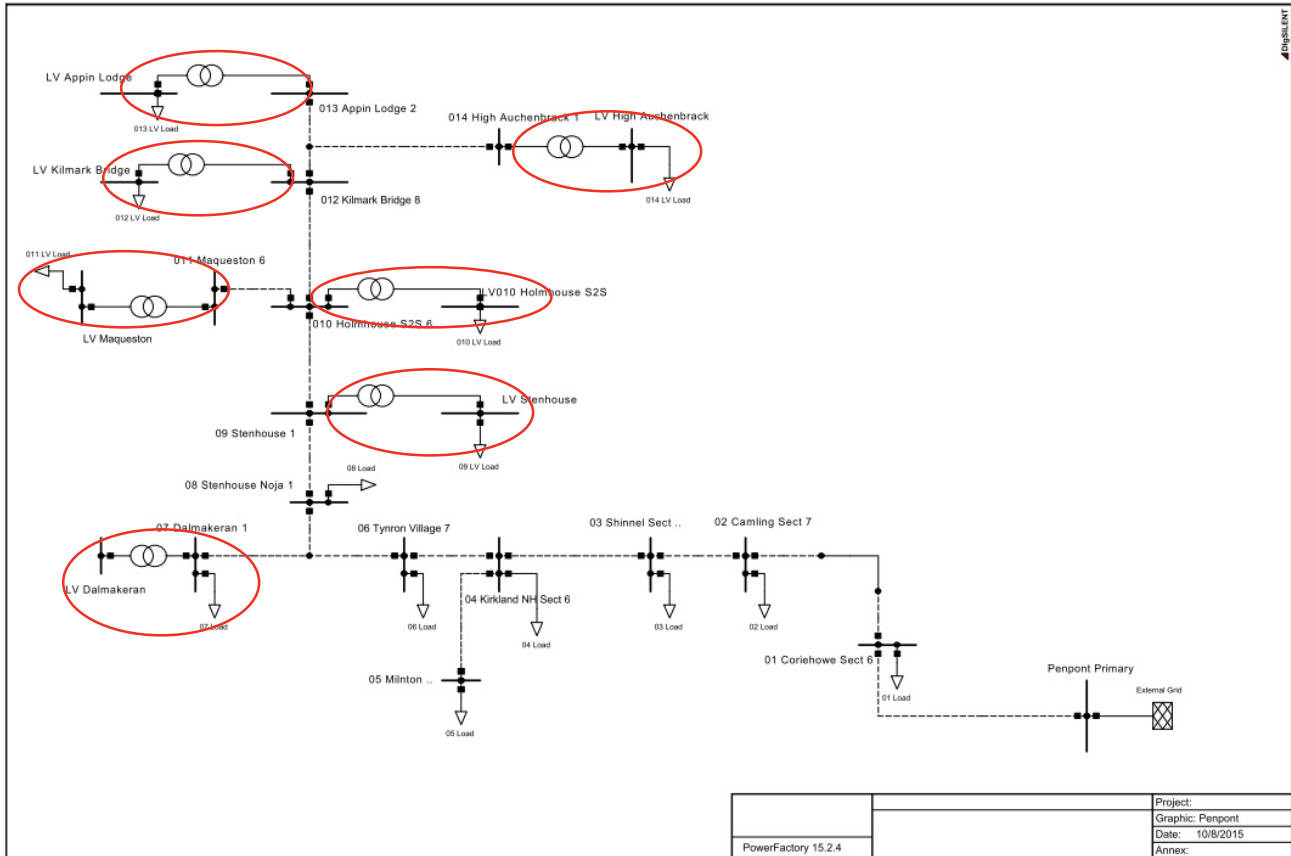

Figure 3: PowerFactory model with LV busbars

The type of the LV transformers at each secondary substation is set in line with consultations with SPEN<sup>3</sup> and they are assumed as:

- 11/0.4k33V 2-winding transformer,
- capacity of 0.05MVA,
- X/R ratio 4.5%, and
- centre tap position of 0%.

Table 2 summarizes all LV busbar names with associated loads.

Number	PowerFactory LV busbar name	LV load name
1.	LV Dalmakeran	N/A
2.	LV Stenhouse	09 LV Load
3.	LV Holmhouse S2S	010 LV Load
4.	LV Maqueston	011 LV Load
5.	LV Kilmark Bridge	012 LV Load
6.	LV High Auchenbrack	013 LV Load
7.	LV Appin Lodge	014 LV Load

Table 2: Summary of LV busbar names and associated LV loads

<sup>3</sup> Transformers' X/R ratio and tap-settings are based on a conversation with Ross Anderson on the 2<sup>nd</sup> of June 2014.

### 2.3 Modelling of the existing and potential generators

Based on provided Shinnel Glen hydropower map shown in Figure 1, firm and non-firm generators are connected to LV busbars at various locations. Similar to the LV loads, all generators are connected to phase A of each LV busbar, as explained in Section 2.1. The final PowerFactory model is shown in Figure 4.

Existing Bennan Burn and Clodderoch Burn generators are modelled together, so the 4 existing generators are presented as 3 firm generators (red circled generators). In this network model the following ones are used:

- *FDG 1* for the DG of 29kW, whose active power is set to 29kW
- *FDG 2* for the DG of 6kW whose active power is set to 6kW
- *FDG 3* for the DG of 4kW whose active power is set to 4kW

These DGs are considered to generate at full capacity at all times.

Potential hydro schemes are modelled as 5 non-firm 'shadow generators' with generation – i.e. active power, set to zero. These are named in the model as 01 DG, 02 DG up to 05 DG. Four of these DGs, 02 DG to 05 DG, (green circled generators) are proposed to be connected after Stenhouse Noja S/S which is the single-phase part of the feeder modelled as 3-phase OHL, as explained in Section 2.1., and 01 DG (blue circled generator) is proposed to be connected before Stenhouse Noja S/S, i.e. to the 3-phase part of the feeder. These 'shadow generators' are used to study various DG scenarios that will be explained in Section 4.

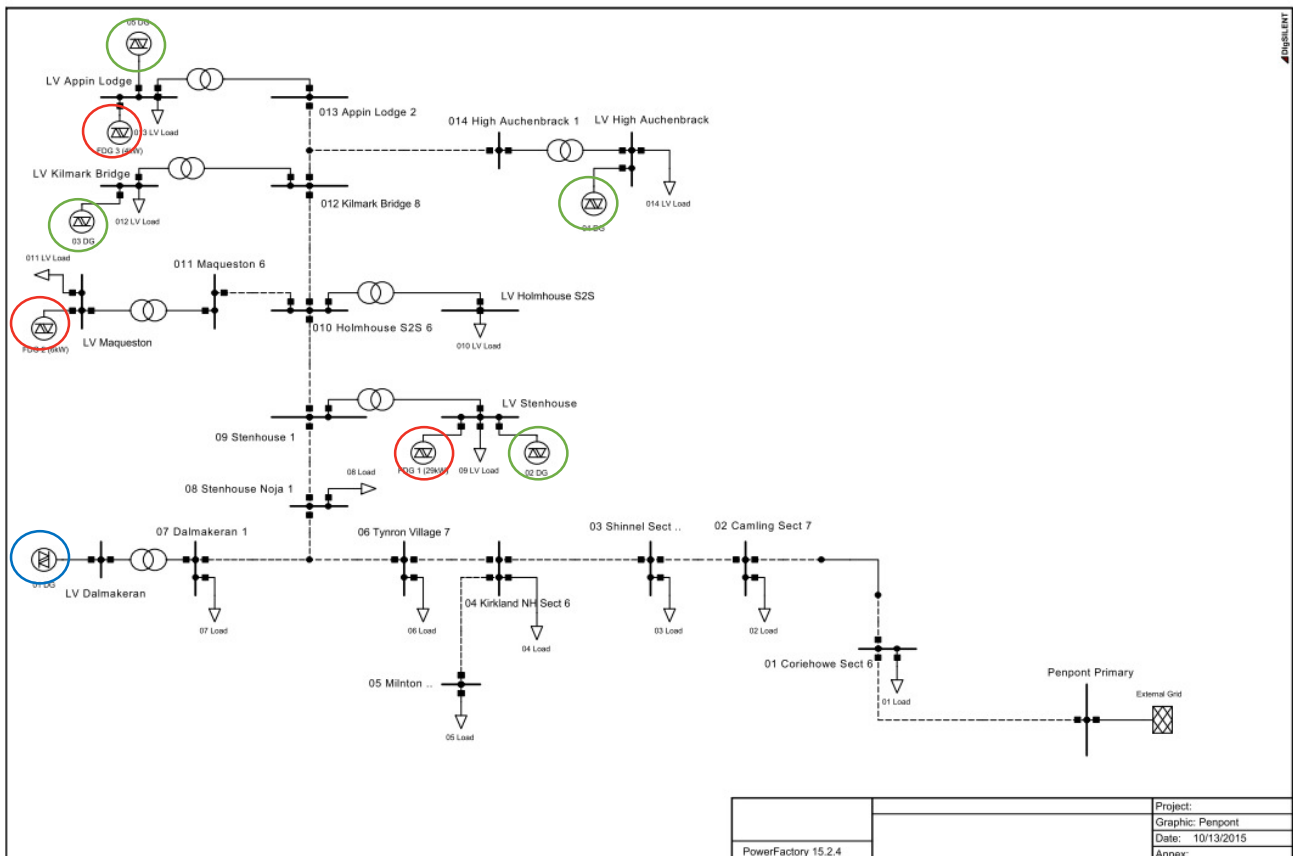

Figure 4: Final PowerFactory model



### 3 Input data

The analysis is carried out for the period from 1<sup>st</sup> Aug to 10<sup>th</sup> Sep 2015. SPEN has provided voltage readings from Penpont primary substation on the 11kV busbar and current data for Feeder 12. As, these data were recorded in different time resolution, for the purpose of the analysis, they are processed and reduced to hourly resolution.

The plot of primary voltage is shown in Figure 5, with the minimum voltage recorded at the primary during the period Aug-Sep 2015 is 10.845kV and the maximum is 11.283kV.

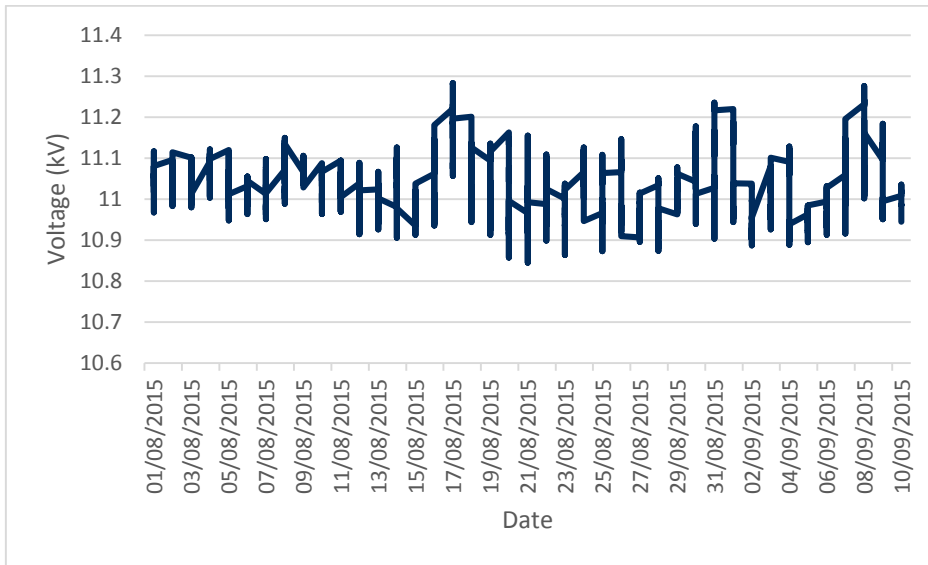

Figure 5: Primary Voltage

Based on voltage and current measurement values from the Penpont primary, the total real power demand on Feeder 12 was calculated and shown in Figure 6. The real power demand ranges from 55.01kW at 14:01, 25/08/2015 to 176.87kW at 20:00, 02/08/2015.

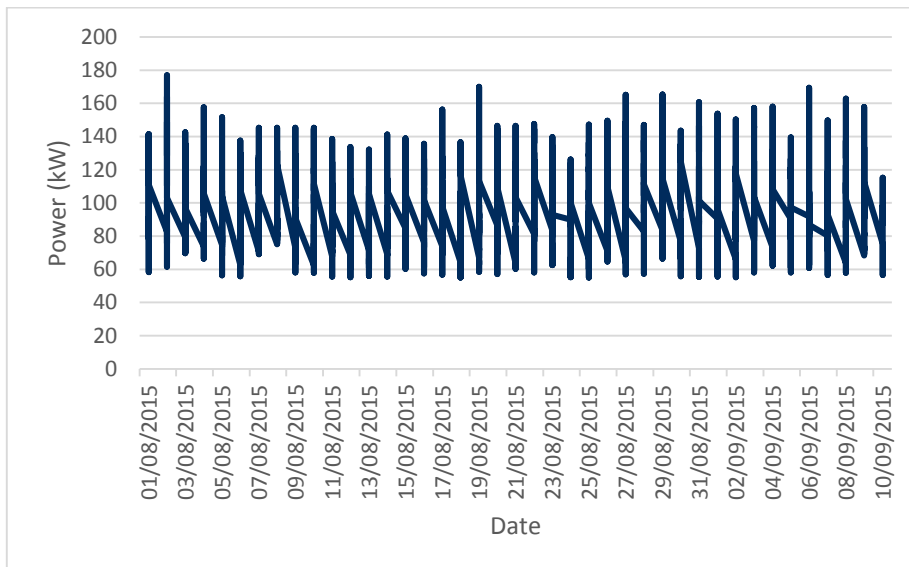

Figure 6: Power on Feeder 12

## 4 Methodology, analysis and results

PowerFactory scripts have been developed to investigate the available capacity available for DGs at different locations of Feeder 12, whilst maintaining both thermal and voltage limits across the entire feeder. An upper limit of 11kV voltage level is set to 11.25kV, while the LV voltage level is constrained to the maximum of 253V. All PowerFactory studies have been run for each hour for a period of time 1<sup>st</sup> August-10<sup>th</sup> September 2015 and the details of developed scripts are given in Appendix 1.

Since a single-phase line in Shinnel Glen area, from Stenhouse Noja S/S up to the end of the feeder is modelled as a 3-phase SCA OHL, as explained in Section 2.1., the output of all generators (firm and non-firm) is increased by 50% to reflect current in 3 conductors instead of 2 conductors<sup>4</sup>.

Different case studies have been analysed, in order to calculate the maximum DG capacity that can be injected at each LV busbar.

### 4.1 First case study

The first case study calculates the maximum DG output assuming that only one shadow DG is connected, and all others are set to zero. Therefore, the calculated output of each generator is independent of the output off all other generators. The methodology used here includes the following steps:

1. For each time step:
  - a. Set primary substation voltage to historically measured value
  - b. Set P value at all 11kV and LV loads by equally distributing total demand calculated at the primary for that time-step
  - c. Set output of all firm generators as explained in Section 2 and increase them by 50%
  - d. Set output of all shadow generators to zero
  - e. For each shadow generator:
    - i. Find the maximum DG output that maintains both thermal and voltage limits
      1. Start from zero
      2. Run load flow
      3. If thermal and voltage limits are satisfied increase capacity for 1kW and repeat (2)
    - ii. Reset calculated DG output to zero
  - f. Repeat (e) for all shadow generators
  - g. Write the maximum output of each shadow generator to the output file and decrease them by 50% since it is assumed that all generator are generating 50% more to reflect current in 3 conductors instead of 2 conductors
2. Repeat 1 for all time-steps

Figure 7 shows the maximum calculated output of each shadow generator for a period of time Aug-Sep 2015.

---

<sup>4</sup> Based on a conversation with Andrew Park and Ken Sharp on the 5<sup>th</sup> of October 2015. They suggested to increase the size of the generators by 50% in order to compensate modelling of a single-phase line (2 conductors) as a 3-phase line (3 conductors).

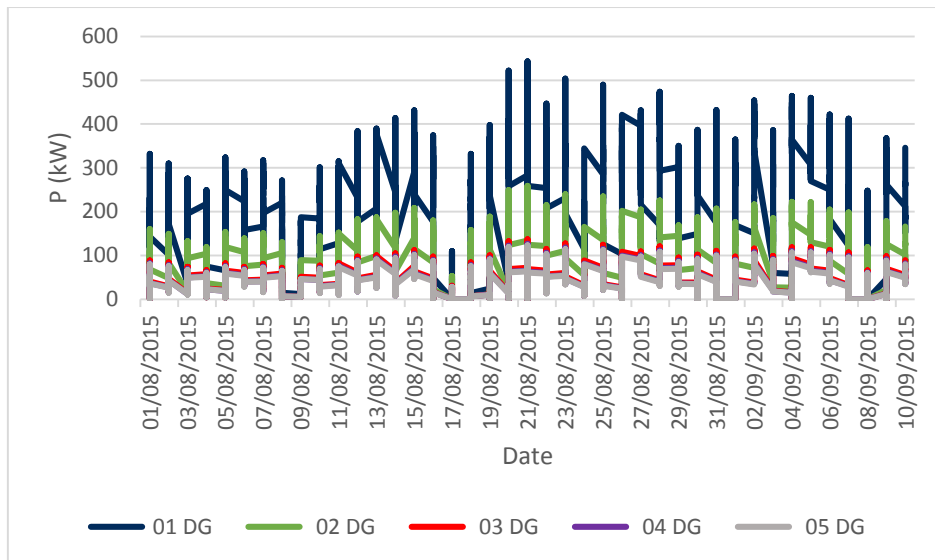

Figure 7: Maximum calculated output of shadow generators in the first case study

The correlation between primary voltage and maximum calculated output of shadow generators is shown in Figure 8. It can be seen that no generation can be connected when voltage at the primary is higher than approximately 11.12kV.

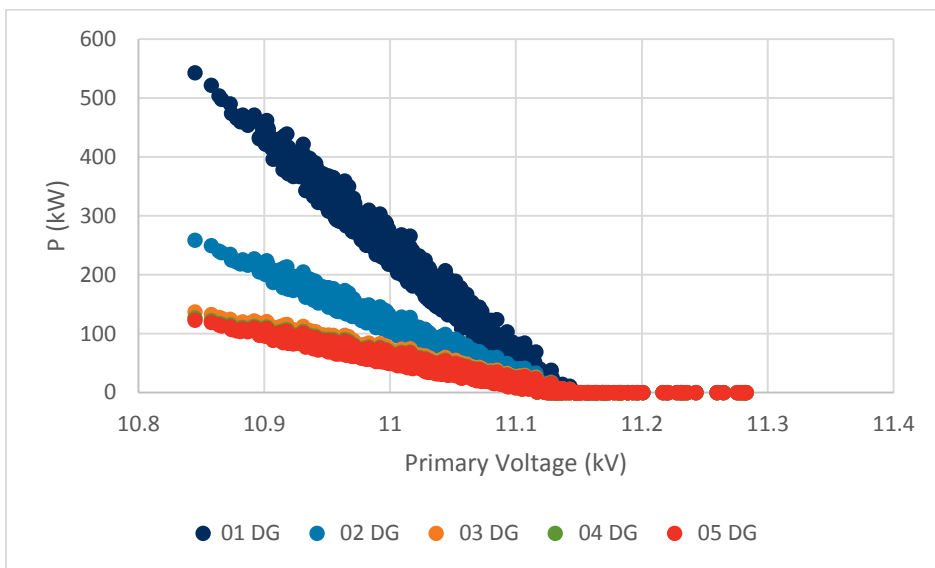

Figure 8: Correlation between primary voltage and maximum calculated output of shadow generators in the first case study

These maximum capacities are constrained with LV voltage limits. With higher capacities, overvoltage at LV busbars would occur, starting from the end of the feeder, LV Appin Lodge.

## 4.2 Second case study

The second case study considers the interaction of more than one DGs. The injection of power at one secondary substation will affect the voltage at all other secondary substations and will therefore affect the remaining capacity for DG at those other substations.

To investigate these effects, the methodology from the first case study is adjusted to consider the remaining capacity for DG after the connection of other DGs. It involves the following steps:

1. For each time step:
  - a. Set primary substation voltage to historically measured value
  - b. Set P value at all 11kV and LV loads by equally distributing total demand calculated at the primary for that time-step
  - c. Set output of all firm generators as explained in Section 2 and increase it by 50%
  - d. Set all shadow generators to zero output
  - e. For each shadow generator:
    - i. Find the maximum DG output that maintains both thermal and voltage limits
      1. Start from zero
      2. Run load flow
      3. If thermal and voltage limits are satisfied increase capacity for 1kW and repeat (2)
    - ii. Keep calculated DG output and move to the next generator
  - f. Repeat (e) for all shadow generators
  - g. Write the maximum output of each shadow generator to the output file and decrease them by 50% since it is assumed that all generator are generating 50% more to reflect current in 3 conductors instead of 2 conductors
2. Repeat 1 for all time-steps

The effects of multiple DGs connected to the feeder for a period of time Aug-Sep 2015 are illustrated in Figure 9 and Figure 10. Figure 9 shows the results when the generators are sorted in ascending order, so the first generator to be connected is at LV Dalmakeran busbar, 01 DG. It can be seen that maximum generation of this generator (01 DG) affects output of all others DGs, i.e. they are not able to generate at all because of LV voltage constraints at the end of the feeder.

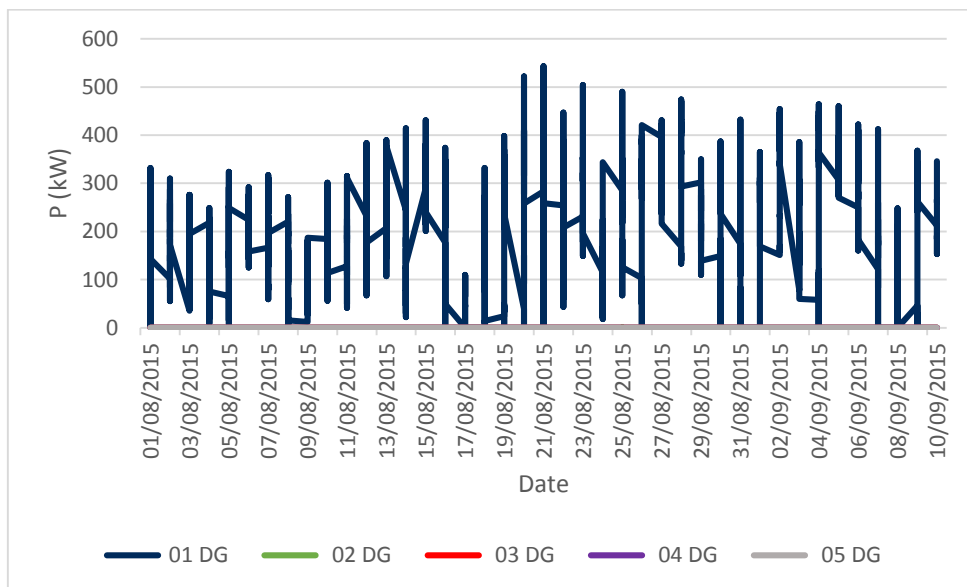

Figure 9: Maximum calculated output of shadow generators in the second case study (ascending order)

Figure 10 shows the results when the generators are sorted in descending order, so the first generator to be connected is at LV Appin Lodge busbar, 05 DG. Similarly, the maximum generation of the first connected generator (05 DG), has an impact on the output of all others DGs. However, in this case the output of other generators are not always constrained to zero.

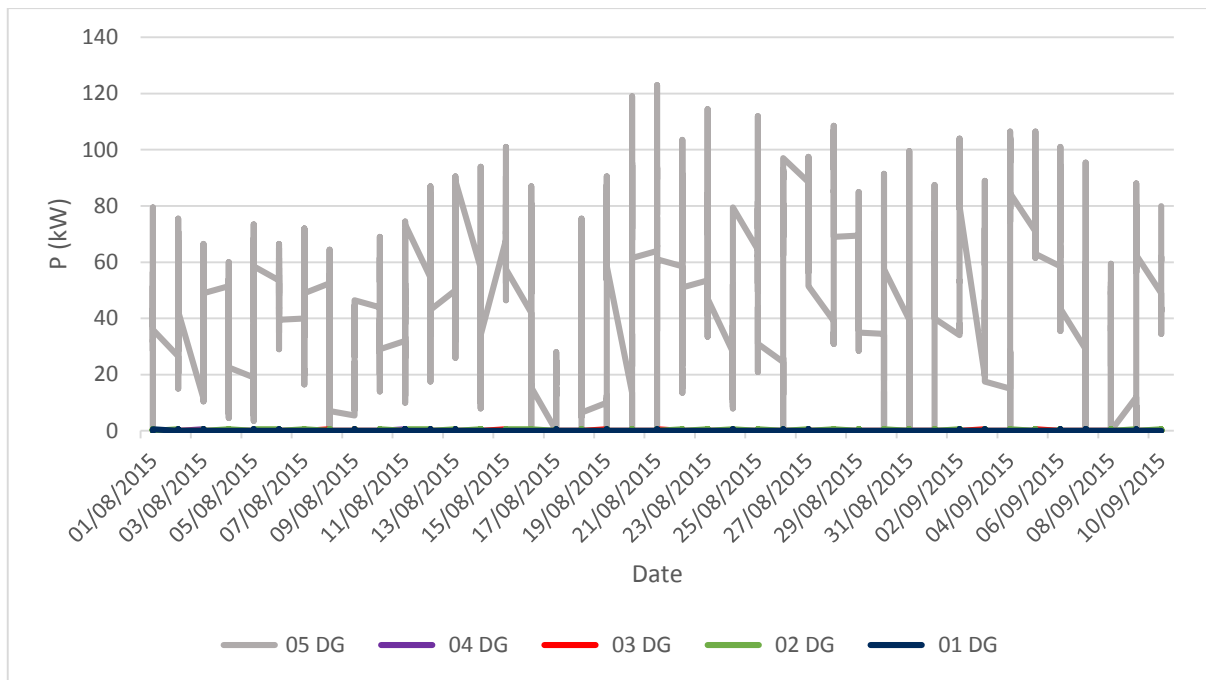

Figure 10: Maximum calculated output of shadow generators in the second case study (descending order)

### 4.3 Third case study

The third case study also considers the interaction of more than one DGs while constrains the output of each generator to 50kW. The results are shown in Figure 11 and Figure 12 for different order of generators, starting from 01 DG and 05 DG, respectively.

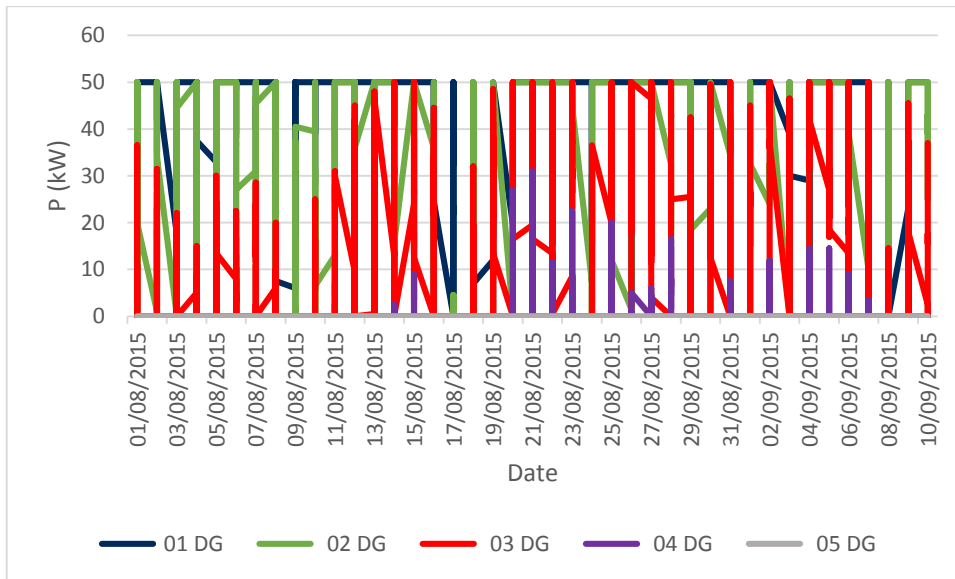

Figure 11: Maximum calculated output of shadow generators in the third case study (ascending order)

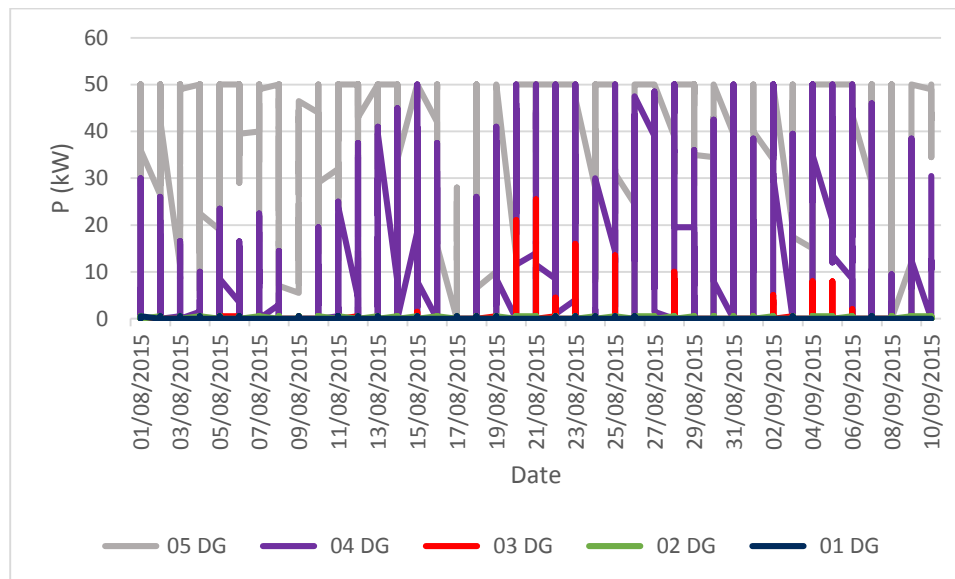

Figure 12: Maximum calculated output of shadow generators in the third case study (descending order)

The results are similar to the results from the second case study. The generation output of the first connected generator affects output of all others DGs. However, as its output is limited to 50kW which is lower than its maximum output calculated in the second case study, other generators are able to generate more than before.

## 5 Conclusions

The work presented in this report represents the development of PowerFactory model and analysis carried out to investigate the maximum capacity of potential hydro schemes in Shinnel Glen area.

The following has been develop:

- 11kV feeder model to test different scenarios and to extract representative results
- A methodology for identifying the time-series of DG capacities for given primary voltage and demand values while maintaining both thermal and voltage limits.
- A methodology for identifying the reduction of DG capacities caused by the connection of multiple generators.

The work also presented tentative results for the period 1<sup>st</sup> August – 10<sup>th</sup> September 2015. The overall results and conclusions are listed below:

- Historically recorded primary voltage values range from 10.845kV to 11.283kV.
- All DGs are voltage constrained.
- When more than one DG connects to a feeder, the location of the first generator affects the remaining capacities.

## Appendix 1: Summary of scripts developed during modelling

During the modelling activities of Shinnel Glen hydro scheme, the University of Strathclyde developed few scripts in order to better understand problems that arise on the distribution network while connecting distributed generators. All the scripts were developed by writing DiGSILENT Programming Language (DPL) script in PowerFactory software. This appendix provides a brief summary of the developed scripts.

### A1.1. Script: TimeStepWithMultipleGen

This is the main script in this case study. It opens csv input file with historical measurements of primary voltage and historical total real power readings for Penpont Feeder 12. It then sets the primary voltage and 11kV and LV load values to represent conditions at a particular time-step.

The script then dispatches three firm generators at full capacity increased by 50% to reflect current in 3 conductors instead of 2 conductors and then calls *DG\_capacityWithMultipleGen* script (see A1.2.) to estimate the remaining capacity for each non-firm DG.

Finally, the script prints a number of completed time-step and closes input and output files.

The flowchart of the script is shown in Figure 13.

Before simulations, the user should set values of the following input parameters:

1. int nt – number of time-steps
2. int index – indicates how the non-firm generators should be sorted by name, 0-ascending, 1-descending
3. int reset – indicates if each generation output should be reset to 0 after finding its maximum, 0-yes, 1-no
4. double gen\_limit – generation limit in MW  
Note that if the maximum generation output should be found, gen\_limit should be set high, i.e. 10MW.
5. string FolderNameRes – result folder path
6. string FolderNameIn – input data folder path

Note that input parameters specified by the user has the following values:

1. First case study  
nt = 931, index = 0, reset = 0, gen\_limit = 10
2. Second case study, ascending  
nt = 931, index = 0, reset = 1, gen\_limit = 10
3. Second case study, descending  
nt = 931, index = 1, reset = 1, gen\_limit = 10
4. Third case study, ascending  
nt = 931, index = 0, reset = 1, gen\_limit = 0.1
5. Third case study, descending  
nt = 931, index = 1, reset = 1, gen\_limit = 0.1



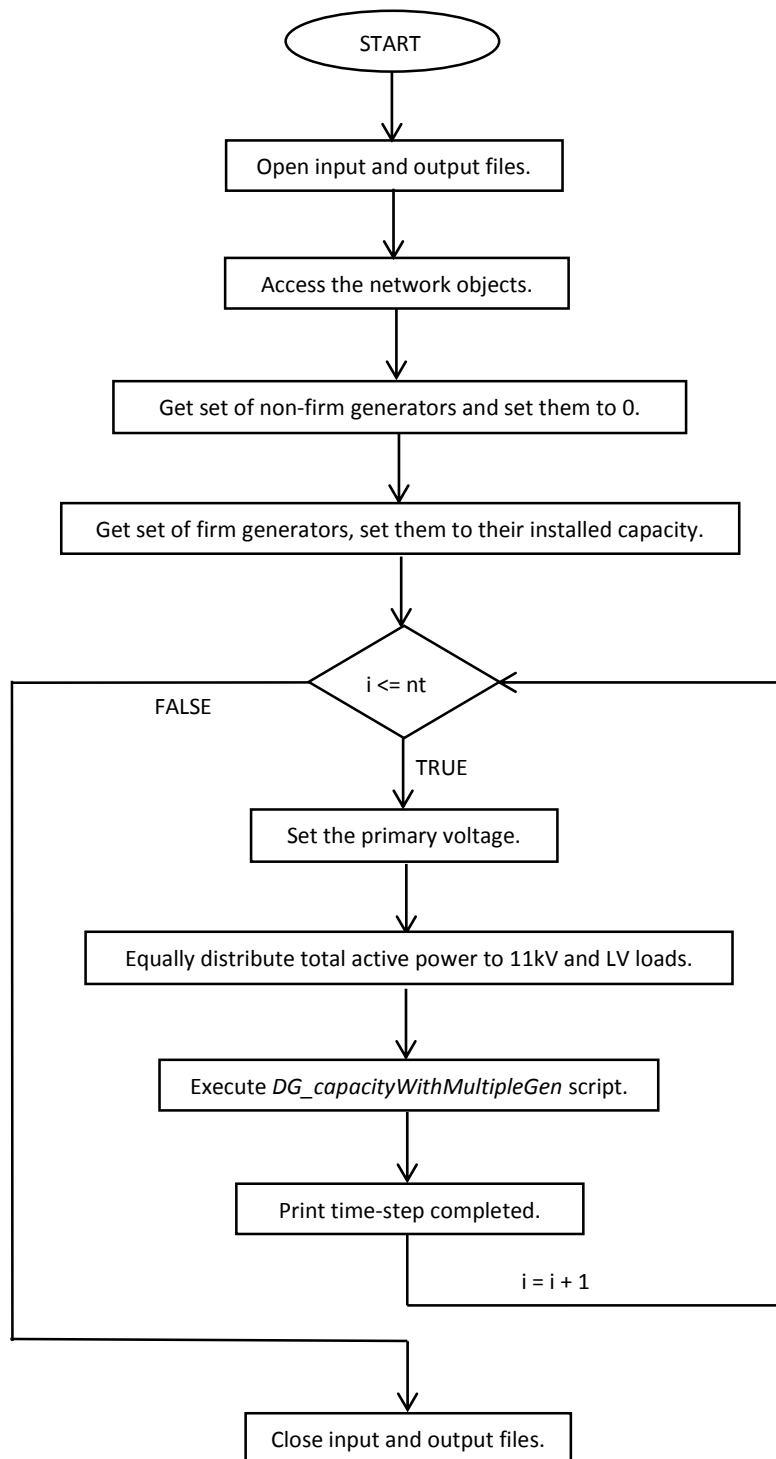

Figure 13: The flow chart of the script TimeStepWithMultipleGen

## A1.2. Script: DG\_capacityWithMultipleGen

The script calculates the maximum power injections for each non-firm DG for the current demand conditions and with three firm generators enabled and generating at full capacity increased by 50% to reflect current in 3 conductors instead of 2 conductors. It maintains thermal limits across the feeder and checks voltage limits of all 11kV and LV busbars. The script loops around each non-firm generator in order to find the maximum DG capacity that could be connected at each secondary substation.

The script uses a binary search algorithm to find the maximum DG that maintains the thermal limit of all lines in the model and the 11kV and LV voltage limits, 11.25kV and 253V, respectively. The load flow is calculated by executing the script *LoadFlow* explained in A1.3. and the thermal loading of all lines by executing the script *checkCableLoading* explained in A1.4. The starting point of DG capacity is 0MW. The DG capacity is increased by the initial step size is 0.001MW while all constraints are satisfied (thermal and voltage limits).

Input parameters are:

- object *ldf* – load flow related to the active study case
- set *sBusesSS* – set of Secondary Substations
- set *sBusesLV* – set of LV buses
- set *sGens* – set of all non-firm generators
- double *vPrimary* – voltage at the primary
- int *outputMaxGen* – index of output file for maximum generation
- int *outputV* – index of output file for buses with voltage violation
- int *reset* – indicates if each generation output should be reset to 0 after finding its maximum, 0 – yes, 1 – no
- double *gen\_limit* – generation limit

The search returns the final capacity of all non-firm generators, which is guaranteed not to breach any limit. The flowchart of the script is shown in Figure 14.

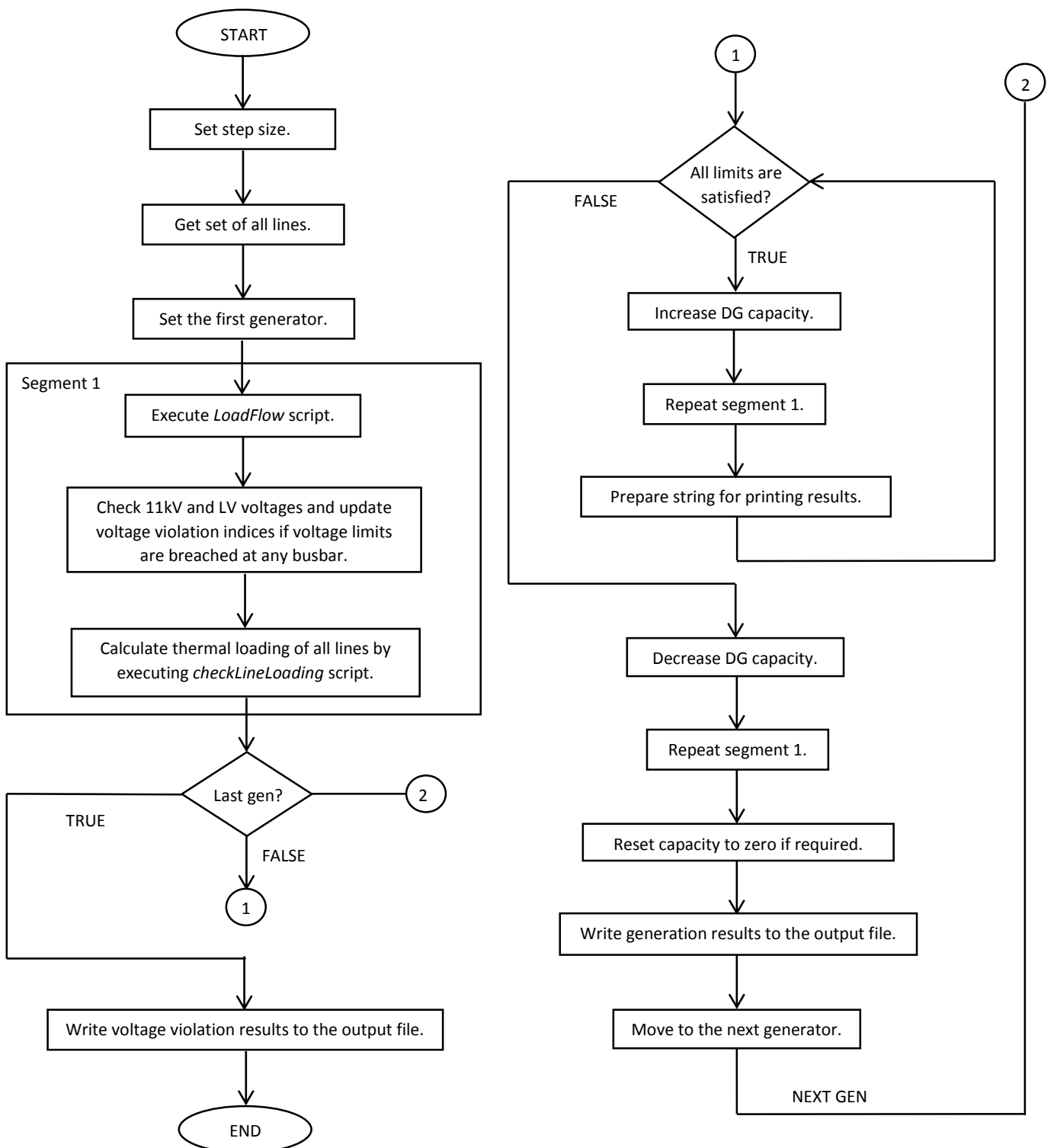

Figure 14: The flow chart of the script DG\_capacityWithMultipleGen

### A1.3. Script: LoadFlow

The script calculates the load flow of the active case study. Both balanced and unbalanced load flow can be executed.

Input parameters are:

- load flow related to the active study case and
- type of the load flow, 0 for balanced and 1 for unbalanced load flow.

The flowchart of the script is shown in Figure 15.

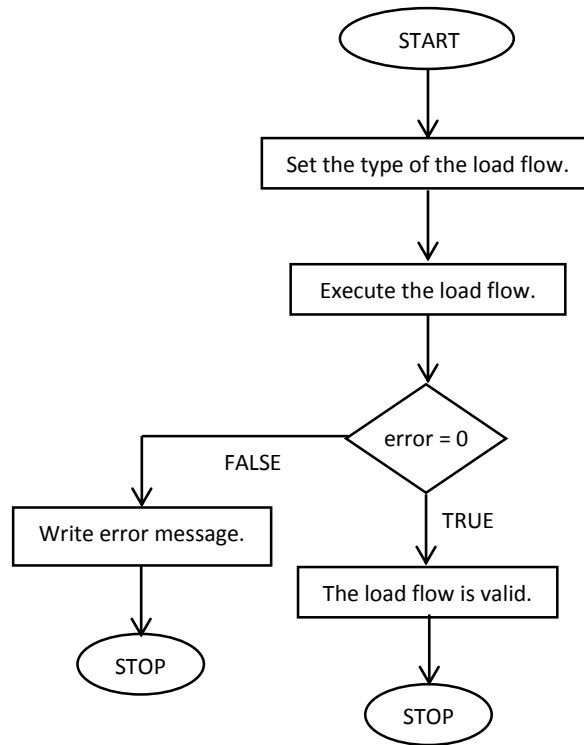

Figure 15: The flow chart of the script LoadFlow

#### A1.4. Script: checkLineLoading

The script calculates the loading of all lines in the model.

Input parameter is:

- set of all lines in the model,

and output parameter is:

- loading of all lines.

The flowchart of the script is shown in Figure 16.

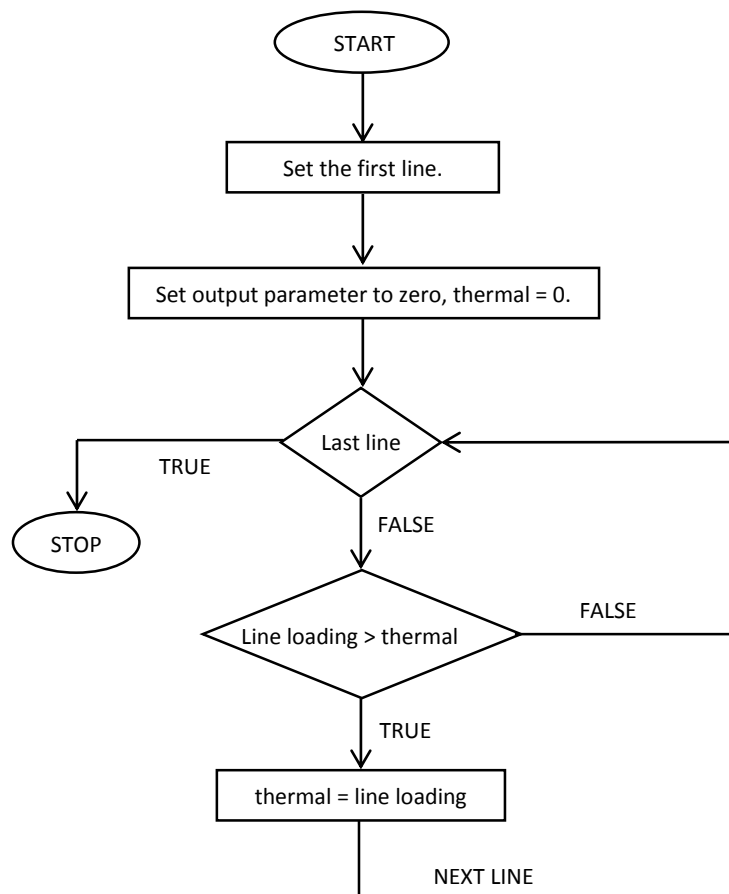

Figure 16: The flow chart of the script `checkLineLoading`