

15th Machining Innovations Conference for Aerospace Industry

# Advances in tool grinding and development of end mills for machining of fibre reinforced plastics

Eckart Uhlmann<sup>a</sup>, Nikolas Schröer<sup>a\*</sup>

<sup>a</sup>*Institute for Machine Tools and Factory Management, Technische Universität Berlin, Berlin, Germany*

\* Corresponding author. Tel.: +49 (0)30 314 21791; Fax: +49 (0)30 314 25895, E-mail address: [schroerer@jwf.tu-berlin.de](mailto:schroerer@jwf.tu-berlin.de)

## Abstract

The extensive use of lightweight construction materials in the aerospace industry poses a great challenge for tool manufacturers. Materials like carbon fibre reinforced plastics (CFRP) are difficult to machine and therefore put high demands on cutting tools in terms of the cutting material as well as the macro- and microscopic design. In this paper two approaches for the improvement of CFRP milling processes are presented. One approach involves the optimization of the flute grinding process for cemented carbide milling tools by the use of innovative grinding wheel specifications and their influence on cutting-relevant tool features. The other approach deals with the development of ceramic end mills for CFRP machining. Investigations about the influence of different process- and tool-related parameters on the work result and process parameters are presented.

© 2015 The Authors. Published by Elsevier B.V. This is an open access article under the CC BY-NC-ND license (<http://creativecommons.org/licenses/by-nc-nd/4.0/>).

Peer-review under responsibility of the International Scientific Committee of the “New Production Technologies in Aerospace Industry” conference

*Keywords:* tool grinding; ceramic; cemented carbide; CFRP; milling

## 1. Introduction

The ongoing awareness for sustainability issues in the industrial sector is resulting in optimization and advancements of existing technological systems in multiple fields to more resource preserving solutions. A usual approach, especially for dynamic systems, is to seek for a lower component weight. Besides constructive measures, further weight savings can usually be reached by the use of innovative materials, which have comparable or even better mechanical properties than conventional materials and at the same time have a lower density. A good example for the substitution of established materials could be observed in the aerospace industry for the last decades and is still ongoing [1]. Huge parts of modern airplanes consist of innovative lightweight materials like carbon reinforced plastics (CFRP) and aluminum alloys. Recently, the automotive industry has also put great efforts in the substitution of car body parts from steel to CFRP in order to compensate the battery induced weight gain of hybrid or fully electric power trains [2]. Thus, but also because of the

increasing use of CFRPs in the wind energy, sports and molding compound sector, a rising demand for fibre reinforced plastics (FRP) is expected in the next years [3].

Since the part quality is insufficient in most cases after the primary shaping manufacturing processes of FRPs, the machining of inner and outer contours is often necessary in order to meet the high dimensional and surface qualities especially for the aerospace industry [4,5]. The superior properties of CFRPs put high demands on machining processes like milling and drilling as their two phase composite structure consisting of fibre and matrix material with diverse attributes goes along with an inhomogeneous and anisotropic configuration. High-tensile, brittle carbon fibres, which are embedded in a temperature sensitive synthetic matrix with high failure strain result in predominant abrasive wear during the machining process [6,7].

The superior properties of CFRPs on the other side pose a great challenge for tool manufacturers. As the characteristics of CFRP materials can vary widely due to different compositions of e.g. fibre types, diameters, lengths and

orientations as well as the synthetic matrix specification, they show also a diverse behavior during machining. Therefore it is often necessary to develop application related cutting tools in order to meet the different requirements that come along with variable workpiece properties. Hence, during machining of CFRPs versatile machining errors like delamination, fraying, fibre fracture, burr formation and burn can be observed. Currently polycrystalline diamond (PCD) and diamond coated cemented carbide tools are widely used [8,9].

There are some specific requirements regarding the tool design and the cutting material that should be met by all used tools. In terms of the tool design, it was investigated, that sharp cutting edges with a low cutting edge radius and chipping are necessary in order to realize a cutting of the fibres and prevent machining errors [10,11]. Another important tool feature with influence on the cutting process is the surface quality of the rake face. It was observed, that the surface quality can influence the adhesion tendency and the coating process significantly [12,13]. Regarding the cutting material a certain resistance against abrasive wear is essential to ensure an economical application of cutting tools. In recent research activities at the Institute for Machine Tools and Factory Management (IWF) different approaches were pursued in order to improve the machining behavior of CFRP cutting tools. In the following, two of them will be described in detail.

As the tool grinding process has a verifiable influence on the machining behavior of cutting tools [14] several investigations on the optimization of the flute grinding process of end mills were conducted. Therefore grinding tests with innovative grinding wheel specifications were carried out and the work result was evaluated in terms of cutting tool relevant parameters. Furthermore results from the development and use of ceramic end mills for CFRP machining are shown. Investigations about the influence of different process- and tool-related parameters on the milling work result and process parameters are presented.

## 2. Optimization of the flute grinding process

Tool grinding as the essential manufacturing process in the generation of the cutting edge geometry of end mills plays an important role because it influences the machining behavior of the milling tool notably. It involves all grinding operations for the generation of shapes and functional surfaces on a cutting tool. For one-piece end mills it can be applied that despite the great variety of tool geometries basically three grinding operations are necessary: flute, peripheral and face grinding. Within these operations the flute grinding process (Fig. 1) itself has a major function because in comparison it possesses a high material removal  $V_w$  that goes along with a high main time and also has the dominating influence on the cutting edge generation [14,15]. Due to economical reasons flute grinding processes are generally performed in creep feed grinding mode.

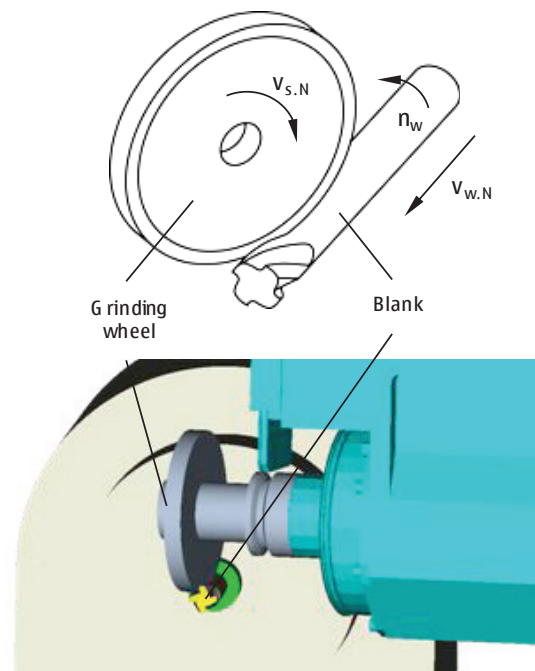

Fig. 1. Kinematics of a flute grinding process [14].

Cemented carbide is extensively used in the cutting tool industry and requires the application of superabrasive grinding wheels because of its brittle hard material properties. In many cases resin bonded grinding wheels are used, although the material removal rate  $Q'_w$  is limited, good surface and cutting edge qualities can be achieved [14,16]. In the last years new hybrid bond specifications were developed, which show a high potential for productivity and quality enhancements during flute grinding. Thus, grinding tests were performed with different grinding wheel specifications in terms of the bond and are analyzed regarding grinding forces, surface quality in the flute and cutting edge quality.

### 2.1. Experimental setup

The grinding tests were carried out on a 5-axis tool grinding machine WU 305micro by Alfred H. Schütte GmbH, Cologne. Equipped with 3 translational and 2 rotational linear drives, the grinding forces were evaluated by the analysis of the electric current from the machine control. The surface quality of the flute was analyzed with the tactile stylus instrument nanoscan 855 from Hommel Etamic GmbH, Schwennigen.

For each grinding test three flutes were ground in a round cemented carbide blank in order to neglect grinding-in effects. To determine the work result easily the helix angle was set to  $\lambda = 0^\circ$  with a lead angle of  $\lambda_v = 2.5^\circ$ . After the third flute a material removal of  $V_w = 1700 \text{ mm}^3$  was reached and the work result and process relevant parameters were analyzed. Important properties of the used grinding wheels and cemented carbide blanks are shown in Table 1 and Table 2.

Table 1. Grinding wheel specifications.

Grinding wheel bond	Diameter $d_s$	Grit size $d_k$	Concentration	Young's Modulus E
Resin	75 mm	D64	C100	~23 GPa
Vitrified	75 mm	D64	C100	~65 GPa
Hybrid 1 (Metallic/Vitrified)	75 mm	D64	C100	~49 GPa
Hybrid 2 (Metallic/Resin)	75 mm	D64	C100	~28 GPa

Table 2. Tool blank specification.

Cemented carbide specification	Co Cont.	WC Grit size	Hardness	Fracture Toughness
EMT 100 (K10)	6 %	0.8 $\mu\text{m}$	1800 HV30	9.4 MNmm <sup>-3/2</sup>

## 2.2. Results

In Figure 2 the specific normal force  $F'_n$  and the cutting force ratio  $\mu$  for the tested grinding wheel specifications are plotted as a function of the feed rate  $v_f$  during flute grinding. Concerning the specific normal force  $F'_n$  a nearly linear increasing correlation with the feed rate  $v_f$  can be observed for all grinding wheel specifications. Only the resin bond grinding wheel shows a diverse behavior. With this grinding wheel, higher feed rates than  $v_f > 30$  mm/min were not realized due to overloading of the bond, which could be identified by burning marks on the grinding wheel. The fact that a lowering of the grinding force ratio  $\mu$  in combination with the nonlinear rise of the specific grinding force  $F'_n$  can be observed at a feed rate of  $v_f = 30$  mm/min, supports this assumption. With higher temperatures the grit retention force of the bond is lowered and whole grain breakouts are induced which leads to a less effective grinding process.

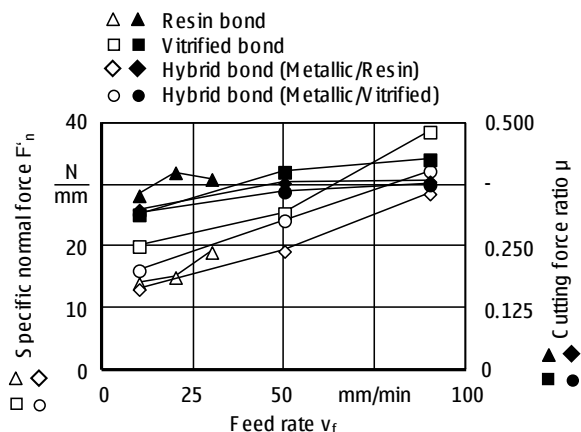

### Grinding wheel:

1A1 D 64 C 100

### Workpiece:

EMT 100 (K10)

### Cooling lubrication

Oil, MKU Rotex S pezial 1734

### Process parameter:

Cutting speed  $v_s = 15$  m/s

Depth of cut  $a_e = 3$  mm

Material removal  $V_w = 1700$  mm<sup>3</sup>

Up grinding

Fig. 2. Specific normal force  $F'_n$  and cutting force ratio  $\mu$  for different grinding wheels as function of the feed rate  $v_f$  during flute grinding.

In comparison to the resin bond grinding wheel the other grinding wheel specifications were capable of higher feed rates  $v_f$  and accordingly material removal rates  $Q'_w$  without an indication of a less effective grinding process through a lower cutting force ratio  $\mu$ . Comparing the specific normal forces  $F'_n$  for all process points to each other, it can be noticed that the vitrified bond grinding wheel induces the highest grinding forces and the hybrid bond grinding wheel with a metallic/vitrified bond the second highest. The other hybrid bond grinding wheel on metallic/resin basis generates the lowest specific grinding force  $F'_n$  for all analyzed process parameters. As all tested grinding wheels are identical except for the bond and also were dressed under the same conditions, the measured differences can be primarily led back to different mechanical and thermal properties of the bond. It can be assumed that the Young's modulus in particular can act as an indicator for the grinding forces under constant boundary conditions.

In terms of the work result the surface quality of the workpiece was analyzed at two different positions for each ground flute. The positions are shown in Figure 3 and were chosen because on the one hand they are representing the rake face quality and on the other hand they show the surface quality in the ground of the flute. Figure 3 shows that the feed rate  $v_f$  has a diverging influence on the ten point height roughness  $R_z$ . While the different grinding wheel specifications show nearly the same result for each tested feed rate in the ground of the flute, the ten point height roughness  $R_z$  is also not varying much between the tested feed rates  $v_f$ . This behaviour can be explained by the high velocity ratios  $q$  that occur during creep feed grinding of cemented carbide. Due to the fact, that the speed ratio varies from  $q = 90,000 - 10,000$  for the tested feed rates from  $v_f = 10 - 90$  mm/min, it can be assumed that the maximal surface quality is already reached at speed ratio of  $q < 10,000$  and cannot be further increased by a lowering of the feed rate.

In contrast to these results the surface quality of the rake face shows a significant tendency for a higher ten point height roughness  $R_z$  with increasing feed rates  $v_f$  for all tested grinding wheels and are in general one decimal lower. The material removal ratio varies along the active grinding wheel width  $b_{s,eff}$  according to Huebert [14] and therefore is lower at the edge of the grinding wheel. It can be assumed that also an increasing wear at the grinding wheel edge caused by higher loads with rising feed rates can be responsible for this behaviour. In combination with the different geometric-kinematic contact conditions at the rake face which are more similar to a face grinding process as to a peripheral grinding process, these differences can be explained.

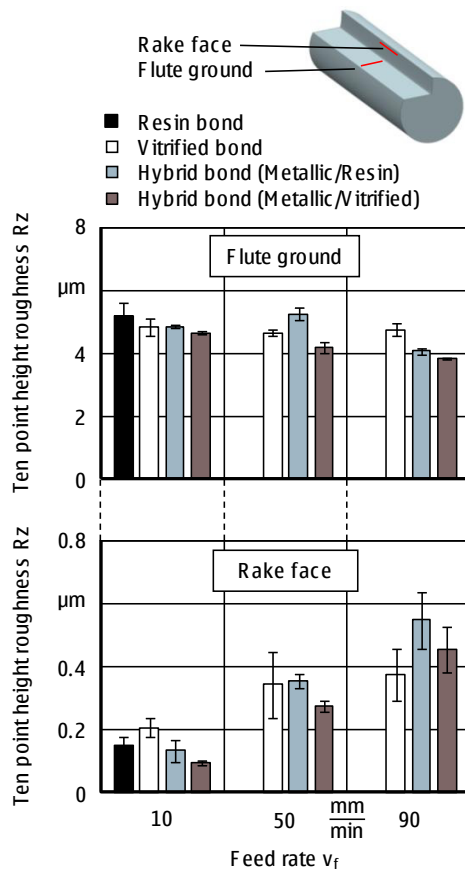
**Measuring conditions:**

3 measurements per workpiece and position  
DIN EN ISO 4287

Cut-off wavelength  $\lambda_c = 0.8 \text{ mm}$

**Grinding wheel:**

1A1 D 64 C 100

**Workpiece:**

EMT 100 (K 10)

**Cooling lubrication:**

Oil, MKU Rotex Spezial 1734

**Process parameter:**

Cutting speed  $v_s = 15 \text{ m/s}$

Depth of cut  $a_e = 3 \text{ mm}$

Material removal  $V_w = 1700 \text{ mm}^3$

Up grinding

Fig. 3. Ten point height roughness Rz for different grinding wheels and different workpiece positions as function of the feed rate  $v_f$  during flute grinding.

At the rake face also a significant difference between the used grinding wheel specifications can be observed. While the difference between all tested grinding wheels for feed rates between  $v_f = 10 \text{ mm/min}$  and  $50 \text{ mm/min}$  is low, the difference of the surface quality between the grinding wheel specifications for a feed rate of  $v_f = 90 \text{ mm/min}$  is remarkable. At this working point the vitrified bond grinding wheel generates the best surface quality, while the hybrid bond wheel on a metallic/resin basis generates the highest ten point height roughness Rz. An explanation for this can be indicated by the grinding forces. Increasing specific normal forces  $F_n^*$  can be a sign of a higher bonding friction, which can be resulting from the structure of the vitrified bond and its

specific grit retention force. Higher bonding friction can go along with a lower workpiece roughness. A potential difference in the wear mechanisms of the grinding wheels will be investigated in further research activities.

### 3. Development and use of ceramic end mills for CFRP machining

Cutting materials for CFRP machining have to meet high requirements in terms of abrasive wear resistance as the two phase composite structure of CFRPs consisting of fibre and matrix material with diverse attributes goes mainly along with this wear mechanism. Hence, PCD and diamond coated cemented carbide tools are widely used, as they have shown appropriate performance in CFRP milling and drilling operations [4]. While PCD cutting tools are very costly and also restricted in terms of feasible cutting tool geometries, diamond coated tools have the disadvantage that they cannot be resharpened, which can result in a low economic efficiency. As innovative ceramic cutting materials can possess a high hardness and adequate fracture toughness at the same time, they have the potential to be used as cutting material for CFRP machining as well. In order to improve the productivity and quality of CFRP milling processes, the potential of an innovative ceramic material, silicium infiltrated silicium carbide, which was developed primarily for this purpose, was analyzed in a research project at the IWF. A holistic approach of the project was realized, from the analysis and development of the cutting material, to the cutting geometry development, the analysis of the manufacturing processes and the cutting performance during milling. Due to the fact that ceramics generally have brittle hard material properties and therefore also show similar chip formation mechanisms as cemented carbides, many findings concerning the influence of the grinding parameters on e.g. the cutting edge formation at cemented carbide tools were transferred and applied during grinding of the ceramic end mills.

As part of the described technological investigations the influence of different tool geometry features on the milling forces were analyzed and presented in the following. Based on these investigations the machining behavior of ceramic and cemented carbide end mills are then compared.

#### 3.1. Tool geometry development

The milling tests were performed on a 3-axis milling machine tool 10V HSC by Mikromat GmbH, Dresden. The milling forces were recorded with a 3 component force measurement system type 9257A from Kistler Instrumente AG, Winterthur, Switzerland.

Based on a tool geometry which was evaluated in preliminary investigations, different geometry features of the end mill were varied. The tool diameter was constant  $d = 8 \text{ mm}$  for all tested geometries while the other relevant tool geometry parameters helix angle  $\lambda$ , number of teeth  $z$ , depth of flute  $t_n$  as well as the rake  $\gamma$  and clearance angle  $\alpha$  were varied. Table 3 gives an overview of the varied geometry features.

Table 3. Varied tool geometry parameters.

Tool No.	No. of teeth $z$	Depth of flute $t_n$	Helix angle $\lambda$	Rake angle $\gamma$	Clearance angle $\alpha$
1	6	0.8 mm	20°	5°	10°
2	8	0.8 mm	20°	5°	10°
3	6	1 mm	20°	5°	10°
4	6	1.2 mm	20°	5°	10°
5	6	1.4 mm	20°	5°	10°
6	6	1 mm	10°	5°	10°
7	6	1 mm	30°	5°	10°
8	6	1 mm	20°	5°	5°
9	6	1 mm	20°	5°	15°
10	6	1 mm	20°	10°	5°
11	6	1 mm	20°	10°	10°
12	6	1 mm	20°	10°	15°
Opt.	6	1.4 mm	20°	5°	15°

In Figure 4 the feed force  $F_f$  during peripheral milling is shown for the thirteen tested tool geometries. For each geometry two identical end mills were brought into the milling process and the milling forces after a tool life travel path of  $L_c = 3.5$  m were evaluated. Regarding the feed force a clear correlation between the number of teeth  $z$  as well as the clearance angle  $\alpha$  can be seen. It can be seen that the optimized tool geometry shows the lowest feed force in comparison. In addition to the analysis of the milling forces, the work result and the wear behavior were also taken into account to develop an optimized tool geometry.

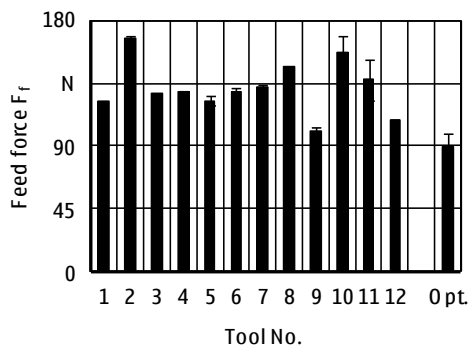

**Tool:** Ceramic end mill  
**d = 8 mm**

**Process:** Peripheral milling

**Workpiece:** CFRP HT-C-Fiber  
 60 % Fiber volume content

**Process parameter:**  
 $v_s = 370$  m/min  
 $a_e = 2$  mm  
 $a_p = 5$  mm  
 $f_z = 0.0125$  mm

$L_c = 3.5$  m

**Cooling Lubrication:**  
 Up milling Dry

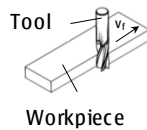
Fig. 4. Feed Force  $F_f$  for different tool geometries during peripheral milling of CFRP.

### 3.2. Comparative analysis of the machining behavior of ceramic end mills

For the evaluation of the wear behavior of cutting tools usually the maximal width of flank wear land  $VB_{max}$  is used. For CFRP materials which tend to delamination and fraying, the workpiece edge quality can also be assessed as wear criterion. In order to classify the developed ceramic end mills in comparison with other types of tools, comparative technological investigations were carried out. Besides the ceramic end mill, a cemented carbide tool with the same geometry was used and the workpiece quality was evaluated after the same tool life travel path. The results of these technological investigations are presented in Figure 5. It can be seen that both tools cause solely fraying at the workpiece and that the ceramic tool generates better workpiece qualities after the same tool life travel path. These effects can be led back to the cutting edge condition during milling.

#### Workpiece quality with ceramic tool



#### Workpiece quality with cemented carbide tool



Fig. 5. Workpiece quality for end mills out of different cutting materials during peripheral milling of CFRP.

Hence, SEM photographs of both tools have been evaluated additionally. The results can be seen in Figure 6. While abrasive flank wear seems to appear at both tools, the surface structure for the cutting materials are significantly different. It can be assumed that the microgeometrical cutting edge parameters like chipping and radius are in correlation with the observed differences concerning the workpiece quality. Due to the brittleness of ceramic materials they have a higher potential for cutting edge chipping and breakouts, although no breakouts could be observed during these tests. A more detailed investigation of these influences on the workpiece quality will be performed in future research activities.

a) C ceramic tool

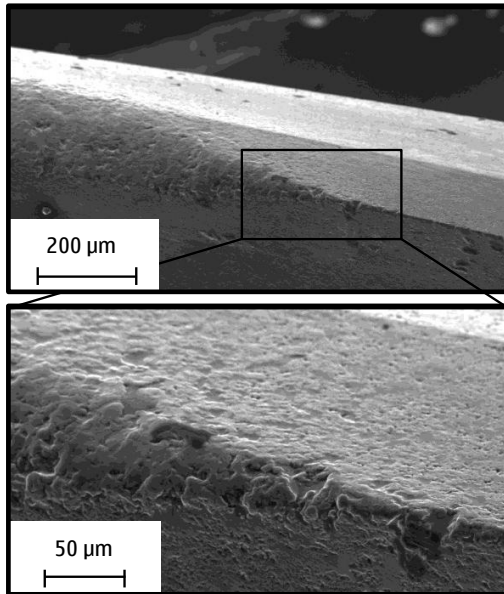

b) C emented carbide tool

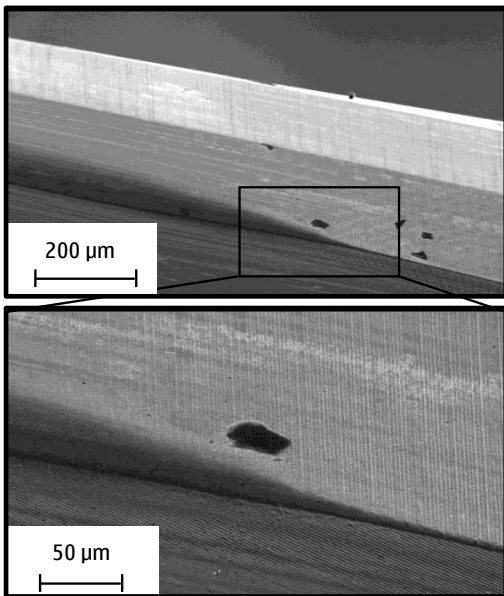

Fig. 6. SEM pictures of the cutting edges for a) ceramic tool and b) cemented carbide tool.

Additionally the milling forces were analyzed and shown in Figure 7. It can be seen that higher forces concerning the transverse, feed and passive force occur at the cemented carbide tool. As they have the same tool geometry, were ground under the same conditions and tested with the same process parameters during milling these differences can be related back to the diverging microstructure of the cutting edges, different friction conditions between the tool and the workpiece as well as differences in the thermal conductivity of the cutting materials.

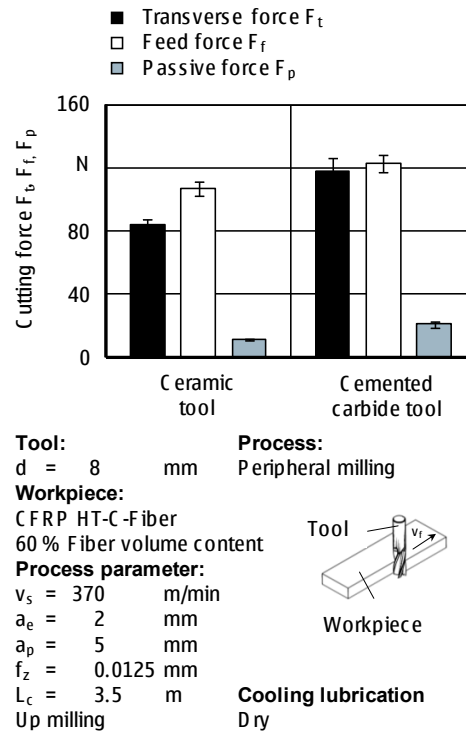

Fig. 7. Cutting forces for end mills out of different cutting materials during peripheral milling of CFRP.

#### 4. Summary and Outlook

Within the presented paper, technological investigations for the improvement of CFRP milling processes are shown. Therefore different approaches were conducted. One approach deals with the use of innovative grinding wheel specifications during flute grinding of end mills and their influence on milling relevant parameters. It was shown that different bonding systems result in varying grinding forces during flute grinding and thus can have an impact on the shape and dimensional accuracy of the ground tool. Furthermore it was demonstrated that a change of feed speed  $v_f$  during flute grinding has diverging impacts on the surface quality depending on the face that is examined. It was identified, that the influence of grinding process parameters on the surface quality of the rake face is significant. As the properties of the rake face are essential for the cutting mechanisms this should be taken into account by tool manufacturers. Upcoming research works will consider graded grinding tools for flute grinding processes in order to respect the complex non-constant contact conditions during grinding of helical flutes. Thereby further improvements of quality and productivity in tool grinding are targeted.

The other approach respectively research field which is pursued by the IWF is about the development of ceramic end mills and the analysis of their behavior during milling of CFRP. By the presented results it can be assumed that the developed milling tools have a high potential as an economic alternative for conventional CFRP milling tools like coated cemented carbide end mills.

## Acknowledgements

The authors would like to thank the German Research Foundation (DFG) for the support. Parts of the presented research work were undertaken within the project DFG UH 100/162-1. Furthermore the authors would like to thank the German Federal Ministry for Economic Affairs and Energy (BMWi) which supported the other parts of the presented work within the Central Innovation Programme for SME's (ZIM).

## References

- [1] Breuer U. Herausforderungen an die CFK-Forschung aus Sicht der Verkehrsflugzeug-Entwicklung und Fertigung. 10. Nationales Symposium SAMPE Deutschland e.V.; 2005.
- [2] Kleinhans C. Entwicklung: Der Markt für Karosserieleichtbau wächst weltweit - mit China als Hauptmarkt Leichter wird's nicht. *Automobil Industrie* (58) 2013; 11/12:60-2.
- [3] Kraus T, Kühnel M. Der globale CFK-Markt 2014. AVK Industrie-vereinigung Verstärkte Kunststoffe, Composites Marktbericht 2014.
- [4] Neitzel M, Mitschang P, Breuer U. *Handbuch Verbundwerkstoffe*. 2. aktualisierte und erweiterte Auflage. Munich: Hanser; 2014
- [5] Campbell FC, et al. Post-Processing and Assembly. In: *ASM Handbook*, Vol. 21 Composites, Materials Park: ASM International; 2001.
- [6] Sakuma K, Seto M, Taniguchi M Yokoo Y. Tool Wear in Cutting Carbon-Fiber-Reinforced Plastics: The Effect of Physical Properties of Tool Materials. *Bull JSME* (245) 1985; 28:2781-2788.
- [7] Wang X, Kwon PY, Sturtevant C, Kim D, Lantrip J. Tool Wear of Coated Drills in Drilling CFRP. *J Manuf Processes* (1) 2012;15:127-135.
- [8] Lantrip J. New Tools Needed. *Cutt Tool Eng* (8) 2008;60:72-84.
- [9] Spur G, Wunsch UE. Turning of Fiber-Reinforced Plastics. *Manuf Rev* (2) 1988;1:124-129.
- [10] Hartmann D. Delamination an Bauteilkanten beim Umrissfräsen kohlenstofffaserverstärkter Kunststoffe. In: Hintze W, et al., editors. *Wissen schafft Innovation*. Hamburg; 2012
- [11] Rumenhöller S. Werkstofforientierte Prozeßauslegung für das Fräsen kohlenstofffaserverstärkter Kunststoffe. In: Eversheim W, et al., editors. *Berichte aus der Produktionstechnik*. Aachen: Shaker; 1996.
- [12] Fuller KNG, Tabor D. The effect of surface roughness on the adhesion of elastic solids. *Proc R Soc Lond* 1975;345:327-342.
- [13] Hühns T. Charakterisierung und Auslegung der Grenzschicht PVD-beschichteter Schneidkeramiken. In: Uhlmann E, editor. *Berichte aus dem Produktionstechnischen Zentrum Berlin*. Stuttgart: Fraunhofer IRB; 2010.
- [14] Hübner C. Schleifen von Hartmetall- und Vollkeramik-Schaftfräsern. In: Uhlmann E, editor. *Berichte aus dem Produktionstechnischen Zentrum Berlin*. Stuttgart: Fraunhofer IRB; 2012.
- [15] Uhlmann E, Hübner C. Tool Grinding of End Mill Cutting Tools Made from High Performance Ceramics and Cemented Carbides. *CIRP Annals* 2011;60:359-362.
- [16] von Brevern P. Untersuchungen zum Tiefschleifen von Hartmetall unter besonderer Berücksichtigung von Schleiföl als Kühlschmierstoff. In: *Fortschrittberichte VDI, Reihe 2*, Nr 401. Düsseldorf: VDI; 1996.