



**Vítor Rodrigues do Nascimento**

Licenciatura em Ciências da Engenharia Biomédica

**Evaluation of thermometers for ear  
temperature measurement at the wards  
in a university hospital.**

Dissertação para obtenção do Grau de Mestre em  
Engenharia Biomédica

Orientador: Heikki Teriö, Ph.D. R&D Manager, Karolinska  
Institutet

Co-orientador: Mário Secca, Ph.D, FCT-UNL

Júri:

Presidente: Prof. Doutora Maria Adelaide de Almeida Pedro de Jesus

Arguente(s): Prof. Doutor Hugo Gamboa

Vogal(ais): Prof. Doutor Mário Forjaz Secca



**Vítor Rodrigues do Nascimento**

Licenciatura em Ciências da Engenharia Biomédica

**Evaluation of thermometers for ear  
temperature measurement at the wards  
in a university hospital.**

Dissertação para obtenção do Grau de Mestre em  
Engenharia Biomédica

Orientador: Heikki Teriö, Ph.D. R&D Manager, Karolinska  
Institutet

Co-orientador: Mário Secca, Ph.D, FCT-UNL

Universidade Nova de Lisboa - Faculdade de Ciências e Tecnologia

Lisboa - 2012

# **Evaluation of thermometers for ear temperature measurement at the wards in a university hospital.**

**Copyright © 2012**

**Vítor Rodrigues do Nascimento, FCT/UNL, UNL.**

A Faculdade de Ciências e Tecnologia e a Universidade Nova de Lisboa têm o direito, perpétuo e sem limites geográficos, de arquivar e publicar esta dissertação através de exemplares impressos reproduzidos em papel ou de forma digital, ou por qualquer outro meio conhecido ou que venha a ser inventado, e de a divulgar através de repositórios científicos e de admitir a sua cópia e distribuição com objectivos educacionais ou de investigação, não comerciais, desde que seja dado crédito ao autor e editor.

Faculdade de Ciências e Tecnologia and Universidade Nova de Lisboa have the perpetual and unlimited geographic right to archive and publish this dissertation through printed or digital versions or any other known or still to be invented way, and to disclose it through scientific repositories and to admit its copy and distribution for educational or research purposes, non-commercial, as long as due credit is given to its author and editor.

## **Abstract**

Since mercury thermometers were banned due to environmental concerns, hospitals started to use electronic thermometers for measuring body temperature. Body temperature can be measured from different body parts, although the least invasive and quickest is preferred and therefore eardrum measurements are frequently taken. However, lately the staff feels that the taken measurements are not accurate. A new purchasing agreement for the purchase of these devices renders a good opportunity to study further the use of these devices at the wards of the university hospital, study their maintenance process, identify what performance is essential for the clinical usage, the parameters that are essential to measure and also identify ear thermometers in the market that can be used for comparative study.

Temperature measurements were taken with the help of an infrared ear thermometer, Covidien Genius2, in its calibration blackbody device at the R&D department of the Huddinge Hospital in order to verify accuracy claims. This data were compared against other studies and measurements of other infrared ear thermometers devices, the Braun ThermoScan Pro 4000 and also a digital contact thermometer, Welch Allyn Suretemp Plus, applied to different body sites. Informal meetings also took place in order to get more information about the devices and to know where they were used and repaired.

It was found that Genius2 measured temperature accurately when compared with a blackbody radiator. Regarding the Braun, it showed an accurate estimate of core temperature in comparison to invasive pulmonary artery catheter thermometry.

Electronic tympanic thermometers proved to be a good replacement for conventional methods of thermometry. However, preventive maintenance should occur more often, since the devices are very fragile. Tympanic thermometers are generally very accurate instruments. Most likely, problems are not related to the thermometers themselves, they are possibly the result of an inadequate understanding of the limitations of ear thermometry.

## **Resumo**

Desde que o uso de termómetros de mercúrio foi proibido, começaram a ser utilizados nos hospitais termómetros electrónicos para medição da temperatura corporal. A temperatura corporal pode ser medida em diversos locais no corpo, mas tendo em conta que é preferível uma medição mais rápida e menos invasiva, é costume que as medições sejam feitas no tímpano. Contudo, ultimamente o staff do hospital sente que as medições não são precisas. O novo acordo de compra para este tipo de aparelhos é uma boa oportunidade para estudar melhor o seu uso no hospital, o seu processo de manutenção, identificar a performance essencial para uso clínico, parâmetros essenciais para a medição e identificar que tipo de termómetros timpânicos no mercado podem ser usados para um estudo comparativo.

Usando um termómetro timpânico, Covidien Genius2, mediu-se, no Hospital de Huddinge, a temperatura no aparelho de calibração (corpo negro) para verificar a sua precisão e exactidão. Comparou-se com estudos e medições de outros termómetros, Braun ThermoScan Pro 4000 e Welch Allyn SureTemp Plus (termómetro contacto) aplicados e comparados com diferentes partes do corpo. Houve várias reuniões com o staff de forma a ter mais informação sobre os aparelhos, saber onde se encontram e como são reparados.

Verificou-se que o Genius2 mediu correctamente a temperatura, quando comparado com o corpo negro. O Braun tem uma estimativa precisa da temperatura corporal quando comparado com um cateter arterial pulmonar.

Os termómetros timpânicos provam ser uma boa alternativa aos métodos convencionais de termometria, contudo a manutenção preventiva deve ocorrer mais frequentemente. Muito provavelmente os problemas não estão relacionados com os aparelhos em si, mas devido à falta de compreensão das limitações da termometria timpânica.

## **Key Words**

Electronic ear thermometer, tympanic thermometer, thermometry, infrared, total cost of ownership, temperature.

## **Palavras-chave**

Termómetro auricular digital, termómetro timpânico, infra vermelho, custo total de posse, temperatura.

# Index

Abstract .....	III
Resumo.....	IV
Key Words .....	IV
Index.....	V
Figure index .....	IX
Table index.....	XI
1. Introduction - Analysis of the situation.....	1
2. State of the art .....	5
3. Methods used .....	11
3.1 Overview .....	11
3.2 Meetings.....	11
3.3 Experiments and data gathering .....	11
3.4 Market Analysis .....	12
4. Temperature .....	13
4.1 Normal Temperature .....	14
4.2 Fever.....	15
4.3 Hypothermia.....	15
5. Thermometry.....	17
5.1 Oral.....	17
5.2 Ear / Tympanic .....	18
5.3 Axillary .....	18
5.4 Rectal.....	18
5.5 Temporal .....	19
5.6 Core .....	19
5.7 Infrared sensing thermometers .....	19
5.7.1 Radiation .....	19

5.7.2	How they measure temperature.....	20
5.7.3	Thermopile .....	21
5.8	Hospital equipment .....	24
6.	Essential parameters .....	25
6.1	Essential Principles of Safety and performance of Medical devices.....	25
6.2	Accuracy and Clinical repeatability .....	26
6.3	Total cost of ownership, product life and maintenance.....	26
6.4	Breakdowns and down time .....	27
6.5	Performance according to specification .....	27
6.6	Cleaning and infection control issues.....	27
6.7	Storage and ambient operating environment.....	27
6.7.1	Effect of (ambient) conditions.....	28
6.7.2	Electromagnetic Interference .....	28
6.8	Lifetime costs .....	28
6.8.1	Disposable/sterile covers.....	28
6.8.2	Batteries.....	29
6.8.3	Re-Calibration .....	29
6.8.4	Maintenance costs .....	29
7	Clinical use.....	31
8	Manufacturing Standards .....	33
8.1	CE Marking.....	33
8.2	International safety and performance standards .....	34
9	Result of comparison.....	37
9.1	Calibration and Maintenance Process .....	37
9.1.1	Covidien Genius 2.....	37
9.1.2	Braun ThermoScan Pro 4000 .....	38
9.1.3	Welch Allyn SureTemp.....	38
10	Data and Results.....	41
10.1	Costs.....	41



10.2	Accuracy claims .....	43
10.2.1	Covidien Genius2 .....	43
10.2.2	Braun ThermoScan Pro 4000 .....	45
10.2.3	Welch Allyn Suretemp .....	48
10.2.4	Braun ThermoScan Pro4000 and Covidien Genius2.....	53
11	Discussion of results.....	61
11.1	Market Analysis .....	36
12	Conclusions .....	63
	Bibliography.....	65
A.	Printed Sources.....	65
B.	Manuals .....	67
C.	Electronic Sources .....	68
	Annex I – Market Research.....	69
	A Cute Baby MT510 Infrared Ear Thermometer .....	70
	A Cute Baby MT511 Infrared Ear Thermometer .....	71
	Actherm 8000R .....	72
	Alaris Med IVAC Core-Check.....	73
	Beurer FT-55 .....	74
	Bosotherm Medical .....	75
	Braun IRT 3020.....	75
	Braun ThermoScan 4000.....	76
	Comdek Industrial HD-7 .....	78
	Comdek Industrial HD-11 .....	79
	Comdek Industrial HD-21 .....	80
	Covidien Genius2.....	81
	DigiO2 ETH-101 .....	82
	Easytem BT-020.....	83
	Easytem BT-021.....	84
	Exergen Ototemp 3000SD .....	85

Exergen Ototemp Light touch .....	86
GF Health Products Deluxe Instant-Read Ear Thermometer Model 2215.....	87
HuBDIC NET100.....	88
HuBDIC NET100.....	89
Microlife IR 100.....	90
Microlife IR 120.....	91
Microlife IR 1DA1 .....	92
Omron Gentle Temp MC-510-E .....	93
Predictor Ear Thermometer.....	94
Riester ri-Thermo N Professional .....	95
Rossmax TD100.....	96
Rossmax TE100 .....	97
Spengler Temp'O.....	98
Topcom Ear&Forehead 301 .....	99
Veridian VTemp Pro .....	100
Devices Specifications .....	101
Annex II .....	105

## Figure index

Figure 2.1 Galileo's first thermometer .....	5
Figure 5.1 The electromagnetic Spectrum .....	20
Figure 5.2 General scheme of the evolution of the output and the target temperature .....	22
Figure 5.3 The linear region matches the conventional thermocouple to a specified tolerance..	23
Figure 5.4 General scheme of a thermopile .....	23
Figure 5.5 Distribution of the devices according to their type .....	25
Figure 8.1 Flowchart depicting the process of CE Marking .....	33
Figure 10.1 Scatter Plot for Covidien Genius2 measurement .....	43
Figure 10.2 Histogram for Covidien Genius2 measurement.....	44
Figure 10.3 Bland Altman plot: ThermoScan Pro 4000 vs. pulmonary artery catheter. ....	46
Figure 10.4 Bland Altman plot: ThermoScan Pro 4000 vs. tympanic membrane probe. ....	47
Figure 10.5 Welch Allyn Monitor mode Vs Paediatric axillary mode.....	49
Figure 10.6 Welch Allyn Difference between pulmonary artery and axillary temperature. ....	51
Figure 10.7 Welch Allyn Difference between pulmonary artery and oral temperature. ....	51
Figure 10.8 Covidien Genius2 difference between right ear and left ear and, right ear and rectal measurements.....	55
Figure 10.9 Braun ThermoScan difference between right ear and left ear and, right ear and rectal measurements.....	55
Figure 10.10 Covidien Genius2 difference between right ear and rectal and, right ear and core measurements.....	57
Figure 10.11 Braun ThermoScan difference between right ear and rectal and, right ear and core measurements.....	57



## Table index

Table 5.1 Normal body temperature ranges depending on site and age.....	17
Table 8.1 Key Parameters in European Standard EN 12470-5:2003 .....	34
Table 8.2 Key requirements in ASTM E1865-98 .....	35
Table 10.1 Cost estimatesof the devices used in Karolinska.....	42
Table 10.2 Genius2 Frequency and percentage of the acquired measurements.....	43
Table 10.3 Statistical data .....	44
Table 10.4 Descriptive statistics for measurement differences .....	54



## **1. Introduction - Analysis of the situation**

Measuring body temperature is one of the most common clinical procedures in hospitals. Temperature has been recognized as an aid in diagnosing and treating diseases (Konopad et al. 1994, Purssell et al. 2009) and core temperature, in particular provides essential information about health and illness (Smith 1998). Temperature is an SI base quantity related to our sense of hot and cold. It is measured with a thermometer, which contains a working substance with a measurable property, such as length or pressure, that changes in a regular way as the substance becomes hotter or colder (Halliday et al. 2010).

Due to Swedish regulations, the manufacture and sale of products containing mercury, such as thermometers has been prohibited since the early 1990s. Nowadays, digital thermometers are widely used in hospital wards or at home in order to measure body temperature. These thermometers are, generally, either contact thermometers, which have a sensor on the tip (with different types of sensor for each specific use), or infrared thermometers, which are almost contact free. The most common digital thermometers are ear/tympanic, oral, axillar, rectal and pulmonary artery catheter thermometers. Measuring the core temperature using an invasive method, like the pulmonary artery catheter, is referred to as the gold standard for measuring body temperature (Smith 1998, Giuliano et al. 1999, Bock & Hohfeld, 2005, Nimah et al. 2006, Edelu et al. 2011). As this seldom is applicable outside the intensive care unit and operation room, rectal measurement has been the standard method for centuries in clinical practice, however, temperature changes in the rectum are relatively slow and do not always reflect the core temperature. This is especially true for patients under general or regional anesthesia who may develop rapid changes in core temperature (Bock & Hohfeld, 2005). Still, another common method to determine body temperature, during daily clinical practice, is the evaluation of axillar temperature. During the measurement, the thermometer is positioned in the axilla and the arm should be held tight against the thorax for about four minutes or until the sound alarm is set off.

Infrared ear thermometers allow users to measure body temperature quickly and noninvasively by inserting a probe into the patient's ear canal. These thermometers do not contact any mucous membranes, reducing the incidence of cross-contamination, and can be used on unconscious and uncooperative patients. With the growing need of quick and less invasive measurement devices, hospitals and other healthcare facilities have a strong need to introduce this kind of devices in their wards, not only because of the patients, but also for the personnel in charge of their use. But what is an Infrared Thermometer? According to Omega Engineering, an Infrared Thermometer is a non-contact temperature measurement device able to detect the infrared energy emitted by all

materials, at temperatures above absolute zero, (0°Kelvin), converting the energy factor into a temperature reading.

On the technical side, there are many pitfalls in the everyday usage of the ear thermometers at the wards in a hospital, per example the devices fall on the floor, they become dirty, the batteries are not charged properly, there is no disposable protection caps when the thermometer is needed, calibration is not done, the staff feels that the device is difficult to use. Also, some of the technical staff feels that some of the devices are not working properly, and asked for a revision of the aforementioned devices. On the other hand, body temperature is one of the five vital signs measured by health professionals. It's predicted that 3–4 out of 10 febrile cases can be missed by using infrared tympanic thermometers instead of rectal thermometry. The reasons are the variability of the auditory canal, unwanted hair in the ear, the lack of reproducibility and the fact that ear temperature can be lower than rectal temperature (Smith R et al. 2008).

A slight elevation in body temperature might lead to the prescription of medicine, prolonged stay in a healthcare facility or other medical procedures, leading to rising costs. At home it might lead to incorrect auto-medication, also leading to increased costs and patient safety issues.

After a literature revision it is possible to note that up until now, there have been several studies regarding the accuracy, in a clinical setting, of previous generations of Infrared tympanic thermometers, some revealing misdiagnosis and questioning those early models (Banitalebi et al. 2002, Nordås et al. 2005, Dodd et al. 2006, Duberg et al. 2007, Lawson et al. 2007), while others say the devices proved to be accurate (Kocoglu & Goksu, 2002, Nimah et al. 2006, Villaescusa et al. 2008, Jefferies et al. 2011). However there are not many studies for the new generation, especially in a clinical practice environment. Some of the existing studies on these devices demonstrate that the accuracy of Infrared ear thermometers is not the same as the one stated by the manufacturers, being complicated to reach a consensus (Haugan et al. 2012). So, since infrared tympanic thermometers are, along with digital contact thermometers for rectal and axillary temperature measurements, the most common way to measure patient's temperature, it is necessary to measure their reliability, ownership costs and accuracy with other known and reliable body temperature monitoring sites.

The hospitals in the region of Stockholm (Stockholm County Council) are reduced to buy new infrared ear thermometers according to the agreement from the purchasing process in late 2011. This proved to be a good opportunity to start a new study on these devices. This agreement is for three years with the possible extension of one year. The supplied equipment is calculated according to hospital needs in a 3 year interval, but also based on historical data from purchasing database. There is no mandatory yearly quota that the hospital binds to buy from certain suppliers.



The equipment that is to be compared is electronic tympanic thermometers that are currently in the market, which have replaced conventional mercury thermometers and rectal or axillary thermometers in the hospital wards. This comparison covers infrared thermometers that measure patient temperature by collecting emitted thermal radiation from the ear canal and/or tympanic membrane and displaying the temperature in Celsius or Fahrenheit degrees on a liquid crystal display (LCD) or light-emitting diode (LED) display.

The purpose of this report is to identify the essential performance parameters for the clinical usage of Infrared Tympanic Thermometers.



## 2. State of the art

Nowadays temperature control and measurement are of the utmost importance, whether it is in industries (chemical, plastic, paper, automobile, pharmaceutical, and aviation), laboratories, home or the human body (TME Electronics). In the past such measurements were not accurate and they were difficult to make, and most of the times they were based on sensorial experiences, rather than on physical or chemical processes. Due to these reasons, there was a great need to create some kind of instrument that could consistently measure a correct temperature, no matter the user – the thermometer, which is the standard device to measure body temperature.

Regarding the human condition, body temperature, pulse, respiratory rate, blood pressure and pain are the five vital signs that show the organism's capability to control body temperature, blood flow and oxygenation of body tissues in the presence of environmental change, physical and psychological stress (Oliveira D. 2010).

The following section encompasses the evolution of the thermometer and thermometry and is based on some sources, but mostly Cabral, P. essay "*Breve História da Medição de Temperaturas*", Ostman H. "*The evolution of the thermometer*" and TME Electronics "*The history of thermometers*".

Historical records date the first attempt to establish a temperature scale around 170AD, by the hand of Greek doctor Claudius Galenus of Pergamum (129 – 201AD). He suggested that the hot and cold feelings should be measured on a scale with four divisions, above and under a neutral point. In that scale he assigned, to boiling water, the designation of "4 degrees of heat" and, to ice, was assigned the designation of "4 degrees of cold". The neutral scale was a mix of equal quantities of both substances, boiling and ice water.

In spite of thermometry dating to remote times, the invention of the first "thermometer" is credited to Galileo Galilei (1564 – 1642AD). The device consisted on a small glass vessel with colored water, where the tip of a thin glass tube was inserted, suspended, and with a hollow sphere on the opposite extremity. An increase of the air in the hollow sphere's temperature expands the air, making the liquid go down, and a decrease of the temperature would make the liquid rise. Even though this device is able to register a temperature change, the absence of a scale means

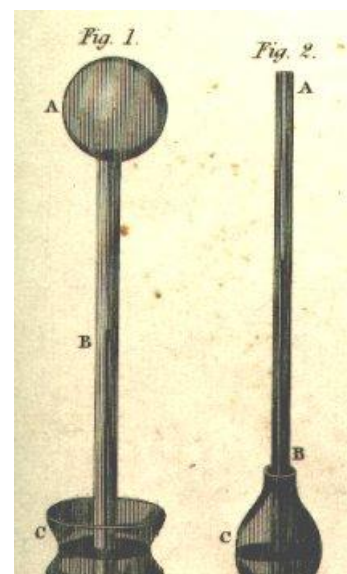

**Figure 2.1 Galileo's first thermometer**

that the device is, in fact, a thermoscope. A “true thermometer” must include a temperature sensor where physical change occurs with changes in temperature - and a means of converting that physical change into a readable value. For a long time, this meant a bulb (containing some form of liquid) and a scale, generally displayed on the tube through which the liquid expanded or contracted with changes in temperature.

The first “true thermometer” is credited to Robert Fudd (1574 – 1637AD), since it was the first diagram with both temperature sensor and scale, but the first person that developed the idea of the thermometer and actively used it was Santorio Santorio (1561 – 1636AD). He developed a clinical thermometer, using it to produce an estimated heat of a patient’s heart by measuring the heat of his expired air.

In 1644, Evangelista Torricelli (1608 – 1647AD) discovered the variability of air pressure so, unfortunately, all the early thermometers and thermoscopes suffered of the same design flaw. They were sensitive to air pressure as well as temperature, functioning, therefore also as a barometer, rather than a pure thermometer.

In 1654, Ferdinando II de’Medici (1610 – 1670AD) created the first thermometer, which gave a clear reading of temperature, unaffected by any other factor. He used a liquid instead of air as a thermometric mean, sealing a tube with alcohol, with an engraved arbitrary scale of 50 degrees, although there was no point marked as a zero. He also created the first blueprints for many thermometer manufacturers, but there was one big problem. Each manufacturer had its own scale and own system for temperature measurement. The scales were not standardized or calibrated to one another.

In 1664, the London Royal Society proposed the use of Robert Hook’s (1635 – 1703AD) thermometer scales as a standard. He used red dye on alcohol and although his scale was volume dependent (each degree was 1/500 of the total volume of the liquid in the thermometer), it had a fixed point. Water’s freezing point. Still, the London Royal Society had no real power to implement Hook’s scale, but slowly a scale evolved Christian Huygens in 1665 suggested the melting and boiling points of water as standard lower and upper limits, and in 1701 Isaac Newton (1643 – 1727AD) proposed a scale of twelve degrees, with the extremes being melting ice and body temperature.

In 1702, Danish astronomer Ole Rømer (1644 – 1710AD) also used two fixed points in his scale, the upper value was the armpit temperature of a healthy adult and the lower limit was a mixture of salt and ice. It was after Daniel Gabriel Fahrenheit (1686 – 1738AD), German physicist and engineer, visited Rømer in 1708, and started to use his scale in 1724, that it really caught on. Fahrenheit was also the first manufacturer to use mercury in thermometers instead of alcohol. Mercury is a better substance to use because its movement corresponds more exactly to

temperature change, and so a thermometer containing it can produce a more accurate reading than a thermometer using alcohol. So Fahrenheit's thermometers became the most popular designs, and eventually the standard ones. Fahrenheit's scale is still used nowadays in the U.S.A.

Still, the scale most widely used in thermometers of all kind is the Celsius scale. The Celsius scale was developed in 1742 by Anders Celsius (1701 – 1744 A.D.), a Swedish astronomer who devised a scale of 100 degrees, with zero as the boiling point of water and 100 as its freezing point. As he died just two years later, his assistant Carolus Linnaeus was instrumental in developing and publicizing the scale, and in encouraging its use among thermometer manufacturers. Linnaeus reversed the scale, making zero the freezing point of water and 100 its boiling point, and used it in his patented Linnaeus-thermometers, which were thermometers for use in greenhouses. In 1794 it was defined that a thermometric degree should be the hundredth part of the distance between the freezing and boiling temperature of water, giving birth to the centigrade scale, other denomination for the Celsius scale. The scale caught on and, since about 1950 has been the most widely used on all almost all kinds of industries and thermometers, with the exception of some scientific fields such as astrophysics, where the Kelvin scale is used.

The development of thermometers has moved quickly since the eighteenth century. In 1866, Sir Thomas Clifford Allbutt (1836 – 1925AD) devised a clinical thermometer which produced a body temperature reading in five minutes rather than twenty. Since then, thermometers have become essential and highly accurate devices used to analyze and control chemical reactions in fields as diverse as astrophysics, restaurant catering, and electronical manufacture.

Since the introduction of the International Temperature Scale in 1990 many different thermometer designs have been required to cover the whole range of temperatures. These range from 'absolute zero', where all energy (expressed as heat) has been removed from a substance or atmosphere, to very hot temperatures – thermometers have been developed that can even measure the temperature of the surface of the sun (5526 degrees Celsius).

Nowadays, many different types of thermometer exist, including the alcohol thermometer, the mercury thermometer, the medical thermometer, the reversing thermometer, the maximum minimum thermometer, the thermistor, the thermocouple, the coulomb blockade thermometer, the Beckmann differential thermometer, the bi-metal mechanical thermometer, the silicon band gap temperature sensor, and the liquid crystal thermometer. However, the most common in general manufacturing purposes is still the electronic thermometer, which uses tiny microchips to pick up and to measure information on temperature.

The thermocouple is now the most widely used thermometer, or 'temperature sensor.' It uses electrical technology to show temperature. Two metals are used, one contained within the thermocouple, and one forming a probe which acts as a sensor to test the temperature of a

substance or atmosphere. The word 'thermocouple' comes from the idea of the 'coupling' of two different metals.

The difference between their temperatures is expressed electrically through their difference in voltage. As the temperature of the metal inside the thermocouple is already known, the difference between the two temperatures can let us easily deduce the temperature of the metal attached to the probe. This deduction is usually carried out electronically by a tiny microchip inside the instrument, so that the scale or display on a thermocouple thermometer simply shows the temperature which the probe has sensed.

Thermocouples are used extensively in electrical engineering and industry. For instance, they are essential in fields such as heating appliance safety, radiation testing and in many areas of manufacture. The principle behind thermocouples was discovered by the German-Estonian physicist Thomas Johann Seebeck (1770 – 1831AD) in 1821, and is known as the thermoelectric effect or Seebeck effect.

In 1867, English physician, Sir Thomas Allbutt (1836 – 1925AD) invented the first practical medical thermometer used for taking the temperature of a person.

In 1884, Ludwig Boltzmann (1844 – 1906AD) derives Josef Stefan's (1835 – 1893AD) black body radiation law, being named father of infrared thermometry. In 1899, the first patent for a disappearing-filament optical pyrometer is granted to Everett F. Morse. In 1931 the first total radiation thermometer is made available. In 1977, the first miniature thermopile appears, decreasing its size to 4 mm<sup>2</sup>. In 1984, Theodore Hannes Benzinger (1905 – 1999AD), a German surgeon invented the first ear thermometer, with Englishman David Phillips inventing the first infrared ear thermometer, receiving the Inventor of the Year Award in 1986.

Regarding clinical thermometers, the development of infrared thermometers, brought us temporal artery scanners, and some devices are now ear, forehead and ambient thermometers. Nowadays, infrared ear thermometers are getting smaller, more accurate, they require less radiation to achieve a usable signal, have a faster response time between carrying the measurement and displaying the result and, of course, are now cheaper due to the mass production. There are several companies worldwide, such as Braun, Covidien, Omron, Exergen, Microlife, Comdek, among several others, investing in research and development of safe, accurate and reliable thermometers. In the future it might be possible to constantly monitor patient's temperature, with such a device. Infrared tympanic thermometers were of great importance during the SARS epidemic outbreak between November 2002 and July 2003, enabling rapid and accurate checking of body temperature at the Lo Wu Border between Hong Kong and continental China. The use of these devices was pivotal in preventing further spread of SARS carriers (Wing, 2004).

New clinical thermometers may be in the form of pills, like the CorTemp, with the temperature display in a near monitor and the receiver is a small and thin coil placed under the sheet or mattress, lasting up to eight days or more. It is possible to record a temperature measurement every 30 seconds with memory up to 4500 measurements. It is also possible to turn it off remotely. They are more practical, cheaper and safer than catheters and require no surgery.

Much has changed since 170AD, however, the basic principles for measuring temperature still remain the same. All thermometers require a temperature sensor and a means of translating a change in temperature into a numerical value. For example, in a mercury thermometer the temperature sensor is the mercury. The change in numerical value is registered on the scale on the thermometer.





### **3. Methods used**

#### **3.1 Overview**

During the working period a study plan was developed, several meetings were held with technicians and nursing staff to discuss general characteristics, learn about the maintenance procedures and problems associated with the devices. Experiments and data collection from the inventory systems were carried out in the Biomedical/R&D department and a market analysis was also conducted.

#### **3.2 Meetings**

The meetings were held with several technicians (Laszlo Fabian, Pernilla Holm, Pierre Foglöv, and some of the nursing staff). On one of the meetings there was a visit to the neonatal ward of the hospital. The meetings were informal, and consisted on information and advice exchange.

Laszlo provided some of the device manuals and his expertise on how to do the calibration and maintenance of the devices.

Pernilla talked about previous experience, the motive behind the previous research and the problems encountered when making the device measurements. She found that the devices had a temperature variation of  $0.8^{\circ}\text{C}$ , with standard deviation of  $0.4^{\circ}\text{C}$ . She also proposed some alternatives to the devices.

Pierre gave his input regarding Infrared thermometry and the standards used in Karolinska, Huddinge, also referring to some previous research on infrared thermometry (Falk et al. 2003).

The nursing staff gave their opinions on the devices, their most common problems and difficulties.

Everybody gave their input regarding the devices being used in the hospital, their pros and cons, and also a better perspective on how to attack the problem.

#### **3.3 Experiments and data gathering**

Experiments were done at the Biomedical/R&D department of the Huddinge Hospital. They consisted on temperature acquisition with the Genius2 thermometer with the aid of its calibration device.

The device was connected, and the instructions in the monitor were followed. For one measurement, a new probe cover was installed and a measurement was taken in the low temperature blackbody. The cover was then ejected and replaced by a new one and a new measurement was taken in the high temperature blackbody. The temperature difference was then displayed in the monitor and registered.

The calibration device also gave a log with the ambient temperature at the time of the calibration. For the other devices, the data was gathered on scientific papers, independent research, through Welch Allyn and the medical device inventory system (both the old and the new, which has replaced the system that had been developed in Karolinska for over 20 years). This data was later processed either with MS Excel or SPSS.

### **3.4 Market Analysis**

The market analysis was conducted by an on-line search, exchanging e-mails with the manufacturers, suppliers and reading the adequate literature (References B and C). A total of thirty one thermometers were analyzed. 4 thermometers provide an oral equivalent temperature while the other twenty seven provide the ear temperature. 12 provide either a “3-in-1” (ear, ambient and surface temperature) or a “2-in-1” (ear and forehead temperature) system, 10 are thermometers that provide ear temperature, the other 2 oral. There is also one thermometer that can display several offsets (oral, rectal, ear and core). The specifications of these devices can be found in Appendix I.

## 4. Temperature

It is of the utmost importance to accurately measure body temperature at the wards of a hospital. A slight temperature elevation may lead to drug prescriptions, longer time in the hospital or surgical procedures, leading to rising costs and risking patient safety. For these reasons it is important to safely and accurately monitor body temperature.

Body temperature can be comprised by the temperatures of the core and shell. The core temperature refers to the temperatures of the cranial, thoracic and abdominal cavities whereas the shell temperature refers to the temperatures of the skin, subcutaneous tissue and muscles.

The human body is considered homeothermic, which means that it is able to maintain constant temperature. The division of body temperature into core temperature and shell temperature is unique in that the core temperature is endothermic, regulated by the brain, whereas shell temperature is ectothermic, being influenced by external environment. During heat stress, skin blood flow is increased, resulting in an elevated shell temperature and an increase in heat dissipation to the environment. In contrast, cold stress reduces blood flow to the skin, leading to a decrease in shell temperature and conservation of heat in the body. The ectothermic properties of shell temperature and the endothermic properties of core temperature function in synchrony to maintain thermal balance within the body.

Heat transfer between the body and the external environment occurs through the processes of conduction, convection, radiation and evaporation. Heat transfer through convection, conduction and radiation is bi-directional, where heat transfer between the skin surface and the environment is driven by the temperature gradient between the skin and the surrounding environment. Heat is transferred from the environment to the skin if the ambient temperature is warmer than the shell temperature and vice-versa. Based on these mechanisms of heat exchange between the skin and the surrounding environment, it is recommended that strenuous physical activities should be conducted during the cooler hours of the day and under the shade whenever possible. Deviation from resting body temperature affects various physiological systems in the body, which is indicative of the span of biological functions and dysfunctions that interact with the thermoregulatory mechanisms (Lim C. 2008).

## 4.1 Normal Temperature

There are several factors which affect normal body temperature. In equilibrium, body temperature is generally stable at 37°C, with extremes at 36.1°C and 37.2°C. This equilibrium is maintained through the balance between loss and production or acquisition of heat (Oliveira D. 2010). Body temperature can be divided in core temperature, the “inner” temperature that varies around 0.5°C and surface temperature which is the superficial temperature of the skin which suffers greater variation during the day, mostly due to its exposure to the environment. Body temperature varies during the day and is approximately 0.5°C higher in the afternoon than during the morning. Temperature also varies with extremes of age and tends to be lower in the elderly. Temperature is also influenced by other factors such as gender (temperature rises in women around the time of ovulation) or exercise (Oliveira D, 2010).

Hence, it is best to define normal temperature as a range of values, rather than a specific value. It is necessary to be aware that when measuring temperature in patients, there are several other factors which are also important and will influence the normal range:

- Site of measurement (mouth, axilla, rectum, ear);
- Type of thermometer used (mercury, infrared, electronic, chemical change);
- Clinical reason for which temperature is being measured (detection of fever in a newborn, monitoring of rewarming after surgery, etc.).

The variation in normal temperature between body sites is probably one of the key factors in thermometry, and there have been several attempts to determine the difference in temperature between the different body sites (called physiological offsets). Some thermometers have the capacity to encode the physiologic offset figure into the thermometer’s displayed value, so the temperature at a “familiar” body site (e.g. oral or core) is predicted from measurements at other sites (e.g. forehead or ear). Other thermometers do not automatically add the physiologic offset and provide the actual temperature measured at that site. It is of the utmost importance to know from the operator’s manual for a particular thermometer which body site is displayed.

Since “normal” temperature is dependent on the body site and varies accordingly, the threshold for clinical action may need to be adjusted depending on the thermometer being used. Some manufacturers recommend that ideally individual temperature records should be recorded when in normal health, due to the fact that individual differences also contribute to the variation of normal temperature range. This is particularly crucial for patient groups in whom changes in temperature might be of clinical significance, such as young children and patients with

immunosuppression. In addition, in hospitalized patients frequent monitoring is important in order to detect shifts in temperature that might correlate with changes in clinical condition (e.g. monitoring response to antimicrobial therapy, monitoring rewarming after some types of surgery) (Crawford D. et al. 2005).

## **4.2 Fever**

Fever occurs when the body creates extra heat so that a foreign organism cannot survive therefore temperature monitoring and evaluation is part of the normal health care response to infection and many other disease processes. The exact temperature that is used to define fever varies between clinicians, and may also vary depending on the patient population (e.g. a lower definition of “fever” may be used in some immunosuppressed patients). In general, the upper limit of normal temperature varies from 37.0°C to 38.0°C, and most clinicians will use fever to be a temperature that exceeds some figure in this range (Crawford et al. 2005, Bridges & Thomas, 2009). Nevertheless review of the manufacturer’s data reveals that some manufacturers disclose information on the normal temperatures that can be expected for their device and some document an upper limit which is different from 37.0°C.

## **4.3 Hypothermia**

Hypothermia can occur accidentally (e.g. due to environmental reasons) or intentionally, such as during certain types of surgery. So it can be of vital importance to reliably measure body temperatures well below 36.0°C. Reviewing the operating range for these digital thermometers it is possible to observe that not all of the devices can match the range of a conventional mercury thermometer (Omega Engineering, *“Principles of Infrared thermocouple”*). Some infrared sensing devices will measure low temperatures but these values may be less accurate as they are well beyond the temperature range used for clinical validation (and as shown on Figure 5.2 General scheme of the evolution of the output and the target temperature).

Accurate and reliable measurement of body temperature well below the normal range is likely to be particularly relevant for emergency rescue teams, emergency admissions, staff working in post-operative intensive care and possibly community healthcare workers. It is also important for clinicians to know that different body sites respond at different speeds to rewarming the body, and for example the rectal site may lag behind the tympanic membrane measurements in some situations (Crawford et al. 2005).



## 5. Thermometry

The variation in normal temperature between body sites is probably one of the key factors in thermometry, and there have been several attempts to determine the difference in temperature between the different body sites, therefore temperature measurements can be taken in several parts of the body. Table 5.1 Normal body temperature ranges depending on site and age (Welch Allyn SureTemp Plus Manual, 2006) shows the range of temperature variation by site and age.

The temperature measurement can be more invasive such as rectal or with the help of catheters or they can be less invasive like axillary or ear. Each of these types may provide different results, which can also be affected by age, gender (Welch Allyn SureTemp Plus manual, 2006, Oliveira, 2010) or even the time of the day when the measurement is taken, so it's best to define normal temperature as a range of values, rather than a specific value. Measurements from different areas of the body should not be directly compared, even if taken at the same time. Some devices possess the capacity to encode a physiological offset figure into the displayed value, so the thermometer predicts the temperature at a familiar site such as oral.

**Table 5.1 Normal body temperature ranges depending on site and age (Welch Allyn SureTemp Plus Manual, 2006)**

***Normal Body Temperature Ranges***

°C	0 - 2 years	3 - 10 years	11 - 65 year	> 65 years
Oral	—	35.5 — 37.5	36.4 — 37.5	35.8 — 37.0
Rectal	36.6 — 38.0	36.6 — 38.0	37.0 — 38.1	36.1 — 37.3
Axillary	34.7 — 37.3	35.9 — 36.7	35.2 — 36.9	35.5 — 36.3
Ear	36.4 — 38.0	36.1 — 37.8	35.9 — 37.6	35.8 — 37.5
Core	36.4 — 37.8	36.4 — 37.8	36.8 — 37.9	35.9 — 37.1

### 5.1 Oral

Oral temperature may only be taken from a patient who is capable of holding the thermometer securely under the tongue, which generally excludes small children or people who are unconscious or overcome by coughing, weakness, or vomiting. Mouth breathing, heated gases and hot or cold fluids can distort the reading. Oral probes can damage oral mucosa, especially in patients with abnormal mucosa due to trauma, thermal injury, infection, surgery, cancer, or cytotoxic drugs. In critically ill patients, oral temperatures are often not practical due to intubation or inability of the patient to cooperate (Lawson et al. 2007).

## **5.2 Ear / Tympanic**

A digital ear thermometer measures the infrared energy emitted from the patient's eardrum in a calibrated length of time. The infrared energy falls on a thin pyroelectric crystal which develops a charge proportional to that collected energy (Hyperphysics). Discharging the crystal sends a current pulse through filters and conversion circuits which compare the signal to tabulated data on temperature and calculate a body temperature for the display (Lawson et al. 2007). This kind of temperature from the eardrum has been found to be a clinically reliable indicator of body core temperature.

Tympanic membrane temperature is believed to reflect the temperature of the hypothalamus (Grady, 2010, Matzukawa et al. 1996, Villaescusa et al. 2008, Gentle Temp 510 Digital Ear Thermometer manual, 2007) and thus the core body temperature. Direct measurement of the tympanic membrane temperature requires an electronic probe, and risks trauma to the tympanic membrane. Infrared ear thermometry is used to detect radiant energy from the tympanic membrane and ear canal through an otoscopic probe (Kocoglu & Goksu, 2002, Lawson et al. 2007). Infrared ear thermometers may not be accurate if inflammation of the auditory canal or tympanic membrane is present, or if there is obstruction of the external canal. Infrared devices do not always correlate well with other measurement devices, which may be due to poor maintenance or calibration.

## **5.3 Axillary**

Axillary temperature is a skin temperature for an area that is somewhat protected from the ambient air. The axillary temperature consistently varies from the core temperature. A digital thermometer may be used to take an axillary which can be taken in patients of all ages, most digital thermometers are easy and fast to use and measure body temperature in a short period, although mercury or liquid-based thermometers may also be used (Lawson et al. 2007).

## **5.4 Rectal**

Rectal temperatures obtained with a mercury thermometer or an electronic probe (intermittent or continuous) is a traditional measurement device. Readings from the rectum are often a few tenths of a degree higher than core temperature. Rectal temperature measurement is often perceived by patients as unpleasant and intrusive. Access to the rectum may be limited by patient position. Moreover, there is a small risk of trauma or perforation to the rectum that is a particular problem in patients who are neutropenic, coagulopathic, or who have had recent rectal surgery. Rectal temperature measurements have also been implicated in spreading enteric pathogens via the device or the operator (Naomi et al. 1998).



## 5.5 Temporal

The temporal scanning is a relatively new technology for temperature measurement, which uses the infrared principle to accurately report a patient's skin temperature directly over the superficial temporal artery (forehead), with accuracy comparable to rectal thermometry. A technique known as Arterial Heat Balance method is used to correct radiant heat loss, measuring the ambient temperature at the same time that it measures the absolute temperature of the skin surface over the artery (Lawson et al. 2007).

## 5.6 Core

Core temperature measurements are generally taken with the help of a pulmonary catheter (Lawson et al. 2007). It's the operating temperature of the human body, it is essentially the temperature of the blood in the circulation, or in deep structures of the body such as the liver (it is measured in the pulmonary artery because it is possible to monitor several other health parameters such as pressure in the right atrium and right ventricle, detect heart failure, sepsis and evaluate the effect of administered drugs). So that enzymatic reactions may occur, it's maintained in a narrow range.

## 5.7 Infrared sensing thermometers

### 5.7.1 Radiation

One of the methods by which an object and its environment can exchange energy as heat is via electromagnetic waves. No medium is required for heat transfer via radiation. The radiation can travel through vacuum from the Sun to any bystander on Earth.

The rate  $P$ , at which an object emits energy via electromagnetic radiation depends on the object's surface area  $A$  and the temperature  $T$  of that area in Kelvin degrees and is given by  $P = \epsilon \sigma AT^4$ . In order to absorb all radiated energy it intercepts, rather than sending a portion back away from itself through reflection or scattering, it should have an emissivity,  $\epsilon = 1$ , thus being an ideal blackbody radiator.

Because an object will radiate energy to the environment while it absorbs energy from the environment, the object's net rate of energy exchange due to thermal radiation is the difference between the absorption rate and the radiation rate. It is positive if net energy is being absorbed via radiation and negative if it is being lost via radiation (Halliday et al. 2010).

Infrared radiation lies between visible light and radio waves on the electromagnetic spectrum. Infrared light has wavelengths between about 1 millimeter and 750 nanometers, as shown in Fig. 5.1. The wavelength of red light is 700 nanometers. Infrared radiation oscillates at rates between 300 gigahertz and 400 terahertz. The infrared spectrum is sometimes subdivided into the far

infrared (1 mm to 10  $\mu\text{m}$  wavelengths), mid infrared (10 to 2.5  $\mu\text{m}$  wavelengths), and near infrared (2,500 to 750 nm wavelengths). A portion of the far IR, including wavelengths between 100 and 1,000  $\mu\text{m}$ , is sometimes referred to as the extreme infrared. Boundaries aren't always distinct, and difference between extreme infrared radiation and microwave radio frequencies is less than crystal clear.

Due to the fact that heat or thermal radiation are the primary sources of infrared radiation, any object which has a temperature radiates in the infrared. Even objects that we think of as being very cold, such as an ice cube, emit infrared. When an object is not quite hot enough to radiate visible light, it will emit most of its energy in the infrared. For example, hot charcoal may not give off light but it does emit infrared radiation which we feel as heat. The warmer the object, the more infrared radiation it emits. (NASA Infrared (IR) Radiation, NASA The electromagnetic spectrum)

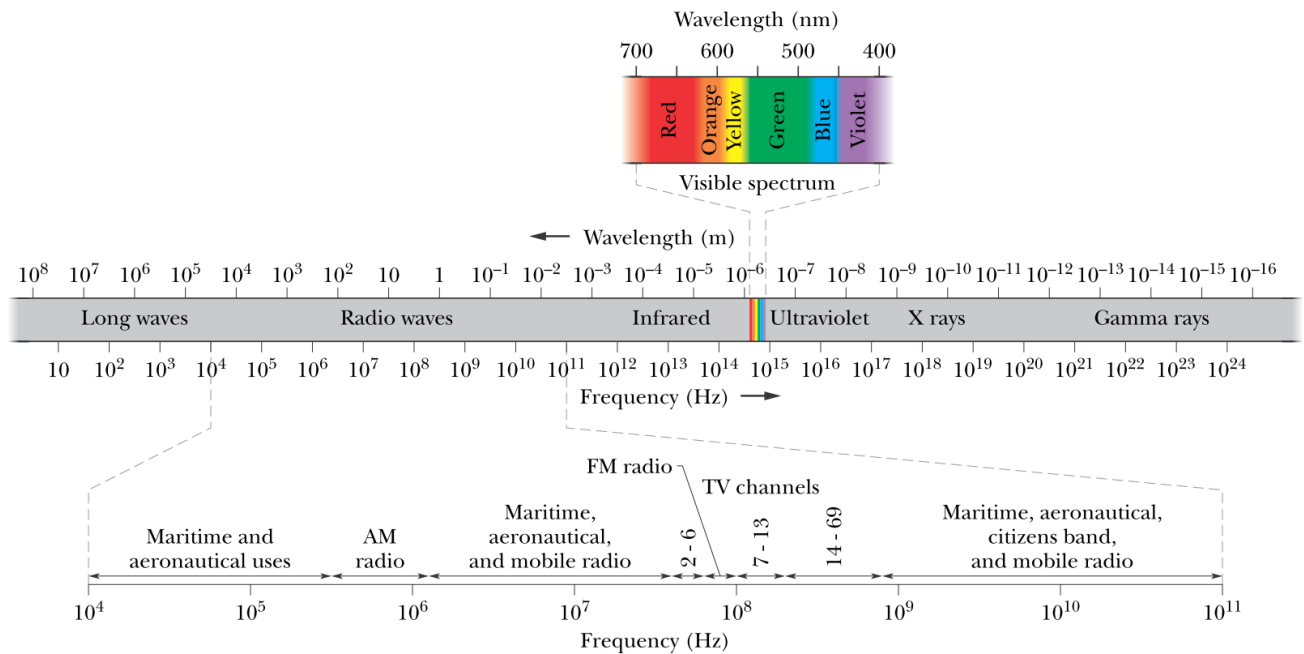

**Figure 5.1** The electromagnetic Spectrum (Halliday, D. Resnick, R. Walker, J. *Fundamentals of physics, 9<sup>th</sup> Edition*. John Wiley and Sons, 2010,)

### 5.7.2 How they measure temperature

An infrared thermometer is composed by an optical sensor, usually a thermopile, which is able to detect the infrared emissions from any hot object (Kocoglu & Goksu, 2002, The thermopile, Virginia Tech, Omega Engineering, “*Principles of Infrared thermocouples*”). The spectrum and magnitude of emitted infrared energy depends on (Falk et al. 2003, Tsai et al. 2006):

- Emissivity which describes the efficiency of their surface for radiating electromagnetic radiation and is a dimensionless number between 0 (smooth shiny surface) and 1 (dark rough surface).
- Internal temperature of the body.
- Filtering effect of optical components, including the probe cover.
- Temperature of the thermometer, which is also radiating infrared energy.

Infrared ear thermometers are designed to sense the temperature of the tympanic membrane within the ear. The measured temperature is an average across the visualized area. The sensor's field of view may encompass adjacent ear structures, approximately 2°C cooler than the tympanic membrane (Crawford et al. 2005). An instrumentation offset is usually applied which incorporates information about the thermometer's temperature and the filtering effect of the optical components. The effect of averaging is also corrected by some of the devices (making assumptions about the relative size of the tympanic membrane in the field of view).

The temperature of the tympanic membrane is displayed by most models however an infrared ear thermometer may be designed to apply a physiological offset to predict the temperature reading for another body site, usually oral, based on data obtained by the manufacturer in clinical testing.

Surface temperature of regions of peripheral skin or other objects may also be measured using models with a wide display range (References B,C). These direct readings will have lower measurement accuracy but will incorporate an instrumentation offset to compensate for the thermometer's internal temperature.

### **5.7.3 Thermopile**

All Infrared thermocouples have a proprietary infrared detection system which receives the heat energy radiated from the objects that the sensor is aimed at, and passively converts the heat into an electrical potential. A millivolt signal is produced, which is scaled to the desired thermocouple characteristics. Since all Infrared thermocouples are self-powered devices, and rely only on the incoming infrared radiation to produce the signal through thermoelectric effects, the signal will follow the rules of radiation thermal physics, and be subject to the non-linearities inherent in the process, as shown on Figure 5.2 General scheme of the evolution of the output and the target temperature (Omega Engineering. *Principles of Infrared thermocouple*). However, over a range of temperatures, the Infrared thermocouples output is sufficiently linear to produce a signal which can be interchanged directly for a conventional thermocouples signal as shown on Figure 5.3 The linear region matches the conventional thermocouple to a specified tolerance (Omega Engineering. *Principles of Infrared thermocouple*). For example, specifying a 2% match to

thermocouple linearity results in a temperature range in which the Infrared thermocouples will produce a signal within 2% of the conventional thermocouples operating over that range. Specifying 5% will produce a somewhat wider range, etc.

Each Infrared thermocouples model is specifically designed for optimum performance in the region of best linear fit with conventional thermocouples, but can be used outside of those ranges by simply calibrating the readout device appropriately. The output signal is smooth and continuous over its entire rated temperature range, and maintains 1% repeatability over its entire range (Omega Engineering. Principles of Infrared thermocouple).

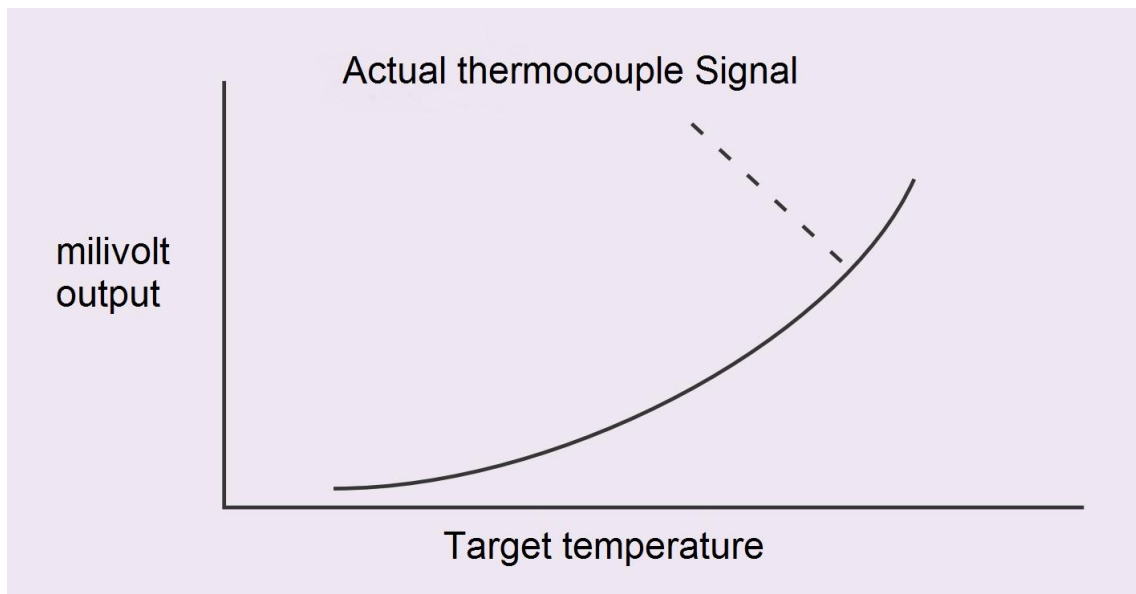

**Figure 5.2** General scheme of the evolution of the output and the target temperature (Omega Engineering. *Principles of Infrared thermocouple*)

The signal generated by the thermocouple can be approximated to a fourth order polynomial function of target temperature. This fourth power dependence is due to radiation physics, Stefan-Boltzmann Law, and not a limitation of the thermocouple.

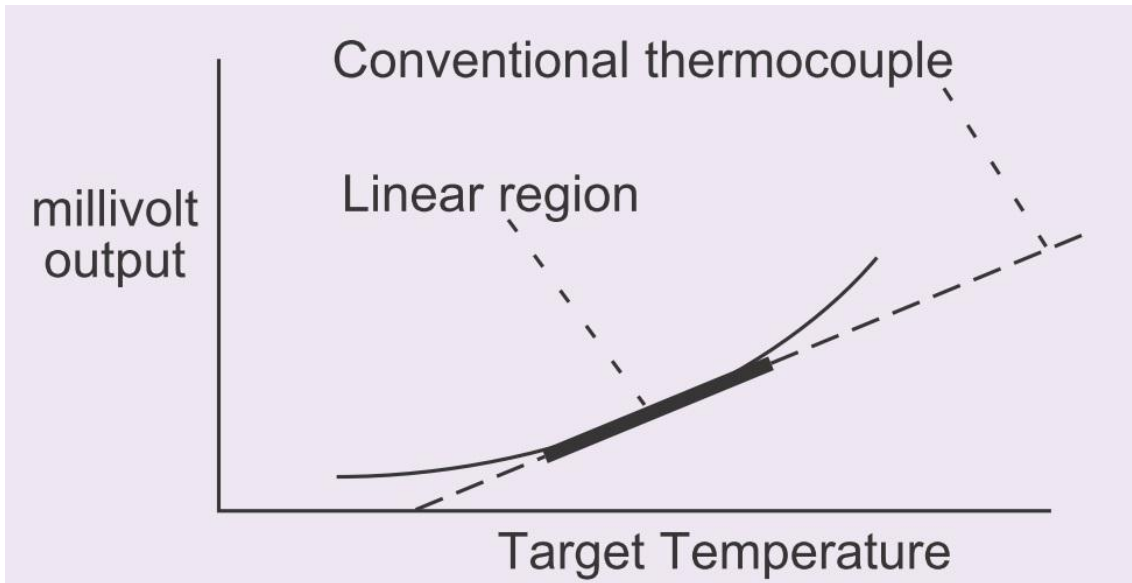

**Figure 5.3** The linear region matches the conventional thermocouple to a specified tolerance (Omega Engineering. *Principles of Infrared thermocouple*)

The atoms and molecules that compose materials are in constant motion, and the interactions among them (collisions and bonding forces) produce displacements in the elementary charges within them. The resulting accelerating charges and changing electrical dipole moments produce thermal radiation. A thermopile is made of thermocouple junction pairs connected electrically, generally in series, as shown in Figure 5.4 General scheme of a thermopile (Virginia Tech, The thermopile).

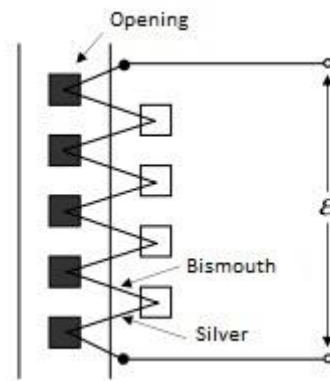

**Figure 5.4** General scheme of a thermopile (Virginia Tech, The thermopile)

This type of arrangement is useful for obtaining a substantial electromagnetic force for measurement of a small temperature difference between two junctions. In this way a relatively insensitive instrument may be used for voltage measurement, whereas a microvolt potentiometer might otherwise be required.

The typical thermocouple measures the difference in temperature between a certain unknown point and another point designated as the reference temperature.

The absorption of thermal radiation by one of the thermocouple junctions, called the active junction, increases its temperature. The differential temperature between the active junction and the reference junction kept at a fixed temperature produces an electromotive force directly proportional to the differential temperature created, this effect is called a thermoelectric effect, or in other words it's any phenomenon involving an interconversion of heat and electrical energy (Virginia Tech, The thermopile).

Thermocouple operation is based on the Seebeck effect; thus, the amount of electrical potential produced can be interpolated as a measure of temperature difference. Some pairs of thermocouple elements give a Seebeck voltage which varies in an anticipated way with temperature. Thermocouples in common use have nearly linear temperature-emf characteristics (Virginia Tech, The thermopile).

## 5.8 Hospital equipment

According to the inventory system, in the Karolinska wards there is a total of 1576 thermometers, they are categorized in the inventory system in four (actually ten, but they are redundant categories) different categories. Digital thermometers (72%), Spirit Thermometers (2%), Thermometer (2%) and Ear thermometers (24%), as shown on Figure 5.5 Distribution of the devices according to their type. There are over 50 different brands of thermometers. The biggest suppliers are Welch Allyn Sverige AB, Covidien Sverige AB, Ottosson AB and Göteborgs Termometerfabrik.

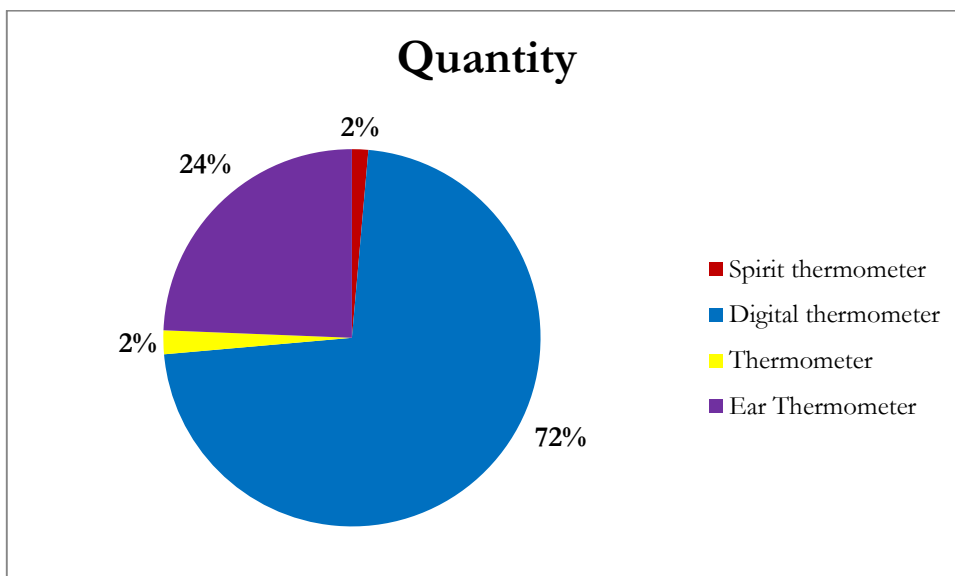

**Figure 5.5 Distribution of the devices according to their type**

## **6. Essential parameters**

The essential performance parameters for clinical usage are: Safety and absence of potential risks, Accuracy, Clinical repeatability, Product life, maintenance, number of break downs, down time and total cost of ownership, ease of use, serving the purpose, performance according to its specification, storage temperature, ambient operating temperature and tolerability by the patient (Kocoglu & Goksu, 2002).

### **6.1 Essential Principles of Safety and performance of Medical devices**

According to the Global Harmonization Task Force (Cheng, 2003, Global Harmonization Task Force Study Group I, 2005):

1. Medical devices should be designed and manufactured in such a way that, when used under the conditions and for the purposes intended and, where applicable, by virtue of the technical knowledge, experience, education or training of intended users, they will not compromise the clinical condition or the safety of patients, or the safety and health of users or, where applicable, other persons, provided that any risks which may be associated with their use constitute acceptable risks when weighed against the benefits to the patient and are compatible with a high level of protection of health and safety.
2. The solutions adopted by the manufacturer for the design and manufacture of the devices should conform to safety principles, taking account of the generally acknowledged state of the art. When risk reduction is required, the manufacturer should control the risk(s) so that the residual risk(s) associated with each hazard is judged acceptable. The manufacturer should apply the following principles in the priority order listed:
  - Identify known or foreseeable hazards and estimate the associated risks arising from the intended use and foreseeable misuse;
  - Eliminate risks as far as reasonably practicable through inherently safe design and manufacture,
  - Reduce as far as is reasonably practicable the remaining risks by taking adequate protection measures, including alarms;
  - Inform users of any residual risks;

3. Devices should achieve the performance intended by the manufacturer and be designed, manufactured and packaged in such a way that they are suitable for one or more of the functions within the scope of the definition of a medical device applicable in each jurisdiction.
4. The characteristics and performances referred to in Clauses 1, 2 and 3 should not be adversely affected to such a degree that the health or safety of the patient or the user and, where applicable, of other persons are compromised during the lifetime of the device, as indicated by the manufacturer, when the device is subjected to the stresses which can occur during normal conditions of use and has been properly maintained in accordance with the manufacturer's instructions.
5. The devices should be designed, manufactured and packed in such a way that their characteristics and performances during their intended use will not be adversely affected under transport and storage conditions (for example, fluctuations of temperature and humidity) taking account of the instructions and information provided by the manufacturer.

The benefits must be determined to outweigh any undesirable side effects for the performances intended.

## **6.2 Accuracy and Clinical repeatability**

All of the chosen devices follow the European Standards EN 12470:5, which states that the maximum permissible error is  $\pm 0.2^{\circ}\text{C}$  for temperatures in the range of  $35.5\text{--}42.0^{\circ}\text{C}$  and  $\pm 0.3^{\circ}\text{C}$  for any other ranges (Shimek & Emmanuel, 2011). The maximum permissible clinical repeatability is  $\pm 0.3^{\circ}\text{C}$  for every patient age group for which the infrared ear thermometer is intended for use (Shimek & Emmanuel, 2011). They also follow ASTM standards.

## **6.3 Total cost of ownership, product life and maintenance**

Every medical device or system should be evaluated based on the total cost of ownership over some period of use, for example: 5 years. This will identify the true cost of operating the device(s) and the effect on annual operating expense. If only the purchase cost is considered, expenses may exceed the expected return on the medical device (Crawford et al. 2003). Variables to consider may include: Initial purchase cost, disposable and single-use supplies required for use, personnel cost, annual service cost (preventive maintenance and repair), software upgrades, utility/space costs (power, A/C), initial and ongoing training costs for the clinical and support staff, interfaces (data and networking), finance charges: lease, rental, present value of the device(s) at the end of analysis period. In this particular case, there is no depreciation, because the equipment will not be sold, it will be used until there is no more support from the supplier, or until it's obsolete.



Assuming an 800 bed hospital with 100% occupation and a minimum of 4 daily measurements, there will be at least a total of 1168000 measurements per year.

#### **6.4 Breakdowns and down time**

This refers to a period of time that the equipment fails to provide or perform its primary function. The lower the downtimes and breakdowns the less expensive it gets, due to not adding repair costs, while its still working, therefore reduction of the breakdowns and their down time is essential, not only in a cost-effective, but also in a way that they fit their purpose (Crawford et al. 2005).

#### **6.5 Performance according to specification**

If the devices are complicated to use, the operating staff may have problems with it, leading to inaccurate measurements, therefore leading to bad equipment performance, making the purchase senseless. The devices should, for that same reason, meet the nursing staff desired characteristics.

#### **6.6 Cleaning and infection control issues**

Even though general recommendation on sterilization, disinfection and cleaning of medical equipment is provided by the local legislation (the Swedish legislation Center is SIQ - Institutet för Kvalitetsutveckling). It is also very important to follow the cleaning and decontamination instructions provided by the manufacturer, since that cleaning instructions vary considerably for thermometers.

Despite the use of sterile covers, some thermometers must be wiped with a soft dampened cloth (References B), although in certain clinical situations this may be considered an unacceptable risk for cross-contamination (Crawford et al. 2005).

Disposable probe covers avoid direct contact of the probe assembly with the patient and reduce the risk of becoming contaminated or damaging the lens; a new probe cover is used for each patient to prevent cross-contamination. Probe covers are attached by simply inserting the probe into the cover and are automatically detached by pressing an eject button or manually by pulling the probe off by hand. Covers can be rigid, pliable opaque plastic or soft, clear polyethylene.

#### **6.7 Storage and ambient operating environment**

If the storage and ambient operating temperatures are outside the range specified by the manufacturers, the thermometer accuracy can be compromised. Generally the storage temperature is a big interval, ranging from -10°C to 40°C with <95% Relative humidity, while the operating temperature has a shorter interval, generally from 10°C to 40°C also with <95% Relative humidity.

The devices should be stored away of direct sunlight, electrical or mechanical shock and away from any dripping liquids, the probe window should be well protected (References B and C).

### **6.7.1 Effect of (ambient) conditions**

Technical literature documents the recommended temperature and humidity conditions for warehouse storage and transportation (References B and C).

While the thermometers are not being used in the clinical setting, it should be stored in the temperature range listed as the “ambient operating temperature” (the appropriate for stated accuracy) as most require between thirty minutes to an hour to acclimatize to the ambient temperature. To prevent measurement errors, most electronic thermometers sample the ambient temperature during the startup checks and use this information to predict the temperature reading of tissue at the measurement site.

Some manufacturers also advise that their models should not be stored under direct sunlight and should also be protected from vibrating shock (References B and C).

### **6.7.2 Electromagnetic Interference**

Another issue for consideration is the risk of false reading when the thermometer is exposed to electromagnetic interference. Electromagnetic interference causes electromagnetic induction in the circuits, interrupting, obstructing, or otherwise degrading or limiting the effective performance of the circuit. Possible strong sources include the surgical diathermy (electro surgery) generator in operating theatre, defibrillators and mobile communication systems such as emergency services two-way radios.

The devices which comply with the international Standard for electromagnetic compatibility, EN60601-1-2, are likely to be immune to most sources of interference but may still be affected by surgical diathermy equipment (Crawford et al. 2005).

## **6.8 Lifetime costs**

The lifetime cost could be more than the double of the acquisition cost for some devices. For instance, some companies may offer the base unit, free of charge because they expect to recover the purchase price through their charges for consumables, maintenance, etc.

### **6.8.1 Disposable/sterile covers**

The manufacturers recommend the use of their own specific disposable covers to help reduce the risk of cross infection for those devices that cannot be cleaned properly. Depending on the thermometer selected, the annual consumable budget cost for probe covers in an 800 bedded hospital can have a daily variance from 96.00€/859,65SEK (0.03€/0.27SEK each, excluding

taxes) to 864.00€/7691.85SEK (0.27€/2.40SEK each, excluding taxes), assuming 4 perfect readings per patient, per day.

### **6.8.2 Batteries**

All electronic thermometers are battery powered. Battery type, battery lifetime (generally in the form of number of measurements) and the existence of a low battery indicator is described in the technical documentation. Generally a good battery lifetime is preferred as it will decrease operational costs, downtimes, and technical staff working hours. All batteries need to be disposed of in accordance with local waste management policies.

### **6.8.3 Re-Calibration**

An infrared thermometer is calibrated to indicate the temperature of a blackbody, which, as stated previously, is an ideal radiator. The blackbody absorbs all incident radiation regardless of wavelength and direction. For a given wavelength and temperature, there is no surface that is able to emit more thermal radiation. Although the radiation emitted by the blackbody is a function of wavelength and temperature, it is independent of direction. An infrared thermometer senses, with its detector, the radiant flux from the target and generates an output signal. The signal is processed with the help of electronics and an algorithm to the thermometer display, which indicates the radiance temperature (Crawford et al. 2005).

Temperature measurement accuracy needs to be checked on a regular basis and especially if the thermometer has been dropped, or exposed to extremes of temperature or humidity. Some manufacturers recommend that professional users arrange for a periodic technical inspection for accuracy but frequently no instructions are provided in the information supplied, so most of the times the devices are only checked when the staff feels that the measurements are not reliable (References B, Crawford et al. 2005).

Some manufacturers sell specific electronic devices for checking or calibrating thermometer accuracy which are designed to be used by local medical technologists. Some manufacturers recommend calibration at their premises, while others offer no advice at all.

### **6.8.4 Maintenance costs**

For some models the purchase cost is so low that any repair work is not cost effective, whilst for other models the maintenance costs can be equal to the purchase cost over the life of the thermometer. Scientists and engineers at the clinical engineering department should be responsible for medical equipment management. The purchase negotiation should also state if the manufacturer (Crawford et al. 2005):

- Will provide all maintenance, re-calibration and repair work, and if it is to be performed at their facilities
- Will provide the service manuals and the specific training to local medical engineering support staff so maintenance, re-calibration and/or repair work can be performed within the local hospital
- Intends the thermometers to be discarded if a fault occurs, other than when covered by the warranty period.

## 7 Clinical use

The key issues covered in the technical documentation for correct temperature measurements with infrared ear thermometers are (References Section B, Critical Care Diagnostic and Nutritional Delivery Group, 2006, Grady, 2010):

- Confirming that the ear canal is unobstructed with excessive earwax or blood, should not contain vernix or any inflammation. It should be clean, dry and with normal appearance;
- Ensuring that the thermometer lens is clean and equipped with a new probe cover. Using only probes recommended by the manufacturer;
- Straightening the ear canal in order to have a clear view of the ear drum, and positioning the probe accordingly, so that the sensor is directed at the tympanic membrane instead of other surface that might be colder. Incorrect placing might give erroneous low temperature readings;
- Using excessive force is not encouraged, especially while inserting the probe, as it may injure the ear drum or canal;
- Guaranteeing that the patient is quiet and still;
- Allowing 30 minutes to pass before taking a reading on a patient that took a shower/bath or was swimming;
- Measuring a temperature in the ear that was lying on a pillow or mattress is not advised;
- Waiting at least two minutes before repeating a measurement in the same ear;
- Personnel should compare the measurements from the same ear;
- Using the maximum of three repeated measurements so that the probe doesn't warm up.



## 8 Manufacturing Standards

### 8.1 CE Marking

Manufacturers of medical devices placed on the market in Europe are required to meet the relevant requirements of European Union Medical Devices Directive and be labeled with CE Marking. A medical device may be classified as Class I (including Is & Im), Class IIa, IIb and III, with Class III covering the highest risk products. Classification of a medical device will depend upon a series of factors, including how long the device is intended to be in continuous use, whether or not the device is invasive or surgically invasive, whether the device is implantable or active, whether or not the device contains a substance (which in its own right is considered to be a medicinal substance and has action ancillary to that of the device) (European Commission, Classification of Medical Devices).

Differences in their mode of operation, and the consequent risk to the patient will alter the appropriate classification for the thermometer. For invasive devices in body orifice or stomas (not surgically) see Figure 8.1 Flowchart depicting the process of CE Marking for a medical device such as an infrared ear thermometer (European Commission, Classification of Medical Devices):

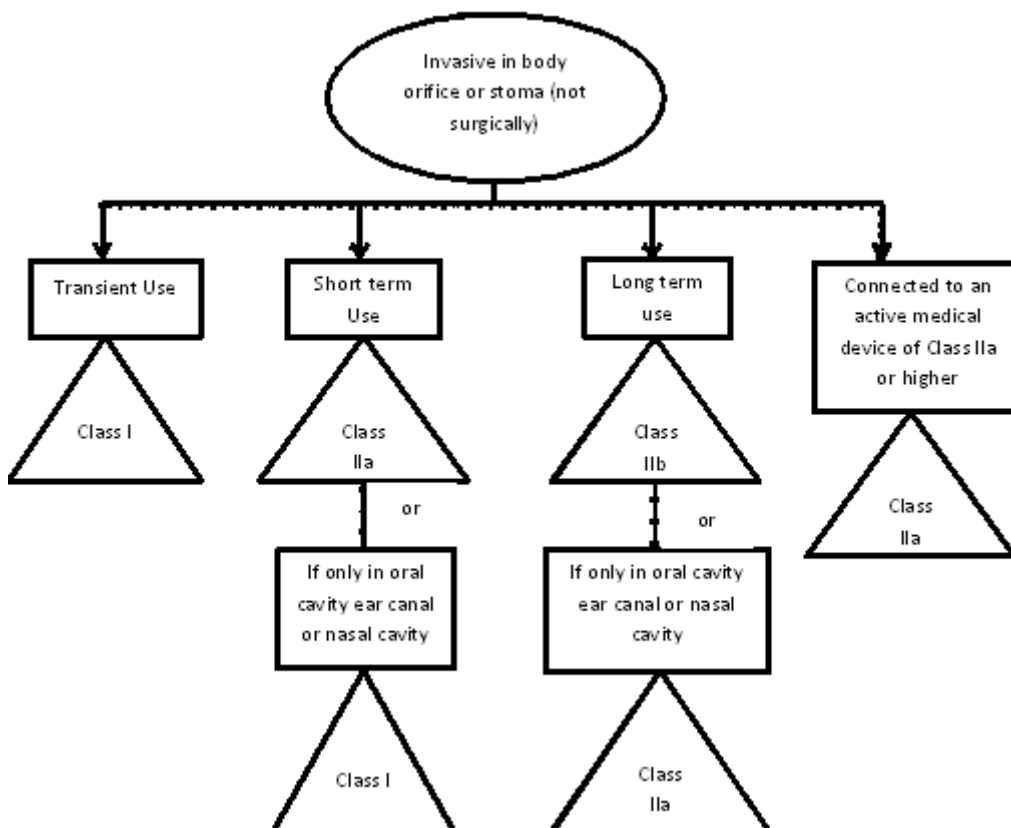

**Figure 8.1** Flowchart depicting the process of CE Marking for a medical device such as an infrared ear thermometer (European Commission, Classification of Medical Devices)

In order to get CE Marking on their devices, manufacturers generally rely on full quality assurance, which is audited and certified by a notified body. Most have used the general quality system standard such as ISO9001 and others comply with additional requirements important for medical device manufacturers as outlined in ISO13485 or ISO13488 (European Comission, Classification of Medical Devices).

## 8.2 International safety and performance standards

European standard EN12470 (see Table 8.1 Key Parameters in European Standard EN 12470-5:2003(Shimek & Emmanuel, 2011)for EN12470:5) comprises five parts each covering a specific thermometer type (Lóio & Lobo, 2011). Other thermometers were designed to comply with other standards, e.g. ASTM (see Table 8.2 Key requirements in ASTM E1865-98 (reapproved 2009) (Shimek & Emmanuel, 2011)for ASTM E1865-98), ISO. In the market analysis, most devices follow both EN and ASTM standards. However some just follow one of them. The Alaris Med and Riester ri-Thermo follow only ASTM, while the Predictor thermometer follows EN. Spengler and Comdek devices follow ISO standards. This may happen, due to the fact that some devices are only marketed in either Europe or U.S.A. so there is no need to comply with other standards.

The relevant standard for all electrical medical devices is EN60601-1, particularly for electronic contact thermometers or those performing infrared sensing. Compliance with EN60601-1-2 demonstrates that electromagnetic compatibility has been tested demonstrating that performance of the thermometer will not be affected by electrical interference from most types of medical and communication equipment like mobile phones, and do not generate significant electromagnetic interference for other devices (Cheng, 2003, Shimek & Emmanuel, 2011).

**Table 8.1 Key Parameters in European Standard EN 12470-5:2003(Shimek & Emmanuel, 2011)**

Parameter	Summary of the specification	Test Procedure
-----------	------------------------------	----------------



Maximum permissible error over the specified temperature range	$\pm 0.2\text{ }^{\circ}\text{C}$	Measuring temperature range: 35.5–42.0 °C Ambient temperature range: 18–28 °C	Method in 7.4 and 7.5 of EN 12470-5:2003
	$\pm 0.3\text{ }^{\circ}\text{C}$	Outside the above measuring range or ambient temperature range	
Minimum measuring range	35.5–40.0 °C		Method in 7.3 of EN 12470-5:2003
Maximum permissible clinical repeatability	$\pm 0.3\text{ }^{\circ}\text{C}$ for every patient age group (newborn, children, adults) for which the infrared ear thermometer is intended for use		Method in 7.7 of EN 12470-5:2003
Resolution (digital increment)	0.1 °C or less		Visual inspection
Ambient temperature operating range	16–35 °C		Method in 7.4 of EN 12470-5:2003
Note: If the infrared ear thermometer uses a protective probe cover, the thermometer together with the probe cover must meet the requirements above. If the probe cover is intended for multiple uses, the above requirements must be met after the probe cover has been cleaned, disinfected and/or sterilized according to the manufacturer's specifications.			

**Table 8.2 Key requirements in ASTM E1865-98 (reapproved 2009) (Shimek & Emmanuel, 2011)**

Parameter	Summary of the specification		Section
Maximum permissible laboratory error for given blackbody temperature range	$0.3\text{ }^{\circ}\text{C}$	$<36\text{ }^{\circ}\text{C}$	5.3 (see test method in 6.1.4)
	$0.2\text{ }^{\circ}\text{C}$	$36\text{--}39\text{ }^{\circ}\text{C}$	
	$0.3\text{ }^{\circ}\text{C}$	$>39\text{ }^{\circ}\text{C}$	
Minimum measuring range	34.4–42.2 °C unless otherwise labeled		5.2
Clinical accuracy	To be determined and disclosed upon request for each device model, adjustable display mode and age group intended for use		5.5.1 (see also 6.2)
Display resolution	0.1 °C		5.8.1
Operating temperature	The device should meet the laboratory error requirement operating in the range of 16°C–40°C unless otherwise marked		5.6.1.1
Operating humidity range	Up to 95% for the specified operating temperature range		5.7

## **9 Market Analysis**

In the analysis a total of thirty one thermometers were included. 4 provide an oral equivalent temperature while the other twenty seven provide the ear temperature. 12 provide either a “3-in-1” (ear, ambient and surface temperature) or a “2-in-1” (ear and forehead temperature) system, 10 are thermometers that provide ear temperature, the other 2 oral. There is also one thermometer that can display several offsets (oral, rectal, ear and core).

A majority of these devices are sold in Europe, other fail to meet the required European standards and cannot be marketed. 12 of the 31 are sold in Sweden through a supplier.

Five devices claim to be probe cover free when measuring ear temperature, “3-in-1” or “2-in-1” devices do not require probe covers when measuring non-ear temperatures.

However there is a lack of information regarding the devices. Some manuals consist on a leaflet (general with a picture depicting bad technique) including only the basic information (accuracy, the type of batteries used and cleaning instructions), leaving aside the basic operation techniques such as the ear tug. Some suppliers or manufacturers do not disclose certain information regarding their devices (prices or materials used for the disposable covers).

## **10 Result of comparison**

Most of the devices accounted for in the market analysis were marketed as a “home care device”, therefore they could not provide reliable measurements in the heavy use environment that is a hospital. Also ECRI (Emergency Care Research Institute) suggests the use of only one model of ear thermometer in any given institution. For that same reason only the Braun ThermoScan Pro4000 and the Covidien Genius2 were considered, especially taking into account the numbers of the devices registered in the inventory database. In this report both devices will be compared against the Welch Allyn SureTemp 690/692 (digital non-IR thermometer) also used in the hospital wards which has the characteristics and reliability to be a good option. According to the inventory database there are 117 Covidien Genius2, 61 Braun ThermoScan Pro 4000 (and 66 Braun devices from previous generation) and 55 Welch Allyn SureTemp.

Covidien states that pre-recalibration, their device, Genius2, has an accuracy that lies between  $\pm 0.1$  to  $\pm 0.2^{\circ}\text{C}$ , depending on the target temperature. However, post-recalibration the values lay within  $\pm 0.2^{\circ}\text{C}$  and  $\pm 0.3^{\circ}\text{C}$ . Braun claims a constant  $\pm 0.2^{\circ}\text{C}$  accuracy, while Welch Allyn, being a digital contact thermometer claims a  $\pm 0.1^{\circ}\text{C}$  accuracy for their device. They’re all battery powered and can be used on patients of all ages. The Genius2 can be set to Oral, Core, and Rectal equivalent temperatures (physiological offset). The Welch Allyn can be set to take instant temperatures at different places, such as in the mouth, axilla or the rectum; it can also be set to monitor the temperature during a period of time (although these temperatures will not be memorized for future recall).

All devices have their own probe covers that must be used in order to prevent erroneous measurements and cross contamination.

### **10.1 Calibration and Maintenance Process**

The steps required for the calibration or maintenance process are described below.

#### **10.1.1 Covidien Genius 2**

The procedure at the department is to start with an inspection of the probe lens with a magnifying glass, and clean it if needed with a cotton swab moistened with alcohol. Clean the excess alcohol with another swab. Use compressed air on the probe to dry it and wait around 5 minutes. In the meanwhile turn on the calibration device, and then disassemble the back cover and take out the batteries. Connect the thermometer to the calibrating device using the connector. Place a new cover and follow the steps on the screen. Generally at least four measurements are needed (two in the low temperature blackbody and two in the high temperature). Save the calibration log to

the USB stick. Control the batteries and then assemble the back-cover of the device. If needed, the device is also cleaned.

At the moment there are three improvements used in the calibrations and maintenance process of the Genius2:

First, for a better inspection of the probe lens a magnifying glass is used. Second, to reduce waiting time, compressed air is used to dry the lens after using a swab moistened with alcohol. Third, when connecting the Genius2 with the calibration device, a strap is used to hold both pieces firmly, this is a great addition since the connector doesn't fit tightly, is a bit loose and is very easy to disconnect, and when it disconnects the process has to restart from that step.

A new string of code could be introduced in order to know the time and number of measurements between the last calibration or other repair service. If the logs from the calibration machine could be updated in the same file instead of rewritten, useful information could be extracted. Or if after every calibration the log would be stored in some computer (without re-writing), the same information (mean time between failures/maintenance) could be extracted.

### **10.1.2 Braun ThermoScan Pro 4000**

According to technical documentation, the device should have an operational verification every year. The device goes to the factory for calibration. For the preventive maintenance service, a cotton swab moistened in alcohol is used to clean the probe lens, and the batteries are also checked. If needed, the exterior cover of the device is also cleaned (ThermoScan Pro 400 usermanual, 2006).

There are no other improvements in the ThermoScan Pro 4000, because the calibration of these devices happens in factory and not at the R&D/Biomedical Department, the possible improvement would be to acquire the 9600 Plus Calibration Tester, to ensure the devices (Thermoscan and Suretemp) are calibrated to factory settings.

### **10.1.3 Welch Allyn SureTemp**

This maintenance consists in a visual inspection of the device for any physical damage that might cause future failure, removing the probe, the "probe well" and the batteries and replace them. The batteries should be removed if the instrument is not used for a long period of time, in order to avoid damage to the device due to battery leakage.

Cleaning of the thermometer and probe should be done regularly using a cloth dampened with warm water and a mild detergent solution for the case and a 70% isopropyl alcohol solution for

the probe. Steam, heat, or gas sterilization must not be used on the thermometer or probe. The device must also never be immersed in any type of fluid. Cleaning of the “probe well” should be done by removing the “probe well” from the unit, unplugging the latching probe connector to prevent the device from consuming battery and then cleaning the inner surface of the “probe well” by swabbing the surface with a cloth dampened with a mild detergent solution or 70% isopropyl alcohol solution (Welch Allyn SureTemp Plus manual, 2006).

The Welch Allyn is in the same situation for improvements as the Braun ThermoScan Pro 4000.



## **11 Data and Results**

Gathered data was processed either with SPSS or MS Office.

### **11.1 Costs**

All of the data was extracted from both of the inventory systems in use at Karolinska. The approximate annual costs for the 3 devices are shown in the table below (Table 10.1). Depreciation of equipment and the cost of the nursing personnel are not included in the estimated costs, however it is easily possible to conclude the amount of time invested by nurses in taking the ear temperature measurements: According to Stavem et al. the total time to conclude a tympanic measurement (collection, insertion of the probe cover, measurement, and reading and documenting the temperature) is 108s. So,  $1168000\text{measurements} \times 108\text{seconds} = 35040$  hours (spent in just measuring temperature during a year). Assuming a single nurse works 40 hours per week and 48 weeks in a year, 18 nurses are needed per year just to take the temperature measurements of patients. The average yearly salary of a nurse, according to Statistiska Centralbyrån ([www.sbc.se](http://www.sbc.se)), is 363600SEK, so the total expense, regarding the nursing staff, just for the tympanic temperature measurement would be around 6.54Million SEK.

**Table 11.1 Cost estimates, in Swedish Crowns, of the devices used in Karolinska**

	<b>Braun ThermoScan Pro4000</b>	<b>Covidien Genius2</b>	<b>Welch Suretemp 690/692</b>	<b>Allyn</b>
<b>Price of the Device</b> * <sup>1</sup>	1095	2300	2800	
<b>Price box covers (number)</b> * <sup>2</sup>	67,2 (96)	126 (200)	160 (250)	
<b>Price per cover</b>	0,7	0,63	0,8	
<b>Price per covers per year</b>	817600	735840	934400	
<b>Battery price per measurement</b> * <sup>3</sup>	0,018	0,0018	0,0045	
<b>Battery changes per year</b>	1168	78	195	
<b>Battery Price per year</b> * <sup>4</sup>	20245	2025	5061	
<b>Maintenance price (Yearly)</b> * <sup>5</sup>	6157	49065	10589	
<b>Training</b>	No	No	No	
<b>Total Running Price per year</b> * <sup>6</sup>	844003	786930	950050	
<b>Total acquisition price</b> * <sup>7</sup>	131400	276000	336000	
<b>TCO for 3 and 5 years</b>	2663407 4351413	2636788 4210648	3186150 5086251	
<b>Work hours per year</b> * <sup>5</sup>	6,8	51,9	9,6	

\*<sup>1</sup> Lowest price paid by the Hospital for the device, as per the inventory system. \*<sup>2</sup> Average price from on-line stores. \*<sup>3</sup> assuming 9SEK per battery \*<sup>4</sup> 24 unit boxes-208SEK each \*<sup>5</sup> Maintenance work hours. Values taken from inventory system and adjusted to the number of devices. \*<sup>6</sup>Sum of covers, batteries and maintenance price \*<sup>7</sup> 120 devices per 3 years. All prices are in Swedish Crowns.

There is no training required, due to the fact that these devices are already in use at the wards of the hospital. If indeed it is needed, the cost would still be relatively low due to the fact that most of the staff is already familiar with both devices. The maintenance price of the Covidien Genius2 is much higher than the Braun ThermoScan Pro4000, which might be due to the fact that when these devices need a bigger repair, the Braun is disposed, while the Covidien is indeed repaired.

From the inventory database it was possible to see that 71 Covidien Genius2, 39 Braun ThermoScan Pro 4000 and 11 Welch Allyn SureTemp underwent repair, but it is not possible to see how many devices were disposed.



## 11.2 Accuracy claims

### 11.2.1 Covidien Genius2

In order to test the accuracy of the calibration, the general accuracy of the devices and confirm if it is in agreement with Ms. Pernilla Holm's findings, the following data was gathered according to the procedure in paragraph 9.1.1.

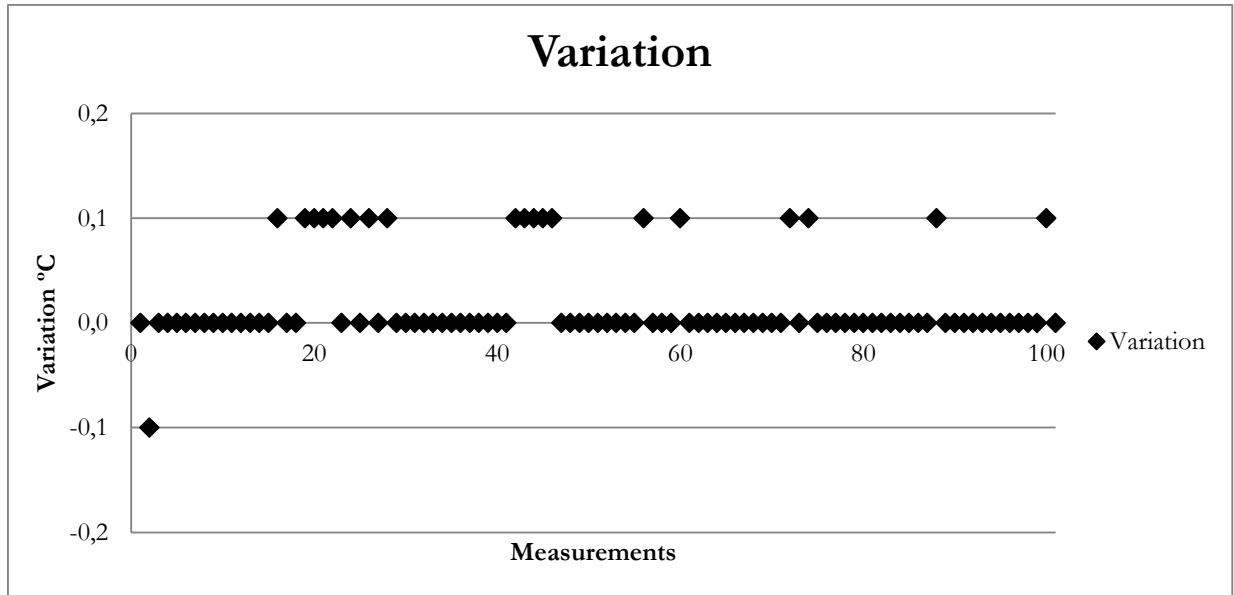

**Figure 11.1 Scatter Plot of the value of the measurements**

These 101 measurements were taken with the Covidien Genius2 thermometer in the calibration device, which contains 2 blackbodies, one with a low temperature (around 32.2°C) and another with a higher temperature (around 40.5°C). SPSS frequency analyzer shows that, regarding the stated blackbody temperature, a single measurement taken by the thermometer had a temperature variation of -0.1°C, 81 had no variation and 19 had a variation of +0.1°C.

**Table 11.2 Frequency of the acquired measurements and their percentage**

		Measurements			
		Frequency	Percent	Valid Percent	Cumulative Percent
Valid	-0,10	1	1,0	1,0	1,0
	0,00	81	80,2	80,2	81,2
	0,10	19	18,8	18,8	100,0
	Total	101	100,0	100,0	

Table 10.2 explains Figure 10.1 in more detail, breaking the graph into a table showing the frequency and the corresponding percent of the taken measurements, for an easier read.

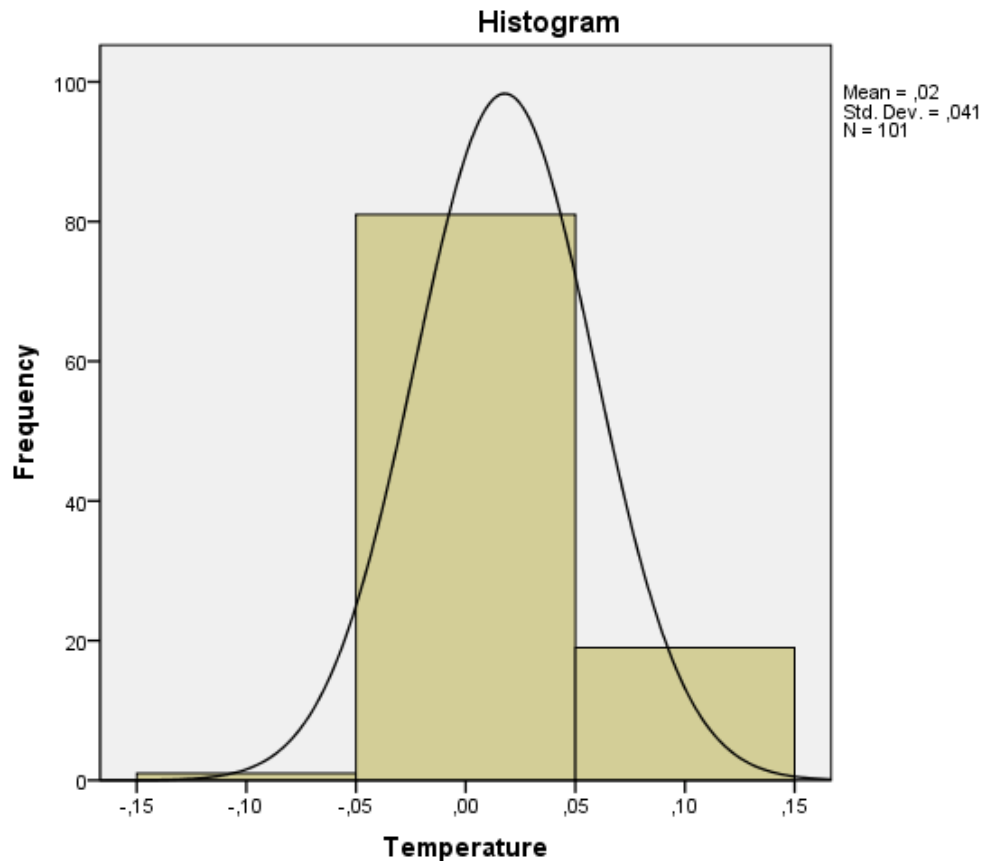

**Figure 11.2 Histogram depicting the frequency of the measurements, and the normal curve. Temperature in °C**

Examining Fig. 10.2 it is possible to see that the majority of the values within the normal curve fall between a temperature variation of 0.0°C and 0.1°C, this is also easily observed in Table 10.2. The peak of the curve is at 0.02°C. Measurements vary from -0.1°C to 0.1°C, with 81 out of 101 measurements proving to be exact, this is, with 0.0°C variation, and the standard deviation is standing at 0.04°C. This Histogram and the following statistical data (Table 10.3), were obtained through SPSS Frequency Analyzer function.

**Table 11.3 Statistical data**

Statistics	
<b>N</b>	101
<b>Mean</b>	0,0178
<b>Std. Error of Mean</b>	0,00408
<b>Median</b>	0,00
<b>Mode</b>	0,00
<b>Std. Deviation</b>	0,04098
<b>Variance</b>	0,002
<b>Skewness</b>	1,253
<b>Std. Error of Skewness</b>	0,240
<b>Kurtosis</b>	0,927
<b>Std. Error of Kurtosis</b>	0,476

The measured temperatures varied from 32.2-32.3°C in the low temperature black body to 40.5-40.6°C in the high temperature blackbody. Ambient temperature at the time of the experiment was 27.2°C.

Using the same method as Haugan et al. where the accuracy was defined as 2 x SD (standard deviation), the accuracy for these measurements is  $\pm 0.082$ , falling within the parameters specified by the manufacturer.

### **11.2.2 Braun ThermoScan Pro 4000**

Due to the fact there are no devices to calibrate the Braun ThermoScan Pro 4000 device at the Biomedical/R&D department of Karolinska, it was impossible to make similar measurements to the ones in chapter 10.1.1. For this reason, other studies were used to help in the evaluation process and which are described below.

The following study was carried out at the Heidelberg University Hospital (Bock & Hohfeld, 2005) with the purpose of evaluating the equivalency between an infrared ear thermometer and the temperature measurements of a pulmonary artery catheter and a contact probe on the tympanic membrane. In this research the device used as an infrared ear thermometer is the Braun ThermoScan Pro 4000, making it a valuable contribution to the present study, since it was not possible to carry out measurements for this device.

The study consisted on obtaining a total of 729 measurements on 26 patients, with ages ranging from 48 to 81 years (with a median of 67.5 year). The median duration of all operations was 153 min (range 97–263 min) with a median duration of the extra corporal circulation of 69.5 min (range 33–123 min). Patients with an acute or chronic infection of the external auditory canal, the middle ear, the mastoid, and those with a congenital or acquired anomaly of the auditory canal as well as a defect of the tympanum, and impacted cerumen were excluded from the study. Also, patients with clinically significant microangiopathy, cerebral circulatory disease and migraine headaches were excluded. Infections in the external auditory canal or cerumen were excluded by preoperative otoscopy. It should be noted that this practice is not applicable for a routine use in a clinical setting. In this study, and unlike previous studies, the infrared thermometer was evaluated in a population undergoing rapid changes in core temperature, using a large number of measurements by an expert observer.

Twenty-two data sets were excluded because strong artefacts caused by bipolar high frequency coagulation interfered with the data registration of the ThermoScan Pro 4000, leaving 707 data sets for statistical analysis. These artefacts consisted of temperatures on the display which were obviously higher than the range of human thermoregulation. Per patient, a mean of 26.3 and a

median of 23 measuring episodes (range 11–53) were included in the analysis. The temperatures evaluated in the calculations ranged from 33.6 to 37.6°C.

Ambient temperature ranged from 18.2 to 27.7°C which is within the range specified for the ThermoScan Pro 4000 (10–40°C).

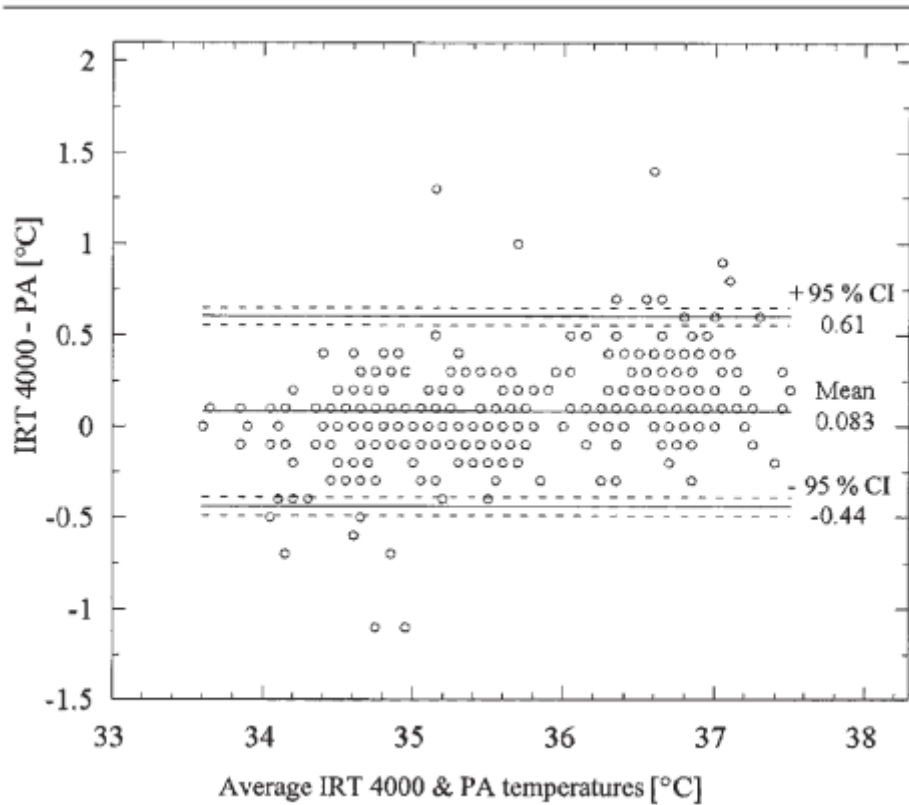

**Figure 11.3 Bland Altman plot of the paired measurements displayed against the average of the pair when the prototype of the infrared ear thermometer (ThermoScan Pro 4000) was compared to the pulmonary artery (PA) catheter.**

Fig. 10.3 shows that, concerning the pulmonary artery catheter, the agreement between measurements of the infrared thermometer ThermoScan Pro 4000 and those of the pulmonary artery catheter was +0.08°C, with a precision between .61 (upper 95% CI) and -0.44 (lower 95% CI).

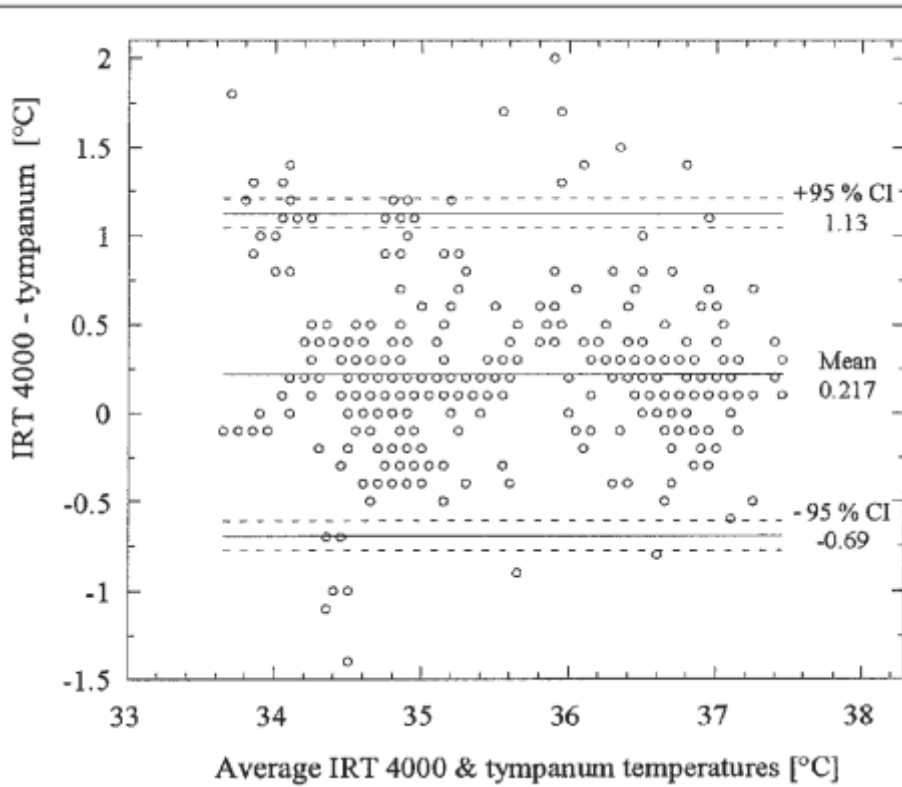

**Figure 11.4 Bland Altman plot of the paired measurements plotted against the average of the pair when the prototype of the infrared ear thermometer ThermoScan Pro 4000 was compared to the tympanic membrane probe.**

Fig. 10.4 shows that, regarding the tympanic contact probe, the agreement between measurements of the infrared thermometer ThermoScan Pro 4000 and those of the tympanic contact probe was +0.22°C, with a precision between 1.13 (upper 95% CI) and -0.69 (lower 95% CI;).

### **11.2.3 Welch Allyn Suretemp**

The following study was conducted by Welch Allyn (Welch Allyn, 2007) with the purpose of demonstrating the accuracy of this device in the pediatric mode. In the following researches the device used was the Welch Allyn Suretemp Plus 690/692, making it an important addition to the present study, since it was not possible to carry out measurements for this device, due to the fact there are no devices to calibrate the Welch Allyn Suretemp device at the Biomedical/R&D department of Karolinska, so it was impossible to make similar measurements to the ones in chapter 10.1.1.

The purpose of this Welch Allyn study was to demonstrate the accuracy of the SureTemp in Pediatric Axillary mode and consisted on collecting one hundred and ten temperature data sets. Sixteen percent of the data represent newborns, while thirty percent of the data (excluding the newborns) represent patients with fever (in this particular study, fever is a temperature superior to  $37.77^{\circ}\text{C}$ ). For each subject, an initial axillary temperature was taken in the predict mode. Once the temperature was recorded, the probe was left in place and the thermometer was switched to the monitor mode for five minutes to establish a reference temperature. A direct comparison was then made between each predicted temperature and the corresponding reference temperature.

Data were then analyzed by comparing each subject's predicted temperature to the corresponding five-minute monitor mode reference temperature.

**SureTemp® Plus Monitor Mode  
Temperature vs. Predicted Temperature  
Paediatric Axillary Mode**

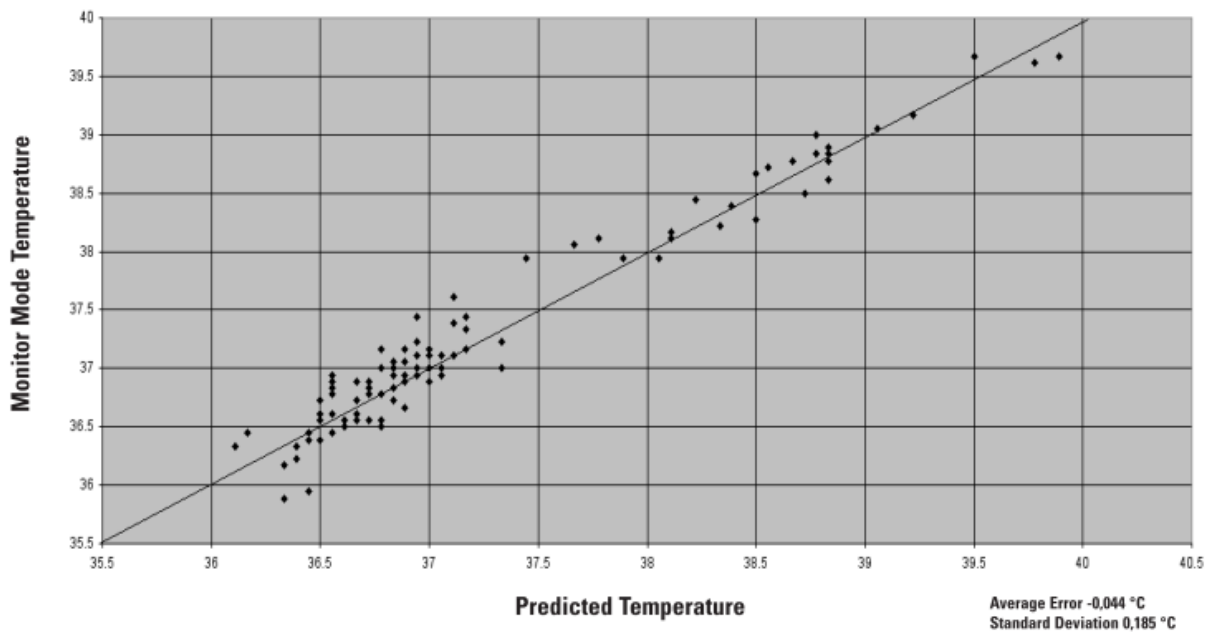

**Figure 11.5 Welch Allyn Monitor mode Vs Paediatric axillary mode (Welch Allyn, 2007)**

Monitor mode is a function of an electronic thermometer used to monitor a temperature reading until it reaches the thermal steady state. The thermal steady state for axillary temperatures is reached in approximately five minutes.

Predicted temperatures are from any thermometer that renders a temperature reading before the steady state is achieved. Predictive thermometers reduce the time required for measurement by predicting what the temperature would be if the probe were left in the site until steady state is reached.

Regarding the Data of the newborn, axillary temperatures ranged from 35.88°C to 37.38° C. The total number of data sets was twenty. Subjects ranged from 1 hour to 3 days old. The average error was 0.044° C with a Standard Deviation of 0.199°C (Figure 10.5).

For the Pediatric Axillary Data, 17 years and younger, excluding newborns (subjects ranged in age from 1 month to 16 years). Axillary temperatures ranged from 36.16° C to 39.66° C. The total number of data sets was 90, with 27 of those being in a febrile state. An equal number of axillary data sets were also collected from three age groups: one month to 4 years, 5 years to 10 years, and 11 years to 17 years. The average error was 0.055° C with a Standard Deviation of 0.175° C (Figure 10.5).

The next study was conducted in the ICU at the University of Washington Medical Centers in Seattle (Lawson et al. 2007) with the purpose of determining the accuracy and precision of oral, ear-based, temporal artery, and axillary temperature measurements compared with pulmonary artery temperature. In this research one of the devices used is the Welch Allyn Suretemp 692, making it an important addition to the present study, since it was not possible to carry out measurements for this device.

During a 6-month period, a convenience sample (n = 60) of adult Intensive Care Unit patients at the University of Washington Medical Centers, Seattle, Washington (an academic medical center) were studied. Patients who had a pulmonary artery catheter in place because of clinical necessity participated in the study. Patients were excluded if they had an oral abscess, stomatitis or oral trauma.

The probe, which was placed in the posterior sublingual pocket, was held by the investigator during the temperature measurement to maintain contact between the probe tip and the tissue. Patients who were intubated also were included in the study. A repeated-measures design was used to describe the accuracy and precision of noninvasive temperature measurements (oral) compared with pulmonary artery temperature. Study participants served as their own controls. The thermometer was placed in the “axillary” mode. The temperature probe requires direct contact with the skin, although no shaving or clipping of hair is required.

Temperature measurements were obtained in the following manner: The thermometer was placed in the “axillary” mode. The temperature probe requires direct contact with the skin, although no shaving or clipping of hair was required. With the axillary mode indicator flashing, the patient’s arm was lifted so that the entire axilla was easily seen. The probe was then placed as high as possible in the axilla. The probe tip did not come into contact with the patient until the probe was placed in the measurement site. After verifying that the probe tip was completely surrounded by axillary tissue, the patient’s arm was then snugly placed at his side. The patient’s arm was held in this position to avoid movement of the arm or the probe during the measurement cycle.



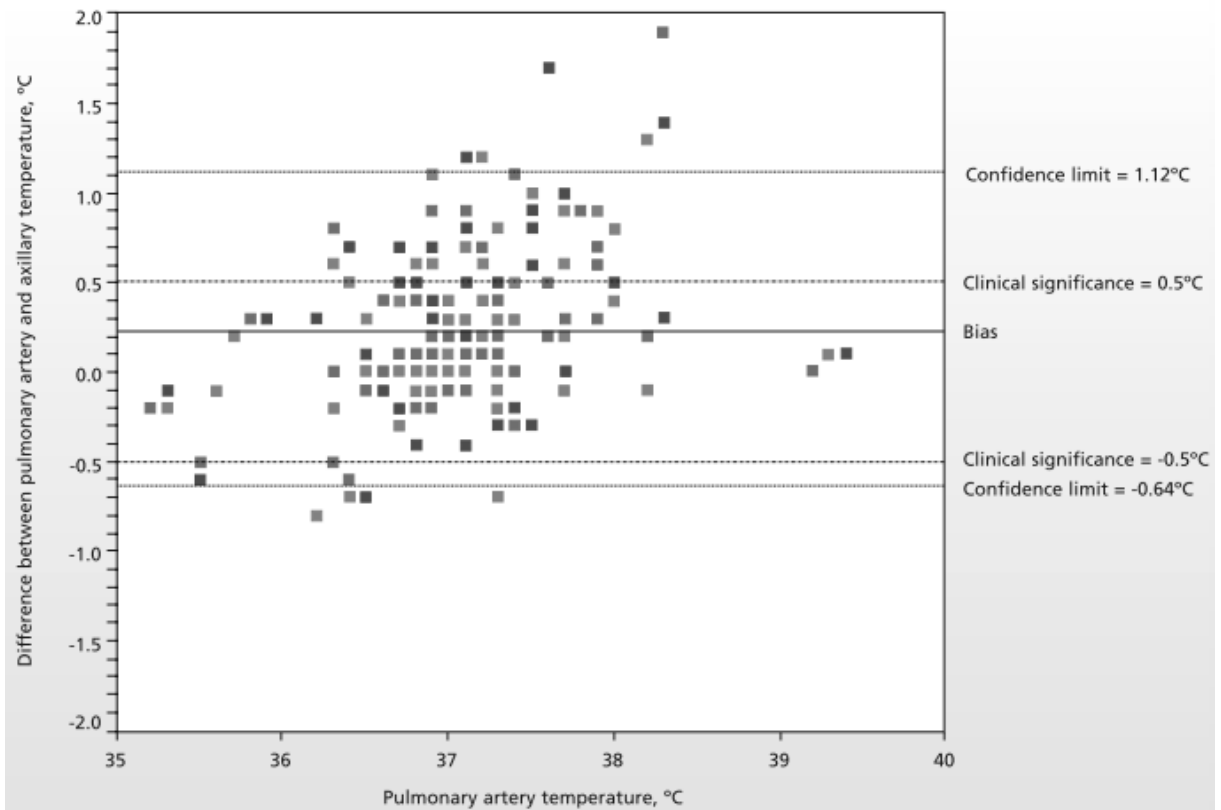

**Figure 11.6 Welch Allyn Difference between pulmonary artery and axillary temperature. The bias was 0.23°C, with a standard deviation of 0.44°C, indicating that the axillary temperatures tended to underestimate the pulmonary artery temperature. (Lawson et al. 2007)**

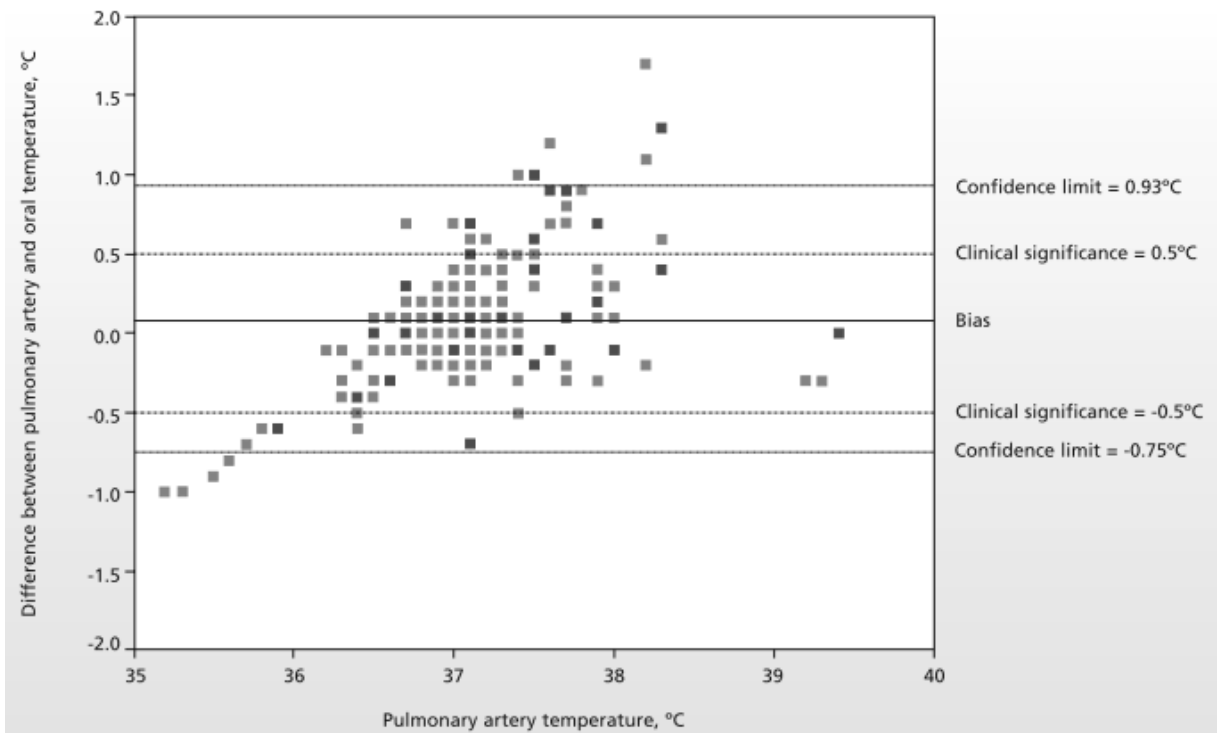

**Figure 11.7 Welch Allyn Difference between pulmonary artery and oral temperature. The bias was 0.09°C, with a standard deviation of 0.43°C, indicating that the oral temperatures tended to underestimate the pulmonary artery temperature. (Lawson et al. 2007)**

Figure 10.6 shows the 180 measurements (60 triplicate sets) obtained to compare axillary and pulmonary artery temperature measurements. The accuracy was 0.23°C and the precision was 0.44°C, indicating that the axillary temperature measurements underestimated the pulmonary artery temperature. The confidence limits ranged from -0.64°C to 1.12°C. Of the 180 data points, 49 (27%) were outside the  $\pm 0.5^\circ\text{C}$  range.

Figure 10.7 shows the 180 measurements (60 triplicate sets) were obtained to compare oral and pulmonary artery temperature measurements. The accuracy was 0.09°C and the precision was 0.43°C, indicating that the oral temperatures slightly underestimated the pulmonary artery temperature. The confidence limits ranged from -0.75°C to 0.93°C. Of the 180 data points, 34 (19%) were outside the  $\pm 0.5^\circ\text{C}$  range.

#### **11.2.4 Braun ThermoScan Pro4000 and Covidien Genius2**

According to a study carried in a University Hospital in Oslo (Haugan et al. 2012), with the purpose of exploring the reliability and validity of the new generation of infrared tympanic thermometers, ear temperature measurements were compared by taking measurements in both ears, and also by comparing ear temperature with rectal and core.

The study was carried in a surgical ward and one Intensive Care Unit. All patients were 18 or older, and patients with ear infection, acute pain or bandage over the ear were excluded. At the ward, temperature was measured with two infrared tympanic thermometers of different brands in both ears. Finally, the rectal temperature was measured. These five measurements were taken twice, once in the morning and once in the evening, either on the same day or on two consecutive days. If the measurements were taken on two consecutive days, the evening measurement was taken first. The staff, both at the ICU and at the surgical ward went through training in infrared tympanic thermometer handling. All thermometers followed cleaning procedures as instructed by the manufacturers and were calibrated before the study. The pulmonary artery catheter temperature was measured with a Swan-Ganz catheter, using a Pulse-Induced Contour Cardiac Output (PICCO) catheter. The rectal temperature measurements were taken, with several digital thermometers of the same brand (DIGItemp). The core and rectal temperature measurements were taken not more than 3 minutes after infrared thermometry. Measurements taken with the infrared tympanic thermometers followed manufacturer's guidelines. Data were collected for nine months.

**Table 11.4 Overall descriptive statistics for the differences in pairs of temperature measurements. The measurements were rectal temperature and ear temperature measured in left and right ears, by Braun and Genius thermometers (ward) and the same measurements supplemented by the core temperature at the Intensive Care Unit**

<b>Ward</b>	<b><i>n</i></b>	<b>Mean</b>	<b>SD</b>	<b>Min</b>	<b>Max</b>
Braun Right vs Left	371	0.04	0.32	-1.50	1.00
Genius Right vs Left	370	-0.01	0.36	-1.50	1.20
Rectal vs Braun Right	378	0.34	0.38	-1.00	1.90
Rectal vs Braun Left	379	0.39	0.39	-1.00	2.10
Rectal vs Genius Right	378	0.87	0.47	-1.10	2.30
Rectal vs Genius Left	378	0.85	0.47	-1.00	2.40
<b>ICU</b>					
Rectal vs Core	240	0.16	0.18	-0.40	0.70
Braun Right vs Left	243	0.06	0.38	-1.40	1.70
Genius Right vs Left	244	0.07	0.48	-1.40	1.50
Core vs Braun Right	245	-0.05	0.30	-1.10	1.20
Core vs Braun Left 2	245	0.02	0.31	-1.10	1.50
Core vs Genius Right	246	0.03	0.36	-1.00	1.40
Core vs Genius Left	245	0.02	0.31	-1.10	1.50
Rectal vs Braun Right	237	0.11	0.33	-1.00	1.20
Rectal vs Braun Left	236	0.17	0.34	-0.80	1.60
Rectal vs Genius Right	238	0.18	0.38	-1.30	1.40
Rectal vs Genius Left	236	0.17	0.34	-0.80	1.60

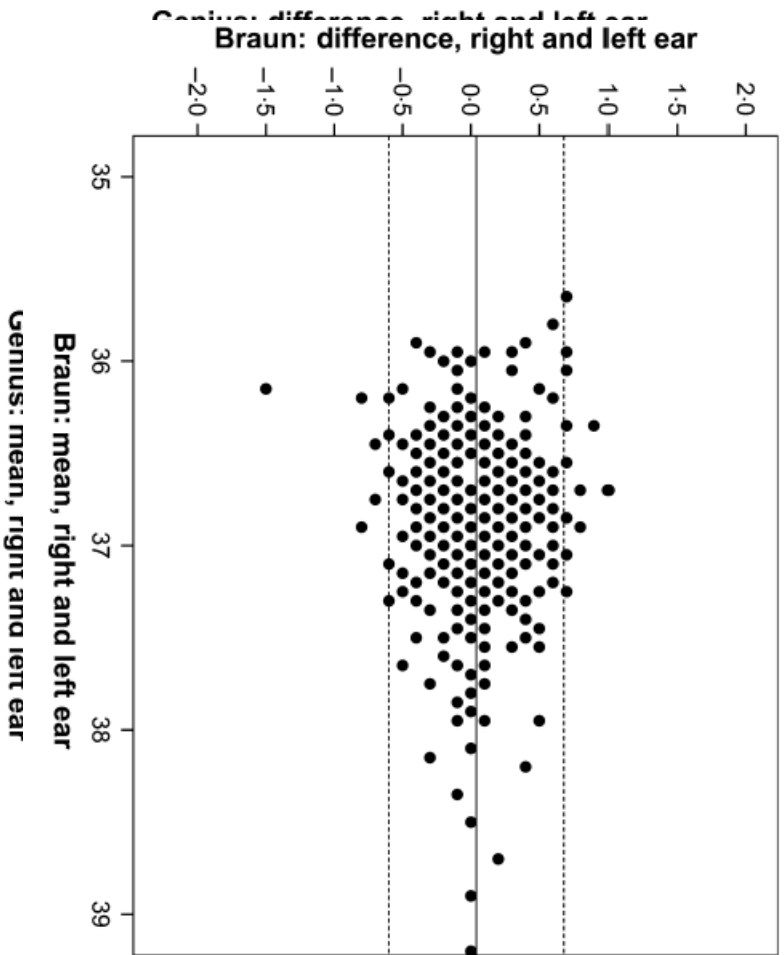

Figure 11.8 On the left side, Measurements from the ward: Bland–Altman plots of the tympanic temperature in left and right ears measured by Covidien devi On the right side On the right side Measurements from the ward: Bland–Altman plots of the tympanic temperature in right ear measured by Braun instruments. Similar res found for left ear were found for left ear. For both graphics, the solid lines are the mean difference, and the dashed lines are the 95% limits of agreement. (Haugan et al. 2012

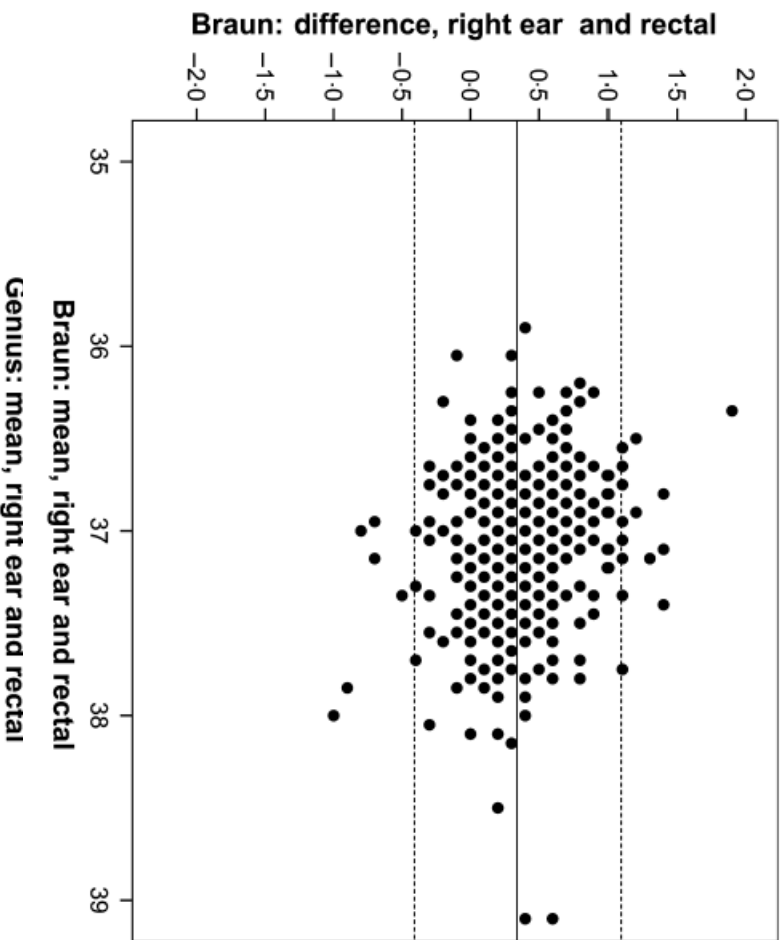
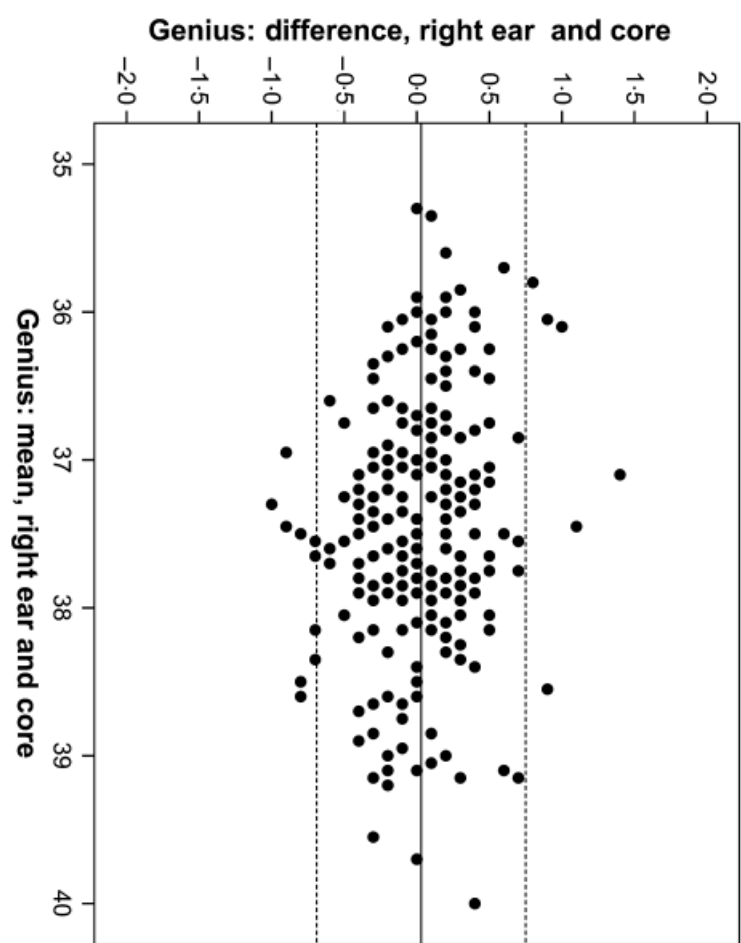
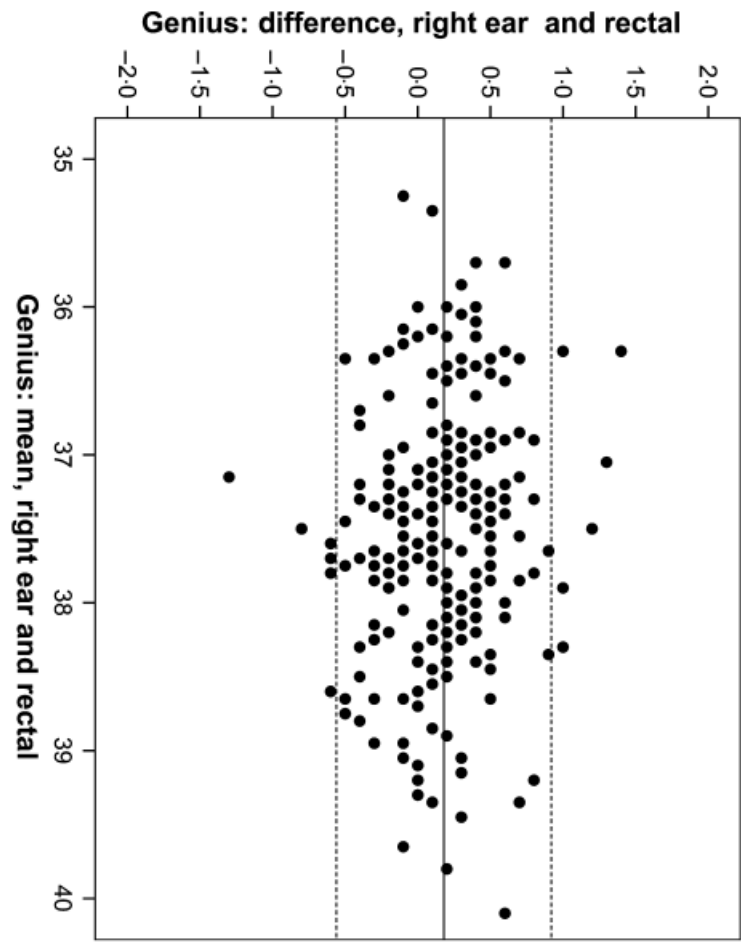

Figure 11.9 On the right side On the right side Measurements from the ward: Bland–Altman plots of the tympanic temperature in right ear measured by Covidien devi On the right side On the right side Measurements from the ward: Bland–Altman plots of the tympanic temperature in right ear measured by Braun instruments. Similar res found for left ear were found for left ear. For both graphics, the solid lines are the mean difference, and the dashed lines are the 95% limits of agreement. (Haugan et al. 2012



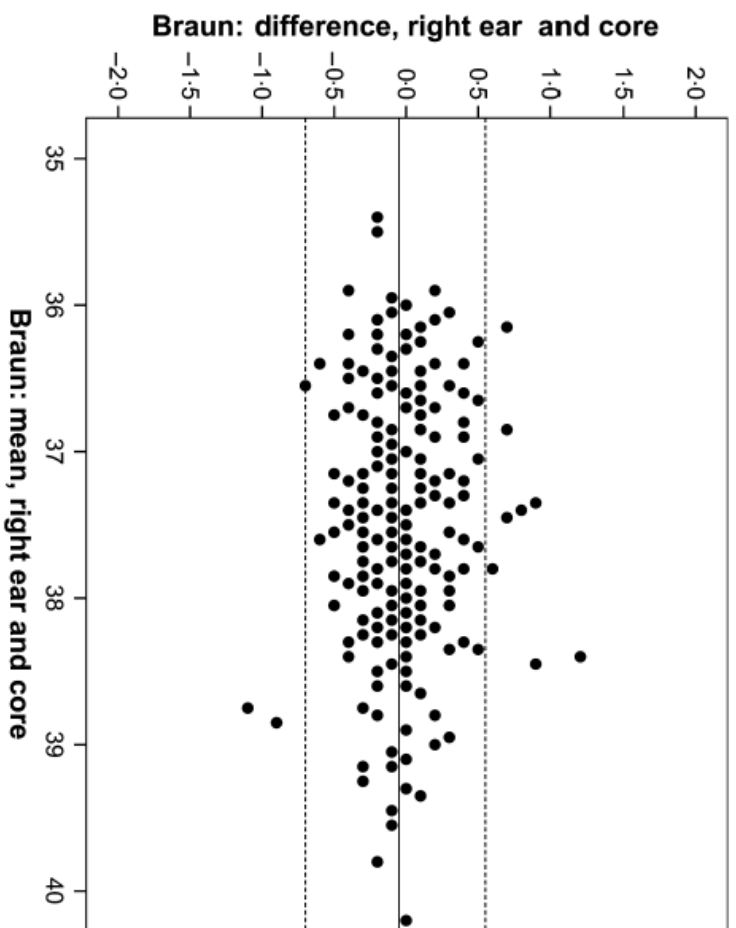
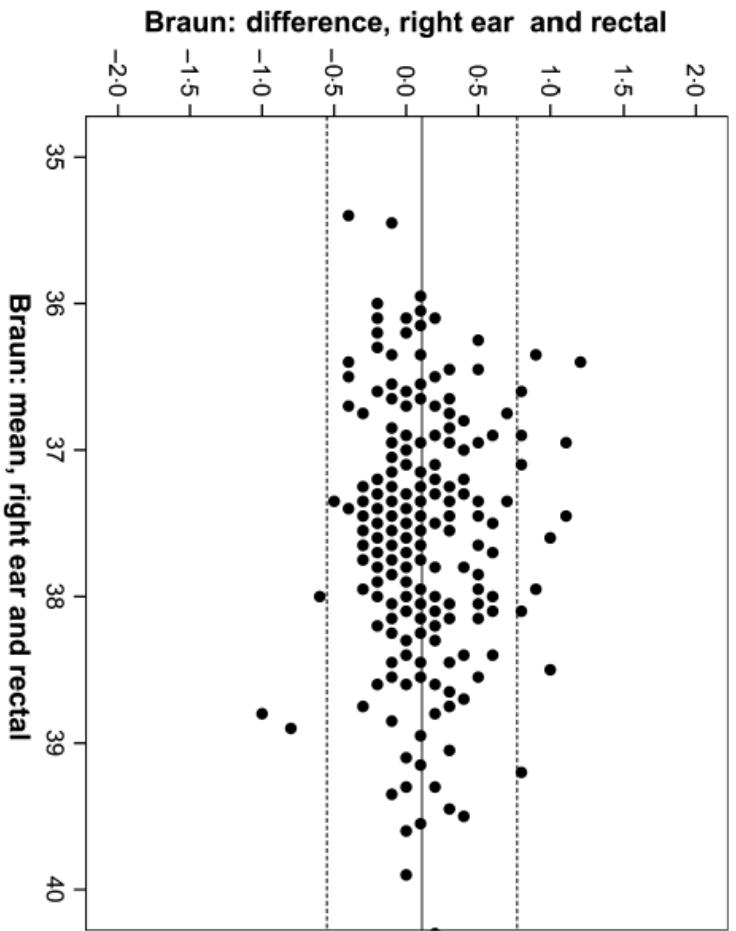

Figure 11.10 On the left, measurements from the intensive care unit: Bland–Altman plots of the tympanic temperature in right ear measured by Covidien instruments, compared with the rectal temperature. On the right, Measurements from the intensive care unit: Bland–Altman plots of the tympanic temperature in right ear measured by Covidien instruments, compared with the core temperature. The solid lines are the mean difference, and the dashed lines are 95% limits of agreement. Similar results were found for left ear. (Haugan et al. 2012)

Figure 11.11 On the left, measurements from the intensive care unit: Bland–Altman plots of the tympanic temperature compared with the rectal temperature. On the right, Measurements from the intensive care unit: Bland–Altman plots of the tympanic temperature compared with the core temperature. The solid lines are the mean difference, and the dashed lines are 95% limits of agreement. Similar results were found for left ear. (Haugan et al. 2012)





Regarding the measurements taken at the wards, the descriptive statistics indicate higher variation in temperature measurements made in the ear. The greatest variation was found in measurements from Genius instruments. The mean difference between right and left ears was 0.04°C for Braun and -0.01°C for Genius (Table 10.4, and on the right side of Fig. 10.8 and Fig. 10.9). The differences were not more than 1.5°C for either brand, with 50% of the differences between -0.2°C and 0.2°C for both brands.

The differences between rectal temperature and ear temperature are outlined on the right side of Fig. 10.8 and Fig. 10.9 and Table 10.4. Both brands consistently measured a temperature lower than the rectal temperature, with Genius showing the largest deviation.

The difference between rectal temperature and temperatures measured by Braun instruments was statistically significant ( $p < 0.001$ ) and estimated to be 0.36°C. The difference between rectal temperature and temperatures measured by Genius instruments was statistically significant ( $p < 0.001$ ) and estimated to be 0.85°C.

Regarding the temperature measurements taken at the Intensive Care Unit, the descriptive statistics indicate a higher overall mean temperature and an overall larger variation in the temperature measurements in the Intensive Care Unit as compared with the ward. The agreement between left and right ears is shown in Table 10.4. The mean rectal temperature was higher than the mean core temperature (Table 10.4, Fig. 4), with minor differences in ear temperature as compared with the core temperature. The differences between rectal temperature and ear temperature are outlined on the left side of Fig. 10.10 and Fig. 10.11 and in Table 10.4. The corresponding differences between core temperature and ear temperature are outlined on the right side of Fig. 10.10 and Fig. 10.11 and on Table 10.4.

According to Haugan et al. a mixed model analysis restricted to ear temperature measurements showed a slight, but statistically significant, difference in measurements from left ear vs. right ear, with the temperature measured in the left ear being on average 0.06°C lower than that in the right ear ( $p = 0.02$ ). Because of the magnitude of this difference and the fact that 'left' and 'right' were only attributable to the ear temperature measurements, this difference was disregarded in further analyses. When the core temperature was left out of the mixed model analyses, it was found that the same overall trends at the ICU as at the ward, but with less discrepancy between Braun and Genius instruments, as compared with the rectal temperature (mean effect -0.13°C,  $p < 0.001$  for Braun and mean effect -0.21°C,  $p < 0.001$  for Genius). Rectal temperatures were the only temperature measurements that significantly differed from the core temperature.

The Department of Clinical and Biomedical Engineering did the recalibration tests after the data collection. One of the Genius instruments did not pass the recalibration test. Excluding the

measurements with this instrument from the sample did not change the results of the analyses. One of the Braun thermometers had lower readings during the calibration. Dirt covering the lens was discovered on visual inspection. After cleaning the lens, all Braun thermometers passed the calibration test.

Regarding the limitations of this study, it should be noticed that few patients in this study had a fever because most patients receive treatment against fever, as it is ethically wrong not to give the patients optimal treatment like antipyretics, steroids and antibiotics.

## 12 Discussion of results

The aim of this examination was to examine the accuracy, prices and reliability of infrared ear thermometers when compared against normal contact digital thermometry equipment. Two tympanic thermometers and one digital thermometer were evaluated in the present study. Each of these thermometers is commercially available in the European Union.

All recorded temperatures lay within the temperature range specified by the manufacturers.

One of the experiments was conducted in Karolinska University Hospital, while the results from the others were compiled from different sources, such as the Canadian Journal of Anesthesia, American Journal of Critical Care, Welch Allyn and Journal of Clinical Nursing.

Gathered data (Fig. 10.1, Fig. 10.2, Table 10.1 and Table 10.2) show that the Covidien Genius2 can measure temperature with high accuracy and precision, detecting accurately hypothermia or fever. It should be noted however that the Covidien Genius2 measurements were not done on human subjects, but on the calibration machine (black bodies), so the human error, the ear anatomy, or other factors were not taken into account. It is also to be noted that these results differ from the results obtained by Ms. Pernilla Holm, who used the same method as the one used in this study. Pernilla found the devices to be very inaccurate, with temperature variations reaching the 0.8°C, with standard deviation of 0.4°C. It was confirmed by Covidien that a certain batch of devices, were not packed accordingly to their standards, and suffered some damage on the probes while being transported. Those devices were replaced.

It has been demonstrated that the Braun ThermoScan Pro 4000 (Fig. 10.3 and Fig. 10.4) offers an accurate estimate of core temperature in comparison to invasive pulmonary artery catheter thermometry and contact measurement on the tympanic membrane, as well as high reproducibility. A major advantage of the ThermoScan Pro 4000 compared to the pulmonary artery catheter is the non-invasive operation of the device. The ThermoScan Pro 4000 may therefore be used as an alternative to the pulmonary artery thermometry for the measurement of core temperature in the perioperative setting, however it is important to note that limited access to the aural canal might interfere with the measurements when the thermometer's infrared collecting cylinder cannot be centered exactly towards the tympanum.

Regarding the Welch Allyn, the data (Figure 10.5) shows excellent correlation and no clinically significant differences between the five-minute monitor mode reference temperatures and the predicted axillary temperatures. Axillary temperatures in children are often preferred over other sites because of safety, hygiene, and simplicity.

The axillary temperature measurements (Figure 10.6) underestimated the pulmonary artery temperature, although the precision of temporal artery measurements was comparable to the precision of the oral temperature measurements.

The oral temperature measurements (Figure 10.7) agreed closely with the pulmonary artery temperature, with mean differences less than 0.1°C. The axillary temperature measurements underestimated the pulmonary artery temperature.

Regarding the study done by Haugan et al. they showed that there is a good agreement between both ears for the two brands of infrared tympanic thermometers. It was found that, at the intensive care unit, the tympanic temperature was closer to core temperature than to the rectal temperature, so there is also the possibility that the same happens at the surgical ward.

Haugan et al have also done some calculations regarding the clinical accuracy of the tympanic thermometers. They defined the error limits as 2 x SD (standard deviation) of left vs. right ear, finding  $\pm 0.64^{\circ}\text{C}$  at the ward and  $\pm 0.76^{\circ}\text{C}$  at the Intensive Care Unit for the Braun ThermoScan Pro 4000 and, for the Covidien Genius2  $\pm 0.72^{\circ}\text{C}$  at the ward and  $\pm 0.96^{\circ}\text{C}$  at the Intensive Care Unit.

Prior to the study, they also hypothesized 95% confidence limits of  $\pm 0.5^{\circ}\text{C}$  for the true difference between rectal and ear temperature to be acceptable to introduce IRTT at the ward. Except from the differences found at the ward between rectal temperature and temperatures measured by Geniu2, all comparisons in the study conducted by Haugan et al. met these criteria.

These results clash with several other studies, which state that in a clinical setting, ear thermometry is not an adequate alternative to the golden standard, rectal thermometry, being inaccurate and possibly revealing misdiagnosis (Banitalebi et al. 2002, Nordås et al. 2005, Dodd et al. 2006, Duberg et al. 2007, Lawson et al. 2007). However the results are in agreement with other studies that state that the infrared thermometers proved to be accurate (Kocoglu & Goksu, 2002, Nimah et al. 2006, Villaescusa et al. 2008, Jefferies et al. 2011). However most of the previous studies were either made on previous models of the devices or for infrared devices that were not built for human temperature measurement, but for other purposes and possess a much wider range (from 50°C to 200°C), although the same thermometry principles still apply. Nevertheless, a newer study (Haugan et al. 2012) seems to be in agreement with the conducted research.

On a price related view, for 3 years the Covidien Genius2 proves to be the cheapest option by a small margin of around 27000SEK, while for 5 years the difference increases to 140765SEK. Also the device with larger life expectancy, according to the technicians is the Covidien Genius2. And the stated initial accuracy of the Genius2 is 0.1°C better than the ThermoScan Pro 4000.

## 13 Conclusions

It is of vital importance to understand that body temperature varies according to body location and is not a specific value, but rather a set of values.

Infrared tympanic thermometry is easy to learn and to perform and, although training has some impact on the accuracy of the measurements, it is a viable option for use in daily clinical practice (results suggest that infrared ear thermometers are a good alternative to traditional methods of thermometry and that infrared ear thermometers are accurate instruments), however ear thermometers should be used only for tracking or trending of patient temperature status and never used on critical patients.

Several factors, such as lack of training or poor equipment handling, may affect the measurement of tympanic membrane temperature. Most likely, problems are not related to the thermometers themselves, rather they are likely the result of an inadequate understanding of the limitations of ear thermometry. In order to avoid measurement problems, the devices should have their accuracy checked more periodically, once a year, as recommended, every time they are exposed to electrical and mechanical shock or water, or when the staff feels unsure about the measurements.

It is of vital importance to have studies on medical equipment before purchasing. During an economic crisis like the one we are going through, cost reduction and cost effectiveness are of the utmost importance. It was possible to see that the operation of a simple device such as a tympanic thermometer implies significant annual costs for the hospital. Even though a single measurement is quite inexpensive, barely reaching 1SEK, however it is the heavy utilization of the device that must be taken into account. In this case, using the least expensive devices (regarding only its running cost) has an annual cost of 786930SEK, when we add the cost with the non-technical staff, which is around 6.54Million SEK, the total cost of usage of the infrared ear thermometer devices is roughly 7.33Million SEK, which is a considerable value, for a task (temperature measurement) that is most often perceived as “trivial”, by medical staff and regular people.

During the course of three years, Covidien Genius2 it is still 26619SEK cheaper than its direct competitor and for five years the difference is 140765SEK. Covidien’s Genius2 has a larger life and it can be used to display temperatures at a known body site, such as oral, rectal or axillary if needed. They are also relatively easy to fix and most of the work can be done “in house”. Regarding accuracy, both tympanic thermometers are proven to be accurate devices. Therefore, taking into account the personnel opinion, features, specifications, and total cost of ownership of the devices the optimal buying decision would be the Covidien Genius2 thermometer.

Since core temperature is considered the golden standard, it is recommended that further data be obtained on the Covidien Genius2 and the Braun ThermoScan Pro4000 for comparison of tympanic measurements with a pulmonary artery catheter, providing the possibility to further

compare the performance of the different thermometers. Further research is also recommended on febrile patients.

## Bibliography

### A. Printed Sources

1. Banitalebi H, Bangstad H. *Measurement of fever in children--is infrared tympanic thermometry reliable?* Tidsskrift for Den norske legeforening, Vol.122(28), Nov. 2002, pp2700-2701
2. Bock, M. & Hohlfeld, U. *The accuracy of a new infrared ear thermometer in patients undergoing cardiac surgery.* Canadian Journal of Anesthesia, 2005.52:10 pp1083-1087
3. Bridges, E. Thomas, K. *Noninvasive measurement of body temperature in critically ill patients.* Critical Care Journal Vol.29 2009 pp94-97
4. Cabral P. *Breve História da Medição de Temperaturas.* Qualitria, n°24, Jan./Mar. 1995
5. Cheng, M. *Medical Device Regulations; Global overview and guiding principles.* Geneva: World Health Organization. 2003 ISBN 92 4 154618 2
6. Crawford, D. Greene, N. Wentworth, S. *Thermometer Review: UK market survey 2005.* London: Medicines and Healthcare products Regulatory Agency. Jan. 2005 pp2-10; 59-73
7. Critical Care Diagnostic and Nutritional Delivery Group. *Genius2 Tympanic Thermometer Tips and Techniques.* Kendall 2006
8. Dodd, S. Lancaster, G. Craig, J. Smyth, R. Williamson, P. *In a systematic review, infrared ear thermometry for fever diagnosis in children finds poor sensitivity.* Journal of Clinical Epidemiology 2006, Vol.59 pp 354–357.
9. Duberg, T. Lundholm, C. Holmberg, Hans. *Örontermometer inte fullgott alternativ till rektaltermometer.* Läkartidningen Vol. 104, NO 19 2007 pp1479-1482
10. Duggan, J. Sinha, V.K. *What's hot and what's not: Pitfalls in infrared tympanic thermometry.* Journal of the Association of Anesthetists of Great Britain and Ireland, Anaesthesia 2010, pp1042-1043
11. ECRI. *Thermometers, Electronic Thermistor/Thermocouple, patient.* Pennsylvania: Healthcare Product Comparison System. Jan. 2003
12. ECRI. *Thermometers, Electronic, Infrared, Ear.* Pennsylvania: Healthcare Product Comparison System. Jan. 2003
13. Edelu BO, Ojinnaka NC, Ikefuna AN. *Fever detection in under 5 children in a tertiary health facility using the infrared tympanic thermometer in the oral mode.* Italian Journal of Pediatrics, Vol. 22, Jan. 2011 pp37-38
14. Edling, L. Carlsson, R. Magnuson, A. Holmberg, H. *Rektaltermometern fortfarande bäst för temperaturmätning.* Läkartidningen, Oct. 13, NO 42 2009 pp1479-1482
15. European Commission Enterprise and Industry Directorate General *Clinical Evaluation: A Guide for Manufacturers and Notified Bodies.* MEDDEV. 2.7.1 Rev.3. Dec.2009
16. Fadzil, F.M, Choon, D. & Arumugan, K. *A comparative study of the accuracy of noninvasive thermometers.* Australian Family Physician Vol34, NO. 4, April 2010 pp 237-239
17. Falk, R. Ivarsson, J. et al. *Blackbody radiators for calibration of wide-looking IR thermometers.* SP Report 2003:20. ISBN: 91-7848-953-9
18. Frim, J. & Ducharme, M.D. *Physical properties of several infrared tympanic thermometers.* Defence and civil institute of Environmental Medicine, Sixth Int. Conf. on Envir. Ergon. Canada, Sept. 25-30, 1994 pp144-145
19. GHFTF Study Group 1. *Essential principles of Safety and Performance of Medical Devices.* The Global Harmonization Task Force. May 20, 2005

20. Giuliano KK, Scott SS, Elliot S, Giuliano AJ. *Temperature measurement in critically ill orally intubated adults: a comparison of pulmonary artery core, tympanic, and oral methods.* Journal of Critical Care Medicine, Vol. 27(10), Oct. 1999, pp2188-2193
21. Grady, J. *Nursing Procedure: Measuring and Monitoring Temperature in the Highly Dependent or Critically Ill Infant or Child – Tympanic temperature.* NHS:Greater Glasgow and Clyde. Nov. 2010
22. Grant, W. Fitzgerald, E. MacLachlan, E. *Ear Thermometer Design Reduces Measurement Variability* New York: Welch Allyn Costumer Service. 2005
23. Haugan, B. Langerud, A. Kalvøy, H. et al. *Can we trust the new generation of infrared tympanic thermometers in clinical practice?* Journal of Clinical Nursing, Aug. 2012
24. Halliday, D. Resnick, R. Walker, J. *Fundamentals of physics, 9<sup>th</sup> Edition.* John Wiley and Sons, 2010, ISBN-10: 0471216437
25. Hollestelle, M. Hillbers, E. van Dronghelen, A. *Risks associated with the lay use of "over-the-counter" medical devices.* National Institute for Public Health and the Environment, Sept. 2007
26. Jefferies S, Weatherall M, Young P, Beasley R. *A systematic review of the accuracy of peripheral thermometry in estimating core temperatures among febrile critically ill patients.* Critical care and resuscitation, Journal of the Australasian Academy of Critical Care Medicine, Vol.13, Sep. 2011, pp194-199
27. Kocoglu, H. Goksu, S. et al. *Infrared tympanic thermometer can accurately measure the body temperature in children in an emergency room setting.* International Journal of Pediatric Otorhinolaryngology. Vol. 65 2002. pp39-43
28. Konopad E, Kerr JR, Noseworthy T, Grace M. *A comparison of oral, axillary, rectal and tympanic-membrane temperatures of intensive care patients with and without an oral endotracheal tube.* Journal of Advanced Nursing, Vol. 20(1), Jul 1994 pp77-84.
29. Lawson, L. Bridges, E. et al. *Accuracy and precision of noninvasive temperature measurements in adult intensive care patients.* American Journal of Critical Care. Vol.16 2007 pp485-496
30. León, K. Rodriguez, A. Fernandez, A. Flores, L. *Infrared ear thermometry in the critically ill patient. An alternative to axillary thermometry.* Journal of Critical Care. Vol.20, 2005, pp106–110
31. Lim, C. Byrne, C. *Human Thermoregulation and Measurement of Body Temperature in Exercise and Clinical Settings.* Annals of the Academic of Medicine Singapore: Vol. 37, Apr. 2008, pp347-353
32. Lóio, I. Lobo, I. *Norma NP EN 12470-5.* Instituto Português da Qualidade, Dec. 2011
33. Matzukawa, T. Ozaki, M. et al. *A comparison of four tympanic thermometers with tympanic membranes measured by thermocouples.* Canadian Journal of Anesthesia, 1996.43:12 pp1224-1228
34. Modell, J. Katholi, C. Kumaramangalam, S. Hudson, E. Graham, D. *Unreliability of the infrared tympanic thermometer in clinical practice: a comparative study with oral mercury and oral electronic thermometers.* SouthernMedical Journal 1998, Vol.91, pp 649–54.
35. Naomi, P. Philip, S. et al. *Practice parameters for Evaluating new fever in critically ill adult patients.* Critical Care medicine. Vol. 26(2) Feb. 1998, pp392-408
36. Nimah M, Bshesh K, Callahan D, Jacobs R. *Infrared tympanic thermometry in comparison with other temperature measurement techniques in febrile children.* Journal of Pediatric Critical Care Medicine, Vol. 7(1), Jan. 2006, pp48-55
37. Nordås G, Leiren S, Hansen S. *Can ear temperature measurement be used in a hospital?* Tidsskrift for Den norske legeförening. Vol. 125(20), Oct. 2005, pp2763.2765



38. Oliveira, D. *Monitorizacão da Temperatura Corporal com Termómetro Digital Timpanico e Termómetro Digital Axilar: Análise da Reprodutibilidade e da Validade*. Faculdade de Medicina da Universidade do Porto. Oct. 2010
39. Pompei F, Pompei M. *Non-invasive temporal artery thermometry. Presented at: Physics, Physiology, and Clinical Accuracy Medical Thermometry for SARS Detection*. SPIE Defense and Security Symposium; Orlando, FL. 2004;
40. Purssell E, While A, Coomber B. *Tympanic thermometry--normal temperature and reliability*. Paediatric Nursing, Vol. 21(6), Jul. 2009, pp40-43
41. Pusnik, I. van der Ham, E. Drnovsek, J. *IR ear thermometers: What do they measure and how they comply with the EU technical regulations?* Delft: Institute of Physics Publishing, Physiol. Meas. Vol. 25, 2004 pp699-708
42. Shimek, J. Emmanuel, J. *Replacement of mercury thermometers and sphygmomanometers in health care: Technical guidance*. Geneva: World Health Organization. 2011, pp35-36 ISBN 978 92 4 154818 2
43. Smith J. *Are electronic thermometry techniques suitable alternatives to traditional mercury in glass thermometry techniques in the paediatric setting?* Journal of Advanced Nursing, Vol.28(5), Nov. 1998 pp1030-1039
44. Smith R, Wøldike PM, Linneberg A. *Methods of first-choice for clinical temperature measurement in Danish hospital wards*. Ugeskrift for Laeger, Vol.170 (22), May 2008, pp1930-1933
45. Stavem K, Saxholm H, Erikssen J. *Tympanic or rectal temperature measurement? A cost-minimization analysis*. Scandinavian Journal of Infectious Diseases Vol.32, 2000 pp299–301
46. Teriö, H. *Procurement of medical equipment in Sweden*. Zdrav Vestn, Vol.79 2010 pp156-163
47. Tsai, S. Ko, H. Wen, B. & Li, C. *Standard blackbody for infrared tympanic thermometers*. Simposio de Metrologia, Oct. 25-27 2006
48. Villaescusa, M. Pérez, A. Fenoll, A. *Reliability of an infrared auditory thermometer in the measurement of oral temperature*. Med Oral Patol Cir Bucal. Jun. 1-13(6) 2008, pp E385.389
49. Welch Allyn. *Accuracy Study for the Welch Allyn Model 692/690 SureTemp Plus Paediatric Axillary Thermometer*. Dublin: Welch Allyn European Customer Service. 2007
50. Wing, A. *Screening SARS carriers from the Crowds*. Science in Hong Kong: Vol. 1, Spring 2004 pp13-14
51. Zakaria, D. Mierzwinski-Urban, M. *Measuring temperature with infrared tympanic thermometers versus oral, axillary and rectal thermometers for proper patient management*. Canadian Agency for Drugs and Technologies in Health, Aug. 30, 2007

## **B. Manuals**

52. *Gentle Temp 510 Digital ear thermometer*. Omron.2008
53. *IFR100*. Microlife
54. *IR100*. Microlife
55. *IR1DA1*. Microlife
56. *Normal Body Temperature ranges*. Welch Allyn
57. *Operating manual Genius2 Tympanic thermometer and base*. 2011
58. *ri-Thermo N professional*. Riester

59. *Service manual ThermoScan Pro 4000*. Braun GmbH.
60. *User manual ThermoScan Pro 4000*. Braun GmbH. Mar. 2006
61. *Welch Allyn SureTemp Plus*. Welch Allyn

## C. Electronic Sources

62. European Commission. *Medical Devices: Guidance document - Classification of Medical devices*. <[http://ec.europa.eu/health/medical-devices/files/meddev/2\\_4\\_1\\_rev\\_9\\_classification\\_en.pdf](http://ec.europa.eu/health/medical-devices/files/meddev/2_4_1_rev_9_classification_en.pdf)> (13-06-2012)
63. <http://hyperphysics.phy-astr.gsu.edu/hbase/thermo/eartherm.html> (20-06-2012)
64. NASA. *Infrared (IR) Radiation*. [http://www.windows2universe.org/physical\\_science/magnetism/em\\_infrared.html](http://www.windows2universe.org/physical_science/magnetism/em_infrared.html) (29-07-2012)
65. NASA. *The Electromagnetic Spectrum*. <http://science.hq.nasa.gov/kids/imagers/ems/infrared.html> (29-07-2012)
66. Omega Engineering. *Introduction to Infrared Thermometers*. <http://www.omega.com/prodinfo/infraredthermometer.html> (26-07-2012)
67. Omega Engineering. *Principles of Infrared thermocouples*. <http://www.omega.com/temperature/z/pdf/z076-080.pdf> (26-07-2012)
68. Ostman H. *The Evolution of the Thermometer*. <http://ezinearticles.com/?The-Evolution-of-the-Thermometer&id=2732962> (28-07-2012)
69. TME Electronics. *The history of thermometers* [http://www.tmelectronics.co.uk/acatalog/History\\_of\\_Thermometry.pdf](http://www.tmelectronics.co.uk/acatalog/History_of_Thermometry.pdf) (28-07-2012)
70. Virginia Tech. *The Thermopile*. Available from: <<http://scholar.lib.vt.edu/theses/available/etd-8497-205315/unrestricted/chap2.pdf>> (08-06-2012)
71. [www.actherm.com.tw](http://www.actherm.com.tw)
72. [www.brannan.co.uk/](http://www.brannan.co.uk/)
73. [www.carefusion.com/medical-products/infusion/alaris-system/](http://www.carefusion.com/medical-products/infusion/alaris-system/)
74. [www.comdek.com/](http://www.comdek.com/)
75. [www.digio2.com/](http://www.digio2.com/)
76. [www.easytem.co.kr/](http://www.easytem.co.kr/)
77. [www.exergen.com/](http://www.exergen.com/)
78. [www.grahamfield.com/](http://www.grahamfield.com/)
79. [www.hubdic.com/](http://www.hubdic.com/)
80. [www.microlife.com/](http://www.microlife.com/)
81. [www.predictor.eu/](http://www.predictor.eu/)
82. [www.rossmaxhealth.com](http://www.rossmaxhealth.com)
83. [http://www.scb.se/Pages/TableAndChart\\_\\_\\_\\_28319.aspx](http://www.scb.se/Pages/TableAndChart____28319.aspx) (29-08-2012)
84. [www.spengler.fr/](http://www.spengler.fr/)
85. [www.topcom.net/](http://www.topcom.net/)
86. [www.veridianhealthcare.com/](http://www.veridianhealthcare.com/)
87. Zytemp. *Infrared History*. <http://www.zytemp.com/infrared/history.asp> (29-07-2012)

## **Annex I – Market Research**

The introductory part of the market analysis was incorporated in the report. The following pages contain the specifications and characteristics of several devices currently in the market.

Some of the terms used are explained below:

CE Mark: European Conformity Mark

Temperature Range: Range of displayed temperatures in the monitor in °C or °F

Ambient Operating temperature: The range of optimal operating temperature

LCD: Liquid crystal display

LED: Light-emitting diode

Dimensions, L x dia, mm: The shape of the probe is typically conical, with the tip of the cone sliced off for the lens opening. The height of the cone is designated as the length, and the diameter is that of the circular lens opening

No. of Measurements: Average life span of the batteries

## A Cute Baby MT510 Infrared Ear Thermometer

Measures infrared energy emitted from the tympanic membrane.

**Intended Use:** Home care

**Measurement Site:** Ear, surface, scan

**Patient group:** Adults, children and Infants

**Size LWD:** 12.6 x 3.0 x 2.2

**Weight:** 55g



**User's information:** Gently pull the ear back to straighten the ear canal and snugly position the probe into the ear canal, aiming towards the membrane of the eardrum

**Special features:** 3in1 ear thermometer (measurement in the ear, ambient and surface temperature), ten memories, fever alarm, automatic switch-off

**Self-check on start-up:** Yes

**Calibration and Maintenance:**

According to legislation

**Measurement Range:** 0°C-50°C

**Accuracy:**  $\pm 0.2^{\circ}\text{C}$  36°C –39°C and  $\pm 0.3^{\circ}\text{C}$  34°C –36°C and 39°C –43°C

$\pm 1^{\circ}\text{C}$  other temperatures

**Storage conditions:** 10°C+40°C, RH $\leq$ 95%

**Cleaning probe tip:** Cotton swab with Alcohol (70% concentration)

**Cleaning body:** Soft cloth moistened with a soap solution

**Disposable covers:** Required

**Battery:** CR2032 3V (1)

**Manufacturing standards:** ASTM E1965-98, EN12470-5

**CE Mark:** Yes

**Website:** [www.acuteideas.com](http://www.acuteideas.com)

**Email:** [acute@acuteideas.com](mailto:acute@acuteideas.com)

**Manufacturer:** A Cute Baby  
3F, No.11, Lane35, Jihu Road,  
Taipei

114

**Tel.:** 886-2-87514868

## A Cute Baby MT511 Infrared Ear Thermometer

Measures infrared energy emitted from the tympanic membrane.

**Intended Use:** Home care

**Measurement Site:** Ear, surface and scan

**Patient group:** Adults, children and Infants

**Size LWD:** 11.0 x 5.0 x 3.4

**Weight:** 30g

**User's information:** Gently pull the ear back to straighten the ear canal and snugly position the probe into the ear canal, aiming towards the membrane of the eardrum

**Special features:** 3in1 ear thermometer (measurement in the ear, ambient and surface temperature), ten memories, two colours backlight, automatic switch-of

**Self-check on start-up:** Yes

**Calibration and Maintenance:**

According to legislation

**Measurement Range:** 0°C-50°C

**Accuracy:**  $\pm 0.2^{\circ}\text{C}$  36°C –39°C and  $\pm 0.3^{\circ}\text{C}$  34°C –36°C and 39°C –43°C  $\pm 1^{\circ}\text{C}$  other temperatures

**Storage conditions:** 10°C+40°C, RH $\leq$ 95%

**Cleaning probe tip:** Cotton swab with Alcohol (70% concentration)

**Cleaning body:** Soft cloth moistened with a soap solution



**Disposable covers:** Required for ear measurements

**Battery:** CR2032 3V (1)

**Manufacturing standards:** ASTM E1965-98, EN12470-5

**CE Mark:** Yes

**Website:** [www.acuteideas.com](http://www.acuteideas.com)

**Email:** [acute@acuteideas.com](mailto:acute@acuteideas.com)

**Manufacturer:** A Cute Baby  
3F, No.11, Lane35, Jihu Road,  
Taipei

114

**Tel:** 886-2-87514868f

## Actherm 8000R

Measures infrared energy emitted from the tympanic membrane.

**Intended Use:** Hospital, primary and home care

**Measurement Site:** Ear

**Patient group:** Adults, children and Infants

**Size LWD:** n/d

**Weight:** n/d

**User's information:** Several "packs" available, Simple, Cradle, Desktop and Wall mount.

**Special features:** Extra-large and Backlight LCD for easy reading, rechargeable, 10 memories, beeper alarm, Hygienic and Hands-Free Probe Cover Installation and Disposal, Probe Cover Positioning Detective System, Back-light Display Optional for Easy Reading

**Self-check on start-up:** Yes

**Calibration and Maintenance:** According to legislation

**Measurement Range:** 26.0°C - 43.9°C

**Accuracy:**  $\pm 0.2^{\circ}\text{C}$  or  $\pm 0.3^{\circ}\text{C}$  if outside ambient operating parameters

**Storage conditions:** 16.0°C-40°C

**Cleaning probe tip:** Use a cotton swab moistened with alcohol

**Cleaning body:** Use a dampened cloth



**Disposable covers:** Required

**Battery:** AAA 1.5V (2) or rechargeable battery pack

**Manufacturing standards:**

EN 12470-5: 2003 & ASTM E1965-98

**CE Mark:** Yes

**Website:** [www.actherm.com.tw](http://www.actherm.com.tw)

**Manufacturer**

6F, No. 18, Jhanye 2nd Rd.  
Hsinchu Science Park, Hsinchu  
30078, Taiwan, R.O.C

**TEL:** 886 3 666 9596

**FAX:** 886 3 666 9697

**E-mail:**

[actherm@actherm.com.tw](mailto:actherm@actherm.com.tw)

## Alaris Med IVAC Core-Check

Measures infrared energy emitted from the tympanic membrane.

**Intended Use:** Hospital, primary or home care

**Measurement Site:** Ear

**Patient group:** Adults, children and Infants

**Size LWD:** 19.05 x 3.81 x 7.62

**Weight:** 266g with batteries

**User's information:** Place a probe cover on the device. Centre the probe tip far enough into the ear canal to firmly seal the ear canal opening and point in the direction of the tympanic membrane. Gently restrain the head if necessary. Press and hold the temperature switch until the green light flashes and temperature reading is displayed.

**Special features:** Anti-theft, video and wall charts are available to aid in training

**Self-check on start-up:** Yes

**Calibration and Maintenance:** In house, according to legislation

**Measurement Range:** 25°C-43.3°C

**Accuracy:** ±0.1°C

**Storage conditions:** -35°C - 60°C

**Cleaning probe tip:** Use a cotton swab moistened with Isopropanol

**Cleaning body:** Use a cloth dampened with Ammonium or mild detergent



**Disposable covers:** Required

**Battery:** 9V (1)

**Manufacturing standards:**

ASTM E1112-86

**CE Mark:** Yes

**Supplier:** Alaris Med

**Website:**

<http://www.carefusion.com/>

**Manufacturer:**

CareFusion V. Mueller

1500 Waukegan Rd.

Waukegan, IL 60085

**Email:** CS.Sweden@carefusion.com

## Beurer FT-55

Converts the ear temperature to display its “oral equivalent”

**Intended Use:** Hospital, Clinics and home care

**Measurement Site:** Ear, surface, ambient

**Patient group:** Adults, children and Infants

**Size LWD:** 14.5 x 3.4 x 2.8

**Weight:** 57g

**User's information:** Gently pull the ear back to straighten the ear canal and snugly position the probe into the ear canal, aiming towards the membrane of the eardrum to obtain an accurate reading

**Special features:** 3in1 ear thermometer (measurement in the ear, ambient and surface temperature), 9 memories, Large display, Display of normal or elevated temperature with colour LEDs, automatic switch-off

**Self-check on start-up:** Yes

**Calibration and Maintenance:**

Factory every 2 years

**Measurement Range:** 34°C-42.2°C

**Accuracy:** ±0.2°C 35.5°C – 42°C and ±0.3°C other temperatures

**Storage conditions:** -20°C+50°C, RH≤85%

**Cleaning probe tip:** Cotton swab with Alcohol, Water or disinfectant

**Cleaning body:** Soft cloth moistened with a soap solution

**Disposable covers:** Required



**Battery:** CR2032 3V (1)

**Manufacturing standards:**

ASTM E1965-98, EN12470-5: 2003, IEC/EN60601-1-2

**CE Mark:** Yes

**Website:** <http://beurer.com>

**Email:** [export@beurer.de](mailto:export@beurer.de)

**Manufacturer:** Beurer GmbH

Soeflinger Strasse 218

89077 Ulm

Germany

**Tel.:** +49(0)7 31/39 89-0



## Bosotherm Medical

Infrared detector measures emitted radiation from the inner ear and predicts ear temperature

**Intended Use:** Home care

**Measurement Site:** Ear and surfaces

**Patient group:** Adults, children and Infants?

**Size LWD:** 14.1 x 2.6 x 2.0

**Weight:** 45g with battery

**User's information:** While gently pulling the ear, insert the probe carefully into the ear canal and press the "START" button. A beep sound confirms the end of measurement.

**Special features:** "Nite glow",  
Fever alarm, automatic switchoff

**Self-check on start-up:** Yes

**Calibration and Maintenance:**

According to legislation.

**Measurement Range:** 0°C-100°C

**Accuracy:** ±0.2°C

**Storage conditions:** -25°C-55°C  
40%-80% RH

**Cleaning probe tip:** Use an alcohol sponge or cotton swab moistened with alcohol (70% Isopropyl) to clean the thermometer casing and the measuring probe.

**Cleaning body:** Never use abrasive cleaning agents, thinners or benzene for cleaning



**Disposable covers:** Required

**Battery:** 3.0V CR2032 (1)

**Manufacturing standards:**  
EN 12470-5; ASTM E1965

**CE Mark:** Yes

**Website:** [www.boso.de](http://www.boso.de)

**Manufacturer:**

BOSCH + SOHN GMBH U. CO.  
KG

Bahnhofstrasse 64

72417 Jungingen/Germany

**Email:** [zentrale@boso.de](mailto:zentrale@boso.de)

## Braun IRT 3020



Measures the infrared heat generated by the eardrum and surrounding tissues.

**Intended Use:** Hospital and primary care

**Measurement Site:** Ear

**Patient group:** Adults, children and Infants

**Size LWD:** 15.5 x 3.5 x 4.5

**Weight:** 120g

**User's information:** Detailed user manual provided. Information on range for normal temperature readings is supplied for site and patient age group.

**Special features:** Displays message for position error, Ambient temperature error, no probe cover attached, measured temperature too high or too low, system error, low battery, battery too low to take correct temperature measurements, thermometer stand.

Anti-theft

**Self-check on start-up:** Yes

**Calibration and Maintenance:** Done in factory (once a year or according to legislation)

**Measurement Range:** 20°C-42.2°C

**Accuracy:**  $\pm 0.2^{\circ}\text{C}$  if in the range between 35.5°C-42.0°C or 0.3°C if outside 35.5°C-42.0°C

**Storage conditions:** -20°C-40°C  
RH up to 95%

**Cleaning probe tip:** gently wipe its surface with a cotton swab slightly moistened with alcohol and then wipe dry with a clean cotton swab



**Cleaning body:** Use a soft cloth slightly moistened with alcohol to clean the thermometer display and exterior. Do not use abrasive cleaners.

**Disposable covers:** Required

**Battery:** AA 1.5V (2)

**Manufacturing standards:**  
ASTM:E 1965-98; EN 60601-1: EN 12470-5: 2003

**CE Mark:** Yes

**Supplier:** Welch Allyn AB  
Svärdvägen 21  
182 33 Danderyd

**Website:** [www.welchallyn.se](http://www.welchallyn.se)

**Email:** [sverige@welchallyn.com](mailto:sverige@welchallyn.com)

**Manufacturer:** Braun GmbH

## Comdek Industrial HD-7

Takes body temperature by measuring infrared heat from the eardrum.

**Intended Use:** Home use

**Measurement Site:** Ear

**Patient group:** Adults, children and Infants

**Size LWD:** 15 x 3.3 x 9

**Weight:** 101g without batteries

**User's information:** Gently pull the ear back to straighten the ear canal and gently position the probe into the ear canal, aiming towards the membrane of the eardrum to obtain an accurate reading

**Special features:** Large LCD, low battery indicator, hold sign

**Self-check on start-up:** Yes

**Calibration and Maintenance:** According to legislation

**Measurement Range:** 34°C-42°C

**Accuracy:**

**Storage conditions:** 5°C+55°C, RH<=95%

**Cleaning probe tip:** Use a cotton swab moistened with alcohol

**Cleaning body:** Use a dampened cloth

**Disposable covers:** Required

**Battery:** AA 1.5V (2)

**Manufacturing standards:** ISO9001, ISO13485, CE0434

**CE Mark:** Yes



**Website:**

<http://www.comdek.com>

**Email:**

[matthewjonse@comdek.com](mailto:matthewjonse@comdek.com)

**Manufacturer:** Comdek Industrial

9F-1, No. 3, Yuan Qu Street, Nan-Kang,

Taipei 11503, Taiwan

Tel: 886-2-2655-7810

## Comdek Industrial HD-11

Takes body temperature by measuring infrared heat from the eardrum.

**Intended Use:** Professional use

**Measurement Site:** Ear

**Patient group:** Adults, children and Infants

**Size LWD:** 15 x 3.3 x 9

**Weight:** 101g without batteries

**User's information:** Continuous scanning, Gently pull the ear back to straighten the ear canal and gently position the probe into the ear canal, aiming towards the membrane of the eardrum to obtain an accurate reading

**Special features:** Large LCD, low battery indicator, hold sign, 2 minutes auto shut-off, continuous scanning

**Self-check on start-up:** Yes

**Calibration and Maintenance:** According to legislation

**Measurement Range:** 20°C-50°C

**Accuracy:**

**Storage conditions:** 5°C+55°C, RH<=95%

**Cleaning probe tip:** Use a cotton swab moistened with alcohol

**Cleaning body:** Use a dampened cloth

**Disposable covers:** Required

**Battery:** AA 1.5V (2)



**Manufacturing standards:** ISO9001, ISO13485, CE0434

**CE Mark:** Yes

**Website:** [www.comdek.com](http://www.comdek.com)

**Email:** [matthewjonse@comdek.com](mailto:matthewjonse@comdek.com)

**Manufacturer:** Comdek Industrial

9F-1, No. 3, Yuan Qu Street, Nan-Kang,

Taipei 11503, Taiwan

Tel: 886-2-2655-7810

## Comdek Industrial HD-21

Takes body temperature by measuring infrared heat from the eardrum.

**Intended Use:** Home use

**Measurement Site:** Ear

**Patient group:** Children and Infants

**Size LWD:** 9.2 x 4.5 x 6.5

**Weight:** 101g without batteries

**User's information:** Continuous scanning, Gently pull the ear back to straighten the ear canal and gently position the probe into the ear canal, aiming towards the membrane of the eardrum to obtain an accurate reading

**Special features:** Foldable design, Large LCD, low battery indicator, hold sign, continue sign, 2 minutes auto shut-off, continuous scanning

**Self-check on start-up:**

**Calibration and Maintenance:**

According to legislation

**Measurement Range:** 34°C-42°C

**Accuracy:**

**Storage conditions:** 5°C+55°C,  
RH<=95%

**Cleaning probe tip:** Use a cotton swab moistened with alcohol

**Cleaning body:** Use a dampened cloth

**Disposable covers:** Required

**Battery:** AA 1.5V (2)

**Manufacturing standards:**  
ISO9001, ISO13485, CE0434



**CE**

**Mark:** Yes

**Website:**

<http://www.comdek.com>

**Email:**

[matthewjonse@comdek.com](mailto:matthewjonse@comdek.com)

**Manufacturer:** Comdek

Industrial

9F-1, No. 3, Yuan Qu Street, Nan-Kang,

Taipei 11503, Taiwan

Tel: 886-2-2655-7810

## Covidien Genius2

The Genius2 thermometer uses its proprietary Peak Select System technology to determine the body's accurate temperature directly from the tympanic membrane.

**Intended Use:** Hospital

**Measurement Site:** Ear with several offset modes

**Patient group:** All Ages

**Size LWD:** 17.8cm

**Weight:** 160g, base 100g

**User's information:** Place the probe in the ear canal and seal the opening with the probe tip. Once positioned lightly in the ear canal press and release the scan button. Wait for the triple beep before removing the thermometer.

**Special features:** Ambidextrous use, Peak select system, Oral, Rectal, Core and Ear offsets

**Self-check on start-up:** Yes

**Calibration and Maintenance:** In house, 12 months checks recommended

**Measurement Range:** 33°C-42°C

**Accuracy:**  $\pm 0.2^{\circ}\text{C}$  -  $\pm 0.3^{\circ}\text{C}$  (after recalibration)

**Storage conditions:**  $-25^{\circ}\text{C}$ - $55^{\circ}\text{C}$  up to 95% of non-condensing RH



**Cleaning probe tip:** Isopropyl alcohol wipe

**Cleaning body:** may be wiped clean with a damp cloth. Water temperature should not exceed  $55^{\circ}\text{C}$

**Disposable covers:** Required

**Battery:** AAA 1.5V (3)

**Manufacturing standards:** EN12470:5-2003, ASTM E1965-98, ISO

**CE Mark:** Yes

**Website:**

**Email:** csSweden@covidien.com

**Manufacturer:** Covidien/Kendall  
Principal Executive Office

Covidien plc

20 Lower Hatch Street

Dublin 2, Ireland

# DigiO2 ETH-101

Measures infrared energy emitted from the tympanic membrane.

**Intended Use:** Home care

**Measurement Site:** Ear

**Patient group:** Adults, children and Infants

**Size LWD:** n/d

**Weight:** n/d

**User's information:** is designed to provide a reliable yet convenient and easy to use thermometer.

**Special features:** Suspended tip, avoiding surface contact; 2 inches large screen, intuitive 3 colour LCD backlight for temperature indication, 30 memory recall with time and date, anti-bacterial probe

**Self-check on start-up:**

**Calibration and Maintenance:** According to legislation

**Measurement Range:** 34°C-43°C

**Accuracy:**  $\pm 0.2^{\circ}\text{C}$ - $\pm 0.3^{\circ}\text{C}$

**Storage conditions:** -20°C-50°C

**Cleaning probe tip:** Isopropyl alcohol wipe

**Cleaning body:** may be wiped clean with a damp cloth

**Maintenance and ongoing costs:**

**Disposable covers:** Required

**Battery:** n/d

**Manufacturing standards:**

EN127470-5 and ASTM E-1965-98

**CE Mark:** Yes

**Supplier:** DigiO2

**Website:**

**Email:** Sales@digio2.com

**Manufacturer:** DigiO2

No. 582, Kuo-Hwa Rd. Miaoli  
360, Taiwan

+88637330099





## Easytem BT-020

The Easytem BT-020 makes the reading by measuring the heat through infrared light.

**Intended Use:** Hospital, primary or home care

**Measurement Site:** Ear

**Patient group:** Adults, children and Infants

**Size LWD:** 13.6 x 3.8 x 5.1

**Weight:** 53g

**User's information:** takes a total of nine different measurements in one second and displays the highest reading

**Special features:** Beeps when measurement completes, memory for ten readings, automatic power-off after 20 seconds, may be used without probe cover

**Self-check on start-up:**

**Calibration and Maintenance:**  
According to legislation

**Measurement Range:** 0°C-100°C

**Accuracy:** 36 to 39°: ±0.2°C.  
Other temperatures: 2%

**Storage conditions:** From 25°C to 50°C with RH from 15 to 95%

**Cleaning probe tip:** Wipe lightly with a soft dry cloth or a cotton swab



**Cleaning body:** Wipe with a clean or a damp cloth.

**Disposable covers:** Required

**Battery:** 3.0V CR2032 (1)

**Manufacturing standards:**  
n/d

**CE Mark:** Yes

**Website:**

<http://www.easytem.co.kr>

**Email:** Easytem@easytem.co.kr

**Manufacturer:** Easytem Co. Ltd.

# Easytem BT-021

The Easytem BT-021 makes the reading by measuring the heat through infrared light.

**Intended Use:** Hospital, primary or home care

**Measurement Site:** Ear and forehead

**Patient group:** Adults, children and Infants

**Size LWD:** 13.6x3.8x5.3

**Weight:** 53g

**User's information:** takes a total of nine different measurements in one second and displays the highest reading

**Special features:** switch off automatically after 20s, memory for 10 readings, beeps when measurement completes, may be used without covers

**Self-check on start-up:**

**Calibration and Maintenance:** According to legislation

**Measurement Range:** 0°-100°C // 22°C -43°C

**Accuracy:** 36 to 39°C : ±0.2°C

Other temperatures: ±0.3°C //

Forehead Mode: ±0.3°C

**Storage conditions:**-25°C-50°C

Relative humidity: 15-95%



**Cleaning probe tip:** Isopropyl alcohol wipe

**Cleaning body:** Wipe clean with a damp cloth.

**Disposable covers:** Not Required

**Battery:** DC 3.0V CR2032 (1)

**Manufacturing standards:**

n/d

**CE Mark:** Yes

**Website:**

<http://www.easytem.co.kr>

**Email:** Easytem@easytem.co.kr

**Manufacturer:** Easytem Co. Ltd.

## Exergen Ototemp 3000SD

Scans to read actual tympanic temperature without offsets

**Intended Use:** Operation in harsh conditions

**Measurement Site:** Ear

**Patient group:** patients over 3 years old

**Size LWD:** 16.5 x 8.9 x 1.9

**Weight:** 184g

**User's information:** The Ototemp 3000 Special Duty Tympanic Thermometer was designed specifically for field use in harsh, demanding environments, such as at Marathons, Olympic Games, and in Desert Shield.

**Special features:** Special heavy duty thermometer. Can scan to read actual tympanic temperature without offsets

**Self-check on start-up:** Yes

**Calibration and Maintenance:** In House and in factory, according to legislation

**Measurement Range:** 18.3°C-54.4°C

**Accuracy:** n/d

**Storage conditions:** n/d

**Cleaning probe tip:** Wipe lightly with a soft dry cloth or a cotton swab

**Cleaning body:** Wipe with a clean or a damp cloth.

**Disposable covers:** Required

**Battery:** 9V (1)

**Manufacturing standards:**

n/d

**CE Mark:** Yes

**Website:** [www.exergen.com](http://www.exergen.com)

**Email:** [industrial@exergen.com](mailto:industrial@exergen.com)

**Manufacturer:** Exergen

400 Pleasant St. Watertown, MA 02472

**Phone:** 617-923-9900 F // (800) 422-3006



## Exergen Ototemp Light touch

Scans to measure arterial heat balance at ear

**Intended Use:**

**Measurement Site:** Ear and forehead

**Patient group:** Neonates

**Size LWD:** 5x20x3

**Weight:** 184g

**User's information:** informacoes simples sobre o aparelho, ou como tirar a temperatura

**Special features:** Probe does not enter ear canal; scans to measure arterial heat balance at ear; complete copper coating for EMI/RFI protection; impact-resistant casing; hermetically sealed sensing system; stainless steel probe.

**Self-check on start-up:** Yes

**Calibration and Maintenance:** In House and in factory, according to legislation

**Measurement Range:** 16.6°C-43.3°C

**Accuracy:** n/d

**Storage conditions:** n/d

**Cleaning probe tip:** Use a cotton swab with alcohol to gently clean the surface of the lens.

**Cleaning body:** Use a cloth moistened with alcohol

**Disposable covers:** Required

**Battery:** 9V alkaline

**Manufacturing standards:**

n/d

**CE Mark:** Yes

**Website:** www.exergen.com

**Email:**

industrial@exergen.com

**Manufacturer:** Exergen

400 Pleasant St. Watertown, MA  
02472

**Phone:** 617-923-9900 F // (800)  
422-3006



# GF Health Products Deluxe Instant-Read Ear Thermometer Model 2215

Measures infrared energy emitted from the tympanic membrane.

**Intended Use:** Home care

**Measurement Site:** Ear

**Patient group:** Adults, children

**Size LWD:** 11.4 x 3.8 x 3.0

**Weight:** 64g

**User's information:** Straighten the ear canal by pulling the ear back and insert the probe

**Special features:** No probe cover required, Auto Shut off, LCD colour changes with temperature, automatically converts measured ear temperature reading to oral temperature, 10 memory capability

**Self-check on start-up:** Yes

**Calibration and Maintenance:** Factory, in house, according to legislation

**Measurement Range:** 20°C-42.2°C

**Accuracy:** ±0.2°C

**Storage conditions:** -25°C-55°C and <95%RH

**Cleaning probe tip:** Use a cotton swab with alcohol to gently clean the surface of the lens.

**Cleaning body:** Use a cloth moistened with alcohol



**Disposable covers:** Not Required

**Battery:** DC 3.0V CR2032 (1)

**Manufacturing standards:** EN12470-5, ASTM1965-98, ISO13485

**CE Mark:** Yes

**Supplier:** Graham Field

**Website:** [www.grahamfield.com](http://www.grahamfield.com)

**Email:** [export@grahamfield.com](mailto:export@grahamfield.com)

**Manufacturer:** GF Health Products, Inc.

2935 Northeast Parkway

Atlanta, Georgia 30360

678-291-3207

## HuBDIC NET100

Measures infrared energy emitted from the tympanic membrane.

**Intended Use:** Home care

**Measurement Site:** Ear

**Patient group:** Adults, children and Infants

**Size LWD:** 14.9 x 3.2 x 3.1

**Weight:** 50g w/batteries

**User's information:** Gently pull the ear back to straighten the ear canal and snugly position the probe into the ear canal, aiming towards the membrane of the eardrum to obtain an accurate reading

**Special features:** Probe cover free

**Self-check on start-up:** Yes

**Calibration and Maintenance:**

According to legislation

**Measurement Range:** 32°C-42.2°C

**Accuracy:**  $\pm 0.2^{\circ}\text{C}$

**Storage conditions:**

**Cleaning probe tip:** Cotton swab with Alcohol (70% concentration)

**Cleaning body:**

**Disposable covers:** Not required

**Battery:** CR2032 3V (1)

**Manufacturing standards:** n/d



**CE Mark:** Yes

**Website:** [www.hubdic.com](http://www.hubdic.com)

**Email:** [e-sales@hubdic.com](mailto:e-sales@hubdic.com)

**Manufacturer:** Hubdic

B-301, Taekwang-industrial building, 191-1, Anyang 7-dong, Manan-gu, Anyan-si, Gyeonggi-do, Korea

430-815

## HuBDIC NET100

Measures infrared energy emitted from the tympanic membrane

**Intended Use:** Home care

**Measurement Site:** Ear

**Patient group:** Adults, children and Infants

**Size LWD:** 14.9 x 3.2 x 3.1

**Weight:** 50g w/batteries

**User's information:** Gently pull the ear back to straighten the ear canal and snugly position the probe into the ear canal, aiming towards the membrane of the eardrum to obtain an accurate reading

**Special features:** Probe cover free

**Self-check on start-up:** Yes

**Calibration and Maintenance:**

According to legislation

**Measurement Range:** 0°C-100°C

**Accuracy:** ±0.2°C

**Storage conditions:**

**Cleaning probe tip:** Cotton swab with Alcohol (70% concentration)

**Cleaning body:** Alcohol-moistened cotton tissue

**Disposable covers:** Not required

**Battery:**

CR2032

3V (1)

**Manufacturing standards:** n/d

**CE Mark:** Yes

**Website:** [www.hubdic.com](http://www.hubdic.com)

**Email:** [e-sales@hubdic.com](mailto:e-sales@hubdic.com)

**Manufacturer:** Hubdic

B-301, Taekwang-industrial building, 191-1, Anyang 7-dong, Manan-gu, Anyan-si, Gyeonggi-do, Korea

430-815



# Microlife IR 100

Infrared detector measures emitted radiation from the inner ear and predicts ear temperature

**Intended Use:** Home use

**Measurement Site:** Ear

**Patient group:** All ages

**Size LWD:** 12.0 x 3.5 x 6.0

**Weight:** 53g

**User's information:** This thermometer offers a wide measurement range feature from 0 °C to 100.0 °C

**Special features:** Multiple Uses, 0° C -100° C measurement, Probe is cover free, Fever alarm, Auto-Display Memory

**Self-check on start-up:** Yes

**Calibration and Maintenance:**  
According to legislation

**Measurement Range:** 0° C - 100°C

**Accuracy:** ±0.2°C

**Storage conditions:** -25°C-55°C,  
15-95 % maximum relative humidity

**Cleaning probe tip:** Alcohol-moistened cotton tissue

**Cleaning body:** Alcohol-moistened cotton tissue

**Disposable covers:** Required



**Battery:**

DC 3.0V CR2032 (1)

**Manufacturing standards:**

EN 12470-5; ASTM E1965;  
IEC 60601-1; IEC 60601-1-2  
(EMC)

**CE Mark:** Yes

**Website:** [www.microlife.com](http://www.microlife.com)

**Email:** [sales@microlife.ch](mailto:sales@microlife.ch)  
[service@microlife.ch](mailto:service@microlife.ch)

**Manufacturer:** Microlife AG  
Swiss Corporation  
Esenstrasse 139  
CH-9443 Widnau/ Switzerland  
Tel. +41 71 727 70 00



# Microlife IR 120

Infrared detector measures emitted radiation from the inner ear and predicts ear temperature

**Intended Use:** Home use

**Measurement Site:** Ear

**Patient group:** All ages

**Size LWD:** 14.0 x 4.7 x 1.5

**Weight:** 59g

**User's information:** This thermometer offers a wide measurement range feature from 0 °C to 100.0 °C

**Special features:** Multiple Uses, 0° C -100° C measurements, Fever alarm, Auto-Display Memory, High temperature indication

**Self-check on start-up:** Yes

**Calibration and Maintenance:**

According to legislation

**Measurement Range:** 0° C - 100°C

**Accuracy:** ±0.2°C

**Storage conditions:** -25°C-55°C, 15-95 % maximum relative humidity

**Cleaning probe tip:** Alcohol-moistened cotton tissue

**Cleaning body:** Alcohol-moistened cotton tissue

**Disposable covers:** Required

**Battery:** CR2032 3V (1)



**Manufacturing standards:**

EN 12470-5; ASTM E1965;

IEC 60601-1; IEC 60601-1-2 (EMC)

**CE Mark:** Yes

**Website:** [www.microlife.com](http://www.microlife.com)

**Email:** [sales@microlife.ch](mailto:sales@microlife.ch)  
[service@microlife.ch](mailto:service@microlife.ch)

**Manufacturer:** Microlife AG  
Swiss Corporation

Espenstrasse 139

CH-9443 Widnau/ Switzerland

Tel. +41 71 727 70 00

# Microlife IR 1DA1

Infrared detector measures emitted radiation from the inner ear and predicts ear temperature

**Intended Use:** Home use

**Measurement Site:** Ear

**Patient group:** All ages

**Size LWD:** 14.1 x 2.6 x 2.0

**Weight:** 45g

**User's information:** This thermometer offers a wide measurement range feature from 0°C to 100.0 °C

**Special features:** Multiple Uses, 0° C -100° C measurements, Fever alarm, Auto-Display Memory, High temperature indication

**Self-check on start-up:** Yes

**Calibration and Maintenance:**

**Measurement Range:** 0° C - 100°C

**Accuracy:** ±0.2°C to 1°C

**Storage conditions:** -25°C-55°C, 15-95 % maximum relative humidity

**Cleaning probe tip:** Alcohol-moistened cotton tissue

**Cleaning body:** Alcohol-moistened cotton tissue

**Disposable covers:** Required

**Battery:** CR2032 3V (1)



**Manufacturing standards:**

EN 12470-5; ASTM E1965;  
IEC 60601-1; IEC 60601-1-2  
(EMC)

**CE Mark:** Yes

**Website:** [www.microlife.com](http://www.microlife.com)

**Email:** [sales@microlife.ch](mailto:sales@microlife.ch)  
[service@microlife.ch](mailto:service@microlife.ch)

**Manufacturer:** Microlife AG  
Swiss Corporation

Espenstrasse 139

CH-9443 Widnau/ Switzerland

Tel. +41 71 727 70 00

## Omron Gentle Temp MC-510-E

Infrared detector measures emitted radiation from inner ear and uses to predict ear temperature

**Intended Use:** Hospital and home care

**Measurement Site:** Ear

**Patient group:** All ages

**Size LWD:** 9.3 x 4.6 x 5.7

**Weight:** 50g

**User's information:** Movement of the unit in the ear enables maximum temperature detected. Three repeated measurements warms up the device, so ten minutes must pass before further readings. Do not use portable phone near the unit.

**Special features:** Fast measurement (1-3seconds) and 10 second measurement for difficult measurement conditions, auto shut off, low battery

**Self-check on start-up:** Yes

**Calibration and Maintenance:** Comes with factory calibration. Recommended once a year for professional units

**Measurement Range:** 34°C – 42.2°C

**Accuracy:** ±0.2°C

**Storage conditions:** 10°C to 40°C, Relative humidity: 30 - 85%

**Cleaning probe tip:** Wipe it lightly with a soft dry cloth or a cotton swab.

**Cleaning body:** Lightly wipe off any dirt from the main unit with a soft dry cloth.

**Disposable covers:** Required



**Battery:** 3.0V CR2032 (1)

**Manufacturing standards**

EN 12470-5:2003, ASTM E1965-98, ISO9001:2000

**CE Mark:** Yes

**Website:** [www.omron.com](http://www.omron.com)

**Manufacturer:** OMRON HEALTHCARE CO. LTD.

24, Yamanouchi Yamanoshita-cho, Ukyo-ku, Kyoto, 615-0084 Japan

## Predictor Ear Thermometer

The Predictor ear thermometer converts the temperature taken in the ear into an oral temperature

**Intended Use:** Home care

**Measurement Site:** Ear

**Patient group:** All ages

**Size LWD:** n/d

**Weight:** n/d

**User's information:** Insert the sensor into the ear canal in the direction of the eardrum and briefly press the On/Off button. An arrow is displayed on the screen to indicate that temperature measurement is in progress.

A double beep then sounds to indicate that the measurement is completed.

**Special features:** Rotating head positions, 1 memory, auto shut off, low battery, large display, easy to handle, compact design

**Self-check on start-up:** Yes

**Calibration and Maintenance:**  
According to legislation

**Measurement Range:** 32.2°C – 43.3°C

**Accuracy:**  $\pm 0.2^{\circ}\text{C}$  between 36°C and 39°C,  $\pm 0.3^{\circ}\text{C}$  for other temperatures

**Disposable covers:** Required

**Battery:** 3.0V CR2032 (1)

**Manufacturing standards**

EN 12470-5 EN60601-1,  
ISO9001:2000

**CE Mark:** Yes

**Storage conditions:**  $-25^{\circ}\text{C}$  to  $55^{\circ}\text{C}$ , Relative humidity below 85%

**Cleaning probe tip:** cotton swab lightly dipped in alcohol. **Cleaning body:** Lightly wipe off any dirt from the main unit with a soft dry cloth.

**Supplier:** Laboratoires Omega Pharma France

BP850 - 92542 Montrouge Cedex

**Website:** [www.predictor.be](http://www.predictor.be)

**Manufacturer:** Thermofina - 77 France



## Riester ri-Thermo N Professional

Takes body temperature by measuring infrared heat

**Intended Use:** Hospital and home care

**Measurement Site:** Ear

**Patient group:** Adults, children and Infants

**Size LWD:** 15.7 x 4.1 x 6.9

**Weight:** 150g

**User's information:** informacoes simples sobre o aparelho, ou como tirar a temperature

**Special features:** Temperature curves can also be plotted retrospectively or different measured values compared, so patients large and small can be monitored even more closely.

Sounds a handy acoustic signal when it has finished measuring and if it detects a fever

**Self-check on start-up:** Yes

**Calibration and Maintenance:** According to legislation

**Measurement Range:** 0°C-100°C

**Accuracy:** ±0.2°C

**Storage conditions:** -25°C - +55°C

**Cleaning probe tip:**

**Cleaning body:** Lightly wipe off any dirt from the main unit with a soft dry cloth.

**Disposable covers:** Required

**Battery:** 3.0V CR2032 (1)



**Manufacturing standards:**

ASTM E-1965

**CE Mark:** No

**Supplier:** AB Henry Eriksson  
Skebokvarnsvägen 267  
SE-12453 Bandhagen  
0046 8 647 4805

**Website:** [www.riester.de](http://www.riester.de)

**Email:** [info@henryeriksson.se](mailto:info@henryeriksson.se)

**Manufacturer:** Riester

## Rossmax TD100

Converts the ear temperature to display its “oral equivalent”

**Intended Use:** Hospital, Clinics and home care

**Measurement Site:** Ear

**Patient group:** Adults, children and Infants

**Size LWD:** n/d

**Weight:** n/d

**User’s information:** Gently pull the ear back to straighten the ear canal and snugly position the probe into the ear canal, aiming towards the membrane of the eardrum to obtain an accurate reading

**Special features:** Smallest hygiene probe cover, 9 memories, Fever Alarm

**Self-check on start-up:** Yes

**Calibration and Maintenance:** Factory every 3 years

**Measurement Range:** 34°C-42.2°C

**Accuracy:** ±0.2°C 35.5°C – 42°C and ±0.3°C other temperatures

**Storage conditions:** -20°C+50°C, RH≤85%

**Cleaning probe tip:** Cotton swab with Alcohol (70% concentration)

**Cleaning body:** Lightly wipe off any dirt from the main unit with a soft dry cloth.



**Disposable covers:** Required

**Battery:** CR2032 3V (1)

**Manufacturing standards:** ASTM E1965-98, EN12470-5: 2003, IEC/EN60601-1-2, IEC/EN60601-1

**CE Mark:** Yes

**Website:**

<http://www.rossmaxhealth.com>

**Email:** [emea@rossmaxhealth.com](mailto:emea@rossmaxhealth.com)

**Manufacturer:** Tramstrasse 16  
CH-9442 Berneck  
Switzerland

**Tel:** +41 71 747 11 93

## Rossmax TE100

Converts the ear temperature to display its “oral equivalent”

**Intended Use:** Home care

**Measurement Site:** Ear, Forehead, scan

**Patient group:** Adults, children and Infants

**Size LWD:** n/d

**Weight:** n/d

**User’s information:** Gently pull the ear back to straighten the ear canal and snugly position the probe into the ear canal, aiming towards the membrane of the eardrum to obtain an accurate reading

**Special features:** 3 in 1 (forehead, ear, room), High/low temperature, risk indicator, Free of probe cover, 9 memories, Fever Alarm, Date & Time indicator

**Self-check on start-up:** Yes

**Calibration and Maintenance:**  
Factory every 3 years

**Measurement Range:** 34°C-42.2°C

**Accuracy:**  $\pm 0.2^{\circ}\text{C}$  35.5°C – 42°C  
and  $\pm 0.3^{\circ}\text{C}$  other temperatures

**Storage conditions:**  $-20^{\circ}\text{C}+50^{\circ}\text{C}$ ,  
RH $\leq$ 85%

**Cleaning probe tip:** Cotton swab  
with Alcohol (70% concentration)

**Cleaning body:** Lightly wipe off any  
dirt from the main unit with a soft dry  
cloth.



**Disposable covers:** Not Required

**Battery:** CR2032 3V (1)

**Manufacturing standards:**  
ASTM E1965-98, EN12470-5: 2003,  
IEC/EN60601-1-2, IEC/EN60601-1

**CE Mark:** Yes

**Website:**

<http://www.rossmaxhealth.com>

**Email:** [emea@rossmaxhealth.com](mailto:emea@rossmaxhealth.com)

**Manufacturer:** Tramstrasse 16  
CH-9442 Berneck  
Switzerland

**Tel:** +41 71 747 11 93

## Spengler Temp'O

Takes body temperature by measuring infrared heat

**Intended Use:** Home care

**Measurement Site:** Ear

**Patient group:** Adults, children and Infants?

**Size LWD:** n/d

**Weight:** 500g

**User's information:** Gently pull the ear back to straighten the ear canal and snugly position the probe into the ear canal, aiming towards the membrane of the eardrum to obtain an accurate reading

**Special features:** Compact, takes measurement in 1 second,

**Self-check on start-up:** Yes

**Calibration and Maintenance:** Factory or in house, according to legislation

**Measurement Range:** 32.2°C – 43.3°C

**Accuracy:** ±0.3°C

**Storage conditions:** -25°C+55°C

**Cleaning probe tip:** Cotton swab with Alcohol (70% concentration)

**Cleaning body:** Lightly wipe off any dirt from the main unit with a soft dry cloth.

**Disposable covers:** Required

**Battery:** AAA 1.5V (2)

**Manufacturing standards:** ISO9001

**CE Mark:** Yes

**Website:** [www.spengler.fr](http://www.spengler.fr)

**Email:** [export@spangler.fr](mailto:export@spangler.fr)

**Manufacturer:** Spengler SAS  
39/41, avenue Aristide Briand  
92163 Antony Cedex  
France





## Topcom Ear&Forehead 301

Uses infrared technology to measure infrared energy emitted from the forehead or eardrum and surrounding tissue, and then converts it into temperature value.

**Intended Use:** Home care

**Measurement Site:** Ear, forehead and scan

**Patient group:** Adults, children and Infants

**Size LWD:** n/d

**Weight:** 65g

**User's information:** While holding the ear, insert the probe to seal the ear canal. Press the START button once. You will hear a short beep. The ear mode icon is displayed. When you hear a double beep, the measurement is finished. Take out the thermometer from the ear canal. The result is displayed.

**Special features:** Temperature LED indication, 30 Memory feature recall, fever alarm, sequential measurement, Auto shut-off

**Self-check on start-up:** Yes

**Calibration and Maintenance:** According to legislation

**Measurement Range:** 32°C - 42.9°C

**Accuracy:** ±0.2°C 35.5°C - 42°C- ±0.3°C for other temperatures

**Storage conditions:** -10°C-55°C, RH 30%-80%

**Cleaning probe tip:** cotton swab moistened with alcohol



**Cleaning body:** Lightly wipe off any dirt from the main unit with a soft dry cloth.

**Disposable covers:** Required

**Battery:** CR2032 3V (1)

**Manufacturing standards:** n/d

**CE Mark:** Yes

**Website:** [www.topcom.se](http://www.topcom.se)

**Email:** [info@topcom.se](mailto:info@topcom.se)

**Manufacturer:** Energigatan 10  
434 37 Kungsbacka, Sverige

## Veridian VTemp Pro

Takes body temperature by measuring infrared heat

**Intended Use:** Hospital, primary and home care

**Measurement Site:** Ear

**Patient group:** Adults, children and Infants

**Size LWD:** 11.5x9.5x5.5

**Weight:** 1.04Kg (with all accessories)

**User's information:** Straighten the ear canal by pulling the ear back and insert the probe

**Special features:** Oversized illuminated LCD, 10 Memory feature recall, Auto shut-off, docking station, hands free probe cover application and disposal

**Self-check on start-up:** Yes

**Calibration and Maintenance:**

According to legislation

**Measurement Range:** 26.0°C – 43.9°C

**Accuracy:** n/d

**Storage conditions:** -25°C+55°C

**Cleaning probe tip:** Cotton swab with Alcohol (70% concentration)

**Cleaning body:** Lightly wipe off any dirt from the main unit with a soft dry cloth.

**Disposable covers:** Required



**Battery:** AA1.5V (2)

**Manufacturing standards:** n/d

**CE Mark:** Yes

**Supplier:** Veridian Healthcare, LLC

**Website:**

[www.veridianhealthcare.com](http://www.veridianhealthcare.com)

**Email:**

[info@veridianhealthcare.com](mailto:info@veridianhealthcare.com)

**Manufacturer:** Veridian Healthcare, LLC

1465 S. Lakeside Drive Waukegan, Illinois 60085

**Phone:** 866-799-8181

## Devices Specifications

The following tables contain the specifications of each of the devices

	<b>A Cute Baby MT510 Infrared Ear Thermometer</b>	<b>A Cute Baby 511 Infrared Ear Thermometer</b>	<b>Atherm ACT 8000/8000R</b>	<b>Alaris Med IVAC Core- Check</b>
Highest Accuracy	±0.3°C	±0.3°C	±0.2°C	±0.1°C
Lowest accuracy (eg outside operating range)	±1°C	±1°C	±0.3°C	n/d
Operating Range	0°C-50°C	0°C-50°C	26.0°C - 43.9°C	25°C-43.3°C
Ambient temperature range	10.0°C-40.0°C	10.0°C-40.0°C	16.0°C-40.0°C	18.3°C-43.3°C
Storage Conditions	RH<=95%	RH<=95%	n/d	RH<=90%
Warning if reading is outside display range	Yes	Yes	n/d	Yes
Batteries (num)	CR2032 3V (1)	CR2032 3V (1)	AAA 1.5V (2)	9V (1)
	<b>Beuer FT-55</b>	<b>BOSO Bosotherm Medical</b>	<b>Braun IRT 3020</b>	<b>Braun Thermoscan 4000</b>
Highest Accuracy	±0.2°C	±0.2°C	±0.2°C	±0.2°C
Lowest accuracy (eg outside operating range)	±0.3°C	±1°C	±0.3°C	±0.3°C
Operating Range	34°C-42.2°C	0°C-100°C	34°C-42.2°C	20°C-42.2°C
Ambient temperature range	10.0°C-40.0°C	5°C - 40°C	10°C-40°C	10°C-40°C
Storage Conditions	RH<=85%	40% -80% RH	-20°C+50°C, RH<=95%	-20°C+40°C, RH<=95%
Warning if reading is outside display range	n/d	Yes	Yes	Yes
Batteries (num)	CR2032 3V (1)	CR2032 3V (1)	CR2032 3V (1)	CR2032 3V (1)

	<b>Comdek Industrial HD- 7</b>	<b>Comdek Industrial HD- 11</b>	<b>Comdek Industrial HD- 21</b>	<b>Covidien Genius2</b>
Highest Accuracy	n/d	n/d	n/d	±0.2°C
Lowest accuracy (eg outside operating range)	n/d	n/d	n/d	±0.3°C
Operating Range	34°C-42°C	0°C -100°C	5°C -50°C	33.0°C-42.0°C
Ambient temperature range	5°C -40°C	5°C -40°C	15°C -40°C	16°C-33°C
Storage Conditions	5°C+55°C	5°C+55°C	5°C+55°C	-25°C+55°C, RH≤95%
Warning if reading is outside display range	n/d	n/d	n/d	Yes
Batteries (num)	AA 1.5V (2)	AA 1.5V (2)	AA 1.5V (2)	AAA 1.5V (3)
	<b>DigiO2 ETH- 101</b>	<b>Easytem BT- 020</b>	<b>Easytem BT- 021</b>	<b>Exergen Ototemp 3000SD</b>
Highest Accuracy	±0.2°C	±0.2°C	±0.2°C	n/d
Lowest accuracy (eg outside operating range)	±0.3°C	2%	2%	n/d
Operating Range	34.0°C-43°C	0°C-100°C	0°C-100°C	18.3°C-54.4°C
Ambient temperature range	10°C-40°C	10°C-40°C	10°C-40°C	0°C-54°C
Storage Conditions	-20°C+50°C	-25°C+50°C, RH 19%-95%	-25°C+50°C, RH 19%-95%	n/d
Warning if reading is outside display range	Yes	Yes	Yes	n/d
Batteries (num)	AAA 1.5V (2)	CR2032 3V (1)	CR2032 3V (1)	9V (1)

	<b>Exergen Ototemp Light touch</b>	<b>GF Health Products DELUXE MODEL 2215</b>	<b>HuBDIC NET100</b>	<b>HuBDIC TB100</b>
Highest Accuracy	n/d	±0.2°C	±0.2°C	±0.2°C
Lowest accuracy (eg outside operating range)	n/d	n/d	n/d	n/d
Operating Range	16.6°C-43.3°C	20°C-42.2°C	32.0°C – 42.2°C	0°C-100.0°C
Ambient temperature range	16.6°C-43.3°C	10°C-40°C	15°C-35°C	15°C-35°C
Storage Conditions	n/d	-25°C+55°C, RH<=95%	n/d	n/d
Warning if reading is outside display range	n/d	Yes	Yes	Yes
Batteries (num)	9V (1)	CR2032 3V (1)	CR2032 3V (1)	CR2032 3V (1)
	<b>Microlife IR 120</b>	<b>Microlife IR 100</b>	<b>Microlife IR 1DA1</b>	<b>Omron Gentle Temp MC-510- E</b>
Highest Accuracy	±0.2°C	±0.2°C	±0.2°C	±0.2°C
Lowest accuracy (eg outside operating range)	n/d	n/d	±1°C	n/d
Operating Range	0°C-100.0°C	0°C-100.0°C	0°C-100.0°C	34°C – 42.2°C
Ambient temperature range	5°C -40°C	5°C -40°C	5°C -40°C	10°C – 40°C
Storage Conditions	-25°C+55°C, RH<=95%	-25°C+55°C, RH<=95%	-25°C+55°C, RH<=95%	10°C – 40°C,, RH 30%-85%
Warning if reading is outside display range	Yes	Yes	Yes	n/d
Batteries (num)	CR2032 3V (1)	CR2032 3V (1)	CR2032 3V (1)	CR2032 3V (1)

	<b>Predictor Ear Thermometer</b>	<b>Riester ri-Thermo N Professional</b>	<b>Rossmax TD100</b>	<b>Rossmax TE100</b>
Highest Accuracy	±0.2°C	±0.2°C	±0.2°C	±0.2°C
Lowest accuracy (eg outside operating range)	±0.3°C	n/d	±0.3°C	±0.3°C
Operating Range	32.2°C-43.3°C	0°C-100.0°C	34°C-42.2°C	34°C-42.2°C
Ambient temperature range	16°C-40°C	5°C -40°C	n/d	n/d
Storage Conditions	-25°C+55°C, RH<=85%	-25°C+55°C	20°C+50°C, RH<=85%	-20°C+50°C, RH<=85%
Warning if reading is outside display range	Yes	Yes	Yes	Yes
Batteries (num)	CR2032 3V (1)	CR2032 3V (1)	CR2032 3V (1)	CR2032 3V (1)
	<b>Spengler Temp'O</b>	<b>Topcom Ear&amp;Forehead 301</b>	<b>Veridian V Temp Pro</b>	
Highest Accuracy	±0.3°C	±0.2°C	n/d	
Lowest accuracy (eg outside operating range)	n/d	±0.3°C	n/d	
Operating Range	32,2°C – 43,3°C	32°C - 42.9°C	26.0°C-43.9°C	
Ambient temperature range	5°C -40°C	15°C-35°C	5°C -40°C	
Storage Conditions	-25°C+55°C	-10°C-55°C, RH 30%-80%	-25°C+55°C	
Warning if reading is outside display range	Yes	Yes	Yes	
Batteries (num)	AAA 1.5V (2)	CR2032 3V (1)	n/d	

## Annex II

The following table should be given to all personnel handling the devices. It shows a set of guidelines, written by NHS:Greater Glasgow and Clyde(Grady, 2010) and Kendall( gnostinc and Nutritional Delivery Group, 2006)that should be followed and the appropriate explanation for each step. All staff involved in the measuring and monitoring of should be familiar with this procedural guideline

Procedure:	Explanation:
Provide age appropriate explanation of procedure	To ensure the child (and parent) understand and consent to the procedure.
Wash hands thoroughly with appropriate antibacterial skin cleanser and disposable gloves.	To minimize the risk of cross infection.
Choose tympanic temperature measurement device required and document which type chosen.  Where possible use same type of equipment and same ear each time. Document if infant or child in heated environment.	To ensure consistency in temperature readings. Switching between sites and changing from one type of thermometer to another can produce misleading results.  There may be differing measurements if temperature measured in exposed or non-exposed ear or if in a superheated environment.  Anatomical differences between the two ears can result in a difference of up to 1°C.
Remove thermometer from base unit and check lens clean and intact.  If dirty then a dry wipe may be used.	If lens is cracked or dirty then it may result in an inaccurate reading.  Alcohol based wipes can lead to a false low temperature measurement.
Place disposable cover on the probe tip, ensuring the manufacturer's instructions are followed.	The disposable probe cover protects the tip of the thermometer probe and is needed for the unit to function correctly.  A disposable thermometer tip cover can help minimize the risk of cross infection.

<p>Use a gentle ear tug by pulling the pinna down and back in infants and small children, and up and back for older children.</p> <p>Gently place the probe tip in the outer third of the ear canal and seal the opening, ensuring a snug fit.</p>	<p>For an accurate reading it is vital that the tympanic membrane is ‘visualized’ by the thermometer tip. The gentle ‘ear tug’ can help align the thermometer probe toward the tympanic membrane.</p> <p>This prevents ambient air interfering with the temperature reading and causing a false low temperature measurement.</p>
<p>Ensure the thermometer is ‘set’ to correct mode according to the individual manufacturers’ instructions.</p>	<p>An inappropriate mode setting may not give an accurate ‘core’ reading.</p> <p>Predictive mode is quicker as temperature is estimated but direct mode may be more accurate for temperature recording.</p>
<p>Press and release SCAN button.</p> <p>Ensure thermometer stays in situ (either a few seconds or few minutes) until reading appears and thermometer ‘beeps’.</p> <p>Once thermometer beeps and displays DONE, remove thermometer probe tip from ear immediately.</p> <p>The disposable probe tip cover can be removed (according to manufacturer’s instructions) and discarded</p>	<p>This commences the thermometer scanning.</p> <p>Movement of the thermometer and probe may interfere with its ability to ‘visualize’ the tympanic membrane or risk exposing the probe to the ambient air and can interfere temperature recording.</p>
<p>The nurse should now read and document the child’s temperature and site – i.e. left ear</p>	