

---

# The EMU-SDMS

Raphael Winkelmann

---



München 2017



---

# The EMU-SDMS

Raphael Winkelmann

---

## 1. Dokumentation

Dissertation  
zur Erlangung des Doktorgrades der Philosophie  
am Department II der Fakultät 13  
(Sprach- und Literaturwissenschaften)  
der Ludwig-Maximilians-Universität München

vorgelegt von  
Raphael Winkelmann  
aus München

München, den 23. März 2017

Erstgutachter: Prof. Dr. Jonathan Harrington

Zweitgutachter: PD Dr. Florian Schiel

Tag der mündlichen Prüfung: 17. Juli 2017





# Acknowledgements

This body of work would not have been possible if it were not for a fairly large group of people that have been invested in developing and improving this software suite as well as trying to keep me sane throughout the development process.

First and foremost, I would like to thank my supervisor Jonathan Harrington for giving me the opportunity to work on this exciting project and for giving me the freedom to explore various technical solutions and keeping an open mind about pushing his original EMU concept(s) in various new directions.

I thank Florian Schiel for his technical oversight and his eagerness to support and help out during the development of the EMU-SDMS. I want to especially thank him for being an exceptionally bad software tester (i.e., an excellent software tester, because every time he touches software it seems to break), which led to the discovery of many bugs and inconsistencies.

Many thanks to Christoph Draxler for being an invaluable source of information for annotation data modeling, database systems and front-end usability design. Many relational back-end problems would not have been solved as easily and as quickly and the EMU-webApp would look and behave differently were it not for his input.

I am also extremely grateful to Klaus Jansch. Not only does he keep the entire IPS infrastructure running but he has been an invaluable contributor to the EMU-SDMS. Thank you for writing (and fighting with) the first drafts and internal data models of emuR and sharing my griefs with R as a programming language. I also thank him for being an encyclopedia in all this IT and for graciously sharing that knowledge with me!

Thanks to Markus, Georg and Nina! Not only for contributing to the code base and teaching me new things but also for sometimes being more excited about new features of the EMU Speech Database Management System (EMU-SDMS) than me. That definitely helped to keep me motivated!

I am grateful to Lasse, Steve, Tina and Michel for all their contributions to the legacy system and their input and advice on the new EMU-SDMS. I especially want to thank Lasse for showing me the ins and outs of the legacy system and guiding me through C code that would not have been as accessible to me if it were

not for his help.

Further, I would like to thank all the EMU users for their feedback, usability tests (sometimes on very early alpha releases) and feature requests. Without their critical input this project would not have been possible.

To Uwe for his guidance, trust and friendship and for being the reason that I went into this profession in the first place. To all my past and present office mates and to the group of people at the IPS that have become more than just colleagues (you know who you are ;-)): you guys are the reason I am still in this profession! A special thanks to Manfred for keeping me sane with many a late night “Frust Halbe” and for sharing the load during the final stages of our PhDs.

I thank all my band mates for giving me a platform for my creative and emotional outlet.

My undying gratitude goes to my family for their never ending unconditional support. I will never be able to thank you enough!

To my partner Jessica and our four legged son: what to say? This and many many other things would not have been possible without you!



# Contents

Acknowledgements	vii
Installing the EMU-SDMS	xx
<b>I Overview and tutorial</b>	<b>1</b>
<b>1 An overview of the EMU-SDMS</b>	<b>2</b>
1.1 The evolution of the EMU-SDMS . . . . .	3
1.2 EMU-SDMS: System architecture and default workflow . . . . .	5
1.3 EMU-SDMS: Is it something for you? . . . . .	7
<b>2 A tutorial on how to use the EMU-SDMS</b>	<b>9</b>
2.1 Converting the TextGrid collection . . . . .	12
2.2 Loading and inspecting the database . . . . .	14
2.2.1 Overview . . . . .	14
2.2.2 Database annotation and visual inspection . . . . .	15
2.3 Querying and autobuilding the annotation structure . . . . .	16
2.3.1 Autobuilding . . . . .	19
2.3.2 Querying the hierarchical annotations . . . . .	23
2.4 Signal extraction and exploration . . . . .	25
2.5 Vowel height as a function of word types (content vs. function): evaluation and statistical analysis . . . . .	29
2.6 Conclusion . . . . .	34
<b>II Main components and concepts</b>	<b>36</b>
<b>3 Annotation Structure Modeling</b>	<b>37</b>
3.1 Per database annotation structure definition . . . . .	41
3.2 Parallel labels and multiple attributes . . . . .	43

---

3.3	Metadata strategy using single bundle root nodes . . . . .	45
3.4	Conclusion . . . . .	46
<b>4</b>	<b>The emuDB Format</b>	<b>47</b>
4.1	Database design . . . . .	49
4.2	Creating an emuDB . . . . .	50
4.2.1	Creating an emuDB from scratch . . . . .	50
4.2.2	Loading and editing an empty database . . . . .	51
4.2.3	Level definitions . . . . .	52
4.2.4	Link definitions . . . . .	57
4.2.5	File handling . . . . .	58
4.2.6	SSFF track definitions . . . . .	61
4.2.7	Configuring the EMU-webApp and annotating the emuDB . . .	62
4.3	Conclusion . . . . .	62
<b>5</b>	<b>The query system</b>	<b>64</b>
5.1	emuRsegs: The resulting object of a query . . . . .	66
5.2	EQL: The EMU Query Language version 2 . . . . .	67
5.2.1	Simple queries . . . . .	67
5.2.2	Combining simple queries . . . . .	69
5.2.3	Position queries . . . . .	73
5.2.4	Count queries . . . . .	75
5.2.5	More complex queries . . . . .	76
5.2.6	Deducing time . . . . .	77
5.2.7	Requery . . . . .	78
5.3	Discussion . . . . .	80
<b>6</b>	<b>Signal data extraction</b>	<b>82</b>
6.1	Extracting pre-defined tracks . . . . .	84
6.2	Adding new tracks . . . . .	86
6.3	Calculating tracks on-the-fly . . . . .	87
6.4	The resulting object: trackdata vs. emuRtrackdata . . . . .	88
6.5	Conclusion . . . . .	91
<b>7</b>	<b>The R package wrassp</b>	<b>92</b>
7.1	Introduction . . . . .	92
7.2	File I/O and the AsspDataObj . . . . .	95
7.3	Signal processing . . . . .	99
7.3.1	The wrasspOutputInfos object . . . . .	99
7.3.2	Formants and their bandwidths . . . . .	100

---

7.3.3	Fundamental frequency contour . . . . .	102
7.3.4	RMS energy contour . . . . .	103
7.4	Logging <code>wrassp</code> 's function calls . . . . .	105
7.5	Using <code>wrassp</code> in the EMU-SDMS . . . . .	106
7.6	Storing data in the SSFF file format . . . . .	108
7.7	Conclusion . . . . .	111
<b>8</b>	<b>The EMU-webApp</b> . . . . .	<b>112</b>
8.1	Main layout . . . . .	113
8.2	General usage . . . . .	113
8.2.1	Annotating levels containing time information . . . . .	115
8.2.2	Working with hierarchical annotations . . . . .	118
8.3	Configuring the EMU-webApp . . . . .	121
8.3.1	Basic configurations using <code>emuR</code> . . . . .	121
8.3.2	Signal canvas and level canvas order . . . . .	123
8.3.3	Advanced configurations made by editing the <code>_DBconfig.json</code> . . . . .	125
8.3.4	2D canvas . . . . .	128
8.4	Conclusion . . . . .	131
<b>III</b>	<b>Main <code>emuR</code> function and object index</b> . . . . .	<b>132</b>
<b>9</b>	<b><code>emuR</code> - package functions</b> . . . . .	<b>133</b>
9.1	Import and conversion routines . . . . .	133
9.1.1	Legacy EMU databases . . . . .	134
9.1.2	TextGrid collections . . . . .	134
9.1.3	BPF collections . . . . .	135
9.1.4	txt collections . . . . .	136
9.2	<code>emuDB</code> interaction and configuration routines . . . . .	137
9.3	EMU-webApp configuration routines . . . . .	138
9.4	Data extraction routines . . . . .	138
9.5	Central objects . . . . .	139
9.6	Export routines . . . . .	140
9.7	Conclusion . . . . .	142
<b>IV</b>	<b>Implementation</b> . . . . .	<b>144</b>
<b>10</b>	<b>Implementation of the query system</b> . . . . .	<b>145</b>
10.1	Query expression parser . . . . .	148

---

10.2 Redundant links . . . . .	150
<b>11 wrassp implementation</b>	<b>154</b>
11.1 The libassp port . . . . .	154
<b>12 EMU-webApp implementation</b>	<b>158</b>
12.1 Communication protocol . . . . .	159
12.2 URL parameters . . . . .	160
12.2.1 Websocket server parameters . . . . .	160
12.2.2 Label file preview parameters . . . . .	160
<b>Appendices</b>	<b>162</b>
<b>A Use cases</b>	<b>163</b>
A.1 Use case 1 . . . . .	164
A.2 Use case 2 . . . . .	165
A.3 Use case 3 . . . . .	167
A.4 Use case 4 . . . . .	170
<b>B File Formats</b>	<b>176</b>
B.1 File descriptions . . . . .	176
B.1.1 DBconfig.json . . . . .	176
B.1.2 _annot.json . . . . .	185
B.1.3 The SSFF file format . . . . .	186
B.2 Example files . . . . .	189
B.2.1 _bundleList.json . . . . .	189
B.2.2 _bndl.json . . . . .	190
<b>C The EMU-webApp-websocket-protocol Version 2.0</b>	<b>191</b>
C.1 Protocol overview . . . . .	191
C.2 Protocol commands . . . . .	191
C.2.1 GETPROTOCOL . . . . .	191
C.2.2 GETDOUSERMANAGEMENT . . . . .	193
C.2.3 LOGONUSER . . . . .	194
C.2.4 GETGLOBALDBCONFIG . . . . .	194
C.2.5 GETBUNDLELIST . . . . .	195
C.2.6 GETBUNDLE . . . . .	196
C.2.7 SAVEBUNDLE . . . . .	197
C.2.8 DISCONNECTWARNING . . . . .	197
C.2.9 Error handling . . . . .	198

<b>D</b>	<b>EQL EBNF</b>	<b>199</b>
D.1	Terminal symbols of EQL2 (operators) and their meaning . . . . .	199
D.2	Terminal symbols of EQL2 (brackets) and their meanings. . . . .	200
D.3	Terminal symbols of EQL2 (functions) and their meanings. . . . .	200
D.4	Formal description of EMU Query Language Version 2 . . . . .	200
D.5	Restrictions . . . . .	202
<b>E</b>	<b>EQL: further examples</b>	<b>203</b>
E.1	Simple equality, inequality, matching and non-matching queries (single-argument) . . . . .	203
E.2	Sequence queries using the $\rightarrow$ sequence operator . . . . .	205
E.2.1	Subsequent sequence queries using nesting of the $\rightarrow$ sequence operator . . . . .	206
E.3	Conjunction operator $\&$ . . . . .	207
E.4	Domination operator $\wedge$ (hierarchical queries) . . . . .	208
E.4.1	Simple domination . . . . .	209
E.4.2	Multiple domination . . . . .	210
E.5	Position . . . . .	210
E.5.1	Simple usage of <code>Start()</code> , <code>End()</code> and <code>Medial()</code> . . . . .	210
E.5.2	Position and boolean $\&$ . . . . .	212
E.5.3	Position and boolean $\wedge$ . . . . .	212
E.6	Count . . . . .	213
E.6.1	Count and boolean $\&$ . . . . .	213
E.6.2	Count and $\wedge$ . . . . .	214
E.7	Combinations . . . . .	215
E.7.1	$\wedge$ and $\rightarrow$ (domination and sequence) . . . . .	215
E.7.2	$\wedge$ and $\rightarrow$ and $\&$ (domination and sequence and boolean $\&$ ) . . . . .	216
E.8	A few more questions and answers . . . . .	217
E.9	Differences to the legacy EMU query language . . . . .	219
E.9.1	Function call syntax . . . . .	219
E.9.2	Empty result . . . . .	219
E.9.3	The result modifier hash tag $\#$ . . . . .	219
E.9.4	Interpretation of the hash tag $\#$ in conjunction operator queries . . . . .	220
E.9.5	legacy EMU . . . . .	220
E.10	Bugs in legacy EMU function <code>emu.query()</code> . . . . .	221
E.10.1	Alternative labels in inequality queries . . . . .	221
E.10.2	legacy EMU . . . . .	221
E.10.3	<code>emuR</code> . . . . .	222
E.10.4	Errors caused by missing or superfluous blanks or parentheses . . . . .	222
E.10.5	Order of result segment list . . . . .	222
E.10.6	Additional features . . . . .	223

<b>F wrassp</b>	<b>224</b>
F.1 Using Praat's signal processing routines in the EMU-SDMS . . . .	224
<b>Disclosure of pre-published data</b>	<b>227</b>
<b>Zusammenfassung</b>	<b>229</b>

# List of Figures

1.1	Schematic architecture of the EMU-SDMS . . . . .	6
1.2	Example of a hybrid annotation combining time-based ( <i>Phonetic</i> level) and hierarchical ( <i>Phoneme</i> , <i>Syllable</i> , <i>Text</i> levels including the inter-level links) annotations . . . . .	7
2.1	TextGrid annotation of the <code>emuR_demoData/TextGrid_collection/msajc003.wav / .TextGrid</code> file pair containing the tiers (from top to bottom): <i>Utterance</i> , <i>Intonational</i> , <i>Intermediate</i> , <i>Word</i> , <i>Accent</i> , <i>Text</i> , <i>Syllable</i> , <i>Phoneme</i> , <i>Phonetic</i> , <i>Tone</i> , <i>Foot</i> . . . . .	13
2.2	Screenshot of <b>EMU-webApp</b> displaying <code>msajc003</code> bundle of <i>myFirst</i> <code>emuDB</code> . . . . .	17
2.3	Example of a hierarchical annotation of the content ( $==C$ ) word <i>violently</i> belonging to the <code>msajc012</code> bundle of the <i>myFirst</i> demo <code>emuDB</code> . . . . .	19
2.4	Schematic annotation structure of the <code>emuDB</code> after calling the auto-build function in R Example 2.3.2. . . . .	21
2.5	Screenshot of <b>EMU-webApp</b> displaying the autobuilt hierarchy of the <i>myFirst</i> <code>emuDB</code> . . . . .	24
2.6	<code>dp1ot()</code> plots of F1 trajectories. The left plot displays all trajectories while the right plot displays the ensemble average of all @ vowels. . . . .	28
2.7	95% ellipses for F2 x F1 data extracted from the temporal midpoint of the vowel segments . . . . .	30
2.8	Ensemble averages of F1 contours of all tokens of the central 60% of vowels grouped by word type (function ( <i>F</i> ) vs. content ( <i>W</i> )). . .	31
2.9	Boxplot produced using <code>ggplot2</code> to visualize the difference in F1 depending on whether the vowel occurs in content ( <i>C</i> ) or function ( <i>F</i> ) word . . . . .	33
2.10	Plots of density distributions of vowels in content words (left plot) and vowels in function words (right plot) in R Example 2.5.3. . . .	35

3.1	<b>A:</b> a purely time-aligned annotation; <b>B:</b> a purely timeless, symbolic annotation; <b>C:</b> a time-aligned hierarchical annotation. . . . .	39
3.2	<b>A:</b> a schematic representation of the hierarchical structure of an <code>emuDB</code> that corresponds to the annotation depicted in 3.1C; <b>B:</b> example of a more complex, intersecting hierarchical structure. . . . .	42
3.3	Schematic representation of annotation structure modeling difference between <b>A:</b> linearly linked levels and <b>B:</b> an annotation structure using multiple attributes. . . . .	44
3.4	Hierarchical annotation displaying single bundle root node metadata strategy where the label of the primary attribute definition ( <i>bundle</i> ) is empty, <i>gender</i> encodes the speaker's gender, <i>COB</i> encodes the speakers city of birth and <i>age</i> encodes the speaker's age in the form of a string. . . . .	45
4.1	Schematic <code>emuDB</code> file and directory structure. . . . .	49
4.2	A schematic representation of the simple hierarchical structure of the <i>fromScratch</i> created by the <code>add_linkDefinition()</code> function call in R Example 4.2.9. . . . .	58
5.1	Simple partial hierarchy of an annotation of the word <i>amongst</i> in the <i>msajc003</i> bundle in the <i>ae</i> demo <code>emuDB</code> . . . . .	65
5.2	Partial hierarchy depicting all annotation items that are dominated by the strong syllable ( <i>S</i> ) of the <i>Syllable</i> level (inside dashed box). Items marked green belong to the <i>Phoneme</i> level, items marked orange belong to the <i>Phonetic</i> level and the purple dashed box indicates the set of items that are dominated by <i>S</i> . . . . .	72
5.3	Illustration of what is returned by the <code>Start()</code> , <code>Medial()</code> and <code>End()</code> functions depending if they are set to <b>A:</b> <code>TRUE</code> (green) or <b>B:</b> <code>FALSE</code> (orange). . . . .	74
5.4	Partial hierarchy depicting a <i>Syllable</i> containing one <i>Phoneme</i> and <i>Phonetic</i> item (green) and a <i>Syllable</i> containing five <i>Phoneme</i> and six <i>Phonetic</i> items (orange). . . . .	75
5.5	Three-step ( <code>query</code> → <code>requer_hier</code> → <code>requer_seq</code> ) requer procedure, its single query counterpart and their color coded movements within the annotation hierarchy. . . . .	79
6.1	Segment of speech with overlaid annotations and time parallel derived signal data contour. . . . .	83
7.1	Oscillogram generated from samples stored in the <code>audio</code> track of the object <code>au</code> . . . . .	98



---

7.2	Matrix plot of formant values stored in the <code>fm</code> track of <code>fmBwVals</code> object . . . . .	102
7.3	Plot of fundamental frequency values stored in the <code>F0</code> track of <code>f0vals</code> object . . . . .	104
7.4	Plot of RMS values stored in <code>rms</code> track of the <code>rmsvals</code> object . . . . .	105
7.5	A single cycle sine wave consisting of 16000 samples . . . . .	109
8.1	Screenshot of <code>EMU-webApp</code> displaying the <i>ae</i> demo database with overlaid areas of the main screen of the web application (see text). . . . .	114
8.2	Screenshot of segment level as displayed by the <code>EMU-webApp</code> with superimposed mouse cursor displaying the automatic boundary pre-selection of closest boundary (boundary marked blue). . . . .	115
8.3	Screenshot of two levels as displayed by the <code>EMU-webApp</code> , where the lower level is preselected (i.e., marked in a darker shade of gray). . . . .	116
8.4	Screenshot of level as displayed by the <code>EMU-webApp</code> , where the <code>/@/</code> segment is currently preselected as it is marked yellow. . . . .	116
8.5	Screenshot of segment level with three attribute definitions. The radio buttons that switch between the parallel labels are highlighted by a red square. . . . .	117
8.6	Screenshot of the hierarchy modal window level displaying a path through the hierarchy of the <i>ae</i> <code>emuDB</code> in its horizontal form. . . . .	119
8.7	Screenshot of top of hierarchy modal window of the <code>EMU-webApp</code> in which the area marked 1 shows the drop-down menus for selecting the parallel label for each level and area 2 marks the hierarchy path drop-down menu. . . . .	119
8.8	Screenshot of the hierarchy modal window of the <code>EMU-webApp</code> displaying an annotation item's context menu. . . . .	120
8.9	Screenshot of the hierarchy modal window of the <code>EMU-webApp</code> displaying an annotation item's context menu. . . . .	122
8.10	Screenshot of signal and level canvases displays of the <code>EMU-webApp</code> after the changes made in R Examples 8.3.4 and 8.3.6. . . . .	126
8.11	Screenshot of signal canvases display of the <code>EMU-webApp</code> after the changes made in R Examples 8.3.4 and 8.3.6. . . . .	127
8.12	Screenshot of signal canvases area of the <code>EMU-webApp</code> displaying formant contours that are overlaid on the spectrogram and frequency-aligned. . . . .	127
8.13	Screenshot of 2D canvas of the <code>EMU-webApp</code> displaying two-dimensional electromagnetic articulography (EMA) data. . . . .	128
8.14	Screenshot of 2D canvas of the <code>EMU-webApp</code> displaying electropalatography (EPG) palate traces. . . . .	130

---

9.1	Relationship between various key functions in <code>emuR</code> and their output. Figure is an updated version of Figure 5.7 in Harrington (2010)	141
9.2	<code>TextGrid</code> annotation generated by the <code>export_TextGridCollection()</code> function containing the tiers (from top to bottom): <i>Text</i> , <i>Syllable</i> , <i>Phonetic</i> .	143
10.1	Schematic architecture of <code>emuDB</code> interaction functions of the <code>emuR</code> package. <b>Orange</b> paths show examples of functions interacting with the files of the <code>emuDB</code> , while <b>green</b> paths show functions accessing the relational annotation structure. Actions like saving a changed annotation using the <code>EMU-webApp</code> first save the <code>_annot.json</code> to disk then update the relational annotation structure.	146
10.2	Example of how the query expression parser parses and evaluates an EMU Query Language (EQL) expression and merges the result according to the respective EQL operators.	149
10.3	Schematic of hierarchy graph <i>ae</i> ; <b>A</b> : legacy redundant strategy vs. <b>A</b> : cleaner non-redundant strategy.	153
A.1	F1 by F2 distribution for <i>I</i> , <i>o</i> ; <i>u</i> ; <i>V</i> and <i>@</i> .	167
A.2	Time-normalized first spectral moment trajectories color coded by sibilant class	172
A.3	Time-normalized first spectral moment ensemble average trajectories per sibilant class	173
A.4	Boxplots of the first spectral moments grouped by their sibilant class	175
B.1	Schematic representation of the data block of the <code>msajc003.fms</code> file of R Example B.1.1.	189
C.1	Schematic of the <code>EMU-webApp-websocket-protocol</code> .	192

# List of Tables

5.1	EQL V2: examples of simple and complex query strings using RegEx operators including their function descriptions. . . . .	69
9.1	Overview of the <code>emuDB</code> interaction routines provided by <code>emuR</code> . . . .	138
9.2	Overview of the <code>EMU-webApp</code> configuration functions provided by <code>emuR</code> . . . . .	138
9.3	Overview of the data extraction functions provided by <code>emuR</code> . . . .	139
9.4	Overview of the central objects of the <code>emuR</code> package. . . . .	140
12.1	Main <code>EMU-webApp</code> protocol commands. . . . .	159

# Installing the EMU-SDMS

- R
  - Download the R programming language from [www.cran.r-project.org](http://www.cran.r-project.org)
  - Install the R programming language by executing the downloaded file and following the on-screen instructions.
- emuR
  - Start up R.
  - Enter `install.packages("emuR")` after the `>` prompt to install the package. (You will only need to repeat this if package updates become available.)
  - As the `wrassp` package is a dependency of the `emuR` package, it does not have to be installed separately.
- EMU-webApp (prerequisite)
  - The only thing needed to use the EMU-webApp is a current HTML5 compatible browser (Chrome/Firefox/Safari/Opera/...). However, as most of the development and testing is done using Chrome we recommend using it, as it is by far the best tested browser.

## Version disclaimer

This document describes the following versions of the software components:

- `wrassp`
  - Package version: 0.1.6
  - Git tag name: v0.1.6 (on master branch)
- `emuR`

- Package version: 1.0.0
- Git tag name: v1.0.0 (on master branch)
- EMU-webApp
  - Version: 0.1.12
  - Git SHA1: 7b044a9f9fe19f2eb6d03ec6ec3f20d5b1d25db2

As the development of the EMU Speech Database Management System is still ongoing, be sure you have the correct documentation to go with the version you are using.

## For developers and people interested in the source code

The information on how to install and/or access the source code of the developer version including the possibility of accessing the versions described in this document (via the Git tag names mentioned above) is given below.

- wrassp
  - Source code is available here: <https://github.com/IPS-LMU/wrassp/>
  - Install developer version in R: `install.packages("devtools"); library("devtools"); install_github("IPS-LMU/wrassp")`
  - Bug reports: <https://github.com/IPS-LMU/wrassp/issues>
- emuR
  - Source code is available here: <https://github.com/IPS-LMU/emuR/>
  - Install developer version in R: `install.packages("devtools"); library("devtools"); install_github("IPS-LMU/emuR")`
  - Bug reports: <https://github.com/IPS-LMU/emuR/issues>
- EMU-webApp
  - Source code is available here: <https://github.com/IPS-LMU/EMU-webApp/>
  - Bug reports: <https://github.com/IPS-LMU/EMU-webApp/issues>

The data carrier that accompanies this documentation contains a cloned version of all three Git repositories of the software components described here.

# Part I

## Overview and tutorial

# Chapter 1

## An overview of the EMU-SDMS<sup>\*</sup>.



The EMU Speech Database Management System (EMU-SDMS) is a collection of software tools which aims to be as close to an all-in-one solution for generating, manipulating, querying, analyzing and managing speech databases as possible. It was developed to fill the void in the landscape of software tools for the speech sciences by providing an integrated system that is centered around the R language and environment for statistical computing and graphics (R Core Team, 2016). This manual contains the documentation for the three software components **wrassp**, **emuR** and the **EMU-webApp**. In addition, it provides an in-depth description of the **emuDB** database format which is also considered an integral part of the new system. These four components comprise the EMU-SDMS and benefit the speech sciences and spoken language research by providing an integrated system to answer research questions such as: *Given an annotated speech database, is the vowel height of the vowel *i*: (measured by its correlate, the first formant frequency) influenced by whether it appears in a strong or weak syllable?*

---

<sup>\*</sup>Sections of this chapter have been published in Winkelmann et al. (2017)

This manual is targeted at new EMU-SDMS users as well as users familiar with the legacy EMU system. In addition, it is aimed at people who are interested in the technical details such as data structures/formats and implementation strategies, be it for reimplementing purposes or simply for a better understanding of the inner workings of the new system. To accommodate these different target groups, after initially giving an overview of the system, this manual presents a usage tutorial that walks the user through the entire process of answering a research question. This tutorial will start with a set of `.wav` audio and Praat `.TextGrid` (Boersma and Weenink, 2016) annotation files and end with a statistical analysis to address the hypothesis posed by the research question. The following Part II of this documentation is separated into six chapters that give an in-depth explanation of the various components that comprise the EMU-SDMS and integral concepts of the new system. These chapters provide a tutorial-like overview by providing multiple examples. To give the reader a synopsis of the main functions and central objects that are provided by EMU-SDMS's main R package `emuR`, an overview of these functions is presented in Part III. Part IV focuses on the actual implementation of the components and is geared towards people interested in the technical details. Further examples and file format descriptions are available in various appendices. This structure enables the novice EMU-SDMS user to simply skip the technical details and still get an in-depth overview of how to work with the new system and discover what it is capable of.

A prerequisite that is presumed throughout this document is the reader's familiarity with basic terminology in the speech sciences (e.g., familiarity with the international phonetic alphabet (IPA) and how speech is annotated at a coarse and fine grained level). Further, we assume the reader has a grasp of the basic concepts of the R language and environment for statistical computing and graphics. For readers new to R, there are multiple, freely available R tutorials online (e.g., [https://en.wikibooks.org/wiki/Statistical\\_Analysis:\\_an\\_Introduction\\_using\\_R/R\\_basics](https://en.wikibooks.org/wiki/Statistical_Analysis:_an_Introduction_using_R/R_basics)). R also has a set of very detailed manuals and tutorials that come preinstalled with R. To be able to access R's own "An Introduction to R" introduction, simply type `help.start()` into the R console and click on the link to the tutorial.

## 1.1 The evolution of the EMU-SDMS

The EMU-SDMS has a number of predecessors that have been continuously developed over a number of years (e.g., Harrington et al., 1993; Cassidy and Harrington, 1996, 2001; Bombien et al., 2006; Harrington, 2010; John, 2012). The components presented here are the completely rewritten and newly designed, next incarnation of the EMU system, which we will refer to as the EMU Speech Database Manage-



ment System (EMU-SDMS). The EMU-SDMS keeps most of the core concepts of the previous system, which we will refer to as the legacy system, in place while improving on things like usability, maintainability, scalability, stability, speed and more. We feel the redesign and reimplementation elevates the system into a modern set of speech and language tools that enables a workflow adapted to the challenges confronting speech scientists and the ever growing size of speech databases. The redesign has enabled us to implement several components of the new EMU-SDMS so that they can be used independently of the EMU-SDMS for tasks such as web-based collaborative annotation efforts and performing speech signal processing in a statistical programming environment. Nevertheless, the main goal of the redesign and reimplementation was to provide a modern set of tools that reduces the complexity of the tool chain needed to answer spoken language research questions down to a few interoperable tools. The tools the EMU-SDMS provides are designed to streamline the process of obtaining usable data, all from within an environment that can also be used to analyze, visualize and statistically evaluate the data.

Upon developing the new system, rather than starting completely from scratch it seemed more appropriate to partially reuse the concepts of the legacy system in order to achieve our goals. A major observation at the time was that the R language and environment for statistical computing and graphics (R Core Team, 2016) was gaining more and more traction for statistical and data visualization purposes in the speech and spoken language research community. However, R was mostly only used towards the end of the data analysis chain where data usually was pre-converted into a comma-separated values or equivalent file format by the user using other tools to calculate, extract and pre-process the data. While designing the new EMU-SDMS, we brought R to the front of the tool chain to the point just beyond data acquisition. This allows the entire data annotation, data extraction and analysis process to be completed in R, while keeping the key user requirements in mind. Due to personal experiences gained by using the legacy system for research purposes and in various undergraduate courses (course material usually based on Harrington, 2010), we learned that the key user requirements were data and database portability, a simple installation process, a simplified/streamlined user experience and cross-platform availability. Supplying all of EMU-SDMS's core functionality in the form of R packages that do not rely on external software at runtime seemed to meet all of these requirements.

As the early incarnations of the legacy EMU system and its predecessors were conceived either at a time that predated the R system or during the infancy of R's package ecosystem, the legacy system was implemented as a modular yet composite standalone program with a communication and data exchange interface to the R/Splus systems (see Cassidy and Harrington, 2001, Section 3 for details). Recent

developments in the package ecosystem of R such as the availability of the DBI package (R Special Interest Group on Databases (R-SIG-DB) et al., 2016) and the related packages `RSQLite` and `RPostgreSQL` (Wickham et al., 2014; Conway et al., 2016), as well as the `jsonlite` package (Ooms, 2014) and the `httpuv` package (RStudio and Inc., 2015), have made R an attractive sole target platform for the EMU-SDMS. These and other packages provide additional functional power that enabled the EMU-SDMS's core functionality to be implemented in the form of R packages. The availability of certain R packages had a large impact on the architectural design decisions that we made for the new system.

R Example 1.1.1 shows the simple installation process which we were able to achieve due to the R package infrastructure. Compared to the legacy EMU and other systems, the installation process of the entire system has been reduced to a single R command. Throughout this documentation we will try to highlight how the EMU-SDMS is also able to meet the rest of the above key user requirements.

### R Example 1.1.1

```
# install the entire EMU-SDMS  
# by installing the emuR package  
install.packages("emuR")
```

It is worth noting that throughout this manual R Example code snippets will be given in the form of R Example 1.1.1. These examples represent working R code that allow the reader to follow along in a hands-on manor and give a feel for what it is like working with the new EMU-SDMS.

## 1.2 EMU-SDMS: System architecture and default workflow

As was previously mentioned, the new EMU-SDMS is made up of four main components. The components are the `emuDB` format; the R packages `wrassp` and `emuR`; and the web application, the `EMU-webApp`, which is EMU-SDMS's new graphical user interface (GUI) component. An overview of the EMU-SDMS's architecture and the components' relationships within the system is shown in Figure 1.1. In Figure 1.1, the `emuR` package plays a central role as it is the only component that interacts with all of the other components of the EMU-SDMS. It performs file and DB handling for the files that comprise an `emuDB` (see Chapter 3); it uses the `wrassp` package for signal processing purposes (see Chapter 7); and it can serve `emuDBs` to the `EMU-webApp` (see Chapter 8).

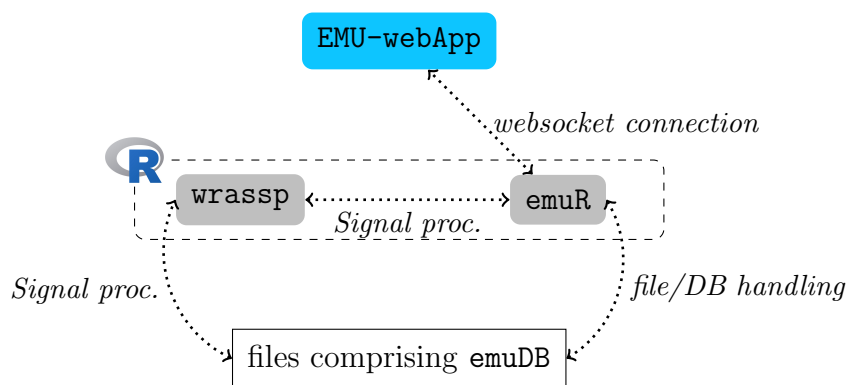

Figure 1.1: Schematic architecture of the EMU-SDMS

Although the system is made of four main components, the user largely only interacts directly with the `EMU-webApp` and the `emuR` package. A summary of the default workflow illustrating these interactions can be seen below:

1. Load database into current R session (`load_emuDB()`).
2. Database annotation / visual inspection (`serve()`). This opens up the `EMU-webApp` in the system's default browser.
3. Query database (`query()`). This is optionally followed by `requery_hier()` or `requery_seq()` as necessary (see Chapter 5 for details).
4. Get trackdata (e.g. formant values) for the result of a query (`get_trackdata()`).
5. Prepare data.
6. Visually inspect data.
7. Carry out further analysis and statistical processing.

Initially the user creates a reference to an `emuDB` by loading it into their current R session using the `load_emuDB()` function (see step 1). This database reference can then be used to either serve (`serve()`) the database to the `EMU-webApp` or query (`query()`) the annotations of the `emuDB` (see steps 2 and 3). The result of a query can then be used to either perform one or more so-called requeries or extract signal values that correspond to the result of a `query()` or `requery()` (see step 4). Finally, the signal data can undergo further preparation (e.g., correction of outliers) and visual inspection before further analysis and statistical processing is carried out (see steps 5, 6 and 7). Although the R packages provided by the EMU-SDMS do provide functions for steps 4, 5 and 6, it is worth noting that the

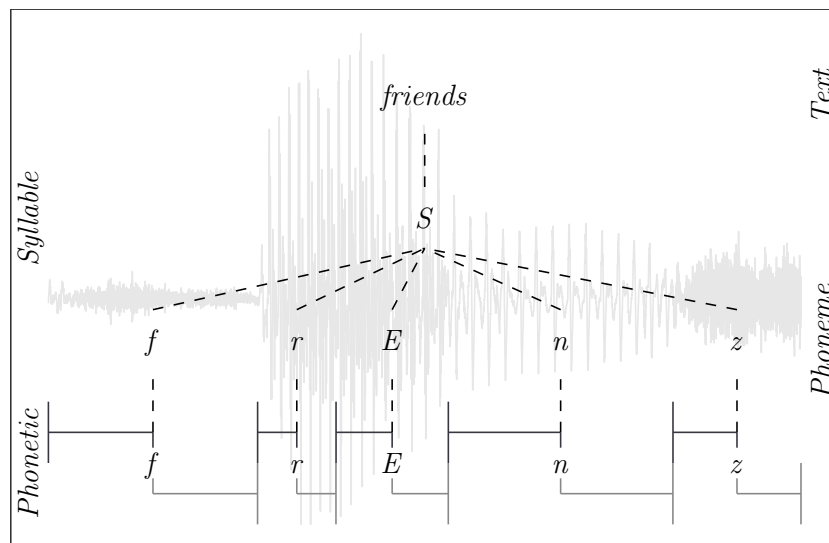

Figure 1.2: Example of a hybrid annotation combining time-based (*Phonetic* level) and hierarchical (*Phoneme*, *Syllable*, *Text* levels including the inter-level links) annotations.

plethora of R packages that the R package ecosystem provides can and should be used to perform these duties. The resulting objects of most of the above functions are derived `matrix` or `data.frame` objects which can be used as inputs for hundreds if not thousands of other R functions.

### 1.3 EMU-SDMS: Is it something for you?

Besides providing a fully integrated system, the EMU-SDMS has several unique features that set it apart from other current, widely used systems (e.g., Boersma and Weenink, 2016; Wittenburg et al., 2006; Fromont and Hay, 2012; Rose et al., 2006; McAuliffe and Sonderegger, 2016). To our knowledge, the EMU-SDMS is the only system that allows the user to model their annotation structures based on a hybrid model of time-based annotations (such as those offered by Praat’s tier-based annotation mechanics) and hierarchical timeless annotations. An example of such a hybrid annotation structure is displayed in Figure 1.2. These hybrid annotations benefit the user in multiple ways, as they reduce data redundancy and explicitly allow relationships to be expressed across annotation levels (see Chapter 3 for further information on hierarchical annotations and Chapter 5 on how to query these annotation structures).

Further, to our knowledge, the EMU-SDMS is the first system that makes

use of a web application as its primary GUI for annotating speech. This unique approach enables the GUI component to be used in multiple ways. It can be used as a stand-alone annotation tool, connected to a loaded `emuDB` via `emuR`'s `serve()` function and used to communicate to other servers. This enables it to be used as a collaborative annotation tool. An in-depth explanation of how this component can be used in these three scenarios is given in Chapter 8.

As demonstrated in the default workflow of Section 1.2, an additional unique feature provided by EMU-SDMS is the ability to use the result of a query to extract derived (e.g., formants and RMS values) and complementary signals (e.g., electromagnetic articulography (EMA) data) that match the segments of a query. This, for example, aids the user in answering questions related to derived speech signals such as: *Is the vowel height of the vowel i: (measured by its correlate, the first formant frequency) influenced by whether it appears in a strong or weak syllable?* Chapter 2 gives a complete walk-through of how to go about answering this question using the tools provided by the EMU-SDMS.

The features provided by the EMU-SDMS make it an all-in-one speech database management solution that is centered around R. It enriches the R platform by providing specialized speech signal processing, speech database management, data extraction and speech annotation capabilities. By achieving this without relying on any external software sources except the web browser, the EMU-SDMS significantly reduces the number of tools the speech and spoken language researcher has to deal with and helps to simplify answering research questions. As the only prerequisite for using the EMU-SDMS is a basic familiarity with the R platform, if the above features would improve your workflow, the EMU-SDMS is indeed for you.

# Chapter 2

## A tutorial on how to use the EMU-SDMS<sup>\*</sup>

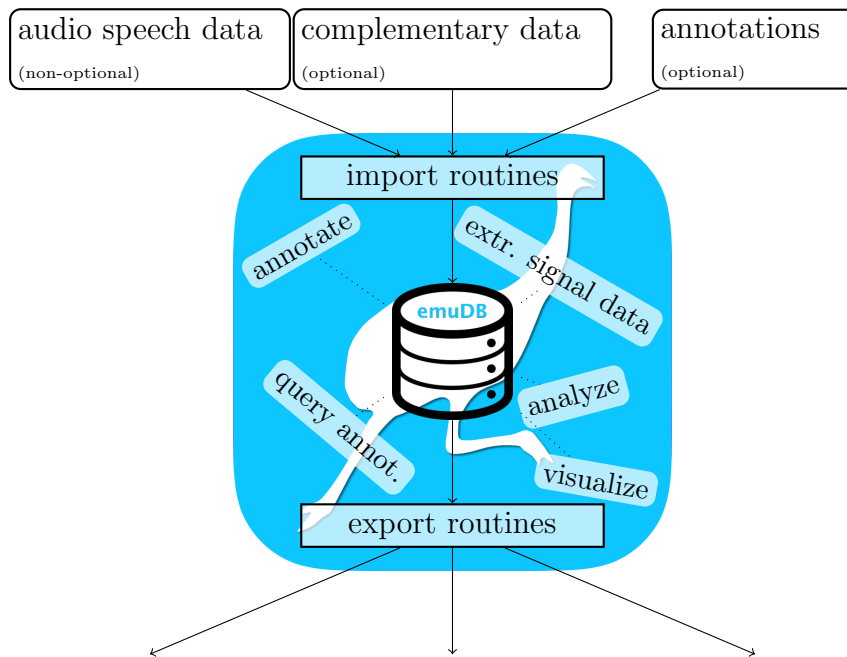

Using the tools provided by the EMU-SDMS, this tutorial chapter gives a practical step-by-step guide to answering the question: *Given an annotated speech database, is the vowel height of the vowel @ (measured by its correlate, the first formant frequency) influenced by whether it appears in a content or function word?* The tutorial only skims over many of the concepts and functions provided by the

---

<sup>\*</sup>Some examples of this chapter are adapted versions of examples of the `emuR_intro` vignette.

EMU-SDMS. In-depth explanations of the various functionalities are given in later chapters of this documentation.

As the EMU-SDMS is not concerned with the raw data acquisition, other tools such as `SpeechRecorder` by Draxler and Jansch (2004) are first used to record speech. However, once audio speech recordings are available, the system provides multiple conversion routines for converting existing collections of files to the new `emuDB` format described in Chapter 4 and importing them into the new EMU system. The current import routines provided by the `emuR` package are:

- `convert_TextGridCollection()` - Convert TextGrid collections (`.wav` and `.TextGrid` files) to the `emuDB` format,
- `convert_BPFCollection()` - Convert BAS Partitur Format (BPF) collections (`.wav` and `.par` files) to the `emuDB` format,
- `convert_txtCollection()` - Convert plain text file collections format (`.wav` and `.txt` files) to the `emuDB` format,
- `convert_legacyEmuDB()` - Convert the legacy EMU database format to the `emuDB` format and
- `create_emuDB()` followed by `add_link/levelDefinition` and `import_mediaFiles()` - Creating `emuDBs` from scratch with only audio files present.

The `emuR` package comes with a set of example files and small databases that are used throughout the `emuR` documentation, including the functions help pages. These can be accessed by typing `help(functionName)` or the short form `?functionName`. R Example 2.0.1 illustrates how to create this demo data in a user-specified directory. Throughout the examples of this documentation the directory that is provided by the base R function `tempdir()` will be used, as this is available on every platform supported by R (see `?tempdir` for further details). As can be inferred from the `list.dirs()` output in R Example 2.0.1, the `emuR_demoData` directory contains a separate directory containing example data for each of the import routines. Additionally, it contains a directory containing an `emuDB` called `ae` (the directories name is `ae_emuDB`, where `_emuDB` is the default suffix given to directories containing a `emuDB`; see Chapter 4).

### R Example 2.0.1

```
# load the package  
library(emuR)
```

```

# create demo data in directory provided by the tempdir() function
# (of course other directory paths may be chosen)
create_emuRdemoData(dir = tempdir())

# create path to demo data directory, which is
# called "emuR_demoData"
demoDataDir = file.path(tempdir(), "emuR_demoData")

# show demo data directories
list.dirs(demoDataDir, recursive = F, full.names = F)

## [1] "ae_emuDB"          "BPF_collection"
## [3] "legacy_ae"        "TextGrid_collection"
## [5] "txt_collection"

```

This tutorial will start by converting a TextGrid collection containing seven annotated single-sentence utterances of a single male speaker to the emuDB format<sup>1</sup>. In the EMU-SDMS, a file collection such as a TextGrid collection refers to a set of file pairs where two types of files with different file extensions are present (e.g., `.ext1` and `.ext2`). It is vital that file pairs have the same basenames (e.g., `A.ext1` and `A.ext2` where `A` represents the basename) in order for the conversion functions to be able to pair up files that belong together. As other speech software tools also encourage such file pairs (e.g., Kisler et al., 2015) this is a common collection format in the speech sciences. R Example 2.0.2 shows such a file collection that is part of emuR's demo data. Figure 2.1 shows the content of an annotation as displayed by Praat's "Draw visible sound and Textgrid..." procedure.

### R Example 2.0.2

```

# create path to TextGrid collection
tgColDir = file.path(demoDataDir, "TextGrid_collection")

# show content of TextGrid_collection directory
list.files(tgColDir)

## [1] "msajc003.TextGrid" "msajc003.wav"
## [3] "msajc010.TextGrid" "msajc010.wav"
## [5] "msajc012.TextGrid" "msajc012.wav"
## [7] "msajc015.TextGrid" "msajc015.wav"

```

<sup>1</sup>The other input routines are covered in the Section 9.1.



```
## [9] "msajc022.TextGrid" "msajc022.wav"  
## [11] "msajc023.TextGrid" "msajc023.wav"  
## [13] "msajc057.TextGrid" "msajc057.wav"
```

## 2.1 Converting the TextGrid collection

The `convert_TextGridCollection()` function converts a TextGrid collection to the `emuDB` format. A precondition that all `.TextGrid` files have to fulfill is that they must all contain the same tiers. If this is not the case, yet there is an equal tier subset that is contained in all the TextGrid files, this equal subset may be chosen. For example, if all `.TextGrid` files contain only the tier `Phonetic: IntervalTier` the conversion will work. However, if a single `.TextGrid` of the collection has the additional tier `Tone: TextTier` the conversion will fail. In this case the conversion could be made to work by specifying the equal subset (e.g., `equalSubset = c("Phonetic")`) and passing it on to the `tierNames` function argument `convert_TextGridCollection(..., tierNames = equalSubset, ...)`. As can be seen in Figure 2.1, the TextGrid files provided by the demo data contain eleven tiers. To reduce the complexity of the annotations for this tutorial we will only convert the tiers *Word* (content: *C* vs. function: *F* word annotations), *Syllable* (strong: *S* vs. weak: *W* syllable annotations), *Phoneme* (phoneme level annotations) and *Phonetic* (phonetic annotations using Speech Assessment Methods Phonetic Alphabet (SAMPA) symbols - Wells et al. (1997)) using the `tierNames` parameter. This conversion can be seen in R Example 2.1.1.

### R Example 2.1.1

```
# convert TextGrid collection to the emuDB format  
convert_TextGridCollection(dir = tgColDir,  
                           dbName = "myFirst",  
                           targetDir = tempdir(),  
                           tierNames = c("Word", "Syllable",  
                                          "Phoneme", "Phonetic"))
```

The above call to `convert_TextGridCollection()` creates a new `emuDB` directory in the `tempdir()` directory called `myFirst_emuDB`. This `emuDB` contains annotation files that contain the same *Word*, *Syllable*, *Phoneme* and *Phonetic* segment tiers as the original `.TextGrid` files as well as copies of the original (`.wav`) audio files. For further details about the structure of an `emuDB`, see Chapter 4 of this document.

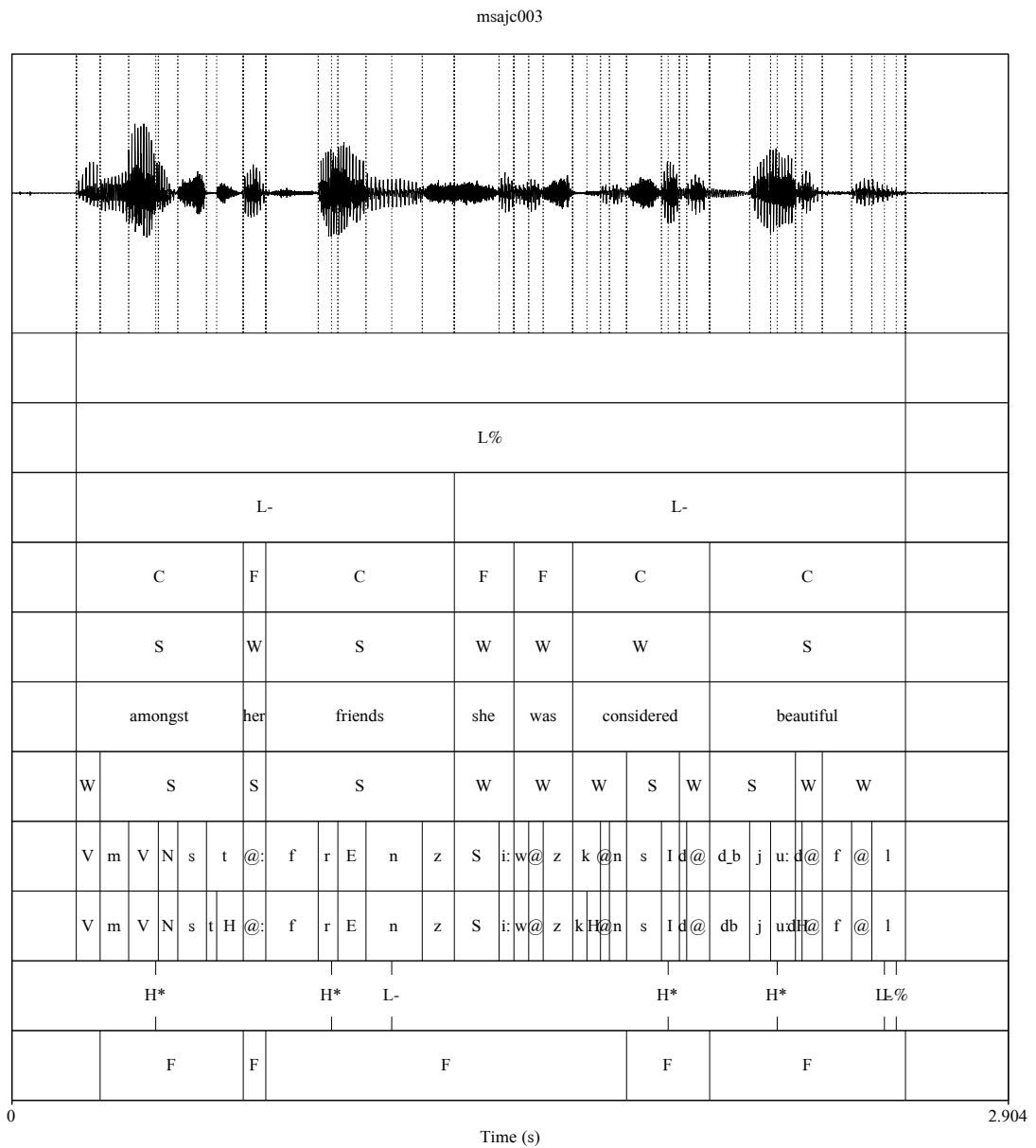

Figure 2.1: TextGrid annotation of the `emuR_demoData/TextGrid_collection/msajc003.wav` / `.TextGrid` file pair containing the tiers (from top to bottom): *Utterance*, *Intonational*, *Intermediate*, *Word*, *Accent*, *Text*, *Syllable*, *Phoneme*, *Phonetic*, *Tone*, *Foot*.

## 2.2 Loading and inspecting the database

As mentioned in Section 1.2, the first step when working with an emuDB is to load it into the current R session. R Example 2.2.1 shows how to load the converted TextGrid collection into R using the `load_emuDB()` function.

### R Example 2.2.1

```
# get path to emuDB called "myFirst"
# that was created by convert_TextGridCollection()
path2directory = file.path(tempdir(), "myFirst_emuDB")

# load emuDB into current R session
dbHandle = load_emuDB(path2directory, verbose = FALSE)
```

### 2.2.1 Overview

Now the *myFirst* emuDB is loaded into R, an overview of the current status and configuration of the database can be displayed using the `summary()` function as shown in R Example 2.2.2.

### R Example 2.2.2

```
# show summary
summary(dbHandle)

## Name: myFirst
## UUID: 99a206b4-3d15-4a5c-bf58-ef30a365f180
## Directory: /private/var/folders/yk/8z9tn7kx6hbcg_9n4c1sld9800...
## Session count: 1
## Bundle count: 7
## Annotation item count: 664
## Label count: 664
## Link count: 0
##
## Database configuration:
##
## SSFF track definitions:
## NULL
##
## Level definitions:
```

```
##      name      type nrOfAttrDefs attrDefNames
## 1   Word SEGMENT      1         Word;
## 2 Syllable SEGMENT      1       Syllable;
## 3 Phoneme SEGMENT      1        Phoneme;
## 4 Phonetic SEGMENT      1       Phonetic;
##
## Link definitions:
## NULL
```

The extensive output of `summary()` is split into a top and bottom half, where the top half focuses on general information about the database (name, directory, annotation item count, etc.) and the bottom half displays information about the various Simple Signal File Format (SSFF) track, level and link definitions of the `emuDB`. The summary information about the level definitions shows, for instance, that the *myFirst* database has a *Word* level of type `SEGMENT` and therefore contains annotation items that have a start time and a segment duration. It is worth noting that information about the SSFF track, level and link definitions corresponds to the output of the `list_ssffTrackDefinitions()`, `list_levelDefinitions()` and `list_linkDefinitions()` functions.

### 2.2.2 Database annotation and visual inspection

The EMU-SDMS has a unique approach to annotating and visually inspecting databases, as it utilizes a web application called the `EMU-webApp` to act as its GUI. To be able to communicate with the web application the `emuR` package provides the `serve()` function which is used in R Example 2.2.3.

#### R Example 2.2.3

```
# serve myFirst emuDB to the EMU-webApp
serve(dbHandle)
```

Executing this command will block the R console, automatically open up the system's default browser and display the following message in the R console:

```
## Navigate your browser to the EMU-webApp URL:
## http://ips-lmu.github.io/EMU-webApp/ (should happen autom...
## Server connection URL:
## ws://localhost:17890
## To stop the server press the 'clear' button in the
## EMU-webApp or close/reload the webApp in your browser.
```

The `EMU-webApp`, which is now connected to the database via the `serve()` function, can be used to visually inspect and annotate the `emuDB`. Figure 2.2 displays a screenshot of what the `EMU-webApp` looks like after automatically connecting to the server. As the `EMU-webApp` is a very feature-rich software annotation tool, this documentation has a whole chapter (see Chapter 8) on how to use it, what it is capable of and how to configure it. Further, the web application provides its own documentation which can be accessed by clicking the `EMU` icon in the top right hand corner of the application's top menu bar. To close the connection and free up the blocked R console, simply click the `clear` button in the top menu bar of the `EMU-webApp`.

## 2.3 Querying and autobuilding the annotation structure

An integral step in the default workflow of the `EMU-SDMS` is querying the annotations of a database. The `emuR` package implements a `query()` function to accomplish this task. This function evaluates an EMU Query Language (EQL) expression and extracts the annotation items from the database that match a query expression. As Chapter 5 gives a detailed description of the query mechanics provided by `emuR`, this tutorial will only use a very small, hopefully easy to understand subset of the EQL.

The output of the `summary()` command in R Example 2.2.2 and the screenshot in Figure 2.2 show that the *myFirst* `emuDB` contains four levels of annotations. R Example 2.3.1 shows four separate queries that query various segments on each of the available levels. The query expressions all use the matching operator `==` which returns annotation items whose labels match those specified to the right of the operator and that belong to the level specified to the left of the operator (i.e., `LEVEL == LABEL`; see Chapter 5 for a detailed description).

### R Example 2.3.1

```
# query all segments containing the label
# "C" (== content word) of the "Word" level
sl_text = query(emuDBhandle = dbHandle,
                query = "Word == C")

# query all segments containing the label
# "S" (== strong syllable) of the "Syllable" level
sl_syl = query(emuDBhandle = dbHandle,
               query = "Syllable == S")
```

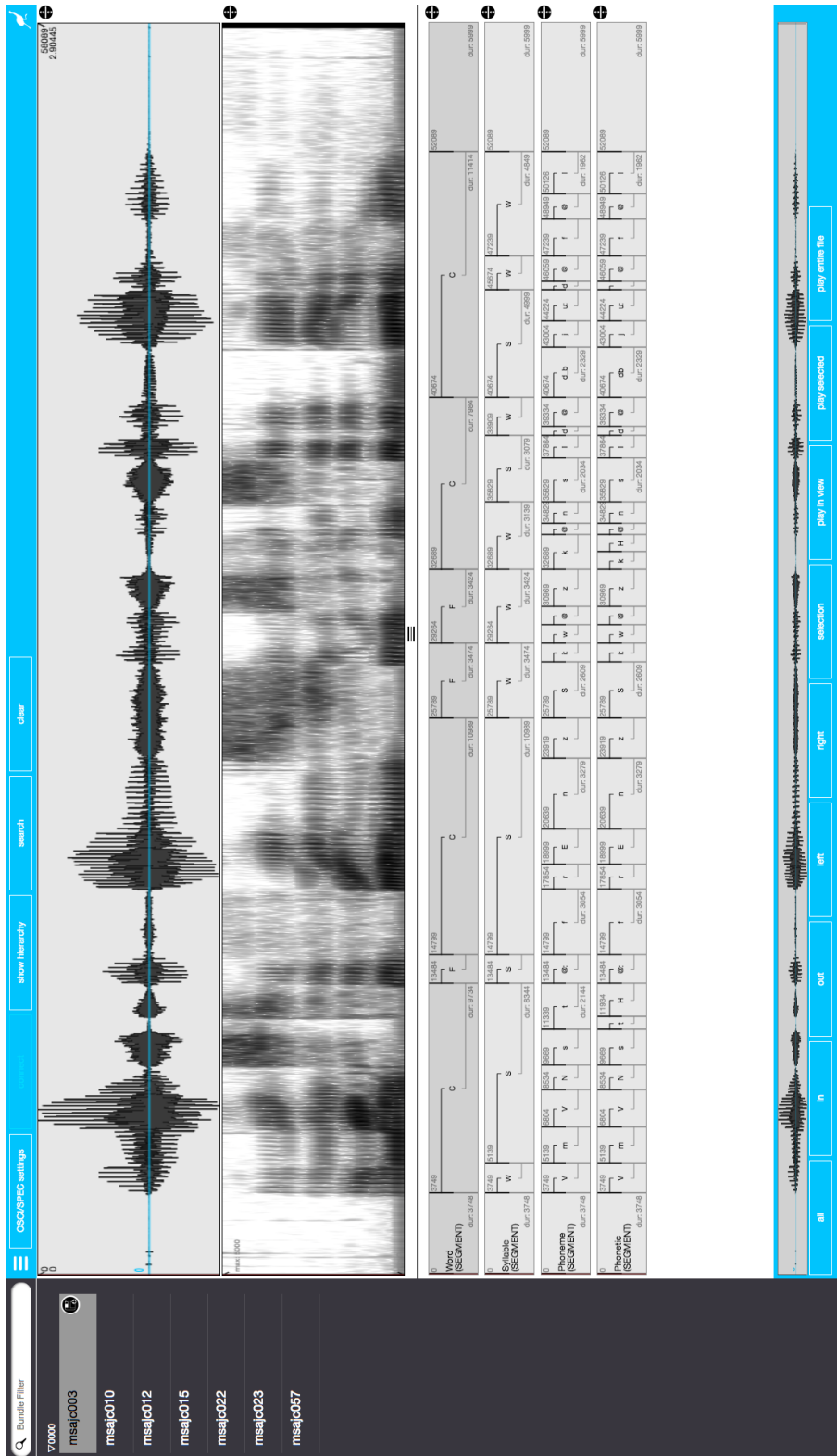

Figure 2.2: Screenshot of EMU-webApp displaying msajc003 bundle of *myFirst* emuDB.

```
# query all segments containing the label
# "f" on the "Phoneme" level
sl_phoneme = query(dbHandle,
                  query = "Phoneme == f")

# query all segments containing the label
# "n" of the "Phonetic" level
sl_phonetic = query(dbHandle,
                   query = "Phonetic == n")

# show class vector of query result
class(sl_phonetic)

## [1] "emuRsegs" "emusegs" "data.frame"

# show first entry of sl_phonetic
head(sl_phonetic, n = 1)

## segment list from database: myFirst
## query was: Phonetic == n...
## labels start end session bundle level
## 1 n 1031.925 1195.925 0000 msajc003 Phonetic
## type
## 1 SEGMENT

# show summary of sl_phonetic
summary(sl_phonetic)

## segment list from database: myFirst
## query was: Phonetic == n
## with 12 segments
##
## Segment distribution:
##
## n
## 12
```

As demonstrated in R Example 2.3.1, the result of a query is an `emuRsegs` object, which is a super-class of the common `data.frame`. This object is often referred to as a segment list, or “seglist”. A segment list carries information about the extracted annotation items such as the extracted labels, the start and end

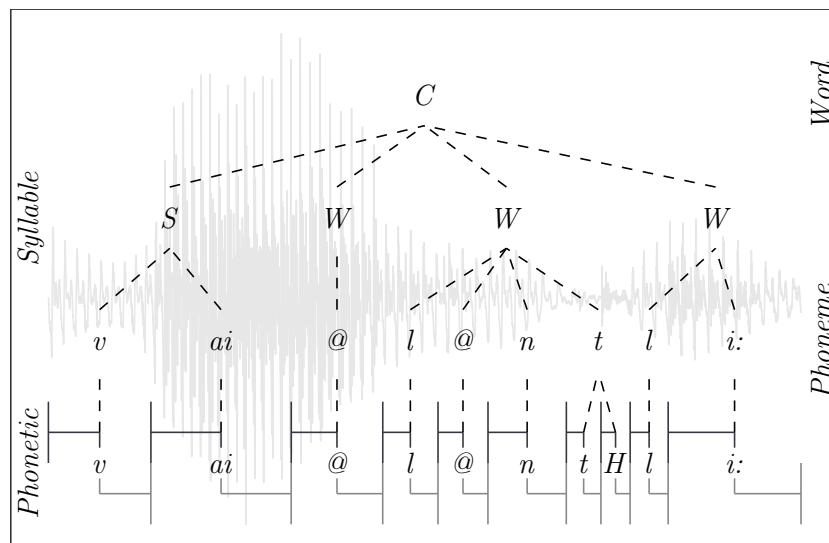

Figure 2.3: Example of a hierarchical annotation of the content ( $==C$ ) word *violently* belonging to the *msajc012* bundle of the *myFirst* demo *emuDB*.

times of the segments, the sessions and bundles the items are from and the levels they belong to. An in-depth description of the information contained in a segment list is given in Section 5.1. R Example 2.3.1 shows that the `summary()` function can also be applied to a segment list object to get an overview of what is contained within it. This can be especially useful when dealing with larger segment lists.

### 2.3.1 Autobuilding

The simple queries illustrated above query segments from a single level that match a certain label. However, the EMU-SDMS offers a mechanism for performing inter-level queries such as: *Query all Phonetic items that contain the label “n” and are part of a content word.* For such queries to be possible, the EMU-SDMS offers very sophisticated annotation structure modeling capabilities, which are described in Chapter 3. For the sake of this tutorial we will focus on converting the flat segment level annotation structure displayed in Figure 2.2 to a hierarchical form as displayed in Figure 2.3, where only the *Phonetic* level carries time information and the annotation items on the other levels are explicitly linked to each other to form a hierarchical annotation structure.

As it is a very laborious task to manually link annotation items together using the EMU-webApp and the hierarchical information is already implicitly contained in the time information of the segments and events of each level, we will now



use a function provided by the `emuR` package to build these hierarchical structures using this information called `autobuild_linkFromTimes()`. R Example 2.3.2 shows the calls to this function which autobuild the hierarchical annotations in the *myFirst* database. As a general rule for autobuilding hierarchical annotation structures, a good strategy is to start the autobuilding process beginning with coarser grained annotation levels (i.e., the *Word/Syllable* level pair in our example) and work down to finer grained annotations (i.e., the *Syllable/Phoneme* and *Phoneme/Phonetic* level pairs in our example). To build hierarchical annotation structures we need link definitions, which together with the level definitions define the annotation structure for the entire database (see Chapter 3 for further details). The `autobuild_linkFromTimes()` calls in R Example 2.3.2 use the `newLinkDefType` parameter, which if defined automatically adds a link definition to the database.

### R Example 2.3.2

```
# invoke autobuild function
# for "Word" and "Syllable" levels
autobuild_linkFromTimes(dbHandle,
                        superlevelName = "Word",
                        sublevelName = "Syllable",
                        convertSuperlevel = TRUE,
                        newLinkDefType = "ONE_TO_MANY")

# invoke autobuild function
# for "Syllable" and "Phoneme" levels
autobuild_linkFromTimes(dbHandle,
                        superlevelName = "Syllable",
                        sublevelName = "Phoneme",
                        convertSuperlevel = TRUE,
                        newLinkDefType = "ONE_TO_MANY")

# invoke autobuild function
# for "Phoneme" and "Phonetic" levels
autobuild_linkFromTimes(dbHandle,
                        superlevelName = "Phoneme",
                        sublevelName = "Phonetic",
                        convertSuperlevel = TRUE,
                        newLinkDefType = "MANY_TO_MANY")
```

As the `autobuild_linkFromTimes()` function automatically creates backup

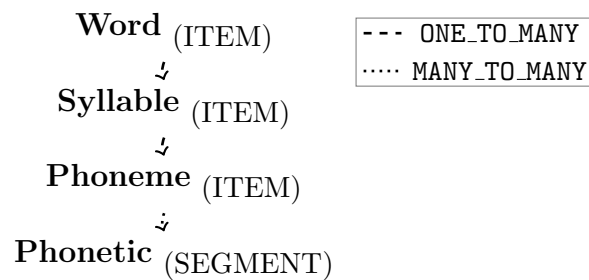

Figure 2.4: Schematic annotation structure of the `emuDB` after calling the `autobuild` function in R Example 2.3.2.

levels to avoid the accidental loss of boundary or event time information, R Example 2.3.3 shows how these backup levels can be removed to clean up the database. However, using the `remove_levelDefinition()` function with its `force` parameter set to `TRUE` is a very invasive action. Usually this would not be recommended, but for this tutorial we are keeping everything as clean as possible.

### R Example 2.3.3

```

# list level definitions
# as this reveals the "-autobuildBackup" levels
# added by the autobuild_linkFromTimes() calls
list_levelDefinitions(dbHandle)

##           name      type nrOfAttrDefs
## 1           Word      ITEM             1
## 2       Syllable      ITEM             1
## 3         Phoneme      ITEM             1
## 4       Phonetic SEGMENT             1
## 5 Word-autobuildBackup SEGMENT             1
## 6 Syllable-autobuildBackup SEGMENT             1
## 7 Phoneme-autobuildBackup SEGMENT             1
##           attrDefNames
## 1           Word;
## 2       Syllable;
## 3         Phoneme;
## 4       Phonetic;
## 5 Word-autobuildBackup;
## 6 Syllable-autobuildBackup;
## 7 Phoneme-autobuildBackup;
  
```

```

# remove the levels containing the "-autobuildBackup"
# suffix
remove_levelDefinition(dbHandle,
                       name = "Word-autobuildBackup",
                       force = TRUE,
                       verbose = FALSE)

remove_levelDefinition(dbHandle,
                       name = "Syllable-autobuildBackup",
                       force = TRUE,
                       verbose = FALSE)

remove_levelDefinition(dbHandle,
                       name = "Phoneme-autobuildBackup",
                       force = TRUE,
                       verbose = FALSE)

# list level definitions
list_levelDefinitions(dbHandle)

##      name      type nrOfAttrDefs attrDefNames
## 1   Word      ITEM          1      Word;
## 2 Syllable    ITEM          1      Syllable;
## 3 Phoneme     ITEM          1      Phoneme;
## 4 Phonetic   SEGMENT       1      Phonetic;

# list level definitions
# which were added by the autobuild functions
list_linkDefinitions(dbHandle)

##      type superlevelName sublevelName
## 1 ONE_TO_MANY      Word      Syllable
## 2 ONE_TO_MANY      Syllable   Phoneme
## 3 MANY_TO_MANY     Phoneme    Phonetic

```

As can be seen by the output of `list_levelDefinitions()` and `list_linkDefinitions()` in R Example 2.3.2, the annotation structure of the *myFirst* emuDB now matches that displayed in Figure 2.4. Using the `serve()` function to open the emuDB in the EMU-webApp followed by clicking on the `show hierarchy` button in the top menu (and rotating the hierarchy by 90 degrees by clicking the `rotate by 90 degrees` button) will result in a view similar to the

screenshot of Figure 2.5.

### 2.3.2 Querying the hierarchical annotations

Having this hierarchical annotation structure now allows us to formulate a query that helps answer the originally stated question: *Given an annotated speech database, is the vowel height of the vowel @ (measured by its correlate, the first formant frequency) influenced by whether it appears in a content or function word?* R Example 2.3.4 shows how all the @ vowels in the *myFirst* database are queried.

#### R Example 2.3.4

```
# query annotation items containing
# the labels @ on the Phonetic level
sl_vowels = query(dbHandle, "Phonetic == @")

# show first entry of sl_vowels
head(sl_vowels, n = 1)

## segment list from database: myFirst
## query was: Phonetic == @...
## labels start end session bundle level
## 1 @ 1506.175 1548.425 0000 msajc003 Phonetic
## type
## 1 SEGMENT
```

As the type of word (content vs. function) for each @ vowel that was just extracted is also needed, we can use the requery functionality of the EMU-SDMS (see Chapter 5) to retrieve the word type for each @ vowel. A requery essentially moves through a hierarchical annotation (vertically or horizontally) starting from the segments that are passed into the requery function. R Example 2.3.5 illustrates the usage of the hierarchical requery function, `requery_hier()`, to retrieve the appropriate annotation items from the *Word* level.

#### R Example 2.3.5

```
# hierarchical requery starting from the items in sl_vowels
# and moving up to the "Word" level
sl_wordType = requery_hier(dbHandle,
                           seglist = sl_vowels,
                           level = "Word",
```

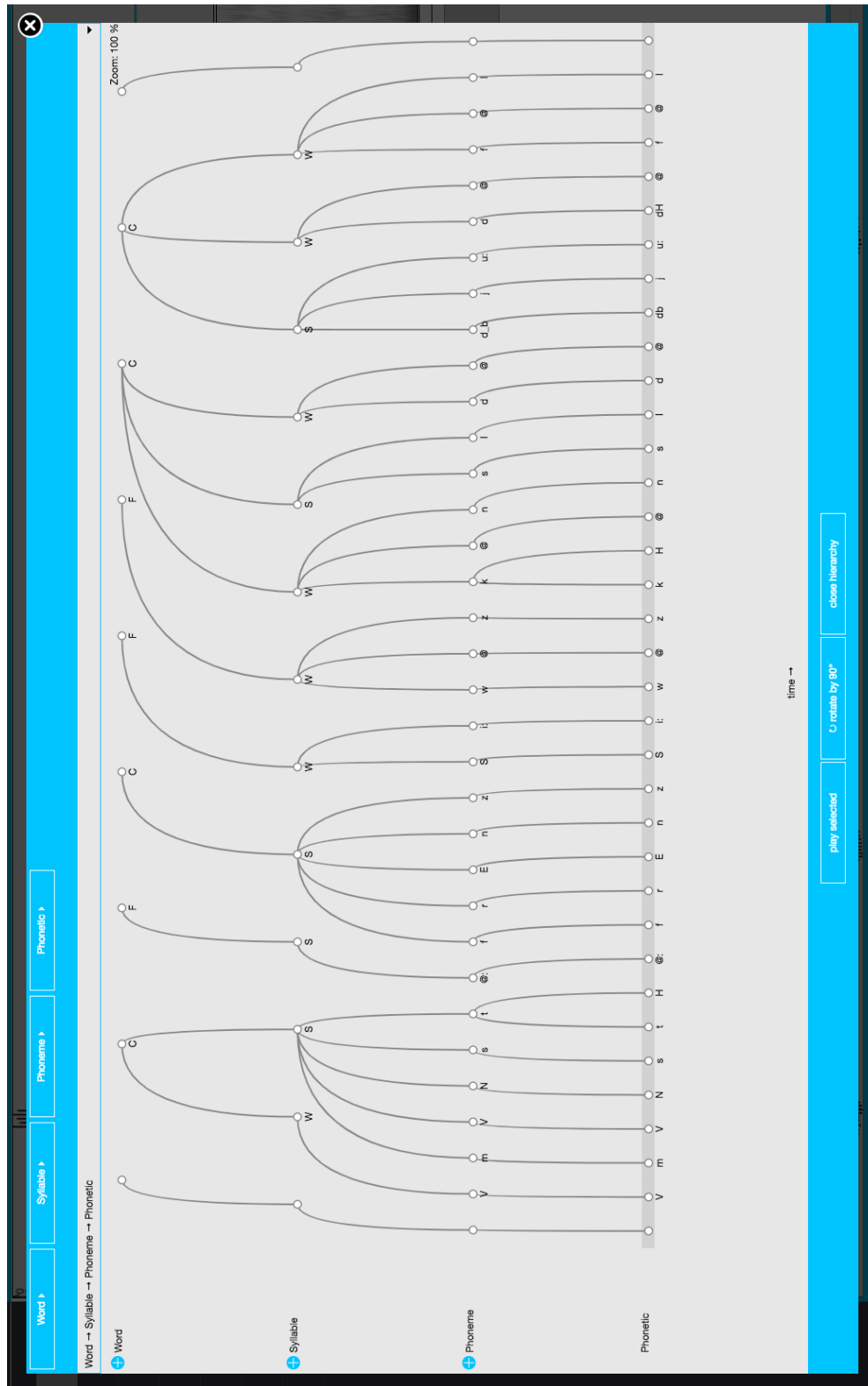

Figure 2.5: Screenshot of EMU-webApp displaying the autobuilt hierarchy of the *myFirst* emuDB.

```
                                calcTimes = FALSE)

# show first entry of sl_wordType
head(sl_wordType, n = 1)

## segment list from database: myFirst
## query was: FROM REQUERY...
## labels start end session bundle level type
## 1      F    NA  NA    0000 msajc003 Word ITEM

# show that sl_vowel and sl_wordType have the
# same number of row entries
nrow(sl_vowels) == nrow(sl_wordType)

## [1] TRUE
```

As can be seen by the `nrow()` comparison in R Example 2.3.5, the segment list returned by the `requery_hier()` function has the same number of rows as the original `sl_vowels` segment list. This is important, as each row of both segment lists line up and allow us to infer which segment belongs to which word type (e.g., vowel `sl_vowels[5,]` belongs to the word type `sl_wordType[5,]`).

## 2.4 Signal extraction and exploration

Now that the vowel and word type information including the vowel start and end time information has been extracted from the database, this information can be used to extract signal data that matches these segments. Using the `emuR` function `get_trackdata()` we can calculate the formant values in real time using the formant estimation function, `forest()`, provided by the `wrassp` package (see Chapter 7 for details). R Example 2.4.1 shows the usage of this function.

### R Example 2.4.1

```
# get formant values for the vowel segments
td_vowels = get_trackdata(dbHandle,
                          seglist = sl_vowels,
                          onTheFlyFunctionName = "forest",
                          verbose = F)

# show class vector
class(td_vowels)
```

```
## [1] "trackdata"

# show dimensions
dim(td_vowels)

## [1] 28  4

# display all values for fifth segment
td_vowels[5,]

## trackdata from track: fm
## index:
## left right
##      1    12
## ftime:
##      start    end
## [1,] 2447.5 2502.5
## data:
##      T1  T2  T3  T4
## 2447.5 303 1031 2266 3366
## 2452.5 289  967 2250 3413
## 2457.5 296  905 2273 3503
## 2462.5 321  885 2357 3506
## 2467.5 316  889 2397 3475
## 2472.5 306  863 2348 3548
## 2477.5 314  832 2339 3611
## 2482.5 325  795 2342 3622
## 2487.5 339  760 2322 3681
## 2492.5 335  746 2316 3665
## 2497.5 341  734 2306 3688
## 2502.5 361  733 2304 3692
```

As can be seen by the call to the `class()` function, the resulting object is of the type `trackdata` and has 28 entries. This corresponds to the number of rows contained in the segment lists extracted above (i.e., `nrow(s1_vowels)`). This indicates that this object contains data for each of the segments that correspond to each of the row entries of the segment lists (i.e., `td_vowels[5,]` are the formant values belonging to `s1_vowels[5,]`). As the columns T1, T2, T3, T4 of the printed output of `td_vowels[5,]` suggest, the `forest` function estimates four formant values. We will only be concerned with the first (column T1) and second (column T2). R Example 2.4.2 shows a call to `emuR`'s `dplot()` function which produces

the plot displayed in Figure 2.6. The first call to the `dplot()` function plots all 28 first formant trajectories (achieved by indexing the first column i.e., `T1: x = td_vowels[, 1]`). To clean up the cluttered left plot, the second call to the `dplot()` function additionally uses the `average` parameter to plot only the ensemble averages of all @ vowels and time-normalizes the trajectories (`normalise = TRUE`) to an interval between 0 and 1.

#### R Example 2.4.2

```
# two plots next to each other
formantNr = 1

par(mfrow = c(1,2))

dplot(x = td_vowels[, formantNr],
      labs = sl_vowels$labels,
      xlab = "Duration (ms)",
      ylab = paste0("F", formantNr, " (Hz)")

dplot(x = td_vowels[, 1],
      labs = sl_vowels$labels,
      normalise = TRUE,
      average = TRUE,
      xlab = "Normalized time",
      ylab = paste0("F", formantNr, " (Hz)")

# back to single plot
par(mfrow = c(1,1))
```

Figure 2.6 gives an overview of the first formant trajectories of the @ vowels. For the purpose of data exploration and to get an idea of where the individual vowel classes lie on the  $F_2 \times F_1$  plane, which indirectly provides information about vowel height and tongue position, R Example 2.4.3 makes use of the `eplot()` function. This produces Figure 2.7. To be able to use the `eplot()` function, the `td_vowels` object first has to be modified, as it contains entire formant trajectories but two dimensional data is needed to be able to display it on the  $F_2 \times F_1$  plain. This can, for example, be achieved by only extracting temporal mid-point formant values for each vowel using the `get_trackdata()` function utilizing its `cut` parameter. R Example 2.4.3 shows an alternative approach using the `dcut()` function to essentially cut the formant trajectories to a specified proportional segment. By using only the `left.time = 0.5` (and not specifying `right.time`) only the formant values



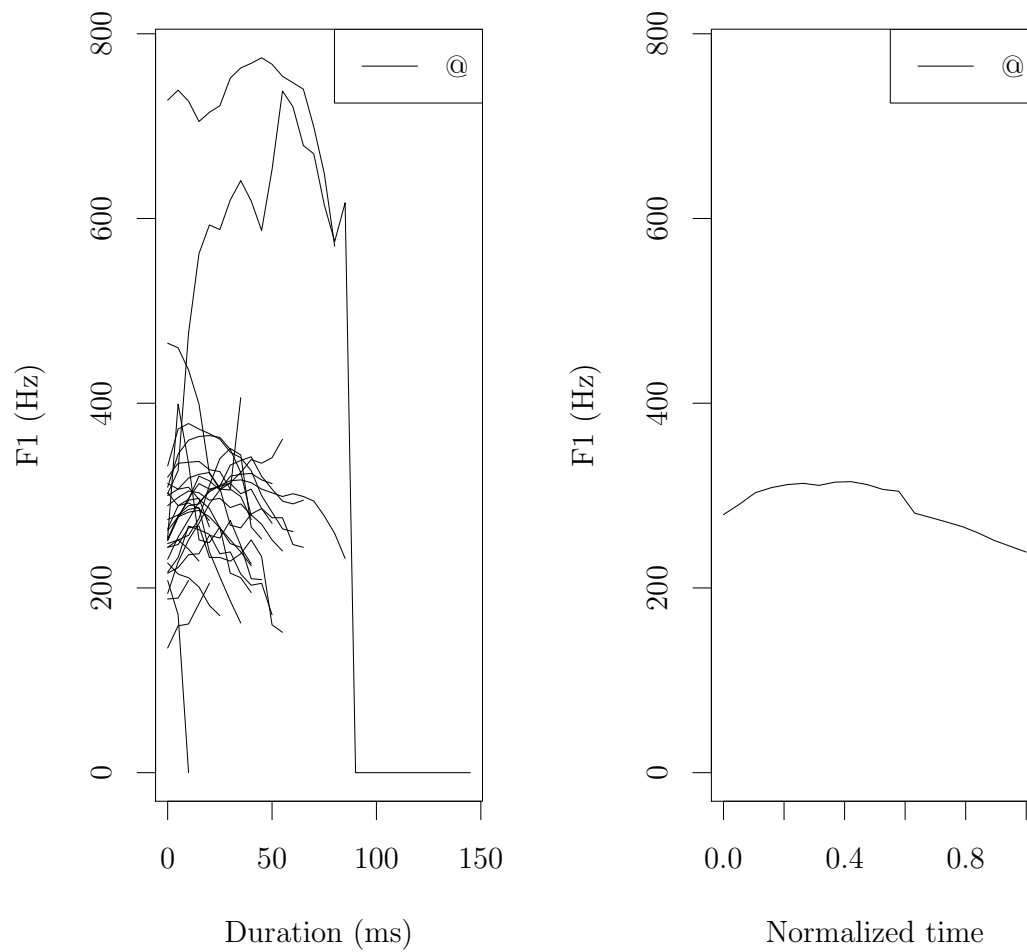

Figure 2.6: `dplot()` plots of F1 trajectories. The left plot displays all trajectories while the right plot displays the ensemble average of all '@' vowels.

that are closest to the temporal mid-point are cut from the trajectories.

### R Example 2.4.3

```
# cut formant trajectories at temporal mid-point
td_vowels_midpoint = dcut(td_vowels,
                          left.time = 0.5,
                          prop = TRUE)

# show dimensions of td_vowels_midpoint
dim(td_vowels_midpoint)

# generate plot
eplot(x = td_vowels_midpoint[,1:2],
      labs = sl_vowels$labels,
      dopoints = TRUE,
      formant = TRUE,
      xlab="F2 (Hz)",
      ylab = "F1 (Hz)"
    )
```

Figure 2.7 displays the first two formants extracted at the temporal midpoint of every @ vowel in `sl_vowels`. These formants are plotted on the F2 x F1 plane, and their 95% ellipsis distribution is also shown. Although not necessarily applicable to the question posed at the beginning of this tutorial, the data exploration using the `dplot()` and `eplot()` functions can be very helpful tools for providing an overview of the data at hand.

## 2.5 Vowel height as a function of word types (content vs. function): evaluation and sta- tistical analysis

The above data exploration only dealt with the actual @ vowels and disregarded the syllable type they occurred in. However, the question in the introduction of this chapter focuses on whether the @ vowel occurs in a content (labeled *C*) or function (labeled *F*) word. For data inspection purposes, R Example 2.5.1 initially extracts the central 60% (`left.time = 0.2` and `right.time = 0.8`) of the formant trajectories from `td_vowels` using `dcut()` and displays them using `dplot()`. It should be noted that the call to `dplot()` uses the labels of the `sl_wordType` object as opposed to those of `sl_vowels`. This causes the `dplot()`

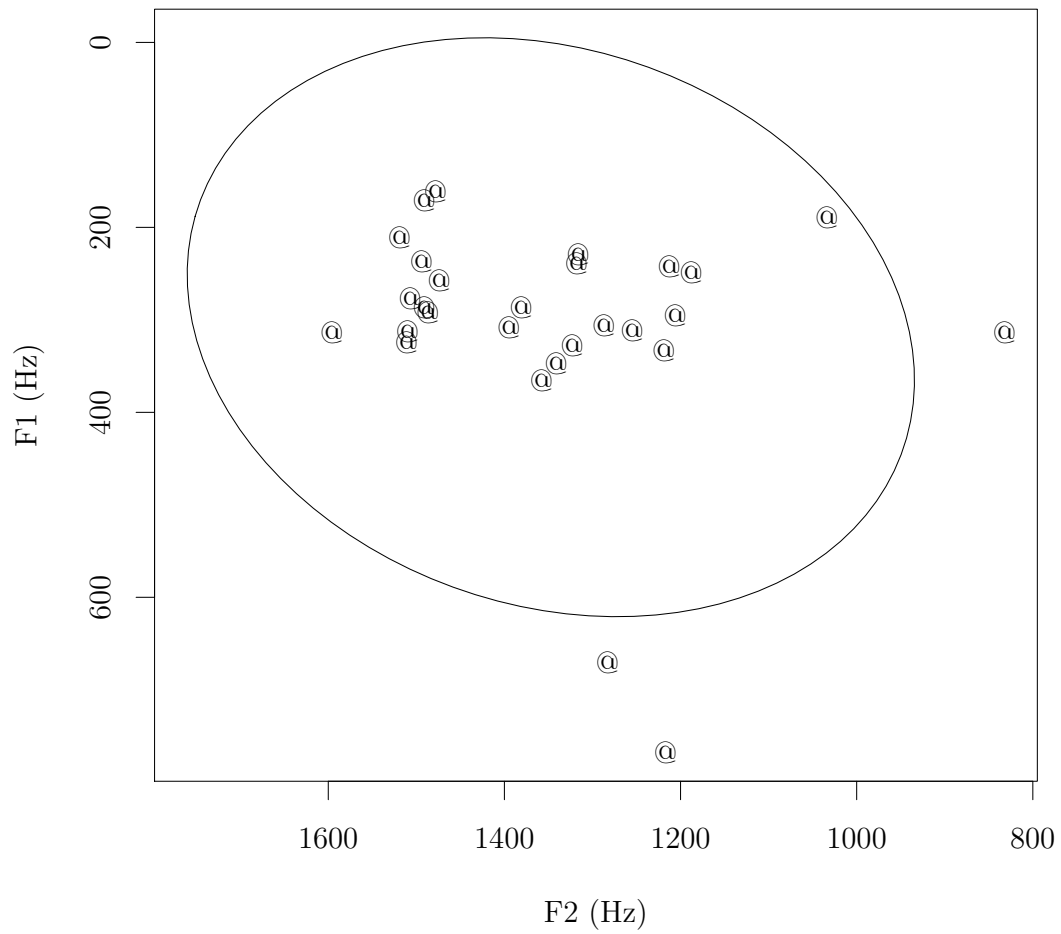

Figure 2.7: 95% ellipses for F2 x F1 data extracted from the temporal midpoint of the vowel segments.

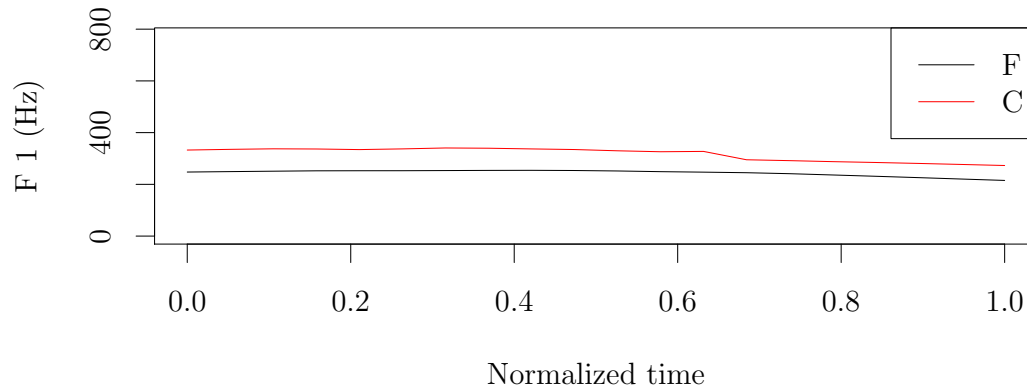

Figure 2.8: Ensemble averages of F1 contours of all tokens of the central 60% of vowels grouped by word type (function ( $F$ ) vs. content ( $W$ )).

functions to group the trajectories by their word type as opposed to their vowel labels as displayed in Figure 2.8.

#### R Example 2.5.1

```
# extract central 60% from formant trajectories
td_vowelsMidSec = dcut(td_vowels,
                      left.time = 0.2,
                      right.time = 0.8,
                      prop = TRUE)

# plot first formant trajectories
formantNr = 1
dplot(x = td_vowelsMidSec[, formantNr],
      labs = sl_wordType$labels,
      normalise = TRUE,
      average = TRUE,
      xlab = "Normalized time",
      ylab = paste("F", formantNr, " (Hz)"))
```

As can be seen in Figure 2.8, there seems to be a distinction in F1 trajectory height between vowels in content and function words. R Example 2.5.2 shows the

code to produce a boxplot using the `ggplot2` package to further visually inspect the data (see Figure 2.9 for the plot produced by R Example 2.5.2).

### R Example 2.5.2

```
formantNr = 1
# use trapply to calculate the means of the 60%
# formant trajectories
td_vowelsMidSec_mean = trapply(td_vowelsMidSec[, formantNr],
                               fun = mean,
                               simplify = T)

# create new data frame that contains the mean
# values and the corresponding labels
df = data.frame(wordType = sl_wordType$labels,
                meanF1 = td_vowelsMidSec_mean)

# load library
library(ggplot2)

# create boxplot using ggplot
ggplot(df, aes(wordType, meanF1)) +
  geom_boxplot() +
  labs(x = "Word type", y = paste0("mean F", formantNr, " (Hz)"))
```

To confirm or reject this, R Example 2.5.3 presents a very simple statistical analysis of the F1 mean values of the 60% mid-section formant trajectories<sup>2</sup>. First, a Shapiro-Wilk test for normality of the distributions of the F1 means for both word types is carried out. As only one type is normally distributed, a Wilcoxon rank sum test is performed. The density distributions (commented out `plot()` function calls in R Example 2.5.3) are displayed in Figure 2.10.

### R Example 2.5.3

```
# calculate density for vowels in function words
distrF = density(df[df$wordType == "F",]$meanF1)

# uncomment to visualize distribution
# plot(distrF)
```

---

<sup>2</sup>It is worth noting that the sample size in this toy example is quite small. This obviously influences the outcome of the simple statistical analysis that is performed here.

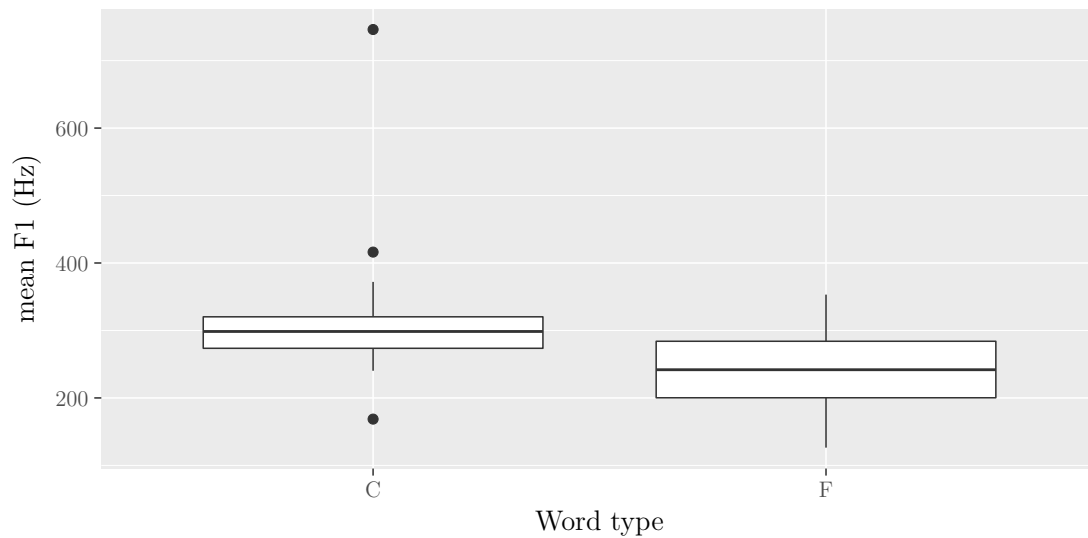

Figure 2.9: Boxplot produced using `ggplot2` to visualize the difference in F1 depending on whether the vowel occurs in content (*C*) or function (*F*) word.

```
# check that vowels in function
# words are normally distributed
shapiro.test(df[df$wordType == "F",]$meanF1)

##
## Shapiro-Wilk normality test
##
## data:  df[df$wordType == "F", ]$meanF1
## W = 0.98687, p-value = 0.9887

# p-value > 0.05 implying that the distribution
# of the data ARE NOT significantly different from
# normal distribution -> we CAN assume normality

# calculate density for vowels in content words
distrC = density(df[df$wordType == "C",]$meanF1)

# uncomment to visualize distribution
# plot(distrC)

# check that vowels in content
```

```
# words are normally distributed:
shapiro.test(df[df$wordType == "C",]$meanF1)

##
## Shapiro-Wilk normality test
##
## data:  df[df$wordType == "C", ]$meanF1
## W = 0.66506, p-value = 1.506e-05

# p-value < 0.05 implying that the distribution
# of the data ARE significantly different from
# normal distribution -> we CAN NOT assume normality
# (this somewhat unexpected result is probably
# due to the small sample size used in this toy example)
# -> use Wilcoxon rank sum test

# perform Wilcoxon rank sum test to establish
# whether vowel F1 depends on word type
wilcox.test(meanF1 ~ wordType, data = df)

##
## Wilcoxon rank sum test
##
## data:  meanF1 by wordType
## W = 121, p-value = 0.03752
## alternative hypothesis: true location shift is not equal to 0
```

As shown by the result of `wilcox.test()` in R Example 2.5.3, word type (*C* vs. *F*) has a significant influence on the vowel's F1 ( $W=121$ ,  $p<0.05$ ). Hence, the answer to the initially proposed question: *Given an annotated speech database, is vowel height of the vowel @ (measured by its correlate, the first formant frequency) influenced by whether it appears in a content or function word?* is yes!

## 2.6 Conclusion

The tutorial given in this chapter gave an overview of what it is like working with the EMU-SDMS to try to solve a research question. As many of the concepts were only briefly explained, it is worth noting that explicit explanations of the various components and integral concepts are given in following chapters. Further, additional use cases that have been taken from the `emuR.intro` vignette can be

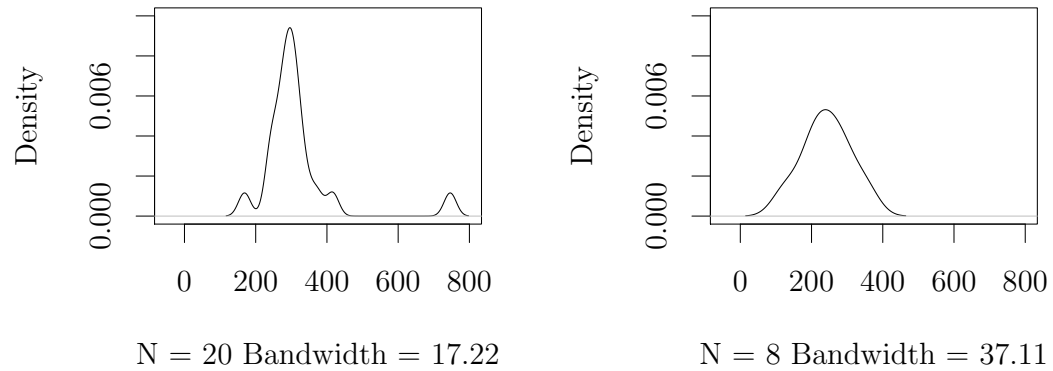

Figure 2.10: Plots of density distributions of vowels in content words (left plot) and vowels in function words (right plot) in R Example 2.5.3.

found in Appendix A. These use cases act as templates for various types of research questions and will hopefully aid the user in finding a solution similar to what she or he wishes to achieve.



## **Part II**

### **Main components and concepts**

## Chapter 3

# Annotation Structure Modeling<sup>\*</sup>

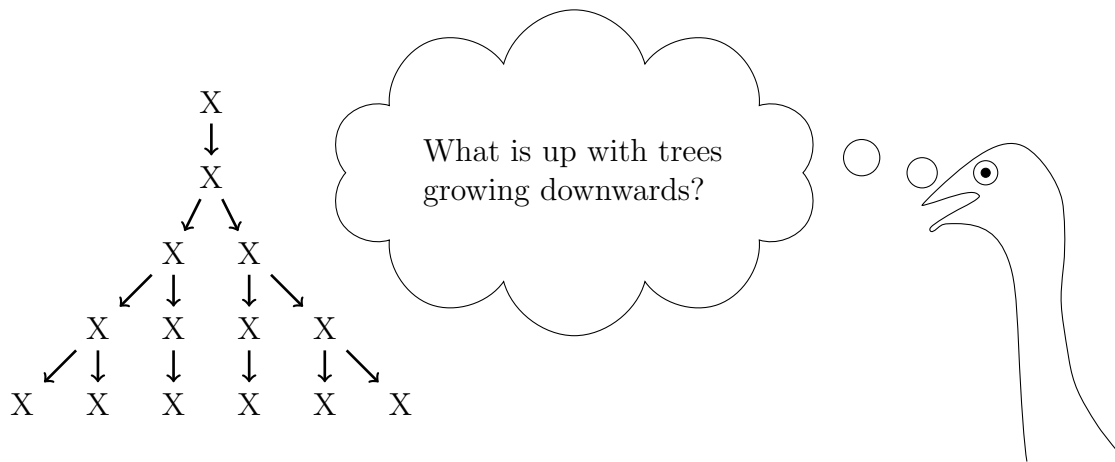

The EMU-SDMS facilitates annotation structure modeling that surpasses that available in many other commonly used systems. This chapter provides an in-depth explanation of the annotation structure modeling capabilities the EMU-SDMS offers. One of the most common approaches for creating time-aligned annotations has been to differentiate between events that occur at a specific point in time but have no duration and segments that start at a point in time and have a duration. These annotation items are then grouped into time-ordered sets that are often referred to as tiers. As certain research questions benefit from different granularities of annotation, the timeline is often used to relate implicitly items from multiple tiers to each other as shown in Figure 3.1A. While sufficient for single or unrelated tier annotations, we feel this type of representation is not suitable for more complex annotation structures, as it results in unnecessary, redundant

---

<sup>\*</sup>Sections of this chapter were previously published in Winkelmann et al. (2017).

data and data sets that are often difficult to analyze. This is because there are no explicit relationships between annotation items, and it is often necessary to introduce error tolerance values to analyze slightly misaligned time values to find relationships iteratively over multiple levels. The main reason for the prevalence of this sub-optimal strategy is largely because the available software tools (e.g., Praat by Boersma and Weenink, 2016) do not permit any other forms of annotations. These widely used annotation tools often only permit the creation and manipulation of segment and event tiers which in turn has forced users to model their annotation structures on these building blocks alone.

Linguists who deal with speech and language on a purely symbolic level tend to be more familiar with a different type of annotation structure modeling. They often model their structures in the form of a vertically oriented, directed acyclic graph that, but for a few exceptions that are needed for things like elision modeling (e.g., the /ɪ/ elision that may occur between the canonical representation of the word *family* /fæmili/ and its phonetic representation [fæmli]), loosely adheres to the formal definition of a tree in the graph-theoretical sense (Knuth, 1968) as depicted in Figure 3.1B. While this form of modeling explicitly defines relationships between annotation items (represented by dashed lines in Figure 3.1B), it lacks the ability to map these items to the timeline and therefore the matching speech signal.

To our knowledge, the legacy EMU system (Cassidy and Harrington, 2001) and its predecessors (e.g., Harrington et al., 1993) were the first to fuse pragmatically purely time-aligned and symbolic tree-like annotations. This was achieved by providing software tools that allowed for these types of annotation structures to be generated, queried and evaluated. In practice, each annotation item had its own unique identifier within the annotation. These unique IDs could then be used to reference each individual item and link them together using dominance relations to form the hierarchical annotation structure. On the one hand, this dominance relation implies the temporal inclusion of the linked sub-level items and was partially predicated on the *no-crossing constraint* as described in Coleman and Local (1991). This constraint does not permit the crossing of dominance relationships with respect to their sequential ordering (see also Section 4.2 of Cassidy and Harrington, 2001). Since the dominance relations imply temporal inclusion, events can only be children in a parent-child relationship. To allow for timeless annotation items, a further timeless level type was used to complement the segment and event type levels used for time-aligned annotations. Each level of annotation items was stored as an ordered set to ensure the sequential integrity of both the time-aligned and timeless item levels. The legacy system also reduced data redundancy by allowing parallel annotations to be defined in the form of linearly linked levels for any given level (e.g., a segment level bearing SAMPA annotations as well as IPA UTF-8 annotations).

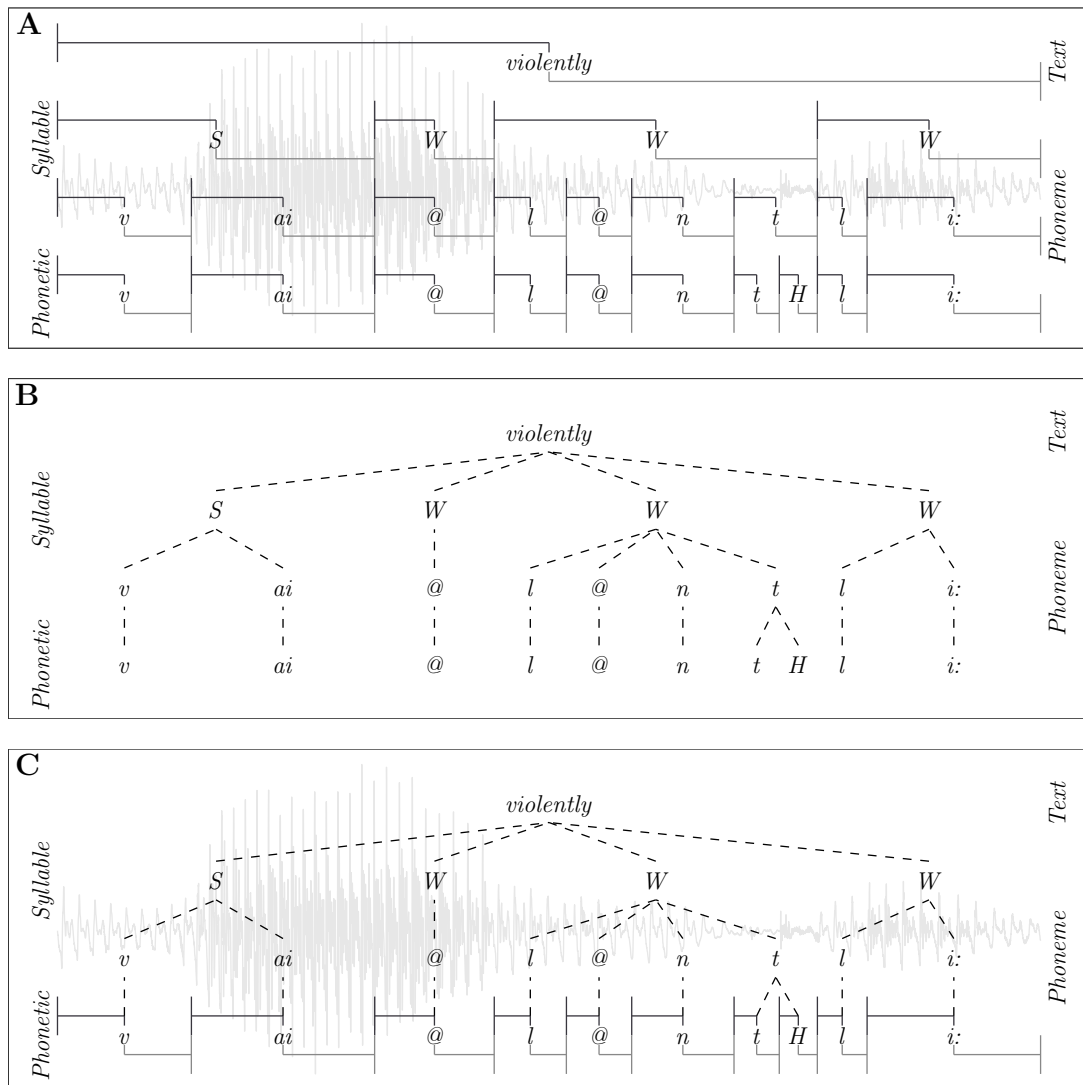

Figure 3.1: **A**: a purely time-aligned annotation; **B**: a purely timeless, symbolic annotation; **C**: a time-aligned hierarchical annotation.

---

The new EMU-SDMS has adopted some concepts of the legacy system in that levels of type **SEGMENT** and **EVENT** contain annotation items with labels and time information, similar to the tiers known from other software tools such as Praat, while levels of type **ITEM** are timeless and contain annotation items with labels only. **SEGMENT** and **EVENT** levels differ in that units at the **SEGMENTS** level have a start time and a duration, while units at the **EVENT** level contain a single time point only. Additionally, every annotation item is able to contain multiple labels and has a unique identifier which is used to link items across levels. These building blocks provide the user with a general purpose annotation modeling tool that allows complex annotation structures to be modeled that best represent the data. An example of a time-aligned hierarchical annotation is depicted in Figure 3.1C, which essentially combines the annotation of Figure 3.1B with the most granular time-bearing level (i.e. the “Phonetic” level) of Figure 3.1A.

In accordance with other approaches (among others see Bird and Liberman, 2001; Zipser and Romary, 2010; Ide and Romary, 2004), the EMU-SDMS annotation structure can be viewed as a graph that consists of three types of nodes (**EVENTS**, **SEGMENTS**, **ITEMS**) and two types of relations (**dominance** and **sequence**) which are directed, transitive and indicate the dominance and sequential relationships between nodes of the graph. As was shown in a pseudo-code example that converted an Annotation Graph (Bird and Liberman, 2001) into the legacy EMU annotation format in Cassidy and Harrington (2001), these formats can be viewed as conceptually equivalent sub- or super-set representations of each other. This has also been shown by developments of meta models with independent data representation such as **Salt** (Zipser and Romary, 2010), which enable abstract internal representations to be derived that can be exported to equal-set or super-set formats without the loss of information. We therefore believe that the decision as to which data format serializations are used by a given application should be guided by the choice of technology and the target audience or research field. This is consistent with the views of the committee for the Linguistic Annotation Framework (LAF) who explicitly state in the ISO CD 24612 (LAF) document (ISO, 2012);

Although the LAF pivot format may be used in any context, it is assumed that users will represent annotations using their own formats, which can then be transduced to the LAF pivot format for the purposes of exchange, merging and comparison.

The transduction of an EMU annotation into a format such as the LAF pivot format is a simple process, as they share many of the same concepts and are well defined formats.

## 3.1 Per database annotation structure definition

Unlike other systems, the EMU-SDMS requires the user to define the annotation structure formally for all annotations within a database. Much as document type definitions (DTD) or XML schema definitions (XSD) describe the syntactically valid elements in an Extensible Markup Language (XML) document, the database configuration file of an `emuDB` defines the valid annotation levels and therefore the type of items that are allowed to be present in a database. Unlike DTDs or XSDs, the configuration file can also define semantic relationships between annotation levels which fall outside the scope of traditional, syntactically oriented schema definitions and validation. This global definition of an annotation structure has numerous benefits for the data integrity of the database, as the EMU-SDMS can perform consistency checks and prevent malformed as well as semantically void annotation structures<sup>1</sup>. Because of these formal definitions, the EMU system generally distinguishes between the actual representations of a structural element which are contained within the database and their formal definitions. An example of an actual representation, that is a subset of the actual annotation, would be a level contained in an annotation file that contains `SEGMENTS` that annotate a recording. The corresponding formal definition would be a level definition entry in the database's configuration file, which specifies and validates the level's existence within the database.

As mentioned above, the actual annotation files of an `emuDB` contain the annotation items as well as their hierarchical linking information. To be able to check the validity of a connection between two items, the user specifies which links are permitted for the entire database just as for the level definitions. The permitted hierarchical relationships in an `emuDB` are expressed through link definitions between level definitions as part of the database configuration. There are three types of valid hierarchical relationships between levels: `ONE_TO_MANY`, `MANY_TO_MANY` and `ONE_TO_ONE`. These link definitions specify the permitted relationships between instances of annotation items of one level and those of another. The structure of the hierarchy that corresponds to the annotation depicted in Figure 3.1C can be seen in Figure 3.2A. The structure in Figure 3.2A is a typical example of an EMU hierarchy where only the *Phonetic* level of type `SEGMENT` contains time information and the others are timeless as they are of the type `ITEM`. The top three levels, *Text*, *Syllable* and *Phoneme*, have a `ONE_TO_MANY` relationship specifying that a single item in the parent level may have a dominance relationship with multiple items in the child level. In this example, the relationship between *Phoneme* and *Phonetic* is `MANY_TO_MANY`: this type of relationship can be used to represent schwa elision and

---

<sup>1</sup>Although the consistency is ensured by the EMU-SDMS while annotation editing operations are performed, currently no actual consistency checks are performed while loading or saving an annotation. However, we plan to add this functionality in future releases.

subsequent sonorant syllabification, as when the final syllable of *sudden* is *d@n* at the *Phoneme* level but *dn* at the *Phonetic* level. Figure 3.2B displays an example of a more complex, intersecting hierarchical structure definition where Abercrombian feet (Abercrombie, 1967) are incorporated into the Tones and Break Indices (ToBI) (Beckman and Ayers, 1997) prosodic hierarchy by allowing an intonational phrase to be made up of one or more feet (for further details see Harrington, 2010, page 98).

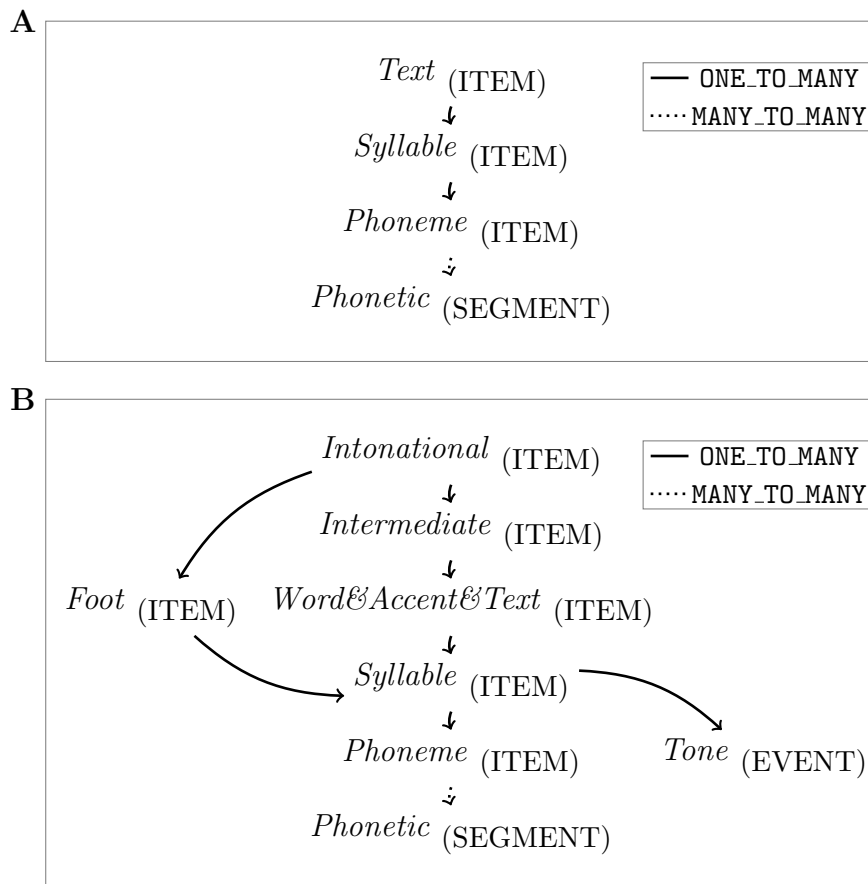

Figure 3.2: **A:** a schematic representation of the hierarchical structure of an *emuDB* that corresponds to the annotation depicted in 3.1C; **B:** example of a more complex, intersecting hierarchical structure.

Based on our experience, the explicit definition of the annotation structure for every database which was also integral to the legacy system addresses the excessively expressive nature of annotational modeling systems mentioned in Bird and Liberman (2001). Although, in theory, infinitely large hierarchies can be defined for a database, users of the legacy system typically chose to use only

moderately complex annotation structures. The largest hierarchy definitions we have encountered spanned up to fifteen levels while the average amount of levels was between three and five. This self-restriction is largely due to the primary focus of speech and spoken language domain-specific annotations, as the number of annotation levels between chunks of speech above the word level (intonational phrases/sentences/turns/etc.) and the lower levels (phonetic segmentation/EMA gestural landmark annotation/tone annotation/etc.) is a finite set.

## 3.2 Parallel labels and multiple attributes

The legacy EMU system made a distinction between linearly and non-linearly linked inter-level links. Linearly linked levels were used to describe, enrich or supplement another level. For example, a level called *Category* might have been included as a separate level from *Word* for marking words' grammatical category memberships (thus each word might be marked as one of adjective, noun, verb, etc.), or information about whether or not a syllable is stressed might be included on a separate *Stress* tier (description taken from Harrington, 2010, page 77). Using `ONE_TO_ONE` link definitions to define a relationship between two levels, it is still possible to model linearly linked levels in the new EMU-SDMS. However, an additional, cleaner concept that reduces the extra level overhead has been implemented that allows every annotation item to carry multiple attributes (i.e., labels). Further, using this construct reduces the number of levels, items and links and therefore the hierarchical complexity of an annotation. The generic term “attribute” (vs. “label”) was chosen to have the flexibility of adding attributes that are not of the type `STRING` (i.e., labels) to the annotation modeling capabilities of the EMU-SDMS in future versions. Figure 3.3 shows the annotation structure modeling difference between linearly linked levels (see Figure 3.3A) and an annotation structure using multiple attributes (see Figure 3.3B). Figure 3.3A shows three separate levels (*Word*, *Accent* and *Text*) that have a `ONE_TO_ONE` relationship. Each of their annotation items is linked to exactly one annotation item in the child level (e.g., *A1-A3*). Figure 3.3B shows a single level that has three attribute definitions (*Word*, *Accent* and *Text*) and each annotation item contains three attributes (e.g., *A1-A3*).

It is worth noting that every level definition must have an attribute definition which matches its level name. This primary attribute definition must also be present in every annotation item belonging to a level. As `emuR`'s database interaction functions, such as `add_levelDefinition()`, and the `EMU-webApp` automatically perform the necessary actions this should only be of interest to (semi-)advanced users wishing to automatically generate the `_annot.json` format.



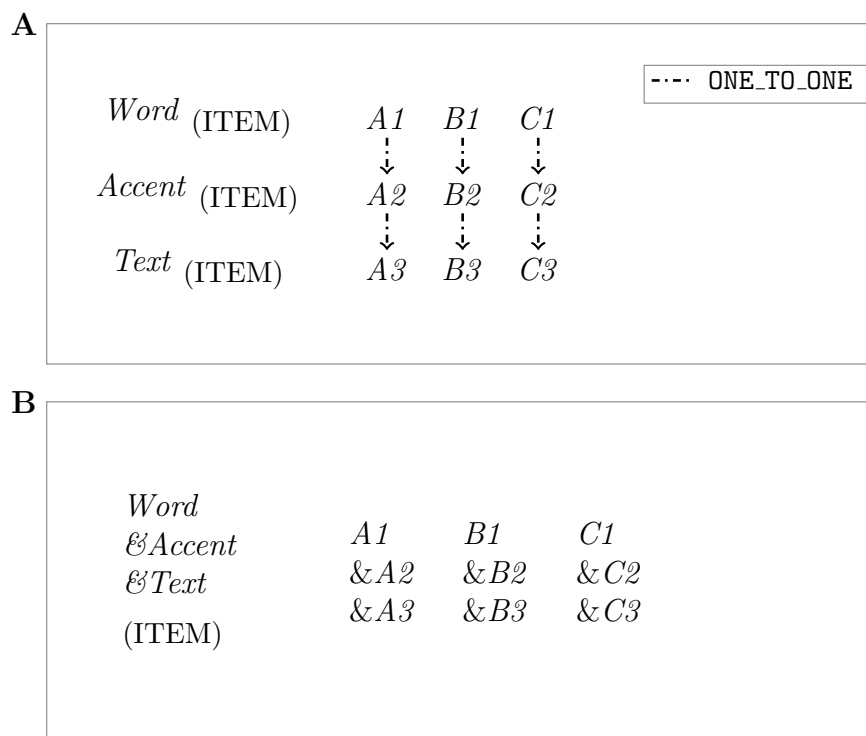

Figure 3.3: Schematic representation of annotation structure modeling difference between **A**: linearly linked levels and **B**: an annotation structure using multiple attributes.

### 3.3 Metadata strategy using single bundle root nodes

As the legacy EMU system and the new EMU-SDMS do not have an explicit method for storing metadata associated with bundles<sup>2</sup>, over the years an annotation structure convention has been developed to combat this issue. The convention is to use a generic top level (often simply called *bundle*) that contains a single annotation item in every annotation file. Using the multiple attribute annotation structure modeling capability of the EMU-SDMS, this single annotation item can hold any meta data associated with the bundle. Additionally linking the item to all the annotation items of its child level effectively makes it a parent to every item of the hierarchy. This linking information can later be exploited to query only bundles with matching meta data (see Chapter 5 for details). Figure 3.4 displays a hierarchical annotation where the top level (*bundle*) contains information about the speaker's *gender*, the city of birth (*COB*) and *age*.

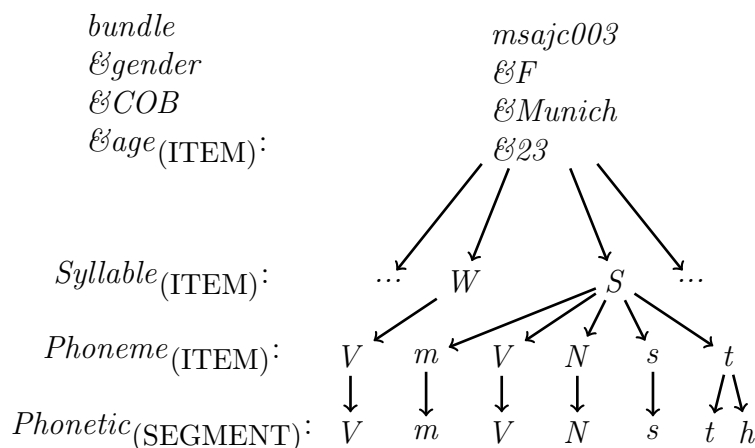

Figure 3.4: Hierarchical annotation displaying single bundle root node metadata strategy where the label of the primary attribute definition (*bundle*) is empty, *gender* encodes the speaker's gender, *COB* encodes the speakers city of birth and *age* encodes the speaker's age in the form of a string.

<sup>2</sup>Future versions of *emuR* may allow *\_meta.json* files containing meta information in the form of key-value pairs to be placed in either the *\_emuDB*, the *\_ses* or the *\_bnd1* directories.

## 3.4 Conclusion

The annotation structure modeling capabilities of the EMU-SDMS surpass those of many other commonly used systems. They do so by not only allowing the use of levels containing time information (levels of type **SEGMENT** and **EVENT**) but also timeless levels (levels of type **ITEM**). Additionally, they allow users to define hierarchical annotation structures by allowing explicit links to be implemented from one level's items to those of another. Although it is not obligatory to use them in the EMU-SDMS, we feel the usage of hierarchical annotations allow for complex rich data modeling and are often cleaner representations of the annotations at hand.

# Chapter 4

## The emuDB Format<sup>\*</sup>

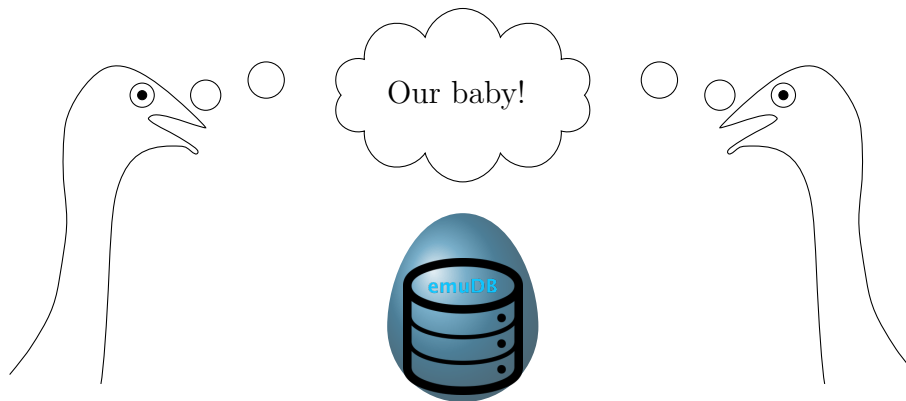

This chapter describes the **emuDB** format, which is the new database format of the EMU-SDMS, and shows how to create and interact with this format. The **emuDB** format is meant as a simple, general purpose way of storing speech databases that may contain complex, rich, hierarchical annotations as well as derived and complementary speech data. These different components will be described throughout this chapter, and examples will show how to generate and manipulate them. On designing the new EMU system, considerable effort went into designing an appropriate database format. We needed a format that was standardized, well structured, easy to maintain, easy to produce, easy to manipulate and portable.

We decided on the JavaScript Object Notation (JSON) file format<sup>1</sup> as our primary data source for several reasons. It is simple, standardized, widely-used and

---

<sup>1</sup>JSON schema files available here <https://github.com/IPS-LMU/EMU-webApp/tree/master/dist/schemaFiles>

<sup>\*</sup>Sections of this chapter were published in Winkelmann et al. (2017) and some examples taken from the **emuDB** vignette of the **emuR** package.

text-based as well as machine and human readable. In addition, this portable text format allows expert users to (semi-) automatically process and/or generate annotations. Other tools such as the BAS Webservices (Kisler et al., 2012) and SpeechRecorder (Draxler and Jänsch, 2004) have already taken advantage of being able to produce such annotations. Using database back-end options such as relational or graph databases of either the SQL or NoSQL variety as the primary data source for annotations would not directly permit other tools to produce annotations because intermediary exchange file formats would have to be defined to permit this functionality with these back-ends. Our choice of the JSON format was also guided by the decision to incorporate web technologies as part of the EMU-SDMS for which the JSON format is the de facto standard (see Chapter 8). Further, as the default encoding of the JSON format is UTF-8 the EMU-SDMS fully supports the Unicode character set for any user-defined string within an emuDB (e.g. level names and labels)<sup>2</sup>.

We chose to use the widely adopted Waveform Audio File Format (WAVE, or more commonly known as WAV due to its filename extension) as our primary media/audio format. Although some components of the EMU-SDMS, notably the `wrassp` package, can handle various other media/audio formats (see `?wrassp::AsspFileFormats` for details) this is the only audio file format currently supported by every component of the EMU-SDMS. Nevertheless, the `wrassp` package can be utilized to convert files from one of its other supported file formats to the WAV format<sup>3</sup>. Future releases of the EMU-SDMS might include the support of other media/audio formats.

In contrast to other systems, including the legacy EMU system, we chose to fully standardize the on-disk structure of speech databases with which the system is capable of working. This provides a standardized and structured way of storing speech databases while providing the necessary amount of freedom and separability to accommodate multiple types of data. Further, this standardization enables fast parsing and simplification of file-based error tracking and simplifies database subset and merging operations as well as database portability. An overview of all database interaction functions is given in Section 9.2.

---

<sup>2</sup>According to the JSON specification (see <https://json.org/>) the only characters that have to be escaped within a JSON string are: " (as this marks the start/end of a string), \ (as this is the escape character) or control-characters (\b = backspace, \f = form feed, \n = new line, \r = carriage return, \t = tab). Unicode characters in their hexadecimal form using the \u followed by four-hex-digits may also be used.

<sup>3</sup>However, if things like resampling are required we suggest using other tools such as the freely available Sound eXchange (SoX) command line tool (see <http://sox.sourceforge.net/>) to perform these operation

## 4.1 Database design

An `emuDB` consists of a set of files and directories that adhere to a certain structure and naming convention (see Figure 4.1). The database root directory must include a single `.DBconfig.json` file that contains the configuration options of the database such as its level definitions, how these levels are linked in the database hierarchy and how the data is to be displayed by the graphical user interface. A detailed description of the `.DBconfig.json` file is given in Appendix B.1.1. The database root directory also contains arbitrarily named session directories (except for the obligatory `.ses` suffix). These session directories can be used to group the recordings of a database in a logical manner. Sessions can be used, for example, to group all recordings from speaker `AAA` into a session called `AAA.ses`.

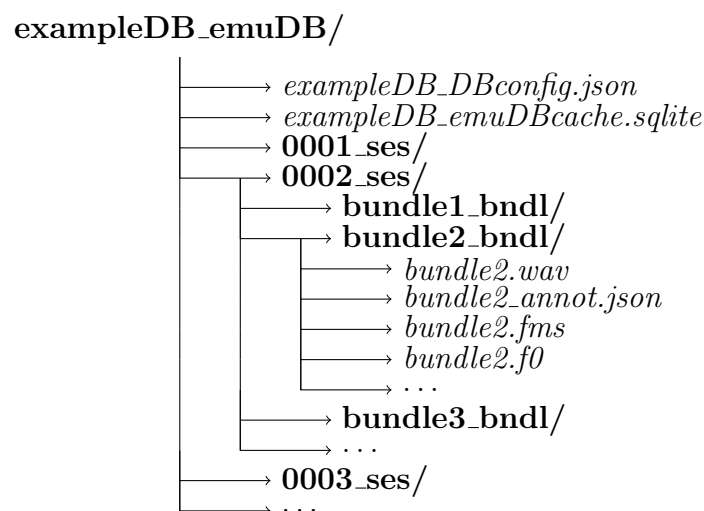

Figure 4.1: Schematic `emuDB` file and directory structure.

Each session directory can contain any number of `_bndl` directories (e.g., `rec1_bndl` `rec2_bndl` ... `rec9_bndl`). All files belonging to a recording (i.e., all files describing the same timeline) are stored in the same bundle directory. This includes the actual recording (`.wav`) and can contain optional derived or supplementary signal files in the SSFF file format (Cassidy, 2013) such as formants (`.fms`) or the fundamental frequency (`.f0`), both of which can be calculated using the `wrassp` package (see Chapter 7). Each bundle directory contains the annotation file (`_annot.json`) of that bundle (i.e., the annotations and the hierarchical linking information; see Appendix B.1.2 for a detailed description of the file format). JSON schema files for all the JSON files types used have been developed to ensure the syntactic integrity of the database (see <https://github.com/IPS-LMU/EMU-webApp/tree/master/dist/schemaFiles>). All files within a bun-

dle that are associated with that bundle must have the same basename as the `_bnd1` directory prefix. For example, the signal file in bundle `rec1_bnd1` must have the name `rec1.wav` to be recognized as belonging to the bundle. The optional `_emuDBcache.sqlite` file in the root directory (see Figure 4.1) contains the relational cache representation of the annotations of the `emuDB` (see Chapter 10 for further details). All files in an `_emuDB` directory that do not follow the above naming conventions will simply be ignored by the database interaction functions of the `emuR` package.

## 4.2 Creating an emuDB

The two main strategies for creating `emuDBs` are either to convert existing databases or file collections to the new format or to create new databases from scratch where only `.wav` audio files are present. Chapter 2 gave an example of how to create an `emuDB` from an existing TextGrid file collection and other conversion routines are covered in Section 9.1. In this chapter we will focus on creating an `emuDB` from scratch with nothing more than a set of `.wav` audio files present.

### 4.2.1 Creating an emuDB from scratch

R Example 4.2.1 shows how an empty `emuDB` is created in the directory provided by R's `tempdir()` function. As can be seen by the output of the `list.files()` function, `create_emuDB()` creates a directory containing a `_DBconfig.json` file only.

#### R Example 4.2.1

```
# load package
library(emuR, warn.conflicts = F)

# create emuDB called "fromScratch"
create_emuDB(name = "fromScratch",
             targetDir = tempdir(),
             verbose = F)

# generate path to the empty fromScratch created above
dbPath = file.path(tempdir(), "fromScratch_emuDB")

# show content of empty fromScratch emuDB
list.files(dbPath)
```

```
## [1] "fromScratch_DBconfig.json"
```

### 4.2.2 Loading and editing an empty database

The initial step in manipulating and generally interacting with a database is to load the database into the current R session. R Example 4.2.2 shows how to load the *fromScratch* database and shows the empty configuration by displaying the output of the `summary()` function.

#### R Example 4.2.2

```
# load database
dbHandle = load_emuDB(dbPath, verbose = F)

# show summary of dbHandle
summary(dbHandle)

## Name: fromScratch
## UUID: 6f2778d0-0116-405a-9d9c-a468c842f3aa
## Directory: /private/var/folders/yk/8z9tn7kx6hbcg_9n4c1sld9800...
## Session count: 0
## Bundle count: 0
## Annotation item count: 0
## Label count: 0
## Link count: 0
##
## Database configuration:
##
## SSFF track definitions:
## NULL
##
## Level definitions:
## NULL
##
## Link definitions:
## NULL

# show class vector of dbHandle
class(dbHandle)

## [1] "emuDBhandle"
```



As can be seen in R Example 4.2.2, the class of a loaded `emuDB` is `emuDBhandle`. A `emuDBhandle` object is used to reference a loaded `emuDB` in the database interaction functions of the `emuR` package. In this chapter we will show how to use this `emuDBhandle` object to perform database manipulation operations. Most of the `emuDB` manipulation functions follow the following function prefix naming convention:

- `add_XXX` add a new instance of `XXX` / `set_XXX` set the current instance of `XXX`,
- `list_XXX` list the current instances of `XXX` / `get_XXX` get the current instance of `XXX`,
- `remove_XXX` remove existing instances of `XXX`.

### 4.2.3 Level definitions

Unlike other systems, the EMU-SDMS requires the user to formally define the annotation structure for the entire database. An essential structural element of any `emuDB` are its levels. A level is a more general term for what is often referred to as a tier. It is more general in the sense that people usually expect tiers to contain time information. Levels can either contain time information if they are of the type `EVENT` or of the type `SEGMENT` but are timeless if they are of the type `ITEM` (see Chapter 3 for further details). It is also worth noting that an `emuDB` distinguishes between the definition of an annotation structure element and the actual annotations. The definition of an annotation structure element such as a level definition is merely an entry in the `_DBconfig.json` file which specifies that this level is allowed to be present in the `_annot.json` files. The levels that are present in an `_annot.json` file, on the other hand, have to adhere to the definitions in the `_DBconfig.json`.

As the *fromScratch* database (already loaded) does not contain any annotation structural element definitions, R Example 4.2.3 shows how a new level definition called *Phonetic* of type `SEGMENT` is added to the `emuDB`.

#### R Example 4.2.3

```
# show no level definitions
# are present
list_levelDefinitions(dbHandle)

## NULL
```

```
# add level definition
add_levelDefinition(dbHandle,
                    name = "Phonetic",
                    type = "SEGMENT")

# show newly added level definition
list_levelDefinitions(dbHandle)

##      name      type nrOfAttrDefs attrDefNames
## 1 Phonetic SEGMENT          1    Phonetic;
```

R Example 4.2.4 shows how a further level definition is added that will contain the orthographic word transcriptions for the words uttered in our recordings. This level will be of the type `ITEM`, meaning that elements contained within the level are sequentially ordered but do not contain any time information.

#### R Example 4.2.4

```
# add level definition
add_levelDefinition(dbHandle,
                    name = "Word",
                    type = "ITEM")

# list newly added level definition
list_levelDefinitions(dbHandle)

##      name      type nrOfAttrDefs attrDefNames
## 1 Phonetic SEGMENT          1    Phonetic;
## 2   Word      ITEM           1      Word;
```

The function `remove_levelDefinition()` can also be used to remove unwanted level definitions. However, as we wish to further use the levels *Phonetic* and *Word*, we will not make use of this function here.

### Attribute definitions

Each level definition can contain multiple attributes, the most common, and currently only supported attribute being a label (of type `STRING`). Thus it is possible to have multiple parallel labels (i.e., attribute definitions) in a single level. This means that a single annotation item instance can contain multiple labels while sharing other properties such as the start and duration information. This can be

useful when modeling certain types of data. An example of this would be the *Phonetic* level created above. It is often the case that databases contain both the phonetic transcript using IPA UTF-8 symbols as well as a transcript using SAMPA symbols. To avoid redundant time information, both of these annotations can be stored on the same *Phonetic* level using multiple attribute definitions (i.e., parallel labels). R Example 4.2.5 shows the current attribute definitions of the *Phonetic* level.

#### R Example 4.2.5

```
# list attribute definitions of 'Phonetic' level
list_attributeDefinitions(dbHandle,
                          levelName = "Phonetic")

##      name      level  type hasLabelGroups hasLegalLabels
## 1 Phonetic Phonetic STRING             FALSE             FALSE
```

Even though no attribute definition has been added to the *Phonetic* level, it already contains an attribute definition that has the same name as its level. This attribute definition represents the obligatory primary attribute of that level. As every level must contain an attribute definition that has the same name as its level, it is automatically added by the `add_levelDefinition()` function. To follow the above example, R Example 4.2.6 adds a further attribute definition to the *Phonetic* level that contains the SAMPA versions of our annotations.

#### R Example 4.2.6

```
# add
add_attributeDefinition(dbHandle,
                       levelName = "Phonetic",
                       name = "SAMPA")

## NULL

# list attribute definitions of 'Phonetic' level
list_attributeDefinitions(dbHandle,
                          levelName = "Phonetic")

##      name      level  type hasLabelGroups hasLegalLabels
## 1 Phonetic Phonetic STRING             FALSE             FALSE
## 2  SAMPA Phonetic STRING             FALSE             FALSE
```

## Legal labels

As can be inferred from the columns `hasLabelGroups` and `hasLegalLabels` of the output of the above `list_attributeDefinitions()` function, attribute definitions can also contain two further optional fields. The `legalLabels` field contains an array of strings that specifies the labels that are legal (i.e., allowed or valid) for the given attribute definition. As the EMU-webApp does not allow the annotator to enter any labels that are not specified in this array, this is a simple way of assuring that a level has a consistent label set. R Example 4.2.7 shows how the `set_legalLabels` and `get_legalLabels` functions can be used to specify a legal label set for the primary *Word* attribute definition of the *Word* level.

### R Example 4.2.7

```
# define allowed word labels
wordLabels = c("amongst", "any", "are",
              "always", "and", "attracts")

# show empty legal labels
# for "Word" attribute definition
get_legalLabels(dbHandle,
               levelName = "Word",
               attributeDefinitionName = "Word")

## [1] NA

# set legal labels values
# for "Word" attribute definition
set_legalLabels(dbHandle,
               levelName = "Word",
               attributeDefinitionName = "Word",
               legalLabels = wordLabels)

# show recently added legal labels
# for "Word" attribute definition
get_legalLabels(dbHandle,
               levelName = "Word",
               attributeDefinitionName = "Word")

## [1] "amongst" "any" "are" "always" "and"
## [6] "attracts"
```

## Label groups

A further optional field is the `labelGroups` field. It contains specifications of groups of labels that can be referenced by a name given to the group while querying the emuDB. R Example 4.2.8 shows how the `add_attrDefLabelGroup()` function is used to add two label groups to the *Phonetic* attribute definition. One of the groups is used to reference a subset of *longVowels* and the other to reference a subset of *shortVowels* on the *Phonetic* level.

### R Example 4.2.8

```
# add long vowels label group
add_attrDefLabelGroup(dbHandle,
                      levelName = "Phonetic",
                      attributeDefinitionName = "Phonetic",
                      labelGroupName = "longVowels",
                      labelGroupValues = c("i:", "u:"))

# add short vowels label group
add_attrDefLabelGroup(dbHandle,
                      levelName = "Phonetic",
                      attributeDefinitionName = "Phonetic",
                      labelGroupName = "shortVowels",
                      labelGroupValues = c("i", "u", "@"))

# list current label groups
list_attrDefLabelGroups(dbHandle,
                        levelName = "Phonetic",
                        attributeDefinitionName = "Phonetic")

##           name  values
## 1 longVowels  i;; u:
## 2 shortVowels i; u; @

# query all short vowels
# Note the result of this query
# is empty as no annotations are present
# in the 'fromScratch' emuDB
query(dbHandle, "Phonetic == shortVowels")

## segment  list from database:  fromScratch
```

```
## query was: Phonetic == shortVowels...
## [1] labels start end session bundle level type
## <0 rows> (or 0-length row.names)
```

For users who are familiar with or transitioning from the legacy EMU system, it is worth noting that the label groups correspond to the unfavorably named `Legal Labels` entries of the GTemplate Editor (i.e., legal entries in the `.tpl` file) of the legacy system. In the new system the `legalLabels` entries specify the legal or allowed label values of attribute definitions while the `labelGroups` specify groups of labels that can be referenced by the names given to the groups while performing queries.

A new feature of the EMU-SDMS is the possibility of defining label groups for the entire `emuDB` as opposed to a single attribute definition (see `?add_labelGroups` for further details). This avoids the redundant definition of label groups that should span multiple attribute definitions (e.g., a *longVowels* subset that is to be queried on a level called *Phonetic\_1* as well as a level called *Phonetic\_2*).

#### 4.2.4 Link definitions

An essential and very powerful conceptual and structural element of any `emuDB` is its hierarchy. Using hierarchical structures is highly recommended but not a must. Hierarchical annotations allow for complex, rich data modeling and are often cleaner representations of the annotations at hand. As Chapter 3 contains in-depth explanations of the annotation modeling capabilities of the EMU-SDMS and Chapter 5 shows how these structures can be queried using `emuR`'s query mechanics, this chapter will omit an explanation of hierarchical annotation structures. R Example 4.2.9 shows how a `ONE_TO_MANY` relationship between the *Word* and *Phonetic* in the form of a link definition is added to an `emuDB`.

##### R Example 4.2.9

```
# show that currently no link definitions
# are present
list_linkDefinitions(dbHandle)

## NULL

# add new "ONE_TO_MANY" link definition
# between "Word" and "Phonetic" levels
add_linkDefinition(dbHandle,
                   type = "ONE_TO_MANY",
```

```

        superlevelName = "Word",
        sublevelName = "Phonetic")

# show newly added link definition
list_linkDefinitions(dbHandle)

##           type superlevelName sublevelName
## 1 ONE_TO_MANY           Word      Phonetic

```

A schematic of the simple hierarchical structure of the *fromScratch* created by R Example 4.2.9 is displayed in Figure 4.2.

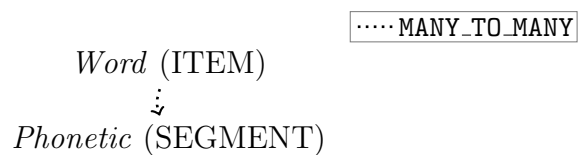

Figure 4.2: A schematic representation of the simple hierarchical structure of the *fromScratch* created by the `add_linkDefinition()` function call in R Example 4.2.9.

### 4.2.5 File handling

The previous sections of this chapter defined the simple structure of the *fromScratch* emuDB. An essential element that is still missing from the emuDB is the actual audio speech data<sup>4</sup>. R Example 4.2.10 shows how the `import_mediaFiles()` function can be used to import audio files, referred to as media files in the context of an emuDB, into the *fromScratch* emuDB.

#### R Example 4.2.10

```

# get the path to directory containing .wav files
wavDir = file.path(tempdir(), "emuR_demoData", "txt_collection")

# Import media files into emuDB session called fromWavFiles.
# Note that the txt_collection directory also contains .txt files.
# These are simply ignored by the import_mediaFiles() function.
import_mediaFiles(dbHandle,

```

<sup>4</sup>As the EMU-webApp currently only supports mono 16 Bit .wav audio files, we currently recommend using this format only.

```

        dir = wavDir,
        targetSessionName = "fromWavFiles",
        verbose = F)

# list session
list_sessions(dbHandle)

##           name
## 1 fromWavFiles

# list bundles
list_bundles(dbHandle)

##      session      name
## 1 fromWavFiles msajc003
## 2 fromWavFiles msajc010
## 3 fromWavFiles msajc012
## 4 fromWavFiles msajc015
## 5 fromWavFiles msajc022
## 6 fromWavFiles msajc023
## 7 fromWavFiles msajc057

# show first two files in the emuDB
library(tibble) # convert to tibble only to prettify output
as_tibble(head(list_files(dbHandle), n = 2))

## # A tibble: 2 x 4
##   session      bundle  file      absolute_file_path
## * <chr>         <chr>   <chr>    <chr>
## 1 fromWavFiles msajc003 msajc0~ /private/var/folders/yk/8z~
## 2 fromWavFiles msajc003 msajc0~ /private/var/folders/yk/8z~

```

The `import_mediaFiles()` call in R Example 4.2.10 added a new session called *fromWavFiles* to the *fromScratch* emuDB containing a new bundle for each of the imported media files. The annotations of every bundle, despite containing empty levels, adhere to the structure specified above. This means that every `_annot.json` file created contains an empty *Word* and *Phonetic* level array and the links array is also empty.

The `emuR` package also provides a mechanism for adding files to preexisting bundle directories, as this can be quite tedious to perform manually due to the nested directory structure of an emuDB. R Example 4.2.11 shows how preexisting



.zcr files that are produced by wrassp's `zcrana()` function can be added to the preexisting session and bundle structure. As the directory referenced by `wavDir` does not contain any .zcr files, R Example 4.2.11 first creates them and then adds them to the emuDB (see Chapter 7 for further details).

#### R Example 4.2.11

```
# load wrassp package
library(wrassp)

# list all wav files in wavDir
wavFilePaths = list.files(wavDir,
                          pattern = ".*.wav",
                          full.names = TRUE)

# calculate zero-crossing-rate files
# using zcrana function of wrassp package
zcrana(listOfFileNames = wavFilePaths,
        verbose = FALSE)

## [1] 7

# add zcr files to emuDB
add_files(dbHandle,
          dir = wavDir,
          fileExtension = "zcr",
          targetSessionName = "fromWavFiles")

# show first three files in emuDB (convert to tibble only
# to prettify output)
as_tibble(head(list_files(dbHandle), n = 3))

## # A tibble: 3 x 4
##   session      bundle  file      absolute_file_path
## * <chr>      <chr>   <chr>    <chr>
## 1 fromWavFiles msajc003 msajc0~ /private/var/folders/yk/8z~
## 2 fromWavFiles msajc003 msajc0~ /private/var/folders/yk/8z~
## 3 fromWavFiles msajc003 msajc0~ /private/var/folders/yk/8z~
```

### 4.2.6 SSFF track definitions

A further important structural element of any emuDB is use of the so-called SSFF tracks, which are often simply referred to as tracks. These SSFF tracks reference data that is stored in the Simple Signal File Format (SSFF) (see Appendix B.1.3 for a detailed description of the file format) within the `_bnd1` directories. The two main types of data are:

- complementary data that was acquired during the recording such as by EMA or electropalatography (EPG); or
- derived data, that is data that was calculated from the original audio signal such as formant values and their bandwidths or the short-term Root Mean Square amplitude of the signal.

As Section 7.5 covers how the SSFF file output of a `wrassp` function can be added to an emuDB, an explanation will be omitted here. R Example 4.2.12 shows how the `.zcr` files added in R Example 4.2.11 can be added as an SSFF track definition (see Chapter 7 for further details).

#### R Example 4.2.12

```
# show that no SSFF track definitions
# are present
list_ssffTrackDefinitions(dbHandle)

## NULL

# add SSFF track definition to emuDB
add_ssffTrackDefinition(dbHandle,
                        name = "zeroCrossing",
                        columnName = "zcr",
                        fileExtension = "zcr")

# show newly added SSFF track definition
list_ssffTrackDefinitions(dbHandle)

##           name columnName fileExtension
## 1 zeroCrossing      zcr          zcr
```

### 4.2.7 Configuring the EMU-webApp and annotating the emuDB

As previously mentioned, the current *fromScratch* emuDB contains only empty levels. In order to start annotating the database, the EMU-webApp has to be configured to display the desired information. Although the configuration of the EMU-webApp is stored in the `_DBconfig.json` file and is therefore a part of the emuDB format, here we will omit an explanation of the extensive possibilities of configuring the web application (see Chapter 8 for an in-depth explanation). R Example 4.2.13 shows how the *Phonetic* level is added to the level canvases order array of the *default* perspective.

#### R Example 4.2.13

```
# show empty level canvases order
get_levelCanvasesOrder(dbHandle, perspectiveName = "default")

## NULL

# set level canvases order to display "Phonetic" level
set_levelCanvasesOrder(dbHandle,
                        perspectiveName = "default",
                        order = c("Phonetic"))

# show newly added level canvases order
get_levelCanvasesOrder(dbHandle, perspectiveName = "default")

## [1] "Phonetic"
```

As a final step before beginning the annotation process, the *fromScratch* emuDB has to be served to the EMU-webApp for annotation and visualization purposes. R Example 4.2.14 shows how this can be achieved using the `serve()` function.

#### R Example 4.2.14

```
# serve "fromScratch" emuDB to the EMU-webApp
serve(dbHandle)
```

## 4.3 Conclusion

This chapter introduced the elements that comprise the new emuDB format and provided a practical overview of the essential database interaction functions provided by the emuR package. We feel the emuDB format provides a general purpose,

flexible approach to storing speech databases with the added benefit of being able to directly manipulate and analyse these databases using the tools provided by the EMU-SDMS.

# Chapter 5

## The query system

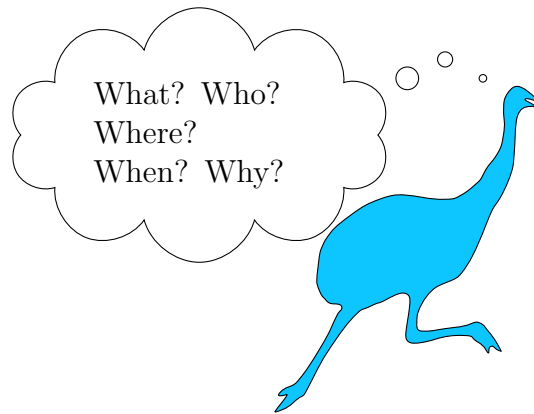

This chapter describes the newly implemented query system of the `emuR` package. When developing the new `emuR` package it was essential that it had a query mechanism allowing users to query a database's annotations in a simple manner. The EMU Query Language (EQL) of the EMU-SDMS arose out of years of developing and improving upon the query language of the legacy system (e.g., Cassidy and Harrington, 2001; Harrington, 2010; John, 2012). As a result, today we have an expressive, powerful, yet simple to learn and domain-specific query language. The EQL defines a user interface by allowing the user to formulate a formal language expression in the form of a query string. The evaluation of a query string results in a set of annotation items or, alternatively, a sequence of items of a single annotation level in the `emuDB` from which time information, if applicable (see Section 5.2.6), has been deduced from the time-bearing sub-level. An example of this is a simple query that extracts all strong syllables (i.e., syllable annotation items containing the label *S* on the *Syllable* level) from a set of hierarchical annotations (see Figure 5.1 for an example of a hierarchical annotation). The respective EQL query string `"Syllable == S"` results in a set of segments containing the

annotation label  $S$ . Due to the temporal inclusion constraint of the domination relationship, the start and end times of the queried segments are derived from the respective items of the *Phonetic* level (i.e., the  $m$  and  $H$  nodes in Figure 5.1), as this is the time-bearing sub-level. The EQL described here allows users to query the complex hierarchical annotation structures in their entirety as they are described in Chapter 3.

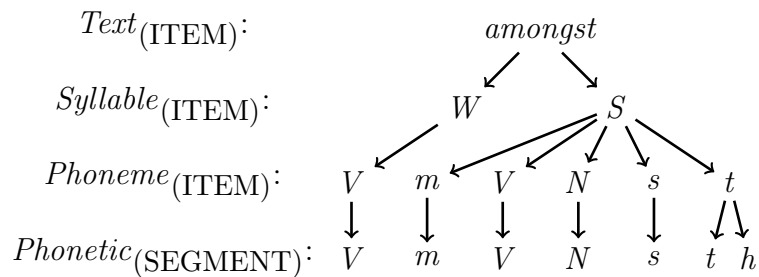

Figure 5.1: Simple partial hierarchy of an annotation of the word *amongst* in the *msajc003* bundle in the *ae* demo **emuDB**.

R Example 5.0.1 shows how to create the demo data that is provided by the **emuR** package followed by loading an example **emuDB** called *ae* into the current R session. This database will be used in all the examples throughout this chapter.

#### R Example 5.0.1

```
# load package
library(emuR)

# create demo data in directory
# provided by tempdir()
create_emuRdemoData(dir = tempdir())

# create path to demo database
path2ae = file.path(tempdir(), "emuR_demoData", "ae_emuDB")

# load database
ae = load_emuDB(path2ae, verbose = F)
```

## 5.1 emuRsegs: The resulting object of a query

In `emuR` the result of a query or requery (see Section 5.2.7) is a pre-specified object which is a superclass of the common `data.frame`. R Example 5.1.1 shows the result of a slightly expanded version of the above query (`"Syllable == S"`), which additionally uses the dominates operator (i.e., the `^` operator; for further information see Section 5.2.2) to reduce the queried annotations to the partial hierarchy depicted in Figure 5.1 in the *ae* demo `emuDB`. In this example, the classes of the resulting object including its printed output are displayed. The class vector of a resulting `emuRsegs` object also contains the legacy EMU system's `emusegs` class, which indicates that this object is fully backwards compatible with the legacy class and the methods available for it (see Harrington, 2010, for details). The printed output provides information about which database was queried and what the query was as well as information about the labels, start and end times (in milliseconds), session, bundle, level and type information. The call to `colnames()` shows that the resulting object has additional columns, which are ignored by the `print()` function. This somewhat hidden information is used to store information about what the exact items or sequence of items were retrieved from the `emuDB`. This information is needed to know which items to start from in a requery (see Section 5.2.7) and is also the reason why an `emuRsegs` object should be viewed as a reference of sequences of annotation items that belong to a single level in all annotation files of an `emuDB`.

### R Example 5.1.1

```
# query database
s1 = query(ae, "[Syllable == S ^ Text == amongst]")

# show class vector
class(s1)

## [1] "emuRsegs"    "emusegs"      "data.frame"

# show s1 object
s1

## segment list from database: ae
## query was: [Syllable == S ^ Text == amongst]...
## labels start end session bundle level type
## 1 S 256.925 674.175 0000 msajc003 Syllable ITEM

# show all (incl. hidden) column names
colnames(s1)
```

```
## [1] "labels"           "start"
## [3] "end"               "utts"
## [5] "db_uuid"          "session"
## [7] "bundle"           "start_item_id"
## [9] "end_item_id"      "level"
## [11] "start_item_seq_idx" "end_item_seq_idx"
## [13] "type"             "sample_start"
## [15] "sample_end"       "sample_rate"
```

## 5.2 EQL: The EMU Query Language version 2

The EQL user interface was retained from the legacy system because it was sufficiently flexible and expressive enough to meet the query needs in most types of speech science research. The EQL parser implemented in `emuR` is based on the Extended Backus-Naur Form (EBNF) (Garshol, 2003) formal language definition of John (2012), which defines the symbols and the relationship of those symbols to each other on which this language is built (see adapted version of entire EBNF in Appendix D). Here we will describe the various terms and components that comprise the slightly adapted version 2 of the EQL. It is worth noting that the new query mechanism uses a relational back-end to handle the various query operations (see Chapter 10 for details). This means that expert users, who are proficient in Structured Query Language (SQL) may also query this relational back-end directly. However, we feel the EQL provides a simple abstraction layer which is sufficient for most speech and spoken language research.

### 5.2.1 Simple queries

The most basic form of an EQL query is a simple equality, inequality, matching or non-matching query, two of which are displayed in R Example 5.2.1. The syntax of a simple query term is `[L OPERATOR A]`, where `L` specifies a level (or alternatively the name of a parallel attribute definition); `OPERATOR` is one of `==` (equality), `!=` (inequality), `=~` (matching) or `!~` (non-matching); and `A` is an expression specifying the labels of the annotation items of `L`<sup>1</sup>. The second query in R Example 5.2.1 queries an event level. The result of querying an event level contains the same

<sup>1</sup>The examples and syntax descriptions used in this chapter have been adapted from examples by Cassidy and Harrington (2001) and Harrington and Cassidy (2002) and were largely extracted from the EQL vignette of the `emuR` package. All of the examples were adapted to work with the supplied *ae* `emuDB`.



information as that of a segment level query except that the derived end times have the value zero.

### R Example 5.2.1

```
# query all annotation items containing
# the label "m" on the "Phonetic" level
sl = query(ae, "Phonetic == m")

# query all items NOT containing the
# label "H*" on the "Tone" level
sl = query(ae, "Tone != H*")

# show first entry of sl
head(sl, n = 1)

## event list from database: ae
## query was: Tone != H*...
## labels start end session bundle level type
## 1 L- 1107 0 0000 msajc003 Tone EVENT
```

R Example 5.2.1 queries two levels that contain time information: a segment level and an event level. As described in Chapter 3, annotations in the EMU-SDMS may also contain levels that do not contain time information. R Example 5.2.2 shows a query that queries annotation items on a level that does not contain time information (the *Syllable* level) to show that the result contains deduced time information from the time-bearing sub-level.

### R Example 5.2.2

```
# query all annotation items containing
# the label S on the Syllable level
sl = query(ae, "Syllable == S")

# show first entry of sl
head(sl, n = 1)

## segment list from database: ae
## query was: Syllable == S...
## labels start end session bundle level type
## 1 S 256.925 674.175 0000 msajc003 Syllable ITEM
```

### Queries using regular expressions

The slightly expanded version 2 of the EQL, which comes with the `emuR` package, introduces regular expression operators (`=~` and `!~`). These allow users to formulate regular expressions for more expressive and precise pattern matching of annotations. A minimal set of examples displaying the new regular expression operators is shown in Table 5.1.

Query	Function
"Phonetic =~ '[AIQOUEV]'"	A disjunction of annotations using a RegEx character class
"Word =~ a.*"	All words beginning with <i>a</i>
"Word !~ .*st"	All words not ending in <i>st</i>
"[Phonetic == n ^ #Syllable =~ .*]"	All syllables that dominate an <i>n</i> segment of the Phonetic level

Table 5.1: EQL V2: examples of simple and complex query strings using RegEx operators including their function descriptions.

### 5.2.2 Combining simple queries

The EQL contains three operators that can be used to combine the simple query terms described above as well as position queries which we will describe below. These three operators are the sequence operator, `->`; the conjunction operator, `&`; and the domination operator, `^`, which is used to perform hierarchical queries. These three types of queries are described below. To start with, we describe the two types of queries that query more complex annotation structures on the same level (sequence and conjunction queries). This is followed by a description of domination queries that query hierarchically linked annotation structures, sometimes spanning multiple annotation levels.

#### Sequence queries

The syntax of a query string using the `->` sequence operator is `[L == A -> L == B]` where annotation item *A* on level *L* precedes item *B* on level *L*. For a sequence query to work, both arguments must be on the same level. Alternatively parallel attribute definitions of the same level may also be chosen (see Chapter 3 for further details). An example of a query string using the sequence operator is displayed in R Example 5.2.3. All rows in the resulting segment list have the start time of `@`, the end time of *n* and their labels are `@->n`, where the `->` substring denotes the sequence.

**R Example 5.2.3**

```

# query all sequences of items on the "Phonetic" level
# in which an item containing the label "@" is followed by
# an item containing the label "n"
sl = query(ae, "[Phonetic == @ -> Phonetic == n]")

# show first entry of sl
head(sl, n = 1)

## segment list from database: ae
## query was: [Phonetic == @ -> Phonetic == n]...
## labels start end session bundle level
## 1 @->n 1715.425 1791.425 0000 msajc003 Phonetic
## type
## 1 SEGMENT

```

**Result modifier**

Because users are often interested in just one element of a compound query such as sequence queries (e.g., the @s in a @->n sequences), the EQL offers a so-called result modifier symbol, #. This symbol may be placed in front of any simple query component of a multi component query as depicted in R Example 5.2.4. Placing the hashtag in front of either the left or the right simple query term will result in segment lists that contains only the annotation items of the simple query term that have the hashtag in front of it. Only one result modifier may be used per query.

**R Example 5.2.4**

```

# query the "@"s in "@->n" sequences
sl = query(ae, "[#Phonetic == @ -> Phonetic == n]")

# show first entry of sl
head(sl, n = 1)

## segment list from database: ae
## query was: [#Phonetic == @ -> Phonetic == n]...
## labels start end session bundle level
## 1 @ 1715.425 1741.425 0000 msajc003 Phonetic
## type

```

```
## 1 SEGMENT

# query the "n"s in a "@->n" sequences
sl = query(ae, "[Phonetic == @ -> #Phonetic == n]")

# show first entry of sl
head(sl, n = 1)

## segment list from database: ae
## query was: [Phonetic == @ -> #Phonetic == n]...
## labels start end session bundle level
## 1 n 1741.425 1791.425 0000 msajc003 Phonetic
## type
## 1 SEGMENT
```

### Conjunction queries

The syntax of a query string using the conjunction operator can schematically be written as: `[L_a1 == A & L_a2 == B & L_a3 == C & L_a4 == D & ... & L_an == N]`, where annotation items on level *L* have the label *A* and also have the parallel labels *B*, *C*, *D*, ..., *N* (see Chapter 3 for more information about parallel labels). By analogy with the sequence operator, all simple query statements must refer to the same level (i.e., only parallel attributes definitions of the same level indicated by the *a1* - *an* may to be chosen). Hence, the conjunction operator is used to combine query conditions on the same level. Using the conjunction operator is useful for two reasons:

- It combines different attributes of the same level: `[Text == always & Accent == S]` where *Text* and *Accent* are additional attributes of level *Word*; and
- It combines a simple query with a function query (see Position Queries Section 5.2.3): `[Phonetic == 1 & Start(Word, Phonetic) == 1]`.

An example of a query string using the conjunction operator is displayed in R Example 5.2.5.

#### R Example 5.2.5

```
# query all words with the orthographic transcription "always"
# that also have a strong word accent ("S")
query(ae, "[Text == always & Accent == S]")
```

```
## segment list from database: ae
## query was: [Text == always & Accent == S]...
## labels start end session bundle level type
## 1 always 775.475 1280.175 0000 msajc022 Text ITEM
```

R Example 5.2.5 does not make use of the result modifier symbol. However, only the annotation items of the left simple query term (`Text == always`) are returned. This behavior is true for all EQL operators that combine simple query terms except for the sequence operator. As it is more explicit to use the result modifier to express the desired result, we recommend using the result modifier where possible. The more explicit variant of the above query which yields the same result is "`[#Text == always & Word == C]`".

### Domination/hierarchical queries

Compared to sequence and conjunction queries, a domination query using the operator  $\wedge$  is not bound to a single level. Instead, it allows users to query annotation items that are directly or indirectly linked over one or more levels. Queries using the domination operator are often referred to as hierarchical queries as they provide the ability to query the hierarchical annotations in a vertical or inter-level manner. Figure 5.2 shows the same partial hierarchy as Figure 5.1 but highlights the annotational items that are dominated by the strong syllable ( $S$ ) of the *Syllable* level. Such linked hierarchical sub-structures can be queried using hierarchical/domination queries.

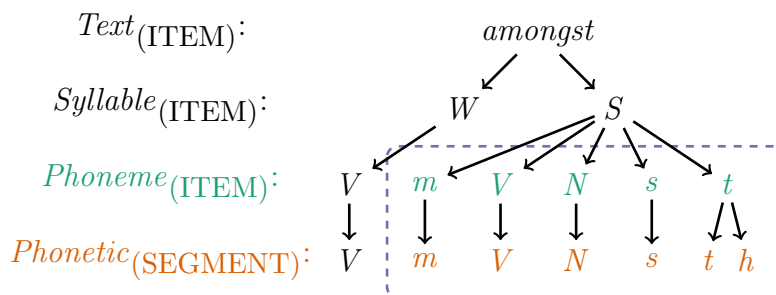

Figure 5.2: Partial hierarchy depicting all annotation items that are dominated by the strong syllable ( $S$ ) of the *Syllable* level (inside dashed box). Items marked green belong to the *Phoneme* level, items marked orange belong to the *Phonetic* level and the purple dashed box indicates the set of items that are dominated by  $S$ .

A schematic representation of a simple domination query string that retrieves all annotation items A of level L1 that are dominated by items B in level L2 (i.e.,

items that are directly or indirectly linked) is  $[L1 == A \wedge L2 == B]$ . Although the domination relationship is directed the domination operator is not. This means that either items in L1 dominate items in L2 or items in L2 dominate items in L1. Note that link definitions that specify the validity of the domination have to be present in the `emuDB` configuration for this to work (see Chapter 4 for details). An example of a query string using the domination operator is displayed in R Example 5.2.6.

### R Example 5.2.6

```
# query all "p" phoneme items that belong
# to / are dominated by a strong syllable ("S")
sl = query(ae, "[Phoneme == p ^ Syllable == S]")

# show first entry of sl
head(sl, n = 1)

## segment list from database: ae
## query was: [Phoneme == p ^ Syllable == S]...
## labels start end session bundle level type
## 1 p 558.575 639.575 0000 msajc015 Phoneme ITEM
```

As with the conjunction query, if no result modifier is present, a dominates query returns the annotation items of the left simple query term. Hence, the more explicit variant of the above query is `"[#Phoneme == p ^ Syllable == S]"`.

### 5.2.3 Position queries

The EQL has three function terms that specify where in a domination relationship a child level annotation item is allowed to occur. The three function terms are `Start()`, `End()` and `Medial()`. A schematic representation of a query string representing a simple usage of the `Start()`, `End()` and `Medial()` function would be: `POSFCT(L1, L2) == TRUE`. In this representation `POSFCT` is a placeholder for one of the three functions, at which level L1 must dominate level L2. Where L1 does indeed dominate L2, the corresponding item from level L2 is returned. If the expression is set to `FALSE` (i.e., `POSFCT(L1, L2) == FALSE`), all the items that do not match the condition of L2 are returned. An illustration of what is returned by each of the position functions depending on if they are set to `TRUE` or `FALSE` is depicted in Figure 5.3, while R Example 5.2.7 shows an example query using a position query term.

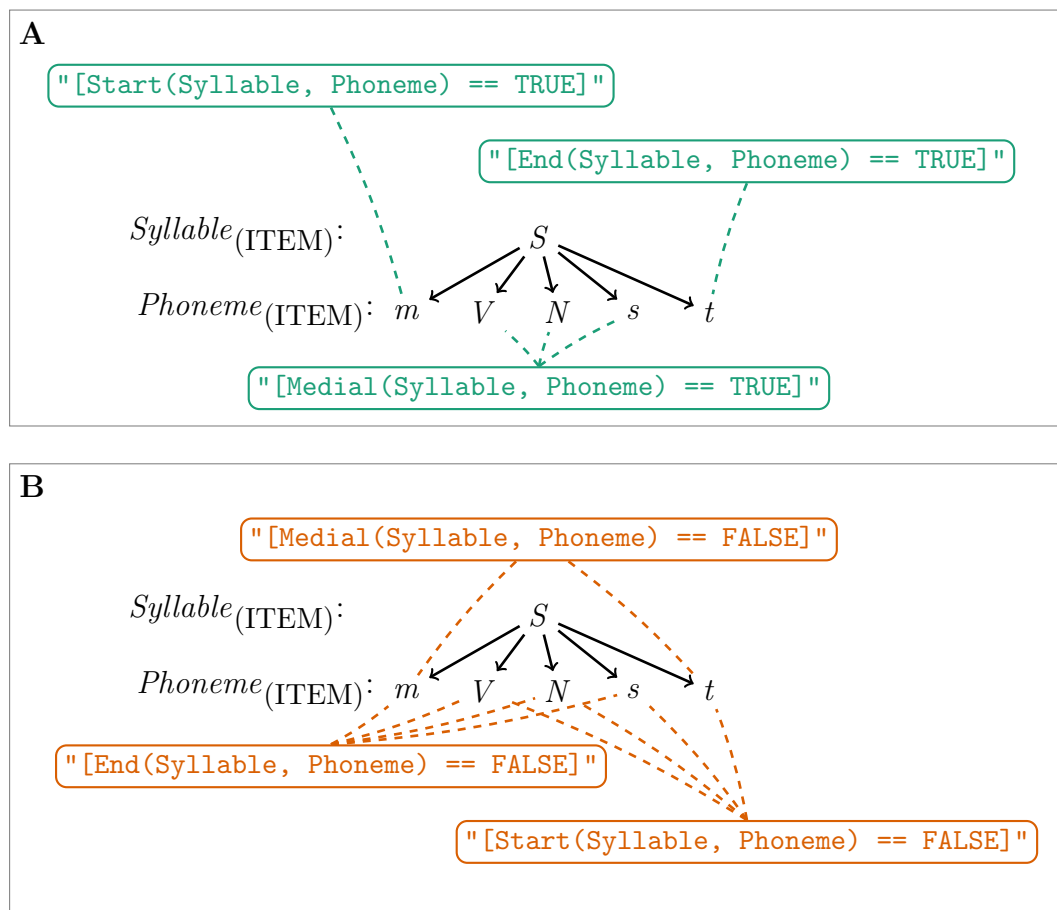

Figure 5.3: Illustration of what is returned by the Start(), Medial() and End() functions depending if they are set to **A: TRUE** (green) or **B: FALSE** (orange).

## R Example 5.2.7

```

# query all phoneme items that occur
# at the start of a syllable
sl = query(ae, "[Start(Syllable, Phoneme) == TRUE]")

# show first entry of sl
head(sl, n = 1)

## segment list from database: ae
## query was: [Start(Syllable, Phoneme) == TRUE]...
## labels start end session bundle level type
## 1 V 187.425 256.925 0000 msajc003 Phoneme ITEM

```

## 5.2.4 Count queries

A further query component of the EQL are so-called count queries. They allow the user to specify how many child nodes a parent annotation item is allowed to have. Figure 5.4 displays two syllables, one containing one phoneme and one phonetic annotation item, the other containing five phoneme and six phonetic items. Using EQL's `Num()` function it is possible to specify which of the two syllables should be retrieved, depending on the number of phonemic or phonetic elements to which it is directly or indirectly linked. R Example 5.2.8 shows a query that queries all syllables that contain five phonemes.

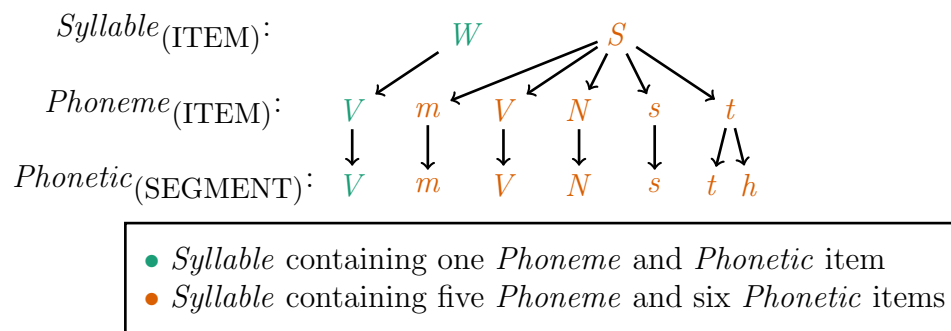

Figure 5.4: Partial hierarchy depicting a *Syllable* containing one *Phoneme* and *Phonetic* item (green) and a *Syllable* containing five *Phoneme* and six *Phonetic* items (orange).

A schematic representation of a query string utilizing the count mechanism would be `[Num(L1, L2) == N]`, where L1 contains N annotation items in L2. For



this type of query to work L1 has to dominate L2 (i.e., be a parent level to L2). As the query matches a number (N), it is also possible to use the operators > (more than), < (less than) and != (not equal to). The resulting segment list contains items of L1.

### R Example 5.2.8

```
# retrieve all syllables that contain five phonemes
query(ae, "[Num(Syllable, Phoneme) == 5]")

## segment list from database: ae
## query was: [Num(Syllable, Phoneme) == 5]...
## labels start end session bundle level type
## 1 S 256.925 674.175 0000 msajc003 Syllable ITEM
## 2 S 739.925 1289.425 0000 msajc003 Syllable ITEM
## 3 W 2228.475 2753.975 0000 msajc010 Syllable ITEM
## 4 S 1890.275 2469.525 0000 msajc022 Syllable ITEM
## 5 S 1964.425 2554.175 0000 msajc023 Syllable ITEM
```

## 5.2.5 More complex queries

By using the correct bracketing, all of the above query components can be combined to formulate more complex queries that can be used to answer questions such as: *Which occurrences of the word “his” follow three-syllable words which contain a schwa (@) in the first syllable?* Such multi-part questions can usually be broken down into several sub-queries. These sub-queries can then be recombined to formulate the complex query. The steps to answering the above multi-part question are:

1. *Which occurrences of the word “his” ...:* [Text == his]
2. *... three-syllable words ...:* [Num(Text, Syllable) == 3]
3. *... contain a schwa (@) in the first syllable ...:* [Phoneme == @ ^ Start(Word, Syllable) == 1]
4. All three can be combined by saying 2 dominates 3 ([2 ^ 3]) and these are followed by 1 ([2 ^ 3] -> 1])

The combine query is depicted in R Example 5.2.9. This complex query demonstrates the expressive power of the query mechanism that the EMU-SDMS provides.

**R Example 5.2.9**

```

# perform complex query
# Note that the use of paste0() is optional, as
# it is only used for formatting purposes
query(ae, paste0("[[Num(Text, Syllable) == 3] ",
                "^ [Phoneme == @ ^ Start(Word, Syllable) == 1]] ",
                "-> #Text = his]"))

## segment list from database: ae
## query was:  [[[Num(Text, Syllable) == 3] ^ [Phoneme == @ ^ Sta...
## labels      start      end session  bundle level type
## 1          his 2693.675 2780.725    0000 msajc015 Text ITEM

```

As mastering these complex compound queries can require some practice, several simple as well as more complex examples that combine the various EQL components described above are available in Appendix E. These examples provide practical examples to help users find queries suited to their needs.

**5.2.6 Deducing time**

The default behavior of the legacy EMU system was to automatically deduce time information for queries of levels that do not contain time information. This was achieved by searching for the time-bearing sub-level and calculating the start and end times from the left-most and right-most annotation items which were directly or indirectly linked to the retrieved parent item. This upward percolation of time information is also the default behavior of the new EMU-SDMS. However, a new feature has been added to the query engine which allows the calculation of time to be switched off for a given query using the `calcTimes` parameter of the `query()` function. This is beneficial in two ways: for one, levels that do not have a time-bearing sub-level may be queried and secondly, the execution time of queries can be greatly improved. The performance increase becomes evident when performing queries on large data sets on one of the top levels of the hierarchy (e.g., *Utterance* or *Intonational* in the *ae emuDB*). When deducing time information for annotation items that contain large portions of the hierarchy, the query engine has to walk down large partial hierarchies to find the left-most and right-most items on the time-bearing sub-level. This can be a computationally expensive operation and is often unnecessary, especially during data exploration. R Example 5.2.10 shows the usage of this parameter by querying all of the items of the *Intonational* level and displaying the NA values for start and end times in the resulting segment list. It is worth noting that the missing time information excluded during the original

query can be retrieved at a later point in time by performing a hierarchical requery (see Section 5.2.7) on the same level.

### R Example 5.2.10

```
# query all intonational items
sl = query(ae, "Intonational =~ .*", calcTimes = F)

# show first entry of sl
head(sl, n = 1)

## segment list from database: ae
## query was: Intonational =~ .*...
## labels start end session bundle level type
## 1 L% NA NA 0000 msajc003 Intonational ITEM
```

## 5.2.7 Requery

A popular feature of the legacy system was the ability to use the result of a query to perform an additional query, called a requery, starting from the resulting items of a query. The requery functionality was used to move either sequentially (horizontally) or hierarchically (vertically) through the hierarchical annotation structure. Although this feature technically does not extend the querying functionality (it is possible to formulate EQL queries that yield the same results as a query followed by 1 :  $n$  requeries), requeries benefit the user by breaking down the task of formulating long query terms into multiple, simpler queries. Compared with the legacy system, this feature is implemented in the `emuR` package in a more robust way, as unique item IDs are present in the result of a query, eliminating the need for searching the starting segments based on their time information. Examples of queries and their results within a hierarchical annotation based on a hierarchical and sequential requery as well as their EQL equivalents are illustrated in Figure 5.5.

R Example 5.2.11 illustrates how the same results of the sequential query `[#Phonetic =~ .* -> Phonetic == n]` can be achieved using the `requery_seq()` function. Further, it shows how the `requery_hier()` function can be used to move vertically through the annotation structure by starting at the *Syllable* level and retrieving all the *Phonetic* items for the query result.

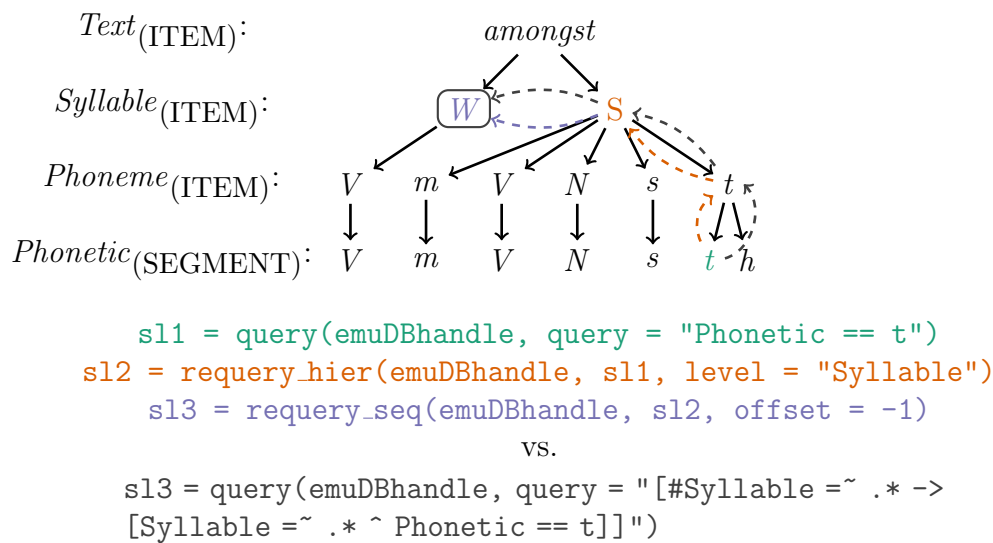

Figure 5.5: Three-step (query → requery\_hier → requery\_seq) requery procedure, its single query counterpart and their color coded movements within the annotation hierarchy.

### R Example 5.2.11

```

#####
# requery_seq()

# query all "n" phonetic items
sl_n = query(ae, "Phonetic == n")

# sequential requery (left shift result by 1 (== offset of -1))
# and hence retrieve all phonetic items directly preceding
# all "n" phonetic items
sl_precn = requery_seq(ae, seglist = sl_n, offset = -1)

# show first entry of sl_precn
head(sl_precn, n = 1)

## segment list from database: ae
## query was: FROM REQUERY...
## labels start end session bundle level type
## 1 E 949.925 1031.925 0000 msajc003 Phonetic SEGMENT

#####

```

```

# requery_hier()

# query all strong syllables (S)
sl_s = query(ae, "Syllable == S")

# hierarchical requery
sl_phonetic = requery_hier(ae, seglist = sl_s,
                           level = "Phonetic")

# show first entry of sl_phonetic
head(sl_phonetic, n = 1)

## segment list from database: ae
## query was: FROM REQUERY...
##          labels start end session bundle
## 1 m->V->N->s->t->H 256.925 674.175 0000 msajc003
## level type
## 1 Phonetic SEGMENT

```

## 5.3 Discussion

This chapter gave an overview of the abilities of the query system of the EMU-SDMS. We feel the EQL is an expressive, powerful, yet simple to learn and domain-specific query language that allows users to adequately query complex annotation structures. Further, the query system provided by the EMU-SDMS surpasses the querying capabilities of most commonly used systems. As the result of a query is a superclass of the common `data.frame` object, these results can easily be further processed using various R functions (e.g., to remove unwanted segments). Further, the results of queries can be used as input to the `get_trackdata()` function (see Chapter 6) which makes the query system a vital part in the default workflow described in Chapter 1.

Although the query mechanism of the EMU-SDMS covers most linguistic annotation query needs (including co-occurrence and domination relationship child position queries), it has limitations due to its domain-specific nature, its simplicity and its predefined result type. Performing more general queries such as: *What is the average age of the male speakers in the database who are taller than 1.8 meters?* is not directly possible using the EQL. Even if the gender, height and age parameters are available as part of the database's annotations (e.g., using the single bundle root node metadata strategy described in Chapter 3) they would be

encoded as strings, which do not permit direct calculations or numerical comparisons. However, it is possible to answer these types of questions using a multi-step approach. One could, for example, extract all height items and convert the strings into numbers to filter the items containing a label that is greater than 1.8. These filtered items could then be used to perform two queries to extract all male speakers and their age labels. These age labels could once again be converted into numbers to calculate their average. Although not as elegant as other languages, we have found that most questions that arise as part of studies working with spoken language database can be answered using such a multi-step process including some data manipulation in R, provided the necessary information is encoded in the database. Additionally, from the viewpoint of a speech scientist, we feel that the intuitiveness of an EQL expression (e.g., a query to extract the sibilant items for the question asked in the introduction: "Phonetic == s|z|S|Z") exceeds that of a comparable general purpose query language (e.g. a semantically similar SQL statement: `SELECT desired_columns FROM items AS i, labels AS l WHERE i.unique_bundle_item_id = l.uniq_bundle_item_id AND l.label = 's' OR l.label = 'z' OR l.label = 'S' OR l.label = 'Z'`). This difference becomes even more apparent with more complex EQL statements, which can have very long, complicated and sometimes multi-expression SQL counterparts.

A problem which the EMU-SDMS does not explicitly address is the problem of cross-corpus searches. Different *emuDBs* may have varying annotation structures with varying semantics regarding the names or labels given to objects or annotation items in the databases. This means that it is very likely that a complex query formulated for a certain *emuDB* will fail when used to query other databases. If, however, the user either finds a query that works on every *emuDB* or adapts the query to extract the items she/he is interested in, a cross-corpus comparison is simple. As the result of a query and the corresponding data extraction routines are the same, regardless of database they were extracted from, these results are easily comparable. However, it is worth noting that the EMU-SDMS is completely indifferent to the semantics of labels and level names, which means it is the user's responsibility to check if a comparison between databases is justifiable (e.g., *are all segments containing the label "@" of the level "Phonetic" in all emuDBs annotating the same type of phoneme?*).

# Chapter 6

## Signal data extraction<sup>\*</sup>

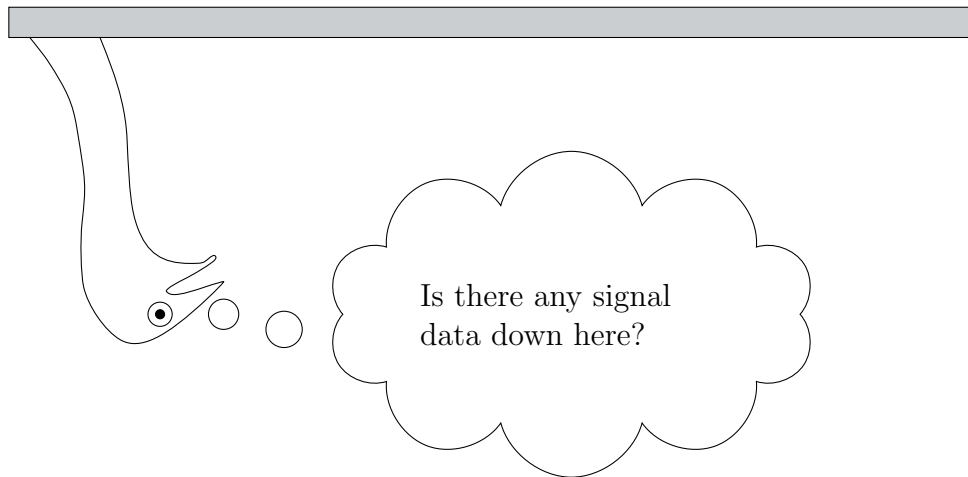

As mentioned in the default workflow of Chapter 1, after querying the symbolic annotation structure and dereferencing its time information, the result is a set of items with associated time stamps. It was necessary that the `emuR` package contain a mechanism for extracting signal data corresponding to this set of items. As illustrated in Chapter 7, `wrassp` provides the R ecosystem with signal data file handling capabilities as well as numerous signal processing routines. `emuR` can use this functionality to either obtain pre-stored signal data or calculate derived signal data that correspond to the result of a query. Figure 6.1A shows a snippet of speech with overlaid annotations where the resulting `SEGMENT` of an example query (e.g., "`Phonetic == ai`") is highlighted in yellow. Figure 6.1B displays a time parallel derived signal data contour as would be returned by one of `wrassp`'s file handling or signal processing routines. The yellow segment in Figure 6.1B marks the corresponding samples that belong to the `ai` segment of Figure 6.1A.

<sup>\*</sup>Parts of this chapter have been published in Winkelmann et al. (2017).

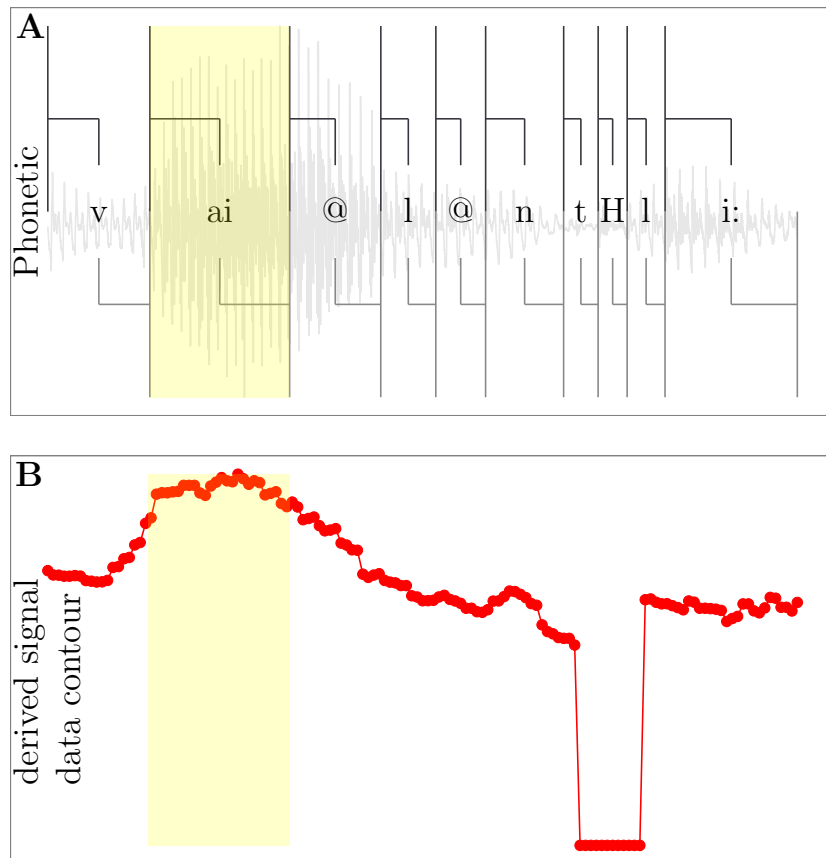

Figure 6.1: Segment of speech with overlaid annotations and time parallel derived signal data contour.



R Example 6.0.1 shows how to create the demo data that will be used throughout this chapter.

#### R Example 6.0.1

```
# load the package
library(emuR)

# create demo data in directory provided by the tempdir() function
create_emuRdemoData(dir = tempdir())

# get the path to a emuDB called "ae" that is part of the demo data
path2directory = file.path(tempdir(), "emuR_demoData", "ae_emuDB")

# load emuDB into current R session
ae = load_emuDB(path2directory)
```

## 6.1 Extracting pre-defined tracks

To access data that are stored in files, the user has to define tracks for a database that point to sequences of samples in files that match a user-specified file extension. The user-defined name of such a track can then be used to reference the track in the signal data extraction process. Internally, `emuR` uses `wrassp` to read the appropriate files from disk, extract the sample sequences that match the result of a query and return values to the user for further inspection and evaluation. R Example 6.1.1 shows how a signal track that is already defined in the `ae` demo database can be extracted for all annotation items on the *Phonetic* level containing the label *ai*.

#### R Example 6.1.1

```
# list currently available tracks
list_ssffTrackDefinitions(ae)

##   name columnName fileExtension
## 1  dft          dft             dft
## 2   fm          fm             fms

# query all "ai" phonetic segments
ai_segs = query(ae, "Phonetic == ai")
```

```
# get "fm" track data for these segments
# Note that verbose is set to FALSE
# only to avoid a progress bar
# being printed in this document.
ai_td_fm = get_trackdata(ae,
                        seglist = ai_segs,
                        ssffTrackName = "fm",
                        verbose = FALSE)

# show summary of ai_td_fm
summary(ai_td_fm)

## Emu track data from 6 segments
##
## Data is 4 dimensional from track fm
## Mean data length is 30.5 samples
```

Being able to access data that is stored in files is important for two main reasons. Firstly, it is possible to generate files using external programs such as VoiceSauce (Shue et al., 2011), which can export its calculated output to the general purpose SSFF file format. This file mechanism is also used to access data produced by EMA, EPG or many other forms of signal data recordings. Secondly, it is possible to track, save and access manipulated data such as formant values that have been manually corrected. It is also worth noting that the `get_trackdata()` function has a predefined track which is always available without it having to be defined. The name of this track is `MEDIAFILE_SAMPLES` which references the actual samples of the audio files of the database. R Example 6.1.2 shows how this predefined track can be used to access the audio samples belonging to the segments in `ai_segs`.

### R Example 6.1.2

```
# get media file samples
ai_td_mfs = get_trackdata(ae,
                        seglist = ai_segs,
                        ssffTrackName = "MEDIAFILE_SAMPLES",
                        verbose = FALSE)

# show summary of ai_td_fm
summary(ai_td_mfs)
```

```
## Emu track data from 6 segments
##
## Data is 1 dimensional from track MEDIAFILE_SAMPLES
## Mean data length is 3064.333 samples
```

## 6.2 Adding new tracks

As described in detail in Section 7.5, the signal processing routines provided by the `wrassp` package can be used to produce SSFF files containing various derived signal data (e.g., formants, fundamental frequency, etc.). R Example 6.2.1 shows how the `add_ssffTrackDefinition()` can be used to add a new track to the *ae* `emuDB`. Using the `onTheFlyFunctionName` parameter, the `add_ssffTrackDefinition()` function automatically executes the `wrassp` signal processing function `ksvF0` (`onTheFlyFunctionName = "ksvF0"`) and stores the results in SSFF files in the `bundle` directories.

### R Example 6.2.1

```
# add new track and calculate
# .f0 files on-the-fly using wrassp::ksvF0()
add_ssffTrackDefinition(ae,
                        name = "F0",
                        onTheFlyFunctionName = "ksvF0",
                        verbose = FALSE)

# show newly added track
list_ssffTrackDefinitions(ae)

##   name columnName fileExtension
## 1  dft         dft         dft
## 2  fm          fm          fms
## 3  F0          F0          f0

# show newly added files
library(tibble) # convert to tibble only to prettify output
as_tibble(list_files(ae, fileExtension = "f0"))

## # A tibble: 7 x 4
##   session bundle  file      absolute_file_path
```

```
## * <chr> <chr> <chr> <chr>
## 1 0000 msajc003 msajc003.f0 /private/var/folders/yk/8z9~
## 2 0000 msajc010 msajc010.f0 /private/var/folders/yk/8z9~
## 3 0000 msajc012 msajc012.f0 /private/var/folders/yk/8z9~
## 4 0000 msajc015 msajc015.f0 /private/var/folders/yk/8z9~
## 5 0000 msajc022 msajc022.f0 /private/var/folders/yk/8z9~
## 6 0000 msajc023 msajc023.f0 /private/var/folders/yk/8z9~
## 7 0000 msajc057 msajc057.f0 /private/var/folders/yk/8z9~

# extract newly added trackdata
ai_td = get_trackdata(ae,
                      seglist = ai_segs,
                      ssffTrackName = "F0",
                      verbose = FALSE)

# show summary of ai_td
summary(ai_td)

## Emu track data from 6 segments
##
## Data is 1 dimensional from track F0
## Mean data length is 30.5 samples
```

## 6.3 Calculating tracks on-the-fly

With the `wrassp` package, we were able to implement a new form of signal data extraction which was not available in the legacy system. The user is now able to select one of the signal processing routines provided by `wrassp` and pass it on to the signal data extraction function. The signal data extraction function can then apply this `wrassp` function to each audio file as part of the signal data extraction process. This means that the user can quickly manipulate function parameters and evaluate the result without having to store to disk the files that would usually be generated by the various parameter experiments. In many cases this new functionality eliminates the need for defining a track definition for the entire database for temporary data analysis purposes. R Example 6.3.1 shows how the `onTheFlyFunctionName` parameter of the `get_trackdata()` function is used.

### R Example 6.3.1

```
ai_td_pit = get_trackdata(ae,
                        seglist = ai_segs,
                        onTheFlyFunctionName = "mhsF0",
                        verbose = FALSE)

# show summary of ai_td
summary(ai_td_pit)

## Emu track data from 6 segments
##
## Data is 1 dimensional from track pitch
## Mean data length is 30.5 samples
```

## 6.4 The resulting object: trackdata vs. emuRtrackdata

The default resulting object of a call to `get_trackdata()` is of class `trackdata` (see R Example 6.4.1). The `emuR` package provides multiple routines such as `dcut()`, `trapply()` and `dplot()` for processing and visually inspecting objects of this type (see Harrington, 2010, and Section 2.4 for examples of how these can be used).

### R Example 6.4.1

```
# show class vector of ai_td_pit
class(ai_td_pit)

## [1] "trackdata"
```

As the `trackdata` object is a fairly complex nested matrix object with internal reference matrices, which can be cumbersome to work with, the `emuR` package introduces a new equivalent object type called `emuRtrackdata` that essentially is a flat `data.frame` object. This object type can be retrieved by setting the `resultType` parameter of the `get_trackdata()` function to `emuRtrackdata`. R Example 6.4.2 shows how this can be achieved.

R Example 6.4.2

```
ai_emuRtd_pit = get_trackdata(ae,
                             seglist = ai_segs,
                             onTheFlyFunctionName = "mhsF0",
                             resultType = "emuRtrackdata",
                             verbose = FALSE)

# show first row (convert to tibble only to prettify output)
as_tibble(ai_emuRtd_pit[1, ])

## # A tibble: 1 x 21
##   sl_rowIdx labels start   end utts  db_uuid session bundle
## *   <int> <chr>  <dbl> <dbl> <chr> <chr>  <chr>  <chr>
## 1       1 ai      863  1016 0000~ 0fc618~ 0000  msajc~
## # ... with 13 more variables: start_item_id <int>,
## #   end_item_id <int>, level <chr>,
## #   start_item_seq_idx <int>, end_item_seq_idx <int>,
## #   type <chr>, sample_start <int>, sample_end <int>,
## #   sample_rate <int>, times_orig <dbl>, times_rel <dbl>,
## #   times_norm <dbl>, T1 <dbl>

# show relative time values of the first segment
# (relative time values always start at 0 for every segment)
ai_emuRtd_pit[ai_emuRtd_pit$sl_rowIdx == 1, ]$times_rel

## [1] 0 5 10 15 20 25 30 35 40 45 50 55 60 65
## [15] 70 75 80 85 90 95 100 105 110 115 120 125 130 135
## [29] 140 145

# show original time values of the first segment
# (absolute time values always start at the original
# time stamp for that sample within the track)
ai_emuRtd_pit[ai_emuRtd_pit$sl_rowIdx == 1, ]$times_orig

## [1] 867.5 872.5 877.5 882.5 887.5 892.5 897.5 902.5
## [9] 907.5 912.5 917.5 922.5 927.5 932.5 937.5 942.5
## [17] 947.5 952.5 957.5 962.5 967.5 972.5 977.5 982.5
## [25] 987.5 992.5 997.5 1002.5 1007.5 1012.5
```

As can be seen by the first row output of R Example 6.4.2, the

`emuRtrackdata` object is an amalgamation of both a `segment list` and a `trackdata` object. The first `sl_rowIdx` column of the `ai_emuRtd_pit` object indicates the row index of the segment list the current row belongs to, the `times_rel` and `times_orig` columns represent the relative time and the original time of the samples contained in the current row (see R Example 6.4.2) and T1 (to Tn in n dimensional `trackdata`) contains the actual signal sample values. It is also worth noting that the `emuR` package provides a function called `create_emuRtrackdata()`, which allows users to create `emuRtrackdata` from a segment list and a `trackdata` object. This is beneficial as it allows `trackdata` objects to be processed using functions provided by the `emuR` package (e.g., `dcut()` and `trapply()`) and then converts them into a standardized `data.frame` object for further processing (e.g., using R packages such as `lme4` or `ggplot2` which were implemented to use with `data.frame` objects). R Example 6.4.3 shows how the `create_emuRtrackdata()` function is used.

### R Example 6.4.3

```
# create emuRtrackdata object
ai_emuRtd_pit = create_emuRtrackdata(sl = ai_segs,
                                     td = ai_td_pit)

# show first row and
# selected columns of ai_emuRtd_pit
ai_emuRtd_pit[1, ]

##   sl_rowIdx labels   start      end session  bundle
## 1         1     ai 862.875 1015.825    0000 msajc010
##   level   type times_orig times_rel times_norm      T1
## 1 Phonetic SEGMENT      867.5         0         0 134.7854
```

The general question remains as to when to use the `trackdata` and when to use the `emuRtrackdata` object and what the benefit of each class is. The `trackdata` object has a number of associated class functions (e.g. `trapply()`, `dcut()`, `dcut()` and `eplot()`) that ease data manipulation and visualization. Further, it avoids data redundancy and therefore has a smaller memory footprint than the `emuRtrackdata` object (this is usually negligible on current systems); however, this makes it rather difficult to work with. The `emuRtrackdata` object is intended as a long term replacement for the `trackdata` object as it contains all of the information of the corresponding `trackdata` object as well as its associated segment list. As is often the case with tabular data, the `emuRtrackdata` object carries certain redundant information (e.g. segment start and end times). However, the benefit

of having a `data.frame` object that contains all the information needed to process the data is the ability to replace package specific functions (e.g. `trapply()` etc.) with standardized `data.frame` processing and visualization procedures that can be applied to any `data.frame` object independent of the package that generated it. Therefore, the knowledge that is necessary to process an `emuRtrackdata` object can be transferred to/from other packages which is not the case for `trackdata` object. Future releases of the `emuR` package as well as this manual will contain various examples of how to replace the functionality of the package-specific functions mentioned above with equivalent data manipulation and visualization using the `dplyr` as well as the `ggplot2` packages.

## 6.5 Conclusion

This chapter introduced the signal data extraction mechanics of the `emuR` package. The combination of the `get_trackdata()` function and the file handling and signal processing abilities of the `wrassp` package (see Chapter 7 for further details) provide the user with a flexible system for extracting derived or complementary signal data belonging to their queried annotation items.



# Chapter 7

## The R package `wrassp`<sup>\*</sup>

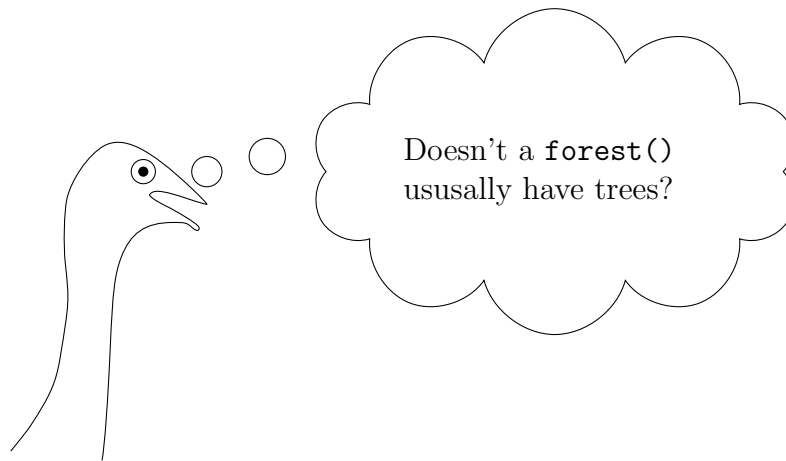

### 7.1 Introduction

This chapter gives an overview and introduction to the `wrassp` package. The `wrassp` package is a wrapper for R around Michel Scheffers' `libassp` (Advanced Speech Signal Processor). The `libassp` library and therefore the `wrassp` package provide functionality for handling speech signal files in most common audio formats and for performing signal analyses common in the phonetic and speech sciences. As such, `wrassp` fills a gap in the R package landscape as, to our knowledge, no previous packages provided this specialized functionality. The currently available signal processing functions provided by `wrassp` are:

---

<sup>\*</sup>Some examples of this chapter are adapted version of examples given in the `wrassp_intro` vignette of the `wrassp` package.

- `acfana()`: Analysis of short-term autocorrelation function
- `afdiff()`: Computes the first difference of the signal
- `affilter()`: Filters the audio signal (e.g., low-pass and high-pass)
- `cepstrum()`: Short-term cepstral analysis
- `cssSpectrum()`: Cepstral smoothed version of `dftSpectrum()`
- `dftSpectrum()`: Short-term DFT spectral analysis
- `forest()`: Formant estimation
- `ksvF0()`: F0 analysis of the signal
- `lpsSpectrum()`: Linear predictive smoothed version of `dftSpectrum()`
- `mhsF0()`: Pitch analysis of the speech signal using Michel Scheffers' Modified Harmonic Sieve algorithm
- `rfcana()`: Linear prediction analysis
- `rmsana()`: Analysis of short-term Root Mean Square amplitude
- `zcrana()`: Analysis of the averages of the short-term positive and negative zero-crossing rates

The available file handling functions are:

- `read.AsspDataObj()`: read a SSFF or audio file into an `AsspDataObj`, which is the in-memory equivalent of the SSFF or audio file.
- `write.AsspDataObj()`: write an `AsspDataObj` to file (usually SSFF or audio file formats).

See R's `help()` function for a comprehensive list of every function and object provided by the `wrassp` package is required (see R Example 7.1.1).

#### R Example 7.1.1

```
help(package="wrassp")
```

As the `wrassp` package can be used independently of the EMU-SDMS this chapter largely focuses on using it as an independent component. However, Section 7.5 provides an overview of how the package is integrated into the EMU-SDMS. Further, although the `wrassp` package has its own set of example audio files (which can be accessed in the directory provided by `system.file('extdata', package='wrassp')`), this chapter will use the audio and SSFF files that are part of the *ae* emuDB of the demo data provided by the `emuR` package. This is done primarily to provide an overview of what it is like using `wrassp` to work on files in an emuDB. R Example 7.1.2 shows how to generate this demo data followed by a listing of the files contained in a directory of a single bundle called *msajc003* (see Chapter 4 for information about the emuDB format). The output of the call to `list.files()` shows four files where the `.dft` and `.fms` files are in the SSFF file format (see Appendix B.1.3 for further details). The `_annot.json` file contains the annotation information, and the `.wav` file is one of the audio files that will be used in various signal processing examples in this chapter.

### R Example 7.1.2

```
# load the emuR package
library(emuR)

# create demo data in directory
# provided by tempdir()
create_emuRdemoData(dir = tempdir())

# create path to demo database
path2ae = file.path(tempdir(), "emuR_demoData", "ae_emuDB")

# create path to bundle in database
path2bndl = file.path(path2ae, "0000_ses", "msajc003_bndl")

# list files in bundle directory
list.files(path2bndl)

## [1] "msajc003_annot.json" "msajc003.dft"
## [3] "msajc003.fms"       "msajc003.wav"
```

## 7.2 File I/O and the AsspDataObj

One of the aims of `wrassp` is to provide mechanisms for handling speech-related files such as audio files and derived and complementary signal files. To have an in-memory object that can hold these file types in a uniform way the `wrassp` package provides the `AsspDataObj` data type. R Example 7.2.1 shows how the `read.AsspDataObj()` can be used to import a `.wav` audio file.

### R Example 7.2.1

```
# load the wrassp package
library(wrassp)

# create path to wav file
path2wav = file.path(path2bndl, "msajc003.wav")

# read audio file
au = read.AsspDataObj(path2wav)

# show class
class(au)

## [1] "AsspDataObj"

# show print() output of object
print(au)

## Assp Data Object of file /var/folders/yk/8z9tn7kx6hbcg_9n4c1....
## Format: WAVE (binary)
## 58089 records at 20000 Hz
## Duration: 2.904450 s
## Number of tracks: 1
##   audio (1 fields)
```

As can be seen in R Example 7.2.1, the resulting `au` object is of the class `AsspDataObj`. The output of `print` provides additional information about the object, such as its sampling rate, duration, data type and data structure information. Since the file we loaded is audio only, the object contains exactly one track. Further, since it is a mono file, this track only has a single field. We will later encounter different types of data with more than one track and multiple fields per track. R Example 7.2.2 shows function calls that extract the various attributes from the object (e.g., duration, sampling rate and the number of records).

## R Example 7.2.2

```
# show duration
dur.AsspDataObj(au)

## [1] 2.90445

# show sampling rate
rate.AsspDataObj(au)

## [1] 20000

# show number of records/samples
numRecs.AsspDataObj(au)

## [1] 58089

# shorten filePath attribute
# to 10 chars only to prettify output
attr(au, "filePath") = paste0(substr(attr(au, "filePath"),
                                     start = 1,
                                     stop = 45), "...")

# show additional attributes
attributes(au)

## $names
## [1] "audio"
##
## $trackFormats
## [1] "INT16"
##
## $sampleRate
## [1] 20000
##
## $filePath
## [1] "/var/folders/yk/8z9tn7kx6hbcg_9n4c1sld980000g..."
##
## $origFreq
## [1] 0
##
## $startTime
## [1] 0
```

```
##
## $startRecord
## [1] 1
##
## $endRecord
## [1] 58089
##
## $class
## [1] "AsspDataObj"
##
## $fileInfo
## [1] 21 2
```

The sample values belonging to a trackdata objects tracks are also stored within an `AsspDataObj` object. As mentioned above, the currently loaded object contains a single mono audio track. Accessing the data belonging to this track, in the form of a matrix, can be achieved using the track's name in combination with the `$` notation known from R's common named `list` object. Each matrix has the same number of rows as the track has records and as many columns as the track has fields. R Example 7.2.3 shows how the audio track can be accessed.

### R Example 7.2.3

```
# show track names
tracks.AsspDataObj(au)

## [1] "audio"

# or an alternative way to show track names
names(au)

## [1] "audio"

# show dimensions of audio attribute
dim(au$audio)

## [1] 58089      1

# show first sample value of audio attribute
head(au$audio, n = 1)

##      [,1]
## [1,]  64
```

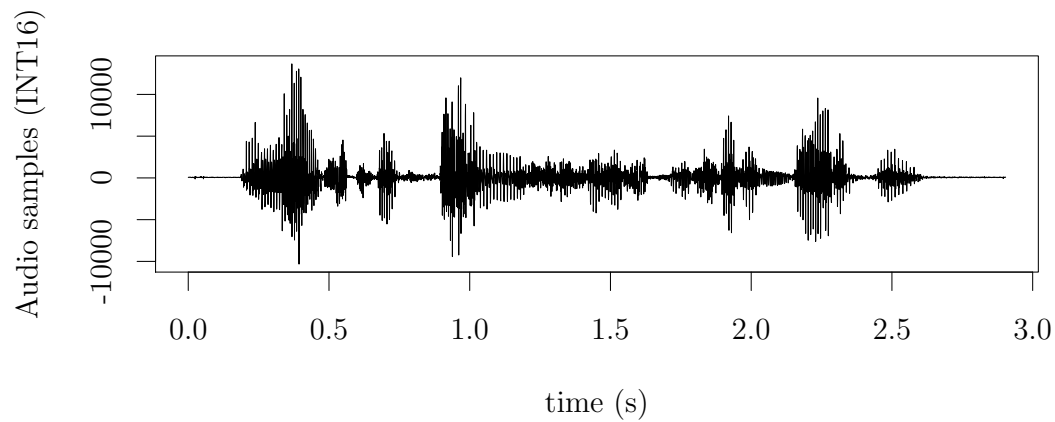

Figure 7.1: Oscillogram generated from samples stored in the `audio` track of the object `au`.

This data can, for example, be used to generate an oscillogram of the audio file as shown in R Example 7.2.4, which produces Figure 7.1.

#### R Example 7.2.4

```
# calculate sample time of every 10th sample
samplesIdx = seq(0, numRecs.AsspDataObj(au) - 1, 10)
samplesTime = samplesIdx / rate.AsspDataObj(au)

# extract every 10th sample using window() function
samples = window(au$audio, deltat=10)

# plot samples stored in audio attribute
# (only plot every 10th sample to accelerate plotting)
plot(samplesTime,
      samples,
      type = "l",
      xlab = "time (s)",
      ylab = "Audio samples (INT16)")
```

The export counterpart to `read.AsspDataObj()` function is `write.AsspDataObj()`. It is used to store in-memory `AsspDataObj` objects to disk and is particularly useful for converting other formats to or storing data in

the SSFF file format as described in Section 7.6. To show how this function can be used to write a slightly altered version of the `au` object to a file, R Example 7.2.5 initially multiplies all the sample values of `au$audio` by a factor of 0.5. The resulting `AsspDataObj` is then written to an audio file in a temporary directory provided by R's `tempdir()` function.

#### R Example 7.2.5

```
# manipulate the audio samples
au$audio = au$audio * 0.5
# write to file in directory
# provided by tempdir()
write.AsspDataObj(au, file.path(tempdir(), 'newau.wav'))
```

## 7.3 Signal processing

As mentioned in the introduction to this chapter, the `wrassp` package is capable of more than just the mere importing and exporting of specific signal file formats. This section will focus on demonstrating three of `wrassp`'s signal processing functions that calculate formant values, their corresponding bandwidths, the fundamental frequency contour and the RMS energy contour. Section 7.3.2 and 7.3.3 demonstrates signal processing to the audio file saved under `path2wav`, while Section 7.3.4 addresses processing all the audio files belonging to the `ae` `emuDB`.

### 7.3.1 The `wrasspOutputInfos` object

The `wrassp` package comes with the `wrasspOutputInfos` object, which provides information about the various signal processing functions provided by the package. The `wrasspOutputInfos` object stores meta information associated with the different signal processing functions `wrassp` provides. R Example 7.3.1 shows the names of the `wrasspOutputInfos` object which correspond to the function names listed in the introduction of this chapter.

#### R Example 7.3.1

```
# show all function names
names(wrasspOutputInfos)

## [1] "acfana"      "afdifff"     "affilter"    "cepstrum"
## [5] "cssSpectrum" "dftSpectrum" "ksvF0"       "mhsF0"
```



```
## [9] "forest"      "lpsSpectrum" "rfcana"      "rmsana"  
## [13] "zcrana"
```

This object can be useful to get additional information about a specific `wrassp` function. It contains information about the default file extension (`$ext`), the tracks produced (`$tracks`) and the output file type (`$outputType`). R Example 7.3.2 shows this information for the `forest()` function.

### R Example 7.3.2

```
# show output info of forest function  
wrasspOutputInfos$forest  
  
## $ext  
## [1] "fms"  
##  
## $tracks  
## [1] "fm" "bw"  
##  
## $outputType  
## [1] "SSFF"
```

The examples that follow will make use of this `wrasspOutputInfos` object mainly to acquire the default file extensions given by a specific `wrassp` signal processing function.

### 7.3.2 Formants and their bandwidths

The already mentioned `forest()` is `wrassp`'s formant estimation function. The default behavior of this formant tracker is to calculate the first four formants and their bandwidths. R Example 7.3.3 shows the usage of this function. As the default behavior of every signal processing function provided by `wrassp` is to store its result to a file, the `toFile` parameter of `forest()` is set to `FALSE` to prevent this behavior. This results in the same `AsspDataObj` object as when exporting the result to file and then importing the file into R using `read.AsspDataObj()`, but circumvents the disk reading/writing overhead.

### R Example 7.3.3

```
# calculate formants and corresponding bandwidth values  
fmBwVals = forest(path2wav, toFile=F)
```

```

# show class vector
class(fmBwVals)

## [1] "AsspDataObj"

# show track names
tracks.AsspDataObj(fmBwVals)

## [1] "fm" "bw"

# show dimensions of "fm" track
dim(fmBwVals$fm)

## [1] 581  4

# check dimensions of tracks are the same
all(dim(fmBwVals$fm) == dim(fmBwVals$bw))

## [1] TRUE

```

As can be seen in R Example 7.3.3, the object resulting from the `forest()` function is an object of class `AsspDataObj` with the tracks "fm" (formants) and "bw" (formant bandwidths), where both track matrices have four columns (corresponding to F1, F2, F3 and F4 in the "fm" track and F1<sub>bandwidth</sub>, F2<sub>bandwidth</sub>, F3<sub>bandwidth</sub> and F4<sub>bandwidth</sub> in the "bw" track) and 581 rows. To visualize the calculated formant values, R Example 7.3.4 shows how R's `matplot()` function can be used to produce Figure 7.2.

#### R Example 7.3.4

```

# plot the formant values
matplot(seq(0, numRecs.AsspDataObj(fmBwVals) - 1)
        / rate.AsspDataObj(fmBwVals)
        + attr(fmBwVals, "startTime"),
        fmBwVals$fm,
        type = "l",
        xlab = "time (s)",
        ylab = "Formant frequency (Hz)")

# add legend
startFormant = 1

```

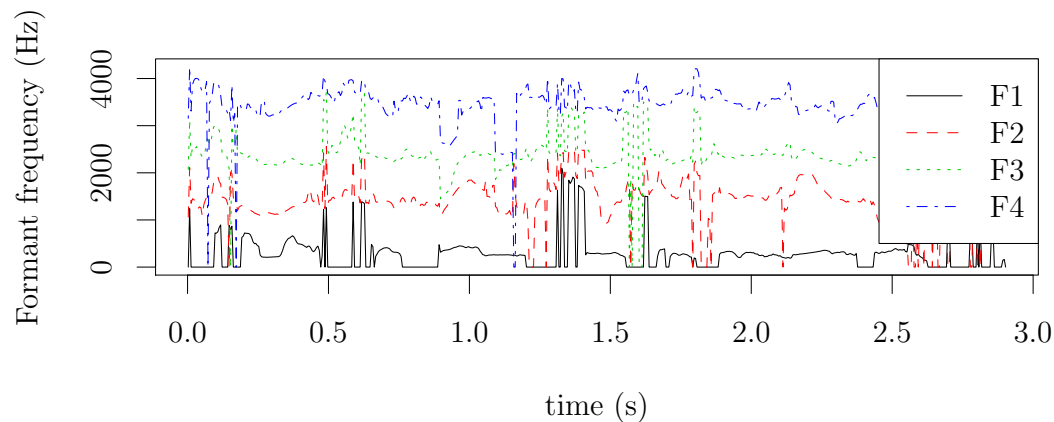

Figure 7.2: Matrix plot of formant values stored in the `fm` track of `fmBwVals` object.

```
endFormant = 4
legend("topright",
      legend = paste0("F", startFormant:endFormant),
      col = startFormant:endFormant,
      lty = startFormant:endFormant,
      bg = "white")
```

### 7.3.3 Fundamental frequency contour

The `wrassp` package includes two fundamental frequency estimation functions called `ksvF0()` and `mhsF0()`. R Example 7.3.5 shows the usage of the `ksvF0()` function, this time not utilizing the `toFile` parameter but rather to show an alternative procedure, reading the resulting SSFF file produced by it. It is worth noting that every signal processing function provided by `wrassp` creates a result file in the same directory as the audio file it was processing (except if the `outputDirectory` parameter is set otherwise). The default extension given by the `ksvF0()` is stored in `wrasspOutputInfos$ksvF0$ext`, which is used in R Example 7.3.5 to create the newly generated file's path.

**R Example 7.3.5**

```
# calculate the fundamental frequency contour
ksvF0(path2wav)

# create path to newly generated file
path2f0file = file.path(path2bndl,
                        paste0("msajc003.",
                               wrasspOutputInfos$ksvF0$ext))

# read file from disk
f0vals = read.AsspDataObj(path2f0file)
```

By analogy with to the formant estimation example, R Example 7.3.6 shows how the `plot()` function can be used to visualize this data as in Figure 7.3.

**R Example 7.3.6**

```
# plot the fundamental frequency contour
plot(seq(0, numRecs.AsspDataObj(f0vals) - 1)
     / rate.AsspDataObj(f0vals) +
     attr(f0vals, "startTime"),
     f0vals$F0,
     type = "l",
     xlab = "time (s)",
     ylab = "F0 frequency (Hz)")
```

### 7.3.4 RMS energy contour

The `wrassp` function for calculating the short-term Root Mean Square (RMS) amplitude of the signal is called `rmsana()`. As its usage is analogous to the above examples, here we will focus on using it to calculate the RMS values for all the audio files of the *ae* `emuDB`. R Example 7.3.7 initially uses the `list.files()` function to acquire the file paths for every `.wav` file in the *ae* `emuDB`. As every signal processing function accepts one or multiple file paths, these file paths can simply be passed in as the main argument to the `rmsana()` function. As all of `wrassp`'s signal processing functions place their generated files in the same directory as the audio file they process, the `rmsana()` function will automatically place every `.rms` into the correct bundle directory.

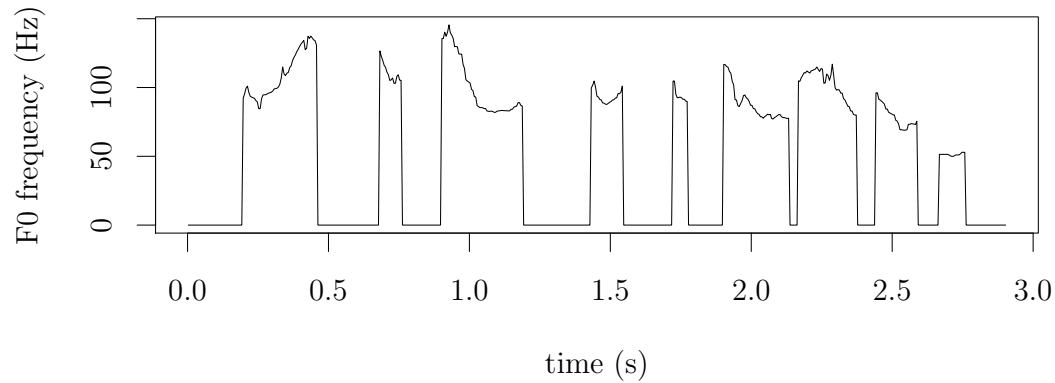

Figure 7.3: Plot of fundamental frequency values stored in the F0 track of `f0vals` object.

#### R Example 7.3.7

```
# list all .wav files in the ae emuDB
paths2wavFiles = list.files(path2ae, pattern = ".*wav$",
                             recursive = TRUE, full.names = TRUE)

# calculate the RMS energy values for all .wav files
rmsana(paths2wavFiles)

# list new .rms files using
# wrasspOutputInfos->rmsana->ext
rmsFPs = list.files(path2ae,
                    pattern = paste0(".*",
                                      wrasspOutputInfos$rmsana$ext),
                    recursive = TRUE,
                    full.names = TRUE)

# read first RMS file
rmsvals = read.AsspDataObj(rmsFPs[1])
```

R Example 7.3.8 shows how the `plot()` function can be used to visualize this data as in Figure 7.4.

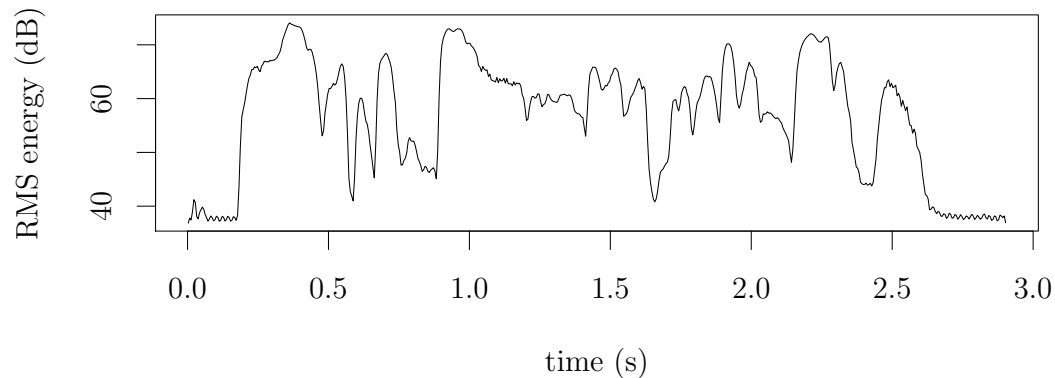

Figure 7.4: Plot of RMS values stored in `rms` track of the `rmsvals` object.

#### R Example 7.3.8

```
# plot the RMS energy contour
plot(seq(0, numRecs.AsspDataObj(rmsvals) - 1)
     / rate.AsspDataObj(rmsvals)
     + attr(rmsvals, "startTime"),
     rmsvals$rms,
     type = "l",
     xlab = "time (s)",
     ylab = "RMS energy (dB)")
```

## 7.4 Logging wrassp's function calls

As it can be extremely important to keep track of information about how certain files are created and calculated, every signal processing function provided by the `wrassp` package comes with the ability to log its function calls to a specified log file. R Example 7.4.1 shows a call to the `ksvF0()` function where a single parameter was changed from its default value (`windowShift = 10`). The content of the created log files (shown by the call to `readLines()`) contains the function name, time stamp, parameters that were altered and processed file path information. It is worth noting that a log file can be reused for multiple function calls as the log function does not overwrite an existing file but merely appends new log information to it.

## R Example 7.4.1

```

# create path to log file in root dir of ae emuDB
path2logFile = file.path(path2ae, "wrassp.log")

# calculate the fundamental frequency contour
ksvF0(path2wav, windowShift = 10,
      forceToLog = T, optLogFilePath = path2logFile)

## [1] 1

# display content of log file (first 8 lines)
readLines(path2logFile)[1:8]

## [1] ""
## [2] "#####"
## [3] "#####"
## [4] "##### ksvF0 performed #####"
## [5] "Timestamp: 2018-04-17 17:10:36 "
## [6] "windowShift : 10 "
## [7] "forceToLog : T "
## [8] " => on files:"

```

## 7.5 Using wrassp in the EMU-SDMS

As shown in Section 7.3.4, the `wrassp` signal processing functions can be used to calculate SSFF files and place them into the appropriate bundle directories. The only thing that has to be done to make an `emuDB` aware of these files is to add an SSFF track definition to the `emuDB` as shown in R Example 7.5.1. Once added, this SSFF track can be referenced via the `ssffTrackName` parameter of the `get_trackdata()` function as shown in various examples throughout this documentation. It is worth noting that this strategy is not necessarily relevant for applying the same signal processing to an entire `emuDB`, as this can be achieved using the on-the-fly `add_ssffTrackDefinition()` method described in R Example 7.5.2. However, it becomes necessary if certain bundles are to be processed using deviating function parameters. This can, for example, be relevant when setting the minimum and maximum frequencies that are to be considered while estimating the fundamental frequencies (e.g., the `maxF` and `minF` of `ksvfF0()`) for female versus male speakers.

## R Example 7.5.1

```

# load emuDB
ae = load_emuDB(path2ae)

# add SSFF track definition
# that references the .rms files
# calculated above
# (i.e. no new files are calculated and added to the emuDB)
ext = wrasspOutputInfos$rmsana$ext
colName = wrasspOutputInfos$rmsana$tracks[1]
add_ssffTrackDefinition(ae,
                        name = "rms",
                        fileExtension = ext,
                        columnName = colName)

```

A further way to utilize `wrassp`'s signal processing functions as part of the EMU-SDMS is via the `onTheFlyFunctionName` and `onTheFlyParams` parameters of the `add_ssffTrackDefinition()` and `get_trackdata()` functions. Using the `onTheFlyFunctionName` parameter in the `add_ssffTrackDefinition()` function automatically calculates the SSFF files while also adding the SSFF track definition. Using this parameter with the `get_trackdata()` function calls the given `wrassp` function with the `toFile` parameter set to `FALSE` and extracts the matching segments and places them in the resulting `trackdata` or `emuRtrackdata` object. In many cases, this avoids the necessity of having SSFF track definitions in the `emuDB`. In both functions, the optional `onTheFlyParams` parameter can be used to specify the parameters that are passed into the signal processing function. R Example 7.5.2 shows how R's `formals()` function can be used to get all the parameters of `wrassp`'s short-term positive and negative Zero Crossing-Rate (ZCR) analysis function `zcrana()`. It then changes the default window size parameter to a new value and passes the parameters object into the `add_ssffTrackDefinition()` and `get_trackdata()` functions.

## R Example 7.5.2

```

# get all parameters of zcrana
zcranaParams = formals("zcrana")

# show names of parameters
names(zcranaParams)

## [1] "listOfFiles"      "optLogFilePath"  "beginTime"

```



```
## [4] "centerTime"      "endTime"         "windowShift"
## [7] "windowSize"      "toFile"          "explicitExt"
## [10] "outputDirectory" "forceToLog"      "verbose"

# change window size from the default
# value of 25 ms to 50 ms
zcranaParams$windowSize = 50

# to have a segment list to work with
# query all Phonetic 'n' segments
sl = query(ae, "Phonetic == n")

# get trackdata calculating ZCR values on-the-fly
# using the above parameters. Note that no files
# are generated.
td = get_trackdata(ae, sl,
                  onTheFlyFunctionName = "zcrana",
                  onTheFlyParams = zcranaParams,
                  verbose = FALSE)

# add SSFF track definition. Note that
# this time files are generated.
add_ssffTrackDefinition(ae,
                       name = "zcr",
                       onTheFlyFunctionName = "zcrana",
                       onTheFlyParams = zcranaParams,
                       verbose = FALSE)
```

## 7.6 Storing data in the SSFF file format

One of the benefits gained by having the `AsspDataObj` in-memory object is that these objects can be constructed from scratch in R, as they are basically simple `list` objects. This means, for example, that any set of  $n$ -dimensional samples over time can be placed in a `AsspDataObj` and then stored as an SSFF file using the `write.AsspDataObj()` function. To show how this can be done, R Example 7.6.1 creates an arbitrary data sample in the form of a single cycle sine wave between 0 and  $2 * \pi$  that is made up of 16000 samples and displays it in Figure 7.5.

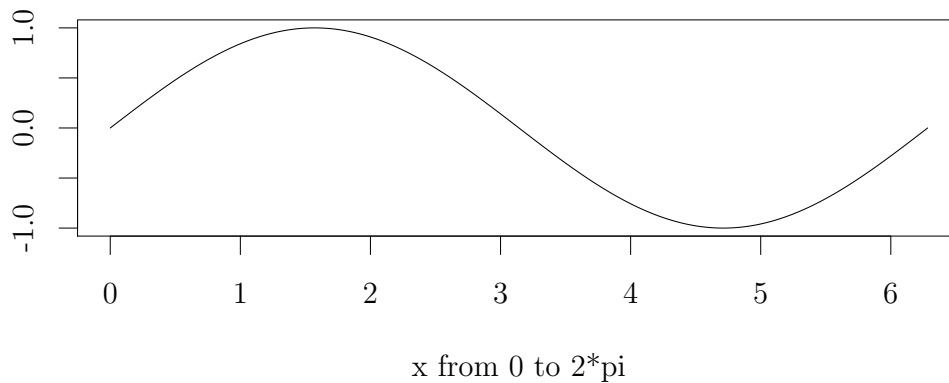

Figure 7.5: A single cycle sine wave consisting of 16000 samples.

#### R Example 7.6.1

```
x = seq(0, 2 * pi, length.out = 16000)
sineWave = sin(x)
plot(x, sineWave, type = 'l',
     xlab = "x from 0 to 2*pi",
     ylab = "")
```

Assuming a sample rate of 16 kHz `sineWave` would result in a sine wave with a frequency of 1 Hz and a duration of one second. R Example 7.6.2 shows how a `AsspDataObj` can be created from scratch and the data in `sineWave` placed into one of its tracks. It then goes on to write the `AsspDataObj` object to an SSFF file.

#### R Example 7.6.2

```
# create empty list object
ado = list()

# add sample rate attribute
attr(ado, "sampleRate") = 16000

# add start time attribute
attr(ado, "startTime") = 0
```

```

# add start record attribute
attr(ado, "startRecord") = as.integer(1)

# add end record attribute
attr(ado, "endRecord") = as.integer(length(sineWave))

# set class of ado
class(ado) = "AsspDataObj"

# show available file formats
AsspFileFormats

##      RAW   ASP_A   ASP_B   XASSP   IPDS_M   IPDS_S   AIFF
##      1     2     3     4     5     6     7
##   AIFC   CSL    CSRE    ESPS    ILS     KTH    SWELL
##      8     9    10    11    12    13    13
##   SNACK   SFS    SND     AU     NIST   SPHERE PRAAT_S
##     13    14    15    15    16    16    17
## PRAAT_L PRAAT_B   SSFF    WAVE   WAVE_X  XLABEL   YORK
##     18    19    20    21    22    24    25
##      UWM
##      26

# set file format to SSFF
# NOTE: assignment of "SSFF" also possible
AsspFileFormat(ado) = as.integer(20)

# set data format (1 == 'ascii' and 2 == 'binary')
AsspDataFormat(ado) = as.integer(2)

# set track format specifiers
# (available track formats for numbers
# that match their C equivalent are:
# "UINT8"; "INT8"; "UINT16"; "INT16";
# "UINT24"; "INT24"; "UINT32"; "INT32";
# "UINT64"; "INT64"; "REAL32"; "REAL64");
attr(ado, "trackFormats") = c("REAL32")

# add track
ado = addTrack(ado, "sine", sineWave, "REAL32")

```

```
# write AsspDataObj object to file
write.AsspDataObj(dobj = ado,
                  file = file.path(tempdir(), "example.sine"))

## NULL
```

Although somewhat of a generic example, R Example 7.6.2 shows how to generate an `AsspDataObj` from scratch. This approach can, for example, be used to read in signal data produced by other software or signal data acquisition devices. Hence, this approach can be used to import many forms of data into the EMU-SDMS. Appendix F.1 shows an example of how this approach can be used to take advantage of Praat's signal processing capabilities and integrate its output into the EMU-SDMS.

## 7.7 Conclusion

The `wrassp` package enriches the R package landscape by providing functionality for handling speech signal files in most common audio formats and for performing signal analyses common in the phonetic and speech sciences. The EMU-SDMS utilizes the functionality that the `wrassp` package provides by allowing the user to calculate signals that match the segments of a segment list. This can either be done in real time or by extracting the signals from files. Hence, the `wrassp` package is an integral part of the EMU-SDMS but can also be used as a standalone package if so desired.

# Chapter 8

## The EMU-webApp<sup>\*</sup>



The EMU-SDMS has a unique approach to its graphical user interface (GUI) in that it utilizes a web application as its primary GUI. This is known as the EMU-webApp (Winkelmann and Raess, 2015). The EMU-webApp is a fully fledged browser-based labeling and correction tool that offers a multitude of labeling and visualization features. These features include unlimited undo/redo, formant correction capabilities, the ability to snap a preselected boundary to the nearest top/bottom boundary, snap a preselected boundary to the nearest zero crossing, and many more. The web application is able to render everything directly in the user's browser, including the calculation and rendering of the spectrogram, as it is written entirely using HTML, CSS and JavaScript. This means it can also be used as a standalone labeling application, as it does not require any server-side calculations or rendering. Further, it is designed to interact with any websocket server

---

<sup>\*</sup>Sections of this chapter have been published in (Winkelmann and Raess, 2015) and some descriptions were taken from the EMU-webApp's own manual.

that implements the `EMU-webApp` websocket protocol (see Section 12.1). This enables it to be used as a labeling tool for collaborative annotation efforts. Also, as the `EMU-webApp` is cached in the user's browser on the first visit, it does not require any internet connectivity to be able to access the web application unless the user explicitly clears the browser's cache. The URL of the current live version of the `EMU-webApp` is: <http://ips-lmu.github.io/EMU-webApp/>.

## 8.1 Main layout

The main screen of the `EMU-webApp` can be split into five areas. Figure 8.1 shows a screenshot of the `EMU-webApp`'s main screen displaying these five areas while displaying a bundle of the *ae* demo database. This database is served to the `EMU-webApp` by invoking the `serve()` command as shown in R Example 8.1.1. The left side bar (area marked 1 in Figure 8.1) represents the bundle list side bar which, if connected to a database, displays the currently available bundles grouped by their sessions. The top and bottom menu bars (areas marked 2 and 5 in Figure 8.1) display the currently available menu options, where the bottom menu bar contains the audio navigation and playback controls and also includes a scrollable mini map of the oscillogram. Area 3 of Figure 8.1 displays the signal canvas area currently displaying the oscillogram and the spectrogram. Other signal contours such as formant frequency contours and fundamental frequency contours are also displayed in this area. Area 4 of Figure 8.1 displays the area in which levels containing time information are displayed. It is worth noting that the main screen of the `EMU-webApp` does not display any levels that do not contain time information. The hierarchical annotation can be displayed and edited by clicking the `show hierarchy` button in the top menu bar (see Figure 8.6 for an example of how the hierarchy is displayed).

### R Example 8.1.1

```
# serve ae emuDB to EMU-webApp
serve(ae)
```

## 8.2 General usage

This section introduces the labeling mechanics and general labeling workflow of the `EMU-webApp`. The `EMU-webApp` makes heavy use of keyboard shortcuts. It is worth noting that most of the keyboard shortcuts are centered around the WASD keys, which are the navigation shortcut keys (`W` to zoom in; `S` to zoom out; `A` to

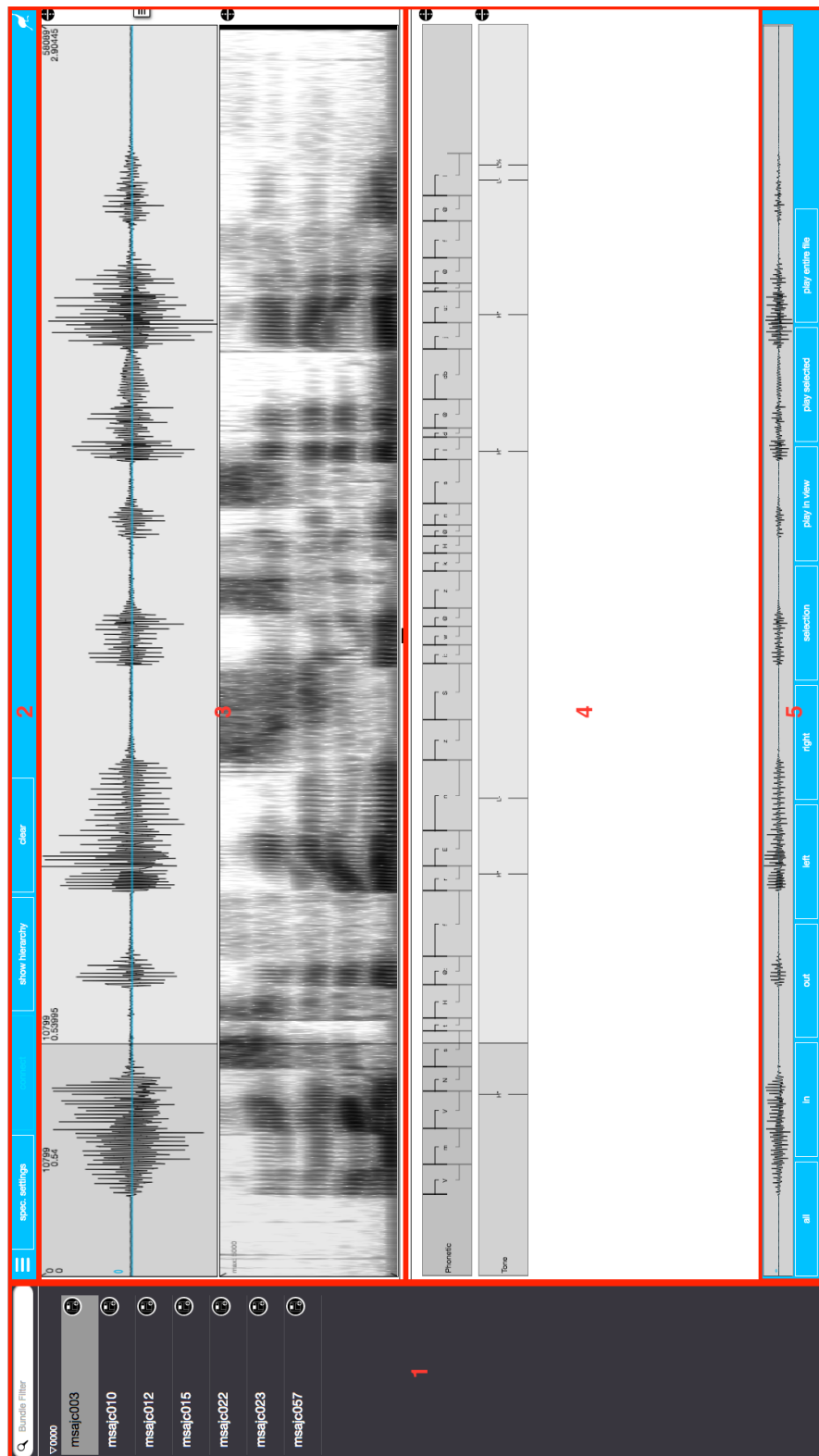

Figure 8.1: Screenshot of EMU-webApp displaying the *ae* demo database with overlaid areas of the main screen of the web application (see text).

move left and D to move right). For a full list of the available keyboard shortcuts see the EMU-webApp's own manual, which can be accessed by clicking the EMU icon on the right hand side of the top menu bar (area 2 in Figure 8.1).

### 8.2.1 Annotating levels containing time information

#### Boundaries and events

The EMU-webApp has slightly different labeling mechanics compared with other annotation software. Compared to the usual click and drag of segment boundaries and event markers, the web application continuously tracks the movement of the mouse in levels containing time information, highlighting the boundary or event marker that is closest to it by coloring it blue. Figure 8.2 displays this automatic boundary preselection.

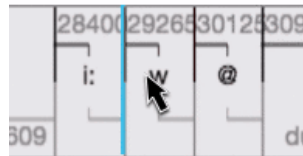

Figure 8.2: Screenshot of segment level as displayed by the EMU-webApp with superimposed mouse cursor displaying the automatic boundary preselection of closest boundary (boundary marked blue).

Once a boundary or event is preselected, the user can perform various actions with it. She or he can, for example, grab a preselected boundary or event by holding down the **SHIFT** key and moving it to the desired position, or delete the current boundary or event by hitting the **BACKSPACE** key. Other actions that can be performed on preselected boundaries or events are:

- snap to closest boundary or event in level above (Keyboard Shortcut **t**),
- snap to closest boundary or event in level below (Keyboard Shortcut **b**), and
- snap to nearest zero crossing (Keyboard Shortcut **x**).

To add a new boundary or event to a level the user initially has to select the desired level she or he wishes to edit. This is achieved either by using the up and down cursor keys or by single-left-clicking on the desired level. The current preselected level is marked in a darker shade of gray, as is displayed in Figure 8.3.

To add a boundary to the currently selected level one first has to select a point in time either in the spectrogram or the oscillogram by single-left-clicking on the



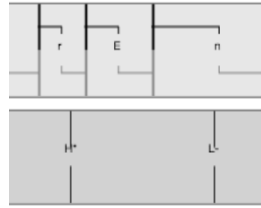

Figure 8.3: Screenshot of two levels as displayed by the **EMU-webApp**, where the lower level is preselected (i.e., marked in a darker shade of gray).

desired location. Hitting the enter/return key adds a new boundary or event to the preselected level at the selected time point. Selecting a stretch of time in the spectrogram or the oscillogram (left-click-and-drag) and hitting enter will add a segment (not a boundary) to a preselected segment level.

### Segments and events

The **EMU-webApp** also allows segments and events to be preselected by single-left-clicking the desired item. The web application colors the preselected segments and events yellow to indicate their pre-selection as displayed in Figure 8.4.



Figure 8.4: Screenshot of level as displayed by the **EMU-webApp**, where the `/@/` segment is currently preselected as it is marked yellow.

As with preselected boundaries or events the user can now perform multiple actions with these preselected items. She or he can, for example, edit the item's label by hitting the enter/return key (which can also be achieved by double-left-clicking the item). Other actions that can be performed on preselected items are:

- Select next item in level (keyboard shortcut **TAB**),
- Select previous item in level (keyboard shortcut **SHIFT** plus **TAB**),
- Add time to selected item(s) end (keyboard shortcut **+**),
- Add time to selected item(s) start (keyboard shortcut **SHIFT** plus **+**),

- Remove time to selected item(s) end (keyboard shortcut -),
- Remove time to selected item(s) start (keyboard shortcut **SHIFT** plus -), and
- Move selected item(s) (hold down **ALT** Key and drag to desired position).

By right-clicking adjacent segment or events (keyboard shortcut **SHIFT** plus left or right cursor keys), it is possible to select multiple items at once.

### Parallel labels in segments and events

If a level containing time information has multiple attribute definitions (i.e., multiple parallel labels per segment or event) the **EMU-webApp** automatically displays radio buttons underneath that level (see red square in Figure 8.5) that allow the user to switch between the parallel labels. Figure 8.5 displays a segment level with three attribute definitions.



Figure 8.5: Screenshot of segment level with three attribute definitions. The radio buttons that switch between the parallel labels are highlighted by a red square.

### Legal labels

As mentioned in Section 4.2.3, an array of so-called legal labels can be defined for every level or, more specifically, for each attribute definition. The **EMU-webApp** enforces these legal labels by not allowing any other labels to be entered in the label editing text fields. If an illegal label is entered, the text field will turn red and the **EMU-webApp** will not permit this label to be saved.

## 8.2.2 Working with hierarchical annotations<sup>1</sup>

### Viewing the hierarchy

As mentioned in Section 8.1, pressing the **show hierarchy** button (keyboard shortcut **h**) in the top menu bar opens the hierarchy view modal window<sup>2</sup>. As with most modal windows in the **EMU-webApp**, it can be closed by clicking on the **close** button, clicking the X circle icon in the top right hand corner of the modal or by hitting the **ESCAPE** key. By default, the hierarchy modal window displays a horizontal version of the hierarchy for a spatially economical visualization. As most people are more familiar with a vertical hierarchical annotation display, the hierarchy can be rotated by hitting the **rotate by 90°** button (keyboard shortcut **r**). Zooming in and out of the hierarchy can be achieved by using the mouse wheel, and moving through the hierarchy in time can be achieved by holding down the left mouse button and dragging the hierarchy in the desired direction. Figure 8.6 shows the hierarchy modal window displaying the hierarchical annotation of a single path (*Utterance ->Intonational ->Intermediate ->Word ->Syllable ->Phoneme ->Phonetic*) through a multi-path hierarchy of the *ae* emuDB in its horizontal form.

### Selecting a path through the hierarchy

As more complex databases have multiple hierarchical paths through their hierarchical annotation structure (see Figure 3.2 for an example of a multi-dimensional hierarchical annotation structure), the hierarchy modal offers a drop-down menu to choose the current path to be displayed. Area 2 in Figure 8.7 marks the hierarchy path drop-down menu of the hierarchy modal.

It is worth noting that only non-partial paths can be selected in the hierarchy path drop-down menu.

### Selecting parallel labels in timeless levels

As timeless levels may also contain multiple parallel labels, the hierarchy path modal window provides a drop-down menu for each level to select which label or attribute definition is to be displayed. Area 1 of Figure 8.7 displays these drop-down menus.

---

<sup>1</sup>This section is an updated version of the *The level hierarchy* section of the *General Usage* chapter that is part of the **EMU-webApp** own brief manual by Markus Jochim.

<sup>2</sup>The term modal window is used in user interface design to refer to pop-up windows that force the user to interact with the window before returning back to the main application.

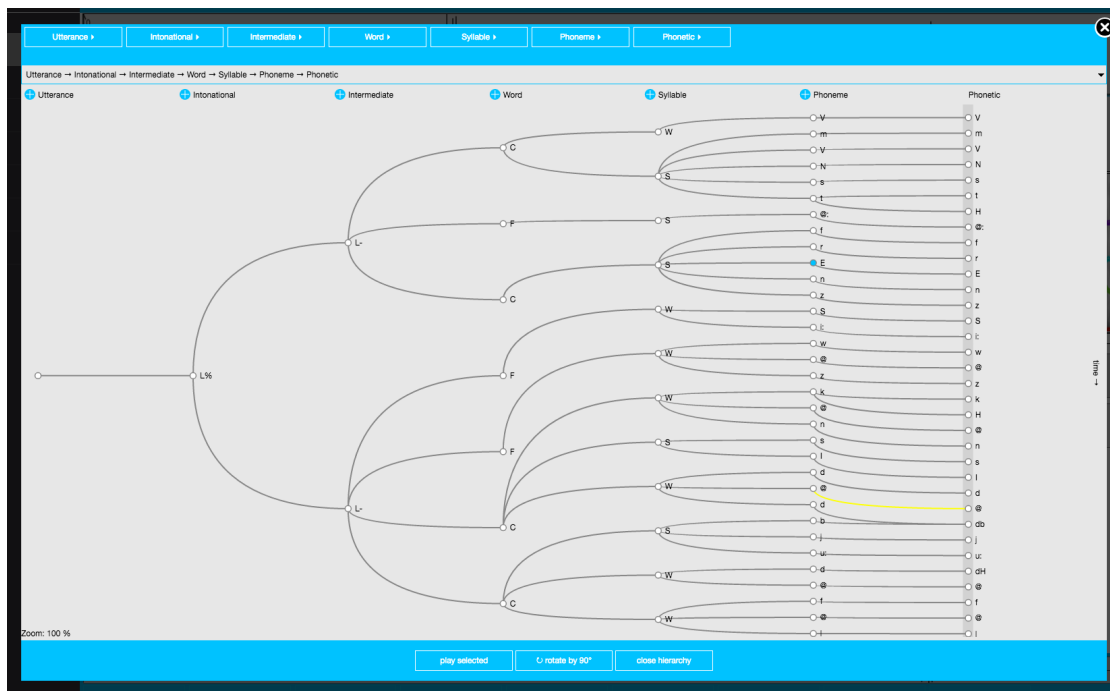

Figure 8.6: Screenshot of the hierarchy modal window level displaying a path through the hierarchy of the *ae* emuDB in its horizontal form.

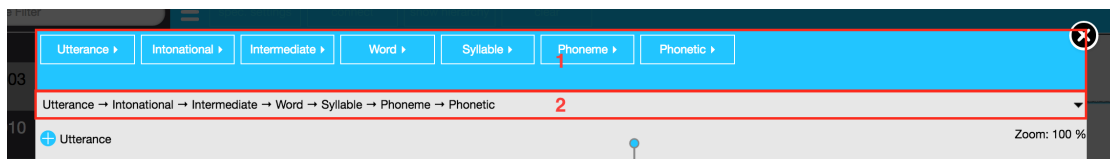

Figure 8.7: Screenshot of top of hierarchy modal window of the EMU-webApp in which the area marked 1 shows the drop-down menus for selecting the parallel label for each level and area 2 marks the hierarchy path drop-down menu.

### Adding a new item

The hierarchy modal window provides two methods for adding new annotation items to a level. This can either be achieved by pressing the blue and white + button next to the level's name (which appends a new item to the end of the level) or by preselecting an annotation item (by hovering the mouse over it) and hitting either the **n** (insert new item before preselected item) or the **m** key (insert new item after preselected item).

### Modifying an annotation item

An item's context menu<sup>3</sup> is opened by single-left-clicking its node. The resulting context menu displays a text area in which the label of the annotation item can be edited, a play button to play the audio section associated with the item and a collapse arrow button allowing the user to collapse the sub-tree beneath the current item. Collapsing a sub-tree can be useful for masking parts of the hierarchy while editing. A screenshot of the context menu is displayed in Figure 8.8.

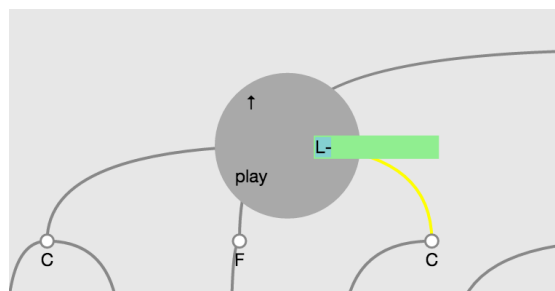

Figure 8.8: Screenshot of the hierarchy modal window of the EMU-webApp displaying an annotation item's context menu.

### Adding a new link

Adding a new link between two items can be achieved by hovering the mouse over one of the two items, holding down the **SHIFT** key and moving the mouse cursor to the other item. A green dashed line indicates that the link to be added is valid, while a red dashed line indicates it is not. A link's validity is dependent on the database's configuration (i.e., if there is a link definition present and the type of link definition) as well as the *non-crossing constraint* (Coleman and Local, 1991) that essentially implies that links are not allowed to cross each other. If the link

---

<sup>3</sup>The term context menu is used in user interface design to refer to a pop-up menu or pop-up area that provides additional information for the current state (i.e., the current item).

is valid (i.e., a green dashed line is present), releasing the **SHIFT** key will add the link to the annotation.

### Deleting an annotation item or a link

Items and links are deleted by initially preselecting them by hovering the mouse cursor over them. The preselected items are marked blue and preselected links yellow. A preselected link is removed by hitting **BACKSPACE** and a preselected item is deleted by hitting the **y** key. Deleting an item will also delete all links leading to and from it.

## 8.3 Configuring the EMU-webApp

This section will give an overview of how the `EMU-webApp` can be configured. The configuration of the `EMU-webApp` is stored in the `EMUwebAppConfig` section of the `_DBconfig.json` of an `emuDB` (see Appendix B.1.1 for details). This means that the `EMU-webApp` can be configured separately for every `emuDB`. Although it can be necessary for some advanced configuration options to manually edit the `_DBconfig.json` using a text editor (see Section 8.3.3), the most common configuration operations can be achieved using functions provided by the `emuR` package (see Section 8.3.1).

A central concept for configuring the `EMU-webApp` are so-called **perspectives**. Essentially, a **perspective** is an independent configuration of how the `EMU-webApp` displays a certain set of data. Having multiple **perspectives** allows the user to switch between different views of the data. This can be especially useful when dealing with complex annotations where only showing certain elements for certain labeling tasks can be beneficial. Figure 8.9 displays a screenshot of the **perspectives** side bar menu of the `EMU-webApp` which displays the three **perspectives** of the *ae* `emuDB`. The *default* perspective displays both the *Phonetic* and the *Tone* levels where as the *Phonetic-only* and the *Tone-only* only display these levels individually.

### 8.3.1 Basic configurations using `emuR`

R Example 8.3.1 shows how to create and load the demo data that will be used throughout the rest of this chapter.

#### R Example 8.3.1

```
# load package  
library(emuR)
```

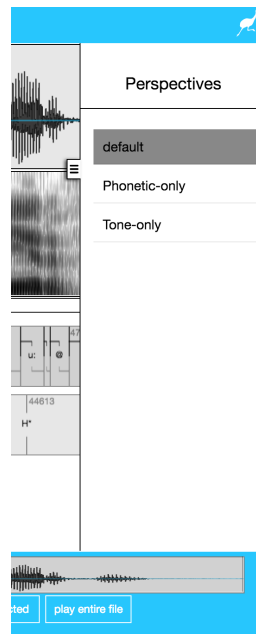

Figure 8.9: Screenshot of the hierarchy modal window of the EMU-webApp displaying an annotation item's context menu.

```
# create demo data in directory provided by tempdir()  
create_emuRdemoData(dir = tempdir())  
  
# create path to demo database  
path2ae = file.path(tempdir(), "emuR_demoData", "ae_emuDB")  
  
# load database  
ae = load_emuDB(path2ae, verbose = F)
```

As mentioned above, the EMU-webApp subdivides different ways to look at an emuDB into so-called **perspectives**. Users can switch between these **perspectives** in the web application. They contain, for example, information on what levels are displayed, which SSFF tracks are drawn. R Example 8.3.2 shows how the current **perspectives** can be listed using the `list_perspectives()` function.

### R Example 8.3.2

```
# list perspectives of ae emuDB  
list_perspectives(ae)
```

```
##           name signalCanvasesOrder levelCanvasesOrder
## 1      default          OSCI; SPEC      Phonetic; Tone
## 2 Phonetic-only          OSCI; SPEC              Phonetic
## 3      Tone-only          OSCI; SPEC              Tone
```

As it is sometimes necessary to add new or remove existing perspectives to or from a database, R Example 8.3.3 shows how this can be achieved using `emuR`'s `add/remove_perspective()` functions.

### R Example 8.3.3

```
# add new perspective to ae emuDB
add_perspective(ae,
               name = "tmpPersp")

# show added perspective
list_perspectives(ae)

##           name signalCanvasesOrder levelCanvasesOrder
## 1      default          OSCI; SPEC      Phonetic; Tone
## 2 Phonetic-only          OSCI; SPEC              Phonetic
## 3      Tone-only          OSCI; SPEC              Tone
## 4      tmpPersp          OSCI; SPEC

# remove newly added perspective
remove_perspective(ae,
                  name = "tmpPersp")
```

### 8.3.2 Signal canvas and level canvas order

As mentioned above, R Example 8.3.2 shows that the *ae* `emuDB` contains three perspectives. The first perspective (*default*) displays the oscillogram (`OSCI`) followed by the spectrogram (`SPEC`) in the signal canvas area (area 3 of Figure 8.1) and the *Phonetic* and *Tone* levels in the level canvas area (area 4 of Figure 8.1). It is worth noting that `OSCI` (oscillogram) and `SPEC` (spectrogram) are predefined signal tracks that are always available. This is indicated by the capital letters indicating that they are predefined constants. R Example 8.3.4 shows how the order of the signal canvases and level canvases can be changed using the `get/set_signalCanvasesOrder()` and `get/set_levelCanvasesOrder()`.



## R Example 8.3.4

```

# get order vector of signal canvases of default perspective
sco = get_signalCanvasesOrder(ae,
                              perspectiveName = "default")

# show sco vector
sco

## [1] "OSCI" "SPEC"

# reverse sco order
# using R's rev() function
scor = rev(sco)

# set order vector of signal canvases of default perspective
set_signalCanvasesOrder(ae,
                        perspectiveName = "default",
                        order = scor)

# set order vector of level canvases of default perspective
# to only display the "Tone" level
set_levelCanvasesOrder(ae,
                       perspectiveName = "default",
                       order = c("Tone"))

# list perspectives of ae emuDB
# to show changes
list_perspectives(ae)

##           name signalCanvasesOrder levelCanvasesOrder
## 1      default          SPEC; OSCI                Tone
## 2 Phonetic-only          OSCI; SPEC                Phonetic
## 3      Tone-only          OSCI; SPEC                Tone

```

After the changes made in R Example 8.3.4, the default perspective will show the spectrogram above the oscillogram in the signal canvas area and only the *Tone* level in the level canvas area. Only levels with time information are allowed to be displayed in the level canvas area, and the `set_levelCanvasesOrder()` will print an error if a level of type ITEM is added (see R Example 8.3.5).

## R Example 8.3.5

```
# set level canvas order where a
# level is passed into the order parameter
# that is not of type EVENT or SEGMENT
set_levelCanvasesOrder(ae,
                        perspectiveName = "default",
                        order = c("Syllable"))

## Error in set_levelCanvasesOrder(ae, perspectiveName = "default",
## order = c("Syllable")): levelDefinition with name 'Syllable' is not
## of type 'SEGMENT' or 'EVENT'
```

The same mechanism used above can also be used to display any SSFF track that is defined for the database by referencing its name. R Example 8.3.6 shows how the existing SSFF track called *fm* (containing formant values calculated by *wrassp*'s `forest()` function) can be added to the signal canvas area.

## R Example 8.3.6

```
# show currently available SSFF tracks
list_ssffTrackDefinitions(ae)

##   name columnName fileExtension
## 1  dft         dft           dft
## 2   fm         fm            fms

# re-set order vector of signal canvases of default perspective
# by appending the fm track
set_signalCanvasesOrder(ae,
                        perspectiveName = "default",
                        order = c(scor, "fm"))
```

A screenshot of the current display of the *default* perspective can be seen in Figure 8.10.

### 8.3.3 Advanced configurations made by editing the `_DBconfig.json`

Although the above configuration options cover the most common use cases, the EMU-webApp offers multiple other configuration options that are currently not configurable via functions provided by `emuR`. These advanced configuration options

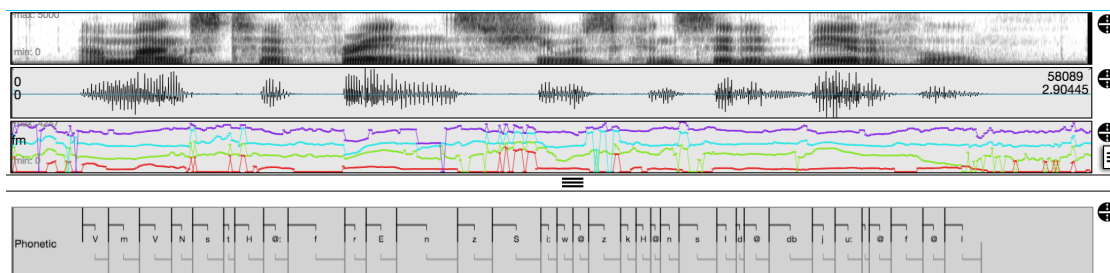

Figure 8.10: Screenshot of signal and level canvases displays of the EMU-webApp after the changes made in R Examples 8.3.4 and 8.3.6.

can currently only be achieved by manually editing the `_DBconfig.json` file using a text editor. As even the colors used in the EMU-webApp and every keyboard shortcut can be reconfigured, here we will focus on the more common advanced configuration options. A full list of the available configuration fields of the `EMUwebAppConfig` section of the `_DBconfig.json` including their meaning, can be found in Appendix B.1.1.

### Overlaying signal canvases

To save space it can be beneficial to overlay one or more signal tracks onto other signal canvases. This can be achieved by manually editing the `assign` array of the `EMUwebAppConfig:perspectives[persp_idx]:signalCanvases` field in the `_DBconfig.json`. Listing 8.1 shows an example configuration that overlays the `fm` track on the oscillogram where the `OSCI` string can be replaced by any other entry in the `EMUwebAppConfig:perspectives[persp_idx]:signalCanvases:order` array. Figure 8.11 displays a screenshot of such an overlay.

Listing 8.1: Overlay configuration of `fm` track over `OSCI`

```
...
"assign": [{
  "signalCanvasName": "OSCI",
  "ssffTrackName": "fm"
}],
...
```

### Frequency-aligned formant contours spectrogram overlay

The current mechanism for laying frequency-aligned formant contours over the spectrogram is to give the formant track the predefined name `FORMANTS`. If

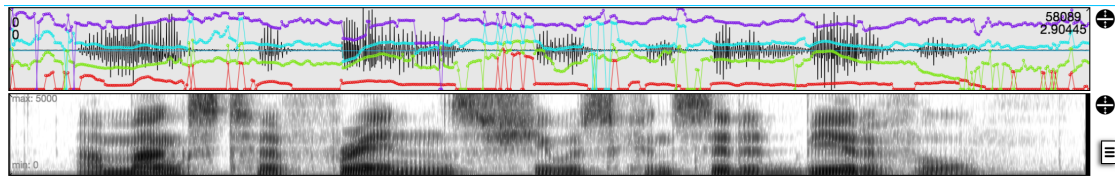

Figure 8.11: Screenshot of signal canvases display of the EMU-webApp after the changes made in R Examples 8.3.4 and 8.3.6.

the formant track is called *FORMANTS* and it is assigned to be laid over the spectrogram (see Listing 8.2) the EMU-webApp will frequency-align the contours to the current minimum and maximum spectrogram frequencies (see Figure 8.12).

Listing 8.2: Overlay configuration of FORMANTS track over SPEC

```

...
"assign": [ {
  "signalCanvasName": "SPEC",
  "ssffTrackName": "FORMANTS"
} ],
...

```

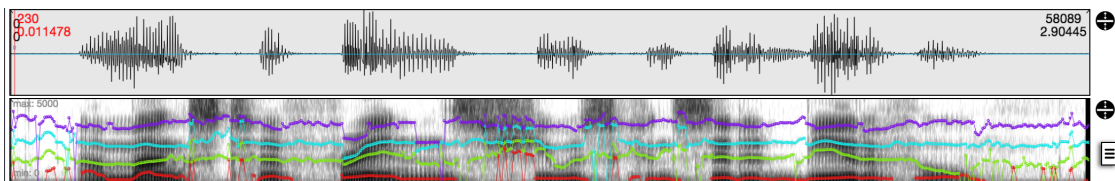

Figure 8.12: Screenshot of signal canvases area of the EMU-webApp displaying formant contours that are overlaid on the spectrogram and frequency-aligned.

### Correcting formants

The above configuration of the frequency-aligned formant contours will automatically allow the *FORMANTS* track to be manually corrected. Formants can be corrected by hitting the appropriate number key (1 = first formant, 2 = second formant, ...). Similar to boundaries and events, the mouse cursor will automatically be tracked in the SPEC canvas and the nearest formant value preselected. Holding down the SHIFT key moves the current formant value to the mouse position, hence allowing the contour to be redrawn and corrected.

### 8.3.4 2D canvas

The EMU-webApp has an additional canvas which can be configured to display two-dimensional data. Figure 8.13 shows a screenshot of the 2D canvas, which is placed in the bottom right hand corner of the level canvas area of the web application. The screenshot shows data representing EMA sensor positions on the mid sagittal plane. Listings 8.3 shows how the 2D canvas can be configured. Essentially, every drawn dot is configured by assigning a column in an SSFF track that specifies the X values and an additional column that specifies the Y values.

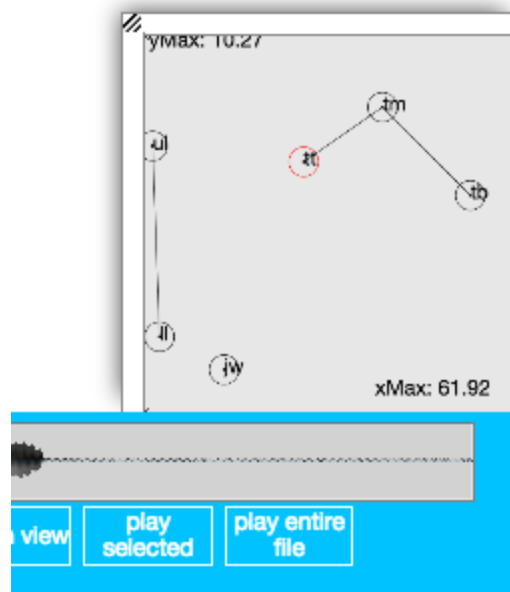

Figure 8.13: Screenshot of 2D canvas of the EMU-webApp displaying two-dimensional EMA data.

Listing 8.3: Configuration of the 2D canvas to display EMA data.

```

...
"twoDimCanvases": {
  "order": ["DOTS"],
  "twoDimDrawingDefinitions": [{
    "name": "DOTS",
    "dots": [{
      "name": "tt",
      "xSsffTrack": "tt_posy",
      "xContourNr": 0,
      "ySsffTrack": "tt_posz",

```

```

        "yContourNr": 0,
        "color": "rgb(255,0,0)"
    },
    ...
    "connectLines": [{
        "fromDot": "tt",
        "toDot": "tm",
        "color": "rgb(0,0,0)"
    }],
    ...

```

## EPG

The 2D canvas of the `EMU-webApp` can also be configured to display EPG data as displayed in Figure 8.14. The SSFF file containing the EPG data has to be formatted in a specific way. The format is a set of eight bytes per point in time, where each byte represents a row of electrodes on the artificial palate. Each binary bit value per byte indicates whether one of the eight sensors is activated or not (i.e., tongue contact was measured). If data in this format and an SSFF track with the predefined name *EPG* referencing the SSFF files are present, the 2D canvas can be configured to display this data by adding the *EPG* to the `twoDimCanvases:order` array as shown in Listing 8.4.

Listing 8.4: Configuration of the 2D canvas to display EPG data

```

"twoDimCanvases": {
    "order": ["EPG"]
}

```

## EMA gestural landmark recognition

The `EMU-webApp` can also be configured to semi-automatically detect gestural landmarks of EMA contours. The functions implemented in the `EMU-webApp` are based on various Matlab scripts by Phil Hoole. For a description of which gestural landmarks are detected and how these are detected, see Bombien (2011) page 61 ff.

Compared to the above configurations, configuring the `EMU-webApp` to semi-automatically detect gestural landmarks of EMA contours is done as part of the level definition's configuration entries of the `_DBconfig.json`. Listing 8.5 shows the `anagestConfig` entry, which configures the *tongueTipGestures* event level for this purpose. Within the web application this level has to be preselected by the user and a region containing a gesture in the SSFF track selected (left click and

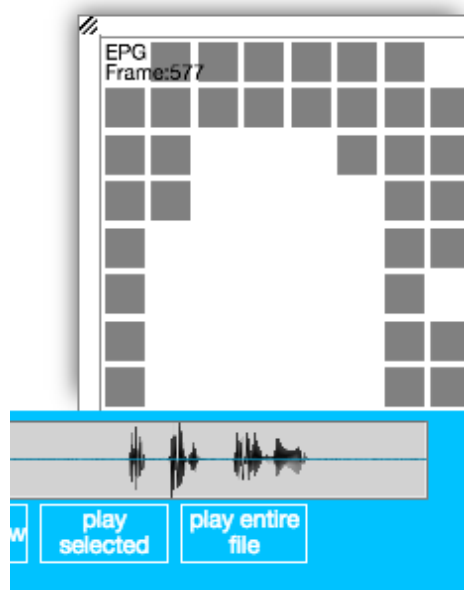

Figure 8.14: Screenshot of 2D canvas of the EMU-webApp displaying EPG palate traces.

drag). Hitting the ENTER/RETURN key then executes the semi-automatic gestural landmark recognition functions. If multiple candidates are recognized for certain landmarks, the user will be prompted to select the appropriate landmark.

Listing 8.5: EMA gestural landmark recognition configuration for the *tongueTipGestures* event level.

```

...
"levelDefinitions": [{
  {
    "name": "tongueTipGestures",
    "type": "EVENT",
    "attributeDefinitions": [{
      "name": "tongueTipGestures",
      "type": "STRING"
    }],
    "anagestConfig": {
      "verticalPosSsffTrackName": "tt_posz",
      "velocitySsffTrackName": "t_tipTV",
      "autoLinkLevelName": "ORT",
      "multiplicationFactor": 1,
      "threshold": 0.2,

```

```
        "gestureOnOffsetLabels": ["gon", "goff"]
        ,
        "maxVelocityOnOffsetLabels": ["von", "
        voff"],
        "constrictionPlateauBeginEndLabels": ["
        pon", "poff"],
        "maxConstrictionLabel": "mon"
    }
    ...
```

The user will be prompted to select an annotation item of the level specified in `anagestConfig:autoLinkLevelName` once the gestural landmarks are recognized. The `EMU-webApp` then automatically links all gestural landmark events to that item.

## 8.4 Conclusion

This chapter provided an overview of the `EMU-webApp` by showing the main layout and configuration options and how its labeling mechanics work. To our knowledge, the `EMU-webApp` is the first client-side web-based annotation tool that is this feature rich. Being completely web-based not only allows it to be used within the context of the EMU-SDMS but also allows it to connect to any web server that implements the `EMU-webApp-websocket-protocol` (see Appendix C for details). This feature is currently being utilized, for example, by the `IPS-EMUprot-nodeWSserver.js` server side software package (see <https://github.com/IPS-LMU/IPS-EMUprot-nodeWSserver>), which allows `emuDBs` to be served to any number of clients for collaborative annotation efforts. Further, by using the URL Parameters (see Chapter 12 for details) the web application can also be used to display annotation data that is hosted on any web server <sup>4</sup>. Because of these features, we feel the `EMU-webApp` is a valuable contribution to the speech and spoken language software tool landscape.

---

<sup>4</sup>See the BAS CLARIN Repository for a further example of an application using the `EMU-webApp-websocket-protocol` to display repository data in the `EMU-webApp`. See the BAS Web Services for an example of an application that creates links that utilize the URL parameters.



## Part III

Main emuR function and object  
index

# Chapter 9

## emuR - package functions

This chapter gives an overview of the essential functions and central objects provided by the `emuR` package. It is not meant as a comprehensive list of every function and object provided by `emuR`, but rather tries to group the essential functions into meaningful categories for easier navigation. The categories presented in this chapter are:

- Import and conversion routines (Section 9.1),
- `emuDB` interaction and configuration routines (Section 9.2),
- `EMU-webApp` configuration routines (Section 9.3),
- Data extraction routines (Section 9.4),
- Central objects in `emuR` (Section 9.5), and
- Export routines (Section 9.6).

If a comprehensive list of every function and object provided by the `emuR` package is required, R's `help()` function (see R Example 9.0.1) can be used.

### R Example 9.0.1

```
help(package="emuR")
```

## 9.1 Import and conversion routines

As most people that are starting to use the EMU-SDMS will probably already have some form of annotated data, we will first show how to convert existing data to the `emuDB` format. For a guide to creating an `emuDB` from scratch and for information about this format see Chapter 4.

### 9.1.1 Legacy EMU databases

For people transitioning to `emuR` from the legacy EMU system, `emuR` provides a function for converting existing legacy EMU databases to the new `emuDB` format. R Example 9.1.1 shows how to convert a legacy database that is part of the demo data provided by the `emuR` package.

#### R Example 9.1.1

```
# load the package
library(emuR)

# create demo data in directory provided by the tempdir() function
create_emuRdemoData(dir = tempdir())

# get the path to a .tpl file of
# a legacy EMU database that is part of the demo data
tplPath = file.path(tempdir(),
                    "emuR_demoData",
                    "legacy_ae",
                    "ae.tpl")

# convert this legacy EMU database to the emuDB format
convert_legacyEmuDB(emuTplPath = tplPath, targetDir = tempdir())
```

This will create a new `emuDB` in a temporary directory, provided by R's `tempdir()` function, containing all the information specified in the `.tpl` file. The name of the new `emuDB` is the same as the basename of the `.tpl` file from which it was generated. In other words, if the template file of the legacy EMU database has path A and the directory to which the converted database is to be written has path B, then `convert_legacyEmuDB(emuTplPath = "A", targetdir = "B")` will create an `emuDB` directory in B from the information stored in A.

### 9.1.2 TextGrid collections

A further function provided is the `convert_TextGridCollection()` function. This function converts an existing `.TextGrid` and `.wav` file collection to the `emuDB` format. In order to pair the correct files together the `.TextGrid` files and the `.wav` files must have the same name (i.e., file name without extension). A further restriction is that the tiers contained within all the `.TextGrid` files have to be equal in name and type (equal subsets can be chosen using the `tierNames` argument of the function). For example, if all `.TextGrid` files contain the tiers `Syl`:

`IntervalTier`, `Phonetic`: `IntervalTier` and `Tone`: `TextTier` the conversion will work. However, if a single `.TextGrid` of the collection has the additional tier `Word`: `IntervalTier` the conversion will fail, although it can be made to work by specifying the equal tier subset `equalSubset = c('Syl', 'Phonetic', 'Tone')` and passing it into the function argument `convert_TextGridCollection(..., tierNames = equalSubset, ...)`. R Example 9.1.2 shows how to convert a `TextGrid` collection to the `emuDB` format.

### R Example 9.1.2

```
# get the path to a directory containing
# .wav & .TextGrid files that is part of the demo data
path2directory = file.path(tempdir(),
                           "emuR_demoData",
                           "TextGrid_collection")

# convert this TextGridCollection to the emuDB format
convert_TextGridCollection(path2directory, dbName = "myTGcolDB",
                           targetDir = tempdir())
```

R Example 9.1.2 will create a new `emuDB` in the directory `tempdir()` called `myTGcolDB`. The `emuDB` will contain all the tier information from the `.TextGrid` files but will not contain hierarchical information, as `.TextGrid` files do not contain any linking information. It is worth noting that it is possible to semi-automatically generate links between time-bearing levels using the `autobuild_linkFromTimes()` function. An example of this was given in Chapter 2. R Example 9.1.2 creates a new `emuDB` in the directory `tempdir()` called `myTGcolDB`. The `emuDB` contains all the tier information from the `.TextGrid` files no hierarchical information, as `.TextGrid` files do not contain any linking information. Further, it is possible to semi-automatically generate links between time-bearing levels using the `autobuild_linkFromTimes()` function. An example of this was given in Chapter 2.

### 9.1.3 BPF collections

Similar to the `convert_TextGridCollection()` function, the `emuR` package also provides a function for converting file collections consisting of BAS Partitur Format (BPF) and `.wav` files to the `emuDB` format. R Example 9.1.3 shows how this can be achieved.

**R Example 9.1.3**

```
# get the path to a directory containing
# .wav & .par files that is part of the demo data
path2directory = file.path(tempdir(),
                           "emuR_demoData",
                           "BPF_collection")

# convert this BPFCollection to the emuDB format
convert_BPFCollection(path2directory, dbName = 'myBPF-DB',
                      targetDir = tempdir(), verbose = F)
```

As the BPF format also permits annotation items to be linked to one another, this conversion function can optionally preserve this hierarchical information by specifying the `refLevel` argument.

**9.1.4 txt collections**

A further conversion routine provided by the `emuR` package is the `convert_txtCollection()` function. As with other file collection conversion functions, it converts file pair collections but this time consisting of plain text `.txt` and `.wav` files to the `emuDB` format. Compared to other conversion routines it behaves slightly differently, as unformatted plain text files do not contain any time information. It therefore places all the annotations of a single `.txt` file into a single timeless annotation item on a level of type `ITEM` called *bundle*.

**R Example 9.1.4**

```
# get the path to a directory containing .wav & .par
# files that is part of the demo data
path2directory = file.path(tempdir(),
                           "emuR_demoData",
                           "txt_collection")

# convert this txtCollection to the emuDB format
convert_txtCollection(sourceDir = path2directory,
                     dbName = "txtCol",
                     targetDir = tempdir(),
                     attributeDefinitionName = "transcription",
                     verbose = F)
```

Using this conversion routine creates a bare-bone, single route node `emuDB` which either can be further manually annotated or automatically hierarchically annotated using the `runBASwebservice.*`<sup>1</sup> functions of `emuR`. It is worth noting that these functions are already part of the `emuR` package; however, they are still considered to have a beta status which is why they are omitted from this documentation. In future versions of this documentation a section or chapter will be dedicated to using the BAS Webservices (Kisler et al., 2012) to automatically generate a hierarchical annotation structure for an entire `emuDB`.

## 9.2 emuDB interaction and configuration routines

This section provides a tabular overview of all the `emuDB` interaction routines provided by the `emuR` package and also provides a short description of each function or group of functions.

Function(s)	Description
<code>add/list/remove_attrDefLabelGroup()</code>	Add / list / remove label group to / of / from <code>attributeDefinition</code> of <code>emuDB</code>
<code>add/list/remove_labelGroup()</code>	Add / list / remove global label group to / of / from <code>emuDB</code>
<code>add/list/remove_levelDefinition()</code>	Add / list / remove level definition to / of / from <code>emuDB</code>
<code>add/list/remove_linkDefinition()</code>	Add / list / remove link definition to / of / from <code>emuDB</code>
<code>add/list/remove_ssffTrackDefinition()</code>	Add / list / remove SSFF track definition to / of / from <code>emuDB</code>
<code>add/list/rename/remove_attributeDefinition()</code>	Add / list / rename / remove attribute definition to / of / from <code>emuDB</code>
<code>add_files()</code>	Add files to <code>emuDB</code>
<code>autobuild_linkFromTimes()</code>	Autobuild links between two levels using their time information <code>emuDB</code>
<code>create_emuDB()</code>	Create empty <code>emuDB</code>
<code>duplicate_level()</code>	Duplicate level
<code>import_mediaFiles()</code>	Import media files to <code>emuDB</code>
<code>list_bundles()</code>	List bundles of <code>emuDB</code>
<code>list_files()</code>	List files of <code>emuDB</code>
<code>list_sessions()</code>	List sessions of <code>emuDB</code>
<code>load_emuDB()</code>	Load <code>emuDB</code>

<sup>1</sup>Functions contributed by Nina Pörner.

Function(s)	Description
<code>replace_itemLabels()</code>	Replace item labels
<code>set/get/remove_legalLabels()</code>	Set / get / remove legal labels of attribute definition of <code>emuDB</code>
<code>rename_emuDB()</code>	Rename <code>emuDB</code>

Table 9.1: Overview of the `emuDB` interaction routines provided by `emuR`.

### 9.3 EMU-webApp configuration routines

This section provides a tabular overview of all the `EMU-webApp` configuration routines provided by the `emuR` package and also provides a short description of each function or group of functions. See Chapter 8 for examples of how to use these functions.

Function(s)	Description
<code>add/list/remove_perspective()</code>	Add / list / remove perspective to / of / from <code>emuDB</code>
<code>set/get_levelCanvasesOrder()</code>	Set / get level canvases order for <code>EMU-webApp</code> of <code>emuDB</code>
<code>set/get_signalCanvasesOrder()</code>	Set / get signal canvases order for <code>EMU-webApp</code> of <code>emuDB</code>

Table 9.2: Overview of the `EMU-webApp` configuration functions provided by `emuR`.

It is worth noting that the legal labels configuration of the `emuDB` configuration will also affect how the `EMU-webApp` behaves, as it will not permit any other labels to be entered except those defined as legal labels.

### 9.4 Data extraction routines

This section provides a tabular overview of all the data extraction routines provided by the `emuR` package and also provides a short description of each function or group of functions. See Chapter 5 and Chapter 6 for multiple examples of how the various data extraction routines can be used.

Function(s)	Description
<code>query()</code>	Query <code>emuDB</code>
<code>requery_hier()</code>	Requery hierarchical context of a segment list in an <code>emuDB</code>
<code>requery_seq()</code>	Requery sequential context of segment list in an <code>emuDB</code>
<code>get_trackdata()</code>	Get trackdata from loaded <code>emuDB</code>

Table 9.3: Overview of the data extraction functions provided by `emuR`.

An overview of how the various data extraction functions in the `emuR` package interact is displayed in Figure 9.1. It is an updated version of a figure presented in Harrington (2010) on page 121 that additionally shows the output type of various post-processing functions (e.g., `dcut()`).

## 9.5 Central objects

This section provides a tabular overview of the central objects provided by the `emuR` package and also provides a short description of each object. See Chapter 5 and 6 for examples of functions returning these objects and how they can be used.

Object	Description
<code>emuRsegs</code>	A <code>emuR</code> segment list is a list of segment descriptions. Each segment descriptions describes a sequence of annotation items. The list is usually a result of an <code>emuDB</code> query using the <code>query()</code> function.
<code>trackdata</code>	A track data object is the result of <code>get_trackdata()</code> and usually contains the extracted signal data tracks belonging to segments of a segment list.



Object	Description
<code>emuRtrackdata</code>	A <code>emuR</code> track data object is the result of <code>get_trackdata()</code> if the <code>resultType</code> parameter is set to <code>emuRtrackdata</code> or the result of an explicit call to <code>create_emuRtrackdata</code> . Compared to the <code>trackdata</code> object it is a sub-class of a <code>data.table/data.frame</code> which is meant to ease integration with other packages for further processing. It can be viewed as an amalgamation of an <code>emuRsegs</code> and a <code>trackdata</code> object as it contains the information stored in both objects (see also <code>?create_emuRtrackdata()</code> ).

Table 9.4: Overview of the central objects of the `emuR` package.

## 9.6 Export routines

Although associated with data loss, the `emuR` package provides an export routine to the common TextGrid collection format called `export_TextGridCollection()`. While exporting is sometimes unavoidable, it is essential that users are aware that exporting to other formats which do not support or only partially support hierarchical annotations structures will lead to the loss of the explicit linking information. Although the `autobuild_linkFromTimes()` can partially recreate some of the hierarchical structure, it is advised that the export routine be used with extreme caution. R Example 9.6.1 shows how `export_TextGridCollection()` can be used to export the levels *Text*, *Syllable* and *Phonetic* of the *ae* demo `emuDB` to a TextGrid collection. Figure 9.2 show the content of the created `msajc003.TextGrid` file as displayed by Praat's "Draw visible sound and Textgrid..." procedure.

### R Example 9.6.1

```
# get the path to "ae" emuDB
path2ae = file.path(tempdir(), "emuR_demoData", "ae_emuDB")

# load "ae" emuDB
```

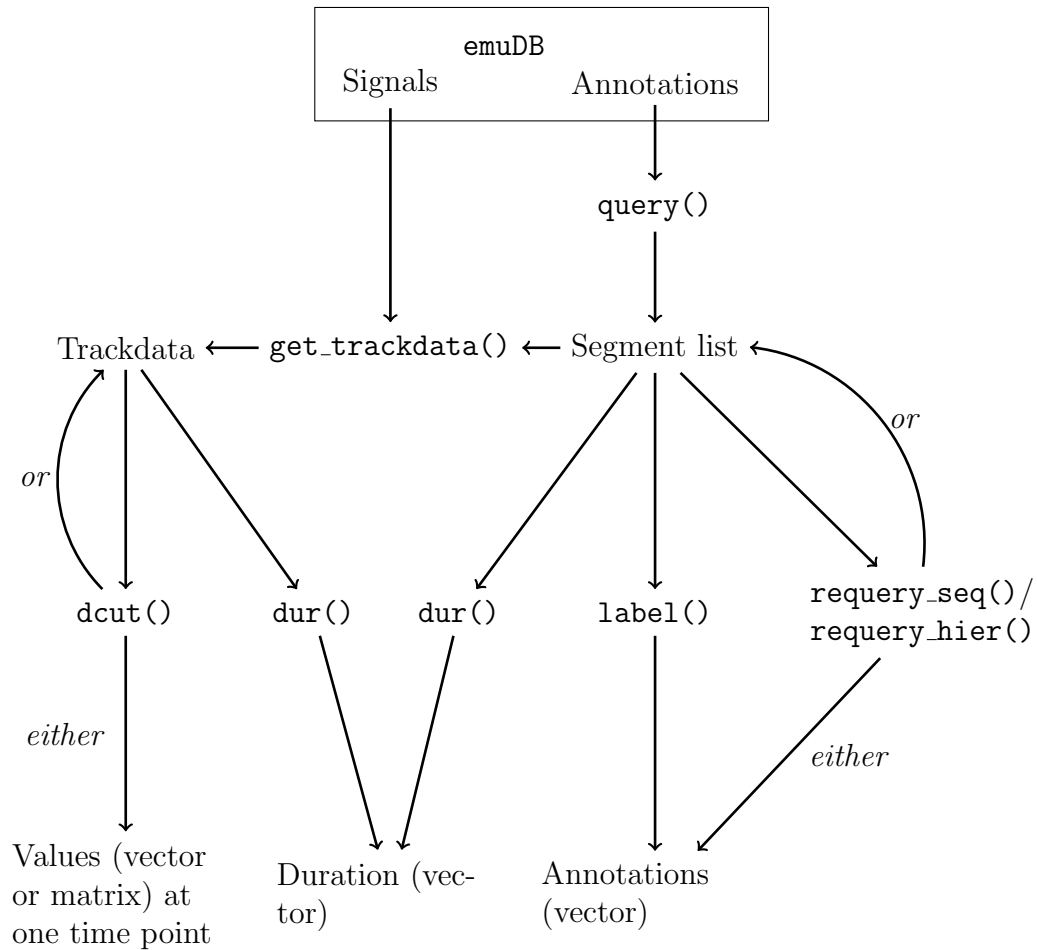

Figure 9.1: Relationship between various key functions in `emuR` and their output. Figure is an updated version of Figure 5.7 in Harrington (2010) on page 121.

```
ae = load_emuDB(path2ae)

# export the levels "Text", "Syllable"
# and "Phonetic" to a TextGrid collection
export_TextGridCollection(ae,
                          targetDir = tempdir(),
                          attributeDefinitionNames = c("Text",
                                                         "Syllable",
                                                         "Phonetic"))
```

Depending on user requirements, additional export routines might be added to the `emuR` in the future.

## 9.7 Conclusion

This chapter provided an overview of the essential functions and central objects, grouped into meaningful categories, provided by the `emuR` package. It is meant as a quick reference for the user to quickly find functions she or he is interested in.

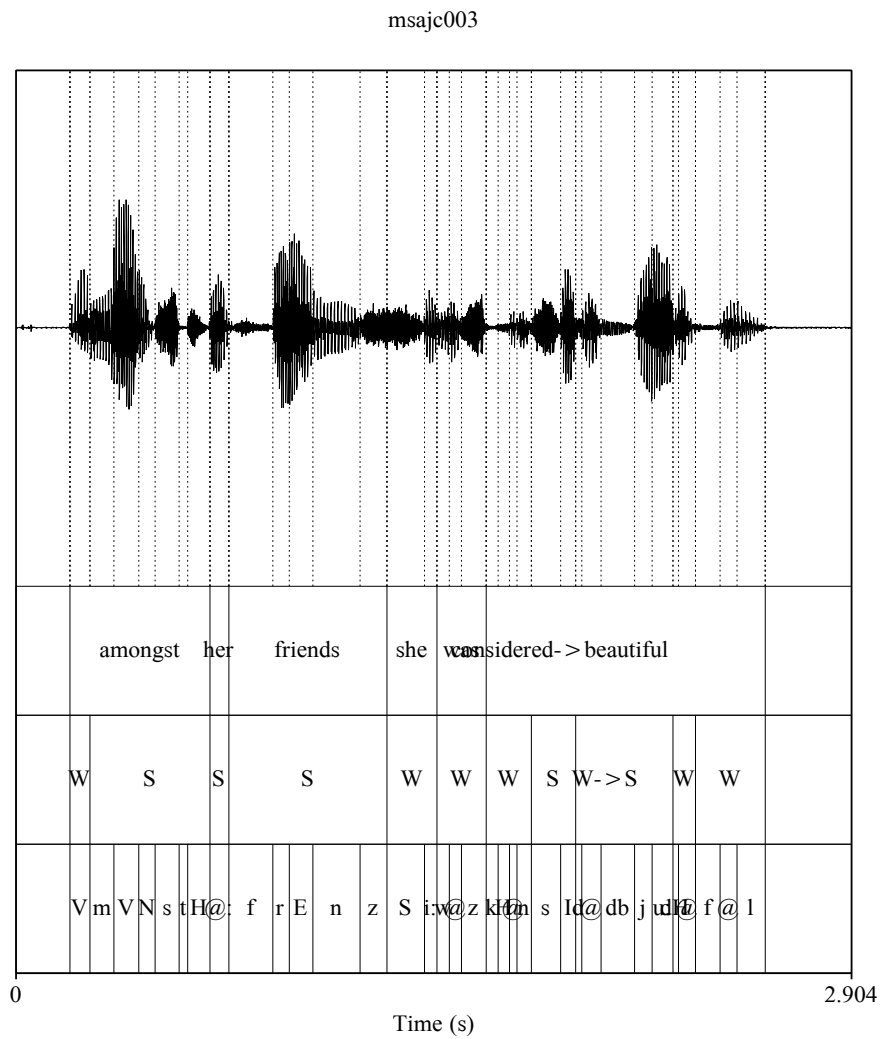

Figure 9.2: TextGrid annotation generated by the `export_TextGridCollection()` function containing the tiers (from top to bottom): *Text*, *Syllable*, *Phonetic*.

**Part IV**  
**Implementation**

# Chapter 10

## Implementation of the query system<sup>\*</sup>

Compatibly with other query languages, the EQL defines the user a front-end interface and infers the query's results from its semantics. However, a query language does not define any data structures or specify how the query engine is to be implemented. As mentioned in Chapter 1, a major user requirement was database portability, simple package installation, tolerable run times over complex queries, and a system that did not rely on external software at runtime. The only available back-end implementation that met those needs and was also available as an R package at the time was (R)SQLite (Hipp and Kennedy, 2007; Wickham et al., 2014). As (R)SQLite is a relational database management system, **emuR**'s query system could not be implemented so as to use directly the primary data sources of an **emuDB**, that is, the JSON files described in Chapter 4. A syncing mechanism that maps the primary data sources to a relational form for querying purposes had to be implemented. This relational form is referred to as the **emuDBcache** in the context of an **emuDB**. The data sources are synchronized while an **emuDB** is being loaded and when changes are made to the annotation files. To address load time issues, we implemented a file check-sum mechanism which only reloads and synchronizes annotation files that have a changed MD5-sum (Rivest, 1992). Figure 10.1 is a schematic representation of how the various **emuDB** interaction functions interact with either the file representation or the relational cache.

Despite the disadvantages of cache invalidation problems, there are several advantages to having an object relational mapping between the JSON-based annotation structure of an **emuDB** and a relation table representation. One is that the user still has full access to the files within the directory structure of the **emuDB**. This means that external tools can be used to script, manipulate or simply interact

---

<sup>\*</sup>Sections of this chapter have been published in Winkelmann et al. (2017).

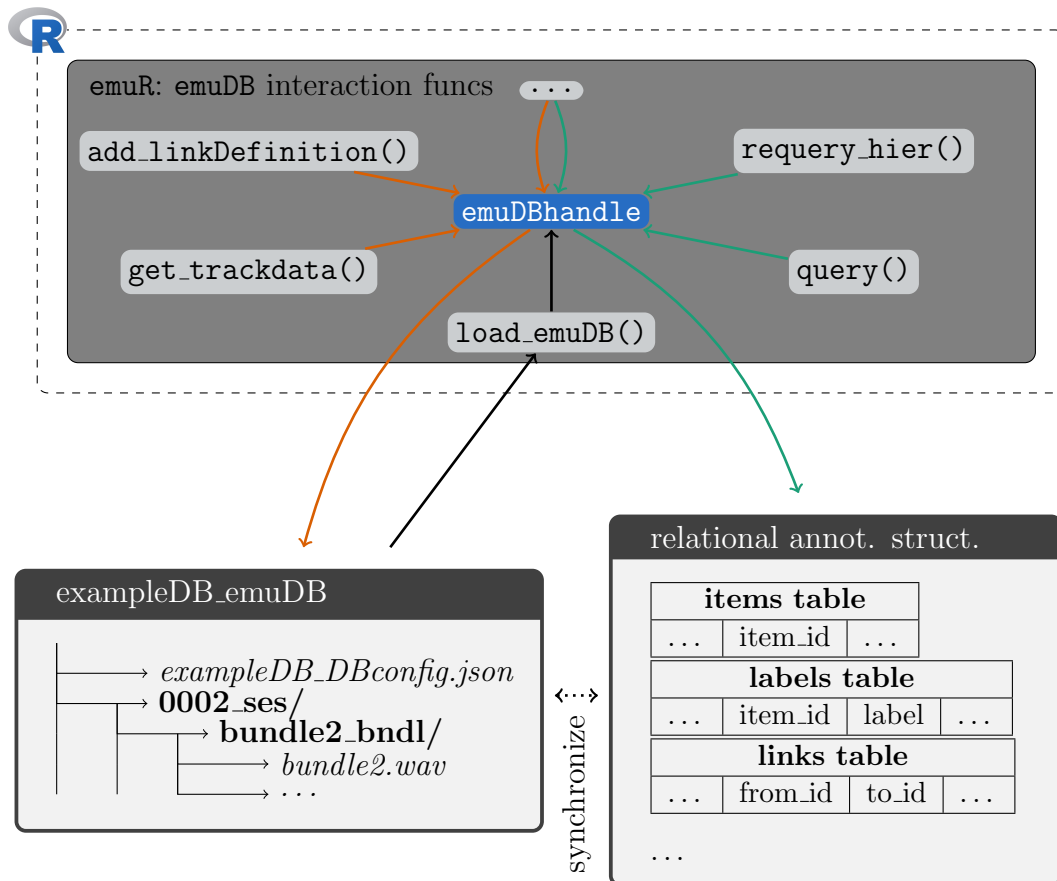

Figure 10.1: Schematic architecture of `emuDB` interaction functions of the `emuR` package. Orange paths show examples of functions interacting with the files of the `emuDB`, while green paths show functions accessing the relational annotation structure. Actions like saving a changed annotation using the `EMU-webApp` first save the `_annot.json` to disk then update the relational annotation structure.





6. **links**: containing all links between annotation items of **emuDB** (columns: **db\_uuid**, **session**, **bundle**, **from\_id**, **to\_id**, **label**).

<b>db_uuid</b>	<b>session</b>	<b>bundle</b>	<b>from_id</b>	<b>to_id</b>	<b>label</b>
0fc61...	0000	msajc003	8	7	NA
...	...	...	...	...	...

While performing a query the engine uses an aggregate key to address every annotation item and its labels (**db\_uuid**, **session**, **bundle**, **item\_id**) and a similar aggregate key to dereference the links (**db\_uuid**, **session**, **bundle**, **from\_id** / **to\_id**) which connect items. As the records in relational tables are not intrinsically ordered a further aggregate key is used to address the annotation item via its index and level (**uuid**, **session**, **bundle**, **level** / **seq\_idx**). This is used, for example, during sequential queries to provide an ordering of the individual annotation items. It is worth noting that a plethora of other tables are created at query time to store various temporary results of a query. However, these tables are created as temporary tables during the query and are deleted on completion which means they are not permanently stored in the **emuDBcache**.

## 10.1 Query expression parser

The query engine parses an EQL query expression while simultaneously executing partial query expressions. This ad-hoc string evaluation parsing strategy is different from multiple other query systems which incorporate a query planner stage to pre-parse and optimize the query execution stage (e.g., Hipp and Kennedy, 2007; Conway et al., 2016). Although no pre-optimization can be performed, this strategy simplifies the execution of a query as it follows a constant heuristic evaluation strategy. This section describes this heuristic evaluation and parsing strategy based on the EQL expression `[[Syllable == W -> Syllable == W] ^ [Phoneme == @ -> #Phoneme == s]]`.

The main strategy of the query expression parser is to recursively parse and split an EQL expression into left and right sub-expressions until a so-called Simple Query (SQ) term is found and can be executed (see EBNF in Appendix D for more information on the elements comprising the EQL). This is done by determining the operator which is the first to be evaluated on the current expression. This operator is determined by the sub-expression grouping provided by the bracketing. Each sub-expression is then considered to be a fully valid EQL expression and once again parsed. Figure 10.2, which is split into seven stages (marked S1-S7), shows the example EQL expression being parsed (S1-S3) and the resulting items being merged to meet the requirements of the individual operator (S4-S6) of the original query. S1 to S3 show the splitting operator character (e.g., `->` in purple) which

splits the expression into a **left** (green) and **right** (orange) sub-expression.

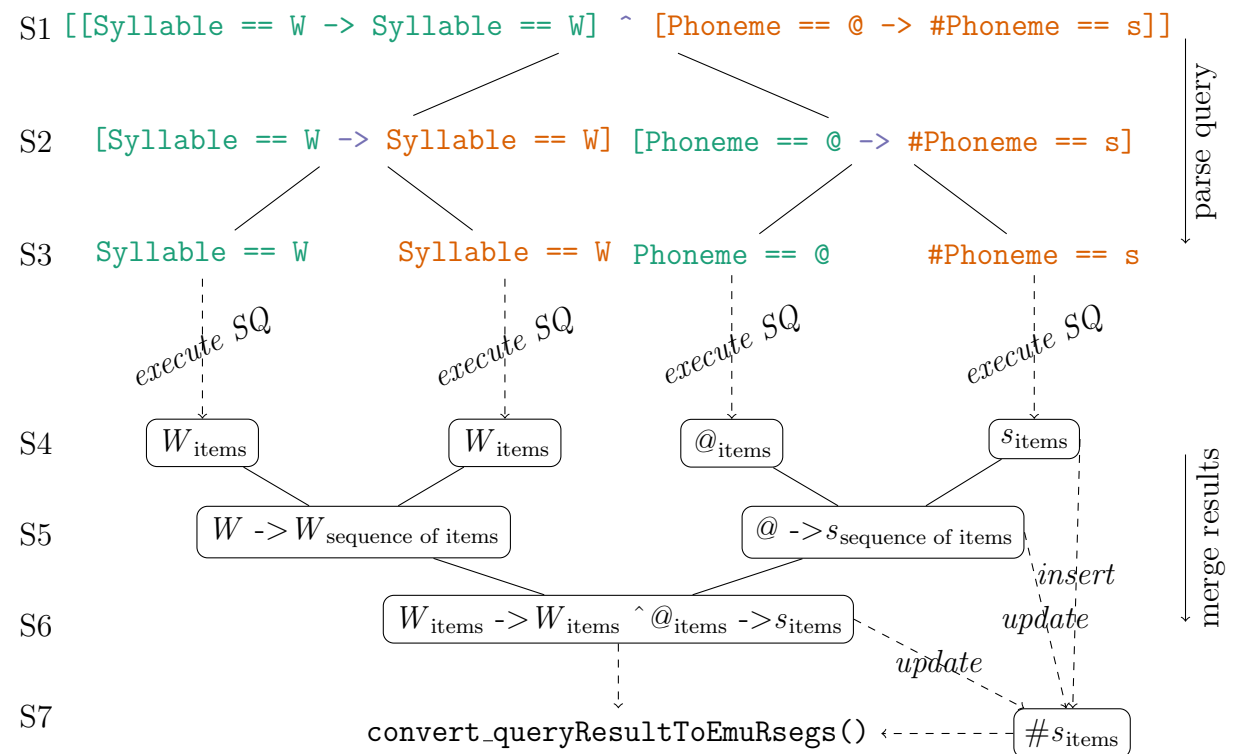

Figure 10.2: Example of how the query expression parser parses and evaluates an EQL expression and merges the result according to the respective EQL operators.

The result modifier symbol (`#`) is noteworthy for its extra treatment by the query engine as it places an exact copy of the items marked by it into its own intermediary result storage (see `#s_items` node on S7 in Figure 10.2). After performing the database operations necessary to do the various merging operation which are performed on the intermediary results, this storage is updated by removing items from it that are no longer present due to the merging operation. As a final step, the query engine evaluates if there are items present in the intermediary result storage created by the presence of the result modifier symbol. If so, these items are used to create an `emuRsegs` object by deriving the time information and extracting the necessary information from the intermediate result storage. If no items are present in the result modifier storage, the query engine uses the items provided by the final merging procedure in S3 instead (which is not the case in the example used in Figure 10.2).

A detailed description of how this query expression parser functions is pre-

sented in a pseudo code representation in Algorithms 1 and 2<sup>1</sup>. For simplicity, this representation ignores the treatment of the result modifier symbol (#) and focuses on the parsing and evaluation strategy of the query expression parser. As stated previously, the presence of the result modifier before an SQ triggers the query engine to place a copy of the result of that SQ into an additional result table, which is then updated throughout the rest of the query. The starting point for every query is the `query()` function (see line 64 in Algorithm 2). This function places the filtered items, links and labels entries that are relevant for the current query into temporary tables. Depending on which query terms and operators are found, the EQL query engine uses the various sub-routines displayed in Algorithms 1 and 2 to parse and evaluate the EQL expression.

## 10.2 Redundant links

A noteworthy difference between the legacy and the new EMU system is how hierarchies are stored. The legacy system stored the linking information of a hierarchy in so-called hierarchical label files, which were plain text files that used the `.h1b` extensions. Within the label files this information was stored in space/blank separated lines:

```
111 139 140 141 173 174 175 185
112 142 143 176 177
113 144 145 146 178 179 180
114 147
115 148
116 149,
```

where the **first number** (green) of each line was the parent's ID and the **following numbers** (orange) indicated the annotation items the parent was linked to. However, it was not just links to the items on the child level that were stored in each line. Rather, a link to all children of all levels below the parent level was stored for each parent item. This was likely due to performance benefits in parsing and mapping onto the internal structures used by the legacy query engine. A schematic representation of this form of linking is displayed in Figure 10.3A. As these redundant links are prone to errors while updating the data model and lead to a convoluted annotation structure models (see excessive use of dashed lines in Figure 10.3A), we chose to eliminate them and opted for the cleaner, non-redundant representation displayed in Figure 10.3B. Although this led to a more

---

<sup>1</sup>The R code that implements this pseudo code can be found here: <https://github.com/IPS-LMU/emuR/blob/master/R/emuR-query.database.R>.

**Algorithm 1** Pseudo Code for Query Engine Algorithm - Part 1

---

```

1: function QUERY_DBEQLFUNCQ(query)
2:   place all parent level items into tmp table
3:   place all child level items into tmp table
4:   QUERY_DBHIER(parentItemsTable, childItemsTable)
5:   if Start End or Medial query then
6:     extract parent items and place in tmp result table
7:   else
8:     extract child items and place in tmp result table
9:   end if
10: end function
11: function QUERY_DBEQLLABELQ(query)
12:   splitLabels  $\leftarrow$  split labels at |
13:   for all splitLabels do
14:     if operator is ==, = or != then
15:       extract items that contain labels which are equal or unequal to label
16:     else if operator is = or !~ then
17:       extract items that contain labels that match or don't match RegEx
18:     end if
19:     merge results in tmp table
20:   end for
21: end function
22: function QUERY_DBEQLSQ(query)
23:   if query contains round brackets then
24:     QUERY_DBEQLFUNCQ(query)
25:   else
26:     QUERY_DBEQLLABELQ(query)
27:   end if
28: end function
29: function QUERY_DBEQLCONJQ(query)
30:   splitItems  $\leftarrow$  split query at &
31:   for all splitItems do
32:     QUERY_DBEQLSQ(splitItems)
33:     merge results in tmp table
34:   end for
35: end function
36: function QUERY_DBHIER(leftTable, rightTable)
37:   hp  $\leftarrow$  extract hier. paths conn. leftTable and rightTable level names
38:   for all child and parent level pairs in hp do
39:     connect child and parent items using links table
40:     reduce to min seq. idx (left side of trapeze)
41:     and to max seq. idx (right side of trapeze)
42:   end for
43: end function

```

---

---

**Algorithm 2** Pseudo Code for Query Engine Algorithm - Part 2
 

---

```

44: function QUERY_DBEQLINBRACKET(query)
45:   qTrim ← remove outer square brackets
46:   leftQuery, rightQuery ← split qTrim at cur. operator
47:   QUERY_DATABASEWITHSQL(leftQuery)           ▷ recursive part of query
48:   QUERY_DATABASEWITHSQL(rightQuery)          ▷ recursive part of query
49:   if cur. operator is domination operator then
50:     QUERY_DBHIER(leftQueryResultTable, rightQueryResultTable)
51:   else if cur. operator is seq. operator then
52:     find seq. of leftQueryResultTable and rightQueryResultTable items
53:   else
54:     QUERY_DATABASEWITHSQL(qTrim)
55:   end if
56: end function
57: function QUERY_DBWITHSQL(query)
58:   if query isn't wrapped in brackets then
59:     QUERY_DBEQLCONJQ(query)
60:   else
61:     QUERY_DBEQLINBRACKET(query)
62:   end if
63: end function
64: function QUERY(query, sesPattern, bndlPattern)
65:   filter items in relational tables by sesPattern
66:   filter items in relational tables by bndlPattern
67:   QUERY_DBWITHSQL(query)
68:   seglst ← CONVERT_QUERYRESULTTOEMURSEGS(tmpResultTableName)
69:   return seglst
70: end function

```

---

complex query parser engine for hierarchical queries and functions, we feel it is a cleaner, more accurate and more robust data representation.

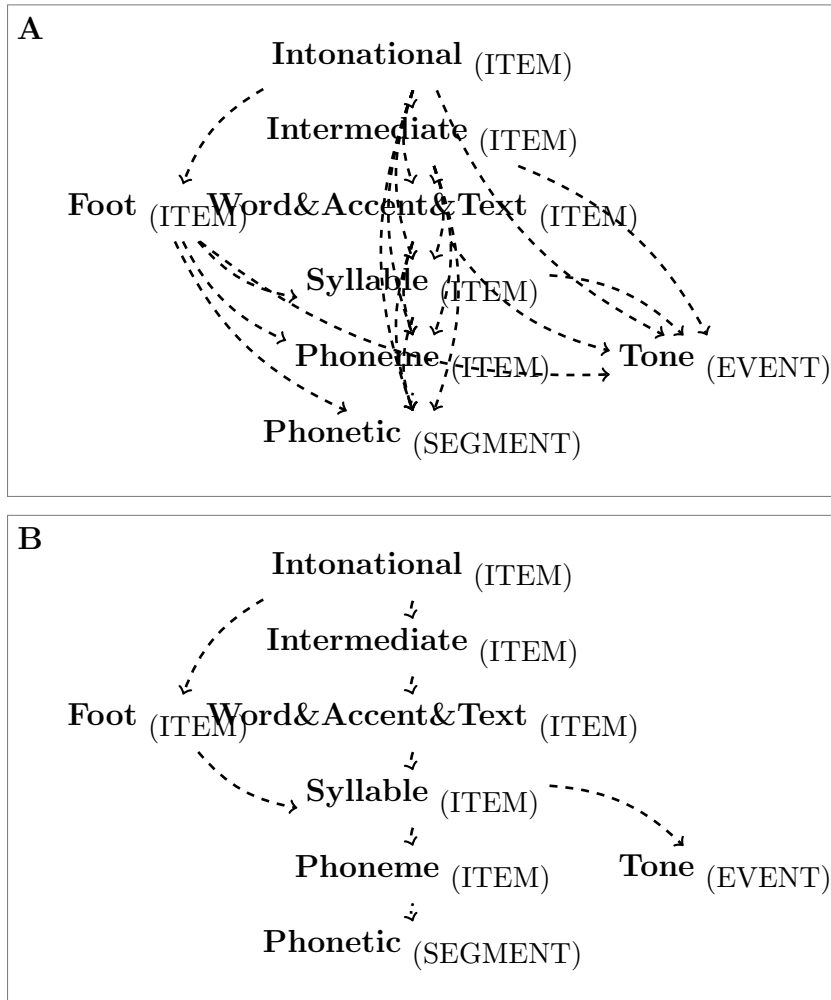

Figure 10.3: Schematic of hierarchy graph *ae*; **A**: legacy redundant strategy vs. **A**: cleaner non-redundant strategy.

# Chapter 11

## wrassp implementation

The `libassp` was originally written by Michel Scheffers as a C library which could be linked against or compiled into separate executable signal processing command line tools. To extend the legacy EMU system, the `libassp` it was integrated into it by using the Tcl Extension Architecture (TEA) to create a native extension to the Tcl programming language. The bulk of this work was done by Lasse Bombien in collaboration with Michel Scheffers. Lasse Bombien also implemented the `tkassp` user interface module as part of the legacy EMU system to allow the user full access to the functionality of the `libassp` from a GUI. The `wrassp` R package was written by Lasse Bombien and Raphael Winkelmann based on a similar approach as the `tclassp` port using the TEA. Since the `libassp` was put under the GPL version 3 (see <https://www.gnu.org/licenses/gpl-3.0.en.html>) by Michel Scheffers, the `wrassp` also carries this license.

### 11.1 The `libassp` port

Here, we briefly describe our strategy for porting the `libassp` to R. The port of the `libassp` to the R eco-system was achieved using the foreign language interface provided by the R system as is described in the R Extensions manual (see <https://cran.r-project.org/doc/manuals/r-release/R-exts.html#Writing>). To port the various signal processing routines provided by the `libassp` and to avoid code redundancy a single C function called `performAssp()` was created. This function acts as a C wrapper function interface to `libassp`'s internal functions and handles the data conversion between `libassp`'s internal and R's data structures. However, to provide the user with a clear and concise Application Programming Interface (API) we chose to implement separate R functions for every signal processing function. This also allowed us to formulate more concise manual entries for each of the signal processing function provided by `wrassp`. R Example 11.1.1 is a pseudo-

code example of the layout of each signal processing function `wrassp` provides.

### R Example 11.1.1

```
##' roxygen2 documentation for genericWrasspFun
genericWrasspSigProcFun = function(listOfFiles,
                                   ...,
                                   forceToLog = useWrasspLogger){

#####
# perform parameter checks
if (is.null(listOfFiles)) {
    stop(paste("listOfFiles is NULL! ..."))
}
# ...

# call performAssp
externalRes = invisible(.External("performAssp", listOfFiles,
                                  fname = "forest", ...))

#####
# write options to options log file
if (forceToLog){
    optionsGivenAsArgs = as.list(match.call(
        expand.dots = TRUE))
    wrassp.logger(optionsGivenAsArgs[[1]],
                  optionsGivenAsArgs[-1],
                  optLogFilePath, listOfFiles)
}

return(externalRes)
}
```

To provide access to the file handling capabilities of the `libassp`, we implemented two C interface functions called `getDObj2()` (where 2 is simply used as a function version marker) and `writeDObj()`. These functions use `libassp`'s `asspFOpen()`, `asspFFill()`, `asspFWrite()` and `asspFClose()` function to read and write files supported by the `libassp` from and to files on disk into R. The public API functions `read.AsspDataObj()` and `write.AsspDataObj()` are the R wrapper functions around `getDObj2()` and `writeDObj()`.



To be able to access some of `libassp`'s internal variables further wrapper functions were implemented. It was necessary to have access to these variables to be able to perform adequate parameter checks in various functions. R Example 11.1.2 shows these functions.

### R Example 11.1.2

```
# load the wrassp package
library(wrassp)

# show AsspWindowTypes
AsspWindowTypes()

## [1] "RECTANGLE" "PARABOLA" "COS" "HANN"
## [5] "COS_4" "HAMMING" "BLACKMAN" "BLACK_X"
## [9] "BLACK_M3" "BLACK_M4" "NUTTAL_3" "NUTTAL_4"
## [13] "KAISER2_0" "KAISER3_0" "KAISER4_0"

# show wrasspOutputInfos
AsspLpTypes()

## [1] "ARF" "LAR" "LPC" "RFC"

# show wrasspOutputInfos
AsspSpectTypes()

## [1] "DFT" "LPS" "CSS" "CEP"
```

The `wrassp` package provides two R objects that contain useful information regarding the supported file format types (`AsspFileFormats`) and the output created by the various signal processing functions. R Example 11.1.3 shows the content of these two objects.

### R Example 11.1.3

```
# show AsspFileFormats
AsspFileFormats

## RAW ASP_A ASP_B XASSP IPDS_M IPDS_S AIFF
## 1 2 3 4 5 6 7
## AIFC CSL CSRE ESPS ILS KTH SWELL
## 8 9 10 11 12 13 13
```

```
## SNACK SFS SND AU NIST SPHERE PRAAT_S
## 13 14 15 15 16 16 17
## PRAAT_L PRAAT_B SSFF WAVE WAVE_X XLABEL YORK
## 18 19 20 21 22 24 25
## UWM
## 26

# show first element of wrasspOutputInfos
wrasspOutputInfos[[1]]

## $ext
## [1] "acf"
##
## $tracks
## [1] "acf"
##
## $outputType
## [1] "SSFF"
```

As a final remark, it is worth noting that porting the C library `libassp` to R enables the functions provided by the `wrassp` package to run at near native speeds on every platform supported by R and avoids almost any interpreter overhead.

# Chapter 12

## EMU-webApp implementation

Here, we briefly describe our strategy for implementing the **EMU-webApp**. The **EMU-webApp** is written entirely in HTML, Javascript and CSS. To ease testing and to enable easy integration and extendability we chose to use the AngularJS Javascript framework (Google, 2014). Most of the components of the **EMU-webApp** (e.g., the spectrogram display) are implemented as so-called Angular directives. This means that, apart from dependencies on data service classes that have to be made available, these components are reusable and can be integrated into other web applications. The **EMU-webApp** makes extensive use of Angular data bindings to keep the display and the various data services in sync with each other. It is also worth noting that we chose to use the SASS (see <http://sass-lang.com/>) preprocessor to compile `.sass` files to CSS. This enabled us to use things like mixins, variables and inheritance for a more concise stylesheet management and generation.

The main reason we chose the JSON file format as the main file type for the EMU-SDMS is because we wanted a web application as the main GUI of the new system. Using JSON files enables the **EMU-webApp** to directly use the annotation and configuration files that are part of an **emuDB** without manipulating or reformatting the data.

The rest of this chapter will focus on the communication protocol and the URL parameters provided by the **EMU-webApp**. These should be of special interest to developers as they describe how to communicate with the web application and how to use the web application to display data that is hosted on other http web servers.

## 12.1 Communication protocol<sup>1</sup>

A large benefit gained by choosing the browser as the user interface is the ability to easily interact with a server using standard web protocols, such as http, https or websockets. In order to standardize the data exchange with a server, we have developed a simple request-response communication protocol on top of the websocket standard. This decision was strongly guided by the availability of the `httpuv` R package (RStudio and Inc., 2015). Our protocol defines a set of JSON objects for both the requests and responses. A subset of the request-response actions, most of them triggered by the client after connection, are displayed in Table 12.1.

Protocol Command	Comments
<code>GETPROTOCOL</code>	Check if the server implements the correct protocol
<code>GETDOUSERMANAGEMENT</code>	See if the server handles user management (if yes, then this prompts a login dialog → <code>LOGONUSER</code> )
<code>GETGLOBALDBCONFIG</code>	Request the configuration file for the current connection
<code>GETBUNDLELIST</code>	Request the list of available bundles for current connection
<code>GETBUNDLE</code>	Request data belonging to a specific bundle name
<code>SAVEBUNDLE</code>	Save data belonging to a specific bundle name

Table 12.1: Main `EMU-webApp` protocol commands.

This protocol definition makes collaborative annotation efforts possible, as developers can easily implement servers for communicating with the `EMU-webApp`. Using this protocol allows a database to be hosted by a single server anywhere on the globe that then can be made available to a theoretically infinite number of users working on separate accounts logging individual annotations, time and date of changes and other activities such as comments added to problematic cases. Tasks can be allocated to and unlocked for each individual user by the project leader. As such, user management in collaborative projects is substantially simplified and trackable compared with other currently available software for annotation.

The `emuR` package implements this websocket protocol as part of the `serve()` function utilizing the `httpuv` package. Further example implementations of this websocket protocol are provided as part of the source code repository of the `EMU-webApp` (see <https://github.com/IPS-LMU/EMU-webApp/tree/master/exampleServers>). A in-depth description of the protocol which includes descriptions of each request and response JSON object can be found in Appendix C.

<sup>1</sup>This section has been published in Winkelmann and Raess (2015).

## 12.2 URL parameters

The EMU-webApp currently implements several URL parameters (see [https://en.wikipedia.org/wiki/Query\\_string](https://en.wikipedia.org/wiki/Query_string) for more information) as part of its URL query string. This section describes the currently implemented parameters and gives some accompanying examples.

### 12.2.1 WebSocket server parameters

The current URL parameters that affect the websocket server connection are:

- **serverUrl**=*URL* is a URL pointing to a websocket server that implements the EMU-webApp websocket protocol, and
- **autoConnect**=*true* / *false* automatically connects to a websocket server URL specified in the **serverUrl** parameter. If the **serverUrl** parameter is not set the web application defaults to the entry in its `default_emuwebappConfig.json`.

#### Examples

- auto connect to local wsServer: `http://ips-lmu.github.io/EMU-webApp/?autoConnect=true&serverUrl=ws:%2F%2Flocalhost:17890`

### 12.2.2 Label file preview parameters

The current URL parameters for using the EMU-webApp to visualize files that are hosted on other http servers are:

- **audioGetUrl**=*URL* GET URL that will respond with `.wav` file,
- **labelGetUrl**=*URL* GET URL that will respond with label/annotation file,
- **DBconfigGetURL**=*URL* GET URL that will respond with `_DBconfig.json` file, and
- **labelType**=*TEXTGRID* / *annotJSON* specifies the type of annotation file.

This mechanism is, for example, currently being used by the WebMAUS web-services of the BASWebServices (see <https://clarin.phonetik.uni-muenchen.de/BASWebServices>) to provide a preview of the automatically segmented speech files.

### Examples

- TextGrid example: `http://ips-lmu.github.io/EMU-webApp/?audioGetUrl=https://raw.githubusercontent.com/IPS-LMU/EMU-webApp/master/app/testData/oldFormat/msajc003/msajc003.wav&labelGetUrl=https://raw.githubusercontent.com/IPS-LMU/EMU-webApp/master/app/testData/oldFormat/msajc003/msajc003.TextGrid&labelType=TEXTGRID`
- annotJSON example: `http://ips-lmu.github.io/EMU-webApp/?audioGetUrl=https://raw.githubusercontent.com/IPS-LMU/EMU-webApp/master/app/testData/newFormat/ae/0000_ses/msajc003_bndl/msajc003.wav&labelGetUrl=https://raw.githubusercontent.com/IPS-LMU/EMU-webApp/master/app/testData/newFormat/ae/0000_ses/msajc003_bndl/msajc003_annot.json&labelType=annotJSON`

# Appendices

# Appendix A

## Use cases

To add to the tutorial of Chapter 2, this chapter will present a few short use cases extracted and updated from the `emuR_intro` vignette. These use cases are meant as practical guides to answering research questions and are to be viewed as generic template procedures that can be altered and applied to similar research questions. They are meant to give practical examples of what it is like working with the EMU-SDMS to answer research questions common in speech and spoken language research. Every use case will start off by asking a question about the *ae* demo database and will continue by walking through the process of answering this question by using the mechanics the `emuR` package provides. The four questions this chapter will address are:

- Section A.1: What is the average length of all  $n$  phonetic segments in the *ae* `emuDB`?
- Section A.2: What does the F1 and F2 distribution of all phonetic segments that contain the labels *I*, *o:*, *u:*, *V* or *@* look like?
- Section A.3: What words do the phonetic segments that carry the labels *s*, *z*, *S* or *Z* in the *ae* `emuDB` occur in and what is their phonetic context?
- Section A.4: Do the phonetic segments that carry the labels *s*, *z*, *S* or *Z* in the *ae* `emuDB` differ with respect to their first spectral moment?

R Example A.0.1 shows how the `emuR` demo data used in this chapter is created.

### R Example A.0.1

```
# load the package  
library(emuR)
```



```
# create demo data in directory provided by the tempdir() function
create_emuRdemoData(dir = tempdir())

# get the path to emuDB called 'ae' that is part of the demo data
path2directory = file.path(tempdir(), "emuR_demoData", "ae_emuDB")

# load emuDB into current R session
ae = load_emuDB(path2directory)
```

## A.1 What is the average length of all $n$ phonetic segments in the *ae* emuDB?

The first thing that has to be done to address this fairly simple question is to query the database for all  $n$  segments. This can be achieved using the `query()` function as shown in R Example A.1.1.

### R Example A.1.1

```
# query segments
sl = query(ae, query = "Phonetic == n")

# show first row of sl
head(sl, n = 1)

## segment list from database: ae
## query was: Phonetic == n...
## labels start end session bundle level
## 1 n 1031.925 1195.925 0000 msajc003 Phonetic
## type
## 1 SEGMENT
```

The second argument of the `query()` contains a string that represents an EQL statement. This fairly simple EQL statement consists of `==`, which is the equality operator of the EQL, and on the right hand side of the operator the label  $n$  that we are looking for.

The `query()` function returns an object of the class `emuRsegs` that is a superclass of the well known `data.frame`. The various columns of this object should be fairly self-explanatory: `labels` displays the extracted labels, `start` and `end` are

the start time and end times in milliseconds of each segment and so on. We can now use the information in this object to calculate the mean durations of these segments as shown in R Example A.1.2.

### R Example A.1.2

```
# calculate durations
d = dur(s1)

# calculate mean
mean(d)

## [1] 67.05833
```

## A.2 What does the F1 and F2 distribution of all phonetic segments that contain the labels *I*, *o:*, *u:*, *V* or *@* look like?

Once again we will initially query the emuDB to retrieve the segments we are interested in as shown in R Example A.2.1.

### R Example A.2.1

```
# query emuDB
s1 = query(ae, query = "Phonetic == I|o:|u:|V|@")
```

Now that the necessary segment information has been extracted, the `get_trackdata()` function can be used to calculate the formant values for these segments as displayed in R Example A.2.2.

### R Example A.2.2

```
# get formant values for these segments
td = get_trackdata(ae, s1,
                  onTheFlyFunctionName = "forest",
                  resultType = "emuRtrackdata")
```

In this example, the `get_trackdata()` function uses a formant estimation function called `forest()` to calculate the formant values in real time. This signal

processing function is part of the `wrassp` package, which is used by the `emuR` package to perform signal processing duties with the `get_trackdata()` command (see Chapter 7 for details).

If the `resultType` parameter is set to `emuRtrackdata` in the call to `get_trackdata()`, an object of the class `emuRtrackdata` is returned. The class vector of the `td` object is displayed in R Example A.2.3.

### R Example A.2.3

```
# show class vector of td
class(td)

## [1] "emuRtrackdata" "data.frame"

# show first line of td
head(td, n = 1)

##   sl_rowIdx labels      start      end session  bundle
## 1         1      V 187.425 256.925    0000 msajc003
##   level      type times_orig times_rel times_norm T1  T2
## 1 Phonetic SEGMENT      187.5         0         0  0 1293
##   T3  T4
## 1 2424 3429
```

As the `emuRtrackdata` class is a superclass to the common `data.table` and `data.frame` classes, packages like `ggplot2` can be used to visualize our F1 and F2 distribution as shown in R Example A.2.4 (see Figure A.1 for the resulting plot).

### R Example A.2.4

```
# load package
library(ggplot2)

# scatter plot of F1 and F2 values using ggplot
ggplot(td, aes(x=T2, y=T1, label=td$labels)) +
  geom_text(aes(colour=factor(labels))) +
  scale_y_reverse() + scale_x_reverse() +
  labs(x = "F2(Hz)", y = "F1(Hz)") +
  guides(colour=FALSE)
```

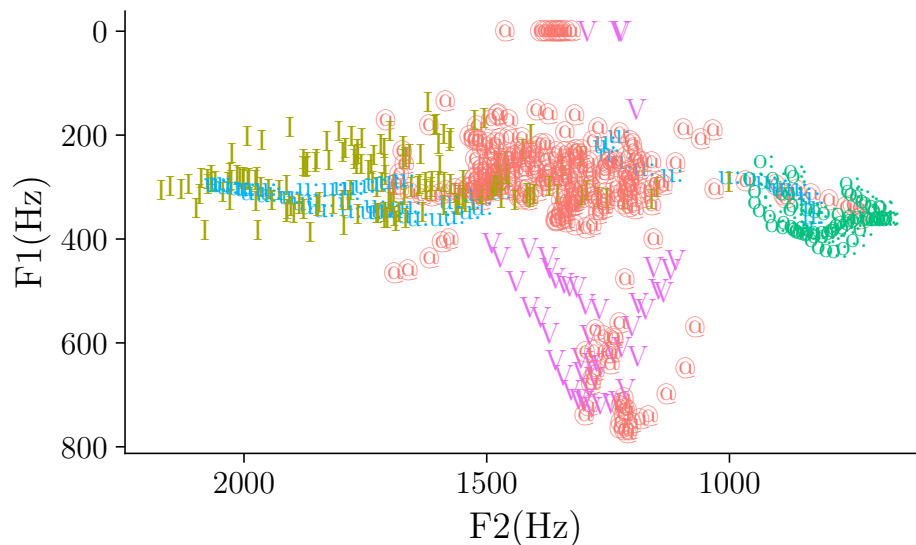

Figure A.1: F1 by F2 distribution for *I*, *o:*, *u:*, *V* and *@*.

### A.3 What words do the phonetic segments that carry the labels *s*, *z*, *S* or *Z* in the *ae* emuDB occur in and what is their phonetic context?

As with the previous use cases, the initial step is to query the database to extract the relevant segments as shown in R Example A.3.1.

#### R Example A.3.1

```
# query segments
sibil = query(ae, "Phonetic==s|z|S|Z")

# show first element of sibil
head(sibil, n = 1)

## segment list from database: ae
## query was: Phonetic==s|z|S|Z...
## labels start end session bundle level type
## 1 s 483.425 566.925 0000 msajc003 Phonetic SEGMENT
```

The `requer_hier()` function can now be used to perform a hierarchical requery using the set resulting from the initial query. This requery follows the

hierarchical links of the annotations in the database to find the linked annotation items on a different level. R Example A.3.2 shows how this can be achieved.

### R Example A.3.2

```
# perform requery
words = requery_hier(ae, sibil, level = "Word")

# show first element of words
head(words, n = 1)

## segment list from database: ae
## query was: FROM REQUERY...
## labels start end session bundle level type
## 1 C 187.425 674.175 0000 msajc003 Word ITEM
```

As seen in R Example A.3.2, the result is not quite what one would expect as it does not contain the orthographic word transcriptions but a classification of the words into content words (*C*) and function words (*F*). Calling the `summary()` function on the `emuDBhandle` object `ae` would show that the *Words* level has multiple attribute definitions indicating that each annotation item in the *Words* level has multiple parallel labels defined for it. R Example A.3.3 shows an additional query that queries the *Text* attribute definition instead.

### R Example A.3.3

```
# perform requery
words = requery_hier(ae, sibil, level = "Text")

# show first element of words
head(words, n = 1)

## segment list from database: ae
## query was: FROM REQUERY...
## labels start end session bundle level type
## 1 amongst 187.425 674.175 0000 msajc003 Text ITEM
```

As seen in R Example A.3.3, the first segment in `sibil` occurred in the word *amongst*, which starts at 187.475 ms and ends at 674.225 ms. It is worth noting that this two-step querying procedure (`query()` followed by `requery_hier()`) can also be completed in a single hierarchical query using the dominance operator (`^`).

As we have answered the first part of the question, R Example A.3.4 will extract the context to the left of the extracted sibilants by using the `requery_seq()` function.

#### R Example A.3.4

```
# get left context by off setting the
# annotation items in sibil one unit to the left
leftContext = requery_seq(ae, sibil, offset = -1)

# show first element of leftContext
head(leftContext, n = 1)

## segment list from database: ae
## query was: FROM REQUERY...
## labels start end session bundle level type
## 1 N 426.675 483.425 0000 msajc003 Phonetic SEGMENT
```

R Example A.3.5 attempts to extract the right context in the same manner as R Example A.3.4, but in this case we encounter a problem.

#### R Example A.3.5

```
# get right context by off-setting the
# annotation items in sibil one unit to the right
rightContext = requery_seq(ae, sibil, offset = 1)

## Error in requery_seq(ae, sibil, offset = 1): 4 of the requested
## sequence(s) is/are out of boundaries.
## Set parameter 'ignoreOutOfBounds=TRUE' to get residual result segments
## that lie within the bounds.
```

As can be seen by the error message in R Example A.3.5, four of the sibilants occur at the very end of the recording and therefore have no phonetic post-context. The remaining post-contexts can be retrieved by setting the `ignoreOutOfBounds` argument to `TRUE` as displayed in R Example A.3.6.

#### R Example A.3.6

```
rightContext = requery_seq(ae, sibil,
                           offset = 1,
                           ignoreOutOfBounds = TRUE)
```

```
## Warning in requery_seq(ae, sibil, offset = 1, ignoreOutOfBounds =
TRUE): Length of requery segment list (28) differs from input list (32)!
These segments where lost while deriving their time (no )

# show first element of rightContext
head(rightContext, n = 1)

## segment list from database: ae
## query was: FROM REQUERY...
## labels start end session bundle level type
## 1 t 566.925 596.675 0000 msajc003 Phonetic SEGMENT
```

However, the resulting `rightContext` and the original `sibil` objects are not aligned any more. It is therefore dangerous to use this option by default, as one often relies on the rows in multiple `emuRsegs` objects that were created from each other by using either `requery_hier()` or `requery_seq()` to be aligned with each other (i.e., that the same row index implicitly indicates a relationship).

## A.4 Do the phonetic segments labeled *s*, *z*, *S* or *Z* in the *ae* emuDB differ with respect to their first spectral moment?<sup>1</sup>

Once again, the segments of interest are queried first. R Example A.4.1 shows how this can be achieved, this time using the new regular expression operand of the EQL (see Chapter 5 for details).

### R Example A.4.1

```
sibil = query(ae, "Phonetic =~ '[szSZ]'")
```

R Example A.4.2 shows how the `get_trackdata()` function can be used to calculate the Discrete Fourier Transform values for the extracted segments.

### R Example A.4.2

```
dftTd = get_trackdata(ae,
                      seglist = sibil,
                      onTheFlyFunctionName = 'dftSpectrum')
```

<sup>1</sup>The original version of this use case was written by Florian Schiel as part of the `emuR_intro` vignette that is part of the `emuR` package.

As the `resultType` parameter was not explicitly set, an object of the class `trackdata` is returned. This object, just like an object of the class `emuRtrackdata`, contains the extracted trackdata information. Compared to the `emuRtrackdata` class, however, the object is not “flat” and in the form of a `data.table` or `data.frame` but has a more nested structure (see `?trackdata` for more details).

Since we want to analyze sibilant spectral data we will now reduce the spectral range of the data to 1000 - 10000 Hz. This is due to the fact that there is a lot of unwanted noise in the lower bands that is irrelevant for the problem at hand and can even skew the end results. To achieve this we can use a property of a `trackdata` object that also carries the class `spectral`, which means that it is indexed using frequencies. R Example A.4.3 shows how to use this feature to extract the relevant spectral frequencies of the `trackdata` object.

#### R Example A.4.3

```
dftTdRelFreq = dftTd[, 1000:10000]
```

R Example A.4.4 shows how the `fapply()` function can be used to apply the `moments()` function to all elements of `dftTdRelFreq`.

#### R Example A.4.4

```
dftTdRelFreqMom = fapply(dftTdRelFreq, moments, minval = T)
```

The resulting `dftTdRelFreqMom` object is once again a `trackdata` object of the same length as the `dftTdRelFreq` `trackdata` object. It contains the first four spectral moments as shown in R Example A.4.5.

#### R Example A.4.5

```
# show first row of data belonging  
# to first element of dftTdRelFreqMom  
dftTdRelFreqMom[1]$data[1,]  
  
## [1] 5.335375e+03 6.469573e+06 6.097490e-02 -1.103308e+00
```

The information stored in the `dftTdRelFreqMom` and `sibil` objects can now be used to plot a time-normalized version of the first spectral moment trajectories, color coded by sibilant class, using `emuR`'s `dplot()` function. R Example A.4.6 shows the R code that produces Figure A.2.



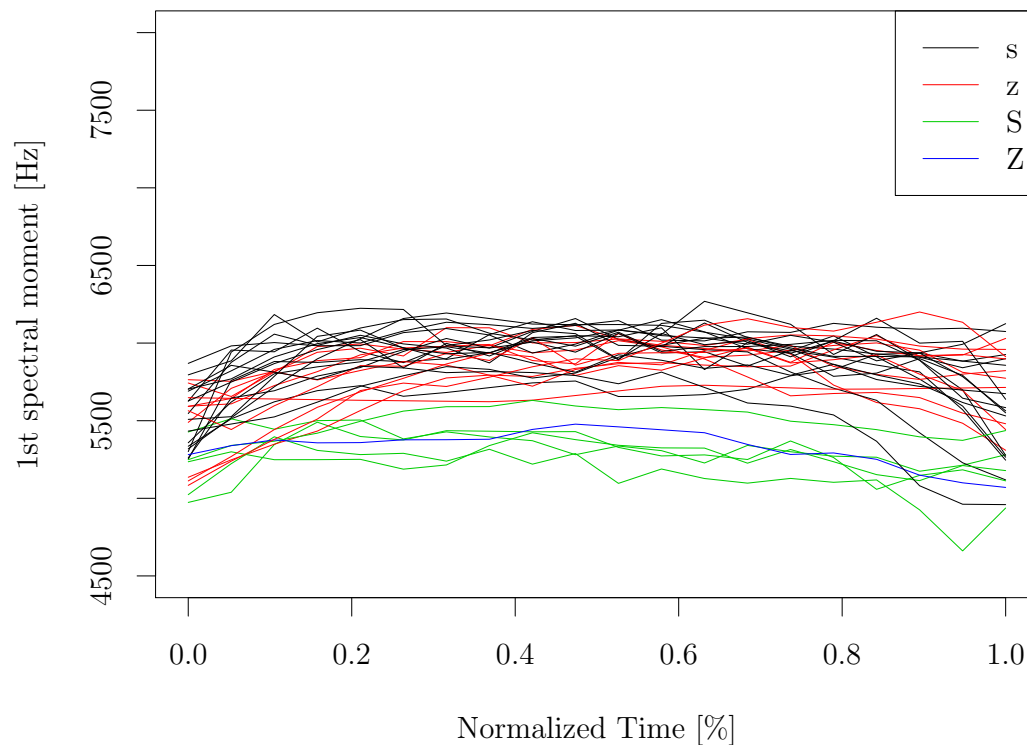

Figure A.2: Time-normalized first spectral moment trajectories color coded by sibilant class.

#### R Example A.4.6

```
dplot(dftTdRelFreqMom[, 1],
      sibil$labels,
      normalise = TRUE,
      xlab = "Normalized Time [%]",
      ylab = "1st spectral moment [Hz]")
```

As one might expect, the first spectral moment (the center of gravity) is significantly lower for postalveolar *S* and *Z* (green and blue lines) than for alveolar *s* and *z* (black and red lines).

R Example A.4.7 shows how to create an alternative plot (see Figure A.3) that averages the trajectories into ensemble averages per sibilant class by setting the

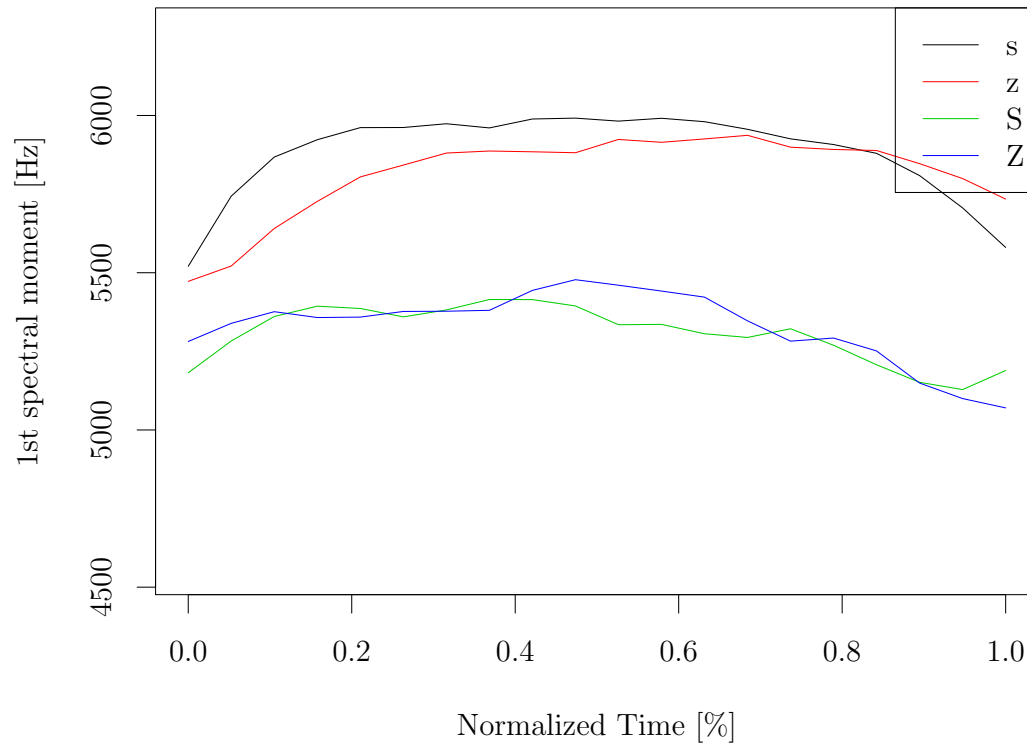

Figure A.3: Time-normalized first spectral moment ensemble average trajectories per sibilant class.

average parameter of `dplot()` to `TRUE`.

#### R Example A.4.7

```
dplot(dftTdRelFreqMom[,1],
      sibil$labels,
      normalise = TRUE,
      average = TRUE,
      xlab = "Normalized Time [%]",
      ylab = "1st spectral moment [Hz]")
```

As can be seen from the previous two plots (Figure A.2 and A.3), transitions to and from a sort of steady state around the temporal midpoint of the sibilants

are clearly visible. To focus on this steady state part of the sibilant we will now extract those spectral moments that fall between the proportional timepoints 0.2 and 0.8 of each segment (i.e., the central 60%) using the `dcut()` function as is shown in R Example A.4.8.

#### R Example A.4.8

```
# cut out the middle 60% portion
dftTdRelFreqMomMid = dcut(dftTdRelFreqMom,
                          left.time = 0.2,
                          right.time = 0.8,
                          prop = T)
```

Finally, R Example A.4.9 shows how to calculate the averages of these trajectories using the `trapply()` function.

#### R Example A.4.9

```
meanFirstMoments = trapply(dftTdRelFreqMomMid[,1],
                           fun = mean,
                           simplify = T)
```

As the resulting `meanFirstMoments` vector has the same length as the initial `sibil` segment list, we can now easily visualize these values in the form of a boxplot. R Example A.4.10 shows the R code that produces Figure A.4.

#### R Example A.4.10

```
boxplot(meanFirstMoments ~ sibil$labels,
        xlab = "Sibilant class labels",
        ylab = "First spectral moment values [Hz]")
```

As final remark, it is worth noting that using the `emuRtrackdata` `resultType` (not the `trackdata` `resultType`) of `get_trackdata()` function we could have performed a comparable analysis by utilizing packages such as `dplyr` for `data.table` or `data.frame` manipulation and `lattice` or `ggplot2` for data visualisation.

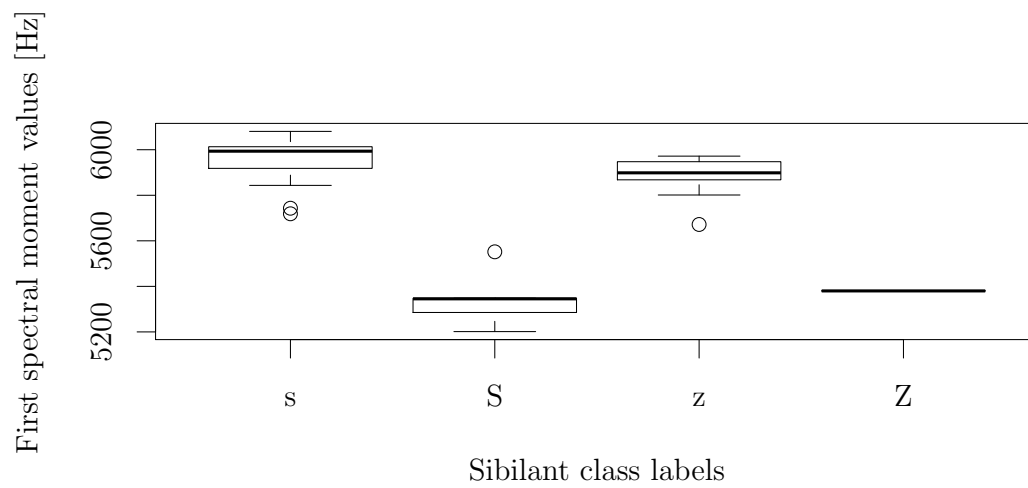

Figure A.4: Boxplots of the first spectral moments grouped by their sibilant class.

# Appendix B

## File Formats

### B.1 File descriptions

#### B.1.1 `_DBconfig.json`

The `_DBconfig.json` file contains the configuration options of the database. People familiar with the legacy EMU system will recognize this as the replacement file for the legacy template (`.tpl`) file. By convention, variables or strings written entirely in capital letters indicate a constant variable that usually has a special meaning. This is also the case with strings like this found in the `_DBconfig.json` (`"STRING"`, `"ITEM"`, `"SEGMENT"`, `"EVENT"`, `"OSCI"`, ...).

The `_DBconfig.json` file contains the following fields:

- `"name"` specifies the name of the database
- `"UUID"` a unique ID given to each database
- `"mediafileExtension"` the main `mediafileExtension` (currently only uncompressed `.wav` files are supported in every component of the EMU system. This is also the recommended audio format for the EMU-SDMS.)
- `"ssffTrackDefinitions"` an array of definitions defining the SSFF tracks of the database. Each `ssffTrackDefinition` consists of:
  - `"name"` the name of the `ssffTrackDefinition`
  - `"columnName"` the name of the column of the matching SSFF file. For more information on the columns the various functions of the `wrassp` produce, see the track fields of the `wrasspOutputInfos` object that is part of the `wrassp` package. Further, although the SSFF is a binary file format, it has a plain text header. This means that if you open a

SSFF file in the text editor of your choice, you will be able to see the columns contained within it. Another way of accessing column information about a specific SSFF file is to use the `wrassp` function `res = read.AsspDataObj('/path/2/SSFF/file')` to read the file from the file system. `names(res)` will then give you the names of the columns present in this file. In the context of the SSFF, we use the term “column”, while in the context of the EMU system we use either “track” or “SSFF track”. Both refer to the same data.

- "fileExtention" the file extension of the matching SSFF file. See also `?wrasspOutputInfos` for the default extensions produced by the `wrassp` functions.
- "levelDefinitions" array of definitions defining the levels of the database. Each "levelDefinitions" consists of:
  - "name" The name of the levelDefinition.
  - "type" Specifies the type of level (either "ITEM" | "EVENT" | "SEGMENT").
  - "attributeDefinitions" an array of definitions defining the attributes of the level. Each attributeDefinition consists of:
    - "name" The name of the "attributeDefinition".
    - "type" Specifies the type of the attribute (currently only "STRING" permitted)
    - "labelGroups" An (optional) array containing label group definitions. These can be used as a shorthand notation for querying certain groups of labels and comprise the following:
      - "name" The name of the label group. This will be the value used in a query to refer to this group.
      - "values" An array of strings representing the labels.
    - "legalLabels" An (optional) array of strings specifying which labels are valid or legal for this attribute definition.
  - "anagestConfig" If specified (optional), this will convert the level into a special type of level for labeling articulatory data. This will also serve as a marker for the EMU-webApp to treat this level differently. This optional field may only be set for levels of the type "EVENT".
    - "verticalPosSsffTrackName" The name of the SSFF track containing the vertical position data.

- "velocitySsffTrackName" The name of the SSFF track containing the velocity data.
  - "autoLinkLevelName" The name of the level to which created events will be linked.
  - "multiplicationFactor" The factor to multiply with (either -1 | 1).
  - "threshold" A value between 0 and 1 defining the absolute threshold.
  - "gestureOnOffsetLabels" An array containing two strings that specify the on- and offset labels.
  - "maxVelocityOnOffsetLabels" An array containing two strings that specify the on- and offset labels.
  - "constrictionPlateauBeginEndLabels" An array containing two strings that specify the begin- and end labels.
  - "maxConstrictionLabel" A string specifying the maximum constriction label.
- "linkDefinitions" An array of the definitions defining the links between levels of the database. The combination of all link definitions specifies the hierarchy of the database. Each `linkDefinition` consists of:
    - "type" Specifies the type of link (either "ONE\_TO\_MANY" | "MANY\_TO\_MANY" | "ONE\_TO\_ONE").
    - "superlevelName" Specifies the name of the super-level.
    - "sublevelName" Specifies the name of the sub-level.
  - "labelGroups" An (optional) array containing label group definitions. These can be used as a shorthand notation for querying certain groups of labels. Compared to the "labelGroups", which can be defined within an `attributeDefinition`, the `labelGroups` defined here are globally defined for the entire database as follows:
    - "name" The name of the label group.
    - "values" An array of strings containing labels.
  - "EMUwebAppConfig" Specifies the configuration options intended for the EMU-webApp (i.e., how the database is to be displayed). This field can contain all the configurations options that are specified in the EMU-webApp's configuration schema (see <https://github.com/IPS-LMU/EMU-webApp/tree/master/dist/schemaFiles>). The "EMUwebAppConfig" contains the following fields:

- "main" Main behavior options:
  - "autoConnect": Auto connect to the "serverUrl" on the initial load of the webApp to automatically load a database (mainly used for development).
  - "serverUrl": The default server URL that is displayed in the connect modal window (and used if "autoConnect" is set to true). The default: "ws://localhost:17890" points to the server started by the serve() function of the emuR package.
  - "serverTimeoutInterval": The maximum amount of time the EMU-webApp waits (in milliseconds) for the server to respond.
  - "comMode": Specifies the communication mode the EMU-webApp is in. Currently the only option that is available is "WS" (websocket).
  - "catchMouseForKeyBinding": Check if mouse has to be in labeler for key bindings to work.
- "keyMappings" Keyboard shortcut definitions. For the sake of brevity, not every key-code is shown (see schema: <https://github.com/IPS-LMU/EMU-webApp/blob/master/dist/schemaFiles/emuwebappConfigSchema.json> for extensive list).
  - "toggleSideBarLeft" integer value that represents the key-code that toggles the left side bar (== bundleList side bar)
  - "toggleSideBarRight" integer value that represents the key-code that toggles the right side bar (== perspective side bar)
  - ...
- "spectrogramSettings" Specifies the default settings of the spectrogram. The possible settings are:
  - "windowSizeInSecs" Specifies the window size in seconds.
  - "rangeFrom" Specifies the lowest frequency (in Hz) that will be displayed by the spectrogram.
  - "rangeTo" Specifies the highest frequency (in Hz) that will be displayed by the spectrogram.
  - "dynamicRange" Specifies the dynamic range for maximum decibel dynamic range.
  - "window" Specifies the window type ("BARTLETT" | "BARTLETTTHANN" | "BLACKMAN" | "COSINE" | "GAUSS" | "HAMMING" | "HANN" | "LANCZOS" | "RECTANGULAR" | "TRIANGULAR").
  - "preEmphasisFilterFactor" Specifies the preemphasis factor (in formula:  $s'(k) = s(k) - \text{preEmphasisFilterFactor} * s(k-1)$  ).



- "transparency" Specifies the transparency of the spectrogram (integer from 0 to 255).
- "drawHeatMapColors" (optional) Defines whether the spectrogram should be drawn using heat-map colors (either true or false)
- "heatMapColorAnchors" (optional) Specifies the heat-map color anchors (array of the form  $[[255, 0, 0], [0, 255, 0], [0, 0, 255]]$ )
- "perspectives" An array containing perspective configurations. Each "perspective" consists of:
  - "name" Name of the perspective.
  - "signalCanvases" Configuration options for the `signalCanvases`.
    - "order" An array specifying the order in which the SSFF tracks are to be displayed. Note that the SSFF track names "OSCI" and "SPEC" are always available in addition to the SSFF track defined in the database.
    - "assign" An array of configuration options that assign one SSFF track to another, effectively creating a visual overlay of one track over another. Each array element consists of:
      - "signalCanvasName" The name of the signal specified in the "order" array.
      - "ssffTrackName" The name of the SSFF track to overlay onto "signalCanvasName".
    - "minMaxValLims" An array of configuration options to limit the y-axis range that is displayed for a specified SSFF track.
      - "ssffTrackName": A name specifying which ssffTrack should be limited.
      - "minVal": The minimum value which defines the lower y-axis limit.
    - "contourLims" An array containing contour limit values that specify an index range that is to be displayed. As a track or column can contain multi-dimensional data (e.g. four formant values per time stamp, 256 DFT values per time stamp, etc.) it is possible to specify an index range that specifies which values should be displayed (e.g., display formant 2 through 4).
      - "ssffTrackName" A name specifying which ssffTrack should be limited.
      - "minContourIdx" The minimum contour index to display (starts at index 0).
      - "maxContourIdx" The maximum contour index to display.

- "contourColors" An array to specify colors of individual contours. This overrides the default of automatically calculating distinct colors for each contour.
- "ssffTrackName" The name of the `ssffTrackName` for which colors are defined.
- "colors" An array of RGB strings (e.g. ["rgb(238,130,238)", "rgb(127,255,212)"]) that specify the color of the contour (first value = first contour color and so on).
- "levelCanvases" Configuration options for the `levelCanvases`:
  - "order" An array specifying the order in which the levels are to be displayed. Note that only levels of the type `EVENT` or `SEGMENT` can be displayed as `levelCanvases`.
- "twoDimCanvases" Configuration options for the 2D canvas.
  - "order" An array specifying the order in which the levels are to be displayed. Note that currently only a single `twoDimDrawingDefinition` can be displayed so this array can currently only contain a single element.
  - "twoDimDrawingDefinitions" An array containing two dimensional drawing definitions. Each two dimensional drawing definition consists of:
    - "dots" An array containing dot definitions. Each dot definition consist of:
      - "name" The name of the dot.
      - "xSsffTrack" The `ssffTrackName` of the track that contains the x axis values.
      - "xContourNr" The contour number of the track that contains the x-axis values.
      - "ySsffTrack" The `ssffTrackName` of the track that contains the y-axis values.
      - "yContourNr" The contour number of the track that contains the y-axis values.
      - "color" The RGB color string specifying the color given to dot.
    - "connectLines" An array specifying which of the dots specified in the "dots" definition array should be connected by a line.
      - "fromDot" The dot from which the line should start.
      - "toDot" The dot at which the line should end.

- "color" The RGB string defining the color of the line.
- "staticDots" An array containing static dot definitions:
  - "name" The name of the static dots.
  - "xNameCoordinate" An x-coordinate specifying the location at which name should be drawn.
  - "yNameCoordinate" y-coordinate specifying the location at which name should be drawn.
  - "xCoordinates" An array of x-coordinates (e.g. [300, 300, 900, 900, 300]).
  - "yCoordinates" An array of y-coordinates (e.g. [880, 2540, 2540, 880, 880]).
  - "connect" A boolean value that specifies whether or not to connect the static dots with lines.
  - "color" An RGB string specifying the color of static dots.
- "staticContours" An array containing static contour definitions:
  - "name" The name of static contour.
  - "xSsffTrack" The `ssffTrackName` of the track that contains the x-axis values.
  - "xContourNr" The contour number of the track that contains the x-axis values.
  - "ySsffTrack" The `ssffTrackName` of the track that contains the y-axis values.
  - "yContourNr" The contour number of the track that contains the y-axis values.
  - "connect" A boolean value that specifies whether or not to connect the static dots with lines.
  - "color" An RGB string specifying color of the static contour.
- "labelCanvasConfig" Configuration options for the label canvases:
  - "addTimeMode" The mode in which time to boundaries is added and subtracted ("absolute" or "relative").
  - "addTimeValue": The amount of samples added to or subtracted from boundaries.
  - "newSegmentName" The value given to the default label if a new SEGMENT is added (default is "" == empty string).

- "newEventName" The value given to the default label if a new EVENT is added (default is "" == empty string).
- "restrictions":
  - "playback" A boolean value specifying whether to allow audio playback.
  - "correctionTool" A boolean value specifying whether correction tools are available.
  - "editItemSize" A boolean value specifying whether to allow the size of a SEGMENT or EVENT to be changed (i.e., move boundaries).
  - "editItemName" A boolean value specifying whether to allow the label of an ITEM to be changed.
  - "deleteItemBoundary" A boolean value specifying whether to allow the deletion of boundaries.
  - "deleteItem" A boolean value specifying whether to allow the deletion of entire ITEMS
  - "deleteLevel" A boolean value specifying whether to allow the deletion of entire levels.
  - "addItem" A boolean value specifying whether to allow new ITEMS to be added.
  - "drawCrossHairs" A boolean value specifying whether to draw the cross hairs on signal canvases.
  - "drawSampleNrs" A boolean value specifying whether to draw the sample numbers in the OSCI canvas if zoomed in close enough to see samples (mainly for debugging and development purposes).
  - "drawZeroLine" A boolean value specifying whether to draw the zero value line in OSCI canvas.
  - "bundleComments" A boolean value specifying whether to allow the annotator to add comments to bundles she or he has annotated. A bundle comment field will show up in the bundle list side bar for each bundle if this is set to true. Note that the server has to support saving these comments, which the `serve()` function of the `emuR` package does not.
  - "bundleFinishedEditing" A boolean value specifying whether to allow the annotator to mark when she or he has finished annotating a bundle. A finished editing toggle button will show up in the bundle list side bar for each bundle if this is set to `true`. Note that the server has to support saving these comments which the `serve()` function of the `emuR` package does not.

- "showPerspectivesSidebar" A boolean value specifying whether to show the perspectives side bar.
- "activeButtons" Specifies which top- or bottom-menu buttons should be displayed by the EMU-webApp.
  - "addLevelSeg" A boolean value specifying whether to show the add SEGMENT level button in the top menu bar.
  - "addLevelEvent" A boolean value specifying whether to show the add EVENT level button in the top menu bar.
  - "renameSelLevel" A boolean value specifying whether to allow the user to rename the currently selected level.
  - "downloadTextGrid" A boolean value specifying whether to allow the user to download the current annotation as a .TextGrid file by displaying a download TextGrid button in the top menu bar.
  - "downloadAnnotation" A boolean value specifying whether to allow the user to download the current annotation as an \_annot.json file by displaying a download annotJSON button in the top menu bar.
  - "specSettings" A boolean value specifying whether to display the spec. settings button in the top menu bar.
  - "connect" A boolean value specifying whether to display the connect button in the top menu bar.
  - "clear" A boolean value specifying whether to display the clear button in the top menu bar.
  - "deleteSingleLevel" A boolean value specifying whether to allow the user to delete a level containing time information.
  - "resizeSingleLevel" A boolean value specifying whether to allow the user to resize a level.
  - "saveSingleLevel" A boolean value specifying whether to allow the user to download a single level in the ESPS/waves+ format.
  - "resizeSignalCanvas" A boolean value specifying whether to allow the user to resize the signalCanvases ("OSCI", "SPEC", ...).
  - "openDemoDB" A boolean value specifying whether to show the open demoDB button.
  - "saveBundle" A boolean value specifying whether to show the save button in bundle list side bar for each bundle.
  - "openMenu" A boolean value specifying whether open bundle list side bar button is displayed.

- "showHierarchy" A boolean value specifying whether to display the show hierarchy button.
- "demoDBs" An array of strings specifying which demoDBs to display in the open demo drop-down menu. Currently available demo databases are ["ae", "ema", "epgdorsal"].

### B.1.2 `_annot.json`

The `_annot.json` files contain the actual annotation information as well as the hierarchical linking information. Legacy EMU users should note that all the information that used to be split into several ESPS/waves+ label files and a `.h1b` file is now contained in this single file.

The `_annot.json` file contains the following fields:

- "name" Specifies the name of the annotation file (has to be equal to the bundle directory prefix as well as the `_annot.json` prefix).
- "annotates" Specifies the (relative) media file path that this `_annot.json` file annotates.
- "sampleRate" Specifies the sample rate of the annotation (should be the same as the sample rate of the file listed in "annotates").
- "levels" Contains an array of level annotation informations. Each element consists of:
  - "name" Specifies the name of the level.
  - "items" An array containing the annotation items of the level.
    - "id" The unique ID of the item (only unique within an `_annot.json` file or bundle, not globally for the `emuDB`).
    - "sampleStart" Contains start sample value of `SEGMENT` item.
    - "sampleDur" Contains sample duration value of `SEGMENT` item. Note that the `EMU-webApp` does not support overlapping `SEGMENTS` or `SEGMENT` sequences containing gaps. This infers that each sample is explicitly and unambiguously associated with a single `SEGMENT`. This means that the `sampleStart` value of a following `SEGMENT` has to be `sampleStart + sampleDur + 1` of the previous `SEGMENT`. When converting the sample values to time values, the `start` time value is calculated with the formula  $start = \frac{sampleStart}{sampleRate} - \frac{0.5}{sampleRate}$  and the `end` time value with the formula  $end = \frac{sampleStart+sampleDur}{sampleRate} +$

$\frac{0.5}{\text{sampleRate}}$ . This is done to have gapless time values for successive SEGMENTS. To avoid a negative time value when dealing with the first sample of an audio file (`sampleStart` value of 0), the `start` time value is simply set to 0 in this case. The `start` and `end` time value calculation is performed by both the query engine of `emuR` if the `calcTimes` parameter is set to `TRUE` and the `EMU-webApp` to display the time information in the signal canvases.

- `"samplePoint"` Contains sample point values of `EVENT` items. When calculating the `start` time values for `EVENTS` the following formula is used:  $start = \frac{\text{samplePoint}}{\text{sampleRate}}$
- `"labels"` An array containing labels that belong to this item. Each element consists of:
  - `"name"` Specifies the `attributeDefinition` that this label is for.
  - `"value"` Specifies the label value.
- `"links"` An array containing links between two items. These links have to adhere to the links specified in `linkDefinitions` of the corresponding `emuDB`. Each link consists of:
  - `"fromID"` The ID value of the item to link from (i.e., item in super-level).
  - `"toID"` The ID value of item to link to (i.e., item in sub-level).

### B.1.3 The SSFF file format

The SSFF file format is a binary file format which has a plain text header. This means that the header is human-readable and can be viewed with any text editor including common UNIX command line tools such as `less` or `cat`. Within R it is possible to view the header by using R's `readLines()` function as displayed in R Example B.1.1.

#### R Example B.1.1

```
# load the emuR and wrassp packages
library(emuR, warn.conflicts = FALSE)
library(wrassp)

# create demo data in directory
# provided by tempdir()
```

```

create_emuRdemoData(dir = tempdir())

# create path to demo database
path2ae = file.path(tempdir(), "emuR_demoData", "ae_emuDB")

# create path to bundle in database
path2bndl = file.path(path2ae, "0000_ses", "msajc003_bndl")

# create path to .fms file
path2fmsFile = file.path(path2bndl,
                          paste0("msajc003.",
                                  wrasspOutputInfos$forest$ext))

# read in first 8 lines of .fms file.
# Note that the header length may vary in other SSFF files.
readLines(path2fmsFile, n = 8)

## [1] "SSFF -- (c) SHLRC"
## [2] "Machine IBM-PC"
## [3] "Record_Freq 200.0"
## [4] "Start_Time 0.0025"
## [5] "Column fm SHORT 4"
## [6] "Column bw SHORT 4"
## [7] "Original_Freq DOUBLE 20000.0"
## [8] "-----"

```

The general line item structure of the plain text head of an SSFF file can be described as follows:

- **SSFF -- (c) SHLRC** (required line): File type marker.
- **Machine IBM-PC** (required line): System architecture of the machine that generated the file. This is mainly used to specify the endianness of the data block (see below). **Machine IBM-PC** indicates little-endian and **Machine SPARC** indicates big-endian. To date, we have not encountered other machine types.
- **Record\_Freq SR** (required line): Sample rate of current file in Hz. If, for example, **SR** is 200.0 (see R Example B.1.1) then the sample rate is 200 Hz.
- **Start\_Time ST** (required line): Time of first sample block in data block in seconds. This often deviates from 0.0 as **wrassp**'s windowed signal processing



functions start with the first window centered around `windowShift / 2`. If the `windowShift` parameter's default value is 5 ms, the start time `ST` of the first sample block will be 0.0025 sec (see R Example B.1.1).

- **Column CN CDT CDL** (required line(s)): A **Column** line entry contains four space-separated values, where **Column** is the initial key word value. The second value, **CN** (`fm` in R Example B.1.1), specifies the name for the column; the third, **CDT** (`SHORT` in R Example B.1.1), indicates the column's data type; and the fourth, **CDL** (`4` in R Example B.1.1), is the column's data length in bytes. As can be seen in R Example B.1.1, it is quite common for SSFF files to have multiple column entries. The sequence of these entries is relevant, as it specifies the sequence of the data in the binary data block (see below).
- **NAME DT DV** (optional line(s)): Optional single value definitions that have a **NAME**, a data type **DT** and a data value **DV** (see `Original Freq DOUBLE 20000.0` in R Example B.1.1 specifying the original sample rate of the audio file the `.fms` file was generated from).
- **Comment CHAR string of variable length** (optional line(s)): The **Comment CHAR** allows for comment strings to be added to the header.
- `-----` (required line): marks the end of the plain text header.

The binary data block of the SSFF file format stores its data in a so-called interleaved fashion. This means it does not store the binary data belonging to every column in a separate data block. Rather, it interleaves the columns to form sample blocks that occur at the same point in time. Figure B.1 displays a sequence of short integer values where the subscript text indicates the index in the sequence. This sequence represents a schematic representation of the data block of the `.fms` file of R Example B.1.1. The first four `INT161-4` (green) blocks represent the first four `INT16` formant values that belong to the `fm` column and the next four `INT165-8` (orange) represent the first four bandwidth values belonging to the `bm` column. Therefore, the dashed square marks the first sample block (i.e., the first eight `F1`, `F2`, `F3` and `F4`; and `F1bandwidth`, `F2bandwidth`, `F3bandwidth` and `F4bandwidth` values) that occur at the time specified by the `Start_Time 0.0025` header entry. The time of all subsequent sample blocks of eight `INT16` values (e.g., `INT169-16`) can be calculated as follows: `0.0025 (== Start_Time) + 1 / 200.0 (== Record_Freq) * sample block index`.

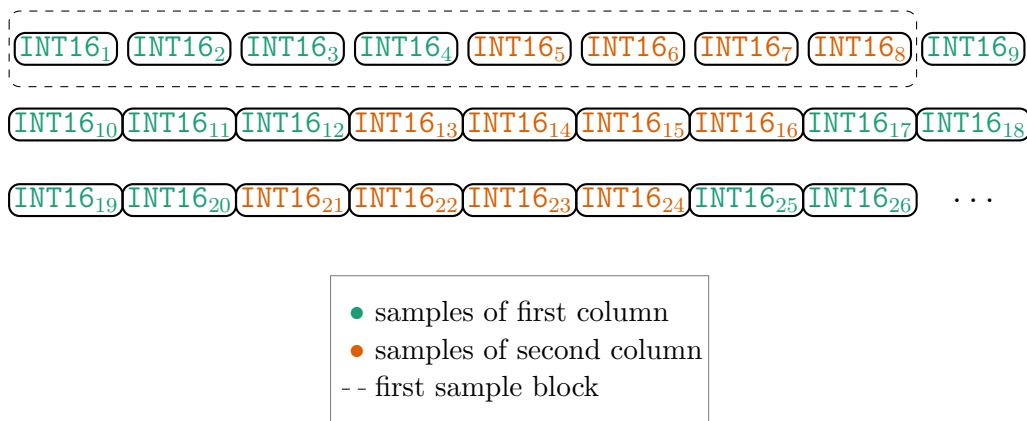

Figure B.1: Schematic representation of the data block of the `msajc003.fms` file of R Example B.1.1.

## B.2 Example files

### B.2.1 `_bundleList.json`

Compared to the `_DBconfig.json` and `_annot.json` files, the `_bndl.json` format is not part of the `emuDB` database specification. Rather, it is part of the `EMU-webApp-websocket-protocol` and is used as a standardized format to transport information about all the available bundles to the `EMU-webApp`. It is not meant as an on-disk file format but rather should be generated on-demand by the server implementing the `EMU-webApp-websocket-protocol`. A schematic example of a `_bndl.json` file is displayed in Listing B.1.

Listing B.1: Schematic example of a `_bundleList.json` file

```
[
  {
    "name": "msajc003",
    "session": "0000",
    "finishedEditing": false,
    "comment": "",
    "timeAnchors": [
      {
        "sample_start": 1000,
        "sample_end": 2000
      }, ...
    ]
  },
]
```

```
{
  "name": "msajc010",
  "session": "0000",
  "finishedEditing": false,
  "comment": ""
}
```

### B.2.2 `_bndl.json`

Compared to the `_DBconfig.json` and `_annot.json` files, the `_bndl.json` format is not part of the `emuDB` database specification. Rather, it is part of the `EMU-webApp-websocket-protocol` and is used as a standardized format to transport all the data belonging to a single bundle to the `EMU-webApp`. It is not meant as an on-disk file format but rather should be generated on-demand by the server implementing the `EMU-webApp-websocket-protocol`. A schematic example of a `_bndl.json` file is displayed in Listing B.2.

Listing B.2: Schematic example of a `_bndl.json` file

```
{
  "ssffFiles": [
    {
      "fileExtension": "fms",
      "encoding": "BASE64",
      "data": "U1N..."
    }
  ],
  "mediaFile": {
    "encoding": "BASE64",
    "data": "Ukl..."
  },
  "annotation": contentOfAnnot.json
}
```

`contentOfAnnot.json` in Listing B.2 refers to the content of a `_annot.json` file.

# Appendix C

## The EMU-webApp-websocket-protocol Version 2.0<sup>\*</sup>

This chapter describes the EMU-webApp-websocket-protocol in its current version.

### C.1 Protocol overview

The EMU-webApp-websocket-protocol consists of a set of request-response JSON files that control the interaction between the client (the EMU-webApp) and a server supporting the protocol. A graph depicting the protocol is shown in the Figure C.1.

### C.2 Protocol commands

#### C.2.1 GETPROTOCOL

Initial request to see if client and server speak the same protocol.

---

<sup>\*</sup>This appendix chapter is an updated version of a similar description that is part of the EMU-webApp manual.

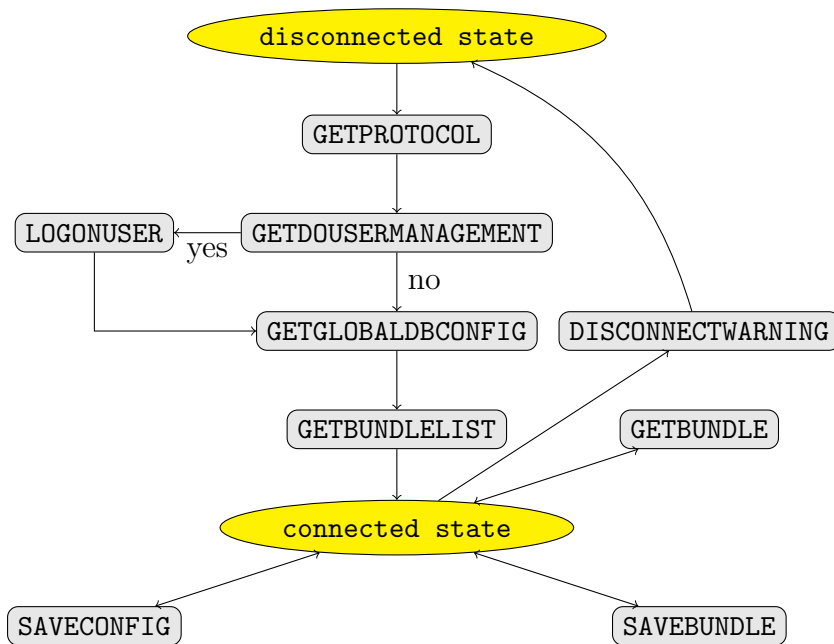

Figure C.1: Schematic of the EMU-webApp-websocket-protocol.

- Request:

Listing C.1: Sent JSON file

```
{  
  'type': 'GETPROTOCOL',  
  'callbackID': 'xxxxxxxx-xxxx-4xxx-yxxx-xxxxxxxxxxxx'  
}
```

- Response:

Listing C.2: Sent JSON file

```
{
  'callbackID': request.callbackID,
  'data': {
    'protocol': 'EMU-webApp-websocket-protocol',
    'version': '0.0.2'
  },
  'status': {
    'type': 'SUCCESS',
    'message': ''
  }
}
```

### C.2.2 GETDOUSERMANAGEMENT

Ask server if it wishes to perform user management (will toggle user login modal window if data is YES).

- Request:

Listing C.3: Sent JSON file

```
{
  'type': 'GETDOUSERMANAGEMENT',
  'callbackID': 'xxxxxxxx-xxxx-4xxx-yxxx-xxxxxxxxxxxx'
}
```

- Response:

Listing C.4: Sent JSON file

```
{
  'callbackID': request.callbackID,
  'data': 'NO'
  'status': {
    'type': 'SUCCESS',
    'message': ''
  }
}
```

### C.2.3 LOGONUSER

Ask server to log user on. Username and password are sent to server (please only use `wss` to avoid password being sent in plain text!). This protocol command is sent by the user login modal window.

- Request:

Listing C.5: Sent JSON file

```
{
  'type': 'LOGONUSER',
  'data': {
    'userName': 'smith',
    'pwd': 'mySecretPwd'
  },
  'callbackID': 'xxxxxxxx-xxxx-4xxx-yxxx-xxxxxxxxxxxx'
}
```

- Response:

Listing C.6: Sent JSON file

```
{
  'callbackID': request.callbackID,
  'data': 'BADUSERNAME' | 'BADPASSWORD' | 'LOGGEDON'
  'status': {
    'type': 'SUCCESS',
    'message': ''
  }
}
```

### C.2.4 GETGLOBALDBCONFIG

Request the `_DBconfig.json` file.

- Request:

Listing C.7: Sent JSON file

```
{
  'type': 'GETGLOBALDBCONFIG',
  'callbackID': 'xxxxxxxx-xxxx-4xxx-yxxx-xxxxxxxxxxxx'
}
```

- Response:

Listing C.8: Sent JSON file

```
{
  'callbackID': request.callbackID,
  'data': configData,
  'status': {
    'type': 'SUCCESS',
    'message': ''
  }
}
```

In the above Listing, `configData` represents the Javascript object that is the `_DBconfig.json` file of the respective database.

### C.2.5 GETBUNDLELIST

Next a `_bundleList.json` is requested containing the available bundles. The information contained in this file is what is displayed in the bundle list side bar. An example of a `_bundleList.json` file is shown in Appendix B.2.1.

- Request:

Listing C.9: Sent JSON file

```
{
  'type': 'GETBUNDLELIST',
  'callbackID': 'xxxxxxxx-xxxx-4xxx-yxxx-xxxxxxxxxxxx'
}
```

- Response:



Listing C.10: Sent JSON file

```
{
  'callbackID': request.callbackID,
  'data': bundleList,
  'status': {
    'type': 'SUCCESS',
    'message': ''
  }
}
```

### C.2.6 GETBUNDLE

After receiving the `_bundleList.json` file by default, the first bundle in the file is requested in the form of a `_bndl.json` file. This request is also sent when the user clicks a bundle in the bundle list side bar of the `EMU-webApp`.

- Request:

Listing C.11: Sent JSON file

```
{
  'type': 'GETBUNDLE',
  'name': 'msajc003',
  'session': '0000',
  'callbackID': 'xxxxxxxx-xxxx-4xxx-yxxx-xxxxxxxxxxxx'
}
```

- Response:

Listing C.12: Sent JSON file

```
{
  'callbackID': request.callbackID,
  'data': bundleData,
  'status': {
    'type': 'SUCCESS',
    'message': ''
  }
}
```

In the Listing above `bundleData` is the Javascript object containing all SSFF files (encoded as a base64 strings) and audio (encoded as a base64 string) and `_annot.json` that are associated with this bundle. An example of `_bndl.json` is given in Appendix B.2.2.

### C.2.7 SAVEBUNDLE

This function should be called if the user saves a loaded bundle (by pushing the save button in the bundle list side bar).

- Request:

Listing C.13: Sent JSON file

```
{
  'type': 'SAVEBUNDLE',
  'data': bundleData,
  'callbackID': 'xxxxxxxx-xxxx-4xxx-yxxx-xxxxxxxxxxxx'
}
```

In the Listing above `bundleData` is a Javascript object that corresponds to a `_bndl.json` file. As currently only annotations and formant tracks can be altered by the `EMU-webApp`, only the `_annot.json` and formant track SSFF file (if applicable) are sent to the server to be saved.

- Response:

Listing C.14: Sent JSON file

```
{
  'callbackID': request.callbackID,
  'status': {
    'type': 'SUCCESS',
    'message': ''
  }
}
```

### C.2.8 DISCONNECTWARNING

Function that tells the server that it is about to disconnect. This is currently needed because the `httpuv` R package cannot listen to the websocket's own "close" event.

- Request:

Listing C.15: Sent JSON file

```
{
  'type': 'DISCONNECTWARNING'
  'callbackID': 'xxxxxxxx-xxxx-4xxx-yxxx-xxxxxxxxxxxx'
}
```

- Response:

Listing C.16: Sent JSON file

```
{
  'callbackID': request.callbackID,
  'status': {
    'type': 'SUCCESS',
    'message': ''
  }
}
```

### C.2.9 Error handling

If an error occurs with any of the request types above, a response should still be sent to the client. The status of this response should be set to **ERROR** and an error message should be given in the message field. This message will then be displayed by the EMU-webApp.

- **ERROR** response:

Listing C.17: Sent JSON file

```
{
  'callbackID': request.callbackID,
  'status': {
    'type': 'ERROR',
    'message': 'An error occurred trying to read a file
               from disk. Please make sure: /path/to/file exists
               or check the config...'
  }
}
```

# Appendix D

## EQL EBNF<sup>\*</sup>

This chapter presents the Extended Backus-Naur Form (EBNF) (Garshol, 2003) that describes version 2 of the EQL. As the original EBNF adapted from John (2012) was written in German, some of the abbreviation terms were translated into English abbreviations (e.g., **DOMA** is the abbreviation for the German term **Dominanzabfrage** and the newly translated **DOMQ** is the abbreviation for the English term **domination query**).

### D.1 Terminal symbols of EQL2 (operators) and their meaning

The terminal symbols described below are listed in descending order by their binding priority.

Symbol	Meaning
#	Result modifier (projection)
,	Parameter list separator
==	Equality (new in version 2 of the EQL; added for cleaner syntax)
=	Equality (optional; for backwards compatibility)
!=	Inequality
=~	Regular expression matching
!~	Regular expression non-matching
>	Greater than
>=	Equal to or greater than
<	Less than

---

<sup>\*</sup>The EBNF presented here is an updated version of the EBNF of the EQL vignette.

Symbol	Meaning
>=	Equal to or less than
	Alternatives separator
&	Conjunction of equal rank
^	Dominance conjunction
->	Sequence operator

## D.2 Terminal symbols of EQL2 (brackets) and their meanings.

Symbol	Meaning
'	Quotes literal string
(	Function parameter list opening bracket
)	Function parameter list closing bracket
[	Sequence or dominance-enclosing opening bracket
]	Sequence or dominance-enclosing closing bracket

## D.3 Terminal symbols of EQL2 (functions) and their meanings.

Symbol	Meaning
Start	Start
Medial	Medial
End	Final
Num	Count

## D.4 Formal description of EMU Query Language Version 2

EBNF term	Abbreviation	Conditions
EQL = CONJQ   SEQQ   DOMQ;	<b>EMU Query Language</b>	

EBNF term	Abbreviation	Conditions
DOMQ = "[" , ( CONJQ   DOMQ   SEQQ ) , "^" , ( CONJQ   DOMQ   SEQQ ) , "]" ;	<b>dominance query</b>	levels must be hierarchically associated
SEQQ = "[" , ( CONJQ   SEQQ   DOMQ ) , "->" , ( CONJQ   SEQQ   DOMQ ) , "]" ;	<b>sequential query</b>	levels must be linearly associated
CONJQ = { "[" } , SQ , { "&" , SQ } , { "]" } ;	<b>conjunction query</b>	levels must be linearly associated
SQ = LABELQ   FUNCQ ;	<b>simple query</b>	
LABELQ = [ "#" ] , LEVEL , ( "="   "=="   "!="   "=~"   "!~" ) , LABELALTERNATIVES ;	<b>label query</b>	
FUNCQ = POSQ   NUMQ ;	<b>function query</b>	
POSQ = POSFCT , "(" , LEVEL , "," , LEVEL , ")" , "=", "0"   "1" ;	<b>position query</b>	levels must be hierarchically associated; second level determines semantics
NUMQ = "Num" , "(" , LEVEL , "," , LEVEL , ")" , COP , INTPN ;	<b>number query</b>	levels must be hierarchically associated; first level determines semantics
LABELALTERNATIVES = LABEL , { " " , LABEL } ;	<b>label alternatives</b>	
LABEL = LABELING   ( "'" , LABELING , "'" ) ;	<b>label</b>	levels must be part of the database structure; LABELING is an arbitrary character string or a label group class configured in the emuDB; result modifier # may only occur once
POSFCT = "Start"   "Medial"   "End" ;	<b>position function</b>	

EBNF term	Abbreviation	Conditions
COP = "="   "=="   "!="   ">"   "<"   "<="   ">=";	comparison operator	
INTPN = "0"   INTP;	integer positive with null	
INTP = DIGIT-"0", { DIGIT };	integer positive	
DIGIT = "0"   "1"   "2"   "3"   "4"   "5"   "6"   "7"   "8"   "9";	digit	

**INFO:** The LABELING term used in the LABEL EBNF term can represent any character string that is present in the annotation. As this can be any combination of Unicode characters, we chose not to explicitly list them as part of the EBNF.

## D.5 Restrictions

A query may only contain a single result modifier # (hashtag).

# Appendix E

## EQL: further examples

Below are examples of query strings that have been adapted from Cassidy and Harrington (2001) and Harrington and Cassidy (2002) and which are displayed as questions and answers. All examples use the *ae* demo `emuDB`, which is provided by the `emuR` package, and were extracted from the EQL vignette of the `emuR` package. Descriptions (some of them duplicates of those in Chapter 5) of the various syntaxes and query components are also included for easier reading. R Example E.0.1 shows how to access the *ae* demo `emuDB`.

### R Example E.0.1

```
# load the package
library(emuR)

# create demo data in directory provided by the tempdir() function
create_emuRdemoData(dir = tempdir())

# get the path to emuDB called 'ae' that is part of the demo data
path2directory = file.path(tempdir(), "emuR_demoData", "ae_emuDB")

# load emuDB into current R session
ae = load_emuDB(path2directory)
```

## E.1 Simple equality, inequality, matching and non-matching queries (single-argument)

The syntax of a simple, equality, inequality, matching and non-matching query is `[L OPERATOR A]` where L specifies a level (or alternatively the name of a parallel



attribute definition), OPERATOR is one of the following operators: == (equality); != (inequality); =~ (matching) or !~ (non-matching), and A is an expression specifying the labels of the annotation items of L.

Example questions and answers:

- **Q:** *What is the query to retrieve all items containing the label “m” in the “Phonetic” level?*

- **A:**

```
query(emuDBhandle = ae,  
      query = "[Phonetic == m]")
```

- **Q:** *What is the query to retrieve all items containing the label “m” or “n” in the “Phonetic” level?*

- **A:**

```
query(emuDBhandle = ae,  
      query = "[Phonetic == m | n]")
```

- **Q:** *What is the query to retrieve all items that do not contain the label “m” or “n”?*

- **A:**

```
query(emuDBhandle = ae,  
      query = "[Phonetic != m | n]")
```

- **Q:** *What is the query to retrieve all items in the “Syllable” level?*

- **A:**

```
query(emuDBhandle = ae,  
      query = "[Syllable =~ .*]")
```

- **Q:** *What is the query to retrieve all items that begin with “a” in the “Text” level?*

- **A:**

```
query(ae, "[Text =~ a.*]")
```

- **Q:** *What is the query to retrieve all items that do not begin with “a” in the “Text” level?*
- **A:**

```
query(ae, "[Text !~ a.*]")
```

The above examples use three operators that are new to the EQL as of version 2. One is the == equal operator, which has the same meaning as the = operator of the EQL version 1 (which is also still available) while providing a cleaner, more precise syntax. The other two are =~ and !~, which are the new matching and non-matching regular expression operators. Further, it is worth noting that the use of parentheses, blanks or characters that represent operands used by the EQL (see EBNF in Appendix D) as part of a label matching string (the string on the right hand side of one of the operands mentioned above), must be placed in additional single quotation marks to escape these characters. For example, searching for the items containing the labels 0\_’ on the Phonetic level could not be written as "[Phonetic == 0\_’]" but would have to be written as "[Phonetic == '0\_’']". Reversing the order of single vs. double quotation marks is currently not supported, that is '[Phonetic == ‘0\_’’]' will currently not work. Hence, to avoid this issue only double quotation marks for the outer wrapping of the query string should be used.

## E.2 Sequence queries using the -> sequence operator

The syntax of a query string using the -> sequence operator is [L == A -> L == B], where item A on level L precedes item B on level L. For a sequential query to work both arguments must be on the same level (alternatively, parallel attribute definitions of the same level may also be chosen).

Example **Q** & **A**’s:

- **Q:** *What is the query to retrieve all sequences of items containing the label “@” followed by items containing the label “n” on the “Phonetic” level?*
- **A:**

```
# NOTE: all row entries in the resulting
# segment list have the start time of "@", the
# end time of "n", and their labels will be "@->n"
query(ae, "[Phonetic == @ -> Phonetic == n]")
```

- **Q:** Same as the question above but this time we are only interested in the items containing the label “@” in the sequences.
- **A:**

```
# NOTE: all row entries in the resulting
# segment list have the start time of "@", the
# end time of "@" and their labels will also be "@"
query(ae, "[#Phonetic == @ -> Phonetic == n]")
```

- **Q:** Same as the first question but this time we are only interested in the items containing the label “n”.
- **A:**

```
# NOTE: all row entries in the resulting
# segment list have the start time of "n", the
# end time of "n" and their labels will also be "n"
query(ae, "[Phonetic == @ -> #Phonetic == n]")
```

### E.2.1 Subsequent sequence queries using nesting of the -> sequence operator

The general strategy for constructing a query string that retrieves subsequent sequences of labels is to nest multiple sequences while paying close attention to the correct placement of the parentheses. An abstract version of such a query string for the subsequent sequence of arguments A1, A2, A3 and A4 would be: [[[A1 -> A2] -> A3] -> A4] -> A5] where each argument (e.g. A1) represents an equality, inequality, matching or non-matching expression on the same level (alternatively, parallel attribute definitions of the same level may also be chosen).

Example questions and answers:

- **Q:** What is the query to retrieve all sequences of items containing the labels “@”, “n” and “s” on the “Phonetic” level?

- A:

```
query(ae, "[[Phonetic == @ -> Phonetic == n] -> Phonetic == s]")
```

- Q: What is the query to retrieve all sequences of items containing the labels “to”, “offer” and “any” on the “Text” level?

- A:

```
query(ae, "[[Text == to -> Text == offer] -> Text == any]")
```

- Q: What is the query to retrieve all sequences of items containing labels “offer” followed by two arbitrary labels followed by “resistance”?

- A:

```
# NOTE: usage of paste0() is optional
# as it is only used for formatting purposes
query(ae, paste0("[[Text == offer -> Text => .*] ",
                 "-> Text => .*] -> Text == resistance]"))
```

As the EQL1 did not have a regular expression operator, users often resorted to using queries such as `[Phonetic != XXX]` (where XXX is a label that was not part of the label set of the *Phonetic* level) to match every label on the *Phonetic* level. Although this is still possible in the EQL2, we strongly recommend using regular expressions as they provide a much clearer and more precise syntax and are less error-prone.

## E.3 Conjunction operator &

The syntax of a query string using the conjunction operator can schematically be written as: `[L == A & L_a2 == B & L_a3 == C & L_a4 == D & ... & L_an == N]`, where items on level L have the label A (technically belonging to the first attribute of that level, i.e., `L_a1`, which per default has the same name as its level) also have the attributes B, C, D, ..., N. As with the sequence operator all expressions must be on the same level (i.e., parallel attribute definitions of the same level indicated by the `a2 - an` may to be chosen).

The conjunction operator is used to combine query conditions on the same level. This makes sense in two cases:

1. when combining different attributes of the same level: "[Phonetic == 1 & sonorant == T]" when *Sonorant* is an additional attribute of level *Phonetic*;
2. when combining a basic query with a function (see sections Position and Count below): "[phonetic == 1 & Start(word, phonetic) == 1]".

Example questions and answers:

- **Q:** What is the query to retrieve all items containing the label "always" in the "Text" attribute definition which also have the label "C" on a parallel attribute definition called "Word"?

- **A:**

```
query(ae, "[Text == always & Word == C]")
```

- **Q:** What is the query to retrieve all items of the attribute definition "Text" of the level "Word" that were also labeled as function words (labeled "F" in the "Word" level)?

- **A:**

```
query(ae, "[Text =~ .* & Word == F]")
```

- **Q:** What is the query to retrieve all items of the attribute definition "Text" of the level "Word" that were also labeled as content words (labeled "C" in the "Word" level) and as accented (labeled "S" in the attribute definition "Accent" of the same level)?

- **A:**

```
query(ae, "[Text =~ .* & Word == C & Accent == S]")
```

## E.4 Domination operator $\hat{\ }^{\wedge}$ (hierarchical queries)

A schematic representation of a simple domination query string that retrieves all items containing label A of level L1 that are dominated by (i.e., are directly or indirectly linked to) items containing the label B in level L2 is [L1 == A  $\hat{\ }^{\wedge}$  L2 == B]. The domination operator is not directional, meaning that either items in L1 dominate items in L2 or items in L2 dominate items in L1. Note that link definitions that specify the validity of the domination have to be present in the emuDB for this to work.

### E.4.1 Simple domination

Example questions and answers:

- **Q:** *What is the query to retrieve all items containing the label “p” in the “Phoneme” level that occur in strong syllables (i.e., dominated by/linked to items of the level “Syllable” that contain the label “S”)?*

- **A:**

```
query(ae, "[Phoneme == p ^ Syllable == S]")
```

- **Q:** *What is the query to retrieve all syllable items which contain a Phoneme item labeled “p”?*

- **A:**

```
query(ae, "[Syllable =~ .* ^ Phoneme == p]")
# or
query(ae, "[Phoneme == p ^ #Syllable =~ .*]")
```

- **Q:** *What is the query to retrieve all syllable items which do not contain a Phoneme item labeled “k” or “p” or “t”?*

- **A:**

```
query(ae, "[Syllable =~ .* ^ Phoneme != p | t | k]")
# or
query(ae, "[Phoneme != p | t | k ^ #Syllable =~ .*]")
```

Even though the domination operator is not directional, what you place to the left and right of the operator does have an impact on the result. If no result modifier (the hash tag #) is used, the query engine will automatically assume that the expression to the left of the operator specifies what is to be returned. This means that the schematic query string `[L1 == A ^ L2 == B]` is semantically equal to the query string `[#L1 == A ^ L2 == B]`. As it is more explicit to mark the desired result we recommend you always use the result modifier where possible.

## E.4.2 Multiple domination

The general strategy when constructing a query string that specifies multiple domination relations of items is to nest multiple domination expressions while paying close attention to the correct placement of the parentheses. A dominance relationship sequence or the arguments A1, A2, A3, A4, can therefore be noted as: "[[[[A1 ^ A2] ^ A3] ^ A4] ^ A5]" where A1 is dominated by A2 and A3 and so on.

Example questions and answers:

- **Q:** *What is the query to retrieve all items on the “Phonetic” level that are part of a strong syllable (labeled “S”) and belong to the words “amongst” or “beautiful”?*

- **A:**

```
# NOTE: usage of R's paste0() function is optional
# as it is only used for formatting purposes
query(ae, paste0("[[#Phonetic =~ .* ^ Syllable == S] ",
                 "^ Text == amongst | beautiful]"))
```

- **Q:** *The same as the question above but this time we want the “Text” items.*

- **A:**

```
# NOTE: usage of R's paste0() function is optional
# as it is only used for formatting purposes
query(ae, paste0("[[Phonetic =~ .* ^ Syllable == S] ",
                 "^ #Text == amongst | beautiful]"))
```

## E.5 Position

The EQL has three function terms to specify where in a domination relationship a child level item is allowed to occur. The three function terms are `Start()`, `End()` and `Medial()`.

### E.5.1 Simple usage of `Start()`, `End()` and `Medial()`

A schematic representation of a query string representing a simple usage of the `Start()`, `End()` and `Medial()` function would be: `"POSFCT(L1, L2) == 1"` or `"POSFCT(L1, L2) == TRUE"`. In this representation POSFCT is a placeholder for

one of the three functions where the level L1 must dominate level L2. The `== 1 / == TRUE` part of the query string indicates that if a match is found (match is `TRUE` or `== 1`), the according item of level L2 is returned. If this expression is set to `== 0 / == FALSE (FALSE)`, all the items that do not match the condition of L2 will be returned. A visualization of what is returned by the various options of the three functions is displayed in Figure 5.4.

As using 1 and 0 for `TRUE` and `FALSE` is not that intuitive to many R users, the EQL version 2 optionally allows for the values `TRUE/T` and `FALSE/F` to be used instead of 1 and 0. This syntax should be more familiar to most R users.

Example questions and answers:

- **Q:** *What is the query to retrieve all word-initial syllables?*

- **A:**

```
query(ae, "[Start(Word, Syllable) == TRUE]")
```

- **Q:** *What is the query to retrieve all word-initial phonemes?*

- **A:**

```
query(ae, "[Start(Word, Phoneme) == TRUE]")
```

- **Q:** *What is the query to retrieve all non-word-initial syllables?*

- **A:**

```
query(ae, "[Start(Word, Syllable) == FALSE]")
```

- **Q:** *What is the query to retrieve all word-final syllables?*

- **A:**

```
query(ae, "[End(Word, Syllable) == TRUE]")
```

- **Q:** *What is the query to retrieve all word-medial syllables?*

- **A:**



```
query(ae, "[Medial(Word, Syllable) == TRUE]")
```

### E.5.2 Position and boolean &

The syntax for combining a position function with the boolean operator is `[L == E & Start(L, L2) == TRUE]`, where item E on level L occurs at the beginning of item L. Once again, L has to dominate L2 (optionally, parallel attribute definitions of the same level may also be chosen).

Example questions and answers:

- **Q:** *What is the query to retrieve all “n” Phoneme items at the beginning of a syllable?*

- **A:**

```
query(ae, "[Phoneme == n & Start(Syllable, Phoneme) == 1]")
```

- **Q:** *What is the query to retrieve all word-final “m” Phoneme items?*

- **A:**

```
query(ae, "[Phoneme == m & End(Word, Phoneme) == 1]")
```

- **Q:** *What is the query to retrieve all non-word-final “S” syllables?*

- **A:**

```
query(ae, "[Syllable == S & End(Word, Syllable) == 0]")
```

### E.5.3 Position and boolean ^

The syntax for combining a position function with the boolean hierarchical operator is `[L == E ^ Start(L1, L2) == 1]`, where level L and level L2 refer to different levels where either L dominates L2, or L2 dominates L.

Example questions and answers:

- **Q:** *What is the query to retrieve all “p” Phoneme items which occur in the first syllable of the word?*

- **A:**

```
query(ae, "[Phoneme == p ^ Start(Word, Syllable) == 1]")
```

- **Q:** *What is the query to retrieve all phonemes which do not occur in the last syllable of the word?*
- **A:**

```
query(ae, "[Phoneme =~ .* ^ End(Word, Syllable) == 0]")
```

## E.6 Count

A schematic representation of a query string using the count mechanism looks like  $[\text{Num}(\text{L1}, \text{L2}) == \text{N}]$ , where L1 contains N items in L2. For this type of query to work, L1 has to dominate L2. As the query matches a number (N), it is also possible to use the operators > (more than), < (less than) and != (not equal). The resulting segment list contains items of L1.

Example questions and answers:

- **Q:** *What is the query to retrieve all words that contain four syllables?*
- **A:**

```
query(ae, "[Num(Word, Syllable) == 4]")
```

- **Q:** *What is the query to retrieve all syllables that contain more than six phonemes?*
- **A:**

```
query(ae, "[Num(Syllable, Phoneme) > 6]")
```

### E.6.1 Count and boolean &

A schematic representation of a query string combining the count and the boolean operators looks like  $[\text{L} == \text{E} \ \& \ \text{Num}(\text{L1}, \text{L2}) == \text{N}]$ , where items E on level L are dominated by L1 and L1 contains N L2 items. Further, L1 dominates L2 on the condition that L and L1 (not L2) refer to the same level (parallel attribute definitions of the same level may also be chosen).

Example questions and answers:

- **Q:** *What is the query to retrieve the “Text” of all words which consist of more than five phonemes?*

- **A:**

```
query(ae, "[Text =~ .* & Num(Text, Phoneme) > 5]")
# or
query(ae, "[Text =~ .* & Num(Word, Phoneme) > 5]")
```

- **Q:** *What is the query to retrieve all strong syllables that contain five phonemes?*

- **A:**

```
query(ae, "[Syllable == S & Num(Syllable, Phoneme) == 5]")
```

### E.6.2 Count and $\wedge$

A schematic representation of a query string combining the count and the boolean operators is  $[L == E \wedge \text{Num}(L1, L2) == N]$  where items E on level L are dominated by L1 and L1 contains N L2 items. Further, L1 dominates L2 on the condition that L and L1 do **not** refer to the same level.

Example questions and answers:

- **Q:** *What is the query to retrieve all “m” phonemes in three-syllable words?*

- **A:**

```
query(ae, "[Phoneme == m ^ Num(Word, Syllable) == 3]")
```

- **Q:** *What is the query to retrieve all “W” syllables in words of three syllables or less?*

- **A:**

```
query(ae, "[Syllable = W ^ Num(Word, Syllable) <= 3]")
```

- **Q:** *What is the query to retrieve all words containing syllables which contain four phonemes?*

- **A:**

```
query(ae, "[Text =~ .* ^ Num(Syllable, Phoneme) == 4]")
```

## E.7 Combinations

### E.7.1 ^ and -> (domination and sequence)

A schematic representation of a query string combining the domination and the sequence operators is  $[[A1 \wedge A2] \rightarrow A3]$ , where A1 and A3 refer to the same level (parallel attribute definitions of the same level may also be chosen).

Example questions and answers:

- **Q:** *What is the query to retrieve all “m” preceding “p” when “m” is part of an “S” syllable?*

- **A:**

```
query(ae, "[[Phoneme == m -> Phoneme =~ p] ^ Syllable == S]")
```

- **Q:** *What is the query to retrieve all “s” preceding “t” when “t” is part of a “W” syllable?*

- **A:**

```
query(ae, "[Phoneme == s -> [Phoneme == t ^ Syllable == W]]")
```

- **Q:** *What is the query to retrieve all “S” syllables, containing an “s” phoneme and preceding an “S” syllable?*

- **A:**

```
query(ae, "[[#Syllable == S ^ Phoneme == s] -> Syllable == S]")
```

- **Q:** *Same question as above but this time we want all “s” items where “s” is part of a “S” syllable and the “S” syllable precedes another “S” syllable.*
- **A:** `"[[Phoneme == s ^ Syllable == S] -> Syllable == S]"` would cause an error as `Phoneme == s` and `Syllable == S` are not on the same level. Therefore, the correct answer is:

```
query(ae, "[[Syllable == S ^ #Phoneme == s] -> Syllable == S]")
```

### E.7.2 ^ and -> and & (domination and sequence and boolean &)

Example questions and answers:

- **Q:** *What is the query to retrieve the “Text” of all words beginning with a “@” on the “Phoneme” level?*
- **A:**

```
# NOTE: usage of paste0() is optional
# as it is only used for formatting purposes
query(ae, paste0("[Text =~ .* ^ Phoneme == @ ",
                 "& Start(Text, Phoneme) == 1]"))
```

- **Q:** *What is the query to retrieve all word-initial “m” items in a “S” syllable preceding “o:”?*
- **A:**

```
# NOTE: usage of paste0() is optional
# as it is only used for formatting purposes
query(ae, paste0("[[Phoneme == m & Start(Word, Phoneme) == 1 ",
                 "-> Phoneme == o:] ^ Syllable == S]"))
```

- **Q:** *Same question as the question above, but this time we want the “Text” items.*
- **A:**

```
# NOTE: usage of paste0() is optional
# as it is only used for formatting purposes
query(ae, paste0("[[Phoneme == m & Start(Word, Phoneme) == 1 ",
                 "-> Phoneme == o:] ^ Syllable == S] ",
                 "^ #Text =~ .*]"))
```

## E.8 A few more questions and answers (because practice makes perfect)

- **Q:** *What is the query to retrieve all “m” or “n” phonemes which occur in the word-medial position?*

- **A:**

```
query(ae, "[Phoneme == m | n & Medial(Word, Phoneme) == 1]")
```

- **Q:** *What is the query to retrieve all “H” phonetic segments followed by an arbitrary segment and then by either “I” or “U”?*

- **A:**

```
# NOTE: usage of paste0() is optional
# as it is only used for formatting purposes
query(ae, paste0("[Phonetic == H -> Phonetic =~ .*] ",
                 "-> Phonetic == I | U]"))
```

- **Q:** *What is the query to retrieve all syllables which do not occur in word-medial positions?*

- **A:**

```
query(ae, "[Syllable =~ .* & Medial(Word, Syllable) == 0]")
```

- **Q:** *What is the query to retrieve the “Text” items of all words containing two syllables?*

- **A:**

```
query(ae, "[Text =~ .* & Num(Text, Syllable) == 2]")
```

- **Q:** *What is the query to retrieve the “Text” items of all accented words following “the”?*

- **A:**

```
query(ae, "[Text == the -> #Text =~ .* & Accent == S]")
```

- **Q:** *What is the query to retrieve all “S” (strong) syllables consisting of five phonemes?*
- **A:**

```
query(ae, "[Syllable = S ^ Num(Word, Phoneme) == 5]")
```

- **Q:** *What is the query to retrieve all “W” (weak) syllables containing a “@” phoneme?*
- **A:**

```
query(ae, "[Syllable == W ^ Phoneme == @]")
```

- **Q:** *What is the query to retrieve all Phonetic items belonging to a “W” (weak) syllable?*
- **A:**

```
query(ae, "[Phonetic =~ .* ^ #Syllable == W]")
```

- **Q:** *What is the query to retrieve “W” (weak) syllables in word-final position occurring in three-syllable words?*
- **A:**

```
# NOTE: usage of paste0() is optional
# as it is only used for formatting purposes
query(ae, paste0("[Syllable == W & End(Word, Syllable) == 1 ",
                 "^ Num(Word, Syllable) == 3]"))
```

- **Q:** *What is the query to retrieve all phonemes dominating “H” Phonetic items at the beginning of a syllable and occurring in accented (“S”) words?*
- **A:**

```
# NOTE: usage of paste0() is optional  
# as it is only used for formatting purposes  
query(ae, paste0("[[Phoneme =~ .* ^ Phonetic == H] ",  
                "^ Start(Word, Syllable) == 1] ^ Accent == S]"))
```

## E.9 Differences to the legacy EMU query language

In this section summarizes the major changes concerning the query mechanics of `emuR` compared to the legacy R package `emu` Version 4.2. This section is mainly aimed at users transitioning to `emuR` from the legacy system.

### E.9.1 Function call syntax

In `emuR` it is necessary to load an `emuDB` into the current R session before being able to use the `query()` function. This is achieved using the `load_emuDB()` function. This was not necessary using the legacy `emu.query()` function.

### E.9.2 Empty result

The `query` function of `emuR` returns an empty segment list (row count is zero) if the query does not match any items. If the legacy EMU function `emu.query()` did not find any matches it, returned an error with the message:

```
## Can't find the query results in emu.query: there may have  
## been a problem with the query command.
```

### E.9.3 The result modifier hash tag #

Compared to the legacy EMU system, which allowed multiple occurrences of the hash tag `#` to be present in a query string, the `query()` function only allows a single result modifier. This ensures that only consistent result sets are returned (i.e., all items belong to a single level). However, if multiple result sets in one segment list are desired, this can easily be achieved by concatenating the result sets of separate queries using the `rbind()` function.



### E.9.4 Interpretation of the hash tag # in conjunction operator queries

#### E.9.5 legacy EMU

```
emu.query(template = "andos1",
          pattern = "*",
          query = "[Text=spring & #Accent=S]")}
```

yielded:

```
## moving data from Tcl to R
## Read 1 records
## segment list from database: andos1
## query was: [Text=spring & #Accent=S]
## labels start end utts
## 1 spring 2288.959 2704.466 msajc094
```

and

```
emu.query(template = "andos1",
          pattern = "*",
          query = "[#Text=spring & #Accent=S]")
```

yielded the identical:

```
## moving data from Tcl to R
## Read 1 records
## segment list from database: andos1
## query was: [#Text=spring & #Accent=S]
## labels start end utts
## 1 spring 2288.959 2704.466 msajc094
```

Hence, the hash tag # had no effect.

#### emuR

```
query(emuDBhandle = andos1,
      query = "[Text == spring & #Accent == S]",
      resultType = "emusegs")
```

```
## segment list from database: andos1
## query was: [Text=spring & #Accent=S]
## labels start end utts
## 1 S 2288.975 2704.475 0000:msajc094
```

Returns the same item but with the label of the hashed attribute definition name. The second legacy example is not a valid `emuR` query (two hash tags) and will return an error message.

```
query(dbName = "andos1",
      query = "[#Text == spring & #Accent == S]")
```

```
## Error in query.database.eql.KONJA(dbConfig, qTrim) :
## Only one hashtag allowed in linear query term: #Text=spring & #Accent=S
```

## E.10 Bugs in legacy EMU function `emu.query()`

### E.10.1 Alternative labels in inequality queries

Example:

### E.10.2 legacy EMU

It appears that the OR operator `|` was mistakenly ignored when used in conjunction with the inequality operator `!=`:

```
emu.query(template = "ae",
          pattern = "*",
          query = "[Text != beautiful | futile ^ Phoneme = u:]")
```

yielded:

```
## moving data from Tcl to R
## Read 4 records
## segment list from database: ae
## query was: [Text!=beautiful|futile ^ Phoneme=u:]
## labels start end utts
## 1 new 475.802 666.743 msajc057
```

```
## 2   futile  571.999 1091.000 msajc010
## 3         to 1091.000 1222.389 msajc010
## 4 beautiful 2033.739 2604.489 msajc003
```

### E.10.3 `emuR`

The query engine of the `emuR` package respects the presence of the OR operator in such queries:

```
query(emuDBhandle = ae,
      query = "[Text != beautiful | futile ^ Phoneme == u:]",
      resultType = "emusegs")
```

```
## segment list from database: ae
## query was: [Text!=beautiful|futile ^ Phoneme=u:]
## labels      start      end      utts
## 1          to 1091.025 1222.375 0000:msajc010
## 2          new  475.825   666.725 0000:msajc057
```

### E.10.4 Errors caused by missing or superfluous blanks or parentheses

Some queries in the legacy EMU system required blanks around certain operators to be present or absent as well as parentheses to be present or absent. If this was not the case the legacy query engine sometimes returned cryptic errors, sometimes crashing the current R session. The query engine of the `emuR` package is much more robust against missing or superfluous blanks or parentheses.

### E.10.5 Order of result segment list

To our knowledge, the order of a segment list in the legacy EMU system was never predictable or explicitly defined. In the new system, if the result type of the `query()` function is set to `"emuRsegs"` the resulting list is ordered by UUID, session, bundle and sample start position. If the parameter `calcTimes` is set to `FALSE` it is ordered by UUID, session, bundle, level, `seq.idx`. If it is set to `"emusegs"` the resulting list is ordered by the fields `utts` and `start`.

### E.10.6 Additional features

- The query mechanics of `emuR` accepts the double equal character string `==` (recommended) as well as the single `=` equal character string as an equal operator.
- The EQL2 is capable of querying labels by matching regular expressions using the `=~` (matching) and `!~` (non-matching) operators. It is worth noting that the regular expression pattern is always meant to consume the entire label string i.e. wrapping the RegEx in `"^RegEx$"` is not necessary. If substring matching is desired this must be formulated explicitly (e.g. `"*substring.*"`)
  - For example: `query("andos1", "Text =~ .*tz.*")`



```

arguments = list(0.0,
                5, 5500,
                0.025, 50),
columnNames = c("fm", "bw")){

tmp1FileName = "tmp.ooTextFile"
tmp2FileName = "tmp.table"

tmp1FilePath = file.path(tempdir(), tmp1FileName)
tmp2FilePath = file.path(tempdir(), tmp2FileName)

# remove tmp files if they already exist
unlink(file.path(tempdir(), tmp1FileName))
unlink(file.path(tempdir(), tmp2FileName))

# generate ooTextFile
praat(command = command,
       input=path,
       arguments = arguments,
       output = tmp1FilePath)

# convert to Table
praat("Down to Table...",
      input = tmp1FilePath,
      arguments = list(F, T, 6, F, 3, T, 3, T),
      output = tmp2FilePath,
      filetype="comma-separated")

# get vals
df = read.csv(tmp2FilePath, stringsAsFactors=FALSE)
df[df == '--undefined--'] = 0

fmVals = df[,c(3, 5, 7, 9, 11)]
fmVals = sapply(colnames(fmVals), function(x){
  as.integer(fmVals[,x])
})
colnames(fmVals) = NULL
bwVals = data.matrix(df[,c(4, 6, 8, 10, 12)])
bwVals = sapply(colnames(bwVals), function(x){
  as.integer(bwVals[,x])
})

```

```

    })
    colnames(bwVals) = NULL

    # get start time
    startTime = df[1,1]

    # create AsspDataObj
    ado = list()

    attr(ado, "trackFormats") =c("INT16", "INT16")

    if(arguments[[1]] == 0){
      sR = 1 / (0.25 * arguments[[4]])
    }else{
      sR = 1 / arguments[[1]]
    }

    attr(ado, "sampleRate") = sR

    tmpObj = read.AsspDataObj(path)
    attr(ado, "origFreq") = attr(tmpObj, "sampleRate")

    attr(ado, "startTime") = startTime

    attr(ado, "startRecord") = as.integer(1)

    attr(ado, "endRecord") = as.integer(nrow(fmVals))

    class(ado) = "AsspDataObj"

    AsspFileFormat(ado) <- "SSFF"
    AsspDataFormat(ado) <- as.integer(2)

    ado = addTrack(ado, columnNames[1], fmVals, "INT16")

    ado = addTrack(ado, columnNames[2], bwVals, "INT16")

    return(ado)
  }

```

```
#####
# Use of function on 'ae' emuDB
library(emuR)

# create demo data in tempdir()
create_emuRdemoData(tempdir())

# create path to demo database
path2ae = file.path(tempdir(), "emuR_demoData", "ae_emuDB")

# list all .wav files in the ae emuDB
paths2wavFiles = list.files(path2ae, pattern = "*.wav$",
                             recursive = TRUE, full.names = TRUE)

# loop through files
for(fp in paths2wavFiles){
  ado = PraatToFormants2AsspDataObj(fp)
  newPath = paste0(file_path_sans_ext(fp), '.praatFms')
  # print(paste0(fp, ' -> ', newPath)) # uncomment for simple log
  write.AsspDataObj(ado, file = newPath)
}

# load emuDB
ae = load_emuDB(path2ae, verbose = FALSE)

# add SSFF track definition
add_ssffTrackDefinition(ae,
                         name = "praatFms",
                         columnName = "fm",
                         fileExtension = "praatFms")

# test query + get_trackdata
s1 = query(ae, "Phonetic == n")

td = get_trackdata(ae, s1, ssffTrackName = "praatFms", verbose = F)
```



# Disclosure of pre-published data

For full disclosure, the author of this thesis has been among the authors of the following works: Winkelmann et al. (2017); Winkelmann and Raess (2014); Winkelmann (2015); Reichel et al. (2009); Reichel and Winkelmann (2010); Winkelmann and Jänsch (2015)

# Zusammenfassung

Diese Dokumentation beschreibt die neu entwickelte EMU Speech Database Management System (EMU-SDMS) Softwaresuite, welche es Sprach- und Sprechwissenschaftlern ermöglicht, Sprachdatenbanken innerhalb der Statistiksoftwareumgebung R (R Core Team, 2016) zu bearbeiten und zu analysieren ohne dabei weitere externe Softwarekomponenten verwenden zu müssen. Eines der Hauptziele der Neuentwicklung war, eine Softwarelösung zu implementieren, welche die Notwendigkeit, mit einer Vielzahl an nicht interoperablen Tools arbeiten zu müssen, auf eine sehr begrenzte Anzahl von interoperablen Tools zu reduzieren. Da es in den letzten Jahren den deutlichen Trend unter Sprach- und Sprechwissenschaftlern gab, R für statistische Analysen zu verwenden, bot es sich an, EMU-SDMS vollständig in R zu integrieren. Dies ermöglicht es, Sprachdatenbanken innerhalb derselben Umgebung zu erstellen, zu annotieren, zu manipulieren und zu analysieren (einschließlich der statistischen Analyse).

Das EMU-SDMS besteht aus drei Softwarekomponenten: `emuR`, `wrassp` und der GUI Komponente `EMU-webApp`. Bei den Komponenten `emuR` sowie `wrassp` handelt es sich um R Pakete, welche sich über den normalen R Paket Installationsmechanismus (`install.packages("emuR")`) installieren lassen. Die GUI Komponente `EMU-webApp` wurde als Web-Applikation implementiert, wodurch sie in jedem modernen, HTML5 kompatiblen Browser läuft und nicht explizit installiert werden muss. Eine weitere Komponente des neuen EMU Systems ist das neue Datenbankformat `emuDB`. Die Neuentwicklung des `emuDB` Formats war vonnöten, da bisherige Formate den Ansprüchen des EMU Systems an Dateistrukturierung und Annotationsstrukturmodellierung nicht genügten. Bei dem neuen Format handelt es sich um ein standardisiertes, dateibasiertes Format, welches als allgemeines und flexibles Speicherformat für Sprachkorpora verwendet werden kann.

Die vorliegende Arbeit ist in vier Teile untergliedert: Überblick inklusive Tutorial (Teil I); Zentrale Konzepte und Hauptkomponenten (Teil II); Hauptfunktionen und zentrale Objekte des `emuR` Pakets (Teil III); Implementierung (Teil IV). Der erste Teil verschafft dem Benutzer einen Überblick über die Fähigkeiten des neuen Systems. Des Weiteren skizziert es die EMU-SDMS Arbeitsweise mit Sprachdatenbanken und beschreibt die Alleinstellungsmerkmale des neuen Systems. Um den

Benutzer kurz und pragmatisch in das neue System einzuführen, widmet sich das nächste Kapitel des ersten Teils der Forschungsfrage: “Gegeben eine entsprechend annotierte Sprachdatenbank ist vorhanden. Wie beeinflusst der Silbentyp (starke vs. schwache Silben) die Vokalhöhe (gemessen anhand des ersten Formanten)?”. Die Beantwortung dieser Frage wird inklusive Datenexploration, Datenaufbereitung und einer einfachen statistischen Analyse durchexerziert und entspricht damit einer praktischen Einführung in das neue System.

Der zweite Teil beinhaltet sechs Kapitel, wobei sich drei dieser Kapitel den zentralen Konzepten des neuen Systems widmen: Der Annotationsstrukturmodellierung (Kapitel 3), der Abfrage von Annotationsstrukturen (Kapitel 5) und der Signalextraktion für abgefragte Segmente (Kapitel 6). Die drei weiteren Kapitel beinhalten detaillierte Beschreibungen des `emuDB` Formats (Kapitel 4), des `wrassp` Pakets (Kapitel 7) und der `EMU-webApp` (Kapitel 8). Alle Kapitel des zweiten Teils geben mittels einer Vielzahl an praktischen Beispielen einen tieferen Einblick in die zentralen Konzepte und die Umgangs- und Arbeitsweise mit den einzelnen Komponenten.

Der dritte Teil der vorliegenden Arbeit dient dem Benutzer als Nachschlagewerk der wichtigsten Funktionen und Objekte des `emuR` Pakets. Da das `emuR` Paket eine zentrale Komponente des EMU-SDMS darstellt, gibt es dem Benutzer die Möglichkeit, schnell die relevanten Funktions- oder Objektbeschreibungen zu finden. Um die Navigation zu erleichtern, ist dieser Teil in konzeptuell zusammenhängende Themenbereiche gegliedert.

Die ersten drei Teile der vorliegenden Arbeit richten sich vor allem an den Benutzer der EMU-SDMS in der praktischen Arbeit. Der vierte Teil gibt darüberhinaus einen tieferen Einblick in die technischen Implementationsdetails. Die drei Kapitel dieses Teils beschreiben die Implementationsstrategie der Query-Engine (Kapitel 10), des `wrassp` Pakets (Kapitel 11) und der `EMU-webApp` (Kapitel 12). Diverse Anhänge liefern unter anderem weitere Beispiele und Dateiformatbeschreibungen.

Das EMU-SDMS bietet eine Vielzahl an Möglichkeiten in R mit Sprachdatenbanken zu arbeiten. Zusammenfassend dient die vorliegende Arbeit als Anleitung und Dokumentation zu diesem neuen Softwaretoolset.

# Bibliography

- Abercombie, D. (1967). *Elements of general phonetics*. Aldine Pub. Company.
- Beckman, M. E. and Ayers, G. (1997). Guidelines for ToBI labelling. *The OSU Research Foundation*, 3.
- Bird, S. and Liberman, M. (2001). A formal framework for linguistic annotation. *Speech communication*, 33(1):23–60.
- Boersma, P. and Weenink, D. (2016). Praat: doing phonetics by computer (Version 6.0.19). <http://www.fon.hum.uva.nl/praat/>.
- Bombien, L. (2011). *Segmental and prosodic aspects in the production of consonant clusters: On the goodness of clusters*. PhD thesis, München, Univ., Diss., 2011.
- Bombien, L., Cassidy, S., Harrington, J., John, T., and Palethorpe, S. (2006). Recent developments in the Emu speech database system. In *Proc. 11th SST Conference Auckland*, pages 313–316.
- Cassidy, S. (2013). The Emu Speech Database System Manual: Chapter 9. Simple Signal File Format. <http://emu.sourceforge.net/manual/chap.ssff.html>.
- Cassidy, S. and Harrington, J. (1996). Emu: An enhanced hierarchical speech data management system. In *Proceedings of the Sixth Australian International Conference on Speech Science and Technology*, pages 361–366.
- Cassidy, S. and Harrington, J. (2001). Multi-level annotation in the Emu speech database management system. *Speech Communication*, 33(1):61–77.
- Coleman, J. and Local, J. (1991). The “no crossing constraint” in autosegmental phonology. *Linguistics and Philosophy*, 14(3):295–338.
- Conway, J., Eddelbuettel, D., Nishiyama, T., Prayaga, S. K., and Tiffin, N. (2016). *RPostgreSQL: R interface to the PostgreSQL database system*. R package version 0.4-1 package version 0.4-1.

- Draxler, C. and Jänsch, K. (2004). SpeechRecorder - a Universal Platform Independent Multi-Channel Audio Recording Software. In *Proc. of the IV. International Conference on Language Resources and Evaluation*, pages 559–562, Lisbon, Portugal.
- Fromont, R. and Hay, J. (2012). LaBB-CAT: An annotation store. In *Australasian Language Technology Association Workshop 2012*, volume 113. Citeseer.
- Garshol, L. M. (2003). BNF and EBNF: What are they and how do they work. *acedida pela última vez em*, 16.
- Google (2014). AngularJS. <http://angularjs.org/>.
- Harrington, J. (2010). *Phonetic analysis of speech corpora*. John Wiley & Sons.
- Harrington, J. and Cassidy, S. (2002). The emu-query language (anhang).
- Harrington, J., Cassidy, S., Fletcher, J., and Mc Veigh, A. (1993). The mu+ system for corpus based speech research. *Computer Speech & Language*, 7(4):305–331.
- Hipp, D. R. and Kennedy, D. (2007). Sqlite. <https://www.sqlite.org/>.
- Ide, N. and Romary, L. (2004). International standard for a linguistic annotation framework. *Natural language engineering*, 10(3-4):211–225.
- ISO (2012). Language resource management — Linguistic annotation framework (laf). ISO 24612:2012, International Organization for Standardization, Geneva, Switzerland.
- John, T. (2012). *Emu speech database system*. PhD thesis, Ludwig Maximilian University of Munich.
- Kisler, T., Schiel, F., Reichel, U. D., and Draxler, C. (2015). Phonetic/linguistic web services at BAS. ISCA.
- Kisler, T., Schiel, F., and Sloetjes, H. (2012). Signal processing via web services: the use case WebMAUS. In *Proceedings Digital Humanities 2012, Hamburg, Germany*, pages 30–34, Hamburg.
- Knuth, D. E. (1968). The Art of Computer Programming Vol. 1, Fundamental Algorithms. *Addison-Wesley, Reading, MA*, 9:364–369.
- McAuliffe, M. and Sonderegger, M. (2016). Speech Corpus Tools (SCT). <http://speech-corpus-tools.readthedocs.io/>.

- Ooms, J. (2014). The jsonlite package: A practical and consistent mapping between json data and r objects. *arXiv:1403.2805 [stat.CO]*.
- R Core Team (2016). *R: A Language and Environment for Statistical Computing*. R Foundation for Statistical Computing, Vienna, Austria. ISBN 3-900051-07-0.
- R Special Interest Group on Databases (R-SIG-DB), Wickham, H., and Müller, K. (2016). *DBI: R Database Interface*. R package version 0.4.
- Reichel, U. D., Kleber, F., and Winkelmann, R. (2009). Modelling similarity perception of intonation. In *Proc. 10th Interspeech*, pages 1711–1714, Brighton.
- Reichel, U. D. and Winkelmann, R. (2010). Removing micromelody from fundamental frequency contours. In *Proc. 5th Speech Prosody Conference*, Chicago. 100923:1-4.
- Rivest, R. (1992). The md5 message-digest algorithm. <https://tools.ietf.org/html/rfc1321>.
- Rose, Y., MacWhinney, B., Byrne, R., Hedlund, G., Maddocks, K., O'Brien, P., and Wareham, T. (2006). Introducing phon: A software solution for the study of phonological acquisition. In *Proceedings of the... Annual Boston University Conference on Language Development. Boston University Conference on Language Development*, volume 2006, page 489. NIH Public Access.
- RStudio and Inc. (2015). *httpuv: HTTP and WebSocket Server Library*. R package version 1.3.3.
- Shue, Y.-L., P., K., C., V., and K., Y. (2011). VoiceSauce: A program for voice analysis. In *Proceedings of the ICPHS*, volume XVII, pages 1846–1849.
- Wells, J. C. et al. (1997). Sampa computer readable phonetic alphabet. *Handbook of standards and resources for spoken language systems*, 4.
- Wickham, H., James, D. A., and Falcon, S. (2014). *RSQLite: SQLite Interface for R*. R package version 1.0.0.
- Winkelmann, R. (2015). Managing speech databases with emuR and the EMU-webApp. In *Proceedings of the Sixteenth Annual Conference of the International Speech Communication Association*, volume 1, pages 2611–2612.
- Winkelmann, R., Harrington, J., and Jänsch, K. (2017). EMU-SDMS: Advanced speech database management and analysis in R. *Computer Speech & Language*, pages –.

- Winkelmann, R. and Jänsch, K. (2015). The new R library for the Emu Speech Database System. <https://github.com/IPS-LMU/emuR>.
- Winkelmann, R. and Raess, G. (2014). Introducing a Web Application for Labeling, Visualizing Speech and Correcting Derived Speech Signals. In Calzolari (Conference Chair), N., Choukri, K., Declerck, T., Loftsson, H., Maegaard, B., Mariani, J., Moreno, A., Odijk, J., and Piperidis, S., editors, *Proceedings of the Ninth International Conference on Language Resources and Evaluation (LREC'14)*, Reykjavik, Iceland. European Language Resources Association (ELRA).
- Winkelmann, R. and Raess, G. (2015). EMU-webApp. <http://ips-lmu.github.io/EMU-webApp/>.
- Wittenburg, P., Brugman, H., Russel, A., Klassmann, A., and Sloetjes, H. (2006). Elan: a professional framework for multimodality research. In *Proceedings of LREC*, volume 2006.
- Zipser, F. and Romary, L. (2010). A model oriented approach to the mapping of annotation formats using standards. In *Workshop on Language Resource and Language Technology Standards, LREC 2010*, La Valette, Malta.