



INTEGRATED USER-FRIENDLY ENVIRONMENT FOR A 2-D NONLINEAR ANALYSIS PROGRAM

Hugo Rodrigues¹, Xavier Romão¹, Aníbal Costa² and Humberto Varum³
Department of Civil Engineering, University of Aveiro, Aveiro, Portugal

Received 8 August 2009

Revised 30 November 2009

Accepted 3 December 2009

Nonlinear analyses allow simulating, in a more realistic way, the behaviour of structures subjected to several types of complex loading conditions such as earthquakes. However, it is recognized that these analyses normally generate a considerable amount of results, a factor that difficult its interpretation. Over the last years, considerable progresses have been made in structural nonlinear behaviour modelling, associated to the fast growing development of numerical algorithms and computer capacities. Therefore, a number of computational analysis tools have been developed to meet the analysis requirements from the behaviour viewpoint. However, a similar growth in the development of graphical results visualization tools has not been witnessed and the generalized use of such analysis programs is thus made difficult. To face this, a graphical processor called VISUALANL was developed for an existing nonlinear analysis program for plane frame structures. To observe the potentialities of such tool, an application example is presented illustrating both previously referred stages.

Keywords: graphical interface, engineering software, structural analysis, nonlinear models

1. Introduction

The widespread of performance-based earthquake engineering methodologies has placed an emphasis on simulation of the nonlinear response of structural systems under earthquake loading (Filippou and Fenves, 2004). As severe ground shaking is expected to lead a structure into the inelastic range of the material behaviour through multiple excursions, adequate numerical tools

¹ Ph.D. Student

² Professor

³ Associate Professor

Correspondence to: Dr. Humberto Varum, Department of Civil Engineering, University of Aveiro, 3810-193, Aveiro, Portugal, E-mail: hvarum@ua.pt

are necessary to adequately perform numerical simulations of such phenomena. Moreover, the design of structural systems acknowledges the development of plastic hinges in frame members and state of the art seismic design codes (CEN, 2004 and FEMA-440, 2005) support the use of nonlinear (static or dynamic) analysis for both design and structural assessment purposes, suggesting nonlinear analyses as the reference analysis type to be used in capacity evaluation and verification of structural safety.

Numerical modelling is a powerful technique for the solution of complex engineering problems. One of the significant requirements in the design of a scientific computing program is the ability to store, retrieve, and process data that maybe complex and varied. To the users of such a program, it is important not only to have a powerful solver, but also to work in a convivial graphical interface environment (Feng *et al.*, 2004). Numerous specialized programs have been developed over the years to perform nonlinear analysis of structures under earthquake loading, see (Prakash *et al.*, 1993; Varum, 1996; Carr, 1998; McKenna *et al.*, 2000; SEISMOSOFT, 2004) among others. However, most of these programs lack a proper graphical user interface (GUI). Although for the scientific and academic communities this might not be seen as a considerable downside, it still creates important barriers to the use of such programs by the general practitioners community who is asked to perform more complex (nonlinear) analyses without much guidance.

To normal users of any software, effective graphical interface for both the pre- and post-processors is needed. A number of tasks, such as constructing geometries, discretizing domains, applying loads and constraints, performing analyses, and displaying solutions, must be simple and easy for users (Phongthanapanich and Dechaumphai, 2006). Data input for most of the programs lacking GUIs is carried out through extensive text files that must follow a pre-defined sequence. Result output is also, in most cases, presented in long text files, without any or with poor graphical visualization possibilities.

These two key aspects (data input and result output) are fundamental issues that must be addressed so the realms of the more complex nonlinear structural analysis under earthquake loading particularities can be identified and understood by the practitioners community. To face this situation and to meet some of the current code requirements, a GUI tool called VISUALANL was developed to provide a user front-end for an existing nonlinear dynamic analysis program for plane frames, PORANL (Varum, 1996). By using VISUALANL, introduction and modification of the structural data is made easier due to interactivity and immediate visualization of the data input. Graphical representation at run-time is also possible using dialogue windows. Moreover, it should be also noted that the development of this graphical tool was carried in order to allow the user to input the data without having to follow a pre-defined rigid sequence. In terms of results

output, the program supplies a set of graphical representations able to provide an easier visualization suited for different needs.

The development of VISUALANL, which incorporates the necessary aspects for preparation, manipulation and visualization of a structural analysis problem, that may consider material nonlinearity and dynamic behaviour, was carried out in the programming language Visual Basic, version 6.0 (see for example: Thayer, 1999) that enables an easy implementation of the necessary graphical concepts and tools.

Besides highlighting the potentialities of the graphical processor VISUALANL at the levels of data generation and results visualization, this article briefly describes the structural models available in the program PORANL and presents an application example where the potentialities of VISUALANL can be observed.

The resulting graphical interface is applicable to all stages of the design process and would proffer several benefits already pointed by other authors (Anumba, 1996): (1) minimisation of input; (2) reduction in the potential for errors; (3) greater overall functionality; (4) improved coordination; (5) increased data integrity; (6) improved efficiency in terms of time and cost.

2. Available Models in Program PORANL

To understand more clearly the benefits provided by a tool such as VISUALANL, when performing complex nonlinear analyses, a brief description of the structural models implemented in PORANL is presented in the following.

2.1. Structural Behaviour Models

The initial version of the nonlinear analysis program PORANL, in which a hysteretic behaviour model suited for seismic analysis was implemented, was first developed by (Varum, 1996). The referred nonlinear model implemented is the Costa-Costa model (Costa and Costa, 1987; CEB-231, 1996) which is a modified Takeda hysteretic model suited for seismic analysis of reinforced concrete (RC) frame elements predominantly subjected to bending.

The structural member modelling strategy associated to this hysteretic model considers that inelastic deformations are concentrated in the vicinity of the member's extremities, where nonlinear behaviour is expected under earthquakes. Each structural element is a macro-element subdivided into three sub-elements (as represented in Figure 1), namely a central sub-element with linear elastic behaviour, connected at each end to a sub-element with nonlinear behaviour (the plastic hinge). The behaviour of each plastic hinge under cyclic loading is represented by the referred hysteretic model. This model enables the numerical simulation of several known behaviour characteristics of members subjected to earthquake-type loading, namely: (1) stiffness

degradation with load reversals; (2) strength degradation due to cycling loading; (3) pinching effects accounting for the importance of shear forces; (4) slipping effects accounting for reinforcement slippage; (5) the possibility to define different monotonic envelopes for positive and negative bending, thus accounting for the potential asymmetry of the reinforcement. The reader is referred to CEB-231 (1996) for a more detailed description of these effects.

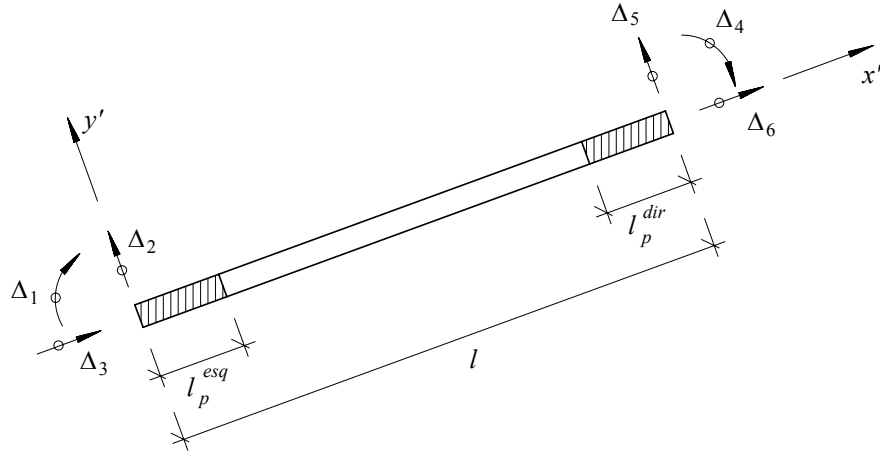

Figure 1. Macro-element of a structural member

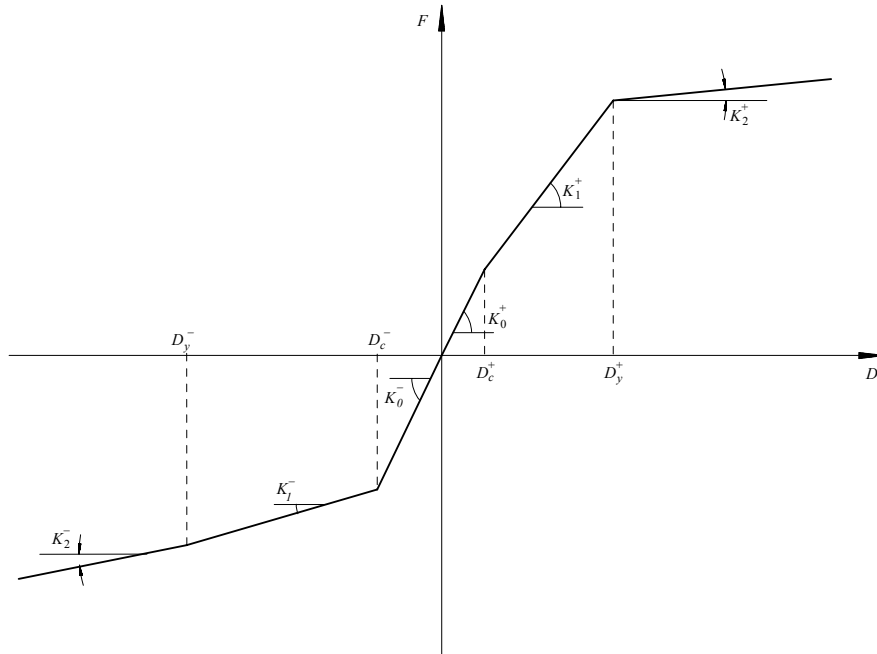

Figure 2. Monotonic behaviour envelope for RC cross sections under bending

The behaviour of each plastic hinge under monotonic loading is represented by a tri-linear moment-curvature envelope, Figure 2, for each bending direction, thus, as stated, allowing the analysis of asymmetric RC cross sections. The trilinear envelope curve is defined by the following nine parameters (Figure 2): K_0 (initial bending stiffness), K_1^+ and K_1^- (post-cracking

stiffness for positive and negative bending, respectively), K_2^+ and K_2^- (post-yield stiffness for positive and negative bending, respectively), D_c^+ and D_c^- (cracking curvatures for positive and negative bending, respectively), D_y^+ and D_y^- (yield curvatures for positive and negative bending, respectively). In addition, three parameters, α , γ and β , must also be set to define the stiffness degradation effect, the strength degradation effect and the pinching and slipping effects, respectively.

The referred trilinear moment-curvature envelopes of RC cross sections can be obtained using a common fibre model approach as the one implemented in the program BIAX developed by (Vaz, 1993). In order to be able to use this program without the user having to leave VISUALANL and run a different application (also developed without a GUI), a special toolbox was developed, and integrated in VISUALANL, that runs as a front-end for the BIAX program Figure 3.

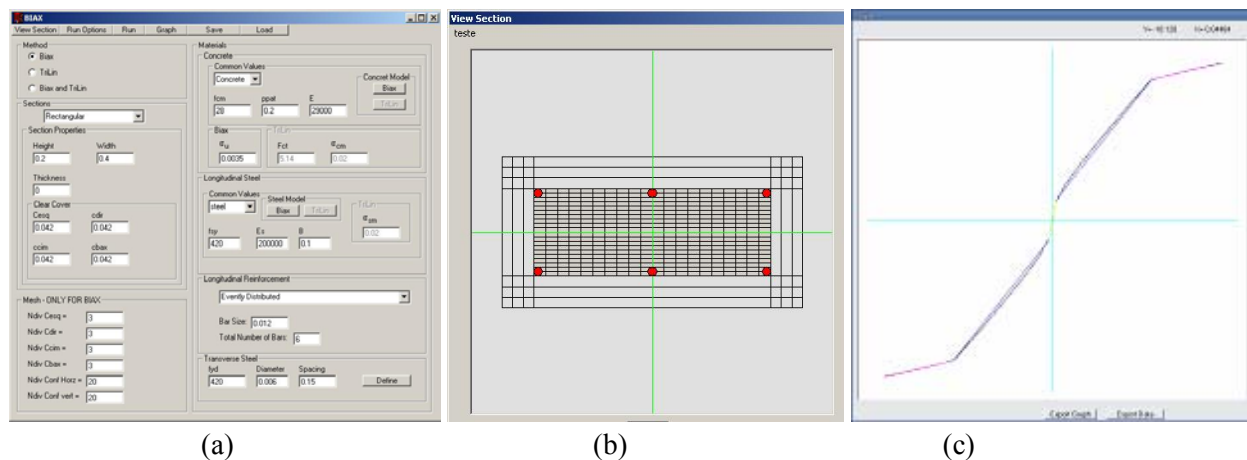

Figure 3. Graphical interface for the fiber model: a) Data generation; b) Section visualization; c) Nonlinear monotonic envelope

In the fibre model approach, the cross sections are divided into slices (in the case of a section under uniaxial bending) or filaments (in the case of a section under biaxial bending), as represented in the Figure 4. Usually, both slices and filaments are generally termed fibres. Sections are then discretized into steel, unconfined and confined concrete fibres that only have nonlinear uniaxial behaviour. The section's global constitutive behaviour is therefore obtained from the integration of the uniaxial behaviour of the individual fibres. However, this approach is only able to consider linear effects of shear strains across the section. The basic assumptions that cross sections remain plane after deformation and that only small deformations take place are also assumed and generally accepted for the problems under analysis. Fibre modelling allows for the calculation of the field of axial strains in the section by equilibrium as a function of the axial strains and curvatures. Based on the deformation of each fibre, the stress at each fibre can be

obtained from the stress-strain relation of its material. Then, integrating the stress field across the cross section yields the internal forces.

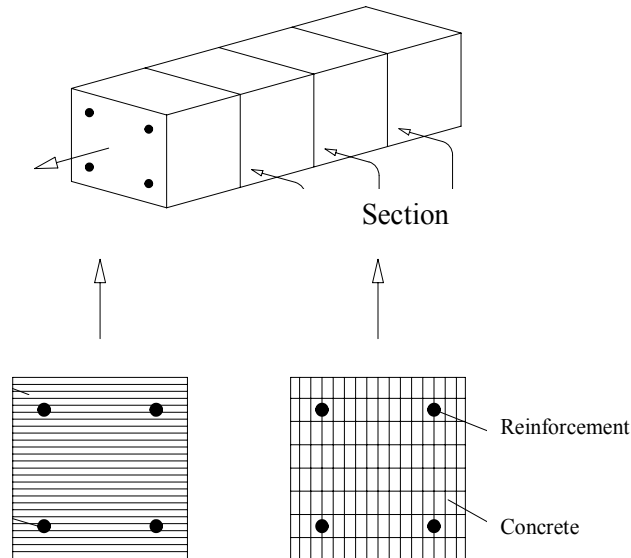

Figure 4. Fibre model definition for RC elements

2.2. Damage Model

Characterization and quantification of structural damage is essential for the structural response assessment of buildings under earthquake loading. The definition of a damage measure and corresponding quantification gives an important contribution for the objective interpretation of nonlinear analysis results. In practical terms, a damage measure indicates how close a specific structural member is from one limit-state such as, for example, collapse. Several damage models have been developed for RC structures to allow the quantification of damage induced by earthquakes (Williams and Sexsmith, 1995). Most of these damage models define indices that can be calculated using the results of nonlinear dynamic analyses.

When subjected to earthquakes, RC structures are generally damaged by a combination of repeated stress reversals and high stress excursions. Therefore, damage definition solely in terms of one factor is often inadequate. The so-called combined damage models (Park and Ang, 1985) are a very commonly used class of damage model formulation for assessment of structural behaviour under earthquake loading. Normally, this type of damage index combines two terms. The first term represents a measure of maximum structural deformation and the second represents a measure of the energy dissipation through hysteretic behaviour. One of the most widely used combined damage formulations is the Park and Ang model (Park and Ang, 1985). This damage index is defined by a linear combination of the normalized maximum deformation and the

normalized hysteretic energy dissipation resulting from cyclic loading. The damage index, DI is therefore defined by Equation (1):

$$DI = \frac{\varphi_{max}}{\varphi_u} + \psi \frac{\int dE}{M_y \cdot \varphi_u} \quad (1)$$

where φ_{max} is the maximum curvature demand of the structural member, φ_u is the ultimate curvature, $\int dE$ is the dissipated hysteretic energy, M_y is the yielding moment of the member and ψ is a degradation parameter that represents the influence of cyclic behaviour in the damage process and is a function of structural parameters (Bento, 1996). A value of $DI \geq 1$ represents total damage (collapse). This damage index is usually calculated for the end zones of the structural members, where, as previously referred, inelastic behaviour is expected under earthquake loads. Global damage of a structure is commonly assumed as being the result of the combination of local damage measures. Therefore, the global damage DI_G of a structure can be obtained by averaging the local damage indices weighed by the energy dissipated through hysteresis of each member by Equation (2):

$$DI_G = \frac{\sum_{i=1}^n DI_i \cdot \int dE_i}{\sum_{i=1}^n \int dE_i} \quad (2)$$

where n is the number of structural members having nonlinear behaviour.

2.3. Infill Masonry Model

It is a common misconception that masonry infills in structural RC frames can only increase the overall lateral load capacity, and therefore, must always be beneficial to seismic performance. Even relatively weak, masonry infills can drastically modify the global stiffness of the structure and, consequently, the structural response, attracting forces to parts of the structure that have not been designed to resist them (Paulay and Priestley, 1992). Recent earthquakes showed numerous examples of severe damage or collapse in buildings due to structural response modification induced by the so-called non-structural masonry partitions and infill panels.

A hysteretic model for the simulation of the cyclic behaviour of infill masonry panels based on the equivalent truss model, as presented in the Figure 5(a), was recently implemented in the program PORANL (Rodrigues et al., 2005; Rodrigues et al., 2004). In this model, each infill panel is represented by diagonal trusses with linear behaviour and a central element that simulates the nonlinear behaviour of the infill panel. The nonlinear behaviour of each panel defined by the central element is simulated by a hysteretic model, contemplating important effects, such as: (1) stiffness degradation with load reversals; (2) strength degradation due to cycling loading; (3) pinching and slipping effects accounting for the influence of shear forces.

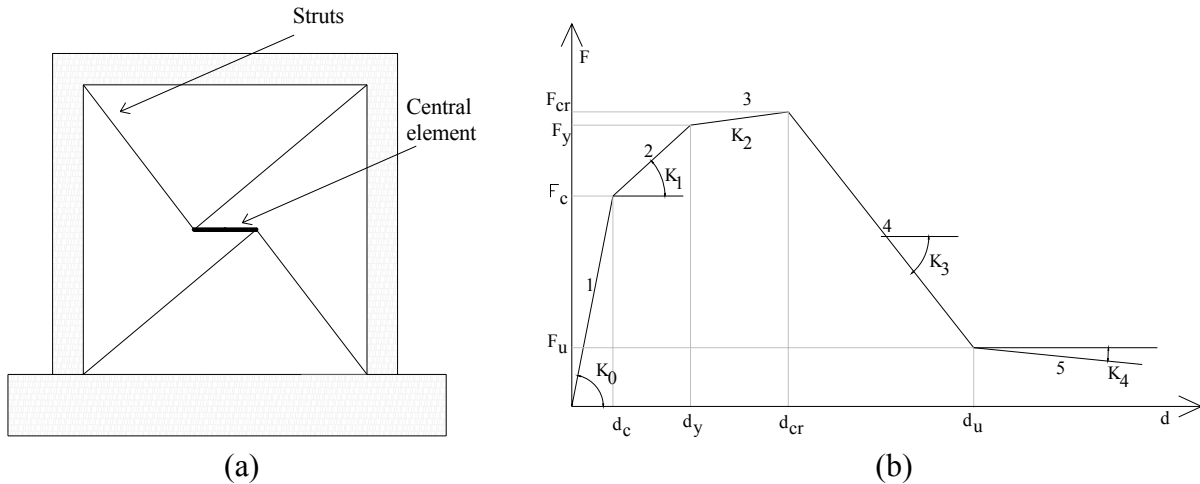

Figure 5. a) Equivalent truss model for infill panels; b) Monotonic behaviour envelope for the infill panel element

The monotonic behaviour of the panels is characterised by a piecewise-linear envelope with five branches for each loading direction, as represented in Figure 5(b), thus allowing for the analysis of infill panels with non-symmetrical behaviour e.g., a panel with a non-centred opening. In addition to the 17 parameters needed for the definition of the piecewise-linear monotonic envelope, it is also necessary to define three additional parameters, α_{inf} , γ_{inf} and β_{inf} , accounting for stiffness degradation, strength degradation and pinching and slipping effects, respectively.

3. Pre-Processing Data with VISUALANL

As previously referred, the graphical framework VISUALANL integrates both pre and post-processing operations, necessary to carry out a structural analysis run. The basic steps of data input using this new interface, namely, definition of geometry, constraints, loads, material characteristics (for members having linear or nonlinear behaviour) are described in the following. Description of the pre-processor steps will be carried out in a logical sequence for the definition of a structural problem. However, as previously referred, one of the major advantages of VISUALANL is the possibility of data definition without following to a rigid sequence.

3.1. Geometry of the Structure

The geometry of the structure can be defined in two different ways (see Figure 6): (1) defining an initial support mesh for the structure's geometry, establishing the number of storeys and bays, and corresponding dimensions; (2) importing a DXF file with the complete structural geometry. After selecting one of the previously referred forms for geometry definition, the user is able to change the length of a bay or the height of a storey, add or delete frame members or change the coordinates of the nodes.

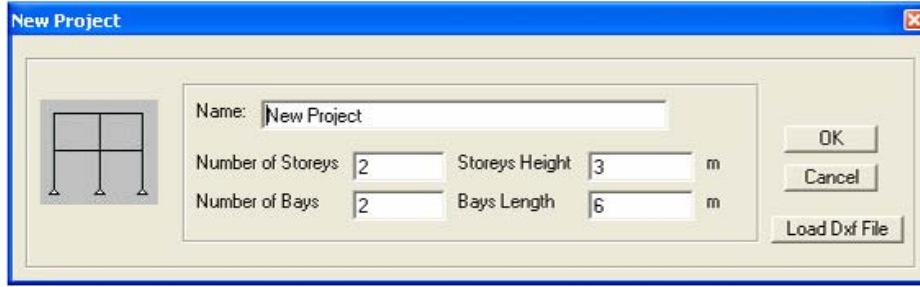
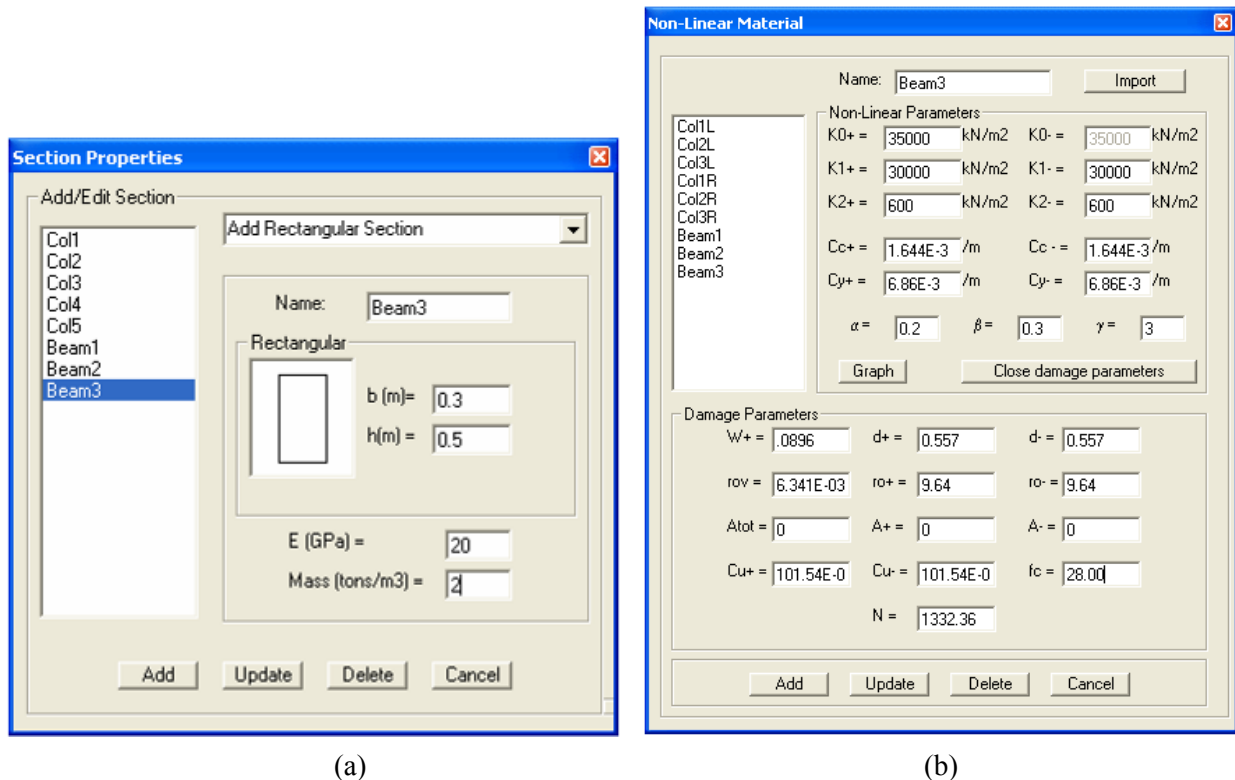

Figure 6. Input of the geometry of the structure

3.2. Sections with Linear and Nonlinear Behaviour

As stated previously, each structural element having nonlinear behaviour is modelled with three sub-elements: a central element with linear behaviour and two sub-elements in the vicinity of the joints with nonlinear behaviour (see Figure 1). To define the characteristics of elements or sub-elements with linear behaviour (see Figure 7(a)), the following parameters are necessary: width and depth of the member cross section, or its corresponding moment of inertia and area, volumetric mass of the material and its Young's modulus.



(a) Definition of elements with linear behaviour; (b) Definition of properties for members with nonlinear behaviour

For each sub-element with nonlinear behaviour the user needs to define the plastic hinge parameters (Varum, 1996). These are the parameters defining the hinges monotonic behaviour (trilinear moment curvature envelope), hysteretic behaviour and the damage index calculation. In addition, properties of the linear and nonlinear sub-elements can be imported from a text file to VISUALANL, and can be modified or deleted at any time (see Figure 7(b)).

3.3. Member Properties

The following properties are assigned to each frame member or group of members (Figure 8): (1) the material defining the elastic properties of the member; (2) the length of the plastic hinges at the member ends; (3) the material defining the nonlinear behaviour of each plastic hinge.

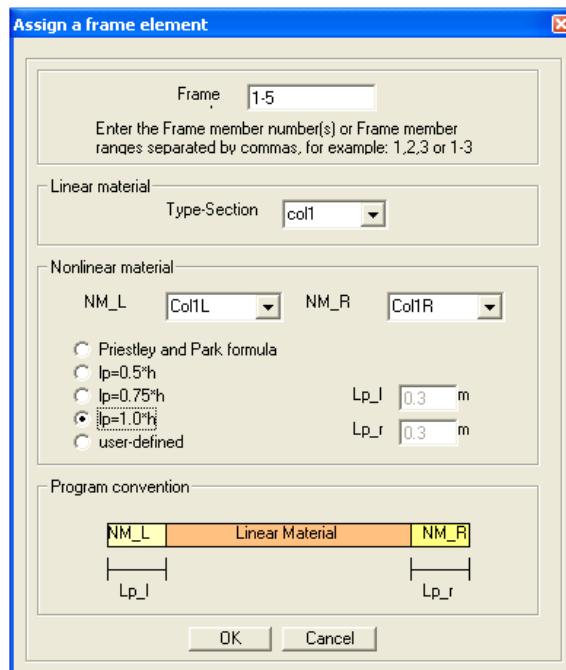

Figure 8. Frame members properties

3.4. Nodal Constraints

Following the basic formulation of a 2D structural model, the user can restrict the degrees of freedom of a node, or group of nodes, namely, displacements in the X and Y directions and the rotation (Figure 9). To facilitate the definition of constraints, shortcut keys were defined for the different constraint types.

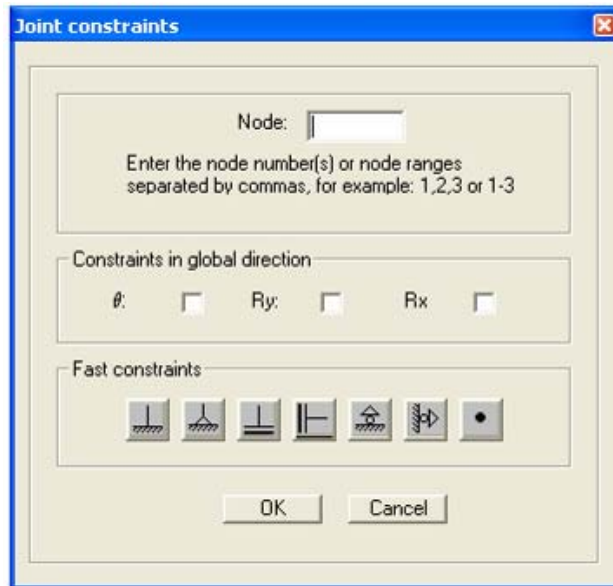

Figure 9. Definition of nodal constraints

3.5. Infill Panels

To add an infill masonry panel to the frame structure, the user has to select the 4 nodes limiting the panel edges. This operation can be performed in two different ways, namely, the user can write the node labels in a dialog box or select in the structure the area where the infill panel must be considered using the mouse, (Figure 10(a)). After adding the infill panel, VISUALANL represents it in the global structure (Figure 10(b)), and the user is now able to define the masonry properties previously described.

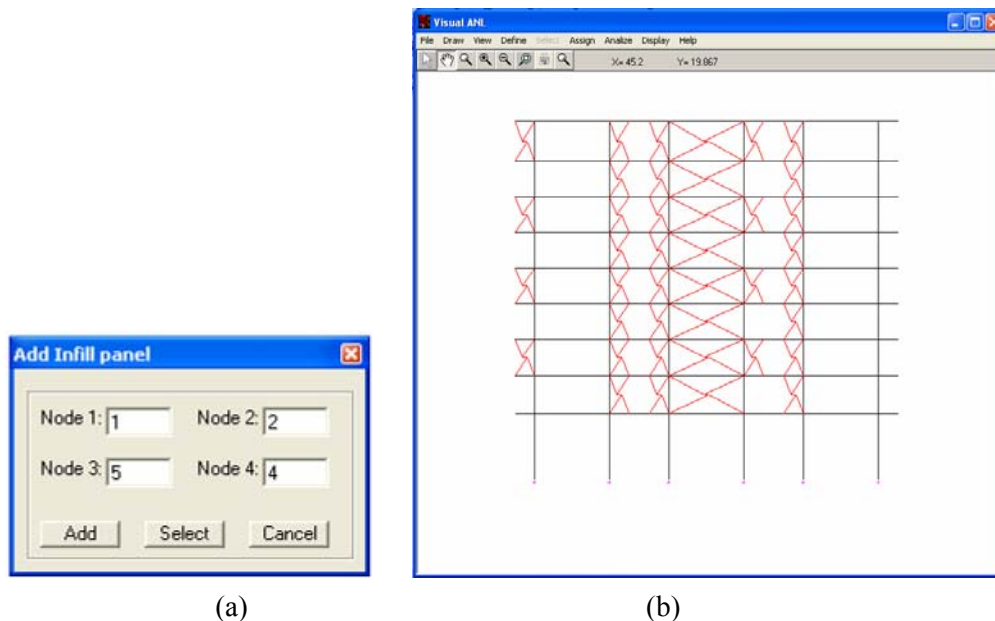

Figure 10. a) Infill panel definition; b) Infill panels geometry representation

3.6. Static Loads

The static loads that the program PORANL is able to consider are concentrated loads applied to nodes and uniformly distributed loads applied to members. The concentrated loads applied directly to the nodes can be forces in X and Y directions and also concentrated bending moments (see Figure 11(a)).

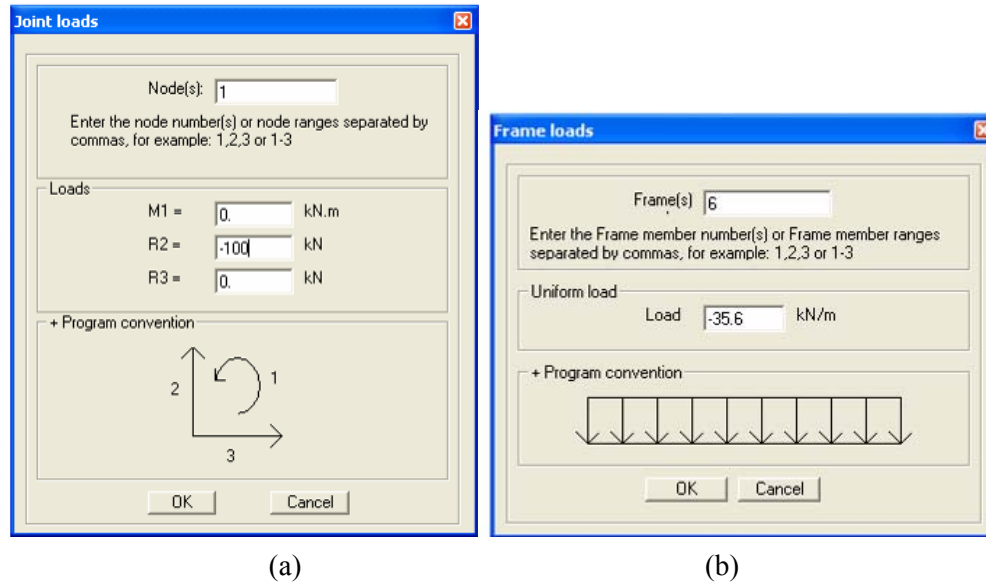

Figure 11. Static loads definition: a) Nodal loads and b) Uniform loads in members

With respect to the distributed loads, only uniform loads applied on the total member length and normal to its axis are considered (as represented in the Figure11(b)). Any other different load case in members can be considered as a set of equivalent nodal forces. For a correct definition of the loading, the loading sign conventions adopted in PORANL are displayed in the dialogue window.

4. Running the Analysis

After completing the input of the structural problem using VISUALANL, the program prepares a series of text files that constitutes the text based input data for the analysis engine PORANL and runs it. Next, VISUALANL reads the results from the PORANL output text files, and, using a series of post-processing options, enables the fast graphical visualisation of the structural response results. As can be interpreted from the above, two different programs are used (VISUALANL and PORANL), although the user only works with the GUI VISUALANL without interacting directly with the analysis engine PORANL. The program PORANL contemplates several analysis types, namely: (1) linear elastic static analysis; (2) linear elastic dynamic analysis; (3) nonlinear static analysis; (4) nonlinear dynamic analysis; (5) nonlinear displacement controlled analysis; and, (6) modal analysis (calculation of the natural frequencies and vibration modes of the structure). Each one of these options was implemented in

VISUALANL and a special module was included for code-compliant nonlinear (also called pushover) analyses (CEN, 2004).

4.1. Static Analysis

After the definition of the geometry, material properties and loading conditions, no additional data is necessary to perform a static analysis. Therefore, the user only has to choose whether the analysis is linear or nonlinear, though for the latter the user must supply the nonlinear material characteristics previously referred.

4.2. Dynamic Analysis

To perform a dynamic analysis the user has to define some additional data (Figure 12), namely: (1) the accelerogram (imported from a text file); (2) the dynamic equilibrium equation integration method to be used (Wilson- θ , Newmark or Central Differences Method, see for example (Clough and Penzien, 1993) for more details on these methods); and, (3) the parameters for the definition of the Rayleigh-type damping matrix. These parameters can be calculated in VISUALANL as a function of an assumed damping value for two different natural frequencies or manually set.

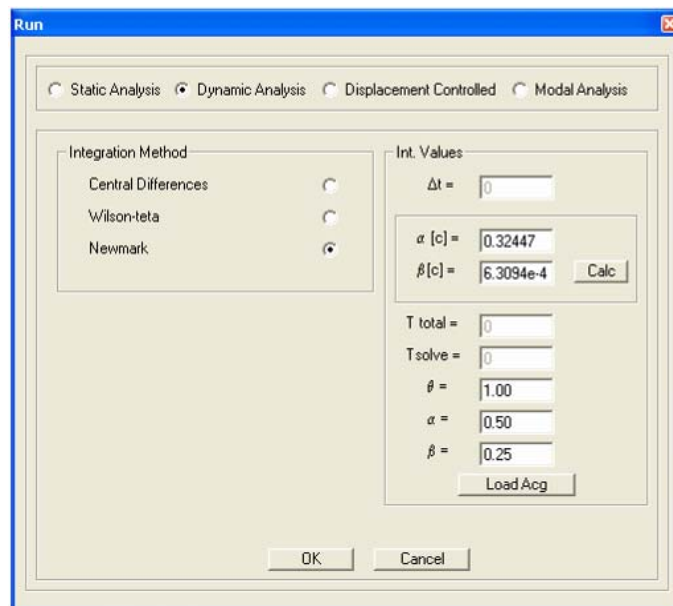

Figure 12. Options for dynamic analysis

After importing the selected accelerogram, it can be visualized (Figure 13) and the user can scale it to increase or reduce its intensity, alter the integration time-step or eliminate part of the accelerogram. In the dialogue window of the accelerogram definition, Figure 13, the user can also define the time interval for which the program PORANL will save results of the analysis in the output files.

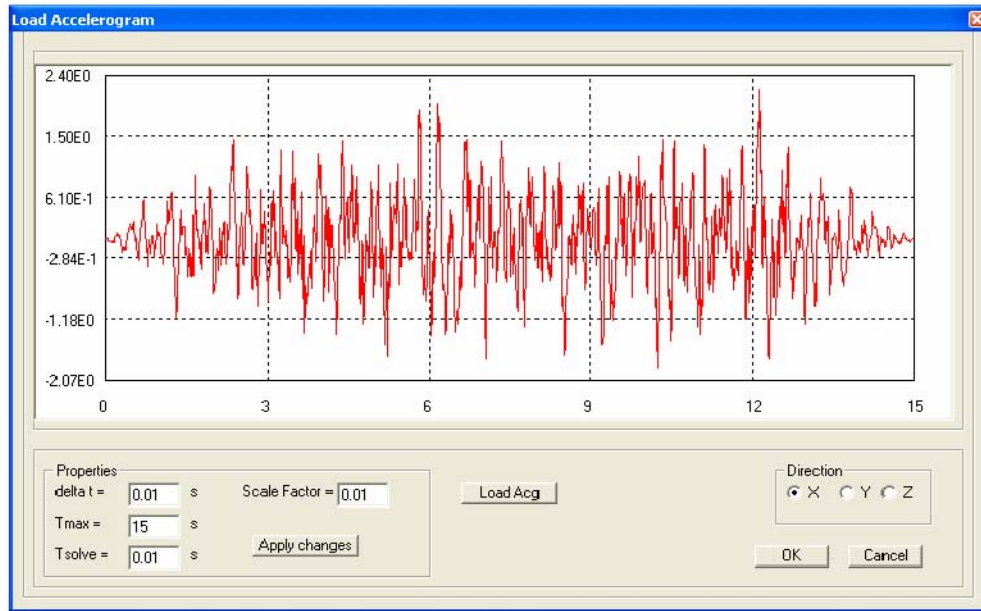

Figure 13. Accelerogram options window

4.3. Displacement Controlled Nonlinear Analysis

In this type of analysis, a set of nodal displacement evolution laws are imposed to one or more nodes in a specific direction. As for the accelerograms, the displacement evolution laws can be imported from text files, and scaling factors can also be applied to increase or reduce the intensity of each individual law (see Figure 14).

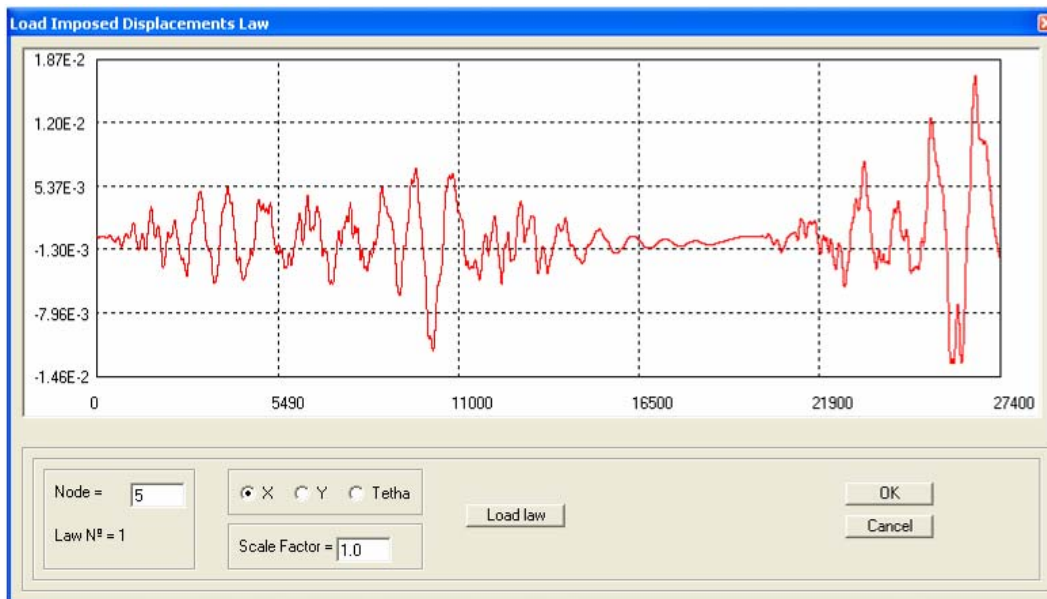

Figure 14. History of imposed displacements

4.4 Modal Analysis

In this option natural frequencies and their corresponding vibration mode configurations are calculated for the structure. The frequencies are presented in a table and the vibration modes are represented graphically. After obtaining the natural frequencies, the previously referred Rayleigh-type damping matrix coefficients can be calculated.

5. Post-Processing

The post-processing operations consist in the visualization of the structural analysis results and imply that all pre-processing instructions have been carried out. The availability of the visualization options will depend on the type of analysis that was performed. For instance, for dynamic analyses it is possible to visualize the time-history evolutions of internal member forces, an option not available for results of a static analysis. Any of the graphics generated in the post-processing options can be exported to an image format or to a compatible MS Excel text file. Also, graphics can be visualized in detail within VISUALANL using common graphical tools like the zoom or pan operations.

5.1. Deformed Shape Plot

This option represents both the original un-deformed and the deformed shapes of the structure, for an automatically calculated scale factor (Figure 15(a)). However, the user can change this scale factor, in order to visualize the deformed structure in a more convenient scale. When the deformed shape is active, the user can use the mouse to select a member and access a new dialogue window where the user can visualize the deformed shape of that member in the local reference axes, the maximum positive and negative values of the displacements and the value of the displacement at any point within the member (Figure 15(b)).

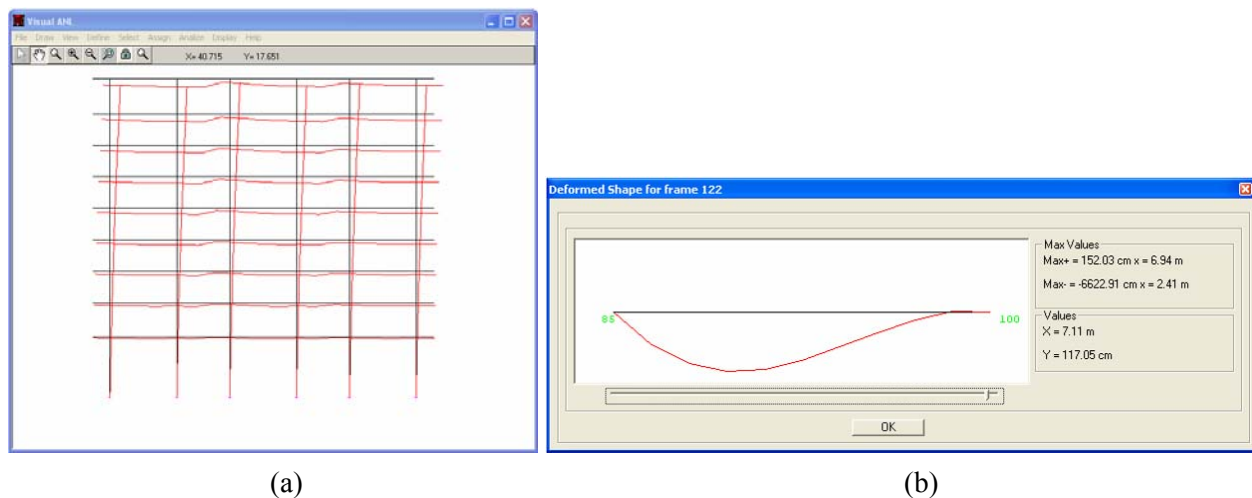

Figure 15. a) Deformed shape of the structure; b) Deformed shape of a frame member

5.2. Internal Forces Diagrams Plot

The visualization of this type of diagram follows a procedure similar to that of the deformed shape. The user selects the time instant, for dynamic analysis results, or the step number, for displacement controlled analysis results, for which the representation of the global internal forces diagrams is required (axial force N , shear force V or bending moment M). Figure 16 shows an example of a bending moment diagram.

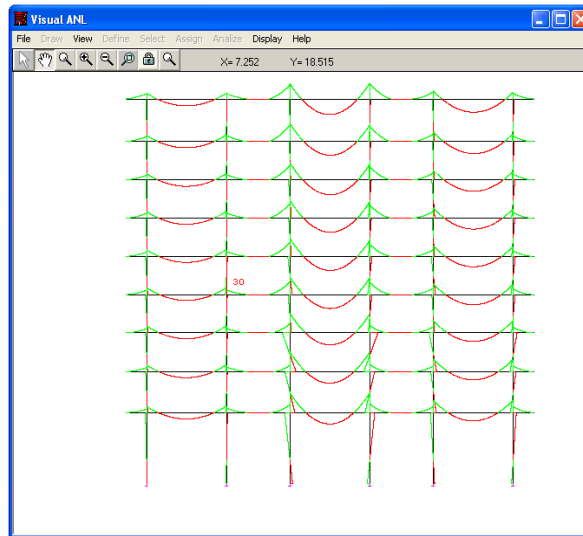
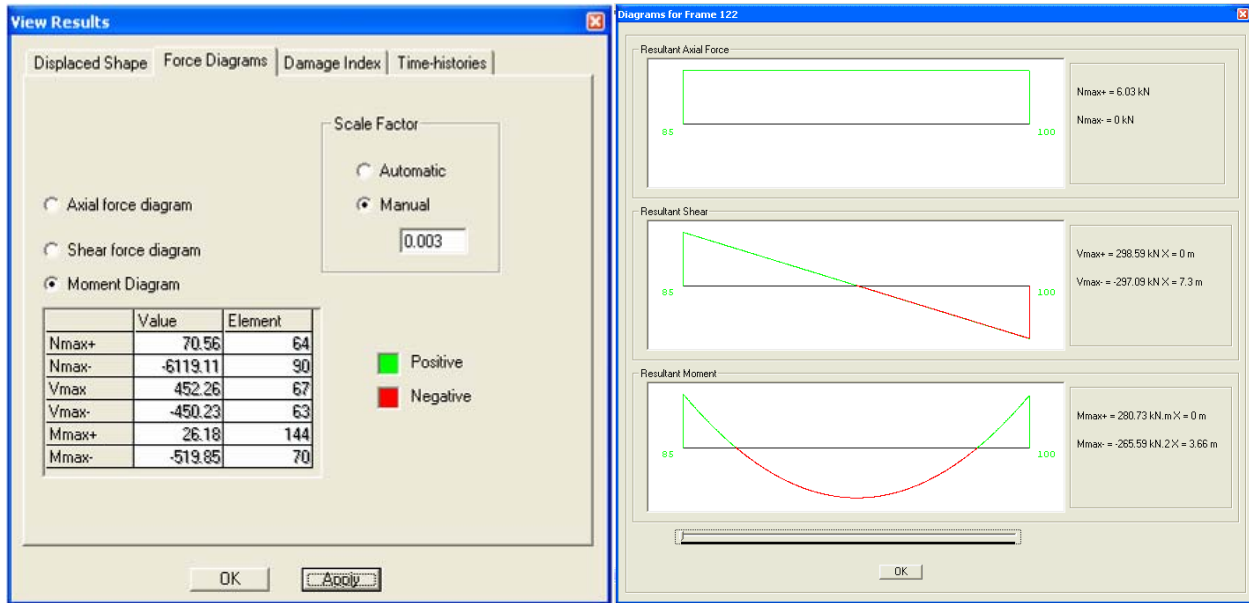

Figure 16. Distribution of bending moments across the structure



(a)

(b)

Figure 17. a) Options for diagrams of internal forces; b) Axial force, shear force and bending moment diagrams of a single frame element

When the diagram plot is active, an options window enables the display of the maximum positive and negative internal force of the whole structure as well as the identification of the member where they occur (Figure 17(a)). In addition, the user can select a member and visualize the three diagrams at the same time with indication of the maximum and minimum values, Figure 17(b). Internal force values at any point in the member can also be displayed.

5.3. Damage Index Plot

Following the previously referred damage index formulation, two different types of results can be visualized: the evolution of the global damage index for the structure and the local damage index for each member for a certain time instant, in the case of a dynamic analysis, or step number, in the case of a displacement controlled analysis (Figure 18). In addition, another measure of damage is also available for visualization. This measure of damage is the maximum inter-storey drift profile that represents the maximum relative displacement between consecutive floors normalized by the height between floors.

For the graphical representation of the different damage intensity values, VISUALANL considers a pre-defined colour scale where each colour is assigned to a damage level. However, the damage limits for each damage level, as well as the colour scheme representing each damage level can be altered by the user.

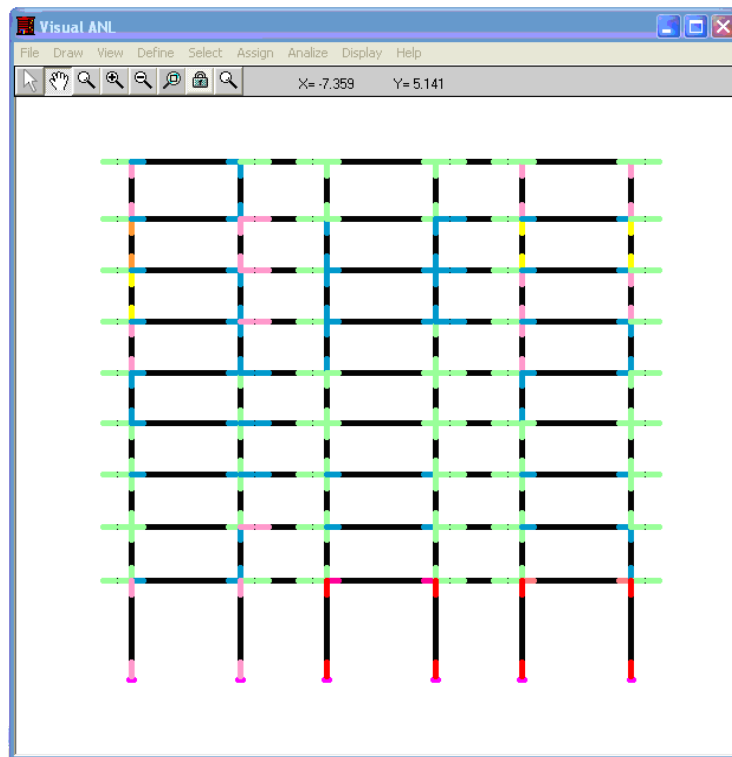

Figure 18. Local damage index distribution across the inelastic zones of the structure

5.4. Time-Wise and Step-Wise Evolutions

In this option, the user can visualize the time-wise evolution, in the case of a dynamic analysis, or the step-wise evolution, in the case of a displacement controlled analysis, of the internal forces (N , V and M), curvatures in a plastic hinge and nodal displacements for a specific direction. In addition the user can also visualize the moment-curvature evolution plot at a selected plastic hinge (Figure 19).

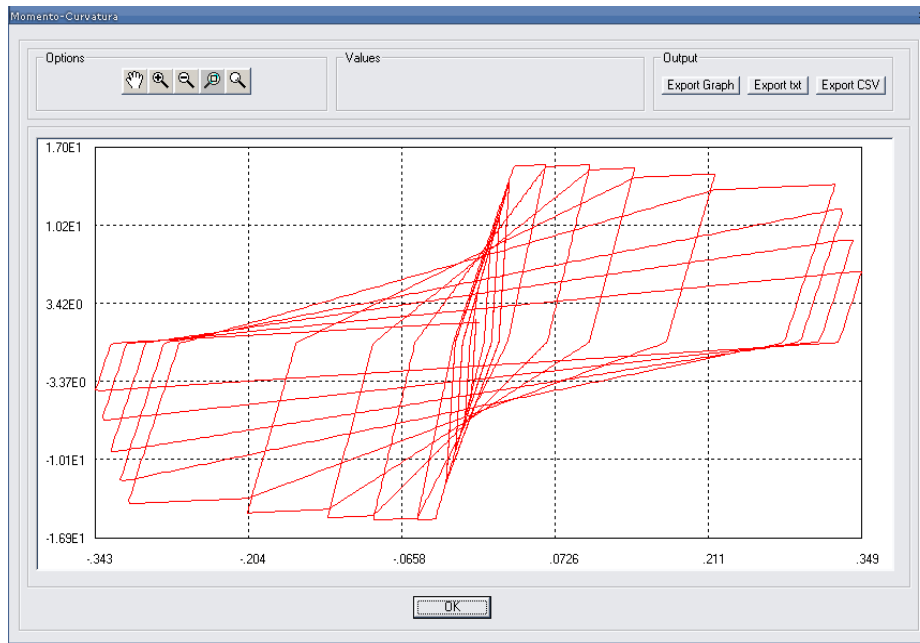

Figure 19. Moment-curvature diagram of a frame element under cyclic loading

6. Example Application

In order to observe the advantages of using a tool such as VISUALANL in a real case situation, a study concerning the seismic vulnerability assessment of a building representative of the Modern Architecture style was developed.

The building is a singular example of the Modern Housing Project. The block plan is rectangular with 11.10m of width and 47.40m of length. The building has 8 storeys and a higher open ground floor (without infill masonry walls). The open ground floor system is very common on this type of building since they were conceived for some flexibility in their use. This peculiar structural characteristic of this type of buildings has a direct influence in the global structural behaviour. Furthermore, at the ground storey, columns are 5.5m height, while in the all upper floors, inter-storey height is 3.0m. This and the open ground floor situation considerably increase the damage potential of the ground floor structural members.

In structural terms, the building is made of twelve plane frames parallel to the building width (column orientation in the direction of larger stiffness) and 2 plane frames parallel to the building length (column orientation in the direction of smaller stiffness). The application presented herein only covers the building analysis for the direction parallel to the building width, termed “transversal direction” in the following. Each frame of the transversal direction has two columns and three beams at each storey, two of them are cantilevers with spans of 2.80m. The distance between consecutive frames is 3.80m.

Although there are twelve individual frames in this direction, there are only three different frame-types. Based on this, an equivalent 2D model associating only the three different frame-types was defined. The frames of this equivalent model are lined up in a two-dimensional plane with consecutive frames linked by rigid strut beams at each storey (Figure 20). This way, the horizontal displacements of each floor are slaved so as to have only one horizontal degree of freedom per floor. This accounts for the rigid slab behaviour of the floors. The width of the members of this equivalent model is the width of the member according to the frame-type it belongs to multiplied by the number of times the frame-type occurs on the real building. The stiffness properties of the members must also be modified according to that same line of reasoning.

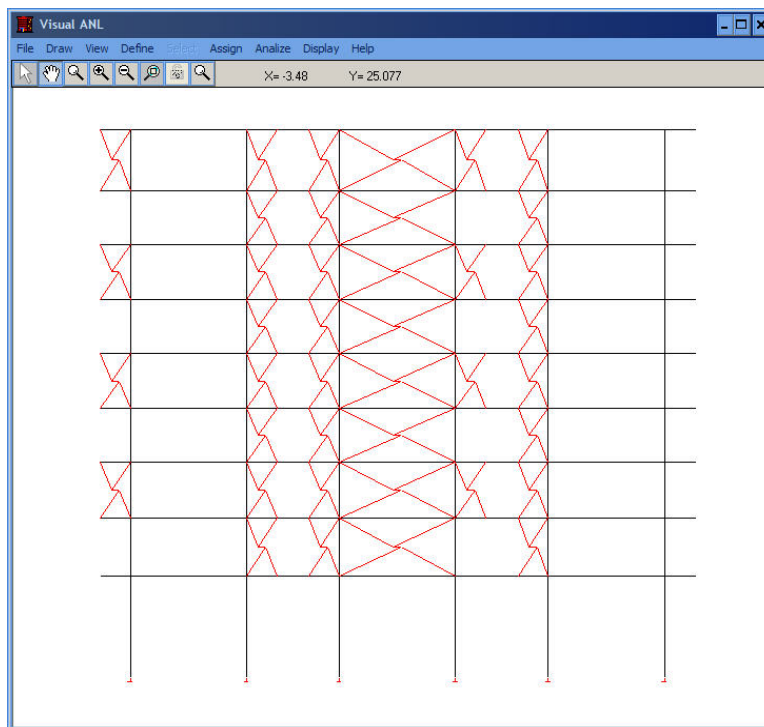

Figure 20. Equivalent structural system for transversal direction

The building geometry and dimensions of the RC elements and infill walls were obtained from the original project drawings (dated around the mid-1950s), and were confirmed during the technical building inspections that were carried out (Miranda et al., 2005). In addition, a 0.20m thick effective width of 1.25m was considered as contributing to the beam stiffness of all storeys.

6.1. Static and Dynamic Loads, Masses and Damping

For the numerical analyses, constant vertical loads distributed over the beams were considered in order to simulate the self-weight, from both the RC elements and the infill walls, the finishings, and the quasi-permanent value of the live loads. A global value of 8.0kN/m^2 was obtained.

An artificial earthquake record was generated for a medium/high seismic risk scenario in Europe (Carvalho et al., 1999) and adopted for the seismic vulnerability analysis of the building. The record was then scaled to match different intensity levels to observe the evolution of the structural behaviour under more intense loading. Table 1 presents the peak ground acceleration and corresponding return period for each earthquake intensity of the considered earthquake record.

For each storey a mass of about 4Mtons was defined and that includes the self-weight of the structure, of the infill walls, of the finishings and the quasi-permanent value of the live loads. For the dynamic analysis, the storey mass is assumed to be uniformly distributed at the storey levels. The viscous damping ratio was considered to be 1%.

Table 1. Reference earthquake action (peak ground acceleration and corresponding return period)

Return period (years)	Peak ground acceleration ($\times g$)
73	0.091
475	0.222
975	0.294
2000	0.380
3000	0.435
5000	0.514

6.2. Analysis Results

The structural response of the building clearly exhibits a soft-storey mechanism behaviour (at the ground floor level). This structural behaviour leads to large inter-storey drift demands at the first storey, while the upper storeys exhibit very low deformation levels. Figure 21 illustrates the numerical results in terms of deformed shape envelop, maximum inter-storey drift, and maximum storey shear, for each earthquake intensity level.

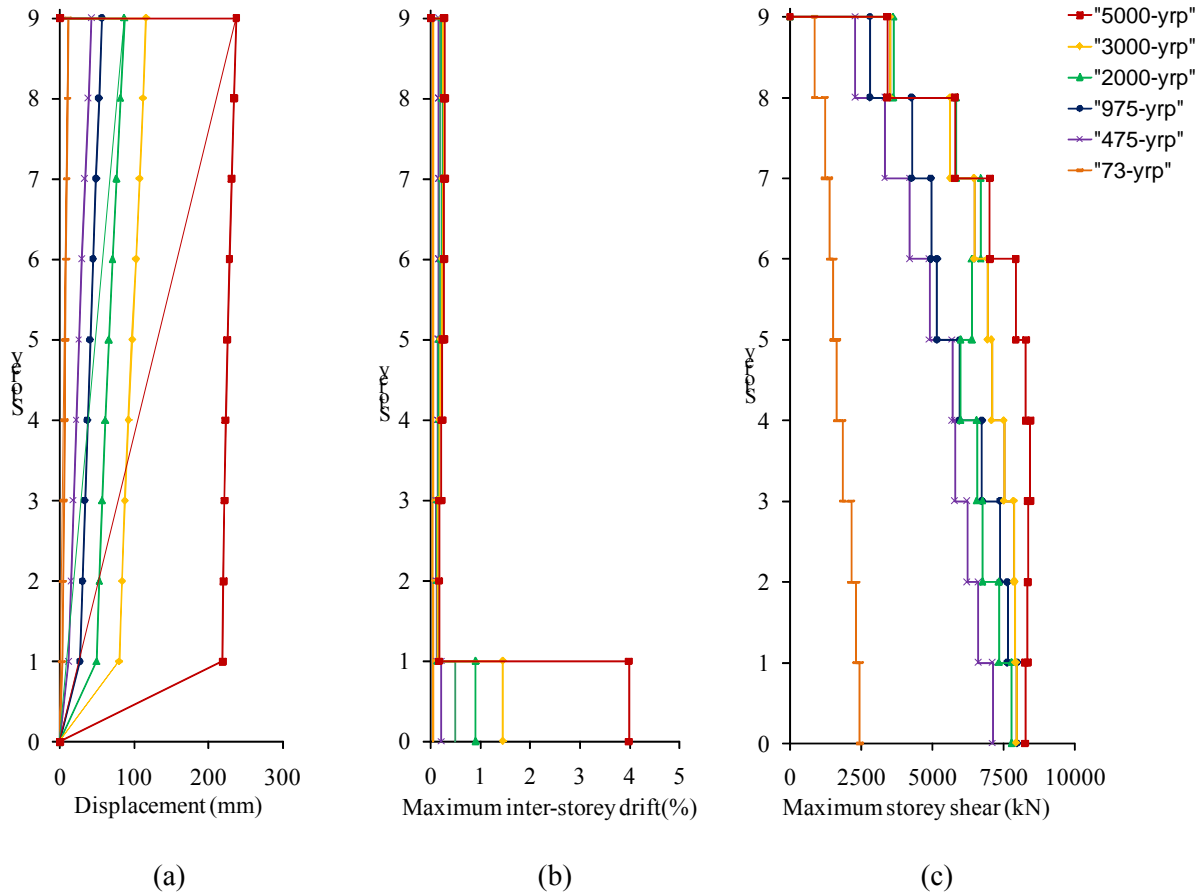

Figure 21. Results for the transversal direction analyses and all earthquake intensities: a) Envelop of the deformed shape; b) Maximum inter-storey drift profile; c) Maximum storey shear demand

From the analysis of the results, in terms of deformed shape and inter-storey drift profile, it can be concluded that deformation demands are concentrated at the first storey level. In fact, the absence of infill masonry walls at the ground storey and the larger storey height (5.50m for the 1st storey and 3.0m for the upper storeys), induces an important vertical structural irregularity, both in terms of stiffness and strength.

For all the structural elements (columns and beams), and for all the seismic input intensity levels, the maximum shear force demand is lower than the corresponding shear capacity, which confirms its safety for shear demand.

7. Conclusions

Structural analysis programs that include nonlinear models are valuable tools in the analysis and verification of structural safety, giving the engineer capacity to represent more precisely the real behaviour of the structures. For design of new structures or capacity assessment of existing ones, nonlinear analyses allow for a better representation of the structural response under any loading

condition, and under earthquake loading in particular. Furthermore, nonlinear models can also be used in the calibration of more simplified numerical models. Current state of the art seismic design codes (CEN, 2004; FEMA-440, 2005) acknowledge these facts, support the use of nonlinear (static or dynamic) analysis for both design and structural assessment purposes and suggest nonlinear analyses as the reference analysis type to be used in capacity evaluation and verification of structural safety.

Nonlinear analyses generate a considerable amount of information (nodal displacements, internal forces in frame elements, deformations, etc.), at each step of the analysis, thus making the treatment and interpretation of the results a rather difficult task. Most of the currently available tools for nonlinear analysis are research programs lacking a convenient GUI, thus presenting several shortcomings from a practical point of view. Although a considerable number of structural programs include state of the art nonlinear material models, few have adequate graphical tools for results visualization. Therefore, the development of a graphical processor like VISUALANL is considered to be a helpful tool for nonlinear analysis as a support for the design of new structures and, especially, in the capacity assessment of existing ones, under severe static and/or dynamic loads. Thus, the definition of a GUI such as VISUALANL allows a wide range of professional practitioners to perform such type of analysis with less difficulty.

To demonstrate the potentialities of the presented GUI, an example application also presented. The application deals with the seismic behaviour assessment of a modern architecture style building in Lisbon, Portugal. This example demonstrates the complexity of the problem at hand which would be increased if studied without the use of VISUALANL. It should be emphasized that in cases where both RC members and infill panels are numerically modelled, the complexity of the modelling and the amount of output results is very large and may not be easily dealt with if no additional tools are used. Therefore, VISUALANL as shown to be a valuable help in the representation of the global response and seismic behaviour of building structures such as the one presented.

Not forgetting about the importance and the necessary reliability of the analysis engine, the aspects of data input and result output are fundamental issues in nonlinear analysis. These must be addressed so the realms of this more complex analysis type, namely when dealing with earthquake loading, can be more clearly understood and executed by the practitioners community.

References

Anumba, C.J. (1996), "Functional integration in CAD systems", *Advances in Engineering Software*, Vol. 23, Pages 103-109.

Bento, R. (1996), “Assessment of the seismic behaviour of reinforced concrete framed structures: An approach based on damage indices”, *PhD Thesis*, IST, Lisbon, Portugal (in Portuguese).

Carr, A.J. (1998), “Ruaumoko: Computer Program Library”, *Christchurch*, Auckland, New Zealand, (available at URL: <http://www.civil.canterbury.ac.nz/ruaumoko/index.html>).

Carvalho, E.C., Coelho, E. and Campos-Costa, A. (1999), “Preparation of the full-scale tests on reinforced concrete frames: Characteristics of the test specimens, materials and testing conditions”, *ICONS Report, Innovative Seismic Design Concepts for New and Existing Structures*, LNEC, Lisbon, Portugal.

CEB-231 (1996), “RC Frames under Earthquake Loading”, *Comité Euro-International du Béton*, Bulletin No. 231, London, England.

CEN (2004), “Eurocode 8: Design of structures for earthquake resistance, Part 1: General rules and rules for buildings”, *European Committee for Standardization*, Brussels, Belgium.

Clough, R.W. and Penzien, J. (1993), “Dynamics of Structures”, *McGraw-Hill*, 2nd Edition, New York, NY., USA.

Costa, A.G. and Costa, A.C. (1987), “Force-displacement hysteretic model adequate for seismic analysis of framed structures”, *Technical Report, Applied Dynamic Nucleus*, National Laboratory of Civil Engineering, Lisbon, Portugal.

FEMA-440 (2005), “Improvement of nonlinear static seismic analysis procedures”, *Applied Technology Council*, Redwood, CA., USA.

Feng, Z.Q., Joli, P. and Seguy, N. (2004), “FER/Mech: A software with interactive graphics for dynamic analysis of multibody system”, *Advances in Engineering Software*, Vol. 35, Pages 1–8.

Filippou, F.C. and Fenves, G.L. (2004), “Methods of Analysis for Earthquake-Resistant Structures, Earthquake Engineering: From Engineering Seismology to Performance-Based Engineering”, (Editors: Bozorgnia, Y. and Bertero, V.V.), Chapter 6, *CRC Press*, Boca Raton, FL., USA.

McKenna, F., Fenves, G.L., Scott, M.H. and Jeremić, B. (2000), “OpenSees - Open system for earthquake engineering simulation”, *Pacific Earthquake Engineering Research Center*, University of California, Berkeley, CA., USA. (available at URL: <http://opensees.berkeley.edu>).

Miranda, L., Rodrigues, H., Fonseca, J. and Costa, A. (2005), “Inspection report of block 3 of the Infante Santo Housing Complex”, *Technical Report*, FEUP, Porto, Portugal.

Park, Y.J. and Ang, H.S. (1985), “Mechanistic seismic damage model for reinforced concrete”, *Journal of Structural Engineering, ASCE*, Vol. 111, No. 4, Pages 722-739.

Paulay, T. and Priestley, M.J.N. (1992), “Seismic Design of Reinforced Concrete and Masonry Buildings”, *John Wiley*, New York, NY., USA.

Phongthanapanich, S. and Dechaumphai, P. (2006), “EasyFEM: An object-oriented graphics interface finite element/finite volume software”, *Advances in Engineering Software*, Vol. 37, Pages 797–804.

Prakash, V., Powell, G.A. and Campbell, S. (1993), “DRAIN-2DX Base program: Description and user guide”, *Technical Report No. UCB 97/13*, Department of Civil Engineering, University of California, Berkeley, CA., USA.

Rodrigues, H., Varum, H. and Costa, A.G. (2005), “Nonlinear numerical model for masonry infill panels of reinforced concrete frames”, *Congreso Métodos Numéricos en Ingeniería, E.T.S. de Ingenieros de Caminos de la Universidad de Granada*, Granada, Spain.

Rodrigues, H., Varum, H., Costa, A.G. and Romão, X. (2004), “Graphical interface for nonlinear analysis of plane frames under dynamic and/or static loads”, *Computational Methods in Engineering Congress: CMCE 2004*, National Laboratory of Civil Engineering, Lisbon, Portugal (in Portuguese).

SEISMOSOFT (2004), “SEISMOSTRUCT: A Computer Program for Static and Dynamic Nonlinear Analysis of Framed Structures”, (available at URL: <http://www.seismosoft.com>).

Thayer, R. (1999), “Visual BASIC 6 Unleashed, Professional Reference Edition”, *SAMS Publishing*, Indianapolis, IN, USA.

Varum, H. (1996), “Numerical model for seismic analysis reinforced concrete plane frames”, *M.Sc. Thesis*, FEUP, Porto, Portugal (in Portuguese).

Vaz, C.T. (1993), “Nonlinear Analysis of Reinforced Concrete Columns under Cyclic Loads”, *National Laboratory of Civil Engineering*, Lisbon, Portugal (in Portuguese).

Williams, M.S. and Sexsmith, R.G. (1995), “Seismic damage indices for concrete structures: A state of the art review”, *Earthquake Spectra*, Vol. 11, No. 2, Pages 319-349.