

MITIGATION OF WELDING DISTORTION AND RESIDUAL STRESSES VIA CRYOGENIC CO₂ COOLING – A NUMERICAL INVESTIGATION

Duncan Camilleri
University of Malta
Department of Mech.Eng.
Faculty of Engineering
Msida MSD 2080
Malta
duncan.camilleri@um.edu.mt

Thomas G F Gray
University of Strathclyde
Department of Mech.Eng.
75 Montrose Street
Glasgow G1 1XJ
Scotland, U.K.
tom.gray@strath.ac.uk

David Nash
University of Strathclyde
Department of Mech.Eng.
75 Montrose Street
Glasgow G1 1XJ
Scotland, U.K.
d.nash@strath.ac.uk

ABSTRACT

Fusion welding remains the most common and convenient fabrication method for large, thin-plate welded structures. However, the resulting tendency to out-of-plane distortion exacts severe design and fabrication penalties in terms of poorer buckling performance, lack of fairness in external appearance, poor fit-up and frequent requirements for expensive rework. There are several ways to mitigate welding distortion and this study concentrates on the use of cryogenic CO₂ cooling to reduce distortion. A feasible combination of welding process and cooling parameters, was investigated computationally and the resulting effects on final deformation were predicted. Three different computational strategies were developed and applied to butt-welding and fillet-welding processes, with and without the inclusion of cryogenic cooling. In the first method, a fully transient, uncoupled thermo-elastoplastic model was investigated. This method is comprehensive but not readily applicable to predict welding distortions in complex, industrial-scale, welded structures, due to the large computational requirement. More computationally efficient models are needed therefore and two further models of this type are suggested in this study. The results show good agreement between the different models, despite substantial differences in computational budget. In butt-welded plates, a significant decrease in out-of-plane distortion is obtained when cryogenic cooling is applied. In fillet-welded plates, cooling had much less effect on welding distortion. This was largely due to the size and configuration of the test case assemblies and the fact that the attached stiffener greatly increased the overall stiffness and resistance to contraction forces.

1. INTRODUCTION

Fusion welded thin plate structures are key elements in the manufacture of lightweight metallic assemblies used typically in transport industries and in many other applications such as box bridges, crane girders and fluid storage systems. The non-uniform expansion and contraction of the weld and the surrounding material gives rise to welding residual stresses and consequently permanent deformations. Different forms of distortion are possible but out-of-plane deformation is the most significant, often resulting in lack of fairness and alignment difficulties. Initial inherent residual stresses locked in the plate can also have a significant effect on the final distorted shape and thus the control of distortion should be addressed at the earliest stages during stock production and in cutting processes (1).

Several techniques are available to minimize distortion (2), applicable at the design stage or during the fabrication process (3). Design related variables deserving attention include, amongst other factors, reduced weld size, through optimized weld joint preparation and configuration and appropriate choice of plate thickness, stiffener spacing and geometry. However these factors are usually constrained by the stiffness and other requirements of the structure under construction. Efforts have been made to reduce welding distortion during the fabrication process, for example by focusing on efficient welding fabrication processes which feature minimal heat input and through control of travel speed and welding sequence (4). Other fabrication related techniques include the use of intermittent welds, using a backstep technique and balancing heat about the neutral axis of the fabrication in out-of-plane bending. Other strategies include preheating and mechanical and thermal tensioning techniques (5), (6), (7). These approaches control the development of residual stresses by reducing welding thermal gradients in the case of preheating procedures and by generating a tensile stress field at the welded region in the case of mechanical and thermal tensioning techniques.

A more feasible and efficient mitigation technique in many situations is to cool the weld more rapidly by means of cryogenic CO₂ application behind the weld (8). Cryogenic cooling reduces welding distortion mainly by decreasing the heat dissipated into the structure, consequently diminishing the size of zones undergoing yielding and permanent plastic deformation. These techniques are complex and their effectiveness depends highly on the individual welding configuration and the materials being welded. The use of finite element analysis to simulate the manufacturing process offers great advantages in this context, with the further possibility of incorporating non-linear temperature-dependent aspects associated with modeling the highly complex multi-physics problems inherent in welding procedures.

This study focuses on the use of cryogenic CO₂ cooling to reduce distortion and residual stresses in butt-welded and fillet welded stiffened CMn plate assemblies (Lloyds 2000 DH36 – BS 4360 Grade 50D). Feasible combinations of welding process and cooling parameters were applied to typical test cases. The resulting deformations were predicted using numerical techniques as described in section 2

2. COMPUTATIONAL MODELS FOR PREDICTION OF WELDING RESIDUAL STRESSES AND DISTORTION

2.1 General

Several interacting physical phenomena are involved in welding, including electromagnetic forces, fluid flow of gases and filler material, heat flow, microstructural transformations and residual stress development. Computational treatments should ideally be considered in terms of multi-physics processing. However, some of the complex interactions are weak and may be neglected (9), (10). Typically, the interactions between electromagnetic force, fluid flow and heat dissipation can be treated simply by assuming a welding 'efficiency' corresponding to the proportion of electrical energy dissipated as heat into the filler and parent material. Studies (11) have also shown that thermal and mechanical interaction is weak in fusion welding and thus the thermo-mechanical welding phenomena can be solved in an uncoupled fashion. In this case the thermal gradients are established first via a transient thermal analysis and these are then fed to a structural model in the form of thermal strains, to establish the final residual stress fields and distortions. Three different computational strategies were developed for the present study, as described in section 2.3.

The models have been devised to simulate the evolution of welding deformation, with or without the inclusion of cryogenic cooling, in butt welded plates of 500mm x 240mm x 2mm thick plates and in single sided fillet welding of a stiffener 500mm x 300mm x 5mm thick attached to a 500mm x 300mm, 5mm thick plate (see figures 1a and 1b).

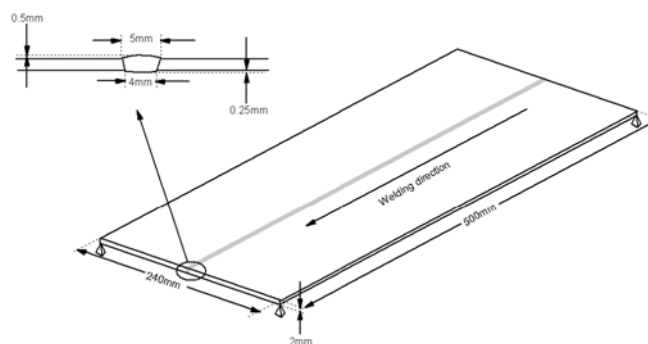

a) Schematic diagram

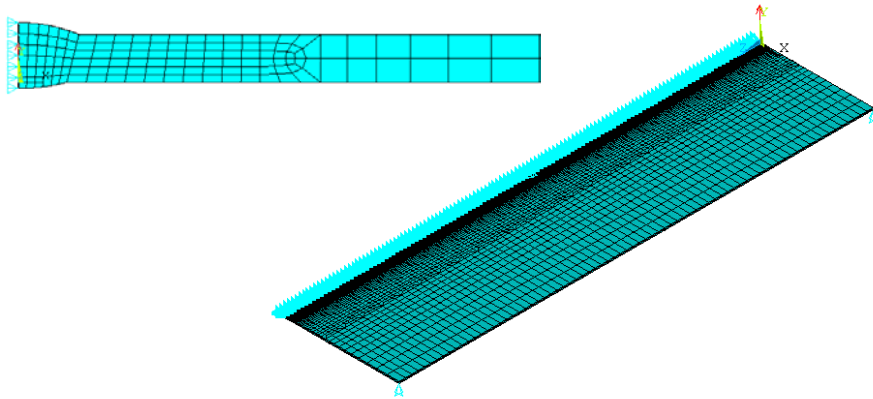

b) Finite element model
Fig.1 Butt welded test plates

In the case of butt welding, the plates are subject to a fusion welding process having nominal welding parameters of 120A, 20V, travelling at a speed of 12 mm/s. In the case of the stiffener attachments, nominal welding parameters corresponding to 180A, 22V and 10.8 mm/s welding speed, are assumed. Figures 1a and 2a also show the dimensions of the fusion zones developed when assuming such welding conditions. These welding parameters and molten regions are typical of welded assemblies modelled in this study.

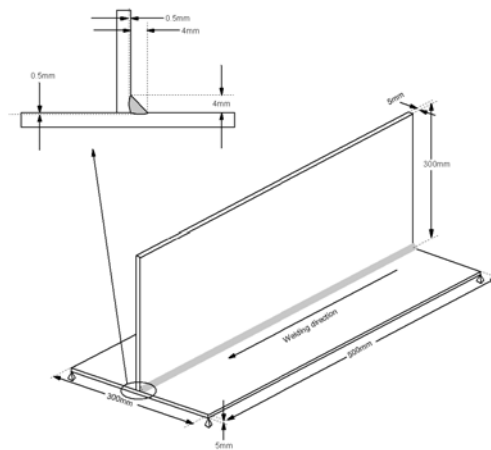

a) Schematic diagram

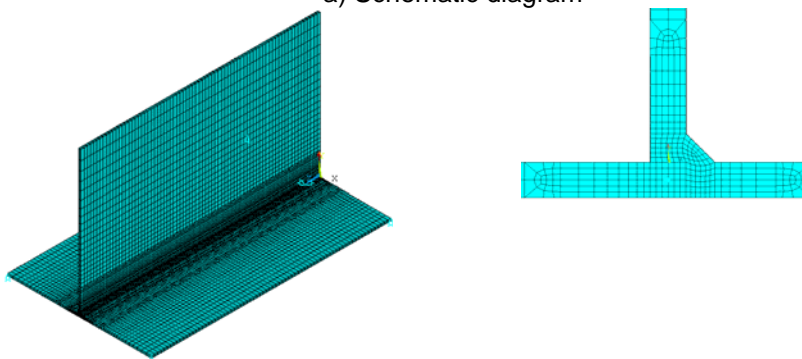

b) Finite element model
Fig.2 Fillet welded test plates

A symmetrical half of the butt-welded plate is modelled using 8-noded linear Lagrangian elements, comprising 19650 elements and 25236 nodes. ANSYS (12), SOLID 70 elements and the equivalent SOLID 45 element are employed for the thermal and structural analyses, respectively. In the case of single-sided fillet welding, the whole stiffened plate structure is

modelled, using similar elements. Here the mesh is made up of 57075 elements and 72042 nodes. A fine mesh is used at sections close to the weld, with coarser mesh at greater distances (see figures 1b and 2b). Both assemblies are supported at the four corners of the plate.

2.2 Thermal transients

The thermal transients in fusion welding are driven mainly by the thermal capacity and conductivity properties of the material being welded. These thermo-physical properties are highly non-linear and temperature dependent. In particular the latent heat of fusion incorporates a significant proportion of the thermal capacity and should be included in the analysis. Natural convection and radiation, together with temperature dependent boundary conditions, are applied to the models. However, previous studies have shown that, for the material under investigation, minimal heat is lost either by convection or radiation (13).

In the thermal analysis, the simulated heat source is moved at constant velocity along the weld line in a series of fine load steps. Thermal energy is applied to the fused zone elements via a volumetric heat input. A weld efficiency of 80% is employed in both test cases to establish the corresponding fused zone boundary temperature of 1486°C. The element 'birth and death' technique is used to deactivate any weld elements ahead of the welding arc position and re-activate them later, on arrival of the heat source. A thermal gap between the plate and stiffener is also assumed in the fillet-welded assemblies, by unmerging nodes at this boundary (14).

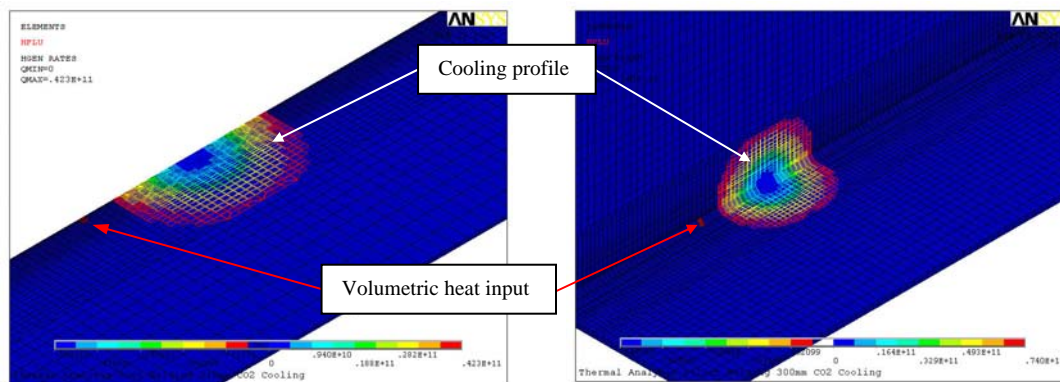

Fig.3 Heat input and CO₂ cooling a) butt-weld and b) fillet-weld

In cryogenic CO₂ cooled welds, heat generated by the welding process is extracted mainly via sublimation of solid CO₂ to gas. The amount of heat lost depends on the flow rate and profile of the solid CO₂ impingement on the fused and parent material. In this study a heat loss of 1.2kW corresponding to 6×10^{-3} kg/s solid CO₂ delivery, is applied at the surface of the plate, 60mm behind the arc in the direction of travel. The solid CO₂ pattern in contact with the plate can assume various profiles following either normal radial distribution or Gaussian distribution. In the present case, a normal radial distribution with radial dimensions 45mm is applied as a surface heat flux. Figure 3 shows the heat input and cooling profile assumed in the butt-welded and fillet-welded test plates.

2.3 Welding residual stresses and distortion

2.3.1 Thermo-elasto-plastic structural model

Various approaches are possible to capture the evolution of welding residual stresses and consequently predict the final out-of-plane deformations. The choice is influenced by the accuracy required and computational resource at hand. A fully transient, uncoupled thermo-elastoplastic model (14), (15) will give the most comprehensive and accurate result in terms of predicting the development of welding residual stress fields and deformations. In this case, temperature dependent expansivities are used for both the fusion zone and parent material and these also reflect volume changes due to phase transformation, as obtained from

dilatometer test results. Temperature dependent stress-strain curves are also employed using bilinear kinematic hardening elasto-plastic material properties as shown in figure 4. Thermal transients obtained from the thermal models described in section 2.2 are applied in a transient fashion as body load forces in the structural analysis, ramped over 140 load-steps during welding and a further 210 load-steps during cooling. Weld metal deposition is simulated using the element 'birth and death' technique as in the thermal analysis. Any elements reaching temperatures above 1000°C are assumed to have negligibly low strength. This temperature is often referred to as the cut-off temperature and any strains (thermal, plastic and elastic) accumulated during heating are neglected. These elements (in particular in the fused zone) are also killed during the heating stage and reactivated at temperatures below the cut-off temperature. Effects due to support conditions are incorporated through the application of gravitational forces.

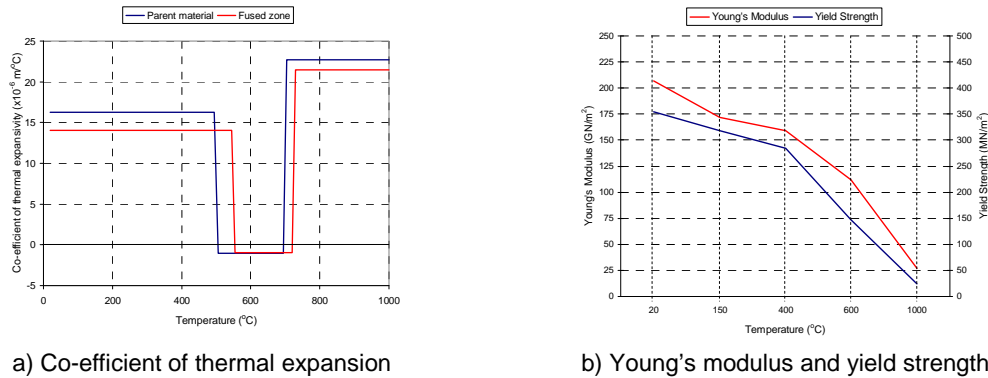

Fig.4 Non-linear material properties

2.3.2 Computationally efficient model based on elasto-plastic algorithms

Fully transient thermo-elasto-plastic models require considerable computational time and are therefore inapplicable to predict welding distortions in complex, industrial-scale, welded structures. More computationally efficient models are needed. Two further models of this type are suggested in this study. The more efficient of the two models establishes the thermal strains in the transverse and longitudinal directions via a thermal numerical analysis and elasto-plastic algorithms (16), (17), (18). Transverse thermal strains establish the angular distortion and are deemed to arise from the contraction forces developed by the fused material from cooling temperatures ranging between the cut-off temperature and ambient temperature. Three regions are identified in the longitudinal direction and depend on the maximum temperature achieved during welding and cooling, at points transverse to the weld line. These include:

- A. A yielded region where the maximum thermal strain, during heating, is greater than twice the yield strain
- B. A region that exhibits purely elastic behaviour where the maximum thermal strain is less than yield strain
- C. A zone bounded by the above two regions, where the final residual strain resides between zero and yield strain

The contraction forces are then applied in a single step to analyse the corresponding structural model of the assembly via a static elastic analysis. Room temperature material properties are assumed in the analysis.

2.3.3 Hybrid models

It is not difficult to encounter cases where a one-step elastic model of the incremental deformation process proves to be inadequate, relative to results from the fully transient model. The main disadvantage of the one-step approach is that the inherent structural constraints of the workpiece on the developing strains are not reflected. The second form of computationally efficient model uses a stepwise, elasto-plastic, static computational approach, which takes material non-linearities and the significant effects of restraints into account (19), (20). The model is divided into discrete sections such that each section and salient points transverse to the weld-line undergo sequentially a heating cycle up to the

maximum temperature, followed by a cooling cycle to ambient temperature. During the heating load-step the fused zone elements are killed and are reactivated while cooling. In the present study the model was divided into five sections.

3. RESULTS AND OBSERVATIONS

3.1 Thermal transients

The addition of CO₂ cryogenic cooling gives very different thermal gradients when compared to the non-cooled welds. Higher cooling rates and rapid changes in thermal gradients are observed in cryogenic cooled welds as shown in fig 5. In both fillet and butt welds with cooling, the maximum temperature reached at salient points is significantly reduced. In butt welding this effect is found in regions 4.75mm transverse to the weld and wider, ultimately giving rise to smaller yielded regions. The thermal contour plots shown in fig 6 suggest that for the test plates and parameters considered in this study, the main effect of CO₂ cooling lies in the heat energy absorption aspect. Saddle shaped thermal contours often associated with cooled welds are not evident for the butt-welded test cases and this is attributed to the fact that the plates investigated are relatively thin.

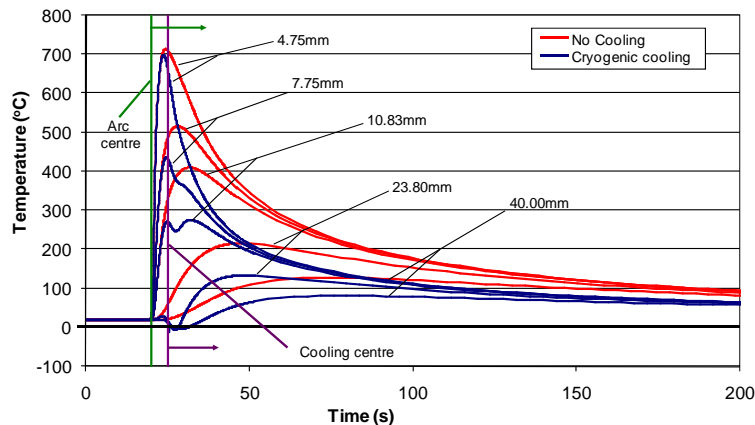
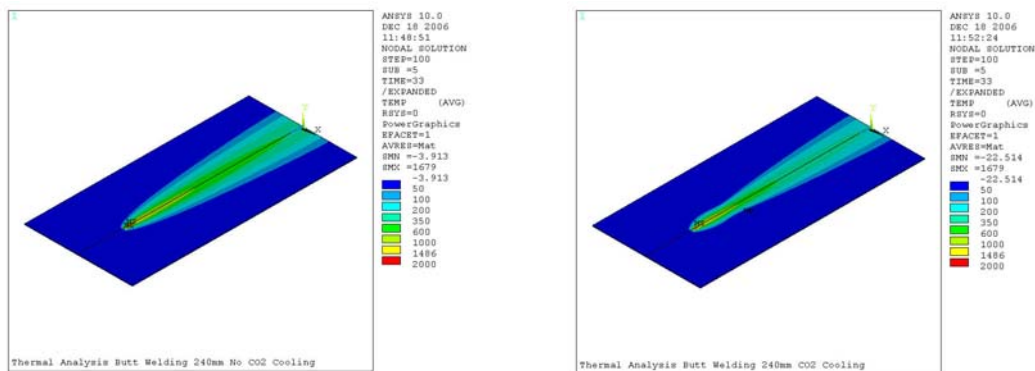
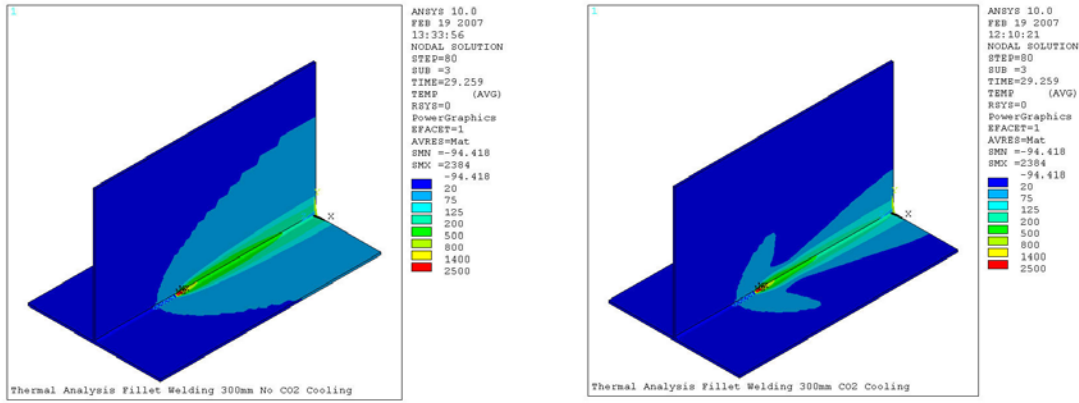

Fig 5: Thermal gradients developed in cryogenic cooled and non-cooled butt welds

In the case of fillet welding, the effect of cryogenic cooling is more evident. Thermal contour plots for fillet welding with and without cooling are given in fig 7. Differences in heat flow patterns are observed at the stiffener, at the welded side of the plate and at the unwelded side of the plate. In all instances higher cooling rates and a reduction in maximum temperature at points transverse to the weld line result when cooling is introduced. However, sudden changes in thermal transients which consequently result in more thermal straining, are observed at the stiffener and at the welded side of the plate. Figure 8 shows the evolution of thermal transients at the welded and unwelded sides of the plate.



a) Non-cooled welds
b) Cooled weld
Fig 6: Thermal contour plots in cryogenic cooled and non-cooled butt welds



a) Non-cooled weld
 b) Cooled weld
Fig 7: Thermal contour plots in cryogenic cooled and non-cooled fillet welding

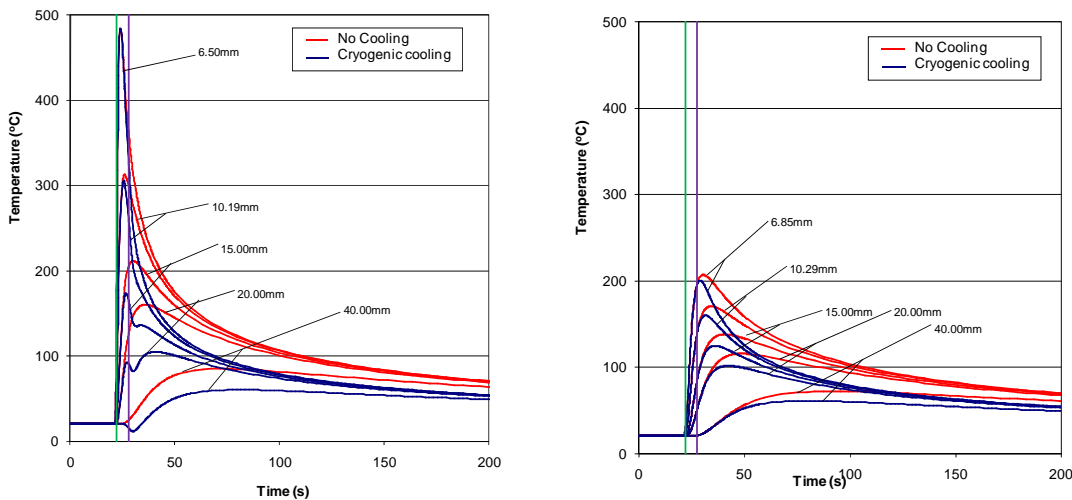

a) Welded side
 b) Non-welded side
Fig 8: Thermal transients in the plate in cryogenic cooled and non-cooled fillet welds

3.2 Residual stresses and out-of-plane deformation

Figure 9 shows the predicted out-of-plane deformations developed in butt-welded plates when the different numerical structural strategies described in section 2.3 are used. Gravitational forces trigger the overall distorted shape in the transient thermo-elasto-plastic approach. A similarly hogged distorted profile, is obtained when applying gravitational forces to the computationally efficient and hybrid models. Similar magnitudes of deformations are obtained for the transient thermo-elasto-plastic and hybrid models for non-cooled welds.

The final non-cooled deformation predicted using the computationally efficient model was significantly less than the others, as any inherent structural constraints ahead of or behind the weld are not included in the analysis. All models showed a reduction in out-of-plane deformation when cryogenic cooling was applied. Nonetheless the transient thermo-elasto-plastic approach resulted in a 63% reduction in out-of-plane deformation as opposed to a nominal reduction of only 28% for the computationally efficient and hybrid models. In both computationally efficient and hybrid models, the time independent assumption, based on maximum temperatures and a two-dimensional cross-sectional slice, ignores any thermal gradients developed ahead and behind the weld, so that any changes due to thermal tensioning and compression arising from cryogenic cooling are excluded. This suggests that in cryogenic cooled welds, some of the reduction in distortion is due to thermal tensioning mechanisms (also known as 'stress engineering') in addition to the heat absorption effect.

In the case of fillet welding, the out-of-plane deformation was characterised predominantly by angular distortion. The assemblies investigated in this study were relatively stiff and negligible

longitudinal bowing was evident. A small reduction in out-of-plane deformation was observed when applying cryogenic cooling and using the thermo-elastoplastic model. Figure 10 shows the out-of-plane distortion when applying this modelling strategy. The computationally efficient and hybrid models resulted in similar modes of deformation but the magnitude of out-of-plane distortions was significantly less. Table 1 gives the range of out-of-plane deformation for all three computational strategies with and without the inclusion of cryogenic cooling. Similar magnitudes of deformations were predicted when applying cryogenic cooling.

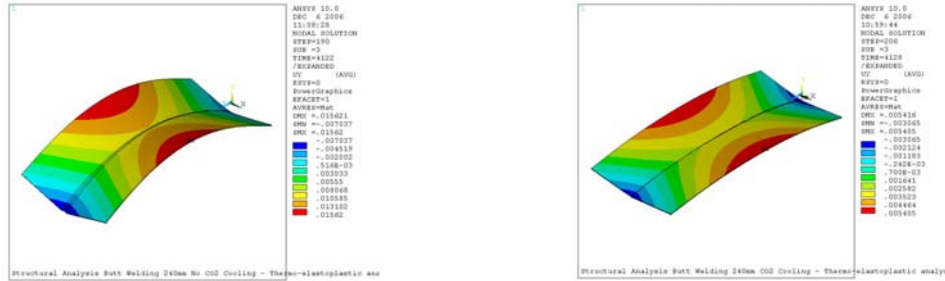

- i) Non-cooled weld – out-of-plane distortion range 22.657mm
 ii) Cryogenic cooling - out-of-plane distortion range 8.470mm - change 62.6%
 a) Thermo-elastoplastic analysis

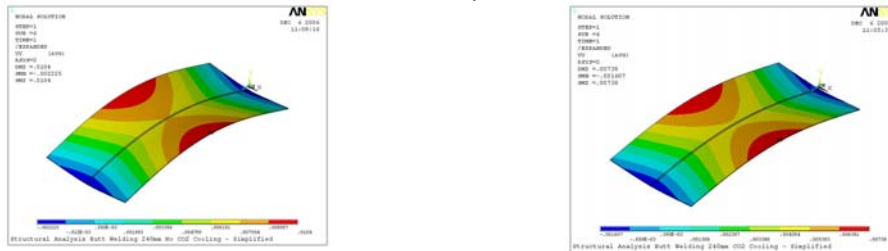

- i) Non-cooled weld – out-of-plane distortion range 12.625mm
 ii) Cryogenic cooling - out-of-plane distortion range 8.987mm - change 28.8%
 b) Computationally efficient model

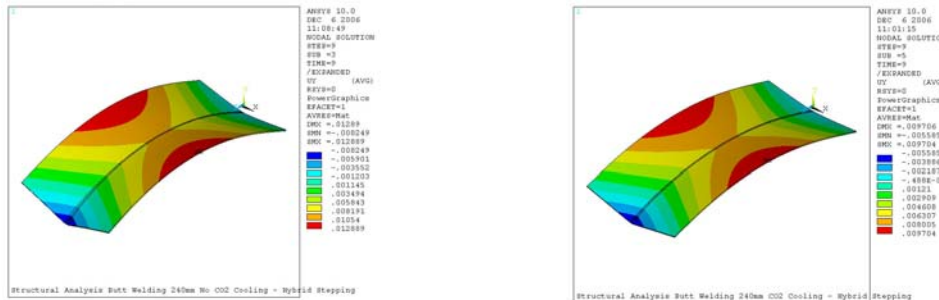

- i) Non-cooled weld Range – out-of-plane distortion range 21.138mm
 ii) Cryogenic cooling Range - out-of-plane distortion range 15.289mm - change 27.7% –
 c) Hybrid model

Fig 9: Predicted out-of-plane deformation in cooled and non-cooled butt welded plates

The predicted residual longitudinal stresses at midsections of the plate and for all three models are shown in fig 11. In all instances the size of yielded regions are reduced when applying cryogenic cooling. The difference in deformation in is not highly pronounced suggesting that not enough cooling was applied to the models.

	No Cooling	CO ₂ cooling
Thermo-elasto-plastic Model	1.951	1.877
Hybrid Model	0.634	0.638
Computationally Efficient Model	0.985	0.974

Table 1: Out-of-plane deformation (range in mm) for fillet welded assemblies

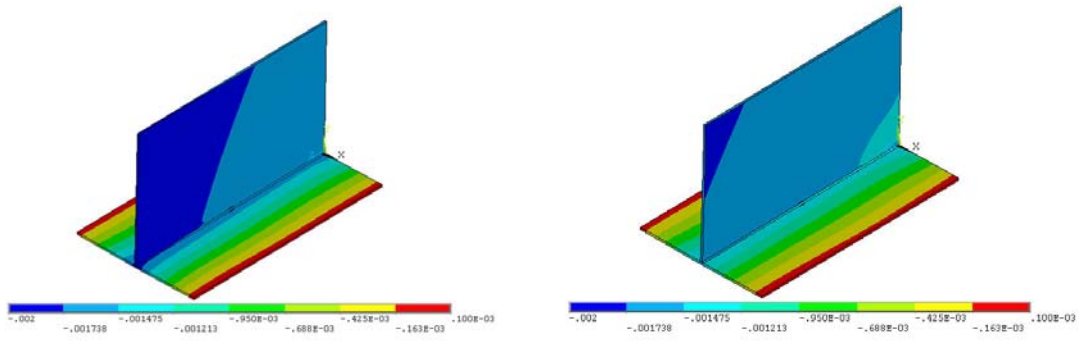

a) Non-cooled fillet welding

b) Cooled fillet welding

Fig 10: Predicted out-of-plane deformation and residual stresses in cryogenic cooled and non-cooled fillet welded plates – thermo-elasto-plastic model

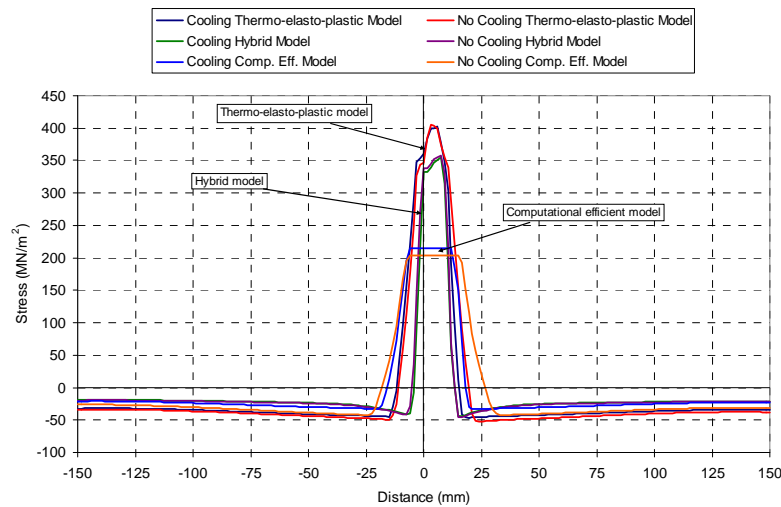

Fig 11: Longitudinal residual stresses at midsection of the plate for fillet welded assemblies

4. CONCLUSIONS

The aim of this study was to investigate strategies for predicting welding deformations in cryogenic cooled welds. Thermal transients were predicted first by assuming a heat extraction model to define the CO₂ cooling factor. The results show that cryogenic cooling reduces the maximum thermal strain developed. Changes in thermal gradients are also observed, thus subjecting the welded plates to thermal tensioning/compression.

For the test specimens investigated in this study, the inclusion of cryogenic cooling in butt-welding reduces the out-of-plane distortion significantly, but less so in the case of fillet welding. All structural computational models give rise to significant differences in the final predicted out-of-plane distortion. However the full transient thermo-elasto-plastic model predicts greater changes due to cooling. The smaller effect predicted by the computationally efficient and hybrid models is due to the time-independent assumption, whereby transient, differential thermal straining effects are ignored. Nonetheless a significant reduction of computational time of the order 4000x times is achieved when using computationally efficient models. These models can thus be used during the initial design stages to establish a basic trend and in particular to identify whether any benefits related to cryogenic cooling, exist. Typically, for the test specimen material and configurations, together with the cooling and welding parameters under investigation, cryogenic cooling did not have a marked effect on the final predicted out-of-plane deformations in fillet welded stiffened plate. In this case the predominant deformation is angular such that the deformations are mainly driven by the fused zone dimensions and any other structural restraints acting against transverse thermal strains.

Transient thermo-elasto-plastic models can be used further to establish a comprehensive evaluation of the cooling parameters which might be applied.

References:

- (1) Spicknall M H, Kumar R and Huang T D: 'Dimensional management in shipbuilding: A case study from the Northrup Grumman ship systems lightweight structures project' *Journal of Ship Production*, 2005 **21** 209-218.
- (2) Hurrell P R, Gregg A, Everett D and Bate S: 'Review of residual stress mitigation methods for application in nuclear power plant' *Proceedings of PVP 2006 ICPVT 11, ASME Pressure Vessels and Piping Division Conference, Vancouver, Canada 2006.*
- (3) Tsai C L, Park S C and Heng W T: 'Welding distortion of a thin plate panel structure' *Welding Journal*, 1999 **78** 156s -65s.
- (4) Conrardy C and Dull R: 'Control of distortion in thin section panels' *Journal of Ship Production*, 1997 **13** 83-92.
- (5) Masubuchi K: 'Analysis of welded structures' Oxford Pergamon Press, 1980.
- (6) Michaleris P and Sun X: 'Finite element analysis of thermal tensioning techniques mitigating weld buckling distortion,' *Welding Journal*, 1997 Nov 451-s
- (7) Guo S Q, Li X H, Xu W L, Liu X S, Wan X and Tian X T: 'Welding distortion control of thin Al alloy plate by static thermal tensioning' *Journal of Material Science Technology*, 2001 **17** 163-4.
- (8) Gabzdyl J, Johnson A, Williams S and Price D: 'Laser weld distortion control by cryogenic cooling,' *Proc. SPIE – The International Society for Optical Engineering Osaka Japan 2002* **4831** 269-74
- (9) Lindgren L E: 'Finite element modeling and simulation of welding. Part 1: increased complexity,' *J. Thermal Stress* 2001 **24** 141-192.
- (10) Camilleri D, Mollicone P, and Gray T G F: 'Computational methods and experimental validation of welding distortion models,' *J. Materials: Design and Application*, 2007 **221** 235 – 249.
- (11) Jiang W, Yahiaoui K, Hall F R and Laoui T: 'Comparison of sequentially and fully coupled generalized plane strain FE modeling of multi-pass welding,' *NAFEMS World Congress, Malta, 2005*
- (12) ANSYS version 10.0, 2006.
- (13) Camilleri D, Comlekci T, Lee C K, Tan H and Gray T G F: 'Investigation of temperature transients during flux-cored Ar/CO₂ butt welding of CMn steel plates,' *Proc. Int. Conf. Metal Fabrication and Welding Technology (METFAB – 2003) Nottingham, UK 2003* 107-16.
- (14) Camilleri D, Mollicone P and Gray T G F: 'Alternative simulation techniques for distortion of thin plate due to fillet-welded structures,' *Model. Simul. Mater. Sci. Eng.*, 2006 **14** 1307-1327.
- (15) Mollicone P, Camilleri D, Gray T G F and Comlekci T: 'Simple thermo-elastic-plastic models for welding distortion simulation,' *J. Mater. Process. Technol.* 2006 **176** 77-86.
- (16) Camilleri D, Comlecki T and Gray T G F: 'Computational prediction of out-of-plane welding distortion and experimental investigation,' *J. Strain Analysis* 2005 **40** 161-176.
- (17) Camilleri D, Comlecki T and Gray T G F: 'Thermal distortion of stiffened plates due to fillet welds – computational and experimental investigation,' *J. Thermal Stress* 2006 **29** 111-137.
- (18) Camilleri D, Comlecki T, and Gray T G F: 'Design support tool for prediction of welding distortion in multiply-stiffened plate structures: experimental and computational investigation,' *J. Ship Prod.*, 2005 **21**, pp 219 -234
- (19) Camilleri D and Gray T G F: 'Computationally efficient welding distortion simulation techniques,' *Model. Simul. Mater. Sci. Eng.* 2005 **13** 1365-1382.
- (20) Camilleri D and Gray T G F: 'Optimization of welded lightweight multiple-stiffener plate structures to minimize unwanted shape distortion,' *Welding Cutting*, 2006 **5** 320-327.