



**Multiannual Programme
of the Joint Research Centre
1980-1983**

1982
Annual Status Report

Solar energy

Published by the
COMMISSION OF THE EUROPEAN COMMUNITIES
Directorate-General
Information Market and Innovation
Bâtiment Jean Monnet
LUXEMBOURG

Reproduction in whole or in part of the
contents of this publication is free, provided
the source is acknowledged

©ECSC-EAEC, Brussels • Luxembourg, 1982
Printed in Italy

ISBN 92-825-3577-0
Catalogue number: CD-ND-83-040-EN-C

SOLAR ENERGY

1982

Research Staff: 60
Budget: 7.086.000 ECU

Projects:

1. ESTI: European Solar Test Installation
2. Habitat and Low Temperature Applications
3. Solar Power Plants: Materials
4. Photoelectrochemistry and Photochemistry

Programme Manager: G. BEGHI
Commission of the European Communities
Joint Research Centre
Ispra Establishment
I-21020 Ispra (Varese), Italy

1. INTRODUCTION

To develop alternatives able to complement or replace present energy sources, thus reducing the dependency from non-renewable or imported primary energies, is the main motivation of European activities on solar energy.

In accordance with the general science and technology policy of the Commission the objective of the JRC Solar Energy Programme is to contribute by specific activities to the development and application of solar energy technologies within the Community. The programme has two main orientations:

- to give a support to an extended application of solar energy technologies in the European Community, particularly with the operation of test facilities and the definition of testing procedures and methodologies.
- to pursue exploratory research in some specific areas, where industrial applications are still uncertain and preliminary information could be useful for orienting future development work.

The programme is structured in four projects.

Project I: ESTI (European Solar Test Installation)

This project deals with the construction and operation of a number of indoor and outdoor test facilities, for thermal and photovoltaic converters and with related «methodology» services as public service to interested organizations and industries within the Community. The specific testing activities are carried out in conjunction with an action for the definition, with the collaboration of national expert groups, of recommended procedures for the qualification of solar components and the development of test methods. Important activities, dealing with the identification of degradation mechanisms and ageing processes, are also performed in the frame of the project, to prepare the necessary background for the evaluation of reliability of solar technologies.

Project II: Habitat and low temperature applications

The project deals with the study and modelling of integrated systems for heating and cooling. Experiments with complete systems are performed, during winters and summers, using a «solar laboratory», and evaluations and comparisons are

made. In the studies on low energy building design, chemical storage of heat is studied. A growing attention is given to passive technologies. Other systems of ground, seasonal storage are also tested. These studies will be completed by techno-economic assessments and are closely linked to corresponding actions of the EC Energy R and D Programme and IEA international cooperations.

Project III: Solar power plant materials

The activities aim at the improvement of solar power plant performances in relation to their efficiencies through appropriate contributions in the field of selective materials.

Special attention is given to the European Community 1 MWe power plant EURELIOS which was built in Sicily (Energy R and D Programme).

Project IV: Photoelectrochemical and photochemical conversion

The objective of these orientative studies is the exploration of advanced techniques for the conversion of solar energy into electrical or chemical energy. Main approaches which are followed are related to liquid-semiconductor junction solar cells and photochemical water splitting.

2. RESULTS

2.1 ESTI (EUROPEAN SOLAR TEST INSTALLATION)

OBJECTIVES

The final goal of solar energy research consists in the development of a cost effective solar energy conversion technology. Any progress in this field requires a comparison of continuously improving devices; in view of the inherent variability of the incident radiation it is essential that this comparison is made under the same well-defined and reproducible conditions.

These conditions should take into account the climatological and irradiation situation of the place chosen for installation. The project ESTI intends to treat part of these problems by means of laboratory measurements: this requires the constructions of «indoor» test facilities and the definition, selection and validation of suitable testing methods.

There are a number of critical problems for the indoor method, as for example the true correlation between indoor and outdoor results, the eventual non-linear superposition of external parameters or the non-reciprocity between an artificially enhanced treatment and the real long time behaviour of a given device. A caution application of the indoor method is therefore necessary, especially during the initial phase. On the other hand, the advantage of being able to measure technical and scientific progress against reproducible and always available reference conditions should by far outweigh those difficulties. These facilities allow to verify if material corresponds to specifications, to differentiate between meteorological and material risk and to eliminate additional costs due to too large

safety margins. This reduction in risks both for producers and for users is considered to be an essential step for the development of a cost effective solar industry.

Since the main obstacle to a large scale use of solar energy lies in the high cost per unit of useful energy, it is necessary to decrease investment costs and to maximize the total energy output.

The conversion efficiency must be high, moreover the life time of the conversion system should be large against its energy pay-back time. Since this condition is to some extent in contradiction to the economic tendency to diminish material and maintenance costs, a careful evaluation of any «progress» is a first prerequisite.

The tasks of the project ESTI may thus be summarized as follows:

- to operate facilities for the test of photothermal and photovoltaic converters in order:
 - to determine their performance under defined and reproducible indoor test conditions;
 - to establish appropriate qualification test and
 - to estimate their service life using accelerated and abbreviated (indoor and outdoor) testing methods.
- to assist in testing of photovoltaic energy conversion systems, especially for pilot and demonstration projects of the CEC.
- to promote and establish E.C. collaboration in solar testing in order to define, develop and validate common performance criteria and standard test procedures as base for an objective inter-comparison of test results.

After a description and the state of the art of facilities, the activities and the results are reported subdividing them into the three following research areas:

- thermal conversion
- photovoltaic conversion
- qualification and endurance testing.

FACILITIES

The facilities of the Project are subdivided in the following groups:

Light Simulators

LS0: a simulator using Xenon lamp and producing sunlight on test area of $20 \times 20 \text{ cm}^2$. Used for calibration of solar cells and for reference purposes.

LS1: installation able to perform measurements on a test plane of $3 \times 4 \text{ m}^2$ under uniform and uncollimated light and over a range of temperature conditions from -40°C to $+60^\circ\text{C}$.

The light source consists of 295 discharge lamps (250 W each) producing an uniform irradiance which may be selected between 250 and 1170 W/m^2 . Four test loops are available for thermal conversion efficiency measurements.

LS2: solar simulator consisting of 25 kW xenon lamp and a collimator mirror. It allows to measure angular incidence effects and the efficiency of concentrator cells. The same simulator without mirror is also used for indoor NOCT measurements.

LS3: a large area pulsed solar simulator allowing measurements on photovoltaic modules and arrays under good irradiation uniformity and without cell heating, at standard test conditions.

All these light simulators LS0, LS1, LS2, LS3 are operational.

Durability and qualification Test Facilities

AT0: Chamber for temperature - humidity freeze cycling of photovoltaic cells.

AT1: a climatic chamber for accelerated ageing tests in a corrosive atmosphere (humidity, sulphur dioxide, ozone).

AT2: a facility for accelerated ageing under intense ultraviolet irradiation.

AT3: a test chamber for rain penetration and for the determination of mechanical resistance to static and dynamic pressure loads. A uniform air pressure can be applied up to 6500 Pa in pressure or up to 4000 Pa in suction.

The inside size of the chamber is 220 × 70 cm. Rain can be simulated with spray nozzles while the collector is in underpressure.

The temperature of the chamber can be varied between room temperature and -15°C. By a special technique ice layers can be formed on the specimen.

AT4: a hail gun. Hail stones between 12 and 40 mm of diameter can be shot, one at a time, with velocities between 10 and 50 m/s.

AT5: facility for testing the pressure resistance of absorbers of thermal collectors and their eventual leakage tested.

AT6: a solar simulator which allows irradiation of one collector for long time. The light source consists of eightyeight 250 W power star lamps giving an irradiance adjustable between 700 and 1200 W/m². The irradiation area is 120 × 340 cm. The purpose of this facility is longtime ageing of collectors in dry or stagnant conditions causing thermal degradation.

The facility allows to simulate thermal shocks caused by «cold filling» or by «water spraying» of hot collectors.

AT7: an irradiation device for ultraviolet and visible light on an area of 100 × 150 m.

The irradiation temperature can be varied by means of adjustable air blowers between 40° and 90°C.

AT8: a test chamber which allows storage in damp atmosphere; it has inside dimensions of 150 × 100 cm.

AT9: a salt mist chamber.

AT10: high temperature storage chamber.

All test facilities are operational, except AT9 and AT10 which are under construction.

Some outdoor facilities for correlation measurements are also available.

Data Acquisition Systems

A system is available with a two-level computer hierarchy to ensure a flexible and individual control of different experiments combined with a powerful back-up in mass storage facilities and power.

It consists of peripheral units (small computers of type PDP-11-03) interfacing directly with the experiments for control and data collection, and a central computer of type PDP-11-60, available for off-line computational and editorial work.

Outdoor Facilities

The development of significant test procedures simulating various atmospheric conditions requires the execution of outdoor correlation tests. Correlation test facilities are available for different purposes.

THERMAL INDOOR PERFORMANCE TESTING

The activity is mainly concentrated on the Thermal Indoor Performance Testing, using the light simulator LS1 which allows accurate measurements of the efficiency of thermal collectors. Accuracy in the measure of these thermal efficiencies is based on very precise determination of the coolant flow, of the temperature difference between inlet and outlet of the coolant, and of the light intensity. The flow is measured by means of magnetic flow meters, giving an accuracy better than 0,5%.

The accuracy in the temperature difference measurements, made by quartz thermometers, is about 10⁻²°C.

Measurements of thermal efficiency were made on 38 types of liquid heating flat plate collectors used for domestic hot water production. The performances of these collectors were measured through the efficiency integral, i.e. the integral over the efficiency curve from T = 0 to T = T_{stag} (see fig. 2).

This efficiency integral is a very useful parameter to compare thermal collector performances, provided that the experimental conditions of the measurements are the same. It has however to be mentioned that performance is only one of the important qualities of a collector: durability, safety system, price are also very significant for the choice of the more suitable thermal converter.

The results of the measurements of thermal efficiency are published in technical reports and are reported in the Semianual Programme Progress Reports.

ESTI EUROPEAN SOLAR TEST INSTALLATION

- EXPLOITATION OF TEST FACILITIES
TEST REPORTS
- SUPPORT TO PHOTOVOLTAIC SYSTEM TESTING
- TEST PROCEDURES, ROUND-ROBIN TESTS

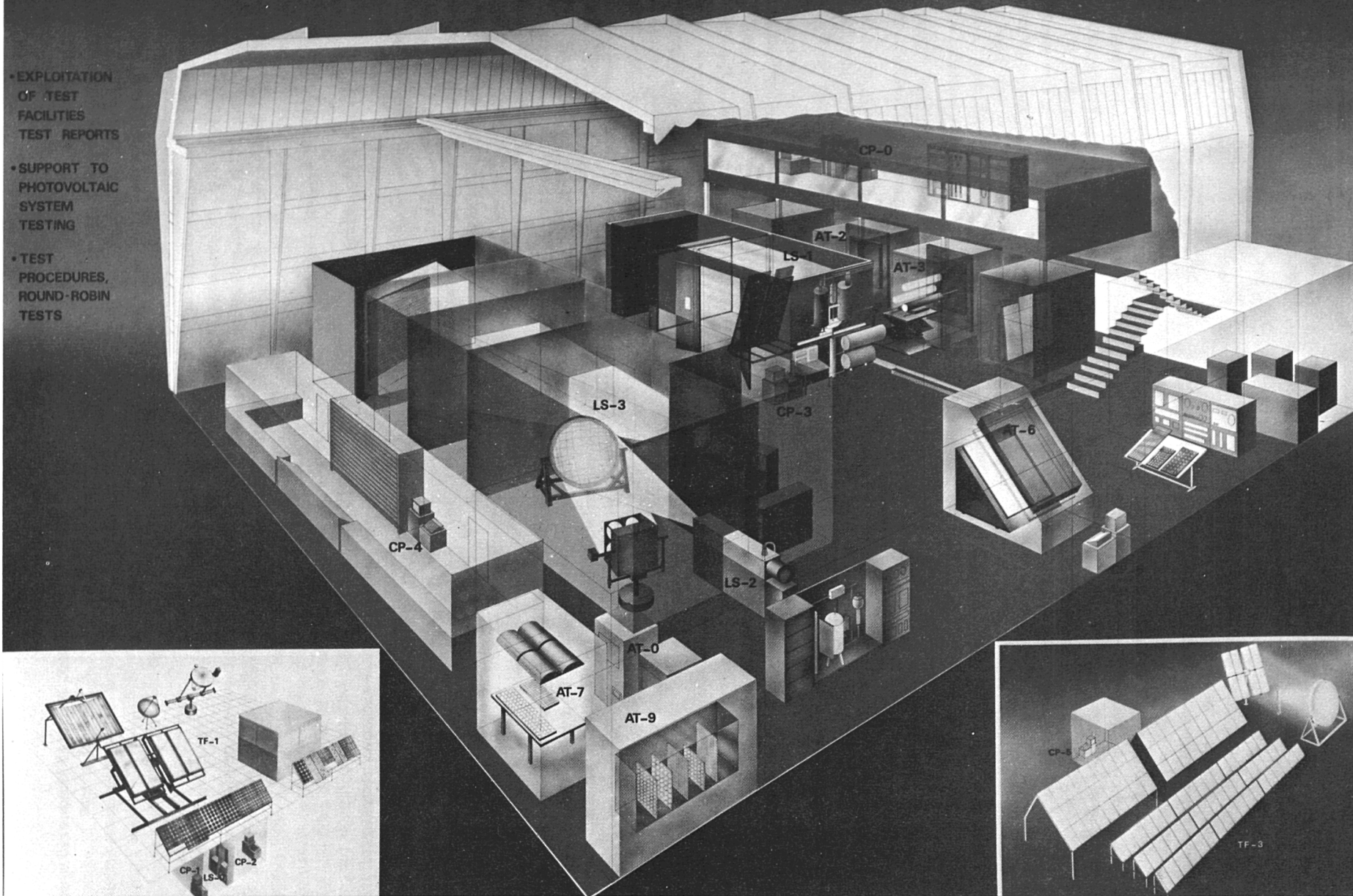

Fig. 1. Artist's view of ESTI FACILITIES

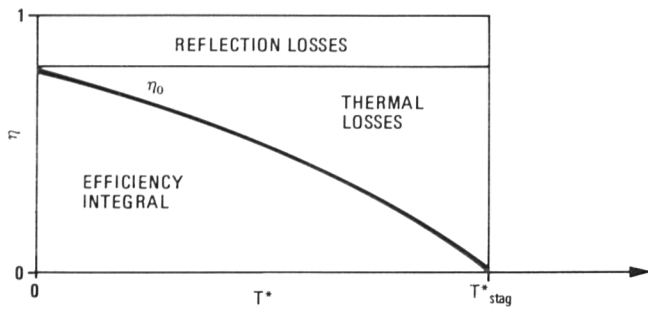

Fig. 2. Simplified diagram of efficiency η versus temperature T^*

PHOTOVOLTAIC TESTING

Concerning Photovoltaic Performance Testing activities, the main effort has been devoted to the extensive module test programme for the 18 photovoltaic pilot plants which are in construction in various sites in the European Community as the Photovoltaic Pilot Project of the Energy R and D Programme managed by General Directorate XII - Brussels (Indirect Action).

The EC-Contract conditions require that for each module type to be used in these plants a control test has to be made at the JRC.

Concerning performance testing, reference is made to the publication «Standard Procedures for Terrestrial Photovoltaic Performance Measurements», CEC Specification No. 101 (Issue 2), EUR Report 7078 EN (1981).

Other tests are made for the Qualification of the modules, in order to have reliable information on a sufficient life time of the components; these tests are made following the procedures published as Report EUR 7545 EN: CEC Specification No. 501 (Photovoltaic Module Control Test Specifications).

The modules for these projects are constructed by European manufacturers, their characteristics vary from 19 W and a size of $56 \times 46 \text{ cm}^2$ to 120 W and $146 \times 100 \text{ cm}^2$.

All the prototype modules for these Pilot Projects have been tested. In addition, a series of other modules has been measured to increase the data for a later intercomparison of photovoltaic technologies.

Up to now 1104 single tests on 121 modules have been performed.

It is already possible to make a preliminary list of defects found during prototype testing. These defects are in general related to the lamination process for encapsulation and are «minor» defects; however they reveal that an improvement of quality could be obtained in general for these devices.

These observations were useful for several manufacturers who revised meanwhile some production steps as consequence of these test results.

For the Photovoltaic Pilot Projects the first on-site acceptance testing of photovoltaic arrays was made in December 1982: the Aghia Roumeli plant on the island of Crete (Greece), the first of the plant terminated and put into operation. Special equipment and software were prepared for this first acceptance test, and will be used for all the other plants, as soon as put into operation.

The test statistics is at present still limited: one of the main objective of this activity of the Project, in connection with the EC

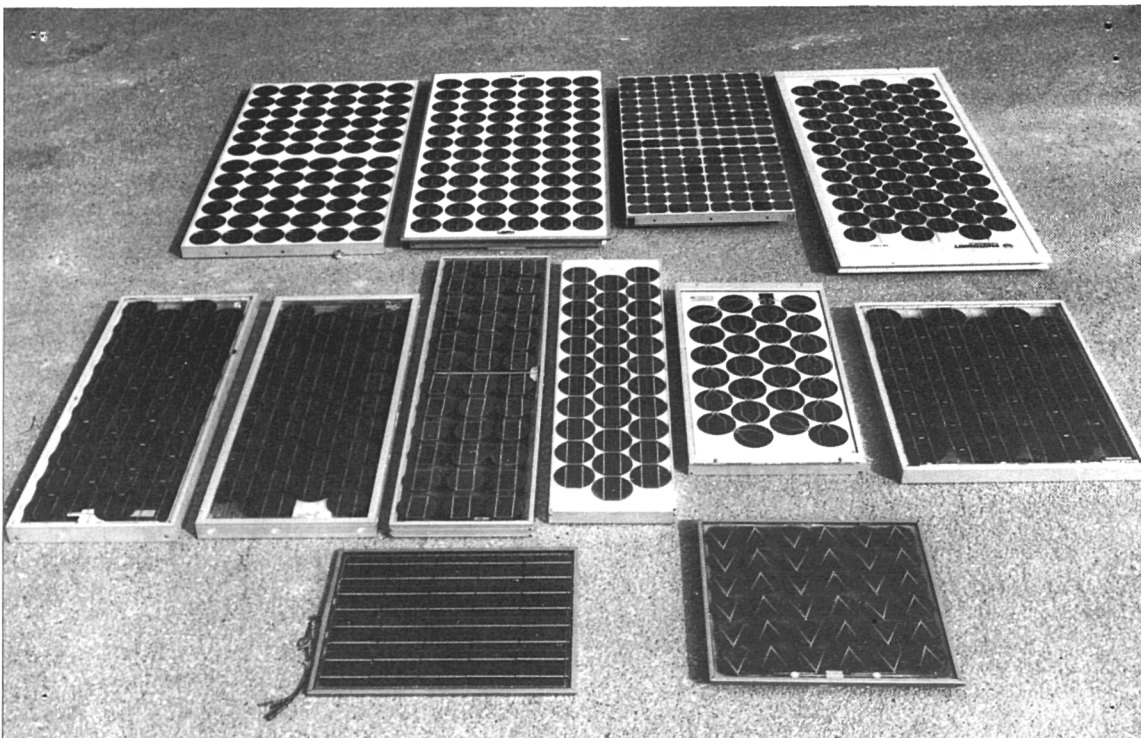

Fig. 3. Some of the modules tested at ESTI

Pilot Plant Programme is to increase the statistical basis for module failure analysis and to improve the present test methods. This important result can be obtained if there is a sufficient experimental background to find where present indoor test method could be relaxed, where other tests are needed, where an increase in stress level could lead to higher acceleration factors without losing the significance of the test; the cost of the tests has also to be always taken into consideration.

To establish the experimental background the JRC is making an effort to prepare efficient data acquisition systems to be installed in different test sites and covering both aspects, energy performance and lifetime or failure rate of the main components.

The hardware and software for a mobile data acquisition system for in situ measurements have been developed; a test facility has been built, with two units of 1 kWp, one of flat plate modules on a sun tracking plane (fig. 4), and other with a concentrator (fig. 5). The systems are used for water pumping, but other types of utilisation are possible. The complete data acquisition system including a computer for control, monitoring and recording purpose is operational.

These units are prototypes for different, future applications, as for instance are experimental plant for water pumping, for a power of 3 kWp, to be installed in Aqaba in the frame of a collaboration between the EC Commission and Jordan-Royal Scientific Society.

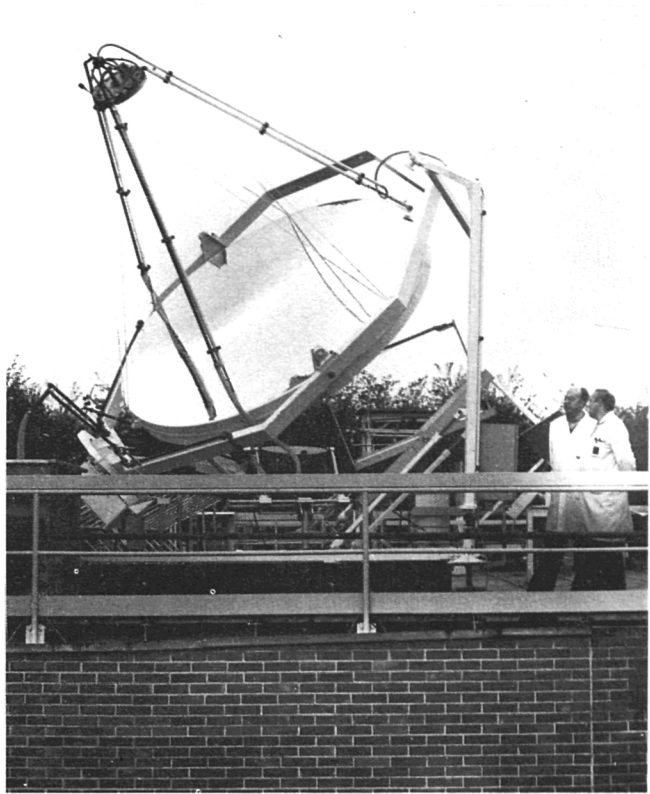

Fig. 5. Concentrator, 1 kWp.

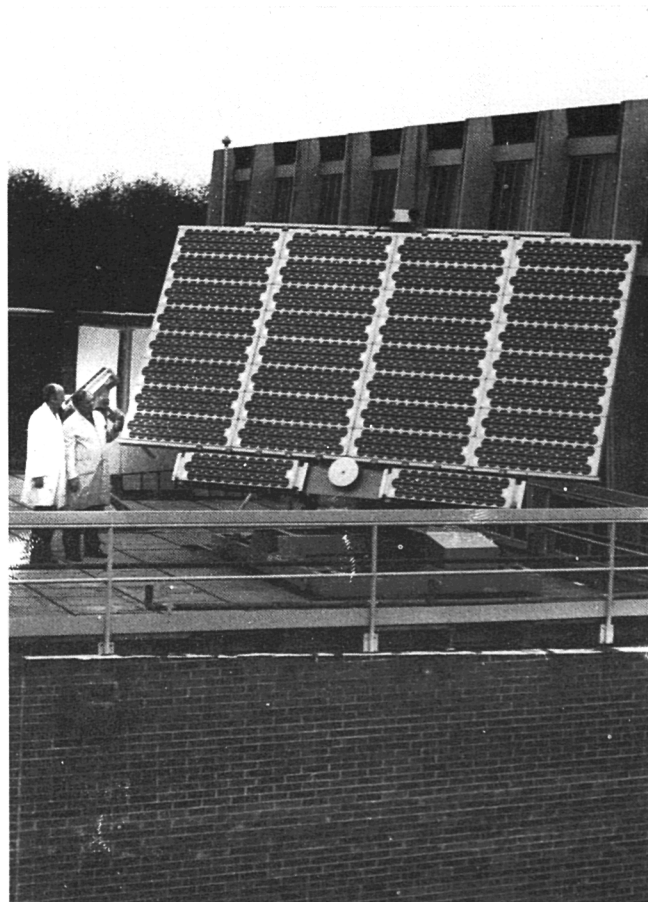

Fig. 4. Unit of 1 kWp., on a sun tracking plane

Collection analysis and intercomparisons of experimental data from different pilot and demonstration plants, together with appropriate indoor qualification testing could become in the future an important contribution to further photovoltaic module improvement.

QUALIFICATION AND DURABILITY TESTING

Main goals are the study and the research on mechanisms of degradation, and the definition and the selection of methods for estimating long time behaviour from measurements during limited test periods or under increased stress levels.

All AT-facilities are now operational and most of them were used for the various qualification tests prescribed in EUR-Specification N°501 for photovoltaic modules (see previous section).

- Other measurements are made in parallel, as it is the resistance of thermal collectors to simulated hail, for flat plate collectors with covers in glass, in plexiglass and in polycarbonate. Tests were made also with evacuated glass tube collectors, of different designs.
- Another aspects which has been considered is the degradation of thermal collectors: a new measuring technique was developed, and verified, to evaluate the efficiency degradation of flat plate collectors. The description of the method and its advantages are given in the Programme Progress Reports of the Programme.

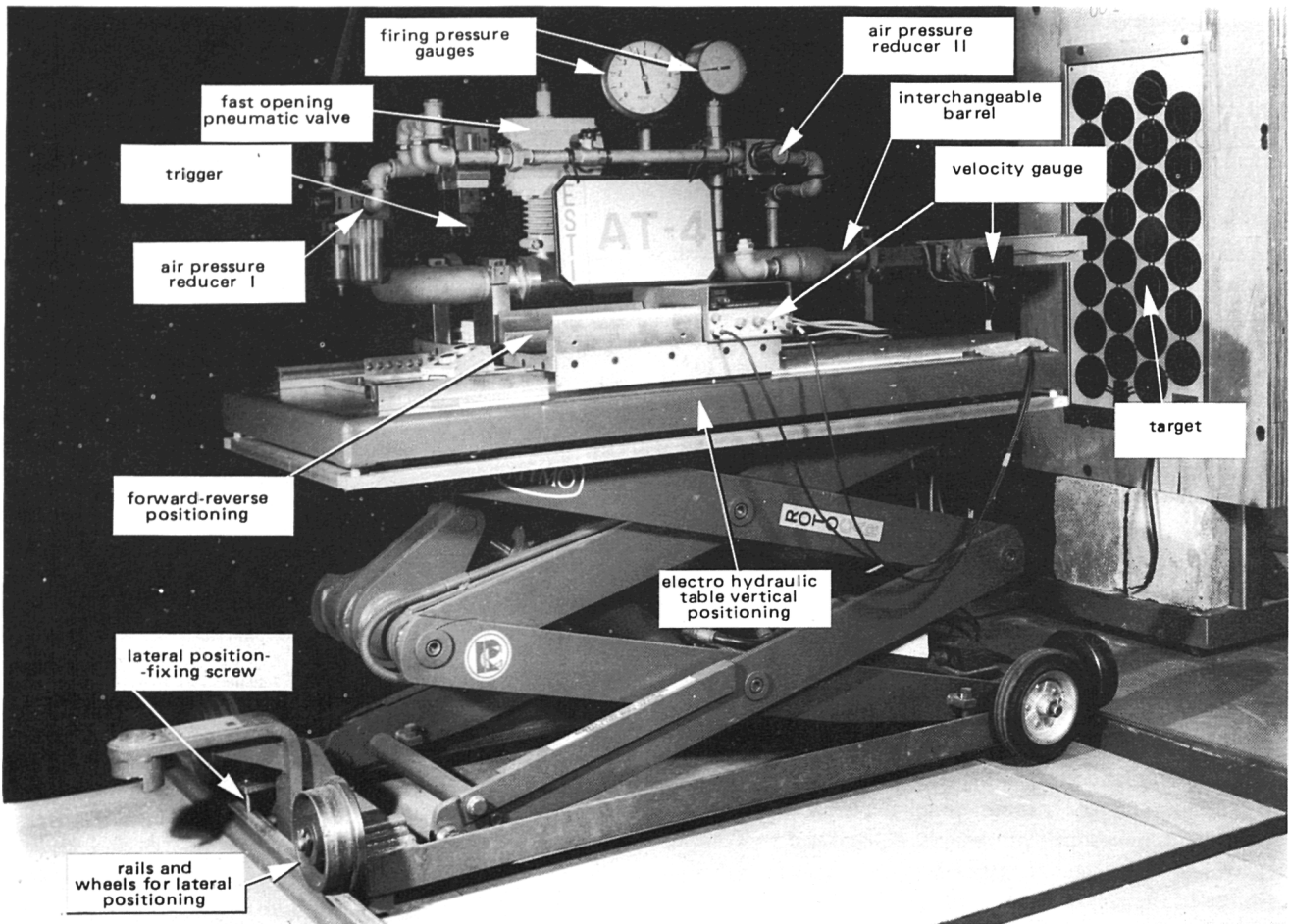

Fig. 6. ESTI AT4 (ageing test) - Simulated hail impact test

- A study was made to verify in simulated conditions the effects of ultraviolet irradiation on collector materials. Three collectors with different covers (plexiglass, polycarbonate, glass) were tested, exposing to irradiation of ultraviolet doses equivalent to several years of outdoor exposure, at temperature around or somewhat less than the normal operating conditions of the collectors. No significant decrease in efficiency or damage could be observed after the exposure on any one of three collectors. These tests, together with the experience gained during several years of operation of collectors, seem to confirm that thermal collectors are not so sensible to ultraviolet irradiation.
- Concerning the corrosion effects from atmosphere in normal operating conditions, for a correlation for indoor tests outdoor weathering experiments are necessary. A prototype experimental set up was designed and built, consisting of a simple air cooled cooling circuit with automatic temperature control. The components of the system have shown their operation reliability running one year without interruption. A first correlation test facility has been installed at Ispra, as reference clean atmosphere and longtime testing is starting.

The installation of a second correlation test facility has been started near a power station of the Italian utility, representative of a typical industrial atmosphere. Negotiations about a third field in a marine atmosphere are in progress.

2.2 HABITAT AND LOW TEMPERATURE APPLICATIONS

OBJECTIVES

The project is mainly concerned with the study and modelling of integrated systems for heating and cooling. Different schemes are considered in view of an evaluation of the potential of the systems and an improvement of the economics of solar energy applications. All these studies are closely linked to the corresponding activities of the Indirect Action, the Energy R and D Programme of the EC Commission managed by the General Directorate of Science, Research and Development. Cooperations are also in progress in the framework of ongoing programmes of the International Energy Agency. The activities and the results are reported, following the subdivision in the various subprojects.

METEOROLOGICAL DATA

The Measurements and Analysis of Meteorological Data are continuing, in connection with the various experiments performed with heating and cooling system.

Particular attention was given to the utilisation of solar data measured at Ispra as inputs for the validation of various simplified mathematical models in the field of cooling applications and long term storage. The activities in connection with the International Energy Agency-Solar Heating and Cooling Agreement are progressing, in view also of a participation in new tasks concerning meteorological measurements.

OUTDOOR PERFORMANCE TESTING OF THERMAL COLLECTORS

Main objective is the study of the essential problem of collector testing: the correlation between the behaviour of a collector as integrated part of a system and its performance when tested as single component, measuring simulated or accelerated degradation.

This subproject is well integrated in the programme of work of the European Collector Testing Group of the Indirect Action (Energy R and D Programme of the G.D. XII).

Particular attention is given to the interaction between the thermal collector and the various components of the systems (coolant fluid, monitoring procedures, control and regulation, etc.) which influence strongly the performance and the durability of the collector.

The activities have been focused on the (i) study and preparation of an air loop (ii) design and construction of a test loop for high temperature solar collectors systems. These are systems able to produce solar heat up to 300°C, using concentrating and evacuated collectors, and suitable for industrial purposes. A special effort has been made on the problem of internal corrosion in a system. An experimental circuit for these tests was designed in cooperation with a chemical company and is in construction.

The purpose is to verify the compatibility of various heating fluids with the materials which are present in the circuits.

In connection with the activities concerning performance testing a «Solar Simulators Workshop», organized jointly by JRC and IEA, was held at Ispra on 9-10 February 1982.

SEASONAL STORAGE OF SENSIBLE HEAT

The economics of space heating solar systems is penalized in most of Europe by the limited sunshine hours available during the periods for which heating is needed. These limitations can be partially overcome by seasonal storage. This activity is oriented to study the behaviour of seasonal storage technologies, using sensible heat in large, ground systems.

The main facilities are in operation:

- a large concrete water vessel of 375 m³ buried in the ground without thermal insulation in order to study interaction with the surrounding ground.

- a system of vertical metallic tubes 10 m long, 20 cm in diameter with a spacing of 2.5 m, heating a volume 2000 m³ of soil.

The two systems are extensively monitored as far as temperature distribution and energy input are concerned.

A charging season was started in May and an extraction season will follow. This activity on seasonal storage is strongly correlated to the corresponding action of Task VII in the frame of the IEA Agreement on Solar Heating and Cooling. A four day Technical Meeting of this Task was held at Ispra, organized by JRC in cooperation with the Operating Agent (Sweden), on 10-14 May 1982, with participation of about 30 experts.

Another international technical Workshop, cosponsored by IEA and JRC, on «Solar Coupled Ground Storage with Heat Pumps» was held at Ispra on 14-16 September 1982.

About 30 participants discussed the state of the art and the perspectives of these techniques.

THERMOCHEMICAL STORAGE AT LOW TEMPERATURE

The activity is concerned with the study of the technological problems and the thermal performance of systems for chemical and latent heat storage at low temperature (20 ÷ 250°C).

The main objectives are:

- to proof the applicability on technological scale of chemical and latent heat storage system.
- to define the optimal exploitation conditions of such systems in view of their possible application in integrated systems for house heating and cooling, and in the building industry.

The study of technological solutions for the use of the salts selected as storage media is continuing; the problem of encapsulation is presenting some difficulties and is studied in collaboration with specialized companies.

In view of a contribution in the definition of methodologies for the evaluation of thermal performance of latent heat storage components, a simple method for measuring the performance of heat storage containers has been set up and used.

The method is described in JRC Progress Reports, and first results will be presented at the Second Engineering International Conference on Energy Storage in May 1983.

SOLAR SPACE HEATING SYSTEMS

The objective is the evaluation, with experiences made in a Solar Laboratory, available since 1977, of the practical performance of various solar space heating systems, using a common methodology and extrapolating through mathematical models the results obtained to other climatic conditions.

Following the experiments made in the previous seasons, the Solar Laboratory has been extensively monitored; active heating systems, heat pump and long term storage, are used.

This work is now entering in the field of models validation and optimization of the size of various components together with techno-economic evaluations.

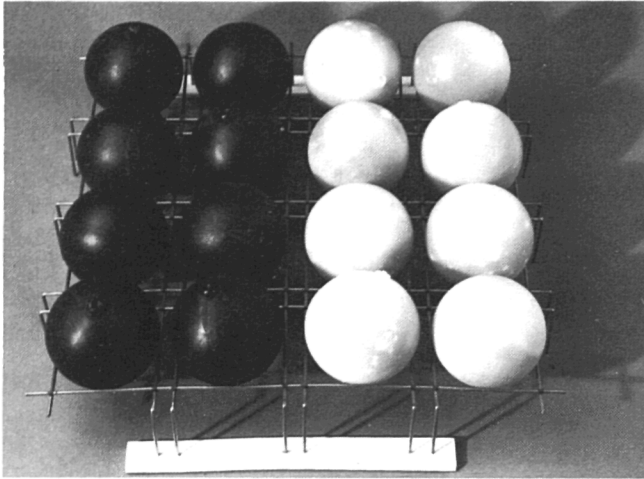

Fig. 7. Polypropylene spheres ($\phi = 45$ mm) containing chemical heat storage material working at 64°C

SOLAR SPACE COOLING SYSTEMS

New experiences were prepared and activities are progressing towards the objective of a complete intercomparison of various types of high performance collectors and different absorption machines. A new campaign has been made in the summer with evacuated collectors of Philips and Sanyo types. Also in this case the activity is connected with the IEA - Agreement Solar Heating and Cooling.

The results of the tests already done indicate that excellent daily collectors efficiencies are possible with evacuated tube collectors at operation temperatures between 80 and 100°C .

From the point of view of durability of these collectors, an improvement is possible and might require a systematic research effort.

Work on cooling systems using zeolites was concentrated during the reporting period on laboratory tests oriented to a better knowledge of the material. Two aspects were studied: the regeneration of zeolite and the adsorption/desorption cycle.

PASSIVE SYSTEMS

A particular effort has been concentrated on the study of Passive Systems and new activities have been started. Various analysis on active systems have shown that, except for specific system in which the thermal collectors are operating all the year, as f.i. active Heating/Cooling systems with long term storage and heat pumps, the cost of such active systems are still too high and the competitiveness is in general doubtful.

Comparison with passive technology solutions should be clearly based on detailed and reliable techno-economic assessments. It is in the field of testing passive components that JRC could bring scientific-technical contribution. Effort is specially concentrated on the realization of second generation passive test cells for components such as special shutter system, roof, structures with storage using latent heat or phase change materials, etc.

An activity in cooperation with other european laboratories and oriented to testing of performance of such passive devices, to the development of common methodology could answer to a real need. Contacts with various european institutes interested in the field are already in progress.

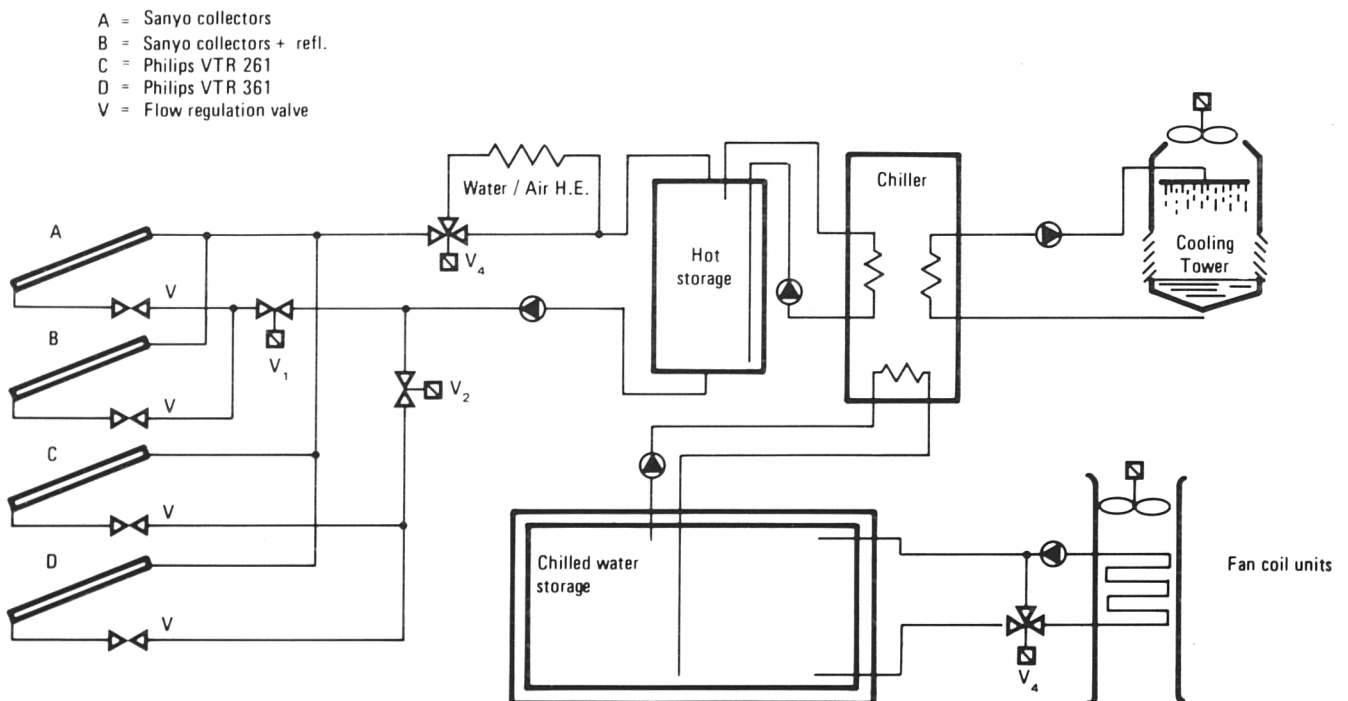

Fig. 8. Schematic view of the solar cooling system

A collaboration has been set up with CNRS (France) as far as instrumentation and modelling are concerned.

The passive Solar Test Facility which is in construction consists of:

- two «Variable Parameter» test cells, in which front wall, ceiling and floor are used as test field for the passive components,
- one «Reference» test cell, where the working conditions of a usual (energy-efficient)-building room are reproduced and accurately controlled.

The cells have the form and dimensions of a small office ($3 \times 2.80 \times 6$ m). The interior is subdivided into two rooms of

variable volume by a sliding non-structural wall in which a door and two ventilation grids are located. One is used as test room, while the second is equipped with control instruments and with a supplementary heat source in order to assure the necessary comfort of living.

A specific design of outside wall with heat storage using particular techniques was studied. An experimental installation to measure the performances of two different systems is in construction.

The above mentioned activities on Passive Systems are in a phase of expansion and are more and more linked with the general objective of rational use of energy in buildings.

2.3 MATERIALS FOR SOLAR POWER PLANTS

The conversion efficiency of solar radiation into heat is depending from the optical properties of the absorber material. An improvement in its solar absorptance and a decrease in its thermal emittance increases the photothermal conversion efficiency.

The aim of this activity is to develop selective metallic surfaces with a morphology particularly suitable to obtain a high thermal conversion efficiency for solar radiation, and a good stability at high working temperatures.

Examples of application are the various types of solar receivers designed for power and industrial heat production.

Two kinds of work are performed:

- preparation of special surfaces using various techniques;
- characterization of the surfaces with measurements of optical properties and thermal stability.

The activities related to the preparation of absorber surfaces are concentrated on a production method using the deposition of vapours of a corrosion resistant metal or alloy on a suitable substrate.

Chromium surfaces with particular morphology were obtained and tested: the absorption characteristics are remarkably improved. These results show that this a promising orientation of the research.

Life duration measurements for time up to 10.000 hours at 500°C in air have been made on samples with different structure: the degradation of the thermal emittance is relatively slow.

Another important work in the frame of the Project is the development of a measurement equipment for a calorimetric determination of the thermal emittance and the solar absorptance. On the basis of the experimental results already obtained a standard measurement procedure will be developed.

2.4 PHOTOELECTROCHEMISTRY AND PHOTOCHEMISTRY

Research is devoted to techniques for the conversion of solar energy that are still in a state which does not allow short term applications, but could play an important role in the long term future if promising results are obtained.

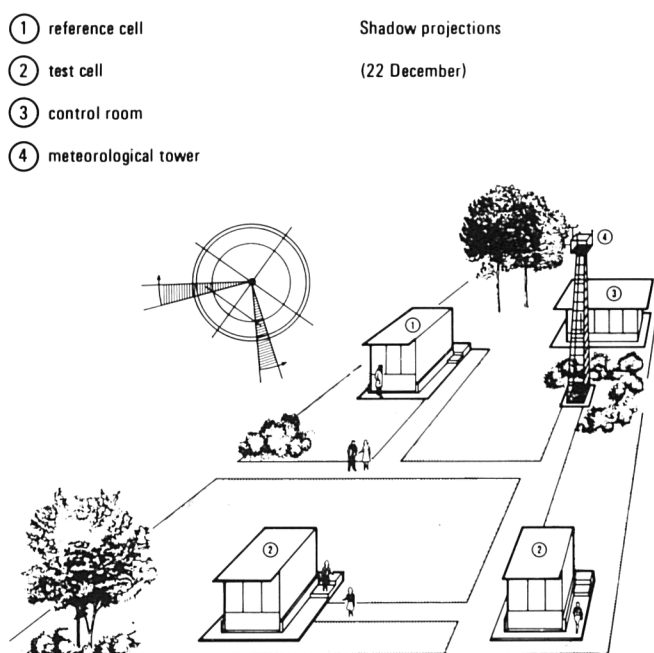

Fig. 9. Passive solar test facility

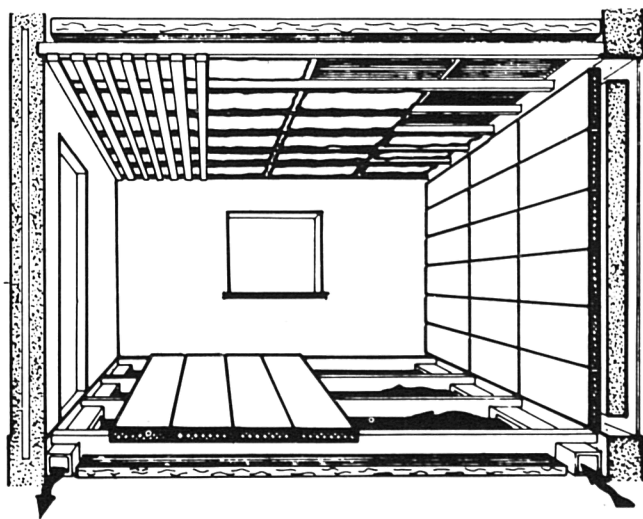

Fig. 10. Variable parameter test cell - Schematic inside view

PHOTOELECTROCHEMISTRY

The semiconductor/electrolyte (SE) photocells can be used like solid state solar cells (photovoltaic cells) for the direct conversion of light into electrical energy (regenerative mode of operation) or can be used for solar conversion into storable chemical energy (e.g. by photoelectrolysis). These SE-solar cells are still in a state where commercial application must be considered premature. Problems arise essentially from stability, in conjunction with limited spectral response and efficiency. Several approaches to solve these problems are under investigation in many laboratories. A first objective of the JRC research activity is to contribute by an investigation of the photoelectrochemical behaviour of less known and surface-coated semiconductors.

During the reporting period research was concentrated on the study of the influence of RuO_2 overlayers on TiO_2 ; the investigation was made in collaboration with the University College Cork (Ireland) and the Ecole Polytechnique Fédérale, Lausanne (Switzerland). Several preparations and measurements were made and the experimental results revealed new effects of significance for the understanding of the mechanism operative in microheterogeneous systems.

Another objective of the project, in collaboration with the Weizmann Institute of Science (Israel) is the investigation of the possibility to reduce CO_2 to organic fuels using semiconductor electrolyte solar cells. A series of experiments was performed under impurity-free conditions, avoiding the problems previously encountered. In all the samples no catalytic effect of TiO_2 , Fe_2O_3 and WO_3 could be observed, within the limits of the experimental error and the experiments will be stopped.

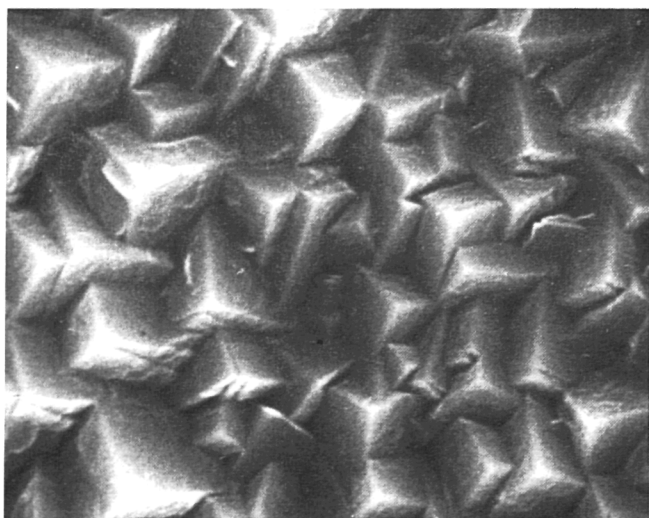

1 μm

Fig. 11. Polyhedric crystalized chromium surface

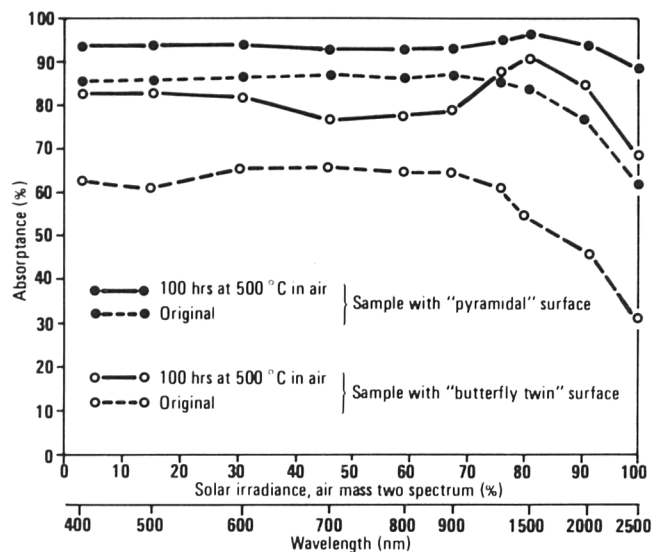

Fig. 12. Absorbance of the "butterfly twin" Chromium surface structure, P181, and the "pyramidal" Chromium surface structure, 370 C, both before and after an ageing treatment of 100 hrs at 500 °C

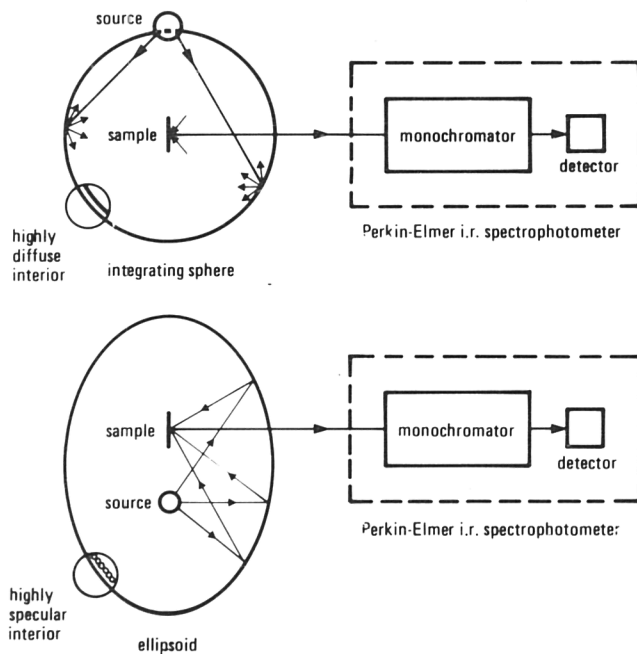

Fig. 13. Principle of the two experimental set-ups for measuring the hemispherical reflectance

PHOTOCHEMISTRY

The main objective of the activity which is at the beginning of the experimental phase is the study of the photoinduced splitting of water into hydrogen and oxygen.

The primary goal is to find out artificial systems which upon irradiation by visible light, i.e. having a wavelength between 400 nm and 700 nm, would produce water decomposition.

Systems made of a semiconductor colloid loaded with redox catalysts seem to be promising; the objective is to try different combinations of this type.

Experimental tests were performed for an investigation on the catalytic effects of RuO₂ and Platinum deposits on TiO₂ tending to improve the efficiency of the two catalysts. Further research is needed to understand the behaviour of the systems.

3. CONCLUSIONS

The Solar Energy Programme, with the achievements obtained during 1982 and the previous years, is confirming the central role of the JRC in support to the Commission programmes and EC activities oriented to an extended application of efficient and low-cost «solar technologies».

This confirmation is referring to the main orientation of the Solar Energy Programme: a contribution to (i) definition of test methodologies (ii) execution of performance measurements (iii) research on durability and reliability. These activities are related both the thermal converters and photovoltaic converters, and concerning components and systems.

All the experimental facilities which were planned are now in full operation; the first procedures for measurements were defined and published and are now in application for specific projects.

During the year 1982, in the field of testing activities main emphasis have been on the module testing for the Photovoltaic Pilot Project of the EC programme of R and D on Solar Energy.

The EC contract requires that for each module type to be used in the pilot plants, 4 prototypes and 8 production modules must pass qualification tests at the JRC. An extensive test programme has been performed, measuring so far more than 120 modules and executing more than 1000 tests. As a results of these measurements, a lot of experience has been gained on the behaviour and the weak points of the present technology of photovoltaic production.

For the same Photovoltaic Pilot Project special equipment and software were prepared to execute on-site acceptance tests of all the pilot plants: the first acceptance tests, for the installation already completed, were made, in Greece (Aghia Roumeli plant in the island of Crete).

In parallel to this important activity, testing of thermal collectors is proceeding on a routine basis.

The study of durability problems is continuing; outdoor test fields for longtime testing and correlation with indoor tests has been installed or are in preparation.

Concerning the other main activity, evaluation of systems for low temperature utilisation of solar energy, full-size ex-

periments were continued in the Solar Laboratory. Cooperations within the Agreement Solar Heating and Cooling of the International Energy Agency were particularly active during the year 1982. Three international workshops were held at Ispra, cosponsored by JRC and IEA: «Solar Simulators» on 9-10 February, «Seasonal Storage» on 10-14 May, «Solar Coupled Ground Storage with Heat Pumps» on 14-16 September.

Comparisons and modelisations are important aspects considered in these activities, together with economic assessments. Attention was increased during 1982 to the problem of evaluation of «passive» technologies, a type of utilisation of solar energy with a good potential for future applications. Main activity was concentrated on the study and the design of «test cells» for the measurement and comparison of performances of passive industrial components; particular attention will be given to the study of methodology for testing walls, windows, etc. using such cells.

All these activities of evaluation and assessments of thermal systems are made in good connection with the similar actions in the frame of the Indirect Action - Programme Energy R and D managed by the General Directorate XII (Brussels).

Research on advanced methods for the preparation of selective surfaces for solar receivers is in progress, with interesting results on metallic surfaces stable at high temperature.

Chromium surfaces with particular morphology and good performances were obtained with interesting results on metallic surfaces stable at high temperature.

Chromium surfaces with particular morphology and good performances were obtained with vapour deposition. A measurement equipment for the determination of thermal emittance and solar absorbance was studied and built for these specific applications.

Another research area is for longer term application: possible solar energy conversion using photoelectrochemical processes (semiconductor-electrolyte photocells) and photochemical processes (photoinduced splitting of water into hydrogen and oxygen). Several experimental tests were performed, investigating the behaviour of different electrodes and the catalytic effects of some compounds. Research is in progress, also in connection with a cooperative programme of the International Energy Agency.

As a general conclusion it can be said that during 1982, the third year of the 1980-83 programme, the Solar Energy Programme at Ispra reached the full level of operation and it is now available, for the Commission and the European Community, a complete set of installation and investments for the evaluation of solar energy technologies and systems, and the related competences.

**Salg og abonnement · Verkauf und Abonnement · Πωλήσεις και συνδρομές · Sales and subscriptions
Vente et abonnements · Vendita e abbonamenti · Verkoop en abonnementen**

BELGIQUE / BELGIË

Moniteur belge / Belgisch Staatsblad
Rue de Louvain 40-42 / Leuvensestraat 40-42
1000 Bruxelles / 1000 Brussel
Tél. 512 00 26
CCP/Postrekening 000-2005502-27

Sous-agents / Agentschappen:

Librairie européenne / Europese Boekhandel
Rue de la Loi 244 / Wetstraat 244
1040 Bruxelles / 1040 Brussel

CREDOC

Rue de la Montagne 34 / Bergstraat 34
Bte 11 / Bus 11
1000 Bruxelles / 1000 Brussel

DANMARK

Schultz Forlag

Møntergade 21
1116 København K
Tlf: (01) 12 11 95
Girokonto 200 11 95

Underagentur:

Europa Bøger

Gammel Torv 6
Postbox 137
1004 København K
Tlf. (01) 15 62 73
Telex 19280 EUROIN DK

BR DEUTSCHLAND

Verlag Bundesanzeiger

Breite Straße
Postfach 10 80 06
5000 Köln 1
Tel. (0221) 20 29-0
Fernschreiber:
ANZEIGER BONN 8 882 595

GREECE

G.C. Eleftheroudakis S.A.

International bookstore
4 Nikis Street
Athens (126)
Tel. 322 63 23
Telex 219410 ELEF

Sub-agent for Northern Greece:

Molho's Bookstore

The Business Bookshop
10 Tsimiski Street
Thessaloniki
Tel. 275 271
Telex 412885 LIMO

FRANCE

**Service de vente en France des publications
des Communautés européennes**

Journal officiel

26, rue Desaix
75732 Paris Cedex 15
Tél. (1) 578 61 39

IRELAND

Government Publications

Sales Office
GPO Arcade
Dublin 1

or by post

Stationery Office

Dublin 4
Tel. 78 96 44

ITALIA

Libreria dello Stato

Piazza G. Verdi, 10
00198 Roma
Tel. (6) 8508
Telex 62 008
CCP 387 001

Licosa Spa

Via Lamarmora, 45
Casella postale 552
50121 Firenze
Tel. 57 97 51
Telex 570466 LICOSA I
CCP 343 509

Subagente:

Libreria scientifica Lucio de Biasio - AEIOU

Via Meravigli, 16
20123 Milano
Tel. 80 76 79

GRAND-DUCHÉ DE LUXEMBOURG

**Office des publications officielles
des Communautés européennes**

5, Rue du Commerce
L-2985 Luxembourg
Tél. 49 00 81
Télex PUBLOF - Lu 1322
CCP 19 190-81
CC bancaire BIL 8-109/6003/300

NEDERLAND

Staatsdrukkerij- en uitgeverijbedrijf

Christoffel Plantijnstraat
Postbus 20014
2500 EA 's-Gravenhage
Tel. (070) 78 99 11

UNITED KINGDOM

H.M. Stationery Office

P O Box 569
London SE1 9NH
Tel. (01) 928 69 77 ext 365
National Giro Account 582-1002

Sub-Agent:

Alan Armstrong & Associates

Sussex Place, Regent's Park
London NW1 4SA
Tel. (01) 723 39 02

ESPAÑA

Mundi-Prensa Libros, S.A.

Castelló 37
Madrid 1
Tel. (91) 275 46 55
Telex 49370-MPLI-E

PORTUGAL

Livraria Bertrand, s.a.r.l.

Rua João de Deus
Venda Nova
Amadora
Tél. 97 45 71
Télex 12709-LITRAN-P

SCHWEIZ / SUISSE / SVIZZERA

FOMA

5, avenue de Longemalle
Case postale 367
CH 1020 Renens - Lausanne
Tél. (021) 35 13 61
Télex 25416

Sous-agent:

Librairie Payot

6, rue Grenus
1211 Genève
Tél. 31 89 50
CCP 12-236

SVERIGE

Librairie C.E. Fritzes

Regeringsgatan 12
Box 16356
103 27 Stockholm
Tél. 08-23 89 00

UNITED STATES OF AMERICA

**European Community Information
Service**

2100 M Street, N.W.
Suite 707
Washington, D.C. 20 037
Tel. (202) 862 95 00

CANADA

Renouf Publishing Co., Ltd.

2182 St. Catherine Street West
Montreal
Québec H3H 1M7
Tel. (514) 937 3519

JAPAN

Kinokuniya Company Ltd.

17-7 Shinjuku 3-Chome
Shinjuku-ku
Tokyo 160-91
Tel. (03) 354 0131

NOTICE TO THE READER

All scientific and technical reports published by the Commission of the European Communities are announced in the monthly periodical 'euro-abstracts'. For subscription (1 year : BFR 2.400) please write to the address below.

ECU	BFR	UKL	IRL	USD
3.40	150	2.10	2.30	3.50

CDNA08523ENC



OFFICE FOR OFFICIAL PUBLICATIONS
OF THE EUROPEAN COMMUNITIES

L-2985 Luxembourg

ISBN 92-825-3577-0



9 789282 535776

