

# Monte Carlo Simulation Approach to Soil Layer Resistivity Modelling for Grounding System Design

Adekitan Israel Aderibigbe, Isaac Samuel, Bukola Adetokun and Shomefun Tobi

Department of Electrical and Information Engineering, Covenant University, Ota, Ogun State, Nigeria.

Orcid: 0000-0002-9998-549X

## Abstract

Soil layer resistivity modelling is a vital component of grounding system design. Grounding system for facility, equipment, power station and general system protection purposes must be designed to be able to handle the anticipated level of fault current. To achieve this; the earth rods, mats and any other equivalent alternatives deployed must be adequately sized in terms of the physical dimensions and the number of such rods required in order to achieve the desired low, overall grounding system resistance. The resistance to earth of a grounding system is a function of the resistivity of the soil in concern, and to ensure appropriate design, the resistivity profile of the soil must be determined via appropriate soil modelling. This paper presents a Monte Carlo simulation approach to two layer soil modelling using the square error as an optimization function. The result of the simulation shows an improvement in model accuracy, and it also conforms significantly with the results of published works that applied genetic algorithm.

**Keywords:** two layer soil modelling, earthing, monte carlo simulation, ground fault protection, optimization, power plant safety

## INTRODUCTION

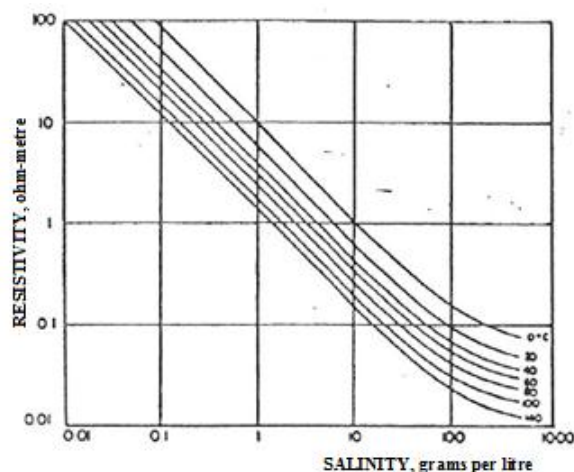
Power systems are inherently prone to faults, and as such adequate provisions must be made to handle such fault situations. High energy lightning impulse current and line to ground faults are very common earth faults in power systems, with ground faults contributing above 50% of all line faults in overhead supply systems [1, 2]. To ensure the safety of personnel and properties it is imperative to deploy an effective and adequate grounding system in power substations.

After designs, grounding systems are installed buried below the soil surface. According to [3] "soil is a natural body comprised of solids (minerals and organic matter), liquid, and gases that occurs on the land surface, occupies space, and is characterized by one or both of the following: horizons, or layers, that are distinguishable from the initial material as a result of additions, losses, transfers, and transformations of energy and matter or the ability to support rooted plants in a natural environment", that is soil is an integration of water, air, minerals and organic matter.

Soil resistivity is known to vary with yearly weather changes, and irrespective of location and region of the world the resistivity profile of any soil is determined by the attributes of such soil. These attributes includes the relative amount, and structure of the soil particles, the amount of soil humidity, the salinity of the soil, the permeability, the prevailing soil temperature etc. [4]. The effect of salinity and temperature on resistivity is shown by the graph of figure 1, which shows salinity and temperature variation for different temperature curves from 0°C up to 140°C.

The field measured resistivity profile of a soil are needed as inputs for developing the model of the soil, and from the developed model the parameters of the grounding system needed to achieve a given design can be determined.

Soil resistivity is a bulk property of the soil material which is analogous to the density of the soil, and as such it varies for different types of soil. The average resistivity for some common soil types is shown in Table I.



**Figure 1:** Dependence of electrical resistivity on temperature and salinity [5]

For safety of life against fault related shocks, step and touch voltage hazards that constitutes a major source of hazard in power station; the grounding system must be of appropriate design to handle the yearly soil resistivity variation which can make a grounding system ineffective.

**Table 1:** Average soil resistivity for common soil types [6]

S/N	Soil	Average Resistivity ( $\Omega$ m)
1	Clay, compacted	100 - 200
2	Clay, soft	50
3	Clayey sand	50 - 500
4	Humus, leaf mould	10 - 150
5	Granite	1500 - 10000
6	Granite, modified	100 - 600
7	Jurassic marl	30 - 40
8	Limestone, fissured	500 - 1000
9	Marl	100 - 200
10	Mica schist	800
11	Peat, turf	5 - 100
12	Sandstone	1500 - 10000
13	Sandstone, modified	100 - 600
14	Schist, shale	50 - 300
15	Siliceous sand	200 - 300
16	Soil, chalky	100 - 300
17	Soil, swampy	1 - 30
18	Stony sub-soil, grass-covered	300 - 500
19	Stony ground	1500 - 3000

For an effective grounding system design that will guarantee a low resistance path from the fault point to the ground, the soil model on which the earth grid design is based must be an accurate representation of the actual soil resistivity profile. This necessitates that the field measured valued must be accurately measured using appropriate method and equipment, and the model developed from the measured resistivity values must be obtained using appropriate optimisation function and model structure. A detailed approach to grounding system design has been carried out by previous works such as [7] that designed a lightning protection system for crude oil tanks.

A common practice among personnel deploying grounding systems is the implementation of such systems based on previous experience without paying due attention to key importance of the soil resistivity of the specific soil which may affect the efficacy of the design on the long run. For optimal result, it is advised that a combination of experience and analytical methods is the best approach [1].

### FIELD MEASUREMENT OF SOIL RESITIVITY

#### A. The Wenner method

This is a suitable and accurate method for soil resistivity measurement when deployed appropriately [8],[9],[10]. It entails deploying four electrode probes into the soil; the

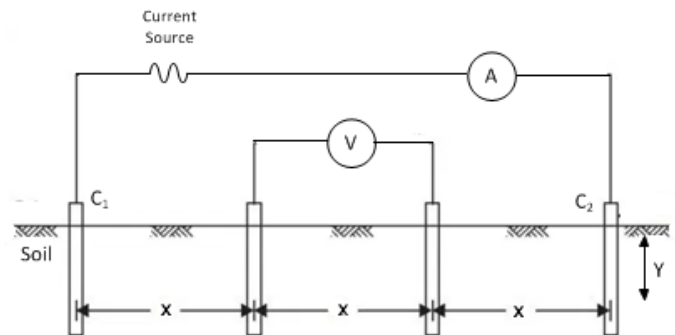
electrodes are spaced at an equal distance from each other and are buried at a relatively short depth (Y) as compared to the electrode spacing (X). A test current (I) is applied to the current electrodes, the resulting field causes a voltage differential (V) to develop across the potential probes, such that:

The apparent soil resistivity is

$$\rho(\Omega m) = \frac{4\pi xR}{1 + \frac{2x}{\sqrt{x^2 + 4y^2}} - \frac{x}{\sqrt{x^2 + y^2}}} \quad (1)$$

$$R = \frac{V}{I} \quad (2)$$

$$\text{Therefore } \rho = 2\pi xR \text{ (ohm-meter); } Y \approx 0 \quad (3)$$



**Figure 2:** Wenner method measurement configuration

### TWO LAYER SOIL MODEL

The profile and distribution of the resultant electric field when electric current is injected in to a soil is a function of the soil structure. Soil structures are assumed to be in N number of layers based on observed electric field profiles. For grounding system design purposes, a two layer soil structure model is sufficient for accurate design [11, 12].

In N-layer soil model, the soil is assumed to have N unique resistivity layers and for a 2-layer model the soil has two unique resistivity layers separated by a thickness height (h). A two layer soil is defined by three parameters and these are the resistivity of layer one ( $\rho_1$ ), resistivity of layer two ( $\rho_2$ ), and the effective thickness of layer one above layer two. This therefore becomes a three parameter optimization problem and these unknown parameters will be determined through soil modelling.

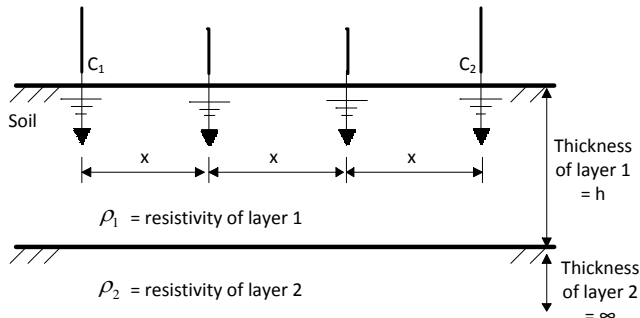


Figure 3: Two layer resistivity soil profile

Data from resistivity measurements performed on the soil under study will be used as inputs into a Monte Carlo based optimization program that utilizes this input to refine the generated set of random values, initially assumed for the three parameters until the generated error is minimized.

For this model, the square error function shall be applied for optimizing the modelled outputs of the Monte Carlo simulation until the generated model error is minimized and the square error function was also applied for error minimization by [9, 13, 14] that applied genetic algorithm; four optimization functions were considered and compared by [9] for the best curve fitting ability.

Among the methods initially developed for determining  $\rho_1$  and  $\rho_2$  is through the use of quantitative interpretation such as the curve matching methods in which the measured resistivity values are plotted using logarithm coordinates and compared with pre-calculated theoretical curves to match all possible surface layers with theoretical models. A major challenge to curve matching is that the number of available theoretical curves may not be sufficient to match all possible soil resistivity structures.

According to [9, 15, 16], the apparent soil resistivity for the Wenner electrodes separated by distance (x) is given by

$$\rho_a = \rho_1 \left( 1 + 4 \cdot \sum_{n=1}^{\infty} k^n \left( \frac{1}{\sqrt{1 + \left(\frac{2nh}{x}\right)^2}} - \frac{1}{\sqrt{4 + \left(\frac{2nh}{x}\right)^2}} \right) \right) \quad (4)$$

$n = 1$  to  $\infty$

The change in resistivity at the boundary between two layers is defined as the reflection coefficient k [12, 17], where

$$k = \frac{\rho_2 - \rho_1}{\rho_1 + \rho_2} \quad (5)$$

For N numbers of soil resistivity experimental measurements  $m(i)$  and for the  $i^{\text{th}}$  value, Let the error function

be defined as:

$$Error(\rho_1, \rho_2, h) = \sum_{i=1}^N \left( \frac{m(i) - \rho_a(i)}{m(i)} \right)^2 \quad (6)$$

### THE MONTE CARLO MODEL

The Numerical Monte Carlo Method can be easily applied for finding solutions to models that cannot be easily solved analytically. Therefore Monte Carlo simulation can be applied for determining the unknown variables of the apparent resistivity equation through error minimization approach that identifies the best fit sample among the members of the solution set. Monte Carlo uses statistical selection techniques for generating probability based approximations as solution to a mathematical model or equation, by using random number sequences as inputs into a model which gives results that indicates how accurate the model is.

The accuracy of Monte Carlo simulation is a direct function of the suitability of the random inputs applied [18]. Therefore, it is imperative to ensure that an appropriate random number distribution is applied in evolving the sample space. In this paper, to ensure even distribution across the sample space, uniformly distribution random samples will be generated within a desirable input range.

#### A. The Procedure

Step 1: Define the pseudo-population space that will represent the unknown model variables

From the experimental resistivity data set identify the highest resistivity value  $\rho_{\max}$  and the lowest resistivity value  $\rho_{\min}$

The actual value of  $\rho_1$  and  $\rho_2$  may be greater than  $\rho_{\max}$  or lower than  $\rho_{\min}$  to ensure proper coverage of the sample set, we define two resistivity data range

$$Data\ set\ 1 = f_A \times \rho_{\min} \rightarrow f_B \times \rho_{\min} \quad (7)$$

$$Data\ set\ 2 = f_C \times \rho_{\max} \rightarrow f_D \times \rho_{\max} \quad (8)$$

$$factor\ (f) = \begin{cases} factor\ A & 0 < f_A < 1 \\ factor\ B & 1 < f_B < 2 \\ factor\ C & 0 < f_C < 1 \\ factor\ D & 1 < f_D < 2 \end{cases} \quad (9)$$

Step 2: Generate the set of independent and identically distributed random numbers. Generate Z pairs of  $\rho_1$ ,  $\rho_2$ , & h uniformly distributed random numbers  $U(a, b)$  between the following parameter value ranges

- a. Data set 1
- b. Data set 2
- c.  $1 \leq h \leq 6$

Step 3: For the generated random values, compute equation 4, 5 and 6, For Z numbers of sample pairs

Step 4: Create an acceptance criteria using equation 6 as the optimization or objective function  $f(z)$

Step 5: The generated error will be minimized and the solution set filtered to select the  $(\rho_1, \rho_2, h)$  pairs that best satisfies the defined acceptance criteria.

Given the solution sample space X of suitable random numbers and an objective real-valued function  $f(z)$  on X, the universal minimum is defined as

$$m(f) = \min_{z \in Z} f(z) \quad (10)$$

Such that for a sequence S  $(\rho_1, \rho_2, h)$  of normally distributed random model input samples

$$m(f) \approx m_Z(f; S) = \min_{1 \leq z \leq Z} f(S_z) \quad (11)$$

This Monte Carlo simulation is based on the set of random samples or particles  $\{X_{0:t}^{(i)}; i = 1, \dots, Z\}$  in accordance with  $\rho(X_{0:t} | S_{1:t})$  and satisfies the law of large numbers [19], such that as  $Z \rightarrow \infty$ , the modelled soil parameter values tends to the true and actual soil values.

The resistivity data in Table II will be applied as input data sets into the model for the Monte Carlo simulation.

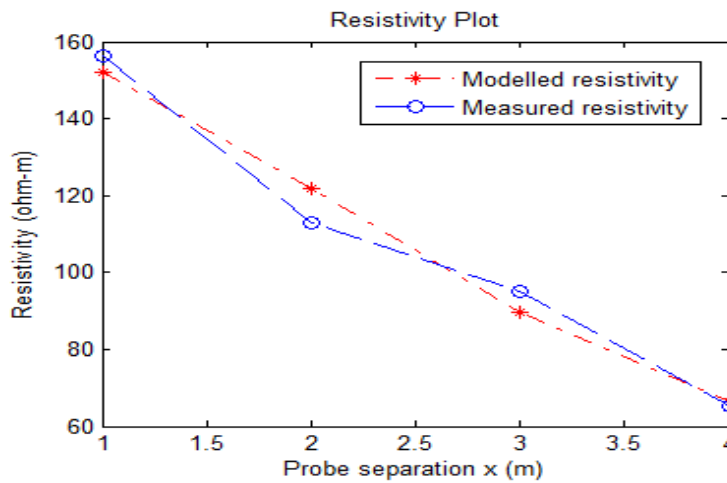
**Table 2:** Experimental soil resistivity data

Experimental Data Set I [20], [15]									
1.	xi [m]	1.0	2.0	3.0	4.0				
	$\rho_i$ [ $\Omega$ m]	156.4	113.1	95.2	65.3				
2.	xi [m]	1.0	2.0	4.0	10.0	20.0	40.0		
	$\rho_i$ [ $\Omega$ m]	136	140	214	446	685	800		
Experimental Data Set II [21], [15]									
3.	xi [m]	2.5	5.5	7.5	10.0	12.5	15.0	20.0	25.0
	$\rho_i$ [ $\Omega$ m]	451.6	366.7	250.2	180.0	144.2	120.2	115.5	96.5
4.	xi [m]	2.0	4.0	6.0	8.0	10.0			
	$\rho_i$ [ $\Omega$ m]	102.26	113.07	129.77	147.52	163.95			

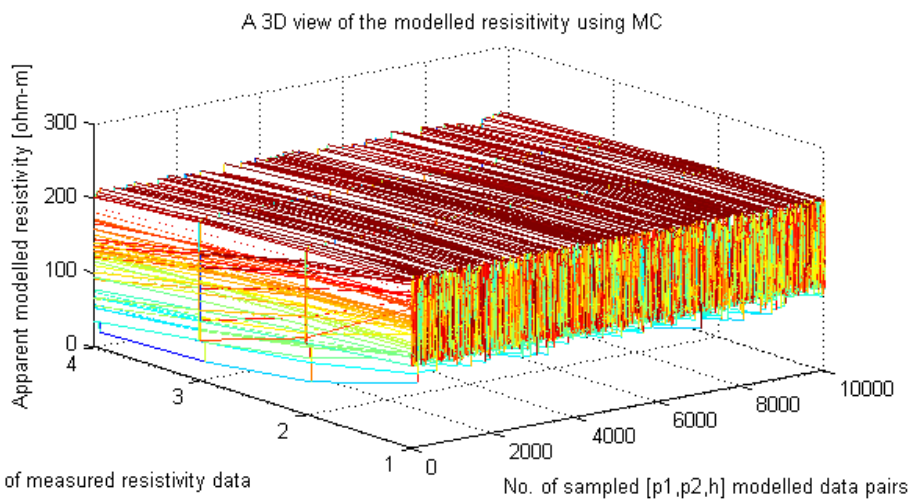
**Table 3:** Soil Model Result

Case	$\rho_1$ [ $\Omega$ m]	$\rho_2$ [ $\Omega$ m]	h	Error	Source
1.	160.776	34.074	1.8480	0.1852	Published
	160.312	31.182	1.9227	0.0026	Monte Carlo
2.	124.957	1146.874	2.7500	0.0151	Published
	125.280	1161.30	2.7312	0.0026	Monte Carlo
3.	492.161	93.785	4.3790	0.0110	Published
	495.603	91.196	4.4738	0.0015	Monte Carlo
4.	99.990	302.640	5.0400	0.0054	Published
	100.9612	288.724	4.9531	0.00003	Monte Carlo

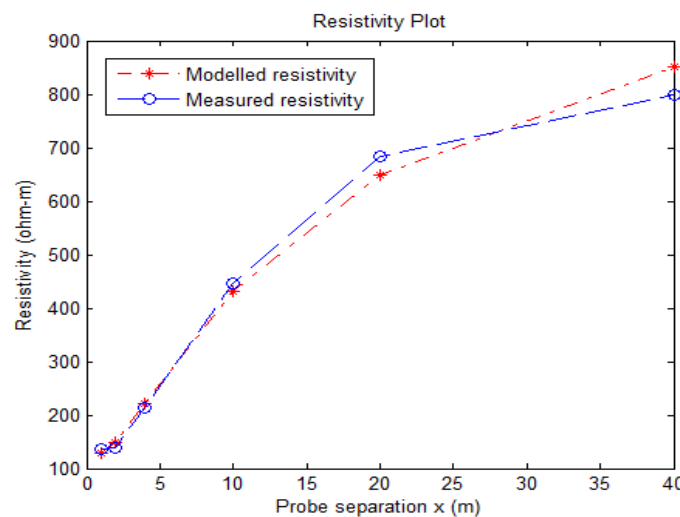
**SIMULATION RESULTS**



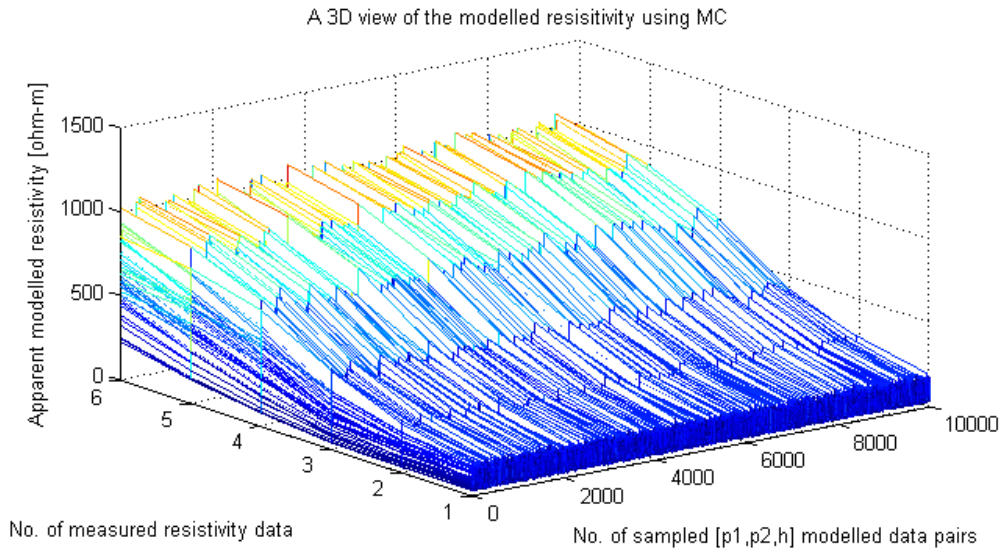
**Figure 4:** Resistivity plot for case 1 data



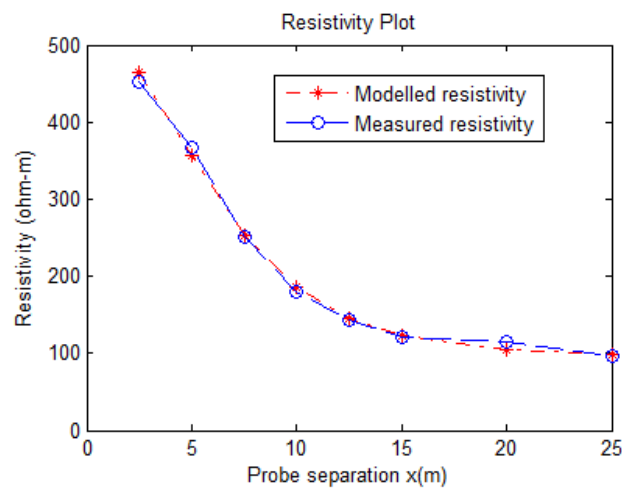
**Figure 5:** A mesh plot of all the modelled apparent soil resistivity solution set for case 1 data



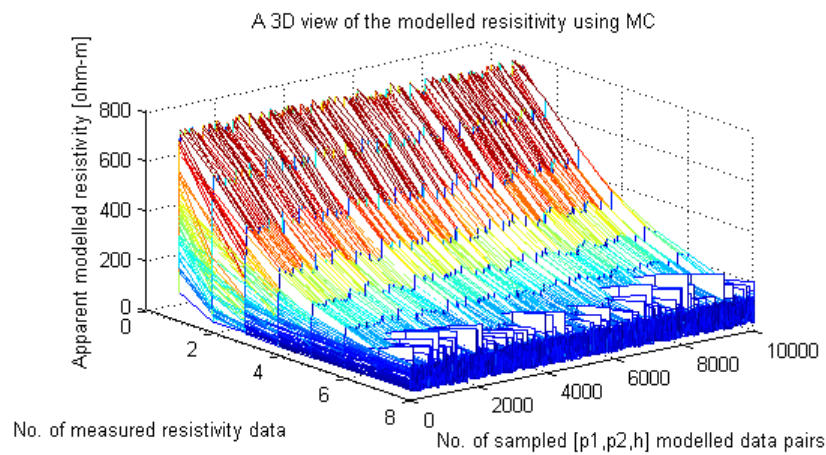
**Figure 6:** Resistivity plot for case 2 data



**Figure 7:** A mesh plot of all the modelled apparent soil resistivity solution set for case 2 data

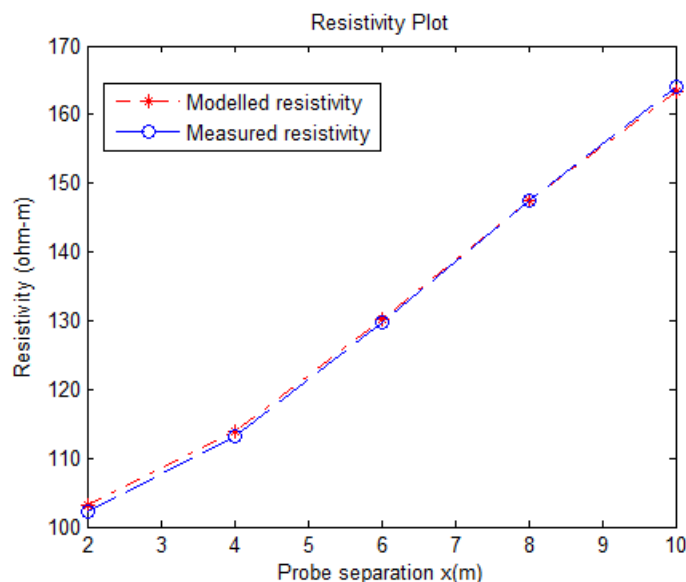


**Figure 8:** Resistivity plot for case 3 data

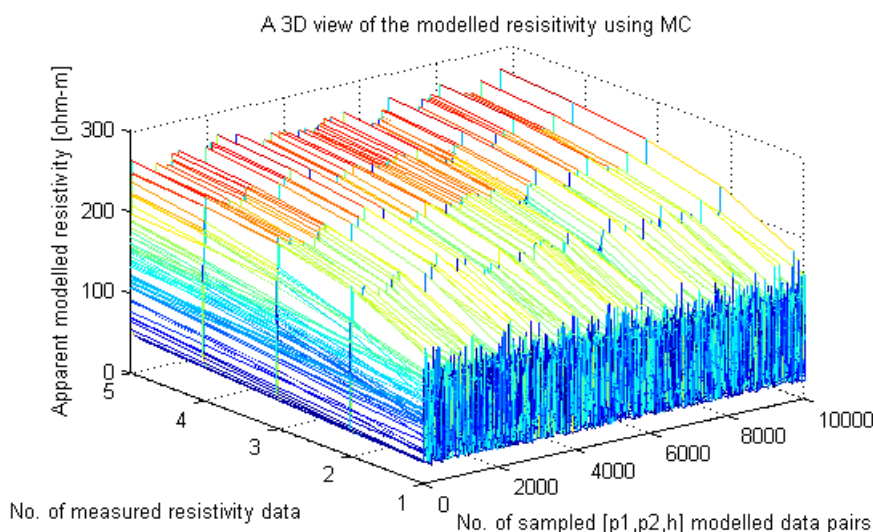


**Figure 9:** A mesh plot of all the modelled apparent soil resistivity solution set for case 3 data





**Figure 10:** Resistivity plot for case 4 data



**Figure 11:** A mesh plot of all the modelled apparent soil resistivity solution set for case 4 data

The result of the Monte Carlo(MC) simulation for the modelled layer one resistivity, layer two resistivity and the thickness of layer one, for the four resistivity data set cases in Table III, conforms to the published values and this confirms the functionality and accuracy of the Monte Carlo method. The graphs and mesh plot of figures 4 -11 are graphical outputs of the simulation. The graphs show how closely the modelled values fit the actual measured experimental values. For the four input data cases, the MC approach gave 98.5%, 82.8%, 86.3% and 99% reduction in the generated error as compared to the published data.

Further, as shown in the mesh plots the MC solution set contains  $\approx 10000$  members; this high number of samples helps to limit result variation between repetitive simulations

and also increase accuracy due to the wide span of the solution population set.

## CONCLUSION

In this paper, a Monte Carlo simulation has been successfully developed and applied in solving the optimization problem of a two layer soil model. The results shows a reduction in the minimized error when compared with published results due to the wide solution set considered in the modelling. The Monte Carlo simulation which has found application in various engineering systems can now be applied as an optimization method for soil modelling when designing grounding system.

## ACKNOWLEDGEMENT

The Authors appreciate Covenant University Centre for Research, Innovation and Discovery for supporting this research publication.

## REFERENCES

- [1] F. Dawalibi and C. J. Blattner, "Earth Resistivity Measurement Interpretation Techniques," *IEEE Transactions on Power Apparatus and Systems*, vol. PAS-103, pp. 374-382, 1984.
- [2] Jeff Roberts, Dr. Daqing Hou, Fernando Calero, and D. H. J. Altuve. (2001, New Directional Ground-Faults Elements improve sensitivity in ungrounded and compensated networks. Available: <https://cdn.selinc.com/assets/Literature/Publications/Technical%20Papers/6124.pdf?v=20151125-111110>
- [3] S. S. S. USDA, *Soil Taxonomy: A Basic System of Soil Classification for Making and Interpreting Soil Surveys*: United States Department of Agriculture Natural Resources Conservation Service, 1999.
- [4] I. Dharmadasa, J. Lucas, L. Udawatta, and E. W. Wijayapala. *Determination of earth resistivity profile in multilayer soil*.
- [5] F. C. Frischknecht and G. V. Keller, *Electrical Methods in Geophysical Prospecting*: Pergamon Press, 1966.
- [6] (05-July-2017). *Soil - Resistivity*. Available: [http://www.engineeringtoolbox.com/soil-resistivity-d\\_1865.html](http://www.engineeringtoolbox.com/soil-resistivity-d_1865.html)
- [7] A. I. Adekitan, "Lightning Protection of Floating Roof Tank," *American Journal of Engineering Research (AJER)* vol. 02, pp. 11-21, October 30, 2013 2013.
- [8] U. Rodney, M. Karl, and "Accurate Soil Resistivity Testing for Power System Earthing," in *Earthing, Lightning & Surge Protection Forum - IDC Technologies*.
- [9] I. F. Gonos, V. T. Kontargyri, I. A. Stathopoulos, A. X. Moronis, A. P. Sakarellos, and N. I. Kolliopoulos, "Determination of two layer earth structure parameters," in *XVII international Conference on Electromagnetic Disturbances EMD' 2007*, Bialystok Poland.
- [10] BSI-Standards, "BS 7430:2011 Code of practice for protective earthing of electrical installations,," in *Measurement of soil resistivity*, ed: British Standards, 2011.
- [11] IEEE, "IEEE Std 80-2000, IEEE Guide for Safety in AC Substation Grounding," in *Equivalent uniform soil model for nonuniform soils*, ed: IEEE-SA Standards Board, 2000, pp. 1-192.
- [12] M. Nassereddine, J. Rizk, and G. Nasserddine, "Soil Resistivity Data Computations; Single and Two - Layer Soil Resistivity Structure and Its Implication on Earthing Design," *International Journal of Electrical, Computer, Energetic, Electronic and Communication Engineering*, vol. 73, pp. 35 - 40, 2013.
- [13] A. I. Aderibigbe and F. A. Olaosebikan, "Algorithm for Determining the Parameters of a Two-Layer Soil Model," *World Academy of Science, Engineering and Technology, International Journal of Electrical, Computer, Energetic, Electronic and Communication Engineering*, vol. 8, pp. 1760-1765, 2014.
- [14] G. Gilbert, "High Voltage Grounding Systems," Ph.D., University of Waterloo, Waterloo, Ontario, Canada, Department of Electrical and Computer Engineering, 2011.
- [15] I. F. Gonos and I. A. Stathopoulos, "Estimation of multilayer soil parameters using genetic algorithms," *IEEE Transactions on Power Delivery*, vol. 20, pp. 100-106, 2005.
- [16] D. Sekki, B. Nekhou, K. Kerroum, K. E. K. Drissi, and D. Poljak, "Transient Behaviour of Grounding System in a Two-Layer Soil Using the Transmission Line Theory," *Journal for Control, Measurement, Electronics, Computing and Communications*.
- [17] B. Gursu and M. C. Ince, "Limiting GPR in a two-layer soil model via genetic algorithms," *Journal of the Franklin Institute*, vol. 346, pp. 768-783, 2009.
- [18] H. Niederreiter, *Random number generation and quasi-monte carlo methods* Philadelphia, Pennsylvania: Society for Industrial and Applied Mathematics, 1992.
- [19] A. Doucet, N. d. Freitas, and N. Gordon, *Sequential Monte Carlo Methods in Practice*: Springer Science, 2001.
- [20] J. L. d. Alamo, "A comparison among eight different techniques to achieve an optimum estimation of electrical grounding parameters in two-layered earth," *IEEE Transactions on Power Delivery*, vol. 8, pp. 1890-1899, 1993.
- [21] H. R. Seedher and J. K. Arora, "Estimation of two layer soil parameters using finite Wenner resistivity expressions," *IEEE Transactions on Power Delivery*, vol. 7, pp. 1213-1217, 1992.