

Energy Crisis 2050?
Global Scenario and Way
Forward for Malaysia



PROFESSOR IR. DR. NORMAN MARIUN

Energy Crisis 2050? Global Scenario and Way Forward for Malaysia

PROFESSOR IR. DR. NORMAN MARIUN

Ph.D (Bradford), M.Sc(North Carolina State),
B.Sc(Hons)(Nottingham), P. Eng, FIEM, SMIEEE

10 JUNE 2011

**Auditorium Jurutera
Fakulti Kejuruteraan
Universiti Putra Malaysia**



Universiti Putra Malaysia Press
Serdang • 2011
<http://www.penerbit.upm.edu.my>

© **Universiti Putra Malaysia Press**

First Print 2011

All rights reserved. No part of this book may be reproduced in any form without permission in writing from the publisher, except by a reviewer who wishes to quote brief passages in a review written for inclusion in a magazine or newspaper.

UPM Press is a member of the Malaysian Book Publishers Association
(MABOPA)

Membership No.: 9802

Perpustakaan Negara Malaysia Cataloguing-in-Publication Data

Norman Mariun

Energy crisis 2050? : global scenario and way forward for Malaysia /

Norman Mariun.

Bibliography: p.

ISBN 978-967-344-223-2

1. Power resources--Malaysia. 2. Renewable energy sources--Malaysia.

3. Energy conservation--Malaysia. I. Title

333.79

Reka letak teks | Sahariah Abdol Rahim @ Ibrahim

Reka bentuk kulit | Md Fairus Ahmad

Design, layout and printed by

Penerbit Universiti Putra Malaysia

43400 UPM Serdang

Selangor Darul Ehsan

Tel: 03-8946 8855 / 8854

Fax: 03-8941 6172

<http://www.penerbit.upm.edu.my>

Dedications

This book is dedicated to my loving and supportive family,
Harison binti Ali my wife, friend, lover and partner who has done an
excellent job taking care of the family in my absence most of the time.

*She fills my heart with her special things
With angel songs, with wild imaginings
She fills my soul with so much love
That anywhere I go, I'm never lonely
With her along who could be lonely
I reach for her hand, it's always there*

My elder children **Farzaana, Harith, Najwaa**, and **Muhammad Zaki** who are very independent, responsible and helpful in taking care of their younger siblings, and the other younger ones **Ibrahim** and **Daleela** for being patient and understanding of my short comings of not giving enough time to them.

*Si man tak dapat diwarisi
Dari seorang ayah yang bertaqwa
Dia tak dapat dijual beli
Dia tiada di tepian pantai
Walaupun apapun caranya jua
Engkau mendaki gunung yang tinggisi
Engkau merentas lautan api
Namun tak dapat jua dimilikii
Jika tidak kembali pada Allah*

Loved ones, I am your “60 minutes Father”, I shall try to be there
whenever you need me.

With lots of love.

Contents

ABSTRACT	1
INTRODUCTION	3
ENERGY STATUS: MALAYSIA vs. WORLD	6
Energy from Nuclear & Fossil Fuel	6
Renewable Energy (RE)	10
Worldwide Energy Consumption	17
Worldwide Future Energy Demand	19
ENERGY RELATED CO ₂ EMISSIONS- HISTORY AND PROJECTION	22
CO ₂ Emissions Trend in OECD and non-OECD Countries	22
Trends of CO ₂ Emissions in East Asia	25
CO ₂ Emissions Trend in Malaysia, 2000–2020	25
FOSSIL FUEL	26
Key Facts of Coal-Fired Electricity Production	27
Improving the Efficiency of Coal-fired Power Plants for CO ₂ Emissions Reduction	28
Price, Supply and Consumption of Global Crude Oil, Liquid Fuels and Coal	29
Fossil Fuel Reserves in Malaysia	33
Consumption of Fossil Fuel in Malaysia	35
Power Plants in Malaysia	36
RENEWABLE ENERGY (RE)	37
Solar Energy	38
Latest Research on Solar	39
Wind Power	41
Hydro Power	47
Smart Hydropower Turbine	49
Osmotic Power- Renewable for Next Generation	50
Biomass power	54

World's Prodigious Biomass Power Plants-Supply and Production	57
Municipal Solid Waste (MSW)	59
Case Study: World's WTE Power Plants	60
Ocean Wave Energy	62
Ocean Wave Energy Technologies	62
Atmospheric Electricity	65
 NUCLEAR ENERGY (NE)	 68
NE- Understanding some Parameters	68
How NPP Works	70
Types of Nuclear Reactors	72
Reactor Fuel Requirements	74
Challenges of NPP	76
 WAY FORWARD FOR MALAYSIA	 83
Options for Malaysia in RE	83
Rice Husk based Cogeneration Plant, Kedah	85
Small Renewable Energy Power Program (SREP)	86
Solar Hybrid System – TNB-ES Projects	
Grid Connected PV Installation in Malaysia- The MBIPV Project	89
Introduce Feed-in Tariff for RE Energy	93
Prospect of Wind Energy in Malaysia	94
Possibilities Energy from Solid Waste in Malaysia	95
WTE Plant in Semenyih	96
Possibilities in NE in Malaysia	96
Why NPP in Malaysia?	97
NE vs. RE	99
 ENERGY EFFICIENCY TECHNOLOGY	 101
EE Sectors	101
Technology Enhancement	102
EE Building	104
EE in Transportation Sector	106
CNG-DI Ignition System	107
Varieties of Ignition System	107

GREEN ENERGY INITIATIVES IN MALAYSIA	113
Green Malaysia Policy and Plan	113
A recent initiative towards Green Energy- Annulled Coal Power Plant in Sabah Malaysia GT	116
CONCLUSION	119
REFERENCES	121
BIOGRAPHY	133
ACKNOWLEDGEMENT	137
LIST OF INAUGURAL LECTURERS	139

ABSTRACT

To meet the energy demand of all households worldwide, energy supplies must double by 2050. While fossil fuels will continue to account for the largest proportion of primary energy requirements through the next four decades, we cannot only double world energy supplies and improve access but also effectively manage greenhouse gas emissions. Our core fossil fuel sources - oil, coal and gas - are finite natural resources, and it is being depleted at a rapid rate. The main driver to address this dual challenge will be higher energy prices. Higher prices will propel the developed world towards greater renewable and Nuclear Energy (NE) and attract higher level of energy efficiency. Many developed countries have an ambitious vision that to be powered by 100% Renewable Energy (RE) sources by the middle of this century.

In many senses NE is clean. But there is always an argument whether NE is an alternative to fossil fuels and a way to fight global warming. There is much public fear about NE, fuelled by accidents such as Chernobyl, Three Mile Island and very recently Fukushima Daiichi. It is, however, an issue which is becoming more important as we approach a time when fossil fuel resources may run out, making it necessary to find quick and secured alternative sources. Technology enhancement in nuclear reactor and efficient use of nuclear fuel can lessen the risk of NE.

The world needs to seriously consider what will be required for transition to a sustainable energy future, and to find solutions to the dilemmas – meet energy demand and mitigate global warming simultaneously. Answering these challenges - the solutions to the energy needs of current and future generations - is one of the most important, challenging and urgent political tasks ahead.

INTRODUCTION

Human beings are struggling to overcome two compelling and daunting challenges: the challenges of self development and the needs for a more effective system of international security. These interlinked challenges are inevitably connected with energy. All aspects of development – from plummeting poverty to convalescent transportation system, latest energy service is highly required. When the development come to a stage, the uncertainty of security arises that often leads to the collapsed of development endeavor.

Energy reservoir is not equally distributed globally. According to International Atomic Energy Agency (IAEA), developed countries that constitute Organization for Economic Cooperation and Development (OECD), consume electricity at a rate per capita of 8600 kWh per year, on average. On the other hand, some of the African countries' electricity consumption per capita is 50 kWh per year. The imbalance energy scenario depicts roughly 170 times higher in OECD countries. Worldwide energy consumption and demand are increasing day by day and by 2035 it will grow by 49% as stated by World Energy Outlook 2010. If the trends of the growth rate continue, the energy consumption will be surpassed than in all of previous history combined. To meet the needs, each nation makes policy to secure its own channels of supply. Also there is a challenge for bottom of the development ladder countries to compete politically with their giant neighbors for fossil fuels.

The environmental impact is other challenge for carbon emissions and green house effect (includes other greenhouse gases) from fossil fuels. The growth in global emissions of CO₂ from fossil fuels over the past ten years is four to five times greater than for the preceding 10 years. The consequences of global warming could lead to natural ecosystem disturbance such as melting polar ice caps and mountain glaciers which would result in the rising sea level and

coastal inundation. The changing climate would alter forests, crop yields, and water supplies, and could lead to famine. Many plant and animal habitats would be threatened, and some species would likely become extinct.

These effects mainly bring us to think about carbon free energy sources. The first solution of the challenges can apply RE. RE technologies like wind turbines, solar panels and biomass *etc.* can be an alternative to fossil fuels abetting reduce greenhouse gas emissions. In the 21st century, the members of OECD countries are highly concerned to harvest maximum energy from RE sources. For example, wind power existed in just a handful of countries in the 1990s but now it is available in over 82 countries, as reported in REN21 Global Status Report 2010. Outside OECD, Asia, Middle East, North Africa, and sub-Saharan Africa have active RE market also. The trend of shifting manufacturing leadership from Europe to Asian countries like China, India, and South Korea, is certainly a good sign of increasing less vulnerable and boosting confidence to RE market.

Besides the environmental benefit, RE has financial benefits too. Investing in a RE technology now basically means pre-buying energy at today's prices for the future where energy may cost a lot more. The scope of this facility has increased since new Feed-in Tariff (FiT) scheme has rolled out in many countries including Malaysia. Under this scheme, energy suppliers have to make regular payments to householders and communities who generate their own electricity from renewable or low carbon sources. In Malaysia Renewable Policy and Action Plan, FiT is applicable to limited indigenous renewable sources such as biogas, biomass, small hydropower and Photovoltaic (PV). We will see explicit description about Malaysia RE status in later section.

However, RE has major drawbacks such as intermittency, unstable and unsecured electricity generation, load uncertainty and generation uncertainty. Exorbitant installation cost is another pivotal reason that is discouraging people to set up. The financial return from RE plants is also not effective as it has many uncertainties and pay back period is quite long. For instance, a 4 kW PV system suited for residential use would cost approximately RM 200,000 and pay back might take more than 11 years, a statistic by the Ministry of Energy, Green Technology and Water.

NE is another option as it provides reliable, large-scale electricity necessary to power the grids of large urban areas. Moreover, we have been witnessing in recent years that NE is driven enormously by energy sector of OECD and non-OECD countries to meet the goal of CO₂ emission slash by the year 2020. This is because it is going to be seen as mutually exclusive in meeting the global rising energy demand and reduction of CO₂ emissions without NE. As of Jan 2011, 29 countries worldwide are operating 442 nuclear reactors for electricity generation and 65 new nuclear plants are under construction in 15 countries. In 2009, Nuclear Energy Institute, the US revealed that NE supplied 14% of the world's total electricity production where top five nuclear generating countries (in billion kWh) were the US (798.7), France (390.0), Japan (260.1), Russia (153) and S Korea (141.1). Besides that, Nuclear Power Plant (NPP) emitted 60 to 90 times less CO₂ than a traditional coal power plant and one 7 gram uranium fuel pellet is equivalent to 564 liters of oil or 1,780 pounds of coal. The other reasons of setting up NE are left in later section. However, many formidable challenges exist to develop NPP in the developing countries. Much more work should be done in addressing these challenges. Technology and policy innovation should focus more intensively on developing new designs and approaches that make nuclear power safe, secure, affordable

and practical. In light of the recent tragedy in Japan, many people are questioning the future use of NPP vs. RE. It appears, for the moment, we all may be sliding down a slippery slope in terms of a worldwide disaster as these NPPs begin to age and break down, causing potential global threats. With the world population of over 6 billion, it is a necessary task for us to find a better solution.

ENERGY STATUS: MALAYSIA VS. WORLD

There is a number of energy scenarios suggested by several organizations such as the International Energy Agency, the United States Energy Information Administration (US EIA), World Energy Association (WEA), Renewable Energy Policy Network for the 21st Century (REN21), Nuclear Energy Institute, and Energy Commission, Malaysia. All scenarios depict energy generation capacity, consumption and foresee future demand by 2050.

Energy from Nuclear & Fossil Fuel

World Installed Generating Capacity

Three types of power plants have been chosen to show the generating capacity categorized by OECD and non-OECD countries in Table 1. Besides the mentioned three fuel capacities in Table 1, the total capacity is the accumulation of Liquids-Fired, Hydroelectric, Wind-Powered, Geothermal, Solar and other renewable generating capacities. The total OECD country capacity is 2,427 GW whereas non-OECD countries capacity is 2,002 GW. On the one hand, nuclear generation capacity is five times more in OECD countries than Non-OECD countries. On the other hand, coal-fired generating capacity in OECD countries is less than Non-OECD countries [US EIA, 2009].

Table 1 World Installed Capacity (GW) by regions and countries in 2007 – Gas fired, Nuclear, Coal-fire and Total

Region/Country	Gas-fired (GW)	Nuclear (GW)	Coal-fired (GW)	Total (GW)
OECD*				
OECD North America	358	115	340	1,176
United States	330	101	313	995
Canada	8	13	21	125
Mexico	19	1	7	56
OECD Europe	175	131	200	836
OECD Asia	107	67	99	415
Japan	74	49	45	279
South Korea	20	18	23	73
Australia/New Zealand	13	0	31	63
Total OECD	640	313	639	2,427

Non-OECD					
Non-OECD Europe and Eurasia	145	43	98	404	
Russia	98	23	44	221	
Others	47	19	54	183	
Non-OECD Asia	135	19	630	1,089	
China	36	9	496	716	
India	20	4	84	159	
Other Non-OECD Asia	78	6	50	215	
Middle East	94	0	6	153	
Africa	40	2	41	117	
Central and South America	51	3	10	238	
Brazil	9	2	2	100	
Other Central and South America	42	1	8	137	
Total Non-OECD	464	66	786	2,002	
Total world	1,103	380	1,425	4,428	

* Current OECD member countries (as of 10 March 2010) are US, Canada, Mexico, Austria, Belgium, Czech Republic, Denmark, Finland, France, Germany, Greece, Hungary, Iceland, Ireland, Italy, Luxembourg, the Netherlands, Norway, Poland, Portugal, Slovakia, Spain, Sweden, Switzerland, Turkey, the United Kingdom, Japan, South Korea, Australia, and New Zealand. Chile became a member on May 7, 2010, but its membership is not reflected in *IEO2010*.

Installed Generating Capacity in Malaysia

According to *Suruhanjaya* or Energy Commission, Malaysia is generating electricity by the support of some companies such as Tenaga Nasional Berhad (TNB), Sabah Electricity Sdn Bhd. (SESB), Syarikat SESCO Bhd (SESCO) and Independent Power Producer (IPP). These companies generate electricity for East and West parts of Malaysia by using fossil fuel and RE. Table 2 shows the total installed generation capacity categorizing different fuels during 2003 to 2008. On the basis of the statistical data of Table 2, Malaysia had the highest generation in 2004 (22,344 MW) during those years. The country had approximately equal production in 2008 (22,150 MW).

Table 2 Installed Generation Capacity (UNIT: MW) by Fuel Type in Malaysia, 2003-2008 [ST, 2008]

Year	Hydro	Gas	Coal	Oil	Diesel	Others	Total
Generation Capacity- MW							
2003	2115	10505	3621	1402	645	6	18792
2004	2115	11051	7470	574	644	6	22344
2005	2070	11766	3900	266	552	0	19035
2006	2100	12804	4610	108	515	0	20618
2007	2083	12804	5980	261	342	0	21951
2008	2083	12833	6145	79	519	0	22150

Table 3 describes the country's total installed generation capacity by its region wise. Electricity demand in the West is more; therefore the production is few times greater than the East [ST, 2008].

Table 3 Total Installed Generation Capacity (UNIT: MW) by Regions in Malaysia, 2003-2008 [ST, 2008]

Year	Peninsular Malaysia	Sabah	Sarawak
Generation Capacity – MW			
2003	17152	770	870
2004	20719	770	855
2005	17426	653	956
2006	18894	757	967
2007	20247	735	969
2008	20235	804	1111

Renewable Energy (RE)

Changes in RE markets, investments, industries, and policies have been so rapid in recent years that perceptions of the status of RE are logging years behind the reality. According to the statement of REN21, existing renewable power capacity worldwide reached an estimated 1,230 GW in 2009 which is 7% more than 2008. RE now comprises about a quarter of global power-generating capacity (estimated at 4,800 GW in 2009) and supplies 18% of global electricity production (Figure 1). When large-scale hydropower is not included, renewable reached a total of 305 GW, a 22% increase over 2008 (Table 4). Among all renewables, global wind power capacity reached 159 GW in 2009. Solar PV capacity is increased by more than 7 GW in 2009 [REN21, 2010].

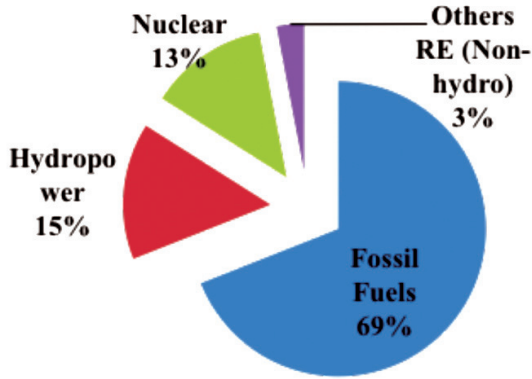

Figure 1 RE Share in global electricity in 2008 [REN21, 2010]

WEA revealed that wind power capacity reached 175 GW worldwide in June 2010 as stated in Figure 2. China became number two in total capacity wind power in Jun 2010, only slightly ahead of Germany. Germany installed around 26,000 MW of wind capacity. All wind turbines installed by the end of 2009 worldwide are generating 340 TWh per annum, equivalent to 2% of global electricity consumption.

Table 4 Renewable electric power capacity, existing as of 2009 [REN21, 2010]

RE Sources	China	US	Germany	Spain	India	Japan	Developing countries	EU-27	World Total
GW									
Wind Power	25.8	35.1	25.8	19.2	10.9	2.1	40	75	159
Small hydropower<10 MW	33	3	2	2	2	4	40	12	60
Biomass Power	3.2	9	4	0.4	1.5	0.1	24	16	54
Solar PV Grid	0.4	1.2	9.8	3.4	~0	2.6	0.5	16	21
Geothermal Power	~0	3.2	0	0	0	0.5	5	0.8	11
Total Renewable Power including small hydropower	62	52	42	25	14	9	110	120	305
Total Hydropower (all types)	197	95	11	18	37	51	580	127	980
Total Renewable Power including all types of hydropower	226	144	51	41	49	56	650	246	1230

Position	Country	Total capacity June 2010 [MW]	Added capacity June 2010 [MW]	Total capacity end 2009 [MW]
1	USA	36.300	1.200	35.159
2	China	33.800	7.800	26.010
3	Germany	26.400	660	25.777
4	Spain	19.500	400	19.149
5	India	12.100	1.200	10.925
6	Italy	5.300	450	4.850
7	France	5.000	500	4.521
8	United Kingdom	4.600	500	4.092
9	Portugal	3.800	230	3.535
10	Denmark	3.700	190	3.497
	Rest of the World	24.500	2.870	21.698
Total		175.000	16.000	159.213

Figure 2 World position of wind power total, added capacity in 2009 and 2010 [WWEA 2010]

In Table 5, some RE indicators were chosen for world ranking based on their annual amounts and existing capacity till the end of 2009. According to Table 5, in existing capacity of overall RE, China has held the 1st position whereas the US stood 1st both in wind and biomass power. In solar energy, Germany reached the 1st position. The US maintained its number one position in terms of existing capacity of wind power and biomass.

Table 5 Top 5 countries in terms of annual amounts and existing capacity in 2009 [REN21, 2010]

Annual amounts for 2009					
RE Indicator	Rank #1	Rank #2	Rank #3	Rank #4	Rank #5
New capacity investment	Germany	China	US	Italy	Spain
Wind power added	China	US	Spain	Germany	India
Solar PV added ^a	Germany	Italy	Japan	US	Czech Republic
Existing Capacity as of end-2009					
RP ^b capacity including small hydro	China	US	Germany	Spain	India
RP including all hydro types)	China	US	Canada	Brazil	Japan
Wind power	US	China	Germany	Spain	India
Biomass power	US	Brazil	Germany	China	Sweden
Solar PV*	Germany	Spain	Japan	US	Italy

^a Grid-connected; ^b Renewable Power

One of Asian countries India achieved 5th ranking in 2009 in terms of wind power addition, renewable power capacity and existing wind power capacity as well. Asia accounted for the largest share of new installations (40.4 %), followed by North America (28.4 %) and Europe fell back to the third place (27.3 %). On the other

hand, according to TNB reports, Malaysia has one wind power plant which generates 200 kW of electricity. Due to the country's unsuitable position, wind power is not viable for big wind project [WWEA, 2010]. Further description of wind power possibility in Malaysia is left in later section.

Solar PV generates electricity in well over 100 countries and continues to be the fastest growing power-generation technology in the world (Figure 3). The three top solar power producing countries in the world in 2009 were Germany, Spain and Japan. Despite solar power has enormous potential, during 2008, only less than 0.02% solar energy is produced of the world's total energy supply. The total worldwide installed capacity is 14.78 GW and 21 GW in 2008 and 2009 respectively [WES, 2010].

The trend towards large-scale (greater than 200 kW) PV plants continued around the globe, with the number of such plants exceeding 3,200 in 2009. Inside Asia, a 950 kW system in Cagayan de Oro City in the Philippines is reportedly one of the largest in any developing country (Figure 4a). And a 250 kW system is the largest grid-connected PV system in sub-Saharan Africa. In the Middle East, installation of Saudi Arabia's first and largest PV system (2 MW) on the roof of King Abdullah University of Science and Technology was completed in May 2010 (Figure 4b).

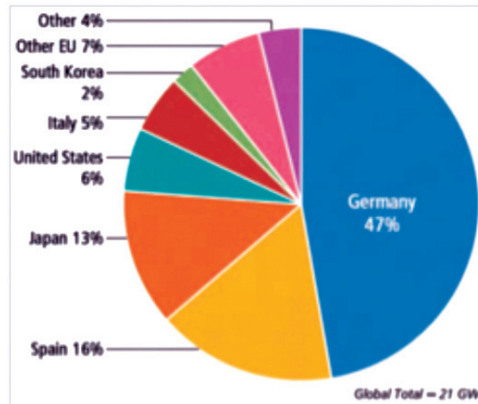

Figure 3 Solar power existing capacities, top 6 countries in 2009 [WES, 2010]



Figure 4 Asia's giant PV plant; (a) - Cagayan de Oro City, the Philippines (950kW); (b) - Roof top of King Abdullah University of Science and Technology, Saudi Arabia (2 MW)

Referring to Table 4, global hydropower capacity reached an estimated 980 GW by the end of 2009, including 60 GW of small hydro. Significant increases in hydropower capacity are in the project pipeline for 2011. Many new hydro development appears to

be concentrated in Brazil, China, India, Malaysia, Russia, Turkey, and Vietnam.

Biomass heating markets are expanding steadily in Europe, particularly in Austria, Finland, Germany, the Netherlands, and Sweden where Sweden, Finland, and Denmark lead the European biomass heating market. Among developing countries, it is common to produce small-scale power and heat from agricultural waste such as rice, coconut husks or palm oil mill wastage. The use of bagasse (sugar cane after juice extraction) for power and heat production is significant in countries that have a large sugar industry, including Argentina, Australia, Brazil, China, Colombia, Cuba, Guatemala, India, Kenya, Mauritius, the Philippines, Tanzania, Thailand, and Uganda. Malaysia is also seeing significant biomass power expansion. It has a biomass power plant fueled by rice husk in Kedah produces approximately 470 kW since 2008.

Biodiesel production increased 9% in 2009. The European Union (EU) remained the center of biodiesel production worldwide, representing nearly 50% of total output in 2009. Significant expansion in percentage occurred in Argentina, Austria, Colombia, Indonesia, Spain, and the United Kingdom, with growth rates of 50% or more. India, which was ranked sixteenth in 2009, increased production more than 100-fold to over 130 million liters. Other biodiesel producers in the top 15 included Brazil, China, Malaysia, and Thailand [REN21, 2010].

Worldwide Energy Consumption

According to Figure 5, energy consumption in OECD countries did not increased significantly during 2004 to 2008. Moreover, consumption dripped down 242.829 Quadrillion British thermal unit (Btu) in 2008 from 245.148 Quadrillion Btu in 2007. The overall scenario of non-OECD countries is different during this interval.

The consumption increased 20.6% from 2004 to 2008. From the statistics, it is observed that energy consumption of Non-OECD countries is less than OECD countries but the opposite scenario is seen in 2008.

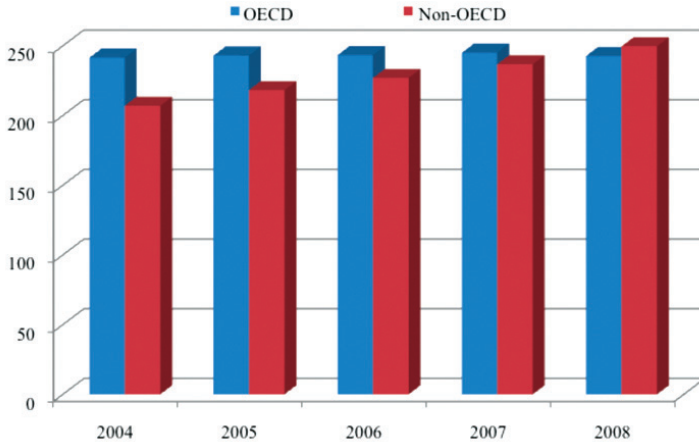

Figure 5 Energy Consumption of OECD and non-OECD countries

The consumption in Malaysia also increased during all of these years. However, it is decreased in approximately 1.7% in 2007 from 2006. Figure 6 shows the energy consumption of Malaysia from 2004 to 2008 [US EIA, 2009].

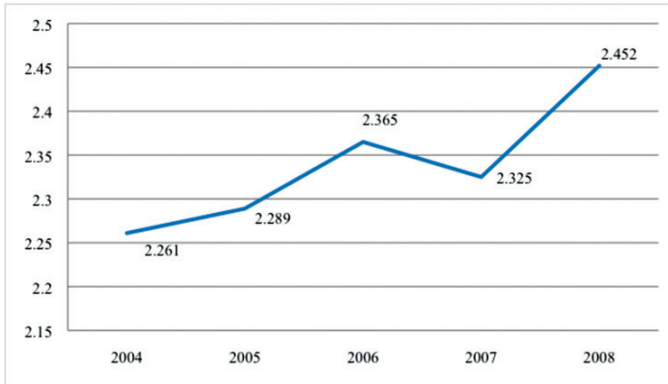

Figure 6 Energy Consumption in Malaysia

Worldwide Future Energy Demand

Current power needs of 15TW are likely to increase from 20 to 25TW, due to population increase from 6.6 billion to 10 billion, by 2050. Global energy demand (at 1.6%/year) will increase from existing 469 EJ (2004) to 716 EJ (2030) (1 EJ=Exajoule= 10^{18} Joule). World electricity demand (at 2.6%/year) will increase from 17.4 EWh (2004) to 33.8 EWh (2030). The population of Asia will increase from 3.9 billion in 2005 to more than 5 billion in 2050. Asia's primary energy demand will grow at an average of 2-3% per year to 2050. They will require approximately 15 billion tons of oil equivalent or 625 EJ/year, about 3 times more than the current level (200 EJ/year) [N. Mariun, 2008].

In the International Energy Outlook (IEO) 2010 Reference case, world marketed energy consumption grows by 49% from 2007 to 2035 of OECD and Non-OECD countries as seen in Figure 7. Total world energy usage rises from 495 quadrillion Btu in 2007 to 590 quadrillion Btu in 2020 and 739 quadrillion Btu in 2035. The most rapid growth in energy demand from 2007 to 2035 occurs

in nations outside the organization for Non-OECD nations. Total Non-OECD energy consumption increases by 84% in the Reference case, compared with a 14% increase in energy use among OECD countries [IEO, 2010].

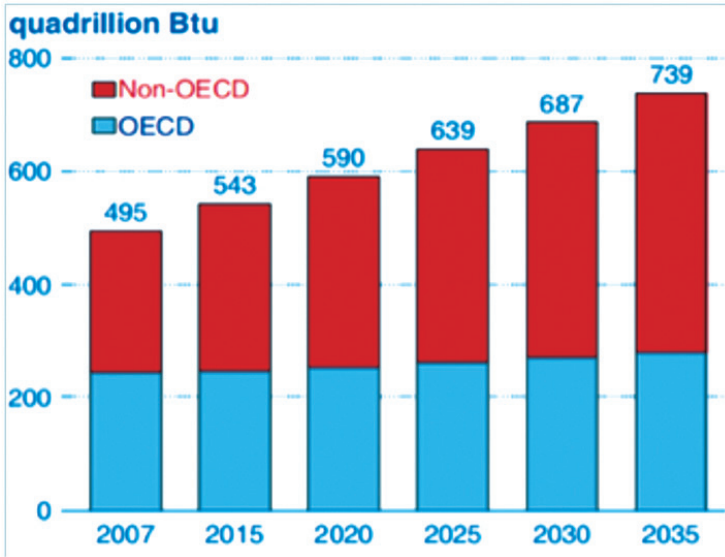

Figure 7 World marketed energy consumption; History and Projection, 2007-2035 [IEO, 2010]

The IEO2010 Reference case projects increase world consumption of marketed energy from all fuel sources over the 2007-2035 projection period (Figure 8a). Fossil fuels are expected to continue supplying much of the energy used worldwide. Although liquid fuels remain the largest source of energy, the liquids share of world marketed energy consumption falls from 35% in 2007 to 30% in 2035. On the other hand, world coal consumption is projected to increase from 132 quadrillion Btu in 2007 to 206 quadrillion Btu in 2035, at an average annual rate of 1.6%. The projected increase

in coal use is seen to occur in non-OECD Asia, which accounts for 95% of the total net increase in world coal use from 2007 to 2035 (Figure 8b).

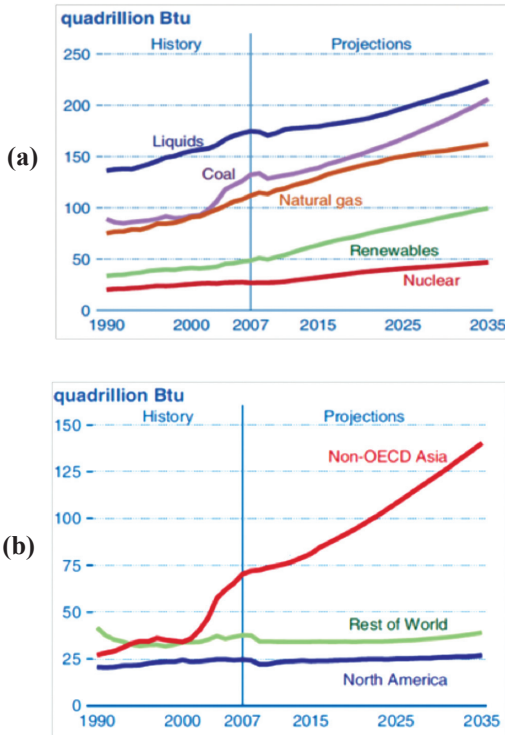

Figure 8 History and Projection from 1990-2035 (a) - World marketed energy use by Fuel Type; (b) - World coal consumption by Regions [IEO, 2010]

ENERGY RELATED CO₂ EMISSIONS- HISTORY AND PROJECTION

CO₂ Emissions Trend in OECD and non-OECD Countries

From 2006-07, total energy-related CO₂ emissions from non-OECD countries grew by 4.9%, while emissions from OECD countries increased by 1.0%. The increase in OECD countries' CO₂ emissions is estimated to have been reversed in 2008 and 2009, as fossil fuel demand contracted during the global recession that began in 2008 and continued through 2009. In 2015, annual emissions from non-OECD countries exceed those from OECD countries by 43%. Figure 9 depicts CO₂ emission scenarios in OECD and non-OECD countries [US EIA, 2010].

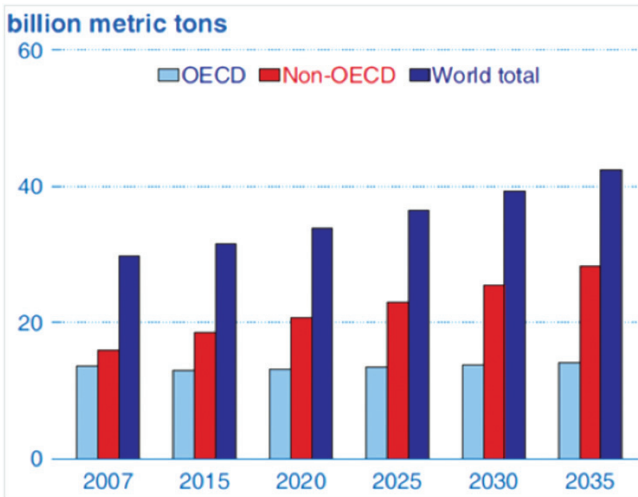
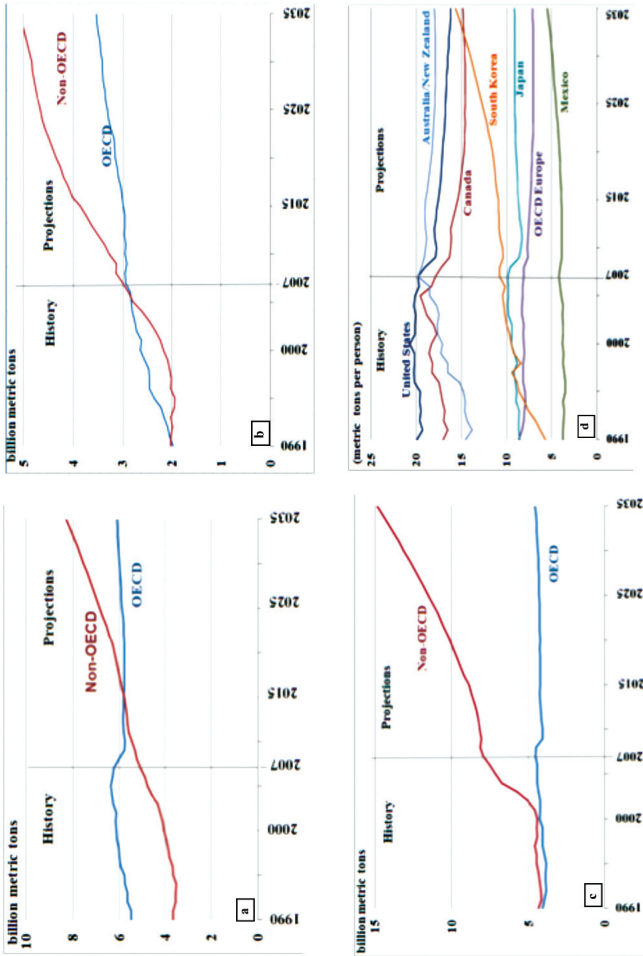

Figure 9 World energy related CO₂ emissions (Btu), 2007 -2035 [US EIA, 2010]

Figure 10 illustrates history and projection of CO₂ emission by fuel type such as liquids (Figure 10a), natural gas (Figure 10b) and, coal (Figure 10c) combustion. World CO₂ emission from the consumption of liquid fuels increases by 27.5% from 2007 to 2035, with all the increase coming from non-OECD countries. CO₂ emissions from natural gas combustion increase for OECD countries averaging 0.7% per year and the increase for non-OECD countries averaging 1.9% per year. And CO₂ emission from coal combustion increases by 56 % that is from 7.5 billion metric tons in 2007 to 15.0 billion metric tons in 2035.

Another measure of CO₂ intensity is according to emission per person. OECD countries have higher levels of CO₂ emission per capita, in part because of their higher levels of income and fossil fuel use per person. In Figure 10d, the US emission per capita falls from 19.8 metric tons in 2007 to 16.2 metric tons in 2035 but remain among the highest, second only to the Australia/New Zealand region. In Mexico, emission per capita increases from about 4 metric tons in 2007 (the lowest level among OECD countries) to 5.5 metric tons in 2035, which still is the lowest among the OECD countries. One of the Asian countries, South Korea, the country's trends of emission per capita increases from 11 metric tons in 2007 to more than 16 metric tons in 2035. Another Asian country Japan has almost the same range of emission during this interval [US EIA, 2010].

Figure 10 History and Projection of OECD and non-OECD countries CO₂ emissions from: (a)- Liquid combustion; (b)- Natural gas combustion; (c)- Coal combustion and, (d)- OECD countries CO₂ emission per capita by countries and regions; 1990 to 2035 and billion metric tons [US EIA, 2010]



Trends of CO₂ Emissions in East Asia

The emissions growth since 1948 reflected not only the growth in India, South Korea and Indonesia, but also in Thailand, Taiwan, Malaysia, Pakistan, Philippines, Singapore and other less populous nations. India, South Korea and Indonesia were responsible for 68% of the region's 2007 fossil-fuel CO₂ emissions, with the other above-mentioned six countries contributing another 28%. Coal is the major source of fossil-fuel CO₂ in this region. Over 62% of the region's consumed coal are burned in India while India, Indonesia and South Korea combined for 59% of liquid-fuel emissions [T.A. Boden *et al.*, 2010].

CO₂ Emissions Trends in Malaysia, 2000-2020

Figure 11 shows CO₂ emissions projection from four main sectors (electricity generation, industrial, transportation, residential) for the period of 2000–2020. Referring to Figure 11, a total of 285.73 million tones CO₂ emissions will be emitted in 2020, mostly by power generation (43.40%), followed by transportation, industrial and finally residential sector. Power generation and transportation sectors should both be identified as key control targets, due to their contribution to emissions. This sector contributes the most due to the increasing use of coal (29%) for power generation [N. Sharliza *et al.*, 2010].

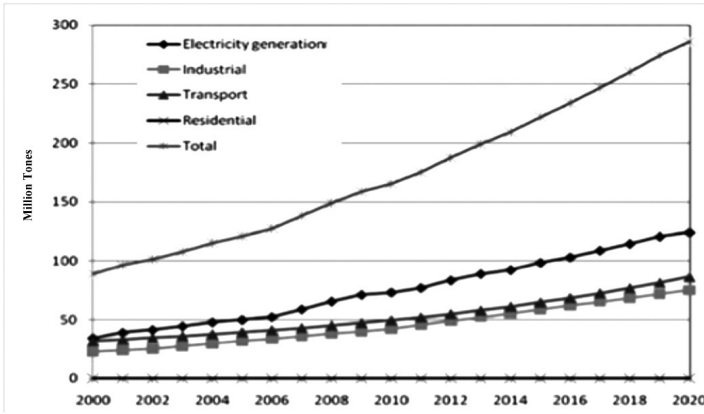

Figure 11 Projected CO₂ emissions of four sectors in Malaysia

FOSSIL FUEL

A fossil fuel power plant is a system of devices for the conversion of fossil fuel energy to mechanical work or electric energy. The main systems are the steam cycle and the gas turbine cycle. The steam cycle relies on the Rankine cycle in which high pressure and high temperature steam raised in a boiler is expanded through a steam turbine that drives an electric generator. The steam gives up its heat of condensation in a condenser to a heat sink such as water from a river or a lake, and the condensate can then be pumped back into the boiler to repeat the cycle. The heat taken up by the cooling water in the condenser is dissipated mostly through cooling towers into the atmosphere. Figure 12 shows a traditional coal power plant.

The gas turbine cycle relies on the Brayton cycle in which air is compressed to high pressure, and is heated to high temperature by the combustion of natural gas or light fuel oil. Combustion is the prevailing fuel utilization technology in both gas and coal turbine

cycles. Coal is the preferred fuel for the steam cycle because of its low cost and, broad and secure availability worldwide [J. Beer, 2010].

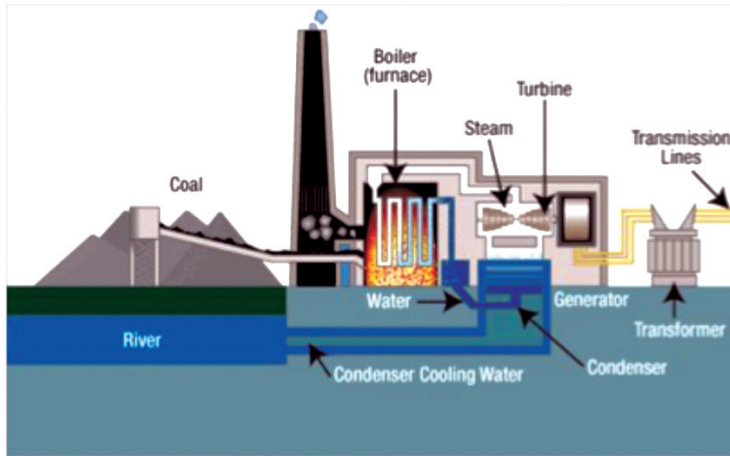

Figure 12 A traditional coal power plant

Key Facts of Coal-Fired Electricity Production

A typical coal fired power plant of 500 MW capacity has the following key properties [Johnzactruba, 2010]:

- Around 2 million tons of coal will be required each year to produce the continuous power.
- Coal combustion in the boiler requires air. Around 1.6 million m³ of air in an hour is delivered by air fans into the furnace.
- Ash produced from this combustion is around 200,000 tons per year.
- The boiler units produce around 1600 tons of steam per hour at a temperature of 540 to 600 degrees centigrade.

- It will require around 50,000 m³ per hour of cooling water to be circulated from lakes, rivers or the sea to condense all the steam.

Improving Efficiency of Coal-fired Power Plants for CO₂ Emissions Reduction

Improving efficiency levels increases the amount of energy that can be extracted from a single unit of coal. Increases in the efficiency of electricity generation are essential in tackling climate change. A one percentage point improvement in the efficiency of a conventional pulverised coal combustion plant results in a 2-3% reduction in CO₂ emissions. Highly efficient modern coal plants emit almost 40% less CO₂ than the average coal plant currently installed [WCA, 2011].

There are many proposals for improving efficiency of coal-fired power plants. Some of them are ammonia based CO₂ capture [G. Xu *et al.*, 2010a] and new environmental friendly evaluation criterion for coal-fired power plant comprehensive performance [G. Xu *et al.*, 2010b]. But according to the World Coal Association (WCA), improvements in the efficiency of coal-fired power plants can be achieved with technologies as well. These include Fluidised Bed Combustion (FBC), Supercritical and Ultrasupercritical Boilers (SUB), and Integrated Gasification Combined Cycle (IGCC).

Fluidised Bed Combustion (FBC)

FBC is a very flexible method for burning most combustible materials which includes coal, biomass and general waste. FBC pressurized systems especially, improve the environmental impact of coal-based electricity, reducing SO_x and NO_x emissions by 90%. The efficiency of FBC can be achieved up to 42-45% in the commercial sector. CO₂ emissions for a medium sized FBC are

around 875 g/kWh (100% coal), 830-860 g/kWh (20% biomass and/ or plastic with coal) [D.R. McIlveen-Wright *et al.*, 2006].

Supercritical and Ultrasupercritical Boiler (SUB)

New Pulverised Coal Combustion (PCC) systems are utilizing SUB technology which operates at higher temperatures (above 593°C) and pressures (24131.65 kPa or higher). Therefore it has become possible to achieve higher efficiencies than conventional PCC units and significant CO₂ reductions. The efficiency using this technology can be from 42% up to 45–50% [D.R. McIlveen-Wright *et al.*, 2006]. Due to this higher efficiency, less fuel is consumed which means less emissions of SO₂ (0.90 lb/MWh), NO_x (0.63 lb/MWh), mercury (Hg), CO₂ (0.96 T/MWh) and particulate and solid waste [AEP, 2009]. One of the examples of using ultrasupercritical technology is Yuhuan, China 1000MW coal-fired power plant which net efficiency is 46%.

Integrated Gasification Combined Cycle (IGCC)

An alternative to achieving efficiency improvements in conventional PCC power stations is through the use of gasification technology. IGCC plants use a gasifier to convert coal (or other carbon-based materials) to syngas (CO and H₂), which drives a combined cycle turbine. The CO₂ emissions from the IGCC technologies are found in simulations which lied between 700 and 770 g/kWh [D.R. McIlveen-Wright *et al.*, 2006].

Price, Supply and Consumption of Global Crude Oil, Liquid Fuels and Coal

The recent unrest in North Africa and Middle East increases the uncertainty in the world oil market. Due to the unstable situation

of the world's largest oil producing area, Libya has shut down 1.8 million bbl/d (barrel per day) liquid production. According to the US EIA Report in March 2011, there are many reasons for market uncertainty that could push oil prices higher or lower than current expectations. Some of the uncertainties are: the continued unrest, war and assaults in producing countries and its potential impact on supply; decisions by key Organization of the Petroleum Exporting Countries (OPEC) regarding their production response to the global recovery in oil demand and recent supply losses; the rate of economic recovery both domestically and globally; and fiscal issues facing national and sub-national governments. Figure 13 depicts crude oil price scenario from 1970 to April 2011. It shows that the price has been fluctuated by many incidents around the world. The highest price was US\$145.29/bbl in Jul 2008 during this interval.

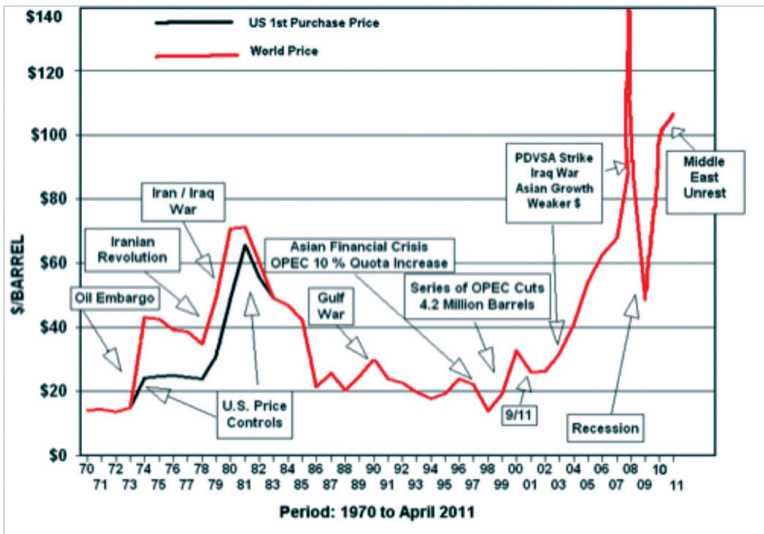

Figure 13 World crude oil price scenarios from 1970 to April 2011
 [Source: WTRG Economics and NYMEX]

Figure 14 represents the world's crude oil and liquid fuels consumption from 2004 to 2010; the rest two years 2011 and 2012 have been left for forecasting of consumption. According to Figure 14, world crude oil and liquid fuels consumption grew by an estimated 2.4 million bbl/d in 2010 to 86.7 million bbl/d. This growth more than offset the reductions in demand during the prior two years and surpassed the 2007 consumption level of 86.3 million bbl/d. It is expected that world liquid fuels consumption will grow by 1.5 million bbl/d in 2011 and by an additional 1.7 million bbl/d in 2012 [US EIA, 2011a].

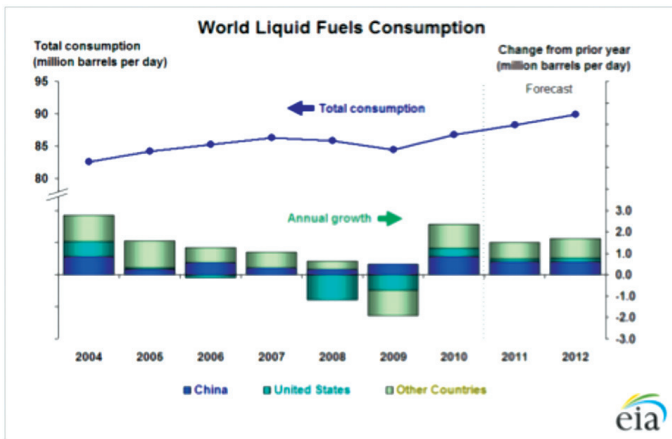

Figure 14 World Liquid Fuel Consumption Chart [US EIA, 2011a]

World crude oil and liquid fuels supply and consumption are depicted in Table 6. Here supply refers to production of crude oil (including lease condensates), natural gas plant liquids, biofuels, other liquids, and refinery processing gains. Referring to Table 6, total world production has increased in 2010 for both supply and consumption cases [US EIA, 2011a].

Albeit among the fossil fuels, coal emits the highest CO₂ in the environment, coal fuels a higher percentage of electricity not only in power generation but also steel and cement production, and other industrial activities. Table 7 shows the percentage of coal usage for some major countries in terms of electricity generation in 2008. Among these countries, Poland has the highest percentage that uses coal for its electricity generation [WCA, 2008].

Table 6 International crude oil and liquid fuels supply and consumption, Million bbl/d; 2007-2010 [US EIA, 2011a]

Region	Year			
	2007	2008	2009	2010
Supply- Million barrels per day				
OECD	21.47	20.94	21.06	21.29
Non-OECD	63.07	64.57	63.27	65.16
Total World Production	84.54	85.51	84.33	86.45
Consumption- Million barrels per day				
OECD	49.32	47.56	45.42	45.95
Non-OECD	36.98	38.2	38.91	40.74
Total World Consumption	86.3	85.76	84.34	86.69

Table 7 Percentages of coal in electricity generation
 [Source: WCA, 2008]

Country	Percentage	Country	Percentage
South Africa	93%	Czech Rep	60%
Australia	77%	USA	49%
Israel	63%	PR China	79%
Greece	52%	India	69%
Poland	92%	Morocco	55%
Kazakhstan	70%	Germany	46%

Fossil Fuel Reserves in Malaysia

Malaysia is a significant oil and natural gas producer. Malaysia’s oil reserves were the 3rd highest in the Asia-Pacific region and world’s 10th largest holder of natural gas reserves in 2010. According to the oil and gas journal, Malaysia held proven oil and natural gas reserves of 4 billion barrels and 83 trillion feet³ as of Jan 2010 (Figure 15). It was also the 2nd largest exporter of Liquefied Natural Gas (LNG) in the world after Qatar in 2009, exporting over 1 trillion feet³ of LNG, which accounted for 12% of total world LNG exports.

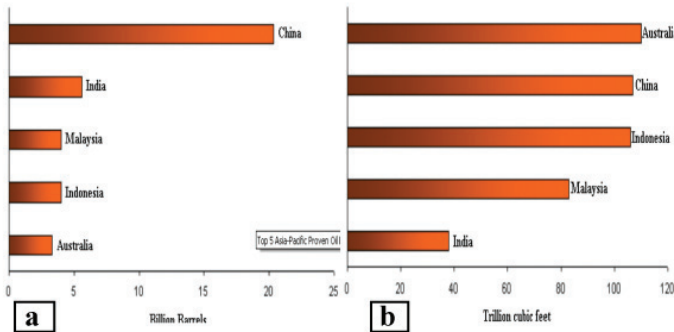

Figure 15 Asian Pacific’s proven oil (a) and natural gas (b) reserves, Jan 2010

Figure 16 portrays the reserves of crude oil, natural gas, and coals of some OECD and non-OECD countries including Malaysia. The statistical data of crude oil, natural gas are as of 2009-2010 but coal statistic is of 2008 [US EIA, 2009].

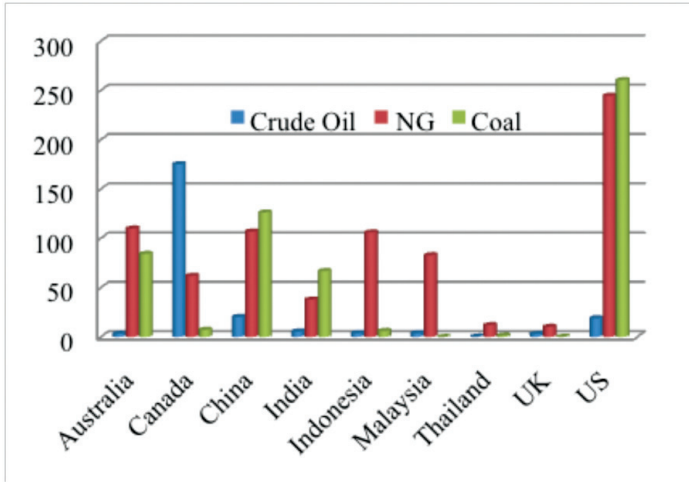

Figure 16 Reserves of crude oil (billion barrels), natural gas (trillion feet³) and coal (billion short tons) [US EIA, 2009]

According to Figure 17a, Malaysian oil production is gradually decreasing since reaching a peak of 862,000 bbl/d in 2004 due to its maturing offshore reservoirs. Malaysia consumes the majority of its production; hence domestic consumption rises as production falls. The reserve of crude oil is likely to last another 24 years, AmResearch unveils in 14 Feb 2011.

Natural gas production rises steadily, reaching 2.1 Tcf (Trillion cubic feet) in 2009, while domestic natural gas consumption increases steadily, reaching 1.0 Tcf in 2009 (Figure 17b). Both AmResearch and Gas Malaysia stated that at the current rate of production, Malaysia's gas reserves are expected to last 36 to 38 years.

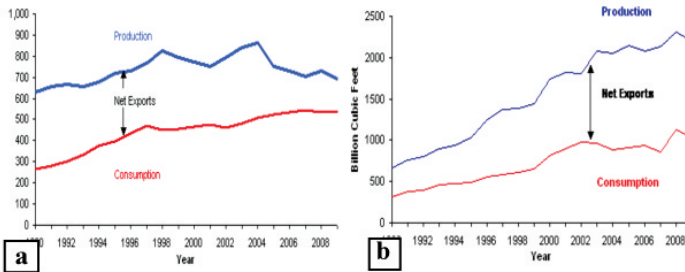

Figure 17 Production, consumption and net export of Malaysia from 1990 to 2009; oil (a) and natural gas (b) [US EIA, 2009]

Consumption of Fossil Fuel in Malaysia

In Malaysia, diesel and fuel oil are considered as petroleum products in power generation. The usage ratio between diesel and fuel oil remained nearly the same (approximately double compare to fuel oil) from 2003 to 2008. However, the scenario is different in 2006 where the diesel consumption was nearly four times than fuel oil. On the other hand, the coal and coke consumption increased two times in 2008 (8,069 KTOE) than 2003 (4,104 KTOE). Similarly, hydro generation also increased two times in 2008. Figure 18 depicts the detail fuel consumption statistics from 2003 to 2008 [ST, 2008].

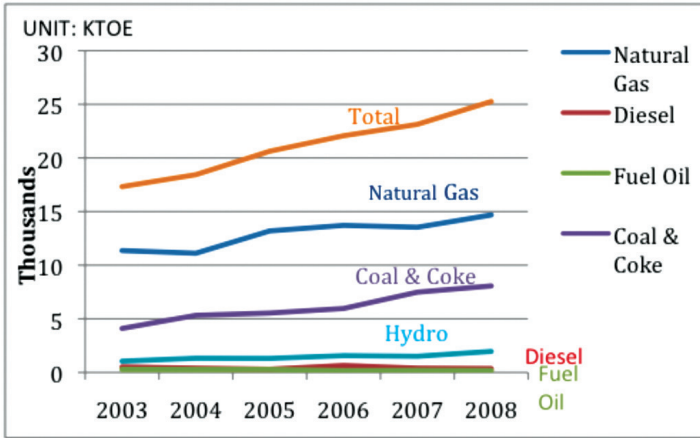

Figure 18 Fuel consumption in Malaysian power sector from 2003-2008; UNIT: KTOE [ST, 2008]

Power Plants in Malaysia

There are three types of fossil fuel power generations in Malaysia. These are Gas-fired, Coal-fired (or combined gas/coal) and Oil-fired power plants. All types of power plants are situated in different states in Malaysia. The owner of majority power plants are TNB, however other companies such as Malakoff Bhd, Sarawak Power Generation Sdn Bhd, Powertek *etc.* also possess some of the plants. The two giant Gas-fired power plants owned by TNB, are Tuanku Jaafar Power Station (1500 MW) and Sultan Ismail Power Station (1,136 MW) located in Negeri Sembilan and Terengganu respectively. The three enormous thermal type coal-fired power plants are Sultan Salahuddin Abdul Aziz Shah Power Station (2,420 MW), Manjung Power Station (2,295 MW) and Tanjung Bin Power Station (2,100 MW). Salahuddin Abdul Aziz Shah Power Station is thermal type and open cycle and it is called triple fuel firing power plants since it is combined of natural gas and coal with oil. Gelugor Power Station

is one of the popular Oil-fired power stations in Peninsular Malaysia with a capacity of 398 MW. Figure 19 depicts some of the power plants located in different states in Malaysia.



Figure 19 Fossil fuel power plants in Malaysia

RENEWABLE ENERGY (RE)

Unlike fossil fuels, ageing assets RE regenerate and can be sustained indefinitely. The six renewable sources used the most are: biomass, water (hydropower), wind, solar, ocean wave, and Municipal Solid Waste (MSW). In this section, a new collection to RE, osmotic power is also discussed. However before going the discussion is elaborated the world's net electricity generation statistics from RE are depicted in Table 8. It shows the electricity net generation from RE by Energy Use Sector and Energy Source from 2004 to 2008 in Thousand kWh [EP, 2010]. Total generation increased from

2004 to 2006, but decreased in 2007. The production of generation increased again in 2008.

Table 8 Electricity net generation from RE by Energy Use Sector and Energy Source, 2004 – 2008, released on Aug 2010

Sector/ Source	2004	2005	2006	2007	2008
Thousand MWh					
Total	351,484.6	357,650.6	385,771.9	352,747.4	381,043.8
Biomass	53,537.5	54,276.8	54,860.6	55,538.6	55,033.6
Geothermal	14,811	14,691.7	14,568	14,637.2	14,951.3
Hydroelectric	268,417.3	270,321.3	289,246.4	247,510	254,831.4
Solar (PV) / Thermal	575.2	550.3	507.7	611.8	864.3
Wind	14,143.7	17,810.5	26,589.1	34,449.9	55,363.1

Solar Energy

Scientists have estimated that the total solar energy absorbed by our planet is approximately 3,850,000 EJ per year. This solar energy has enormous potential, and covering only 4% of the world's deserts with solar panels would be enough to supply all of the world's electricity. However despite having an enormous potential, solar power account less than 0.02% of the world's total energy supply in 2008 as we mentioned earlier. Solar energy currently provides only about 0.5% of globally installed electricity capacity.

Solar energy (at the beginning of the 2010) had the average price of 18 cents (US\$) per kW hour, approximately three times expensive than the price of coal and natural gas. However, statistics showed that PV production grew more than 20% each year since 2002. Top three solar power producing countries in the world in

2009 were Spain, Germany and the US and they represented little less than 89% of the total worldwide PV installed capacity in 2009 (Figure 20) [WES, 2010].

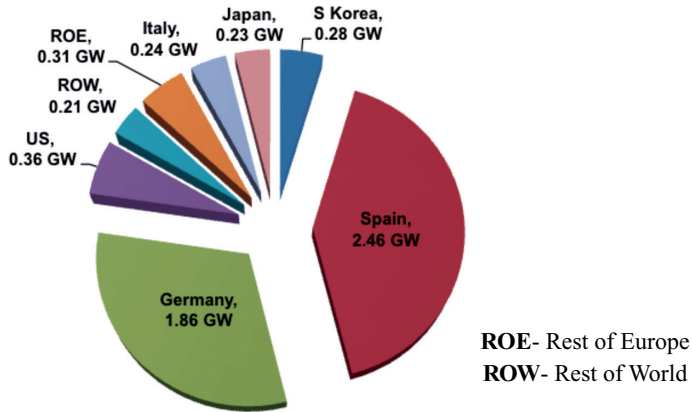

Figure 20 Global PV installed capacity in 2009 [WES, 2010]

Latest Research on Solar

Solar Cells that Work at Night

Solar cells that work at night sounds like an oxymoron, but a new breed of nanoscale light-sensitive antennas would soon make this possible. This new research is published by the US Department of Energy's (DOE) Idaho National Laboratory in Idaho Falls. Nearly half of the available energy in the solar spectrum resides in the Infrared band, and this band is re-emitted by the Earth's surface after the sun has gone down. This means that the antennas can even capture some energy during the night. Unlike PV cells, which use photons to liberate electrons, the new antennas resonate when hit by light waves, and that generates an alternating current that can be harnessed [D. Graham-Rowe, 2010].

Sun and Sand breed Sahara Solar Power

The Sahara solar breeder project is a joint initiative by universities in Japan and Algeria that aim to build enough solar power stations by 2050 to supply 50% of the energy used by humanity. The idea is to begin by building a small number of silicon manufacturing plants in the Sahara, each turning the desert sand into the high-quality silicon needed to build solar panels. Once those panels are operating, some of the energy they generate will be used to build more silicon plants, each churning out more solar panels and generating more energy that can be used to build even more plants [M. Fitzpatrick, 2010]

Plans for 280MW Solar Plant in Arizona

A Spanish company-Albisa corporation has chosen Arizona as a new location for RE firm development headquarters and has selected a site near Kingman as the future location of its 280 MW concentrating solar power plant. The project involves over US\$1 billion capital investment and the value of the produced energy will be about US\$4 billion over 30 years. [E. Clark, 2008]. The plant is supposedly to be completed by 2011. The project model is depicted in Figure 21.

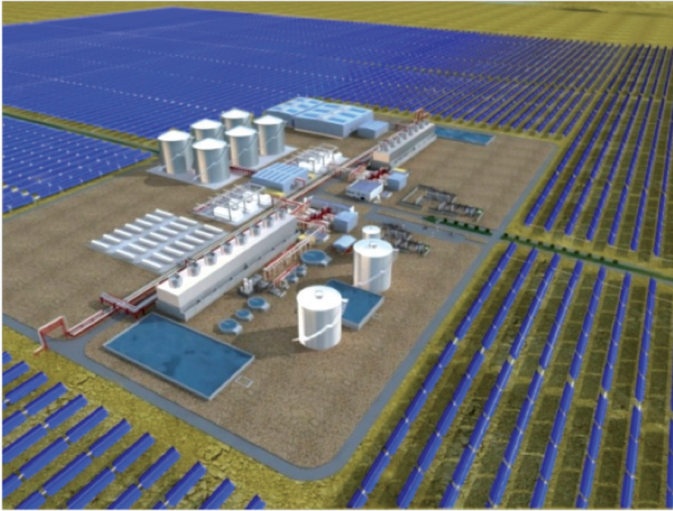

Figure 21 Planned 280 MW concentrating solar power plant in Arizona, US

Wind Power

Wind power is the world's fastest growing electricity generation technology. Wind is a renewable resource because it is inexhaustible. The corresponding daily and seasonal changes in temperature consistently generate wind, producing a fuel source that can never be depleted. Wind power shows a growth rate of 31.7%, the highest rate since 2001. Figure 22 presents the growth trends of wind energy from 2001-2010 [WEA, 2011].

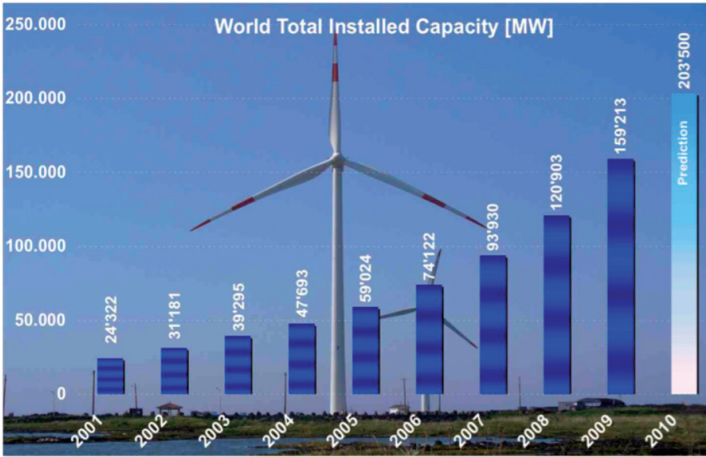

Figure 22 Worldwide wind energy installed capacity (MW) from 2001 to 2010 [WEA, 2011]

Mechanism and Generation Cost

State-of-the-art wind power plants use large spinning blades to capture the kinetic energy in moving wind, which then is transferred to rotors that produce electricity. At the best wind fuel sites, wind plants today are nearly competitive with the conventional natural gas-fired combined-cycle plants. Regions where average wind speeds exceed 19 km/hour are currently the best wind power plant sites.

Current costs of wind-generated electricity at prime sites approach the costs of a new coal-fired power plant. Wind power is the lowest-cost RE technology available on the market today. According to the US DOE, the costs of wind power are projected to continue to fall and may rank the cheapest electricity source of all options by 2020.

Location of Giant Wind Power

Most of the wind power plants in the world are located in Europe and in the US where government programs have supported wind power development. As of 2008 to 2010, the US ranked first in the world in wind power capacity. The top five wind power producing states in the US are Texas, Iowa, California, Minnesota, and Washington. The world's largest wind farm, the Horse Hollow Wind Energy Center in Texas, has 421 wind turbines that generate 9727 MW electricity, enough to power 220,000 homes per year. In Figure 23, wind power locations in the states of US along with each state's capacity have been shown [NREL, 2010].

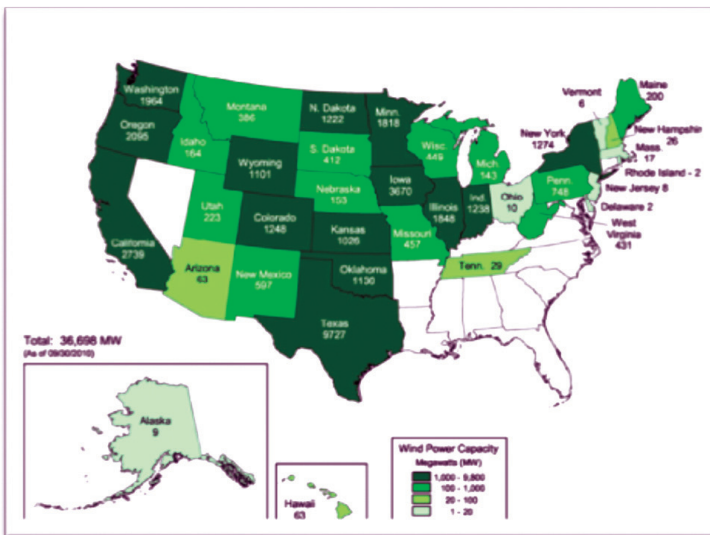

Figure 23 Wind power plant location in the US – data is on 30 Sep 2009 [NREL, 2010]

Offshore Wind Power

A new initiative has been unveiled by the US Government to spend up to US\$50.5 million over the next five years to make offshore wind development along the States' coastlines [J. Dailey, 2011a]. According to the National Renewable Energy Laboratory (NREL) report, more than 11 GW of offshore wind is planned by 2010 worldwide where mostly are in Denmark, Germany, and UK (Figure 24). Britain has opened one of the world largest offshore wind farms on 21 Sept 2010 which has 100 turbines installed but so far with a total of 341 planned. The farm is expected to produce 300 MW of energy at full capacity and it has the potential to power 200,000 homes. The farm is situated around 12 km out to sea; the 115 m high turbines are spread over more than 35 km². The cost of the construction work's at US \$1.2 billion and it has started two years ago (Figure 25-d) [J. Jowit *et al.*, 2010].

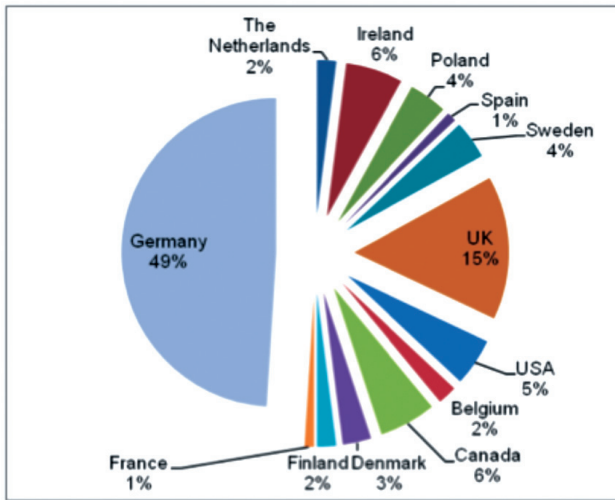

Figure 24 Proposed offshore wind projects: 11,455 MW (through 2010)

To date onshore technology has been directly implied to offshore condition. However, optimal offshore turbine designs are expected to differ from their onshore counterpart because environmental considerations are related. The offshore development technology might consider marine life under sea, birds migrating, marine traffic, electromagnetic noises under seawater etc. In Figure 25(a-c), deep and shallow offshore development architecture is shown.

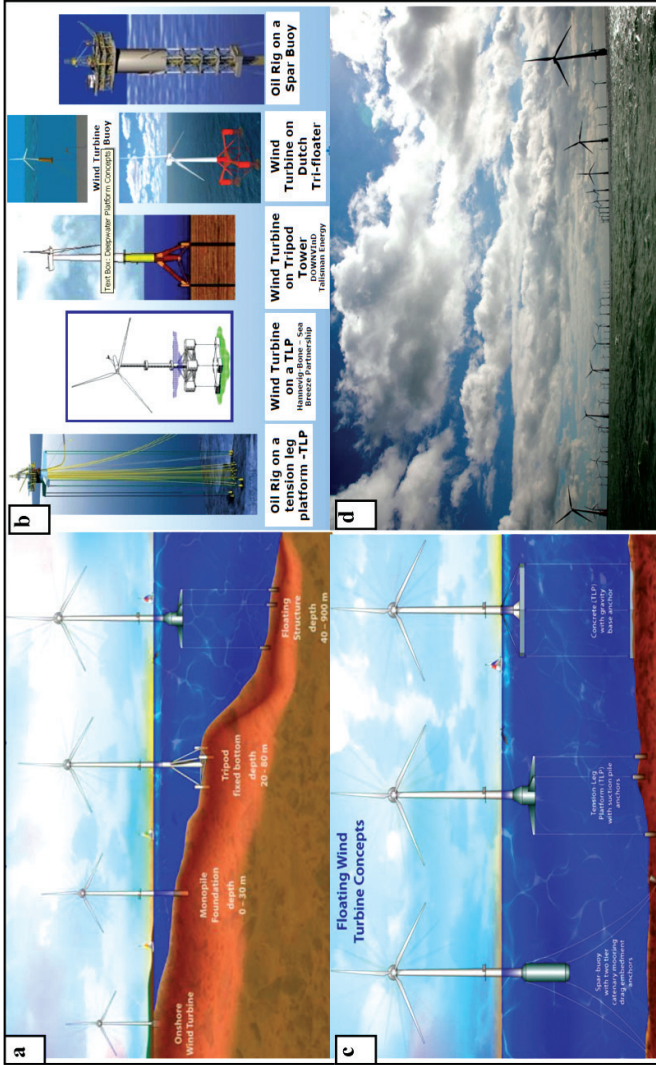

Figure 25 Offshore wind turbine development; (a)- Deep water wind turbine; (b)- Platform structure concept; (c)- Floating wind turbine concept; (d)- A 300 MW offshore wind power plant in Britain is opened on Sept 2010

Hydro Power

Hydroelectric power plants generally range in size from several hundred kilowatts to several hundred megawatts, but a few enormous plants have capacities near 10,000 MW in order to supply electricity to millions of people. According to Water Encyclopedia, world hydroelectric power plants have a combined capacity of 675,000 MW that produces over 2.3 trillion kWh of electricity each year; supplying 24% of the world's electricity to more than 1 billion customers [W.A. Atkins, 2010].

Canada is the world's largest hydroelectric power producer. In 1999, it generated more than 340 billion kWh of power, or 60% of its electric power, far outdistancing the US hydropower percentage. In the US, more than 2,000 hydropower plants make hydro-electric power the country's largest RE source. However, only 8% of the total US electrical power was generated by hydroelectric power plants in 1999.

Types of Hydropower Plants

There are generally three types of hydropower facilities: impoundment, diversion, and pumped storage. Some hydropower plants use dams and some do not. Other popular types are larger, small and micro hydropower. Figure 26 shows some types of hydropower plants.



Types	Synopsis
	It uses a dam to store water. Water is released either to meet changing electricity needs or to maintain a constant water level.
Impoundment	
	A diversion called run-of-river, facilitated by channels of river through a canal or penstock. It may not require the use of a dam. Picture (left)- Tazimina project in Alaska, a diversion hydropower plant. No dam is required.
Diversion	
	A micro hydropower plant has a capacity of less than 300 kW. A small or micro-hydroelectric power system is more consistent than wind or solar, can produce enough electricity for a home, farm, ranch, or village.
Pumped storage	

Figure 26 Types of hydropower plants

Smart Hydropower Turbine

There are some efficient hydropower turbines that abetting procedure more efficiently. Here two smart types of turbines such as Pelton and Francis are discussed.

Pelton turbine is best suited to applications with a high head but a low volume flow rate such as fast flowing shallow water courses. It is used in a wide range of situations with heads from as low as 15 m up to almost 2000 m. High pressure heads give rise to very fast water jets impinging in the blades resulting in very high rotational speeds of the turbine. It is ideal for low power installations with outputs of 10kW or less. However, they have also been used in installations with power outputs of up to 200 MW. Efficiency is up to 95%. Figure 27a shows Peltron type turbine.

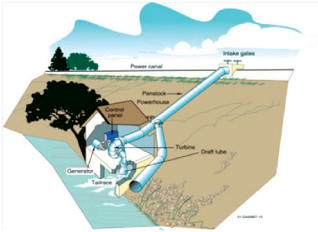
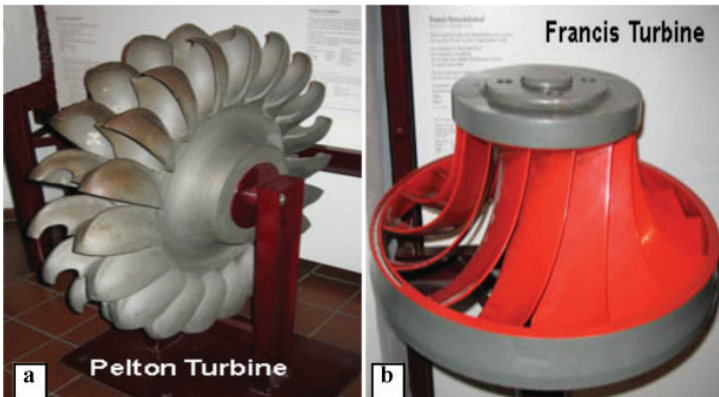

Figure 27 Types of turbines designed for hydro power on different installation power outputs (a)- Peltron Turbine; (b)- Francis Turbine

Francis turbine is a reaction turbine designed for fully submerged. It is suitable for lower heads of water of 500 m or less and is the most commonly used high power turbines. Large scale turbines used in dams are capable of delivering over 500 MW of

power from a head of water of around 100 m with efficiencies of up to 95%. Figure 27b shows the Francis Turbine.

An Example of Hydropower Project: Cornell University, US

Cornell University has generated electricity through 1 MW hydropower plant which is originally able to meet the needs of the campus and the City of Ithaca, New York. It now provides about 2% of the campus's annual electricity consumption (Figure 28) [Cornell University, 2011].



Figure 28 Cornell University leverages hydropower for electricity production through run-of-the-river facility located on Fall Creek in Ithaca, New York

Osmotic Power- Renewable for Next Generation

The principle of harnessing osmosis has the potential to produce enormous amount of energy anywhere in which salt water and fresh water meet. Osmosis occurs wherever two solutions of different concentrations (such as sea and river water) meet at a semipermeable membrane. The spontaneous passage of water from dilute to

concentrated solutions through the membrane generates a pressure difference that can be harnessed to generate power.

Statkraft- World's First Osmotic Power Prototype

Based on the concept, Statkraft, the world's first osmotic power plant prototype had been inaugurated in Tofte, Norway on 24 Nov 2009. The prototype has a limited production capacity and will be used primarily for testing and data validation leading to the construction of a commercial power plant in a few years time. Statkraft claims that the technology has global potential to generate clean RE equivalent to approximately 1600 to 1700 TWh. This project is being financed by Statkraft with support from Enova and the Research Council of Norway [Statkraft, 2009].

How it Works

The working procedure of osmotic power plant is illustrated in Figure 29. The descriptions of the mechanism are given below.

1. Seawater and freshwater through pressure chambers is divided by polymer membranes.
2. The power density depends on semi-preamble membrane. Currently average density of the membrane is 3 W/m^2 which is less than 0.1 W/m^2 is few years earlier. Maximum power density is observed at 5.1 W/m^2 [A. Achilli *et al.*, 2009].
3. The seawater salt molecules draw the freshwater through the membrane creating pressure on the seawater side.

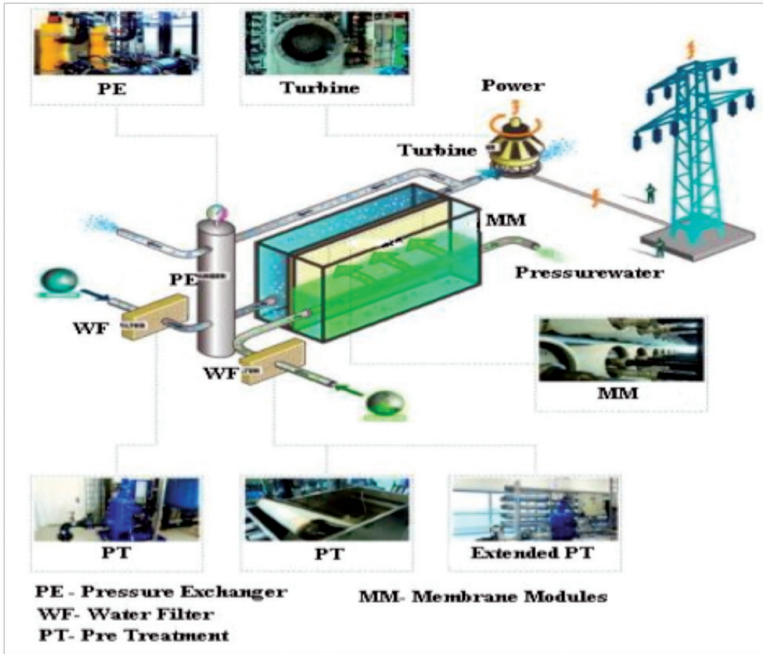

Figure 29 Osmotic power prototype- working procedure

4. The pressure exchanger transfers the increased pressure from the salty outflow of the osmosis membrane to the fresh-water diluted output so that it can drive a turbine.

Challenges of Osmotic Power Plant

The most challenging problem for the osmotic power generation is the design of an optimal membrane so that power density can be reached up to a maximum level. The Toft prototype consists of about 2,000 m² of membrane. A full-size 25 MW osmotic power plant would require 5 million m² of membrane. That would require a plant the size of a soccer stadium. Moreover, to achieve an output of 1 MW, 1 m³ of freshwater per second must be mixed with 2

m^3 of seawater at 12 bars. This means that a typical 25 MW plant would need 25 m^3 of freshwater and 50 m^3 of seawater per second. There are other problems such as the removal of seaweeds and lime sediments. But this can be overcome by regular cleansing of the membrane. Besides these, there are other technical obstacles which Statkraft intends to solve quickly. This is because the company plans to market commercially-built osmotic power plant 2015 enormously. To date the maximum power of a prototype osmotic plant has not exceeded 5 kW. This is not much but its emergence will make it possible to acquire the needed experience, detect emerging problems and optimize the whole process. The world's first osmotic power plant in Norway is shown in Figure 30 [Statkraft, 2009].



Figure 30 World's first osmotic power plant – Norway opened on 24 Nov 2009. Statkraft hopes to go all out commercially by the year 2015

Biomass Power

The familiar and generally understandable forms of RE to many people are wind and solar energy. Biomass on the other hand (plant material and animal waste) is another strong source of RE. According to a statement by EIA, till 2007, biomass supplied the highest percentage of renewable electricity [EIA, 2008].

Production Cycle and Environmental Effect

The use of biomass can be considered part of the terrestrial carbon cycle—the balanced cycling of carbon from the atmosphere into plants and then into soils and the atmosphere during plant decay. When bio-power is developed properly, emissions of biomass carbon are taken up or recycled by subsequent plant growth within a relatively short time, resulting in low net carbon emissions and yields huge electricity production as well. The biomass power production cycle is shown in Figure 31.

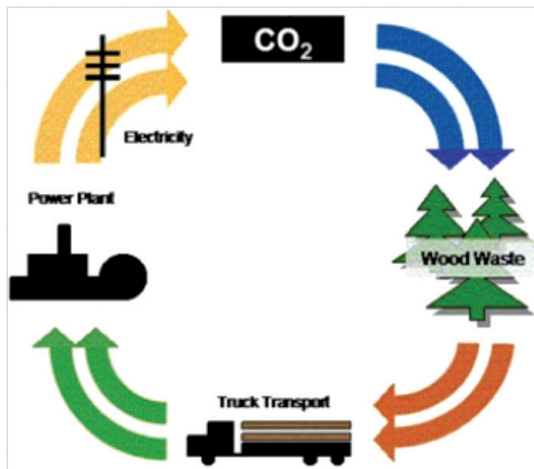

Figure 31 Biomass power production cycle

Sustainable, low-carbon biomass can provide a significant fraction of the new RE. But like all our energy sources, bio-power has environmental risks that need to be mitigated. Emissions of heat-trapping gases like CO₂ must be reduced to a level to save the environment. These emissions vary depending upon the precise fuel and technology used. Some of the technologies are hybrid of conversion and generation technology [M. Loeser *et al.*, 2008], and co-generative system [Z. Husain *et al.*, 2003] *etc.* If wood is the primary biomass resource, very little SO₂ comes out of the stack. NO_x emissions vary significantly among combustion facilities depending on their design and controls. Some biomass power plants show a relatively high NO_x emission rate per kilowatt hour generated if compared to other combustion technologies. CO is also emitted and the levels higher than those for coal plants intermittently. If not managed carefully, biomass for energy can be harvested at unsustainable rates, damage ecosystems, produce harmful air pollution, consume large amounts of water, and produce net greenhouse emissions. NREL and Oak Ridge National Laboratory compared air emissions from different biomass, coal and natural gas power plants with pollution control equipment [B. Richard *et al.*, 2003]. According to the comparison, biomass FBC boilers, have lower emissions than biomass systems with stoker boilers. Biomass systems using stoker boilers emit less SO₂ than coal and natural gas units and less NO_x than stoker boilers combusting coal and reciprocating engines burning natural gas. Biomass systems with FBC boilers are even cleaner, with lower SO₂ and NO_x emissions than coal and natural gas combustion turbines.

Sources of Biomass

Among beneficial biomass resources, the most effective and sustainable resources vary from region to region and also depend on the efficiency of converting biomass to its final application. Energy crops, grasses, crop residues, manure, woody biomass, forest residues, forest treatments, thinned trees, short-rotation trees and urban wastes can be considered as biomass sources. Figure 32 unveils some sources of biomass from the environment.

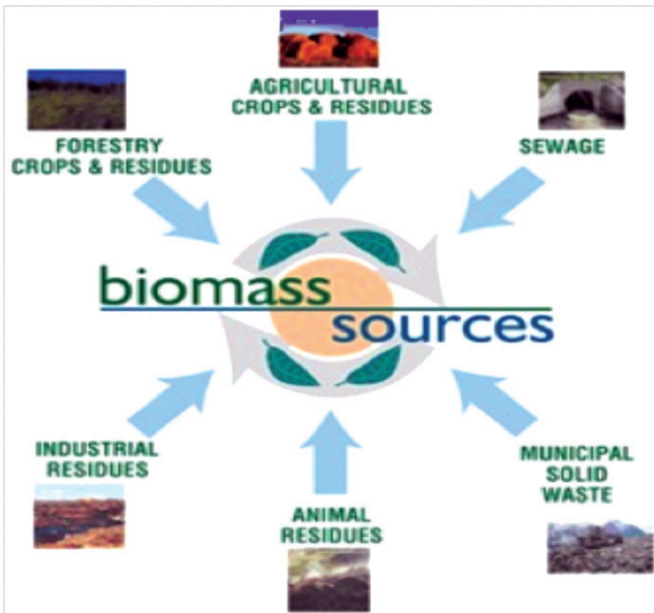

Figure 32 Sources of biomass – grasses, crops and forest residues, livestock and poultry manure etc.

World's Prodigious Biomass Power Plants- Supply and Production

A giant biomass power plant which is running exclusively on chicken manure has opened in the Netherlands (Figure 33). The power plant which costed €150 million, has been built to deliver renewable electricity to 90,000 households. It has a capacity of 36.5 MW, and will generate more than 270 million kWh of electricity per year. The biomass power plant utilizes approximately 440,000 tons of chicken manure, roughly one third of the total amount produced each year in the Netherlands. If the chicken manure were to be spread out over farm land, it would release not only CO₂, but also methane, a very potent greenhouse gas. Many European countries, including the Netherlands, suffer under an excess of different types of animal manure that pollute the environment. By using the manure for power generation, the release of methane is avoided [K. Mok, 2008].



Figure 33 The Netherland 36.5MW biomass power plant using chicken manure to power 90,000 Homes. The plant will convert one third of the country's total 1.2 million tons of poultry waste produced per year.

Besides these, Alholmens Kraft- Finland, launched on 1 Jan 2002 is another largest bio-fuelled power plant in the world. The power plant burns 1000 m³ of fuel per hour at full effect, with 45% of the fuel being bio-fuel. The electricity effect of the power plant is 265 MW [AK Power Plant, 2011]. Alholmens Kraft employs 400 people, 50 for running the plant and 350 for fuel production and handling. The fuels are wood, sawing and forest residues, peat and coal or oil which is the source of pulp and paper mill, sawmills within short distance and forestry sector, production sites close to the plant and imported respectively. Figure 34 presents forest fuel collection procedure of Alholmens Kraft power plant.

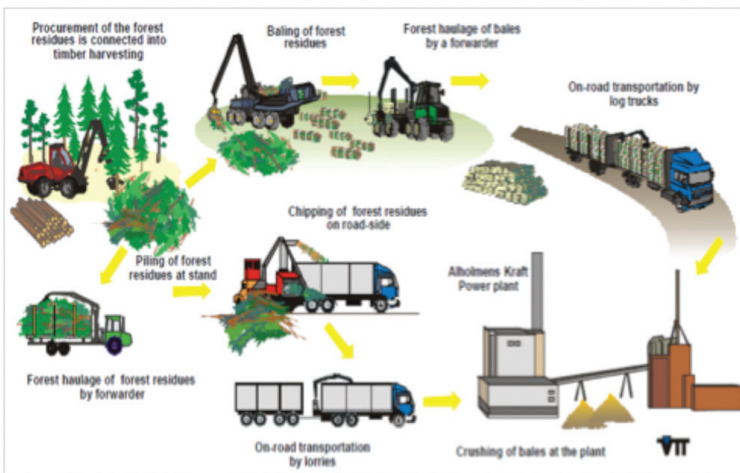

Figure 34 Forest fuel supply chain from forest to the plant, Alholmens Kraft- Finland [source: OPET Finland, VTT Energy]

The UK's Environment Agency has been working for a 350 MW enormous biomass power plant. The project was expected to cost £400 million (US\$643.72 million) in 2007. The power station, called the Prenergy plant, in Port Talbot, South Wales, uses wood chips that come from sustainable sources to produce enough electricity

to power 500,000 Welsh homes. Moreover, this plant is expected to produce electricity with 50 -80% less CO₂ emissions than gas or coal fired power stations [L. Sibley, 2011].

Municipal Solid Waste (MSW)

Municipal waste such as industrial waste, agricultural waste, and sewage sludge can be used as a source of RE from the controlled combustion in order to produce electricity. Currently there are 86 Waste to Energy (WTE) facilities in the US that process 29 million tons of MSW annually and generate 2.3 GW of electricity [ASME, 2011].

Technology: Waste Disposal as a Renewable

A variety of technological options are available for setting up WTE projects. Some of them are Anaerobic Digestion or Biomethanation, Combustion or Incineration, Pyrolysis or Gasification, Landfill Gas Recovery, and Plasma Arc. Any given technology is more beneficial if both heat and electricity can be recovered concerning environmental factors. Choice of technology needs to reflect local circumstances, which vary, but environmentalists expect greenhouse gas emissions to be a key consideration of those developing waste to energy plants. Worldwide landfill method is famous for its low cost but it has serious side effects. These are serious local air and water pollution, release methane etc. New Landfill technology is using the methane gas as an energy source and therefore, emission can be reduced by the application of this. Under the thermal processing, incineration is increasingly being banned in OECD countries due to environmental impacts, such as toxic emissions, and the poor or zero energy recovery from wasted resources. However, pyrolysis and gasification processes are considered partly renewable as wastage is converted into synthesis gas.

Under the bio-chemical process, the digestion of waste is done by the action of bacteria (or enzymes) into simple molecules, either aerobically (with oxygen) or anaerobically (without oxygen). Aerobic digestion produces CO₂ and water, whereas anaerobic digestion produces methane and water, and also some CO₂ and hydrogen sulphide. The gas produced by anaerobic digestion can therefore be combusted and used, either to produce electricity or heat, thereby converting the methane gas to CO₂ (with a lower greenhouse effect). Recent research shows that anaerobic digestion has significant carbon and energy benefits over other options for managing food waste [DEFRA, 2007] [L. Wagner, 2007].

Case Study: World's WTE Power Plants

Keppel Seghers Tuas, Singapore

Keppel Seghers Tuas WTE Plant is Singapore's first WTE plant under the Public-Private Partnership initiative (Figure 35). In early 2006, Keppel Integrated Engineering was awarded the contract to design, build, operate and own the plant for 25 years. The completed plant has the capacity to treat 800 tones of solid waste a day (approximately 47.6% the total volume of waste) to generate more than 20 MW of green energy, contributing to Singapore's electricity supply.



Figure 35 First WTE plant is Singapore under Public-Private Partnership initiative

Greater Manchester EFW CHP Plant, UK

The Greater Manchester Energy-from-Waste (EFW) plant is a waste management project to provide an integrated solution for the 1.3 million tonnes of municipal waste each year. The waste management project, when awarded in 2009, was the largest privatization project in the EU waste management and RE market. As the first of its kind in the UK on this scale, the project can divert more than 75% of Greater Manchester's waste away from landfill by focusing on sorting out waste for recyclable materials and Refuse-Derived Fuel (RDF). With the capacity to treat an additional 375,000 tonnes of RDF, the combined Phase 1 and Phase 2 of the plant will have a total capacity to treat 750,000 tonnes of RDF per year and generate, at full capacity, 70 MW of electricity and 51 MW of heat.

Ocean Wave Energy

Waves are caused by the wind blowing over the surface of the ocean. In many areas of the world, the wind blows with enough consistency and force to provide continuous waves. There is tremendous energy in the ocean waves. Wave power devices extract energy directly from the surface motion of ocean waves or from pressure fluctuations below the surface.

Wave power varies considerably in different parts of the world, and wave energy cannot be harnessed effectively everywhere. Wave-power rich areas of the world include the western coasts of Scotland, northern Canada, southern Africa, Australia, and the northwestern coasts of the US.

Ocean Wave Energy Technologies

A variety of technologies have been proposed to capture energy from waves. Some of the more promising designs are undergoing demonstration testing at commercial scales. The following wave technologies have been the target of recent development [Technology White Paper, 2006].

Permanent Magnet Linear Generator Buoys is an electric coil surrounds a magnetic shaft inside the buoy, and while coil is secured directly to the buoy (Figure 36), the magnetic shaft is anchored to the sea floor. When waves cause the coil to move up and down relative to the fixed magnetic shaft, voltage is induced and electricity is generated. Each buoy could potentially produce 250 kW of power, and the technology can be scaled up or down to suit a variety of energy needs. A lot of researches are going on with this technology [K. Rhinefrank *et al.*, 2006].

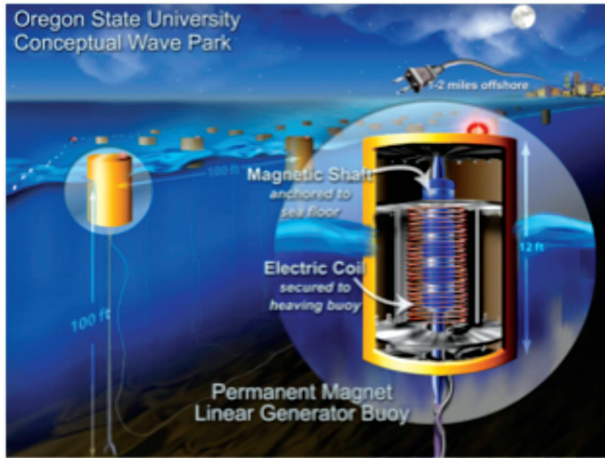

Figure 36 Rendition of a wave farm made up of permanent magnet linear generator buoys [Source: Oregon State University]

A **point absorber** is a floating structure with components that move relatively to each other due to wave action. The relative motion is used to drive electromechanical or hydraulic energy converters. Figure 37 portrays a point absorber.

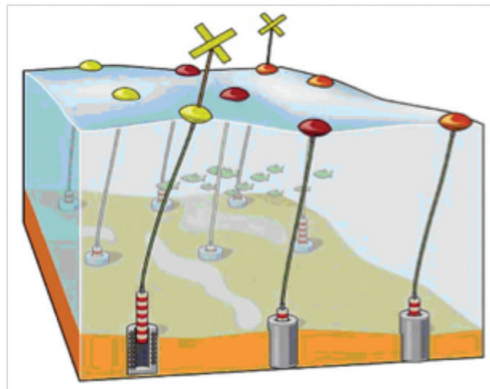

Figure 37 Point absorber wave energy farm [Source: Minerals management service]

Attenuators are long multi-segment floating structures oriented parallel to the direction of the waves. The differing heights of waves along the length of the device cause flexing where the segments connect, and this flexing is connected to hydraulic pumps or other converters (Figure 38).



Figure 38 Attenuator wave energy device
[Source: Ocean Power Delivery Ltd.]

Overtopping devices have reservoirs that are filled by incoming waves to levels above the average surrounding ocean. The water is then released, and gravity causes it to fall back toward the ocean surface. The energy of the falling water is used to turn hydro turbines. Specially built seagoing vessels can also capture the energy of offshore waves. These floating platforms create electricity by funneling waves through internal turbines and then back into the sea (Figure 39).



Figure 39 Wave dragon prototype overtopping device

Atmospheric Electricity

It is well known that large quantities of electrical energy are present in the atmosphere and in lightning. A lightning discharge contains in the order of 10^{10} J of energy. It has been estimated that the total electrical power of lightning across the earth is of the order of 10^{12} W. In the 19th and early 20th centuries, a large number of researchers investigated ways to extract electrical power from the Earth's ambient electric field.

Research on Harnessing Atmospheric Electricity

A high voltage electric field exists between earth and its ionosphere. The magnitude of this field is highly dependent on time and space. The electric field between the earth and the ionosphere may be as high as 500 kV. A fair weather convection current of 1-18 pA/m² continuously flows toward the earth. The magnitude of this current

depends upon atmospheric conditions such as humidity. To maintain this atmospheric charge, the capacitor between the earth and the upper atmosphere is continuously charged by natural activities.

Researchers at Brazil's University of Campinas are finding a way to harness electricity from the atmosphere. The study holds the potential to convert electricity from the atmosphere into an alternative energy source for the future. The team called this new clean energy source "hygroelectricity," which means humidity electricity. They performed a lab experiment that showed that tiny particles of silica and aluminum phosphate became negatively and positively charged when circulated in highly humid air. The team claimed that water in the atmosphere is capable of accumulating electrical charges and transferring them to other materials that are in its contact. They came up with the idea of collectors that gather energy from humid air. These collectors will not only capture atmospheric electricity, but will also prevent lightning strikes [A. Justa, 2010].

Meridian International Research carried out theoretical research into conversion of atmospheric electricity into useable electrical power. From a low level (5m high) simple zinc antenna are able to obtain sufficient charge to light a number of white power LEDs. Under this program, further experimental investigations with metallic aerostat collectors and cavity resonant slow wave antennae concepts are ongoing [MIR, 2005].

Design of distributed feedback laser are proposed by researchers from Universiti Putra Malaysia to conduct experimental evidence of proposed theoretical model of producing an extremely small bore conducting air wire from ground to upper atmosphere to collect the static charges on electrified clouds. Analysis of the existing charge storing devices showed that electrochemical capacitors, so called supercapacitors, are much more attractive than the ordinary

capacitors or storage batteries. The project also attempts to develop a new model that considers the disadvantage of laser-induced opaqueness and limitations of low electron density in ionized air to create a well-sustained controllable conducting wire. The plasma filament is able to provide an electrically conducting path from ground to air to collect stray charges from electrified clouds during rains or ionosphere in clear sky weather to develop a ground-based lightning power plant (Figure 40).

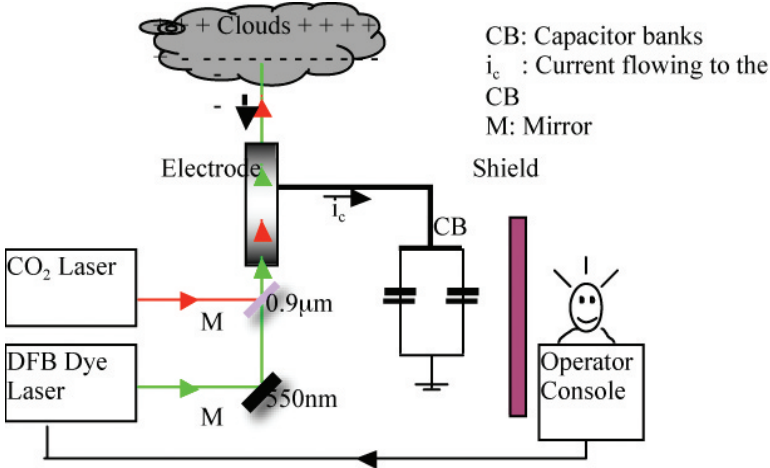

Figure 40 Proposed layout of laser-triggered lightning energy storage [K. Nasrullah *et al.*, 2000]

The theoretical modeling and previous experimental results done by other scientists also showed that the possibility of laser-induced lightning hence the charge accumulation and key installations protection is not an impossible project. Further theoretical and experimental works on the right wavelength, appropriate pulse duration and peak pulse energy are needed [K. Nasrullah *et al.*, 2000].

NUCLEAR ENERGY (NE)

NE is produced when changes occur in the nuclei of atoms structure through nuclear reaction. The NE is deployed to the power plant, which is called NPP, to turn generators for the production of electricity. The difference between NPP and other power plants is that NPP does not burn anything, instead it uses uranium fuel. This power plant obtains the heat needed to produce steam through a physical process. This process is called fission which entails the splitting of uranium atoms through a chain reaction.

NE- Understanding some Parameters

Nuclear Fission

In Nuclear Fission, the nuclei of atoms are split, causing energy to be released. The atomic bomb and nuclear reactors work by fission. One of the radioactive elements, uranium is the main fuel used to undergo nuclear fission to produce energy since it has many favorable properties. Uranium nuclei can be easily split by shooting neutrons at them. The fission fragmentation is shown in Figure 41.

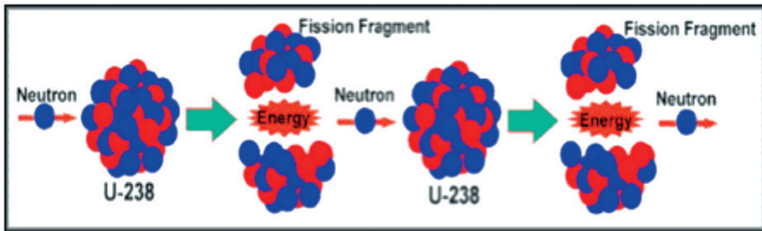

Figure 41 Fission of Uranium 235 (${}_{235}\text{U}$) nucleus

Nuclear Chain Reaction

A nuclear chain reaction is a series of several nuclear reactions. The radioactive elements are involved in the reaction. The radioactive

element of nucleus splits into two lighter nuclei and releases several neutrons and photons along the way to the reaction. The repetitive nature of this process is known as nuclear chain reaction [NCR, 2011].

Nature of Uranium Fission

Nuclear fuel consists of two types of uranium isotopes such as ${}_{238}\text{U}$ and ${}_{235}\text{U}$. ${}_{235}\text{U}$ is fissile, while another isotope ${}_{238}\text{U}$ is not fissile. When a stray neutron strikes a ${}_{235}\text{U}$ nucleus, it is at first absorbed into to create ${}_{236}\text{U}$. ${}_{236}\text{U}$ is unstable and this causes the atom to become fission. Equation (1) and (2) are examples when ${}_{235}\text{U}$ fissions:

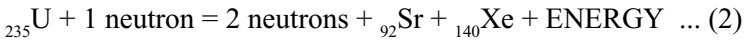
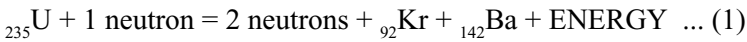

The whole nuclear reaction process is shown in Figure 42.

Thorium as a Nuclear Fuel

As of late, thorium has also been utilized as a fuel for CANDU reactors or in reactors specially designed for this purpose. Neutron efficient reactors, such as CANDU (Canada Deuterium Uranium), are capable of operating on a thorium fuel cycle, once they are started using a fissile material such as ${}_{235}\text{U}$ or Plutonium (${}_{239}\text{Pu}$). Then Thorium (${}_{232}\text{Th}$) atom captures a neutron in the reactor to become fissile ${}_{233}\text{U}$, which continues the reaction. Some advanced reactor designs have been able to make use of thorium on a substantial scale.

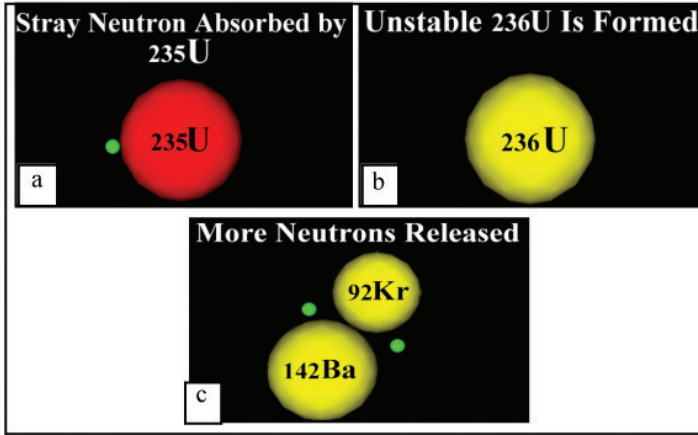

Figure 42 Nuclear reaction of a Uranium isotope (^{235}U). (a)- ^{235}U absorbs a neutron; (b)- Unstable ^{236}U and (c)- products Krypton (Kr), Barium (Ba) and neutrons (green circles)

How NPP Works

The overall working procedure is shown in Figure 43. First, uranium fuel is loaded up into the reactor—a giant concrete dome that is reinforced in case it explodes. In the heart of the reactor (the core), atoms split apart and release heat energy, producing neutrons and splitting other atoms in a chain reaction.

Control rods made of materials such as cadmium and boron can be raised or lowered into the reactor to soak up neutrons and slow down or speed up the chain reaction.

Water or CO_2 is pumped through the reactor to collect the heat energy that the chain reaction produces. It constantly flows around a closed loop linking the reactor with a heat exchanger.

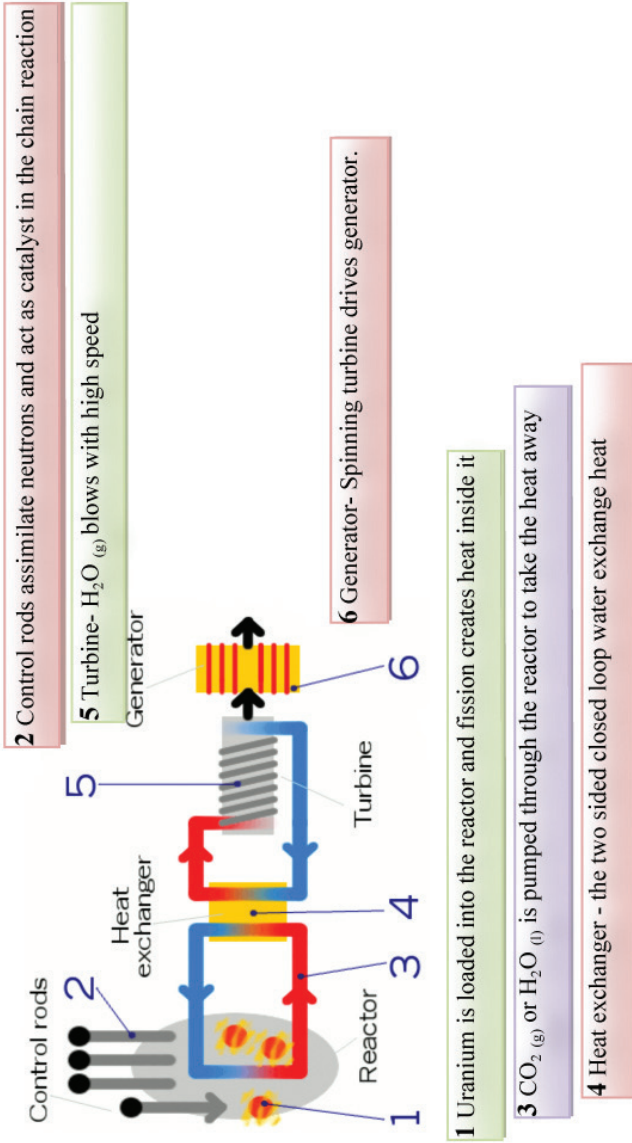

Figure 43 Working Procedure of NPP

Inside the heat exchanger, the water from the reactor gives up its energy to cooler water flowing in another closed loop, turning it into steam. Using two unconnected loops of water and the heat exchanger helps to keep water contaminated with radioactivity safely contained in one place and well away from most of the equipment in the plant. The steam from the heat exchanger is piped to a turbine. As the steam blows past the turbine's vanes, they spin around at high speed. The spinning turbine is connected to an electricity generator and makes that spin too. The generator produces electricity that flows out to the power grid-and to our homes, shops, offices, and factories.

Types of Nuclear Reactors

A nuclear reactor is a system that contains and controls sustained nuclear chain reactions. Different types of nuclear reactors are currently in operation throughout the world. Some widely used types are described here.

Pressurized Water Reactor

Pressurized Water Reactor (PWR) is one of the most common types of nuclear reactor deployed to date (about two-third of nuclear reactors in the US is PWR). Ordinary water is used as both neutron moderators and coolant. In a PWR, water is used as moderator and primary coolant. In order to convert produced heat by the nuclear reaction into electricity, water is contained at pressures 150 times greater than atmospheric pressure [US NRC, 2010]. There are a number of innovative proposals of using light water for coolant for the Generation IV nuclear systems which are described in [B. Vogta *et al.*, 2010] [K. Obaidurrahman *et al.*, 2011]. A worker working in a pressurizer of PWR is shown in Figure 44.

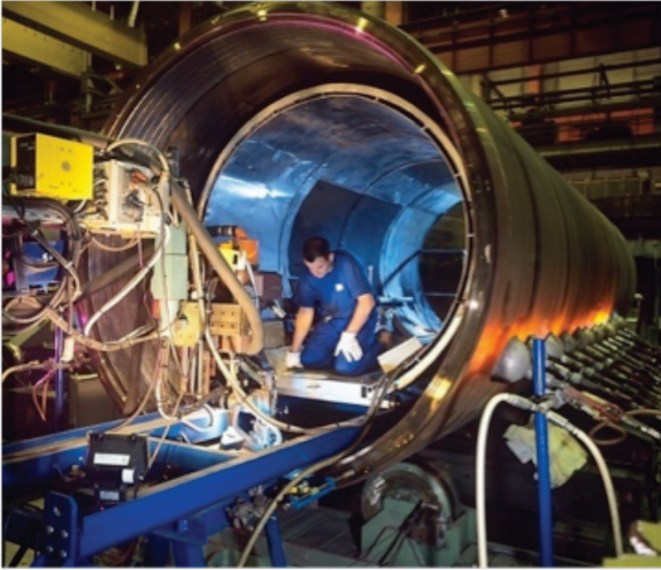

Figure 44 NPP Construction- *A worker, making a visual check inside a pressurizer, being built for a NPP. A pressurizer is a structure used in a PWR to maintain the pressure of water in the primary water circuit. This water circulates from the nuclear reactor to a set of steam generators. The water in the primary circuit is pressurized to prevent it from boiling.*

High Temperature Gas Cooled Reactor

High Temperature Gas Cooled Reactor (HTGCR) operates at significantly higher temperatures than PWRs and uses gas as the primary coolant. The fuel element in a modular HTGCR is crucial for safe and reliably operation. Therefore it has been more than 40 years significant progress in layer, coating materials and particles of HTGCR [C. Tang *et al.*, 2002]. These reactors can achieve significantly higher efficiencies than PWRs but the power output per reactor is limited by the less efficient cooling power of gas. However, one of the cons is that materials that can stay structurally

sound in high temperatures and with many neutrons flying through them are hard to come by.

Besides these common types of reactors, researchers especially from the Nuclear Regulatory Commission (NRC) and the US DOE researchers are involved in designing advanced nuclear reactors. Some of the advanced types are NuScale, Pebble Bed Modular Reactor, and Hyperion etc for the Generation IV nuclear systems [US NRC, 2011].

Reactor Fuel Requirements

The world's power reactors, with combined capacity of some 375 GWe, require about 68,000 tones of uranium from mines or elsewhere each year. While this capacity is being run more productively, with higher capacity factors and reactor power levels, the uranium fuel requirement is increasing, but not necessarily at the same rate. The factors increasing fuel demand are offset by a trend for higher burn-up of fuel and other efficiencies, so demand is steady. According to the statistics from 1980 to 2008, the electricity generated by nuclear power increased 3.6-fold while uranium used increased by a factor of only 2.5.

Today's reactor fuel requirements are met from primary supply (direct mine output - 78% in 2009) and secondary sources: commercial stockpiles, nuclear weapons stockpiles, recycled plutonium and uranium from reprocessing used fuel, and some from re-enrichment of depleted uranium tails.

Abundant Supplies of Uranium

OECD and IAEA in 2010 jointly produced a report on uranium resources: "Uranium 2009: Resources, Production and Demand." As said by the report, there are currently 441 nuclear power reactors

operating in 30 countries. These 441 reactors, with combined capacity of over 376 GW, require 69,000 tones of uranium oxide (U_3O_8). At present consumption levels, uranium resources are adequate to meet NE needs for at least the next 100 years. However, there are 59 power reactors currently being constructed. Overall there are 493 new power reactors planned or proposed with 84 new reactors scheduled to be commissioned by 2017. The world nuclear capacity is projected to grow between 500 and 785 GWe net by 2035. Accordingly, world reactor-related uranium requirements are also projected to rise. Retrospective study states that increased investment in exploration has resulted in important discoveries and the identification of new resources [R. Mills, 2011] [A. Patchimpattapong, 2010].

In addition, current projections of uranium mine production capacities could satisfy projected high-case world uranium requirements until the late 2020s. Thus the deployment of modern reactor to the nuclear industry is positively considerable because it can be anticipated from the demand and supply status that it has long term availability of uranium and could conceivably extend it to thousands of years. Table 9 gives some ideas of our present knowledge of uranium resources. It shows that Australia has a substantial part (about 31%) of the world's uranium, Kazakhstan is 12%, and Canada is 9% [Uranium, 2010].

Table 9 List of some countries possess resources of Uranium (2009)
[Uranium, 2010]

Country	Tones U	World%	Country	Tones U	World%
Australia	1,673,000	31%	India	80,000	1.5%
Kazakhstan	651,000	12%	Brazil	279,000	5%
Canada	485,000	9%	USA	207,000	4%
Russia	480,000	9%	China	171,000	3%
South Africa	295,000	5%	Uzbekistan	111,000	2%
Namibia	284,000	5%	Others	688,000	13%
World Total			5,404,000		

Uranium Production in the US in 2010

According to the report by EIA, the US production of uranium in the fourth quarter of 2010 was 1,153,104 pounds U_3O_8 , up 0.2 % from the previous quarter and up 30 % from the fourth quarter of 2009. So, preliminary the US uranium production total 4,235,015 pounds U_3O_8 in 2010. This amount is 14% higher than the 3,708,358 pounds produced in 2009 [US EIA, 2011].

Challenges of NPP

The Earth has limited supplies of coal and oil. NPP could still produce electricity after coal and oil become scarce. Coal and natural gas plants emit CO_x, NO_x and SO_x emissions and natural gas needs an incredible amount of investment in pipelines and supporting infrastructure. One of the instances is- the overall cost for Nord Stream gas pipeline project from Russia to Western Europe under the Baltic Sea which is estimated at 7.4 billion Euros [BBC news, 2010]. Hence, many countries have started to think about the future of their fuel plan regarding the replacement of fossil fuels

by nuclear generation both for transportation and everyday usage. However, successful implementation, proper utilization and working toward energy independence are likely to have an increasingly significant role in the global energy plan.

Nuclear Wastage and Disposal Technology

Transuranic elements (TRU) and Fission Fragments (FF) are the two main components of nuclear waste, representing respectively 1.1% and 4% of spent nuclear fuel. TRU, which are produced by neutron capture in the fuel eventually followed by decay, can only be destroyed by fission, while FF can only be destroyed by neutron capture. The FF and the leftover of plutonium and uranium remain within the spent fuel in which they are when removed from the reactor they are extremely hot and very radioactive. It is too dangerous to handle and thus it is very important to shield the radioactivity from humans and the environment.

There are mainly three kinds of radioactive waste that have been considered. These are Low-level waste, Waste incidental to reprocessing and High-level waste. Low-level waste- radioactively contaminated clothing, tools, filters, rags, medical tubes, etc. Waste incidental to reprocessing- byproducts of from reprocessing spent nuclear fuel. High-level waste - irradiated or used nuclear reactor fuel, takes up to million years to decay. Another type is *Uranium mill tailings*- residues remaining after the processing of natural ore to extract uranium and thorium.

In EU, the total number of NPPs is 143; therefore the wastage scenario is also noticeably high in EU countries. Figure 45 shows the statistics of NPPs, vitrified and spent fuel storage facilities in EU. Referring to Figure 45, interim storage is defined as spent fuel storage between the time spent fuel leaves a reactor and the time it is disposed of. On the other hand, vitrification is one of the

storage methods where nuclear waste is dissolved in molten glass, then poured into steel canisters, which are buried. The glass later solidifies, trapping the toxic waste.

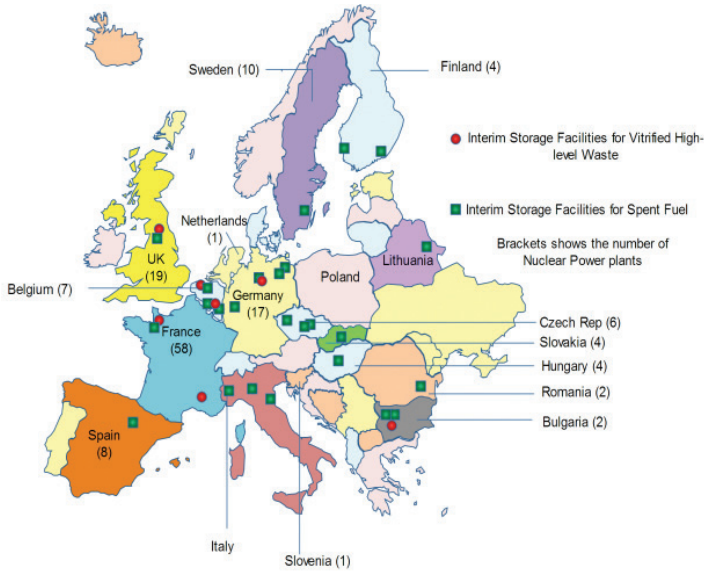

Figure 45 Nuclear wastage storage scenarios in EU with the number of NPP (in bracket); Fourteen of the EU's 27 member states have NPPs where France has 58, the largest number. Total number in use in the EU is 143 [Source: BBC online news on 3 Nov 2010]

There are a number of programs that have seriously mishandled the issue of waste from NPP. The British decision to reprocess spent-fuel appeared to have been both an environmental and financial mistake. The nuclear weapons program at the Hanford site in Eastern Washington State, US, created an enormous environmental impact that has so far costed US\$5.7 billion to clean up. There are some other new options for disposal of long-lived waste which is to burn the waste via either with 'Accelerator Driven Systems' or

within ‘Fourth Generation’ reactors. However these technologies are not yet mature. There are also proposals to use a ‘Fusion-Fission Hybrid’ for waste-disposal. These devices use the powerful neutrons from Deuterium-Tritium plasma to drive nuclear transmutation. In EU, Finland plans to have a long-term waste repository operational in 2020 (Figure 46), Sweden in 2023 and France in 2025.



Figure 46 The world’s first permanent storage site for highly radioactive nuclear waste is set to open in Finland in 2020. After the site is full, the door will be sealed and, eventually, left unmarked.

Nuclear Security

Protection of NPP from land-based assaults, conscious aircraft crashes, and other terrorist threats has been a heightened national priority since the attacks of September 11, 2001. According to [M. Kinnunena *et al.*, 2007], threats can be two types- international and internal albeit internal threats depend on a country’s situation. Some of the cases, an internal threat could be easier to deal with than an

external or international threat; even though these problems may not be solvable in the short term.

The NRC has strengthened its regulations on nuclear reactor security, but critics contend that implementation by the industry has been too slow and that further measures are needed. After the terrorist attacks of 11 Sep 2001, the NRC renovated substantial security enhancements at all NPPs. A taped interview shown September 10, 2002, on Arab TV station al-Jazeera, which contained a statement that Al Qaeda initially planned to include a NPP in its year 2001's attack sites, intensified concern about aircraft crashes.

On the other hand, NPP security requirements are predicated on the need to protect the public from the possibility of exposure to radioactive releases caused by acts of sabotage, including cyber attacks. Intelligence information and incidents around the world are analyzed to ensure that plant protection regulations are updated to reflect potential threats. Furthermore, safety is also important for the workers of NPP. Radiation doses are controlled through – control and monitor equipment in the reactor by remote radiation tolerant autonomous system [A. Giraud *et al.*, 2010], physical shielding, maintain time schedule for a worker in significant radiation level area etc.

Natural catastrophic issue has become another concern about nuclear radiation as disaster might hit NPP which cause the nuclear reactors to explode. These types of explosion cause more effect to the surroundings people. A very recent incident was happened to Fukushima power station in Japan when the country was affected by quake and tsunami. Water is penetrated from sea for cooling and generation of steam. Due to the broken water supply in Fukushima NPP (Figure 47), the steam generated huge pressures inside the reactor vessel and the largely metal core gets too hot and meltdown, with some components being torched. This severe problem should

be considered since the exclusion zone can be extended 20 km or more depending on the nature of explosion.



Figure 47 Explosion at Fukushima Daiichi NPP of 4 units, Japan was hit by devastating earthquake, on 12 Mar 2011 at 0630 GMT [source: BBC online, 13 Mar 2011].

Finally, it is a fruitful idea to train up the nuclear experts in reporting illicit nuclear trafficking, evaluating nuclear security, reducing risk, as well as improving security to protect people, property and the environment from security events involving nuclear or other radioactive materials.

Cost of NPP

Construction costs are very difficult to quantify for the cost analysis of NPP. This is particularly true for NPP because many uncertainties (such as exceed the scheduled cost because the duration of the construction period exceeds expectations, cost of local labor and government regulation) are related to this large-scale NPP implementation [S. Takizawa *et al.*, 2004].

The cost of constructing new NPPs in the US has become polemic and controversial. The nuclear industry generally reports construction costs of about \$2,000 per installed kW whereas the average cost of building a new AP-1000s in China is about \$1,200 per installed kW [B.K. Sovacool, 2008].

However, OECD revealed a case study in 2010 on projected costs of generating electricity. Table 10 shows the overnight capital cost per kW according to the statistics of OECD [OECD/ IEA NEA, 2010]. Here cost refers to operational, maintenance and fuel cost only. Indirect or capital cost is not included.

Table 10 Nuclear overnight (overnight cost is defined as owner's costs and contingency, but excluding interest during construction) capital costs

Country & NPP	Cost (US \$)
South Korea- APR-1400	1556/kW
Japan- ABWR	3009/kW
Gen III+ - USA	3382/kW
France- EPR at Flamanville	3860/kW
Switzerland- EPR	5863/kW
China- CPR-1000 & AP1000	1748/kW & 2302/kW
Russia for WER-1150	2933/kW

WAY FORWARD FOR MALAYSIA

Options for Malaysia in RE

Malaysia is blessed with vast renewable sources of energy, viz. biomass, biogas, solar, wind and mini-hydro. The potential of RE is enormous especially for biomass energy. These resources are not traded and mostly homegrown. The potential of mini-hydro projects especially the run-of-the-river types is also huge, as the energy available from the streams of rivers in the country has been proven to provide considerable contribution to the supply of electricity in the rural areas. Solar energy is another type of RE resource that is abundant and readily available as Malaysia is geographically located on the equator. In view of these potentials, Malaysian Government encourages greater use of these non-depleting and environmentally friendly energy sources. The Government policies on RE have been documented in the 8th and 9th Malaysia Plans (8MP and 9MP), and the ten-year Third Outline Perspective Plan.

Commercial interests can choose several options to achieve overall savings and expand opportunities that capitalize on RE resources. Here three options of biomass fuels in Malaysia have are described [MGTO, 2011]:

Option 1: Change from fossil fuels to cheaper biomass fuels

Most factories use oil-fired boilers. Changing to biomass fuels decreases the cost of steam generation and is cheaper by a factor of three. A typical system requiring 10 tons per hour has an initial investment of RM 2.3 million; whereas, savings from lower fuel costs are expected to be RM 300,000 per month. Thus, the recovery rate of investment is achieved within the first year.

Option 2: Connect existing co-generation plants at palm oil mills to grid

Most mills already produce both steam and electricity, but not enough of the latter to generate enough power for their own consumption. Connecting to the electric grid allows mills to produce more power without waste because excess energy is sold. With co-generation plants already in place, it's possible to reap RM 850,000 per annum after an investment of RM 1.5 million to connect to the grid (assuming close proximity). Hence, recouping costs in just two years.

Option 3: Take advantage of new biomass technologies in the wood processing industry

Replacing diesel generators with biomass boilers and steam turbines not only reduces energy costs, but also utilizes a steady supply of waste material. Comparative costs indicate that electricity produced by diesel is 2.5 times more than biomass.

According to Pusat Tenaga Malaysia (PTM), the total potential biomass-based generation capacity is 3660 MW where the total biomass based installed generation capacity is 700 MW. Figure 48 depicts that the potential of biomass generation is the highest in northern region of Peninsular Malaysia. On the other hand, the comparison scenario of RE potential and RE installation in Malaysia is tabulated in Table 11 [A.F. Hasan, 2010].

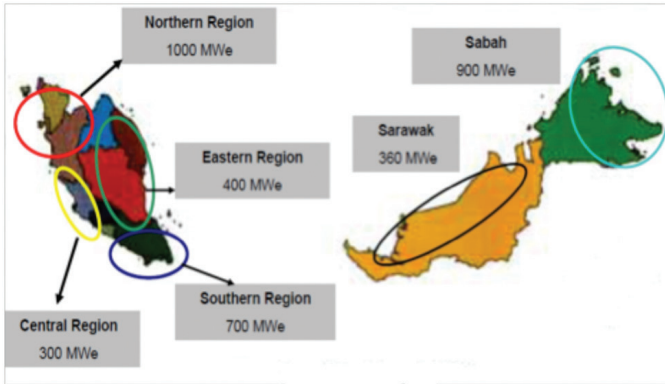

Figure 48 Potential of biomass resource map in Malaysia

Table 11 Scenario of Malaysia's RE Potential and Installation [A.F. Hasan, 2010]

RE Potential (MW)	RE Installation to 2008				
	Mini hydro	Bio gas & Bio mass	PV	Wind	Total
Hydropower: 22000MW					
Mini-hydro: 500 MW					
Biomass and biogas from palm oil mill waste: 400MW					
MSW: 400MW					
Solar PV: 6500 MW					
	Grid-connecte d (MW)				
	Off-grid (MW)				
	Total				

Rice Husk based Cogeneration Plant, Kedah

The biomass power plant which is fueled by rice husk in Kedah generates 470 kW of electricity used in the milling section. The plant displaces 641 tones of fuel oil and 2,868,750 kWh of grid electricity per year. The investment cost is RM2.9 million with a payback period of 4 years. Table 12 shows the savings cost of the power plant.

Table 12 Annual savings calculate from the biomass power plant, Kedah

Cost factor	Annual Savings
Electricity Supply	RM 240,000
Diesel oil or paddy drying	RM 140, 000
Rice husk disposal	RM 40,000

Small Renewable Energy Power Program (SREP)

In line with its commitment to intensify the development of RE as the Fifth Fuel, Government launched SREP program on 11 May 2001. The utilization of all types of RE sources including biomass, biogas, municipal wastes, solar, mini-hydro and wind are allowed in the SREP Program. To date TNB is in the process of finalizing negotiation to conclude 20 REPPAs totaling 150.67 MW with other SREP developers using biogas, biomass, mini hydro, MSW, landfill gas and solar as RE resources. Table 13 shows the status of SREP projects as per March 2010 [ST, 2011b] [TNB, 2010].

Solar Hybrid System – TNB-ES Projects

TNB-ES supports Government policy on RE to generate 200 MW power by implementing Demand Side Management (DSM) as part of an energy efficiency program. It also establishes wide applications of RE and alternative power supply solutions in the absence of grid supply. Besides that, TNB-ES involves rural electrification such as providing facilities providing facilities for 24 hours electricity supply to remote areas or islands that are not connected to the national grid. TNB-ES also has constructed more than 30 solar hybrid projects (more than 4 MW) in different places in Malaysia. Figure 49 shows some of the projects.

Table 13 Status of SREP projects, data on Mar 2010

Projects	Mini hydro		Biomass		Biogas	
	No of project	Capacity MW	No of project	Capacity MW	No of project	Capacity MW
Licensed Projects- operation and construction stage						
Licensed	6	17.8	9	79	3	4.95
Operational	3	8	5	45	2	3.7
Under Construction	2	7.3	1	5	1	1.25
Approved Projects- yet to be installed						
Approved	7	43.5	12	125	6	15.9
Under Construction	-	0	1	10	3	2.9
Total	13	61.3	21	204	9	20.85

Solar Hybrid Power System at the Middle and Top Stations of the Langkawi Cable Car, Pulau Langkawi, Kedah

A solar hybrid system was installed at the middle and top stations of cable car at Gunung Machinchang on 23 Oct 2002. It provides environment friendly solution to serve the electrical load for the cable car stations. Both top and middle stations were set up with 8 kW PV array system including 60kVA diesel generator, 250kWh (top station) and 269 kWh (middle station) battery (Figure 49c). Presently, the load at the middle station is about 60 kWh per day and the load at the top station is about 60 kWh per day and the load at the top station is about 40 kWh per day [B. Ali *et al.*, 2009].



Figure 49 Solar hybrid Projects by TNB-ES in Peninsular Malaysia. (a)- Wind/Solar Hybrid in Pulau Perhentian, Terengganu (Solar - 620 kW and Wind - 200 kW); (b) - Solar Hybrid Stations off Mersing, Johore (10 kW & 15 kW); (c) - Langkawi Cable Car, Langkawi (8 kW); (d) - Kampung Denai, Rompin, Pahang (10 kW)

Solar Hybrid Station at Kampung Denai, Rompin, Pahang

Another solar hybrid system is implemented at an aborigine's village Kampung Denai, Rompin, in Pahang to provide 24-hour electricity supply as an alternative to the village community. Its system configuration is such as PV array- 10kW, battery- 196kWh and diesel generator- 12.5kVA. Figure 49d depicts the Solar hybrid station at Pahang [TNB-ES, 2010] [B. Ali *et al.*, 2009].

Grid Connected PV Installation in Malaysia- The MBIPV Project

Grid Connected (GC) Building Integrated Photovoltaic (BIPV) generates electricity in Malaysia under the Malaysia Building Integrated Photovoltaic (MBIPV) project. The main objective of this project is to reduce electricity than the consumers' need to purchase from the utility and thus reduce electricity bills and operation costs of any commercial building-owner or individual home-owner. Since this is a GC low voltage distributed PV generated electricity, TNB has an approval of a "net-metering (kWh)" billing concept. This means PV generated electricity is valued at the same rate as user's electricity supplied by TNB. More elaborately, the amount of the PV generated electricity is deducted from the total electricity consumed by the user. Universiti Teknologi MARA, Malaysia was appointed and awarded a contract as a Photovoltaic Monitoring Centre by MBIPV team on 29 Nov 2006.

There are two types of PV feeding system that generated electricity to TNB. These Direct Feeding (DF) and Indirect Feeding (IF). In the DF system, the PV meter records the total electricity that is generated by the BIPV system and fed into the TNB network, while the TNB supply meter records the total electricity consumption of the customer. Figure 50 shows the DF configuration and Table 14 shows the billing system.

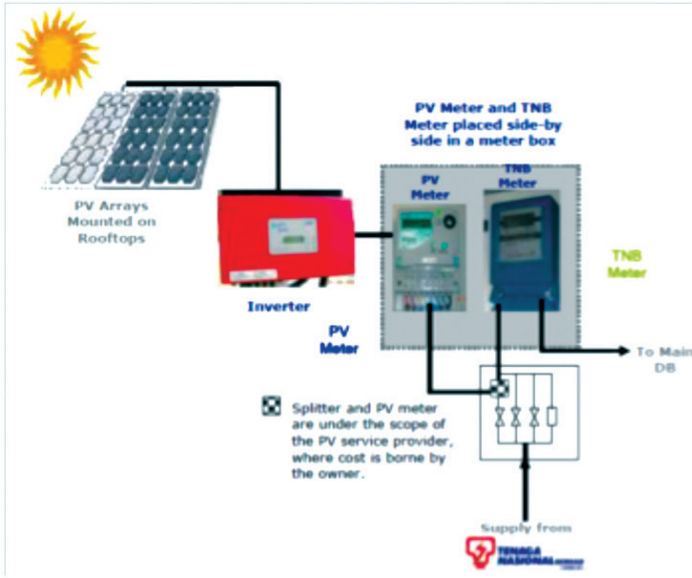

Figure 50 Configuration of DF Grid-Connected PV System

Table 14 Net-metering computation for DF

PV generation to TNB system (kWh)	TNB meter to consumer (kWh)	Consumer consumption (kWh)	Net-billing (kWh)
A	B	C	B-A
400	1500	1500	1100

In IF system, the PV meter still records the total electricity that is generated by the BIPV system and fed into the TNB network, but the TNB supply meter records both the electricity fed from the TNB system to the customers and the surplus electricity exported through the meter to the TNB grid. The IF configuration is shown in Figure 51 and the net-metering for billing system is shown in

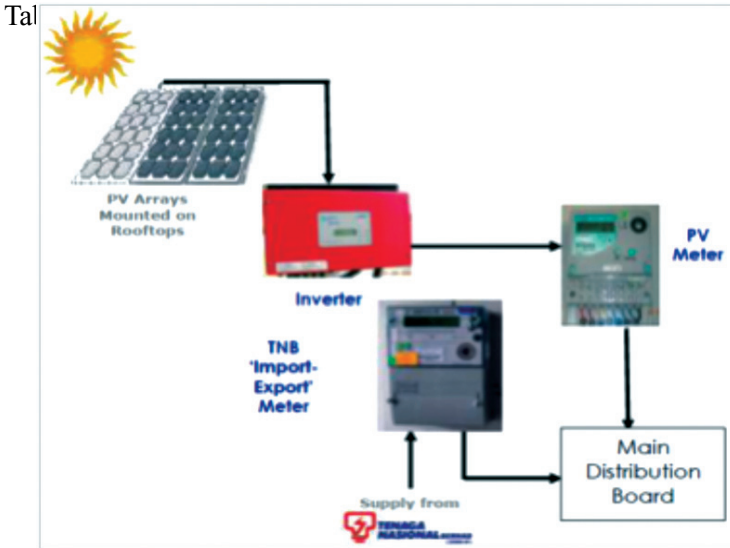

Figure 51 Configuration of IF Grid-Connected PV System

Table 15 Net-metering Computation for IF

PV generation (kWh)	PV generation export to TNB (kWh)	TNB meter to consumer (kWh)	Consumer consumption (kWh)	Net-billing (kWh)
A	E	B	C	B-E
400	200	1300	1500	1100

MBIPV has been creating awareness for distributed PV plants throughout Malaysia along with technical support in small scale household, school, hotels and industries. Figure 52 depicts some of the recent implemented running PV plants maintained by MBIPV [MBIPV, 2011].

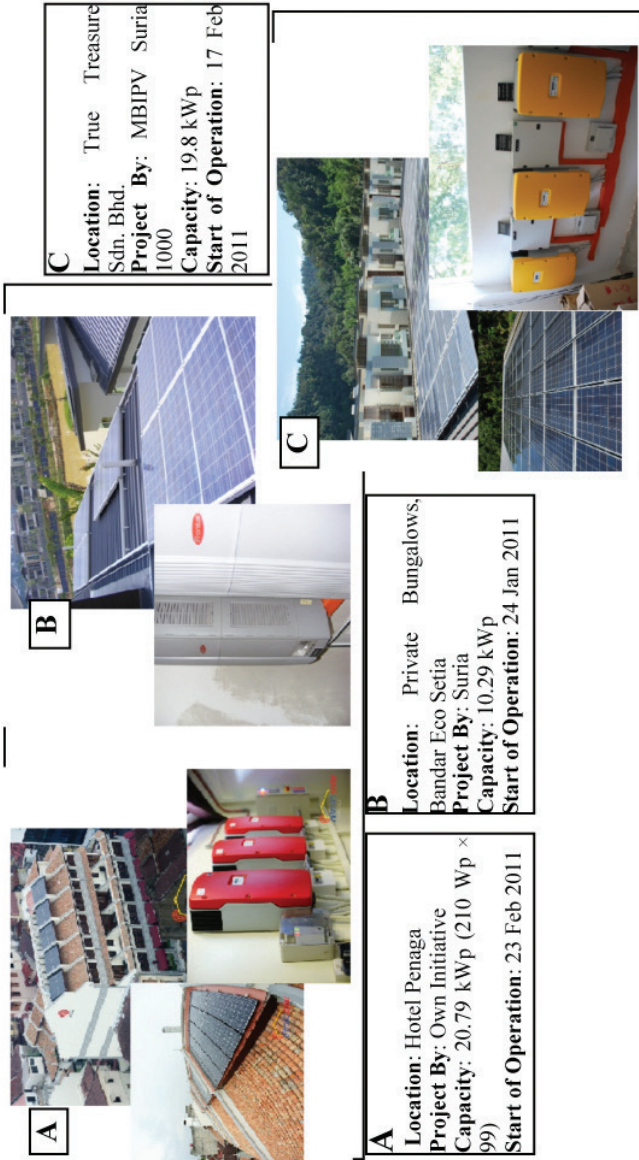

Figure 52 Distributed Low Voltage PV plants at various places in Malaysia under MBIPV Project [MBIPV, 2011]

Introduce Feed-in Tariff (FiT) for RE

FiT is Malaysia's new mechanism under the Renewable Policy and Action Plan to catalyze generation of RE, up to 30 MW in size. This mechanism allows electricity produced from indigenous RE resources (sourced from within the country and are not imported from neighboring countries) to be sold to power utilities at a fixed premium price for a specific duration. With the FiT, it will be easier for everyone, whether individual consumers or companies to generate RE and sell their excess power back to TNB or regional utility companies which would encourage more people to adopt RE sources. The government has planned various programs to promote the application and development of GT including the establishment of GT Financing Scheme amounting to RM1.5 billion. It is expected to implement FiT by mid 2011 [ST, 2011a]. Figure 53 illustrates FiT concept.

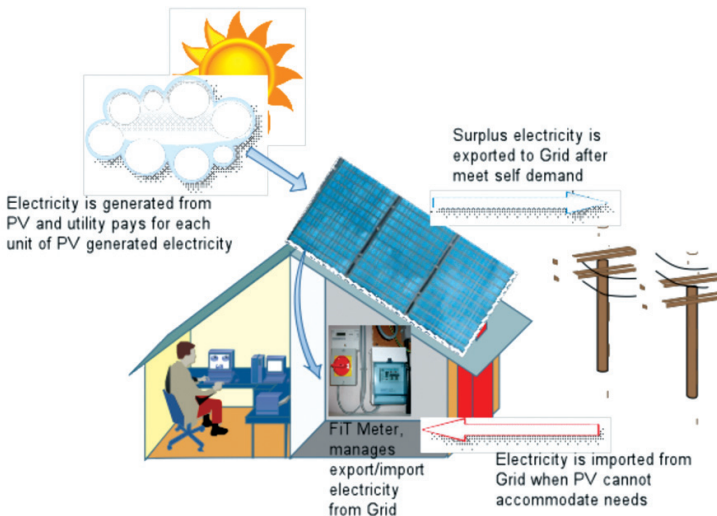

Figure 53 Concept of FiT

Prospect of Wind Energy in Malaysia

Geographically, Malaysia can be divided into West Malaysia and East Malaysia. The country also has only two seasons- southwest monsoon (May/June to Sept) and northeast monsoon (Nov to March). Malaysia's average wind speed is not satisfactory and it does not exceed 2 m/s. Instead wind speed in Malaysia depends on location and season. During southwest monsoon the wind speed is measured less than 7 m/s, however the speed could rev up 15 m/s during northeast monsoon in the east coast of Peninsular Malaysia. Experience of strong wind areas includes Mersing, Kota Baharu, and Kuala Terengganu under Peninsular Malaysia [C. Teh, 2011]. A research was conducted on wind speed in east coast Malaysia. The data stations for the measuring wind speed were Universiti of Malaya and University of Terengganu in 2005 and 2006. With reference to the statistical data, the mean wind speed was 2.8491 m/s and 2.8053 m/s in 2005 and 2006 respectively [A. Zaharim *et al.*, 2009].

TNB is in collaboration with Argentina's RE firm Industrias Metalurgicas Pescarmona S A. It is reported that 500 MW to 2000 MW worth of electricity could be generated from wind energy in Malaysia. The suitable areas are such as the Malaysian-Thailand border which sees wind speeds up to 15 m/s.

It is certainly an avenue for using wind energy in Malaysia, but it can only be used in limited areas and in particular period of year only. Coastal areas, especially in east Peninsular Malaysia and East Malaysia, including small islands could benefit from wind energy. Such an example is Perhentian Island in Terengganu, 200kW wind power project as shown in Figure 54. However, for the majority of Malaysia, the solution of large scale and uninterrupted RE lies elsewhere.



Figure 54 200 kW wind power plant in Perhentian Island in Terengganu

Possibilities of Energy from Solid Waste in Malaysia

Malaysia has a possibility of producing energy from MSW since an average of 2500 tones of MSW is collected every day for the city of Kuala Lumpur. Many researches indicate that it needs nearly 1500 tons of waste to generate 55 MW of electricity [A. H. Khan *et al.*, 2009] [S. Kathirvale *et al.*, 2004]. Organic food, mixed papers, plastic films, glass, leather and metallic stuffs are some of the residential and commercial wastage in Malaysia. The country needs proper recycling and disposal methods to be applied to achieve optimal energy and find beneficial method for the environment as well. Disposal technology is affected by many factors such as economy, geographical and geological conditions, the level of urbanization, waste disposal purposes and requirements, as well as the generated amount, composition, characteristics of garbage and so on [Z. Kun *et al.*, 2002]. Different methods are adopted in each

country. Sanitary landfill, Incineration, and Garbage composting (aerobic composting and anaerobic fermentation) are the most popular methods of WTE management system.

WTE Plant in Semenyih

At Malaysia's first WTE plant, MSW is converted into RDF for use in an integrated steam power plant. The RDF plant prepares the fuel, and the steam power plant. The facility has the capacity to process approximately 700 tons of MSW per day into RDF in fluff form and then use that fuel to produce approximately 8 MW of electricity daily. Electricity produced powers the RDF plant, and the remainder 5.5MW is sold to TNB. The plant is reducing 771,000 metric tones of CO₂ equivalence. Figure 55 shows the WTE plant in Malaysia [CDM, 2008].



Figure 55 WTE Plant in Semenyih, Malaysia; WTE receiving unit (a) and processing unit (b)

Possibilities NE in Malaysia

Electricity demand is expected to grow continuously at 3.2% annually from 15,072 MW in 2010 to 20,669 MW in 2020. In order to meet this demand growth, TNB is exploring the use of low carbon electricity generation technology such as NE technology to

meet Peninsular Malaysia's post-2020 base load demand. Currently, TNB is working closely with the Malaysian Nuclear Agency and the Atomic Energy Licensing Board to prepare the groundwork for potential NPP development in Malaysia. Under this GT policy development program, TNB Research Sdn Bhd signed an agreement with Korea Power Engineering Company Inc. on "Consultancy for Site Selection and Evaluation for Nuclear Power Plant in Peninsular Malaysia" in feasibility study workshop on 28 June 2010. The pivotal areas that would be focused are- public acceptance, regulatory requirements, safety and health considerations, technology identification and site selection. According to The Ministry of Energy, Green Technology and Water, NPP is expected to start operation by 2021 to meet the country's power demand. The ministry has already approved the economic council to look into identifying suitable sites for the first NPP [MEGTW, 2010].

Two Risk Management Forums are organized as a platform to communicate risk information to the appointed Risk Managers, Risk Coordinators and senior management across TNB Group. Topics discussed are governance and risk management in Malaysia emerging risks in view of the second destination in TNB's 20-year strategic plan as well as risks, challenges and issues involved in nuclear power production.

Why NPP in Malaysia?

One of commonly raised question is why does Peninsular Malaysia still need to install NPP despite having high reserve margin. At present, according to the TNB statistics, the peak demand stands at 15,072 MW, as recorded on 25 May 2010. This translates into reserve margin of approximately 40%. The reserve level is not here to stay. With annual load growth and retirement of existing capacity as they reach their economic life, the reserve margin will drop eventually.

We mentioned that electricity demand in Peninsular Malaysia is expected to grow at 3-5% annually from 2010 until 2020. In 2020, peak demand is forecasted at 20,669 MW while energy generation is projected to reach 138,510 GWh. In Peninsular Malaysia, there is no new plant scheduled for installation from now until 2015. Hence, with no added capacity from new plants, higher electricity demand and retirements of older plants, reserve margin is expected to reduce. In 2015, it would settle at approximately 20%. Figure 56 shows the decreasing trend of reserve margin due to increasing demand forecast (assuming no new load is introduced to the system) [TNB, 2011].

In December 2009, the Prime Minister of Malaysia made a commitment in Copenhagen, Denmark to reduce Malaysia's emissions by the year 2020 compared to the levels in 2005. This goal can be achieved by retiring the old fossil fuel plants and replacing them with new NPP since nuclear reaction does not emit CO₂ or other greenhouse gases that threaten the planet's climate. Parliament, senate, ministries and local government of Indonesia have expressed their support to establish NPP for massive electricity production to meet the needs [iStockAnalyst, 2011].

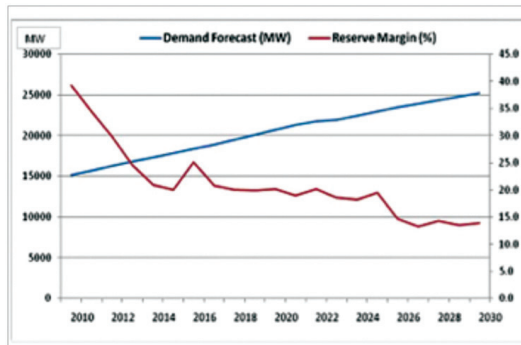

Figure 56 Electricity demand and reserve trend in Malaysia until year 2030

NE vs. RE

Currently, according to the TNB statement, minimum demand stands at approximately 10,000 MW. This minimum demand has to be satisfied by base load plants, which include coal and gas. This base load requirement would not be met by RE utilization as challenges remain in low capacity production. The status until end of Oct 2010, grid-connected RE in Malaysia is totaled 58.2 MW. More explicitly, it is 40 MW from biomass, 1.7 MW from biogas, 8 MW from mini-hydro, 7 MW from solid waste and 1.5 MW from solar PV.

Going worldwide, typical solar PV stations have capacities ranging from 10-60 MW with the biggest solar PV plant installed in Spain (60MW). On the other hand, typical NPP provide capacity between 600-1000MW per unit. This huge disparity of capacity makes RE unpalatable to work similarly as NPP in providing the base load requirements. RE is done in small scale and thus can only supplement to supplying the demand. Relying on RE alone is impossible.

There are other caveats with relying on RE alone. Solar and wind power is subjected to intermittency. Peninsular Malaysia is blessed with sunlight as it sits on equatorial region with an average radiation of 4500 kWh/m². Malaysia receives 4 to 6 hours of sunshine everyday. Based on these facts, solar PV development provides bright future.

However, besides highly capital intensive, another major drawback of solar power is a requirement of vast area to produce reasonable amount of electricity. The comparison depicted in Table 16, shows the need to produce NPP.

With regard to wind power in Peninsular Malaysia, there is limitation to untapped wind potentials. Several studies and research outputs have been referred in earlier section on viability of harnessing wind energy in several regions located in Peninsular Malaysia. From these studies, it can be concluded that wind

potentials are low in Peninsular Malaysia. In addition, wind energy also suffers intermittency which requires electrical compensation and storage.

Biomass, solid waste and biogas plants are among other RE sources that are rigorously being developed. To date, according to the TNB report, RE project with a total of 88 MW are signed under SREP. Out of this figure, 40.35 MW comes from biomass and biogas plants. The challenge remains with possible competition with other industries that use the same input sources. Furthermore, these sources are not completely clean technology since burning of input sources is involved to generate electricity. Table 16 presents comparison between NE and RE.

Table 16 Comparisons between NE and RE

- ☞ One 7 gram uranium fuel pellet has energy to electricity equivalent of 17,000 cubic feet of natural gas, 564 liters of oil or 1,780 pounds of coal
- ☞ Nuclear power's life-cycle emissions range from 2 to 59 gram-equivalents of CO₂ per kWh. Emissions from natural gas fired plants ranged from 389 to 511 grams. Coal produces 790 to 1,182 grams of CO₂ equivalents kW/hour.
- ☞ Operating a 1,000-MW coal plant, for one year, produces 30,000 truckloads of ash that contains large amounts of carcinogens and toxins.
- ☞ A 1,000-MW solar plant would cover 129 to 259 km² and use a thousand times the material needed to construct a NPP of the same capacity.
- ☞ To equal the output of South Korea's Yongwangs six one-thousand-MW nuclear reactors, wind generators would require a 245 km wide extending from San Francisco to Los Angeles. Solar would require roughly 52 km² of collector area.

Source: Uranium Report 2011 Richard (Rick) Mills Published 1/27/2011

ENERGY EFFICIENCY TECHNOLOGY

Energy Efficiency (EE) can be referred as reducing the energy used by specific end-use devices and systems, typically without affecting the services provided. In brief, the definition can be equated to - using less energy to provide the same or improved level of output. For example, replacing a single pane window in house with an energy-efficient one, prevents heat from escaping in the winter or keep the heat out in the summer. This saves energy by using less furnace or electrical heater or does not run the air conditioner often. Similarly, home appliances (e.g. refrigerator or washing machine) or office equipment (e.g. computer) with a more energy-efficient model, the new equipment provide the same service, but use less energy. A research study from Electrolux unveiled that if all households in EU changed their more than ten year old appliances into new ones, 20 billion kWh of electricity would be saved annually, hence CO₂ emissions will be reduced by almost 18 billion tons. [Electrolux, 2007]

EE is not energy conservation. Energy conservation is reducing or going without a service to save energy. For example, turning off a light is EC. Both EE and energy conservation save not only the energy bill but also reduce the amount of greenhouse gases emission.

EE Sectors

EE gains come from the following sectors. These are:

- technology enhancement
- improvements in systems and processes
- better information
- changing human behavior, and
- benefits from efficiency and conservation

In this section, we mainly discuss about technology enhancement.

Technology Enhancement

EE technology can be deployed mainly in appliances, home design, transportation, and RE. RE and EE are said to be *two peas in a pod* of sustainable energy policy. Here we focused on other EE technologies in the following.

Home Appliances and EE Lights

Modern energy efficient appliances, such as refrigerators, freezers, ovens, stoves, dishwashers, and washing machines and dryers, use significantly less energy than older appliances. Current energy efficient refrigerators, for example, use 40% less energy than conventional models. A research from PTM unveiled that a computer with CRT monitor and LCD monitor consume power 120-180W and 70-90W respectively, while the power consumption of a notebook or laptop is only 15-35W.

There are two types of EE light bulbs; Compact Fluorescent Lighting (CFL) and Light Emitting Diode (LED), while standard bulbs are either incandescent or halogen. CFL glass tubes contain gas, and are coated on the inside with a layer of phosphor. When electricity passes through gas, it emits ultraviolet rays which cause the phosphor coating to glow. This is more EE because most of the energy is turned into light instead of wasteful heat. A 15W (some more efficient CFL needs 3-13W) CFL emits the same light as a 60W incandescent bulb. Also a comparison scenario between CFL and incandescent bulb has been shown in Table 17 [CFL, 2011].

Table 17 Cost Comparisons between CFL and Incandescent
[CFL, 2011]

	27W CFL	100W Incandescent
Cost of lamps	US \$14.00	US \$0.50
Lamp life	1642.5 days	167 days
Annual energy cost	US \$5.91	US \$21.90
Lamps replaced in 4.5 years	0	10
Total cost	\$40.60	\$103.55
Savings over lamp life	\$62.95	0

LEDs are already used in electrical equipment and are several times more energy efficient. Now researchers from University of Glasgow introduced a new generation of LEDs into households that are brighter and use even less power than standard EE light-bulbs. The researchers used a technique called nano-imprint lithography to directly imprint the holes, imperceptible to the human eye, onto the LEDs [University of Glasgow, 2008]. Figure 57 presents GaN LEDs which illuminate a bridge with less energy consumption.



Figure 57 Bridge illuminated with white GaN LEDs; could cut the proportion of UK electricity used for lights from 20% - 5%.

(Source: *ScienceDaily*, 30 Jan 2009)

EE Building

EE should be considered regarding an investment for new home or remodelling of an existing home. By this, both energy and money are saved in the long run. EE house requires smart design architecture and components. A whole-house systems approach can help successful architectural strategy for incorporating EE in designing home. Some of the approaches are: advanced wall framing, roof technology, earth-sheltered home, passive solar home *etc.* Advanced house framing, also called optimum value engineering reduces the amount of lumber used and waste generated in the construction of a traditional wood-framed house. Home heating and cooling costs can be reduced through proper insulation and air sealing techniques. Earth-sheltered home provides a comfortable, tranquil, weather-resistant atmosphere especially as it is designed to allow plenty of natural lights and organic architecture in curving walls and ceilings for temperature control (Figure 58).



Figure 58 EE earth-sheltered home

Passive solar homes provide advantage of climatic conditions, because its windows, walls, and floors are made to collect, store, and distribute solar energy in the form of heat during winter and reject solar heat in the summer.

Sensor Technology

Sensor technology is a mission-critical solution, developed in conjunction with EE technology. It forms as the eyes, ears, and fingers of a complex control and information system that facilitates broad, pervasive, and continuous use of sensor data and intelligence, making buildings and cities more efficient and environmentally sensitive. For instance, two dim channels with directed light sensors measure the light levels in two different zones of the room. By automatic reading of actual light level and controlling switch (ON/OFF system), it can save up to 80% of energy potentials. Figure 59 presents an example of sensor light technology.

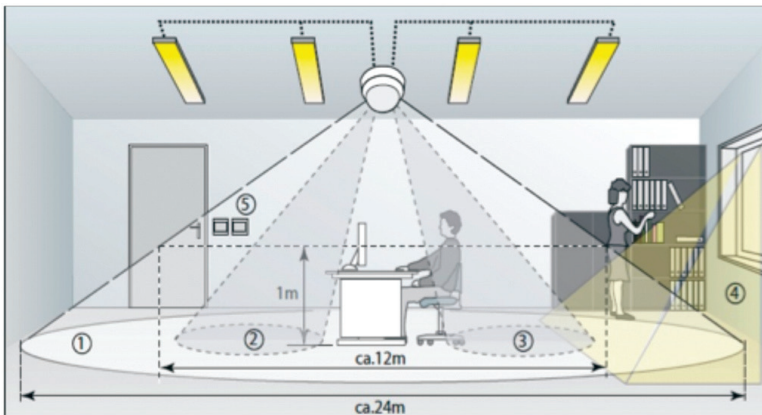

Figure 59 Example of duo dim sensor- the switching channels switch on the light if the occupancy detects the motion and the light level is insufficient; switch off the light if there is no more presence or sufficient light.

EE in Transportation Sector

Passenger vehicle technology is expected to remain dependent on petroleum fuels and internal combustion engines for the foreseeable future. Enhancement of internal combustion engines through clean diesels, hybrids and electric and new combustion techniques ensure increased efficiency. At the same time, alternative fuels increase steadily in penetration, with second generation bio-fuels such as synthetic biomass-to-liquid and synthetic gasto-liquid. Biomass-to-liquid is expected to grow significantly by 2035 and synthetic gasto-liquid is already expected to grow strongly in the coming decade. Hydrogen fuel and fuel cell vehicles are expected to gain a market by 2035 and grow towards 2050. The alternative fuel vehicles emit much less or almost zero greenhouse gases than tradition vehicles. But a lot of challenges have to be overcome before these vehicles will be a successful and competitive alternative for consumers. Figure 60 illustrates fuel cell vehicle along with its major components [WEC, 2007].

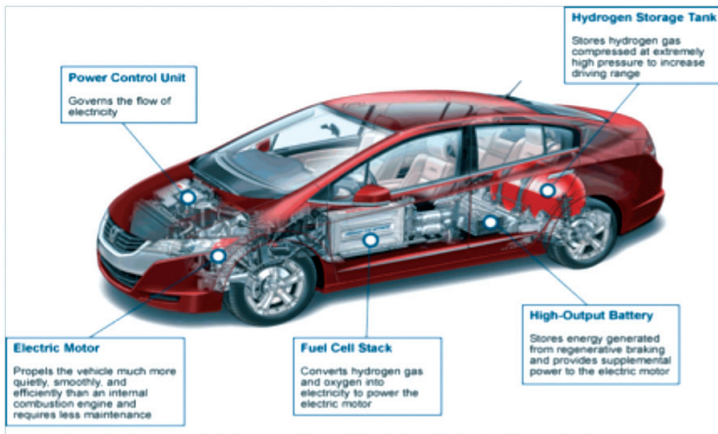

Figure 60 Illustration of major components of fuel cell vehicle
[Source: US DOE, Apr 2011]

CNG-DI Ignition System

The function of the ignition systems is to inject the required energy into the combustion chamber in order to ignite the air-fuel mixture. The amount of the injected energy depends on many factors such as the kind of combustion gas used, air-fuel ratio, and the combustion pressure. To meet the future fuel economy demands, vehicle engine manufacturers try to design engines that run on lean or ultra lean air-fuel ratios. These lean mixtures require more efficient energy injection mechanism to be ignited.

The conventional ignition systems use spark plugs with a narrow spark gap to ignite the air-fuel mixture. The spark plug ionizes the mixture in the gap volume between the electrodes by means of DC high voltage source which is established from the energy stored in a magnetic coil. The drawback of such systems to meet the lean mixture demands is the need to increase the DC voltage between the gap electrodes in order to ignite the lean and ultra lean mixtures. The spark is localized around the spark plug volume and the size of the plasma channel is small. Moreover, going to higher DC voltage levels cause shorter life time for the spark plugs [N. Mariun *et al.*, 2005].

Varieties of Ignition System Technology

Three types of ignition systems are focused here. They are: Electronic Ignition System, Radio Frequency (RF) Ignition System, and Laser Ignition System. Each system has its own technology to improve Compressed Natural Gas and Direct Injection (CNG-DI) engine for energy efficiency. Figure 61 describes characteristics of each ignition system [N. Khan *et al.*, 2005, N. Mariun *et al.*, 2005 and N. Mariun *et al.*, 2007].

Ignition System	Technology Enhanced
 <p data-bbox="303 544 514 564">Electronic Ignition System</p>	<ul style="list-style-type: none"> • An inductive ignition system • Most efficient and controllable spark energy • Can deliver 5 times more energy (150mJ) • Low Electromagnetic interference level • Connected with high-voltage distribution (double spark ignition coil or single spark ignition coil)
 <p data-bbox="351 897 445 917">RF Igniter</p>	<ul style="list-style-type: none"> • To increase DC voltage between the gap electrodes and to increase the plasma channel size. • Proposed microwave plasma source as igniter. • Lower breakdown voltage. • Longer lifetime for the spark electrodes.
 <p data-bbox="291 1233 506 1253">Laser Ignition System</p>	<ul style="list-style-type: none"> • CNG air/fuel ratio is more difficult to ignite, therefore require High Ignition Energies. • Due to increase ignition coil energy, spark plug service life is very low for CNG engine. • Laser Ignition offers the potential for extended service life.

Figure 61 Types of CNG-DI Ignition System Technology [N. Khan *et al.*, 2005, N. Mariun *et al.*, 2005 and N. Mariun *et al.*, 2007].

Testing and Optimizing the Ignition System inside a CNG-DI Engine

The present invention relates to the testing of electronic ignition system inside CNG-DI engines in order to monitor the changes in parameters when using different types of injectors and with different gas pressures. CNG has been considered as the alternative fuel besides the other fuels such as petrol and diesel. However, the CNG engines require high energy ignition system to energize the spark plug in order to ensure the Air Fuel Ratio is at the right value for efficient combustion. In our experiment, the location of the spark plug and the injector are different from the conventional engines. The experimental results show that the spark plug is ignited at ignition timing 2.77 ms or location angle 21 degree Before Top Dead Center. These conditions occur at engine speed 1800 rpm and Air Fuel Ratio within 14:1 to 16:8. Figure 62 presents the experimental diagram of CNG-DI Ignition system [A. Omar *et al.*, 2005].

The benefits of CNG technology is that it is environment friendly and the cleanest among the fossils fuels. It can be promoted because it is much cheaper than gasoline prices. Also DI technology improves the combustion efficiency and fuel consumption. Moreover, the schemes of road tax reduction are 25% and 50% for bi-fuel and dual-fuel vehicle mono-gas vehicle respectively.

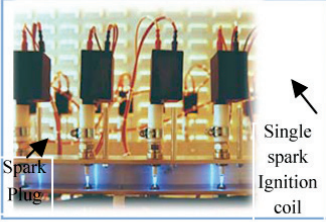
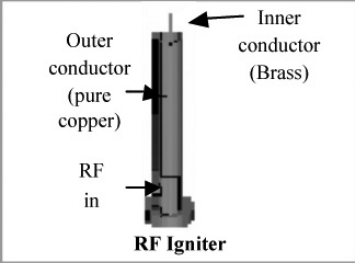
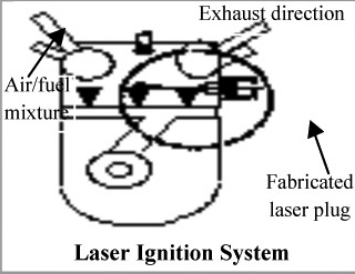
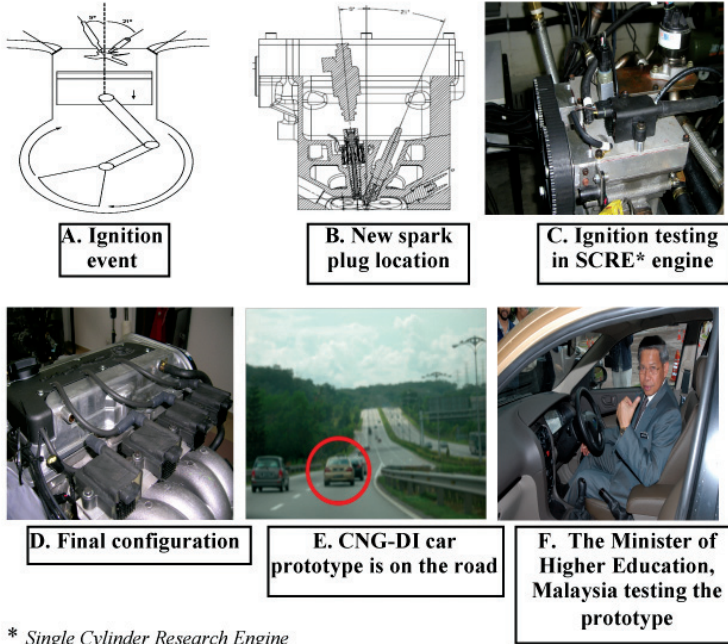

Figure 62 Experimental Diagram of CNG-DI Ignition System, picture order from A to F [A. Omar *et al.*, 2005].

EE Pasteurizer for Food and Beverage

Pasteurization is a treatment for exposing foods and beverages to an elevated temperature for a specified period of time, purposely to inactivate the harmful microorganisms and some undesirable enzyme. Typical pasteurization process is high temperature short time (72°C hold for at least 15 seconds) and low temperature long time (63°C hold for 30 minutes).

Ohmic Heating Technology

Product pasteurized using ohmic heating are superior in quality as compared to products pasteurized in conventional method. Apart from that the application of the technology do not require any heat source, no storage of fuels, no transport of heat and is less capital intensive to acquire and operate as compared to system using steam or gas burners as heat source. Using ohmic heating, energy conversion is expected to be much higher since there is no transport and exchange of heat. Whereas for ohmic pasteurisation with no over temperature occurs, conversion of electrical energy is 95 to 98%. Table 18 shows the comparison factors between electric boiler and ohmic heater for pasteurizing of 500 litre/hour of juice at product density of 1100kg/m³, a specific heat of 4.2 KJ/kg °C and at pasteurization temperature of 80°C.

Table 18 Comparison between electric boiler and ohmic heater for pasteurization

Parameters	Electric Boiler	Ohmic Heater
Thermal energy, Q (kJ/h)	1.155 x 10 ⁵	1.155 x 10 ⁵
Steam flow rate, m _s (kg/h)	42.9	Not Applicable (NA)
Steam energy, Q _s (kJ/h)	1.36 x 10 ⁵	NA
Power (kWh)	42	34
Current usage, I (A)	58.35	46.7

Figure 63 depicts two major sections of ohmic heater such as the ohmic heating cell and fluid handling system, and the ohmic heater control panel. The ohmic heating cell and fluid handling system consist of two positive displacement pumps, ohmic heating cell, and plexisteel hose. The control panel includes the components such

as inverters, thyristor, process controller, paperless chart recorder, and temperature sensors [N.F. Jamaludin *et al.*, 2009].



GREEN ENERGY INITIATIVES IN MALAYSIA

Green Malaysia Policy and Plan

Malaysia has energy policies and development plans. The national policy plan has started since 1979. The country has recently fulfilled the 9th MP and currently is running the 10th MP. Nation Green Technology Policy is under 2009 according to Figure 64. At present TNB has power generation which is a combined of gas (about 58.8%), coal (26.3%), hydro power (14.8%) and oil (less than 1%). The company has taken major initiatives towards Green Energy and Technology and to reduce CO₂ emission by less depending on fossil fuels. The milestone of green RE in Malaysia over 60 years is shown in Table 19. At the same time, the trend towards Green Technology (GT) has started since 1959 and to date many initiatives have been taken to achieve the goal.

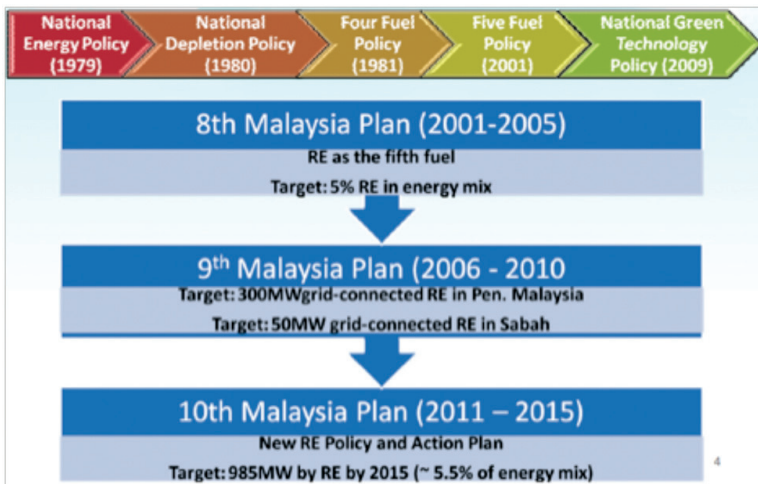

Figure 64 National Energy Policies and Development Plans

Table 19 Milestone of RE in Malaysia over 60 years
[Source: TNB, 2010]

Period	Brief Descriptions
1 September 1949	The Central Electricity Board of the Federation of Malaya was formed.
1959	Work commenced on the development of the Cameron Highlands hydroelectric power plant project
1976	First Grid connection from the West Coast to the East Coast
1980	The start of construction of 150 m based high dam Kenyir hydro project.
1981	First Grid connection (132 kV) to Hadyai, Thailand from Bukit Keteri, Kedah.
June 1982	A total of 30 houses in a fishermen's village in Kampung Apau, Pulau Langkawi, Kedah began receiving electricity supply from solar energy.
November 1995	The first of its kind wind turbine generator hybrid system was installed and constructed in Pulau Layang-Layang, Sabah
April 2004	The Jana Landfill SREP project developed by TNB-ES
September 2007	Completion of the solar hybrid rural electrification project in Pulau Perhentian, Terengganu.
10 June 2010	TNB Nuclear Power Colloquium 2010 was held as part of the initiatives to promote GT, particularly in NE.

Some of the initiatives are [M.N. Shahrudin, 2010 and TNB, 2010] -

1. Development of Biomass Power Plant

10 MW Jengka Biomass power plant in Pahang is being continued to be implemented under joint venture project. This biomass project is at the procurement stage with a target commercial operation date of Oct 2012. The plant shall utilize the waste empty fruit bunch of oil palm as its major source of fuel for firing its boiler. The EFB will be supplied from the 7 nos. of neighboring FELDA palm oil mills within a 70 km radius from the Jengka 9 Site. Annually the project is expected to contribute to about 45,000 tones CO₂ emission reductions.

2. Operation of Mini-hydro plant

Currently TNB is a major contributor to the total industry capacity through three major hydroelectric schemes. In terms of new generation projects, 250 MW Hulu Terengganu and 372 MW Ulu Jelai Pahang hydropower projects that are expected to be online from 2015 onwards (Feb 2015 and Sept 2015 respectively).

3. Solar Hybrid Projects

We have already mentioned that presently TNB is operating all solar hybrid stations up to 300 kW per station at various locations, including Langkawi Cable Car Middle Station for LADA, islands off Mersing, Johor for Kementerian Kemajuan Luarbandar dan Wilayah (KKLW), Orang Asli Settlements in Peninsular Malaysia for KKLW, Pulau Kapas for Terengganu State owned PERMINT and Pulau Perhentian (wind/solar),

off Terengganu for KKLW, remote areas in Sabah for KKLW. TNB-ES is undertaking the supply and delivery of solar hybrid system to rural schools under the Ministry of Education. Other projects on stream include TNB's own 5 MW Solar Showcase which is expected to begin soon and the supply and delivery of solar hybrid stations to Orang Asli Settlements (Phase 3) under KKLW. Moreover, On Aug 2010, TNB had signed 27 RE power purchase agreements with SREP developers in Peninsular Malaysia, with a total capacity of 153 MW. As part of these, TNB continues to evaluate potential new RE projects, including a 5 MW solar farm on a 30 acre plot in Putrajaya which will help meet the needs of the surrounding area.

A Recent Initiative towards Green Energy- Annulled Coal Power Plant in Sabah

Sabah, along with Sarawak, makes up Malaysia's half of Borneo Island, which borders the Coral Triangle, one of the world's most bio-diverse marine environments. The vast region, which spans the seas around East Timor, Indonesia, Malaysia, Papua New Guinea, the Philippines and the Solomon Islands, is home to 75% of all known coral species. Concern about these environmental issues, the very recently Sabah Chief Minister has annulled to build a controversial coal-fired power plant (300 MW) which could be scrapped over fears of its impact on the environment [France24 International News, 2011].

Malaysia GT

GT Goals- 10th MP

Malaysia has four short term national goals. These are under the 10th MP [GT, 2011a].

Goal 1: Increase public awareness and commitment for the adoption and application of GT through advocacy programs;

Goal 2: Widespread availability and recognition of GT in terms of products, appliances, equipment and systems in the local market through standards, rating and labeling programs;

Goal 3: Increased foreign and domestic direct investment in GT manufacturing and services sectors;

Goal 4: Expansion of local research institutes and institutions of higher learning to expand research, development and innovation activities on GT towards commercialization through appropriate mechanisms.

Green Vehicles

The use of petroleum-based fuels for transportation is responsible for a significant share of the developed countries that represents between 25-30% of global warming emissions. For instance, transportation accounts for nearly 40% of California's global warming emissions. Better technology options may be available for producing clean electricity for transportation system. Significant progress can still be made toward cleaner and more efficient vehicles using off-the-shelf technologies and alternative fuels.



Figure 65 Green vehicle (motorbike) run by electric; source: PTM

Malaysia GT stated that like other countries, it also plans to promote alternative fuels such as hybrid, electric, ethanol, hydrogen car and hydrogen fuel cells, natural gas, plug in hybrids, biodiesel and air powered cars. Malaysia's national car maker Proton Holding Bhd seems set to jump onto the GT bandwagon as it is already in talks to replace the current fleet of government vehicles with its range of hybrid cars. Figure 65 shows the green vehicle in PTM [GT, 2011b] [E. Mahalingam, 2010].

CONCLUSION

This lecture contributes to the studies of energy status of the world along with innovative initiatives that are planned to mitigate energy crisis challenges. The discussion has also extended to Malaysia's perspective so that we can adapt demand and supply challenges in the next fifty years to come.

The problems Malaysia may face are not only technical but also the lack of time. 2050 is tomorrow. The longer it takes to adapt Malaysia energy system, the more difficult and costly it will be, with an unknown impact on the environment. On the one hand, the installed grid connected capacity of RE in Malaysia has not reached more than 60 MW as on Oct 2010. Beside supply of oil in the world market has been disrupted and it is becoming more uncertain due to revolution (Iran, 1978-1979), invasion (Iraq-Kuwait, 1990), strike (Venezuela, 2002) and recent Middle East unrest that lead to the fuel prices going higher. Following the outbreak of civil unrest in mid-Feb 2011, Libyan oil and natural gas production has been cut by 60 to 90% and increased half a cent per liter of petrol price. Moreover, experts are estimating fuel oil and natural gas consumption in Japan could increase up to 238,000 barrels per day (bbl/d) and 1.2 billion feet³/d respectively because of tsunami that resulted in a shutdown of 6,800 MW generation capacity out of 12,000 MW.

Over the next 40-50 years, sustained efforts must be directed toward realizing energy crisis as part of a comprehensive strategy that supports a diversity of resource options over the next century. It cannot be a country's wise future milestone to be dependent fully on fossil fuels since the reserve of fossil fuels is depleting day by day. At the same time, the price of fossil fuels especially crude oil has increased approximately 660% for the last 40 years. On the other hand, sustained and long-term support-in various forms are needed to overcome the fundamental challenges of RE. Besides solar

energy, Malaysia has an enormous opportunity of using biomass and MSW as renewables. Offshore wind opportunity may also be considered in some parts of Malaysia. However, RE does not offer a great alternative to us. It may be the answer to global warming in a short way but full dependent on RE cannot be a country's wise roadmap.

Faced with the consequences of an increase in greenhouse gases, the proponents of NE present it as the essential solution to meet the global high energy demand. In the Atoms for Peace speech given by US President Eisenhower in 1953 - he declared that a special purpose of Atoms for Peace would be "*to provide abundant electrical energy in the power-starved areas of the world*". But it should not be taken to mean that NE is the solution for all countries, or for all developing countries. Small scale nuclear reactors can be feasible option instead of large production. Shared regional approaches to NPP infrastructure, construction and operation may also be feasible in developing countries. Conversely, security and environmental constraints pose a considerable challenge for social and economic development. Long-term energy research and development is an essential component to overcome these constraints. Significant progress can be achieved with existing technology but the research community must have the means to pursue promising technology pathway.

REFERENCES

- A. Achilli, T.Y. Cath, A.E. Childress (2009), “*Power generation with pressure retarded osmosis: An experimental and theoretical investigation*” Journal of Membrane Science, Elsevier Science Ltd. Vol. 343, Issue 1-2, pp: 42-52
- A.F. Hasan (2010), “*Energy Efficiency and Renewable Energy in Malaysia*”, Energy Commission, Malaysia
- A. Giraud, J. Veau (2010), “*Full Autonomous Monitoring Tools Inside Nuclear Reactor Building*” IEEE Transactions on Nuclear Science, Vol. 57, No. 5, pp: 2662 - 2669
- A. Justa (2010), Green Diary “*UC researchers hope to harness atmospheric electricity*” online accessed from <http://www.greendiary.com/entry/uc-researchers-hope-to-harness-atmospheric-electricity/> on 4 May 2011
- A. Omar, N. Mariun, N. Khan, I. Aris (2005), “*Testing and Optimization of Ignition System Parameters Inside CNGDI Engine*” Proceedings of International Advanced Technology Congress, IOI Marriott Hotel, Putrajaya, Malaysia
- A. Patchimpattapong (2010), “*Development of Thailand’s first nuclear power plant*” 2010 Proceedings of the International Conference on Energy and Sustainable Development: Issues and Strategies, pp:1-3
- A. Zaharim, S. Khadijah, A.M. Razali, K. Sopian (2009), “*Wind Speed Analysis in the East Coast of Malaysia*” European Journal of Scientific Research Vol.32 No.2, pp: 208-215
- AEP (2009), American Electric Power “*Ultra-Super Critical Generation*” online available: <http://www.aep.com/environmental/climatechange/advancedtechnologies/docs/SuperCriticalFactsheet.pdf>
- AK Power Plant (2002), Alholmens Kraft Power Plant Pietarsaari Finland, accessed from <http://www.alholmenskraft.com/en/company/about.htm> on 13 Feb 2011
- ASME (2011), “*Waste-to-Energy: A Renewable Energy Source from Municipal Solid Waste*” Solid Waste Processing Division and Energy Committee Washington DC online available www.asme.org

- B. Ali, K. Sopian, M.A. Rahman, M.Y. Othman, A. Zaharim, (2009), “*Hybrid Photovoltaic Diesel System in a Cable Car Resort Facility*” European Journal of Scientific Research, Vol.26 No.1, pp: 13-19
- B.K. Sovacool (2008), “*How Much Will New Nuclear Power Plants Cost?*” article published in SCITIZEN on 2 Nov 2008, accessed from <http://scitizen.com/future-energies/how-much-will-new-nuclear-power-plants-cost-a-14-2287.html> on 11 Feb 2011
- B. Richard, W.A. Amos, M. Downing and R.L. Perlack (2003), “*Biopower Technical Assessment: State of the Industry and the Technology*” Department of Energy, National Renewable Energy Laboratory Washington DC online available: http://www.fs.fed.us/ccrc/topics/urban-forests/docs/Biopower_Assessment.pdf
- B. Vogta, K. Fischera, J. Starflingera, E. Laurienb and T. Schulenberg (2010), “*Concept of a pressurized water reactor cooled with supercritical water in the primary loop*” Journal of Nuclear Engineering and Design, Elsevier Science Ltd., Vol. 240, Issue 10, pp: 2789-2799
- BBC news (2010), reported in BBC news titled “*Nord Stream gas pipeline underwater construction starts*”, available on 9 Apr 2010 and accessed from <http://news.bbc.co.uk/2/hi/8607214.stm>
- CDM (2008), Clean Development Mechanism “*Approaches For Solid Waste Treatment*” EU-Asia Solid Waste Management Conference on 28 Oct 2008
- CFL (2011), Compact fluorescent lamp, The Encyclopedia of Alternative Energy and sustainable Living, accessed from http://www.daviddarling.info/encyclopedia/C/AE_compact_fluorescent_lamp.html on 8 Apr 2011
- C. Siwar, A.F. Mohamed, R.A. Begum, J.B. Chibunna (2010), “*Awareness towards E-waste Management: A case study of UKM Malaysia*”, Journal of Solid Waste Technology & Management
- C. Tang, Y. Tang, J. Zhu, Y. Zou, J. Li, X. Ni (2002), “*Design and manufacture of the fuel element for the 10 MW high temperature gas-cooled reactor*” Journal of Nuclear Engineering and Design, Science Direct Ltd., Vol. 218, Issues 1-3, pp:91-102

- C. Teh (2011), “*Possibility of Electricity from Wind Energy in Malaysia: Some rough Cacuations*” available online 8 Nov 2010, accessed from <http://christopherteh.com/blog/2010/11/08/wind-energy/> on 7 Mar 2011
- Cornell University (2011), National Renewable Energy Laboratory (NREL), Climate Neutral Research Campuses, *Leading Example: Cornell University Hydropower Project*, accessed from http://www.nrel.gov/applying_technologies/climate_neutral/hydropower.html on 16 Feb 2011
- D. Graham-Rowe (2010), “*Is night falling on classic solar panels?*” Online Magazine of New Scientist, Issue 2791, published on 20 December 2010, accessed from <http://www.newscientist.com/article/mg20827915.000-is-night-falling-on-classic-solar-panels.html> on 16 Feb 2011
- D.R. McIlveen-Wright, F. Pinto, L. Armesto, M.A. Caballero, M.P. Aznar, A. Cabanillas, Y. Huang, C. Franco, I. Gulyurtlu and J.T. McMullan (2006), “*A comparison of circulating fluidised bed combustion and gasification power plant technologies for processing mixtures of coal, biomass and plastic waste*” Journal of Fuel Processing Technology, Science Direct Ltd., Vol. 87, Issue 9, pp: 793-801
- DEFRA (2007), Department for Environment Food and Rural Affairs, “*Energy from waste and anaerobic digestion*” published on 18 June 2007, accessed from <http://www.defra.gov.uk/environment/waste/strategy/factsheets/energy.htm> on 27 Feb 2011
- E. Clark (2008), “*Plans for 280 megawatt solar plant in Arizona*” ECOGIZMO, published on 21 Feb 2008, accessed from <http://www.gizmag.com/280-megawatt-solar-plant-in-arizona/8861/> on 17 Feb 2011
- Electrolux (2007), Incentives for change - Electrolux Group, Sweden, accessed from <http://group.electrolux.com/en/wp-content/uploads/2010/07/Incentive-for-Change-Electrolux-Dec-2007.pdf> on 7 Apr 2011
- E. Mahalingam (2010), “*Proton set to produce hybrid cars next year*” The Star online Business Section, published online 19 Oct 2010, accessed

Energy Crisis 2050? Global Scenario and Way Forward for Malaysia

from http://biz.thestar.com.my/news/story.asp?file=/2010/10/19/business/7250628&sec=business#12981041976621&if_height=751 on 19 Feb 2011

- EIA (2008), Energy Information Administration “*Renewable energy trends 2007*” Washington DC, accessed from <http://www.eia.doe.gov/cneaf/solar.renewables/page/trends/rentrends.html> on 12 Feb 2011
- EP (2010), Electric Power US Energy Information Administration, Form EIA-923, “*Power Plant Operations Report*” and predecessor forms: Form EIA-906, “*Power Plant Report*” and Form EIA-920, “*Combined Heat and Power Plant Report*”
- France24 International News (2011), “*Malaysia drops coal power plant scheme: minister*” published online 17 Feb 2011, accessed from <http://www.france24.com/en/20110217-malaysia-drops-coal-power-plant-scheme-minister> on 19 Feb 2011
- G. Xu, L. Duan, M. Zhao, Y. Yang, J. Li, L. Li and H. Chen (2010a), “*Performance Analysis of Existing 600MW Coal-Fired Power Plant with Ammonia-Based CO₂ Capture*” International Conference on Electrical and Control Engineering, pp: 3973 – 3976
- G. Xu, S. Lu, Y. Yang, L. Duan, J. Li, L. Li, X. Song (2010b) “*New Environmental Friendly Evaluation Criterion for Coal-Fired Power Plant Comprehensive Performance*” 2010 International Conference on Electrical and Control Engineering, pp: 3908 – 3911
- GT (2011a), Green Technology - National Goals, Malaysia Green Technology Online, accessed from <http://www.greentechmalaysia.my/index.php/green-technology/green-technology-policy/national-goals.html> on 19 Feb 2011
- GT (2011b), Green Technology –Green Vehicles, Malaysia Green Technology Online, accessed from <http://www.greentechmalaysia.my/index.php/transportation/green-vehicles.html> accessed on 19 Feb 2011
- H. Khan and F. Khan (2009), “*Prospects of electricity generation from municipal solid waste of Dhaka city*” 1st International Conference on the Developments in Renewable Energy Technology, pp: 1 – 4

- IEO (2010), “*International Energy Outlook 2010*”, US Energy Information Administration Office of Integrated Analysis and Forecasting, published on July 2010, US Department of Energy, Washington DC, online available: www.eia.gov/oiaf/ieo/index.html
- iStockAnalyst (2011), “*Indonesian president urged to support nuclear development for electricity*” main source from ‘Quotemedia’, Jakarta Xinhua News Agency, published on 21 Feb 2011, accessed from <http://www.istockanalyst.com/article/viewiStockNews/articleid/4907097#> on 23 Feb 2011
- J. Beer (2010), “*Fossil fuel power plant*” Encyclopedia of Earth. Environmental Information Coalition, National Council for Science and the Environment, online available http://www.eoearth.org/article/Fossil_fuel_power_plant on 20 Feb 2011
- J. Dailey (2011), “*Offshore Wind Energy Gets \$50.5 Million Boost from U.S. Government*” published online 8 Feb 2011, accessed from <http://inhabitat.com/offshore-wind-energy-gets-50-5-million-boost-from-u-s-government/> on 17 Feb 2011
- J. Jowit, S. Carrell (2010), “*UK opens world’s biggest offshore windfarm*” the English Channel, accessed from <http://www.guardian.co.uk>, on 23 Sep 2010
- Johnzactruba (2010), “*Coal Fired Thermal Power Plant: The Basic Steps and Facts*” accessed from <http://www.brighthub.com/engineering/mechanical/articles/18082.aspx?p=2> on 21 Feb 2011
- K. Mok (2008), “*Dutch Biomass Plant to Use Chicken Manure to Power 90,000 Homes*” Science & Technology (alternative energy) published on 8 Sep 2008 Montreal, Canada, accessed from <http://www.treehugger.com/files/2008/09/dutch-biomass-plant-chicken-manure-netherlands.php> on 13 Feb 2011
- K. Nasrullah, J. Yeak, N. Mariun and I. B. Aris (2000), “*Atmospheric Electricity – The New Alternative Source of Energy?*” 8th International Energy Forum (ENERGEX’2000), July 23-28 in Las Vegas
- K. Obaidurrahman, J.B. Doshi (2011), “*Spatial instability analysis in pressurized water reactors*”, Journal of Annals of Nuclear Energy, Science Direct Ltd., Vol. 38, Issues 2-3, pp: 286-294

- K. Rhinefrank, E. B. Agamloh, A. Jouanne, A.K. Wallace, J. Prudell, K. Kimble, J. Aills, E. Schmidt, P. Chan, B. Sweeny, A. Schacher (2006), “*Novel ocean energy permanent magnet linear generator buoy*” *Journal of Renewable Energy*, Elsevier Science Ltd., Vol. 31, Issue 9, pp: 1279-1298
- L. Sibley (2011), “*World’s largest biomass plant gets environmental clearance*” Cleantech Group, accessed from <http://cleantech.com/news/5090/world-largest-biomass-plant> on 13 Feb 2011
- L. Wagner (2007), “*Waste-to-Energy (WtE) technology*” Research report, published on Jul 2007
- MIR (2005), Meridian International Research, “*Atmospheric Electricity Research*” online available <http://www.meridian-int-res.com/Energy/Atmospheric.htm> on 4 May 2011
- M. Fitzpatrick (2010), “*Sun and sand breed Sahara solar power*”, Online Magazine of New Scientist, published online Nov 2010, accessed from <http://www.newscientist.com/article/dn19785-sun-and-sand-breed-sahara-solar-power.html> on 16 Feb 2011
- M. Kinnunena, A. Korppoo (2007), “*Nuclear power in Northern Russia: A case study on future energy security in the Murmansk region*” *Journal of Energy Policy*, Elsevier Science Ltd., Vol. 35, Issue 5, pp: 2826-2838
- M. Loeser, M.A. Redfern (2008), “*Overview of biomass conversion and generation technologies*”, 43rd International Universities Power Engineering Conference, pp: 1 – 4
- M.N. Shahrudin (2010), presentation on “*Carbon reduction Policy, Strategy and Technology: Malaysia and TNB Perspectives*” Tenaga Nasional Berhad
- MBIPV (2011), Malaysia Building Integrated Photovoltaic, accessed from <http://www.mbipv.net.my> on 18 Mar 2011
- MEGTW (2010), Ministry of Energy, Green Technology and Water, “*PM Wants To Know Public Opinion On Nuclear Energy*”, news published on 5 May 2010, accessed from <http://www.kettha.gov.my/en/content/pm-wants-know-public-opinion-nuclear-energy> on 17 Feb 2011

- MGTO (2011), Malaysian Green Technology Online, RE Resources Opportunities, accessed from <http://www.greentechmalaysia.my/index.php/energy/renewable-energy/solar-energy.html> on 17 Feb 2011
- N. Dong-xiao, X. Mian, W. Ya-nan, L. Jian-qing (2010), “*Analysis and Application of Environmental Impact Evaluation System for Biomass Power Generation Based on TOPSIS Method*” 2010 International Conference on Challenges in Environmental Science and Computer Engineering, Vol. 1, pp: 114 – 117
- N.F. Jamaludin, H. Jamaludin, N. Mariun, H. Hizam (2009), “*Energy Conservation in the Food Industry*”, 3rd International Engineering Convention, Damascus, Syria
- N. Mariun (2008), Keynote paper “*Are We Prepared for the Energy Crisis 2050s*”, CITISIA July 12-13 2008, Multimedia University Cyberjaya Campus
- N. Mariun, I. Aris, N. Khan, Liyth (2005), “*RF Coaxial Resonant Cavity for CNG Ignition*” Proceedings of Asia Pacific Natural Gas Vehicles Associations, 1st Conference & Exhibition, Kuala Lumpur Convention Centre, Malaysia, pp: 27 – 28
- N. Mariun, N.M. Saad, M. Abas, N. Khan, S. Abdullah (2007), “*Power and Energy Characteristics of Continuous Waves / Pulsed CO₂ Laser Application in CNG-DI Ignition*”, International Journal of Energy, Issues 2 Vol 1, pp 22-27
- N. Khan, N. Mariun, N. Hafizah (2005), “*Laser Absorption Study of Leaner Air/CNG Mixtures*” Proceedings of Asia Pacific Natural Gas Vehicles Associations, 1st Conference & Exhibition Kuala Lumpur Convention Centre, Malaysia
- N. Sharliza, Z. Zainon, Z. Ujang, J. Talib (2010), “*Projection of CO₂ Emissions in Malaysia*” Journal of Environmental Progress & Sustainable Energy, published in Wiley Online Library <http://wileyonlinelibrary.com>
- NCR (2011), Nuclear Chain Reaction, accessed from: <http://www.energyquest.ca.gov/projects/nuclear.html> on 9 Feb 2011

- NREL (2010), National Renewable Energy Laboratory, US Department of Energy, available on 14 Dec 2010, accessed from <http://www1.eere.energy.gov/windandhydro/> on 17 Feb 2011
- OECD/ IEA NEA (2010), Projected Costs of Generating Electricity, published online on Jul 2010, online available: <http://www.world-nuclear.org/info/inf02.html>
- R. Mills (2011), “*Uranium Report 2011*” published in Resource Investor, A Summit Business Media publication on 27 Jan 2011, accessed from <http://www.resourceinvestor.com/News/2011/1/Pages/Uranium-Report-2011.aspx> on 9 Feb 2011
- REN21 (2010), Renewable Energy Policy Network for the 21st Century, “*Renewables 2010 Global Status Report*”, revised edition published on Sep 2010, accessed from <http://www.ren21.net/REN21Activities/Publications/GlobalStatusReport/GSR2010/tabid/5824/Default.aspx> on 22 Feb 2011
- S. Kathirvale, M. Noor, K. Sopian, A.H. Samsuddin (2004), “*Energy potential from municipal solid waste in Malaysia*” Journal of Renewable Energy, Elsevier Science Ltd., Vol. 29, Issue 4, pp:559-567
- S. Takizawa, A. Suzuki (2004), “*Analysis of the decision to invest for constructing a nuclear power plant under regulation of electricity price*” Journal of Decision Support Systems, Elsevier Science Ltd., Vol. 37, Issue 3, pp: 449-456
- ST (2008), Surunghajaya Tenaga, “*Electricity Statistics*”- Electricity Generation data for Installed Capacity by Fuel Type, Installed Capacity by Region and Fuel Consumption data, accessed from http://www.st.gov.my/index.php?option=com_content&view=article&id=5436%3Aelectricity-statistics&catid=837&Itemid=1749&lang=en on 24 Feb 2011
- ST (2011a), Suruhanjaya Tenaga “*Malaysia to Introduce Feed-in Tariff for Renewable Energy in 2011*” accessed from http://www.st.gov.my/index.php?option=com_content&view=article&id=5476%3Amalaysia-to-introduce-feed-in-tariff-for-renewable-energy-in-2011-says-peter-chin&catid=794%3Aenergy-news&Itemid=1201&lang=en on 17 Feb 2011

- ST (2011b), Suruhanjaya Tenaga “*Small Renewable Energy Power Programme (SREP)*” accessed from http://www.st.gov.my/index.php?option=com_content&view=article&id=5245&Itemid=4227&lang=en on 17 Feb 2011
- Statkraft (2009), “*Osmotic power*” published online on 24 Nov 2009, accessed from <http://www.statkraft.com/energy-sources/osmotic-power/> accessed on 26 Feb 2011
- T.A. Boden, G. Marland and R.J. Andres (2010), “*Global Regional and National Fossil-Fuel CO₂ Emissions*” Carbon Dioxide Information Analysis Center (CDIAC), Oak Ridge National Laboratory, US Department of Energy
- Technology White Paper (2006), “*Wave Energy Potential on the US Outer Continental Shelf*” Minerals Management Service RE and Alternate Use Program US Department of the Interior, online available: <http://ocsenergy.anl.gov>
- TNB (2010), Tenaga Nasional Berhad Annual Report 2010, online available: <http://www.tnb.com.my>
- TNB (2011), “*Think Nuclear, Think Green- Why Nuclear Despite High Reserve Margin?*” accessed from <http://www.tnb.com.my/think-nuclear-think-green/why-nuclear-despite-high-reserve-margin.html> on 19 Feb 2011
- TNB-ES (2010), Tenaga Nasional Berhad Energy Services, slide presentation on “*Solar Hybrid System in Malaysia*”, SESB Open and Vendor Day
- University of Glasgow (2008), “*Brighter LED Lights Could Replace Household Light Bulbs Within Three Years*” ScienceDaily, accessed from <http://www.sciencedaily.com/releases/2008/01/080109083914.htm> on 8 Apr 2011
- Uranium (2010), Resources, Production and Demand (Red Book), A Joint Report by the OECD Nuclear Energy Agency and the International Atomic Energy Agency OECD, Paris, ISBN 978-92-64-04789-1
- US EIA (2009), US Energy Information Administration, International Energy Statistics database (as of Nov 2009), online available: www.eia.gov/emeu/international

- US EIA (2010), US Energy Information Administration, International Energy Outlook 2010
- US EIA (2011), US Energy Information Administration “*Domestic Uranium Production Report - Quarterly*”, released on 8 Feb 2011, accessed from <http://www.eia.doe.gov/cneaf/nuclear/dupr/qupd.html> on 21 Feb 2011
- US EIA (2011a), US Energy Information Administration “*Short-Term Energy Outlook*” released on 8 Mar 2011, accessed from <http://www.eia.doe.gov/emeu/steo/pub/contents.html> on 15 Mar 2011
- US NRC (2010), United States Nuclear Regulatory Commission “*Pressurized-water reactor (PWR)*” available on 2 Aug 2010, accessed from <http://www.nrc.gov/reading-rm/basic-ref/glossary/pressurized-water-reactor-pwr.html> on 9 Mar 2011
- US NRC (2011), The United States Nuclear Regulatory Commission “*Advanced Reactors*” available on 8 Feb 2011 accessed from <http://www.nrc.gov/reactors/advanced.html> on 9 Mar 2011
- W.A. Atkins (2010), Water Encyclopedia Science and Issues “*Hydroelectric Power*” online available: <http://www.waterencyclopedia.com/Ge-Hy/Hydroelectric-Power.html>
- WCA (2008), World Coal Association “*Coal Statistics*” accessed from <http://www.worldcoal.org/resources/coal-statistics/> on 22 Mar 2011
- WCA (2011), World Coal Association, “*Improving Efficiencies*” accessed from <http://www.worldcoal.org/coal-the-environment/coal-use-the-environment/improving-efficiencies/> on 15 Mar 2011
- WEA (2011), World Energy Association, accessed from <http://www.wwindea.org/home/index.php> on 22 Feb 2011
- WEC (2007), World Energy Council, “*Transport Technologies and Policy Scenarios to 2050*”
- WES (2010), World Energy Statistics, “*Global solar energy statistics*” published on 19 Sep 2010 accessed from <http://energy-statistics.blogspot.com/2010/09/global-solar-energy-statistics.html> on 22 Feb 2011

- WWEA (2010), World Wind Energy Association, “*World Wind Energy Report 2009*” 9th World Wind Energy Conference & Exhibition Large-scale Integration of Wind Power, Turkey
- Z. Husain, Z.A. Zainal, M.Z. Abdullah (2002), “*Analysis of biomass-residue-based cogeneration system in palm oil mills*”, Journal of Biomass and Bioenergy, Elsevier Science Publication, Vol. 24, No. 2, pp: 117-124
- Z. Kun, L. Zhiqiang (2002), “*The Scheme Selection of MSW Disposal*”, Waste Disposal Technology and engineering examples, Beijing: Chemical Industry Press, pp: 101-105

BIOGRAPHY

Norman Mariun was born in Parit, Perak, Malaysia on 29 January 1957. He obtained his early education at King Edward VII Primary School, Taiping and Darul Reduan Lower Secondary School Taiping. He then completed his secondary school education at Malay College Kuala Kangsar. Later he completed his A-Level at West Bridgford College Nottingham. He received his bachelor degree from University of Nottingham in Electrical and Electronic Engineering in 1980. He obtained MSc in Electrical Engineering from North Carolina State University, USA (1983) and PhD from University of Bradford, United Kingdom (1998).

Ir. Dr. Norman started his career as a tutor in UPM in 1980 and he became a Lecturer in 1983. In the tenure of UPM, he was the Head Department of Electrical and Electronic Engineering (2001-2004), Deputy Dean of Research and Post Graduate Studies for the Faculty of Engineering, UPM (2004-2009), Deputy Director of Research Management Center, UPM (2009-2010). Currently he is serving as Director of Research Management Center, UPM.

Ir. Dr. Norman has more than 30 years of experience in teaching Electrical and Electronics Engineering courses, developing Electrical Engineering Laboratory, developing curriculum for Electrical and Electronic Engineering Program for Bachelor and Post-Graduate level, and supervision of more than 80 undergraduates and 70 post graduates students. Among these he was the main supervisor of 8 PhD and 40 Master students. He has also served as independent examiners of UPM for many PhD and MSc candidates. Besides these, he was invited as an external examiner by Universiti Malaya, Universiti Kebangsaan Malaysia, Universiti Sains Malaysia, Universiti Teknologi Malaysia and Anna University Chennai, India. He was appointed as National Accreditation Board and Board of Engineers Malaysia Panel Member for Engineering Accreditation

Council for assessing B.Eng. Electrical and Electronic Engineering Programs at various universities and institutions of higher learning. He was also a panel assessor member for MQA in the recent APA exercise for 4 universities. He has also served as External Assessor and Examiner for Bachelor of Electrical Engineering Program, UTM (Jan 2000- Dec 2001) and as External Examiner for UCSI (2007-2009), External Examiner and Assessor for UNISEL (2010-2011) and recently appointed as External Examiner for UNIMAP.

His area of research interest is Electrical Power Engineering including Energy Efficiency and Renewable Energy, Laser applications and Power Electronics application in power system and drives. He has completed 10 research projects as research project leader. One of the highest project funds amount is RM1.9 million under the IRPA Top-Down program. He has filed 4 patents and granted 1 patent recently. One of the research output (Ohmic Pasteurizer) has been chosen for commercialization under the MOHE-MTDC-UPM Symbiosis Program. He is author and co-author of more than 250 (75 in journals, 100 in international proceedings, 45 in national proceedings, 30 seminar/workshop) academic and professional papers and reports. He has also served as reviewer for various national and international journals. He has been invited to present as key note, invited speaker, session chairs and reviewers for many international conferences and has been Chairman of conferences organizing committees and International Advisory Committee for various IEEE International Conferences. He has carried out various consulting projects while attached with engineering consultant firms (J&A Associates Sdn Bhd, Hashim & NEH Sdn Bhd, and UKM Perunding Jurutera dan Akitek Sdn Bhd), and with UPM. Currently he is also director of a consulting firm, UKMPKA Sdn Bhd.

Besides the mentioned administrative duties in UPM, Ir. Dr. Norman has also been appointed as Head of Intensive Research Priority Areas Research Groups, Chairman of Panel Member of Intensive Research Priority Areas (Manufacturing), Chair for Evaluation Panel for MOSTE-IGS and MOSTI Techno fund projects *etc.* He was appointed as panel of energy expert/specialist by Malaysian Energy Center. He is also the Member of SIRIM National Technical Committee (IEC TC31) Electrical Apparatus for Explosive Atmospheres Standard (2005-to date).

Ir. Dr. Norman is a Registered Professional engineer with the Board of Engineers Malaysia and an Interviewer for BEM Professional Interview. He is a Fellow of IEM (Institution of Engineers Malaysia), Member of Board of Examiners, IEM. He has also served as a Committee Member of Engineering Education Technical Division and Electrical Engineering Technical Division IEM. He was also a CIRED Committee Member for 2000-2005 and member of IET (UK). With Institute of Electrical and Electronics Engineers, Inc USA, (IEEE) currently he is a Senior Member and globally he is the IEEE MGA Admission and Advancement Committee Member (2011) and IEEE Power and Energy Society Chapter-Section Relation Committee Chair (2010-2011). He is the Past Chair of Malaysia Section (2005-2007); Past Secretary (2002) and Past Vice-Chair (2003-2004); and Past-Chair of IEEE Power and Energy Society Malaysia Chapter (2000-2003). He has also served IEEE at global level as IEEE MGA Geographic Unit Support Committee (2010), and Asia Pacific Region IEEE Executive Committee member (2007-2010).

Ir. Dr. Norman has received UPM's Excellent Service Award three times (1996, 1998 and 2004), Excellent Researcher Award, UPM (2005) and has been awarded the IEEE Asia Pacific Region Outstanding Volunteer Award 2003. He has also been awarded

the ITEX 2005 Silver Medal and Bronze Medal, ITEX 2006 Gold Medal, ITEX 2008 Malaysia Innovative Product Award, and the British Invention Show 2005 Gold Medal, Eureka Brussels 2006 Gold Medal, INPEX 2007 USA Gold Medal, IENA 2008 Nuremberg, German Gold Medal and INNOVA 2009 Brussels, Belgium Special Award and Gold Medal for his research work.

Ir. Dr. Norman has also served as a motivator for youth programs for the Ministry of Youth and Sport, Malaysia working with Dato' Dr. Haji Mohd **Fadzilah Kamsah** group of motivators, as well as giving motivational talk to local primary and secondary schools, and students at UPM.

Socially, he is a life member of MCOBA and MCOBA SELATAN Chapter, and a member of the UPM Golf Club. For community service he has also served the Madrasah Tahfiz Quran Azbah, Kg Dato' Abu Bakar Baginda in various capacities and has been the PTA executive committee of various schools while his children are in schools.

ACKNOWLEDGEMENT

Prof Norman Mariun would like to acknowledge Universiti Putra Malaysia, Ministry of Science, Technology and Innovation, Malaysia, and Ministry of Higher Education, Malaysia for the facilities and financial support to carry out the various research projects.

He also owes his deepest gratitude to his dedicated graduate students, research collaborators, faculty members and technicians for their support, ideas and suggestions.

He would also like to thank Syed Zahurul Islam for assisting in completing this book.

Last, but not the least, praise to Allah, for the guidance, strength and health towards the road of achievements..

LIST OF INAUGURAL LECTURES

1. Prof. Dr. Sulaiman M. Yassin
The Challenge to Communication Research in Extension
22 July 1989
2. Prof. Ir. Abang Abdullah Abang Ali
Indigenous Materials and Technology for Low Cost Housing
30 August 1990
3. Prof. Dr. Abdul Rahman Abdul Razak
Plant Parasitic Nematodes, Lesser Known Pests of Agricultural Crops
30 January 1993
4. Prof. Dr. Mohamed Suleiman
Numerical Solution of Ordinary Differential Equations: A Historical Perspective
11 December 1993
5. Prof. Dr. Mohd. Ariff Hussein
Changing Roles of Agricultural Economics
5 March 1994
6. Prof. Dr. Mohd. Ismail Ahmad
Marketing Management: Prospects and Challenges for Agriculture
6 April 1994
7. Prof. Dr. Mohamed Mahyuddin Mohd. Dahan
The Changing Demand for Livestock Products
20 April 1994
8. Prof. Dr. Ruth Kiew
Plant Taxonomy, Biodiversity and Conservation
11 May 1994
9. Prof. Ir. Dr. Mohd. Zohadie Bardaie
Engineering Technological Developments Propelling Agriculture into the 21st Century
28 May 1994
10. Prof. Dr. Shamsuddin Jusop
Rock, Mineral and Soil
18 June 1994

Energy Crisis 2050? Global Scenario and Way Forward for Malaysia

11. Prof. Dr. Abdul Salam Abdullah
Natural Toxicants Affecting Animal Health and Production
29 June 1994
12. Prof. Dr. Mohd. Yusof Hussein
Pest Control: A Challenge in Applied Ecology
9 July 1994
13. Prof. Dr. Kapt. Mohd. Ibrahim Haji Mohamed
Managing Challenges in Fisheries Development through Science and Technology
23 July 1994
14. Prof. Dr. Hj. Amat Juhari Moain
Sejarah Keagungan Bahasa Melayu
6 Ogos 1994
15. Prof. Dr. Law Ah Theem
Oil Pollution in the Malaysian Seas
24 September 1994
16. Prof. Dr. Md. Nordin Hj. Lajis
Fine Chemicals from Biological Resources: The Wealth from Nature
21 January 1995
17. Prof. Dr. Sheikh Omar Abdul Rahman
Health, Disease and Death in Creatures Great and Small
25 February 1995
18. Prof. Dr. Mohamed Shariff Mohamed Din
Fish Health: An Odyssey through the Asia - Pacific Region
25 March 1995
19. Prof. Dr. Tengku Azmi Tengku Ibrahim
Chromosome Distribution and Production Performance of Water Buffaloes
6 May 1995
20. Prof. Dr. Abdul Hamid Mahmood
Bahasa Melayu sebagai Bahasa Ilmu- Cabaran dan Harapan
10 Jun 1995

Norman Mariun

21. Prof. Dr. Rahim Md. Sail
Extension Education for Industrialising Malaysia: Trends, Priorities and Emerging Issues
22 July 1995
22. Prof. Dr. Nik Muhammad Nik Abd. Majid
The Diminishing Tropical Rain Forest: Causes, Symptoms and Cure
19 August 1995
23. Prof. Dr. Ang Kok Jee
The Evolution of an Environmentally Friendly Hatchery Technology for Udang Galah, the King of Freshwater Prawns and a Glimpse into the Future of Aquaculture in the 21st Century
14 October 1995
24. Prof. Dr. Sharifuddin Haji Abdul Hamid
Management of Highly Weathered Acid Soils for Sustainable Crop Production
28 October 1995
25. Prof. Dr. Yu Swee Yean
Fish Processing and Preservation: Recent Advances and Future Directions
9 December 1995
26. Prof. Dr. Rosli Mohamad
Pesticide Usage: Concern and Options
10 February 1996
27. Prof. Dr. Mohamed Ismail Abdul Karim
Microbial Fermentation and Utilization of Agricultural Bioresources and Wastes in Malaysia
2 March 1996
28. Prof. Dr. Wan Sulaiman Wan Harun
Soil Physics: From Glass Beads to Precision Agriculture
16 March 1996
29. Prof. Dr. Abdul Aziz Abdul Rahman
Sustained Growth and Sustainable Development: Is there a Trade-Off 1 or Malaysia
13 April 1996

Energy Crisis 2050? Global Scenario and Way Forward for Malaysia

30. Prof. Dr. Chew Tek Ann
Sharecropping in Perfectly Competitive Markets: A Contradiction in Terms
27 April 1996
31. Prof. Dr. Mohd. Yusuf Sulaiman
Back to the Future with the Sun
18 May 1996
32. Prof. Dr. Abu Bakar Salleh
Enzyme Technology: The Basis for Biotechnological Development
8 June 1996
33. Prof. Dr. Kamel Ariffin Mohd. Atan
The Fascinating Numbers
29 June 1996
34. Prof. Dr. Ho Yin Wan
Fungi: Friends or Foes
27 July 1996
35. Prof. Dr. Tan Soon Guan
Genetic Diversity of Some Southeast Asian Animals: Of Buffaloes and Goats and Fishes Too
10 August 1996
36. Prof. Dr. Nazaruddin Mohd. Jali
Will Rural Sociology Remain Relevant in the 21st Century?
21 September 1996
37. Prof. Dr. Abdul Rani Bahaman
Leptospirosis-A Model for Epidemiology, Diagnosis and Control of Infectious Diseases
16 November 1996
38. Prof. Dr. Marziah Mahmood
Plant Biotechnology - Strategies for Commercialization
21 December 1996
39. Prof. Dr. Ishak Hj. Omar
Market Relationships in the Malaysian Fish Trade: Theory and Application
22 March 1997

Norman Mariun

40. Prof. Dr. Suhaila Mohamad
Food and Its Healing Power
12 April 1997
41. Prof. Dr. Malay Raj Mukerjee
A Distributed Collaborative Environment for Distance Learning Applications
17 June 1998
42. Prof. Dr. Wong Kai Choo
Advancing the Fruit Industry in Malaysia: A Need to Shift Research Emphasis
15 May 1999
43. Prof. Dr. Aini Ideris
Avian Respiratory and Immunosuppressive Diseases- A Fatal Attraction
10 July 1999
44. Prof. Dr. Sariah Meon
Biological Control of Plant Pathogens: Harnessing the Richness of Microbial Diversity
14 August 1999
45. Prof. Dr. Azizah Hashim
The Endomycorrhiza: A Futile Investment?
23 Oktober 1999
46. Prof. Dr. Noraini Abdul Samad
Molecular Plant Virology: The Way Forward
2 February 2000
47. Prof. Dr. Muhamad Awang
Do We Have Enough Clean Air to Breathe?
7 April 2000
48. Prof. Dr. Lee Chnoong Kheng
Green Environment, Clean Power
24 June 2000
49. Prof. Dr. Mohd. Ghazali Mohayidin
Managing Change in the Agriculture Sector: The Need for Innovative Educational Initiatives
12 January 2002

Energy Crisis 2050? Global Scenario and Way Forward for Malaysia

50. Prof. Dr. Fatimah Mohd. Arshad
Analisis Pemasaran Pertanian di Malaysia: Keperluan Agenda Pembaharuan
26 Januari 2002
51. Prof. Dr. Nik Mustapha R. Abdullah
Fisheries Co-Management: An Institutional Innovation Towards Sustainable Fisheries Industry
28 February 2002
52. Prof. Dr. Gulam Rusul Rahmat Ali
Food Safety: Perspectives and Challenges
23 March 2002
53. Prof. Dr. Zaharah A. Rahman
Nutrient Management Strategies for Sustainable Crop Production in Acid Soils: The Role of Research Using Isotopes
13 April 2002
54. Prof. Dr. Maisom Abdullah
Productivity Driven Growth: Problems & Possibilities
27 April 2002
55. Prof. Dr. Wan Omar Abdullah
Immunodiagnosis and Vaccination for Brugian Filariasis: Direct Rewards from Research Investments
6 June 2002
56. Prof. Dr. Syed Tajuddin Syed Hassan
Agro-ento Bioinformation: Towards the Edge of Reality
22 June 2002
57. Prof. Dr. Dahlan Ismail
Sustainability of Tropical Animal-Agricultural Production Systems: Integration of Dynamic Complex Systems
27 June 2002
58. Prof. Dr. Ahmad Zubaidi Baharumshah
The Economics of Exchange Rates in the East Asian Countries
26 October 2002
59. Prof. Dr. Shaik Md. Noor Alam S.M. Hussain
Contractual Justice in Asean: A Comparative View of Coercion
31 October 2002

Norman Mariun

60. Prof. Dr. Wan Md. Zin Wan Yunus
Chemical Modification of Polymers: Current and Future Routes for Synthesizing New Polymeric Compounds
9 November 2002
61. Prof. Dr. Annuar Md. Nassir
Is the KLSE Efficient? Efficient Market Hypothesis vs Behavioural Finance
23 November 2002
62. Prof. Ir. Dr. Radin Umar Radin Sohadi
Road Safety Interventions in Malaysia: How Effective Are They?
21 February 2003
63. Prof. Dr. Shamsher Mohamad
The New Shares Market: Regulatory Intervention, Forecast Errors and Challenges
26 April 2003
64. Prof. Dr. Han Chun Kwong
Blueprint for Transformation or Business as Usual? A Structural Perspective of the Knowledge-Based Economy in Malaysia
31 May 2003
65. Prof. Dr. Mawardi Rahmani
Chemical Diversity of Malaysian Flora: Potential Source of Rich Therapeutic Chemicals
26 July 2003
66. Prof. Dr. Fatimah Md. Yusoff
An Ecological Approach: A Viable Option for Aquaculture Industry in Malaysia
9 August 2003
67. Prof. Dr. Mohamed Ali Rajion
The Essential Fatty Acids-Revisited
23 August 2003
68. Prof. Dr. Azhar Md. Zain
Psychotherapy for Rural Malays - Does it Work?
13 September 2003

Energy Crisis 2050? Global Scenario and Way Forward for Malaysia

69. Prof. Dr. Mohd. Zamri Saad
Respiratory Tract Infection: Establishment and Control
27 September 2003
70. Prof. Dr. Jinap Selamat
Cocoa-Wonders for Chocolate Lovers
14 February 2004
71. Prof. Dr. Abdul Halim Shaari
High Temperature Superconductivity: Puzzle & Promises
13 March 2004
72. Prof. Dr. Yaakob Che Man
Oils and Fats Analysis - Recent Advances and Future Prospects
27 March 2004
73. Prof. Dr. Kaida Khalid
Microwave Aquametry: A Growing Technology
24 April 2004
74. Prof. Dr. Hasanah Mohd. Ghazali
Tapping the Power of Enzymes- Greening the Food Industry
11 May 2004
75. Prof. Dr. Yusof Ibrahim
The Spider Mite Saga: Quest for Biorational Management Strategies
22 May 2004
76. Prof. Datin Dr. Sharifah Md. Nor
The Education of At-Risk Children: The Challenges Ahead
26 June 2004
77. Prof. Dr. Ir. Wan Ishak Wan Ismail
Agricultural Robot: A New Technology Development for Agro-Based Industry
14 August 2004
78. Prof. Dr. Ahmad Said Sajap
Insect Diseases: Resources for Biopesticide Development
28 August 2004

Norman Mariun

79. Prof. Dr. Aminah Ahmad
The Interface of Work and Family Roles: A Quest for Balanced Lives
11 March 2005
80. Prof. Dr. Abdul Razak Alimon
Challenges in Feeding Livestock: From Wastes to Feed
23 April 2005
81. Prof. Dr. Haji Azimi Hj. Hamzah
Helping Malaysian Youth Move Forward: Unleashing the Prime Enablers
29 April 2005
82. Prof. Dr. Rasedee Abdullah
In Search of An Early Indicator of Kidney Disease
27 May 2005
83. Prof. Dr. Zulkifli Hj. Shamsuddin
Smart Partnership: Plant-Rhizobacteria Associations
17 June 2005
84. Prof. Dr. Mohd Khanif Yusop
From the Soil to the Table
1 July 2005
85. Prof. Dr. Annuar Kassim
Materials Science and Technology: Past, Present and the Future
8 July 2005
86. Prof. Dr. Othman Mohamed
Enhancing Career Development Counselling and the Beauty of Career Games
12 August 2005
87. Prof. Ir. Dr. Mohd Amin Mohd Soom
Engineering Agricultural Water Management Towards Precision Framing
26 August 2005
88. Prof. Dr. Mohd Arif Syed
Bioremediation-A Hope Yet for the Environment?
9 September 2005

Energy Crisis 2050? Global Scenario and Way Forward for Malaysia

89. Prof. Dr. Abdul Hamid Abdul Rashid
The Wonder of Our Neuromotor System and the Technological Challenges They Pose
23 December 2005
90. Prof. Dr. Norhani Abdullah
Rumen Microbes and Some of Their Biotechnological Applications
27 January 2006
91. Prof. Dr. Abdul Aziz Saharee
Haemorrhagic Septicaemia in Cattle and Buffaloes: Are We Ready for Freedom?
24 February 2006
92. Prof. Dr. Kamariah Abu Bakar
Activating Teachers' Knowledge and Lifelong Journey in Their Professional Development
3 March 2006
93. Prof. Dr. Borhanuddin Mohd. Ali
Internet Unwired
24 March 2006
94. Prof. Dr. Sundararajan Thilagar
Development and Innovation in the Fracture Management of Animals
31 March 2006
95. Prof. Dr. Zainal Aznam Md. Jelani
Strategic Feeding for a Sustainable Ruminant Farming
19 May 2006
96. Prof. Dr. Mahiran Basri
Green Organic Chemistry: Enzyme at Work
14 July 2006
97. Prof. Dr. Malik Hj. Abu Hassan
Towards Large Scale Unconstrained Optimization
20 April 2007
98. Prof. Dr. Khalid Abdul Rahim
Trade and Sustainable Development: Lessons from Malaysia's Experience
22 Jun 2007

Norman Mariun

99. Prof. Dr. Mad Nasir Shamsudin
Econometric Modelling for Agricultural Policy Analysis and Forecasting: Between Theory and Reality
13 July 2007
100. Prof. Dr. Zainal Abidin Mohamed
Managing Change - The Fads and The Realities: A Look at Process Reengineering, Knowledge Management and Blue Ocean Strategy
9 November 2007
101. Prof. Ir. Dr. Mohamed Daud
Expert Systems for Environmental Impacts and Ecotourism Assessments
23 November 2007
102. Prof. Dr. Saleha Abdul Aziz
Pathogens and Residues; How Safe is Our Meat?
30 November 2007
103. Prof. Dr. Jayum A. Jawan
Hubungan Sesama Manusia
7 Disember 2007
104. Prof. Dr. Zakariah Abdul Rashid
Planning for Equal Income Distribution in Malaysia: A General Equilibrium Approach
28 December 2007
105. Prof. Datin Paduka Dr. Khatijah Yusoff
Newcastle Disease virus: A Journey from Poultry to Cancer
11 January 2008
106. Prof. Dr. Dzulkefly Kuang Abdullah
Palm Oil: Still the Best Choice
1 February 2008
107. Prof. Dr. Elias Saion
Probing the Microscopic Worlds by Ionizing Radiation
22 February 2008
108. Prof. Dr. Mohd Ali Hassan
Waste-to-Wealth Through Biotechnology: For Profit, People and Planet
28 March 2008

Energy Crisis 2050? Global Scenario and Way Forward for Malaysia

109. Prof. Dr. Mohd Maarof H. A. Moxin
Metrology at Nanoscale: Thermal Wave Probe Made It Simple
11 April 2008
110. Prof. Dr. Dzolkhifli Omar
The Future of Pesticides Technology in Agriculture: Maximum Target Kill with Minimum Collateral Damage
25 April 2008
111. Prof. Dr. Mohd. Yazid Abd. Manap
Probiotics: Your Friendly Gut Bacteria
9 May 2008
112. Prof. Dr. Hamami Sahri
Sustainable Supply of Wood and Fibre: Does Malaysia have Enough?
23 May 2008
113. Prof. Dato' Dr. Makhdzir Mardan
Connecting the Bee Dots
20 June 2008
114. Prof. Dr. Maimunah Ismail
Gender & Career: Realities and Challenges
25 July 2008
115. Prof. Dr. Nor Aripin Shamaan
Biochemistry of Xenobiotics: Towards a Healthy Lifestyle and Safe Environment
1 August 2008
116. Prof. Dr. Mohd Yunus Abdullah
Penjagaan Kesihatan Primer di Malaysia: Cabaran Prospek dan Implikasi dalam Latihan dan Penyelidikan Perubatan serta Sains Kesihatan di Universiti Putra Malaysia
8 Ogos 2008
117. Prof. Dr. Musa Abu Hassan
Memfaatkan Teknologi Maklumat & Komunikasi ICT untuk Semua
15 Ogos 2008
118. Prof. Dr. Md. Salleh Hj. Hassan
Role of Media in Development: Strategies, Issues & Challenges
22 August 2008

Norman Mariun

119. Prof. Dr. Jariah Masud
Gender in Everyday Life
10 October 2008
120. Prof. Dr. Mohd Shahwahid Haji Othman
Mainstreaming Environment: Incorporating Economic Valuation and Market-Based Instruments in Decision Making
24 October 2008
121. Prof. Dr. Son Radu
Big Questions Small Worlds: Following Diverse Vistas
31 Oktober 2008
122. Prof. Dr. Russly Abdul Rahman
Responding to Changing Lifestyles: Engineering the Convenience Foods
28 November 2008
123. Prof. Dr. Mustafa Kamal Mohd Shariff
Aesthetics in the Environment an Exploration of Environmental: Perception Through Landscape Preference
9 January 2009
124. Prof. Dr. Abu Daud Silong
Leadership Theories, Research & Practices: Farming Future Leadership Thinking
16 January 2009
125. Prof. Dr. Azni Idris
Waste Management, What is the Choice: Land Disposal or Biofuel?
23 January 2009
126. Prof. Dr. Jamilah Bakar
Freshwater Fish: The Overlooked Alternative
30 January 2009
127. Prof. Dr. Mohd. Zobir Hussein
The Chemistry of Nanomaterial and Nanobiomaterial
6 February 2009
128. Prof. Ir. Dr. Lee Teang Shui
Engineering Agricultural: Water Resources
20 February 2009

Energy Crisis 2050? Global Scenario and Way Forward for Malaysia

129. Prof. Dr. Ghizan Saleh
Crop Breeding: Exploiting Genes for Food and Feed
6 March 2009
130. Prof. Dr. Muzafar Shah Habibullah
Money Demand
27 March 2009
131. Prof. Dr. Karen Anne Crouse
In Search of Small Active Molecules
3 April 2009
132. Prof. Dr. Turiman Suandi
Volunteerism: Expanding the Frontiers of Youth Development
17 April 2009
133. Prof. Dr. Arbakariya Ariff
Industrializing Biotechnology: Roles of Fermentation and Bioprocess Technology
8 Mei 2009
134. Prof. Ir. Dr. Desa Ahmad
Mechanics of Tillage Implements
12 Jun 2009
135. Prof. Dr. W. Mahmood Mat Yunus
Photothermal and Photoacoustic: From Basic Research to Industrial Applications
10 Julai 2009
136. Prof. Dr. Taufiq Yap Yun Hin
Catalysis for a Sustainable World
7 August 2009
137. Prof. Dr. Raja Noor Zaliha Raja Abd. Rahman
Microbial Enzymes: From Earth to Space
9 Oktober 2009
138. Prof. Ir. Dr. Barkawi Sahari
Materials, Energy and CNGDI Vehicle Engineering
6 November 2009

Norman Mariun

139. Prof. Dr. Zulkifli Idrus
Poultry Welfare in Modern Agriculture: Opportunity or Threat?
13 November 2009
140. Prof. Dr. Mohamed Hanafi Musa
Managing Phosphorus: Under Acid Soils Environment
8 January 2010
141. Prof. Dr. Abdul Manan Mat Jais
Haruan Channa striatus a Drug Discovery in an Agro-Industry Setting
12 March 2010
142. Prof. Dr. Bujang bin Kim Huat
Problematic Soils: In Search for Solution
19 March 2010
143. Prof. Dr. Samsinar Md Sidin
Family Purchase Decision Making: Current Issues & Future Challenges
16 April 2010
144. Prof. Dr. Mohd Adzir Mahdi
Lightspeed: Catch Me If You Can
4 June 2010
145. Prof. Dr. Raha Hj. Abdul Rahim
Designer Genes: Fashioning Mission Purposed Microbes
18 June 2010
146. Prof. Dr. Hj. Hamidon Hj. Basri
A Stroke of Hope, A New Beginning
2 July 2010
147. Prof. Dr. Hj. Kamaruzaman Jusoff
Going Hyperspectral: The "Unseen" Captured?
16 July 2010
148. Prof. Dr. Mohd Sapuan Salit
Concurrent Engineering for Composites
30 July 2010
149. Prof. Dr. Shattri Mansor
Google the Earth: What's Next?
15 October 2010

Energy Crisis 2050? Global Scenario and Way Forward for Malaysia

150. Prof. Dr. Mohd Basyaruddin Abdul Rahman
Haute Couture: Molecules & Biocatalysts
29 October 2010
151. Prof. Dr. Mohd. Hair Bejo
Poultry Vaccines: An Innovation for Food Safety and Security
12 November 2010
152. Prof. Dr. Umi Kalsom Yusuf
Fern of Malaysian Rain Forest
3 December 2010
153. Prof. Dr. Ab. Rahim Bakar
Preparing Malaysian Youths for The World of Work: Roles of Technical and Vocational Education and Training (TVET)
14 January 2011
154. Prof. Dr. Seow Heng Fong
Are there "Magic Bullets" for Cancer Therapy?
11 February 2011
155. Prof. Dr. Mohd Azmi Mohd Lila
Biopharmaceuticals: Protection, Cure and the Real Winner
18 February 2011
156. Prof. Dr. Siti Shapor Siraj
Genetic Manipulation in Farmed Fish: Enhancing Aquaculture Production
25 March 2011
157. Prof Dr. Ahmad Ismail
Coastal Biodiversity and Pollution: A Continuous Conflict
22 April 2011