

Title: The Evolution Of Niche Width

Full Name: Daniel Thomas Reed

For the Qualification: Doctor of Philosophy

School: School of Biology

Month/Year of Submission: March 2016

The Evolution of Niche Width

This thesis examines the ultimate and proximate determinants of niche width, with a focus on how cognition and biological information processing may drive the evolution of niche width. Using both field and laboratory experiments I investigate how learning can alter resource use in syrphids. Modelling biological information processing using artificial neural networks I consider how various ecological factors interact and can impact information processing to determine decision accuracy (a proposed factor in the evolution of niche width). Finally the ability of artificial neural networks to overcome evolutionary dead ends due to specialisation and functional loss is examined. I found that syrphids were able to use external, inter-specific cues to alter their resource use. Specialist artificial neural networks decision accuracy was altered by the introduction of the ecological variables they were subjected to and the loss of functionality can create an evolutionary dead end scenario only in very extreme cases or under specific ecological pressures.

I studied the syrphid (*Episyrphus balteatus*) both in the field and under laboratory conditions. There is a huge amount of literature describing how bees use scent marks to aid decision making before landing on flowers but there is currently no work on the syrphids ability to detect and utilise these scent marks. The question I posed was ‘Can syrphids modify their pattern of resource utilisation by using this scent mark information?’

The field work was carried out using motion detection cameras positioned above flowers of knapweed (*Centaurea nigra*). The flowers had two different treatments: one was bagged overnight to prevent pollinator access and the other was left unbagged allowing foraging insects to deplete the nectar and pollen. Visits from both conditions were recorded and compared. I found that previously bagged flowers received more visits from both bumblebees (*Bombus* spp.) and syrphids suggesting that syrphids could also detect when a flower was depleted without landing.

The laboratory tests were conducted in an arena using artificial flowers. The experiment was split into a learning phase and a testing phase. I tested the syrphids ability to recognise and learn an association to two different compounds, bee scent marks or 1-Hexanol. I found that syrphids could learn to associate both bee scent marks and 1-Hexanol with negative rewards and use this information to change their foraging behaviour.

I used artificial neural networks to investigate differences between the decision accuracy of specialists and generalists when foraging under ecological pressures. Previous work has shown that specialists had higher decision accuracy when non-host selection carried a mild reward and I was interested to see how ecological variables would impact this advantage. The ecological conditions I considered were search costs, resource availability and starvation. To do this I trained neural networks to recognise different numbers of binary images (hosts) over a range of positive and negative non-host rewards or punishments. The fewer hosts a network had the more specialised it was. I found that both starvation and resource availability reduced the range of non-host values across which specialist networks had a fitness advantage over generalists. Interestingly I found that introducing search costs shifts the range of non-host values where specialist advantage occurs rather than narrowing them as in the previous conditions. Specialists suffering from search costs performed better when non-host selection carried a high to intermediate punishment.

Finally, I used artificial neural networks to investigate the evolutionary dead end theory. This theory states that specialist organisms will lose genetic variation and will be unable to respond as effectively to ecological change. I first trained networks as specialists. These networks were then re-trained as generalists. While re-training networks had a percentage of their weights fixed to simulate the suggested reduction in evolutionary potential of specialists. Ecological conditions in these simulations were either non-host penalties, search costs or a combination of the two. I found that networks were relatively robust to loss of evolutionary

potential. All of the networks performed well even at intermediate (50%) weight fixation. The application of search costs reduced overall network fitness but this effect was not as pronounced as when non-host penalties were introduced. Non-host penalties had the greatest effect on the fitness of networks. These results suggest that specialisation should only become an ‘evolutionary dead end’ under very specific and severe conditions.

Dedication

I dedicate this thesis to my mother, Margaret Reed. She was always incredibly proud of me.

Now I have finally done something to deserve it.

Acknowledgements

The author wishes to thank Dr Colin Tosh (Newcastle University) for reviewing drafts of all chapters. Also thanks to Dr Gordon Port and Dr Barry Brogan for comments on chapters.

Assistance with the Rana Motion Capture system was provided by Dr Mark O'Neill and Dr Sarah Barlow.

This work was funded by the Natural Environment Research Council (NERC).

Thanks to Eve Dosh for tolerating me for the last 4 years. That can't have been easy.

Finally thanks to Dr Samuel Logan, Mr Thomas McDaniel, Dr Lucinda Sweet and Mr Alistair Poll for support in recreational activities, usually in The Northern Stage.

Contents

<u>1. Introduction</u>	1
1.1. <i>Niche Theory</i>	1
1.2. <i>Historical Studies</i>	2
1.3. <i>Current Work on Niche Width</i>	3
1.4. <i>Specialists and Generalists</i>	5
1.5. <i>Competition between Specialists and Generalists</i>	7
1.6. <i>Chapter 1</i>	8
1.7. <i>Cognition and Niche Width</i>	8
1.8. <i>Machine Learning and Artificial Neural Networks</i>	9
1.9. <i>Evolving Artificial Neural Networks</i>	10
1.10. <i>Chapter 2</i>	11
1.11. <i>Chapter 3</i>	12
<u>2. Chapter 1: Olfactory Ecology of the Syrphid, <i>Episyrphus balteatus</i></u>	13
2.1. <i>Abstract</i>	13
2.2. <i>Introduction</i>	14
2.3. <i>Methods</i>	17
2.3.1. <i>Field Work</i>	17
2.3.2. <i>Lab Work</i>	17
2.4. <i>Results</i>	21
2.4.1. <i>Field Work</i>	21
2.4.2. <i>Lab Work – Arena</i>	23
2.4.3. <i>Lab Work – Pots</i>	26

2.5. <i>Discussion</i>	30
<u>3. Chapter 2: The Impact of Resource Availability, Search Costs and Starvation on the Evolution of Decision Accuracy</u>	34
3.1. <i>Abstract</i>	34
3.2. <i>Introduction</i>	35
3.3. <i>Methods</i>	38
3.3.1. <i>Differences from the Methods in Tosh et al (2009)</i>	43
3.4. <i>Results</i>	45
3.4.1. <i>Resource Availability</i>	45
3.4.2. <i>Punishment for Extended Search Time</i>	47
3.4.3. <i>Starvation</i>	48
3.5. <i>Discussion</i>	50
<u>4. Chapter 3: Is Specialised Behaviour an Evolutionary Dead End: Predictions from Connectionist Networks</u>	54
4.1. <i>Introduction</i>	54
4.2. <i>Methods</i>	58
4.3. <i>Results</i>	65
4.4. <i>Discussion</i>	68
<u>5. General Discussion</u>	73
5.1. <i>Chapter 1</i>	73
5.2. <i>Chapter 2</i>	76
5.3. <i>Chapter 3</i>	78
5.4. <i>Conclusions</i>	81
<u>6. References</u>	82

<u>A1. Appendix 1: Olfactory Ecology of the Syrphid, <i>Episyrphus balteatus</i></u>	98
A1.1. <i>Methods – Dimensions of Arena</i>	98
A1.2. <i>Methods – Dimensions of Pots</i>	99
A1.3. <i>1-Hexanol Control Graphs</i>	100
<u>A2. Appendix 2: Is Specialised Behaviour an Evolutionary</u>	
<u>Dead End: Predictions from Connectionist Networks</u>	101

List of Figures

Section 2

Figure 2.1: Graphs of the visit data for bumblebees on previously bagged (solid lines) and previously unbagged (dashed lines) flowers over time as in the total visits graph. 19/08/10 – 26/09/10 were recorded on *Centaurea nigra*. 01/09/10 – 02/09/10 were recorded on *Impatiens glandulifera*.

Figure 2.2.: Graphs of the visit data for syrphids on previously bagged (solid lines) and previously unbagged (dashed lines) flowers over time as in the total visits graph. 19/08/10 – 26/09/10 were recorded on *Centaurea nigra*. 01/09/10 – 02/09/10 were recorded on *Impatiens glandulifera*.

Figure 2.3.: Bar chart showing control trials in the arena. Bars show mean visits \pm 1 SE. Trials were run over between 6-7 days for each treatment.

Figure 2.4: Bar chart showing total visits to bee scent marked vs unscented flower in arena experiments. Trials were run over 14 days. Bars are mean \pm 1 SE.

Figure 2.5: Graph showing confidence intervals for the differences between means of the arena experiments. Control is included to illustrate the increased aversion to 1-Hexanol after syrphids had performed the learning trials.

Figure 2.6: Bar graph showing control data from the pot experiments. Bars are mean \pm 1 SE. There were 9 trials in all and each trial used 6 individuals in separate pots.

Figure 2.7: Bar chart showing mean time spent on bee scent marked vs unmarked flowers during the first hour of the testing phase in the pot experiments. Bars are mean \pm 1 SE.

Figure 2.8: Graph showing confidence intervals for the differences between means of the pot experiments. Control is included to illustrate the increased aversion to 1-Hexanol after syrphids had performed the learning trials.

Figure 2.9: Bar chart showing honeysuckle visitation in the arena. Trials were run over three days for each treatment and lasted 3 hours. Bars are mean visits ± 1 SE.

Section 3

Figure 3.1: Body plan images used as host and non-host resources for the neural networks. The asymmetrical body plan was used to represent hosts while the remaining 30 images represented non-hosts. Figure reproduced from C. R. Tosh *et al.* (2009).

Figure 3.2: Example of an input to the network. The ‘retina’ contains the projections of host/non-host resources. Networks can choose any of the 8 larger 5x5 squares. This decision is output as a binary 3 digit code. Based on the area chosen the network is either punished or rewarded. Figure reproduced from C. R. Tosh *et al.* (2009).

Figure 3.3: The effect of resource availability on decision accuracy. Level of network specialisation relates to the number of resources a network considered hosts. Extreme specialists had one host through to the extreme generalists with ten hosts. Network decision accuracy is the number of correct choices the networks make when tested with 250 projections after training. Error bars show $\pm 95\%$ CI, $n = 10$. Only 50% and 10% have been illustrated to show the range of values and the changing pattern of the data.

Figure 3.4: The effect of search time penalties on decision accuracy. Level of network specialisation relates to the number of resources a network considered hosts. Extreme specialists had one host through to the extreme generalists with ten hosts. Network decision accuracy is the number of correct choices the networks make when tested with 250 projections after training. Error bars show $\pm 95\%$ CI, $n = 10$. Punishment values were applied

to networks during training choosing an empty space. Only the extreme punishments have been included in the figure to illustrate the effects of search costs. -1 and -2.5 punishment results were intermediate to these.

Figure 3.5: The effect of starvation on decision accuracy. Level of network specialisation relates to the number of resources a network considered hosts. Extreme specialists had one host through to the extreme generalists with ten hosts. Network decision accuracy is the number of correct choices the networks make when tested with 250 projections after training. Error bars show $\pm 95\%$ CI, $n = 10$.

Section 4

Figure 4.1: Body plan images used as host and non-host resources for the neural networks. The asymmetrical body plan was used to represent hosts while the remaining 30 images represented non-hosts. Figure reproduced from C. R. Tosh *et al.* (2009).

Figure 4.2: Showing control data for the no punishment simulation. Data shows the mean fitness score for all networks at each generation as they retrain as generalists. Included are the data for 0% fixed weights, 100% fixed weights and random selection. Also included is the maximum possible fitness score for comparison. Random data refers to networks choosing one of the 8 hosts at random.

Figure 4.3: Graph showing the final mean fitness score $\pm 2SE$ after retraining as generalists for networks for each percentage of fixed weights. We used $\pm 2SE$ to aid in visualisation as the errors were very small. Included are the data for no punishment (black), search costs (blue), non-host punishment (green) and both search costs and non-host punishment (red).

Figure 4.4: Graph showing the percentage of maximum fitness networks were able to recover. Maximum fitness possible was calculated as the difference between final fitness at 0% fixed weights and final fitness at 100% fixed weights. At each level of fixation we recorded the

difference between that simulations final fitness and final fitness at 100% fixed weights. We then calculated the percentage of final fitness that this represented from the maximum. Error bars have been omitted due to their small size and for ease of visualisation of the data. See Table A2.2 for data.

Section A1

Figure A1.1: Dimensions of arena and artificial flowers.

Figure A1.2: Dimensions of the pots used in the pot trials.

Figure A1.3: Dimensions of pots containing 1-Hexanol solution.

Figure A1.4: 1-Hexanol controls for mineral oil/1-Hexanol solution. Data is from arena trials run over 4 days for one hour each day.

List of Tables

Section 2

Table 2.1: Data from the GLME investigating the relative impacts of different factors relating to syrphid visitation to the previously bagged flower.

Section 4

Table 4.1: Showing the percentage of maximum fitness (difference between fitness at 0% fixed weights and 100% fixed weights) that networks were able to recover at 50% fixed weights and 90% fixed weights. Data is from Table A2.2.

Section A2

Table A2.1: Actual mean final fitness scores for all network conditions after 500 generations at all different weight fixation levels. Maximum fitness possible is the difference between 0% fixed weights and 100% fixed weights. This data was used to produce Figure 4.3 and Table A2.2.

Table A2.2: Percentage of maximum fitness (difference between fitness at 0% fixed weights and 100% fixed weights) networks were able to recover. Figure 4.4 shows a graphical representation of this data and was used to produce Table 4.1.

1. Introduction

1.1. Niche Theory

There are many different descriptions of what an ecological niche is (Grinnell, 1917; Elton, 1927) and it was in fact Grinnell that first used the term as it is used now when he referred to the Californian Thrasher (*Toxostoma redivivum*). He defined the niche as ‘...various circumstances, which emphasize dependence upon cover, and adaptation in physical structure and temperament thereto...’ However this is clearly archaic and the definition of niche that I will use throughout this thesis is that of Hutchinson (1958). He describes a niche as an n-dimensional hypervolume in N-space. Hutchinson’s description of the fundamental niche states that each dimension of the niche will have an upper and lower limit based on the organism’s tolerances or suite of abilities. Together these limiting factors combine to provide a multi-dimensional description of the range of factors that will allow an organism to persist in its environment.

To define niche width we must think about the fundamental niche of an organism in the first instance. This fundamental niche covers the range of habitats and resources the organism can potentially survive within. This, however, is an unrealistic scenario as due to pressures from the abiotic and biotic environment the actual or realised niche of an organism will usually be much narrower than the fundamental niche (Hutchinson, 1958). So the difference between a fundamental niche and a realised niche will depend upon the conditions in which the organism finds itself at any given time and place. Care must be taken when reviewing work on niche theory however as there are many possible definitions and these can differ greatly in their terms (Whittaker *et al.*, 1973).

A major problem when investigating niche width is how it is measured. The nature of the n-dimensional hypervolume creates many axes over which the niche is partitioned. It is not only the measuring of these factors that could potentially be a source of error. It could be argued that a larger problem is actually establishing what the dimensions are. This is often far from intuitive and any errors will change the shape of the recorded niche, possibly skewing data or invalidating the work altogether. Many studies have attempted to clarify this issue (Collier *et al.*, 1972; Vandermeer, 1972) and thanks to this work there are several methods available to minimise errors when accumulating or assessing data relating to the niche of an organism.

1.2. Historical Studies

Historically the methods of studying niche width have stressed the value of using actual ecological data (Colwell and Futuyma, 1971; Pielou, 1972; Roughgarden, 1972) however many of these studies also stress that we must be aware of the relative weighting of the different factors. Simply measuring every aspect of niche width will not provide us with an accurate predictive niche width for our subject. Pielou (1972) also stresses that using data recorded in the field will only provide information on the realised niche and not necessarily on its fundamental niche. This can pose a problem for the ecologist when assessing habitat for the introduction of an organism. Potentially suitable locations could be discounted due to pressures in the study areas preventing colonisation of similar habitat, or unsuitable habitats could be chosen based on factors which have been weighted too highly. Despite these concerns the use of recorded ecological data remains a common method of studying niche width.

Initially the idea of ecological niches was restricted to ecological studies but it was not long until the term moved into other areas with population geneticists (Remington, 1968), microbiologists (Hungate, 1955) and biochemists (Jones, 1961) applying the term to research

in other fields. The term ecological niche was also quickly taken up by evolutionary biologists and has remained very common to the present day in the relevant literature.

1.3. Current Work on Niche Width

Futuyma and Moreno (1988) suggested that the study of “The evolution of ‘niche breadth,’ or ‘niche width,’ was a more popular topic in the evolutionary ecological literature of the 1960s and 1970s”. This may have been true at the time but a great deal of work has been undertaken in this field in more recent years and this remains an active area of research (Fridley *et al.*, 2007; Layman *et al.*, 2007; Bolnick *et al.*, 2010). With new techniques and approaches our ability to investigate this topic has greatly increased. Modern investigations of niche width often concentrate not on the actual niche itself but the mechanisms driving the dimensions of the niche (Bolnick, 2001; Svanbäck and Persson, 2004). This, combined with the numerous studies based on theoretically predicting niche width (Nagelkerke and Menken, 2013; Bar-Massada, 2015), has increased our understanding of the complex relationships that exist between the organism and its niche.

Methods such as geographic information systems (GIS), artificial neural networks (ANNs), and differential equations have been employed successfully to show how variables such as environment and attentional load impact the formation and maintenance of niche width (Holmes *et al.*, 1994; Gehring and Swihart, 2003; Park *et al.*, 2003). The combination of these different techniques have allowed scientists to locate small populations of rare species and have increased the accuracy of assessing where surveys should be performed when recording distributions (Dunn *et al.*, 2015). Our understanding of niche theory has also enabled us to begin to understand how the evolution of an organism is influenced by its ecological niche.

Selection pressures such as competition for resources and changing landscapes will alter the realised niche of a population but when these pressures become high enough the fundamental niche can be affected (Bolnick, 2001). Changes to the fundamental niche will be genetic in nature leading to behavioural or physiological changes which can result in the organism becoming more 'specialised' or more 'generalised'.

Many determinants of niche width exist such as competitive exclusion, habitat fragmentation, local availability of hosts etc. and I will discuss two of these below. These are both important in creating the ecological niche of a species but are not the focus of this thesis and are included for completeness only.

Adaptive trade-offs involve species performing behaviour that could, at first glance, be considered to be non-adaptive. Species reducing their resource range despite many possible hosts, or utilising toxic hosts when non-toxic hosts are present are examples of this. This has been demonstrated in the evolution of some angiosperms towards improved pollination by specialist pollinators. This will reduce the number of animals capable of pollinating the organism. However, this will also improve the pollination benefits from the specialist species that remain (Muchhala, 2007). These trade-offs can also shape the evolution of species that are more mobile than plants. Schluter (2009) demonstrated that changes in morphology of sticklebacks (*Gasterosteus* sp.) can impact fitness in different foraging environments. Larger benthic species suffer reduced growth when foraging in open water, compared with the smaller limnetic species, due to their morphology; this pattern is reversed when both are foraging in the littoral zone. Trade-offs such as these can have significant impacts on the dimensions of the organisms' realised niche which, over time, could alter the fundamental niche.

Enemy-free space is another likely determinant of niche width. Jeffries and Lawton (1984) define enemy-free space as 'ways of living that reduce or eliminate a species' vulnerability to one or more species of natural enemies'. In this case niche width can be altered by a species moving from an area with high predation into a relatively low predation area despite possible reductions in resources or loss of some benefit those resources provide (Ballabeni *et al.*, 2001). Alternatively this could involve egg laying on hosts which are less rewarding for larvae but have less predation risk associated with them (Wiklund and Friberg, 2008; Rodrigues *et al.*, 2010). Reduced predation will allow for longer foraging trips and less vigilance behaviour allowing the organism to maximise fitness in the area. This would not be possible in a high predation area as the need for vigilance and shorter foraging periods could reduce fitness even when resources were more abundant or of higher quality. This will change the realised niche of the organism in the short term but if resource type changes in the enemy-free space the organism moves to then this could, over time, also impact the fundamental niche as the organism evolves in the new environment (Atsatt, 1981).

1.4. Specialists and Generalists

Organisms are often classified as either generalist or specialist species. These can be rather broad terms and a suitable definition is useful. We will use the term generalist mostly as equivalent to polyphagous (many potential hosts) and specialist as equivalent to oligophagous (few hosts) or monophagous (a single host) as in Futuyma and Moreno (1988). The range of resources eaten by an organism is a good proxy of specialisation or generalisation as it provides insight into not only diet but also physiology via the ability to digest several different hosts or potentially toxic resources and cognitive and morphological abilities through the ability to locate and handle different prey types or hosts. Many recent studies in niche theory have investigated the relationship of specialist organisms to their realised or

fundamental niche. It is thought that the wider niche of generalist species means changes in resources or climate should have relatively less of an effect on their fitness than they would with specialists (Kassen, 2002). It should be mentioned that it has been argued that this could lead to the opposite scenario in which specialists react more quickly to evolutionary pressures than generalists (Whitlock, 1996). This is by no means the consensus however with several studies showing that specialist species are more at risk from climate fluctuations in particular than generalists (Warren *et al.*, 2001; Robert J Wilson *et al.*, 2007; Gilman *et al.*, 2010). Obviously given the current rate of climate change and habitat loss for many species this factor is of great concern. The question of whether a species will be sufficiently able to adapt to the changing environment is one being asked of many different species.

Studies of the evolution of specialist and generalist organisms often look at the relative fitness of the different strategies (David Sloan Wilson and Yoshimura, 1994). Different species foraging in the same environment often have very different degrees of specialisation and it is not always readily apparent why this should be the case. The fundamental niches of apparently similar species can be very different. Inter-specific competition is thought to be a common driver of specialisation with less competitive species being forced onto less rewarding hosts and having to then adapt or decline and possibly go extinct (Futuyma and Moreno, 1988). Comparisons of specialist and generalist organisms can be useful for many reasons. In ecology, habitat utilisation information of both specialists and generalists can help build models that predict occurrence of species given the local conditions and community (Dunn *et al.*, 2015).

More recently there has been renewed interest in the idea that generalist and specialist populations are actually made up of individuals whose realised niche is much smaller than the

species' fundamental niche. The realised niche of these individuals can be very different to conspecifics but can result in the observed rapid adaptations to changing conditions (Bolnick *et al.*, 2007) or often, in the case of specialists, the inability to adapt. Many studies have suggested that generalist species are replacing specialists in diverse different habitats, across many different taxa (Fisher *et al.*, 2003; Munday, 2004; Rooney *et al.*, 2004). This loss of specialists can result in functional homogenisation (Clavel *et al.*, 2010). If a habitat undergoes functional homogenisation the range of services provided by that ecosystem will decrease. Specialists are lost and are replaced by generalists lacking the behaviours or adaptations to perform the same tasks as the locally extinct specialists. This will further impact the local environment with species that relied on the specialists, for pollination, as prey etc., suffering fitness losses or becoming locally extinct in turn.

1.5. Competition between Specialists and Generalists

Both specialists and generalists will regularly encounter competition from other species. The effect of competing generalist species was the idea behind the first chapter of this thesis. The overall premise of this initial work was to investigate the effect on the realised niche width of one competing generalist species when foraging closely with another species with similar foraging behaviour. I also wanted to investigate whether generalist – generalist competition could impact evolution via behaviour. There has been a great deal of work on many of the pollinating hymenoptera, especially the European honeybee (*Apis mellifera*) which has been studied for around 100 years (Minnich, 1919; Bitterman *et al.*, 1983; Genersch, 2010).

Bumblebees (*Bombus* spp.) are less commonly studied than honeybees however there is still a huge body of work on these pollinators (Plath, 1923; Kullenberg *et al.*, 1973; Hagen *et al.*, 2011). I was interested in how the behaviour of bumblebees could shape the behaviour and evolution of syrphids, a competing generalist species. In the complex and often patchy

environment in which syrphids forage, information regarding the reward available at any given location would improve foraging efficiency. It is well known that many different species of bee can deposit and detect scent marks of not just their own species but of many conspecifics as well (Giurfa, 1992; D Goulson, Hawson, SA, & Stout, JC, 1998; Gawleta *et al.*, 2005). The benefits of being able to make foraging decisions without having to alight are obvious and we could expect this ability to be found in other species that forage in a similar manner and/or environments.

1.6. Chapter 1

Chapter 1 concerns itself with the foraging of syrphids in both the field and in laboratory based conditions. I wanted to investigate several questions in this chapter: Are syrphids able to detect the scent marks of bumblebees at all? If so, can foraging syrphids use these scent marks to aid their foraging decisions i.e. alter their realised niche? Can other odours be used by syrphids to improve their foraging accuracy?

1.7. Cognition and Niche Width

The cognitive ability of an organism can have a role in niche structure. The neural limitations hypothesis (NLH) is an excellent example of how cognition can alter the niche width of a species. This theory predicts that a generalist species will suffer from reduced decision accuracy when compared to a specialist due to limitations in neural processing ability and a higher attentional load (Futuyma and Moreno, 1988; Dall and Cuthill, 1997; Wee and Singer, 2007). If this is true then generalists should be at a disadvantage when conditions are the same for both the generalists and specialists. This theory was the main focus of chapter two. I used ANNs trained to be resource specialists or generalists via a genetic algorithm and compared

network decision accuracy once trained and how this is affected by different ecological factors during evolution.

1.8. Machine Learning and Artificial Neural Networks

Famously it was Alan Turing (1950), in his paper ‘Computing Machinery and Intelligence’, who made simulated thought and learning popular in both the scientific community and among the public. He described a computer that could evolve to become more adept at problem solving. This was just the beginning however and much work was needed before the development of the methods used by scientists and engineers today. The combination of different techniques has provided many varied solutions to the concepts proposed by Turing since then. Artificial neural networks (ANNs) had been around for some time when he wrote his paper (McCulloch and Pitts, 1943) but at the time they were not capable of the things Turing predicted. Since they were first described ANNs have been applied to a range of diverse fields. These range from civil engineering (Flood and Kartam, 1994), aeronautics (Faller and Schreck, 1996) and even medical procedures (Abbass, 2002). ANNs are now a relatively common tool for scientists in all fields and provide an excellent theoretical approach to solving problems. From the perspective of the biologist ANNs have become a useful tool. They have been applied to several problems such as predicting presence and abundance of species in different habitats (Park *et al.*, 2003), the prediction of adverse ecological effects (Recknagel *et al.*, 1997) and the sorting of biological molecules and sequences (Wu, 1997). More relevant to this work is the application of ANNs to investigating the evolution of behaviour. Using neural networks has provided biologists with an excellent tool to explore evolution in a way that was previously almost impossible. Neural networks have been employed to study the evolution of beneficial grouping behaviour (Ferrauto *et al.*, 2013), the evolution of altruism (Waibel *et al.*, 2011) and attention to conspecifics displays in

túngara frogs (Steven M Phelps and Ryan, 1998; SM Phelps and Ryan, 2000) to name just a few. The use of simple ANNs to study animal behaviour is often called ‘connectionism’.

1.9. Evolving Artificial Neural Networks

There are several methods of evolving ANNs to improve their behaviour (Yao, 1993). A common method, and the one which I have used in this thesis, is the genetic algorithm (GA). John Henry Holland was instrumental in the development of the GA and his work is still the foundation of many GAs to this day (Holland, 1992). Another of the major pioneers of GAs was Hans-Joachim Bremermann (1962). He, along with Holland, helped develop the GA into what it is today. These GAs use the principles of genetic evolution to evolve ANNs stochastically via mutation, insertion and recombination. This allows networks to be modified through random change, simulating Darwinian evolution. The weights connecting the artificial neurons in the ANNs are subjected to this modification and are rewarded for accuracy by way of a fitness value. This fitness score is used to select the highest performing networks which are then used to create the next generation of networks. When creating the next generation the weights from the selected networks are subjected to mutation and crossover to create new, potentially higher performing networks (Mitchell, 1998). Over time this significantly improves the performance of the ANN. As biologists this is a very exciting prospect. It is often very difficult, if not impossible, to study the evolution of a species directly. This is especially true of larger, longer lived organisms. GAs are useful to study the evolution of complex systems and, as much of the organic structure of an organism consists of complex systems, this makes them a very useful tool. Complex interactions at the species or community level can also be studied using this method which would be very difficult to study in the field. The GA allows us to simulate the main processes involved in this evolution and make predictions based on many different variables. GAs are now often used in the study of

behavioural evolution in both robot systems (Floreano and Keller, 2010) as well as more biologically relevant ones (Kamo *et al.*, 1998; C. R. Tosh *et al.*, 2009; Lewis *et al.*, 2010)

1.10. Chapter 2

My studies have focussed on the evolution of ecological niche width and how this can influence the persistence and success of organisms. Specialist and generalist organisms interacting in an environment will face different challenges. This will create pressure on the behaviour and evolution of the species over time. How this impacts on the evolution of niche width is the main focus of this thesis. Chapter 2 investigates the decision accuracy of specialist and generalist ANNs when foraging in a complex environment under ecological pressures. This is an extension of the work of C. R. Tosh *et al.* (2009) who found specialist networks only displayed a higher decision accuracy than generalists when a poor foraging choice was associated with no penalty or a small reward. This work in turn was elaborating on the work of EA Bernays (2001) and her neural constraints hypothesis. Interestingly it was not high punishments for making errors in foraging that improved decision accuracy. In this original work the networks had little in the way of ecological pressures applied to their evolution. In my work I introduced three different ecological factors; search costs, starvation and resource availability. These factors were each applied separately and network decision accuracy was compared across different degrees of specialisation or generalisation. Insight into the mechanisms that drive specialisation could provide us with a better understanding of community structure and resource utilisation within natural ecosystems.

1.11. Chapter 3

Finally I wanted to investigate the evolutionary dead end theory first proposed by George Gaylord Simpson (1944). The theory predicts that specialist organisms should be less able to shift host preferences and thereby change their ecological niche. This is based on the hypothesis that specialist species have lost variation, either in their suite of behaviours or their genetics, for which there is some evidence (PJ Smith and Fujio, 1982; Futuyma and Moreno, 1988; Lahti *et al.*, 2009). This inability to adapt to changing conditions is predicted to cause many specialist species to become trapped in their ecological niche and should the resources or conditions they rely on change then they would be expected to become extinct. This idea has received both support (Nancy A Moran, 1988; Futuyma and Mitter, 1996; Andrew B Smith and Jeffery, 1998; Colles *et al.*, 2009) and criticism (Flessa *et al.*, 1975; Armbruster and Baldwin, 1998; Janz *et al.*, 2001; Nosil and Mooers, 2005) and remains a common thread throughout the literature. Chapter 3 examines the ability of ANNs to evolve from specialists to generalists. During this process the ANNs have a percentage of their network weights fixed to remove some of the variation available. This simulates the reduced variation seen in specialist organisms and should, if the evolutionary dead end theory is correct, impair the ability of specialists to expand their host range. I also introduced ecological variables to assess the impact of external factors. These ecological variables were either non-host penalties, search costs or a combination of the two. Would specialists with limited variability have difficulty re-generalising? How do the introduced ecological penalties affect the ability of these networks to re-generalise? Which ecological factor has the greatest impact on the range expansion of specialists?

2. Chapter 1: Olfactory Ecology of the Syrphid, *Episyrphus balteatus*

2.1. Abstract

The ability of pollinators to detect plant odours and species specific scent marks have been well studied however almost all of this work has concentrated on different species of bees. We investigated the syrphid *Episyrphus balteatus* and its ability to detect and learn to associate these odours with a reward. In field trials we used previously bagged and previously unbagged flowers to test visitation rates. Both bees and syrphids showed a significant preference for the previously bagged flowers. This provided good evidence that bees and syrphids could detect a reward without landing on the flower. We followed this with laboratory trials in which visitation behaviour of syrphids was recorded. We presented different odours and associated these with unrewarding artificial flowers to discover if syrphids were able to learn odour cues when making short range foraging decisions. *E. balteatus* consistently learned and responded to both *Bombus* sp. scent marks and a plant volatile (1-Hexanol). The syrphids were able to develop short term memory based on exposure to these odours and learned to avoid scented artificial flowers when reward in both scented and unscented flower was subsequently equalised. We discuss possible applications of this finding and implications for pollinator and pest management.

2.2. Introduction

Pollinators around the world are in serious decline (Potts *et al.*, 2010). The majority of the current research has focused on bees, especially the European honey bee (*Apis mellifera* (L.)) (Bacandritsos *et al.*, 2010; Genersch, 2010). Much of the remainder of the work has concentrated on bumblebees and solitary bees (D. Goulson *et al.*, 2008; Ricketts *et al.*, 2008). Very little work has concentrated on the syrphids as pollinators, probably due to syrphids being much less commercially important than bees. However, syrphids play a substantial role in wildflower pollination and should not be overlooked (D. Goulson and Wright, 1998). With the global reduction in many pollinator species numbers, particularly bees (Ghazoul, 2005), it is becoming increasingly important to better understand the less well studied groups that could reduce the impact of this decline.

Pollinators must forage in highly complex environments. They face many challenges including competition from many other species as well as conspecifics, variation in reward due to flower size, handling time differences between complex and simple inflorescences and stochastically distributed resources. Optimal gains will only be possible when methods are employed to minimise time spent searching for the next rewarding flower (Zimmerman, 1982; D. Goulson, 1999).

When foraging, pollinators should aim to locate rewarding flowers while avoiding revisiting flowers they or another pollinator have recently depleted. One of the most common and widely used tactics is the direct detection of pollen or nectar using visual cues (D Goulson, Chapman, JW, & Hughes WHO, 2001). Simple radial flowers often have clearly visible rewards which can be easily seen by an animal as it passes allowing the reward contained to

be assessed and enabling a decision to visit the flower to be made. This is likely to be the primary method employed and is arguably the most important.

Flight directionality and flower constancy are used by both bees (L Chittka, Gumbert, A, & Kunze, J, 1997; L. Chittka *et al.*, 1999; Gegeer, 2005) and syrphid pollinators (D. Goulson and Wright, 1998) moving through a patchy environment with differing possible rewards. These methods enable decisions to be made at relatively large distances from a flower.

Night flowering plants such as *Petunia axillaris* (Lam.) attract moths using very specific complex odours while many day flowering plants use different odours depending on their preferred pollinator (Hoballah *et al.*, 2005). Many of the components of these scents are attractive to pollinators individually or as components of other complex compounds. These scents are often used to locate flowers but nectar scents have also been isolated that are thought to provide pollinators with information regarding the size of the reward present at the inflorescence (Howell and Alarcón, 2007). Honey bees (*A. mellifera*), bumblebees (*Bombus* spp.) and several solitary bee species commonly use scent marks deposited from the hind tarsi to provide information about possible nectar content when approaching a flower (Free and Williams, 1983; Wetherwax, 1986; D Goulson, Stout, JC, Langley, J, & Hughes WOH, 2000). Scent marks can be repellent or attractive (Giurfa, 1992; D Goulson, Hawson, SA, & Stout, JC, 1998) and allow these pollinators to avoid revisiting flowers and recognise flowers that are particularly rewarding or have been drained by another individual. Interspecific recognition of scent marks has been illustrated in many studies focusing on bees (D Goulson, Hawson, SA, & Stout, JC, 1998; J. C. Stout *et al.*, 1998; JC Stout, & Goulson, D, 2001). Syrphids forage in the same environments so they will also have to locate rewarding flowers

and could be using bee scent marks to maximise their foraging efficiency.

Odour is also an important aid to learning in many species. Floral scent has been used to elicit a conditioned response (proboscis extension) from harnessed honeybees and bumblebees (bees restrained in a harness leaving only the head free to move) (Bitterman *et al.*, 1983; Laloï *et al.*, 1999). Learning, both long and short term, has been demonstrated in *Drosophila melanogaster* (Belvin and Yin, 1997). *D. melanogaster* have also been trained to select foods based on the association of an odour with a reward or punishment (Fiala, 2007). This method of odour learning would suit the environment in which pollinators forage and would increase foraging success for most species, if not all.

In this study we investigate the effect of *Bombus* spp. scent marks on syrphid foraging behaviour using pollinator excluded flowers in the field, and in focussed experiments in the laboratory. We also examine the ability of a syrphid species (*Episyrphus balteatus* (Degeer)) to learn to associate bee scent and a plant volatile (1-Hexanol) with a lack of reward. *Lonicera periclymenum* (European honeysuckle) flowers were also introduced to investigate the ability of syrphids to use nectar odour as an aid to learning. We initially suggest that bee scent marking behaviour will influence syrphid foraging in the field. We also predict that syrphids will be able to learn to use odours to aid foraging decisions in laboratory trials on artificial flowers. Finally we hypothesise that syrphid behaviour should be influenced by the presence or absence of nectar in honeysuckle flowers.

2.3. Methods

2.3.1. Field Work

Our field site was at the Close House biological field station in Heddon-on-the-Wall in Northumberland, England. Phillips SPC1330 webcams were supported at 20cm above flowers of Knapweed (*Centaurea nigra* (L.)) and Himalayan balsam (*Impatiens glandulifera* (R.)) using clamp stands. The flowers were tied to canes to prevent excessive movement that would interfere with the motion detection software. Data was recorded on six days from the 19th August 2010 – 2nd September 2010. The cameras recorded from 23:00 of one day to 23:00 on the next. Cameras were connected to notebook computers which used the newly developed Rana motion capture software (O'Neill, 2012) to record only when larger pollinators were present. This included most Syrphid and all *Bombus* species but not smaller invertebrates such as pollen beetles or aphids. Visits by both of these groups were recorded separately. To test our first hypothesis, that syrphid behaviour is affected by bee scent marking behaviour, perforated bags were used to seal off pollinator access to two of four inflorescences. This was done at around 4pm the preceding day and flowers were unbagged at around 10am on the day of the experiment. When the bags were removed the pollinators had full unrestricted access to the flowers. The visits to both bagged and unbagged flowers were recorded until the cameras stopped recording due to insufficient light. This footage was then reviewed and the number of visits to each flower was recorded. This was done separately for each hour of the day. Footage was reviewed using software capable of frame by frame playback to enable accurate identification of species visiting the flowers.

2.3.2. Lab Work

Episyrphus balteatus used in the lab were initially acquired from Katz Biotech. These were kept in a BugDorm-2120 Insect Rearing Tent (60x60x60 cm, cat no. BD2120), which doubled

as the flight arena for the free flying trials. Individuals were constantly replaced from our laboratory culture or purchased from Katz Biotech to maintain a population size of 100 to 125 individuals. The laboratory culture was maintained at 20°C with an 18/6 day night cycle with a relative humidity of 60-70%. Syrphids were fed using Raw Living organic bee pollen and a 1:1 mixture of Rouse™ Organic Honey and water. We used this honey/water solution for fly maintenance and as experimental reward (see below) rather than a sucrose solution as the syrphids were reluctant to visit the sucrose when it was offered, no matter the concentration.

Free flying experiments were all done in the BugDorm and the flies had unrestricted access to two artificial flowers with differing treatments. The artificial flowers were positioned within the arena, 15cm apart beneath a camera which recorded visits (for complete dimensions see Figure A1.1). Any treatments using bee scent used a bumblebee (*Bombus terrestris*) that had died within the previous 48 hours. The hind tarsi of the bee were rubbed over the surface of the blotting paper to impregnate it with the scent. This was done directly prior to the flower being introduced to the syrphids. As scent marks can remain repellent for between 20 minutes to 24 hours (J.C. Stout and Goulson, 2002) we reapplied the scent every hour. Renewing the scent was achieved by removing the flower and applying the scent using the same method as mentioned previously. When this was done both of the flowers were removed, the original scent marked flower was treated, then both were re-introduced.

The 1-Hexanol used in these experiments was diluted with mineral oil (Sigma-Aldrich, Cat. no. 33. 077-9) to a concentration of 1:500. Greater concentrations had adverse effects on the syrphids and often caused death. During 1-Hexanol trials the solution was contained in separate pots placed adjacent to one of the flowers to prevent contact with the animals as this also proved to be fatal in most cases. These pots were covered with gauze to further prevent contact (See Figure A1.3). Syrphids could therefore only use olfaction to locate the odour. A

second small pot containing tap water was placed next to the other flower but otherwise set up as above. Honeysuckle (*L. periclymenum*) was purchased from a local grower and was brought to flower in a glasshouse on site. Two plants were used to provide the flowers for these trials. Flowers were removed from the plant immediately prior to being used in the trials. Four flowers were used in each trial. These were all taken from the same plant for each trial. Two were drained of nectar using capillary tubes and the others were unaltered.

The free flying trials were conducted in the BugDorm enclosure and lasted for 5 hours. To test the second hypothesis, that syrphids can learn to use odours to aid foraging decisions, six treatments were used for the learning stage of 3 hours.

1. Both artificial flowers had no odour and contained an equal reward of honey/water (control).
2. Both artificial flowers contained an equal rewards and one had *Bombus* scent marks applied and (control).
3. Both artificial flowers contained equal rewards and one was paired with 0.2 ml of the 1-Hexanol/mineral oil solution (control).
4. The first artificial flower had no reward with *Bombus* scent marks applied. The second had no scent applied and contained a reward of honey/water.
5. The first artificial flower had no reward and was paired with 0.2 ml of the 1-Hexanol/mineral oil solution. The second had no scent applied and contained a reward of honey/water.
6. Artificial flowers were replaced with honeysuckle flowers. These were supported in eppendorf tubes in the same way the artificial flowers were arranged. One of the tubes contained two flowers that had been drained of nectar and the other contained the unmodified flowers.

The three control trials were included to ensure that no innate preference would influence the results. As the reward in all three controls was equal in both flowers there would be no advantage in using odour to aid foraging and therefore any difference in visitation should be due to a reaction to the odour itself and not a potential reward. We had, at this stage, already run directional preference controls. As there is no directional preference there was no necessity for further controls to be used (Figure A1.4). For the remaining two hours (testing phase) the odours remained the same but the rewards were all equalised. Rewarding flowers contained cotton wool soaked in 1:1 honey/water solution while the unrewarding flowers contained only dry cotton wool. Positions of flowers were switched when rewards were equalised in case of any learned positional preference.

We also ran learning trials in small clear pots containing smaller artificial flowers made from eppendorf tubes cut through the centre (for complete dimensions see Figure A1.2.). These were otherwise constructed in the same way as the larger flowers. Treatments were exactly as in the trials in the flight arena with only one syrphid in each bottle. These trials were intended to provide the individual syrphids greater exposure to the experimental odours. In the arena, syrphids had a large area in which to move around and some individuals never came into contact with the artificial flowers during the course of a trial. The reduced area in the bottles was intended to force the individual to make a choice between the two stimuli. Bottles and treatments within the bottles were oriented in opposite directions to correct for any innate directional preference.

2.4. Results

2.4.1. Field Work

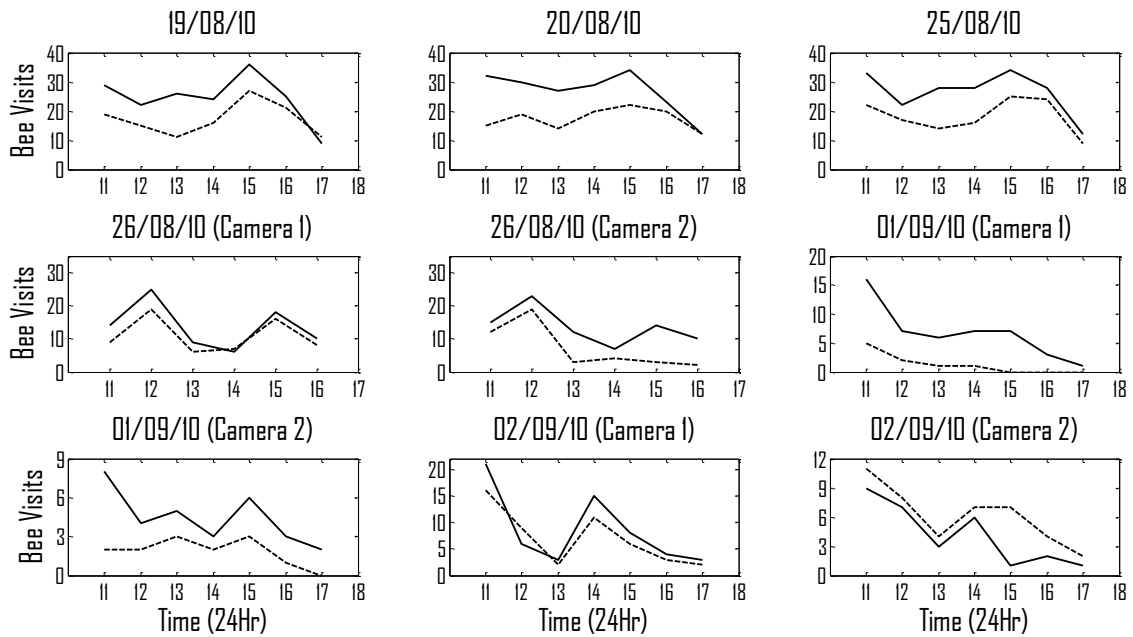

Figure 2.1: Graphs of the visit data for bumblebees on previously bagged (solid lines) and previously unbagged (dashed lines) flowers over time as in the total visits graph. 19/08/10 – 26/09/10 were recorded on *Centaurea nigra*. 01/09/10 – 02/09/10 were recorded on *Impatiens glandulifera*.

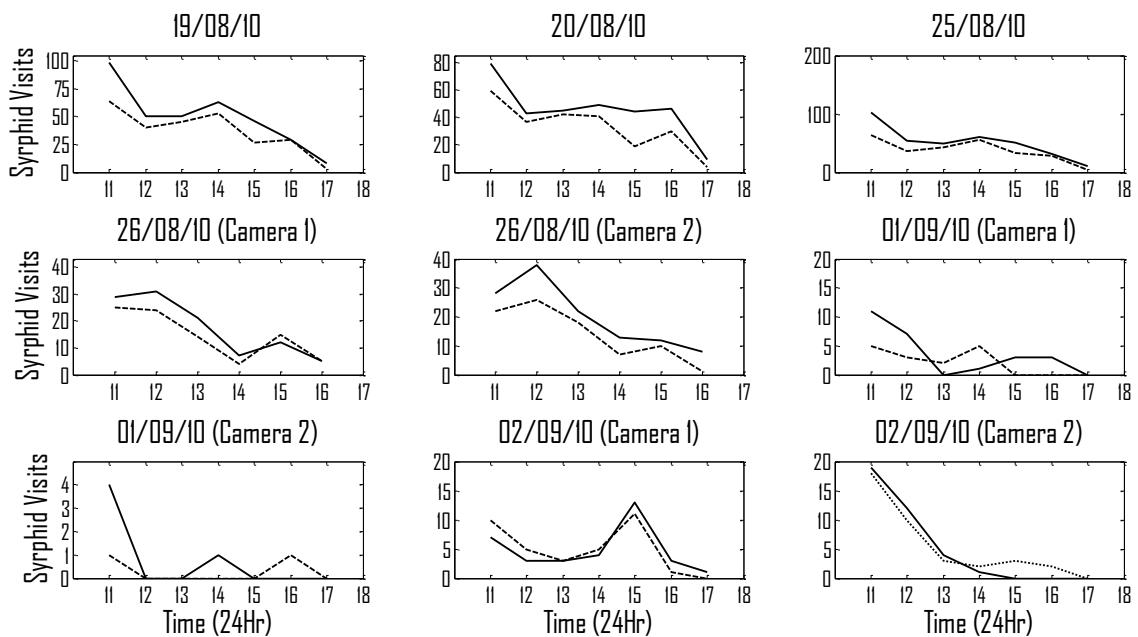

Figure 2.2: Graphs of the visit data for syrphids on previously bagged (solid lines) and previously unbagged (dashed lines) flowers over time as in the total visits graph. 19/08/10 – 26/09/10 were recorded on *Centaurea nigra*. 01/09/10 – 02/09/10 were recorded on *Impatiens glandulifera*.

We fit a generalised linear mixed effects model to our data to investigate the relationship between the syrphid visits to several other variables. The model with the best fit is illustrated below. The best model for the data was selected using Akaike’s information criterion, AIC. As our data is counts of the visits we used a poisson distribution.

$$g = a \sim 1 + b + c + time + flower + \text{random effects}$$

Where a is syrphid visits to the previously bagged flower, b is *Bombus* visits to the previously bagged flower and c is syrphid visits to the unbagged flower. The time was recorded in one hour intervals.

Fixed effects coefficients (95% CIs):

Name	Estimate	SE	tStat	DF	pValue	Lower	Upper
'(Intercept)'	4.3404	0.37563	11.555	56	1.88e-16	3.5879	5.0928
'b'	0.035446	0.005217	6.7949	56	7.55e-09	0.024996	0.045897
'c'	0.019087	0.002615	7.2988	56	1.11e-09	0.013848	0.024325
'time'	-0.07906	0.019604	-4.033	56	0.000168	-0.11833	-0.03979
'flower'	-1.1486	0.12976	-8.8518	56	3.13e-12	-1.4086	-0.88869

Table 2.1: Data from the GLME investigating the relative impacts of different factors relating to syrphid visitation to the previously bagged flower.

R²:

Ordinary	Adjusted
0.8748	0.8659

Of greatest interest, our model suggests that *Bombus* visits to the previously unbagged flower have a significant effect on the visits of the syrphids to the previously bagged flowers.

Additionally, syrphid visits to the unbagged flower and time of day also impact the visits to the bagged flower. The type of flower had a strong effect however this is thought to be due to the complex nature of the flowers of *I. Glandulifera* and the increased handling time they would impose on a syrphid. This model provides good evidence for our first hypothesis; that bee scent marking has an effect on syrphid visitation (Table 2.1).

2.4.2. Lab Work – Arena

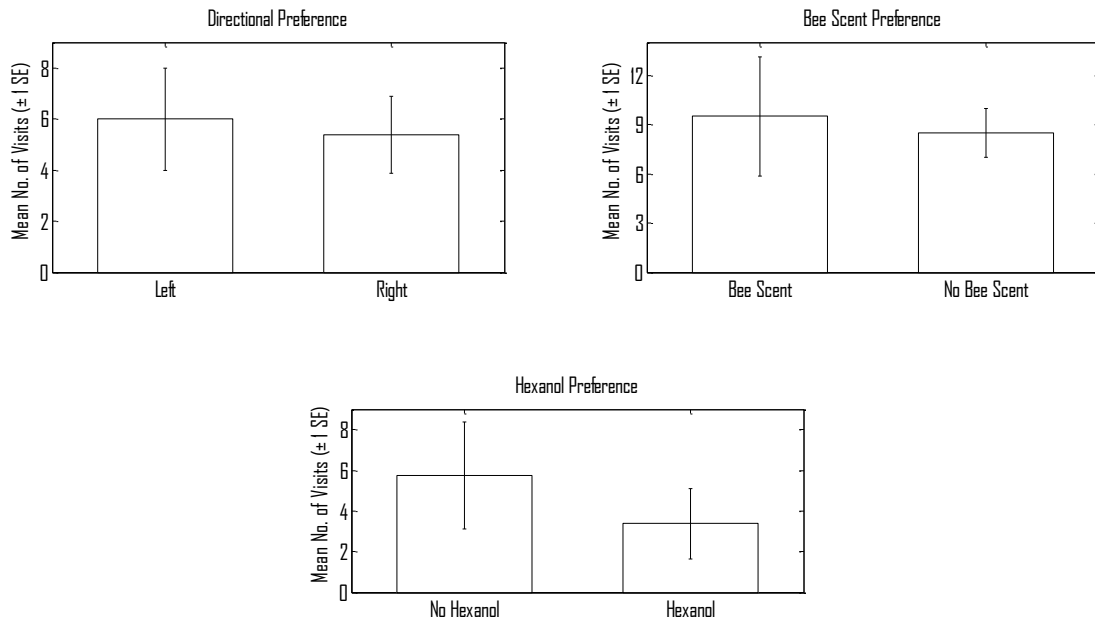

Figure 2.3: Bar chart showing control trials in the arena. Bars show mean visits \pm 1 SE. Trials were run over 6-7 days for each treatment.

Our data showed no significant preference for direction (paired t-test, t -value = 0.72 ($df = 20$), p -value = 0.493) or bee scent (paired t-test, t -value = 1.02 ($df = 20$), p -value = 0.342). A significant difference was found in the 1-Hexanol trials (paired t-test, t -value = 2.68 ($df = 17$), p -value = 0.031) illustrating an innate aversion to this odour (Figure 2.3.). For 1-Hexanol concentration controls see Figure A1.4.

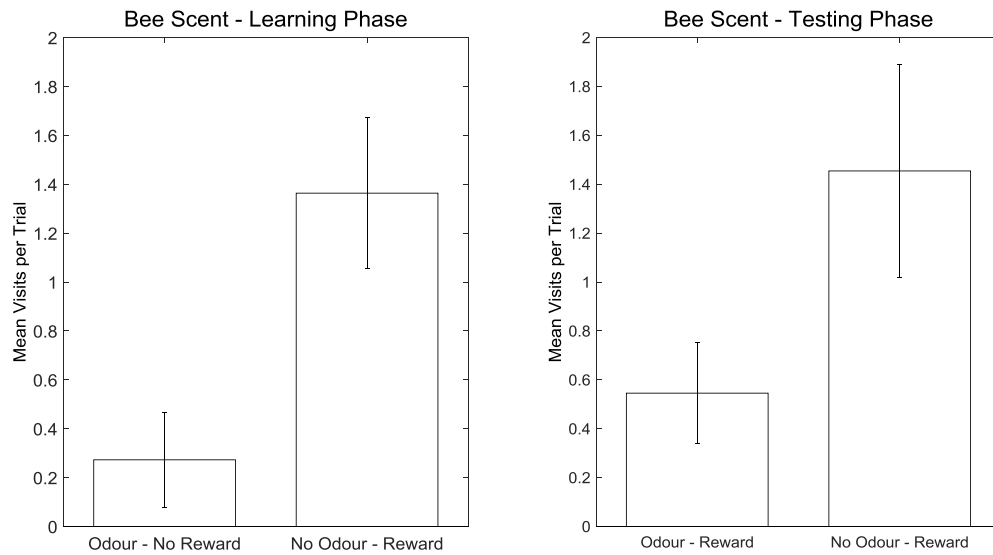

Figure 2.4: Bar chart showing total visits to bee scent marked vs unscented flower in arena experiments. Trials were run over 14 days. Bars are mean \pm 1 SE.

Visits during the learning phase of the bee scent learning experiments showed significant differences (paired t-test, t-value = -2.63 ($df = 13$), p-value = 0.025) (Figure 2.4). The testing phase showed similar differences to the learning phase (paired t-test, t-value = -3.63 ($df = 13$), p-value = 0.005) suggesting that memory was being used to locate the reward.

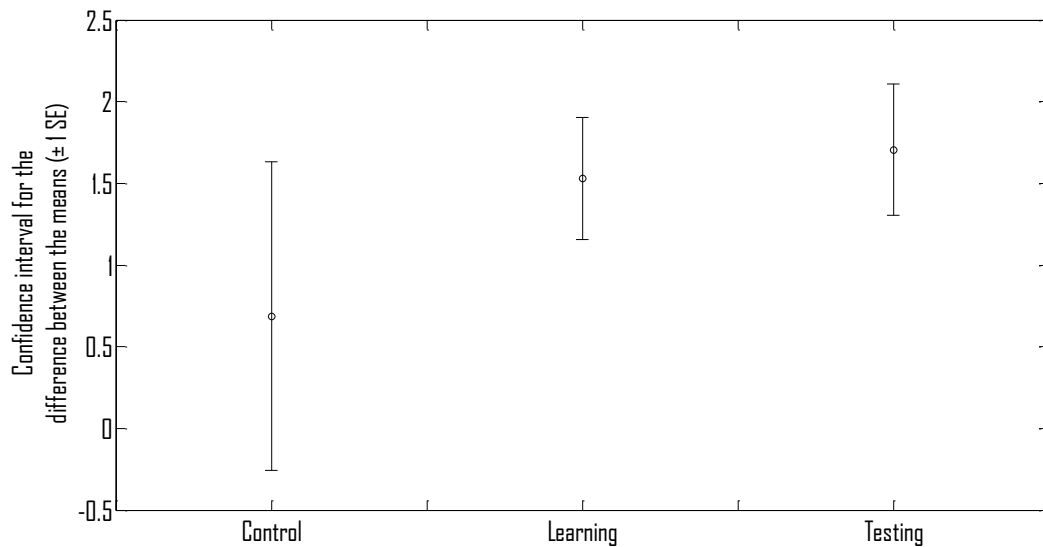

Figure 2.5: Graph showing confidence intervals for the differences between means of the arena experiments. Control is included to illustrate the increased aversion to 1-Hexanol after syrphids had performed the learning trials.

Patterns of visitation within the 1-Hexanol learning experiments were similar to those in the bee scent learning experiments however analysis of the 1-Hexanol results was complicated by the fact that syrphids have an innate aversion to 1-Hexanol. We therefore analysed data by comparing differences between means (effect sizes) (Figure 2.5 & 2.8). Syrphids preferentially visited the flower with no odour in both the learning and the testing phase in the arena trials (Figure 2.5). This effect was more pronounced than in the control trials. This is also despite the fact that rewards in the testing trials were equal and clearly visible. The similarity of visitation patterns between learning and testing phases, coupled with the fact that confidence intervals for the difference between the means in these treatments and the control showed a low degree of overlap, indicated that syrphids use learning and memory when foraging.

2.4.3. Lab Work – Pots

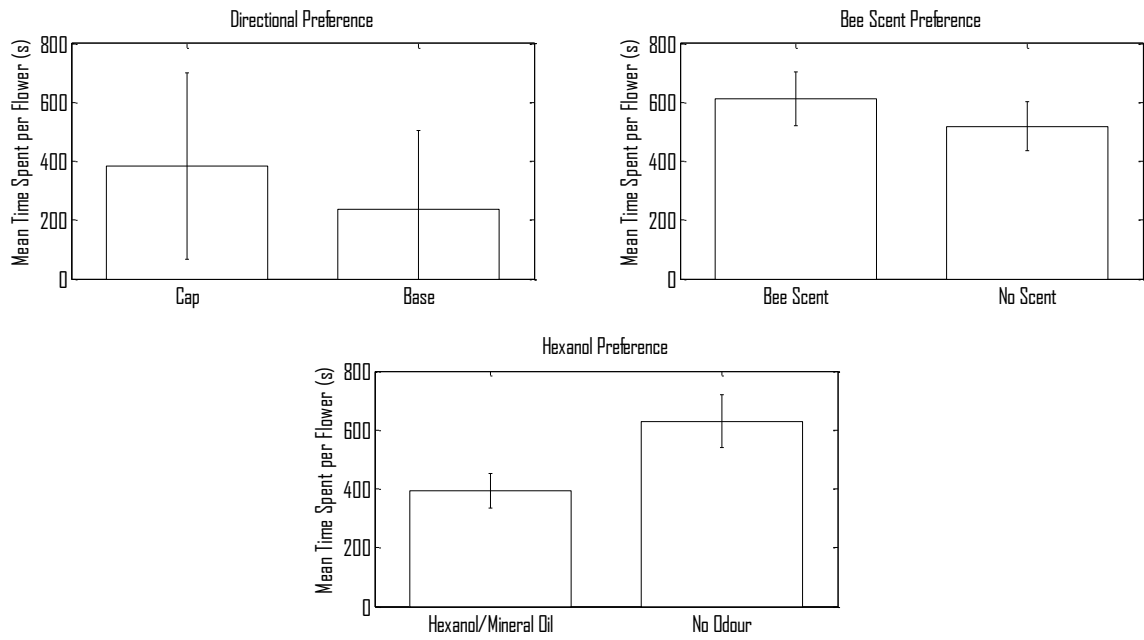

Figure 2.6: Bar graph showing control data from the pot experiments. Bars are mean \pm 1 SE. There were 9 trials in all and each trial used 6 individuals in separate pots.

Controls contained equal reward in both flowers and differed only in the treatment applied (Figure 2.6). Data from our controls showed no significant differences in time spent on the flower nearest the cap of the bottle or the one at the base (t-test, t-value = 0.10 ($df = 53$), p-value = 0.924). We also recorded no significant differences between time spent on a bee scent marked flower or an un-marked flower (t-test, t-value = 0.81 ($df = 53$), p-value = 0.439). There was a difference when 1-Hexanol/mineral oil was present (t-test, t-value = -2.36 ($df = 53$), p-value = 0.046). As in the arena trials the syrphids spent less time on the flower nearest the 1-Hexanol suggesting an innate aversion to this odour.

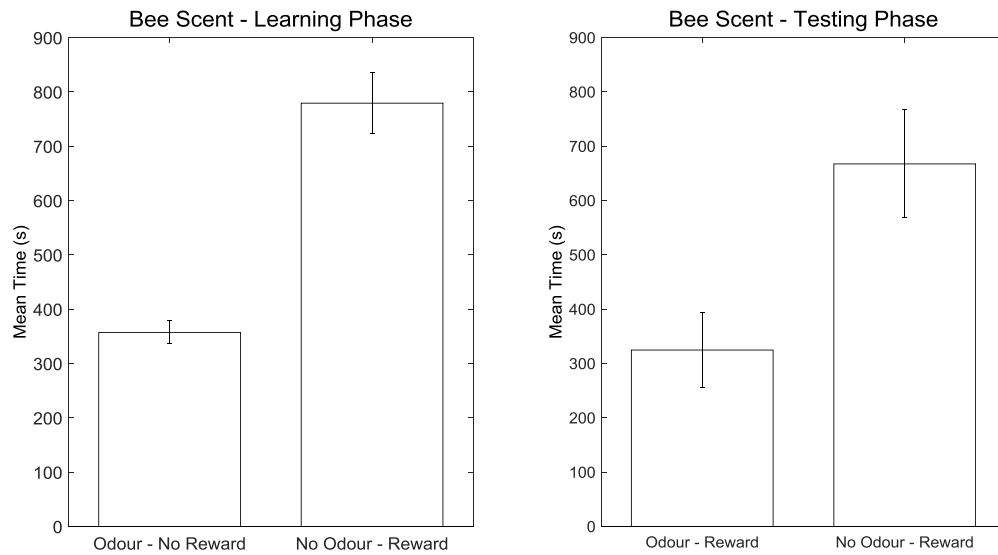

Figure 2.7: Bar chart showing mean time spent on bee scent marked vs unmarked flowers during the last hour of the learning phase and the first hour of the testing phase in the pot experiments. Bars are mean \pm 1 SE.

Syrphids spent significantly less time on the unscented rewarding flower throughout the learning phase (t-test, t-value = -7.23_(df = 45), p-value < 0.001, n = 46) (Figure 2.7). Data from our testing phase using the bee scent shows significant difference (t-test, t-value = -3.35_(df = 45), p-value = 0.002, n = 46). Syrphids displayed strong learning in these enclosed environments and developed an aversion to the bee scent.

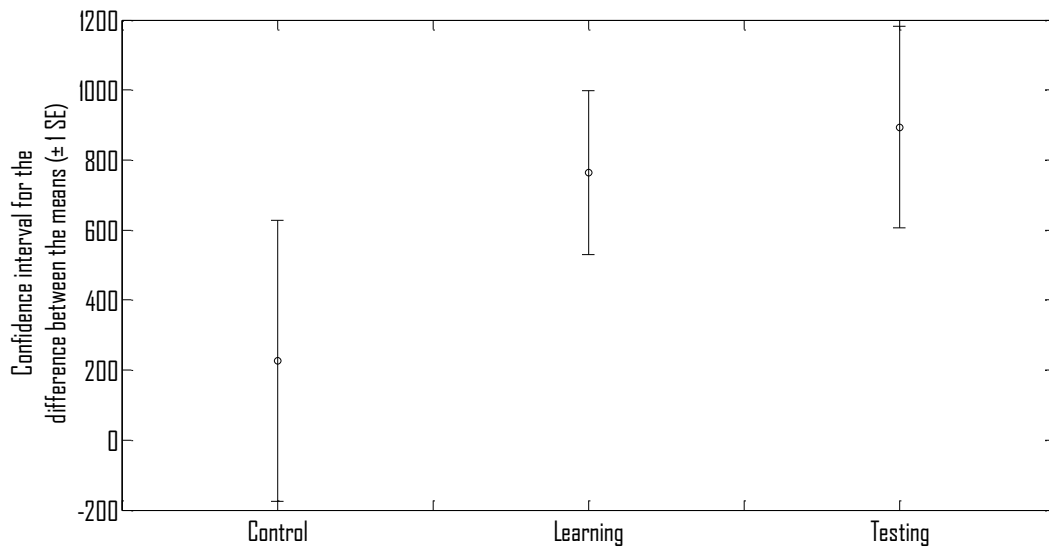

Figure 2.8: Graph showing confidence intervals for the differences between means of the pot experiments. Control is included to illustrate the increased aversion to 1-Hexanol after syrphids had performed the learning trials.

Qualitative patterns of visitation in the pot experiments were essentially the same as those in the free-flying experiments and as the syrphids again showed an innate aversion to 1-Hexanol we analysed differences between means in the learning and testing phases relative to controls. In the 1-Hexanol trials our results also showed an increased preference for the unscented rewarding flower during the learning phase (Figure 2.8). Our data also shows a similar preference for the unscented flower during the testing phase of these trials. This difference was much greater than the difference between treatments within control experiments.

Our second hypothesis was that syrphids would be able to learn to make foraging decisions based on olfactory information. These results show a strong learning effect when the syrphids are in an arena and an enclosed space. Syrphids learned to associate both the bee scent and the 1-Hexanol with no reward quickly and accurately.

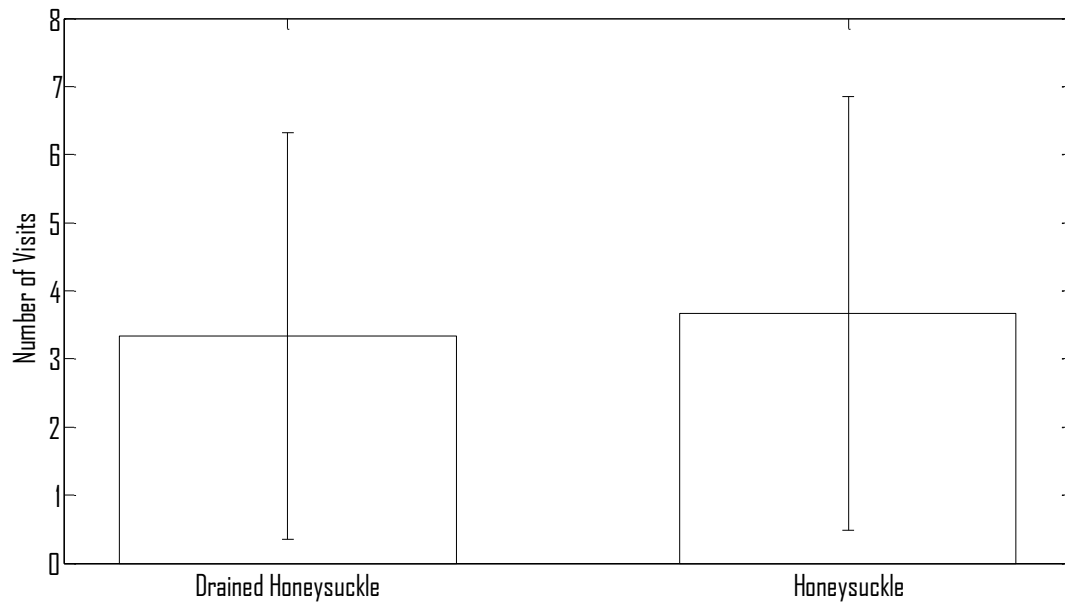

Figure 2.9: Bar chart showing honeysuckle visitation in the arena. Trials were run over three days for each treatment and lasted 3 hours. Bars are mean visits ± 1 SE.

We found no significant differences in visitation to the drained versus the un-drained flowers (paired t-test, t -value = -0.50 ($df = 8$), p -value = 0.667 , $n = 9$) (Figure 2.9). Although plant volatiles such as 1-Hexanol appear to be a potential olfactory cue syrphids are not using honeysuckle nectar odours to guide them towards the flower. Our third hypothesis, that syrphids would use nectar odours to aid in foraging decisions, appears to be incorrect in this instance.

2.5. Discussion

Our initial hypothesis was that *Bombus* scent marking will affect the visitation rate of syrphids. Results from the field work showed a distinct pattern, with the bagged flower regularly receiving more attention from pollinators across the trials. The preference of the bees for the bagged flower seen in the field trials lasts longer than could be explained simply from the use of scent marking. The previously bagged flower should rapidly become scent marked by the high number of bees visiting and would become less attractive quickly. Nectar scents, visual cues and individual memory of a good reward could all be influencing this prolonged preference. Interestingly the syrphids show very similar patterns to the bumblebees, especially over the first three days. Our model results suggest that bee visitation is having an impact on the number of syrphid visits (Table 2.1). This is an interesting finding as there has previously been no record of syrphid behaviour being influenced by bees. It is almost certain that scent marking is being used by the *Bombus* species initially (Free and Williams, 1983; Wetherwax, 1986; Giurfa, 1992). This is then being followed by a longer lasting attraction which could be a learned behaviour based on the individual's recent experiences.

Our experiments demonstrate the syrphids' ability to learn an odour and pair it in memory with an unrewarding host. It was interesting that syrphids showed an innate aversion to 1-Hexanol. It would appear that this odour provides a strong stimulus for syrphid behaviour on its own but can also be an equally strong aid to memory when used as an aversive stimulus. The bee scent marks also had a significant effect on the behaviour of syrphids when choosing where to forage despite the lack of any innate aversion toward these odours. The two flowers in the confined experiments were 50mm apart. From this distance the individuals undergoing testing should have been able to detect the reward in both flowers from anywhere in the bottle. This provides good evidence that they have developed short term memory influencing

aversion to the scented flower. Numbers of visits throughout the arena trials were relatively low. This is most likely due to the reduced appetitive behaviour of syrphids when compared to most bee species. Foraging behaviour of bees is dictated by the energy requirements of the nest (Molet *et al.*, 2008) while syrphids forage only for themselves. Starving the syrphids prior to running trials seemed to have little or no effect other than to greatly increase mortality rates.

Throughout our trials syrphids consistently learned to use olfactory stimuli to avoid an unrewarding host. The reward in all trials apart from the honeysuckle experiments was a 50/50 mix of honey and water. This was a visible yellow colour which suggests that syrphids were not using visual cues when foraging during the testing phases of our trials. Had they been using vision to make a decision both rewards would have appeared to be equal and we would have seen no preference. Our results show that odour is important for hoverflies when attempting to maximise rewards. We have shown that in confined spaces learning through olfaction is fast and accurate but as distance increases and contact with the stimulus diminishes this effect is reduced. These results demonstrate that syrphids are able to learn to associate bee scent marks with a reduced or absent reward. This ability to detect and respond to *Bombus* scent marks is of great interest.

More field work will be required to determine if bee scents are actually being used by syrphids in the field. Their ability to learn scent marks is clear but to what extent, if at all, syrphids use these odours when foraging in the wild is still unclear. If syrphids are using scent marks then their foraging behaviour could be more strongly influenced by other pollinators than previously thought. As the numbers of bees continue to decrease, syrphid foraging efficiency could increase substantially as not only is competition reduced but less aversive

stimuli will be present. However the opposite could also be true. If syrphids in the field are using scent marks to improve foraging, a reduction in the number of bees could negatively affect the ability of syrphids to maximise rewards. Syrphid pollination is unlikely to replace bee pollination in environments containing many complex flowers simply because they typically do not visit these flowers. However on more accessible flowers a reduction in bees could actually promote increased syrphid activity which in turn could reduce the negative effect of dwindling bee numbers on the local pollination.

Our work demonstrates similarities between foraging behaviour of bees and syrphids which have previously been studied less. It has previously been shown that syrphids forage using colour (Haslett, 1989; Campbell *et al.*, 2010) and flower complexity (D. Goulson and Wright, 1998). Adding odour to this list opens up new possibilities for the study of syrphids. In future work it would be interesting to observe syrphid behaviour on recently bee scent marked flowers in the field to assess the impact these odours have on foraging patterns. If *Bombus* scent marks are influencing hoverfly visitations then field margin seed mixes that attract pest control insects should be constructed to be less attractive to bees. Current field margins are designed to attract syrphids using visual cues based on syrphid abundance and persistence at sites (MacLeod, 1999). These mixes include many less complex flowers which are more easily accessible to hoverflies. Our results suggest that using odours could increase the efficacy of the field margin bringing more syrphids into the crop area and greatly reducing the numbers of pest insects. Further investigating which plant volatiles are attractive or aversive could provide information regarding which plant species to select for field margins. Pairing attractive odours with highly rewarding flowers could further increase the attractiveness of the margin. We have shown that syrphids can learn to associate 1-Hexanol with a lack of reward, a negative association. This ability to learn an association should work equally well in the

other direction with syrphids associating an odour with a reward. Syrphid pollination could therefore be manipulated and increased in both commercial and domestic environments. This would in turn reduce pesticide use which would benefit both pollinators and growers.

3. Chapter 2: The Impact of Resource Availability, Search Costs and Starvation on the Evolution of Decision Accuracy

3.1. Abstract

The neural limitations hypothesis states that, given appropriate ecological conditions, animals may evolve towards niche specialisation to improve their decision accuracy. In a previous study it was shown that specialists can evolve to outperform generalists only when a non-host choice carries a small fitness gain. We extend this study to investigate the effects of three environmental conditions on the decision accuracy of artificial neural networks trained as either specialists or generalists. These conditions are resource availability, search time costs and starvation. Low resource availability and starvation lower the range of parameter states (range of punishment/reward values for selecting a non-host) that support a pronounced advantage in decision accuracy to specialists. Search cost shifts the parameter range over which specialists enjoy an advantage: with no search costs specialist networks are better decision makers than generalists when rewarded for selecting non hosts, and they are worse decision makers when punished for selecting a non-host. With high search costs these trends are reversed. Predictions relating to resource abundance and starvation are consistent with other studies concerning their relevant impacts. Predictions relating to search costs are novel and not intuitively obvious, so may be a fresh source of insight for workers in this field.

3.2. Introduction

Individuals are often referred to as using host resources to describe their diet. However resources that would be described as non-hosts are equally rewarding in many cases (Futuyma and Moreno, 1988; Holmgren and Getz, 2000; Egan and Funk, 2006). This apparently counterintuitive fact has been the subject of much discussion throughout diverse areas of biology (Fellows and Heed, 1972; Nancy Moran, 1984; EA Bernays, 1990). Organisms are regularly classified as specialists based on limited diet breadth however, there is some debate regarding how useful this factor is in determining an individual's level of specialisation (Sargeant, 2007). An individual's level of specialisation is related to its ecological niche which includes many factors such as temperature tolerance, preference for oviposition sites and nest site choice among others (Colwell and Futuyma, 1971; Futuyma and Moreno, 1988). Despite this, diet breadth still remains a valuable tool for investigation. Ecological specialisation has been attributed to many factors and it is unlikely that there is one single cause in any species.

The neural limitations hypothesis (NLH) has been demonstrated to be a robust explanation that probably contributes toward many instances of specialisation (Dall and Cuthill, 1997; Elizabeth A Bernays and Funk, 1999; EA Bernays, 2001; Colin R Tosh *et al.*, 2003). The NLH states that generalist individuals will suffer lower decision accuracy due to the higher attentional load relative to specialists. Concentrating on one or a small number of hosts allows faster decision making and a greater degree of accuracy (Futuyma and Moreno, 1988; Janz and Nylin, 1997; EA Bernays, 1998; EA Bernays and Bright, 2001; Wee and Singer, 2007; Forister *et al.*, 2012; Liu *et al.*, 2012). It was previously thought that this would have a greater effect on organisms with limited neural architecture such as insects, but a recent review pointed out that analogous effects have been demonstrated many times in humans (C.R. Tosh

et al., 2011). C. R. Tosh *et al.* (2009) used the NLH as the basis of their theoretical investigation by looking at how decision accuracy is affected by the level of specialisation an organism displays. Using artificial neural networks they found that specialists outperform generalists only when a non-host choice carries no punishment or a small gain in fitness during evolution of host range. This finding suggests ecological conditions which could drive the evolution of specialisation or indeed slow down this process. Here we extend this analysis by considering how an organism's internal physiological environment and its external environment can affect these findings.

The NLH goes some way to explaining how specialisation arose but there are many other influences which can speed up or slow down this process. Competition, both inter- and intra-specific, resource availability, secondary fitness gains such as the ability to sequester plant toxins or cryptic foraging environments and many more have also been suggested as possible drivers of specialisation (Futuyma and Moreno, 1988; Jaenike, 1990; Finch and Collier, 2000; Carletto *et al.*, 2009). We chose to investigate three potential determinants of niche width that we and previous authors (Hoffmann, 1985; Jaenike, 1990; Bolnick *et al.*, 2003; Burns, 2005; Lars Chittka *et al.*, 2009; Beest *et al.*, 2014) consider likely to be fundamental in their effect on the relative fitness of the different strategies: resource availability, search time costs and starvation.

Artificial neural networks have been used for many different ecological and behavioural applications and they lend themselves well to this type of investigation (Joy and Death, 2004; Enquist and Ghirlanda, 2005; Holmgren *et al.*, 2007). Fundamentally we believe that while mathematical and numerical optimisation studies are valuable and may inform on ultimate causes of phenomena, biological system state will be a function of both optima and constraints due to organic structure. Observed system state can, therefore, best be described

by embodying evolution in a meaningful organic structure. While the time is fast approaching where evolutionary simulations can be embodied in an anatomically correct decision making apparatus (Ito *et al.*, 2009) examination of a significant ecological parameter space still requires simplification of the information processing system. We therefore embody simulations in simple neural networks: systems that are relatively computationally inexpensive while displaying several biologically meaningful behaviours (Enquist and Ghirlanda, 2005). We use artificial neural networks trained to different degrees of specialisation/generalisation to assess the impact of different environmental and internal conditions. The networks are trained on different reward/punishment values simulating organisms with the ability to utilise non-host resources with positive benefits through to those which suffer large penalties for choosing a non-host. Resource availability, search time penalties and starvation are introduced to the model to investigate their impact on decision accuracy. We hypothesise that overall decision accuracy will be negatively affected when introducing ecological variables into the model. Additionally we suggest that these ecological variables will have a greater effect on the specialist networks than the generalist networks.

3.3. Methods

We employ the same methods as C. R. Tosh *et al.* (2009) and the methods below are an amalgam of the methods and SI from that paper. Changes to methods from the original model are listed at the end of the present methods section.

We used a 2-layer neural network with 200 input units and 3 output units. The network was “fully connected” in that there was a connection between all input and output units. Output units were binary stochastic elements with p_i , the probability of firing of the i th unit, defined by

$$P_i = g \left(\sum_{j=1}^M w_{ij} x_j \right)$$

where $g(x)$ is the binary sigmoid function $g(x) = 1/(1+\exp(-x))$, the j th input layer unit provides input x_j to the i th unit via the connection w_{ij} , and M is the number of inputs to the unit.

We constructed 40 different artificial resource items, each of which could be projected onto the sensory surface of the consumer. Number of pixels in each resource projection was rounded from random samples of the normal distribution with mean of 11.8 and variance 3.1. These 40 items could be split into 4 types: those with bilateral symmetry (e.g., most animals), those with radial symmetry (e.g., cnidarians, echinoderms, and many flowers), those that were asymmetric (e.g., sponges and many plants in gross morphology), and those that were completely random in conformation. The former 3 categories were, moreover, all designated “cohesive” in body plan in that no pieces of body tissue (no activated pixels) were spatially isolated from the rest (Figure 3.2). Images were input to the network in binary form i.e. where

a resource body part was present the input was represented by 1 and where no resource body part was present the input was 0.

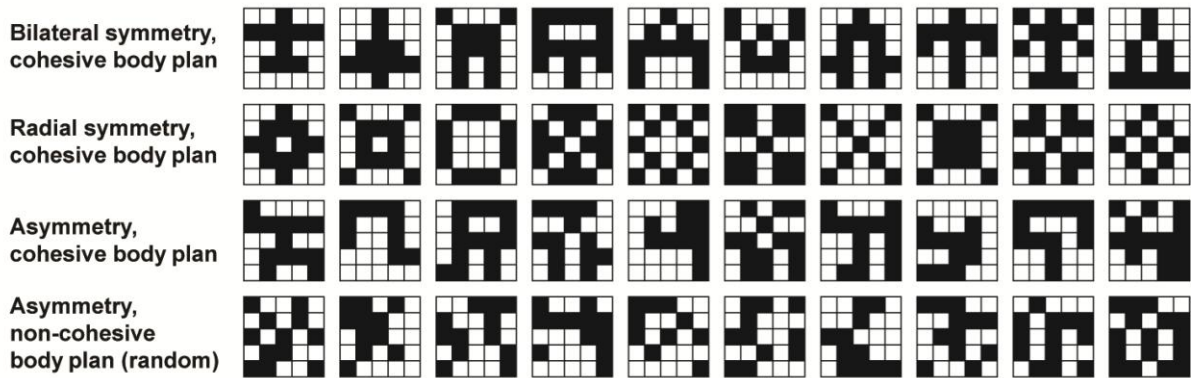

Figure 3.1: Body plan images used as host and non-host resources for the neural networks. The asymmetrical body plan was used to represent hosts while the remaining 30 images represented non-hosts. Figure reproduced from C. R. Tosh *et al.* (2009).

Each neural network could output one of three decisions: select a section of the sensory surface onto which a host resource is projected, select a section of the sensory surface onto which a non-host resource is projected, or select an empty section of the sensory surface (analogous to “continue search”). Depending on the stimulation pattern of the input surface, the network could output 1 of 8, 3-digit binary codes. Each of these codes represented selection of a particular input section. Resources could only be projected within these 8 sections and could not be over an intersection. Input sections ran clockwise from 1 to 8, with segment 1 in the top left corner of the input layer (Figure 3.2), and output firing patterns for each segment were as follows: 1 = (1, 1, 1), 2 = (1, 1, 0), 3 = (1, 0, 0), 4 = (0, 0, 0), 5 = (0, 0, 1), 6 = (0, 1, 1), 7 = (1, 0, 1), 8 = (0, 1, 0).

The basic input–output mapping is not unlike certain systems of visuospatial processing in higher animals (Rolls and Deco, 2002); however, the model is stripped of all but the most fundamental elements of neural processing (namely parallel distributed processing). Although this aspect of the model makes it a more simplified representation of real, organic information processing systems, it also gives it a potentially very wide application across the animal kingdom (Figure 3.2).

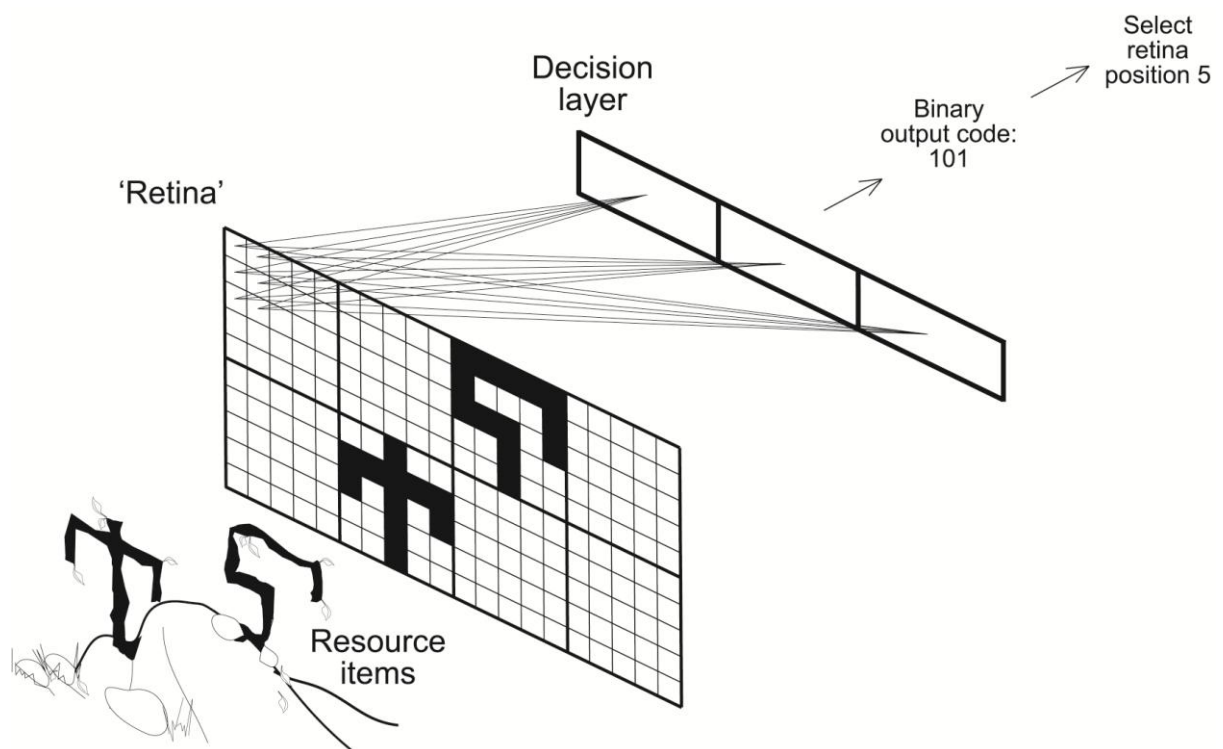

Figure 3.2: Example of an input to the network. The ‘retina’ contains the projections of host/non-host resources. Networks can choose any of the 8 larger 5x5 squares. This decision is output as a binary 3 digit code. Based on the area chosen the network is either punished or rewarded. Figure reproduced from C. R. Tosh *et al.* (2009).

We trained the neural network using a genetic algorithm. Fifty networks were created in each generation of training, with initial weight values for each selected at random between 1 and -1, and the 600 synaptic weights in each encoded in a vector. Within each of these vectors representing weights between different layers of the neural network, the linear position of a weight was given by:

$$S = (l - 1)(d3)(d2)(d1) + (k - 1)(d2)(d1) + (j - 1)(d1) + i$$

where (i,j,k,l) index a position in a 4-dimensional array with dimensions $[d1, d2, d3, \text{ and } d4]$; in this case $(10\ 20\ 1\ 3)$.

Multiple projections containing 1-8 resource items were randomly created from the 40 possible resources (Figure 3.1) and input into the neural network. In all cases a resource projection consisted of a random number, chosen from a uniform random distribution, of resources between 1 and 8, chosen at random from the pool of 40.

We trained networks to select asymmetric resource items from each of these projections and to avoid all others (i.e., asymmetric resources were designated hosts and all other resources were non-hosts), but the number of asymmetric resources that the network was trained to select was also varied. At one extreme, there was a generalist treatment where the network was rewarded for selecting any of the 10 asymmetric resources (i.e., there were 10 resource types designated as host, and the 30 remaining resources were non-hosts). At the other extreme, there was a specialist treatment where only 1 specific asymmetric item was rewarded (only 1 host and the remaining 39 resources were designated non-hosts). We varied the score for choosing a non-host resource within the genetic algorithm. The reward for choosing a host resource was fixed at +5, but punishment/reward for choosing a non-host was sampled as follows: -5, -2.5, -1, -0.5, 0, +0.5, +1, +2.5, and +5. The last value (+5) was a control; the selection of hosts and non-hosts was equally valuable, and thus differential range has not been selected. In the extreme generalist treatment we rewarded selection of all 10 asymmetric items and then removed 2 resources at random from the list of rewarded types, now rewarding selection of only 8 asymmetric resources and punishing selection of all other resources. This

removal process was repeated, removing 2 resources (or 1 if only 2 remained) each time until we arrived at the extreme specialist treatment where only 1 asymmetric resource was rewarded. We thus created a series of networks training on a specific set of resources and varied their level of specialization. This process of training and removal was repeated 10 times to obtain 10 replicates representing unique sets of resources that varied networks ecological range. Each one of these replicates was in turn represented by 10 stochastic repeats of training procedures. These procedures were repeated for various values of reward/punishment for choosing a non-host resource.

Overall scores of each of the 50 neural networks after presentation of 250 projections were calculated, and the top scoring 10% of networks were chosen for mutation and recombination. Networks were paired at random from this 10% to produce 25 pairs, and while a pairing could occur more than once, no network could mate with itself. Pairs were recombined with a probability of 0.6 and during the recombination event sections of the paired weight vectors were swapped at a recombination point chosen at random between 0 and 600. After recombination, or if a recombination event did not occur, vectors were mutated. This occurred with a probability of 0.1 at each vector element, with the amount to be added or subtracted to the present value sampled at random from a normal distribution with mean 0 and variance 3. After recombination and mutation, the 50 networks were passed to the next generation of training, and the same projection set used in the last generation was presented to each network. The average score of networks had invariably settled to an asymptote value after training was run for 300 generations.

When testing the decision accuracy of the trained networks we required a set of input projections that would give us an equivalent, standardized measure of decision accuracy (the

ability of networks to select host resources, those rewarded with +5 during training, from projections containing hosts and non-hosts, those punished/rewarded during training) of networks regardless of training experience. A set of 250 projections was created exactly as described above for training sets. In each projection we then selected the sections on which resources of one of the four shape types were projected (this choice was arbitrary as allocation of resources from the 40 projections is random) and designated these “host locations.” All other locations where resources were projected were designated “non-host locations.” We then modified this template set of projections for each set of networks that were trained to a particular ecological range, and obtained this ecological range on a specific set of resources, inserting appropriate hosts for each treatment randomly into host locations and non-hosts into non-host locations. For example consider a treatment that included 4 asymmetric resources (first, second, sixth, and eighth, from the left of Figure 3.1) during training. During testing of decision accuracy these resources were inserted at random into host locations of the template projections and the remaining 36 resources inserted at random in the non-host sections. Thus, regardless of training experience, decision accuracy of networks was gauged by their ability to select host resources from input projections containing the same number of hosts and non-hosts, at exactly the same positions of the neural network input.

3.3.1. Differences from the Methods in C. R. Tosh *et al.* (2009)

To introduce differential resource availability into the model we limited the number of projections containing a resource during network evolution. In the original model every projection had at least one resource but in this model only a percentage of projections had resources. Projections containing resources increased in ten percent increments from 10% up to 90%. Search time penalties were introduced by including a negative punishment to selection of empty spaces in the projections. Previously selecting these empty spaces carried a

neutral 0 reward/punishment but in this version of the model they carried a penalty as follows: -5, -2.5, -1 and -0.5. Starvation and death occurred when a network's fitness dropped below a pre-set value. This value was set before the training began and for this reason had to be postponed for a number of generations before it took effect as the networks' fitness often fell below the set value early in the simulation. A network starved if its fitness dropped to -250 but this only took effect after 150 generations. We justify this delay in the starvation effect by assuming that any animal choosing to specialise has at least some skill in handling the chosen resource. This would allow us to partially train our networks before allowing them to suffer the effects of starvation. We chose -250 fitness and 150 generations after experimenting with various combinations of both fitness (-200 to -350) and delay (50 to 200). The combination of -250 fitness and a 150 generation delay was the only stable combination we found. The higher fitness (-200) 'killed' too many networks for the simulation to continue irrespective of the delay set. Lower fitness levels (-300 to -350) had no effect on network performance. A network which starved was removed from the model and could not contribute to the next generation of networks via the genetic algorithm i.e. it died. This is in contrast to the original model in which every network reached the end of the simulation and the top scoring 10% were chosen from this pool to create the next generation.

3.4. Results

3.4.1. Resource Availability

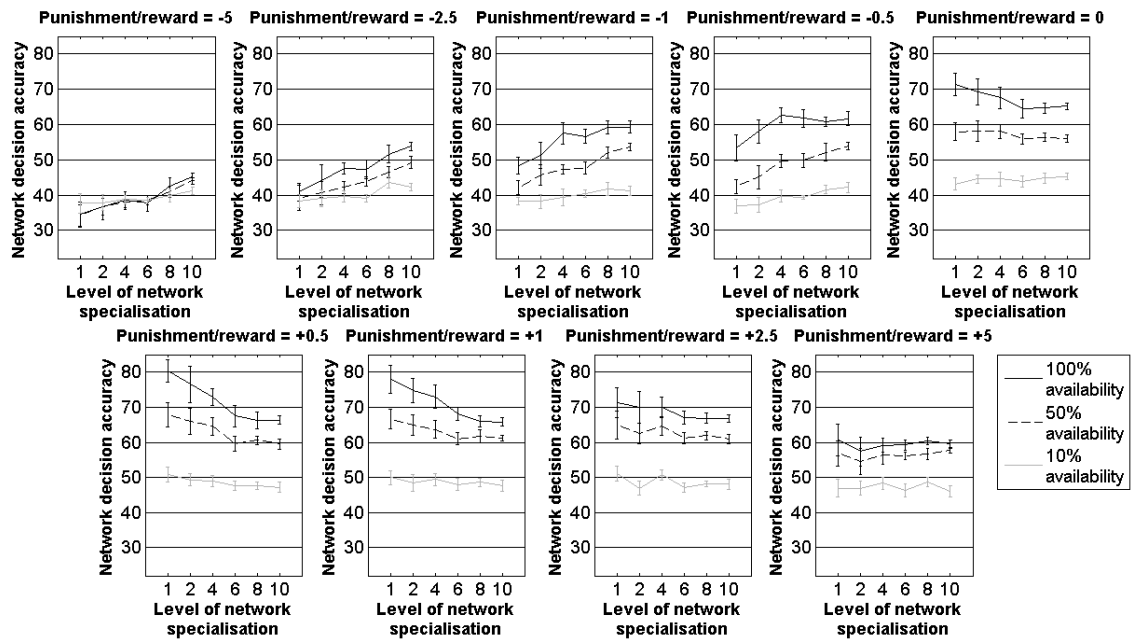

Figure 3.3: The effect of resource availability on decision accuracy. Level of network specialisation relates to the number of resources a network considered hosts. Extreme specialists had one host through to the extreme generalists with ten hosts. Network decision accuracy is the number of correct choices the networks make when tested with 250 projections after training. Error bars show $\pm 95\%$ CI, $n = 10$. Only 50% and 10% resource availability have been illustrated to show the range of values and the changing pattern of the data.

When looking at the effect of resource availability we found that overall decision accuracy was significantly lower across both specialist and generalist networks as resource availability decreased (Figure 3.3). While specialist networks subject to high resource availability outperformed generalist ones across a wide range of reward values (from 0 to +2.5), this range for specialist networks subject to reduced resource availability was lower. There was clearly no advantage to specialisation with 10% resource availability and a non-host punishment/reward of 0, but at the same punishment/reward level and 100% resource

availability, there was a specialist advantage. Also, low resource availability reduced the absolute amount of specialist advantage that a specialist enjoys over a generalist in the region of parameter space where specialist advantage exists i.e. specialists may still enjoy some advantage over generalists at particular values of non-host reward/punishment but the advantage is not great. The finding of C. R. Tosh *et al.* (2009) that specialists can enjoy higher decision accuracy than generalists under realistic ecological conditions, is therefore probably most applicable to the situation where resources are abundant and organisms encounter resources each time they disperse and land. Lower resource availability will generally lower specialist advantage. Both our hypotheses have proved to be true in this set of simulations. The predicted overall reduction in decision accuracy for all networks was apparent and the effect of resource availability was more pronounced in the specialist networks.

3.4.2. Punishment for Extended Search Time

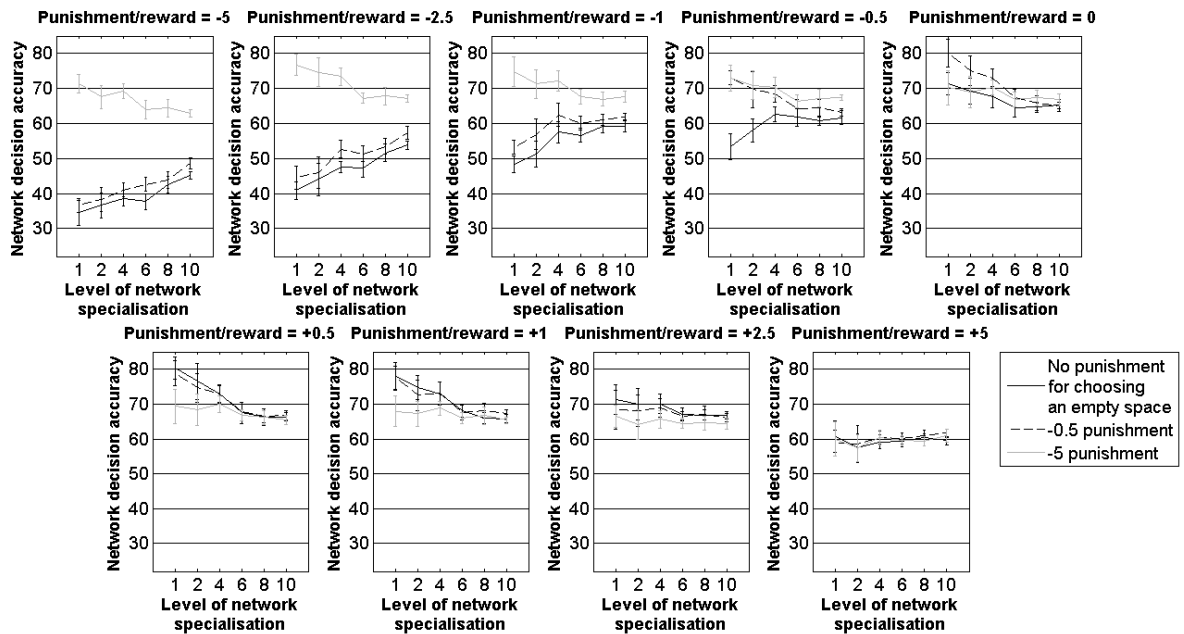

Figure 3.4: The effect of search time penalties on decision accuracy. Level of network specialisation relates to the number of resources a network considered hosts. Extreme specialists had one host through to the extreme generalists with ten hosts. Network decision accuracy is the number of correct choices the networks make when tested with 250 projections after training. Error bars show $\pm 95\%$ CI, n = 10. Punishment values were applied to networks choosing an empty space during training. Only the extreme punishments have been included in the figure to illustrate the effects of search costs (-0.5 and -5). The -1 and -2.5 punishment results were intermediate to these.

A high punishment for continuing search reduces the advantage to specialists in the region where mistakes for selecting a non-host are rewarded. High search punishment increases the advantage to specialists in the region where mistakes for selecting a non-host are punished. Moreover a high punishment for continuing search helps maintain high overall decision accuracy in this latter region. In relation to the results of (C. R. Tosh *et al.*, 2009) increasing search costs shifts rather than narrows the range of parameter space over which specialists enjoy an advantage in decision accuracy. Our first hypothesis, that overall decision accuracy

is reduced for all networks, was again accurate in this simulation. However our prediction that specialists would suffer greater losses in decision accuracy was false. The shifting of the range over which specialists outperform generalists is a very interesting result.

3.4.3. Starvation

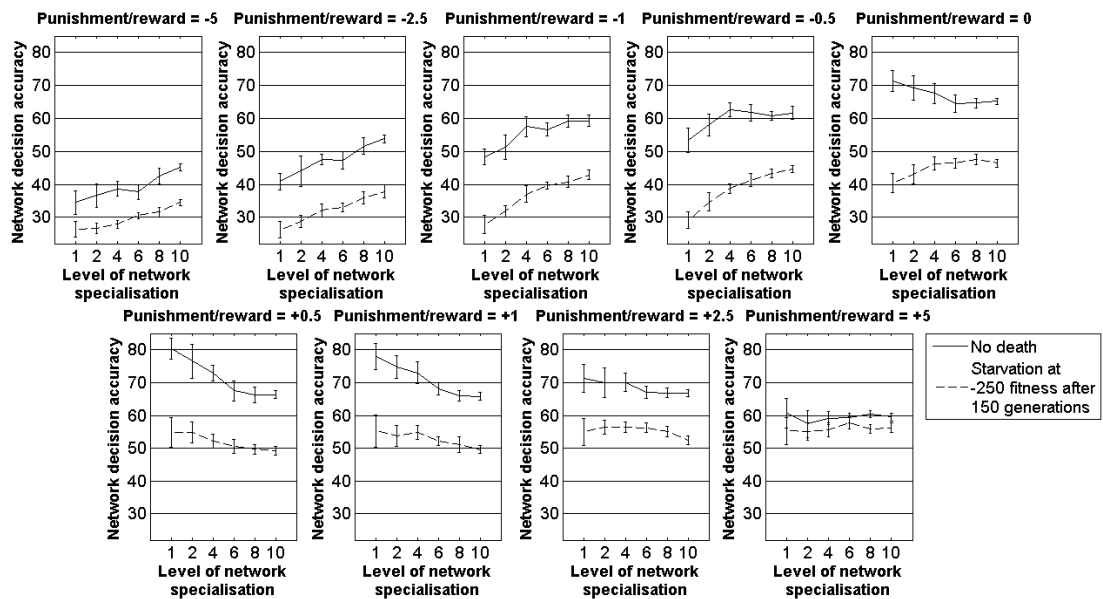

Figure 3.5: The effect of starvation on decision accuracy. Level of network specialisation relates to the number of resources a network considered hosts. Extreme specialists had one host through to the extreme generalists with ten hosts. Network decision accuracy is the number of correct choices the networks make when tested with 250 projections after training. Error bars show $\pm 95\%$ CI, $n = 10$.

While it should be borne in mind that simulation of starvation in our model was only possible for a relatively narrow range of ecological circumstances, simulations indicate that starvation has three main effects (Figure 3.5). It firstly reduces the absolute level of decision accuracy across reward/punishment values for choosing a non –host. Secondly it slightly reduces the range of reward/punishment values for choosing a non –host in which specialists networks enjoy an advantage in terms of decision accuracy. Whereas the specialists networks that do

not starve enjoy superior decision accuracy to generalists when there is 0 reward/punishment for selecting a non-host, the opposite is true when networks can starve. Thirdly, it reduces the absolute amount of specialist advantage that a specialist enjoys over a generalist in the region of parameter space where specialist advantage exists (+0.5, +1). Thus as for resource availability, the addition of this relevant physiological characteristic of animals tends to reduce the parameter space over which specialist networks enjoy a substantial advantage over generalists. As in the resource availability simulations both of our hypotheses have been accurate under the conditions in this simulation. We see lower overall decision accuracy for all networks and also that specialists fail to outperform generalists to a greater degree than when starvation is not included in the simulation.

3.5. Discussion

The model of C. R. Tosh *et al.* (2009) indicated that specialisation is associated with increased decision accuracy when choice of a non-host is associated with a mild reward during evolution of host range. They considered this important because often specialist organisms confined to non-hosts do quite well, hence these predictions provide an explanation for the evolution of specialisation when ecological conditions would commonly appear not to support it. Essentially low resource availability and an increased tendency for death through starvation lower the range of parameter states (the range of punishment/reward values for selecting a non-host) that support a pronounced advantage to specialist networks in terms of decision accuracy. This brings the evolution of niche specialisation through advantages in decision accuracy associated with this strategy in line with previous work considering the role of these factors in the evolution of niche width. Most studies have indicated that low resource availability (Kunin and Iwasa, 1996; Bolnick *et al.*, 2003; Beest *et al.*, 2014) and an increased tendency for death through starvation (Hoffmann, 1985; Hoffmann and Turelli, 1985; Jaenike, 1990) promote generalisation rather than specialisation and it is intuitively reasonable that they should do so.

Predictions relating to search costs produced here are more interesting. Varying search costs shifts the parameter range over which specialists enjoy a decision accuracy advantage: with no search costs specialist networks are better decision makers than generalists when networks are rewarded for selecting non-hosts, and they are worse decision makers when networks are punished for selecting a non-host. With high search costs these trends are reversed. This is a complex scenario and while envisioning of the internal dynamics of the neural network could be attempted, the reason for this shift is not intuitively obvious; however the implications for the dynamics of the evolution of niche width are clear. This work suggests that specialists

enjoy increased decision accuracy when search costs and non-host penalties are high and we could expect narrow niche width to be advantageous under these circumstances. In their model of niche width Ackermann and Doebeli (2004) illustrate this effect on generalist organisms. In their simulations individuals were able to evolve their ecological niche under different conditions. They found that generalist niches tended to persist or even widen when costs were low but when costs were high for a widening of the niche the model split into smaller niches or specialists. Generalist organisms faced with high search costs/non-host penalties would be expected to perform poorly and be outperformed by specialists. This could potentially drive the generalist population niche to become more refined over time or alternatively could remove the generalist from the niche altogether. Previous studies have shown, reasonably, that increased search costs promote the evolution of generalisation: organisms will accept any resource rather than incur further search costs (Ackermann and Doebeli, 2004; Burns, 2005; Lars Chittka *et al.*, 2009). This has not, however, taken into account the possibility of large penalties associated with the non-host resource. Search cost penalties in our model can potentially be understood in the context of the decision speed vs accuracy trade-offs identified in previous studies. Not making a choice (i.e. choosing an empty space) results in a penalty which could be seen as increased time to make a decision. Networks choosing to make a decision to avoid search costs are essentially making a snap decision and would be expected to be, on the whole, less accurate. Lars Chittka *et al.* (2009) demonstrate this effect in bees. Their review of the literature shows that fast, possibly inaccurate decision making can be adaptive when penalties are low for making a poor decision. Our results reflect this in that networks suffering a smaller punishment for search time were less accurate than those that suffered large penalties but only when non-host choice leads to a punishment. When rewarded for choosing a non-host the effect disappears. This effect has also been shown by Burns (2005) who found that faster decisions are better in a rewarding environment even when this results in reduced accuracy in *Bombus terrestris*.

Other studies in bumblebee foraging behaviour support this finding with the most efficient foragers being those making faster decisions but more inaccurate ones (Burns and Dyer, 2008).

Ultimately this model requires further validation. In the first instance we can consider the cross-taxonomic relationships that are already known between niche width and resource abundance, search costs and resistance to starvation (see above). Where less is known about the relationship between a variable we have considered and niche width a focussed quantitative analysis of the literature would be valuable. Another way very specific predictions of our model could be and have been tested is to use learning or artificial selection experiments with an appropriate organism. For example, C.R. Tosh *et al.* (2011) used a human-computer interactive in which humans learned letters appearing on a screen to show that 'specialist' humans are more accurate decision-makers than generalists when their mistakes are rewarded during training to recognise the most valuable letters, but not when mistakes are punished (the principal prediction of the C. R. Tosh *et al.* (2009) model) . Such an approach could easily be extended to the variables studied in the present article.

Alternatively, in an organism with a short generation time that shows active choice of resources, such as *Drosophila melanogaster*, fundamental predictions of the model could be tested through evolution across generations. One last approach that could be adopted is to measure search costs and performance on non-hosts of selected taxa in the field. If decision accuracy is driving specialisation, our work suggests that those taxa with high search costs that are punished for selecting non-hosts in error are those most likely to be host specialists.

Another issue these predictions raise is that of the relative benefits of mathematical (numerical or analytical) vs complex system approaches in ecology and evolution. The use of

an ‘organic’ model (a complex systems model that has some ‘physical’ or computational resemblance to a complex organic structure) can embody some of the constraints inherent in evolution that are difficult to study as comprehensively using mathematical approaches. So it is common now to examine evolutionary dynamics (particularly behavioural evolutionary dynamics) while embodying the system in some form of organic model architecture such as a neural network (Marchiori and Warglien, 2008; Lewis *et al.*, 2010; Delton *et al.*, 2011; McNally *et al.*, 2012). The next step in the development of this research program is to embody study systems within more realistic organic architecture (Ito *et al.*, 2009; Patel *et al.*, 2009).

4. Chapter 3: Is Specialised Behaviour an Evolutionary Dead End:

Predictions from Connectionist Networks

4.1. Introduction

The idea that specialists exist in an evolutionary dead end has been a pervasive theory for many years (Simpson, 1944; Simpson, 1953). It is based on the idea that when an organism specialises then the variation in its suite of abilities is lost (PJ Smith and Fujio, 1982).

Relaxed selection pressure on genes which enabled a more generalist life history can lead to loss of function of receptors and structures or even changes in behaviour (Lahti *et al.*, 2009). Once lost, this variation is thought to be unavailable to the organism, reducing the ability to adapt to changing environments (Futuyma and Moreno, 1988; Jaenike, 1990).

Several studies have supported the evolutionary dead end theory including Nancy A Moran (1988) who suggests that, in aphids, over-specialisation by certain morphs within the aphid life cycle actually constrains evolution making an expansion of host range difficult.

Additionally, host shifts during the evolution of chrysomelid beetles have typically been toward closely related plants suggesting difficulty in major host shifts (Futuyma and Mitter, 1996). Most convincing perhaps are the findings of McBride (2007) who shows that in *Drosophila sechellia*, a recently specialised Dipteran, olfactory and gustatory receptor genes are being lost at a greatly increased rate. This could be due to relaxed selection on those genes no longer regarded as host genes which could render them inoperative or equally could be positive selection on those same genes as increased sensitivity to a new host becomes paramount. This effect will be more pronounced in species moving from generalism to specialism as more genes will become obsolete than in a specialist expanding its host range.

D. sechellia has also seen a greatly reduced female reproductive capacity since becoming a specialist. Although this is offset by the stimulant effect of the host fruit (*Morinda citrifolia*) without the fruit the species would be at a distinct fitness disadvantage (R'kha *et al.*, 1997). Similarly *Drosophila pachea* has lost genetic function in the *neverland* gene which has left it unable to process cholesterol and it now relies on its host plant, senita cactus (*Pachycereus schottii*), to provide uncommon sterols (Lang *et al.*, 2012).

This is of great concern now more than ever due to the accelerating rate of climate change coupled with the many incidences of specialist species at risk from extinction. If specialisation is actually a dead end then many species could be forced to extinction because they cannot adapt (Warren *et al.*, 2001; Travis, 2003; Robert J Wilson *et al.*, 2007; Gilman *et al.*, 2010).

The theory is not without criticism however. Phylogenetic studies of nymphalid butterflies show no trend toward specialisation. The Nymphalidae tribe has seen an increase in host range as often as a reduction (Janz *et al.*, 2001). Termonia *et al.* (2001) found that the most recent evolutionarily derived ability to utilise host plant compounds actually enabled some specialist Chrysomelid beetles to produce a wider range of defensive compounds. Similarly, several phylogenies of phytophagous insects also show no tendency for species to move toward specialisation (for a full list of groups studied see Nosil and Mooers (2005)). Shifts in both directions are equally common despite the dead end theory suggesting that this should not be the case. The same effect has been seen in fruit flies in the genus *Tomoplagia*. No trend towards specialisation has been observed. Despite many of the genus being specialised, host expansions are still common (Yotoko *et al.*, 2005). Kelley and Farrell (1998) provide further evidence of specialist species expanding host range in *Dendroctonus* beetles. Using molecular

phylogenies they show that specialists in this genus have, at least 4 times, expanded host range to become generalists.

Biological neural networks are the basic building blocks of behaviour. Neural networks control all aspects of behaviour from metabolism (Selverston *et al.*, 1976) to movement such as hunting or predator avoidance (Ewert, 1970; Levi and Camhi, 2000). Simplified artificial versions of these networks can provide considerable insight into the underlying mechanisms of behaviour or ecology which are difficult, if not impossible, to study in living organisms or ecosystems (Fukushima, 1986; Lek and Guégan, 1999; Özesmi *et al.*, 2006; Park and Chon, 2007). While there has been much work on creating useful, biologically accurate ANNs (Maass, 1997) we are still at a stage in the study of the evolution of behaviour where we need to reduce the complexity of our models in order to investigate a significant proportion of state space.

Host range expansion or contraction is often mediated initially by behavioural evolution (Thomas *et al.*, 2001). This can have far reaching consequences for an organism as the changes in behaviour can lead to changes in physiology and can eventually produce specialist and generalist species. This link between specialisation and behaviour makes the study of the evolution of behaviour particularly relevant to the theory of specialisation as a dead end.

We used ANNs to investigate the effects of limited evolvability on the evolution of behaviour in a small population. Our interest was in the ability of the networks to reverse the trend toward specialisation and become more generalist. Is re-expansion possible after specialisation and loss of genetic diversity or function and how robust are the networks to

limited evolvability? To investigate this we attempted to answer 2 specific questions:

1. Does a reduction in evolvability prevent specialist networks expanding their host range?
2. Does the introduction of ecological variables increase the likelihood of networks becoming trapped in an evolutionary dead end?

Genetic diversity in this instance is being represented by network weight diversity. A reduction in diversity for a network is easy to achieve by simply preventing a number of the network's weights from changing during crossover and mutation in our model and we were interested to see if this had a similar effect on the network's evolutionary potential as it is predicted to have on specialist species. Artificial neural networks (ANNs) have been applied to many areas of biology and lend themselves well to investigations such as this (Enquist and Ghirlanda, 2005; Holmgren *et al.*, 2007).

To test our first hypothesis we trained networks as resource specialists then, using these same networks, we re-trained them as generalists. However, before re-training a percentage of the network weights were fixed to impair their ability to adapt. This is analogous to the loss of evolvability either genetically or physiologically, through loss of function, that may occur over time when species become specialised. Overall fitness scores were recorded for the resulting generalist networks. When testing our second hypothesis we included variables in our model to simulate ecological factors of interest. These were negative search costs and a non-host punishment value.

4.2. Methods

Our model includes major code additions to the neural network and genetic algorithm in Chapter 2. There are also the introduced ecological factors and the ability to alter the evolvability of the networks to consider. It is therefore described again here in full.

We created 2-layer artificial neural networks with 200 input units and 3 output units. Our networks were fully connected; each input was connected to each of the output units. Output units were binary stochastic elements with p_i , the probability of firing of the i th unit, defined by

$$P_i = g \left(\sum_{j=1}^M w_{ij} x_j \right)$$

where $g(x)$ is the binary sigmoid function $g(x) = 1/(1+\exp(-x))$, the j th input layer unit provides input x_j to the i th unit via the connection w_{ij} , and M is the number of inputs to the unit.

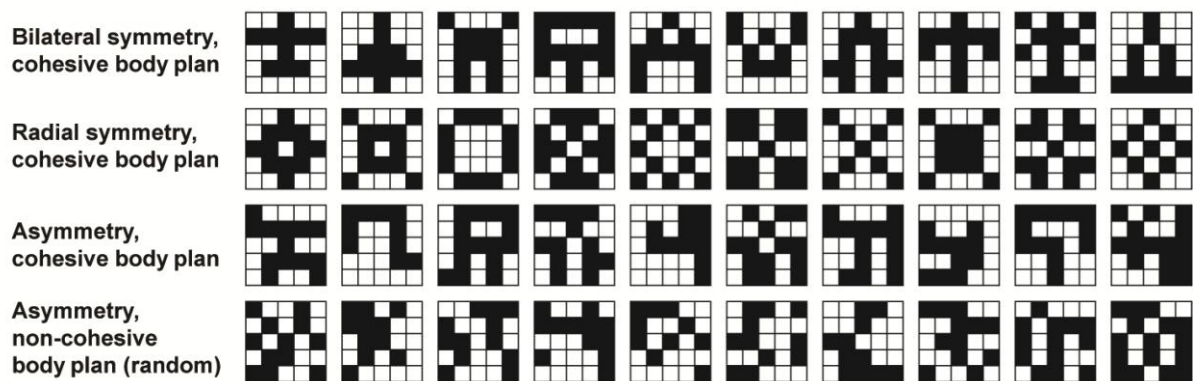

Figure 4.1: Body plan images used as host and non-host resources for the neural networks. The asymmetrical body plan was used to represent hosts while the remaining 30 images represented non-hosts. Figure reproduced from C. R. Tosh *et al.* (2009).

We defined a generalist network as a network trained to recognise ten 'host' projections. Specialist networks were trained to recognise only one 'host' projection which was taken from the same pool of ten 'hosts' recognised by the generalists. Each input consisted of eight 5x5 squares with a random number of host projections, non-host projections and empty squares. Projections were composed of binary structures where the body plan is created from 1s and empty space by 0s. The squares which did not contain a host/non-host were filled with 0s. In total 40 resource projections were created (Figure 4.1). The number of pixels in each resource projection was rounded from random samples of the normal distribution with a mean of 11.8 and variance 3.1. The 40 projections were further split into four groups of ten. The groups were: bilateral symmetry, radial symmetry, asymmetric and random conformation. We classified the first three categories as cohesive i.e. no body parts were completely isolated from the rest. We designated the asymmetric group as hosts for all networks with specialists having one host from this group and generalists using all ten of the asymmetric projections as hosts.

Network outputs were three-digit binary codes relating to the position on the input projection that was being chosen. Networks had three possible choices they could make. Choose a host area, a non-host area, or an empty space (equivalent to continue to search). Resources were always positioned in one of the eight 5x5 sections of the input projection and could not overlap. The network could output eight different codes relating to the eight sections of the input projection. These were : (1, 1, 1) section 1, (1, 1, 0) section 2, (1, 0, 0) section 3, (0, 0, 0) section 4, (0, 0, 1) section 5, (0, 1, 1) section 6, (1, 0, 1) section 7, (0, 1, 0) section 8.

Models were run for 500 generations per training period - specialist training and generalist training. Simulations were limited to 500 generations as after this period there was very little

change, with maximum fitness settling to a stable value. To simulate reduced diversity following specialisation we fixed weights within the network after the first 500 generations. This was the point that trained specialist networks switched and became generalists. Fixing weights was done in steps of 10% from 0% through to 100%. 0% and 100% were included as controls for comparison. To select weights to fix we first randomly selected one individual from our population of trained specialists. We then randomly selected a percentage of the weights from this network to be the fixed weights for all networks. These weights were then inserted into all networks at the position they occupied in the chosen network. For example a simulation with 30% fixed weights would train 50 networks as specialists with no fixed weights. After 500 generations one individual from these specialist networks would be chosen and 30% of its weights would be randomly selected. These weights would then be inserted into all 49 of the other networks at the position they appeared in the chosen networks weight matrix. This allowed us to simplify the coding process dramatically.

This process will only be valid if the variation between weights at the same location across the population is very small; therefore, to validate the process we trained 50 populations of 50 networks to specialisation for 500 generations then selected 30% of their 600 weights and compared these to the other weights at that position in their population. Overall mean variance and mean standard deviation of the final weights after the 500 generations were 0.0374 and 0.0506 respectively ($n = 450000$). The mean value of weights across all control networks was 0.5320.

Final fitness scores for all networks were compared and the top 10% of the networks went on to create the next generation. Networks were randomly paired with each other from this pool. The same pairing could occur more than once but networks could not be paired with

themselves. After each generation networks underwent a mutation and recombination process. Recombination occurred with a probability of 0.6. Networks chosen to recombine had a section of their weight matrix at a randomly chosen point between 1 and 600 swapped with their partner. Mutation was achieved by replacing a weight in the network with a probability of 0.1. The chosen values were changed by a value randomly generated from a normal distribution with a mean of 0 and a variance of 3. After this process was complete any fixed weights were reinserted at their original points in the weight matrix effectively removing any modification that might have occurred.

We rewarded networks with +5 points for a correct host selection. Networks were trained under four different conditions:

To investigate hypothesis 1; does a reduction in evolvability prevent specialist networks expanding their host range?

- Networks suffered no penalty for errors or choosing an empty square – analogous to no search costs and non-toxic non-hosts.

To investigate hypothesis 2; does the introduction of ecological variables increase the likelihood of networks becoming trapped in an evolutionary dead end?

- Networks suffered a minus 5 (-5) penalty for choosing a non-host but no penalty for choosing an empty square - analogous to a toxic or indigestible non-host population with no costs for searching for a host.
- Networks suffered a minus 5 (-5) penalty for choosing an empty square but no penalty for choosing a non-host – analogous to a high search cost and non-toxic hosts.

- Networks suffered a minus 5 (-5) penalty for choosing a non-host and a minus 5 (-5) penalty for choosing an empty square – a combination of search costs and toxic non-hosts

For each simulation the condition the network was trained under to become a specialist was also the condition it retrained under as a generalist. For example networks training as specialists with high search costs would retrain as generalists with high search costs.

4.3. Results

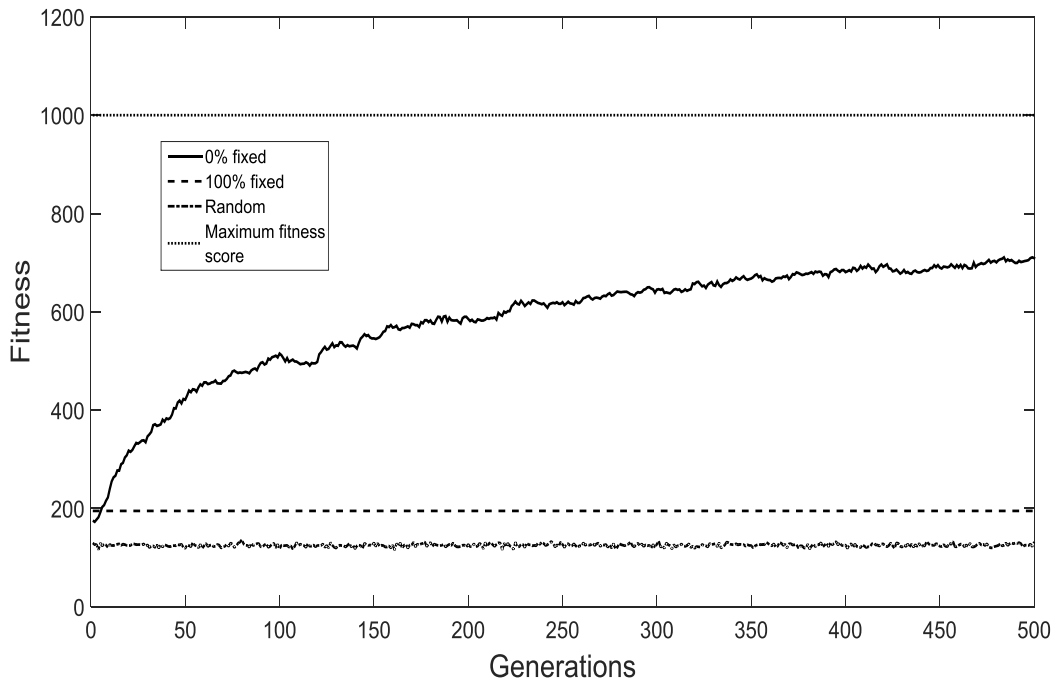

Figure 4.2: Showing control data for the no punishment simulation. Data shows the mean fitness score for all networks at each generation as they retrain as generalists. Included are the data for 0% fixed weights, 100% fixed weights and random selection. Also included is the maximum possible fitness score for comparison. Random data refers to networks choosing one of the 8 hosts at random.

To illustrate our control simulations we have used the data from our no punishment for non-host and no search cost simulations (Figure 4.2). Our controls show that without any reduction in variation (0% fixed weights), networks could achieve similar fitness scores to those seen when generalist networks are trained without previously being trained as specialists (mean final fitness = 723.89, SE = 12.87, n = 20). This lower final fitness for generalist networks could be due to an increased attentional load because of the increased number of hosts.

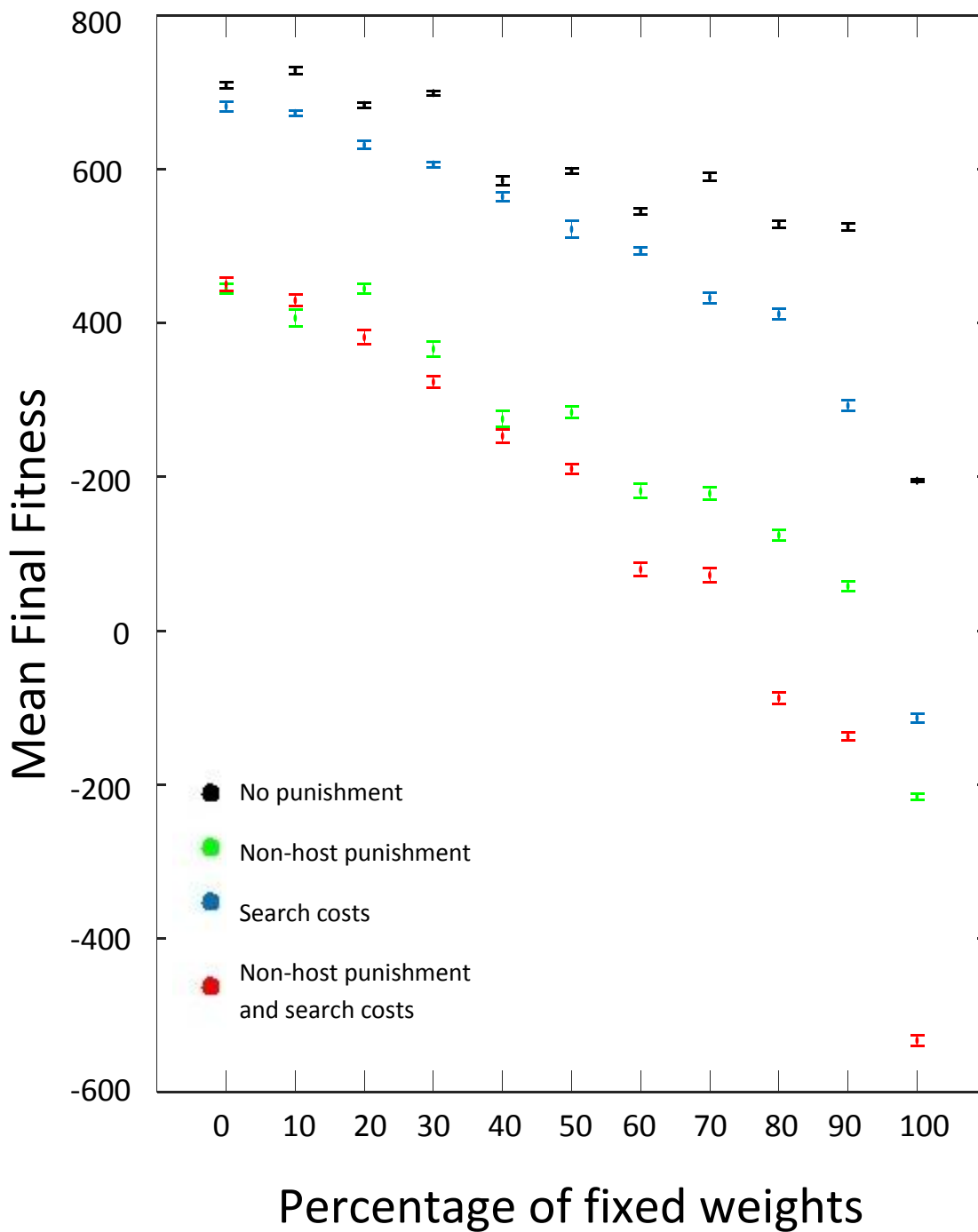

Figure 4.3: Graph showing the final mean fitness score $\pm 2SE$ after retraining as generalists for networks for each percentage of fixed weights. We used $\pm 2SE$ to aid in visualisation as the errors were very small. Included are the data for no punishment (black), search costs (blue), non-host punishment (green) and both search costs and non-host punishment (red).

All ecological parameters introduced reduce overall network fitness (Figure 4.3). Search costs have the least impact with non-host punishment intermediate and the combination of both punishments having the greatest impact. When no punishment is present we can see from the results that networks are very robust when it comes to loss of evolutionary potential (weight fixation). It is not until high fixation values that networks suffer irreversibility and can no longer evolve to generalise. When we start to introduce ecological parameters this becomes more apparent and the ability of networks to evolve decreases. As we might expect the combination of non-host penalties and search costs has the greatest effect on overall fitness (Figure 4.3). What is less intuitive perhaps is the scale of the effect that search costs have when combined with the non-host punishment. Although there is a large reduction in fitness from the no punishment data, when both costs are present search costs have a minor effect on overall fitness until weight fixation reaches 50% versus the non-host penalty simulations. After this a minor reduction in overall fitness is apparent when compared with the non-host penalty alone.

	50% fixed	90% fixed
No punishment	78.38%	64.26%
Non-host punishment	75.67%	41.45%
Search costs	79.92%	51.07%
Non-host punishment and search costs	75.59%	40.18%

Table 4.1: Showing the percentage of maximum fitness (difference between fitness at 0% fixed weights and 100% fixed weights) that networks were able to recover at 50% fixed weights and 90% fixed weights. Data is from Table A2.2.

Overall networks across all simulations perform at a similar level of recovery until around 50% of network weights are fixed (Figure 4.4). After this stage the performance of those

networks with either non-host penalties or both non-host penalties and search costs combined begins to degrade more rapidly. Our results in Table 4.1 show that even in the most extreme condition (90% of weights fixed) networks suffering no punishment for search costs or non-host selection were able to recover 64% of the maximum fitness achievable. Search costs had a reduced effect on fitness when compared to non-host punishment with networks recovering over half of potential fitness even at 90% fixation. Individually non-host punishment had the greatest impact on network fitness. When both of these punishments are applied to networks search costs cause very little impact to the already low score induced by non-host punishment. The introduction of search costs to an environment with high non-host penalties does not have a great effect.

At 50% fixed weights the networks all recover over 75% of the maximum fitness possible. Both the no punishment and search costs conditions perform best with search costs actually maintaining a marginally higher fitness than the networks suffering no punishment. Again we see almost no difference between the non-host punishment condition and the combined search costs and non-host punishment condition suggesting that the non-host punishment effect is effectively cancelling the search cost effect.

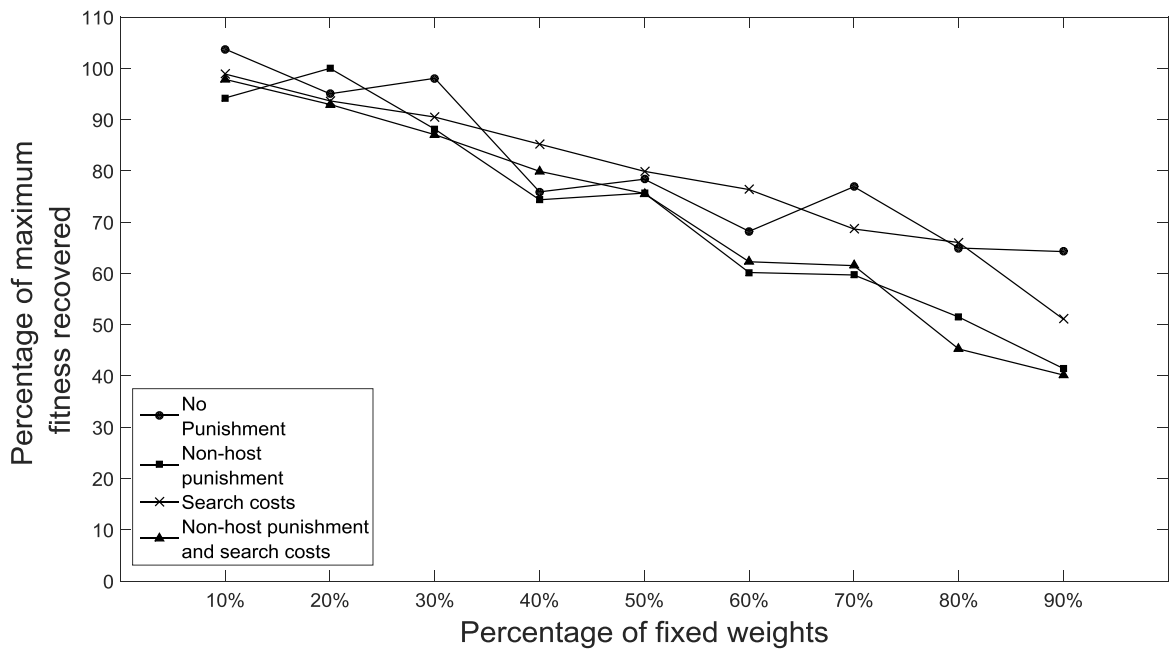

Figure 4.4: Graph showing the percentage of maximum fitness networks were able to recover. Maximum fitness possible was calculated as the difference between final fitness at 0% fixed weights and final fitness at 100% fixed weights. At each level of fixation we recorded the difference between that simulations final fitness and final fitness at 100% fixed weights. We then calculated the percentage of final fitness that this represented from the maximum. Error bars have been omitted due to their small size and for ease of visualisation of the data. See Table A2.2 for data.

Figure 4.4 presents a more complete picture of the relationship between the percentage of maximum fitness recovered and percentage of fixed weights. The overall pattern of the data shows the downward trend we would expect from Table 4.1 however it is clear that these results do not generalise perfectly from the smaller sample of results in Table 4.1. In Table 4.1 I have compared intermediate weight fixation with extreme weight fixation (50% vs 90% weight fixation). When examining that data we must be aware that there is considerable variation in the data and care must be taken when interpreting it.

4.4. Discussion

The most common argument for the evolutionary dead end theory has been that a specialist organism, after undergoing niche specialisation, will have a reduced genetic variability when compared to a similar generalist and that this reduction in evolvability will reduce fitness when attempting to expand its host range or if environmental conditions change (PJ Smith and Fujio, 1982; Frankham *et al.*, 1999; Frankham, 2005; Jump *et al.*, 2009). This is not what our simulations show, however. If this reduction in genetic variation affects the behaviour of the organism in question then our results would suggest that organisms would be robust to this loss of genetic variation and still be free to evolve alternative behavioural states. The performance of our networks remained high when no punishment was applied with all simulations managing to recover over 75% of maximum fitness when 50% of their weights were fixed (Figure 4.4). From this we would expect a behaviourally specialist organism to be able to escape this dead end and become more generalist without too much of a negative impact at low to intermediate reductions in evolvability, even when under ecological pressures.

Specialist networks with limited ability to evolve weights performed reasonably well when allowed to evolve to become generalists when no other pressures are present. In the simulations with no search costs or non-host penalties networks were able to recover over 60% of their maximum possible fitness (Figure 4.4) even at 90% fixation of weights. This condition should therefore be most suited to breaking from specialisation and expanding host range. In biological populations, this ability to adapt despite extremely low variation should allow organisms to avoid suffering a reduction in fitness that would cause a situation such as the evolutionary dead end.

When faced with additional ecological pressure, either from search costs and/or from non-host penalties, networks were still able to perform reasonably well. However the added ecological factors we introduced had a pronounced effect on the ability of specialist networks when retraining as generalists at high levels of weight fixation. This scenario could lead to specialisation becoming a dead end as specialist organisms with low evolvability, from bottleneck events, founder effects, genetic drift or inbreeding etc, should find it more difficult to adapt when under high levels of environmental pressure. In this case then we could expect specialists to become trapped and it would be much more difficult for them to diversify.

When search costs are introduced into the simulation we see a further reduction in overall fitness when compared with the no punishment situation. These networks were only able to recover around 50% of maximum possible fitness when weight fixation reached 90% (Figure 4.4). The extra pressure from this ecological variable creates a situation in which specialisation becomes more difficult to break from. Specialist organisms with high search costs and very limited evolvability attempting to become more generalist are more likely than those under no ecological stress to become trapped in specialisation as their fitness reduces considerably. The finding that search costs impact overall fitness in generalist species agrees with studies such as Futuyma and Moreno (1988) that demonstrate a potentially higher search time and therefore cost for generalist organisms when compared to specialists.

Non-host penalties had the greatest effect on the performance of our networks overall. In both the non-host penalty and the combined non-host penalty and search costs simulations we see a similar negative effect. Both had a low final fitness of ~40% at maximum weight fixation (Figure 4.4). This suggests that non-host penalties are most detrimental to host range expansion. When faced with multiple toxic non-hosts our models predict that evolution from

specialist to generalist would be significantly more difficult to achieve when the ability to adapt is low. This suggests that the dead end theory could, in this type of ecology, be accurate and specialists would effectively become trapped. Both simulations including non-host penalties displayed similar trends across all different levels of weight fixation.

The introduction of search costs to simulations with non-host penalties had very little effect on the performance of the networks versus the simulations with only non-host penalties. The amount of maximum fitness recovered by networks suffering both penalties was only 1.27% less than networks suffering only non-host punishment at 90% weight fixation (Table 4.1). This result would suggest that networks find compensating for search costs a significantly easier task than dealing with toxic non-hosts and even when both are applied they can minimise the impact of negative search costs on their evolution. Across the range of weight fixation applied to the networks we see little difference in the results for non-host punishment when compared to the simulations with both non-host punishment and search costs. Species in ecologically similar habitats to this dual punishment simulation would be more at risk of finding themselves in an evolutionary dead end and indeed we would expect this scenario to be the most difficult to escape from if only marginally more difficult than non-host punishments alone. This raises concerns when considering the patchy nature of many ecosystems and the prevalence of manmade compounds used in crop defence. This combination of enforced search time and the likelihood of encountering toxins could well be preventing specialists expanding their host range and may become a contributing factor in the extinction of these species. Patchy habitats have already been linked to species extinction (Travis, 2003) and the addition of toxic compounds into the environment could be creating a much worse situation. A further compounding factor is the method of application of

pesticides. As they are sprayed over large areas onto highly abundant hosts (crops) the likelihood of contact with these toxins will be high.

We must be aware that the data in Table 4.1 does not generalise perfectly across all levels of weight fixation (Figure 4.4). This suggests that the results we have found could be more complicated than first thought. There are perhaps other factors which are acting on the fitness recovery in these simulations and this will require more work to discover. The data includes several points of interest. In particular the networks suffering search costs appear to be able to perform best at 40% and 60% weight fixation and can exceed the no punishment networks performance at these levels of fixation and also marginally at 80%. Networks suffering no punishments had areas in which they performed better than would be expected, specifically at 30% and 70% fixation. Even when non-host punishments are present network behaviour was slightly variable with these networks scoring highly at 20% and 40% fixation. The reasons for this are as yet unknown but it would be interesting to explore this further. The results found here suggest that the interaction of the ecological factors could be having greater, more complex effects on network fitness than previously thought.

But it is not only direct genetic or synaptic variation that must be considered when investigating behavioural evolutionary dead ends. Many studies, particularly those on *Drosophila*, show that a major contributing factor to host range is the number of active receptor proteins possessed by the organism (McBride, 2007; Dworkin and Jones, 2009). Gustatory and olfactory receptors have an influence over formation and maintenance of host preference (Jordan *et al.*, 2009) and it would be useful to explore the effect of gains and losses of receptors on the evolution of networks with limited evolvability. This would perhaps be better studied using more biologically realistic architecture. A realistically structured network

including receptor neurons and their target areas of the brain would provide much needed insight into how these inputs can shape behaviour. This could be used for many different organisms, although complexity and computer processing power would dictate more simple systems. A good starting point would be the encoding of receptors that can be deactivated during evolution within the input of the network. An investigation of this kind would provide valuable information on the interaction between receptors and their effect on behaviour. There has been a great deal of research on olfactory information processing in *Drosophila* and because of the large amount of information available this would be an excellent candidate to investigate (Stocker, 1994; Couto *et al.*, 2005; Silbering *et al.*, 2008; Masse *et al.*, 2009). These systems are possibly too complex to simulate directly but simplified versions could provide valuable insights into the role of olfactory receptors in behaviour.

The idea of specialisation being an evolutionary dead end is one which cannot be completely discarded. Although possibly not as common as some of the literature would suggest, when under high levels of ecological pressure we clearly see that networks suffered high fitness costs which lends weight to the dead end theory. Empirically these results need more investigation to explore how this may be affecting specialists in the field. Specialist host range expansions and local extinctions would all be useful to examine when attempting to establish how much of an impact the dead end could have in the future. Comparative work with generalist species, such as investigations into the ability of both specialist and generalist species to deal with identical ecological pressures, would also prove valuable and would provide empirical evidence for the differences in the ability of these 2 strategies to react to rapid changes in their environment.

5. General Discussion

In this thesis I have demonstrated three different mechanisms that can shape the niche width of a species'. Olfactory information such as bee scent marks or floral volatiles, external ecological pressures such as search costs, starvation or resource availability, and a reduction in the species' evolvability underlying the properties of a model organic system can all influence resource use. These factors are therefore all important considerations when studying both the fundamental and realised niche of a species and how it evolves over time.

Reasonably, we could expect all of these factors to be having an impact on the evolution of niche width in many natural populations. Without a greater understanding of how these factors shape niche width we could be disregarding important interactions within and between species.

5.1. Chapter 1

Foraging is efficient in most, if not all, pollinator species (Pyke, 1978; Graham and Jones, 1996). Scent marking is a low cost and reliable system used to improve foraging by many different Hymenoptera species (Giurfa, 1992; D Goulson, Hawson, SA, & Stout, JC, 1998; Gawleta *et al.*, 2005). Many bee species can recognise not only conspecific scent marks but also those of other species of bee. Although it is known that syrphids use olfactory cues when foraging to locate specific flowers (Primante and Dötterl, 2010) and oviposition sites (Almohamad *et al.*, 2008) this ability to utilise interspecific scent marks had never been investigated in syrphids. Finding that syrphids can not only learn to recognise these scent marks but can also use them to improve their own foraging accuracy is an important discovery. The olfactory abilities of syrphids could also be an important factor in the

evolution of their ecological niche. Competition with bees will be common and any improvement in foraging efficiency should be favoured over time. Further evidence for the complex nature of syrphids' use of olfactory information was found when they were trained to recognise and respond to 1-Hexanol. As this is another compound they will come into contact with regularly, it being a common component of floral odour (Knudsen *et al.*, 2006), it is perhaps not a surprise that syrphids could use this odour when making foraging decisions.

If syrphids are using this odour learning ability in the field it is also possible that the number of foraging syrphids could increase in the absence of pollinators such as bumblebees or honeybees due to reduced contact with scent marks. Greater numbers of syrphids could reduce the negative impact of recent declines in the number of pollinating hymenoptera in the field (D. Goulson *et al.*, 2008; Bacandritsos *et al.*, 2010). If syrphid behaviour can be affected by these odours in the field it is reasonable to assume that syrphid foraging can be influenced by the artificial application of odours to areas where pollinators are scarce. Manipulating the behaviour of these pollinators could become a useful tool for gardeners or in small scale agriculture. A further advantage of being able to control syrphid behaviour would be their use as a biological control agent. Syrphid larvae predate aphids so greater numbers of syrphids could also reduce damage to plants. Field margins are already managed to increase syrphid numbers for pest management (MacLeod, 1999; Haenke *et al.*, 2009) and the possibility of using odour to attract hoverflies has been demonstrated in other contexts (Laubertie *et al.*, 2006).

It would be useful to test these results in the field. Random application of scent marks on flowers in the field along with bagging flowers overnight to prevent access to bees would provide valuable data regarding how much, if at all, syrphids are using scent mark

information in their foraging. If this work is carried out in areas with different densities of foraging bees, differences in any levels of utilisation of scent marks through previous learning by syrphids could be examined. As the syrphids also learned to avoid 1-Hexanol, investigations into their ability to learn to associate other odours would be welcome.

Another useful experiment would be to test the ability of the syrphids to make positive associations with odour. If they can learn an odour paired with a reward then increased preferences could be formed. Additional investigations into the long term memory capabilities of hoverflies would aid this work. It is well known that Hymenoptera such as wasps (Jander, 1998) and other Diptera such as *Drosophila* sp. (Tempel *et al.*, 1983) are capable of this type of positive reinforcement, long term memory training but no work has yet been done using Syrphids. The ability to form long term memory is important if syrphids are to be considered as a biological control agent or for increased pollination.

This work is only concerned with syrphids however there are many other pollinating insects including several families of Diptera, Lepidoptera and Hymenoptera to which this type of study could be applied. In particular it would be interesting to examine the use of scent marks by the lepidoptera. The butterflies and moths are a well studied group and much is known about their ability to use odour for various tasks from host plant location to communication and mate finding (Hansson, 1995). My work suggests that bee scent marks are utilised by more than just other Hymenoptera and, as many Lepidopterans are rather large insects, I would suggest that the use of interspecific scent marks when foraging could improve foraging efficiency in this order of insects. Further to this one could reasonably expect predatory organisms to utilise scent marks when either hunting or searching for suitable habitat. For example, bee hunting spiders could improve their success rate by inhabiting a flower that is

more heavily scent marked and therefore more frequently visited by bees. Movements of spiders between flowers have been recorded (Schmalhofer, 2001) but no work has yet been done on the mechanism by which the spider chooses a flower. This would not be a difficult behaviour to investigate and could provide useful insight into the foraging strategies of pollinator hunting spiders.

5.2. Chapter 2

The effect of ecological factors on the decision accuracy of artificial neural networks (ANNs) suggests that environmental pressures can have a major effect on the success of both specialist and generalists. In previous work C. R. Tosh *et al.* (2009) demonstrated that specialist networks can outperform generalist networks, in terms of decision accuracy, over a range of non-host values (± 0 , +0.5 and +1 fitness for a non-host selection) when host choice has a fixed value (+5). In Chapter 2, in both the resource availability and the starvation simulations, this range was reduced. Specialist networks suffering from starvation could still outperform generalist networks over +0.5 and +1 non-host fitness values, albeit to a lesser degree than in the absence of this pressure (Figure 4.3). This finding is well supported in the literature (Hoffmann and Turelli, 1985; Jaenike, 1990). The introduction of resource availability had a similar effect with greater reductions in resources further narrowing the range of specialist advantage (Figure 4.3). Again this result agrees with the current literature (Bolnick *et al.*, 2003; Beest *et al.*, 2014). In the field this would suggest that when these ecological pressures are present, specialisation is less likely to evolve through benefits accruing in decision accuracy and existing specialists would see greater declines than generalist species experiencing the same pressures. This would maintain the wider niche width of species or even increase the foraging range of the species under these pressures while reducing the persistence of more specialist species with narrower niches. This does not mean that

specialisation will not occur however, only that it will be less common under these ecological conditions.

More interestingly I have shown that search costs could increase specialists' decision accuracy advantage over generalists in conditions where they otherwise were being out-competed. With no ecological pressures other than non-host penalties, generalists have higher decision accuracy in conditions where a non-host choice is punished. This shifts when high search costs are introduced and under these new conditions specialists' decision accuracy is greater than generalists' at all negative values of non-host punishment. Therefore in natural populations we would expect to see more specialist species in historically patchy resource environments or more sparse habitats when these habitats contain toxic or harmful non-hosts. This finding agrees with both theoretical (Ackermann and Doebeli, 2004) and empirical work (Lars Chittka *et al.*, 2009).

To examine this, a comparative analysis would be useful. The predictions in Chapter 2 should be visible in both neo- and paleoecological studies. It has been suggested that human impacts such as landscape fragmentation will have a greater effect on specialist species (Clavel *et al.*, 2010) however if what I have found in my theoretical studies is also apparent in natural populations then it could be argued that the opposite could be true; specialists will outperform generalists when high search costs are present for both strategies and a non-host choice carries a penalty.

Ecological work, and in particular climate change research, could be improved by work such as this. Currently much ecological work relies on observations and historical studies. The

ability to accurately predict how a species will adapt to a changing environment could improve the efficacy of ecological methods such as reintroductions, habitat management, and aid in choosing which areas to protect. When considering climate change, historical work is of limited use (McCarty, 2001). Comparisons of the same or similar species are of greater value but unless conditions are the same then errors could still skew any results. Predictive models that provide data not on what has happened to a species or a population but on what is most likely to happen in the future will be more useful, particularly as climate change accelerates.

5.3. Chapter 3

The theory that specialisation is an evolutionary dead end has been around for a long time (Simpson, 1944). There is a huge amount of work both in favour of and against this idea (Futuyma and Moreno, 1988; Janz *et al.*, 2001; Nosil and Mooers, 2005; McBride, 2007). Using evolvable ANNs as a simple model of biological information processing, what I have shown, using ANNs subject to different levels of weight fixation, is that the situation is not as simple as many studies would have us believe. It is not a matter of the theory being correct in all scenarios. Rather it seems that, under certain conditions, the evolutionary dead end is more probable. While this is true, it is also true that conditions favouring evolutionary dead ends are rather extreme. Networks at relatively high levels of weight fixation were still able to perform at a high percentage of their maximum possible fitness when tasked with evolving back to generalism. It is not the reduction in evolvability itself that prevented the ANNs from escaping the ‘dead end’ but the ecological factors which they were subjected to alongside this reduction.

More specifically, of all the networks that I trained, the worst performing by far were those networks suffering from non-host penalties. For a specialist to become trapped in specialisation it would need to lose almost all of its ability to evolve and even then my results suggest that they could potentially recover almost 65% of their maximum possible fitness. Introduce non-host penalties and this figure drops ~25%. From this I would suggest that a lack of variability, in isolation, slightly increases the likelihood of a species to suffer from an evolutionary dead end scenario. The introduction of search costs to the simulation had a much reduced effect on the overall fitness of the networks compared to non-host penalties. Fitness was reduced when search costs were present but even when variation was at a minimum these networks only lost a further ~15% of maximum possible fitness compared to networks suffering no ecological pressures. Interestingly when non-host penalties were present the introduction of search costs had a relatively minor effect. The networks suffering both pressures only saw a further reduction of ~10% compared to the non-host penalties only simulation. In the field species will be much less likely to find themselves in an evolutionary dead end when suffering search costs alone but when this is compounded with toxic non-hosts the likelihood of the dead end increases significantly.

This is a difficult area to study experimentally due to the large timescale over which these effects occur. Additionally, the conditions experienced by organisms in evolutionary history are often unknown or poorly understood. Empirical work using organisms with a short generation time could be used to investigate the effects I have described. Artificially selected lines of insects such as *Drosophila* could be used to test predictions in my models. Specialist and generalist lines could be raised and used to look at fitness costs of the different foraging strategies when under similar ecological conditions to those I have applied. Recently collected inbred lines of *Drosophila* would be an ideal subject for this. Preferably this would involve

specialist species which could, if they were subjected to the conditions used in my ANNs, provide evidence either for or against the results I have found with the theoretical work. Equally this would be an interesting experiment to run with a generalist species to see how the two strategies compare. My work suggests that specialists forced to widen their host range will suffer more if their ecological conditions deteriorate dramatically but how generalists would adapt to the same pressures is just as valid when considering these aspects of ecology. To test the effects of non-host penalties bacterial colonies could be employed. If a specialist organism was to be studied then a medium containing a single host resource could be used and fitness measures such as colony size or growth rate could be measured. With the short generation time of microbes, evolution could be observed over many generations. The introduction of additional potential host resources into the medium along with hosts which are toxic should provide insight into the effect that these have on evolution.

The large body of work on larger organisms such as cheetah (May, 1995; Hedrick, 1996), black-footed ferrets (Wisely *et al.*, 2002) and koala (Sherwin *et al.*, 2000; Tsangaras *et al.*, 2012) illustrates the importance of work such as this. The questions I have asked have applications from the microscopic to the higher vertebrates. In all of the studies mentioned above researchers found that very low genetic diversity did not appear to be having the level of negative consequences that would be predicted by the evolutionary dead end theory. My results would certainly agree with these findings however my work goes further in that I investigate the impacts of ecological variables that are perhaps not currently affecting the studied populations. That there seems to be little evidence for the dead end at present my results would suggest that if suitable host resources become scarce then the negative impacts this would incur could lead to a situation in which the populations struggle to adapt.

5.4 Conclusions

The lab work with the syrphids has provided excellent evidence of their ability to learn and recognise odours as well using those odours to aid their foraging. This does not necessarily translate to wild individuals however. More work will be needed to investigate the interaction between syrphids and scent marks before we can be sure that they are utilising these cues.

Much of my work has been performed using computer modelling and theoretical scenarios.

While this can provide valuable insight into subject areas that have previously been difficult to research we must also be careful that these results reflect the systems or organisms we are claiming to study. When using ANNs the network is a much simplified version of the system being studied therefore care must be taken to encapsulate all of the relevant behaviours of the system. Comparisons with the relevant literature at all stages have been useful in building and discussing my models.

6. References

- Abbass, H. A. (2002) 'An evolutionary artificial neural networks approach for breast cancer diagnosis', *Artificial Intelligence in Medicine*, 25(3), pp. 265-281.
- Ackermann, M. and Doebeli, M. (2004) 'Evolution of niche width and adaptive diversification', *Evolution*, 58(12), pp. 2599-2612.
- Almohamad, R., Verheggen, F., Francis, F. and Haubruge, E. (2008) 'Impact of aphid colony size and associated induced plant volatiles on searching and oviposition behaviour of a predatory hoverfly', *Belgian Journal of Entomology*, 10, pp. 17-26.
- Armbruster, W. S. and Baldwin, B. G. (1998) 'Switch from specialized to generalized pollination', *Nature*, 394(6694), pp. 632-632.
- Atsatt, P. R. (1981) 'Lycaenid butterflies and ants: selection for enemy-free space', *American Naturalist*, pp. 638-654.
- Bacandritsos, N., Granato, A., Budge, G., Papanastasiou, I., Roinioti, E., Caldon, M., Falcaro, C., Gallina, A. and Mutinelli, F. (2010) 'Sudden deaths and colony population decline in Greek honey bee colonies', *Journal of Invertebrate Pathology*, 105(3), pp. 335-340.
- Ballabeni, P., Włodarczyk, M. and Rahier, M. (2001) 'Does enemy-free space for eggs contribute to a leaf beetle's oviposition preference for a nutritionally inferior host plant?', *Functional Ecology*, 15(3), pp. 318-324.
- Bar-Massada, A. (2015) 'Immigration rates and species niche characteristics affect the relationship between species richness and habitat heterogeneity in modeled meta-communities', *PeerJ*, 3, p. e832.
- Beest, F. M., Uzal, A., Vander Wal, E., Laforge, M. P., Contasti, A. L., Colville, D. and McLoughlin, P. D. (2014) 'Increasing density leads to generalization in both coarse-grained habitat selection and fine-grained resource selection in a large mammal', *Journal of Animal Ecology*, 83(1), pp. 147-156.
- Belvin, M. P. and Yin, J. C. P. (1997) 'Drosophila learning and memory: recent progress and new approaches', *Bioessays*, 19(12), pp. 1083-1089.

Bernays, E. (1990) 'Plant secondary compounds deterrent but not toxic to the grass specialist acridid *Locusta migratoria*: implications for the evolution of graminivory', *Entomologia Experimentalis Et Applicata*, 54(1), pp. 53-56.

Bernays, E. (1998) 'The value of being a resource specialist: behavioral support for a neural hypothesis', *The American Naturalist*, 151(5), pp. 451-464.

Bernays, E. (2001) 'Neural limitations in phytophagous insects: implications for diet breadth and evolution of host affiliation', *Annual review of entomology*, 46(1), pp. 703-727.

Bernays, E. and Bright, K. (2001) 'Food choice causes interrupted feeding in the generalist grasshopper *Schistocerca americana*: further evidence for inefficient decision-making', *Journal of insect physiology*, 47(1), pp. 63-71.

Bernays, E. A. and Funk, D. J. (1999) 'Specialists make faster decisions than generalists: experiments with aphids', *Proceedings of the Royal Society of London. Series B: Biological Sciences*, 266(1415), pp. 151-156.

Bitterman, M., Menzel, R., Fietz, A. and Schäfer, S. (1983) 'Classical conditioning of proboscis extension in honeybees (*Apis mellifera*)', *Journal of Comparative Psychology*, 97(2), p. 107.

Bolnick, D. I. (2001) 'Intraspecific competition favours niche width expansion in *Drosophila melanogaster*', *Nature*, 410(6827), pp. 463-466.

Bolnick, D. I., Ingram, T., Stutz, W. E., Snowberg, L. K., Lau, O. L. and Paull, J. S. (2010) 'Ecological release from interspecific competition leads to decoupled changes in population and individual niche width', *Proceedings of the Royal Society B: Biological Sciences*, 277(1689), pp. 1789-1797.

Bolnick, D. I., Svanbäck, R., Araújo, M. S. and Persson, L. (2007) 'Comparative support for the niche variation hypothesis that more generalized populations also are more heterogeneous', *Proceedings of the National Academy of Sciences*, 104(24), pp. 10075-10079.

Bolnick, D. I., Svanback, R., Fordyce, J. A., Yang, L. H., Davis, J. M., Hulsey, C. D. and Forister, M. L. (2003) 'The ecology of individuals: Incidence and implications of individual specialization', *American Naturalist*, 161(1), pp. 1-28.

- Bremermann, H. J. (1962) 'Optimization through evolution and recombination', *Self-organizing systems*, 93, p. 106.
- Burns, J. G. (2005) 'Impulsive bees forage better: the advantage of quick, sometimes inaccurate foraging decisions', *Animal Behaviour*, 70(6), pp. e1-e5.
- Burns, J. G. and Dyer, A. G. (2008) 'Diversity of speed-accuracy strategies benefits social insects', *Current Biology*, 18(20), pp. R953-R954.
- Campbell, D. R., Bischoff, M., Lord, J. M. and Robertson, A. W. (2010) 'Flower color influences insect visitation in alpine New Zealand', *Ecology*, 91(9), pp. 2638-2649.
- Carletto, J., Lombaert, E., Chavigny, P., Brevault, T., Lapchin, L. and Vanlerberghe-Masutti, F. (2009) 'Ecological specialization of the aphid *Aphis gossypii* Glover on cultivated host plants', *Molecular Ecology*, 18(10), pp. 2198-2212.
- Chittka, L., Gumbert, A. & Kunze, J (1997) 'Foraging dynamics of bumble bees: Correlates of movements within and between plant species', *Behavioural Ecology*, 8, pp. 239-249.
- Chittka, L., Skorupski, P. and Raine, N. E. (2009) 'Speed-accuracy tradeoffs in animal decision making', *Trends in Ecology & Evolution*, 24(7), pp. 400-407.
- Chittka, L., Thomson, J. D. and Waser, N. M. (1999) 'Flower constancy, insect psychology, and plant evolution', *Naturwissenschaften*, 86(8), pp. 361-377.
- Clavel, J., Julliard, R. and Devictor, V. (2010) 'Worldwide decline of specialist species: toward a global functional homogenization?', *Frontiers in Ecology and the Environment*, 9(4), pp. 222-228.
- Colles, A., Liow, L. H. and Prinzing, A. (2009) 'Are specialists at risk under environmental change? Neoecological, paleoecological and phylogenetic approaches', *Ecology Letters*, 12(8), pp. 849-863.
- Collier, G., Hirsch, E. and Hamlin, P. H. (1972) 'The ecological determinants of reinforcement in the rat', *Physiology & Behavior*, 9(5), pp. 705-716.
- Colwell, R. K. and Futuyma, D. J. (1971) 'On the measurement of niche breadth and overlap', *Ecology*, pp. 567-576.
- Couto, A., Alenius, M. and Dickson, B. J. (2005) 'Molecular, anatomical, and functional organization of the *Drosophila* olfactory system', *Current Biology*, 15(17), pp. 1535-1547.

- Dall, S. R. and Cuthill, I. C. (1997) 'The information costs of generalism', *Oikos*, pp. 197-202.
- Delton, A. W., Krasnow, M. M., Cosmides, L. and Tooby, J. (2011) 'Evolution of direct reciprocity under uncertainty can explain human generosity in one-shot encounters', *Proceedings of the National Academy of Sciences*, 108(32), pp. 13335-13340.
- Dunn, J. C., Buchanan, G. M., Cuthbert, R. J., Whittingham, M. J. and McGowan, P. J. (2015) 'Mapping the potential distribution of the Critically Endangered Himalayan Quail *Ophrysia superciliosa* using proxy species and species distribution modelling', *Bird Conservation International*, pp. 1-13.
- Dworkin, I. and Jones, C. D. (2009) 'Genetic changes accompanying the evolution of host specialization in *Drosophila sechellia*', *Genetics*, 181(2), pp. 721-736.
- Egan, S. P. and Funk, D. J. (2006) 'Individual advantages to ecological specialization: insights on cognitive constraints from three conspecific taxa', *Proceedings of the Royal Society B: Biological Sciences*, 273(1588), pp. 843-848.
- Elton, C. S. (1927) *Animal Ecology*. London: Sidgwick & Jackson.
- Enquist, M. and Ghirlanda, S. (2005) *Neural networks and animal behavior*. Princeton University Press.
- Ewert, J.-P. (1970) 'Neural mechanisms of prey-catching and avoidance behavior in the toad (*Bufo bufo* L.)', *Brain, behavior and evolution*, 3(1-4), pp. 36-56.
- Faller, W. E. and Schreck, S. J. (1996) 'Neural networks: applications and opportunities in aeronautics', *Progress in aerospace sciences*, 32(5), pp. 433-456.
- Fellows, D. P. and Heed, W. B. (1972) 'Factors affecting host plant selection in desert-adapted cactiphilic *Drosophila*', *Ecology*, 53(5), pp. 850-858.
- Ferrauto, T., Parisi, D., Di Stefano, G. and Baldassarre, G. (2013) 'Different genetic algorithms and the evolution of specialization: A study with groups of simulated neural robots', *Artificial life*, 19(2), pp. 221-253.
- Fiala, A. (2007) 'Olfaction and olfactory learning in *Drosophila*: recent progress', *Current opinion in neurobiology*, 17(6), pp. 720-726.

- Finch, S. and Collier, R. (2000) 'Host-plant selection by insects—a theory based on 'appropriate/inappropriate landings' by pest insects of cruciferous plants', *Entomologia Experimentalis Et Applicata*, 96(2), pp. 91-102.
- Fisher, D. O., Blomberg, S. P. and Owens, I. P. (2003) 'Extrinsic versus intrinsic factors in the decline and extinction of Australian marsupials', *Proceedings of the Royal Society of London B: Biological Sciences*, 270(1526), pp. 1801-1808.
- Flessa, K. W., Powers, K. V. and Cisne, J. L. (1975) 'Specialization and evolutionary longevity in the Arthropoda', *Paleobiology*, 1(01), pp. 71-81.
- Flood, I. and Kartam, N. (1994) 'Neural networks in civil engineering. I: Principles and understanding', *Journal of computing in civil engineering*, 8(2), pp. 131-148.
- Floreano, D. and Keller, L. (2010) 'Evolution of adaptive behaviour in robots by means of Darwinian selection', *PLoS Biol*, 8(1), p. e1000292.
- Forister, M., Dyer, L., Singer, M., Stireman III, J. and Lill, J. (2012) 'Revisiting the evolution of ecological specialization, with emphasis on insect-plant interactions', *Ecology*, 93(5), pp. 981-991.
- Frankham, R. (2005) 'Genetics and extinction', *Biological Conservation*, 126(2), pp. 131-140.
- Frankham, R., Lees, K., Montgomery, M. E., England, P. R., Lowe, E. H. and Briscoe, D. A. (1999) 'Do population size bottlenecks reduce evolutionary potential?', *Animal Conservation*, 2(4), pp. 255-260.
- Free, J. B. and Williams, I. H. (1983) 'Scent-Marking of Flowers by Honeybees', *Journal of Apicultural Research*, 22(2), pp. 86-90.
- Fridley, J. D., Vandermast, D. B., Kuppinger, D. M., Manthey, M. and Peet, R. K. (2007) 'Co-occurrence based assessment of habitat generalists and specialists: a new approach for the measurement of niche width', *Journal of ecology*, 95(4), pp. 707-722.
- Fukushima, K. (1986) 'A neural network model for selective attention in visual pattern recognition', *Biological Cybernetics*, 55(1), pp. 5-15.
- Futuyma, D. J. and Mitter, C. (1996) 'Insect-plant interactions: the evolution of component communities', *Philosophical Transactions of the Royal Society B: Biological Sciences*, 351(1345), pp. 1361-1366.

- Futuyma, D. J. and Moreno, G. (1988) 'The evolution of ecological specialization', *Annual Review of Ecology and Systematics*, pp. 207-233.
- Gawleta, N., Zimmermann, Y. and Eltz, T. (2005) 'Repellent foraging scent recognition across bee families', *Apidologie*, 36(3), p. 325.
- Gegeer, R. J. (2005) 'Multicomponent floral signals elicit selective foraging in bumblebees', *Naturwissenschaften*, 92(6), pp. 269-271.
- Gehring, T. M. and Swihart, R. K. (2003) 'Body size, niche breadth, and ecologically scaled responses to habitat fragmentation: mammalian predators in an agricultural landscape', *Biological Conservation*, 109(2), pp. 283-295.
- Genersch, E. (2010) 'Honey bee pathology: current threats to honey bees and beekeeping', *Applied Microbiology and Biotechnology*, 87(1), pp. 87-97.
- Ghazoul, J. (2005) 'Buzziness as usual? Questioning the global pollination crisis', *Trends in Ecology & Evolution*, 20(7), pp. 367-373.
- Gilman, S. E., Urban, M. C., Tewksbury, J., Gilchrist, G. W. and Holt, R. D. (2010) 'A framework for community interactions under climate change', *Trends in Ecology & Evolution*, 25(6), pp. 325-331.
- Giurfa, M., & Nunez, JA (1992) 'Honeybees mark with scent and reject recently visited flowers', *Oecologia*, 89, pp. 113-117.
- Goulson, D. (1999) 'Foraging strategies of insects for gathering nectar and pollen, and implications for plant ecology and evolution', *Perspectives in plant ecology, evolution and systematics*, 2(2), pp. 185-209.
- Goulson, D., Chapman, JW, & Hughes WHO (2001) 'Discrimination of Unrewarding Flowers by Bees; Direct Detection of Rewards and Use of Repellent Scent Marks', *Journal of Insect Behaviour*, 14(5), pp. 669-678.
- Goulson, D., Hawson, SA, & Stout, JC (1998) 'Foraging bumblebees avoid flowers already visited by conspecifics or by other bumblebee species', *Animal Behaviour*, 55, pp. 199-206.
- Goulson, D., Lye, G. C. and Darvill, B. (2008) 'Decline and conservation of bumble bees', *Annu. Rev. Entomol.*, 53, pp. 191-208.

- Goulson, D., Stout, J.C., Langley, J., & Hughes WOH (2000) 'Identity and function of scent marks deposited by foraging bumblebees', *Journal of Chemical Ecology*, 26(12), pp. 2897-2911.
- Goulson, D. and Wright, N. P. (1998) 'Flower constancy in the hoverflies *Episyrphus balteatus* (Degeer) and *Syrphus ribesii* (L.) (Syrphidae)', *Behavioral Ecology*, 9(3), pp. 213-219.
- Graham, L. and Jones, K. N. (1996) 'Resource partitioning and per-flower foraging efficiency in two bumble bee species', *American Midland Naturalist*, pp. 401-406.
- Grinnell, J. (1917) 'The niche-relationships of the California Thrasher', *The Auk*, pp. 427-433.
- Haenke, S., Scheid, B., Schaefer, M., Tschardt, T. and Thies, C. (2009) 'Increasing syrphid fly diversity and density in sown flower strips within simple vs. complex landscapes', *Journal of Applied Ecology*, 46(5), pp. 1106-1114.
- Hagen, M., Wikelski, M. and Kissling, W. D. (2011) 'Space use of bumblebees (*Bombus* spp.) revealed by radio-tracking', *Plos One*, 6(5), p. e19997.
- Hansson, B. (1995) 'Olfaction in lepidoptera', *Experientia*, 51(11), pp. 1003-1027.
- Haslett, J. R. (1989) 'Interpreting Patterns of Resource Utilization - Randomness and Selectivity in Pollen Feeding by Adult Hoverflies', *Oecologia*, 78(4), pp. 433-442.
- Hedrick, P. W. (1996) 'Bottleneck (s) or metapopulation in cheetahs', *Conservation Biology*, pp. 897-899.
- Hoballah, M. E., Stuurman, J., Turlings, T. C. J., Guerin, P. M., Connetable, S. and Kuhlemeier, C. (2005) 'The composition and timing of flower odour emission by wild *Petunia axillaris* coincide with the antennal perception and nocturnal activity of the pollinator *Manduca sexta*', *Planta*, 222(1), pp. 141-150.
- Hoffmann, A. A. (1985) 'Effects of experience on oviposition and attraction in *Drosophila*: comparing apples and oranges', *American Naturalist*, pp. 41-51.
- Hoffmann, A. A. and Turelli, M. (1985) 'Distribution of *Drosophila melanogaster* on alternative resources: effects of experience and starvation', *American Naturalist*, pp. 662-679.
- Holland, J. H. (1992) 'Adaptation in natural and artificial systems'. MIT Press, Cambridge, MA.

- Holmes, E. E., Lewis, M. A., Banks, J. and Veit, R. (1994) 'Partial differential equations in ecology: spatial interactions and population dynamics', *Ecology*, pp. 17-29.
- Holmgren, N. M. and Getz, W. M. (2000) 'Evolution of host plant selection in insects under perceptual constraints: a simulation study', *Evolutionary Ecology Research*, 2(1), pp. 81-106.
- Holmgren, N. M., Norrström, N. and Getz, W. M. (2007) 'Artificial neural networks in models of specialization, guild evolution and sympatric speciation', *Philosophical Transactions of the Royal Society B: Biological Sciences*, 362(1479), pp. 431-440.
- Howell, A. D. and Alarcón, R. (2007) 'Osmia bees (Hymenoptera: Megachilidae) can detect nectar-rewarding flowers using olfactory cues', *Animal Behaviour*, 74(2), pp. 199-205.
- Hungate, R. (1955) 'Symposium on microbiology of the rumen', *Bacteriological reviews*, 19(4), p. 277.
- Hutchinson, G. (1958) *Symposia on Quantitative Biology*.
- Ito, I., Bazhenov, M., Ong, R. C.-y., Raman, B. and Stopfer, M. (2009) 'Frequency transitions in odor-evoked neural oscillations', *Neuron*, 64(5), pp. 692-706.
- Jaenike, J. (1990) 'Host Specialization in Phytophagous Insects', *Annual Review of Ecology and Systematics*, 21, pp. 243-273.
- Jander, R. (1998) 'Olfactory learning of fruit odors in the Eastern yellow jacket, *Vespula maculifrons* (Hymenoptera: Vespidae)', *Journal of Insect Behavior*, 11(6), pp. 879-888.
- Janz, N., Nyblom, K. and Nylin, S. (2001) 'Evolutionary dynamics of host-plant specialization: a case study of the tribe Nymphalini', *Evolution*, 55(4), pp. 783-796.
- Janz, N. and Nylin, S. (1997) 'The role of female search behaviour in determining host plant range in plant feeding insects: a test of the information processing hypothesis', *Proceedings of the Royal Society of London. Series B: Biological Sciences*, 264(1382), pp. 701-707.
- Jeffries, M. and Lawton, J. (1984) 'Enemy free space and the structure of ecological communities', *Biological journal of the linnean society*, 23(4), pp. 269-286.
- Jones, J. (1961) 'Aspects of respiration in *Planorbis corneus* L. and *Lymnaea stagnalis* L. (Gastropoda: Pulmonata)', *Comparative biochemistry and physiology*, 4(1), pp. 1-29.

Jordan, M. D., Anderson, A., Begum, D., Carraher, C., Authier, A., Marshall, S. D., Kiely, A., Gatehouse, L. N., Greenwood, D. R. and Christie, D. L. (2009) 'Odorant receptors from the light brown apple moth (*Epiphyas postvittana*) recognize important volatile compounds produced by plants', *Chemical senses*, 34(5), pp. 383-394.

Joy, M. K. and Death, R. G. (2004) 'Predictive modelling and spatial mapping of freshwater fish and decapod assemblages using GIS and neural networks', *Freshwater Biology*, 49(8), pp. 1036-1052.

Jump, A. S., Marchant, R. and Penuelas, J. (2009) 'Environmental change and the option value of genetic diversity', *Trends in plant science*, 14(1), pp. 51-58.

Kamo, M., Kubo, T. and Iwasa, Y. (1998) 'Neural network for female mate preference, trained by a genetic algorithm', *Philosophical Transactions of the Royal Society of London B: Biological Sciences*, 353(1367), pp. 399-406.

Kassen, R. (2002) 'The experimental evolution of specialists, generalists, and the maintenance of diversity', *Journal of Evolutionary Biology*, 15(2), pp. 173-190.

Kelley, S. T. and Farrell, B. D. (1998) 'Is specialization a dead end? The phylogeny of host use in *Dendroctonus* bark beetles (Scolytidae)', *Evolution*, pp. 1731-1743.

Knudsen, J. T., Eriksson, R., Gershenzon, J. and Ståhl, B. (2006) 'Diversity and distribution of floral scent', *The Botanical Review*, 72(1), pp. 1-120.

Kullenberg, B., Bergström, G., Bringer, B., Carlberg, B. and Cederberg, B. (1973) 'Observations on scent marking by *Bombus* Latr. and *Psithyrus* Lep. males (Hym., Apidae) and localization of the site of production of the secretion', *Zoon-A Journal of Zoology*, (Suppl. 1), pp. 23-30.

Kunin, W. and Iwasa, Y. (1996) 'Pollinator foraging strategies in mixed floral arrays: density effects and floral constancy', *Theoretical Population Biology*, 49(2), pp. 232-263.

Lahti, D. C., Johnson, N. A., Ajie, B. C., Otto, S. P., Hendry, A. P., Blumstein, D. T., Coss, R. G., Donohue, K. and Foster, S. A. (2009) 'Relaxed selection in the wild', *Trends in Ecology & Evolution*, 24(9), pp. 487-496.

- Laloi, D., Sandoz, J., Picard-Nizou, A., Marchesi, A., Pouvreau, A., Taséi, J., Poppy, G. and Pham-Delegue, M. (1999) 'Olfactory conditioning of the proboscis extension in bumble bees', *Entomologia Experimentalis Et Applicata*, 90(2), pp. 123-129.
- Lang, M., Murat, S., Clark, A. G., Gouppil, G., Blais, C., Matzkin, L. M., Guittard, É., Yoshiyama-Yanagawa, T., Kataoka, H. and Niwa, R. (2012) 'Mutations in the neverland gene turned *Drosophila* *pachea* into an obligate specialist species', *Science*, 337(6102), pp. 1658-1661.
- Laubertie, E., Wratten, S. and Sedcole, J. (2006) 'The role of odour and visual cues in the pan-trap catching of hoverflies (Diptera: Syrphidae)', *Annals of Applied Biology*, 148(2), pp. 173-178.
- Layman, C. A., Quattrochi, J. P., Peyer, C. M. and Allgeier, J. E. (2007) 'Niche width collapse in a resilient top predator following ecosystem fragmentation', *Ecology Letters*, 10(10), pp. 937-944.
- Lek, S. and Guégan, J.-F. (1999) 'Artificial neural networks as a tool in ecological modelling, an introduction', *Ecological modelling*, 120(2), pp. 65-73.
- Levi, R. and Camhi, J. M. (2000) 'Wind direction coding in the cockroach escape response: winner does not take all', *The Journal of Neuroscience*, 20(10), pp. 3814-3821.
- Lewis, H., Tosh, C., O'KEEFE, S., Shuker, D., West, S. and Mayhew, P. (2010) 'Constraints on adaptation: explaining deviation from optimal sex ratio using artificial neural networks', *Journal of Evolutionary Biology*, 23(8), pp. 1708-1719.
- Liu, Z., Scheirs, J. and Heckel, D. G. (2012) 'Trade-offs of host use between generalist and specialist *Helicoverpa* sibling species: adult oviposition and larval performance', *Oecologia*, 168(2), pp. 459-469.
- Maass, W. (1997) 'Networks of spiking neurons: the third generation of neural network models', *Neural networks*, 10(9), pp. 1659-1671.
- MacLeod, A. (1999) 'Attraction and retention of *Episyrphus balteatus* DeGeer (Diptera: Syrphidae) at an arable field margin with rich and poor floral resources', *Agriculture, ecosystems & environment*, 73(3), pp. 237-244.
- Marchiori, D. and Warglien, M. (2008) 'Predicting human interactive learning by regret-driven neural networks', *Science*, 319(5866), pp. 1111-1113.

- Masse, N. Y., Turner, G. C. and Jefferis, G. S. (2009) 'Olfactory information processing in *Drosophila*', *Current Biology*, 19(16), pp. R700-R713.
- May, R. M. (1995) 'Population genetics. The cheetah controversy', *Nature*, 374(6520), pp. 309-310.
- McBride, C. S. (2007) 'Rapid evolution of smell and taste receptor genes during host specialization in *Drosophila sechellia*', *Proceedings of the National Academy of Sciences*, 104(12), pp. 4996-5001.
- McCarty, J. P. (2001) 'Ecological consequences of recent climate change', *Conservation Biology*, 15(2), pp. 320-331.
- McCulloch, W. S. and Pitts, W. (1943) 'A logical calculus of the ideas immanent in nervous activity', *The bulletin of mathematical biophysics*, 5(4), pp. 115-133.
- McNally, L., Brown, S. P. and Jackson, A. L. (2012) 'Cooperation and the evolution of intelligence', *Proceedings of the Royal Society B: Biological Sciences*, 279(1740), pp. 3027-3034.
- Minnich, D. E. (1919) 'The photic reactions of the honey-bee, *Apis mellifera* L', *Journal of Experimental Zoology*, 29(3), pp. 343-425.
- Mitchell, M. (1998) *An introduction to genetic algorithms*. MIT press.
- Molet, M., Chittka, L., Stelzer, R. J., Streit, S. and Raine, N. E. (2008) 'Colony nutritional status modulates worker responses to foraging recruitment pheromone in the bumblebee *Bombus terrestris*', *Behavioral Ecology and Sociobiology*, 62(12), pp. 1919-1926.
- Moran, N. (1984) 'Reproductive performance of a specialist herbivore, *Uroleucon nigrotibium* (Homoptera), on its host and on a non-host', *Oikos*, pp. 171-175.
- Moran, N. A. (1988) 'The evolution of host-plant alternation in aphids: evidence for specialization as a dead end', *American Naturalist*, pp. 681-706.
- Muchhala, N. (2007) 'Adaptive trade-off in floral morphology mediates specialization for flowers pollinated by bats and hummingbirds', *The American Naturalist*, 169(4), pp. 494-504.
- Munday, P. L. (2004) 'Habitat loss, resource specialization, and extinction on coral reefs', *Global Change Biology*, 10(10), pp. 1642-1647.
- Nagelkerke, C. J. and Menken, S. B. (2013) 'Coexistence of habitat specialists and generalists in metapopulation models of multiple-habitat landscapes', *Acta biotheoretica*, 61(4), pp. 467-480.

- Nosil, P. and Mooers, A. (2005) 'Testing hypotheses about ecological specialization using phylogenetic trees', *Evolution*, 59(10), pp. 2256-2263.
- O'Neill, M. A. (2012) *Rana*. Available at: <http://www.tumblingdice.co.uk/rana> (Accessed: 14th Jan).
- Özesmi, S. L., Tan, C. O. and Özesmi, U. (2006) 'Methodological issues in building, training, and testing artificial neural networks in ecological applications', *Ecological modelling*, 195(1), pp. 83-93.
- Park, Y.-S., Céréghino, R., Compin, A. and Lek, S. (2003) 'Applications of artificial neural networks for patterning and predicting aquatic insect species richness in running waters', *Ecological modelling*, 160(3), pp. 265-280.
- Park, Y.-S. and Chon, T.-S. (2007) 'Biologically-inspired machine learning implemented to ecological informatics', *Ecological modelling*, 203(1), pp. 1-7.
- Patel, M., Rangan, A. V. and Cai, D. (2009) 'A large-scale model of the locust antennal lobe', *Journal of computational neuroscience*, 27(3), pp. 553-567.
- Phelps, S. and Ryan, M. (2000) 'History influences signal recognition: neural network models of tungara frogs', *Proceedings of the Royal Society of London B: Biological Sciences*, 267(1453), pp. 1633-1639.
- Phelps, S. M. and Ryan, M. J. (1998) 'Neural networks predict response biases of female tungara frogs', *Proceedings of the Royal Society of London B: Biological Sciences*, 265(1393), pp. 279-285.
- Pielou, E. (1972) 'Niche width and niche overlap: a method for measuring them', *Ecology*, pp. 687-692.
- Plath, O. (1923) 'Breeding experiments with confined *Bremus* (*Bombus*) queens', *Biological Bulletin*, 45(6), pp. 325-341.
- Potts, S. G., Biesmeijer, J. C., Kremen, C., Neumann, P., Schweiger, O. and Kunin, W. E. (2010) 'Global pollinator declines: trends, impacts and drivers', *Trends in Ecology & Evolution*, 25(6), pp. 345-353.
- Primante, C. and Dötterl, S. (2010) 'A syrphid fly uses olfactory cues to find a non-yellow flower', *Journal of Chemical Ecology*, 36(11), pp. 1207-1210.
- Pyke, G. H. (1978) 'Optimal foraging: movement patterns of bumblebees between inflorescences', *Theoretical Population Biology*, 13(1), pp. 72-98.

- R'kha, S., Moreteau, B., Coyne, J. A. and David, J. R. (1997) 'Evolution of a lesser fitness trait: egg production in the specialist *Drosophila sechellia*', *Genetical research*, 69(01), pp. 17-23.
- Recknagel, F., French, M., Harkonen, P. and Yabunaka, K.-I. (1997) 'Artificial neural network approach for modelling and prediction of algal blooms', *Ecological modelling*, 96(1), pp. 11-28.
- Remington, C. L. (1968) 'The population genetics of insect introduction', *Annual review of entomology*, 13(1), pp. 415-426.
- Ricketts, T. H., Regetz, J., Steffan-Dewenter, I., Cunningham, S. A., Kremen, C., Bogdanski, A., Gemmill-Herren, B., Greenleaf, S. S., Klein, A. M. and Mayfield, M. M. (2008) 'Landscape effects on crop pollination services: are there general patterns?', *Ecology Letters*, 11(5), pp. 499-515.
- Rodrigues, D., Kaminski, L. A., Freitas, A. V. and Oliveira, P. S. (2010) 'Trade-offs underlying polyphagy in a facultative ant-tended florivorous butterfly: the role of host plant quality and enemy-free space', *Oecologia*, 163(3), pp. 719-728.
- Rolls, E. T. and Deco, G. (2002) *Computational neuroscience of vision*. Oxford university press Oxford.
- Rooney, T. P., Wiegmann, S. M., Rogers, D. A. and Waller, D. M. (2004) 'Biotic impoverishment and homogenization in unfragmented forest understory communities', *Conservation Biology*, 18(3), pp. 787-798.
- Roughgarden, J. (1972) 'Evolution of niche width', *American Naturalist*, pp. 683-718.
- Sargeant, B. L. (2007) 'Individual foraging specialization: niche width versus niche overlap', *Oikos*, 116(9), pp. 1431-1437.
- Schluter, D. (2009) 'Evidence for ecological speciation and its alternative', *Science*, 323(5915), pp. 737-741.
- Schmalhofer, V. R. (2001) 'Tritrophic interactions in a pollination system: impacts of species composition and size of flower patches on the hunting success of a flower-dwelling spider', *Oecologia*, 129(2), pp. 292-303.
- Selverston, A. I., Russell, D. F., Miller, J. P. and King, D. G. (1976) 'The stomatogastric nervous system: structure and function of a small neural network', *Progress in neurobiology*, 7, pp. 215-289.

- Sherwin, W. B., Timms, P., Wilcken, J. and Houlden, B. (2000) 'Analysis and conservation implications of koala genetics', *Conservation Biology*, 14(3), pp. 639-649.
- Silbering, A. F., Okada, R., Ito, K. and Galizia, C. G. (2008) 'Olfactory information processing in the *Drosophila* antennal lobe: anything goes?', *The Journal of Neuroscience*, 28(49), pp. 13075-13087.
- Simpson, G. G. (1944) *Tempo and mode in evolution*. Columbia University Press.
- Simpson, G. G. (1953) *The Major Features of Evolution*. New York: Columbia University Press.
- Smith, A. B. and Jeffery, C. H. (1998) 'Selectivity of extinction among sea urchins at the end of the Cretaceous period', *Nature*, 392(6671), pp. 69-71.
- Smith, P. and Fujio, Y. (1982) 'Genetic variation in marine teleosts: high variability in habitat specialists and low variability in habitat generalists', *Marine Biology*, 69(1), pp. 7-20.
- Stocker, R. F. (1994) 'The organization of the chemosensory system in *Drosophila melanogaster*: a review', *Cell and tissue research*, 275(1), pp. 3-26.
- Stout, J., & Goulson, D (2001) 'The use of conspecific and interspecific scent marks by foraging bumblebees and honeybees', *Animal Behaviour*, 62, pp. 183–189.
- Stout, J. C. and Goulson, D. (2002) 'The influence of nectar secretion rates on the responses of bumblebees (*Bombus* spp.) to previously visited flowers', *Behavioral Ecology and Sociobiology*, 52(3), pp. 239-246.
- Stout, J. C., Goulson, D. and Allen, J. A. (1998) 'Repellent scent-marking of flowers by a guild of foraging bumblebees (*Bombus* spp.)', *Behavioral Ecology and Sociobiology*, 43(4-5), pp. 317-326.
- Svanbäck, R. and Persson, L. (2004) 'Individual diet specialization, niche width and population dynamics: implications for trophic polymorphisms', *Journal of Animal Ecology*, 73(5), pp. 973-982.
- Tempel, B. L., Bonini, N., Dawson, D. R. and Quinn, W. G. (1983) 'Reward Learning in Normal and Mutant *Drosophila*', *Proceedings of the National Academy of Sciences of the United States of America-Biological Sciences*, 80(5), pp. 1482-1486.
- Termonia, A., Hsiao, T. H., Pasteels, J. M. and Milinkovitch, M. C. (2001) 'Feeding specialization and host-derived chemical defense in Chrysomeline leaf beetles did not lead to an evolutionary dead end', *Proceedings of the National Academy of Sciences*, 98(7), pp. 3909-3914.

- Thomas, C. D., Bodsworth, E., Wilson, R. J., Simmons, A., Davies, Z. G., Musche, M. and Conradt, L. (2001) 'Ecological and evolutionary processes at expanding range margins', *Nature*, 411(6837), pp. 577-581.
- Tosh, C. R., Krause, J. and Ruxton, G. D. (2009) 'Theoretical predictions strongly support decision accuracy as a major driver of ecological specialization', *Proceedings of the National Academy of Sciences of the United States of America*, 106(14), pp. 5698-5702.
- Tosh, C. R., Powell, G. and Hardie, J. (2003) 'Decision making by generalist and specialist aphids with the same genotype', *Journal of insect physiology*, 49(7), pp. 659-669.
- Tosh, C. R., Ruxton, G. D., Krause, J. and Franks, D. W. (2011) 'Experiments with humans indicate that decision accuracy drives the evolution of niche width', *Proceedings of the Royal Society B: Biological Sciences*, 278(1724), pp. 3504-3509.
- Travis, J. (2003) 'Climate change and habitat destruction: a deadly anthropogenic cocktail', *Proceedings of the Royal Society of London B: Biological Sciences*, 270(1514), pp. 467-473.
- Tsangaras, K., Ávila-Arcos, M. C., Ishida, Y., Helgen, K. M., Roca, A. L. and Greenwood, A. D. (2012) 'Historically low mitochondrial DNA diversity in koalas (*Phascolarctos cinereus*)', *BMC genetics*, 13(1), p. 92.
- Turing, A. M. (1950) 'Computing machinery and intelligence', *Mind*, 59(236), pp. 433-460.
- Vandermeer, J. H. (1972) 'Niche theory', *Annual Review of Ecology and Systematics*, pp. 107-132.
- Waibel, M., Floreano, D. and Keller, L. (2011) 'A quantitative test of Hamilton's rule for the evolution of altruism', *PLoS Biol*, 9(5), p. e1000615.
- Warren, M., Hill, J., Thomas, J., Asher, J., Fox, R., Huntley, B., Roy, D., Telfer, M., Jeffcoate, S. and Harding, P. (2001) 'Rapid responses of British butterflies to opposing forces of climate and habitat change', *Nature*, 414(6859), pp. 65-69.
- Wee, B. and Singer, M. C. (2007) 'Variation among individual butterflies along a generalist–specialist axis: no support for the ‘neural constraint’ hypothesis', *Ecological Entomology*, 32(3), pp. 257-261.
- Wetherwax, P. (1986) 'Why do honeybees reject certain flowers? ', *Oecologia*, 69, pp. 567-570.

- Whitlock, M. C. (1996) 'The red queen beats the jack-of-all-trades: the limitations on the evolution of phenotypic plasticity and niche breadth', *American Naturalist*, pp. S65-S77.
- Whittaker, R. H., Levin, S. A. and Root, R. B. (1973) 'Niche, habitat, and ecotope', *American Naturalist*, pp. 321-338.
- Wiklund, C. and Friberg, M. (2008) 'Enemy-free space and habitat-specific host specialization in a butterfly', *Oecologia*, 157(2), pp. 287-294.
- Wilson, D. S. and Yoshimura, J. (1994) 'On the coexistence of specialists and generalists', *American Naturalist*, pp. 692-707.
- Wilson, R. J., Gutierrez, D., Gutierrez, J. and Monserrat, V. J. (2007) 'An elevational shift in butterfly species richness and composition accompanying recent climate change', *Global Change Biology*, 13(9), pp. 1873-1887.
- Wisely, S., Buskirk, S., Fleming, M., McDonald, D. and Ostrander, E. (2002) 'Genetic diversity and fitness in black-footed ferrets before and during a bottleneck', *Journal of Heredity*, 93(4), pp. 231-237.
- Wu, C. H. (1997) 'Artificial neural networks for molecular sequence analysis', *Computers & chemistry*, 21(4), pp. 237-256.
- Yao, X. (1993) 'A review of evolutionary artificial neural networks', *International journal of intelligent systems*, 8(4), pp. 539-567.
- Yotoko, K. S., Prado, P. I., Russo, C. A. and Solferini, V. N. (2005) 'Testing the trend towards specialization in herbivore–host plant associations using a molecular phylogeny of *Tomoplagia* (Diptera: Tephritidae)', *Molecular Phylogenetics and Evolution*, 35(3), pp. 701-711.
- Zimmerman, M. (1982) 'Optimal Foraging - Random Movement by Pollen Collecting Bumblebees', *Oecologia*, 53(3), pp. 394-398.

A1. Appendix 1: Olfactory Ecology of the Syrphid, *Episyrphus balteatus*

A1.1. Methods – Dimensions of Arena

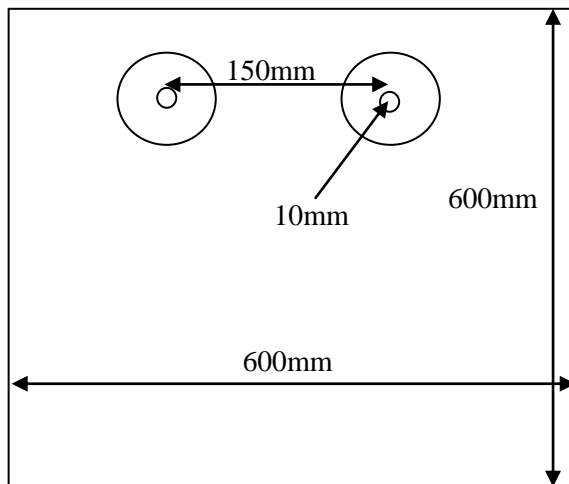

Figure A1.1: Dimensions of arena and artificial flowers.

Our BugDorm arena was 600mm³. Flowers were 70mm tall and constructed from a crocodile clip glued to a card base of 40mm² holding 1.5ml eppendorf tubes containing the reward. The diameter of these tubes was 10mm. The eppendorf tube was pushed through the centre of a card disc of 40mm diameter. A disc of blotting paper was used to cover the top of the card. The bee scent was applied directly to the blotting paper. Smaller 0.5ml eppendorf tubes with a 7mm diameter were used to hold the 1-Hexanol solution. These were cut to 20mm and attached to the card disc. These smaller tubes contained 0.2ml of the 1-Hexanol solution and were covered by a 10mm² fine mesh to prevent any direct contact between syrphids the solution (Figure A1.3). Flowers were 150mm apart.

A1.2. Methods – Dimensions of Pots

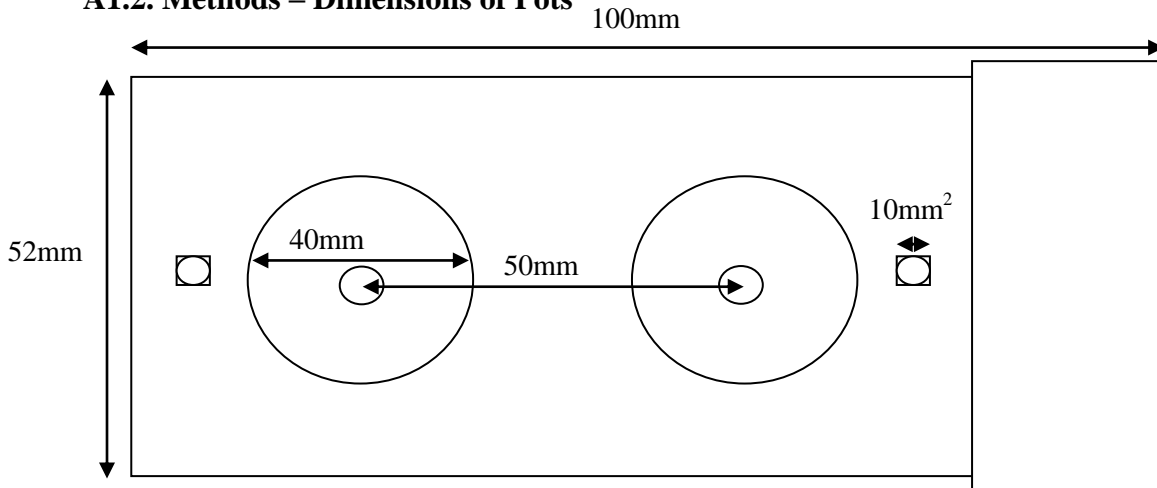

Figure A1.2: Dimensions of the pots used in the pot trials.

Pots were 100mm tall with a diameter of 52mm. Pots were placed on their side for the trials. Flowers were constructed of a 1.5ml eppendorf tube cut down to 20mm tall. A disc of blotting paper was placed over this to provide a landing platform. The bee scent was applied directly to the paper. Flowers were set up 50mm apart. 1-Hexanol solution was contained in smaller 0.5ml tubes also cut to 20mm in height (Figure A1.3). The 0.5ml tubes were secured at the cap and the base of the pot using Blu-Tac. Flowers were likewise attached to the pot using small amounts of Blu-Tac.

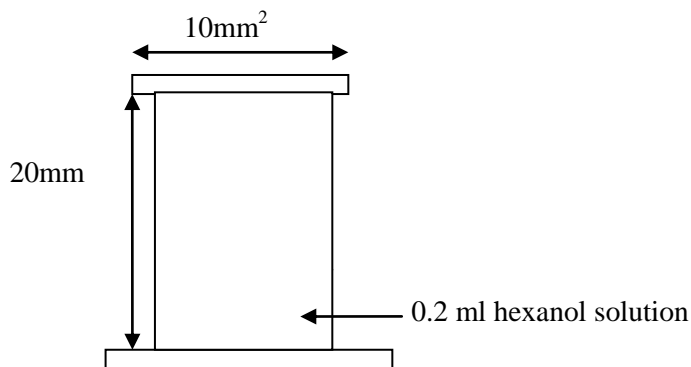

Figure A1.3: Dimensions of pots containing 1-Hexanol solution.

A1.3. 1-Hexanol Control Graphs

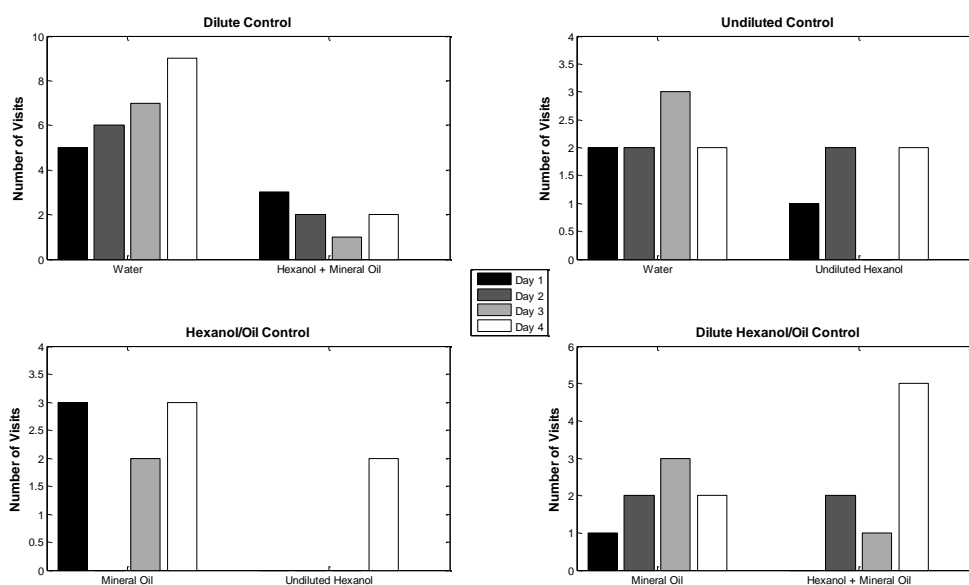

Figure A1.4: 1-Hexanol controls for mineral oil/1-Hexanol solution. Data is from arena trials run over 4 days for one hour each day.

Syrphids showed an aversion to our dilute (1:500) 1-Hexanol/mineral oil solution when it was paired with water (paired t-test, $t = 4.28$ ($df = 3$), $P < 0.05$). No other preference was recorded. Pure 1-Hexanol with water (paired t-test, $t = 1.41$ ($df = 3$), $P > 0.05$), 1-Hexanol with mineral oil (paired t-test, $t = 2.32$ ($df = 3$), $P > 0.05$), 1-Hexanol/mineral oil solution with mineral oil (paired t-test, t -value < 0.001 ($df = 3$), $P > 0.05$). What was interesting was the aversion seen in our other control trials for 1-Hexanol appears to be absent when using pure 1-Hexanol. This result could be explained by the extremely high mortality seen in syrphids when we used pure 1-Hexanol in the pot experiments. Within two hours all flies were dead. This strong toxic effect, although reduced in the arena trials, could have been having an effect on the behaviour of the syrphids. We therefore decided to use only the dilute 1-Hexanol in our trials despite the small innate aversion.

A2. Appendix 2: Is Specialised Behaviour an Evolutionary Dead End: Predictions from Connectionist Networks

	0% fixed	10% fixed	20% fixed	30% fixed	40% fixed	50% fixed	60% fixed	70% fixed	80% fixed	90% fixed	100% fixed
No punishment	709.30	728.60	683.80	699.30	585.40	598.10	545.80	590.60	529.10	525.50	195.00
Non-host punishment	444.75	406.63	444.75	366.44	275.38	283.99	181.62	178.50	124.27	57.8800	-216.00
Search costs	682.05	673.18	631.59	606.50	564.47	522.28	494.01	432.80	411.81	292.750	-113.50
Non-host and search costs	450.76	429.62	381.54	323.52	253.20	210.58	79.70	72.16	-87.62	-137.720	-533.00

Table A2.1: Actual mean final fitness scores for all network conditions after 500 generations at all different weight fixation levels. Maximum fitness possible is the difference between 0% fixed weights and 100% fixed weights. This data was used to produce Figure 4.3 and Table A2.2.

	10% fixed	20% fixed	30% fixed	40% fixed	50% fixed	60% fixed	70% fixed	80% fixed	90% fixed
No punishment	103.75%	95.04%	98.06%	75.91%	78.38%	68.21%	76.92%	64.96%	64.26%
Non-host punishment	94.23%	100.00%	88.15%	74.37%	75.67%	60.18%	59.70%	51.50%	41.45%
Search Costs	98.89%	93.66%	90.50%	85.22%	79.92%	76.36%	68.67%	66.03%	51.07%
Non-host and search costs	97.85%	92.96%	87.07%	79.92%	75.59%	62.28%	61.52%	45.27%	40.18%

Table A2.2: Percentage of maximum fitness (difference between fitness at 0% fixed weights and 100% fixed weights) networks were able to recover. Figure 4.4 shows a graphical representation of this data and was used to produce Table 4.1.