

**PLANNING AND OPERATING ENERGY STORAGE FOR  
MAXIMUM TECHNICAL AND FINANCIAL BENEFITS  
IN ELECTRICITY DISTRIBUTION NETWORKS**

**Oghenetejiri Anuta**

A thesis submitted for the degree of

*Doctor of Philosophy*

March 2016

Electric Power Systems Research Group

School of Electrical and Electronic Engineering



To my parents Jeff and Mabel Anuta

“I am on the world's extreme corner,  
I am not sitting in the row with the eminent  
But those who are lucky  
Sit in the middle and forget  
I am on the world's extreme corner  
I can only go beyond and forget.

My people, I have been somewhere  
If I turn here, the rain beats me  
If I turn there the sun burns me  
The firewood of this world  
Is for only those who can take heart  
That is why not all can gather it.  
The world is not good for anybody  
But you are so happy with your fate;  
Alas! The travelers are back  
All covered with debt”.

Kofi Nyidevu Awoonor

A journey of a thousand miles begins with a single step

-Lao Tzu

The more you know, the more you know you don't know

-Aristotle

If we knew what it was we were doing, it would not be called research would it?

-Albert Einstein

# Abstract

The transmission and distribution networks are facing changes in the way they will be planned, operated and maintained as a result of the rise in the deployment of Low Carbon Technologies (LCTs) on the power grid. These LCTs provide the benefits of a decarbonised grid and reduce reliance on fossil fuels and large centralised generation. As LCTs are close to the demand centres, a significant amount will be deployed in distribution networks. The distribution networks face challenges in enabling a wide deployment of LCTs because they were traditionally built for centralised generation and most are operated passively as demand patterns are well understood and power flows are unidirectional to load centres. The opposite will be the case for distribution networks with LCTs. Utilities that own and operate distribution networks such as the DNOs in the UK will face a host of problems, such as voltage and thermal excursions and power quality issues on their networks. Traditional reinforcement methods will be expensive for DNOs, so they are considering innovative solutions that provide multiple benefits; this is where Energy Storage Systems (ESS) could play a role to provide multiple technical and economic benefits across the grid from voltage and power flow management to upgrade deferral of network assets. This is due to the multifunctional nature of ESS allowing it to act as generation, transmission, demand or demand response based on requirements at any specific time based on the requirements of the stakeholder involved with the asset.

ESS is technically capable of providing benefits to DNOs and other stakeholders on the electricity grid but the business case is not proven. Unless multiple benefits are aggregated, investment in ESS is challenging as they have a substantial capital cost and some components will require more frequent replacement than traditional network assets which typically last between 20 – 40+ years. As a result there is a reluctance to include them in future distribution network planning arrangements.

Furthermore, the electricity regulatory and market design, which was set up in the time of traditional centralised generation and networks, limits investment in ESS by regulated bodies such as DNOs. The regulations and market structures also affects revenue streams and the resulting business case for ESS.

This thesis investigates the feasibility of ESS in distribution networks by first studying the effect of current electricity regulatory and market practices on ESS deployment, investigating how ESS can be used under the present rules, and establishing whether there are limitations that can be reduced or removed. Secondly, short and medium term planning is carried out on model Medium Voltage distribution networks (6.6 kV) provided by the IEEE and Electricity North West Limited to establish the technical and financial viability of investing in ESS over conventional reinforcement methods by:

- Assessing the impact of the proliferation of LCTs in distribution networks using both deterministic and stochastic methods under different scenarios based on current developments and government policies in the UK. This stochastic evaluation considers both spatial and temporal aspects of LCTs in distribution networks with datasets obtained from real distribution network customers;
- Developing and applying ESS voltage and power flow management, and market control algorithms to resolve distribution network issues resulting from growing LCTs and allowing ESS to participate in the electricity spot market over a planning period up to the year 2030;
- Providing a framework for assessing the business case of ESS under a DNO or third-party ownership structure where technical and commercial benefits from network asset upgrade deferral, energy arbitrage, balancing market and ancillary services (frequency response and short term operating reserves), distribution and transmission system use of system benefits are evaluated;

- Optimising the operation of ESS considering multiple technical and commercial objectives to establish the technical benefits and revenues that can be obtained from an ESS deployment and the trade-off of benefits that applies for differing ownership types.

The simulation results show that, under the scenarios investigated, ESS can be used as a technical solution for DNOs. They show that the ESS capital costs can be offset by aggregating benefits from both technical and commercial applications in distribution networks if regulatory and market changes are made. The conclusions offer a perspective to DNOs and third parties' considering investing in ESS on the electricity grid as it evolves towards a more active, decarbonised system.

## **Declaration**

I hereby declare that this thesis is a record of work undertaken by myself except where explicitly mentioned otherwise in the text, that it has not been the subject of any previous application for a degree, and that all sources of information have been duly acknowledged.

© Copyright 2015, Oghenetejiri Anuta

## Acknowledgement

I would like to express my most profound gratitude to my first supervisor Neal Wade for considering me for this PhD research, his kindness and guidance all through my years of study under him. Without his tutelage, patience, care and encouragement I would never have been able to get to this stage – I remain truly thankful. I would also like to extend my utmost gratitude to my second supervisor Phil Taylor for also considering me for the opportunity and providing the much needed feedback during periods that counted. I am thankful to have been involved with Phil's Power Systems research group. Electricity North West Limited and Scottish Power Energy Networks sponsored my study and I would like to acknowledge them for the opportunity to do this research on energy storage. I particularly would like to thank Darren Jones for sharing his time with the group and being very supportive of our research work.

It has been an eventful period filled with highs and lows which I would not have been able to get through during my stint at Durham and Newcastle University without the help of my two work colleagues, Andrew Crossland and Lei Wang (AKA Allen). Acknowledgements go out to them for keeping the group cohesive and ensuring we all supported each other mentally and emotionally through some tough times. I would also like to thank my PhD friends and researchers at the Power Systems Group both at Durham and Newcastle University as they were helpful at crucial stages of my research. One cannot forget those many coffee/tea breaks where ideas resonated from and which also served as a form of escapism during those low periods when it felt like things were crashing down. Christian Barteczko-Hibbert was a fantastic collaborator and with whom I was glad to meet during the middle of my PhD research. I also want to thank Chris Mullen, Mansoureh Zangiabaddi, Odiri



Oghre, Xavier Raimundo, Rukiya Sood, Chiara Bordin, Leonard Raphael, Pengfei Wang, Jialiang Yi, Barbara Alimisi and the many friends who are too numerous to mention the I had the pleasure to meet and share moments with.

I would like to thank my girlfriend Abby Anoff for putting up with me and for being there throughout this process. Joe Asah, Charles Adewuyi, Ray Asah, Yinka Olarinde and Anu Shokunbi are all great friends who helped me escape from work when necessary and provided motivation when it was most needed. My parents Jeff and Mabel Anuta are the most wonderful parents anyone can ever wish for and I am eternally grateful for all the emotional and financial support they provided through all my years of study. Who can forget my siblings Eji, Ese and Nero, thanks for the support.

Finally, I extend my deepest and most profound gratitude to God with whom all things are possible.

# TABLE OF CONTENTS

## CHAPTER ONE: INTRODUCTION AND BACKGROUND ON UK POWER SYSTEMS, DISTRIBUTION NETWORKS

|  |          |
|--|----------|
| <b>AND ENERGY STORAGE .....</b>  | <b>1</b> |
| 1 INTRODUCTION .....   | 1        |
| 1.1 <i>Challenges in the UK electricity sector</i> .....                         | 1        |
| 1.2 <i>Motivation for research</i> .....   | 4        |
| 1.3 <i>Challenges of this research</i> .....                                     | 6        |
| 1.4 <i>Limitations of this research</i> .....                                    | 8        |
| 1.5 <i>Contributions of this thesis</i> .....                                    | 8        |
| 1.6 <i>List of publications</i> .....  | 9        |
| 1.7 <i>Outline of thesis</i> .....   | 11       |
| 2 BACKGROUND ON UK POWER SYSTEMS, DISTRIBUTION NETWORKS AND ENERGY STORAGE ..... | 12       |
| 2.1 <i>Overview of the UK electricity system</i> .....                           | 13       |
| 2.2 <i>Evolution of the UK electricity system</i> .....                          | 13       |
| 2.3 <i>UK Regulatory framework</i> .....   | 22       |
| 3 ENERGY STORAGE OVERVIEW .....  | 27       |
| 3.1 <i>Energy storage technologies types and properties</i> .....                | 29       |
| 3.2 <i>Functions and Benefits</i> .....  | 32       |
| 4 SUMMARY .....  | 34       |

## CHAPTER TWO: LITERATURE REVIEW ON METHODS FOR PLANNING AND OPERATING ENERGY STORAGE IN

|  |           |
|--|-----------|
| <b>DISTRIBUTION NETWORKS .....</b>   | <b>35</b> |
| 1 INTRODUCTION .....   | 35        |
| 2 FINANCIAL VALUATION OF ESS IN DISTRIBUTION NETWORKS .....  | 38        |
| 3 PLANNING OF DISTRIBUTION NETWORKS .....  | 41        |
| 3.1 <i>The Planning problem</i> .....  | 41        |
| 3.2 <i>Planning for the optimum location and capacity of energy storage in distribution networks</i> ..... | 46        |
| 4 SUMMARY .....  | 51        |

## CHAPTER THREE: DISTRIBUTION NETWORK AND ENERGY STORAGE SYSTEMS MODELLING AND TEST

|   |           |
|---|-----------|
| <b>SYSTEMS .....</b>  | <b>54</b> |
| 1 INTRODUCTION .....  | 54        |
| 2 DISTRIBUTION NETWORK MODELLING AND SOFTWARE TOOLS .....   | 55        |
| 2.1 <i>Software Tools</i> .....                             | 55        |
| 2.2 <i>Modelled networks</i> .....                          | 56        |
| 3 LOAD AND GENERATION TEMPORAL DATASETS .....               | 60        |
| 3.1 <i>DNO Metered Data for Deterministic Studies</i> ..... | 60        |

|   |   |     |
|---|---|-----|
| 3.2   | <i>DNO Metered Data for Probabilistic Studies</i> .....   | 65  |
| 3.3   | <i>Processing of data</i> .....   | 69  |
| 4   | SUMMARY .....   | 72  |
| <b>CHAPTER FOUR: REGULATION, MARKETS AND THEIR IMPACT ON ELECTRICAL ENERGY STORAGE SYSTEMS IN GB.....73</b>   |   |     |
| 1   | INTRODUCTION .....  | 73  |
| 2   | REGULATION AND THE ELECTRICITY MARKET.....  | 74  |
| 2.1   | <i>Regulation of the power sector</i> .....   | 75  |
| 2.2   | <i>Overview of the electricity market</i> .....   | 76  |
| 2.3   | <i>Energy storage deployments and business models</i> .....   | 77  |
| 3   | POLICIES, REGULATORY AND ELECTRICITY MARKET ENVIRONMENT .....   | 82  |
| 3.1   | <i>The EU</i> .....   | 82  |
| 3.2   | <i>Vertically integrated electricity system in Asia-Pacific - Japan</i> .....   | 87  |
| 3.3   | <i>Mixture of unbundled and vertically integrated electricity system in North America - USA</i> .....                       | 88  |
| 4   | STORAGE REGULATORY AND ELECTRICITY MARKET BARRIERS .....  | 91  |
| 4.1   | <i>Regulatory barriers</i> .....  | 91  |
| 4.2   | <i>Storage market design barriers</i> .....   | 94  |
| 5   | RECOMMENDATION ON CHANGES REQUIRED TO CURRENT POLICIES AND REGULATORY FRAMEWORKS.....                                       | 98  |
| 5.1   | <i>Alignment of RES policies and regulation with that of ESS</i> .....  | 98  |
| 5.2   | <i>New asset class and regulation for ESS</i> .....   | 99  |
| 5.3   | <i>Ownership of ESS by regulated monopolies</i> .....   | 100 |
| 5.4   | <i>Standardised frameworks for evaluation and procedures for connection and operation</i> .....                             | 100 |
| 5.5   | <i>Establishing a nationwide roadmap and mandate for ESS</i> .....  | 101 |
| 5.6   | <i>Utilising ESS for renewables firming to prevent curtailment</i> .....  | 101 |
| 5.7   | <i>Reuse of electric vehicle batteries for grid storage applications</i> .....  | 102 |
| 6   | RECOMMENDATION ON CHANGES REQUIRED TO CURRENT ELECTRICITY MARKETS .....   | 102 |
| 6.1   | <i>Update of electricity market rules to allow simultaneous operation of ESS</i> .....                                      | 102 |
| 6.2   | <i>Revision of ancillary services market requirements and payment structures for high accuracy and responsiveness</i> ..... | 103 |
| 6.3   | <i>Mechanism for ESS to compete fairly with established generation technologies</i> .....                                   | 103 |
| 6.4   | <i>Price cap of wholesale electricity</i> .....   | 104 |
| 6.5   | <i>Floor market price for carbon</i> .....  | 104 |
| 7   | SUMMARY .....   | 104 |
| <b>CHAPTER FIVE: MEDIUM TERM PLANNING STUDY TO ASSESS THE VALUE OF IMPLEMENTING ENERGY STORAGE SYSTEMS IN AN UNBUNDLED MEDIUM VOLTAGE DISTRIBUTION NETWORK .....106</b> |   |     |
| 1   | INTRODUCTION .....  | 106 |
| 1.1   | <i>ESS as a solution</i> .....  | 107 |

|  |   |     |
|--|---|-----|
| 1.2  | <i>The problem of evaluating the financial viability of ESS</i> .....         | 109 |
| 1.3  | <i>Markets considered for ESS commercial services</i> .....                   | 110 |
| 2  | PROBLEM DESCRIPTION .....   | 111 |
| 2.1  | <i>Network Model</i> .....  | 112 |
| 2.2  | <i>Commercial Model</i> .....   | 117 |
| 2.3  | <i>ESS model</i> .....  | 124 |
| 2.4  | <i>ESS Implementation</i> .....   | 126 |
| 3  | PROBLEM FORMULATION .....   | 135 |
| 3.1  | <i>Cost and Revenue Streams</i> .....   | 135 |
| 3.2  | <i>Assessment of the profitability of ESS under different scenarios</i> ..... | 147 |
| 4  | LONG TERM PLANNING CASE STUDY .....   | 148 |
| 5  | RESULTS .....   | 149 |
| 5.1  | <i>Analysis of the base-case</i> .....  | 149 |
| 5.2  | <i>Implementation of ESS on the network</i> .....                             | 152 |
| 5.3  | <i>Financial analysis</i> .....   | 162 |
| 5.4  | <i>Considering FFR and STOR potential in Year 15</i> .....                    | 166 |
| 6  | CONCLUSION .....  | 168 |
| <br>   |   |     |
| <b>CHAPTER SIX: PLANNING AND OPERATING ESS IN DISTRIBUTION NETWORKS USING PROBABILISTIC LOAD</b> |   |     |
| <b>FLOW AND A MULTI-OBJECTIVE OPTIMISATION METHODS ..... 170</b>                                 |   |     |
| 1  | INTRODUCTION .....  | 170 |
| 2  | BACKGROUND ON PROBABILISTIC LOAD FLOW AND NSGA-II HEURISTICS .....            | 172 |
| 2.1  | <i>Monte-Carlo simulations</i> .....  | 172 |
| 2.2  | <i>Introduction to genetic algorithms</i> .....                               | 173 |
| 2.3  | <i>Updating the population</i> .....  | 180 |
| 2.4  | <i>Convergence of solutions and termination</i> .....                         | 180 |
| 2.5  | <i>Multi-objective optimisation for distribution expansion planning</i> ..... | 181 |
| 3  | PROBLEM DESCRIPTION .....   | 186 |
| 3.1  | <i>Probabilistic load flow</i> .....  | 186 |
| 3.2  | <i>Multi-objective optimisation</i> .....                                     | 189 |
| 4  | PROBLEM FORMULATION AND CASE STUDY .....                                      | 198 |
| 4.1  | <i>Monte Carlo simulations approach</i> .....                                 | 198 |
| 4.2  | <i>Optimisation approach for Intra-Day ESS operation</i> .....                | 206 |
| 5  | RESULTS AND DISCUSSION.....   | 215 |
| 5.1  | <i>Monte Carlo simulations</i> .....  | 215 |
| 5.2  | <i>NSGA-II optimisation</i> .....   | 219 |
| 6  | DISCUSSION AND CONCLUDING REMARKS .....                                       | 239 |
| <br>   |   |     |
| <b>CHAPTER SEVEN: CONCLUSIONS AND RECOMMENDATIONS FOR FURTHER WORK ..... 242</b>                 |   |     |

|     |   |            |
|-----|---|------------|
| 1   | CONCLUSIONS .....   | 242        |
| 1.1 | <i>Summary of Chapters</i> .....  | 243        |
| 1.2 | <i>Conclusions from review into regulatory and electricity market barriers limiting ESS growth</i> .....                                    | 246        |
| 1.3 | <i>Conclusions from the medium term planning for ESS on a MV distribution network</i> .....   | 248        |
| 1.4 | <i>Conclusions from the planning for ESS use on a MV distribution network using a stochastic and multi-objective heuristic method</i> ..... | 251        |
| 2   | CONTRIBUTIONS OF THESIS AND LIMITATIONS OF THE RESEARCH .....   | 253        |
| 2.1 | <i>Contributions of this thesis</i> .....   | 253        |
| 2.2 | <i>Limitations of research and suggestions for further Research</i> .....   | 254        |
| 3   | CONCLUSION FROM THESIS.....   | 256        |
|     | <b>REFERENCES.....</b>  | <b>261</b> |
|     | <b>APPENDIX ONE .....</b>   | <b>284</b> |

# Table of Figures

|   |     |
|---|-----|
| FIGURE 1-1: DEPICTION OF UK POWER SYSTEM; TRADITIONAL ARRANGEMENT WITH CENTRALISED GENERATION AND ONE-WAY POWER FLOWS IN A PASSIVE DISTRIBUTION NETWORK (A), FUTURE ARRANGEMENT WITH RENEWABLES AND CENTRALISED STORAGE, DISTRIBUTED STORAGE AND GENERATION, AND TWO WAY POWER FLOWS IN AN ACTIVE DISTRIBUTION NETWORK (B)[10]..... | 3   |
| FIGURE 1-2: CUMULATIVE ELECTRICITY GENERATION FROM NEW BUILD CAPACITY BY TECHNOLOGY FROM 2012 - 2030 (ADAPTED FROM [20]) .....  | 14  |
| FIGURE 1-3: PROJECTED UK INSTALLED CAPACITY BY TECHNOLOGY AND RES-E FROM 2012 - 2030 (ADAPTED FROM [20]).....   | 15  |
| FIGURE 1-4: UK REGULATORY FRAMEWORK [49] .....  | 23  |
| FIGURE 1-5: COMPONENTS OF THE RIIIO MODEL [53].....   | 26  |
| FIGURE 2-1 ELECTRICAL ENERGY STORAGE INSTALLATIONS (EXCEPT PHS) IN THE UK [73] .....  | 38  |
| FIGURE 3-1: VOLTAGE LEVELS IN THE UK TRANSMISSION AND DISTRIBUTION NETWORK.....   | 58  |
| FIGURE 3-2: IEEE 33 BUS TEST NETWORK.....   | 59  |
| FIGURE 3-3: IPSA SINGLE LINE DIAGRAM OF ELSWICK 6.6 kV NETWORK.....   | 60  |
| FIGURE 3-4: SAMPLE OF NORMALISED SEASONAL DEMAND PROFILES USED IN CASE STUDY DISTRIBUTION NETWORK.....  | 61  |
| FIGURE 3-5: DOMESTIC CUSTOMER HP PROFILES USED IN CASE STUDY DISTRIBUTION NETWORK .....   | 62  |
| FIGURE 3-6: SAMPLE OF LAND FILL GENERATION NORMALISED SEASONAL PROFILE.....   | 63  |
| FIGURE 3-7: SAMPLE OF UKGDS PV NORMALISED PROFILE .....   | 64  |
| FIGURE 3-8: SAMPLE OF UKGDS NORMALISED WIND PROFILE .....   | 64  |
| FIGURE 3-9: POSITIVE SKEWED URBAN DOMESTIC DEMAND STATISTICAL DISTRIBUTION FOR THE AUTUMN SEASON .....  | 67  |
| FIGURE 3-10: LOG-TRANSFORMED URBAN DOMESTIC DEMAND STATISTICAL DISTRIBUTION FOR THE AUTUMN SEASON .....   | 68  |
| FIGURE 3-11: WINTER WEEKEND PROFILE FOR AN URBAN CUSTOMER.....  | 72  |
| FIGURE 4-1: WORLDWIDE ENERGY STORAGE CAPACITY BY REGION (DATA SOURCE: [17, 51]) .....   | 78  |
| FIGURE 4-2: GROWTH IN DEMAND MET BY RENEWABLES BETWEEN 2005 AND 2013 IN THE EU (DATA SOURCE: [150]). .....  | 83  |
| FIGURE 4-3: EU RENEWABLES TARGET FOR RENEWABLE GENERATION AND DEMAND MET BY RENEWABLE GENERATION IN 2020 (DATA SOURCE: [150]). .....  | 83  |
| FIGURE 5-1: SCENARIO FROM THE SMART GRID FORUM WORKSTREAM ON THE PROJECTED INCREASE IN PEAK ELECTRICITY DEMAND [220].....   | 114 |
| FIGURE 5-2: PERCENTAGE INCREASE IN LCT DEMAND AND GENERATION ON THE CASE STUDY NETWORK OVER THE SIMULATION TIME .....   | 115 |
| FIGURE 5-3: PERCENTAGE CHANGE IN NETWORK LOAD FACTOR OVER PLANNING PERIOD .....   | 115 |
| FIGURE 5-4: (A) WEEKDAY MEAN SPOT MARKET PRICE (B) WEEKEND MEAN SPOT MARKET PRICES (IN 2013 PRICES). .....  | 119 |
| FIGURE 5-5: DECC CENTRAL SCENARIO PERCENTAGE CHANGE IN WHOLESALE PRICES FROM YEARS 2014 TO 2030 [DERIVED FROM [237]].....   | 120 |
| FIGURE 5-6: VOLTAGE AND THERMAL CONSTRAINT MANAGEMENT.....  | 128 |
| FIGURE 5-7: INTERNAL OLTC CONTROL.....  | 129 |
| FIGURE 5-8: CONTROL STRATEGY FOR ESS MARKET OPERATION .....   | 132 |

|   |     |
|---|-----|
| FIGURE 5-9: MARKET OPERATION FOR ESS BASED ON 15% TRIGGER FOR PEAK PERIOD ESS OPERATION BASED ON 2013 MARKET PRICES.....  | 133 |
| FIGURE 5-10: PLANNING PROCEDURE FOR LCT IMPACT ASSESSMENT AND ESS DEPLOYMENT AND FINANCIAL EVALUATION .....   | 149 |
| FIGURE 5-11: MAXIMUM AND MINIMUM VOLTAGE LEVELS ACROSS THE NETWORK FROM YEAR 6 – 15 .....   | 150 |
| FIGURE 5-12: INCREASE IN VOLTAGE EVENTS AND NUMBER OF BUSBARS AFFECTED FROM YEAR 6 – 15 .....   | 151 |
| FIGURE 5-13: FREQUENCY PLOT OF NET NETWORK DEMAND ON THE NETWORK IN YEARS 6, 10 AND 15.....   | 152 |
| FIGURE 5-14: CUMULATIVE DENSITY FUNCTION OF TRANSFORMER POWER IN YEARS 6, 10 AND 15.....  | 152 |
| FIGURE 5-15: (A) PRIMARY AND SECONDARY SUBSTATION ENERGY STORAGE OPERATION FOR OVERVOLTAGE IN YEAR 13, (B) NET INFEEED POWER ON THE FEEDER IN YEAR 13 WITH REVERSE POWER LEADING TO OVERVOLTAGE, AND MAXIMUM VOLTAGE ON NETWORK AFTER ESS INTERVENTION..... | 154 |
| FIGURE 5-16: SECONDARY SUBSTATION ESS OPERATION FOR UNDERVOLTAGE MITIGATION OVER A REPRESENTATIVE WINTER DAY  | 155 |
| FIGURE 5-17: MAXIMUM AND MINIMUM VOLTAGE LEVELS IN YEARS 10, 14 AND 15 WITH AND WITHOUT ESS RESPECTIVELY FOR (A) A SUMMER PERIOD, (B) WINTER PERIOD.....  | 156 |
| FIGURE 5-18: (A) ESS PEAK SHAVING TRANSFORMER LOAD IN YEAR 15 WINTER DAY (B) ESS MAINTAINING VOLTAGE WITHIN LIMITS DURING DAYS WITH HIGH DEMAND AND TRANSFORMER OVERPOWER IN YEAR 15 WINTER DAY .....   | 157 |
| FIGURE 5-19: ESS EFFECTIVENESS IN MITIGATING REVERSE POWER FLOWS PAST THE 5 MW SET THRESHOLD IN YEAR 15 WINTER DAY .....  | 158 |
| FIGURE 5-20: PERCENTAGE IMPROVEMENT IN REAL POWER LOSS ON THE NETWORK.....  | 159 |
| FIGURE 5-21: SUMMER AND WINTER SPOT MARKET PRICE IN YEAR 15 OF THE STUDY.....   | 160 |
| FIGURE 5-22: OPERATION REGIME FOR ESS-2 OVER TWO REPRESENTATIVE DAYS IN THE SUMMER FOR MARKET ONLY AND TECHNICAL/MARKET OPERATION IN YEAR 15.....   | 160 |
| FIGURE 5-23: OPERATION REGIME FOR ESS-2 OVER TWO REPRESENTATIVE DAYS IN THE WINTER FOR MARKET ONLY AND TECHNICAL/MARKET OPERATION IN YEAR 15.....   | 161 |
| FIGURE 5-24: PIE CHART OF REVENUE STREAMS FOR DIFFERENT CASE STUDIES.....   | 165 |
| FIGURE 5-25: NET PRESENT VALUE OF ESS IMPLEMENTATION FROM YEAR 6 – 15 (WITHOUT ESS SALVAGE VALUE).....  | 166 |
| FIGURE 5-26: NET PRESENT VALUE OF ESS IMPLEMENTATION FROM YEAR 6 – 15 (INCLUDING ESS SALVAGE VALUE) .....   | 166 |
| FIGURE 6-1 : GENETIC ALGORITHM IMPLEMENTATION PROCESS .....   | 174 |
| FIGURE 6-2: PARETO FRONT OF A PROBLEM WITH TWO OBJECTIVES [109] .....   | 182 |
| FIGURE 6-3: SORTING OF SOLUTIONS WITHIN A POPULATION INTO FRONTS TO ASSIGN FITNESS VALUES.....  | 184 |
| FIGURE 6-4: CALCULATION OF CROWDING DISTANCE WITH THE FILLED CIRCLES REPRESENTING SOLUTIONS WITHIN THE SAME NON-DOMINATED FRONT [287] .....   | 185 |
| FIGURE 6-5: LOSS AND VSF RELATIONSHIP ON IEEE 33 BUS TEST NETWORK FROM 100 MONTE CARLO SIMULATIONS WITH NO ESS .....  | 191 |
| FIGURE 6-6: STAGE 1 OF PLF METHOD TO DETERMINE THE NUMBER OF CUSTOMER TYPES ON A BUSBAR .....   | 200 |
| FIGURE 6-7: STAGE 2 OF PLF SHOWING CREATION OF DEMAND AT EACH HALF HOUR FROM STATISTICAL DISTRIBUTIONS AND AGGREGATION OF DEMAND TO CARRY OUT LOAD FLOW USING IPSA.....   | 204 |
| FIGURE 6-8 – ALTERNATIVE ENCODING OF INDIVIDUALS USED FOR OPTIMISATION .....  | 208 |
| FIGURE 6-9: UPDATING ESS REAL POWER AND STATE OF CHARGE BOUNDS .....  | 210 |

|  |     |
|--|-----|
| FIGURE 6-10: FLOW CHART OF OPTIMISATION METHOD AND DESCRIPTION .....   | 212 |
| FIGURE 6-11: WINTER AND SUMMER 2015 AND 2030 SPOT MARKET PRICE DATA USED FOR ELECTRICITY MARKET ARBITRAGE<br>OPERATION (2013 PRICES). .....  | 213 |
| FIGURE 6-12: PERCENTAGE CHANGE IN HALF INTERVAL OF FOR MINIMUM VOLTAGE AT EACH HALF HOUR .....   | 215 |
| FIGURE 6-13: PERCENTAGE CHANGE IN HALF INTERVAL OF FOR MAXIMUM VOLTAGE AT EACH HALF HOUR .....   | 216 |
| FIGURE 6-14: HALF INTERVAL OF MINIMUM VOLTAGE AT EACH HALF HOUR ON THE IEEE 33 BUS TEST NETWORK.....   | 217 |
| FIGURE 6-15: HALF INTERVAL OF MAXIMUM VOLTAGE AT EACH HALF HOUR ON THE IEEE 33 BUS TEST NETWORK.....   | 217 |
| FIGURE 6-16: DETERMINING REQUIRED POPULATION SIZE AT 100 GENERATIONS.....  | 223 |
| FIGURE 6-17: PERCENTAGE IMPROVEMENT ON MULTIPLE OBJECTIVES FOR ESS OPTIMISATION .....  | 223 |
| FIGURE 6-18: AVERAGE FITNESS VALUES FOR 100 GENERATIONS WITH A POPULATION SIZE OF 80 .....   | 224 |
| FIGURE 6-19: PERCENTAGE CHANGE IN AVERAGE FITNESS VALUES FOR 100 GENERATIONS WITH A POPULATION SIZE OF 80 .....  | 224 |
| FIGURE 6-20: BADLY AFFECTED AREAS FROM MC SIMULATIONS AND POTENTIAL ESS LOCATIONS FOR DIFFERENT NETWORK<br>GENERATION AND DEMAND SCENARIOS .....                                     | 226 |
| FIGURE 6-21: PARETO OPTIMAL FRONT FOR THE EXTREME THERMAL EXCURSION CASE WITH .2% PV AND 1% HP IN THE WINTER .   | 227 |
| FIGURE 6-22: ESS REAL AND REACTIVE POWER OUTPUT AND STATE OF CHARGE OVER A DAY FOR THE BEST SOLUTIONS FOR OBJECTIVES<br>2 AND 3 IN THE BASE-CASE SCENARIO .....                      | 228 |
| FIGURE 6-23: PARETO OPTIMAL FRONT SCENARIO 1 CASE 1.....   | 229 |
| FIGURE 6-24: ESS REAL AND REACTIVE POWER OUTPUT AND STATE OF CHARGE OVER A DAY FOR THE BEST SOLUTIONS FOR OBJECTIVES<br>2 IN SCENARIO 1 CASE 1 (THERMAL EXCURSION CASE) .....        | 231 |
| FIGURE 6-25: PARETO-OPTIMAL SOLUTIONS SCENARIO 1 CASE 2 .....  | 232 |
| FIGURE 6-26: ESS REAL AND REACTIVE POWER OUTPUT AND STATE OF CHARGE OVER A DAY FOR THE BEST SOLUTIONS FOR OBJECTIVES<br>2 AND 3 IN SCENARIO 1 CASE 2 (VOLTAGE EXCURSION CASE).....   | 233 |
| FIGURE 6-27: PARETO-OPTIMAL SOLUTIONS SCENARIO 2 CASE 1 .....  | 234 |
| FIGURE 6-28: ESS REAL AND REACTIVE POWER OUTPUT AND STATE OF CHARGE OVER A DAY FOR THE SOLUTION BASED ON OBJECTIVES<br>2 (SCENARIO 2 CASE 1 - THERMAL EXCURSION CASE).....           | 235 |
| FIGURE 6-29: PARETO-OPTIMAL SOLUTIONS SCENARIO 1 CASE 2 .....  | 236 |
| FIGURE 6-30: ESS REAL AND REACTIVE POWER OUTPUT AND STATE OF CHARGE OVER A DAY FOR THE BEST SOLUTIONS FOR OBJECTIVES<br>2 IN SCENARIO 2 CASE 2 (WINTER VOLTAGE EXCURSION CASE).....  | 237 |
| FIGURE 6-31: PARETO-OPTIMAL SOLUTIONS SCENARIO 1 CASE 2 .....  | 238 |
| FIGURE 6-32: ESS REAL AND REACTIVE POWER OUTPUT AND STATE OF CHARGE OVER A DAY FOR THE BEST SOLUTIONS FOR OBJECTIVES<br>2 IN SCENARIO 2 CASE 3 (SUMMER VOLTAGE EXCURSION CASE) ..... | 239 |



# Table of Tables

|   |     |
|---|-----|
| TABLE 1-1: LOW CARBON DEMAND AND GENERATION INCENTIVES AND TECHNOLOGIES [19, 22, 23].   | 18  |
| TABLE 1-2: CHALLENGES CAUSED BY LCTs ON THE UK ELECTRICITY SYSTEM [35].   | 20  |
| TABLE 1-3: EXPECTED INCREASE IN ADMD, DOMESTIC CUSTOMERS AND DG IN THE UK [28].   | 27  |
| TABLE 1-4: PUMPED-HYDRO STORAGE SCHEMES IN THE UK [11, 12].   | 28  |
| TABLE 1-5: ENERGY STORAGE TECHNOLOGY TYPES [61].  | 30  |
| TABLE 4-1: ESS OWNERSHIP TYPES AND REVENUE STREAMS [75, 146].   | 81  |
| TABLE 5-1: AVERAGE STOR SERVICE FEES AND PERCENTAGE CHANGE IN FEES OVER PREVIOUS YEAR [243-245].  | 122 |
| TABLE 5-2: EVENTS MONITORED AND DEFINED THRESHOLDS.   | 126 |
| TABLE 5-3: MONTHLY FREQUENCY OF OCCURRENCE OF TRIAD FROM 1991 TO 2014.  | 135 |
| TABLE 5-4: PLANNING STUDY ECONOMIC ASSUMPTIONS.   | 136 |
| TABLE 5-5 STORAGE PARAMETERS AND COST [264] [258] [265].  | 137 |
| TABLE 5-6: ESS OWNERSHIP AND BUSINESS TYPES WITH REVENUE STREAMS AND COSTS.   | 148 |
| TABLE 5-7: NETWORK EVENTS OVER 15 YEARS (BASE-CASE SIMULATIONS).  | 150 |
| TABLE 5-8: ESS REINFORCEMENT PLAN OVER THE PLANNING PERIOD.   | 153 |
| TABLE 5-9: COMPARISON OF NETWORK CONDITIONS UNDER BASE-CASE AND ESS USED FOR MARKET AND MARKET/TECHNICAL OPERATION.   | 162 |
| TABLE 5-10: TOTAL ESS CAPITAL COST OVER PROJECT LIFETIME (UNDISCOUNTED). THE BANK OF ENGLAND DOLLAR TO POUND EXCHANGE RATE IN AUGUST 2014 OF \$1.68 TO £1 WAS USED [268]. | 162 |
| TABLE 5-11: REVENUE, COST AND NPV OF ESS INVESTMENT.  | 163 |
| TABLE 5-12: STOR MAXIMUM POSSIBLE REVENUES.   | 167 |
| TABLE 5-13: FFR MAXIMUM POSSIBLE REVENUE.   | 167 |
| TABLE 6-1 : ENCODING OF GA SOLUTIONS.   | 176 |
| TABLE 6-2: NETWORK CONSTRAINTS MONITORED.   | 188 |
| TABLE 6-3: SIMULATION RUNS FOR WEEKDAY OVER WINTER AND SUMMER.  | 189 |
| TABLE 6-4: INTEGER ENCODING OF TAP POSITION.  | 207 |
| TABLE 6-5: BASE-CASE SIMULATION WITH WORST-CASE ISSUE.  | 218 |
| TABLE 6-6: SCENARIO 1 SIMULATION WITH WORST-CASE ISSUE.   | 218 |
| TABLE 6-7: SCENARIO 2 SIMULATIONS WITH WORST-CASE ISSUES.   | 219 |
| TABLE 6-8: DETERMINING THE $\eta$ WITH 10 GENERATIONS AND A POPULATION SIZE OF 20.  | 221 |
| TABLE 6-9: DETERMINING THE $MUT_{INDPB}$ WITH 10 GENERATIONS AND A POPULATION SIZE OF 20.   | 221 |
| TABLE 6-10: DETERMINING THE $CX_{PB}$ PARAMETER WITH 10 GENERATIONS AND A POPULATION SIZE OF 20.  | 222 |
| TABLE 6-11: RESULTS BASED ON BEST SOLUTION FOR INDIVIDUAL OBJECTIVE FUNCTIONS IN THE BASE-CASE SCENARIO.  | 228 |
| TABLE 6-12: SOLUTION TRADE-OFF BASED ON STAKEHOLDER REQUIREMENTS FOR SCENARIO 1 CASE 1.   | 230 |
| TABLE 6-13: SOLUTION TRADE-OFF BASED ON STAKEHOLDER REQUIREMENTS FOR SCENARIO 1 CASE 2.   | 231 |

|  |     |
|--|-----|
| TABLE 6-14: SOLUTION TRADE-OFF BASED ON STAKEHOLDER REQUIREMENTS FOR SCENARIO 2 CASE 1.....  | 234 |
| TABLE 6-15: SOLUTION TRADE-OFF BASED ON STAKEHOLDER REQUIREMENTS FOR SCENARIO 2 CASE 2 ..... | 236 |
| TABLE 6-16: SOLUTION TRADE-OFF BASED ON STAKEHOLDER REQUIREMENTS FOR SCENARIO 2 CASE 2.....  | 238 |

# Acronyms

| Acronym | Definition   |
|---------|--|
| ADMD    | After Diversity Maximum Demand                     |
| ANM     | Active Network Management                          |
| DECC    | Department of Energy and Climate Change            |
| DEP     | Distribution Expansion Planning                    |
| DG      | Distributed Generation                             |
| DNO     | Distribution Network Operator                      |
| DNO-StO | Distribution Network Operator Storage Operator     |
| DoD     | Depth of Discharge                                 |
| DOPF    | Dynamic Optimal Power Flow                         |
| DSR     | Demand Side Response                               |
| ESS     | Energy Storage System                              |
| GA      | Genetic Algorithm                                  |
| GHG     | Green House Gas emissions                          |
| HI      | Half Interval                                      |
| HP      | Heat Pump  |
| IEEE    | Institute of Electrical and Electronic Engineering |
| LCT     | Low Carbon Technology                              |
| LCT-D   | Low Carbon Demand Technology                       |
| LCT-G   | Low Carbon Generation Technology                   |
| LFG     | Land Fill Gas                                      |
| LV      | Low Voltage  |
| MIDP    | Market Index Data Price                            |
| MOEA    | Multi-Objective Evolutionary Algorithm             |
| MC      | Monte Carlo  |
| MV      | Medium Voltage                                     |

|         |  |
|---------|--|
| NSGA-II | Non Dominated Sorting Genetic Algorithm – Version 2              |
| NPV     | Net Present Value Analysis                                       |
| OLTC    | On Load Tap Changer  |
| OPF     | Optimal Power Flow   |
| PV      | Photovoltaics  |
| PHS     | Pumped Hydro Storage   |
| PWF     | Present Worth Factor   |
| RIIO    | Revenue Set to Deliver strong Incentives, Innovation and Outputs |
| RTE     | Round Trip Efficiency  |
| SBP     | System Buy Price   |
| SSP     | System Sell Price  |
| SoC     | State of Charge  |
| T&D     | Transmission and Distribution                                    |
| TP-StO  | Third Party Storage Owner  |
| WT      | Wind Turbine   |

# Chapter One: Introduction and Background on UK Power Systems, Distribution Networks and Energy Storage

---

## 1 INTRODUCTION

### 1.1 CHALLENGES IN THE UK ELECTRICITY SECTOR

The UK's electricity system was one of the first to be liberalised, privatised and restructured in the European Union. This started in the late 1980s and early 1990s leading to massive changes in the mode of operation, with the objectives of providing benefits to customers by making the electricity system efficient, secure and reliable while driving down prices through competition [1] [2]. Since this, a new challenge has emerged: to ensure the future electricity system is sufficiently robust and resilient to manage:

- The significant increase in the amounts of low carbon and renewable generation that result from the 15% target for energy for electricity, transport and heating to come from renewables by 2020, and the 34% and 80% reduction targets for Greenhouse Gas Emissions (GHG) compared to 1990 levels by 2020 and 2050 [3]. Low Carbon Generation Technologies (LCT-G) are often decentralised and weather dependent, which is contrary to the current centralised and controllable generation. This requires changes to be made to the way the electricity system is regulated and operated.
- The ageing of generation, transmission and distribution network assets, most of which were built in the 1950s – 60s and will reach the end of their operating life by the year 2020 [4]. By the year 2016, 20 GW representing 26 % [5] of the UK's generation capacity, will be retired. 30 GW of generation is expected to be commissioned with over two-thirds of the capacity coming from renewables [6]. The Office of Gas and Electricity Markets (Ofgem), responsible for regulating the electricity and gas sectors, estimate that £200

billion of investment is required to upgrade outdated energy assets [7]. Out of the required investment capital, approximately 10% makes up requirement for investment in electricity network assets [4, 7], the rest going to investment in gas network assets, power generation (renewable and conventional), upstream oil and gas and energy efficiency and heating.

- Increase in electricity demand due to electrification of heating and road transports as a result of GHG reduction targets. Demand is expected to double by 2050 and this will require significant investment in generation and network assets.

The Department of Energy and Climate Change (DECC) listed energy storage, interconnections and Demand Side Response (DSR) as major elements that would enable the move towards a decarbonised power sector [8, 9].

### ***1.1.1 The UK electricity distribution networks***

The electricity distribution networks bear a lot of the burden in the push towards a decarbonised power sector as LCT-G such as Solar Photovoltaics (PV), Wind Turbines (WT), Combined Heat and Power (CHP), and Low Carbon Demand Technologies (LCT-D) such as Heat Pumps (HP) and Electric Vehicles (EV), are concentrated in the distribution networks. This is contrary to centralised and larger generation connected to the high voltage transmission networks. Figure 1-1 illustrates the current (a) and future (b) electricity sector with a higher concentration of Distributed Generation (DG). This would require a combination of solutions, which may include network reinforcement, active network management or a combination of both (depending on the most cost effective solution required by regulation) to accommodate the adoption of Low Carbon Technologies (LCTs). The Office of Gas and Electricity Markets (Ofgem) have put a new regulation model in place (enforced from 2015) called Revenue Set to Deliver strong Incentives, Innovation and Outputs (RIIO) which enables investment in new and innovative

technologies such as Energy Storage Systems (ESS) and DSR on the distribution network to support the low carbon transition.

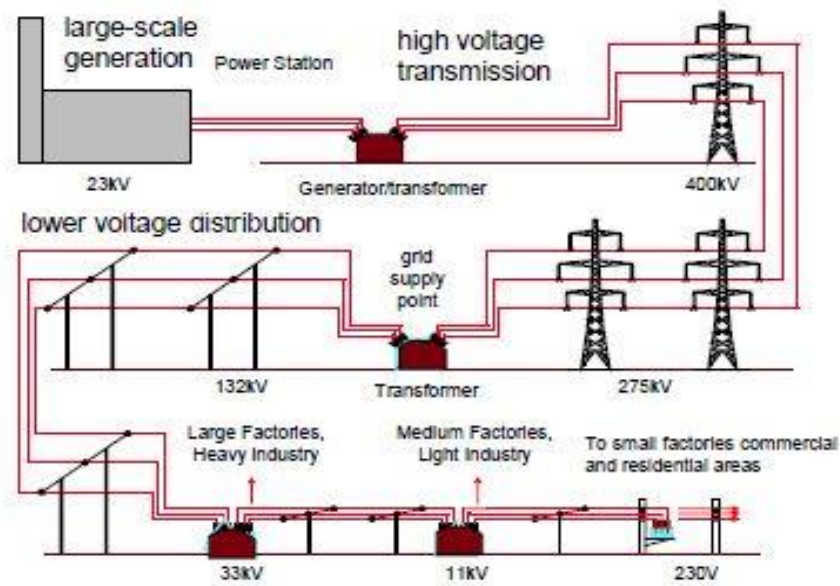

(a)

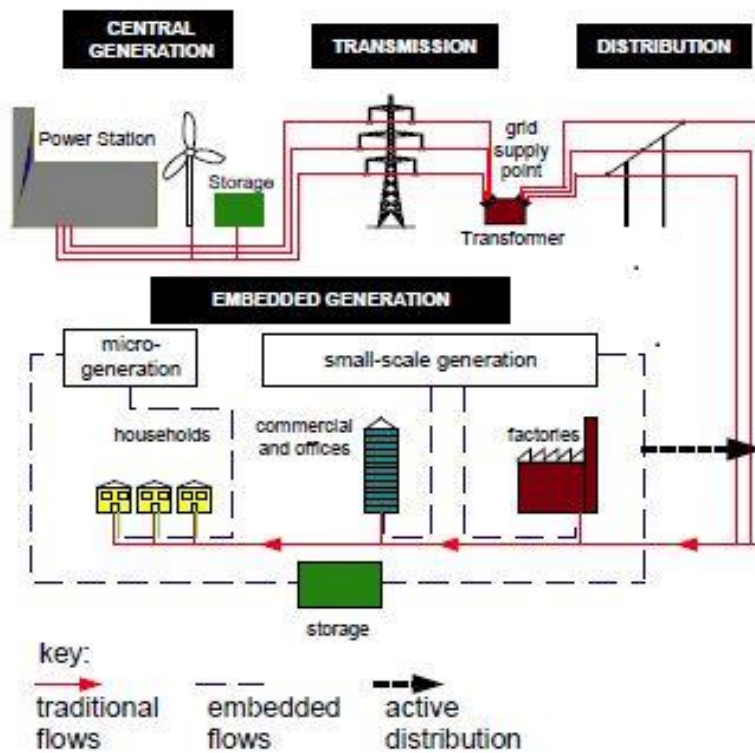

(b)

Figure 1-1: Depiction of UK power system; traditional arrangement with centralised generation and one-way power flows in a passive distribution network (a), future

arrangement with renewables and centralised storage, distributed storage and generation, and two way power flows in an active distribution network (b)[10]

## **1.2 MOTIVATION FOR RESEARCH**

Apart from the four Pumped Hydro Storage (PHS) systems providing an estimated 2.8 GW of storage in the UK [11, 12], the UK electricity system has to date been managed without the need for ESS to balance electricity supply and demand. The physical balancing actions in real time are handled by the System Operator (SO) National Grid, who forecast demand and generation and plan for contingencies to ensure smooth running of the power system. With growing renewables, from large transmission connected plants and LCT-G, the balancing activities will become increasingly difficult for National Grid to carry out as the intermittent generation will affect accurate forecasting. The need for additional measures such as ESS and/or DSR becomes increasingly more apparent as DG, which according to a report by Carbon Connect made up 11% of UK's generating capacity in 2012 (with 55% coming from LCT-Gs), contribute a greater proportion to the renewable energy mix [13]. Hence a more active role in balancing the grid is likely to be required by the DNOs in the future electricity system.

ESS are being considered alongside conventional network reinforcement equipment as a suitable solution to manage anticipated future problems on the distribution networks as power systems evolve towards a lower carbon grid with large amounts of decentralised generation. ESS could be beneficial in distribution networks as they can provide planning and operational benefits, which include distribution upgrade deferral; improved power quality; voltage control; power flow management; improved reliability and outage mitigation, improved security of supply, and network management. Regulation requires DNOs to make the least cost investments in network assets so as not to increase the customer's electricity bill. There is no justification for investing in ESS which is expensive when compared to alternative



network interventions because of the present regulatory structures that prevents DNOs from recovering system wide benefits.

Evidence from UK investment in ESS shows that while the viability of implementing large ESS has been proven, the feasibility of small to medium size ESS (termed distributed ESS) located on the distribution networks have not been proven. More so, it is not understood how a DNO or third party investor can plan (size and locate) and operate ESS on a distribution network to recover the investment costs. This is because most network ancillary service benefits such as voltage support and power quality improvements do not have a set monetary value like wholesale and ancillary service market values. In planning and operating ESS, the valuation of these network ancillary service benefits is important. Furthermore, the aggregation of multi-stakeholder benefits, both competitive (i.e. electricity market services) and network related, is crucial in developing a viable business case for investing in ESS.

Therefore, planning and operating ESS in future electricity distribution networks under the current regulatory and electricity market structures in the UK is an area of growing concern. Understanding and potentially reforming this will aid in assessing the feasibility of implementing distributed ESS. The results from technical and financial evaluations of implementing ESS can be used in recommending changes to all stakeholders that would enable the adoption of ESS, if it is indeed a viable option for DNOs.

### ***1.2.1 Aims and Objectives of thesis***

The potential benefits and viability of distributed ESS will depend firstly on the levels of LCT implementations on the distribution networks in the short, medium and long term; the extent of issues that would occur; and the current state of the distribution network assets. This will dictate the level and cost of investment required. Secondly, the regulatory structures and ongoing updates will need to be considered as this will influence the planning, operation and aggregation of multi-stakeholder benefits.

This thesis contributes to the debate on the value of distributed ESS in the UK by testing the hypothesis that consolidating multiple benefits of ESS can lead to profitability from investing in ESS. Planning and operating strategies are developed for DNO and third party implementations of ESS on a distribution network that recover value from different revenue streams and maximise total benefits for both parties. This work quantifies the short and medium term (i.e. time period of up to 15 years) financial benefits of operating ESS, while remaining agnostic to any specific technology by investigating:

1. Issues that could affect distribution networks in the future as a result of increasing LCT-G and LCT-D and the effectiveness of using ESS to mitigate these issues;
2. Regulatory and electricity market barriers from a theoretical standpoint to understand limits of planning and operating ESS for DNOs or third parties under the current UK regulatory and market frameworks;
3. Planning and operating strategies (using analytical and heuristic methods) for implementing ESS with existing voltage and power flow management equipment in distribution networks;
4. Technical and financial benefits obtained from implementing ESS on Medium Voltage (MV) distribution networks;
5. Viability of DNOs investing in ESS under current and hypothetical regulatory and electricity market frameworks and the updates to regulation and electricity market structures that would enable ESS profitability if it is deemed the best technical option.

### **1.3 CHALLENGES OF THIS RESEARCH**

There are various challenges in quantifying the benefits of implementing ESS in distribution networks. Predicting future demand and generation on a distribution network, aggregating multi-stakeholder benefits, and assessing the viability of ESS

implementation in different network configurations are common challenges encountered.

### ***1.3.1 Determining future demand and generation***

Future demand and generation will be determined based on economic development, government policies, and suitable geographical locations for various LCT-G technologies. Policies and economic development are not certain and could change as the year's progress. Additionally, as DNOs do not control where LCTs are installed, it is difficult to pinpoint the accurate locations where these technologies will be installed. This brings uncertainty into accurate prediction, which could impact medium to long term planning for distribution networks. As DNOs plan based on worst case scenarios, this may lead to an over or underestimation of reinforcement requirements. Therefore, planning for ESS needs to take into account these uncertainties in demand and generation.

### ***1.3.2 Representative distribution networks***

Distribution network models are used in studies to evaluate the benefits of distributed ESS. These representative sections of a distribution network are used to draw conclusions on the viability of implementing ESS. However, as network characteristics vary, so will the benefits of ESS. Therefore assessing the performance of ESS on different network configurations with varying customer type concentrations is important.

### ***1.3.3 Multi-benefits aggregation***

Reports have shown that the aggregation of multi-stakeholder benefits is important in getting the maximum potential of an ESS implementation. ESS implementations in the distribution network, depending on size and location would provide benefits to multiple stakeholders (regardless of who invested in the systems). Therefore optimising the planning and operation of ESS to meet multi-stakeholder benefits is an important aspect in evaluating investment in ESS.

#### **1.4 LIMITATIONS OF THIS RESEARCH**

An implementation of ESS on one part of a network could delay or eliminate the need to upgrade a network. In planning at a strategic level, it is important to have an overview of the entire distribution network owned and operated by a DNO in order to fully assess the need for ESS, for example in a case where an ESS can be used for a certain amount of years for network deferral on one MV network in the DNOs portfolio and moved somewhere else where it is required to mitigate another issue, if it is still operational. This will increase the viability of an ESS investment.

Dynamic network studies which was beyond the scope of this thesis is also required to assess the benefits and impacts of LCTs and storage.

#### **1.5 CONTRIBUTIONS OF THIS THESIS**

The contributions of the research are summarised as follows:

1. Presents a comprehensive overview of the regulatory and electricity market barriers to the deployment of ESS in the UK electricity system;
2. Develops a coordinated OLTC and ESS voltage control algorithm, and a control algorithm for managing network constraints with high amounts of LCTs;
3. Develops a method that can be adapted by DNOs to plan and operate ESS on distribution networks with increasing LCTs for network benefits and commercial benefits in the UK wholesale and balancing markets. The planning and operating method considers both deterministic and stochastic nature of load and LCTs
4. Develops a method to quantify the multi-stakeholder benefits of implementing ESS in a distribution network;
5. Informs DNOs, policymakers and regulators on the investment decision of implementing ESS and contributes to the current discourse on the viability of ESS.

These contributions are made by evaluating the technical and financial benefits of implementing ESS in case study distribution networks:

- Under deduced changes in demand and generation;
- Using different ESS ownership types, which include DNO owned ESS, third party owned ESS, or a hybrid ownership model, where both parties are involved with the ESS investment; and
- Under current and anticipated regulatory requirements with different trading strategies in the wholesale and balancing market.

## **1.6 LIST OF PUBLICATIONS**

Below is a list of journal and conference publications from work carried while working on this thesis, all of which are related to ESS as a solution in grid connected or off-grid electricity systems.

### **1.6.1 Journal Papers**

#### Accepted and published

1. Anuta, Oghenetejiri Harold, Taylor, Phil, Jones, Darren, McEntee, Tony and Wade, Neal, (2014), An international review of the implications of regulatory and electricity market structures on the emergence of grid scale electricity storage, *Renewable and Sustainable Energy Reviews*, 38, issue C, p. 489-508.
2. Crossland, Andrew F., Anuta, Oghenetejiri H. and Wade, Neal S., (2015), A socio-technical approach to increasing the battery lifetime of off-grid photovoltaic systems applied to a case study in Rwanda, *Renewable Energy*, 83, issue C, p. 30-40.

#### Submitted or in preparation

3. Crossland, A; Anuta, O.; Wang, L.; Jones, D.; Wade, N., (2015), A method for determining the voltage constraints on LV networks containing stochastically located photo-voltaics and energy storage, *Applied Energy*.

4. Anuta, Oghenetajiri Harold, Jones, Darren, Wade, Neal, (2015), Valuing the benefits of energy storage in distribution networks under limiting market and regulatory structures, Energy Policy (planned submission)
5. Anuta, O., Barteczko-Hibbert, C., & Wade, N, (2015), Planning and optimising the operation of energy storage under the uncertainty of low carbon technology contribution in an evolving distribution network, Energy (planned submission)

### 1.6.2 Conferences

1. Bordin, C., Anuta, O.H., Crossland, A., Gutierrez, I.L., Dent, C., Vigo, D., A linear programming approach for optimal battery operation in off-grid solar power schemes, with consideration of battery degradation, 2015. 27<sup>th</sup> European Conference on Operational Research.
2. Anuta, O., Barteczko-Hibbert, C., & Wade, N. Future low carbon technologies, impacts and energy storage solutions on UK distribution networks. CIRED 2014 Workshop.
3. Anuta, O.; Wade, N.; McWilliam, J., "Coordinated operation of energy storage and on-load tap changer on a UK 11kV distribution network," Electricity Distribution (CIRED 2013), 22nd International Conference and Exhibition on.
4. Anuta, O., Crossland, A., Wade, N., & Dargan, S. Techno-economic study on the performance of PV systems in schools and health centres in Rural Rwanda. 2013. International Conference on Alternative Energy in Developing Countries and Emerging Economies. Bangkok, Thailand.
5. Crossland, A., Anuta, O., & Wade, N. Assessing the impact of society and energy storage on the success of solar photovoltaic systems utilized for healthcare in rural Rwanda, 2013. International Conference on Alternative

Energy in Developing Countries and Emerging Economies. Bangkok, Thailand.

6. Anuta, O.; Crossland, A; Jones, D.; Wade, N., "Regulatory and financial hurdles for the installation of energy storage in UK distribution networks," Integration of Renewables into the Distribution Grid, CIRED 2012 Workshop.

## 1.7 *OUTLINE OF THESIS*

This section provides a review of the work described in this thesis. The body of the thesis is divided into eight chapters and an appendix. Section 2 of this chapter provides a background on UK Power Systems and an overview of ESS.

**Chapter 2** presents a review of relevant literature on studies that have looked at the techno-economic evaluation of planning and operating ESS on a distribution network.

In **Chapter 3**, demand and generation profiles are developed from live network data collected from ENW, UKGDS and the Customer Led Network Revolution Project. These are used in the two final chapters to create scenarios for future LCT and demand increase in a distribution network.

**Chapter 4** investigates the regulatory and financial barriers limiting the adoption of ESS worldwide. The lessons learned from this review are used to develop scenarios for planning and operating ESS in distribution networks in succeeding chapters.

**Chapter 5** presents an evaluation is carried out on the profitability of implementing ESS on a test network in the UK with landfill generation and a wind farm and increased levels of solar PV and HP under different ESS ownership types. This study looks at the planning and operation of ESS under a 15 year period and explores different revenue streams derived from different ownership types, which are limited by current regulation and electricity market rules. The sensitivity of different ESS cost values, and impact of ESS dispatch error on profitability are considered along with the potential for other ancillary services market revenue streams which include

transmission and distribution network charge avoidance, frequency response and short term operating reserves.

A power flow and voltage control algorithm that enables coordinating ESS and OLTC operations to manage network voltage and power flow constraints was developed. This was combined with an algorithm for spot market arbitrage operation. Both algorithms were used independently or combined for financial evaluation under different business models.

**Chapter 6** presents a stochastic analysis of future LCT-D and LCT-G in distribution networks by using Monte Carlo simulations to create possible demand and generation profiles on a case study distribution network (the IEEE 33 bus test network). Afterwards, an operational planning method using a multi-objective heuristic method called the Non-Dominated Sorting Genetic Algorithm II (NSGA-II) is used to optimise the dispatch of ESS to meet the conflicting technical and commercial objectives of a DNO and third party storage owner.

**Chapter 7** presents the conclusions of the studies carried out in this thesis and provides recommendations to extend this research further in light of the speed of changes and development in the power sector.

## **2 BACKGROUND ON UK POWER SYSTEMS, DISTRIBUTION NETWORKS AND ENERGY STORAGE**

This section provides an overview of the evolution of power systems and the UK electricity system where the policies are leading to increase in renewables, decentralised generation and LCTs. The challenges these changes present in the operation and maintenance of the electricity system are also discussed. A review is presented on ESS technologies, characteristics, applications and benefits across the electricity system.



## 2.1 OVERVIEW OF THE UK ELECTRICITY SYSTEM

Modern power systems have large central generators feeding power over long distances through the transmission network at extra high voltages transformed to lower voltages in the distribution network for transport and delivery to as illustrated in Figure 1-1(a) in section 1. The electricity system in the UK comprises of [10, 14-16]:

- Up to 60 large centralised generators (fossil fuels and nuclear power); and
- A transmission network conveying power from centralised generation through ~25,000 km of Extra High Voltage (EHV) overhead lines rated at 400/275kV.
- Distribution networks dispersed geographically and spanning ~800,000 km of overhead lines and underground cables at lower voltages from the Grid Supply Points (GSP) at 132kV to customers at (66kV to 230V);
- Interconnections to Europe providing 3.5 GW of electricity, which is approximately 5% of GB's peak demand [9].
- A wholesale and retail market for competitive buying and selling of electricity for the needs of ~29 million customers.

## 2.2 EVOLUTION OF THE UK ELECTRICITY SYSTEM

Climate change policies have been set for industrialised countries to meet emission reduction targets established by the Kyoto protocol agreement, which was adopted in 1997 and enforced in 2005 [17]. The UK government has developed policies to meet climate change targets and increase energy security. These policies have enabled the high uptake of renewables in order to decarbonise the grid. Eight key technologies have been identified as part of the renewable energy roadmap [18] which are: renewable transport, which includes biofuels, electric vehicles and ultra-low emission vehicles; onshore wind; offshore wind; marine energy; biomass electricity; biomass heat; ground source heat pumps and air source heat pumps.

A 15% energy consumption from renewables target was set by the UK government for 2020 along with Greenhouse Gas (GHG) reduction targets of 34% by 2020 and 80% by 2050 [3]. Connor et al state the key to achieving these targets will be by meeting the 30% requirement for Renewable Energy Sources of Electricity (RES-E) from DECC’s Renewable Energy Roadmap [19], up from 14.8% recorded in 2013 [18]. This has led to policies that will enable the growth in renewables, increased energy efficiency and increased electrification of transportation and heating, and carbon intensive industrial sectors by 2030 [9]. Gas, renewables and nuclear generation are the major technologies where huge investments are being made. Figure 1-2 illustrates the increase in cumulative new build generation capacity in the UK based on current government policies and central price scenario estimates for economic growth and fossil-fuel prices [20]. Investment in new renewable generation up to 2030 is projected to reach up to 42.2 GW, which is over 50% of the investment in gas generation.

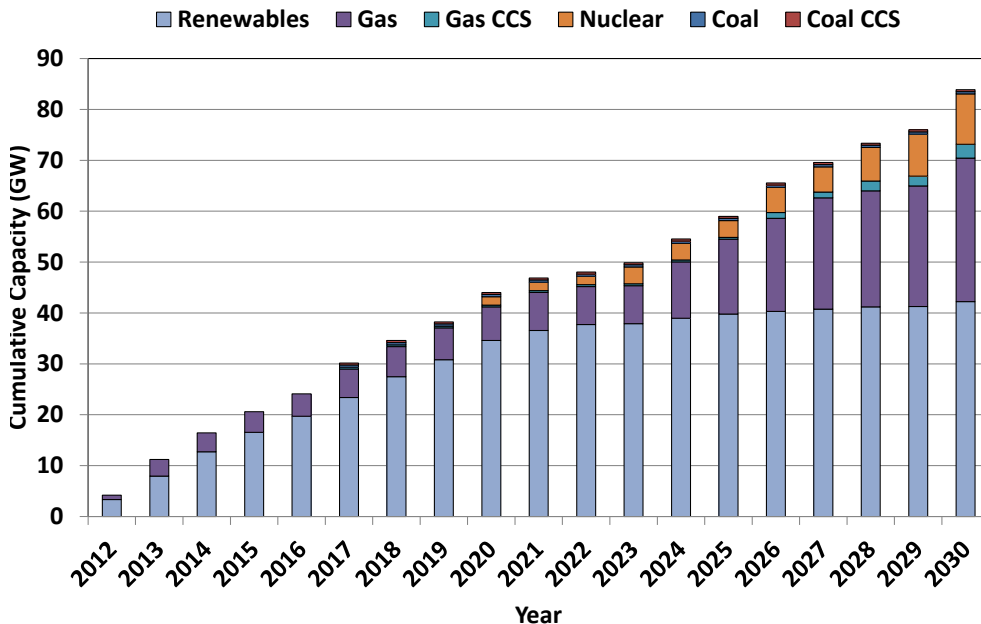

Figure 1-2: Cumulative electricity generation from new build capacity by technology from 2012 - 2030 (adapted from [20])

The contribution of renewables to gross electricity consumption, i.e. RES-E increases from 12% in 2012 to over 41% in 2030 based on the central scenario for the electricity

generation. This is illustrated in Figure 1-3, which also shows the growth in total installed capacity of renewables projected to be at 43% of total generation capacity in the UK.

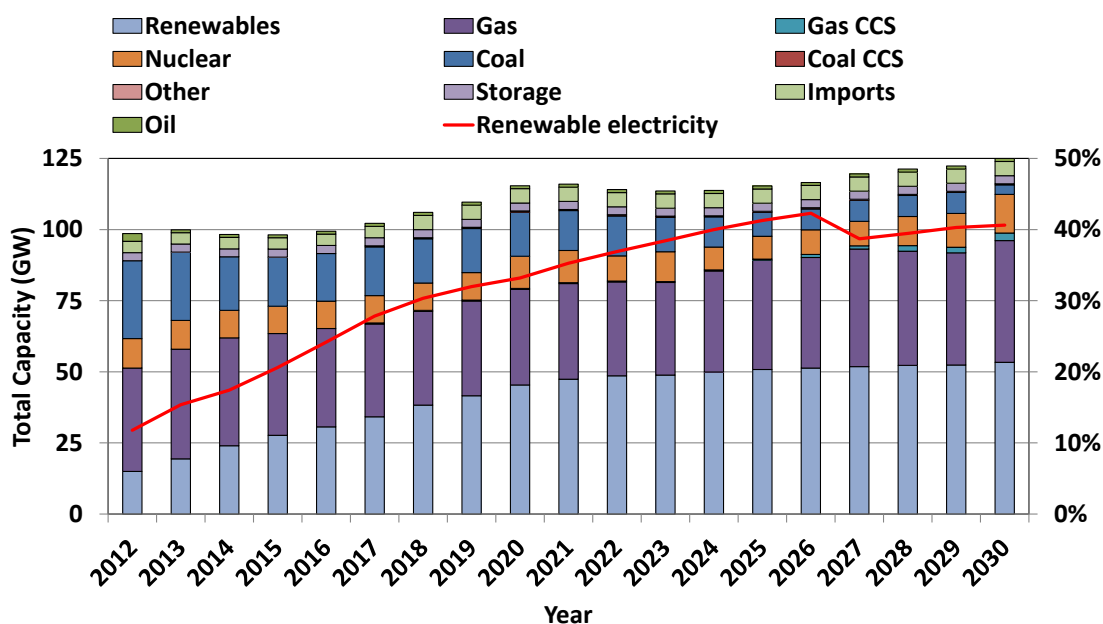

Figure 1-3: projected UK installed capacity by technology and RES-E from 2012 - 2030 (adapted from [20])

Renewables present challenges because generation is non-dispatchable, units are smaller in size and dispersed throughout the country where the renewable resources are prevalent, which may not be high demand locations. This is contrary to the current centralised generation arrangement where most of the power generation is located in the North and the large demand centres are located in the South. This leads to requirements for larger balancing and system reserves to manage peaks and troughs as dispatchable baseload generation gets displaced by renewables, particularly if renewable generation surpasses 20% contribution to the electricity grid [21]. A large proportion of renewable generators such as solar PV and WTs will be located closer to customers on the distribution networks. This leads to a paradigm shift from centralised to decentralised generation in power systems with high energy contributions from LCTs. This will require adequate systems and coordination between all power system stakeholders to enable a synergistic operation of

centralised and decentralised features of the grid. Table 1-1 shows the different type of LCTs on distribution networks and the policies supporting them.

| LCT/ Incentives   | Description  | Technologies   |
|---|--|--|
| <p><b>Generation:</b> Feed-in tariffs (FIT) for microgeneration with tariff levels set for different low carbon technologies and generation capacities under 5MW.</p> | <p>Pays a generation tariff for electricity generated (even if electricity is self-consumed), export tariff for electricity exported to the grid. It also provides savings to end users in form of electricity bill reduction.</p>   | <p>Solar PV, Hydro, Biomass, Micro-CHP and wind.</p>   |
| <p><b>Generation:</b> Renewable Obligation (RO)<sup>1</sup> for LCT-G with a capacity over 50 kW.</p>   | <p>Main mechanism to support the growth of large scale RES-E. Suppliers are obligated to provide a percentage of electricity they supply to customers from renewable energy sources. This is achieved by procuring Renewable Obligation Certificates (ROCs) from the ROCs market or directly from renewable generators</p> | <p>Biomass combustion for generation and heat, geothermal, biogas (anaerobic digestion and landfill), hydro, sewage gas, solar PV onshore and offshore wind, tidal, ground and air source heat pump, wave.</p> |

---

<sup>1</sup> The RO scheme will be phased out by 2017 and the Contract for Difference (CfD) will be the replacement incentive.

|   |  |  |
|---|--|--|
| Demand and generation: Green Deal                                   | Provides capital to meet upfront costs associated with energy saving improvements in homes and businesses. Costs are recovered from electricity bill savings as a result of improved efficiency.                                   | Various energy efficiency technologies and measures, for example improved efficiency from insulation and lighting, and microgeneration and renewables. |
| <b>Demand and generation:</b> Renewable Heat Incentive (RHI)        | This is the Feed-In Tariff for renewable heat generation for domestic and non- domestic customers providing a fixed tariff for every unit of heat produced. This is expected to increase Renewable Energy Sources of Heat (RES-H). | Biomass, heat pumps, solar thermal and biogas combustion, geothermal.  |
| <b>Demand and generation:</b> Renewable Heat Premium Payment (RHPP) | This provides support upfront payments to households, communities and landlords in social dwellings.   | Biomass, heat pumps, solar thermal.  |
| <b>Demand:</b> Plug-in car grant scheme                             | Provides purchase incentives (25% or 20% off procurement cost of electric plug in cars or vans).   | Electric vehicles (EV), hydrogen fuel cell vehicles and plug-in hybrid vehicles.   |
| <b>Demand:</b> Plugged in places                                    | Funding provision to businesses and other investors to install infrastructure (charging points) for EVs.   | Electric vehicles.   |

Table 1-1: low carbon demand and generation incentives and technologies [19, 22, 23].

### 2.2.1 *Changes to regulatory and market frameworks*

Ofgem and the UK government have implemented and continue to consider changes to the policy, regulatory and electricity market frameworks to ensure the UK meets its targets in a safe, secure and reliable manner. The Electricity Market Reform (EMR) is a major legislative and policy consultation to ensure the frameworks are updated. The major changes that have been agreed on are [19]:

1. Contracts for Difference (CfD), which replaces RO to support large scale RES (> 5 MW). It provides stable revenues for renewable generators compared to what is already offered, by using a 'strike price', which requires that generators pay back the difference or receive a top up accordingly if over or under a reference price (the day-ahead hourly market price).
2. Carbon Price Floor (CPF), which creates a minimum price for carbon to counter low carbon prices and volatility. Carbon prices based on the European Union Emissions Trading Scheme (ETS) have fallen from 30 Euros per tonne in 2008 to 5 Euros in 2014 as a result of demand and supply imbalance of carbon permits [24]. This has been caused by a high yearly emission limits for companies, the economic crisis which affected industry and energy consumption in the EU, and oversupply of GHG allowances relative to demand [24, 25]. The CPF requires industries to pay the difference based on a floor price for carbon if the carbon price falls below a threshold.
3. Emissions Performance Standard (EPS), which sets a limit of 450 g CO<sub>2</sub>/kWh for new generating plants. Thus promoting the use of gas technology and Carbon Capture and Storage (CCS) for new coal power plants.
4. Capacity market, which will provide a market to procure energy capacity to meet peak demands. This includes generating capacity and non-generating capacity, such as DSR and ESS.

### *2.2.2 Challenges of low carbon technologies*

This high uptake of LCTs on the Transmission and Distribution (T&D) networks provides technical, economic and environmental benefits, such as a reduction in network losses, improved system reliability and security, improved voltage profile, network upgrade deferral, reduced GHG emissions, reduced network congestion, and reduced electricity bills for customers [26, 27]. However, they also pose challenges which include greater difficulty in forecasting demand and supply for balancing purposes, higher demand peaks and greater energy throughput. The Transmission System Operators (TSO) and DNOs have traditionally designed network assets based on a 'fit and forget' approach to handle large centralised generation and a small range of demand conditions [28]. While a small quantity of LCT-G can provide network deferral benefit, larger sizes and concentrations will cause technical problems because the T&D networks are not designed to handle smaller dispersed and variable decentralised generation. The challenges include voltage rise leading to voltage management issues, reverse power flows, fault level rising above network equipment rating, thermal overload of cables, lines and transformers, increased network losses, diminished power quality and other issues discussed in [27, 29-33].

Low Carbon Demand Technologies (LCT-D) such as EVs and HPs are expected to be rolled out on distribution networks in the UK. LCT-Ds together with electrification of other forms of transport will lead to a higher peak demand on the networks, estimated by Pudjianto et al to be up to two to three times of current peak demand [34]. This would require investment worth tens of billions of pounds to reinforce the networks using conventional methods [34]. Table 1-2 shows the challenges posed by LCTs on the UK electricity system according to timescales.

| <b>Timescale</b> | <b>Challenge</b>   |
|------------------|--|
| Seconds          | Harmonics and reduced power quality introduced into the power system by increase in renewable generation.  |
| Minutes          | Variable supply from renewable generation will require rapid ramping and fast responding frequency response to deal with the intermittency affecting normal grid operations.         |
| Hours            | Daily peak demand will be higher as a result of demand for charging EVs and heating requirement. This will require larger amounts of peaking power plants on the electricity system. |
| Hours – Days     | Wind variability will require back-up power supply and/or demand side response   |
| Months           | Seasonal demand requirements would increase due to the electrification of heating.   |

Table 1-2: Challenges caused by LCTs on the UK electricity system [35]

There will be requirements for huge investments in network assets to prevent curtailment and facilitate a larger uptake of renewables. In the UK, T&D networks are designed to meet different reliability standards for peak demand at different demand groups based on an  $N-i$  redundancy criteria, which signifies that demand must be met by  $i$  circuits on outage [36]. Transmission networks are planned to meet  $N-2$  redundancy [37], and distribution networks down to 11 kV are designed to meet  $N-1$  redundancy, while LV networks have a  $N-0$  criterion [38] [36]. This means there is a requirement on higher voltage network assets to transport two or three times the amount of power in the event of loss of circuit on a neighbouring network. These networks are over-rated to meet peak power flows which may occur for a short period over a year with utilisation at 50% for network assets in the UK [39]. As a result, reliability figures in the UK T&D networks are over 99% [15]. With growing demand from electrification and variable renewables, traditional methods of planning will result in expensive upgrade and reinforcement requirements. The



ENA estimates the cost to upgrade the T&D networks at £126 billion with distribution networks taking up to 76% of the associated costs [15]. At present, T&D network costs make up 19% of customer electricity bills in the UK (they are the second highest contributor to bills) [15]. These network reinforcements and upgrade costs will lead to an increase in electricity bills.

### *2.2.3 Solution to challenges*

The UK government has identified flexible technology options that include ESS, interconnection and DSR as key solutions to enable the transformation of the electricity system by the year 2030 [40]. The identified technologies provide a means of balancing supply and demand as LCTs increase on the grid towards government targets. Thus ensuring the diversification of supply, and operational and adequate security is in place in the UK.

Although the transmission system is already actively managed, investment will be required to increase the active management capabilities and to increase the capacity to accommodate more renewable generation. Distribution networks on the other hand are operated passively with little active management. The current network assets are not designed to actively manage high amounts of LCTs which bring a higher element of unpredictability to demand and generation forecasts. DNOs are pushing for changes in the UK due to the climate change policies for LCTs in order to optimise utilisation of existing assets, defer reinforcement and plan adequately for replacing ageing assets [41]. This leads to the requirements for a smart grid, which has the main aim of “intelligently integrating the actions of all users, both generators and consumers to the electricity grid in order to allow for a more sustainable, economic and efficient power system with low losses, increased safety, quality and security of supply” [42, 43]. Agrell et al identify the six priority areas of the smart grid as [43]:

1. the optimisation of grid infrastructure;

2. operation and utilisation;
3. implementation of Information and Communications Technology on the grid;
4. decentralised resource integration to the grid;
5. active distribution networks; and
6. updated or new markets and end user services that allow for DSR and decentralised generation.

### 2.3 *UK REGULATORY FRAMEWORK*

The European electricity sector was deregulated in the early 1990s to promote competitiveness between stakeholders in the electricity market and drive down the cost of electricity. Deregulation has so far been successful in fulfilling the objective of driving down electricity prices for industrial customers in Europe over the past decade with an average drop in prices of 15% [44, 45]. Deregulation led to unbundling of generation and supply (competitive services) from transmission and distribution network monopolies [45]. T&D networks are licensed by an independent regulator, enabling monopolies to be monitored and supervised. This mimics competition so that network monopolies [46-48]:

- Drive down cost of transporting and balancing electricity thereby ensuring a low electricity tariff for customers;
- Provide a return on investment for electricity network investors;
- Stimulate innovation; and
- Are incentivised to improve their network and operating efficiency to enable all stakeholders benefit from these improvements.

As a result of deregulation and unbundling, the UK electricity sector has:

- Four TSOs operating in England and Wales, North Scotland, East Scotland and Northern Ireland;
- Six DNOs in GB operating in 14 services areas and one DNO in Northern Ireland;

- One System Operator (SO) in GB and 1 in Northern Ireland that balances the supply and demand of electricity in real time.

Ofgem has the responsibility of regulating the electricity sector in the UK comprising both the regulated and competitive segments while DECC is responsible for energy policies and provides guidance to Ofgem [49]. Figure 1-4 illustrates the current regulatory framework in the UK and the responsibilities of Ofgem to all stakeholders in the electricity sector.

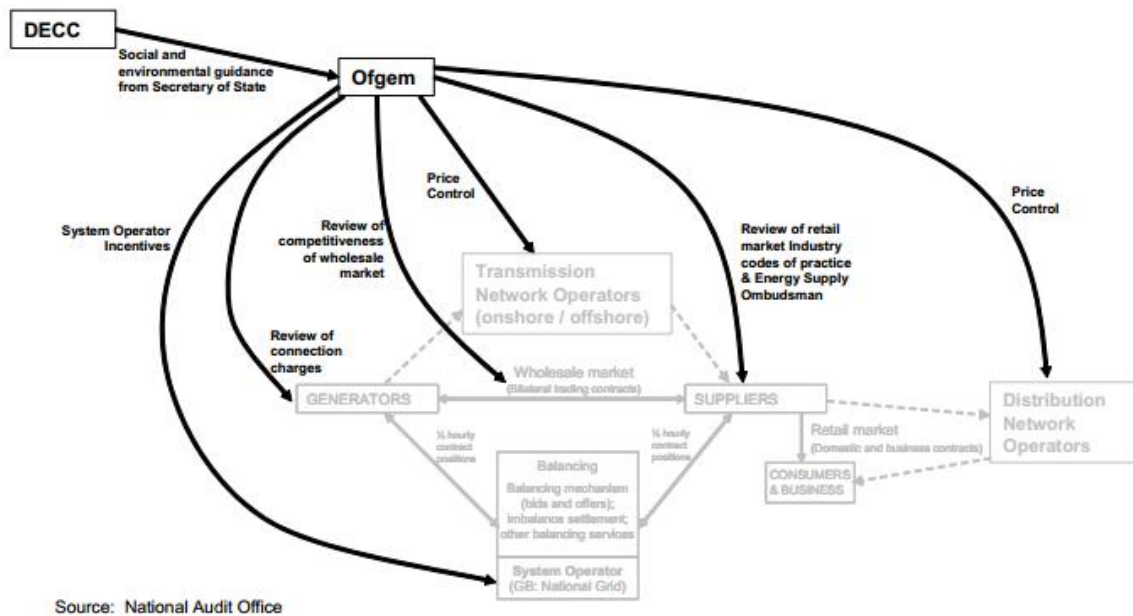

Figure 1-4: UK regulatory framework [49]

The UK is a pioneer in the regulation of the electricity markets with the RPI-X model implemented for network monopolies in 1990 [47]. Ofgem regulates the structure and price charged for utilising the transmission and distribution systems in GB using price controls and incentives. Ofgem does this by analysing information provided on capital expenses, operating costs, performance outputs (network losses and reliability) and financial issues by the four TSOs and six DNOs operating in the UK. The analysis is used to establish performance of the T&D operators in order to produce cost allowances and performance benchmarks which are used as the foundation for the price control and incentive frameworks. The allowed revenue

from capital and operating expenditures is based on the DNOs Regulatory Asset Base (RAB). This allowed revenue is recovered by charging users of the T&D networks through use of system charges.

### **2.3.1 UK electricity markets**

The electricity market in Great Britain (GB) is made up of wholesale and retail and follows the British Electricity Transmission and Trading Arrangements (BETTA).

The electricity market is made up of [50] [51]:

- Forward and futures market: This is made up of the futures and spot market where bilateral contracts are made between generators and suppliers for electricity from years up to 24 hours ahead in a given half hour period. This accounts for 90% of electricity traded;
- Power exchange market (short-term bilateral markets): This is where power stakeholders can correct imbalances in trading positions in half hour settlement periods in the forward market for up to 24 hours before consumption. This accounts for 3% of electricity traded;
- Balancing mechanism: This is where the SO balances the grid in real time by accepting bids and offers from generators and suppliers when the electricity system is short or long<sup>2</sup>. This covers 2% - 3% of electricity traded; and
- Ancillary services market: This covers the rest of the energy traded in GB. The SO procures services in this market to maintain the system frequency and voltage within limits, and to mitigate any unforeseen circumstances. Ancillary services such as Short Term Operating Reserves (STOR) and Firm Frequency Response (FFR) are procured from this market.

---

<sup>2</sup> The electricity system being short happens when generation does not meet demand on the grid or demand exceeds generation as a result of forecast errors, or generators or suppliers not meeting their contracted energy volumes for generation or consumption. The prices the SO uses to balance the grid are usually high in this case than when the system is long. The system is long when there is excess generation or reduced demand on the grid from what was forecasted.

### ***2.3.2 Electricity Distribution Network management and DG***

The DNOs plan, design and maintain distribution networks to meet voltage and power flows requirements and to ensure a reliable and high quality of power supply to end users. They minimise voltage deviations and ensure the voltage on the networks is within statutory limits of [52]:

- 132/66/33 kV  $\pm 10\%$  at the subtransmission or High Voltage (HV) level;
- 11/6.6 kV  $\pm 6\%$  at the primary or Medium Voltage (MV) level; and
- 400 V  $+10\%$   $-6\%$  at the secondary or Low Voltage (LV) level.

They also maintain power flows within thermal and fault ratings of network assets (switchgear, transformers, overhead lines and underground cables). Other responsibilities of the DNOs are to:

- Prevent faults from occurring on the network;
- Maintain network assets;
- Minimise system losses;
- Restore power promptly in the event of a supply interruption;
- Connect new demand customers;
- Allow for the maximum uptake of DG (renewable and fossil fuel based) by managing network connections to ensure they do not affect the performance and operation of the distribution network.

### ***2.3.3 Distribution network regulatory framework changes***

The regulatory framework which was not setup for a low carbon economy will be migrated in 2015 from the price cap model (RPI-X) to a new framework called “Revenue = Incentives + Innovation + Outputs” also known as RIIO, which is an evolved version of the RPI-X framework. RIIO will be used to develop future price controls and has the objectives of allowing DNOs to fully and actively take part in adopting sustainable energy and delivering long term value for money to current

and future customers [53]. Figure 1-5 shows components of the RIIO model. RIIO has a strong emphasis on [53]:

- Increased flexibility to deal with the uncertainties that may be encountered as a result of growth in LCT-G and LCT-D;
- Long term planning to guide decisions for current or future changes in demand;
- Innovation in all aspects of the DNOs business from design to operation to ensure the move towards a smarter grid.

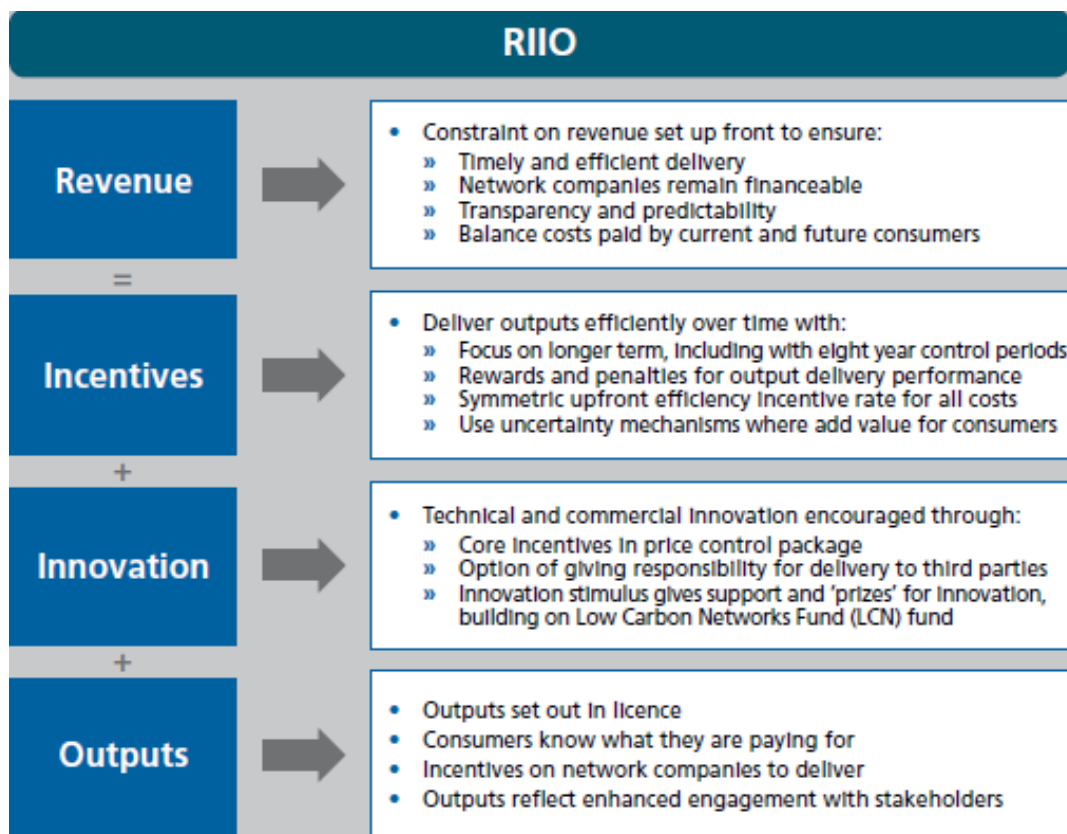

Figure 1-5: Components of the RIIO model [53]

Load growth forecasting was crucial in guiding DNO investment decisions under traditional planning methods where DNOs expand the networks to meet maximum or peak demand. The increase in LCT-D technologies for electrifying heat and transport will increase peak demand requirements on the network. For example, it is projected that the 2.5 kW peak demand for an average household in the UK will rise

up to 10 kW – 12 kW as a result of EVs and HPs, which require the largest amounts of electricity [28]. Table 1-3 shows the current and expected levels of ADMD, households and DG on distribution networks based on DECC projections. This will require expensive network upgrade costs that can be delayed, reduced or eliminated by introducing innovative network solutions. RIIO provides an avenue for innovative solutions to be used to provide upgrade deferral and more flexible and actively managed networks capable of managing issues caused by large LCT deployments. These innovative technologies will be capable of providing solutions, which include voltage control, thermal overload management, management of fault level and protection, loss reduction and improved power quality. ESS is one of such technologies capable of providing one or more of the required solutions.

| <b>Year</b> | <b>ADMD (kW)</b> | <b>Number of Homes (millions)</b> | <b>Distributed Generation (GW)</b> |
|-------------|------------------|-----------------------------------|------------------------------------|
| 2010        | 2.5 kW           | 26                                | 8                                  |
| 2030        | 4.7 kW           | 31                                | 16                                 |
| 2050        | 7 kW             | 36                                | 20                                 |

Table 1-3: Expected increase in ADMD, domestic customers and DG in the UK [28]

### **3 ENERGY STORAGE OVERVIEW**

The traditional power systems comprises mainly of conventional, dispatchable fossil fuelled generating plants on the transmission network that can be ramped up or down daily to meet daily electricity demand. As a result, a widespread means of storing energy was not considered a priority in these traditional power systems. Nonetheless, most traditional power systems have an amount of Pumped hydro storage (PHS). In the UK, the total PHS power capacity is 3 GW and energy capacity is ~27.6 GWh [11, 21]. In 2008 PHS supplied 4075 GWh of energy from 5371 GWh of input energy used for pumping, representing approximately 1.1% of the total electricity supplied to the UK grid [40]. A list of the pumped-hydro storage schemes in the UK is shown in Table 1-4.

| Name         | Storage Capacity (GWh) | Output (MW) | Location | Duration at Peak Output (hours) | Year of Commission |
|--------------|------------------------|-------------|----------|---------------------------------|--------------------|
| Ffestiniog   | ~1.3                   | 360         | Wales    | 20                              | 1963               |
| Ben Cruachan | ~10                    | 440         | Scotland | 22                              | 1966               |
| Foyers       | ~6.3                   | 305         | Scotland | N/A <sup>3</sup>                | 1974               |
| Dinorwig     | ~10                    | 1728        | Wales    | 5                               | 1983               |

Table 1-4: Pumped-hydro storage schemes in the UK [11, 12]

PHS is the major form of ESS deployed worldwide covering 99% of installed ESS capacity at approximately 127 GW [54], amounting to 3% of worldwide generation capacity in 2008 [55]. Most PHS schemes are old systems that were installed in most countries prior to the increase in intermittent renewable generation, the PHS schemes in the UK provide a good example. Now the interest in ESS (PHS and other technologies) has been revived as a result of [56]:

- Storage technology advancements;
- Escalation of the prices of fossil fuels;
- Ageing network assets and demand growth and the resulting challenges of building new transmission and distribution infrastructure;
- Advancement of deregulated energy markets with markets for ancillary services requiring fast response and high ramp rates; and
- Increase in intermittent renewable generation as a result of climate change policies.

PHS implementations are limited by geography, due to requirements for two reservoirs at different elevations; environmental impacts; and long construction time. This means power system stakeholders will have to rely on alternative ESS

---

<sup>3</sup> Data is not available



technologies such as batteries and other storage technologies to meet storage requirements on the grid.

ESS is considered as an alternative to reinforcement on the T&D networks and to defer the need to upgrade or replace network infrastructure. In an unbundled electricity system, ESS could be used to provide grid support services, which are provided by regulated network monopolies; or competitive (deregulated) services, which involves suppliers, and generators and other third parties. Studies have been carried out that show the versatility of ESS when used for T&D network applications that include renewables integration and smoothing dispatch, voltage and frequency regulation, power quality management, power flow management (peak shaving and load levelling), increased asset utilisation, loss reduction, and network capacity management to defer or avoid network upgrade [57-59]. A study carried out by Strbac et al indicate that in the short to medium term, ESS can be used to drive down distribution network reinforcements costs, which are expected to be higher than transmission investments costs in GB [60].

Developing viable business models for T&D operators and third party storage owners, outside of those applied for large PHS systems remains a challenge because of the complexities in valuing the benefits ESS can provide (outside of competitive electricity market services) across the electricity value chain. These difficulties are as a result of limited knowledge of the technology and deployment outside of PHS, and regulatory and electricity market barriers preventing ESS use for multiple applications on the grid [61]. An international review of the regulatory and electricity market structures that impact the use of ESS internationally is presented in Chapter 4.

### **3.1 ENERGY STORAGE TECHNOLOGIES TYPES AND PROPERTIES**

ESS can store energy in various forms, e.g. thermal or chemical for later conversion via a Power Conversion System (PCS) into electricity. The varying forms of storing

energy and the difference in the storage medium properties influence the applications of different ESS technologies. Table 1-5 describes classifications of ESS technologies and the various technologies being developed or used in power systems [61].

| <b>Storage Technology</b> | <b>Technology Type</b>   |
|---------------------------|--|
| <b>Electrical</b>         | Double-layer capacitors (DLC) or Super capacitor energy storage (SES);<br>Superconducting Magnetic Energy Storage (SMES)   |
| <b>Mechanical</b>         | Flywheel energy storage (FES); Pumped hydro storage (PHS); Compressed Air Energy Storage (CAES)  |
| <b>Electrochemical</b>    | Flow batteries (e.g., Vanadium Redox, Zinc-bromine, Polysulphide Bromine)<br>Batteries (e.g., Lead-acid, Lithium-ion, Sodium-sulphur, Nickel-cadmium, Sodium-nickel-chloride (Zebra)); |
| <b>Chemical</b>           | Hydrogen ( H <sub>2</sub> ); Synthetic Natural Gas (SNG)   |
| <b>Thermal</b>            | Sensible heat technology (e.g. water, synthetic oils, concrete); Latent heat technology (e.g. liquid air, molten salt)   |

Table 1-5: Energy storage technology types [61].

The key properties of ESS technologies based on usage and technical application are the maximum and minimum power that can be transferred into or out of the ESS (MW), and the maximum and minimum energy content (MWh) [62]. Other key important properties are:

1. DoD: This is relevant to battery and flow battery technologies and is a percentage of ESS capacity that is discharged during a cycle (where a cycle represents a charge and discharge operation). Operation cycles at a high DoD can lead to a degradation of the ESS, causing the useful storage capacity to decline.
2. Discharge time (DT): This represents the duration the ESS can provide output at the maximum or average power. DT is directly proportional to the energy capacity when there is constant output power and is dependent on the DoD and the system operating conditions [63].
3. Charge/discharge Ratio (CDR): This ratio represents the time required to charge an ESS relative to the time required to discharge the ESS.
4. Efficiency: This represents the ratio of energy input into the system to the energy output by the system. The amount of losses experienced when converting power transferred into or out of the energy storage medium (charge or discharge) is referred to as conversion efficiency or roundtrip efficiency (RTE), and storage efficiency refers to the time associated losses encountered during storage. The overall efficiency of ESS is affected by a combination of RTE and self-discharge losses.
5. Response time and ramping ability: Response time is the reaction time of the ESS to be activated and begin charging or discharging and ramping ability is the time taken to switch between charging and discharging modes.

From a cost effective implementation perspective, other important parameters that affect the application, selection and design of ESS are durability which represents the lifetime of the device as a result of degradation; autonomy, which represents the maximum amount of time a fully charged ESS can discharge energy before it is fully discharged. Additionally the investment/capital cost for power and energy capacity, operating constraints (for example, a distribution network ESS operation will be restricted by network constraints), and operational and maintenance costs required

which will vary based on the technology type (for example, flooded lead acid batteries will require periodic electrolyte refills, and will require replacement after the cycles to failure has been reached).

### **3.2 FUNCTIONS AND BENEFITS**

Energy storage can be used for a host of functions in the power system to provide technical and economic benefits to all stakeholders. Energy storage can act as generation, transmission, demand or demand response based on the requirements at any specific time for a given stakeholder. It is desirable to aggregate the benefits to increase financial viability of an ESS investment. A breakdown of the applications and revenue streams for ESS across the electricity value chain, derived from [57-59], is discussed in the following economic and technical sections.

#### **3.2.1 Economic**

1. Capacity management: In a location where network asset replacement or upgrade is required to manage power flows within a network's thermal constraints resulting from increasing demand and/or generation on the distribution network. This enables high capital investment deferral on overhead lines, underground cables, switchgear and substations, and increases the utilisation of network assets.
2. Energy arbitrage: Arbitrage is carried out by buying energy generated during off-peak periods when electricity prices are low and selling during peak periods when prices are highest because peak generation is needed to cover peak demand not covered by cheaper baseload generation. Arbitrage could also provide capacity management on the T&D networks if peak electricity prices coincide with periods of peak demand on the network. It increases the utilisation factor of the network and capacity utilisation of renewable generators. This provides financial benefits to the networks, and both renewable generators (as a result of firmed capacity) and ESS owners from arbitrage operations through the wholesale electricity market.

3. Balancing and reserve services: ESS can be used to provide frequency regulation and reserve (spinning and non-spinning) services on the grid to manage grid imbalances and events. It reduces the need for flexible fossil fuel generation to provide these services and can provide more rapid responses than the current fossil-fuel flexible generation technologies. These generators have unpredictable costs due to the changing fossil-fuel prices and government policies that place a price or restriction on carbon and other greenhouse gas emissions.
4. Energy conservation: Implementation of ESS to manage LCT issues will enable more industrial, domestic and commercial customers to install LCTs that provides heating and electricity and thereby reduces their electricity and gas bills. As a result this reduces GHG emissions from the fossil fuel generators that would have been used to provide the energy needs of the different customers.

### 3.2.2 *Technical*

- Black Start: ESS can be used to set and control the voltage and frequency in a power system if a collapse occurs on the T&D networks. This blackstart application enables disconnected systems to be restored and reconnected back to the grid thus ensuring a reliable electricity system.
- Power quality: With increasing levels of renewable DGs, issues of power quality and harmonics will increase on the T&D networks. ESS can be used for power quality management to reduce or resolve various power quality issues such as harmonics and transients, voltage sags, swells, and flicker.
- Voltage regulation: ESS can be used to manage voltage and reactive power requirements on the T&D networks providing benefits of managing and maintaining network voltage within regulatory requirements.
- Renewables firming: With the growth of LCT-G, ESS can be used to reduce the unpredictability of renewable generation by managing ramp rates and

dispatchability. This provides benefits of reduced reserve and frequency regulation requirements for system balancing, improved utilisation of RES, increased RES deployments and reduced volatility in the spot market (due to RES low marginal costs) caused by a high renewables contribution to the generation portfolio.

- Increased asset utilisation and reduced losses: ESS can be used for load levelling to increase the utilisation of network and generation assets; and
- Reduced losses: losses on the transmission and distribution networks during peak demand can be reduced by using energy storage for peak shaving, and losses can also be reduced from load levelling (reducing ratio of peak to off-peak demand on T&D networks) [64].

#### **4 SUMMARY**

This chapter introduces the UK electricity sector and its evolution. This is shaped by targets for decarbonisation and the need to increase security of supply, and provide affordable electricity to the UK public. The technical challenges of increasing LCTs on the grid, and the government policies and regulatory changes in place to enable more LCTs were discussed with ESS, DSR and interconnections seen as solutions. It is anticipated that the distribution networks will have a high amount of LCTs connected to them and this will require DNOs to invest in innovative solutions that enables this and increases the flexibility of the distribution networks. A background on the ESS technology types, functions and benefits was provided. This chapter provides background for the subsequent chapters which provide a literature review on the planning and operation of ESS in chapter two, and the regulatory and electricity market barriers affecting the viability ESS in chapter three.

## **Chapter Two: Literature review on methods for planning and operating energy storage in distribution networks**

---

### **1 INTRODUCTION**

Chapter 1 provided a background on the UK electricity system, particularly the distribution networks and the evolution towards a low carbon economy which will result in changes that will affect all power system stakeholders. There will be a significant impact on distribution networks where LCTs such as plug in hybrid electric vehicles (PHEV), solar PV and WTs are expected to increase annually in line with government targets and policies. These LCTs could lead to issues if not actively managed and will require investment in network assets to mitigate issues. Active Network Management (ANM) which is the practice of planned and real time management of distribution networks and network equipment to operate within acceptable limits [65, 66], defers or eliminates the need to upgrade network assets. Consequently, ESSs can be used to provide ANM in the distribution network because of increasing developments in ESS technologies and power electronics [67].

ESS can be used for multiple applications to provide a variety of benefits across the electricity value chain, the applications and benefits were examined by Corey et al [68]. It can be inferred from [61, 68, 69], that due to notable challenges, which includes the difficulty in aggregating benefits, lack of knowledge and experience with using ESS, and high technology installation cost, it is a hard task for power systems stakeholders to prove its commercial viability. This is more apparent in an unbundled and liberalised electricity sector, where the division between competitive stakeholders (generators and suppliers), and network monopolies (transmission and distribution operators) affects transparency in establishing the maximum potential of ESS. Furthermore, regulatory rules prevent network monopolies from operating asset that provide competitive services in the electricity market.

Klocl et al suggest that the reason for the slow technological progress in ESS development is caused by the uncertainty on the potential stakeholders that would benefit from an ESS implementation on the grid, which is a result of the lack of modelling and assessment done in this area [70]. Consequently, the development of methods to assess and improve understanding of the value of ESS in a power system is becoming an increasingly interesting topic of investigation in academia and in the power sector at large. Research on the impact of different regulatory and electricity market regimes is also important as this directly impacts the applications ESS can be used for on the grid and the resulting profitability. Substantial research and evaluation has been completed or is being carried out globally to establish the feasibility of utilising ESS in power systems. This includes key studies from which assess the role and value of ESS in the UK's low carbon energy future [60], and [58] which discusses the prospective breadth of values and applications for ESS in the US. Based on the analysis of distribution network ESS (DN-ESS) benefit in the UK, Strbac et al concluded that DN-ESS can significantly reduce or delay the need to upgrade network assets caused by the electrification of transport and heating and other LCTs [60]. They further concluded that in the UK, DN-ESS provides a higher overall aggregated value than bulk ESS. Hence, it is crucial for DNOs in the UK to understand the commercial viability of ESS on their networks in order to inform future network investments.

Optimising the planning and operation of ESS is essential to obtain the maximum value from ESS on a distribution network. However, this is a relatively new area for DNOs, as ESS is not a conventional network asset. In the UK, ESS have not been implemented in distribution networks outside of trial deployments making up 5.1 MW and 6.4 MWh of commissioned ESS, with 7.2 MW and 13.8 MWh scheduled to be deployed or under construction. The spread of deployments showing the interest in ESS across the UK is illustrated in Figure 2-1.



DNOs in the UK are required to invest wisely to ensure continued safe and reliable services; implement innovative solutions that reduce network costs for consumers; and enable the transition to a low carbon economy [71]. Thus, there is the need to investigate the benefits of using ESS as an alternative solution in an unbundled power distribution network to enable DNOs meet the expected operational goals set by the Office of Gas and Electricity Markets (Ofgem). Distribution network investments are dictated by planning, which in turn are driven by planning standards that consider expenditure to meet network security requirements, system fault levels, network losses, and service quality (to increase network reliability) [72]. Hence, the question arises: should DNOs invest in ESS and what are the financial implications?

In evaluating the benefits of ESS, it is important to understand the impact of the operation of DN-ESS depending on where it is installed and the mode of operation as it could be used for network ancillary services or commercial services in the energy markets (for example energy arbitrage or frequency regulation). This requires an evaluation approach where an understanding of the regulatory and electricity market frameworks is used to guide the planning and operating strategies for implementing ESS in a distribution network.

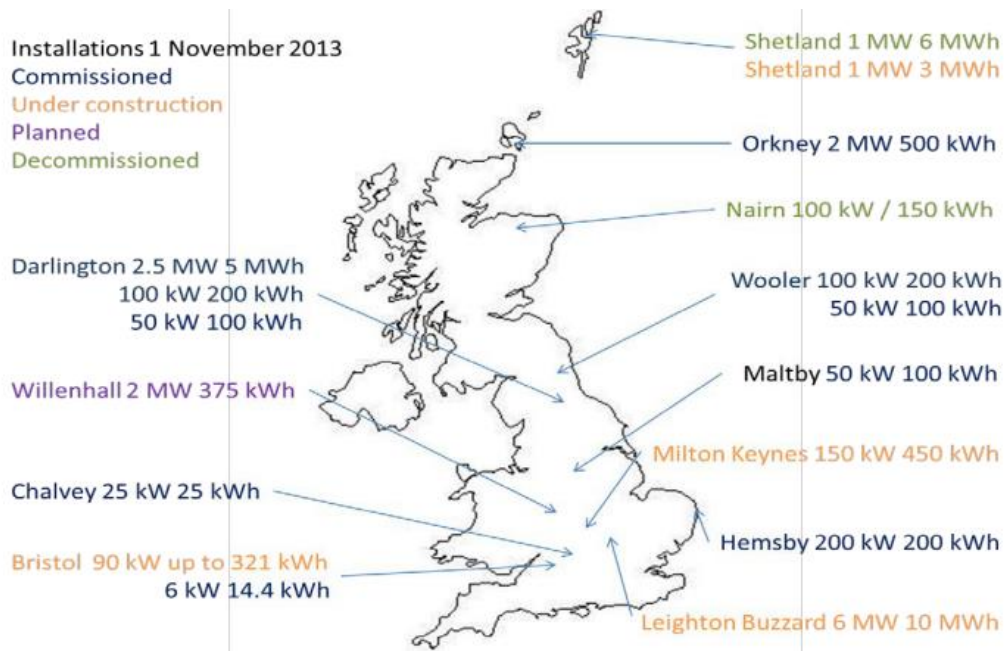

Figure 2-1 Electrical energy storage installations (except PHS) in the UK [73]

A literature review of the approaches for planning, operating and valuing ESS is presented in this chapter. As ESS implementation in distribution networks is outside of conventional planning methods, there is limited research on planning methods that consider locating, sizing and operating ESS. DG planning in distribution networks has some similarities to ESS planning so it is also considered in this review. The following points are covered:

- Review of literature covering the valuation of ESS benefits in power systems and specifically power distribution networks;
- Review of literature covering the planning and operation of storage (storage size, location, time of installation and operation);
- Discussion of the weaknesses of the methods used and establishment of the relevance of this research.

## 2 FINANCIAL VALUATION OF ESS IN DISTRIBUTION NETWORKS

The interest in deploying ESS in power systems has continued to grow and as a result it is estimated that the global demand for ESS will be worth £72 billion by 2017

[54]. A German study by Fürsch et al concludes that grid extensions are a first choice investment in a way forward for the European Union (EU) to achieve its targets for RES-E and GHG reductions [74]. They mention ESS as an alternative investment option if grid extension is not feasible. Strbac et al establish the need for ESS in the UK electricity system and estimate annual system benefits of £0.12 billion by 2020, £2 billion by 2030 and £10 billion by 2050 [60]. The study confirms that the higher the share of renewables, the higher the value of ESS in the UK and that DN-ESS can significantly reduce distribution network reinforcement expenditure in the UK. Vasconcelos et al suggest that the main challenge for ESS profitability is the ability to combine the multiple services that ESS can provide and afterwards maximising the resulting multiple income streams [75]. For this reasons, a DNO in the UK (UK Power Networks) was awarded £13.2 million by Ofgem (with a total budget of £18.7 million) to implement and explore the ways of improving the economics of ESS [76]. This is the largest ESS trial project in the UK in Leighton Buzzard (with a power rating and energy capacity of 6 MW and 10 MWh) as shown in Figure 2-1.

Research studies surveyed look at the benefits of ESS from an electricity market perspective, for example, [77-79] look at the benefits of renewables integrated with ESS on the transmission network to maximise electricity market revenues; Ohtaka et al evaluate the benefit of dynamic control of sodium sulphur (NaS) ESS to manage line overloads during faults on a transmission network [80]; and Ippolito et al assess the technical benefits of ESS in an islanded distribution network with firm and non-firm distributed generation [81]. Other studies have analysed the benefits on the distribution network, where Sugihara et al study the benefits of customer ESS controlled by DNOs in providing voltage support in a network with high amounts of fluctuating generation from PV [82], and Chacra et al evaluate the benefits and value of DNO owned ESS in a network with increasing demand [67]. Gill et al assess a method to maximise the revenue from renewable DG while keeping the network within constraints [65], and Nick et al investigates the benefits of using ESS to

minimise losses and energy costs from the grid, and manage the distribution network voltage [83]. Chen et al evaluate a cost-effective implementation of recycled electric vehicle batteries from the point of view of a network operator to minimise voltage deviations and reduce line losses on a distribution network al [84].

Studies assessing the feasibility of ESS for only market based or network ancillary services have shown that to consider only one revenue stream is not profitable. Poonpun et al analyse the extra cost added to unit cost of electricity and they show that using ESS (excluding PHS) is not feasible for market based operations or to provide transmission and distribution applications to delay network investment [55]. Kazempour et al show that the use of batteries, in this case NaS for electricity market operation (regulation, spinning reserves and energy market) alone is not feasible without financial support [85]. Zucker et al discuss the impact of DN-ESS dispatch strategies on profitability and identify a German study where grid costs were increased by 35% when DN-ESS was operated based on market signals [86]. Conversely, operation based on grid requirements led to a 17% reduction in grid costs [86]. This shows that operating ESS for maximum benefits can result in conflicts between objectives.

From the literature surveyed, using ESS for various applications on the T&D networks has been shown to provide technical and financial benefits to the ESS owner. However, whilst single stakeholder benefits have been proven, successful implementation of ESS for multiple applications to provide multiple benefits to all stakeholders involved is yet to be proven. For example, ESS installed in a distribution network that acts on electricity market signals during peak price periods (which usually coincides with network peak demand periods) for discharge may be contrary to maintaining a networks voltage and thermal constraint on a network with high amounts of renewables that are also generating at that period. Aggregation of the benefits from multiple applications is important in ensuring the viability of investing in ESS investment. Thus in considering ESS in distribution

networks, all aspects of technical and commercial operation must be considered in tandem based on the requirements of the respective stakeholder. These operations must be translated into revenue streams for financial assessment.

Assessing the financial viability of deploying ESS in distribution networks is a complex planning problem that involves considering a combination of power system stakeholders in order to provide a thorough cost-benefit analysis. An evaluation approach requires:

- Medium (up to five years) to long term (greater than five years) prediction of changes in demand and generation on the distribution networks, by using experience and knowledge of the locations, geography, government policies and country economics to develop future scenarios, and with deterministic and stochastic demand and generation data;
- Medium to long term assessment of anticipated regulatory and policy changes that impacts the amount of LCTs on the distribution network, energy efficiency of customers and implementation of ESS solutions;
- Methods and tools for planning the rollout of ESS on the distribution networks by determining the optimum location, size and when to install ESS across a DNOs portfolio of networks; and
- If ESS is seen as a viable option, the creation of an operating strategy that maximises the cost savings and revenues of planned ESS installations on the networks within network constraints.

### **3 PLANNING OF DISTRIBUTION NETWORKS**

Due to the importance of planning in understanding the potential benefits of ESS on a distribution network, this topic is now reviewed in detail.

#### **3.1 THE PLANNING PROBLEM**

Conventional means of planning involves ensuring that existing networks can be operated and maintained in a reliable and economically efficient manner to meet

technical constraints and cope with load growth, new customers and the ageing of network assets. It ensures that optimal economic targets are fulfilled, such as minimising system losses, investment, operating costs and maintenance costs. In planning electricity distribution networks, the owners and operators have to consider [87]:

1. Strategic or long-term planning to determine the best future network arrangements and guide key network investment, and the timing of these investments in order to gain maximum benefits;
2. Short-term planning for individual network investments in the immediate future. For example to deal with the installation of DG at a node on the network that will lead to voltage rise or a recurrent voltage drop issue; and
3. Construction design or planning, which considers the structural design of network components, based on the availability of materials.

Capital and operating costs, which include expenses on maintaining or replacing network components and network losses are considered as part of long-term planning as it influences the strategic performance of the DNOs. Neimane et al outline short-term planning in distribution networks to be 6 years ahead or less and long term planning to be over 20 years in the future [88]. Short-term planning has to be considered in light of the long-term planning decisions of a DNO. Planning at any level (short or long-term) involves assessing solutions that enable the DNOs to meet their objectives, and estimating and comparing the cost of different solutions to determine the most viable techno-economic solution. As planning involves finding the optimal solution to meet various technical and economic requirements on a network, the objectives to meet these requirements or goals are often conflicting hence multi-objective optimisation is required [89-91]. Common goals include minimising investment requirements for an affordable, sustainable, safe, secure and reliable electricity supply, and improved power quality to customers. The four key

criteria important in planning for distribution network expansion or reinforcement are [92]:

1. Equipment variables: such as the capacity of network equipment, which includes HV and LV overhead lines and underground cables, substation transformers; and HV/LV network configurations and location of substations.
2. Power system stakeholder objectives: This differs based on the regulatory requirements and the end goals of the party or parties involved. Ippolito et al formulate an objective function that minimises grid energy losses, total electricity generation cost and GHG in an islanded network with renewable energy sources [81]. Other studies have developed objective functions that maximise revenues. Korpaas et al maximise the arbitrage revenue of ESS in the electricity markets [78], and Gill et al maximise renewable DG utilisation on a distribution network [65]. Multi-objective planning problems have been solved as a single objective problem using weights to represent multi-objectives [83, 84], or with multiple objective functions optimised simultaneously [93, 94].
3. Constraints: In operating the distribution networks, technical requirements have to be met to ensure safe, secure and reliable electricity supply to customers. In the UK, the P2/6 standards dictate the network security requirements [95]. To operate the distribution networks, voltage and thermal constraints, fault level, phase unbalance and protection requirements have to be satisfied. Constraints could also be set outside of network standards, these will be based on the DNOs requirements. Limitations could be placed on technically or socially impossible locations for network asset to be installed; or the maximum amount that can be spent on the asset, for example, when considering an alternative solution on a network it has to be less than the cost of conventional solutions.

4. Planning period: Falaghi et al list the two types of long term network planning as static and dynamic [96]. Static planning involves obtaining an optimal network solution over a planning period with no consideration for the time of installation and reinforcement. El-Khattam et al carry out static planning to derive an optimal solution for DG capacity and location to accommodate forecasted load growth modelled as a mixed-integer non-linear programming problem in the Generalised Algebraic Modelling System (GAMS) [97]. On the contrary, multistage or dynamic planning considers the optimal network solution sequentially over a planning period as part of the optimal solution. Falaghi et al analyse a multistage distribution expansion planning (MDEP) mixed-integer nonlinear optimisation problem using a combined Genetic Algorithm (GA) to determine DG size and location, and Optimal Power Flow (OPF) to determine the DG operating strategy over planning horizon with four stages of two years each. Gitizadeh et al analyse an MDEP problem with DG using a combination of particle swarm optimisation and shuffled frog leaping algorithm over a four year planning period [98]. The dynamic expansion planning approach is also used in [99] where planning network expansion is analysed for DG investment against conventional reinforcement solutions, and GA optimisation is applied to get the optimal solution, while considering DG output and demand uncertainty.

Established methods and standards are not in place for planning for the use of ESS in distribution networks as it is not conventional equipment. This was the case for DNOs planning for DG uptake on their networks, which is still not fully addressed in planning methods due to uncertainty of DG output and lack of clarity on where these DG schemes, for example PV will be installed [92].

### ***3.1.1 Planning for new technologies***

Distribution networks are designed with a very low load factor (which represents the degree at which network assets are utilised) based on worst case scenarios. This



means managing the voltage at the remote end of a distribution network during high load conditions. When planning for DG, the voltages and power flows at the most extreme scenarios of high DG output and low network demand or vice versa are considered. In traditional planning, existing networks are used as a basis to direct future investment decisions and the methods are based on the “fit-and- forget” strategy [99]. For example, conventional distribution expansion planning (DEP)<sup>4</sup> involves considering solutions that include installing or upgrading HV and LV substations and feeders, network reconfiguration by closing normally opened switches, and installing new normally open switches [99-101]. These planning methods will need to become innovative in future as DG installations increase in the distribution networks, otherwise applying such methods will lead to higher capital investments than necessary. New methods that employ ANM with solutions such as ESS, DSR, and other smart grid technologies to aid a higher implementation of DG on the grid may be more cost effective [102].

Numerous studies have been carried out to investigate ways to maximise the profitability of ESS for power system stakeholders. DEP is considered to be a very difficult problem involving complex mathematical modelling and thorough numerical calculations to obtain an optimal solution to problems that involve multiple opposing objectives, uncertainties, and a high number of variables [88, 96, 101, 103]. As the network size increases and LCTs increase, planning for ANM schemes that use new technologies to increase LCT uptake and manage issues on the networks will add further complexity to the planning process.

---

<sup>4</sup> Distribution expansion planning, which involves determining the size, location and time for installing new network assets under network constraints is a combinatorial optimisation problem.

## 3.2 *PLANNING FOR THE OPTIMUM LOCATION AND CAPACITY OF ENERGY STORAGE IN DISTRIBUTION NETWORKS*

### 3.2.1 *Optimisation methods for planning and operating distributed energy resources*

Mathematical programming methods, which include dynamic programming, mixed integer programming, non-linear programming, linear programming, and heuristic or hybrid heuristic optimisation methods, have been used in many distribution network planning problems [67, 80, 81, 96, 98, 99, 104, 105]. These methods have been used for the planning and operation of renewable power generators and ESS in both grid-connected and islanded T&D networks. They have also been used for solving optimisation problems that involve generating maximum revenues from the electricity market [65, 78, 79, 106, 107].

Mathematical programming methods can find the optimal solutions to problems efficiently [89]. However, the accuracy of the solutions is only as good as the approximated mathematical formulas used to represent the networks and solve for the optimal solution [89, 108]. Non-linearity in power systems planning problems complicates representation of network/system models [109-111]. Linear programming methods cannot be used to solve non-linear problems, which represents most distribution expansion and distributed energy resource planning problems [67, 100, 109]. Although non-linear programming can be applied for such cases, there are issues with getting trapped at a local minima, complexity of algorithms and convergence problems [112]. Heuristic search algorithms, which tackle optimisation by the use of guided search techniques, are useful when the problems requiring optimisation are mathematically difficult to represent and have the problem of multiple-local optima [111]. This is the case for power systems problems with distributed energy resources (DER) which present non-linear, non-convex combinatorial and global optimisation problems [89, 109]. Optimisation methods used in most power system studies are termed meta-heuristics as they are a

level higher than heuristic methods (which are based on experience of the problem). They can be applied to many types of combinatorial optimisation problems, where searching for the best solution is carried out on a large number of alternative possible solutions. The implementations of most meta-heuristics are based on physical, biological or natural phenomena. These methods can be adapted for different problems and can be used to solve both discrete or continuous, convex or non-convex and linear or nonlinear problems [89]. The drawbacks of heuristic methods are the lack of a guarantee of finding a feasible or global optimum solution [111]. The major meta-heuristic algorithms are evolutionary algorithms for example, GA and particle swarm optimisation; simulated annealing, tabu search, ant colony search, neural networks and fuzzy programming [111].

Rivas-Davalos et al discuss the relevance of effective and efficient multi-objective evolutionary algorithms (MOEA) in power and distribution systems planning and operation [113]. In multi-objective (multi-criteria) optimisation, there is no optimum solution but a set of alternative solutions with different trade-offs, which are called the Pareto-optimal solutions. Multi-objective optimisation involves three stages, which are the development of a model, optimisation, and the final decision making from a solution space of optimal solutions. The final decision making from a set of optimal solutions gives it an advantage over single objective optimisation which puts the decision making process before the optimisation as all objectives are defined under a composite objective function [114]. This is done by selecting preferences (for example, through the use of weights) before alternatives are known. Different MOEAs like Niche Pareto Genetic Algorithm (NPGA), Strength Pareto Evolutionary Algorithm 1 (SPEA-1), Strength Pareto Evolutionary Algorithm and 2 (SPEA-2), Non-dominated Sorting Genetic Algorithm (NSGA), and Non-dominated Sorting Genetic Algorithm 2 (NSGA-2) have been applied for planning and operation studies in power and distribution systems. Alarcon et al discuss the relevance of MOEAs and the flexibility they provide in incorporating inner

optimisation algorithms which enable the controllability of distributed energy resources, such as OPF [109]. Solving OPF problems is widely used to inform operation, planning and control in power systems because it allows for the integration of economic and technical requirements into a mathematical formulation [65, 115]. The aim of applying OPF is to obtain an optimal solution based on an objective function and constraints in a power system. Examples of objective functions include maximising DG output on a distribution network by adjusting distribution network control variables, while ensuring physical and operational constraints are met. Control and state variables and constraints include [115]:

- Control variables: Real power output of generators, and reactive power output from reactive power compensation devices, and On-Load Tap Changer (OLTC) position;
- State variables: These include network power flows, power at the slack bus, bus voltage magnitude and phase angle;
- Constraints: These can be classed as inequality constraints and equality constraints. Inequality constraints are the limits of control and state variables and represent the physical and operational limits of the network which can be discrete and/or continuous. Examples include technical constraints of ESS, DG, network line and voltage constraints. Equality constraints are the power flow equations and are continuous.

OPF optimisation problems are non-convex, nonlinear, extensive and static with discrete and continuous variables [115]. OPF problems are optimised for a single time step, however, studies have been carried out that have extended its application to multiple time steps, also called Dynamic Optimal Power Flow (DOPF). Gill et al use DOPF to schedule ESS and flexible demand to allow for maximum renewable uptake by reducing DG curtailment. Geth et al use DOPF to site, size and dispatch ESS for maximum revenue in the electricity market and for managing voltage constraints [116].

### ***3.2.2 Planning and operation of ESS in distribution networks***

Sedghi et al analyse the distribution system expansion problem over a six year period using a modified PSO method to optimise a combination of solutions that includes DG and ESS, and installing new HV/MV substations and main and reserve feeders, with the goal of minimising costs and improving reliability [101]. The ESS was used for peak shaving and improving network reliability. The authors showed the importance of ESS operating strategies, considering the economics, on the success of its use in distribution planning. Miranda et al use GA for optimal multistage planning of a distribution network and develop a model to solve problems resulting from load growth by finding the optimal sizes, time and location for distribution substation and feeder expansions [110]. Huang develops and analyses a model for long term planning of LV and MV distribution networks by determining the optimal network expansion and reinforcement plans with deterministic and probabilistic DG and demand models under regulatory policies in Europe [92]. The author analysed the impacts of regulation on network planning methods and developed risk analysis methods for integrating DG while considering uncertainties.

Ippolito et al show how the planning strategy for ESS, i.e. location and power and energy capacity, affects the optimal operation [81]. Strbac et al highlight the impact of ESS operating strategy on its optimal location based on a UK system wide study on the value of bulk and distributed ESS [60]. This reinforces the need to address both planning and operation when modelling ESS implementation. Furthermore, there may have to be compromises on planning and operation parameters when selecting an optimal solution.

### ***3.2.3 Planning and operation of ESS for market operation***

Kazempour et al itemise the ways ESS can operate as selling, purchasing and off-line mode (unused capacity which can be used for spinning reserve) to provide a variety of services in the ancillary services market, energy market and regulation market

[85]. Suazo et al investigate the techno-economic effects of ESS integration on the grid, with the Chilean Northern Interconnected Power System used as a case study [117]. Short term operation planning to provide energy arbitrage, primary, and secondary reserves in a centralised spot electricity market via stochastic unit commitment was analysed. The authors use two distinct models of evaluating ESS with one considering the price of energy as an external parameter that does not influence the market in which the price taker approach and optimisation was carried out for profit maximisation<sup>5</sup>[117]. The other valuation method in this study involved considering the influence of ESS on electricity market prices, i.e. on power system operation and shows the need to assess profit maximisation when there is a high amount of ESS on the grid.

Kazempour et al compare emerging and traditional ESS technologies by evaluating the maximum profits that can be made from either NaS or pumped hydro storage by performing self-scheduling [85]. The problem was formulated as a mixed integer non-linear programming (MINLP) problem and solved using GAMS. In Ref. [85] the authors state that in considering the operation capability of ESS in a self-scheduling problem, optimisation on a weekly basis is the best approach because one day is not enough to consider the optimal utilisation of ESS and one month is too long to forecast electricity prices. Dicorato et al develop a method based on a dynamic programming algorithm for planning and operating a wind energy plant with ESS to increase the operational value for the generator owner [79]. An economic feasibility study was carried out on the method which evaluates planning based on technical characteristics of NaS batteries with or without consideration of the electricity market, i.e. one or two staged planning process to determine the operation of the ESS at every hour. The technical planning stage considers limitations of the ESS, i.e.,

---

<sup>5</sup> This is classed as an approach where electricity prices are used as exogenous inputs and cannot be modified.

state of charge (SoC), power rating and energy capacity; and the market based planning considers forecasted electricity market prices.

Korpaas et al present a method for scheduling and operating energy storage for wind power plants in electricity markets using dynamic programming [78]. This study is based at transmission level and considers transmission constraints with the goal of enabling owners of wind power plants to be competitive in the electricity market. An operating strategy was developed that involved forecasting wind velocity, operation scheduling to determine the hourly power exchange in the electricity spot market that yields the most profit over a scheduling period, and an online operation following the hourly scheduling. Kahrobaee et al model a wind generation Compressed Air Energy Storage (CAES) system for the generation, storing and selling of electricity to the grid [118]. The authors evaluate the optimum short term operation and long term planning of the wind-CAES system to maximise profits for a generator on the transmission network using PSO.

#### **4 SUMMARY**

The literature reviewed shows that there is a lack of studies that consider the multiple benefits for both technical and electricity market applications on a T&D network. The studies reviewed focus their analysis either on network ancillary benefits or benefits in the electricity market for energy arbitrage or reserve and other ancillary services. However, research from the literature reviewed have shown that multiple benefit valuation is necessary for ESS to be a profitable solution.

Most studies reviewed are carried out using static demand and generation data (worst case assessments) or over a short term planning period (within an hour to a year) and do not consider different regulations and their impact on the operation of ESS. The studies simplify the dynamic aspect of the energy markets using fixed energy peak and/or off-peak prices for assessment and use small radial distribution network test models, which are good for proving that methods work but do not

reflect the situation on real and much larger distribution networks. The location and capacity of ESS selected during planning has a direct impact on the optimal operation that can be achieved. Likewise, the operating strategy of ESS will also influence the optimal location of ESS on a network. Studies reviewed revealed that the multi-objectives of planning and operating an ESS can be contradictory and impede or reduce the ability to achieve maximum benefits.

From the review, it has been shown that MOEA optimisation methods have been proven to be efficient and useful in power and distribution systems planning and operation. If MOEA methods are applied to the DN- ESS planning and operation problem, they can be used to present a set of optimal solutions (that satisfies both market and network ancillary services) to a DNO planner to make the final decision. ESS has been shown to be a viable solution if properly located, sized and operated to yield maximum benefits for the ESS owner. Although some benefits can be realised from ESS operation, the relatively high investment cost makes them unprofitable when compared with conventional network investments in the current market. This can only be addressed in the near term by aggregating multiple benefits of ESS, and in the longer term by also restructuring regulations and electricity markets. Hence the underlying question that needs to be answered is under what circumstances can ESS be more favourable than alternative investments in distribution networks?

In this research, methods are developed to plan and operate DN-ESS for the technical and commercial applications that provide the greatest financial benefits to DNOs and/or private ESS investors (third party stakeholders such as electricity generators). In doing so, government policies, current and hypothetical regulatory and electricity market frameworks are considered to develop possible scenarios. These developed scenarios are then used to conduct a sensitivity analysis value of DN-ESS on real UK distribution networks. Based on case studies, the research assesses if DNOs should invest in ESS as an alternative to conventional network investments and thus answers the question of whether ESS is a viable investment



alternative in distribution networks. To do this, the following activities were undertaken:

- Assessment of the network expansion planning problem for a test and real distribution networks in the UK based on future demand and generation predictions; and
- Analysis of different operating strategies for ESS using expert knowledge and developed algorithm for arbitrage, voltage and power flow management operations, and formulation of a DOPF problem to maximise active power dispatch from the energy storage (for energy arbitrage and balancing mechanism revenue) while maintaining the network within its constraints (minimising losses, maintaining voltage and power flows within the network limits). The DOPF problem is optimised using the NSGA-2 MOEA optimisation method.

Chapter 3 presents the test networks and the methods used to create load and generation profiles that will be used to develop future scenarios of demand and generation for evaluation throughout this thesis.

## Chapter Three: Distribution network and Energy Storage Systems modelling and Test Systems

---

### 1 INTRODUCTION

Chapter two discussed the high amounts of LCTs expected in the UK distribution networks and the need to plan in the short and long term for solutions that provide flexibility and that are economically viable. Chapter two also discussed the need for adequate planning using the right models and methods. Accurate modelling of networks, scenarios for future low carbon generation and demand, and solutions such as ESS will provide a solid basis for technical and financial assessment of the impact of LCTs and the effectiveness of ESS as a solution in distribution networks. This chapter presents the two distribution network models used in this thesis, which comprises a test network and an actual network in England. In order to capture the time-varying impacts and effectiveness of LCTs and ESS, the performance of these networks has to be evaluated using temporal load and generation models. This is because demand and generation LCTs will have different operating patterns based on customer demand, which varies by hour, day, week and season; and renewables generation, which is affected by weather in different seasons (for example, solar output is high in the spring and summer months and relatively lower in the autumn and winter months).

Deterministic and probabilistic approaches are used to generate the demand and generation data. For load modelling, the top to bottom approach involves using aggregated data to determine deterministic demand and generation across the network. In this approach, normalised datasets from published data and DNO data are scaled based on observed peak demand on the network under study to get the load shape and magnitude. This approach is used in the long term planning study on a real distribution network model. The second approach used in the probabilistic

studies involves a bottom to top approach. This involves using statistical distributions to create possible demand and generation profiles of individual customers across the network. This is then aggregated to make up total net network demand.

The modelled networks and methods used to generate current and future temporal conventional and LCT demand and generation profiles are now described.

## **2 DISTRIBUTION NETWORK MODELLING AND SOFTWARE TOOLS**

### **2.1 SOFTWARE TOOLS**

There is a wide variety of software use in academia and industry to model distribution networks and for load flow studies such as PSS/E, DigSilent and OpenDSS and IPSA. IPSA was selected as it is used by the partner DNO in the UK for operational and long term planning. IPSA as described in [119] provides the functionality to carry out load flow studies in the steady state using the fast decoupled load flow method to compute the power flows in a modelled distribution network. The studies carried out in this thesis makes use of IPSA for modelling the networks and Python to develop and run scripted automation, control and optimisation algorithms using time series demand and generation data with a half-hour time resolution. The Distributed Evolutionary Algorithm in Python (DEAP) optimisation package [120] was used to implement the NSGA-II multi-objective optimisation method which is described in Chapter 6.

Load flow studies are carried out on the model networks so that the following network parameters: real and reactive power losses, voltages and power flows above standard operating thresholds can be investigated. When voltages or power flows are reported, this is called an 'event' that is logged and may be used to trigger a control action.

## 2.2 MODELLED NETWORKS

Two networks with different configurations were used for studies in subsequent chapters. The networks studied were made duo of a test network and real network, both operating on the MV voltage level of 6.6 kV.

- All the networks are assumed to have only residential customers; and
- In order to maintain consistency, the After Diversity Maximum Demand (ADMD) is used to determine the number of customers on both networks.

ADMD is defined as the maximum demand per customer on a network as the number of customers on the network approaches infinity [121], which in practical terms can be described as the mean of peak demand for a collection of customers. It serves as a standard for describing peak demand and demand variation in an aggregated load profile. In the UK, the ADMD is derived from peak demand in a winter month. Richardson et al state a 2 kW ADMD is used by DNOs to represent residential households without electric heating [122]. Gozel et al mention an ADMD of approximately 1 kW for domestic customers without electric heat pumps [123]. The range of 1 – 2 kW will be used for studies in this thesis.

All time series automation of generator operation and OLTC operation, network demand and ESS operation in IPSA are scripted using Python. IPSA serves as software to build the network models and as a load flow engine. The default OLTC functionality in IPSA is used for establishing the base-case for assessments. This is then supplemented by a scripted OLTC algorithm in Chapter 5 which enables OLTC and ESS coordination. In Chapter 6, the OLTC operation is optimised using NSGA-II.

The key network components modelled in the network are:

- Load centre: modelled as a real and reactive power sink attached to a busbar on a network. This represents an LV network or multiple LV networks depending on the detail of the network model;

- Grid: modelled as a grid infeed which provides power at a voltage of 33 kV; this is stepped down from the Grid Supply Point (GSP) which is at 132 kV. The power from the grid infeed is then fed to the primary transformer which steps down the voltage to 6.6 kV. The grid infeed busbar also serves as a slack bus for the network. Figure 3-1 presents a breakdown of the voltage levels and highlights the area that studies in this thesis will concentrate on.
- Energy storage: this is modelled as a component that injects and absorbs real and reactive power, with time series controls and a system model that is operated based on limitations of maximum energy and power ratings.
- Generation: this is modelled as a generator component with time series control and profiles.
- Transformer: the rating, resistance and reactance and type of winding are specified. The OLTC requirements of maximum and minimum tap settings, nominal tap settings, target voltage, relay bandwidth and resistance and reactance for line drop compensation are also specified.
- Lines/Cables: The line impedance and ratings are used.

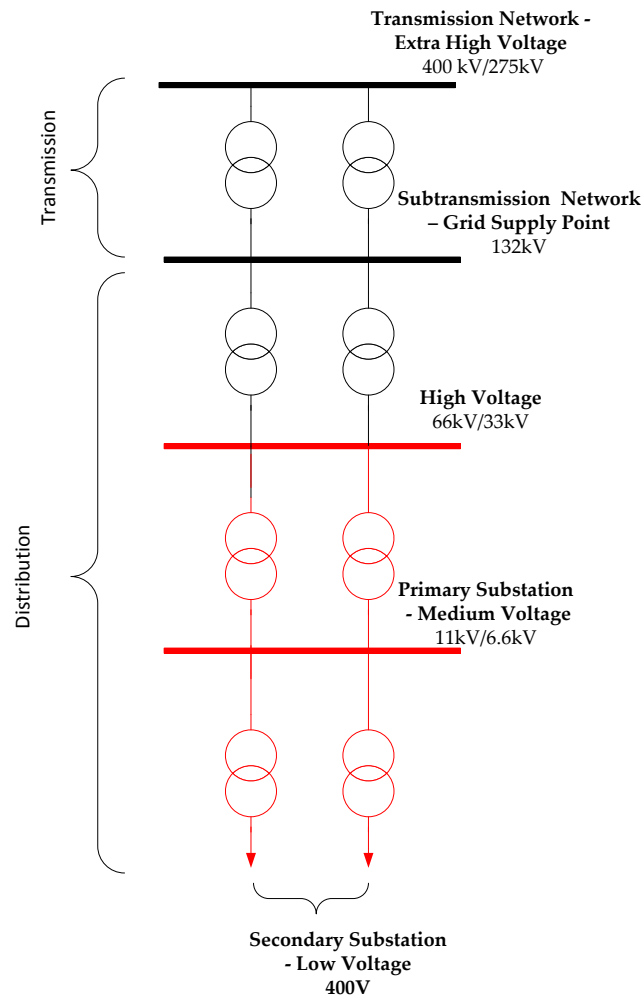

Figure 3-1: Voltage levels in the UK transmission and distribution network

### 2.2.1 IEEE 33 Bus Test System

Baran et al describe the IEEE 33 bus radial distribution test network used in this thesis [124]. A single line diagram illustration of the network from IPSA is presented in Figure 3-2 and the built IPSA model and network parameters are provided in the Appendix. The network has 32 buses with a peak demand of 4.4 MVA (3.715 MW and 2.3 MVar). The network was adapted by changing the voltage levels from a 12.66 kV (US MV voltage level) to a 6.6 kV network in order to be directly comparable with one of the MV voltage levels (11 kV and 6.6 kV) in the UK MV distribution network. The network has a 33/6.6 kV On-Load Tap Changing (OLTC) transformer connected to the grid infeed as shown in Figure 3-2. The transformer is

rated at 9 MVA (based on N-1 reliability requirements) and the OLTC has a tap range of 15% to 4.5% with 14 tap changing steps of 1.393%.

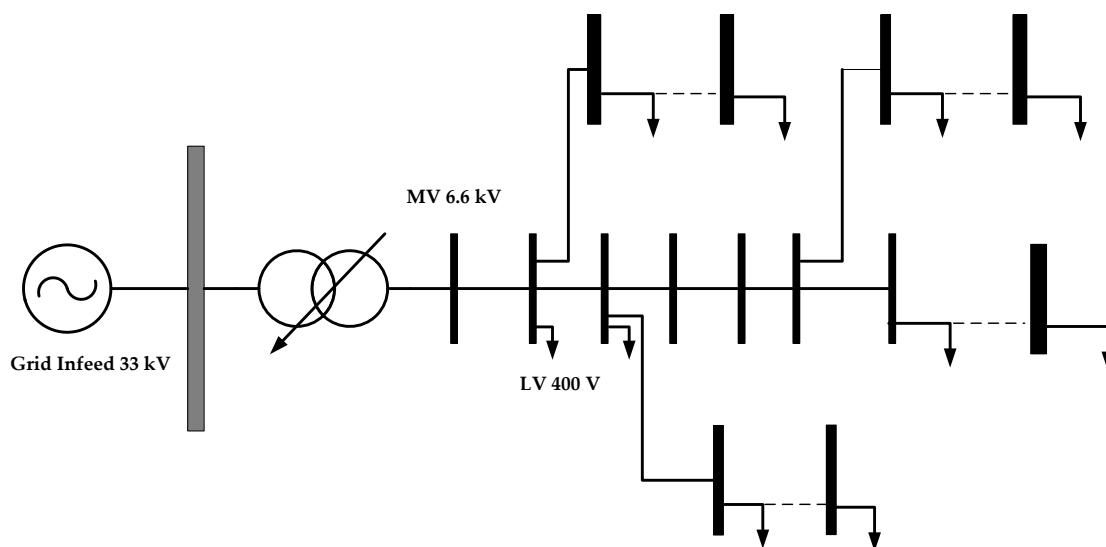

Figure 3-2: IEEE 33 bus test network

### 2.2.2 DNO Network

The second case study network used in subsequent chapters is a 6.6 kV radial MV distribution network located in the North West of England. The network is fed from the grid infeed via two 33/6.6 kV OLTC transformers rated at 10 MVA. The network model is made up of a feeder modelled in detail to LV with 57 busbars and 5 feeders with lumped loads representing a collection of LV networks. The feeder modelled in detail will provide a good understanding during load flow analysis of the impact of demand and increasing LCTs. The historical net total demand on the network was recorded as approximately 7 MVA. The OLTC used has a tap range of -15% to 4.5% in steps of 1.393% (14 tap steps). Figure 3-3 shows the case study MV network and an annotation on the figure that shows the feeder on the network that is modelled in detail, which also has a Land Fill Generator (LFG) connected. The LFG has a maximum power export of 0.4 MW.

Area of network with detailed model of 11 kV – 400 V networks

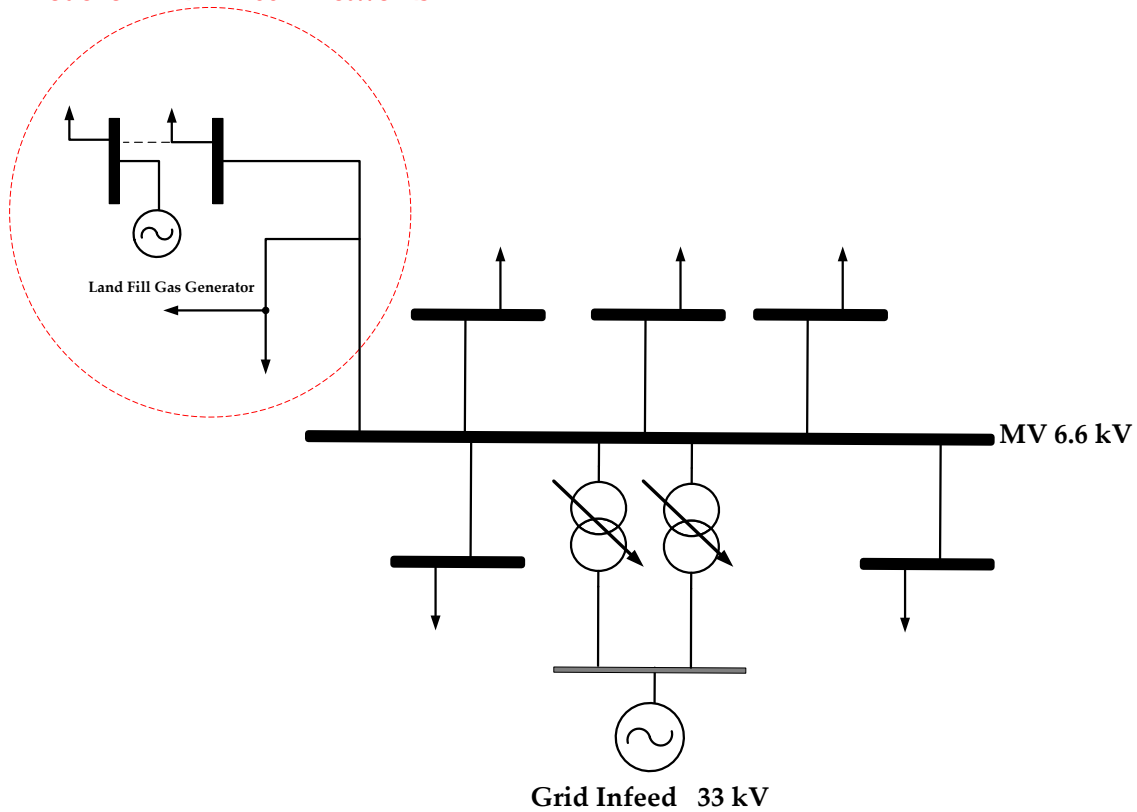

Figure 3-3: IPSA single line diagram of Elswick 6.6 kV network

### 3 LOAD AND GENERATION TEMPORAL DATASETS

#### 3.1 DNO METERED DATA FOR DETERMINISTIC STUDIES

##### 3.1.1 Demand from DNO metered data

The normalised demand data was created from the MV network meter readings from an 11 kV MV distribution network in the UK. There are seasonal variations in demand in UK distribution networks as illustrated in Figure 3-4 which shows a sample of the processed normalised one year demand profiles over different seasons. The demand on the network has a 57% load factor, which is the ratio of mean demand to peak demand on the network, over a year. This normalised profile over a year is applied to the UK case study network, to create a year demand profile.



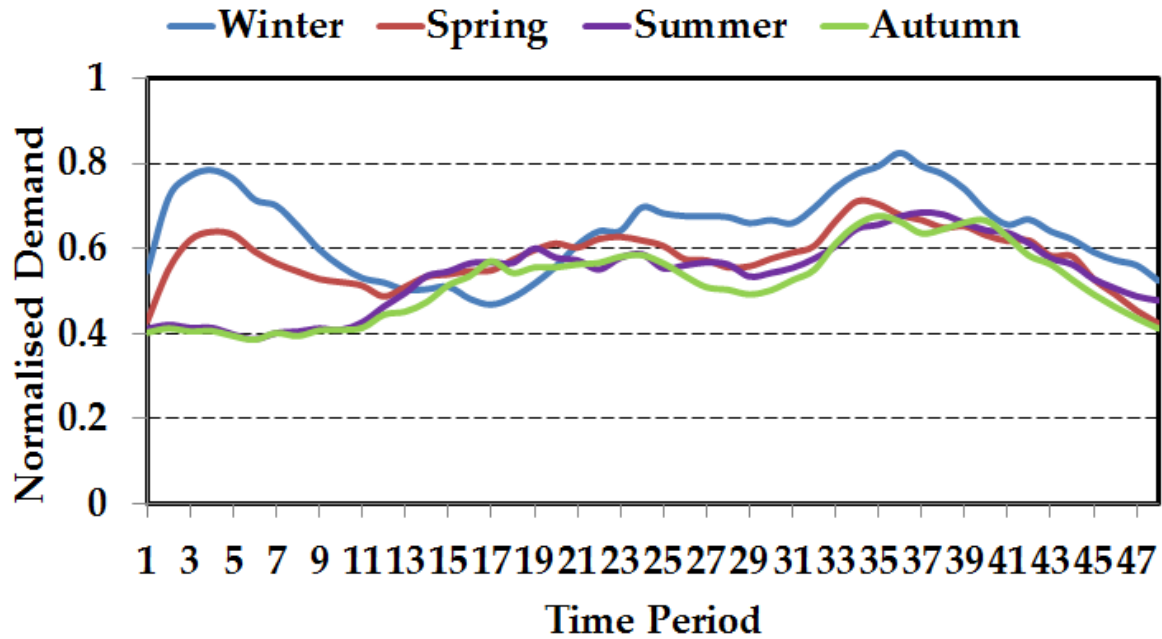

Figure 3-4: Sample of normalised seasonal demand profiles used in case study distribution network

### 3.1.2 HP demand from literature

The HP profiles were obtained from studies by Boait et al[125] on ground source HPs as illustrated in the scatter graph in Figure 3-5. Boait et al discuss the impact of domestic hot water heating and outside ambient temperature on the operation of HPs, this is reflected in the profiles from the HPs they study [125]. The HP half hourly profiles in the winter have a peak at midnight and between 8am to 9am. The highest peak of 1.4 kW is at midnight in the winter season. The HP profiles were assumed to be typical profiles of a HP in the UK, without considering the differences in air source HPs from ground source HPs. The profiles were added to the domestic demand profiles to create the total demand on each busbar and across the network.

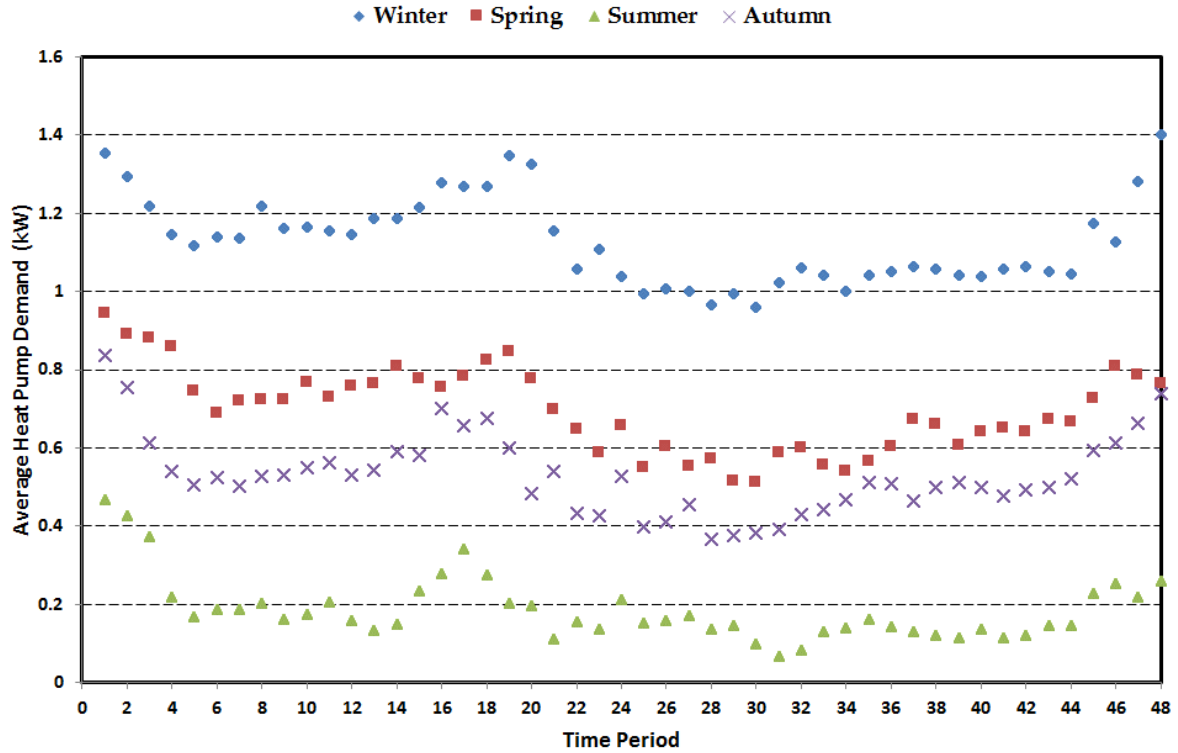

Figure 3-5: Domestic customer HP profiles used in case study distribution network

### 3.1.3 DNO Metered Generation Data

#### Generation from DNO metered data

LFGs often run at a fairly constant output if the fuel source is available and the cost to generate energy is profitable for the owners. The LFG profile used was obtained from measurements from a distribution network operated by Scottish Power Energy Networks in North Wales and shows a 77% capacity factor. The data from this particular network had periods of low or zero output and this could be for reasons such as maintenance or lack of fuel source. The normalised generation profile was chosen for LFG representation in the Elswick network, which has a LFG in the study carried out in Chapter 5. Figure 3-6 illustrates a sample from the normalised yearly LFG profile over four seasons.

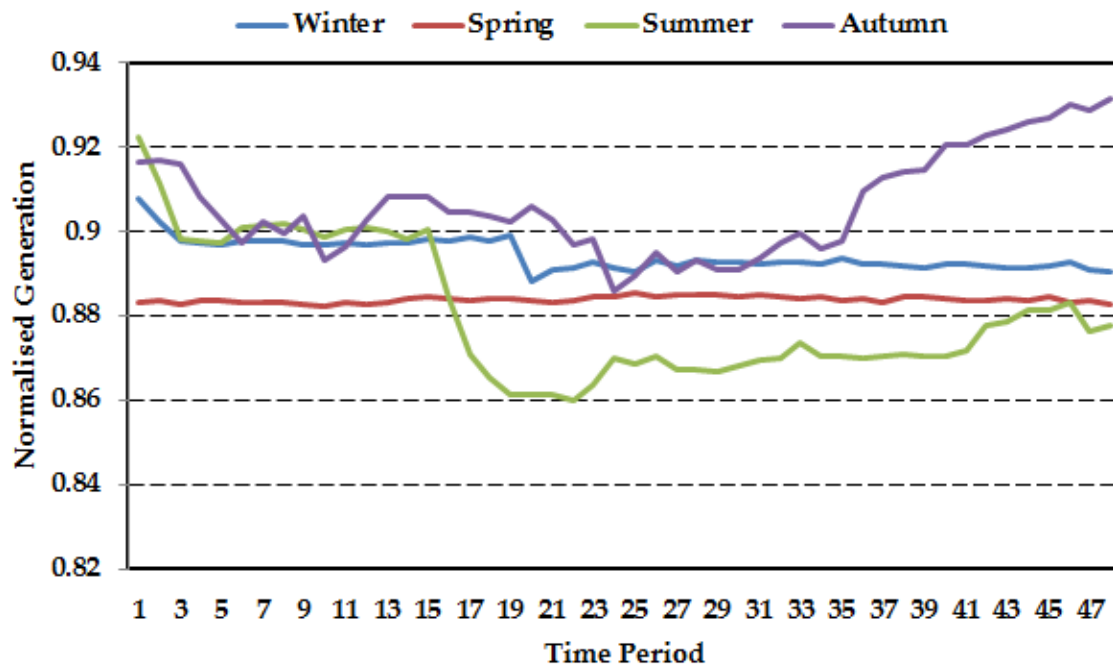

Figure 3-6: Sample of land fill generation normalised seasonal profile

UKGDS wind and PV data set

Normalised profiles for wind generation and solar PV were obtained from the UKGDS dataset [126]. An illustration of a sample of the normalised profiles over the different seasons obtained from the normalised yearly profile is shown in Figure 3-7 and Figure 3-8. These figures show the pattern of wind and solar generation from these standardised datasets representing typical outputs in the UK. From the samples illustrated, the profile for wind is not as defined as that of solar PV, which is predictable on most days with the magnitude of export affected by the levels of insolation, which is the solar radiation on the earth’s surface. The patterns from the PV output profile over a year will vary daily and over the seasons. From the illustration of the PV seasonal outputs from the normalised year profile used, it can be seen that high exports occurs in all but one season in the winter. The output of PV across the year is also affected by factors which includes cloud cover, PV orientation, technology type and overall weather conditions. This is the reason for the capacity factor of 10% for the PV output from the UKGDS dataset.

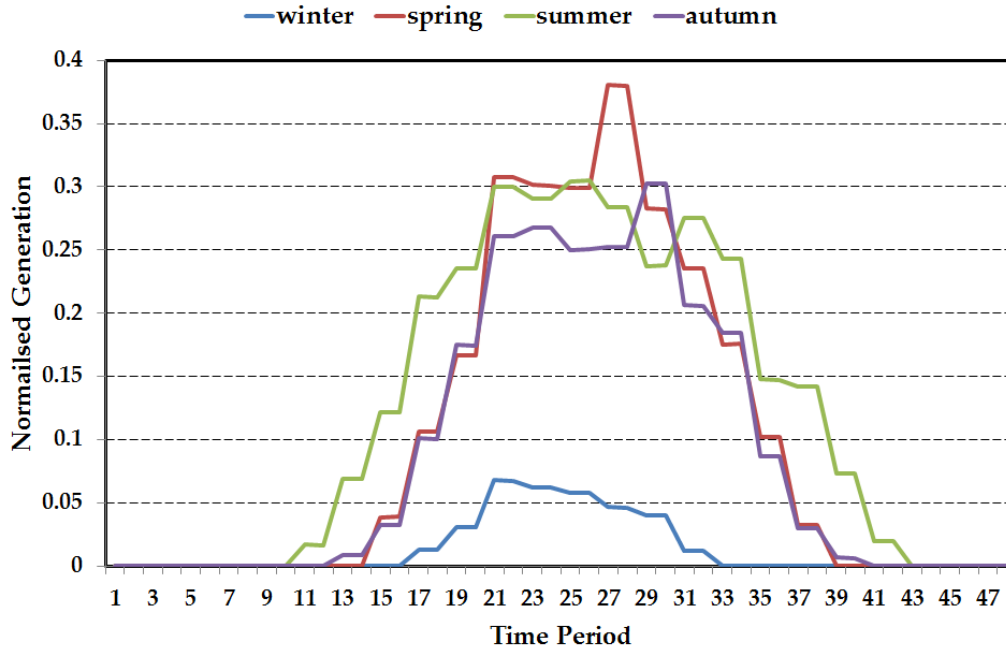

Figure 3-7: Sample of UKGDS PV normalised profile

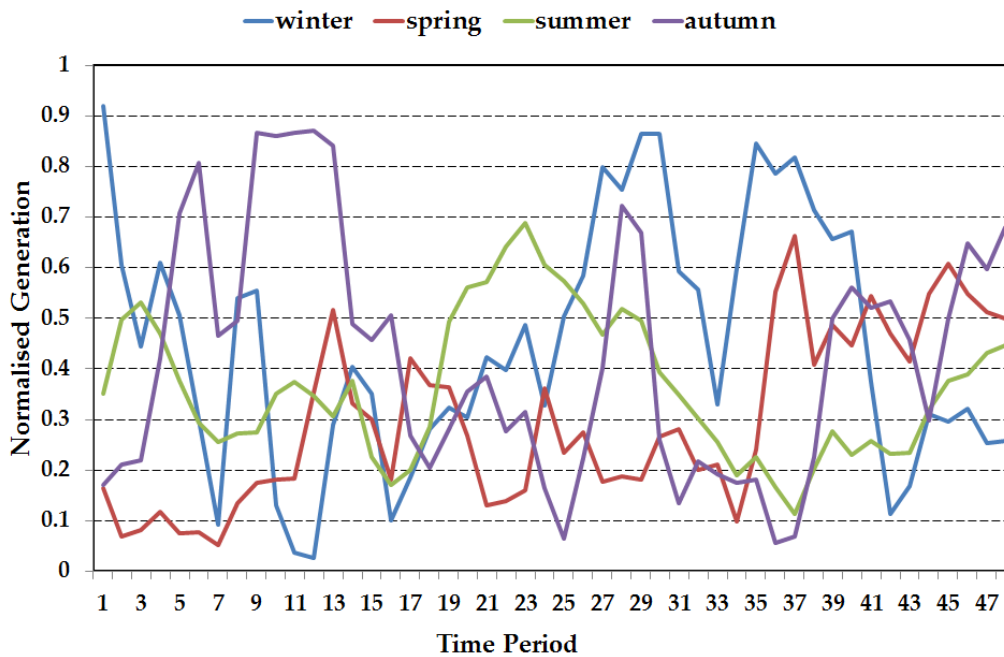

Figure 3-8: Sample of UKGDS normalised wind profile

The PV output is very different from that of wind, with more intermittent output all through the year. However, the operation is not affected by sunlight as wind blows all through the day hence wind generation has a higher capacity factor over a year. The capacity factor for the UKGDS data is 27% and from the sample of the wind

profile, the autumn and winter months provide the highest output over the day with the lowest output occurring in the summer.

These yearly normalised profiles for both PV and wind over a year were used as the basis for further analysis of the impacts of wind and solar on the case study UK distribution network in the medium term planning study of ESS implementation on a real distribution network carried out in Chapter 5.

### 3.2 DNO METERED DATA FOR PROBABILISTIC STUDIES

#### 3.2.1 CLNR Demand and generation data set

The demand and generation data used here was obtained from work carried out in [127, 128] and part of ongoing work to be published by Anuta et al titled “Planning and optimising the operation of energy storage under the uncertainty of low carbon technology contribution in an evolving distribution network”.

Metered data for HP demand, domestic demand and PV generation was collected as part of the CLNR project covering the four seasons in the UK. From the metered data, statistical distributions were created for each customer type, i.e. domestic customers, HP customers (domestic and HP consumption) and solar PV customers (metered generation). The distributions were created for each half hourly time period for both weekend and weekdays using the metered customer data for each quarter (season). Based on the Central Limit Theorem, the statistical distribution for a large grouping of customers  $N$  can be approximated by

$$y_{c,m,d,t} \sim N(\mu_{m,d,t}, \sigma_{m,d,t}) \quad 1$$

Where the random variable  $y_{c,m,d,t}$  represents the average demand of customer  $c$  at time  $t$  for each day  $d$  over a season;  $m$   $\mu_{m,d,t}$  and  $\sigma_{m,d,t}$  are the average half hour demand and standard deviation for a customer in a season  $m$ . To increase the random variables, the distributions are composed of each customer demand at time  $t$  for each day  $d$  over an entire season. The seasons are defined quarterly to represent autumn, winter summer and spring.

48 distributions (representing 48 half hours in a day) were created for each customer type (i.e. HP, domestic demand and PV) for each season. A distribution of power demand for each half hour instance, which excludes zero loads, showed a large positive skew with demands greater than 10kW resulting in the distributions not being normal as illustrated in Figure 3-9, which shows the statistical distribution in the autumn for urban customers in the weekday for every half hour through the day. The same trend was noticed for the HP domestic demand and solar generation distributions. This meant that some form of transformation had to be carried out on the data to restore the symmetry before the demand and generation output profiles can be created from the distributions. Log-transforming the group seasonal demand and generation distributions using natural logarithm allowed for a more symmetric (normal) distribution, which satisfies the approximation provided by the central limit theorem. An illustration of the 48 log-normal statistical distributions from the same dataset used in Figure 3-9 is illustrated in Figure 3-10.

Autumn weekday Urban demand (kW)

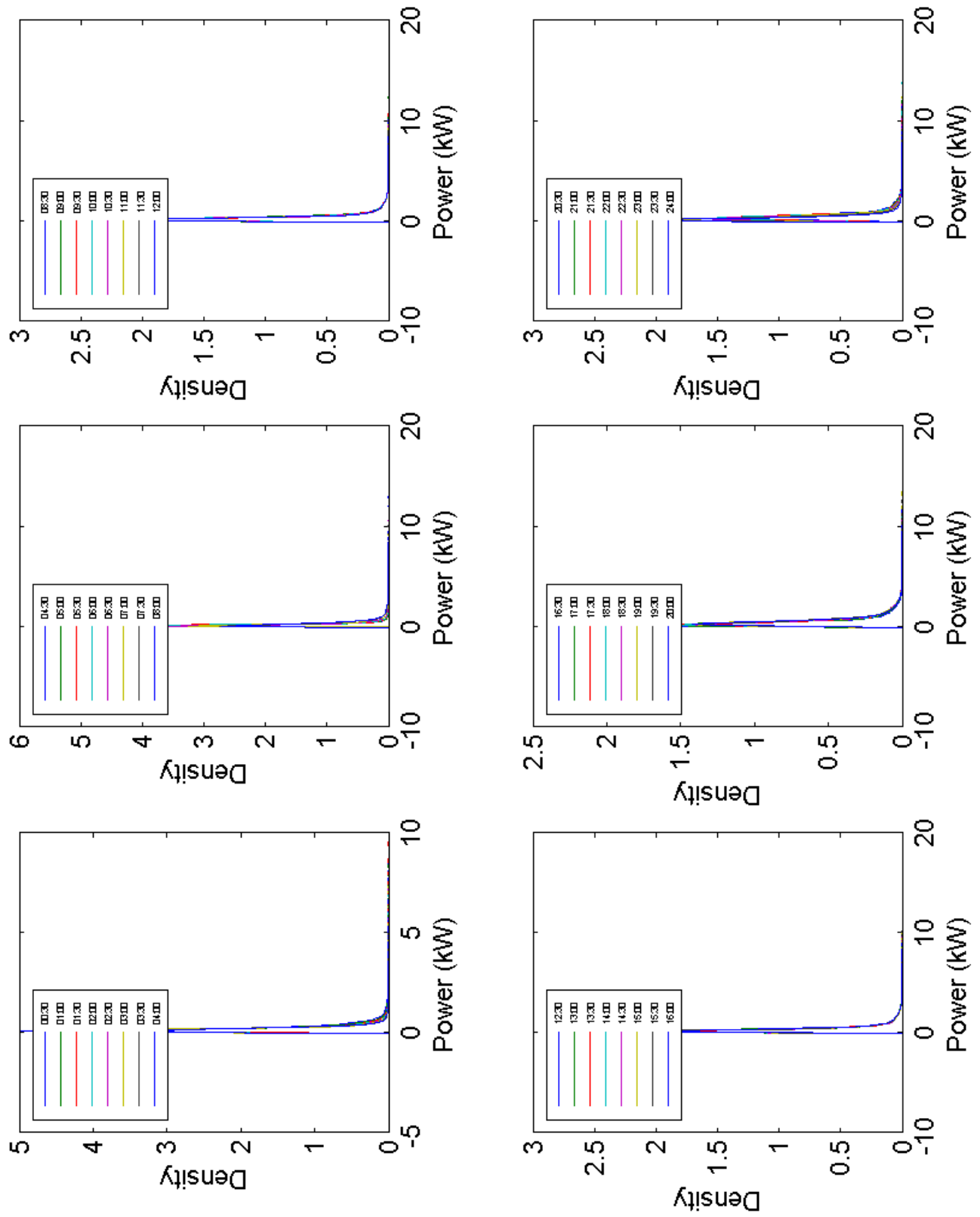

Figure 3-9: Positive skewed urban domestic demand statistical distribution for the autumn season

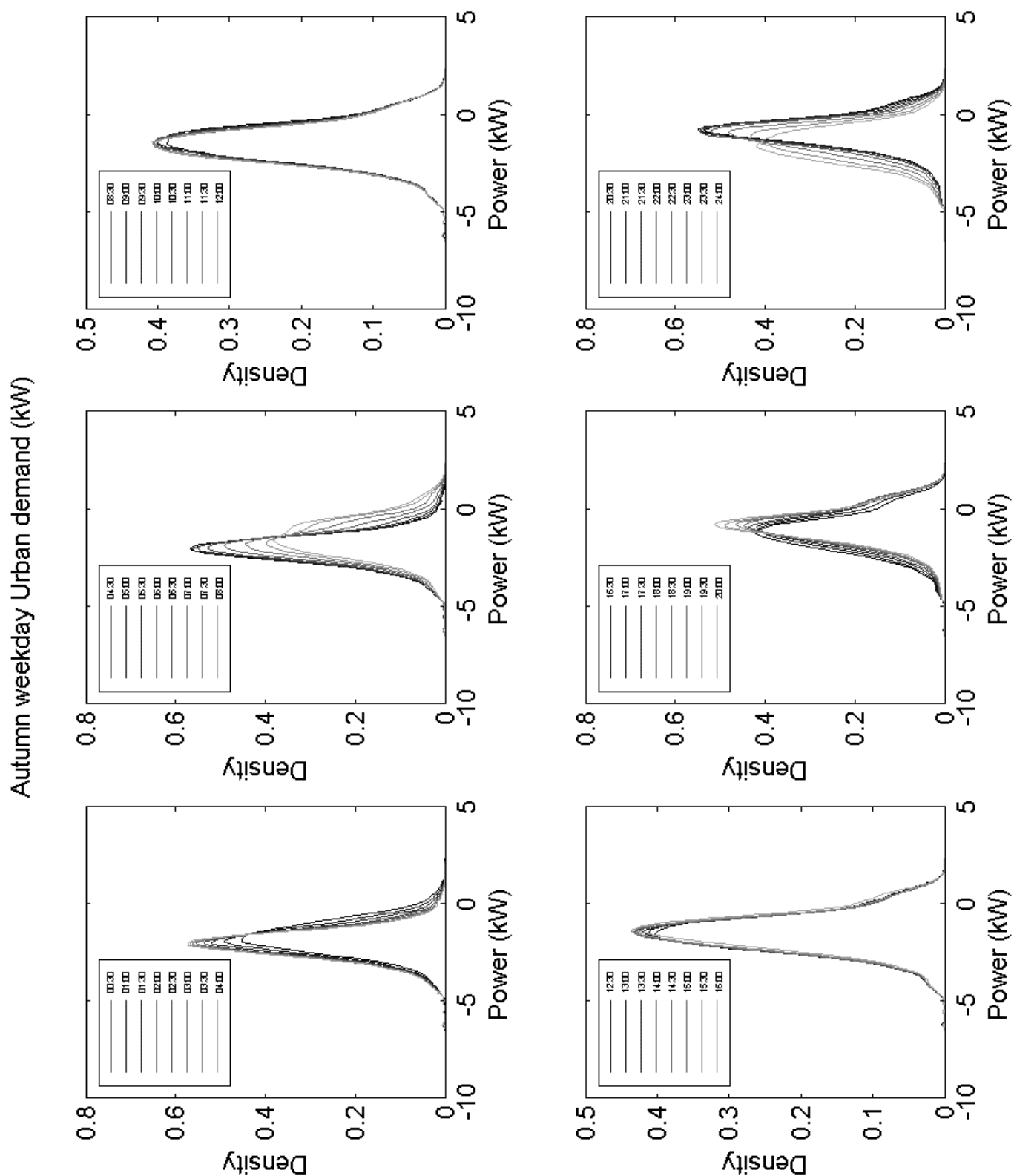

Figure 3-10: Log-transformed urban domestic demand statistical distribution for the autumn season



### 3.3 PROCESSING OF DATA

Demand on both networks is assumed to be only for domestic customers. For the IEEE 33 bus test network described in section 2.2, A 1 kW ADMD was used in estimating the number of customers on this network. The ADMD figure was chosen based on studies by Gozel et al [123]. The number of customers was then computed as approximately 3715, which [123] will then be used to work out the level of LCT demand and generation concentration required to meet the developed LCT concentration scenarios on each network. Appendix 1 provides the network parameters for the test network, which includes the real and reactive power demand on each busbar along with line impedances and length. This was used in building the model in IPSA.

For the Elswick network model described in section 2.2, since the available data for net demand is an aggregate, the ADMD can also be used to determine the number of residential customers across the networks. This was carried out by using the rounded up peak demand on each feeder with the assumption that they are rated at twice the peak demand following N-1 requirements. The total KVA rating of all transformers on the 6 feeders is 13.5 MVA. Assuming a 2 kW ADMD is used based on suggestions by Richardson et al on ADMD in the UK without electric heating [122]. This results in an estimate of 6750 domestic customers on the network.

Two sources of data have been used to model demand and generation on the model networks. In Chapter 5, for long term planning and financial evaluation, conventional and LCT demand and generation data was gathered from the UKGDS project [126] and from Boait et al [125] to create half hourly time varying demand and generation profiles used on the Elswick distribution network. In Chapter 6, medium term planning and short term operational planning studies (for ESS daily operation) were carried out on the IEEE test network that considered the stochastic nature of the location and operation of domestic demand, LCT demand and generation. For this, the statistical distributions discussed in section 3.2.1 in this

chapter were used with Monte Carlo simulations to create different conventional and LCT demand and generation profiles on the network. The two ways demand and generation is simulated on the two study networks is discussed below.

### 3.3.1 Top to bottom approach

This is aggregated demand and generation on the network created from normalised profiles. Normalised LCT half hour resolution profiles are scaled up to the peak real or apparent power measurements for the required demand or generation LCT on the network. The same approach is taken for conventional demand on the network with normalised demand scaled based on the peak demand seen at the primary transformer. Demand for parts of the network with lumped loads (i.e. load centres with aggregated LV networks to the primary) are calculated as the peak measured demand multiplied by the normalised demand at that half hour period. Likewise, generation is peak generation on a busbar multiplied by the normalised generation profile for each half hour period. For detailed modelled feeders, the peak demand at each half hour is distributed across the network to LV substations based on transformer ratings. For example a network with a total demand of 10 MVA with a 2 MVA secondary transformer situated along the network has a Load Ratio (LR) of 1/5 applied to the total feeder demand at that half hour period. The LR constant is computed for all busbars on the network based on their LV transformer MVA ratings  $S_{i,LV\_TX}$  and this is used to distribute the total load in each half hour  $t$ .

$$LR = \frac{S_{i,LV\_TX}}{S_{MV\_TX}} \quad 2$$

$$S_{i,t}^{LV} = LR \times S_{i,t}^{Feeder} \quad 3$$

Where,  $S_{MV\_TX}$  the apparent power rating of the primary transformer,  $S_{i,t}^{LV}$  is the MVA demand on busbar  $i$  on the feeder in a half hour period and  $S_{i,t}^{Feeder}$  is the MVA demand on the detailed modelled feeder at a half hour period.

### 3.3.2 Bottom to top approach:

Demand and generation profiles are created from typical domestic consumption and generation obtained from statistical distributions for each demand and generation type. These statistical distributions are created from measured data from distribution networks in the North East of England, discussed further in section 3.2. In this method, the demand and generation profile for the entire network is created by determining the number of domestic customers on the network and scaling the typical time varying profiles for HP demand, domestic demand and PV generation for one customer across the entire network. The generated profiles are then aggregated and the net temporal demand is simulated at the primary transformer.

A deterministic or stochastic method (Monte- Carlo simulations) can be used to extract the demand and generation for a user defined number of customers for each half hour based on the log-normalised distributions. Different confidence levels of the distributions based on the Z score ( $z_\alpha$ ), i.e. the probability of sections of the standard normal distribution that falls between the 5th and 95th percentile, are used at each half hour to create representative customer demand. In the stochastic method,  $z_\alpha$  is varied and constant  $z_\alpha$  is used for deterministic assessment.

For a busbar on a network we have  $n$  number of customers, if the half hourly demand of each customer can be approximated as normal out to the  $\alpha$ th percentile, the demand  $d_c$  for a customer  $c$  at a given time  $t$  is:

$$d_c = e^{(\mu+z_\alpha\sigma)} \quad 4$$

Where  $\mu$  is the mean of the distribution,  $e$  is the exponent, and  $z_\alpha$  represents the  $\alpha$ th percentile of the standard normal distribution for example, the 90<sup>th</sup> percentile for a two tail distribution,  $z_\alpha = 1.28$ . The percentiles represent the diversity in demand and generation across a busbar and network as a result of characteristics such as size of dwelling, occupancy patterns and customer social classification. An illustration of

urban customer autumn weekday customer profile generated from selecting different percentiles from the log-normalised statistical distributions is shown in Figure 3-11.

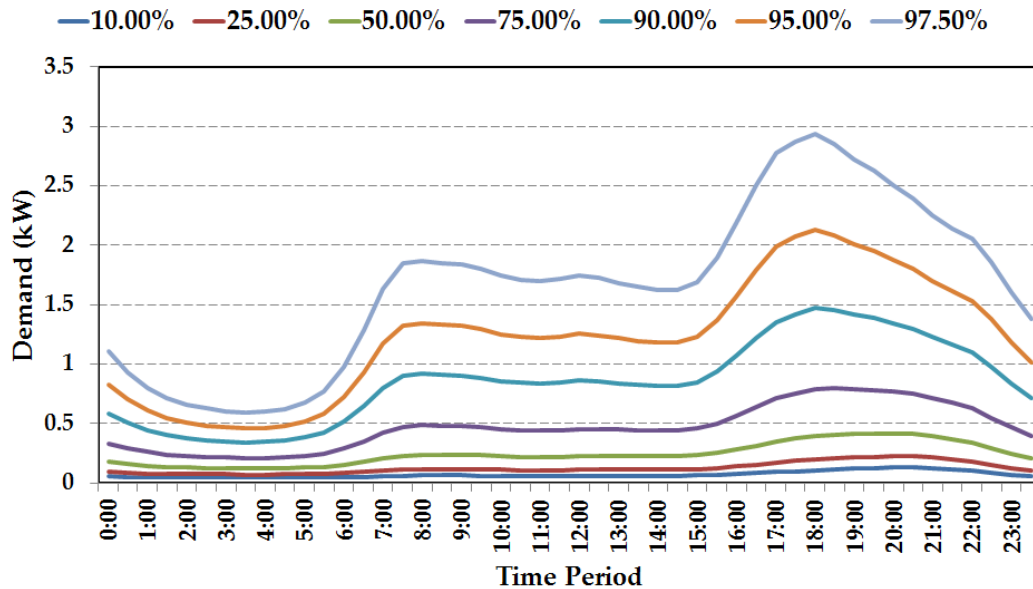

Figure 3-11: Winter weekend profile for an urban customer

This method is used in Chapter 6 and allows the stochastic nature of domestic and LCT demand and generation to be simulated.

#### 4 SUMMARY

The chapter presents the networks used in carrying out most of the studies in this thesis. It also describes the different sources of demand and generation data (primarily wind, PV, HP and domestic) and how profiles are created and simulated as daily demand and generation on the networks. The data used in the creation of profiles were obtained from the UKGDS; DNO primary substation metered readings and metered readings from individual customers through a large project investigating LCTs in the UK (CLNR). Data obtained from the CLNR datasets was used in creating distributions that will be used in deterministic and stochastic modelling of network demand which will be used in short term planning studies carried out in Chapter 6 that involves the optimisation of ESS resource for daily network and commercial benefits to DNO and third party stakeholders.

## Chapter Four: Regulation, markets and their impact on electrical energy storage systems in GB

---

### 1 INTRODUCTION

As discussed in Chapter 1, the planning and operation of ESS in electricity distribution networks is of interest to generators, T&D network operators, regulators and other stakeholders. Chapter 2 presented a review of research on the financial valuation and planning and operation of ESS in the power system and briefly touched on the impact of regulatory and electricity market structures on successfully implementing ESS. Regulatory and market structures, and government policies could serve as a boost or deterrent to the successful implementation of ESS on the grid. The success of ESS also hangs on the development of ESS technologies, public acceptance of the technology and the developments in the wider electricity system [59]. In this chapter, the deployments of ESS worldwide and some of the business models in use are discussed. Afterwards, a review of the policies, regulatory and market structures in countries with high renewable targets and/or high installation levels of ESS is conducted. This will provide an understanding of the common problems facing the rollout of ESS and the changes that have been made to remove limits and promote investment in ESS in countries where ESS was identified as a major asset in the future grid. Suggested updates on policies and regulatory and electricity market frameworks are established based on the lessons learned from the investigation in this chapter. An understanding of the changes that need to be made to regulatory and electricity market frameworks provides the basis to investigate different hypothetical scenarios of ESS ownership and business models in Chapters 5 and 6.

The work in this chapter led to the publication titled “An international review of the implications of regulatory and electricity market structures on the emergence of grid

scale electricity storage” [61]. The outputs from this chapter help to break down the current obstacles and what changes are being made.

## **2 REGULATION AND THE ELECTRICITY MARKET**

The current regulatory and electricity market structures will need to be revised as the deployment of renewables and LCTs increase in electricity systems that were not designed for them. Solutions that can enable more renewables such as ESS are at present limited by the regulatory and market environment, particularly in unbundled electricity systems. As ESS technologies are novel and expensive, the lack of enabling policies, regulations, legislation and electricity market rules will limit investment in ESS as a result of the higher risk they present to investors. The high risk raises investment cost which goes against one of the objectives of unbundling, which is to drive down consumer costs. The limited operational experience of using ESS (excluding PHS) on the grid has led to few changes being made to regulation and the electricity markets and inconsistencies in policies or a lack of policies supporting the use of ESS.

In countries where there is vertical integration, ESS is easier to implement for a variety of services in the electricity market and to support the grid. Vertically integrated utilities are able to decide on the best investment strategy for using ESS to meet their requirements as a result of the visibility they have with exposure to all parts of the electricity system from generation to customers. Contrarily, the applications and resulting benefits from ESS in an unbundled system are more difficult to implement and determine because of the different goals, practices and regulatory systems in place for different stakeholders. An EU report surmised that the benefits an ESS owner gets from providing competitive services are not enough in an unbundled electricity system to be cost-effective [129]. Section 2.1 and 2.2 provides a background on regulation and the electricity markets.

## **2.1 REGULATION OF THE POWER SECTOR**

Deregulation was introduced in the electricity system to drive competitiveness, improve the quality of service and drive down the costs for customers [130].

Deregulation leads to liberalisation of the electricity sector, whereby competition is introduced and investors worldwide are allowed to participate in a countries electricity industry. Whilst deregulation and liberalisation of the power sector has increased globally from its start in 1982 in Chile [131], there are still other countries with partially liberalised markets and vertically integrated state owned utilities, for example China, India and Brazil [132-134].

Unbundling is usually practised in restructured and deregulated electricity systems, for example in the EU as part of the directive European directive 2003/54/EG [135]. Here, power transmission and distribution networks are regulated and operated as network monopolies while electricity supply and generation are operated competitively [136]. In an unbundled system, regulation of the T&D network serves as a means to provide a return on investment to the T&D operators, improve network efficiency check exploitation which could result due to lack of competition and drive down the cost of electricity to customers [61]. Unbundling is also seen as a major step in the development of a competitive electricity market [137]. An example of the forms of regulation that are currently being used or that have been used in the past for services with infrastructure are rate of return, cost of service, price cap, revenue cap, yardstick regulation, performance standards, and earnings-sharing [138]. Most regulation in the electricity sector applies ex-ante regulation where the regulator determines the price or revenue a utility is allowed to make over a regulatory period, and the regulated industry is aware of the decision before the beginning of a regulatory period [138]. This enables utilities to plan for the use or upgrade of their infrastructure over the regulatory period. Tariff charges to customers are based on regulation of the network company costs, which is primarily made up of capital investments and operating expenses [139].

## 2.2 OVERVIEW OF THE ELECTRICITY MARKET

The wholesale electricity markets are operated either as centralised market (power pool or power exchange) where price and volumes of generated electricity are matched to real-time demand and supply or as a decentralised market, where contracts are made bilaterally without matching the demand and supply [140]. In the power pool or single buyer market operation, generators offer prices for electricity based on an already determined variable cost (i.e. cost based pool), or based on prices the generators are willing to offer. This then forms a price-quantity pair for electricity supply. The market operators then centrally dispatch the generators based on forecasted demand in a one-sided pool. In two-sided pools, generators are centrally dispatched based on a demand curve created from price-quantity bids from buyers participating in the electricity market [140]. Here trading can be done in day-ahead, intra-day or close to real time, i.e. five minutes ahead [140].

The bilateral contract market model involves generators operating based on self-dispatch mode. Electricity buyers and sellers enter into bilateral contracts for the supply of self-dispatched electricity based on future delivery. Long term contracts are made in weeks up to years for delivery of power. In this model, the differences in contracted volumes and outturns mean that the system operator (party in charge of balancing the grid) will have to balance demand and supply. More advanced markets for the system operator will be a balancing (energy) market, which will allow markets settlement prices to be set based on the imbalances on the grid. From this, the system operator will agree on generator or supplier contracts to buy and sell in this market to balance the grid. Barros et al discuss a voluntary power exchange or spot market which is a short term market (day ahead and intra-day trading) set up by market participants in a market with a bilateral contract mechanism [140].

Countries such as Germany, Norway, Denmark and the UK implement this market model. Due to the minimal amounts of storage on the grid, demand and supply is not balanced and apart from the balancing markets, the ancillary services markets is also setup to provide the means for a grid/system operator to purchase other



services to maintain stability of the grid. Such services include spinning reserves and frequency regulation, reactive power for voltage regulation and blackstart.

Countries such as the UK have a competitive retail electricity market, where suppliers buy electricity from the wholesale market via bilateral contracts or through the power exchange, and sell to consumers. The consumers are also allowed to switch suppliers to those offering the most competitive prices for their service.

High electricity prices in the wholesale market generally reflects lack of supply to match the demand on the grid and a low or negative price reflects excess supply.

The result of liberalised electricity markets is volatility in electricity prices as it relies on competition [141]. Vertically integrated utilities can pass down the impacts of volatility in terms of costs to consumers but in a liberalised electricity system, all risks and cost impacts associated with volatility also affects the stakeholders [137].

The increase in volatility is caused by the impact of demand and supply, economic and operational factors [142], and a growth in renewables which are non-dispatchable and weather dependent. Stan discusses the impact of deregulation on increasing the volatility of electricity prices [143]. The mechanism of capping electricity prices has been used by regulators as a mechanism to reduce electricity price volatility and the risk it presents to market participants. A report by the IEA discusses the impacts of volatility and states that price caps are justified for economic purposes but can lead to negative consequences such as distorted market price signals, market slow down, and impact on long term investment [137].

## **2.3 ENERGY STORAGE DEPLOYMENTS AND BUSINESS MODELS**

### **2.3.1 Energy storage Deployment worldwide**

There is a rise in research, development and deployment of ESS worldwide. In 2012, there was a reported 665 deployments of ESS worldwide estimated at 152 GW [54]. Figure 4-1 illustrates the worldwide storage capacity by region with PHS making up 99% of ESS deployments and other, non-conventional, technologies such as batteries and flywheels making up the remaining 1% deployed worldwide.

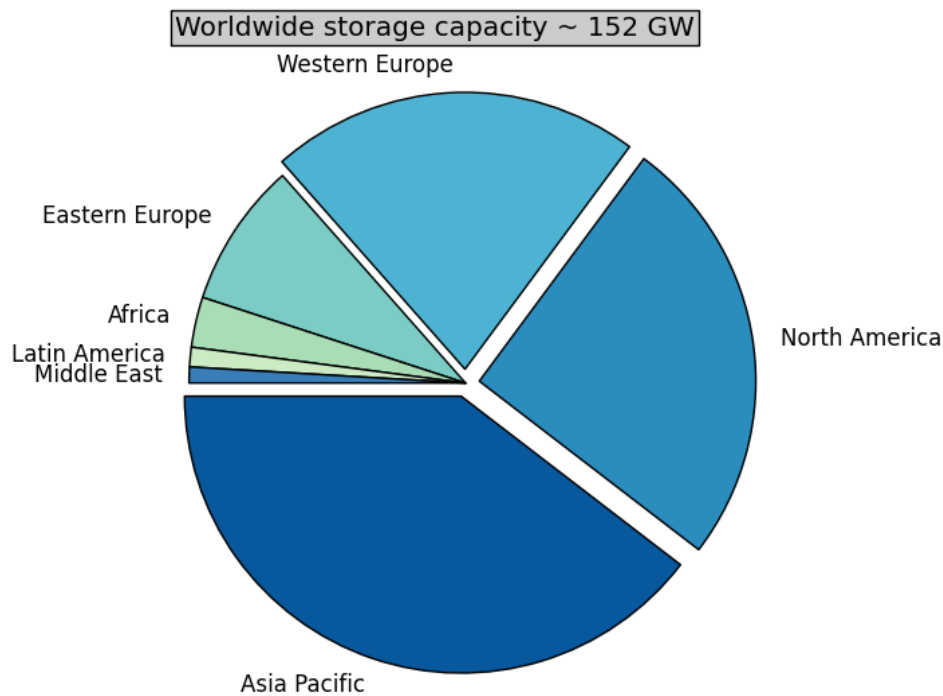

Figure 4-1: Worldwide energy storage capacity by region (data source: [17, 51])

### 2.3.2 Energy storage business models and ownership types

Implementing the right business models is important for enabling the deployment of ESS on the grid. Business models that use ESS for limited applications often affect ESS viability. In these cases, ESS cannot compete with conventional solutions due to the higher costs they add to capital intensive T&D networks or renewables deployments. Business models are determined by the end-services required and the market and regulatory frameworks in place, which will determine the ownership type and revenue streams for the ESS [75, 144].

In a deregulated and unbundled electricity system, the business models can be classed as competitive (or deregulated) business model, the regulated business model, or a hybrid of both models. The different models are discussed below:

1. Competitive business model: ESS operated using the competitive business model participates in the wholesale electricity market. The revenue streams in this model of operation are not guaranteed as they are affected by the changing electricity prices or price of other electricity products (e.g. frequency response), which are competitively tendered. The change in electricity prices

as a result of policies, regulation and economics was discussed by Vasconcelos et al [75]. Relying solely on this model for ESS operation could be further affected by the growth in renewables spearheaded by government policies, which adds to the volatility of market prices. This could provide an opportunity for profitability but adds to uncertainty of quantifying revenues. Renewables could also depress market prices depending on the concentration of renewables on the grid and their participation in the market as they have a zero marginal cost of operation compared to conventional generating plants. This reduces the ability for ESS owners to be profitable as prices drop and the spreads between peak and off-peak prices also reduces. Germany provides a good example of a country suffering from price volatility and depression; this has led to a drop in net income for its utility companies operating baseload (fossil fuel and nuclear) generation [145]. Under this model, the quantification of revenues is difficult for investors as a result of all the uncertainties.

2. Regulated business model: The ESS is operated in this model based on contractual terms for provision of grid support services for regulated utilities. Examples of such services include voltage control and asset peak shaving. If regulation permits, the revenue stream for the utility that owns the asset is guaranteed from asset deferral benefits and also cost recovery from the regulated asset. This reduces complexity of quantifying the benefits over a long period.
3. Hybrid business model: In this model, ESS is operated to provide regulated and competitive services. The order of operation here would be set based on the most profitable service at any particular time. If the ESS is used to provide regulated services, the remaining capacity can be used competitively. The drawback here is that the regulated utilities have control and priority over use of the ESS for grid support services during the contracted period. Therefore the availability for competitive use in the electricity market would not be guaranteed for the ESS owner, if it is owned by a third party. There may also be complications if the ESS is used competitively in the electricity market as

there could be conflicting requirements for time and capacity for use both competitively and for other network (grid support) services. Quantification of revenue streams is more complex here but if the model is well implemented, this model could provide the most revenue and profit for an investor.

The ownership types that can dictate the business models can according to Pomper et al be categorised under five types: merchant providers, transmission system operators, distribution system operators, customer group and contract storage operators [146]. A description of the ownership types and business model/revenue streams is shown in Table 4-1.

| <b>Owner Type</b>             | <b>Description</b>   | <b>Revenue Stream</b>   |
|-------------------------------|--|---|
| Merchant providers            | RES and non-conventional generation providers or ESS owners who provide storage services based on market prices or power purchase agreements to different customers.   | Use ESS for competitive operations. Services provided based on market prices to different customers.  |
| Transmission System Operators | Owners and operators of transmission infrastructure. They may provide transmission only services (Regional Transmission Operators in the US) and/or transmission services and market based services (National Grid in the UK). | Use ESS to assist and improve transmission services with the ESS implementation cost recovered based on regulatory conditions. Depending on regulation, they may or may not be able to use ESS to provide services in the electricity market. |

|                               |  |  |
|-------------------------------|--|--|
|                               |  |  |
| Distribution System Operators | Owners and operators of distribution network infrastructure.   | Use ESS to assist and improve distribution services with costs recovered based on regulatory conditions. Also depending on regulation, they may or may not be allowed to provide services in the electricity market. |
| Customer group                | Electricity suppliers or ESS providers who use a collection of end-user ESS (via contractual arrangements) to provide cost savings to customers, and for grid/market related services.                           | Utilise aggregated ESS from customers or other stakeholders to provide electricity market services or regulated services to T&D network operators.   |
| Contract storage operators    | Third parties that only lease ESS services to generators, T&D operators, suppliers or consumers. They do not control the operation and its use on the grid. Operation will be based on the client's instruction. | Provide ESS facilities based on instructions from clients for regulated or competitive services with revenues derived from contractual agreement.  |

Table 4-1: ESS ownership types and revenue streams [75, 146]

### **3 POLICIES, REGULATORY AND ELECTRICITY MARKET ENVIRONMENT**

This section presents the key policies, and the regulatory and electricity market environment that affects ESS investment in the EU; the United States in the Americas and Japan in Asia Pacific.

#### **3.1 THE EU**

European investment in ESS makes up 20% of the market for ESS worldwide [54, 144, 147]. An European Union energy technology plan and policy was set up to enable the EU transition to a low carbon economy as part of plans by the EU to reduce greenhouse gas emissions by 95% compared to emissions in Europe in 1990 [148]. Figure 4-2 illustrates the high growth in electricity demand met by renewables in the EU between 2005 and 2013 and Figure 4-3 depicts the 2020 EU renewables target where a high proportion of electricity consumption is expected to be provided by renewables, reaching up to 70% in Austria.

The lacking performance and high cost of ESS technology was cited by the EU as an inhibiting factor in the deployment of ESS [149]. Consequently, the EU plan includes research, development and demonstration activities of ESS to enable improvements in performance, growth and commercialisation of ESS technologies to increase levels of deployment [59, 149]. However, in general the market and regulatory environment does not support ESS, and it is deemed there is a lack of alignment of policies on ESS within the EU member states.

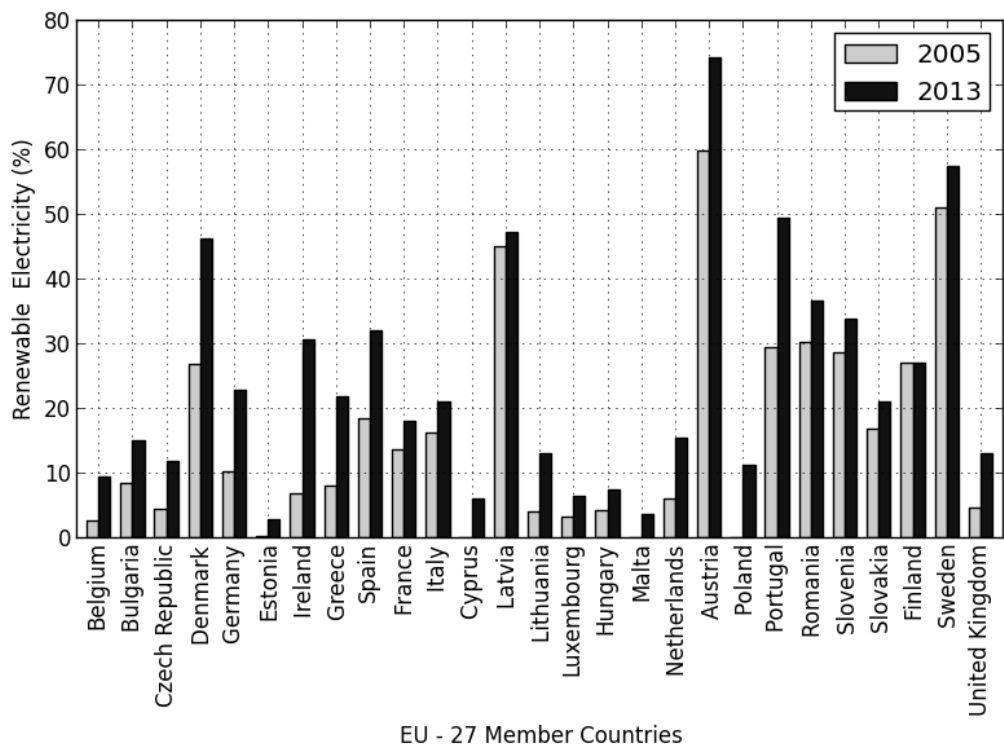

Figure 4-2: Growth in demand met by renewables between 2005 and 2013 in the EU (Data source: [150]).

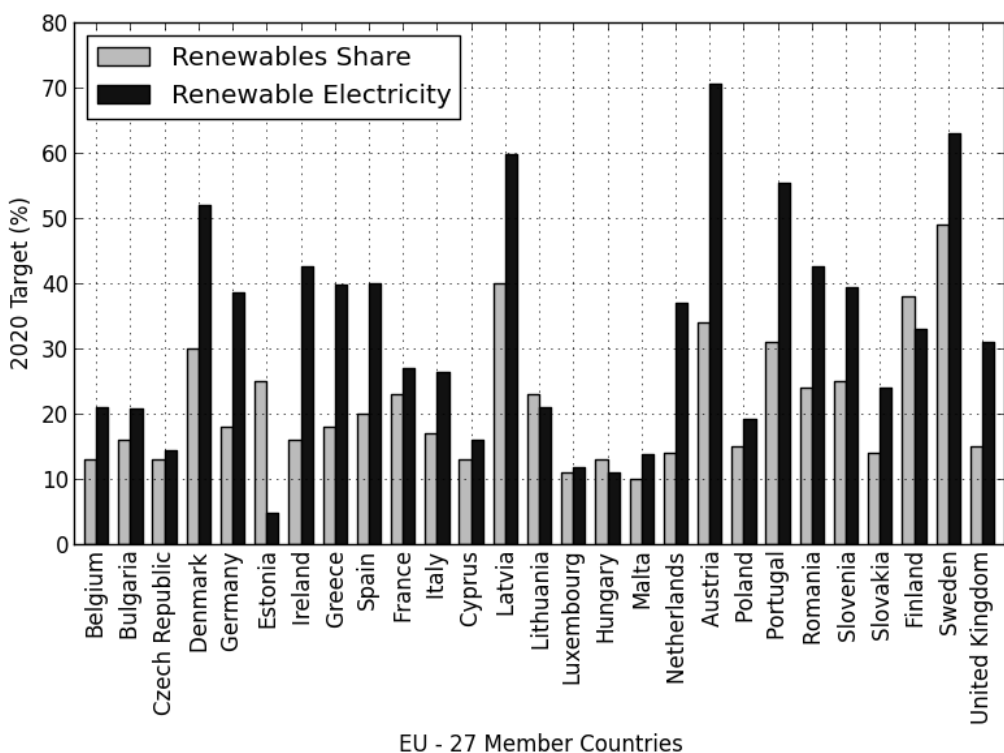

Figure 4-3: EU renewables target for renewable generation and demand met by renewable generation in 2020 (Data source: [150]).

There are different rules governing the electricity and balancing markets of EU member countries limiting cross border interaction which means returns from investment in ESS technology will mostly have to be recouped from within the country ESS assets are located [151]. In terms of targets, plans and policies affecting ESS use, the following are some major findings:

- There is a push for increase in research, development and demonstration activities of ESS to meet performance objectives of ESS materials and drive down ESS costs;
- Price driven mechanisms for renewable energy generators using schemes such as Feed-in-Tariffs (FiTs) do not provide the incentive for renewable generators to control power exported to the grid, regardless of the impact this has on the grid or the electricity market;
- A target was set by EU-27 countries to increase the PHS installed capacity by 40% from levels in 2010 [152];
- The policies for ESS in the EU are not aligned.

The following are the key discoveries on the directives, legislation and regulatory environment in the EU:

- In the provision of system flexibility and security of supply, ESS is not specified as an asset to provide such services;
- In EU Directive 2009/28/EC, ESS use in future electricity networks to support RES integration in T&D network was stated, most of which is from traditional ESS technologies, i.e. PHS [152-154].
- The nature of the legally unbundled electricity, which is part of the EU directives prevents network operators from owning generation asset and engaging in competitive activities in the electricity market [155]. ESS falls under the category of a generation asset;



- Most schemes introduced to support growing renewables and to meet future capacity requirements, for example the capacity mechanism in EU member states mainly supports peaking generation technologies [156];

### *3.1.1 The case in the UK*

Policies and plans have been set by the government to enable the UK reach its target for 15% electricity from renewables by 2020 and for increased electrification of transportation and heating by 2030 [9]. However, there are negative perceptions of ESS use in the UK due to unsuccessful ESS projects such as the pilot flow cell battery trial carried out in 2001 that failed as a result of technical issues and was decommissioned in 2003 [157]. ESS, interconnection and DR are seen as crucial technologies in enabling the UK transform its electricity system by 2050 [9].

However, the role of ESS in the future grid is not explicit. There are no regulations supporting the use of ESS. The regulations in place actually hinder the use of ESS by T&D network operators, as a result of the dual functionality of ESS (generation and demand by discharging and charging). ESS is considered as generation under regulation and ownership of generation, including ESS technologies, by T&D network operators is subject to approval and restricted to a maximum power capacity of 10 MW or 50 MW if the declared net capacity is less than 50 MW [158]. The upper 50 MW limit is on the basis that the maximum power capacity of the ESS or generation owned by the T&D operators, including system efficiency losses and consumption by auxiliary components is less than 100 MW [158].

Taylor et al identify the limitations of using ESS for balancing and improving system reliability in the transmission network as the high capital cost of ESS, low renewables penetration, and high grid charges regardless of the benefits ESS provides [59]. EA technology cite the conservative nature of stakeholders in the power sector and the likelihood of power systems stakeholders contending for conflicting ESS services as the two major challenges affecting ESS use in the UK [159]. A report by the Energy Research Partnership in the UK, cite the narrow spot market gate closure time and the robustness of current T&D networks as factors

making ESS non-viable as a system wide solution [160]. Policies, which include the Renewable Obligation Certificates (ROCs) and FiTs allow renewables priority access to the grid and compensate renewable generators based on export to the grid regardless of the state of the T&D networks or the electricity market.

ESS is not considered as a regulatory asset for network or system operators and therefore they cannot recover costs for investing in ESS to provide services on their networks. This means ESS is not considered amongst other conventional measures when networks need upgrade or reinforcement. This affects DNOs in the UK who will need to be able to curtail DG, reinforce or upgrade their network assets to ensure quality and security of supply. ESS, much like DG can provide deferral and security of supply benefits but while DG is considered as an asset for security of supply as part of the ER P2/6 standards as a non-network solution, ESS is not considered in this light [95]. Furthermore, the DNOs are not required to actively manage the distribution networks or provide demand response services as the system operator in the UK (National Grid) is solely responsible for balancing the grid [159, 161]. This represents a conflict as LCTs going into the distribution networks, will change the way the grid is balanced due to bidirectional power flows and their stochastic nature. These changes will require active management by the DNOs to reduce the impacts they may have and enable a higher proliferation of LCTs. To reduce regulatory restrictions, Ofgem updated the price control regulation for network operators to the RIIO framework with a focus on innovation, long term planning and increased flexibility to allow transition to future low carbon networks based on the government's policies [53]. This will allow T&D operators consider cost effective and innovative technologies such as ESS when upgrading or reinforcing the network for the future.

### ***3.1.2 ESS support in other EU member countries:***

In Germany, PV proliferation is high with PV contributing 6.1 percent to the 31 percent of gross electricity consumption from renewables in 2014 [162]. Subsidies

have been set up to promote the development of ESS use in small to medium sized PV with a power capacity of up to 30 kW connected to the grid [163]. Germany currently has the largest amount of PV with residential storage in the world [164]. Other policies, regulatory and market changes made include:

- While old PHS plants are liable to grid charges, new PHS plants and expansions, and other ESS technologies are excluded from paying grid charges for 20 years [165, 166].
- An update to Germany's Energy Act allows all ESS technologies to participate in the control energy (reserves) market [165, 167].
- ESS providing electricity from renewables are excluded from electricity consumer taxes and as part of regulation, grid system operators are required to pay power system stakeholders who feed stored power from renewables [129, 168].

Italy with a 17% renewables target is one of the countries in the EU with a great increase in renewables in the distribution network [153, 169]. As part of changes to regulation in Italy, the Transmission System Operators (TSO) and Distribution System Operators (DSO) are allowed to own and control ESS, if they are evaluated as the most financially viable solution to solve problems identified on their networks [151]. However, the revenue obtained from ESS investment is limited to the revenues that will be gained from savings on the cost of an alternative solution.

### **3.2 VERTICALLY INTEGRATED ELECTRICITY SYSTEM IN ASIA-PACIFIC - JAPAN**

The power generation and retail sectors in Japan are liberalised but the electricity system is not unbundled and the bulk of the electricity market (88%) is controlled by vertically integrated utilities [170, 171]. Japan has one of the highest support mechanisms (FiTs) for solar PV to increase gross electricity consumption from renewables [172]. The government also has a target of 30% renewable electricity by 2030 [170]. This is all part of a bigger plan to reduce dependence on nuclear power generation after the Fukushima nuclear disaster in 2011. The government is also

interested in improving the security of supply using ESS technologies and has a target of 15% ESS capacity on the grid [173]. Residential ESS is included in government plans as part of targets for increasing solar PV levels from 3.6 GW in 2010 to 28 GW in 2020 [59, 174, 175]. A roadmap has been set in Japan for deploying ESS between 2010 and 2050 following two pathways:

- One supports the use of energy storage facilities in EVs; and
- The second pathway is related to the use of ESS for RES integration, load levelling, power quality improvement, and local level energy management systems [176].

There are also subsidies in place for battery ESS technologies connected to the grid with compensation limits based on the ESS capacity [175]. The regulation was also updated with a requirement for guaranteed and dispatchable wind generation [35, 177]. The Japanese government provides subsidies covering one-third of the cost for renewable generators to use ESS to support the regulation [35, 177].

### **3.3 MIXTURE OF UNBUNDLED AND VERTICALLY INTEGRATED ELECTRICITY SYSTEM IN NORTH AMERICA - USA**

The government in the US has a goal for 80% renewable energy by 2050 [178]. The Renewable Portfolio Standard (RPS) requiring a 10% - 40% electricity contribution from RES has been set in 29 of the 50 states in the US [179]. Investment in ESS is growing along with that of renewables as a result of government policies. The Energy Independence and Security Act of 2007 acknowledged the use of advanced electricity storage and peak shaving technologies as a requirement to meet increasing demand, modernise the grid in the US and maintain a reliable and secure electricity infrastructure [144, 180]. Following from this, the US Department of Energy created an energy storage technologies program [181]. There are vertical market segments for wholesale electricity trade and an open-bid market for ancillary services required by Independent System Operators (ISO), both of which are accessible to ESS [182-184]. The regulator, Federal Energy Regulatory Commission

(FERC) approved ESS to provide transmission support services, participate in the electricity market, and for ancillary services.

The lack of experience of using ESS and conservatism of stakeholders in the power sector limits the wide scale use of ESS in the US [185]. The following are other major challenges faced by implementing ESS in the US [146, 185-189].

- FERC classifies ESS used on the grid individually because they don't fall under conventional generation or network asset;
- FERC faces challenges with updating the markets in deregulated states and developing adequate evaluation frameworks in regulated states which makes it difficult to assess the economic value of ESS from its provision of a range of benefits
- There is an element of complexity in the jurisdiction of FERC and the State Public Utility Commissions (PUC) regarding interstate wholesale transmission involving ESS. The State PUCs regulate retail electricity prices and generation, transmission and distribution functions apart from interstate transmission markets which are handled by FERC. This translates to an impact on revenues for ESS owners based on different jurisdictional rates for charging and discharging an ESS, either in a FERC jurisdictional wholesale transaction or PUC jurisdictional retail transaction. This difference makes it difficult to assess the value of ESS.
- There is reduced liquidity in the balancing markets which affects the participation of ESS;
- In states like New York, ESS is paid like other generation technologies providing regulated services, for actual energy discharged to the network and not for the total energy charged and discharged Furthermore, ESS is not compensated for the fast response service it can provide;
- The development of new PHS plants are affected by regulatory, environmental and site location challenges;

- The policies of other competing technologies or solutions also impact investing in ESS, e.g. peaking power plants.

The following are the key legislation and policies that have been put in place to support the use of ESS in the US [183, 185, 186, 189-191]:

- FERC Order no. 719: This updates regulations to improve the operation of the wholesale electricity markets, including pricing and DR in periods when there is a shortage of operating reserves;
- FERC's Order no. 755: This requires the ISOs and Regional Transmission Operators (RTO) to develop two tiered rates determined by the markets that consider payment for capacity and performance for frequency regulation services;
- FERC's Order no. 784: This is an expansion to Order 755 and allows ESS owners to participate competitively in the ancillary services market and provides compensation based on speed and accuracy for the regulation and frequency response services they provide. Thus allowing ESS owners to utilise the fast responsiveness and high ramp rate of ESS technologies. This order also allows utilities to gain a cost recovery on ESS asset;
- FERC Order no. 890: This requires transmission services on the grid to be provided by non-generation resources, such as ESS along with generation resources;
- Bills were proposed in the US congress to create tax incentives for ESS investments that provide the benefits of increased reliability, renewables integration and grid efficiency. The bills proposed include a 20% investment tax credit for new grid connected ESS rated up to least 1MW/ 1MWh, a 30% investment tax credit for ESS rated up to least 4kW/ 20kWh and new residential ESS rated at up 500W/ 2 kWh.

The most ambitious move to enable more ESS on the grid was carried out in California where a bill directing utilities to define viable and economic targets for

deploying ESS for grid services was put in place by the California PUC [189, 192]. Furthermore, the California PUC set policies and mechanisms for the procurement of ESS with targets for the three biggest utilities in California to acquire an estimated 1.325 GW of ESS over the 10 years from 2014 [193].

## **4 STORAGE REGULATORY AND ELECTRICITY MARKET BARRIERS**

### **4.1 REGULATORY BARRIERS**

#### **4.1.1 Renewables integration policies and energy storage**

Network curtailment or grid expansion is currently used to manage problems caused by renewables and LCTs. ESS can be used to prevent curtailment or serve as an alternative to expensive network expansions. The support mechanisms in place for renewables give priority and provide financial compensation to renewable owners for exporting renewable energy regardless of the impact on the grid. There is little incentive given to investment in ESS which will increase the start-up costs for renewable owners. And for the T&D networks, ESS co-located with a renewable plant to make generation dispatchable may not be suitably located to relieve network congestion [168].

There is uncertainty on whether to include ESS under renewable energy schemes which are implemented as part of government policies or create a separate scheme for ESS. It is also not determined whether to allow ESS to benefit from the current support mechanisms in place for renewable schemes as ESS is a potential solution for firming renewables on the grid. This may be attributed to the fact that not all ESS deployed will be directly supporting renewables by firming capacity, which affects ESS from being classified under renewables. Krajačić et al discuss this issue and suggest a guarantee of resource origin as possible way to categorise ESS under a country's renewable generation mix to meet government targets [154].

#### *4.1.2 Transmission and distribution use charge and tax exclusions*

Due to the nature of ESS operating as a generator when discharging and as demand when charging, regulation in place dictates whether ESS is liable to be charged as a generator, a consumer, or both regardless of the benefits they provide to the grid. The lack of transparency in determining the charges as is the case with DG in the EU will also affect ESS [168]. Furthermore it is not clear if ESS used as load (when charging) is required to pay electricity taxes liable to consumers as its category is not defined within the regulation.

#### *4.1.3 Undetermined asset classification*

The regulation for the ownership and operation of network assets is based on the functionality of that network equipment on the grid [58]. Classification of ESS is complicated because of the multifunctional operation of ESS across the power system leading to an undetermined asset classification. This directly affects the options for ESS asset ownership and economic valuation when considering grid tariffs and return on regulated assets.

#### *4.1.4 Lack of framework and incentives for storage in transmission and distribution networks*

As more renewables are added to the grid the power quality will be affected, particularly with LCTs. Regulation does not support the use of ESS by network operators to manage and maintain the operation of T&D their networks.

Furthermore, it is complex to quantify the benefits from improving power quality and there is a lack of incentives for improvement [194]. Other benefits ESS provides such as improved network capacity, increased efficiency of centralised generation and support for LCT growth on distribution networks are also difficult to measure.

The current regulatory environment makes investing in ESS less attractive because of the high levels of risks involved with such an investment, which is contrary to investment in conventional network assets and methods where there are lower risks involved and revenues are guaranteed.



#### ***4.1.5 Unwillingness to take risks or innovate caused by the current regulatory environment & lack of standards and practises***

There is cautiousness in using non-conventional methods and solutions to plan, operate and maintain the electricity system as a result of the conservative nature of current regulatory frameworks in most countries. The high risk nature of such an investment in this regulatory environment drives up the cost to deploying new solutions. This is more so with most ESS technologies (excluding PHS) which are not technically and commercially proven for large scale deployment within the power system. There is also a lack of standards and common practices as a result of limited deployment experience of ESS on the grid. With the exclusion of PHS, most ESS technologies are not commercially justified. They are new and still developing with little or no implementation experience worldwide. This limits being able to carry out thorough economic assessments, system design and deployment that will lead to the development of standards and common practices. Government policies tend to promote established technologies and solutions which provide flexibility such as DR, interconnections and gas peaking power plants and even curtailment, over ESS which has limited operational experience.

#### ***4.1.6 Investment dilemma***

Regulation will require all stakeholders that benefit from services provided by an ESS implementation to contribute towards the payment for deployment. For example, in the UK, all stakeholders have to pay by virtue of taxes for schemes that enable the growth of renewables via schemes such as the FiT and Contracts for Difference (CfD). The complexity of reconciling the value of the range of benefits (and the stakeholders involved) of an ESS implementation and the high risk involved (as it is a non-conventional solution) impacts the profitability of investing in ESS, which deters investors.

#### ***4.1.7 No benefit for controlled and dispatchable RES***

Priority dispatch and support mechanisms via FiTs or market premiums form part of government regulatory frameworks and policies to support the growth in

renewables. The inclusion of controllability of these renewable generators, i.e. self-dispatch, which is part of conventional generation requirements, is not considered and renewable generators do not get compensated for dispatchability. The inclusion of ESS will increase the costs of a renewable plant and this will deter renewable generators from investing in them particularly if there are no incentives in place for controlling exports to the grid to aid with balancing demand and supply and reducing network constraints.

## **4.2 STORAGE MARKET DESIGN BARRIERS**

### **4.2.1 *Limitations on market participation, requirements for market operation and fees***

The ancillary services market tends to be more cost-effective for ESS owners and other smaller flexible generation technologies in some liberalised electricity markets because of the potential to make profits from providing reserve services [195, 196]. Reserve market participation requires provision of reserve services close to real time at all circumstances and there are financial penalties involved for not being able to provide the contracted service. ESS used for multiple applications may be difficult for an ESS owner to control (by managing the state of charge), particularly if also participating in the spot market and providing grid support services. Most services will require priority and guaranteed reservation of the ESS which can lead to lower utilisation of ESS as it will be impossible to guarantee use in other markets. The rules do not allow for simultaneous operation because the capacity has to be available and unused at the contracted times, except for the service it is contracted for. For example, plants are paid for availability to provide Short Term Operating Reserves (STOR) in the UK regardless of whether they are called upon. During that period of contracted service, the generators are not allowed to operate to provide other services.

The inability to use ESS in a multifunctional mode as a result of the market designs and rules will impact on the profitability of ESS. Wasowicz et al carried out a study

which showed that revenues for ESS owners increased between 6.2% to 19.2% when ESS participates in grid support activities and reserve services [168]. Lastly, high fees for ESS participating and operating in the wholesale or retail market depending on the location of the ESS could deter investment in ESS and participation of ESS in these markets. Market fees currently affects the participation of DG in Europe [197].

#### ***4.2.2 Lack of market liquidity***

Liberalised electricity markets promote market liquidity as a result of higher participation by generators, transparency and competition [198]. Contrary to this, bigger generators in these markets engage in bilateral contracts to reduce exposure to risks that may result from volatility in wholesale electricity prices. For example, generators in the EU engage in bilateral contracts and this affects DG operators [199]. This will also affect ESS owners as a low market liquidity deters investment by new entrants because of the limited access and unreliability of such markets [198]. Ropenus et al discuss the disadvantages of a vertically integrated electricity system where the utilities can limit the access to market and participation of smaller generators and ESS owners due to economies of scale and larger access to the market [200].

#### ***4.2.3 Decline in spread of electricity prices***

ESS owners can operate ESS based on the spread in energy prices during peak and off-peak periods for energy arbitrage revenue. Countries with huge price spreads usually have ESS deployed [201]. Electricity prices are affected by factors which include the changes in demand and generation mix and output caused by change in consumption patterns, weather, policies and regulations, and unpredictable fuel and carbon dioxide (CO<sub>2</sub>) prices affecting base and peak load generation [202, 203]. Studies on wind integration carried out in Canada and the US over a six year period showed that an increase in wind generation resulted in a depression in spot electricity prices [202]. The reduction in prices was more pronounced during high wind and low demand situations, leading to higher spreads [202]. On the contrary, excess PV or wind generation during peak periods reduces the spread and the

potential profits from arbitrage. A good example of this is the case in Germany where there was a reduction in prices spreads between 2010 and 2011 as a result of high PV exports to the grid which resulted in lower peak energy prices during the midday and reduced the profit margins for PHS owners [166, 168, 203].

Electrification of other sectors such as heating and transportation could also reduce prices spreads as charging of EVs and heating at higher levels will occur at night time during off-peak periods thus increasing demand and the off-peak electricity prices [202].

#### ***4.2.4 Monopolies and competition***

T&D owned ESS that is allowed to participate in the electricity market will give network monopolies an unfair advantage and impact the competitiveness of the electricity market. This is because the T&D owners will have an advantage over competitors without T&D assets, for example in connecting their own ESS first on their network and denying access to other ESS or DG owners and can influence electricity market prices. This will affect generators and ESS owners and prevent them from participating in the market, which goes against the regulatory requirements of unbundling.

#### ***4.2.5 Market price control mechanisms***

Price control mechanisms such as fixed balancing market prices or price caps can affect possible revenue streams for ESS owners and the business case for investing in ESS [75]. The US regulator (FERC) used a price cap to reduce rapidly increasing wholesale electricity prices, which led to a power company in California going out of business [151, 204]. In the UK, Ofgem have implemented price caps in the past to reduce volatility [205]. The opportunity to gain high amounts of profits during periods of volatility in the markets is crucial for ESS owners in recovering investment costs. This is particularly so because ESS are smaller and will operate for shorter durations compared to conventional generation plants.

#### *4.2.6 Distortion of wholesale and retail market prices*

The mix-up of wholesale and retail prices was recognised in the California Rule Making for Energy Storage AB2514 [185]. This is linked to the issue of monopoly utilities and competition as discussed in 4.2.4. Distortion occurs when T&D operators gain revenues from ESS as a regulated network asset also participate in the wholesale and retail market leading to unfair advantage against competing individual ESS owners. The market distortion could also result from a T&D operators ESS asset (depending on agreed contract) being charged using energy purchased at wholesale prices and discharged by selling energy at retail prices if there is insufficient coordination in place [185].

#### *4.2.7 Low remuneration for reserves and other ancillary services*

Compensation for ESS providing ancillary services is in most cases the same as that for conventional generators providing these services regardless of the rapid ramp rates and high responsiveness of ESS if providing frequency response services. This was an issue in the US until regulation was updated to compensate generators based on capacity and performance. These low payments for services provided in the reserve and other ancillary service markets will affect the large scale investment in ESS as is currently the case in the EU [201].

#### *4.2.8 Difficulties with long term value assessment from market operations*

The changing electricity market environment caused by changing economics (for example, commodity price changes), regulations and government policies, increasing renewables, and external factors such as the weather, demand and generation output leads to high uncertainty for participants in the market. This leads to complexities in assessing the long term revenues that an ESS could make from participating in the electricity market especially for new entrants with little knowledge of the sector and a less diverse portfolio that can allow them hedge risks as is the case with bigger generators.

#### **4.2.9 Sizing requirements**

Participation in ancillary services markets is usually restricted to generators that meet criteria for minimum duration the generation can provide a service, and minimum generation capacity (power and energy). For example, there is a minimum power capacity for generators in the EU between 1 MW - 5 MW [156, 206]. This restricts participation in these markets by ESS owners with smaller capacities. This limit can however be overcome by ESS owners partnering with other stakeholders to aggregate their capacity in these markets.

## **5 RECOMMENDATION ON CHANGES REQUIRED TO CURRENT POLICIES AND REGULATORY FRAMEWORKS**

### **5.1 ALIGNMENT OF RES POLICIES AND REGULATION WITH THAT OF ESS**

RES development and proliferation required government intervention by means of setting policies and legislation and amending regulations to enable RES to compete against conventional fossil fuel generation. The government policies do not support ESS even if they are used to firm the capacity of renewables. It may be the case that not all ESS implementations will be directly used to support renewables.

Nonetheless, because of the myriad of benefits ESS can provide (discussed in Chapter 2, section 3.2), with one of it being the firming of renewables, regulators and government's should work to align RES policies and regulatory changes with that of ESS. Direct and indirect methods of support such as those discussed by Batlle et al. could be used to support ESS [207]. However, it is recommended that direct methods such as tax incentives and subsidies are used to support ESS because of the complexities in calculating all the benefits an ESS investment may provide. However, fiscal incentives for ESS, will increase costs to utilities and at the end tax payers and so the right balance of policies that provides the most benefits to customers' needs to be in place.

ESS should be considered as a major enabler in increasing the levels of renewables to meet government targets because of the capacity firming benefits it can provide.

Regulations and incentives for renewable owners to provide dispatchable exports should be put in place with incentives such as a faster access to the grid and discounted T&D network connection charges. If this is in place, RES owners will be driven to invest in ESS and the need for flexible generation from peaking generation plants to manage peak demand variability caused by renewables intermittency will be reduced. Krajačić et al propose policy allowing a two tariff system for renewables providing intermittent generation or dispatchable generation from ESS [208]. This should be considered when revising or creating renewables policies. This two tariff system is currently practised on islanded power systems in Greece [208].

Future renewables policies should not only consider large ESS, but should also consider smaller distributed and community ESS, the applications and benefits they offer to distribution networks. This is because, LCTs which are located closer to customers in the distribution networks will change the way these networks are operated and maintained, particularly as most of these networks are operated passively. Finally, once ESS contribution to the security of supply in T&D networks is understood much like that of DG in distribution networks in the UK [95], the security of supply standards should recognise ESS as a tool to maintain or improve the security of supply on T&D networks.

## **5.2 NEW ASSET CLASS AND REGULATION FOR ESS**

Amendments should be made to regulation to recognise ESS as a separate asset from generation or demand because of its operational characteristics. This will lead to an accurate use of system method, charging scheme and compensation mechanism being set up for ESS based on its applications and the operational benefits it provides. This new asset class would encourage unbundled T&D operators who are otherwise prevented by regulation from owning generation to invest in ESS. If the creation of a separate asset category for ESS is not possible, grid tariff exemptions would be recommended. An European Commission report on grid reliability and operability with DG using flexible Storage (GROWDERS) discusses the use of a

subsidised grid connection charge incentive for ESS owners operating to provide network support services [129].

### **5.3 OWNERSHIP OF ESS BY REGULATED MONOPOLIES**

The ownership of ESS should be allowed for all stakeholders on the grid including T&D operators. In T&D networks, it could serve as an alternative to conventional network asset and as such investment could be lower because of the lower risks involved (if it is a regulated asset) and thus guarantee returns on the regulated asset. The regulation should however limit the impact such a change will cause from T&D operators operating competitively and influencing the markets. This could be achieved by regulating the commercial activities a T&D owned ESS can participate in along with the remuneration. This will ensure T&D operators do not have an unfair advantage over other stakeholders that own ESS.

T&D operators should be encouraged by regulation to consider and include ESS when planning for their networks to accommodate high levels of LCTs if ESS use in T&D networks is proven.

### **5.4 STANDARDISED FRAMEWORKS FOR EVALUATION AND PROCEDURES FOR CONNECTION AND OPERATION**

An understanding of the lifecycle impact of ESS technologies by regulators and other stakeholders in the electricity sector will provide the knowhow for the right operational and maintenance procedures to be set up. This can only come from increased research, development, deployment and rollout, all of which will provide much needed experience on ESS applications on the grid. This will lead to more awareness and understanding of ESS so that the right standards and procedures for evaluating, operating, maintaining and disposing of ESS can be developed to update the regulatory frameworks and guide owners of ESS. This reduces the uncertainties and resulting risks of investing in ESS. Based on the evaluation framework, it is suggested that all stakeholders that benefit from the ESS operation make a



contribution to the ESS investment costs based on the value of benefits it will provide to them.

### **5.5 ESTABLISHING A NATIONWIDE ROADMAP AND MANDATE FOR ESS**

If ESS is deemed as a potential solution in a future electricity system, it is important a roadmap is in place to reduce risk and provide a level of assurance to ESS investors and facilitate uptake of ESS. A roadmap will include plans, targets and goals for the use of different large, distributed and customer ESS similar to those set for renewables in the countries reviewed. Mandates for ESS such as those implemented in California could also be set for utilities to invest in an amount of ESS on their networks, or for renewable generators to invest in levels of ESS to control exports. However, mandates may lead to increased capital costs for utilities or renewable owners because of the long payback period for ESS investments. This could lead to issues for utilities that are regulated to drive down system costs and for renewable owners who are already investing in capital intensive renewable deployments. This conflict needs to be carefully considered when setting mandates for ESS.

Both roadmaps and mandates will reduce the level of risk involved in investing in ESS and reduces the complexity involved with assessing the viability of ESS, which will be assessed over varying periods of time (short to long term). The outcome of this will be an increase in investment, development and deployment experience of ESS technologies.

### **5.6 UTILISING ESS FOR RENEWABLES FIRING TO PREVENT CURTAILMENT**

In countries like the UK, huge amounts of money have been spent on curtailing excess energy from renewables that cause constraints on the T&D networks. The money spent on curtailment could be invested in ESS solutions that allow for capacity firming of renewables. The ESS could then be used to prevent curtailment, delay or eliminate the need for expensive upgrades or reinforcements, and be used for other useful applications on the grid, when any capacity is available.

## **5.7 REUSE OF ELECTRIC VEHICLE BATTERIES FOR GRID STORAGE APPLICATIONS**

The development in battery ESS technologies will lead to more EVs being deployed on the roads to reduce levels of current fossil fuel vehicles. As these EVs will be connected to the grid daily to gain charge, it is possible for T&D operators to exploit the batteries on EVs for grid applications if the right infrastructure (Vehicle to Grid) is rolled out. However, there are technical, social, political, economic and cultural barriers to EVs used on the grid as discussed in [209]. Patten et al emphasise that 50% of capacity remains in batteries at the end of their technical life in EVs [210]. This could serve as a way of exploiting the increase in EV deployments, with old batteries from EVs being reused for grid storage applications before disposal or recycling. Patten et al show an example of battery reuse by proposing a concept to use recycled batteries for up to 10 years after they have been removed from EVs as a means of increasing the renewable energy portfolio in Michigan, USA [210]. This option of EV battery reuse provides advantages that include: a reduction in the environmental impacts brought by disposing EV batteries, when they are high amounts of EVs; and discount on capital cost of reused batteries compared to new batteries. Both of these advantages increase the feasibility of using battery ESS technologies for grid storage applications.

## **6 RECOMMENDATION ON CHANGES REQUIRED TO CURRENT ELECTRICITY MARKETS**

### **6.1 UPDATE OF ELECTRICITY MARKET RULES TO ALLOW SIMULTANEOUS OPERATION OF ESS**

In the countries reviewed, ESS can be used in multiple markets to derive the most financial benefits. However, there are limitations on simultaneous operation because of the regulations or requirements for participating in markets such as the balancing and ancillary services market. For example, rules for generators and ESS providing regulation services require a commitment for the period the service is required. An ESS operating in the energy (balancing) or capacity markets would in this case be limited from participating in the regulation market. A US study by Cutter et al inferred that if rules permit, ESS participating in asymmetric (bi-directional) bidding

in the regulation up and down (high and low frequency response) markets can increase potential revenues to over 400% [211]. The ability for ESS to operate simultaneously in multiple markets would lead to an increased return on investment and improve the viability of deploying ESS for competitive services.

## **6.2 REVISION OF ANCILLARY SERVICES MARKET REQUIREMENTS AND PAYMENT STRUCTURES FOR HIGH ACCURACY AND RESPONSIVENESS**

The regulations applied to ESS technologies are the same as those for generators although ESS has different operating characteristics (i.e. charge and discharge operations). There are rules on energy delivery requirements, minimum energy capacity and power rating which would need to be amended to enable smaller ESS technologies with smaller energy capacity that meet power rating requirements to participate in the market [211]. In addition amendments could also be made to allow the participation of aggregated ESS, which will enable different stakeholders purchase multiple ESS services which may or may not be owned by them.

ESS can provide highly accurate, fast responding and high ramp rate services to the ancillary services market. It is important that extra compensation is provided to ESS technologies for providing such services.

## **6.3 MECHANISM FOR ESS TO COMPETE FAIRLY WITH ESTABLISHED GENERATION TECHNOLOGIES**

Most fossil based technologies are advanced in terms of deployments and development resulting in lower risks and reduced investment costs. ESS technologies cannot compete fairly with such established technologies unless support mechanisms are set up. For example, in the UK a capacity market has been set up and ESS will be competing with other established generation technologies in capacity auctions to provide capacity in the future [212]. In this market, because of the limited capacity, high investment cost and complexity of making ESS operational forecasts up to four years in advance (requirements for primary auction), interim time banded products were created with different delivery requirements in a

capacity market for DR/ESS to participate in a secondary auction for capacity over a shorter period of up to a year.

#### **6.4 PRICE CAP OF WHOLESALE ELECTRICITY**

Price caps could be implemented by regulators if volatility in the electricity markets increases dramatically as a result of high levels of intermittent renewables on the grid in the years ahead. This will ensure the extreme wholesale electricity market prices are restricted. In this case, it is important that consideration is given to flexible and back-up forms of generation and demand such as ESS that require operation during periods of high volatility to recover their investment costs.

#### **6.5 FLOOR MARKET PRICE FOR CARBON**

Promotion of a floor market price for carbon in countries where the emissions trading scheme is active. In the UK the Carbon Price Floor (CPF) is a regulatory policy used to offset the low price of carbon in the EU emissions trading scheme (ETS), which is a result of a surplus of permits and the economic recession [213]. It was introduced by the UK government in 2013 to manage the uncertainty and low price of carbon in the EU market. The CPF was set up to reduce GHG emissions and promote investment in cleaner generation technologies. The increase in cleaner technologies such as renewables will increase the need for more flexible demand and generation solutions such as ESS on the grid to balance future peak demand and the intermittent generation from LCTs. The increase in LCTs and the carbon price floor will lead to a reduction in carbon emitting technologies such as gas peaking power plants [213].

## **7 SUMMARY**

In this chapter, the regulatory and electricity market environment was introduced along with some of the obstacles they pose to deploying ESS in countries or regions with high levels of renewables and ESS deployment. The review led to establishing some key regulatory and electricity market barriers affecting ESS deployment across

countries worldwide. Changes to the regulatory and electricity market environment are required in order to develop a viable business case for ESS to compete against conventional and other alternative technologies, if ESS is seen as a useful tool in a country's power system. Presently conventional methods are used by generators and T&D operators because the regulatory and market environments were made around such conventional technologies; they are also seen as cheaper solutions and are proven in comparison to ESS. The true value of ESS is not properly taken into consideration because of different cost requirements and complexities in deriving revenue from different value streams. This is expected to change in the future as ESS technologies continue to advance and are deployed, capital costs reduce, and regulations and market structures change allowing for proper valuation of ESS

It was established from the review in this chapter, that all stakeholders on the grid should be involved with deploying ESS. Furthermore a combination of multiple applications in the regulated and competitive environments is likely to be necessary for an investment in ESS to yield maximum benefits for investors. It is unequivocally important that the policies, regulatory requirements and electricity markets are stable to reduce the uncertainties in investing in ESS and promote research, development and deployment. Updates made to the policies, regulatory and market frameworks should consider the role of ESS in the grid and its potential in enabling the achievement of decarbonisation targets.

Some of the recommended changes considering ESS use to increase renewables firming and provide grid support and competitive services under different ownership types and business models based on the ones described in Table 4-1 are considered in the analysis carried out on ESS implementation in distribution networks in Chapter 5 and 6.

## **Chapter Five: Medium term planning study to assess the value of implementing energy storage systems in an unbundled medium voltage distribution network**

---

### **1 INTRODUCTION**

The government targets to electrify transportation and heating will result in the increase in LCTs on the distribution network. LCTs are generation and demand technologies of which some are renewable based such as solar PV and WTs, which are non-dispatchable and intermittent. On the demand side of LCTs, technologies such as HPs and EVs are being rolled out. These LCT technologies will lead to different demand and generation characteristics outside of present conventions. EV, HP and PV are anticipated to have the highest impact on the low voltage distribution network [214]. The current design practice for DNOs when planning for the connection of Distributed Generation (DG) to their networks is to carry out studies for the critical case of maximum DG output and minimum load or minimum DG output and maximum load. With LCTs growing, it will be more complex for DNOs to ascertain the maximum output and operating patterns from generation LCTs (LCT-G) and the increased demand variations as a result of demand LCTs (LCT-D).

LCTs can provide technical, economic and environmental benefits to the power system, such as, loss reduction, renewables capacity firming, improved system reliability and security, improved voltage profile, network upgrade deferral, reduced GHG emissions, reduced cost of fuel compared to fossil fuel generation, reduced transmission and distribution network congestion [26] [27]. However, they can also impact on power system planning and lead to problems with under-voltage and over-voltage, reverse power flow, thermal overload of cables and transformers, increased losses, reduced power quality and other unfavourable issues discussed in [27, 29-33]. DG output can be curtailed by DNOs if there is insufficient hosting

capacity on the network but they will have to pay for the constrained output, which leads to a loss of revenue. To prevent this, DNOs determine the levels of reinforcement required and DG scheme developers pay reinforcement costs if needed and use of system costs to ensure the network is not affected by the installation. This is not the case for domestic LCT schemes such as PV, and Combined Heat and Power (CHP), which are connected without requiring consent from the DNO and cannot be controlled by the DNO. As domestic LCT owners are not currently constrained by the network, increasing levels will lead to domestic LCT-G being cut off from the grid if voltage levels rise above DNO statutory limits. This will limit the levels of LCT-G and impact on government policies for the growth of such schemes.

Pudjianto et al infer that due to the higher peak demand caused by the electrification, which is estimated at two to three times the UK electricity baseload, investment worth tens of billions of pounds will need to be spent to reinforce the networks using conventional methods [34]. Higher LCT deployments will lead to the need for high network reinforcement investments to avoid curtailing excess renewable generation and maintain network operating requirements [215, 216]. It will also lead to changes in the way distribution networks are operated and maintained [215, 216]. Hence an understanding of LCT impacts on DNO networks is necessary for them to plan wisely to manage emerging issues on the distribution networks using a combination of conventional and innovative technologies and processes.

### **1.1 ESS AS A SOLUTION**

Active Network Management (ANM)<sup>6</sup>, which enables the real time management of distribution networks and network devices is a potential solution for DNOs to accommodate the growing amounts of LCTs on their networks without the need to upgrade network infrastructure [65, 66]. ANM allows Demand Response (DR), ESS,

---

<sup>6</sup> ANM involves real time monitoring and control equipment, communications infrastructure to deliver network information and control instructions, and distributed energy resources.

voltage control devices and renewable DG to be actively controlled to meet distribution network requirements. ESS as part of an ANM scheme is considered as a possible reinforcement alternative to resolve or mitigate anticipated issues on the transmission and distribution (T&D) networks thereby deferring the need to upgrade or replace network infrastructure. Studies have been carried out that show the versatility of ESS when used for T&D network applications that include renewables integration and smoothing dispatch, voltage and frequency regulation, power quality management, power flow management (peak shaving and load levelling), increased asset utilisation, loss reduction, and network capacity management to defer or avoid network upgrade [57-59, 217]. A study carried out by Strbac et al indicates that in the short to medium term, ESS can be used to drive down distribution network reinforcements costs, which are expected to be higher than transmission investments costs in GB [60]. Strbac et al highlights the need for ESS to be deployed in the UK grid and ties the increase in ESS value with an increase in the renewables share on the grid [60]; further inferring that ESS could provide annual system benefits reaching up to £2 billion in the year 2020, with distributed ESS providing savings in distribution network reinforcement costs.

In an unbundled electricity system, ESS could be used as a network asset to provide network support services, which are provided by regulated network monopolies; or competitive (deregulated) services, which involves stakeholders such as suppliers, and generators. Regulated network services provide a guaranteed revenue source, while ESS used competitively will not have a guaranteed source of revenue due to the volatility of the wholesale market and changing ancillary services market revenues. In distribution networks that are part of an unbundled electricity system, the question remains, should DNOs or third parties invest in ESS and what are the implications? For DNOs, there is an issue under a regulatory landscape where T&D network operators are barred from owning generation assets (which ESS is classed under) and participating in competitive or deregulated business activities, which an ESS owner will be involved in (directly or indirectly) via charging and discharging



of energy. Therefore, the opportunity to use ESS for multiple benefits is limited, which reduces financial viability. For third party owners, operating in the electricity market alone may not be viable and operating the ESS without coordination with the DNO could negatively impact the network, much like DG can.

Wade et al categorises the five key applications for ESS as voltage control, power flow management, energy market, commercial/regulatory, and network management [217]. This chapter considers the use of ESS for voltage control, power flow management and for operation in the energy market. It then explores the multi-stakeholder benefits of ESS used for the above mentioned applications in a distribution network under both DNO and third party ownership. The limits of current regulation are highlighted and recommendations are presented on how to derive the maximum benefits from a Distribution Network ESS (DN-ESS).

## **1.2 THE PROBLEM OF EVALUATING THE FINANCIAL VIABILITY OF ESS**

Research has shown one of the main challenge of ESS becoming a feasible investment is the ability to combine multiple services ESS can provide as a result of regulatory and electricity market frameworks [61, 75]. Studies have evaluated the benefits of ESS in firming renewables on the transmission network [77-79], and distribution network [65] to maximise electricity market revenues. Zucker et al [85] have shown that financial support is required for battery ESS (Sodium-Sulphur) used only for electricity market operation. Ohtaka et al evaluate the benefit of ESS to manage thermal overload of lines when faults occur on a transmission network [80]; and Ippolito et al assess the benefit of ESS on an islanded grid with DG [81]. Chacra et al evaluate the benefits and value of DN-ESS on a network with growing energy consumption [67], and Sugihara et al evaluate the value of customer controlled ESS for providing voltage support on a network with increased levels of PV [82]. Nick et al investigate the use of ESS use in managing distribution network voltage and reducing losses in an active distribution network with PV [83]. These studies show that the profitability of ESS is tied to providing market based competitive services

(e.g. energy arbitrage, frequency regulation), and regulated network support services (e.g. voltage support and peak shaving).

Zucker et al show the impact of ESS operated based on market signal increases grid costs by 35% and ESS operation based on network requirements resulted in a 17% reduction in grid costs [86]. This shows the opposing nature of operating ESS for different stakeholders and shows that cooperation is required to ensure successful implementation and profitability for all parties involved.

### **1.3    *MARKETS CONSIDERED FOR ESS COMMERCIAL SERVICES***

The following market applications are considered:

1. **Energy arbitrage in the power exchange market.** This market accounts for 3% of electricity sold in GB. The price of energy sold at each half hour represented by the Market Index Data Price (MIDP), influences the prices in other markets. The MIDP follows demand and generation availability during the day. In the UK, the prices are volatile but show a general trend daily of low prices during off-peak (night time), and high prices during peak (daytime) periods ;
2. **Bidding and offering energy in the balancing mechanism market.** This is run by National Grid for real-time balancing of demand and supply in GB to correct imbalances resulting from trading in the forward, day-ahead and spot market. Generators and suppliers who are part of the balancing and settlement code (BSC) are exposed to imbalance prices based on their agreed contracts, what they deliver, and the conditions of the grid during the periods of delivery.
3. **Firm Frequency Response (FFR) in the ancillary services market.** This is open to ESS, generators and Demand Response (DR) providers to provide dynamic and non-dynamic (static) active power output or reduced demand based on changes in the system frequency. Response is triggered by deviations from statutory limits of +/-0.5 Hz, and the maximum allowed drop during an abnormal event (caused by a loss of GB generation up to 1800 MW) is -0.8 Hz [218, 219];

4. **Short Term Operating Reserve (STOR) in the ancillary services market.** This is procured by the National Grid a day ahead based on demand and generation forecasts, where an imbalance is expected as a result of generator unavailability or if actual demand exceeds forecasted demand. STOR is used to provide reserve power at certain times of the day to ensure security of supply.

## 2 PROBLEM DESCRIPTION

A planning study over a 15 year period is carried out in this chapter and the effectiveness of implementing ESS in a distribution network to provide both competitive and network support services is evaluated to show different revenue streams for ESS and to examine if it could be a profitable investment. The aim of the planning study is to assess issues that could arise from a rapid increase in LCTs on a MV distribution network with Land Fill Gas (LFG), WT, growing PV and HP concentrations and underlying domestic demand growth. The growing concentration here refers to the contribution to of PV and HP to energy demand on the network. The following are the objectives of the work:

- Develop a centralised control strategy for operating ESS to resolve or limit the impacts of overvoltage, undervoltage, thermal excursions and reverse power flows.
- Assess DNO and third party ownership types with the ESS control strategy for technical operations (i.e. network support services) which is under a regulated business model, or market (commercial) operations which is under a deregulated business model (i.e. third party commercial owner), or a combination of technical and commercial operation. The regulated business model evaluates the value of using ESS to provide regulated network support services against conventional network reinforcement options (such as installing capacitor banks, voltage regulators, and network reconductoring), and the deregulated business model assesses the value of ESS in arbitraging in the spot (intra-day) market and participating in the balancing mechanism, and providing balancing market services. Short Term Operating Reserve (STOR), and Firm Frequency Response

(FFR) are also evaluated in the final year of the study to show the possible revenues from both ancillary services. The impact of T&D use of system charges on the feasibility of an ESS investment based on ownership types/business models is also evaluated.

- And finally, evaluate which business model provides the most benefit for a DNO and third party in the UK under the current regulatory structure.

The approach taken is composed of three stages. The first part assesses an MV network's ability to remain within network constraints without reinforcement when there is a set amount of DG from a WT and LFG, and yearly increases in renewables share from solar PV and in heating energy consumption from HP rollout. The second part involves a control and operating strategy using ESS and the networks OLTC to manage adverse impacts on the network from the increase in renewables share and HP concentration and from energy arbitrage with the ESS. The final part sets the control and operating strategy based on hypothetical business models for either regulated or third party stakeholders. The following sections provide a breakdown of the model components and the underlying assumptions used.

## **2.1 NETWORK MODEL**

The 6.6 kV network model described in Chapter 3 section 2.2.2 called the Elswick model, which is located in the North West of England is used in this study. To reiterate, the network has a total of 64 busbars and a current net total demand of approximately 7 MVA and a LFG installed with a maximum export power of 0.4 MW.

### **2.1.1 Network demand data**

The normalised demand (HP and domestic demand) and generation (WT and PV) datasets described in Chapter 3 are used in developing the net network demand projections at the primary substation over the 15 year planning period starting from 2015 to 2030. The profiles were normalised and scaled to produce profiles based on the number of customers on the network. Demand and generation profiles for the

first year (base-case) were used with the annual HP and PV percentage increase rates to calculate the net demand on each feeder. The percentage rates were derived using:

$$\%Growth_{RES} = \left[ \left( \frac{Export_{RES,Y_{15}}}{Export_{RES,Y_1}} \right)^{1/Y_{15}-Y_1} \right] - 1 \quad 5$$

$$D_{Y_{15},t} = \left[ e^{\{\ln(\%D_{inc}+1) \times Y_{15}-Y_0\}} \right] \times D_{Y_{end},t} \quad 6$$

where  $Growth_{RES}$  is the percentage increase required to get to a defined renewable percentage share at the end of the project lifetime;  $Export_{RES,Y_{15}}$  is the required export levels for renewables in year 15 ( $Y_{15}$ ) and  $Export_{RES,Y_1}$  is the current export level in year 1 ( $Y_1$ );  $D_{Y_{15},t}$  is the demand in year 15 at time period  $t$ , based on the percentage underlying demand increase  $D_{inc}$ . The percentage share of LCT concentration is obtained using equation 7.

$$\gamma = \left( \sum_{t=1}^T \frac{LCT_{i/e_t}}{D_t} \right) \times 100 \quad \forall y \quad 7$$

Where  $\gamma$  is the percentage share of LCTs on the network in a year;  $LCT_{i/e_t}$  is the LCT contribution in export from PV, WT and LFG, and import (demand) for HP in a year  $y$ ,  $T$  represents the maximum time period  $t$  (17520 time periods) in a year;  $D_t$  is the demand on the network in MWh at a time period.

The demand on the network was assumed to grow at the observed historical rate of 0.1%. This is a conservative increase that factors the drop in demand in GB mainly as a result of government policies promoting the increase in embedded low carbon generation, energy efficiency and the prolonged economic downturn [220, 221], and increase in demand side response, embedded generation and transmission network loss reduction [222]. The low growth in peak baseload electricity demand is illustrated in Figure 5-1, where a high growth is shown for EV and HP load and PV generation up until 2050 with an increase of over 40 GW from current 60 GW figures [220].

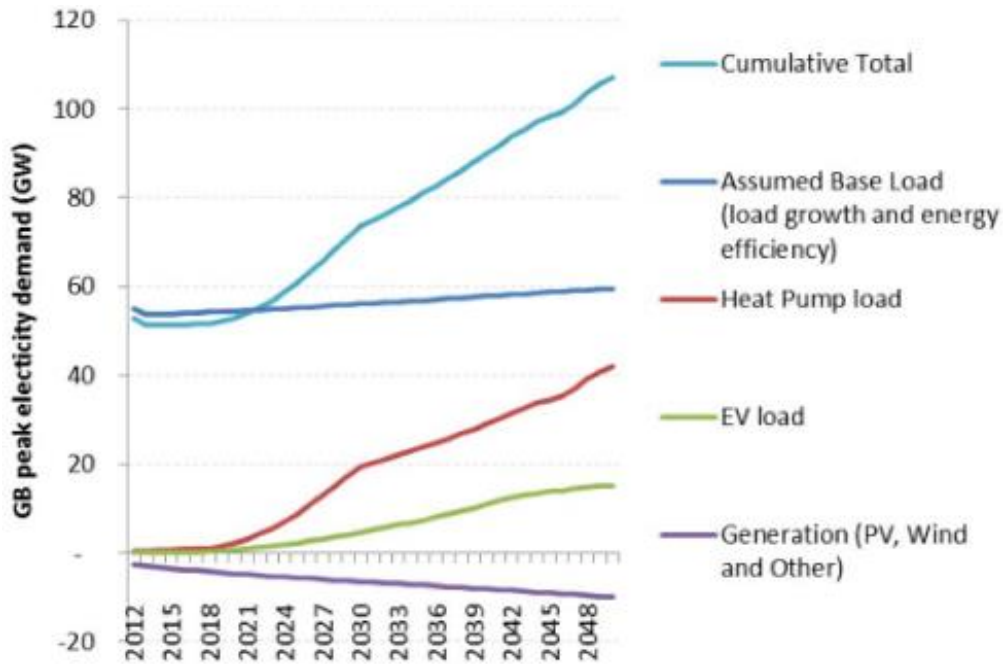

Figure 5-1: Scenario from the Smart Grid Forum Workstream on the projected increase in peak electricity demand [220].

It was assumed that an initial estimate of 1.9% of customers on each feeder had PV installed in the first year of the study based on the number of domestic customers in the UK that had installed solar PV in January 2014 [223]<sup>7</sup>. There was also one WT installed in year 1 of the study rated at 0.5 MW. The power rating was chosen based on the minimum capacity of operational WTs installed in the North West of England, which is the location of the network under study, at the end of 2013 [224]. The WT was located on the network busbar most affected by overvoltage to simulate a worst case scenario. Renewable contribution to electricity in 2030 is set at 30% in line with the central case in the UK highlighted in [225], based on that 30% target, the annual growth in PV is set to follow this trajectory.

Based on the number of GB households estimated at 27 million [226], and the number of HPs installed in GB estimated at 90,000 in 2012 [227, 228], HPs are installed in an estimated 0.3% of domestic households. This was applied as the number of HP customers in year 1 on the MV network. Subsequent growth in HP concentration on the MV network was applied following government predictions

<sup>7</sup> This is based on 27 million domestic households in the UK and approximately 512,378 solar PV installed in January 2014 under the Feed in Tariff scheme.

that 25% of GB households will have HPs installed by 2030. Figure 5-2 shows the percentage increase in LCT-G export compared to year 1, which reached 130% in year 15 and it also shows the RE share on the network increased from an estimated 12% to 18% over the 15 year planning period.

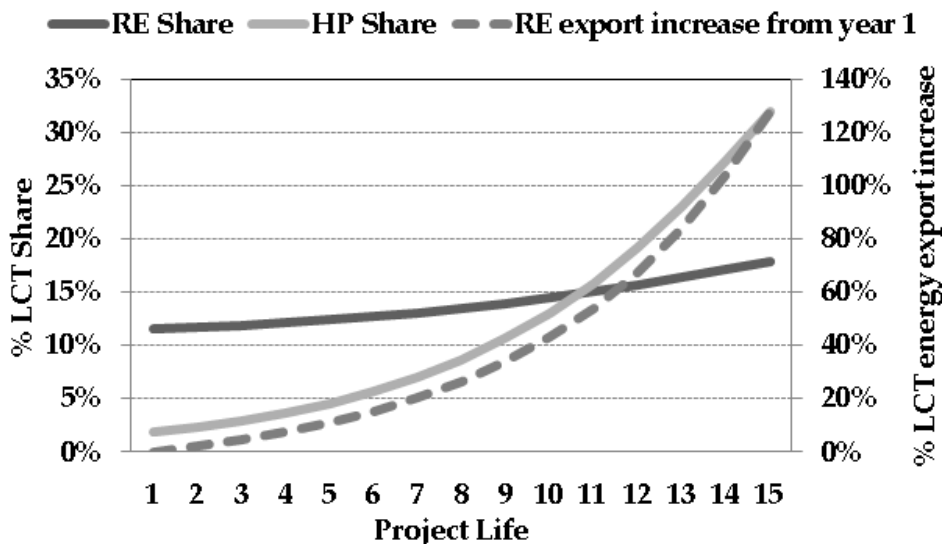

Figure 5-2: Percentage increase in LCT demand and generation on the case study network over the simulation time

There is an increase by only 6 percentage points because of the growth in HP installations and domestic demand; this is confirmed by the change in load factor on the network shown in Figure 5-3, which only increases by 2 percentage points. HP consumption as a percentage of demand on the network peaked at 32%.

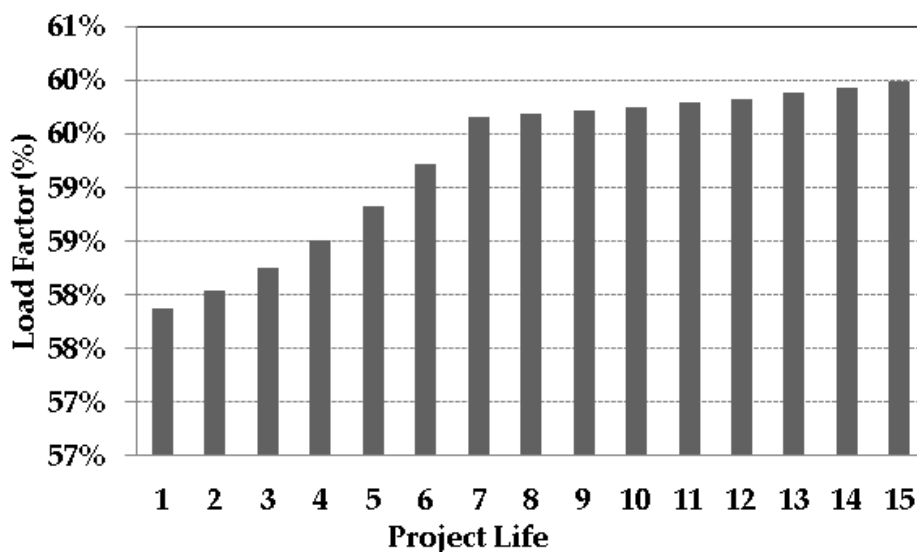

Figure 5-3: Percentage change in network load factor over planning period

### 2.1.2 Modelling assumptions

The following assumptions were made in developing the 15 year scenario of demand and LCT increase:

- All domestic loads are assumed to operate at a 0.98 power factor , and all HPs operate at a 0.9 power factor [229].
- The LFG, WT and PV operate at unity power factor with no voltage control capabilities, which is common practice for grid connected PV and a requirement for DG [230, 231]. All customers install PV with a 3.5 kWp rating, which is the average size of PV installations in GB {Energy Savings Trust, 2013 #1435.
- The PV generation characteristics are the same for all customers across the network. Capturing the seasonal variation in generation and demand is of more importance in this study than individual customer's demand and generation variation.
- There is an even distribution of HP and PV across each feeder on the network;
- The MV network has only residential customers, which makes up 25% of UK energy demand {Department of Energy & Climate Change (DECC), 2015 #1508}. The number of customers on the network was calculated based on UK standards for average After Diversity Maximum Demand (ADMD) of 2 kW for residential dwellings without electrical heating [122]. To reiterate, the ADMD is the ratio of maximum yearly load on a network against the number of customers served by the network. It is used in calculating the rating for MV/LV transformers and voltage drop on LV feeders, service cables and MV/LV transformers.
- At the time of this study, seasonal profiles were available only for GSHPs and they were used as the profile for customers with HPs, regardless of whether the HPs are air source or ground source. This assumption is backed by a report by Fawcett et al, which establishes that GSHPs are more rapidly deployed than Air Source Heat Pumps (ASHPs) [232] and by the DECC figures for 2012 where the ratio of GSHP to ASHP is approximately 3.5:1.



- It is assumed that customers install HPs with a 4 kWp rating.
- The usage patterns of HPs across the network are the same representing a worst case scenario. The seasonal variation is of more importance in this study than the customer variation in HP consumption.
- The WT was installed in year 1 of the study with no further WTs installed.

## 2.2 *COMMERCIAL MODEL*

Following the present regulatory structure in the UK, the ESS is half hourly metered and treated as a generator with negative demand when discharging and as a consumer with positive demand when charging.

There are five separate markets for electricity in the UK, which are the forward, power exchange, balancing mechanism, ancillary services and capacity market. These markets enable the trading of electricity and services that are required to balance demand and supply on the grid. ESS can participate in any of these markets if they meet the relevant criteria for the respective services. This study assumes:

- the ESS deployed meets requirements as a Balancing Mechanism Unit (BMU), which is a unit (demand centre or generation) with meters connected to the grid to register export and import as part of the UK's balancing and settlement code. These BMUs can participate in the balancing mechanism;
- the ESS capacity is combined with other providers using an aggregator to meet the relevant criteria for providing ancillary services; and
- the aggregator's tenders for the ancillary services are accepted;

### 2.2.1 *Electricity market services*

Prices in the markets considered in this work vary based on the current and future conditions of the grid and economic factors, such as price of commodities. The wholesale market is influenced by factors such as condition and performance of generation portfolio, fuel supply, and the bidding activities of energy suppliers, weather conditions, and social events. In wholesale electricity market modelling, prices can be modelled based on a top-down approach, which uses stochastic models

to infer electricity prices based on historical prices and other data such as futures prices [233]. This captures the trends (futures market model) and volatility (spot market model) of market [233, 234]. On the other hand, the bottom-up approach involves using more detailed model such as a dispatch model which considers market dynamics by taking a view of the market using the generation fleet and operation characteristics (for example, gas, coal, offshore wind have different short run marginal costs); current levels and growth figures for storage, interconnections, renewables, gross electricity demand; and future prices (forward prices) for wholesale electricity and commodities [233]. Another approach is to use purely historical prices to gain an understanding of the upper boundary of revenue available to a system, for example from arbitrage [235]. This was recommended by Barbour et al, who indicated that historical prices provides a form of perfect forecasting as it eliminates errors involved in forecasting prices, due to the availability of a rich data set [235].

Historical prices, government published price growth, and historical variations are used to deduce indicative prices for the different markets in this study. This provides a good basis to estimate arbitrage, balancing mechanism and ancillary services revenue without electricity market modelling, which is beyond the scope of this work.

#### *Spot and balancing mechanism prices*

Barbour et al make use of historical electricity price data to deduce potential arbitrage revenues in the spot market [235]. This work uses historical MIDP in £/MWh obtained from [236] for the periods 2004 -2013 to infer future spot market prices. The prices were adjusted for inflation and the mean for each half hour of each quarter in a year for the 9 year period was calculated. This provides an approximation of half hourly prices; consideration of prices every quarter ensures the seasonality in market prices is covered. As would be expected, the prices are higher in the winter quarters and lower in the summer quarters as illustrated in Figure 5-4 (a) and (b). In addition, the prices are generally higher in the weekday

compared to the weekend, with both prices having a peak and a pronounced super peak period for the Q1 and Q4 periods, which fall in the winter. Afterwards, a percentage change illustrated in Figure 5-5, derived from DECC's wholesale market price assumptions for a central growth scenario was applied for spot market price projection [237]. The growth scenario is based on central estimates of economic growth and changes in fossil fuel prices in the UK.

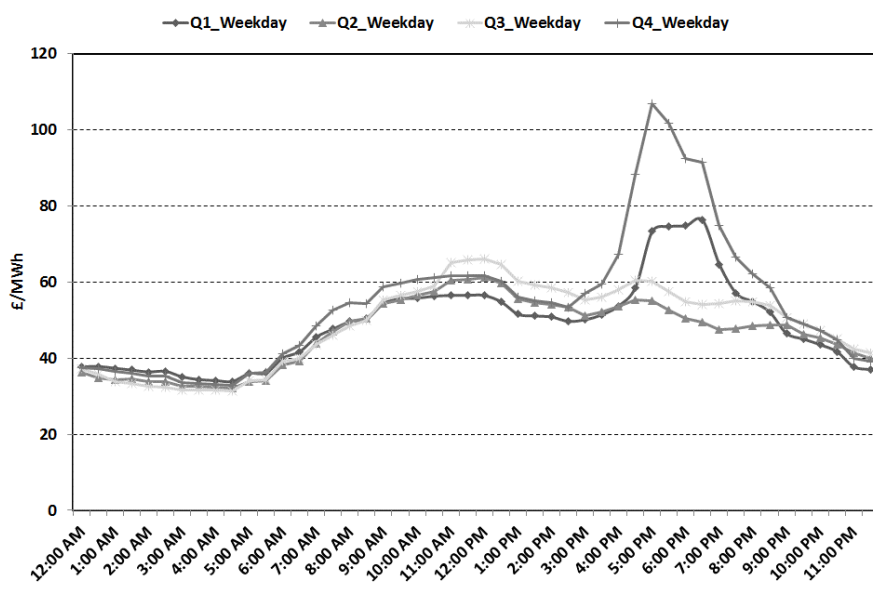

(a)

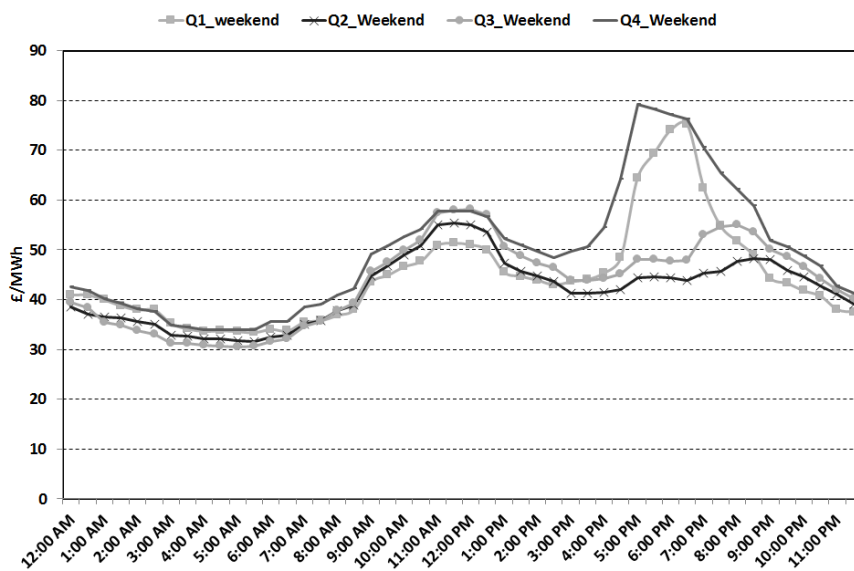

(b)

Figure 5-4: (a) Weekday mean spot market price (b) Weekend mean spot market prices (in 2013 prices).

The same method was applied to the System Buy Price (SBP) and System Sell Price (SSP) used in the balancing mechanism with data available over the periods of 2003 - 2013 with the data obtained from Elexon [236]. The Imbalance prices (SBP and SSP) are determined by bids and offers when a participant’s energy imbalance occurs in the same direction with that of the transmission system, which is the cost to balance the transmission system. This is also known as the main pricing method [238]. The spot market prices (MIDP) are used (reverse pricing method), when imbalances happen in the opposite direction, which is when the supply or generating party reduces the imbalance of the transmission system [238]. However, in this work, the annual change in SBP and SSP uses the annual percentage changes in wholesale prices derived from DECC [237], in determining future imbalance prices for each quarter in a year.

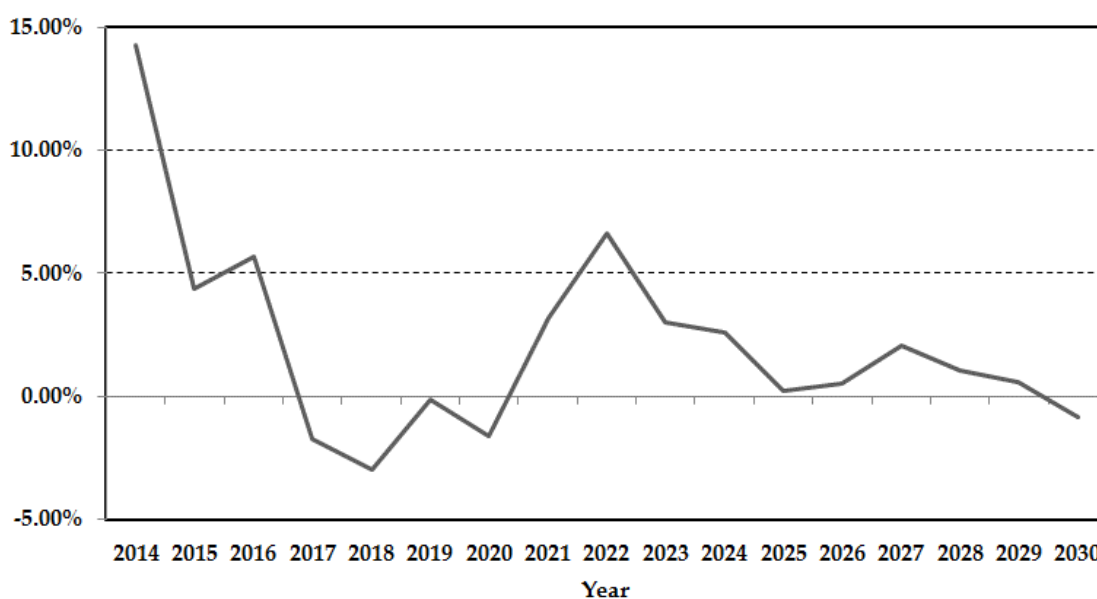

Figure 5-5: DECC central scenario percentage change in wholesale prices from years 2014 to 2030 [Derived from [237]]

Firm Frequency Response

Dynamic primary, secondary and high frequency response services are provided by the deployed ESS, with the first two representing low frequency events, i.e. periods when demand exceeds generation. High frequency events occur when generation exceeds demand on the grid. The requirements for the three services are:

- Primary response: active power output within 10 seconds of an event occurring with the output sustained for 20 seconds;
- Secondary response: active power within 30 seconds of an event occurring with the output sustained for 30 minutes;
- High frequency response: reduction in active power (demand) within 10 seconds after an event occurs and sustained until further notice from the system operator.

There is a minimum requirement of 10 MW of response energy and this study assumes the ESS output is aggregated and the tendered volumes and prices are accepted. The payments considered for this service are a fee for availability (£/hr), and a holding or nomination fee (£/hr), for the use of the service [239]. The average availability and nomination fees used based on National Grids post assessment tender report for the year 2013, are £8.7/MW/hr and £8.4/MW/hr respectively [240]. There are other payments for window initiation fee (£/window), tendered window revision (£/hr) and response energy fee (£/MWh), which are not considered as the prices were not available and FFR providers are not required to tender for all the revenue streams for a service.

#### Short Term Operating Reserve

STOR participants are paid an availability payment (£/MW/h) for making their service available within a window, and they are also paid for utilisation of the energy (£/MWh) when it is required during the window.

The ESS will be used to provide a committed STOR service, where the ESS is available for all availability windows within a contracted term. As the ESS is assumed to be aggregated, it meets the minimum requirements of 3 MW of generation or demand reduction, which can be aggregated with a response time within 20 minutes and for delivery up to 4 hours [241]. There is also a requirement that the contracted power can be provided for at least two hours and the provider

can recover within 20 hours and provide the STOR service at least 3 times a week (ibid.). The following are assumed:

- The ESS is available for up to the maximum period of approximately 43% of the hours in a year, i.e. 3800 hours [241];
- Within the availability windows, fees for utilisation are paid within a 50 – 80 one hour utilisation periods.

STOR windows vary based on the seasons but usually occur during the period 07:00 - 22:30 for approximately 11 hours each day [242]. Table 5-1 shows the discounted availability and utilisation fees for 2010 – 2013 obtained from National Grid annual STOR review reports [243-245], and the calculated annual percentage changes in those years. This was used to work out the possible future fees for STOR services

| Year      | Availability (£/MW/h)/%increase from previous year | Utilisation / %increase from previous year |
|-----------|--|--|
| 2010-2011 | £9.08/MW/h/13%                                     | £251.70/MWh/-11%                           |
| 2011-2012 | £9.13/MW/h/0.6%                                    | £232.37/MWh/-7.7%                          |
| 2012/2013 | £7.38/MW/h /-19%                                   | £202.27/MWh./-13%                          |

Table 5-1: Average STOR service fees and percentage change in fees over previous year [243-245]

### 2.2.2 *Transmission and distribution use of system charges*

From the literature reviewed in Chapter 2, most of the studies on the benefits of ESS do not consider grid tariffs, i.e. generation and demand distribution use of system charges. These grid charges are part of embedded benefits which can be negotiated with an offtaker/supplier in the market to provide revenue for benefits that include reduced transmission losses and avoided cost of Balancing Services Use of System (BSUoS) and Transmission Network Use of System (TNUoS). This work considers grid-tariffs in the form of an annual (TNUoS) half hour zonal tariff (£/kW) during winter peak periods also called Triad and Distribution Network Use of System

(DUoS) zonal charges. TRIAD describes the tariffs for demand on the transmission networks based on annual energy consumption during three half hour settlement periods (occurring in periods 33 to 38 or 16:00 hrs – 19:00 hrs) in a financial year starting from November to February [246]. Generally, Triad periods occur more frequently between 17:30 hrs – 18:00 hrs from analysis of National Grid published Triad data on historical triad periods spanning back to 1990. Both the Triad and DUoS charges provide avoidance benefits in form of payments to suppliers when the ESS is discharging, and tariff charges for when the ESS is charging.

A 12% annual change in the TNUoS tariff calculated from the average percentage change in historic tariffs from 2005/06 – 2013/14 was used in calculating the annual TRIAD charges over the planning period of this study based on analysis of National Grid published historical tariffs [247]. DUoS charges in the UK, like the TNUoS charges are not fixed and change based on the time and region. The DUoS charges considered for the ESS deployed in the North West region are:

- Unit charges in p/kWh for transportation of electricity across the distribution network. This is split into time bands of red, amber and green with charges highest during red (peak periods) and significantly lower during the green periods. This is a benefit for generators and a cost for demand customers. The unit charges for demand customers are approximately two times as much as the compensation for providing generation or reduced demand during the different time banded periods for users of the ENW network [248];
- Capacity charge in p/kVA/day for demand customers for agreed maximum import capacity;
- Fixed charge in p/meter/day for both generation and demand customers

For the DUoS charges/benefits, a 7% annual increase was applied based on conclusions on indicative projections of DUoS charges from [249]. The DUoS charges where the 7% annual increase figure was applied to were obtained from ENWs 2014 schedule of charges obtained from [248].

### 2.3 ESS MODEL

The ESS is modelled as a load or generator depending on whether it is charging or discharging and with a varying power factor between zero and one to allow for sourcing and sinking of real and/or reactive power when a problem (event) occurs on the network. Charge and discharge efficiencies were assumed to be symmetric and thus equivalent to the Round Trip Efficiency (RTE), which is assumed to be fixed at 85% efficiency. The RTE causes a difference in the amount of power required to get the ESS to a specific State of Charge (SoC). This will be factored in when charging and discharging the ESS for network support or market operations. The ESS is specified to be operated up to the zero SoC, which is a full Depth of Discharge (DoD). This was assumed following the cycle life for a lithium ion battery which between an 80% - 100% depth of discharge as shown in the manufacturer sheet [250] presents the same number of cycles before end of life of the battery. The end of life is defined as the increase in impedance or 20 to 30% reduction in the capacity of the battery after the maximum number of cycles is reached [250].

The ESS energy throughput is used to model the useful life of the ESS after each year of deployment. This is used to estimate the lifetime of the ESS, which is difficult to model and is affected by among other things, operating conditions, temperature and individual battery materials. The throughput  $E_{th}$  is derived as shown in 8, where a summation is done on the product of the depth of discharge,  $DoD_n$ ; ESS cycles to failure,  $CTF_n$  at 100%  $DoD$ ; and the energy capacity of the ESS,  $E_n$  for each ESS  $n$  to the total number on the network  $N$ . The remaining life of the ESS, LR expressed in 9 is used to calculate when a replacement is required each year  $y$  and the remaining life of the ESS over the project lifetime  $Y$ ;  $E_i$  is the total energy used to charge the ESS in a year and  $E_o$  is the total energy exported from the ESS.

The salvage value fraction derived from [251] and expressed in 10 is used in determining the value of the ESS based on remaining capacity after the project lifetime. SR is the salvage ratio of the  $n$  ESS installed on the network based on the ratio of the yearly throughput used to the overall throughput of ESS



installed  $E_{th,max}$ . The SR is multiplied by the ESS energy capacity cost  $CC$  to calculate the salvage value as shown in 11.

$$E_{th} = \sum_{n=1}^N (D_o D_n \times CTF_n \times E_n) \quad 8$$

$$LR = \frac{E_{th}}{\sum_{y=1}^Y (E_i + E_o)} \quad 9$$

$$SR = \frac{\sum_{y=1}^Y (E_{th,y})}{E_{th,max}} \quad 10$$

$$\text{Salvage value} = SR \times CC \quad 11$$

### 2.3.1 Locating the ESS

The ESS was located based on the Voltage Stability Factor (VSF) calculation method developed by Kayal et al [252]. The VSF is an analytical measure used to quantify the levels of voltage stability on busbars in T&D networks. The VSF for a busbar is represented in 12 and the total VSF on the network which considers all busbars on the network is shown in 13 where  $VSF_{b+1}$  is the VSF of buses  $b$  on the network excluding the primary substation;  $V_b$  is the magnitude of the primary substation voltage and  $V_{b+1}$  is the magnitude of other buses  $1, \dots, B$  across the network. A busbar with a VSF closer to zero signifies higher voltage instability, which would lead to a consequent voltage collapse of the network. This busbar would require the most contribution from any form of voltage regulation on the network. In considering the overall voltage performance of the network, the  $VSF_{total}$  metric shown in 13 was used. A higher value for  $VSF_{total}$  across the network signifies improved voltage stability on the network.

$$VSF_{b+1} = 2V_{b+1} - V_b \quad 12$$

$$VSF_{total} = \frac{\sum_{b=1}^{B-1} (VSF_{b+1})}{B - 1} \quad 13$$

## 2.4 ESS IMPLEMENTATION

The ESS is controlled to resolve or mitigate problems triggered by user defined thresholds for particular events that indicate voltage constraint and power flow conditions have been breached. The defined events and set thresholds are listed in Table 5-2. For thermal constraints, during normal operating conditions, the cables and transformers on the network are designed to have 25 to 50% extra capacity to increase reliability (for example, a feeder on a network can support load on another feeder during system reconfiguration in the event of an outage on the network) [128]. Two control interventions are applied on the network to maintain the network within operating limits for voltage and thermal constraints, which are aligned with DNO operating practices, as shown in Figure 5-6. The following assumptions were made:

- The target voltage at the primary substation is fixed at a level that maintains the voltage on the network within limits in the base-case simulations;
- There are Remote Terminal Units (RTU) distributed across the network to provide information on voltage on all busbars and power flows across the network lines and cables to a centralised controller, which makes decisions and sends out control signals to any ESS located on the network to source and sink real and reactive power based on the events defined in Table 5-2;

| Event                                      | Threshold                                    |
|--|--|
| Overvoltage/Undervoltage                   | $\geq +6\%$ / $\leq -6\%$ of nominal voltage |
| Transformer overpower (forward or reverse) | $\geq 50\%$ of transformer rating            |
| Cable/line (branch) overpower              | $\geq 75\%$ of branch rating                 |

Table 5-2: Events monitored and defined thresholds

The ESS operates based on order of severity, with the most severe events tackled first. Transformer overpower is handled first followed by branch (line) overpower,

undervoltage, reverse power flow and overvoltage Overpower events were chosen as the most severe because of the high cost of replacement of network lines/cables and transformers. Reverse power flow was chosen to be handled before overvoltage because it also leads to overpower and is a major cause of overvoltage. If excess power from reverse power flow is absorbed, it will reduce overvoltage events. Figure 5-6 illustrates the voltage and thermal constraint management algorithm implemented in this study to mitigate the events itemised in Table 5-2. The voltage and thermal constraint management is explained in the following subsections.

#### **2.4.1 Voltage regulation**

The line/cable impedance on the network demand and source voltage affects the voltage on the network. Due to low X/R ratios on the distribution network, control of real and reactive power flows are both important in maintaining the network voltage. As reactive power use does not require energy purchase, the control algorithm preferentially uses reactive power to resolve a voltage excursion. Real power is then used in situations where reactive power is not effective after several iterations or the converter rating limits are reached.

The coordinated operation of the OLTC and ESS for voltage regulation is based on the work carried out by Anuta et al [253]. Initially, the OLTC regulates network voltages as normal convention. If the OLTC is unable to keep voltage within the limits  $V_b^{min} < V_b < V_b^{max}$ , where  $V_b^{min}$  and  $V_b^{max}$  are the minimum and maximum voltage thresholds of busbar  $b$  as described in Table 5-2, the OLTC is locked and the ESS control algorithm is initiated. The ESS iteratively sources or sinks reactive power for undervoltage or overvoltage events until the voltage excursion is resolved. If at full reactive power the event still prevails and a higher reactive power above the power converter rating is required, then real power is used in addition, following the same iterative process to resolve the issue. If the real power required goes over the converter rating or the energy is depleted and the event is not resolved, then the tap changer is initialised to provide the additional voltage regulation required after the ESS real and reactive power limits are reached.

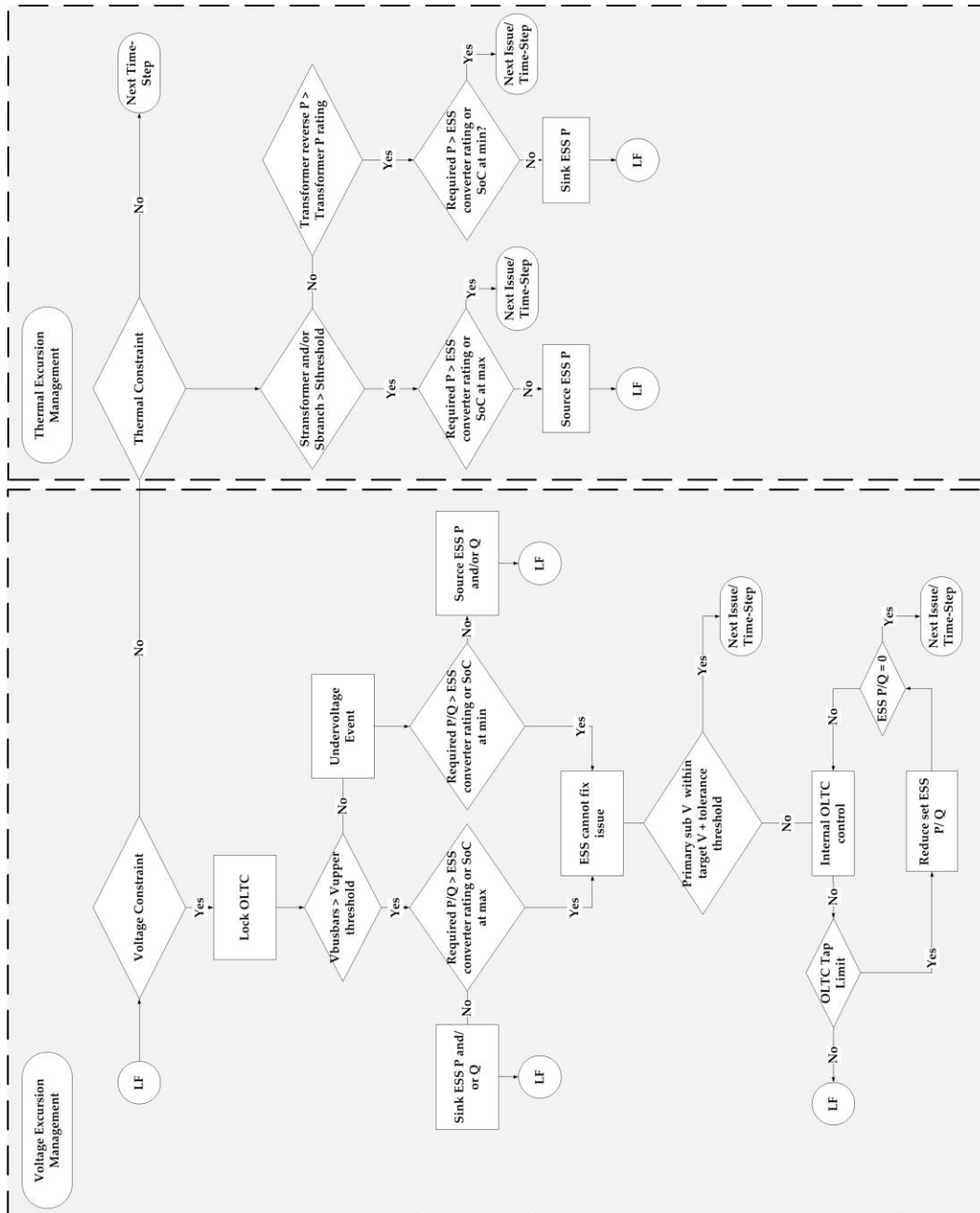

Figure 5-6: Voltage and thermal constraint management

### 2.4.2 Internal OLTC control

The internal OLTC control algorithm is used instead of the OLTC algorithm used in the IPSA load flow program. It enables the OLTC operation to be coordinated with the operation of the ESS as part of the voltage constraint management system illustrated in the process diagram in Figure 5-7. The OLTC and ESS control is initiated when the OLTC alone cannot maintain the voltage within limits  $\Delta V$ , which is the difference in voltage of the primary substation against a set target voltage  $V_{target}$  is calculated as shown in 14.

$$\Delta V = V_{sub} - V_{target} \quad 14$$

This triggers the AVC relay when the voltage is above a set threshold. The OLTC is locked and a value for  $\Delta Tap$  is derived based on  $\Delta V$ , the OLTC tap step percentage  $\%T_{step}$ , and  $V_{target}$ . This is represented in 15. The OLTC is then moved following  $\Delta Tap$  requirements.

$$\Delta Tap = \frac{\Delta V}{\%T_{step} \times V_{target}} \quad 15$$

The process diagram internal OLTC control algorithm is represented in Figure 5-7. The OLTC operation will be triggered as part of the voltage constraint management algorithm whenever there is a voltage excursion on the network.

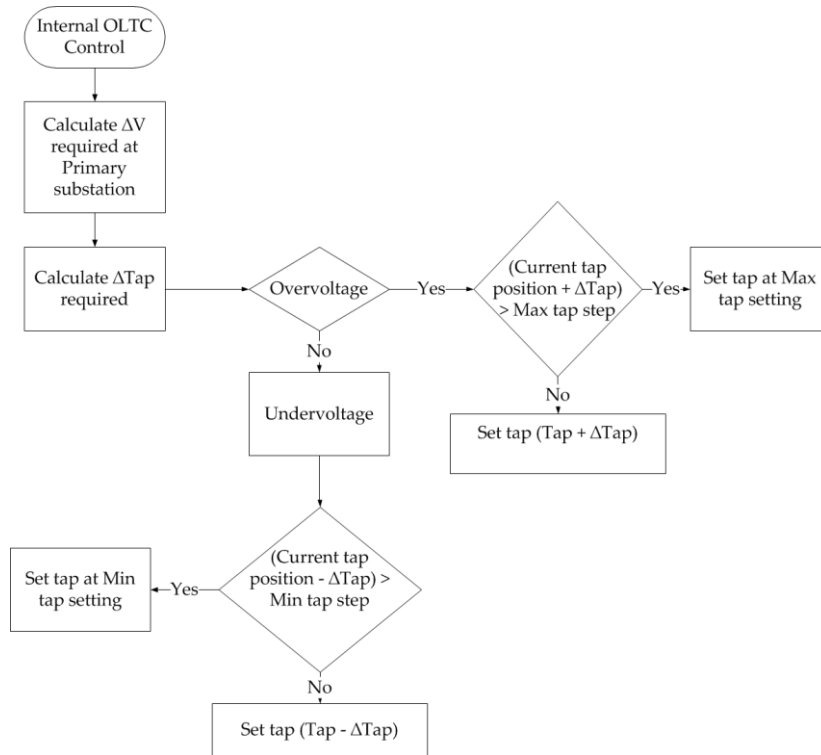

Figure 5-7: Internal OLTC control

### 2.4.3 Power flow management

The branch and transformer capacities are monitored against set thresholds  $S_{br} < S_{br}^{\max}$  and  $S_{tfmr} < S_{tfmr}^{\max}$ , where  $S_{br}^{\max}$  and  $S_{tfmr}^{\max}$  are the maximum power rating or allowed thresholds for the branches and transformer as listed in Table 5-2. The threshold for the transformer is based on the N-1 condition. In the event of overpower caused by increased demand, the ESS intervenes by sourcing real power

to reduce the amount of power flows through the lines or transformers. Reverse power flows that lead to overpower on the transformer are resolved by sinking the excess power. The control is initiated when the power monitored at the transformer goes beyond the set threshold for real power  $S_{\text{export}} < S_{\text{tfmr}}^{\text{max}}$ , where  $S_{\text{export}}$  is the apparent power seen at the primary transformer.

#### **2.4.4 Electricity market operation in energy market**

An operating strategy was created for the ESS that enables it to charge and discharge based on spot market prices and/or network constraint limits to meet the requirements of a particular business model. An illustration of the operation algorithm developed is shown in Figure 5-8. The following assumptions are made for electricity market operation:

- An operation error of +/-10% is assumed for the ESS charge and discharge at every half hour. This explores the impact of a shortfall in operation where there is either not enough energy to meet contracted generation volumes or the ESS is too full to meet contracted demand in a half hour delivery period. A sensitivity analysis could be carried out on this, but this is beyond the scope of this study;
- The half hourly electricity prices in the spot market are known before the next day;
- Negative prices and default prices are not considered in the balancing mechanism as this study uses averages of balancing mechanism prices over a season for each quarter to represent daily weekday and weekend prices. Negative prices occur when no BSC trading party (generator or supplier) is willing to reduce generation or increase demand leading to low or zero prices for bids in the transmission system [254]. Default prices occur when weighted average imbalance prices cannot be calculated because there is no MIDP and/or accepted offers and or bids for the balancing mechanism [254];
- The market activities of a DNO owned ESS would be managed by suppliers or aggregators;

Three operating strategies are tested, this includes technical, market only and technical and market. For the ESS technical operation, the ESS is only triggered by technical events and uses the control strategy described in Figure 5-6 to operate the ESS. In this case, the ESS only participates in the market only when real power intervention is required for voltage and thermal constraint management. The ESS is charged to its full SoC during the off-peak period, if active power was discharged during the day. For ESS technical and market operation, the ESS is triggered first to mitigate any defined events and afterwards, the remaining capacity is used to participate in energy arbitrage, within the network operating constraints. If there is no network intervention required, the ESS operation is triggered by changes in the daily market price, also within network constraints. For market based operation, the ESS is triggered solely based on daily market prices and operation does not take into account network constraints.

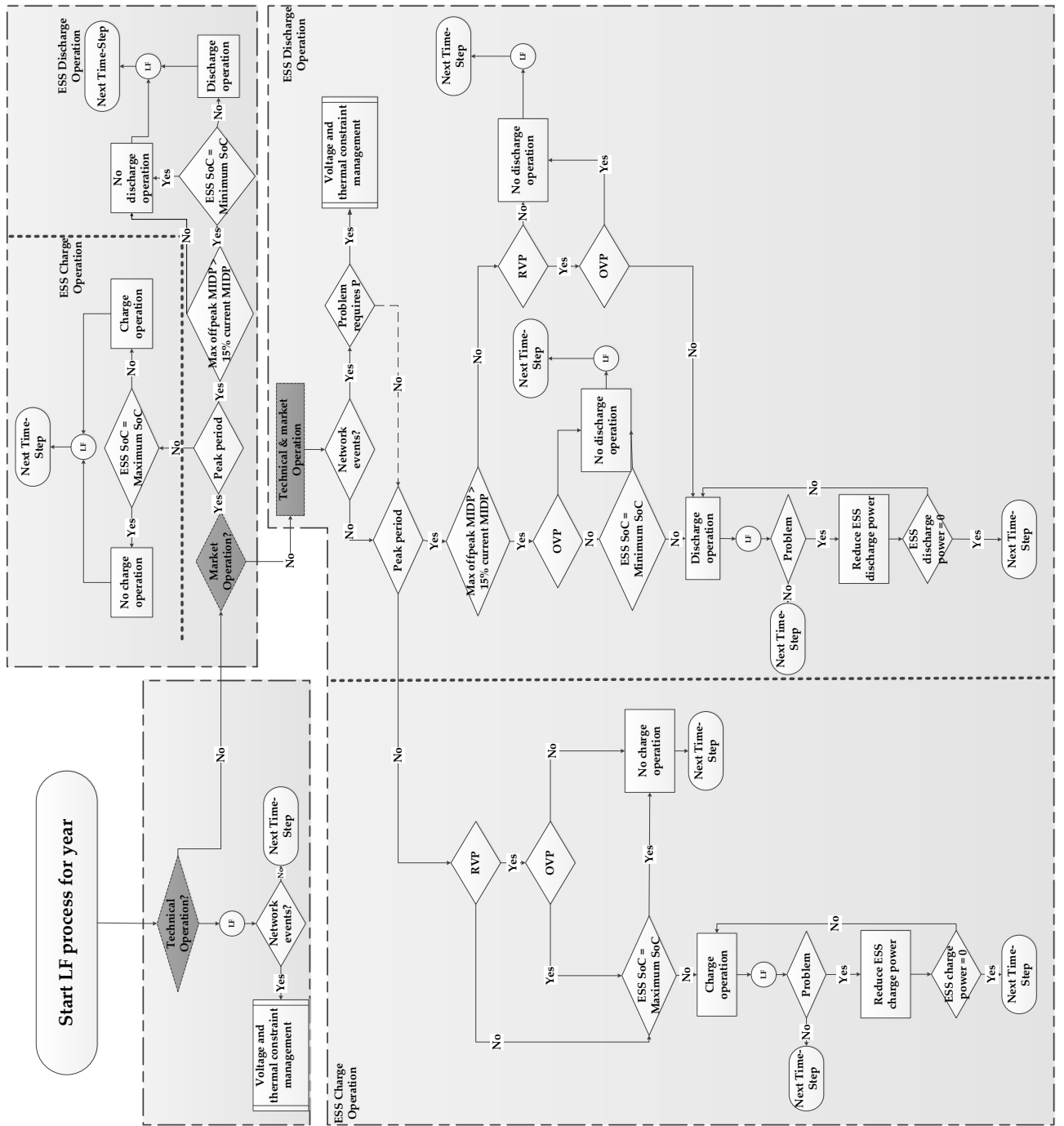

Figure 5-8: Control strategy for ESS market operation

The off-peak period was defined as periods between 00:00 hrs – 06:30 hrs and the peak period was classed as any half hour period after 7:00 hrs. The ESS is controlled to charge to full SoC during the off-peak period and discharge when the market price after the defined off-peak periods surpasses 15% (arbitrage operation threshold) of the maximum off-peak electricity price used for charging the ESS during the off-peak period. The 15% figure ensures losses from charging the ESS are recovered when discharging during peak periods. Figure 5-9 shows an example of



when the ESS will charge based on the market prices for 2013 on a weekday with a 15% setting for arbitrage operation. There are 10, 15, 22 and 17 operations for quarter 1 (January - March), quarter 2 (April - June), quarter 3 (July – September) and quarter 3 (October – December).

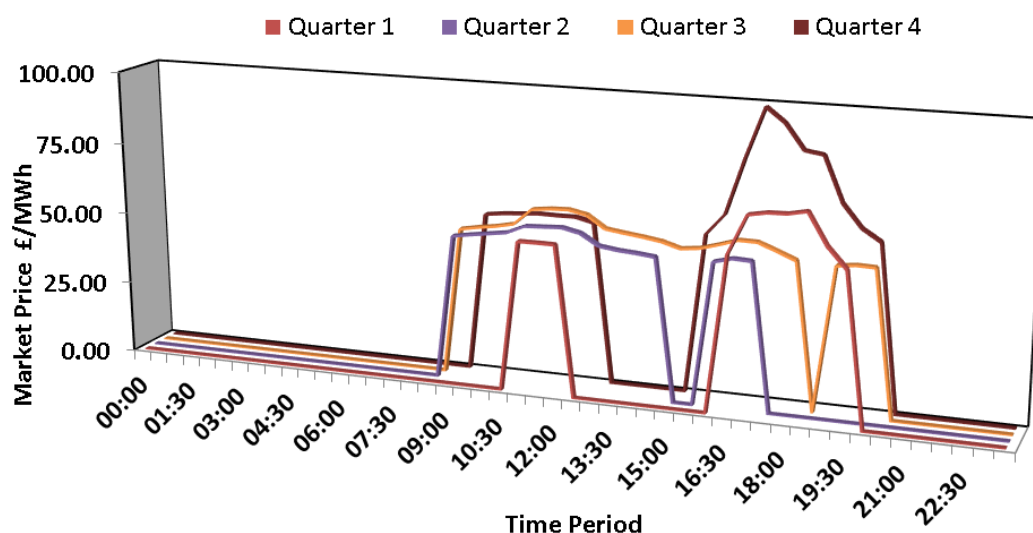

Figure 5-9: Market operation for ESS based on 15% trigger for peak period ESS operation based on 2013 market prices

The key points to note under the ESS market operation are that based on the day ahead prediction for demand on the network assuming a 95% accuracy, and day ahead knowledge of the MIDP, the ESS is controlled accordingly to ensure:

- If there is an over-power and reverse power incident in a half hour period, overpower is considered more important than reverse power and overrides the decision to keep the ESS uncharged during the off-peak periods to have sufficient room to sink excess power above thermal constraints during periods of reverse power. In the case of overpower, the ESS is not discharged during the peak period (or is fully charged during the off-peak period) and is only used for peak shaving on the network on that day;
- Otherwise, if there is a reverse power event only (which usually happens in the afternoon when there is excess power export from PV) and the ESS is at full SoC, it will be fully discharged before the period when reverse power

occurs, otherwise, if the ESS is at the minimum SoC, it remains in that condition to absorb excess power later in the day.

- The efficiency loss from charging and discharging the ESS is factored into the decision to charge and discharge during the day based on the trigger for arbitrage operation. As more power will be required to charge up the ESS to full charge during off-peak periods due to the losses. The cost of the loss is factored into the price calculation to trigger arbitrage. For a purely technical operation, this cost of the efficiency loss is factored into the operating cost of the ESS.

#### Revenue from balancing market

The imbalances caused by the ESS discharging past or charging below its contracted position (ESS is long) represents imbalance revenues and the imbalance cost is considered when the ESS charges past its contracted demand or discharges below its contracted position (ESS is short). The imbalance revenue is then added to the revenue from the spot market, and likewise the imbalance cost is subtracted from the spot market revenue for that half hour. Afterwards, the average of both values makes the revenues from the spot market and the balancing mechanism.

#### **2.4.5 Other commercial revenues**

Triad is implemented as two events occurring in January and one in December based on analysis of historical occurrences of Triad events shown in Table 5-3 using data provided by National Grid on historical Triad events [255]. Triad avoidance revenues are assumed to be gained in the time periods when the ESS is discharged for market or technical interventions on the network. If the Triad period doesn't fall within the periods when the ESS is used for market or technical interventions, it is possible to gain similar forms of revenue by acting purely on Triad warnings provided by electricity suppliers [256]. However, the warnings and the three Triad events vary yearly based on requirements from National Grid and is beyond the scope of this study.

| Winter Month | Leg 1 | Leg 2 | Leg 3 |
|--------------|-------|-------|-------|
| November     | 4     | 1     | 4     |
| December     | 11    | 9     | 8     |
| January      | 7     | 12    | 10    |
| February     | 2     | 2     | 2     |

Table 5-3: Monthly frequency of occurrence of Triad from 1991 to 2014

The value of the ESS operation in the final year of the planning period is also evaluated for FFR and STOR services. This is done by post processing the output from the two ESS operating on the network to determine the parameters used to calculate FFR payments discussed in Section 3. It is worth noting the parameters used to determine payment, i.e FFR nomination window and STOR average yearly utilisation are assumed based on figures provided by Strickland, 2014 #1456} and [257].

### 3 PROBLEM FORMULATION

#### 3.1 COST AND REVENUE STREAMS

Money available today has a higher value than the same amount of money available in a future year. This is taken into account using a discount rate to get the present value of all cost and revenue streams using the Present Worth Factor (PWF) over the planning period. The PWF is used for the Net Present Value (NPV) analysis of the ESS investment under different business models. The economic assumptions used in calculating cost and revenue streams are shown in Table 5-4. The *PWF* derived from [258] is calculated as shown in 16, where  $d$  is the discount rate  $Y$  is the lifetime of the project over  $y$  years.. The commercial model (non-regulated model) should have a higher discount rate applied and the DNO owned ESS model (DNO-StO) should have a lower discount rate because they are regulated and have a cheaper cost of capital. However, for consistency, only the nominal discount (interest) rate is considered in the NPV analysis of the ESS investment over the planning period to discount to the year of assessment (2015). The discount rate used is high at 6%

because the investment in ESS is classed as a risky investment. This is the usual approach used in cost-benefit analysis to avoid estimating the future values of inflation, which is unpredictable and affected by social, economic and political factors [259].

$$PWF = \sum_{y=1}^Y \frac{1}{1 + d^{(y-0.5)}} \quad 16$$

| Parameter                            | Value  |
|--------------------------------------|--|
| Discount rate for third party        | 6% (riskier investment)                        |
| Assumed economic asset life (years)  | 20 years                                       |
| Asset operation and maintenance cost | 1.4% [260, 261]                                |
| Return on regulated equity           | 7% [261] [260]                                 |
| FFR nomination windows               | 750 (low frequency) 750 (high frequency) [262] |
| STOR average yearly utilisation      | 50 – 80 [257]                                  |

Table 5-4: Planning study economic assumptions

### 3.1.1 ESS Cost

The ESS costs considered include cost of energy capacity (in this case, from batteries) and of the power converter. If the ESS is owned by a third party, the Third Party ESS owner (Tp-StO) is liable to DUoS connection costs and ongoing charges [263].

One-off charges, i.e. shallow connection cost covers the cost of asset equipment and work needed to connect the ESS to the distribution network. This is a grid access requirement regulated under the GB Grid code for generators. The DNOs will require a connection charge from the third party if they have to reinforce a part of the network for the ESS or provide a new connection. Connection charges also cover extra costs such as, feasibility studies and budget estimate costs. Ongoing charges on the other hand cover costs for reinforcement, operation and maintenance. This will depend on the agreement with the DNO and TP-StO, i.e. if they provide network support services, charges could be discounted partially or fully. Only ongoing charges, i.e. DUoS charges are considered in this paper. Contrarily, DNO ESS owners (DNO-StO) are not liable to such charges as the ESS is deemed a network

asset. Table 5-5 shows the cost and operating parameters for the ESS and 17-21 express the capital and operating costs, which are now discussed.

| Technology            | Power Conversion System Cost (\$/kW) | Energy Storage Subsystem Cost (Including Balance of Plant cost) (\$/KWh) | Round Trip Efficiency (%) | Cycles |
|-----------------------|--------------------------------------|--|---------------------------|--------|
| Battery Upper Limit   | 2000                                 | 2000   | 85                        | 4000   |
| Battery Lower Limit   | 500                                  | 400  | 85                        | 400    |
| Lithium Ion Batteries | 400                                  | 600  | 85                        | 4000   |

Table 5-5 Storage parameters and cost [264] [258] [265]

The following are not considered for the ESS costs:

- Balance of Plant (BOP) costs, which vary based on factors, such as location, planning permits, civils works and size of installation;
- The yearly fixed operating costs for the ESS, other than the cost of charging the ESS, are not taken into account in the ESS model as this varies based on the battery type, cost of maintenance, and mode of daily use of the battery;
- Connection costs for both DNO and Tp-StO ownership types. These costs have to be estimated by DNOs or consultants based on detailed network studies and are beyond the scope of this study [263].

The economic feasibility of using the ESS on the distribution network is based on the utilisation of the ESS to offset the capital cost  $CC$  and operating costs  $OC$ . The  $CC$  comprises the cost of the power converter and energy capacity:

$$CC = \sum_{y=1}^Y \sum_{n=1}^N \left[ \left( P_{ess,y,n} \times P_{cap\ cost_y} + E_{ess,y,n} \times E_{cap\ cost_y} \right) \right] \times PWF_y \quad 17$$

The  $OC$  covers the cost to operate the ESS (i.e. charge and discharge in the electricity market) to meet technical and/or market requirements of stakeholders:

$$OC = \sum_{y=1}^Y \sum_{n=1}^N \sum_{t=1}^T \left[ \left( E_{ess,y,n,t} \times MIDP_{y,t}^{discharge} \right) - \left( E_{ess,y,n,t} \times MIDP_{y,t}^{charge} \right) \right] + rep_{ess,y,n} + C_{T\&D,y,n,t} \times PWF_y \quad 18$$

The  $OC$  also covers the cost of replacement of batteries during the project life.

$$rep_{ess} = \left( E_{ess,y,n} \times E_{cap\ cost,y} \right) \quad 19$$

The replacement cost  $rep_{ess}$  is based on degradation due to the amount of energy cycled through the ESS during the lifetime of the project. And finally the network charges from the transmission and distribution network  $C_{T\&D}$  is calculated as:

$$C_{T\&D} = \left( E_t^{charge} \times unit_t^{DUoS} \right) + \left( P_{ess,d} \times MIC_d^{DUoS} \right) + fixed_d^{DUoS} \quad 20$$

where the capital cost is calculated using the power rating,  $P_{ess,y,n}$  of ESS  $n$  up to the total number of ESS  $N$ ;  $P_{cap\ cost,y}$  is the cost of the power converter over a year which changes yearly based on  $PWF_y$ ;  $E_{ess,y,n}$  represents the energy capacity of an ESS on the network and  $E_{cap\ cost,y}$  represents the energy capacity cost of the ESS, also affected by the  $PWF_y$ .

The  $OC$  is for a DNO-StO (or ESS used purely for technical interventions). It will include the revenue from discharging the ESS to offset the cost of charging the ESS, if the DNO-StO is allowed by regulation. In the business case with a TP-StO or DNO-StO leasing the ESS services to a third party, this  $OC$  becomes the arbitrage revenue and is optimised to ensure more money is made from operating the ESS in the spot market. The  $OC$  comprises the  $MIDP_{y,t}^{discharge}$ , which is the price in £/MWh that is used to determine the amount paid to the DNO for discharging energy  $E_{ess,y,n,t}$  from ESS  $n$  over time  $t$  for a year of study  $y$ ; and  $MIDP_{y,t}^{charge}$  which is the price in £/MWh paid by the DNO for charging energy.

For a DNo-StO ownership type and network support services business model, only ESS replacement  $rep_{ess}$  is considered and the ESS is treated as a network asset with no use of system costs  $C_{T\&D}$ .  $C_{T\&D}$  is the charge levied to an ESS owner when the ESS acts as a consumer (discharging) or the financial benefit for the ESS acting as a

consumer (charging). The complete list of DUoS charges are discussed in [266].

However, the charges considered for this paper are:

- Capacity charge ( $MIC_d^{DUoS}$ ), this is a fixed DUoS charge based on the Maximum Import Capacity (MIC) of the ESS in a day ( $d$ ) based on GB p/kVA/day;
- Unit charges ( $unit_t^{DUoS}$ ) for charging the ESS at each time period, which is broken down into red, amber and green depending on the time of day and whether it is a weekday or weekend based on GB p/kWh;
- Fixed charge ( $fixed_d^{DUoS}$ ), which is a fixed daily charge for using the distribution network based on p/day.

### 3.1.2 ESS Revenues

Revenue streams for different ownership types are limited by regulatory and electricity market rules. This entails different types of business models, which will require collaboration between stakeholders in order to be able to realise the wide ranging benefits of ESS for all parties.

### 3.1.3 ESS Salvage value

At the end of the planning period, the salvage value (based on the remaining energy throughput) of the ESS reduces the costs of owning the ESS. This is a fraction of the capital cost of the ESS energy capacity cost is calculated by:

$$salvage\_value_{ESS} = \left( salvage\_ratio_{ESS_n} \times lf\_r_{ESS} \times E_{cap\ cost_y} \right) \times PWF_y \quad 21$$

The salvage value  $salvage\_value_{ESS}$  is derived from the ESS salvage ratio,  $salvage\_ratio_{ESS_n}$  for  $n$  number of ESS expressed in equation 10, the remaining life of the ESS,  $lf\_r_{ESS}$  and the capacity cost of the ESS  $E_{cap\ cost_y}$ .

### 3.1.4 Network Deferral Benefits

The returns from network upgrade avoidance or deferral using ESS are dependent on levels of demand and LCT growth and the resulting effect it has on the network.

The traditional reinforcement options used by DNOs and considered in this study are:

- Voltage control – using capacitor banks for shunt regulation to raise the voltage at problem areas where they will be connected and inline voltage regulators for series regulation to raise the voltage downstream along a feeder much like the OLTC;
- Power flow management: line or cable reconductoring and/or substation transformer upgrade to increase the thermal capacity of the network.

The annual revenue from upgrade deferral ( $R_{def}$ ) using ESS against traditional reinforcement options was derived from asset deferral value calculated in [260] and is expressed in 22-25.

$$R_{def} = \sum_{y=1}^Y (P_{Dpr} + P_{rtn} + P_{O\&M}) \times PWF_y \quad 22$$

$$P_{Dpr} = \frac{rfmt_{cap}}{AL} \quad 23$$

$$P_{rtn} = Cap_{rft} \times rtn_{asset} \quad 24$$

$$P_{O\&M} = Cap_{rft} \times PC_{O\&M} \quad 25$$

where  $P_{dpr}$  is the depreciation cost of network reinforcement or upgrade over the project life,  $AL$  is the equipment asset life, and  $rfmt_{cap}$  is the capital cost for reinforcement;  $P_{rtn}$  is the return on DNO assets,  $rtn_{asset}$  is the percentage return on network asset for DNOs set by Ofgem;  $P_{O\&M}$  is the operation and maintenance cost of network reinforcement and  $PC_{O\&M}$  is the annual percentage operation and maintenance cost for network asset.

### 3.1.5 Spot Market and Balancing Mechanism Annual Revenue

In order to test the impact of not meeting contracts for power export or import in the power market, the ESS is assumed to charge or discharge over or under the contracted position based on an imbalance error set at 10%. This will lead to an increase or reduction in overall market revenues gained from arbitrage operations



from participating in the balancing mechanism. The revenue from ESS operating in the spot market and balancing mechanism is expressed using 26- 29.

$$R_{\text{mkt}} = \sum_{y=1}^Y \text{mean}\{(R_{\text{arb},y} - \text{short}_{\text{ESS}}) + (R_{\text{arb},y} + \text{long}_{\text{ESS}})\} \times PWF_y \quad 26$$

$$R_{\text{arb}} = \sum_{n=1}^N \sum_{t=1}^T [(E_{\text{ess},n,t} \times \text{saleprice}_t^{\text{pk}}) - (E_{\text{ess},n,t} \times \text{buyprice}_t^{\text{off pk}})] \quad 27$$

$$\text{long}_{\text{ESS}} = \sum_{n=1}^N \sum_{t=1}^T (E_{\text{ess},n,t} \times \text{err}_{\text{imb}} \times \text{sellprice}_t^{\text{bm}}) \quad 28$$

$$\text{short}_{\text{ESS}} = \sum_{n=1}^N \sum_{t=1}^T (E_{\text{ess},n,t} \times \text{err}_{\text{imb}} \times \text{buyprice}_t^{\text{bm}}) \quad 29$$

Where  $R_{\text{mkt}}$  is the revenue from participating in the spot market and balancing mechanism;  $R_{\text{arb}}$  is the arbitrage revenue from the electricity market over a day;  $\text{long}_{\text{ESS}}$  and  $\text{short}_{\text{ESS}}$  are the revenues or penalties from the balancing mechanism that are incurred from deviating from contracted energy over a day;  $\text{buyprice}_t^{\text{off pk}}$  is the spot market (MIDP) price in £/MWh at a half hour time period  $t$  (off-peak period) used to calculate the cost of energy  $E_{\text{ess},n,t}$  for charging the ESS and  $\text{saleprice}_t^{\text{pk}}$  is the price (MIDP) used to calculate the revenues from discharging energy from the ESS during peak periods;  $\text{buyprice}_t^{\text{bm}}$  and  $\text{sellprice}_t^{\text{bm}}$  is the SBP or SSP price in the balancing mechanism to correct imbalances;  $\text{err}_{\text{imb}}$  is the error of imbalance on contracted energy position. If the balancing mechanism is not considered, the revenue from arbitrage will equal the revenue from the market.

### 3.1.6 Other market revenues

#### Ancillary services markets

Generators and other market participants cannot provide simultaneous or more than one service at a time in the ancillary services market [267]. Hence STOR and FFR services are considered independently as market operations and the ESS value from both markets is post-processed only for year 15 of the planning study using the ESS operation pattern from the technical operation. The value is calculated when the ESS is not used and established to be available for FFR or STOR services. It assumed the ESS gains long term contracts for FFR or STOR. The revenue from dynamic frequency response ( $R_{ffr}$ ), for either High Frequency (HF) and/or Low Frequency (LF) services is:

$$R_{ffr} = \sum_{y=1}^Y \sum_{n=1}^N \left\{ \left( [MWh_{ffr,y,n} \times Avail_{ffr,y}] \times [N\_window \times Nom_y] \right) - OC \right\} \times PWF_y \quad 30$$

Where  $MWh_{ffr,y,n}$  is availability of each ESS  $n$  to provide energy for FFR services over the year  $y$ ;  $N\_window$  is the nomination window in a year when National Grid calls on generators for high and low frequency events;  $Avail_{ffr,y}$  is the fee for availability of dynamic FFR services (£/MW/hr); and  $Nom_y$  is the holding or nomination fee (£/MW/hr);  $OC$  is the operating cost for using the ESS expressed in 18. The upper and low frequency nomination figures were obtained from the assumptions in Table 5-5. The following steps were used in calculating FFR revenue:

1. Get the FFR availability in days for HF and LF events:
  - Periods between 07:00 – 23:30 hours are classed as the peak period when LF events occur (ESS discharging occurs) and periods between 00:00 and 06:30 hours are classed as periods with HF events (ESS charging occurs). The availability for both periods is calculated by determining the average daily SoC of the ESS over the year. Afterwards, a count of when the SoC equals the maximum SoC value all through the year is carried out to obtain the average availability of the ESS in days over the year. The ESS will be at maximum SoC when it is not being used for other services;

2. Get the ESS availability for FFR services in hours:
  - Calculate how long the charge operation for HF events and discharge operation for LF events can last at the maximum converter rating by dividing the maximum average daily SoC over the year by maximum energy discharged (limited by converter rating) in a half hour period over the year (this factors in the 85% RTE of the ESS). The obtained figure is then converted to figures for the hour as opposed to half- hourly availability to give  $MWh_{ffr,y,n}^{HF}$  and  $MWh_{ffr,y,n}^{LF}$  for HF and LF services respectively.
3. Calculate the availability payments for HF and LF services. The availability of the ESS to provide FFR services during the HF and LF periods for the calculated amount of hours and respective days over the year is multiplied by  $Avail_{ffr,y}$  to derive the HF and LV availability payments.
4. Calculate the nomination payments based on the nomination windows for HF and LF events in a year  $N\_window_y$  multiplied by the nomination fee  $Nom_y$ .
5. The net FFR revenue from HF and LF services  $Net_{FFR}$  is determined by summing the  $R_{ffr}$  revenues for both services  $R_{ffr}^{HF}$  and  $R_{ffr}^{LF}$ , and subtracting the total revenue from the energy cost  $EC$  of providing the FFR services  $MWh_{ffr,y,n}^{HF}$  and  $MWh_{ffr,y,n}^{LF}$ , and the cost of technical operation  $OC_{Tech}$  to fix network issues – if it is not a pure ancillary service based ESS operation.

$$Net_{FFR} = R_{ffr}^{HF} + R_{ffr}^{LF} - EC + OC_{Tech} \quad 31$$

$$EC = \left\{ \left[ \left( MWh_{ffr,y,n}^{HF} \times \text{Mean\_MIDP}_y^{\text{off-peak}} \right) + \left( MWh_{ffr,y,n}^{LF} \times \text{Mean\_MIDP}_y^{\text{peak}} \right) \right] - OC_{Tech} \right\} \times PWF_y \quad 32$$

$$OC_{Tech} = \sum_{y=1}^Y \sum_{n=1}^N \sum_{t=1}^T \left[ \left( E_{ess,y,n,t} \times \text{MIDP}_{y,t}^{\text{discharge}} \right) - \left( E_{ess,y,n,t} \times \text{MIDP}_{y,t}^{\text{charge}} \right) \right] \times PWF_y \quad 33$$

Where  $\text{Mean\_MIDP}_y^{\text{peak}}$  is the mean of peak prices in the spot market between the periods of 7:00 – 23:30 hours,  $\text{Mean\_MIDP}_y^{\text{off-peak}}$  is the mean of off-peak prices in the other periods; and  $OC_{\text{Tech}}$  is the operational cost to resolve technical issues outside of FFR services during the year, if the ESS is not used purely for market operation.

### Short term operating reserves

The revenue from STOR ( $R_{\text{STOR}}$ ) is expressed in 34.

$$R_{\text{STOR}} = \sum_{y=1}^Y \sum_{n=1}^N \left\{ \left( [MWh_{\text{STOR}_{y,n}} \times Avail_{\text{STOR}_y}] \times [MWh_{\text{util}_{y,n}} \times Util_y] \right) - OC_{\text{ESS}} \right\} \times PWF_y \quad 34$$

$MWh_{\text{STOR}_{y,n}}$  is the availability of each ESS to provide energy for STOR services over the year,  $MWh_{\text{util}_{y,n}}$  is the number of times energy is provided in a year,  $Avail_{\text{STOR}_y}$  is the fee for availability to provide STOR services (£/MW/hr),  $Util_y$  is fee for utilising each ESS in £/MWh; and  $OC_{\text{ESS}}$  is the operation cost for using the ESS expressed in 18.  $MWh_{\text{STOR}_{y,n}}$  is calculated by determining the number of days in a year and hours in each day the ESS can discharge at peak power. This has to fit with the requirements of minimum 2 hour availability for each call from National Grid and a maximum of 3800 hours allowed for utilisation in a year. ESS availability is considered between 6:30 – 22:30, which covers the window period STOR service are usually used in a year [242]. The ESS is modelled as providing services as a committed provider by providing the STOR service in every STOR window.

The STOR revenue for availability payments is calculated following the steps:

1. Get the STOR availability in days:
  - Assuming the ESS is called upon during the STOR window between 06:30 – 23:30 hours, calculate the average daily SoC of the ESS over the year during that window. This indicates if the ESS is available all day for STOR. Afterwards, count when the SoC equals the maximum SoC value all through the year. This is used to obtain the average

availability of the ESS in days. The ESS will be at maximum SoC when it is not being used for other services;

2. Get the STOR availability in hours:
  - Calculate how long the discharge operation can last at the maximum converter rating by dividing the maximum average daily SoC over the year by maximum energy discharged (limited by converter rating) in a half hour period over the year (this factors in the 85% RTE of the ESS). The obtained figure should be converted to availability in hours over the year from half hourly availability to give  $MWh_{STOR,y,n}$ .
3. Calculating the availability payment. Firstly, the hours from the ESS in operation has to be greater than the minimum 2 hour specified for STOR services. If this is the case, then the availability in hours is multiplied by the availability in days. If this is greater than the peak allowed hours for availability of 3800 hours, the ESS availability is capped at 3800 hours, otherwise, it is whatever was initially calculated. This availability in hours is then multiplied by the peak power that can be discharged over the year giving MW/hr over the year, which is then multiplied by the payment in £/MW/hr ( $Avail_{stor,y}$ ) for providing STOR services. This provides the availability payment.

The STOR revenue for utilisation payments is calculated following the steps:

4. The payment for utilisation in £/MWh is also multiplied by the available energy that can be provided over the year based on the average of the maximum SoC and the maximum utilisation in figure set at 80 per year to get the maximum utilisation payment possible. For the minimum utilisation payment, utilisation is reduced to 50 utilisations a year. This provides a range of maximum and minimum utilisation payments.
5. The energy cost is then subtracted from the availability and utilisation payments to get the maximum and minimum net STOR revenue  $Net_{STOR}$ .

based on the 50/80 minimum and maximum number of utilisations per year. The  $Net_{STOR}$  energy cost for the STOR operation  $EC$  is calculated as:

$$Net_{STOR} = R_{STOR} - EC \quad 35$$

$$EC = MWh_{STOR,y,n} \times Mean\_MIDP_y^{peak} + OC_{Tech} \quad 36$$

$$OC_{Tech} = \sum_{y=1}^Y \sum_{n=1}^N \sum_{t=1}^T \left[ \left( E_{ess,y,n,t} \times MIDP_{y,t}^{discharge} \right) - \left( E_{ess,y,n,t} \times MIDP_{y,t}^{charge} \right) \right] \times PWF_y \quad 37$$

Where  $Mean\_MIDP_{y,t}^{peak}$  is the mean of peak prices in the spot market between the periods of 7:00 – 23:30 hours over the year; and  $OC_{Tech}$  is the operational cost to resolve technical issues outside of STOR services during the year, if the ESS is not operated purely for market purposes.

### 3.1.7 Transmission and distribution network use of system charge

The Transmission network or Triad ( $R_{Triad}$ ) revenue for the project life is expressed in 38.

$$R_{Triad} = \sum_{y=1}^Y \sum_{n=1}^N \left( Triad_y \times \frac{1}{3} \sum_{p=1}^P E_{n,p}^{out} \right) \times PWF_y \quad 38$$

$Triad_y$  is the half hour Triad cost for each year  $y$ , based on the location of the ESS,  $E_{n,p}^{out}$  is the energy discharged for each ESS  $n$  over a Triad period  $p$ . It is assumed that TRIAD period falls within periods when the ESS is operating in December and January, which are the months in which TRIAD events have most occurred since 1990 based on analysis from historical data provided by National Grid[247]. Peak ESS power is calculated for those months from the daily changes in SoC.

For the DUoS, generation connected at HV and LV are not subjected to DUoS charges but they get credit under the Common Distribution Charging Methodology (CDCM). ESS much like DG can get embedded benefits from reducing demand by discharging, particularly during peak periods when DUoS unit charges for demand

customers is at its highest. The revenue from DUoS,  $R_{DUoS}$  for the ESS acting as a generator is based on unit charge and fixed charges as represented in equation 39.

$$R_{DUoS} = \sum_{y=1}^Y \sum_{n=1}^N \left( (E_{y,n,t}^{out} \times unit_{y,n,t}^{DUoS}) + fixed_{y,d}^{DUoS} \right) \times PWF_y \quad 39$$

Where  $E_{y,n,t}^{out}$  is the energy of each ESS  $n$  discharged over each time period  $t$  in a year  $y$ ;  $unit_{y,n,t}^{DUoS}$  is the DUoS amount paid to each ESS over the red, amber and green periods if the ESS is discharging,  $fixed_{y,d}^{DUoS}$  is the fixed DUoS charge every day  $d$ .

### 3.2 ASSESSMENT OF THE PROFITABILITY OF ESS UNDER DIFFERENT SCENARIOS

For financial feasibility, the NPV of the investment should be greater than zero

$$(R_{tot}) - (ESS_{cap} + ESS_{op}) \geq 0 \quad 40$$

Where  $R_{tot}$  is a combination of different revenue streams, which is dependent on the ownership type and business model. The ownership types will provide different revenues for the ESS from either network support or competitive services, or from both services. The case studies based on ownership type and business models are:

1. Operation as a third party for market operation only (TP-StO);
2. Operation as DNO owned ESS for network support services (technical operation) only (DNO-StO);
3. Operation as third party ESS for market operation with leased service to a DNO for network support (TP-StO). In this case, the ESS could also be owned by the DNO as a non-regulated asset with services leased to a third party for market operations.

For the collaborative model with the DNO and third party (business model 3), the network support service is given priority and extra capacity is used for competitive services, while for the TP-StO without DNO contract (business model 1), only competitive services are considered for the ESS operation. Table 5-6 shows the cost and revenue streams explored for operating the ESS based on the different business models, where  $CC$  is the capital cost and  $OC$  is the operational cost.

| Case | Service/Business Model  | Revenue Streams  | Costs            |
|------|---|--|------------------|
| 1    | Spot market and balancing market - TP-StO                                       | $R_{tot}$<br>$= R_{mkt} + R_{TRIAD}$<br>$+ R_{DUoS}$           | $CC+OC+C_{T\&D}$ |
| 2    | Network support – DNO-StO   | $R_{tot} = R_{def}$  | $CC+OC$          |
| 3    | Network support and spot market/balancing market – DNO-StO                      | $R_{tot}$<br>$= R_{def} + R_{mkt}$<br>$+ R_{TRIAD}$            | $CC+OC$          |
| 4    | Network support and spot market/balancing market – TP-StO and DNO collaboration | $R_{tot}$<br>$= R_{def} + R_{mkt}$<br>$+ R_{TRIAD} + R_{DUoS}$ | $CC+OC+C_{T\&D}$ |

Table 5-6: ESS ownership and business types with revenue streams and costs

The business model which involves evaluating FFR and STOR services is only considered in the last year of study (year 15) from post processing the results from the ESS technical operation. This is when the ESS's used will be at their largest power and energy rating and provides an indication of the potential revenues that both services can provide an ESS owner.

#### 4 LONG TERM PLANNING CASE STUDY

The simulation runs load flows at half-hour resolution for one year of data on the MV case study network over a 15 year planning period to determine the effect on the network if no reinforcement is carried out; this establishes the base-case. The results are analysed to determine when the ESS should be deployed and the energy and power rating required for resolving all events on the network. The ESS is modular as the events severity will increase yearly and so the energy capacity and power rating will need to be increased. The three ESS operating strategies are tested by simulation. The results are analysed and a financial assessment is made to determine the most feasible business model(s). Figure 5-10 illustrates the steps carried out for the planning study.



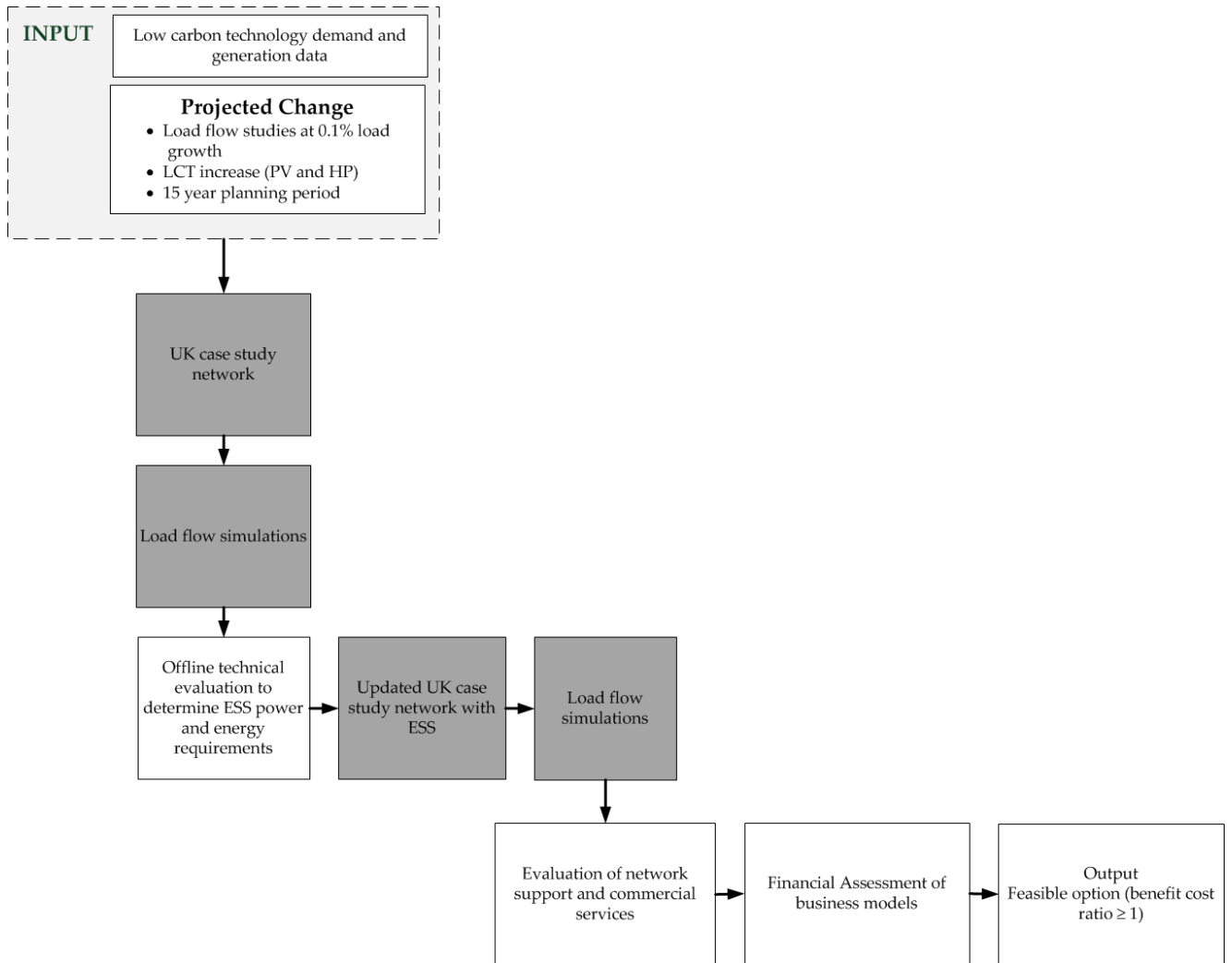

Figure 5-10: Planning procedure for LCT impact assessment and ESS deployment and financial evaluation

## 5 RESULTS

### 5.1 ANALYSIS OF THE BASE-CASE

Network results were collected from the yearly load flow simulations carried out over the 15 year planning period with an annual increase in renewables share on the case study network from solar PV and growth in HP concentration. The results are shown in Table 5-7 for the defined events listed in Table 5-2. The results serve as a base-case to assess the LCT impacts and determine the improvements that can be provided by implementing ESS on the network.

| Busbars affected times voltage excursion (busbar events) <sup>8</sup> | Overvoltage event count | Undervoltage event count | Transformer overload event | Reversepower event count |
|---|-------------------------|--------------------------|----------------------------|--------------------------|
| 114,997   | 873                     | 4,588                    | 112                        | 10                       |

Table 5-7: Network events over 15 years (base-case simulations)

There were no events until year 6 where voltage limits were breached leading to undervoltage events on the network for the whole year; the overvoltage events started from year 9, with 10 recorded excursions. Figure 5-11 shows the changes in maximum and minimum voltage levels on the network as LCT level increase. as identified in Table 5-7.

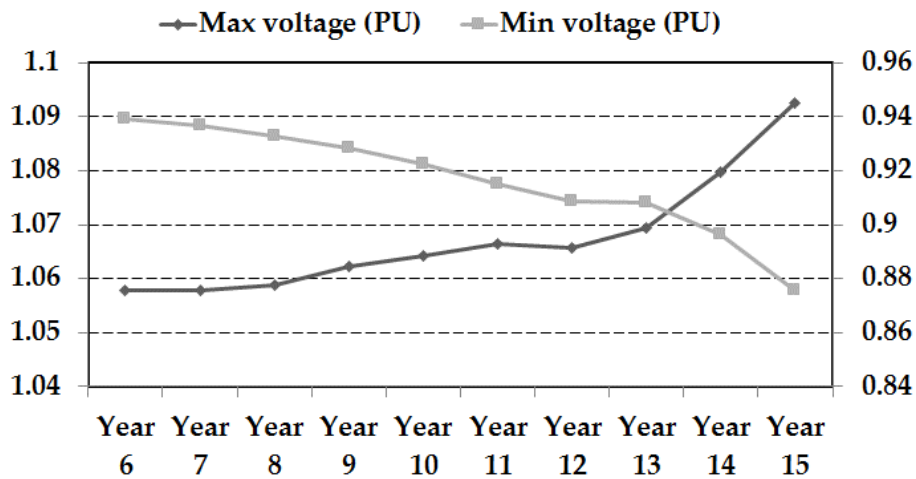

Figure 5-11: Maximum and minimum voltage levels across the network from year 6 – 15

The level of voltage excursions increased exponentially as seen in Figure 5-12, which illustrates the overvoltage and undervoltage network events and the number of busbars affected on the network from year 6 – 15, with a cumulative figure of 114,997. The increase voltage excursions follows the exponential increase in PV export and HP consumption with the final year having a total of 2245 undervoltage and 389 overvoltage events. Figure 5-12 shows that the network was stressed more

<sup>8</sup> This equals the sum of all busbars with voltage excursions at every half hour over the year of assessment.

by undervoltage than overvoltage event, with a ratio of approximately 5.3 to 1 over the nine year period. This is as a result of the demand increase from HPs to meet the target of 25% by year 2030.

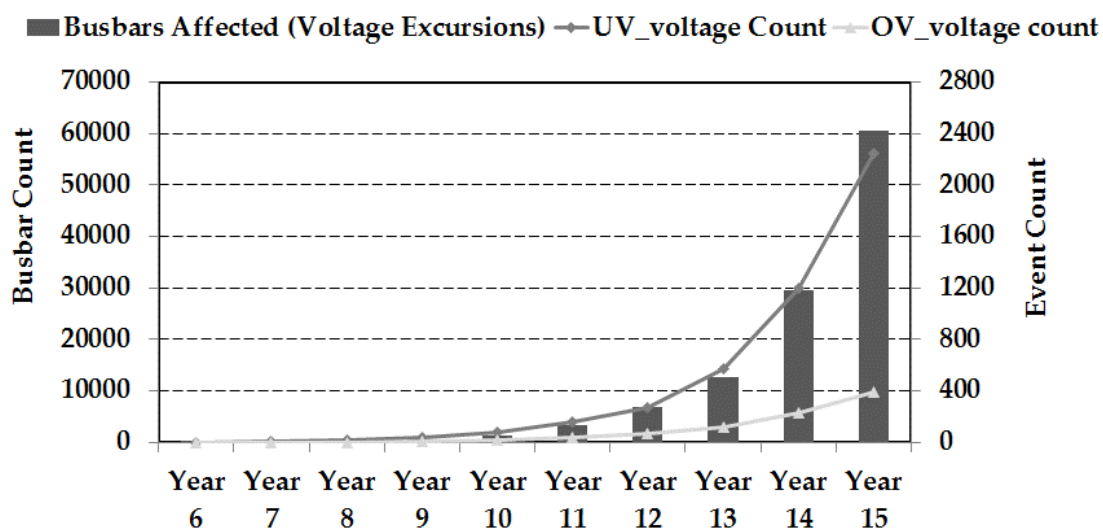

Figure 5-12: Increase in voltage events and number of busbars affected from year 6 – 15

Table 5-7 shows that thermal excursions on the 10 MVA primary transformer started occurring in year 14. This is due to the high level of concentration of HP on the network. There is also reverse power flow in year 15 caused by the increased levels of PV. Figure 5-13 illustrates the change in net power on the network with year 6 and 10 having peak demands of 6.8 MW and 7.5 MW respectively and year 15 having a higher peak demand of 9.81 MW and occurrences of reverse power flows. Figure 5-14 illustrates the change in demand with over 30% of net power greater than 6 MW in year 15 in comparison to 5% in year 10 and 2% in year 6. This increase in PV generation and HP demand also results in a 102% increase in real power loss in year 15 compared to year 6, with an average annual increase of 8%.

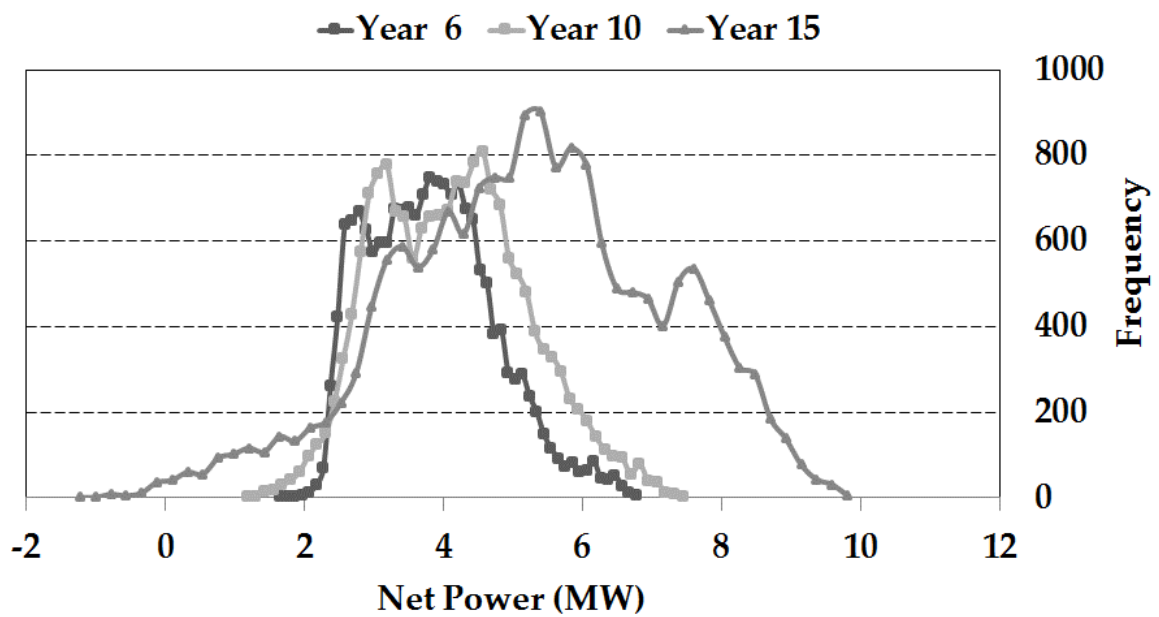

Figure 5-13: Frequency plot of net network demand on the network in years 6, 10 and 15

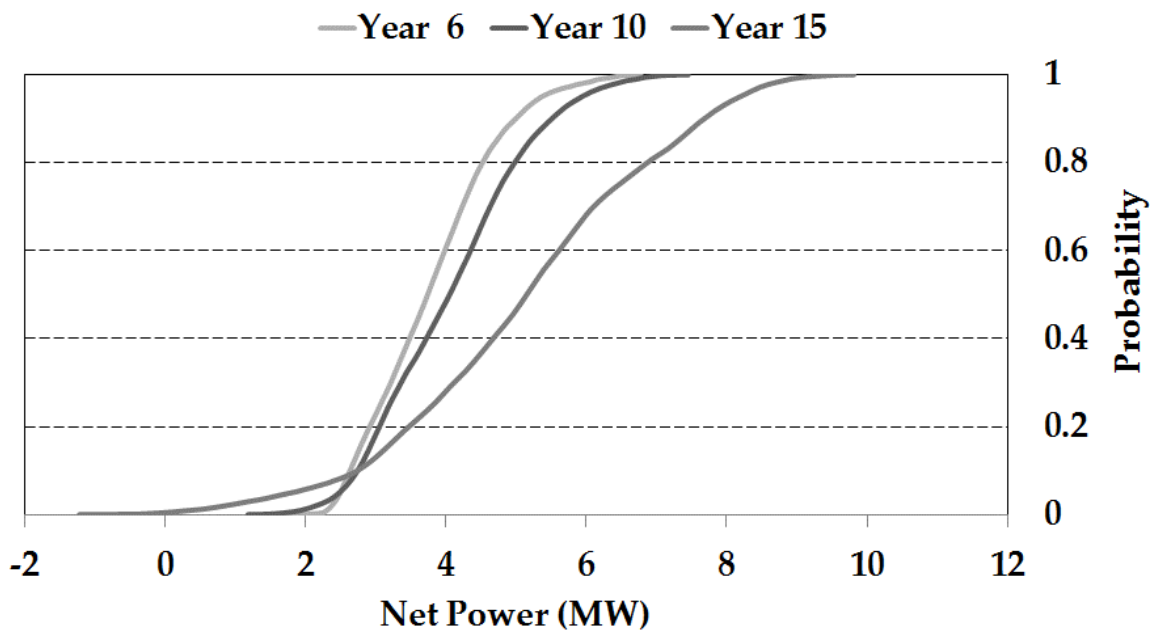

Figure 5-14: Cumulative density function of transformer power in years 6, 10 and 15

## 5.2 IMPLEMENTATION OF ESS ON THE NETWORK

Two ESSs were installed on the network with the first ESS (ESS-1) located at a remote end of the network on the LV substation (busbar) with the lowest VSF for solving voltage excursions and the second ESS (ESS-2) located at the primary substation for power flow management operations on the network. Both ESS were installed as modular units from the year network events were first observed. The

rated power and energy capacity was increased over the project lifetime as LCT levels increased, to ensure the ESS is capable of resolving all events each year. The specifications for both ESS and periods they were deployed or upgraded are shown in Table 5-8. The maximum allowable discharge or charge power was limited by the power flow equation constraints, with higher power ratings leading to the load flow not converging. This resulted in using a peak power of 1.325 MW for the substation ESS (ESS-2) and 1.25 MW for the ESS installed at the remote end (ESS-1).

| <b>Reinforcement plan (remote end – ESS-1)</b> | <b>MW/MVAr</b> | <b>MWh</b> | <b>Reinforcement plan (primary substation – ESS-2)</b> | <b>MW/MVAr</b> | <b>MWh</b> |
|--|----------------|------------|--|----------------|------------|
| Year 6 – 10                                    | 0.25           | 0.25       | Year 9 – 10  | 0.25           | 0.25       |
| Year 11 – 13                                   | 0.5            | 0.5        | Year 11 – 13   | 0.5            | 0.5        |
| Year 14  | 1              | 1          | Year 14  | 1              | 1          |
| Year 15  | 1.25           | 1.25       | Year 15  | 1.325          | 13.25      |

Table 5-8: ESS reinforcement plan over the planning period

### 5.2.1 Voltage constraint management

There were high levels of undervoltage in the winter due to high winter demand, particularly from HPs on the network. Overvoltage was more prevalent in the spring and summer period, which is when solar output increases and then peaks in the summer. Figure 5-15 (a) illustrates the action of the two ESS in a representative day in year 13 in mitigating voltage problems on the network in the summer (May) when there is overvoltage. In year 13, there was 118 overvoltage events. Both ESS sink reactive power from periods 17-20, 23-26, and 29-30, where there is a high level of reverse power flow occurring for over 30% of the time. The magnitude of the reverse power flow events were not enough to trigger the ESS to sink the excess power. The high level of reverse power is shown in Figure 5-15 (b) along with the maximum voltage on the network before and after using the ESS. The net infeed power remains the same as reactive power is used to resolve the overvoltage problems. It is also worth noting that during the period illustrated, the minimum voltage across the network was above 0.98 P.U.

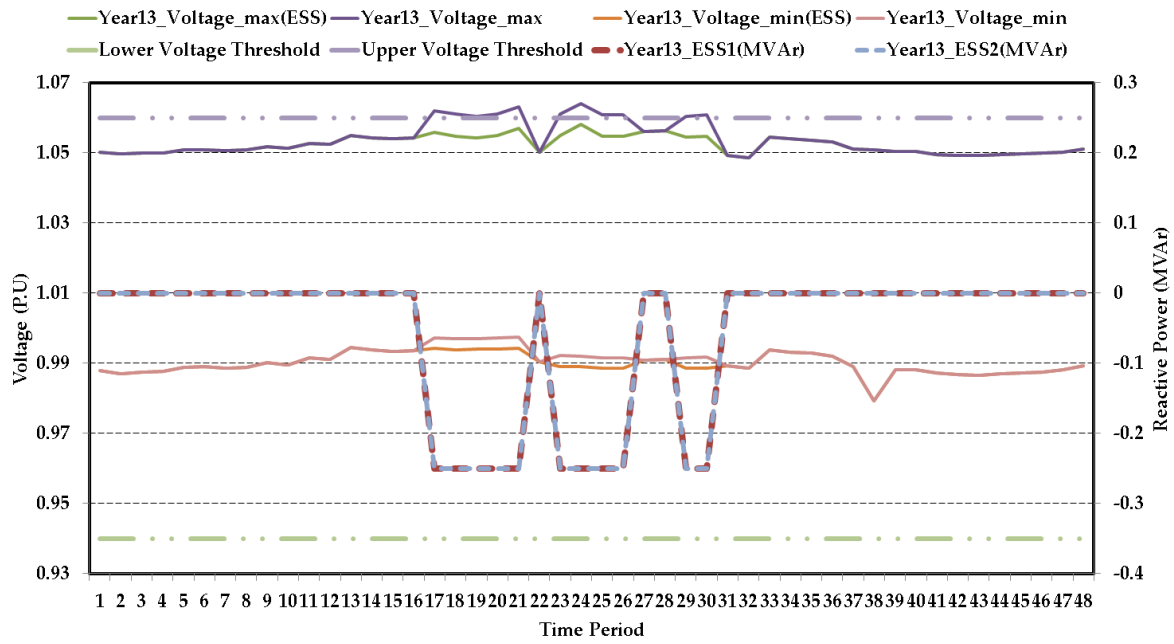

(a)

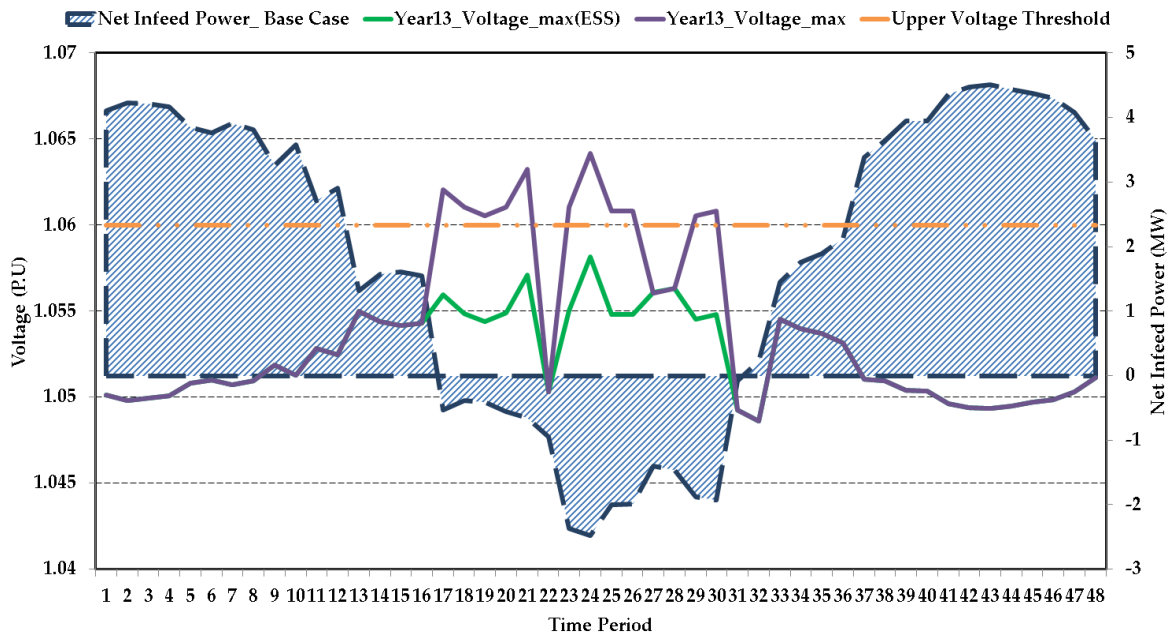

(b)

Figure 5-15: (a) Primary and secondary substation energy storage operation for overvoltage in year 13, (b) Net infeed power on the feeder in year 13 with reverse power leading to overvoltage, and maximum voltage on network after ESS intervention.

Figure 5-16 illustrates the secondary substation ESS (ESS-1) operation in mitigating undervoltage in year 15 where there were 2245 undervoltage events, which were all resolved by the ESS implementation. The ESS sources reactive power during periods

of undervoltage that occurs between periods 1-9, 15-18, and 32 and 41. The ESS has to sustain reactive power for output for 48% of the time undervoltage occurred in the day.

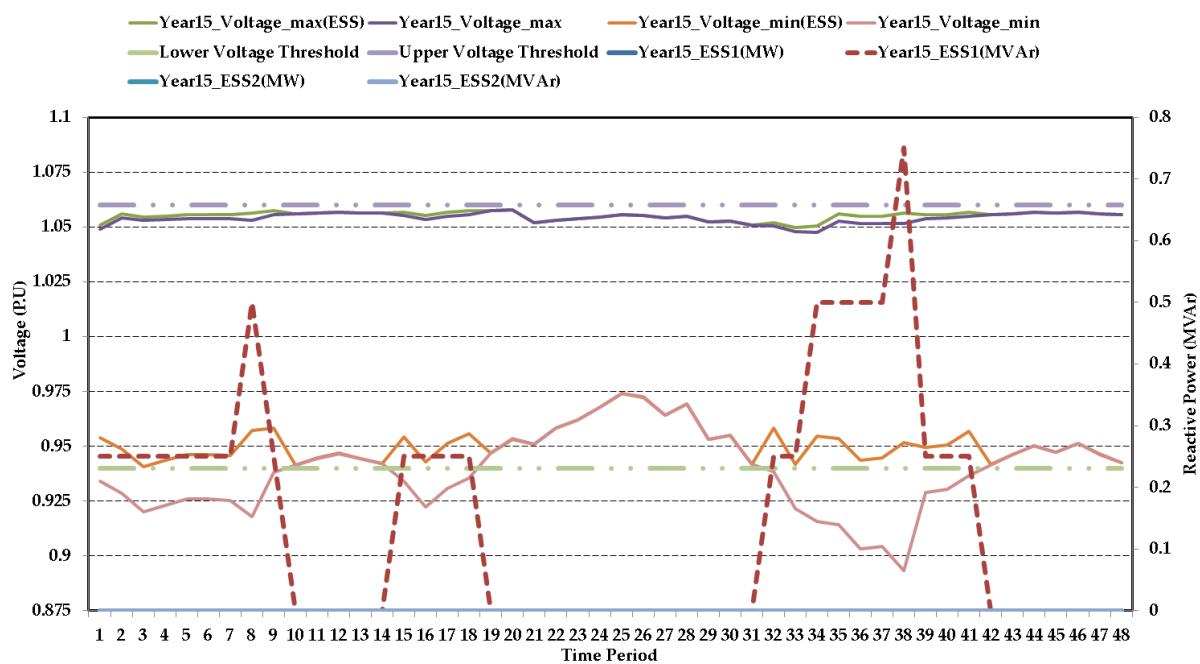
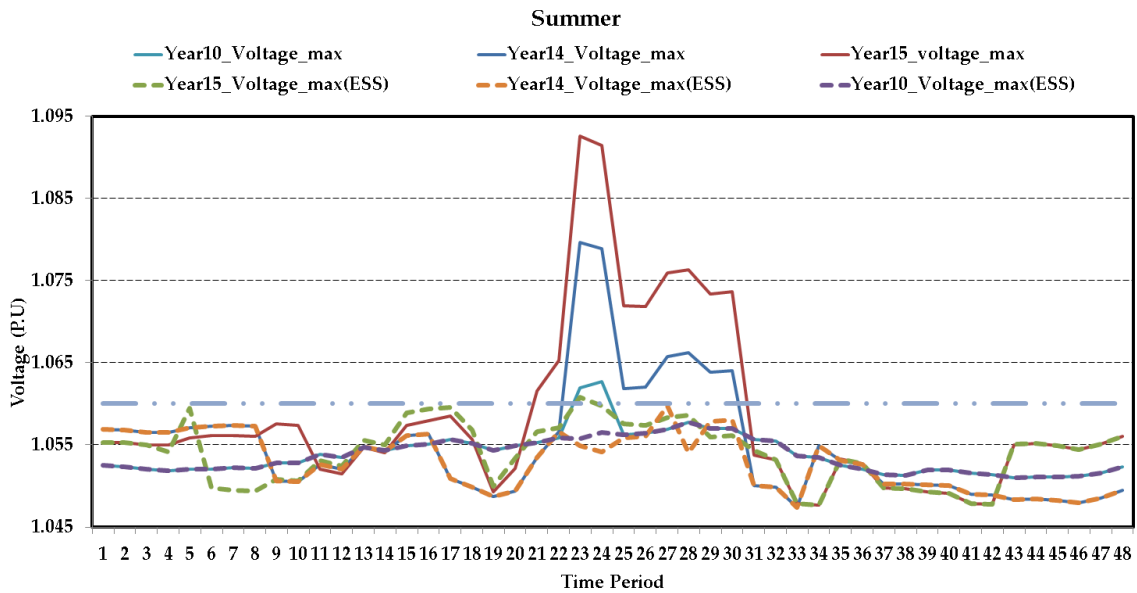
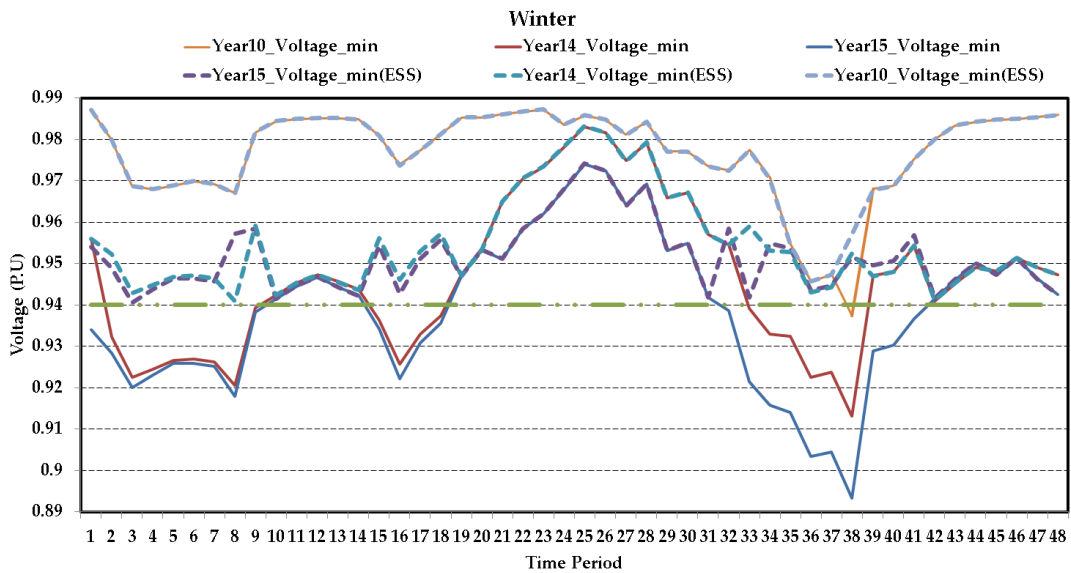

Figure 5-16: Secondary substation ESS operation for undervoltage mitigation over a representative winter day

Figure 5-17 illustrates the maximum and minimum voltage excursion for year 10, 14 and 15 on the network on a summer day (a) and winter day (b) with and without ESS implemented. The maximum voltage in the summer rises from years 10 to 15 and the ESS implementation maintains the voltage within the limit over those years, except for year 15 when there is only one overvoltage event at approximately 1.06 P.U in one period affecting two busbars, this was the only overvoltage occurrence with the ESS implemented. This is compared to the base-case in year 15 where there were 389 overvoltage events reaching up to 1.093 P.U (7.21 kV) and 2245 undervoltage events with an extreme of 0.876 P.U (5.78 kV). In year 15, there was a total of events times busbars affected (busbar events) over the period at 60577, compared to 2 at 1.06 P.U with the ESS implementation. A similar situation occurs in the winter with the minimum voltages kept within the limits after the ESS was implemented.



(a)



(b)

Figure 5-17: Maximum and minimum voltage levels in years 10, 14 and 15 with and without ESS respectively for (a) a summer period, (b) winter period

### 5.2.2 Power flow management

The primary substation ESS (ESS 2) worked to reduce overpower at the transformer during the winter as a result of high demand (particularly from HPs) and to reduce reverse power flow in the summer from high amounts of PV exporting to the grid.

Figure 5-18 (a) depicts the action of the ESS in a representative day in peak shaving at the primary transformer with overpower occurring between periods 35-38 in the winter in year 15.



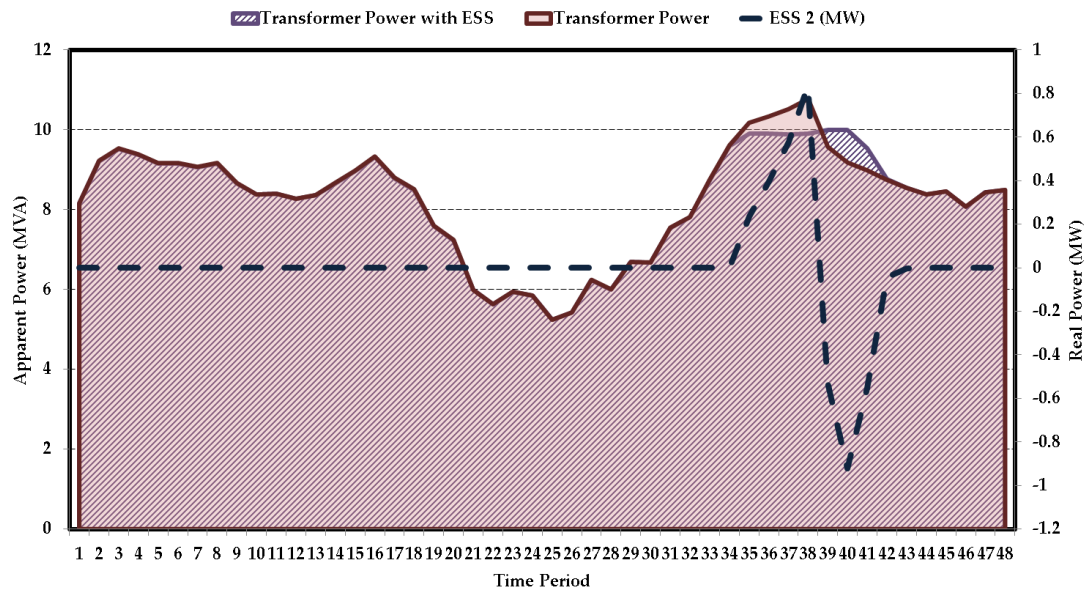

(a)

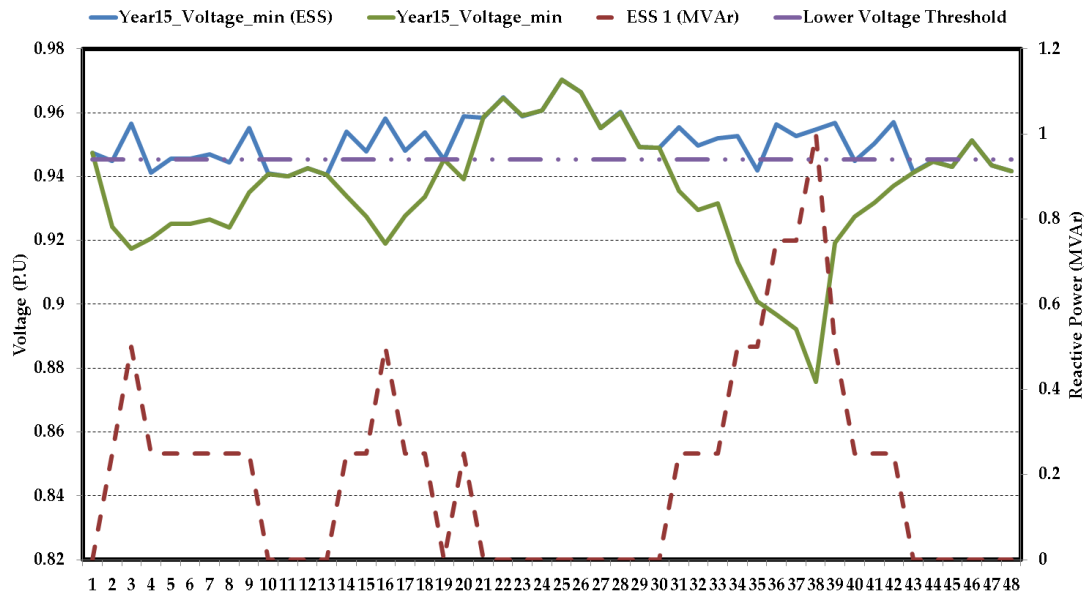

(b)

Figure 5-18: (a) ESS peak shaving transformer load in year 15 winter day (b) ESS maintaining voltage within limits during days with high demand and transformer overpower in year 15 winter day

The ESS then charges back up to get the ESS back to a maximum SoC full after the discharge operation. As the ESS is used purely for technical intervention and considers a network asset under this technical operation business model (i.e. DNO owned ESS), the cost to charge during peak periods is not considered here.

During the periods of overpower, there was severe undervoltage problems occurring as shown in Figure 5-18 (b), which depicts a representative winter day in year 15.

There was over 50 busbars affected by undervoltage during the periods of overpower (period 35-38). The Voltage before and after intervention with the ESS and the reactive power output from ESS-1 (the smaller ESS) shows the ESS impact in maintaining the voltage within limits. In handling reverse power flows, an example in year 15 of the outcome of the ESS operation to resolve reverse power flow against the set threshold and to maintain the upper voltage levels within limits is shown in Figure 5-19.

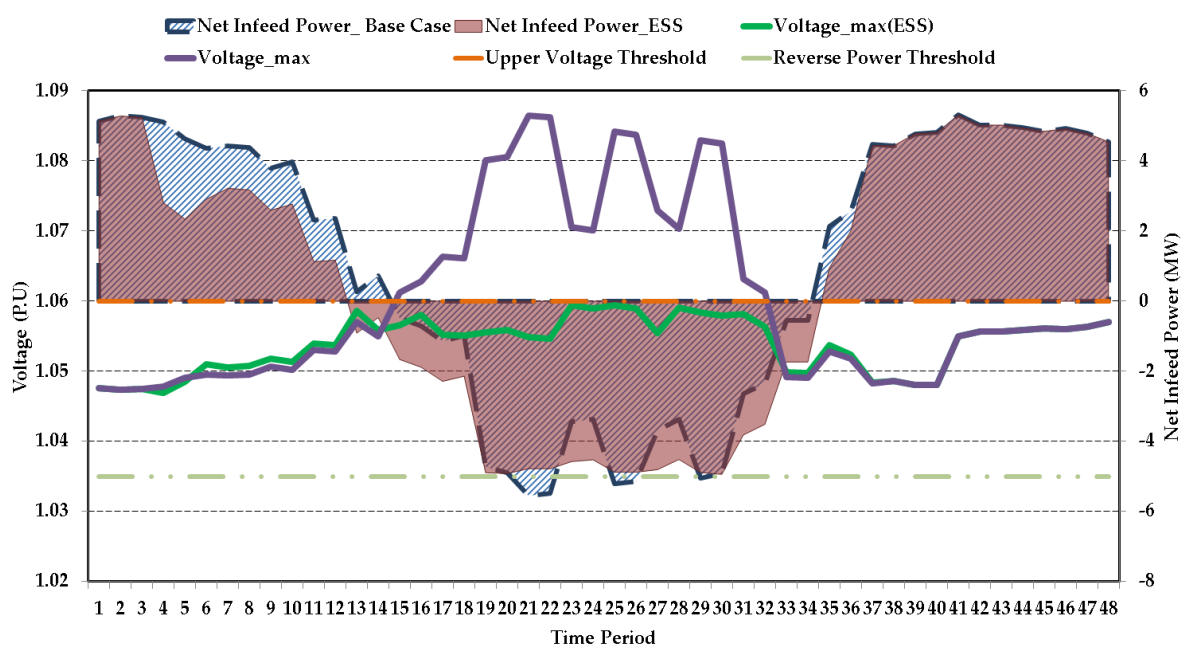

Figure 5-19: ESS effectiveness in mitigating reverse power flows past the 5 MW set threshold in year 15 winter day

### 5.2.3 Network real power losses

The ESS used purely for technical intervention worsens the real power losses by a very small amount in year 6 and 7, at 0.008% and 0.004% respectively. From year 7 onwards, the real power losses reduce by small amounts with an improvement of up to 0.5% in year 15 as shown in Figure 5-20, and an average improvement of 0.15% over the 10 year period the ESS was installed. However if the ESS efficiency losses are considered at a round trip efficiency of 85%, the reduction is only 0.07%. The efficiency losses added up to an estimated 20 MW in losses over the 10 year ESS operating period.

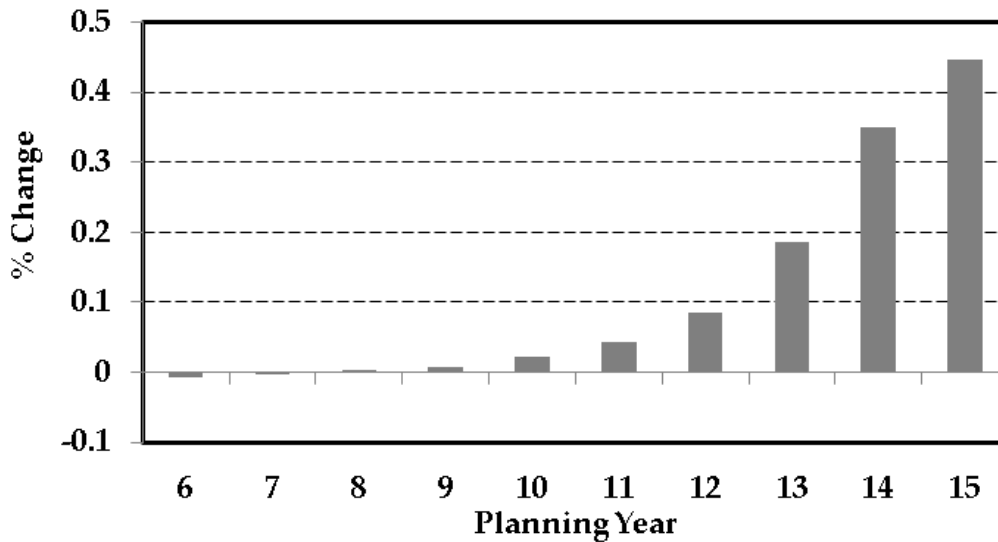

Figure 5-20: Percentage improvement in real power loss on the network

#### 5.2.4 ESS market operation

The ESS specified based on the requirements for technical intervention from analysing the base-case results was used to explore potential revenues from using the ESS for only market or technical and market operation each year based on the ESS reinforcement plan in Table 5-8. Figure 5-21 displays the representative summer and winter spot market prices over a week from Sunday to Saturday used to control the ESS. Although the market price over the winter at a time period during peak is higher at over £100/MWh when compared to summer prices, the prices over the summer have market prices in the peak periods that are over 20% of off-peak price for a longer period of time during the day. For example, in the weekday, the peak prices are 15% higher than off-peak prices for 22 periods in the summer period (Q3) compared to 10 in the winter period (Q1). This influences the ESS operating regime based on the operating and control strategy of the ESS. As a result, there are more charge and discharge operations for both ESS deployed over the summer than in winter as illustrated in Figure 5-22 and Figure 5-23, which shows the charge and discharge regime for ESS 2 over two days based on the market and technical/market operation in the summer and winter of year 15 of the planning study.

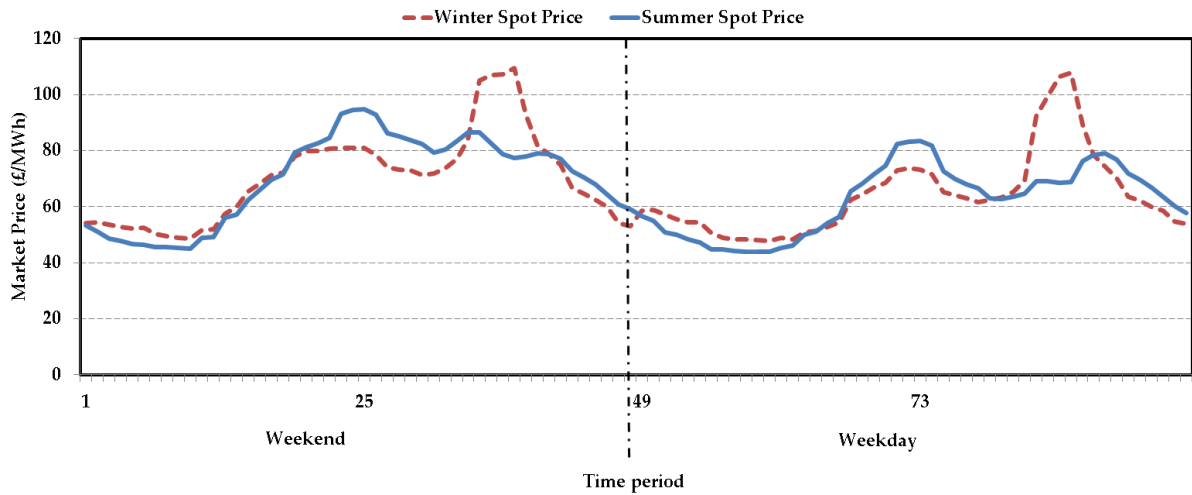

Figure 5-21: Summer and winter spot market price in year 15 of the study

The ESS energy discharge during peak periods for the technical and market operation is limited by the technical constraints and requirements of the network (for example, if the ESS is used prior to a market operation to peak-shave, there would be no capacity left for discharging during a peak period. This is illustrated in Figure 5-22 and Figure 5-23, which shows the primary substation ESS operation (ESS-2) over two days. The difference in operation is more pronounced in Figure 5-23 which shows the limits in ESS charge and discharge power over the winter when compared to the ESS used purely for market operation. There is generally more restrictions on operation in the winter where high levels of overpower and undervoltage prevail.

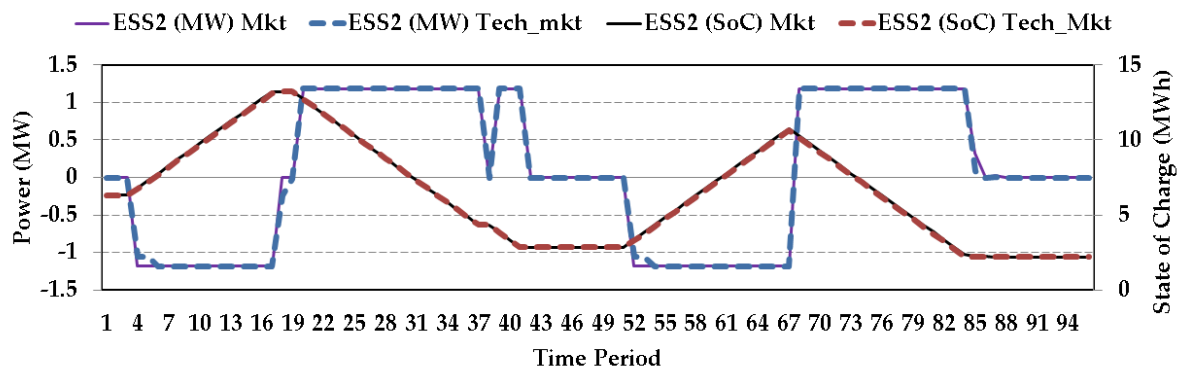

Figure 5-22: Operation regime for ESS-2 over two representative days in the summer for market only and technical/market operation in year 15

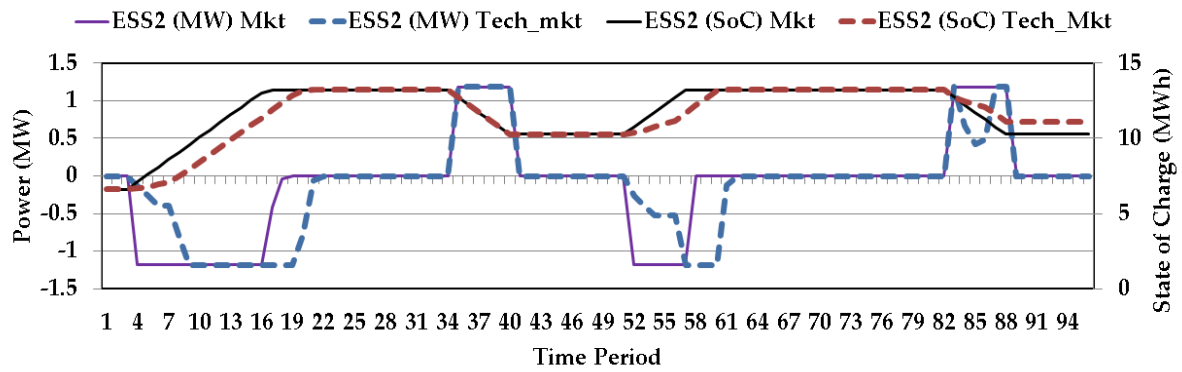

Figure 5-23: Operation regime for ESS-2 over two representative days in the winter for market only and technical/market operation in year 15

The ESS used for technical and market operation satisfies both market and network requirements but the ESS used purely for market operations worsens the problems on the network. The market only ESS operation results in an increase in network events and also increases the real power losses on the system to 3%. ESS market and technical operation has a lower number of market operations for both ESS as the network issues are prioritised in the control scheme and the ESS energy charged or discharged is reduced or not used at all depending on the severity of issues on the network. This resulted in the opposite of the pure market operation with an estimated 3% reduction in losses. Apart from an increase in losses for the ESS market operation only, the network conditions were worsened when compared to the base-case as shown in Table 5-9. The network overpower events at the primary transformer was worsened by over 535% in terms of occurrences at every half hour. In addition, the overvoltage event count increased by 36% and the undervoltage had a higher increase in number events by 171%. This was not the case for the ESS used for technical and market operations with only 2 overvoltage events occurring in year 15 which were borderline on the voltage threshold at 1.06 P.U.

| Cases                                | Reverse power flow | Thermal excursions (transformer) | Thermal excursions (conductor) | Half hour overvoltage event count | Half hour undervoltage event count | No. of times Busbars exceed voltage limits every half hour | No. of times network exceeds thermal limits every half hour |
|--------------------------------------|--------------------|----------------------------------|--------------------------------|-----------------------------------|------------------------------------|--|---|
| Base-case                            | 10                 | 77                               | 0                              | 4588                              | 873                                | 114997   | 0   |
| ESS (market only operation)          | 50                 | 489                              | 139                            | 6258                              | 2366                               | 245188   | 303   |
| ESS (market and technical operation) | 0                  | 0                                | 0                              | 1                                 | 0                                  | 2  | 0   |

Table 5-9: Comparison of network conditions under base-case and ESS used for market and market/technical operation

### 5.3 FINANCIAL ANALYSIS

The capital cost of the ESS to provide network support services based on an upper and lower limit of battery technology costs from research, and lithium ion costs are shown in Table 5-10 using the cost figures in Table 5-5 [264] [258] [265]. This shows the potential variation in the capital cost to deploy ESS.

|              | Upper Limit (£)   | Lower Limit (£)  | Lithium Ion (£)  |
|--------------|-------------------|------------------|------------------|
| ESS 1        | 2,000,000         | 454,000          | 504,000          |
| ESS 2        | 10,700,000        | 2,640,000        | 3,600,000        |
| <b>Total</b> | <b>12,700,000</b> | <b>3,094,000</b> | <b>4,104,000</b> |

Table 5-10: Total ESS capital cost over project lifetime (undiscounted). The Bank of England dollar to pound exchange rate in August 2014 of \$1.68 to £1 was used [268]

Table 5-11 shows the breakdown of cost, revenue and NPV of deploying ESS over the 15 year planning period. When the ESS was used for arbitrage only, both ESS

discharged more during the peak demand periods and gained more DUoS revenue compared to the ESS used for technical and market operation based on operation limits discussed in section 5.2 . This is because for the technical and market operation business model, ESS-2 (substation ESS) either sinks real power to resolve reverse power flow and overvoltage problems in the summer and does not discharge during the peak period when reverse power flows occur. The remote ESS (ESS-1) did however discharge more when used for technical and market operations as opposed to only technical operation because of its use of real power in resolving undervoltage and overvoltage problems. The ESS peak power discharge for market operation is also 70% higher in year 14 of the study compared to ESS technical and market operation leading to higher revenues from Triad.

| <b>Source of Value</b>                                | <b>ESS market only</b> | <b>ESS market and technical</b> | <b>ESS Technical</b> |
|---|------------------------|---------------------------------|----------------------|
| Wholesale market (£)                                  | 258,000                | 251,000                         | -680                 |
| Wholesale market + Balancing service (@10% error) (£) | 510,000                | 492,000                         | -1340                |
| Market Operations (ESS-1/ESS-2)                       | 32620/32712            | 33109/29475                     | 79/385               |
| TRIAD (£)   | 271,000                | 269,000                         | 16,000               |
| DUOs benefit/charge (£)                               | 228,100                | 223,000                         | -5000                |
| Network deferral benefit                              | None                   | 2,620,000                       | 2,620,000            |

Table 5-11: Revenue, cost and NPV of ESS investment

Table 5-6 listed the ownership and business models and resulting revenue streams that an ESS implementation could get, which in this study will be based on the results from Table 5-11. Figure 5-24 depicts the percentage composition of revenue over the 15 years for the different cases. In the purely commercial business model based on a Tp-StO, at 27%, the proportion of revenues derived from Triad is the highest compared to other business cases. The business model with a collaboration

between the Tp-StO and DN-StO derives a lower revenue from Triad at 7% (case 3b). The asset deferral benefit provides the highest revenue stream for the DNO/ third party operated ESS.

Figure 5-25 shows the NPV of the ESS implementation over the 15 year period without considering salvage value (based on the energy throughput for the different batteries considered) for the different cases. Without considering the salvage value for the ESS, neither of the business models are profitable under the different battery categories. This is as a result of the high number of replacements required during the planning period. With the upper limit, the capital cost of the ESS (discounted based on the year of replacement) makes the implementation unfeasible and with the lower limit ESS, although the capital cost of the battery is low, the number of replacements is higher because of the low cycles to failure. The upper limit category is the least feasible investment. For the lower limit category, the case 2 business model (with only deferral benefits) is the least worse case at a loss of (£20,000) while for the lithium ion battery, the business model with DNO and third party collaboration with deferral and all commercial benefits presents the least worst case at a loss of (£53,000).



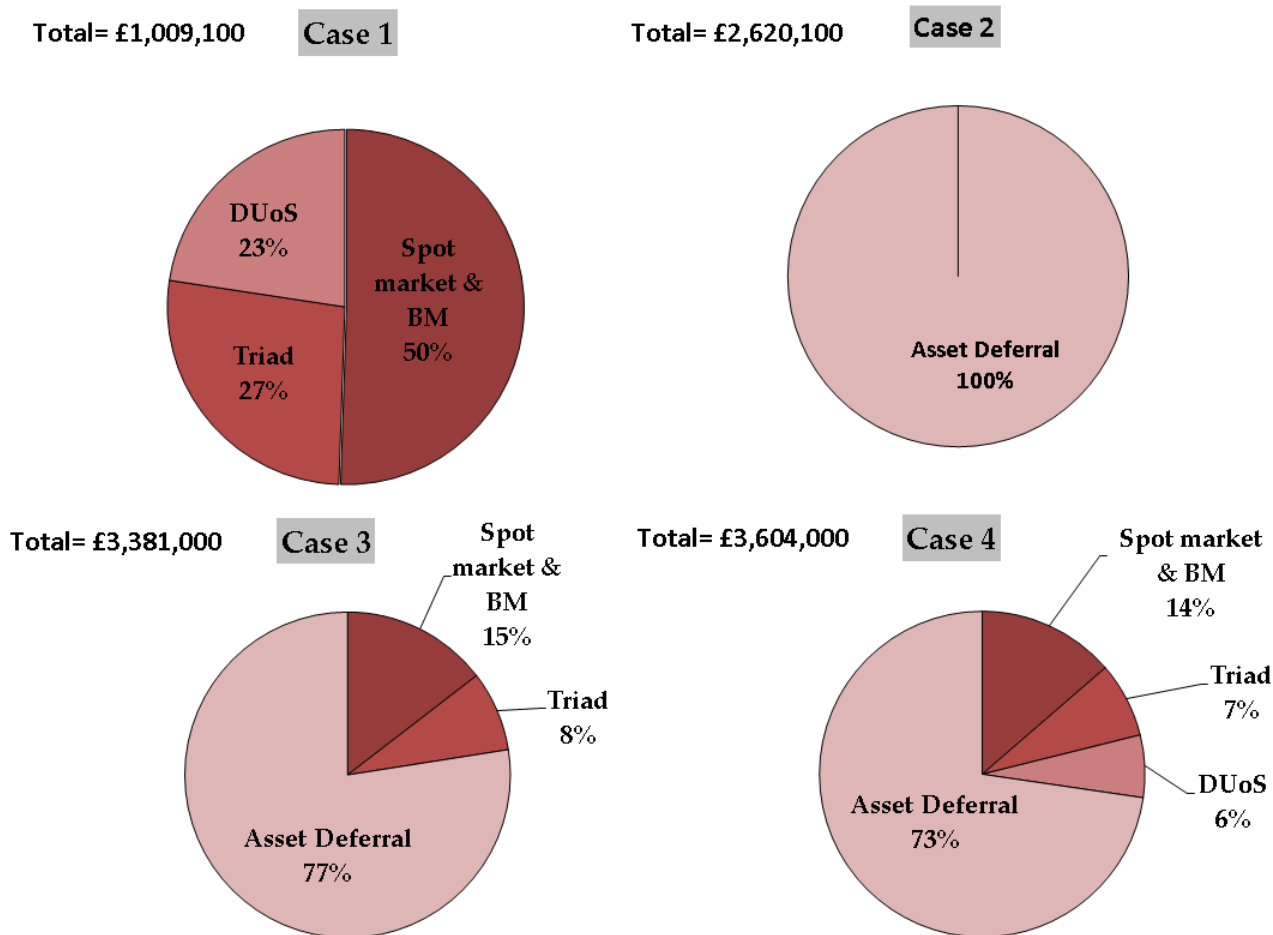

Figure 5-24: Pie chart of revenue streams for different case studies

Figure 5-26 shows the NPV considering salvage value. When salvage value is considered, all technologies under the case 2 model are feasible, even the upper limit costs category provides a positive NPV of approximately £560,000. However, if competitive services are considered, only the lithium ion category provides a positive NPV for all the business models with the percentage difference in NPV of the DNO only owned ESS (case 2) and the collaborative business models only at approximately 11% for case 3 and 21% for case 4. This shows that the DNO owned, i.e. DN-StO ESS business model without market and other commercial revenues can still be feasible. Nonetheless, the extra revenues that can be generated from collaboration is still significant. The spot/BM market only operation (case 1a) is feasible only when using the lithium ion batteries, so a third party owner could implement an ESS purely to make revenues on the distribution network, but

considering the number of problems generated from this business model operation as discussed in section 5.2 , this model model will not be feasible as the ESS owner will have to pay the DNO to reinforce the network for their operation.

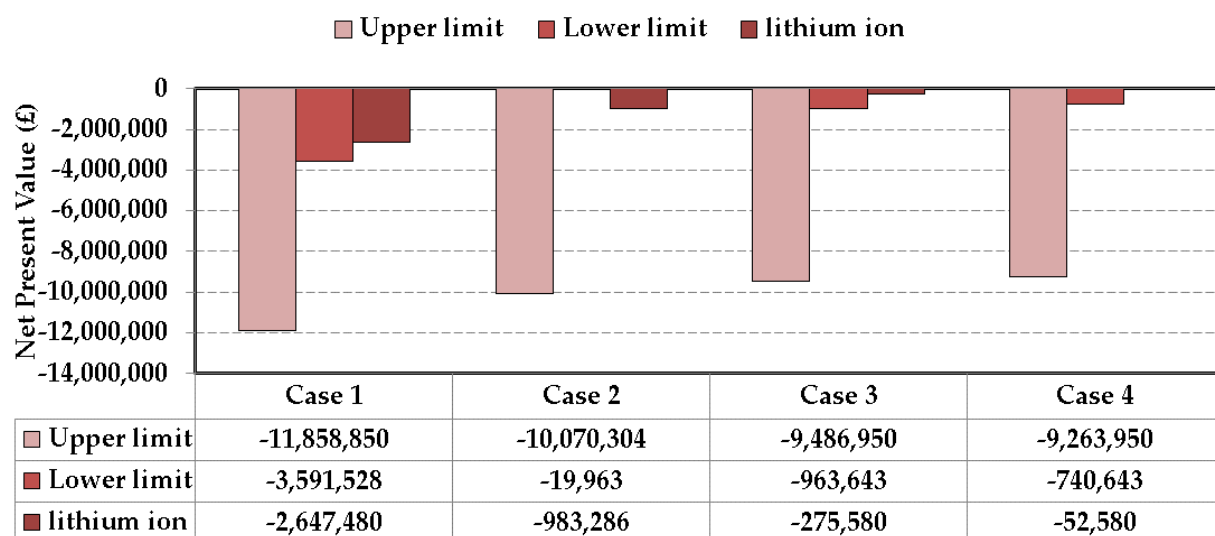

Figure 5-25: Net present value of ESS implementation from year 6 – 15 (without ESS salvage value)

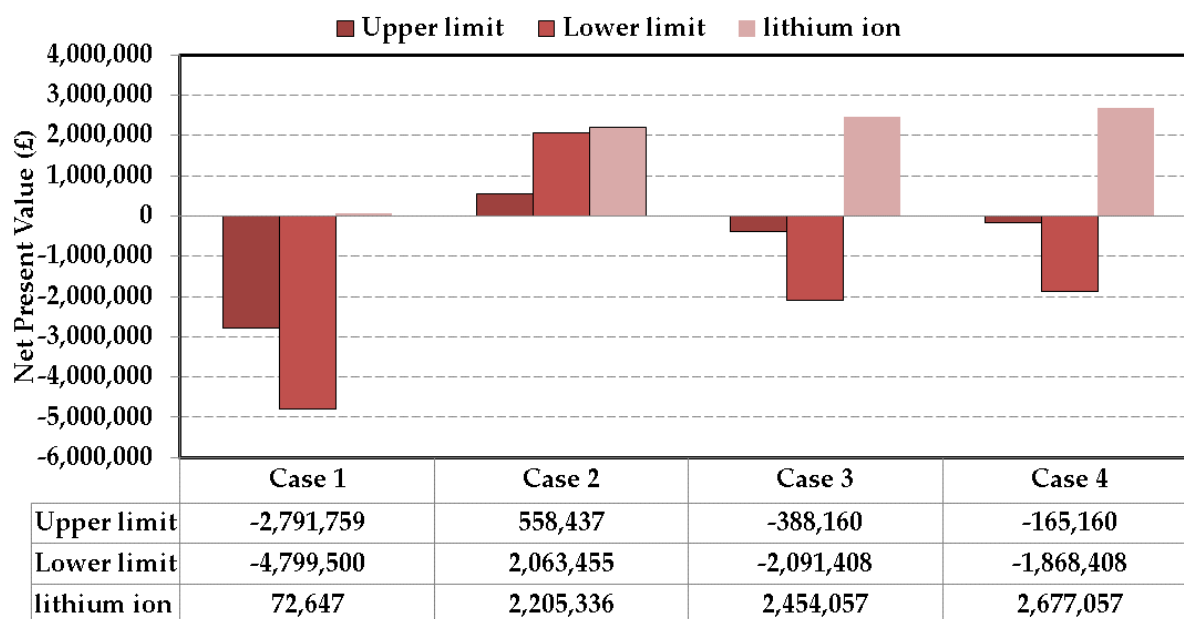

Figure 5-26: Net present value of ESS implementation from year 6 – 15 (including ESS salvage value)

#### 5.4 CONSIDERING FFR AND STOR POTENTIAL IN YEAR 15

Ancillary services were explored for FFR and STOR for the ESS operation pattern (used purely for technical operation) experienced in year 15 to show potential

revenues when both ESS have the highest capacity during the assessment period. The revenues that could be gained from the high ramp rates and responsiveness that ESS can provide were not explored. Such services are currently being considered in the UK much like the US, where fast frequency response services are widely successful. Table 5-12 shows the maximum and minimum STOR revenues in year 15 based on a maximum availability of 3800 hours (although the ESS was available for 5209 hours over the year) and for 50 to 80 utilisations.

|                                  |         |
|----------------------------------|---------|
| <b>Total availability (£)</b>    | 64,900  |
| <b>Total utilisation_max (£)</b> | 281,120 |
| <b>Total utilisation_min (£)</b> | 175,700 |
| <b>STOR MAX (£)</b>              | 684,660 |
| <b>STOR MIN (£)</b>              | 579,240 |

Table 5-12: STOR maximum possible revenues

Table 5-13 shows the maximum possible FFR revenues for both ESS (based on the available power capacity for both ESS ) on the network based on 750 high frequency and low frequency nominations and from the availability of the ESS all year based on the ESS power rating and maximum DoD. The energy cost is the cost to purchase energy to charge or discharge during periods of FFR operation for high frequency and low frequency events respectively.

| <b>Parameters</b>                  | <b>ESS1</b> | <b>ESS2</b> | <b>energy cost</b> |
|------------------------------------|-------------|-------------|--------------------|
| High frequency availability (£)    | 5,200       | 54,700      | -172,000           |
| Low frequency availability (£)     | 5,200       | 54,700      | 261,400            |
| High frequency nomination (£)      | 14,600      |             | N/A                |
| Low frequency nomination (£)       | 14,600      |             | N/A                |
| FFR Revenue/ total energy cost (£) | 149,000     |             | 89,600             |
| Total FFR revenue (£)              | 240,000     |             |                    |

Table 5-13: FFR maximum possible revenue

While participation in the balancing market can increase ESS profitability, ancillary services markets should not be discounted as can be seen in Table 5-12 and Table 5-13 where revenues from only operation in year 15 can provide up to £930,000.

## 6 CONCLUSION

The investigation carried out in this chapter shows the potential impact of increasing levels of LCTs on a medium voltage distribution network based in the North East of England and the technical and financial feasibility of an ESS implementation to mitigate the issues and aid the growth of LCTs, which is the target of government policies globally.

ESS owners are currently unable to realise full market value from ESS operation, which positively impacts multiple stakeholders. The realisation of total ESS value will depend on all stakeholders from DNOs to suppliers and aggregators to collaborate and maximise the flexibility of ESS to derive all the potential benefits it can provide. This chapter evaluated the key revenue streams for ESS deployed on the distribution network. The ESS implementation almost breaks even for the DNO owned ESS at a loss of £20,000, without considering salvage value for the lower limit battery sensitivity. The DNO and third party operated storage resulted in a loss of £53,000 without salvage value for the lithium ion battery sensitivity. When salvage value was considered, the ESS was profitable with lower limit sensitivity when considered for market operation, albeit with compounded network events on the network. With salvage value, the ESS was profitable in all sensitivities (low limit, high limit and lithium ion) for the sole DNO ESS because of the lower number of operations required in this case to resolve network issues. The ESS was also profitable for the lithium ion sensitivity when used for network and competitive services (third party and DNO collaboration) with an NPV above £2.4 million. It was not profitable for other sensitivities because of the high cycling required for market and network operations, which requires an ESS with high cycles to failure. This shows ESS implementation can become profitable with lower battery costs when stakeholders collaborate to operate the ESS infrastructure. As ESS technology

continues to improve, particularly regarding enhanced lifetime (cycles to failure), and there is investment in ESS technologies and renewables, costs would continue to drop and the profitability of using ESS will continue to increase, even if the salvage value is not considered.

Balancing market and ancillary services markets can increase the potential of ESS for use in distribution networks and the regulations should be considered to enable multiple stakeholders to use ESS in different markets. Currently, it will be difficult to manage ESS used competitively, for the networks, and for ancillary services as the regulations for the latter services require a commitment of the energy or power to be used for reserves or frequency response services. A party unable to meet these requirements is penalised, and presently, ESS owners will not be able to provide such services if they cannot commit their ESS resources indefinitely. ESS installed on the network can be called on at different times for network intervention hence multi-operation without proper coordination is not feasible. Coordination is not possible without understanding and collaboration between all parties.

Policies or regulations should be in place that provide benefits to DNOs or third parties who implement innovative solutions to enable more levels of LCTs on the grid. This will increase the feasibility of implementing ESS, increase LCT proliferation and assist in fulfilling the government's renewables targets. While the results do not provide a silver bullet for policy decisions, they provide an indication of the viability of a DNO to consider investing in storage.

# Chapter Six: Planning and operating ESS in distribution networks using probabilistic load flow and a multi-objective optimisation methods

---

## 1 INTRODUCTION

In this chapter, medium term planning is carried out on a test network to evaluate the extent of issues that could affect a distribution network using a test network based on developed medium term scenarios for LCT proliferation on the test network. This is carried out using Monte Carlo simulations. Afterwards, short term planning to schedule ESS resource to mitigate the identified worst-case issues is carried out using the Non Dominated Sorting Genetic Algorithm 2. As discussed in Chapter 2 DNOs use a combination of short, medium and long term planning to ensure their networks are operated and maintained to meet reliability, economic and technical criteria set by regulation. It was also identified that if ESS is to be used by DNOs as a network asset, the conventional Distribution Expansion Planning (DEP) process will need to be upgraded. The complexities arising from planning for ESS deployments comes from conflicting multi-objectives from its application, ESS capacity limitations, and regulatory and electricity market barriers. All these factors lead to difficulties in reconciling different ESS benefits.

With the changes to the way power flows in the distribution networks, consideration for the stochasticity of LCTs and how they affect the network security standards is important. DNOs in the UK use deterministic planning standards for DEP following the N-2 criteria for 133 kV – 33 kV distribution networks offering two levels of network redundancy, N-1 criterion offering one level of network redundancy for 11 kV networks, and N-0 criterion with no redundancy for LV networks (0.4 kV) [36, 38]. Networks are designed to have enough capacity for loading conditions during an outage based on peak demand. When considering LCT-Gs, the networks are planned to provide firm access based on the scenario of maximum generation and

minimum load [109]. This approach will lead to operating an expensive network due to expensive network upgrade requirements to reinforce networks for increasing LCTs [34]. The upgrades are required to mitigate the impacts caused by peak generation or demand from LCTs, which may be for a small proportion of the time during the day, week or year as is the case with intermittent renewables which are weather dependent. Understanding the uncertainties in demand and generation from LCTs is an increasingly important input to planning studies as deterministic studies cannot provide an accurate representation of the critical loading conditions that arise as LCTs are adopted over the years. It will also provide an avenue to implement cheaper alternative solutions such as ESS to mitigate or resolve issues caused by LCTs.

The medium term planning, DEP is carried out through running Monte Carlo (MC) simulations on the IEEE 33 bus test network using the IPSA load flow engine. From the MC simulations, the probabilities of demand and generation on the network and the network events/constraints that result on a distribution network based on different concentrations of HP and PV will be determined. The demand and generation patterns are created based on different scenarios for LCT-D and LCT-G proliferation in line with government policies and observed growth trends. The MC studies based on the developed scenarios are carried out using the derived log-normal statistical distributions for demand and generation discussed in Chapter 3, Section 3.2. The extreme cases from the chosen scenarios are used to determine the capacity and location of the ESS on the case study network. Afterwards, short term operation planning which considers the stochasticity of ESS operation using a multi-objective evolutionary algorithm technique is applied to the network. The NSGA-II metaheuristic optimises the half hourly charge and discharge operation of the ESS to satisfy DNO and commercial/third party multi-objectives. In chapter 5, the OLTC was controlled automatically using the OLTC control in IPSA and also with a control algorithm that integrated the ESS and OLTC for a coordinated operation. In this

chapter, the OLTC operation is handled by the employed NSGA-II heuristic optimisation method.

The result from the optimisation provides a set of optimal operating patterns (Pareto front) in the winter and summer for the selected scenarios based on the worst-case scenario from the MC simulations. The operational planning to derive the maximum storage power and energy capacity required is carried out on the worst-case results for scenarios 1 and 2. The NSGA-II optimisation is used to determine the effectiveness, daily cost and potential revenue of operating ESS under the aforementioned scenarios. Finally the trade-off of benefits for different stakeholders is assessed in these cases. The method used and results are aimed at facilitating the decision making process on whether to use ESS and how to operate it in an extreme case.

## **2 BACKGROUND ON PROBABILISTIC LOAD FLOW AND NSGA-II HEURISTICS**

### **2.1 MONTE-CARLO SIMULATIONS**

The classical load flow methods employed by T&D network operators use static, deterministic analyses to inform planning, operation and assessment of the performance of networks. These classic load flow methods use mean or expected values for static load flow and disregard uncertainties or stochastic deviations in conventional demand, and emerging demand and generation from LCTs [269] [270]. This method of load flow is also called the Deterministic Load Flow (DLF) method. A Probabilistic Load Flow (PLF) approach is developed in this chapter to include demand and generation stochasticity into the planning problem. The PLF approach requires the network state variable such as customer demand to be represented by a Probability Density Function (PDF) to provide the network with all possibilities of these state variables and the resulting network performances and probabilities of different issues that may occur.

Monte-Carlo simulations (MC) in this study are used in this chapter as a numerical approach to carry out PLF analysis. The two main features of MC simulations are



random number generation and random sampling [270]. MC simulations involve carrying out large amounts of DLF based on randomly generated and sampled state variables from a statistical distribution (The PDFs of HP, wind and PV introduced in Chapter 3) to substitute for deterministic values (i.e. net demand profiles) in a distribution network. The MC simulation provides the basis to evaluate different possibilities of powers flows across distribution lines or cables, and the resulting network performance by gathering results on the voltage and thermal profile on the bubaras and lines/transformer respectively.

## 2.2 INTRODUCTION TO GENETIC ALGORITHMS

The principle of Genetic Algorithms (GA) is introduced as it is an essential concept which the NSGA-II method is derived from. GA is an evolutionary metaheuristic algorithm that is widely used to solve a variety of optimisation problems. It is based on the theory of evolution, where weaker species in a population face extinction via natural selection and stronger species reproduce and pass on their genes. GA is seen as an efficient evolutionary algorithm (or optimisation method) that makes use of two processes, exploration and exploitation, to find the global optima [271].

Exploration is needed to cover the whole solution search space (population diversity) to prevent convergence to a local optima while exploitation uses known problem to generate better solutions from solutions that are already good (reducing diversity) [272]. Variation (crossover and mutation) and selection operators, and the representation of the problem and the size of the population are used to achieve exploration and exploitation [272]. Selecting the right set of parameters is crucial to getting the right amounts of exploration and exploitation.

Individuals within a population in GA are called the chromosome (or genotype) are made up of individual characteristics called genes, which control aspects of the chromosome. Chromosomes are encoded to represent a solution for an optimisation problem. As GA is a metaheuristic method, it can be used to solve any optimisation problem and does not require direct knowledge of the problem as it works on the mappings and not on the problem itself [273]. Genes in a chromosome can be

represented as binary numbers or real numbers and a fitness value is given to each chromosome based on its performance against the optimisation problem which forms the set of solutions (phenotype). The encoding of the chromosomes and the fitness functions that are optimised (maximised or minimised) by GA are two main aspects that need to be well thought of and defined [274].

The population within a GA is created randomly and optimised using crossover and mutation and selection operators over several generations (evolution), allowing fitter (better) solutions to be created after each generation. At the end of the evolutionary process, the solution then converges to a single solution which dominates other solutions in a population, i.e. the global optima, or Pareto-optimal solutions in a population (i.e. all possible non-dominated solutions within a Pareto front) for multi-objective problems. A solution in a Pareto front is one where an improvement in one objective is not possible without affecting any other objectives [109]. The key GA parameters are:

- Population size;
- Probability of mutation;
- Proportion of solution to apply recombination; and
- Number of generations.

The key steps in implementing GA are illustrated in Figure 6-1 and discussed next.

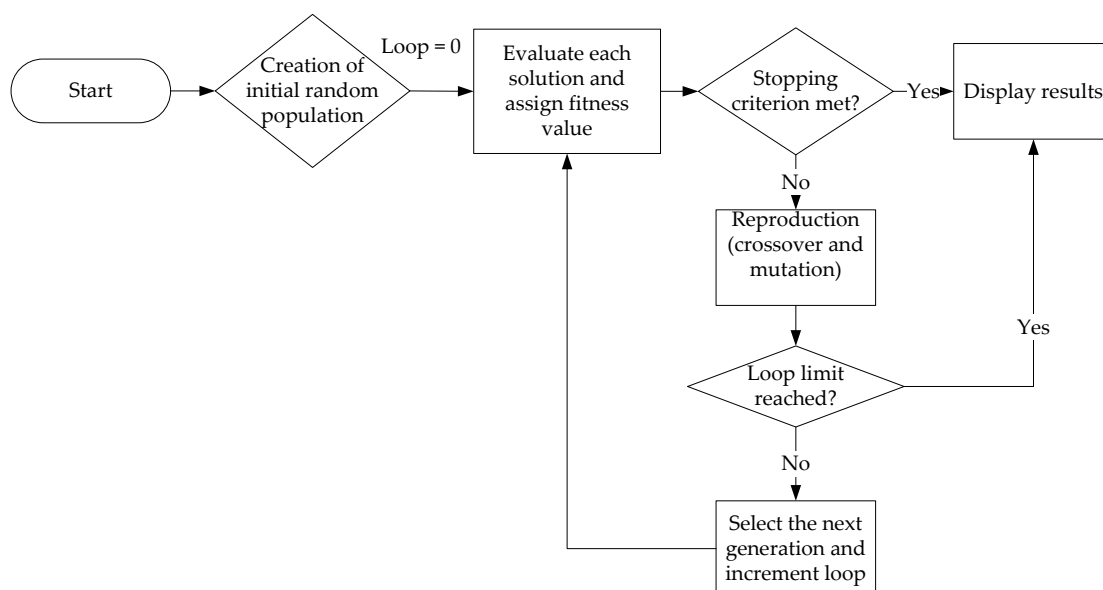

Figure 6-1 : Genetic Algorithm implementation process

### ***2.2.1 Initial population***

The first population comprises a set of randomly generated solutions (chromosomes or individuals) for the optimisation problem. This initial population is important in influencing the performance of the GA. Early convergence to local optima can be prevented and the evaluation time can be reduced with a good population size [275, 276]. Contrarily, a bad population size leaves only mutation as the operator to help in finding the global optima [277]. The number of chromosomes within a population (i.e. the population size) plays a key role in the efficiency of the GA [275, 276]. A larger population size will lead to a more diverse set of solutions (or schemata) and better convergence to the global optima but will increase computational complexity due to the selection methods used in ordering and ranking the population [275]. On the contrary, a small population size may lead to early convergence to local optima as a result of the lack of diversity. Deb et al have shown that the required population size is dependent on the complexity of the problem [278]. As a rule of thumb, the population size should increase with complexity of the problem.

The individuals within a population can be generated randomly using a random number generator with uniform distribution of numbers in a given range or using prior knowledge of the problem to create a population of chromosomes close to the optimal solution [279].

### ***2.2.2 Representation of solutions***

Genes which are decision variables within a chromosome can be encoded in binary, integer or real number format. The variables in the decision space which require encoding to represent individual genes within a chromosome (genotype) are called the phenotype. Table 6-1 shows two methods of encoding using binary (4 bits) or integer format where X represents the decision space. Silva et al concluded that there is no optimal method of encoding and that problems can be solved efficiently using domain-specific knowledge of optimisation problems to derive accurate representation of genes [280].

|                   |  |      |      |  |         |      |      |      |   |  |  |  |   |    |    |    |
|-------------------|--|------|------|--|---------|------|------|------|---|--|--|--|---|----|----|----|
| <b>Phenotype</b>  | X = [4,12,25,13]   |      |      |  |         |      |      |      |   |  |  |  |   |    |    |    |
| <b>Chromosome</b> | <table border="1"> <tr> <td>0010</td> <td>0110</td> <td>1101</td> <td>0111</td> </tr> </table> |      |      |  | 0010    | 0110 | 1101 | 0111 | <table border="1"> <tr> <td>4</td> <td>12</td> <td>25</td> <td>13</td> </tr> </table> |  |  |  | 4 | 12 | 25 | 13 |
| 0010              | 0110   | 1101 | 0111 |  |         |      |      |      |   |  |  |  |   |    |    |    |
| 4                 | 12   | 25   | 13   |  |         |      |      |      |   |  |  |  |   |    |    |    |
| <b>Genotype</b>   | 0010011011010111   |      |      |  | 4122513 |      |      |      |   |  |  |  |   |    |    |    |

Table 6-1 : Encoding of GA solutions

### 2.2.3 Evaluation of solution and fitness assignment

In this step, each individual or chromosome is evaluated and assigned a fitness value based on its fulfilment of the objective(s) for optimisation. It involves decoding the genes in the individual into the decision variables (i.e. genotype to phenotype) and evaluating the decision variables by measuring the performance to an objective or set of objectives. A fitness function is usually used to translate objectives into a fitness value. An example of decoding in this method is the translation of real number used to represent an OLTC tap position and ESS real and reactive power state (import or export) for a voltage and power flow management problem.

Constraints are part of the fitness evaluation and in GA are usually applied as a penalty to the fitness function [281]. The implementation of constraints ensures that individuals that do not meet defined constraints are penalised with a lower fitness value, thus ensuring a search is only carried out with more feasible solutions. An example of a constraint in a power systems context are voltage and thermal excursion constraints, which are usually set for T&D networks based on planning standards that ensure adherence to regulation.

The evaluation and fitness assignment step is carried out when the initial and next population set is created (i.e. every generation) and after a crossover and mutation has been carried out.

### 2.2.4 Reproduction - Selection

Finally selection of the chromosomes of individuals is carried out for the next generation based on the fitness values (from the evaluation stage) of individuals in a

population to form a mating pool (with a collection of parents). The set of selected fit individuals after every generation are copied to a mating pool. This stage ensures that fitter individuals within the population have better chances during reproduction. The two most popular selection procedures are briefly discussed below:

#### **2.2.4.1 *Tournament selection***

This is one of the most common processes for selection and copies the process of competition for mating because of the ease of implementation and efficiency [282, 283]. Tournament selection involves picking a subset of individuals from a population and comparing each individual based on their fitness values in a tournament. The fittest individual wins more tournaments and is then selected and copied over to the mating pool and this process continues until the mating pool is full. The individuals that are fitter within the population are given a better chance for reproduction during this process as they win more tournaments. This method has the advantage that the subset of individuals to be picked from a population can be varied to enhance the selection pressure and increase the convergence speed of the GA [277]. The tournament selection is more efficient compared to other reproduction methods or operators in terms of the convergence and calculation properties [278]. Gentle et al from empirical evidence suggest that tournament selection outperforms roulette wheel selection discussed next [282].

#### **2.2.4.2 *Roulette wheel selection***

A random number generator is used to choose individuals from a population, where the probability of selection is relative to the individual's fitness value. In this approach, the probability of selecting a parent from a population is equivalent to spinning a roulette wheel which has each segment's size proportional to the fitness of each parent with the fittest individual having the largest segment in the roulette wheel and vice versa for the least fit individual [283]. The selected individual is then added to a mating pool and the step continues until the pool is filled up with individuals that are guaranteed to be the best out of the population. This method

preserves diversity as all individuals in the population are given a chance to be selected, which is the opposite of tournament selection where the tournament size and outcome from a tournament prevent all individuals within a population from being considered, thus reducing diversity [283]. Deb et al highlight a major obstacle with using the roulette wheel selection method as the reliance on the absolute fitness values which can lead to scaling problems when carrying out selection [282].

#### **2.2.4.3 *Reproduction parameter used***

Based on the evidence provided from the review carried out on both selection methods, the tournament selection method provides more advantages when used and will be used later on in this chapter.

#### **2.2.5 *Crossover***

Crossover (or recombination) is crucial in a GA and involves the combination of two parents (individuals) from the mating pool created from the selection process to form an offspring. This enables the transfer of good genes from the parents to the offspring. All pairs of individuals in the mating pool have to be picked for crossover before the process is completed, however, this does not mean that all parents will be combined. The number of parents combined is determined by the probability of crossover. A zero crossover probability means that the offspring are a direct clone of the parents. Parents that are not combined are copied over to the next population for the next generation where the whole process of evaluation, fitness assignment, selection and the crossover is carried out again. As the crossover operation is carried out over each generation, all good genes will appear more frequently within each individual. This will lead the optimisation to converge towards an optimal solution. The convergence will however be dependent on the complexity of the problem. The following are the main crossover methods in GA:

- Single point crossover: In this crossover method, each parent is split at a single random point and the offspring are created by inheriting one sequence of genes from each of the two parents that have split genes.

- Double point crossover: The parents in this method are split up at two points and the area of genes in between the two split points of the individual is exchanged between the two parents to create the offspring.
- Multiple point crossover: this is a more disruptive method compared to the single and double point crossover methods because it could completely change the structure of the population. Using this method, the individuals are divided into multiple segments which are swapped to create new offspring.
- Uniform crossover: this requires creating a randomly created crossover mask which is then used in determining which genes are transferred from parents to offspring. For example, if there are two parents, two masks will be used. If the mask is 1, the genes are transferred from parent 1 to the offspring and if the mask is 0, the genes are transferred from parent 2 to the offspring as illustrated in Afterwards, the complement of the mask or a new mask is used in creating a second child.

### 2.2.6 *Mutation*

Mutation also plays a key role in GA as it enables the search space to escape from the local optima by maintaining the diversity of a population. Mutation restores genetic diversity to a set of solutions (individuals) that already have similar genes as a result of the selection operation. It also ensures a larger region of the decision space that is not already explored is considered [278]. Mutation applies to GAs that are encoded using binary, integers or real numbers. For real coded GA's mutation is carried out by assigning a random value to a selected gene within the decision space to get a different gene for the offspring. Methods such as random mutation, Gaussian mutation and polynomial mutation have been used [284].. For binary encoded GAs a bit-swapping operation is used to apply mutation.

A mutation rate is specified to assign a probability for each bit or gene within a parent to be mutated. Ochoa et al recommend a low and constant mutation rate as the optimal strategy when recombination is carried out in evolutionary algorithms [285]. The need for time varying mutation is only relevant when no recombination is

applied to an EA problem [285]. The diversity of a set of solutions can be preserved by having large population size or by selecting a suitable mutation operator [276]. Thus there is an inverse relationship between the mutation rate and the population size, with a larger population size requiring a lower mutation rate (as the mutation rate becomes less efficient with a larger population size) and vice-versa [285]. However, regardless of the population size, a higher mutation rate (i.e. greater than 0.5) could result in a random search thus impeding convergence to an optimal solution [286].

### **2.3     *UPDATING THE POPULATION***

After all the steps of evaluation, fitness evaluation, selection, and reproduction (from crossover and mutation), the newly created offspring either replaces the old population (generation replacement process) or replaces the least fit members of the old population (steady state replacement process). Elitism is applied during the update of the population to ensure that the fittest individuals from the old population remain in the new population. In this stage, the fittest parents are either copied directly to the new population or they are compared with the offspring to determine which parents will be added to the new population instead of the offspring. Elitism ensures reproduction does not result in the loss of a good solution by ensuring a good solution is kept in the population until a better performing offspring is generated that can replace the parent. Elitism is employed by multi-objective evolutionary algorithms (MOEA) techniques including the version 2 Non Dominated Sorting Genetic Algorithm (NSGA-II) method used in this chapter. It has been proven to improve the convergence of GA to a global optima [287].

### **2.4     *CONVERGENCE OF SOLUTIONS AND TERMINATION***

During the evolution process of a GA, i.e. after each generation from the initial population, the population will get better solutions which will eventually converge. One or more criteria has to be selected to judge convergence and stop the GA when the set of solutions are close enough to the true Pareto front. At this point the set of solutions is deemed to be within the region of the global optima. Convergence



criteria that have been used for single objective optimisation include, a set number of generations, target value for objectives, or a chosen percentage of the population having the same fitness values [288].

## 2.5 MULTI-OBJECTIVE OPTIMISATION FOR DISTRIBUTION EXPANSION PLANNING

Optimisation of ESS and other Distributed Energy Resources (DER) in most planning problems is usually considered as a single objective problem, with one example being the minimisation of line losses on a distribution network with DERs [109]. The loss minimisation objective is applicable to a DNO. On the other hand, a third party/commercial owner of a DER will have a objectives to minimise the cost of operating the DER to generate revenue in the electricity market while reducing distribution network costs and costs of operation/maintenance, which can be represented as a single or multi-objective problem. Most distribution network DER optimisation problems are multi-objective as they will involve a trade-off of cost against performance. For example, the revenue derived by exporting from a wind generator against how this affects the network's performance in terms of constraints. This may be a DNO responsibility or DNO/third party multi-objective problem. In this case, multi-objective optimisation is required to get the best solution. Multi-objective optimisation provides a planner with the ability to search for all possible non-dominated solutions called the Pareto front. A non-dominated solution can be explained as a solution that satisfies multiple objectives where it is no worse than the solution it is being compared to in all objectives and is better than that solution in at least one objective [278]. The solution that is dominated is called a sub-optimal solution. Alarcon et al explain a solution belonging to a Pareto front as a solution where an improvement in one objective is not possible without affecting any other objectives [109]. Figure 6-2 illustrates the Pareto front for a multi-objective problem with two objectives  $f_1(x)$  and  $f_2(x)$ .

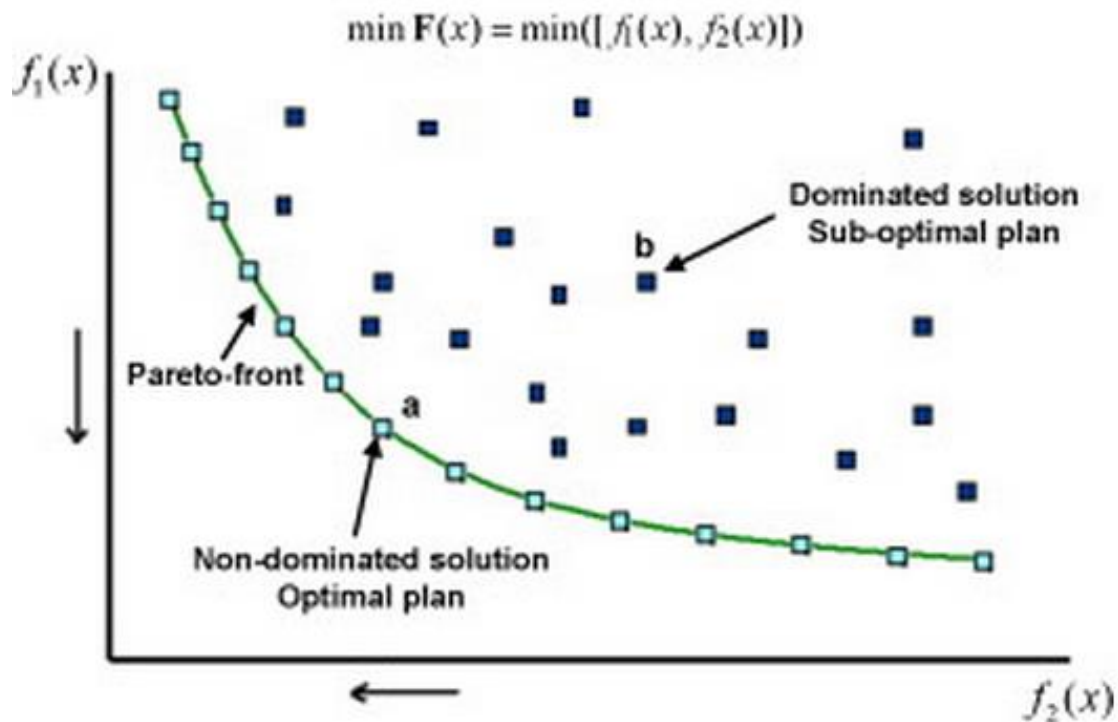

Figure 6-2: Pareto front of a problem with two objectives [109]

Settling on a solution for a multi-objective problem is a two stage process involving optimisation and decision making which can be carried out in any order [289]. If multi-objective optimisation is carried out first, searching is carried out for a set of optimal solutions making up a Pareto front after which decision making is carried out to choose a solution from the Pareto set based on the preferences of the stakeholder involved. For example, network based solutions for DNOs as opposed to market based solutions if an ESS was optimised for voltage constraint management and energy arbitrage. If decision making is carried out first (traditional approach), this is usually based on experience of the problem to derive a single solution either via combining all objectives and assigning weights based on the importance of the objectives to create a single-objective for optimisation or by having a master objective optimised with other objectives considered as constraints [109, 289]. Alarcon et al reviewed literature which drew conclusions that the multi-objective optimisation before decision making method is ideal because [109]:

1. It allows better decisions to be made because of the wider range of solutions to choose from;

2. It provides less subjectivity, is more practical and logical compared to the decision making before single optimisation approach;
3. It provides a better representation of real problems, most of which are multi-objective;
4. It provides information about the multi-objective problems under study and allows for an understanding of the scope of all objectives and provides the ability to evaluate the correlations between the objectives.

The approach of multi-objective optimisation before decision making is employed for the multi-objective optimisation in this chapter.

### ***2.5.1 Selection of Multi-objective optimisation method***

Finding a set of solutions as close as possible to the Pareto front (accuracy); finding the most diverse set of solutions; and getting a good spread of solutions covering the true Pareto front are all important aspects of solving a multi-objective problem to derive an optimal set of solutions (Pareto-optimal solutions) [273, 278]. MOEA methods are distinguished based on the approach to ensure diversification, fitness assignment method and elitism [273]. Alarcon et al highlight that NSGA-II and SPEA-II are the two most recognised multi-objective evolutionary optimisation algorithms [109]. Alarcon et al confirm the relevance and use of NSGA-II in providing an accurate, diverse and spread out set of optimal solutions for multi-objective planning of distributed energy resource [109]. Ippolito et al discuss the efficiency of using NSGA-II for power systems planning and operation, and use it to solve a multi-objective problem on an islanded network with RES [81]. The study in this chapter makes use of the NSGA-II algorithm which is discussed now. NSGA-II is a multi-objective optimisation method that can be used to solve non-convex single and multi-objective optimisation problems, which is the category the DEP problem considering ESS for multiple stakeholder benefits falls under. This is because the problem is represented as a dynamic OPF problem and there is a trade-off of benefits with solutions that are non-convex, which will require the final solution to be decided by a decision maker.

NSGA is a metaheuristic method that was developed by Deb et al [287]. NSGA-II is a Pareto based multi-objective optimisation approach, which uses non-dominated ranking, crowding distance and selection to guide a set of solutions based on a multi-objective problem towards a Pareto front. A summary of the extensions NSGA-II adds to GA are [287].

1. Non-domination ranking: Sorting a set of solutions (individuals) in a population based on levels of non-domination into non-dominated fronts, with the first front (non-dominated set of solutions) closest to the optimal solution. The first front individuals are removed and sorting is carried out for subsequent fronts which will have a decrease in fitness as they will be dominated by individuals from the previous front(s). This sorting continues until all fronts are identified for the population. The individuals are assigned fitness values (or ranks) based on the fronts they belong to, i.e. non-domination level. This rank is the first criterion used during the selection process. An illustration of sorting of solutions into three fronts is shown in Figure 6-3.

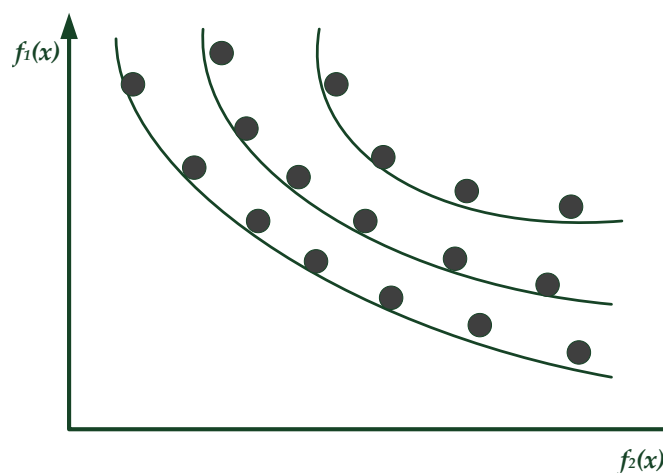

Figure 6-3: Sorting of solutions within a population into fronts to assign fitness values

2. Crowding distance: The crowding distance is a fitness measure which is assigned to each solution within each front for each objective function. This is the measured normalised distance of a solution to neighbouring solutions in a front as shown in Figure 6-4. Once the crowding distance is assigned, the

population is sorted based on the value of the first objective function, with solutions that have the smallest and largest values assigned infinite distance values. Other solutions are assigned the normalised individual difference in distance of the objective function values for adjacent solutions. This is repeated for other objective function values (which are all normalised) and the crowding distance for the solution is simply the summed up assigned distances for each objective function value. The crowding distance is used to compare spread and diversity of solutions with a large average crowding distance signifying diversity in the population [290]. Solutions in less crowded areas within a front are deemed better than solutions in that are in highly crowded areas.

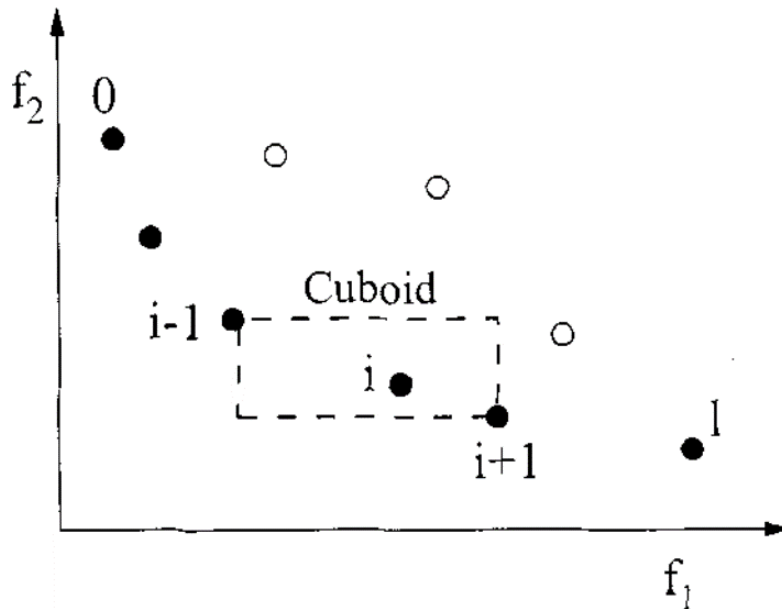

Figure 6-4: Calculation of crowding distance with the filled circles representing solutions within the same non-dominated front [287]

### 2.5.2 The NSGA process

A random population is created and then the individuals are evaluated and assigned fitness values. Afterwards non-domination ranking and the crowding distance is assigned to individuals in a population based on their fitness values. Then binary tournament selection, recombination using the crossover operator, and mutation

using the mutation operators is carried out to create offspring also of the same size  $N$  of the original population thus making an intermediate population of  $2N$  individuals. Afterwards, a new population made up of  $N$  individuals is created from the parents and offspring using information on the least crowded and non-dominated solutions. This ensures the best solutions (Pareto dominance) are kept during each generation and provides a form of elitism by storing non-dominated solutions to improve convergence. The selection is carried out using the Binary Tournament Selection based on a crowded comparison operator  $\alpha_n$  which ensures a spread out set of Pareto-optimal solutions by guiding the EA through each generation [287]. This process is continued through each generation until the algorithm satisfies a stopping criterion or criteria set by the user.

### **3 PROBLEM DESCRIPTION**

The term planning process for energy storage in this section can be seen as a two tier planning study where probabilistic load flows and analysis of the distribution network (medium term planning), and multi-objective optimisation is used to understand and decide on the ESS location and optimal ESS daily operation respectively (short term planning).

#### **3.1 PROBABILISTIC LOAD FLOW**

Deterministic load flows used in DEP ignore the uncertainties in power systems as approximated specific values are used to represent power generation and demand on the networks in order to calculate network power flows. The introduction of demand and generation LCTs will increase uncertainty on the networks and will require probabilistic approaches to planning in order to fully ascertain and analyse the types and severities of risks that could prevail on distribution networks.

Probabilistic load flows are carried out here on the IEEE 33 bus test network discussed in Chapter 3. This was carried out by using MC simulations to generate stochastic 48 half hour demand and generation profiles over a day from log-normalised statistical distributions created, also discussed in Chapter 3.

Automated temporal DLFs are carried out using IPSA with Python during each MC

simulation and the network performance from each half hour period is collected for each simulation. Extreme (worst-case) conditions taken from a large number of random load flow simulations over a day in different seasons for different scenarios of PV and HP proliferation will then be identified. Due to time and computer resource limitations, the MC simulations are carried out for a day in the extreme of seasons, i.e. winter and summer. Afterwards the NSGA-II MOEA optimisation is applied to an installed ESS on the determined location(s) from the MC simulation studies to decide the maximum ESS power and energy capacity required for daily operation of the ESS to resolve the issues from the extreme cases identified from the MC simulations. Here short-term scheduling and dispatch operation of ESS and MV OLTC at the primary substation over a day is considered and this is translated to a set of solutions and an objective function to compute the Pareto-optimal solutions using the NSGA-II multi-objective algorithm.

### ***3.1.1 Application of MC approach to case study network***

The IEEE 33 bus test network is assumed to have only domestic customers with an ADMD of 1 kWh without HPs following conclusions from a study by Gozel et al using ENWL profiles [123]. Based on the assumed ADMD and the given rating of network components, the network was modelled to have 3715 customers. This was also explained in Chapter 3 and was chosen instead of the 2 kW ADMD used in Chapter 5 to present a worst-case scenario with higher number of customers and therefore a higher number of LCT concentrations.

The scenarios initially studied were weekday and weekend over four seasons: winter, spring, summer and autumn. This was then narrowed down to only weekday over winter and summer due to computational intensity, hence only results for the abovementioned scenarios are presented in section 5. The network constraints monitored (also termed events) during the load flows are listed Table 6-2. From the MC simulations, the results for extreme cases (winter for high demand from HP and domestic and summer, high generation from PV and reduced demand) are ranked in terms of the worst case for the number of events listed.

| Network constraints(events)  | Triggers (>=)             | Order of severity |
|------------------------------|---------------------------|-------------------|
| Overvoltage                  | +6%                       | 5                 |
| Undervoltage                 | -6%                       | 3                 |
| Primary Transformer overload | 50% of transformer rating | 1                 |
| Branch overload              | 75% of conductor rating   | 2                 |
| Reverse power flow           | 50% of transformer rating | 4                 |

Table 6-2: Network constraints monitored

The following ranking steps were carried out:

- The results are ranked for the worst case based on the number of busbars (under and overvoltage event) and number of branches affected (thermal overpower event) over the day in the winter and summer season.
- The worst-case demand profile for each scenario was selected as the MC simulation result with the most thermal events and/or voltage events. This was used to determine the location of the ESS on the network, i.e. based on the most badly affected busbar (for a voltage event) or close to a badly affected branch for thermal overpower.

Independent simulations for a day are run for different scenarios of LCT proliferation. For the base-case year (2014), there was 2% of PV installed based on GB figures of PV installation [223], and 1% (rounded up from actual percentage of 0.3%) of installed HP from GB figures for domestic HP installations (derived using number of domestic customers and HP installed by domestic customers in 2013) [226, 227]. In the final year i.e. 2030, two scenarios will be considered to run the MC simulations. Analysis of the DECC average yearly growth in PV for installations  $\leq$  50 kW from 2009 - 2014 provided a figure of 25% average yearly growth in PV installations [223]. The study here took that into account and applied the average yearly growth for number of customers with installed PV on the test network to finish with an approximate concentration of 60% PV concentration, chosen as scenario 2 for PV as shown in Table 6-3. Scenario 1 was specified to be half the percentage concentration in scenario 2, 30% to present a less severe scenario. For HPs, the Committee on Climate Change provided predictions of HP to be installed



in 7 million homes by 2030, scenario 2 was specified with 25% HP penetration on the network (worst-case scenario). This has however now been revised to 4 million homes or approximately 13% uptake, which was used in scenario 1[291, 292]. The conventional domestic demand is left constant across all scenarios because there is a trend in the UK of demand reduction as discussed in Chapter 5, section 2.1.1.

| <b>Simulations</b> | <b>PV</b> | <b>HP</b> | <b>Number of simulations</b> |
|--------------------|-----------|-----------|------------------------------|
| Base-case Scenario | 2%        | 1%        | 2 (weekday over two seasons) |
| Scenario 1 (2030)  | 30%       | 13%       |                              |
| Scenario 2 (2030)  | 60%       | 25%       |                              |

Table 6-3: Simulation runs for weekday over winter and summer

Although a typical day in each season is used, the variability of daily demand is covered on the busbars across the network following the stage 2 process of MC simulations where different demand profiles within the season statistical distributions are used to create the demand profile for each customer on a busbar and across the network in each half hour. Only the winter and summer seasons were considered because the demand and generation variation is greatest between those seasons in the UK, largely because of the heating requirements in the winter. This is well established across the UK and can be seen in the UK Department of Energy and Climate Change analysis [293] and from the sample UKGDS demand data profile in Chapter 3 section 3.1.1. This is reflected in the wholesale electricity market where power forwards are traded by winter and summer seasons, when significant changes in demand patterns are expected, with the winter season having a higher demand due to heating requirements.

### **3.2 MULTI-OBJECTIVE OPTIMISATION**

Chapter 4 discussed business models for ESS and deterministic studies were carried out on a case study network over a 15 year period in Chapter 5 to establish the viability of different ESS ownership types and business models. From assessing the most likely to extreme scenarios for LCT-G and LCT-D proliferation resulting from

the probabilistic study in Section 3.1, the problem of picking the optimal capacity and dispatch for a distribution network ESS was formulated into a multi-objective optimisation problem for two business models:

- A DNO owned ESS optimised purely for technical constraints on the network;
- A third party or DNO owned ESS optimised to provide network and commercial services all with equal priority.

The technical objectives are based on indices created for optimised network performance relative to base-case network performance. The indices show the levels of improvement of the optimised set of solutions against the base-case with no ESS. The technical objectives cover the total real power losses on the network and the VSF, which is the first objective; and the number of voltage and power flow constraints on the network, which is the second objective. Loss minimisation is an important technical objective factored into planning studies and was chosen as part of the first objective because the increase in LCTs spread across distribution networks would worsen the real power losses because of increases in peak demand and power flows [294]. The VSF signifying voltage stability on the network as discussed in Chapter 5 evaluates the range of voltage variations across the network, which should be within the network limits. The VSF is linked to the first objective as an increase in VSF is correlated to a reduction in loss as shown in Figure 6-5, which presents results based on 100 random simulations carried out on the IEEE 33 bus test network from LCT-D, LCT-G and domestic demand raw samples used in the study by Anuta et al [128]. No financial penalties or benefits are attached to these two technical parameters that form the loss/VSF index.

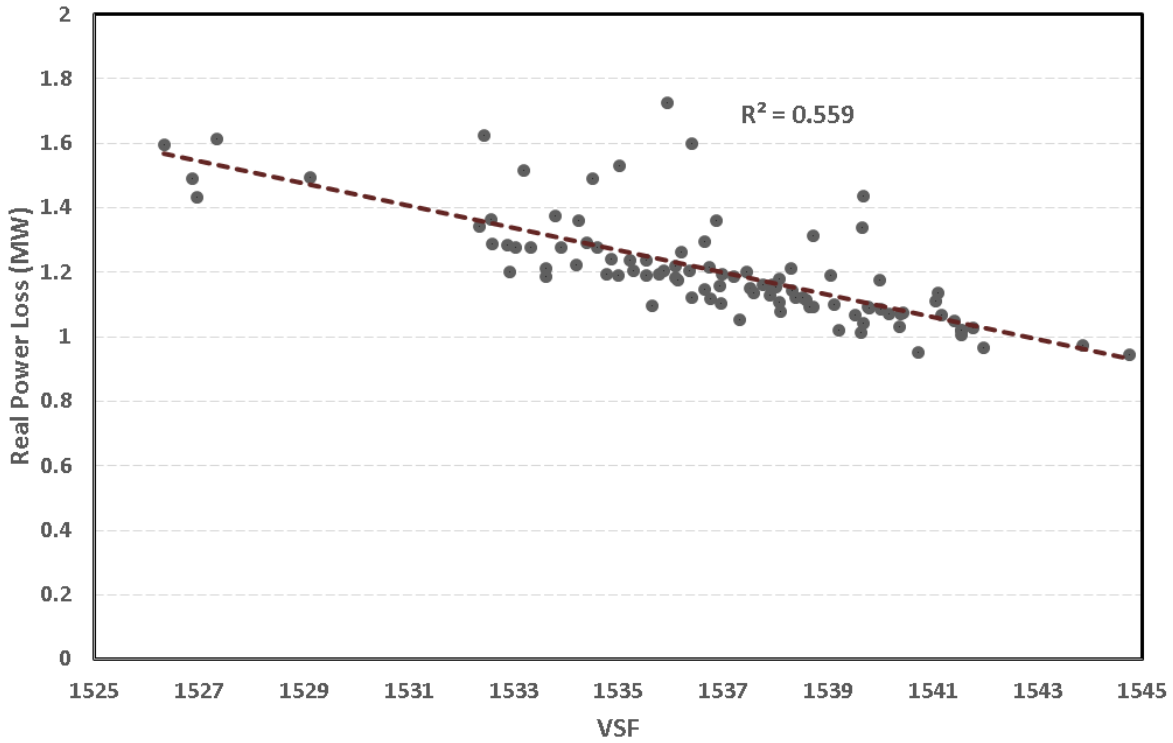

Figure 6-5: Loss and VSF relationship on IEEE 33 bus test network from 100 Monte Carlo simulations with no ESS

The third objective maximises the revenue from the ESS from commercial operations. This is used by the ESS owner to maximise revenues from the spot market and to provide ancillary services to the T&D network from reducing peak power flows. This provides embedded benefits in a way of financial compensation using a set tariff (based on geographical location) to distributed generators, DR providers and ESS owners. Such services include TRIAD avoidance services to suppliers, and DUoS demand reduction and generation increase (ESS discharge) during peak periods on the distribution network (red and amber) as discussed in Chapter 5.

The technical objectives tend to conflict with commercial objectives. This sort of problem with conflicting multi-objectives that have to be optimised simultaneously with equality and inequality constraints is a general feature of multi-objective problems [295]. General multi-objective OPF problems are formulated as follows [115, 295] :

$$\text{Min } f_k(x), \quad k = 1, 2, \dots, M \quad 6-1$$

$$\begin{aligned} \text{Subject to: } g_l(x), & \quad l = 1, 2, \dots, N & 6-2 \\ h_i(x), & \quad i = 1, 2, \dots, J \end{aligned}$$

Where  $f_k$  is the  $k$ th objective function,  $x$  is the decision vector of a solution and  $M$  is the number of objective functions;  $g_l(x)$  is the vector of equality constraints  $N$  which includes power flow equations. This limits the amount of power injected or required on the network.  $h_i(x)$  is a vector of inequality constraints  $J$  which represent the physical and operational limits of the power system. This includes generation, network thermal (transformer and line) and voltage limits.

### 3.2.1 Increasing voltage stability factor and reducing losses

The Voltage Stability Factor Index (*VSFI*) and the Power Loss Index (*PLI*) are used to measure improvements against the base-case results on the network. The objective function  $f_1$  is minimised in this objective as shown.

$$f_1 = \min(VSFI + PLI) \quad 6-3$$

The *VSFI* is the ratio of the  $VSF_{\text{total}}$  with no ESS (the base-case),  $VSF_{\text{total},t}^{\text{No Ess}}$  to the  $VSF_{\text{total}}$  with ESS  $VSF_{\text{total},t}^{\text{Ess}}$

$$VSFI = \frac{\sum_{t=1}^T VSF_{\text{total},t}^{\text{No Ess}}}{\sum_{t=1}^T VSF_{\text{total},t}^{\text{Ess}}} \quad 6-4$$

Where  $t$  is the time up to the maximum 48 time periods  $T$ . The  $VSF_{\text{total}}$  which is the total voltage stability factor of all the busbars on the network. It signifies improved voltage stability of the network and can be expressed as

$$VSF_{\text{total}} = \sum_{bb=1}^{bb-1} 2V_{bb+1} - V_{bb} \quad 6-5$$

Where  $bb$  is the total number of busbars in the network;  $V_{bb}$  is the magnitude of the primary voltage and secondary substation voltages. The *PLI* is a ratio of total losses on the network with and without ESS as shown

$$PLI = \frac{\sum_{t=1}^T (\sum_{br=1}^{Br} P_{loss,br,t}^{Ess} + \sum_{tx=1}^{TX} P_{loss,tx,t}^{Ess})}{\sum_{t=1}^T (\sum_{br=1}^{Br} P_{loss,br,t}^{No\ Ess} + \sum_{tx=1}^{TX} P_{loss,tx,t}^{No\ Ess})} \quad 6-6$$

Where  $P_{loss,br}^{Ess}$  and  $P_{loss,tx}^{Ess}$  are the real power loss across a branch and transformer with ESS and  $P_{loss,br}^{No\ Ess}$  and  $P_{loss,tx}^{No\ Ess}$  are the real power loss across a branch and transformer with no ESS.

### 3.2.2 Reducing the number of network constraints

This second objective function  $f_2$  minimises the events index EI as shown

$$f_2 = \min(EI) \quad 6-7$$

The EI represents the number of constraint violations (events) resulting from using ESS  $events_t^{ESS}$  are compared against the number of events in the base-case with no ESS  $events_t^{No\ ESS}$  as shown

$$EI = \sum_{t=1}^T \frac{events_t^{ESS}}{events_t^{No\ ESS}} \quad 6-8$$

The set of constraints monitored on the network are shown in Table 6 2.

### 3.2.3 Maximising revenues from commercial operations

The maximisation of ESS revenues which is a commercial operation is the third objective  $f_3$  and can be expressed as follows:

$$f_3 = \max(R_{ESS}) \quad 6-9$$

Where  $R_{ESS}$  is the revenue obtained from operating the ESS over a day (in the base-case year (2015) and 15<sup>th</sup> year) from commercial operations all discounted based on the present worth factor  $PWF_y$  for the scenario year  $y$  as described in Chapter 5 section 3.1.

$$R_{ESS} = \{R_{Arbitrage} + R_{TRIAD} + R_{DUoS}\} \times PWF_y \quad \forall t, y \quad 6-10$$

The details of each revenue stream are as follows:

1. Revenue from energy arbitrage  $R_{\text{Arbitrage}}$  from procuring electricity

$E_t^{\text{discharge}}$  at periods with off-peak electricity prices  $E_{\text{buyprice},y,t}^{\text{off pk}}$  to charge the ESS and selling the electricity  $E_t^{\text{charge}}$  at peak electricity prices  $E_{\text{saleprice},y,t}^{\text{pk}}$  during peak periods of time  $t$  daily.

$$R_{\text{Arbitrage}} = \left[ \left( E_t^{\text{discharge}} \times E_{\text{saleprice},y,t}^{\text{pk}} \right) - \left( E_{\text{ess},t}^{\text{charge}} \times E_{\text{buyprice},y,t}^{\text{off pk}} \right) \right] \times PWF_y \quad \forall t, y \quad 6-11$$

2. Revenue from Triad avoidance,  $R_{\text{TRIAD}}$

$$R_{\text{TRIAD}} = TNUoS_{y,t} \times E_{\text{TRIAD},t}^{\text{discharge}} \times PWF_y \quad \forall t, y \quad 6-12$$

where  $TNUoS_t$  is the half hour Triad charge based on the location of the network the ESS is implemented,  $E_{\text{TRIAD},t}^{\text{discharge}}$  is the energy discharged from the ESS over the triad periods in the winter which falls in time period  $t$  in the winter. The average of power in three Triad periods of discharge which is used in Chapter 5, section 3.1 is not used in this case because the optimisation is intraday.

3. Revenue from DUoS  $R_{\text{DUoS}}$ , which is the combination of the DUoS generation revenue and demand cost discussed in Chapter 5 is

$$R_{\text{DUoS}} = \left\{ \left( \left( E_t^{\text{discharge}} \times G_{\text{Unit}}^{\text{DUoS}} \right) + G_{\text{Fixed}}^{\text{DUoS}} \right) - \left( \left( E_t^{\text{charge}} \times D_{\text{Unit}}^{\text{DUoS}} \right) + \left( E_{\text{ess},T}^{\text{Peak}} \times MIC_{y,T}^{\text{DUoS}} \right) + D_{\text{Fixed}}^{\text{DUoS}} \right) \right\} \times PWF_y \quad \forall t, y \quad 6-13$$

where  $D_{\text{Unit}}^{\text{DUoS}}$  is the DUoS unit charge (per kWh) paid to the DNO over the red, amber and green periods if the ESS is charging,  $G_{\text{Unit}}^{\text{DUoS}}$  is amount paid to generators for every kWh of energy discharged during the day; the fixed DUoS charge for HV substation connected generator (ESS discharging) for the whole day  $T$  is  $G_{\text{Fixed}}^{\text{DUoS}}$  or HV and LV connected demand (ESS charging with different charges based on voltage level) is  $D_{\text{Fixed}}^{\text{DUoS}}$  in pence per meter point administration number (MPAN) per day;  $E_{\text{ess},T}^{\text{Peak}}$  is the peak apparent power during charging operations over the

whole day and  $MIC_T^{DUoS}$  is the DUoS maximum import demand capacity charge when the ESS is charging. The charges will vary based on whether the ESS is connected at HV or LV with the latter resulting in a higher charge. Generation connected at High Voltage (HV) and Low Voltage (LV) is not subject to DUoS charges but they get credit under the common distribution charging methodology (CDCM). ESS much like DG can get embedded benefits from reducing demand by discharge operations during the day. ESS can also be charged like a demand customer when charging. The unit charges or generator benefit in p/kWh is higher during red periods and reduces during amber periods with the lowest charge or benefit during green periods. Red amber and green periods vary during weekday and weekends for different DNOs. The revenue from DUoS ( $R_{DUoS}$ ) for the ESS discharging (generator)  $E_t^{\text{discharge}}$  and charging (demand)  $E_t^{\text{charge}}$  is based on unit charge and fixed charges. The  $G\_Fixed_{y,T}^{DUoS}$  and  $D\_Fixed_{y,T}^{DUoS}$  are negligible when considered for only a day as a result both prices are set to zero for this study.

### 3.2.4 Constraints

The optimisation model considers seven constraints which are as follows:

1. Equality constraints: These are the constraints of the power flow equation expressed as follows:

$$\begin{aligned}
 P_{\text{ESS},bb_i} + P_{\text{LCTG},bb_i} - P_{d,bb_i} \\
 = V_{bb_i} \sum_{bb_j=1}^{BB} V_{bb_j} (G_{bb_{ij}} \cos\theta_{bb_{ij}} + B_{bb_{ij}} \sin\theta_{bb_{ij}}) \quad \forall t
 \end{aligned} \tag{6-14}$$

$$\begin{aligned}
 Q_{\text{ESS},bb_i} + Q_{\text{LCTG},bb_i} - Q_{d,bb_i} \\
 = V_{bb_i} \sum_{bb_j=1}^{BB} V_{bb_j} (G_{bb_{ij}} \sin\theta_{bb_{ij}} - B_{bb_{ij}} \cos\theta_{bb_{ij}}) \quad \forall t
 \end{aligned} \tag{6-15}$$

Where  $BB$  is the number of buses,  $P_{d,bb_i}$  and  $Q_{d,bb_i}$  are the active and reactive load at busbar  $i$  respectively,  $Q_{\text{ESS},bb_i}$  and  $Q_{\text{LCTG},bb_i}$  are the reactive power

export from the ESS and LCT at busbar  $i$  respectively,  $P_{ESS,bb_i}$  and  $P_{LCTG,bb_i}$  are the real power export from the ESS and LCT at busbar  $i$  respectively  $G_{bb_{ij}}$  and  $B_{bb_{ij}}$  are the transfer conductance and susceptance between busbar  $i$  and  $j$  respectively,  $\theta_{bb_{ij}}$  is the voltage phase angle difference between busbar  $i$  and  $j$ .

2. Inequality constraints: these constraints include the voltage and thermal constraints of the network, power (real and reactive) and energy capacity limits of the ESS, and reverse power flow limits. The inequality constraints are represented as follows:

$$\text{ESS power rating limits} \quad \pm P_{ESS,t} \leq P_{ESS}^{\max} \quad \forall t \quad 6-16$$

$$\pm Q_{ESS,t} \leq Q_{ESS}^{\max} \quad \forall t$$

$$\text{ESS energy capacity limits} \quad SoC_{min} \leq E_{ESS,t} \pm SoC_t \leq SoC_{max} \quad \forall t \quad 6-17$$

$$\text{Voltage constraints} \quad V_{bb}^{\min} < V_{bb_i,t} < V_{bb}^{\max} \quad \forall t \quad 6-18$$

$$\text{Thermal constraints (lines and transformer)} \quad S_{c,t} < S_c^{\max} \quad \forall t \quad 6-19$$

$$\text{Reverse power flow limits} \quad P_{tfmr,t} < -P_{tfmr}^{\max} \quad \forall t \quad 6-20$$

And the OLTC limits are represented as:

$$tap_{l\_limit} < t_{pos,t} < tap_{u\_limit} \quad \forall t \quad 6-21$$

Where  $P_{ESS}^{\max}$  and  $Q_{ESS}^{\max}$  is the maximum and minimum real and reactive power limits of the ESS respectively,  $SoC_{max}$  and  $SoC_{min}$  are the maximum state of charge of the ESS based on the energy capacity limit and the minimum state of charge based on user defined depth of discharge respectively.  $V_{bb_i,t}$  is the voltage at busbar  $i$  at time  $t$  limited by the maximum  $V_{bb}^{\max}$  and minimum  $V_{bb}^{\min}$  limits for voltage on all busbars across the network,



$S_{c,t}^{\max}$  is the maximum apparent power limit of conductors on the network (comprising the transformers and lines/cables) and  $S_{c,t}$  is the apparent power through the conductor at time  $t$ ,  $P_{\text{tfmr},t}$  is the power through the primary substation transformer at time  $t$  which has to be within the user defined real power threshold for reverse power flows on the network  $P_{\text{tfmr}}^{\max}$ .  $\text{tap}_{l,\text{limit}}$  and  $\text{tap}_{u,\text{limit}}$  are the lower and upper limits of the OLTC and  $\text{tap}_{\text{pos},t}$  is the tap position.

Although the problem is constructed as a dynamic OPF problem, all constraints are fully enforced apart from the network constraints in equation 6-18 - 6-20 where no penalties are applied if the solution violates the constraints. This is because of:

- The difficulty in implementing constraints in MOGA's as a result of the non-dominance ranking of solutions as opposed to using the objective function values. Alarcon et al highlight that constraint handling for MOGA's has not been fully researched and that most multi-objective GA do not consider constraints as part of a problem [109]; and
- The opportunity to explore more possibilities for commercial operations by means of operating the ESS for arbitrage and embedded benefits (Triad and DUoS). It is important that network constraints are not in place to explore the search space for optimal ESS operation based on the third objective for commercial operations. The Pareto front should have solutions that do not violate the constraints and fully meet the DNOs requirements or solutions where constraints are violated at the least possible levels, i.e. minimisation of  $f_2$  with the maximum of possible revenues for a third party.

### 3.2.5 Application of NSGA-II optimisation method

The problem described above is a multi-objective optimisation problem with two technical DNO related objectives and a conflicting third objective for commercial ESS operation with seven constraints. The problem has been formulated as a non-linear multi-objective problem using the NSGA-II MOEA method. Taking into account the

definition of all the objectives and equality and inequality constraints, the problem has been optimised using the objective function

$$f(x) = \begin{cases} f_1 \\ f_2 \\ f_3 \end{cases} \quad 6-22$$

to find the decision vector representing a solution

$$X^* = [P_1^*, Q_1^*, T_1^*, \dots, P_{48}^*, Q_{48}^*, T_{48}^*] \quad 6-23$$

which represents the ESS real and reactive power output and primary substation OLTC tap position over 48 half hour time periods. This is subject to the constraints defined in equation 6-14 to 6-21.

#### 4 PROBLEM FORMULATION AND CASE STUDY

This section presents the approaches employed in this chapter for medium and short term planning. The first stage involves running MC simulations based on 2030 scenarios for PV and HP uptake using the generation and demand distributions discussed in Chapter 3 which are then evaluated for the worst-case results of thermal overload and voltage violations. In the second stage, the resulting load profiles from the stage 1 MC simulations are then used as the daily load profiles that are put through the IEEE 33 bus test network for short-term scheduling optimisation of the ESS based on multiple objectives. The Pareto-optimal solutions are then analysed to understand the trade-offs of technical and revenue making objectives for DNO and third party stakeholders.

##### 4.1 MONTE CARLO SIMULATIONS APPROACH

The statistical distributions used for the HP, domestic demand and PV profiles are discussed in Chapter 3 and were derived as part of the CLNR project in the UK with results published in [127, 128]. The method used for the MC simulations is a follow up to the work carried out by Anuta et al using raw data sets from the CLNR customer sites to carry out MC simulations [128]. The author improved and adapted the MC method that was developed as a collaborative work in [128] to fit in with the

IPSA load flow engine and Python automation scripts. The method was also improved and adapted to use statistical distributions and improve the speed of the algorithm, including the collection of results for analysis.

Demand and generation is distributed across each busbar on the test network according to the number of customers. A bottom-up approach is used here where the demand and generation on the network is determined using stochastic variables obtained from the statistical distributions for solar PV, HP and domestic demand.

The Probabilistic Load Flow (PLF) approach is broken down into two stages as shown in Figure 6-6 and Figure 6-7. The steps in summary cover:

- Random sampling of independent busbars and random generation of concentration levels of LCTs and domestic demand on each busbar
- Random sampling of statistical distributions for HP, PV and domestic demand to create net busbar demand that is fed to the network model to allow for load flow analysis to be carried out.

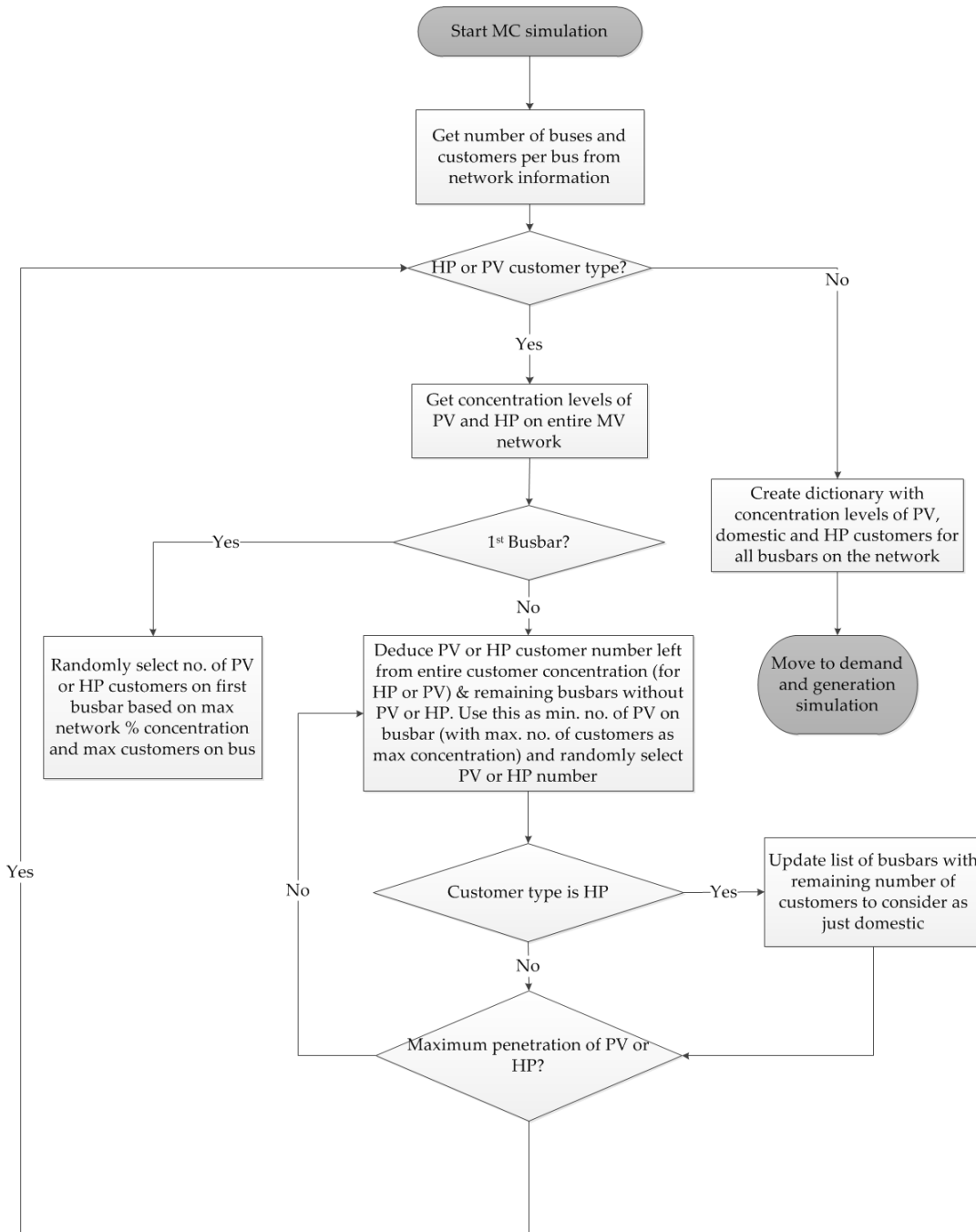

Figure 6-6: Stage 1 of PLF method to determine the number of customer types on a busbar

From the simulations, the realisations of the variations in demand and generation on the distribution network under study and the resulting network performances are collected. A detailed description of each stage is provided below.

#### 4.1.1 Stage 1 – MC simulation

1. The number of customers on each busbar is calculated and the total percentage concentration of HP and PV specified is used to determine the

total number of HP and PV customers across the network. Concentration refers to the number of HP or PV installed out of all the customers on each busbar at LV, and in total on the MV network. Each busbar is randomly selected and randomly populated based on the required percentage concentration of HP and PV on the network.

2. For the first busbar randomly selected, the maximum number of percentage concentration (lower bound) is used to determine the number of customers with either HP or PV. This is used with the maximum number of customers on that busbar (upper bound), to pseudo-randomly determine the number of HP or PV customers. For example a busbar with 100 customers and with a total network concentration of 50% HP, will mean that a random number of HP customers between 50 – 100 is selected for the first busbar.
3. The busbar is then taken out of the list used to determine customers and then pseudo-random concentration determination is carried out again, but this time using an updated percentage concentration (%total concentration) that takes into account an updated quota for number of customers left for each technology type after each random selection ( $Net\_LCT_{tot,i}$ ), the total number of customers across the network for each LCT type ( $Net\_LCT_{tot,I}$ ), and the total remaining customers left after the randomly selected busbar has been removed ( $Net\_Cust_{tot,i}$ ) as shown in:

$$\%total\ concentration = \left( \frac{Net\_LCT_{tot,I} - Net\_LCT_{tot,i}}{Net\_Cust_{tot,i}} \right) \quad 6-24$$

Where  $Net\_LCT$  refers to the total network LCT customers, tot means total,  $I$  represents all busbars on the network and  $i$  represents busbars left after random selection.

4. The subsequent busbars are then selected in a loop to determine concentration levels of the different customer types following step 3 and this is repeated until the required concentration levels on the network has been reached for all customer types or the maximum number of busbars has been reached.

#### 4.1.2 Stage 2 – Demand and generation creation and deterministic load flow

After setting the number of customers on each busbar for HP and PV and the remaining domestic customers have been ascertained and stored following the stage 1 process, the demand and generation for each customer on each busbar is individually created from the temporal statistical distributions generated for this study discussed in Chapter 3. Figure 6-7 describes the process used to create and aggregate demand and generation profiles across the network to create a net demand at the LV networks (busbars) for the 48 time periods in a day. The following steps outline the process:

1. For each customer type on a busbar, demand or generation for a half hour period is calculated by selecting a uniform random sample of z-scores from the statistical distribution for HP, PV and domestic demand covering the 99.7<sup>th</sup> percentile (i.e. z-score between -3/+3 of a two-tail distribution);
2. The randomly selected z-score is used to calculate the demand or generation  $d_{c,t}$ , following:

$$d_{c,t} = e^{(\mu_t + z\sigma_t)} \quad 6-25$$

from the statistical distributions for each half-hour  $t$  of mean  $\mu_t$  and standard deviation  $\sigma_t$  for that customer based on their customer type (i.e. conventional domestic demand, domestic demand with HP, and customer with PV) on the busbar. The z-score remains the same for each customer on a busbar for the 48 half-hourly periods in the day. Variability of demand and generation is covered by the percentile diversity for different customers on a busbar and across the network;

3. The total demand (domestic and HP) and generation (PV) values at each half hour for each busbar is then converted to the apparent power (MVA) requirement at the transformer by multiplying the sum total of demand for a customer type on a busbar  $d_{c,t}^{bb}$  by the chosen power factor for that customer type  $PF_{c\_type}$ . Assumptions of 0.95 power factor for HP and a 0.98 power

factor for domestic demand is assumed. The PV works at a unity PF in the UK [296].

4. The values are then summed to build a demand profile with generation from PV taken off the total demand (HP and/or domestic). The result obtained is applied as the net MVA requirement  $Net\_Pri_t$  of the network for each half hour as shown:

$$Net\_Pri_t = \sum_{bb=1}^{BB} \sum_{c=1}^C (d_{c,t}^{bb} \times PF_{c\_type}) \quad 6-26$$

$BB$  is the total number of busbars on the network and  $bb$  is an individual busbar on the network

5. The demand profile is then loaded onto the distribution network under study and automated load flows are carried out for each half hour using the IPSA load flow engine.
6. The results are collected and the process is repeated again from stage 1 until the required number of MC simulations is reached.

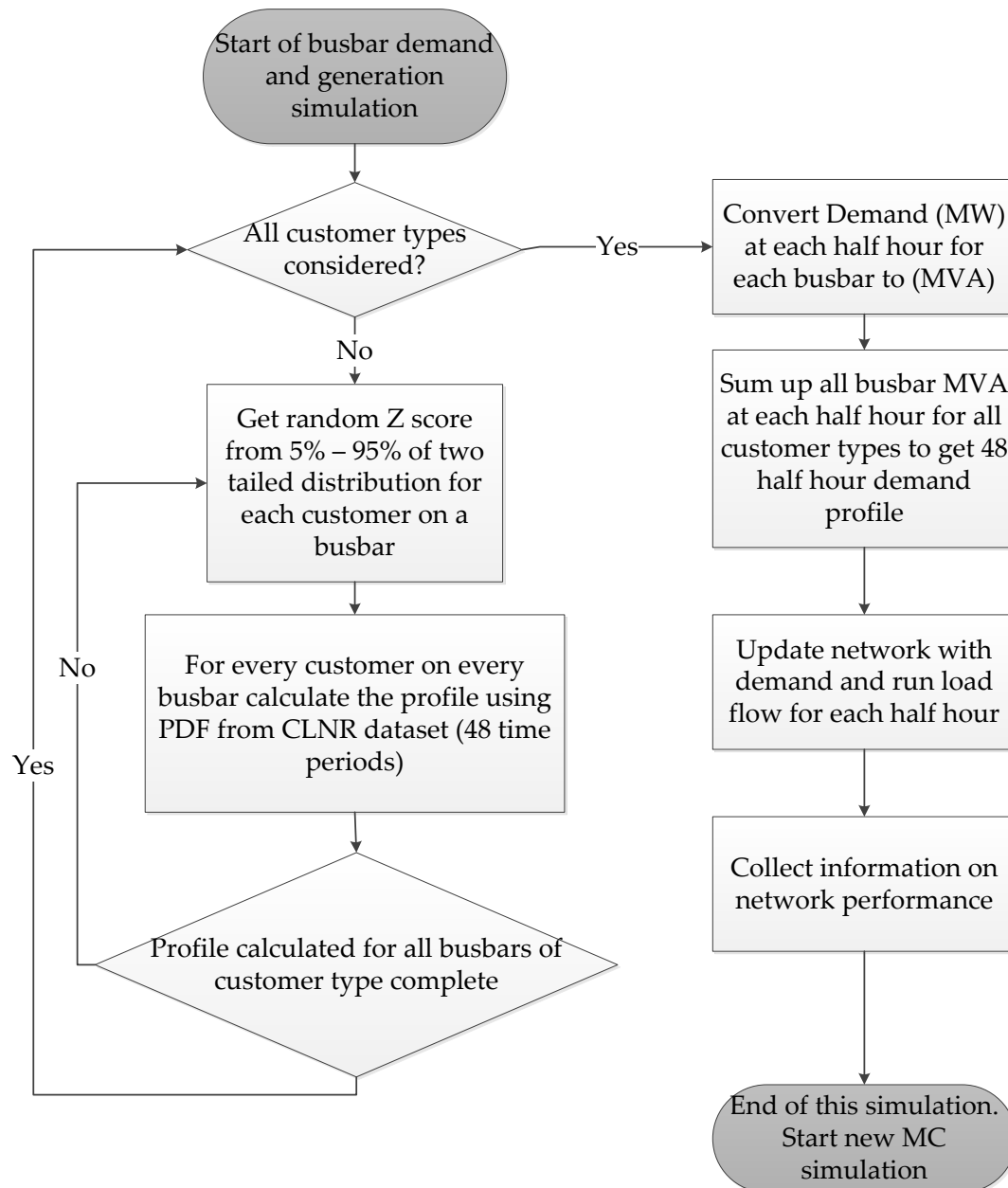

Figure 6-7: stage 2 of PLF showing creation of demand at each half hour from statistical distributions and aggregation of demand to carry out load flow using IPSA

#### 4.1.3 Determination of number of Monte Carlo Simulations

The MC simulations are carried out following stage 1 and 2 with a defined number of simulation runs based on a convergence study. MC simulations have to be stopped after a criterion or criteria have been met to judge convergence of the set of solutions. The maximum voltage and minimum voltage at each half hour across the network are used to determine the right number of simulation runs. These network conditions were collected for a varied number of MC simulations and confidence



intervals were calculated and used to judge convergence of the results. Confidence Intervals (CI) are used as a way of establishing where a set of true values lie within a range of values. CIs provide a chance of understanding the probability of correctness [297]. For example, a confidence interval at a 99% confidence level for a sample of population means that 99% of the time, the mean of the population will lie within the CI. The smaller the CI, the more close it gets (from running the MC simulation) to getting a true representation of issues that could occur on the distribution network as a result of the increased LCT concentrations. This means that the results are converging and a larger number of MC simulations will not be necessary once fully converged. For the research in this chapter, two-sided confidence intervals were calculated for the mean of up to 15,000 MC simulations for collected load flow results at each half hour as shown in:

$$\bar{X} - Z_{\alpha/2} \frac{(\sigma)}{\sqrt{n}} \leq \mu \leq \bar{X} + Z_{\alpha/2} \frac{(\sigma)}{\sqrt{n}} \quad \forall t \quad 6-27$$

Where  $\bar{X}$  is the mean of load flow results collected,  $n$  is the sample size of the results at each half hour  $t$ ,  $Z_{\alpha/2}$  is the value of random variables to consider from the standard normal distribution of results with a percent cut-off on the two tail distribution at  $(1 - \gamma/2)$ ,  $\frac{(\sigma)}{\sqrt{n}}$  is the standard error of the population with  $\sigma$  representing the standard deviation of the population.

A 95% confidence level ( $Z_{.95}$ ) for the population mean is 1.96. This was used to calculate the CIs for this study. A simpler representation of 6-27 is:

$$\bar{X} \pm HI \quad \forall t \quad 6-28$$

Where  $HI$  is the half interval  $Z_{\alpha/2} \frac{(\sigma)}{\sqrt{n}}$ .

As more MC simulations are carried out, the  $HI$  of the results will decrease, signifying the sample mean of the results is approaching the population mean and the sample standard deviation is approaching the standard deviation of the population. The  $HI$  will be one measure used to judge convergence of the results.

## 4.2 OPTIMISATION APPROACH FOR INTRA-DAY ESS OPERATION

The ESS is optimised to fully resolve or mitigate the issues identified in the results of the MC simulation from the particular demand and generation realisation, while ensuring the constraints are satisfied. The aim of the optimisation is to operate the ESS (charge and discharge operation) to solve technical issues on the test distribution network and to provide revenues from arbitrage operations, and other commercial operations that include providing DUOS embedded generator and TRIAD revenues. The formulated optimisation problem is implemented using Python with the Distributed Evolutionary Algorithm Python (DEAP) framework which provides the platform for tailoring evolutionary algorithms to different user problems [120, 298].

### 4.2.1 Encoding of solutions - Mixed-integer representation of ESS and OLTC operation

All individuals in the initial population are created randomly satisfying the power rating and energy capacity upper and lower bounds and the tap changer's discrete bounds. The creation of the initial population is seeded during parameter tuning and optimisation and in the base-case and LCT scenarios to ensure: the same initial population is created and used to determine the right parameters for the NSGA-II algorithm, and that the results from optimisation can be replicated. The parameters that were selected based on multiple runs using a scenario of increased LCT concentration are:

- Individual probability of mutation ( $Mut_{\text{Indpb}}$ )
- Crossover probability ( $CX_{\text{pb}}$ )
- Size of population ( $N_{\text{pop}}$ )
- Number of generations ( $N_{\text{gen}}$ )
- Crowding degree of crossover and mutation ( $\eta$ )

The individual length is determined by the control variables over a day in half hour time steps. The control variables are the ESS real and reactive power output, which are continuous variables; and the tap positions, which are discrete control variables

with each individual tap position represented by an integer. Table 6-4 shows a representation of the integer encoding of the tap position of an OLTC with 14 tap positions with a tap step of 1.393% and a limit of -15% - 4.5%.

| Integer Code | Tap position | Integer Code | Tap position | Integer Code | Tap position | Integer Code | Tap position |
|--------------|--------------|--------------|--------------|--------------|--------------|--------------|--------------|
| 0            | 0            | -1           | -1.393       | -5           | -6.965       | -9           | -12.537      |
| 1            | 1.393        | -2           | -2.786       | -6           | -8.358       | -10          | -13.93       |
| 2            | 2.786        | -3           | -4.179       | -7           | -9.751       |              |              |
| 3            | 4.179        | -4           | -5.572       | -8           | -11.144      |              |              |

Table 6-4: Integer encoding of tap position

The ESS output for real and reactive power are continuous control variables represented by floating point numbers. Mixed-integer representation is allowed by NSGA-II to represent the genes of the individuals in the population. Figure 6-8 shows the mixed-integer representation of the individual used in this study. The ESS output and tap movement variables are executed with a control variable which will signify whether an operation should be implemented or not. The individual comprises a set of discrete and continuous variables over 48 half hour periods and has a length which is a product of 48 and the number of control variables. The individual is represented in this form because of:

- Reduced complexity, since running 48 load flows can be run in one go before the optimisation (i.e. evaluation, selection, crossover, mutation);
- Representing the individual over the 48 time steps means that different charging and discharging patterns are considered over an entire day. This is necessary when considering electricity market operations with electricity prices varying at each half hour.

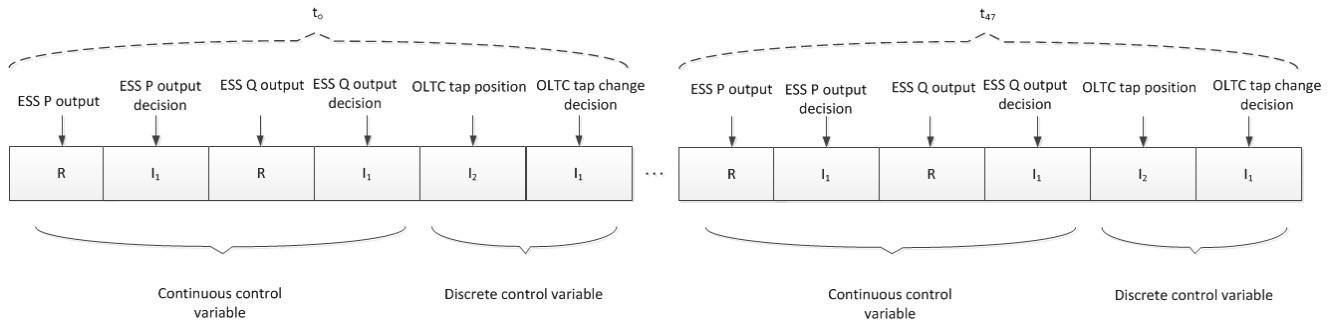

Figure 6-8 – Alternative encoding of individuals used for optimisation

Representing an individual over one time step would make updating the state of charge easier as the previous SoC bounds can be used to generate the maximum/minimum  $P$  values for the individual in the next time step. If the optimisation was for a purely technical operation, this would have been considered. A drawback to this approach would be the need to run multiple load flows for one time step.

The NSGA-II individuals are encoded using an array consisting of:

- Real numbers in floating point ( $F$ ), which specifies the ESS real and reactive power output;
- Real numbers in the range 0 – 1 ( $I_1$ ), which specifies whether the ESS  $P$  and  $Q$  generated values should be implemented (either discharge or charge) in the range 0 – 0.5 or no action should be taken in the range > 0.5 – 1. The same is applied to the OLTC, with action to implement generated tap values carried out in the range 0 – 0.5 and no action in the range > 0.5 – 1.
- Integers ( $I_2$ ), which represents positive and negative integers that represent discrete tap positions.

The population as shown in equation 6-29 is composed of a set of the individuals illustrated in Figure 6-8.

$$\begin{bmatrix} \{P_0, Q_0, T_0, T_{c,0}, \dots, P_{47}, Q_{47}, T_{47}, T_{c,47}\}, \\ \{P_0, Q_0, T_0, T_{c,0}, \dots, P_{47}, Q_{47}, T_{47}, T_{c,47}\}, \\ \dots \dots \dots \dots \dots \dots \dots \dots \\ \vdots \\ \{P_0, Q_0, T_0, T_{c,0}, \dots, P_{47}, Q_{47}, T_{47}, T_{c,47}\} \end{bmatrix} \quad 6-29$$

#### 4.2.2 Bounds for individual

The individuals are created with the bounds for real power, reactive power and tap changer position as shown in equations 6-16 for real and reactive power rating, 6-17 for SoC limits and 6-17 for OLTC limits.  $P$  and  $Q$  are randomly generated real numbers. However the limits to  $P$  is dependent on the SoC and are updated for each time step based on the previous SoC as well as the maximum power rating of the ESS, which also limits reactive power output. The SoC is a moving bound that has to be updated inter-temporally for each randomly generated individual and for individuals that have gone through the crossover and mutation stages of the NSGA-II process. This moving bound is shown in equation 6-30.

$$\begin{bmatrix} \{SOC_0, SOC_0, SOC_1, SOC_1, \dots, SOC_{47}, SOC_{47}\}, \\ \{SOC_0, SOC_0, SOC_1, SOC_1, \dots, SOC_{47}, SOC_{47}\}, \\ \dots \dots \dots \dots \dots \dots \dots \dots \\ \vdots \\ \{SOC_0, SOC_0, SOC_1, SOC_1, \dots, SOC_{47}, SOC_{47}\} \end{bmatrix} \quad 6-30$$

The available real power at any half hour can be calculated using equation 6-31.

$$P_{avail,t} = \begin{cases} [SOC_t - P_{dch,t} \times 0.5] \times 2 \\ [SOC_t + P_{ch,t} \times 0.5] \times 2 \end{cases} \quad 6-31$$

Where  $P_{avail,t}$  is the available real power in the ESS at a half hour period of time  $t$  limited by the maximum power rating of the ESS and  $SOC_t$  is the SoC at that time period.  $P_{dch,t}$  and  $P_{ch,t}$  represents the power from discharging or charging the ESS during a half hour period. When  $t = 0$ , the SoC is at maximum capacity as it is assumed the ESS is fully charged from the day prior. The process of updating the

SoC and P during the creation of the population and after every crossover and mutation operation is shown in Figure 6-9. If the ESS real power real power value from the random individual creation and crossover and mutation operation goes above the updated SoC at that half hour, the real power value is updated to discharge only the real power left in the ESS or charge up to the maximum SoC of the ESS. If the ESS cannot take any extra charge or cannot discharge any more power because the maximum SoC or minimum SoC has been reached, the real power will equal zero at that time step.

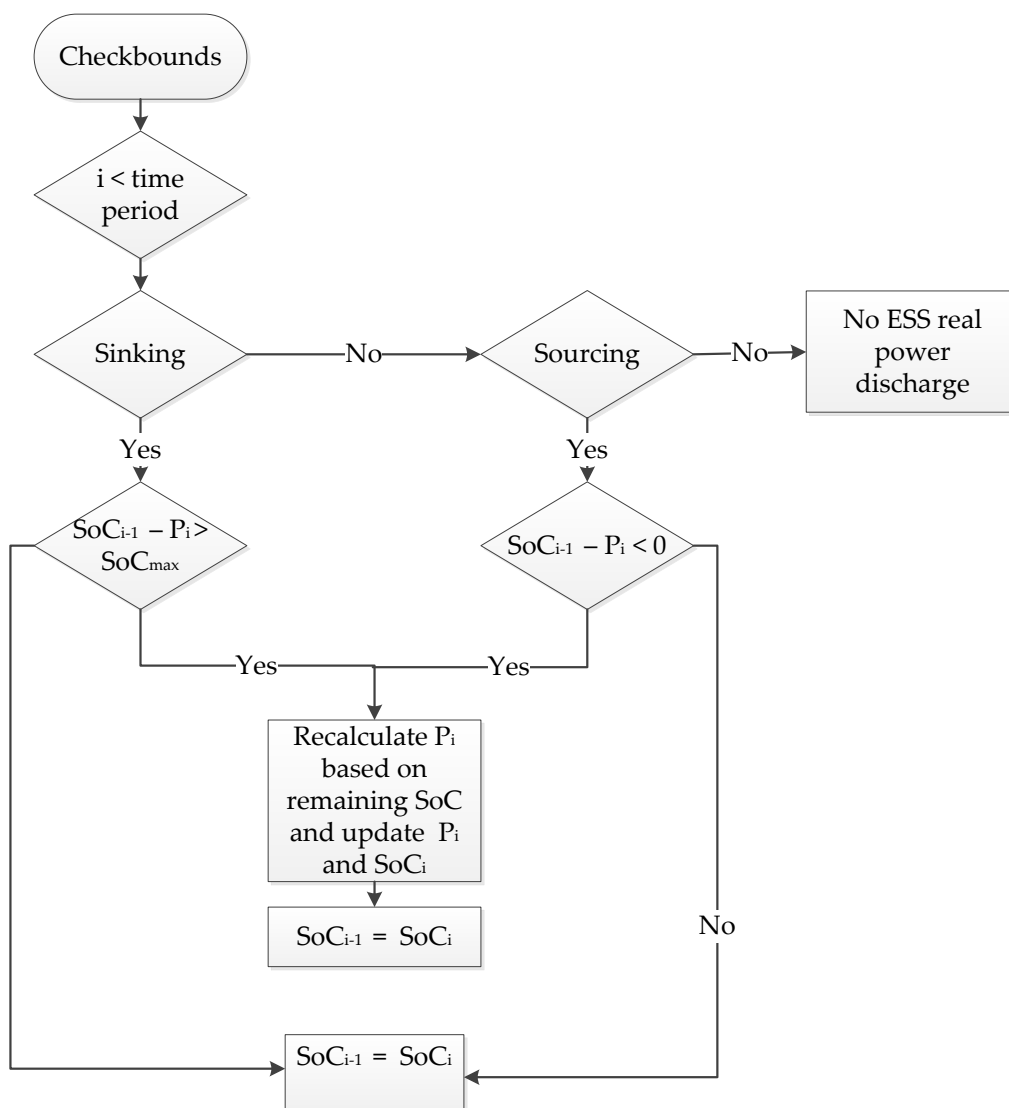

Figure 6-9: Updating ESS real power and state of charge bounds

### 4.2.3 Integration with IPSA load flow engine

The fast decoupled load flow method used by IPSA is iterative and set to 1000 iterations with convergence tolerance set at the IPSA default of 0.01 (this dictates the

accuracy of load flow solutions with a lower number providing a more accurate solution). In half hour periods when the load flow refuses to converge as a result of the combination of the tap, ESS P and/or Q settings, a high penalty is set that affects the two technical objective functions:

- VSF is set to 1 and real power loss is set to 100 MW;
- A penalty is assigned based on voltage excursions occurring on all 32 busbars and thermal excursions assumed on all network lines (34) and the primary transformer (i.e. 32+34);
- Finally a penalty of 1 is assigned for reverse power flow problems.

These steps ensure these individuals are removed from the population during the selection process. The method used to carry out the NSGA-II optimisation method is summarised in Figure 6-10.

#### ***4.2.4 Electricity wholesale market assumptions***

The electricity market data used is shown in Figure 6-11. Note that a scaling factor was applied to the winter and summer prices as done in Chapter 5, with no change in the actual shape of the market prices. The scaling factor to derive prices up to 2030 was obtained from DECC assumptions for future wholesale electricity prices based on a central scenario [237]. The created prices provide a representative estimate of the daily shape and magnitude of market prices in 2015 and in future. However, in reality the market price and shape will be dictated by UK generation fleet, renewables, gross demand, planned and unplanned plant outages and other political and economic situations. This market price representation is used to show the performance and effectiveness of the NSGA-II optimisation in getting optimal charge and discharge daily patterns for the ESS to make the most profit. Note, inflation (Retail Price Index) figures from [299] were used to bring the mean of the historical prices from 2004 – 2012 up to 2013 prices before the scaling was applied using the DECC assumptions.

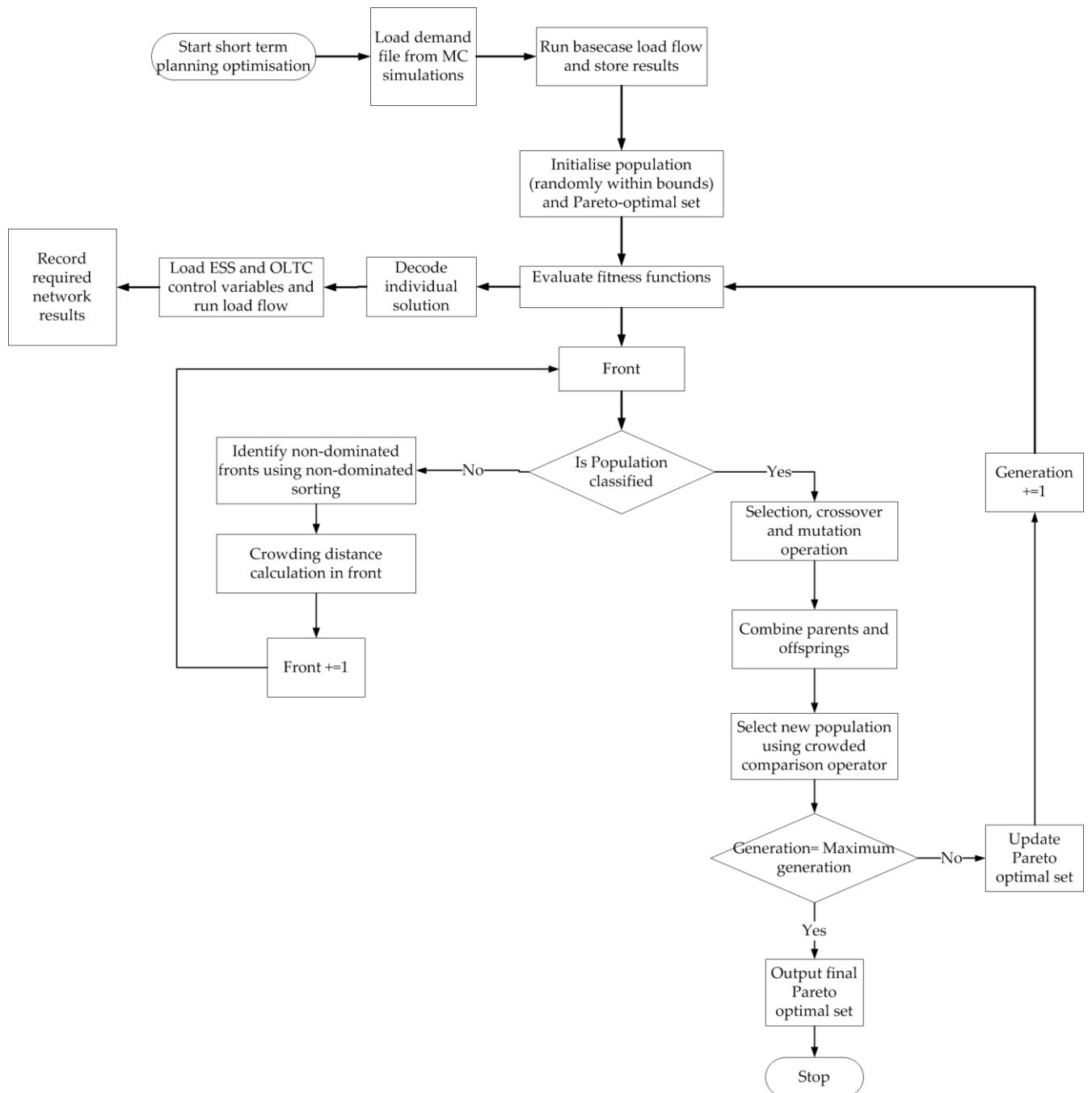

Figure 6-10: Flow chart of optimisation method and description



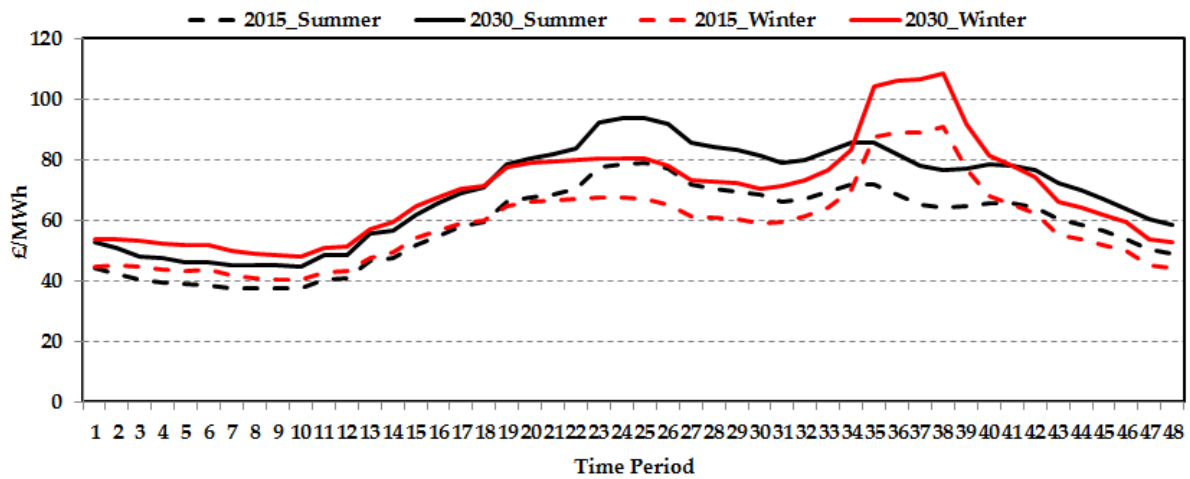

Figure 6-11: Winter and summer 2015 and 2030 spot market price data used for electricity market arbitrage operation (2013 prices).

The round trip efficiency impacts the arbitrage strategy due to the efficiency losses that occur when charging the ESS during off-peak periods that have to be recovered during the peak periods along with the profit the ESS owner requires. This strategy was discussed in Chapter 5, Section 2.4.3. Considering an ESS round trip efficiency of 85% and assuming the ESS is charged during the off peak periods, the maximum peak price during the off-peak period is used as the trigger to start arbitrage operations. Once the percentage arbitrage figure is agreed, this is applied to the maximum off-peak price to trigger the ESS to discharge. In this case, a 15% profit over the highest off-peak price was used as the threshold to determine how much the ESS can discharge. This was then used to determine the ESS capacity rating, which has to fall below or up to the cost of reconditioning. The following were observed from analysing the market prices to identify when market prices in the day surpass off-peak market prices:

- The ESS can be discharged at full output in the winter in 2.5 hours (5 half hour periods) from 17:00 – 19:00 hours;
- In the summer, the ESS can be operated for 4.5 hours (9 half hour periods) from 10:30 – 13:30 hours and from 16:30 to 17:00 hours.

#### *4.2.5 Other economic assumptions*

The values used for the DUOS generation and demand charges, and TRIAD charges are the same as those from Chapter 5. These values are not adjusted for inflation in the future, which is hard to forecast up to the year 2030, instead the final revenue from commercial operation is discounted using the nominal discount rate used in Chapter 5. It is assumed the TRIAD period falls within the winter day of optimisation.

#### *4.2.6 Determination of the ESS power and energy capacity*

The boundaries for the ESS power and energy capacity during the optimisation will be set at a fixed level, which will be pegged up to the maximum cost for conventional reinforcement cost for the scenarios under study. Network reconductoring is assumed as the default solution to resolve voltage problems and thermal overload with the cost set at £60,000/km for LV and £1,000,000/km for HV based on provided costs from two DNOs in the UK<sup>9</sup>. The network data used for calculating the cost to reductor the network is presented by Ameli et al and also presented in the Appendix [93]. In addition, based on winter or summer scenarios, the upper bounds for the energy capacity of the ESS are set by ensuring the ESS can be discharged at the peak power rating when there are peak power prices for 2.5 hours and 4.5 hours respectively. The optimal ESS power rating and energy capacity, operation pattern will be a solution selected from the Pareto-optimal solution space. Each result from the optimal set of solutions will have a corresponding maximum charge or discharge power over the day which will be the peak power rating for the ESS. The maximum depth of discharge based on a defined capacity will determine the maximum ESS capacity. For example, if the ESS is specified to have a boundary of 2 MW rating and 2 MWh energy capacity, if the peak of either charging or discharging during the day is 1.5 MW, that will be the ESS power rating for that

---

<sup>9</sup> Indicative reinforcement costs were provided by Scottish Power Energy Networks and Electricity North West.

solution and likewise if during the day the minimum SoC is 1 MWh, the energy capacity of the ESS will be 1 MWh for that solution.

## 5 RESULTS AND DISCUSSION

### 5.1 MONTE CARLO SIMULATIONS

#### 5.1.1 Selecting the number of simulations

MC simulations are resource intensive computationally and time-wise hence the convergence of simulations based on changes in HI is used in selecting the right number of simulations that covers all possibilities of HP and PV concentrations on the network under study. On the IEEE 33 bus network, HP and PV concentrations were set at 50% and 25% respectively to judge the convergence of results in order to settle on a fixed number of MC simulations. Due to computational limitations, the maximum number of MC simulations was set at 15000. Figure 6-12 and Figure 6-13 shows the percentage change in HI for maximum and minimum voltage on the network from 7 am to 7pm. After the huge change in HI from 1000 simulations to 2000 simulations, the percentage change continues to drop as expected, however the changes after 5000 simulations are less than 10% for each time period as illustrated in

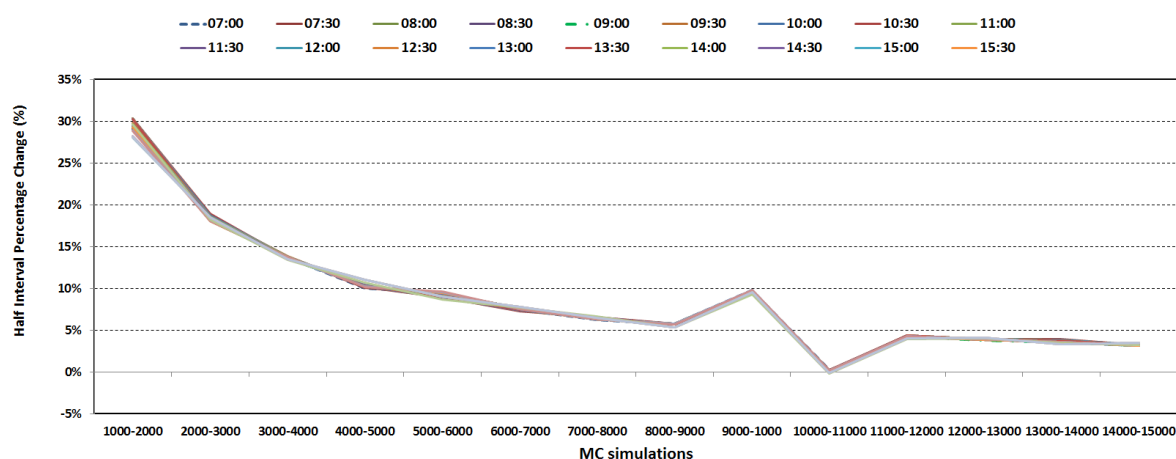

Figure 6-12: Percentage change in half interval of for minimum voltage at each half hour

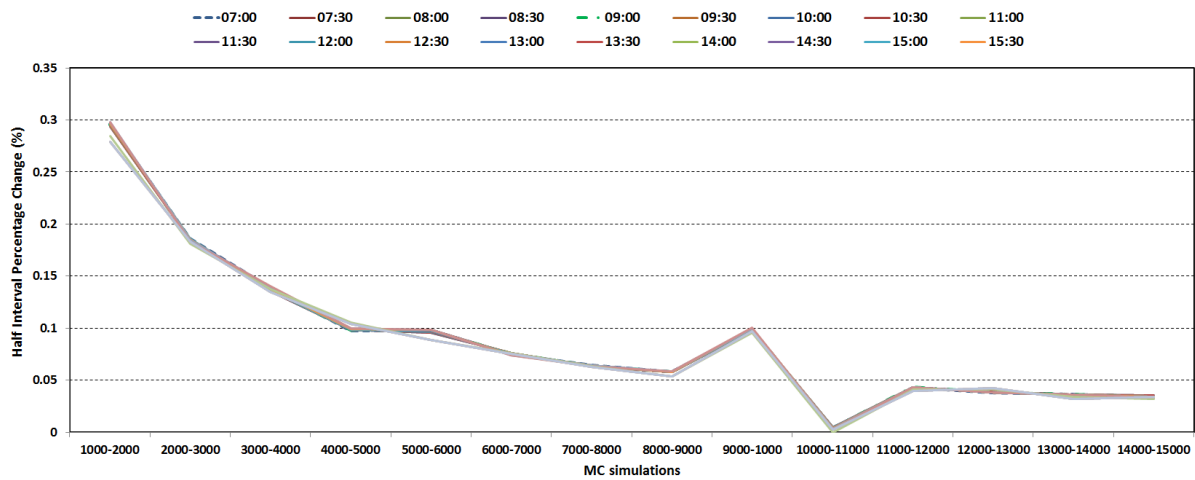

Figure 6-13: Percentage change in half interval of for maximum voltage at each half hour

Figure 6-14 and Figure 6-15 shows the reduction in HI over a day after every thousand MC simulation up to 10000 simulations. The reduction in HI based on different MC simulations happens at all time periods for the minimum network voltage results; this is not the same for the maximum network voltage results where a great reduction is pronounced only at time periods 35 - 44. This is a representation of the fact that undervoltage is rampant on the network under the chosen scenario of HP and PV concentration. Therefore, from the results, there was a larger variation in minimum voltage as a result of the high demand from HPs on the network as opposed to large amounts of generation.

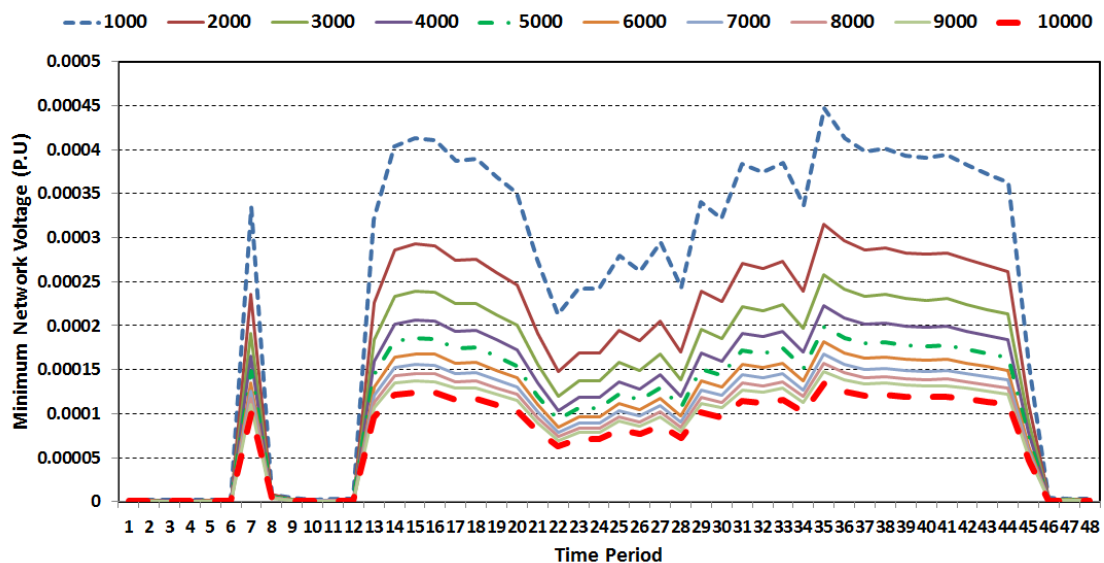

Figure 6-14: Half interval of minimum voltage at each half hour on the IEEE 33 bus test network

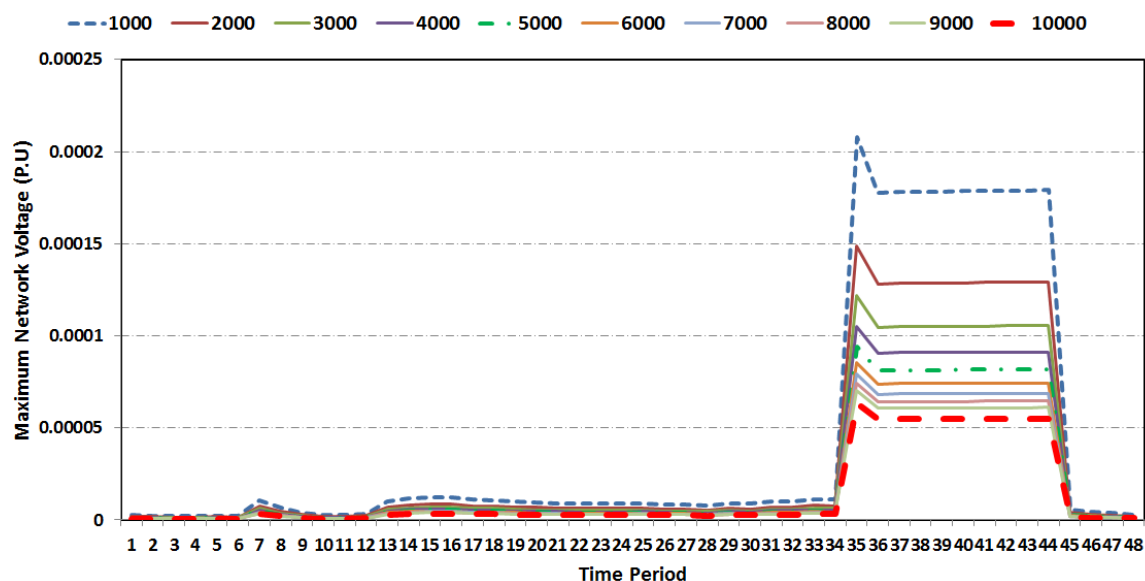

Figure 6-15: Half interval of maximum voltage at each half hour on the IEEE 33 bus test network

For the purpose of the study in this section a less than 10% change in HI was chosen as the cut-off for simulations. Beyond this, the computational resources and time produces little change in the result. 5000 simulations was chosen as the number of MC simulations to be used for the studies on the stochastic nature of future demand and generation in distribution networks.

### 5.1.2 Results from the different scenarios studied

MC simulations were carried out based on the scenarios for HP and PV concentration on the network listed in Table 6-3. The thermal limits monitored covers all lines on the network and the transformer and includes cases of reverse power flow. From the MC simulations, the simulation with the worst-case network issues are discussed in the following subsections.

### 5.1.3 Base-case

Table 6-5 shows the results from the worst-case simulation for the base-case. This occurred over the winter season. Line 17 on the network was identified as the area with thermal overcapacity issues and this will be selected as the ESS location during

optimisation. Line 17 is 3.2 km long and will cost £3,200,000 to reconductor based on the costs assumed in section 4.2.6.

| Season | Thermal/voltage event | VSF  | Losses (MW) | Min/Max voltage (PU) | Max. Thermal constraint (%) | Most severe area affected |
|--------|-----------------------|------|-------------|----------------------|-----------------------------|---------------------------|
| Winter | 4/0                   | 1578 | 1.910       | 0.961/1.051          | 83.2%                       | Line 17                   |

Table 6-5: Base-case simulation with worst-case issue

#### 5.1.4 Scenario 1 - 30%PV 13% HP

Under this scenario there are two profiles selected for ESS implementation in the next section as shown in Table 6-6. In the winter, the prevalent issue is thermal overcapacity which affects line 17 which can be attributed to the high demand from conventional domestic customers, and customers with HP, in the winter. In the summer, while there are no thermal excursions, there are overvoltage issues on busbar 18 on the network and this is correlated with solar PV export coinciding with below average demand.

| Season | Case | Thermal event | Voltage event | VSF  | Losses (MW) | Min/Max voltage (P.U) | Max. Thermal constraint (%) | Most severe area affected |
|--------|------|---------------|---------------|------|-------------|-----------------------|-----------------------------|---------------------------|
| Winter | 1    | 29            | 0             | 1565 | 2.575       | 0.946/1.051           | 99.6                        | Line 17                   |
| Summer | 2    | 0             | 5             | 1625 | 0.466       | 0.990/1.061           | 34.9                        | Busbar 18                 |

Table 6-6: Scenario 1 simulation with worst-case issue

#### 5.1.5 Scenario 2- 60% PV and 25% HP

The simulations under this scenario result in the selection of three different profiles for optimisation. In the winter, there are voltage and thermal excursions as shown in Table 6-7 hence two profiles are selected for the winter period. One of them results in the worst-case event for thermal overcapacity with 40 monitored thermal excursions and no voltage issues this is correlated with the higher demand from the customers with HP and conventional domestic customers over the winter. The

second winter profile had 17 voltage excursions all of which are undervoltage events. This difference in worst-case results is attributable to the different locations and concentrations of HP and PV simulated on the network from the Monte Carlo simulations. In the summer, while there are no thermal excursions, there is a high amount of overvoltage on the network similar to the case in scenario 1, but more extreme at 1.081 P.U. This is expected as the PV concentration was increased by 30 percentage points.

| Season | Case | Thermal event | Voltage event | VSF  | Losses (MW) | Min/Max voltage (P.U) | Max. Thermal constraint (%) | Most severe area affected |
|--------|------|---------------|---------------|------|-------------|-----------------------|-----------------------------|---------------------------|
| Winter | 1    | 40            | 0             | 1571 | 2.484       | 0.952/1.051           | 100.1                       | Line 21                   |
| Winter | 2    | 0             | 17            | 1559 | 3.041       | 0.932/1.051           | 75                          | Busbar 18                 |
| Summer | 3    | 0             | 246           | 1640 | 0.604       | 0.990/1.081           | 38.5                        | Busbar 18                 |

Table 6-7: Scenario 2 simulations with worst-case issues

During the winter, the high levels of demand on the network also led to a higher amount of losses and a lower VSF as the network generally had lower voltages across the busbars. Busbar 18 and line 21 are identified here as the locations affected by undervoltage and thermal overcapacity and will be used as the sites for the ESS installation during optimisation (both of which will be tested with the ESS installed independently).

## 5.2 NSGA-II OPTIMISATION

### 5.2.1 Selection of NSGA-II operators and parameters

The NSGA-II optimisation algorithm parameters of the crossover probability ( $CX_{pb}$ ), the probability for mutation or individual probability ( $Mut_{indpb}$ ), the crowding degree of crossover and mutation ( $\epsilon$ ), population size ( $MU$ ) and the number of generations ( $N_{gen}$ ) were tuned against fitness statistics collected for the three

objective functions in equation 6-3, 6-7, 6-9 in section 3.2. For the tuning process, firstly the parameters were selected using profile 2 from scenario 2 (60% PV and 25% HP scenario) where there were voltage issues.  $N_{gen}$  was fixed at 10 and the population size at 20 to reduce the computation time required to determine the right parameters. The objective in this selection process is to identify how the control parameters affects the solutions, hence an exhaustive population size or number of generations was not deemed necessary. In selecting the parameters, objectives 1 and 2 which are related to the loss and VSF, and number of problems on the network are used as main indicators when selecting the parameters. This is based on the assumption of the DNO procuring ESS services from a third party as both objectives are important for DNOs. The importance of tuning the NSGA-II parameters is to understand how the different parameters affect the optimisation algorithm in getting the Pareto-optimal solutions. Table 6-8 to Table 6-10 shows the different values tested for different parameters and the selected values (highlighted in grey) that yielded the best fitness values for the three objective functions.

The tests were carried out using a random number generators with a fixed seeded for generating individuals and for assigning the probability of crossover at each generation. This ensures the tests for each parameter are compared with the same random generated values and can be replicated.

### 5.2.2 *Selecting the eta*

The simulated binary bounded crossover and polynomial mutation operators used in DEAP for this optimisation are adapted from the original work by Deb et al [287]. For these operators the choice of the crowding degree of crossover and mutation (*eta*) needs to be carefully selected. A high *eta* will mean the children resemble their parents and a low *eta* will yield the opposite. The *eta* was the first parameter selected with  $CX_{pb}$  set at 0.9 and  $Mut_{Indpb}$  at 3/288 as shown in Table 6-8.  $f_1$  represents the objective for loss and VSF index,  $f_2$ , represents the objective for the problem index and  $f_3$  represents the objective for commercial revenues from the spot market, DUoS and Triad, all of which are defined in section 3.2.



| <i>eta</i> | <i>f1</i><br>(MIN) | <i>f2</i> (MIN) | <i>f3</i><br>(MAX) |
|------------|--------------------|-----------------|--------------------|
| 1          | 1.78               | 1.01            | £736.89            |
| <b>5</b>   | <b>1.72</b>        | <b>0.79</b>     | <b>£825.5</b>      |
| 10         | 1.77               | 2.13            | £711.99            |
| 15         | 1.79               | 1.51            | £756.62            |
| 20         | 1.78               | 1.58            | £711.99            |

Table 6-8: Determining the *eta* with 10 generations and a population size of 20

### 5.2.3 Selecting the $Mut_{Indpb}$

After the *eta* was selected to be 5 based on the trade-off on the best objective functions, it was fixed and used to determine the  $Mut_{Indpb}$  as shown in Table 6-9. The individual probability of mutation suggested by Deb et al for real coded problems is  $1/n$  where  $n$  is the number of genes, and one gene in each individual is mutated in every generation[287]. However, from the tuning process,  $3/n$  was selected as the individual probability as it yields the lowest fitness values for objectives 1 and 2, although objective 3 yields the second lowest fitness value. This was a judgement selection based on a compromise between technical performance of the network and revenues from the ESS.

| $Mut_{Indpb}$ | <i>f1</i><br>(MIN) | <i>f2</i><br>(MIN) | <i>f3</i> (MAX) |
|---------------|--------------------|--------------------|-----------------|
| 1/288         | 1.76               | 1.29               | £787.8          |
| <b>3/288</b>  | <b>1.72</b>        | <b>0.79</b>        | <b>£825.5</b>   |
| 10/288        | 1.72               | 1.16               | £879.33         |
| 15/288        | 1.77               | 1.73               | £980.39         |
| 30/288        | 1.76               | 1.11               | £936.57         |

Table 6-9: Determining the  $Mut_{Indpb}$  with 10 generations and a population size of 20

### 5.2.4 Selecting the $CX_{pb}$

After the  $Mut_{Indpb}$  and *eta* have both been selected, the parameter of  $CX_{pb}$  is evaluated for the NSGA-II algorithm. Deb et al mention a crossover probability between 0.5 - 0.8 is mostly used in evolutionary algorithms [300]. However, in this study, a  $CX_{pb}$  of 0.9 was selected and the results from the tests are shown in Table 6-10. Although objective 3 yields the lowest fitness value, objectives 1 and 2 are used in

selecting the  $CX_{pb}$  in this case. This was selected based on the same compromise used in selecting  $Mut_{Indpb}$

| $Cx_{pb}$  | $f1$ (MIN)  | $f2$ (MIN)  | $f3$ (MAX)    |
|------------|-------------|-------------|---------------|
| 0.5        | 1.86        | 1.16        | £769.77       |
| 0.6        | 1.82        | 1.99        | £859.82       |
| 0.7        | 1.75        | 2.34        | £1072.43      |
| 0.8        | 1.8         | 1.92        | £866.89       |
| <b>0.9</b> | <b>1.72</b> | <b>0.79</b> | <b>£825.5</b> |
| 0.95       | 1.77        | 1.55        | £899.93       |

Table 6-10: Determining the  $CX_{pb}$  parameter with 10 generations and a population size of 20

### 5.2.5 Selecting $MU$ and $N_{gen}$

The population size and number of generations was chosen to get a trade-off between convergence of the solutions towards the Pareto-optimal solutions and reduction in large computation time. Of particular importance is the population size, as a large population does not necessarily result in a proportional increase in the quality of the solutions but increases the computational complexity and time required for the algorithm. Due to time and resource limits, the number of generations was set at a maximum of 100. The NSGA-II algorithm was run on the test network and ESS model, and the change in fitness function values for population sizes 40, 80, 200, 300 and 400 were used. The change in the best fitness values is illustrated in Figure 6-16. The values for objectives 1 and 2 do not improve after using population size of 80. The values for objective 3 start to drop after 200 simulations and remains at the very similar values for a population size of 80 and 200 (at £2660 and £2687). This is more apparent in Figure 6-17 which shows the percentage improvement in the three objective functions with the different population sizes. The most improvement happens with a population size of 80.

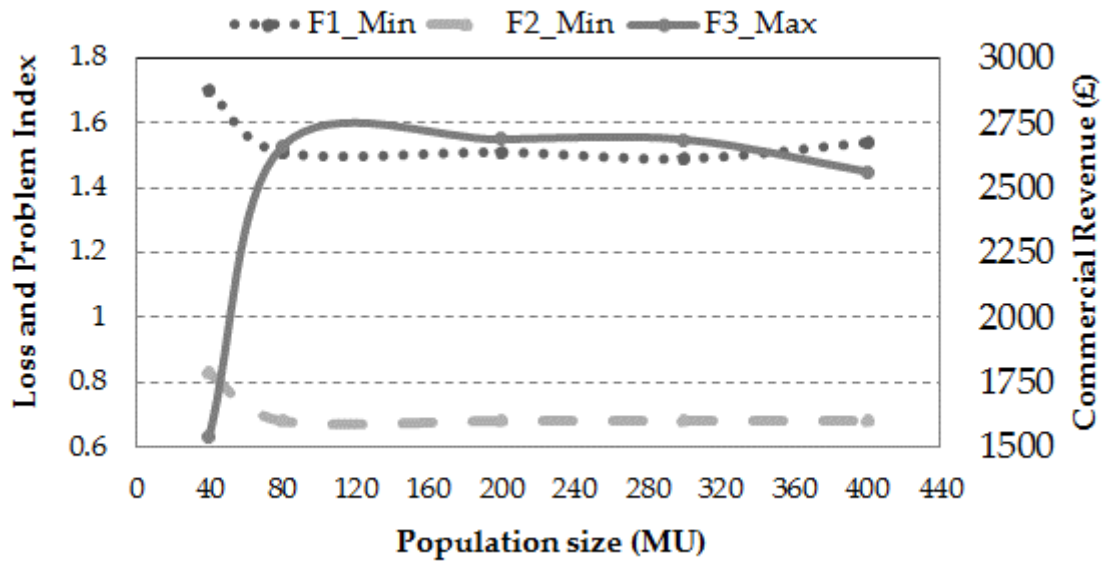

Figure 6-16: Determining required population size at 100 generations

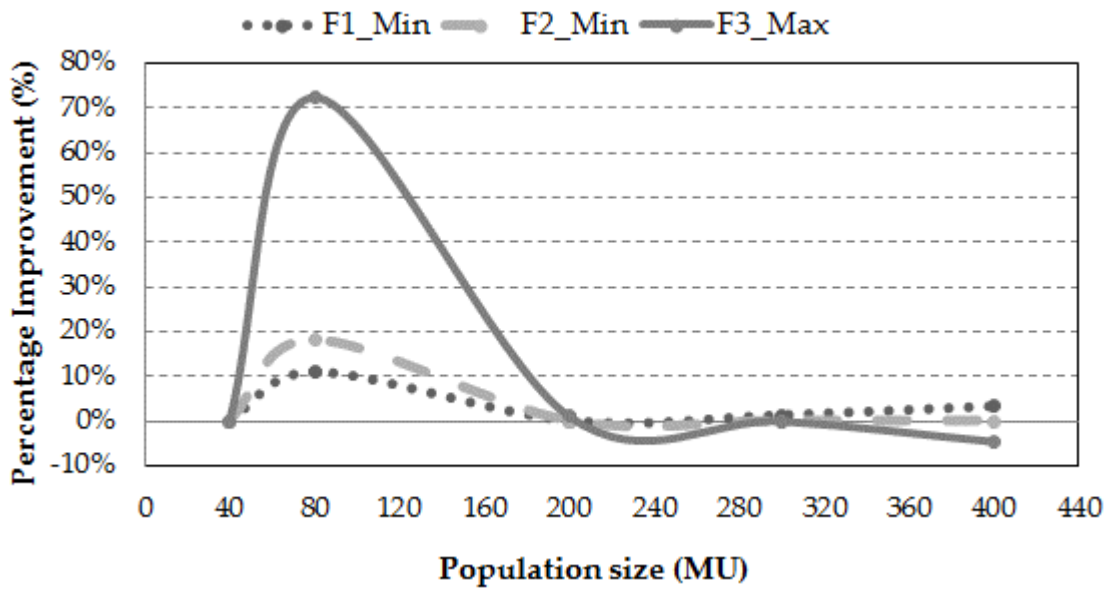

Figure 6-17: Percentage improvement on multiple objectives for ESS optimisation

As the population converges, it will be expected that the average fitness will approach that of the best individual. The population average of the fitness value for each objective function in the Pareto-optimal solutions after each generation is used to judge convergence. If there is no significant change in the average fitness values, it is inferred that the optimisation has converged. This is illustrated in Figure 6-18 and Figure 6-19 which show the average fitness values and the percentage change in the average fitness values.

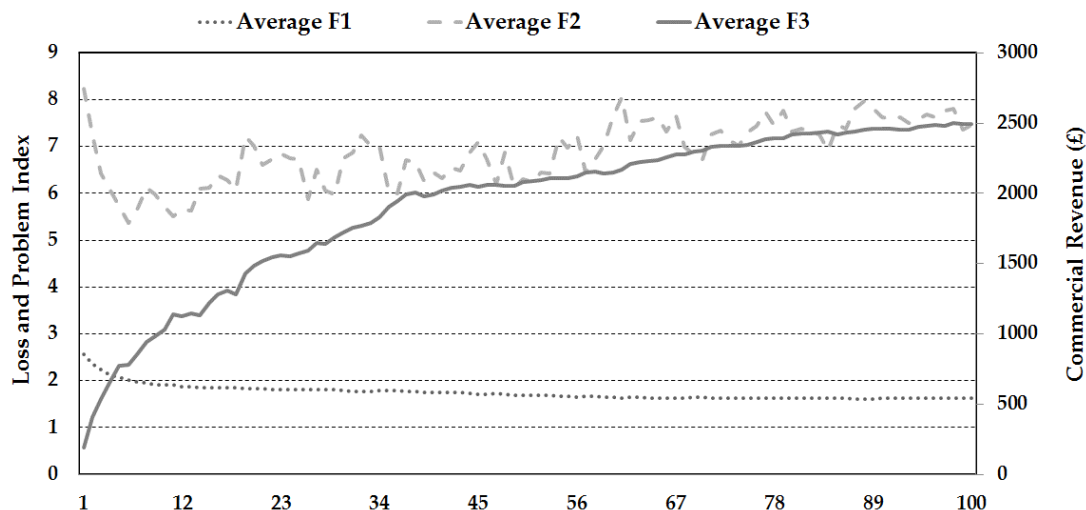

Figure 6-18: Average fitness values for 100 generations with a population size of 80

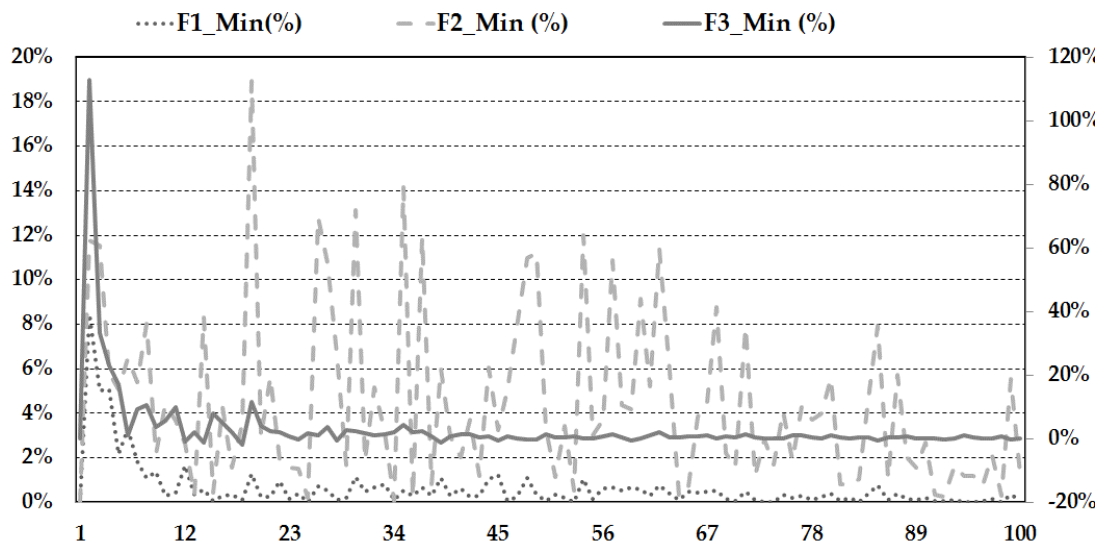

Figure 6-19: Percentage change in average fitness values for 100 generations with a population size of 80

The improvement in the fitness value of objective 1 for the set of solutions is minimal after 11 generations. For the second objective function, the fitness value only stabilises after 84 generations with improvements less than 8%, however the best average fitness value occurs after 6 generations. The last objective function shows a continued improvement, however, after 36 generations, only a 1% improvement or less is obtained in subsequent generations. The improvements in fitness values for the three objectives was taken into account and based on the computing resources available, 90 generations was selected to run the operation planning optimisation for the ESS implemented on the network. It is not the intention to get the most optimum parameters, including generation and population size as this in itself is another topic of study under multi-objective optimisation with heuristic methods. The result from the NSGA-II optimisation will provide a good spread of representative Pareto-optimal solutions, and more so, it will show the trade-offs of the technical objectives against the commercial objectives of a third party.

#### ***5.2.6 Potential ESS locations***

The badly affected areas from the selected cases from the MC simulations (section 5.1) will be tested as locations for the ESS with the optimisation algorithm. The four candidate locations tested are illustrated in Figure 6-20. The locations considered are one just after the primary transformer (busbar 1), at the MV side of the network which is at the midpoint of the network (busbar 6) and two remote locations where voltage and thermal overpower problems occurred, i.e. busbar 18 and busbar 22, all shown in Figure 6-20.

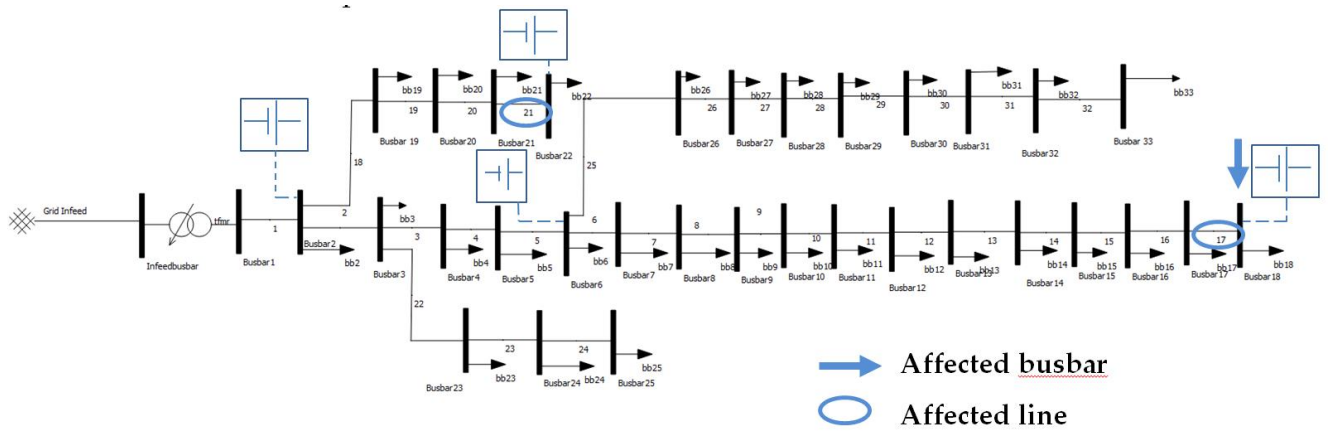

Figure 6-20: Badly affected areas from MC simulations and potential ESS locations for different network generation and demand scenarios

The ESS is optimised at these different locations for the different extreme scenarios obtained from the MC simulations. The final results from the multi-objective optimisation yields a set of Pareto-optimal solutions for the three objective functions when applied to the different profiles from section 5.1. The revenue from the optimised ESS operation obtained from objective 3 ( $f_3$ ) is discounted using a 6% discount rate which was the same value used in Chapter 5.

### 5.2.7 Base-case scenario

The ESS selected is rated at 1 MW with a 4.5 MWh energy capacity to allow for a 2.5 hours of peak power discharge in the winter. Based on the cost for lithium ion technology listed Chapter 5, this will cost £3,100,000. The energy and power rating was selected to be under the cost for reconductoring the area of the network affected by problems as presented in section 5.1.

The optimised operation with the ESS located at the busbar after the worst affected line (busbar 18) provided the most benefit in reducing the thermal overpower problems, improving losses and the VSF on the network against the base-case. The result from the optimisation is illustrated in the plot of the set of solutions for the multiple objectives in Figure 6-21.

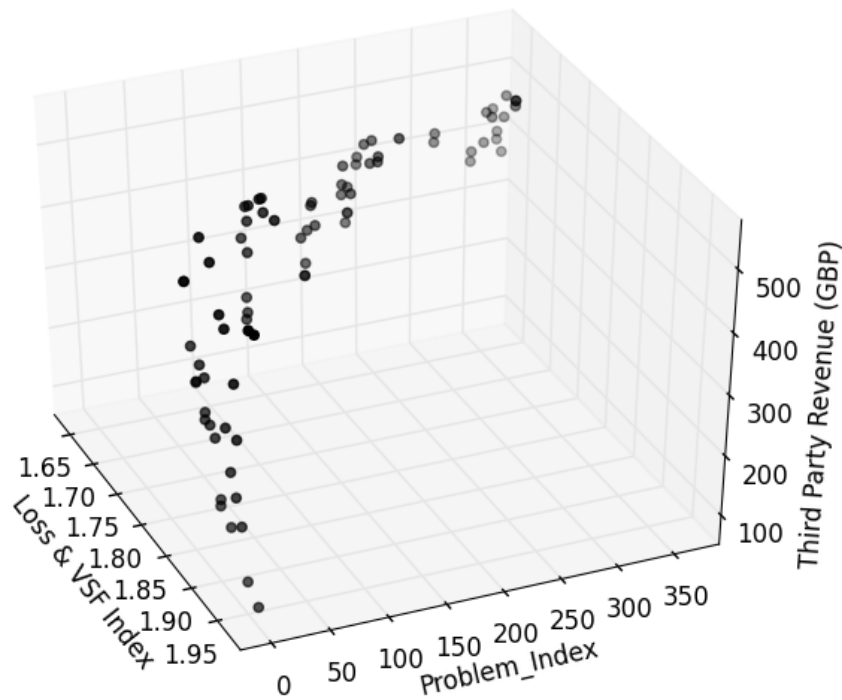

Figure 6-21: Pareto optimal front for the extreme thermal excursion case with 2% PV and 1% HP in the winter

From the Pareto-front, the selected optimal solution based on each individual objective showing the reduction in fitness of the other objectives is shown in Table 6-11. The ESS operation based on the solution with the lowest amount of problems (objective 2) and maximum revenue (objective 3) is shown in Figure 6-22. The ESS discharges only during two half-hour periods in the evening for the best solution based on objective 2. For the solution based on objective 3 real power is discharged at several periods through the day leading to a lower SoC at the end of the day, with the ESS almost fully discharged. Reactive power is also discharged at 22:30 hours.

| Selection of Solution      | $f_1$ | $f_2$ | $f_3$ (£) | Loss (MW) | VSF  | Events | Max Voltage (P.U) | Min Voltage (P.U) | % Thermal Utilisation |
|----------------------------|-------|-------|-----------|-----------|------|--------|-------------------|-------------------|-----------------------|
| $f_1$ - Loss and VSF       | 1.64  | 362   | 447       | 1.38      | 1708 | 1448   | 1.14              | 0.97              | 399                   |
| $f_2$ - Number of problems | 1.97  | 0.25  | 84        | 1.83      | 1568 | 1      | 1.05              | 0.96              | 83                    |
| $f_3$ - Commercial revenue | 1.84  | 15.25 | 542       | 1.63      | 1597 | 61     | 1.07              | 0.98              | 422                   |

Table 6-11: Results based on best solution for individual objective functions in the base-case scenario

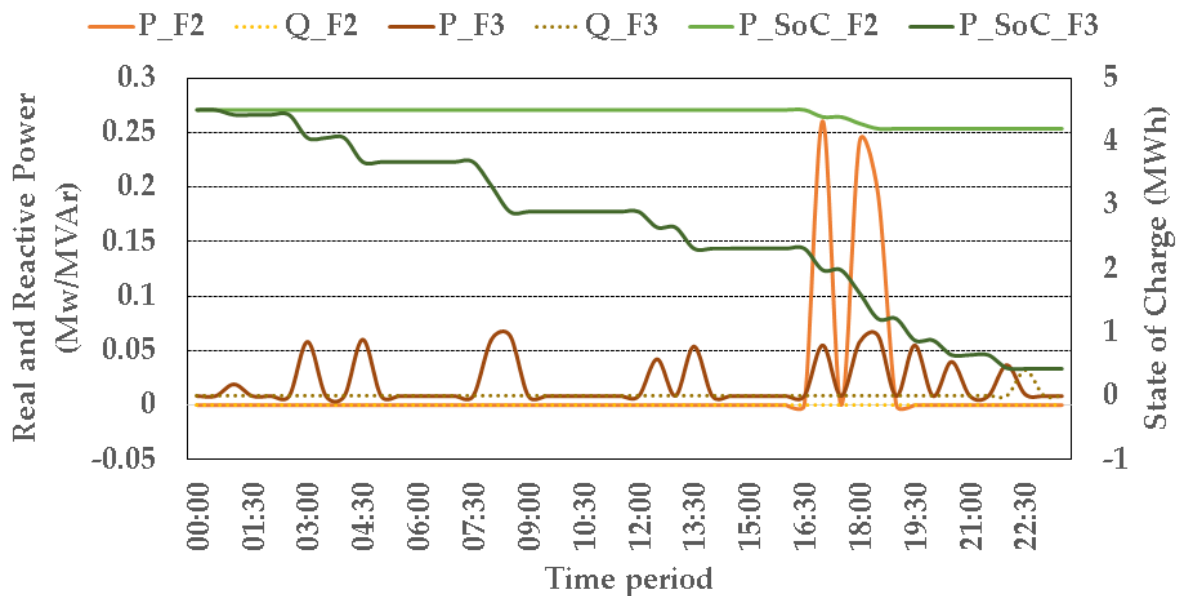

Figure 6-22: ESS real and reactive power output and state of charge over a day for the best solutions for objectives 2 and 3 in the base-case scenario

Taking the best solution for  $f_2$ , the problem index was reduced to 0.25, with only one thermal overpower problem left unresolved compared to the base-case with 4 events, the thermal utilisation was not reduced from 83.2% as in the base-case. There was a 4% reduction in real power losses, the VSF was worsened with a 1% reduction but there was no change in the maximum and minimum voltage on the network. The operating revenue was also considerably less than the other set of solutions at £84.



Performance when looking at the best solutions for objectives 1 and 3 are not feasible from a DNO point of view as the number of problems was significantly increased with a thermal utilisation of the line at up to and over 4 times the line rating.

### 5.2.8 Scenario 1 – 30% PV and 13% HP

As presented in section 5.1, there were problems with thermal overload and undervoltage in the winter extreme case, and overvoltage in the summer extreme case. The ESS was sized based on the cost to reconductor line 17 on the network at a rating of 1 MW and 4.5 MWh, with the latter determined based on the required discharge time based on a 15% arbitrage operation trigger for off-peak to peak price as discussed in section 4.2.4 . This size allows allow for a peak power discharge for up to 4.5 hours in the summer month where there are overvoltage problems.

#### Case 1 (Winter) – Thermal Overload Problems

The ESS operation was optimised when located remotely at busbar 18 and at busbar 6 (the midpoint of the network) with analysis carried out to determine the location that yields the best solutions for the three objectives at the end of the defined number of generations. Figure 6-23 illustrates the Pareto-optimal solutions.

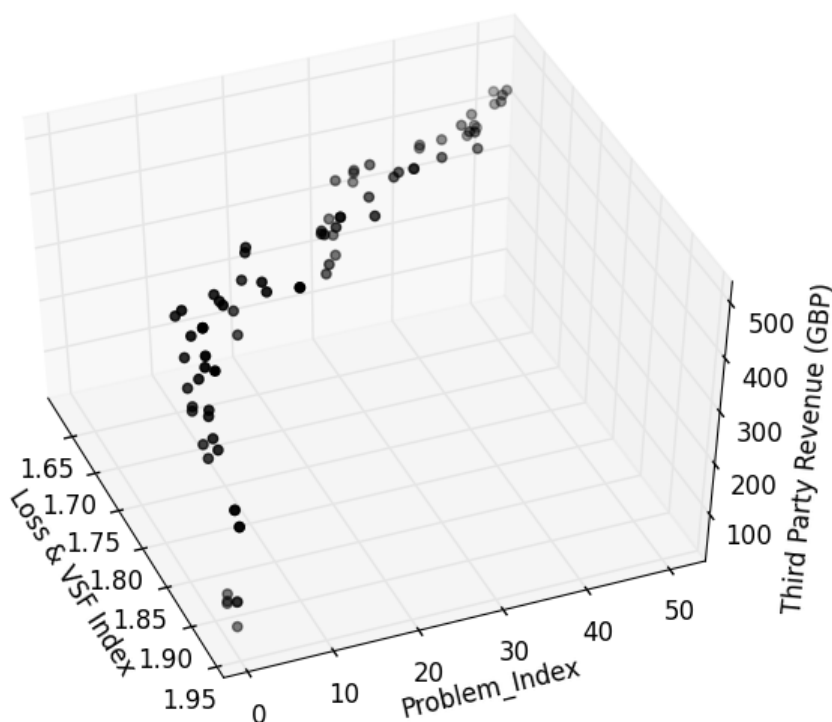

Figure 6-23: Pareto optimal front scenario 1 case 1

The best solution for each objective was used to select the Pareto-optimal solution to investigate. The ESS located at busbar 18 was the best location to mitigate the problems. There was a reduction in losses and improvement in VSF when selecting the best solution for all objectives when compared to the base-case where no action was taken. The number of events are high relative to the base-case when the best solution was selected based on objectives 1 and 3 with the thermal utilisation for both solutions over 4 times the line rating. All the problems were not fully mitigated in this case as shown in Table 6-12. The solution based on objective 2 provided a reduction in the number of thermal overload problems by 14% with a problem index of 0.86 and reduces the maximum thermal utilisation by 1 percentage point to 99%. The losses were reduced by 6 %, the minimum voltage level was improved to 0.96 PU and the VSF was increased by 1%. This solution however yields the least financial revenue at £40. A lower loss and higher VSF is linked here to a higher number of problems on the network.

| <b>Selection of Solution</b>   | <i>f1</i> | <i>f2</i> | <i>f3</i> (£) | <b>Loss (MW)</b> | <b>VSF</b> | <b>Events</b> | <b>Max Voltage (P.U)</b> | <b>Min Voltage (P.U)</b> | <b>% Thermal Utilisation</b> |
|--------------------------------|-----------|-----------|---------------|------------------|------------|---------------|--------------------------|--------------------------|------------------------------|
| <i>f1</i> - Loss and VSF       | 1.62      | 50.48     | 441           | 1.82             | 1707       | 1464          | 1.16                     | 0.97                     | 423.6                        |
| <i>f2</i> - Number of problems | 1.93      | 0.86      | 40            | 2.41             | 1581       | 25            | 1.06                     | 0.96                     | 99.0                         |
| <i>f3</i> - Commercial revenue | 1.78      | 26.28     | 504           | 2.10             | 1632       | 762           | 1.19                     | 0.93                     | 467.6                        |

Table 6-12: Solution trade-off based on stakeholder requirements for scenario 1

case 1

The ESS operating strategy is shown in Figure 6-24. The ESS starts discharging to resolve issues on the network from midnight until 22:00 hours with no reactive power used in this case as there are no voltage issues.

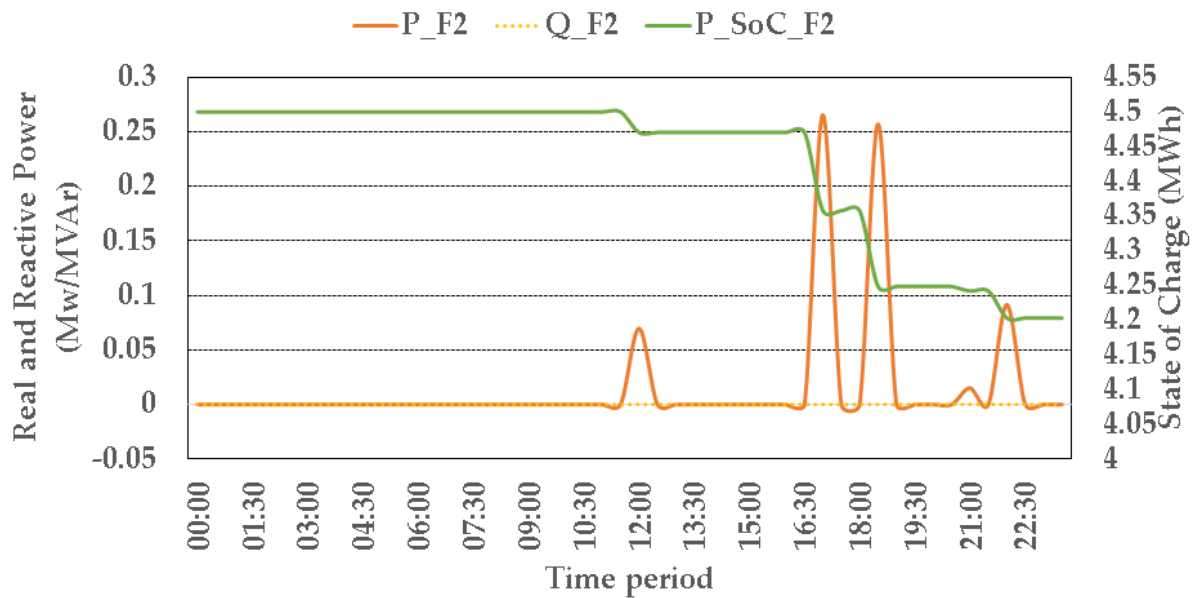

Figure 6-24: ESS real and reactive power output and state of charge over a day for the best solutions for objectives 2 in scenario 1 case 1 (thermal excursion case)

Case 2 (Summer) – Overvoltage Problems

The ESS installed at the midpoint of the network (busbar 6) provided the best set of solutions when considering both technical objectives ( $f1$  and  $f2$ ) and was chosen as the candidate location for analysis with the results presented in Table 6-13.

| Selection of Solution     | $f1$ | $f2$  | $f3$ (£)   | Loss (MW) | VSF  | Events | Max Voltage (P.U) | Min Voltage (P.U) | % Thermal Utilisation |
|---------------------------|------|-------|------------|-----------|------|--------|-------------------|-------------------|-----------------------|
| $f1$ - Loss and VSF       | 1.61 | 316.8 | 262        | 0.33      | 1780 | 1584   | 1.16              | 1.00              | 34.9                  |
| $f2$ - Number of problems | 1.85 | 0     | 250        | 0.39      | 1617 | 0      | 1.06              | 0.98              | 34.9                  |
| $f3$ - Commercial revenue | 2.06 | 0     | 368.8<br>2 | 0.48      | 1565 | 0      | 1.03              | 0.96              | 34.9                  |

Table 6-13: Solution trade-off based on stakeholder requirements for scenario 1 case 2.

The trade-offs in the different objectives in influencing the optimal solution is shown in Figure 6-25. The problems on the network were reduced to 0 in 6 of the 80 set of

solutions when considering the optimal solution based on objective 2. The optimum solution based on objective 2 in this case will be based on the solution with the most reduction in losses. In this case, the real power loss was also reduced by 16% but the commercial revenue from operating the ESS is the lowest at £250 when compared to the other 5 solutions with zero problems but higher real power losses in the pareto-optimal solution set. The solution based on third party commercial revenues reduced the network problems to 0 but there was a 2% increase in loss and a 4% reduction in the network VSF relative to the bas-case. The solution based on objective 1 (loss and VSF) is not feasible as it increases the overvoltage events over a day at all the busbars on the network to 1584 and the maximum voltage on the network was also increased by 9% to 1.16 PU.

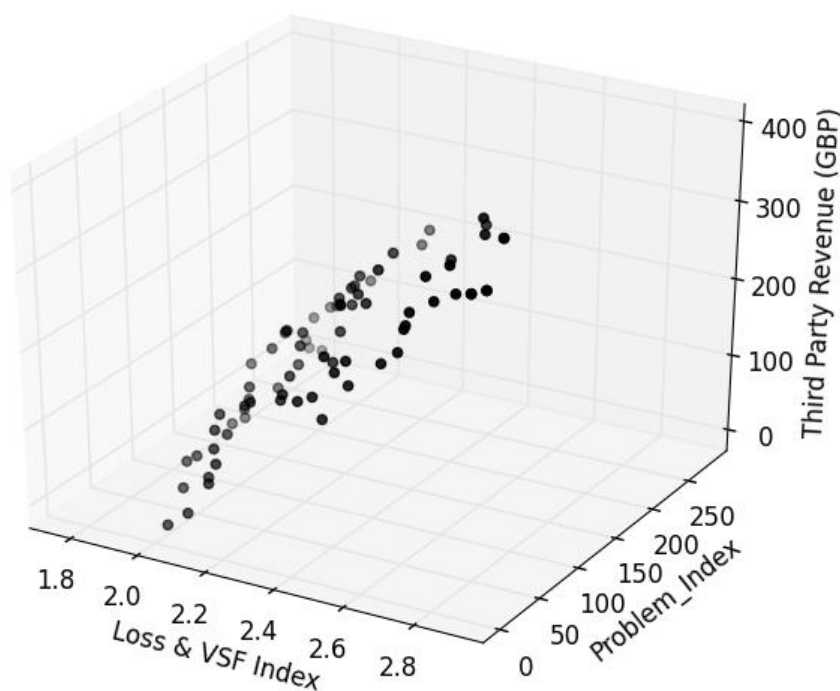

Figure 6-25: Pareto-optimal solutions scenario 1 case 2

The operating pattern for the ESS based on the commercial revenue objective ( $f_3$ ) is more frequent but at a lower output through the day compared to the operating pattern for the ESS based on the problem index ( $f_2$ ) as illustrated in Figure 6-26

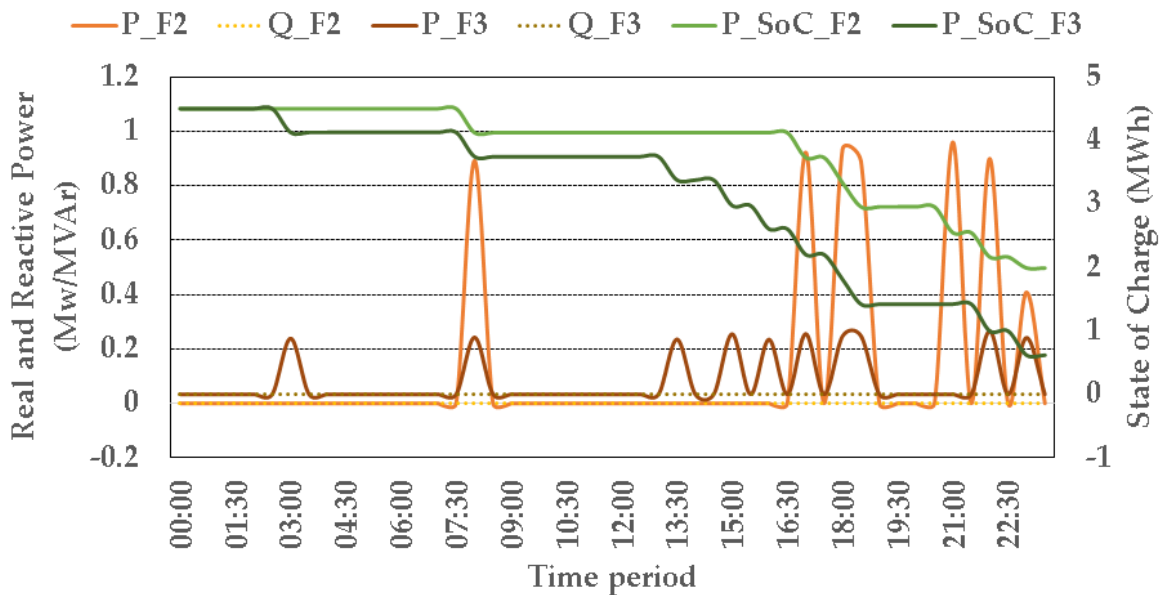

Figure 6-26: ESS real and reactive power output and state of charge over a day for the best solutions for objectives 2 and 3 in scenario 1 case 2 (voltage excursion case)

### 5.2.9 Scenario 2 – 60% PV and 25% HP

In this scenario, the bulk of the thermal overload issues in the winter extreme case affected line 21 while busbar 18 was affected in summer extreme case with high amounts of overvoltage on the network. In this case, the ESS was specified based on the cheapest cost to reinforce the network, i.e. the cost to reconductor line 21 for the winter thermal overload problem. This means the ESS was rated at 0.25 MW and 1.125 MWh costing roughly £775,000, which is under the reinforcement cost for that line (£800,000).

#### Case 1 (Winter) – Thermal Excursion

Busbar 22 which is just after the badly affected line was chosen as the candidate location for the ESS. The optimisation yielded the following results presented in Table 6-14. The Pareto-front from the optimisation showing the trade-off in solutions for each objective is illustrated in Figure 6-29. The solutions based on  $f1$  and  $f3$  led to more events on the network including overvoltage which was not present on the network with maximum voltages for both cases at 1.15 PU and 1.12 PU respectively. There is however a reduction of 20% and 9% in losses respectively, and an improvement in VSF of 10% and 2% respectively. When considering  $f2$ , the

number of thermal excursions is reduced by 38% to 25 over the day, however the level of maximum thermal utilisation was only reduced by -0.3%. The losses on the network is reduced by 2% but there is however no change in the network VSF. Improvements in network real power losses and VSF in this case leads to a lower revenue and a higher number of problems on the network.

| Selection of Solution     | $f1$ | $f2$  | $f3$ (£) | Loss (MW) | VSF  | Events | Max Voltage (P.U) | Min Voltage (P.U) | % Thermal Utilisation |
|---------------------------|------|-------|----------|-----------|------|--------|-------------------|-------------------|-----------------------|
| $f1$ - Loss and VSF       | 1.71 | 37.15 | 81       | 1.98      | 1723 | 1486   | 1.16              | 0.97              | 100.1                 |
| $f2$ - Number of problems | 1.99 | 0.63  | 116      | 2.44      | 1566 | 25     | 1.06              | 0.95              | 99.8                  |
| $f3$ - Commercial revenue | 1.9  | 12.5  | 141      | 2.27      | 1595 | 500    | 1.12              | 0.95              | 100.2                 |

Table 6-14: Solution trade-off based on stakeholder requirements for scenario 2 case 1

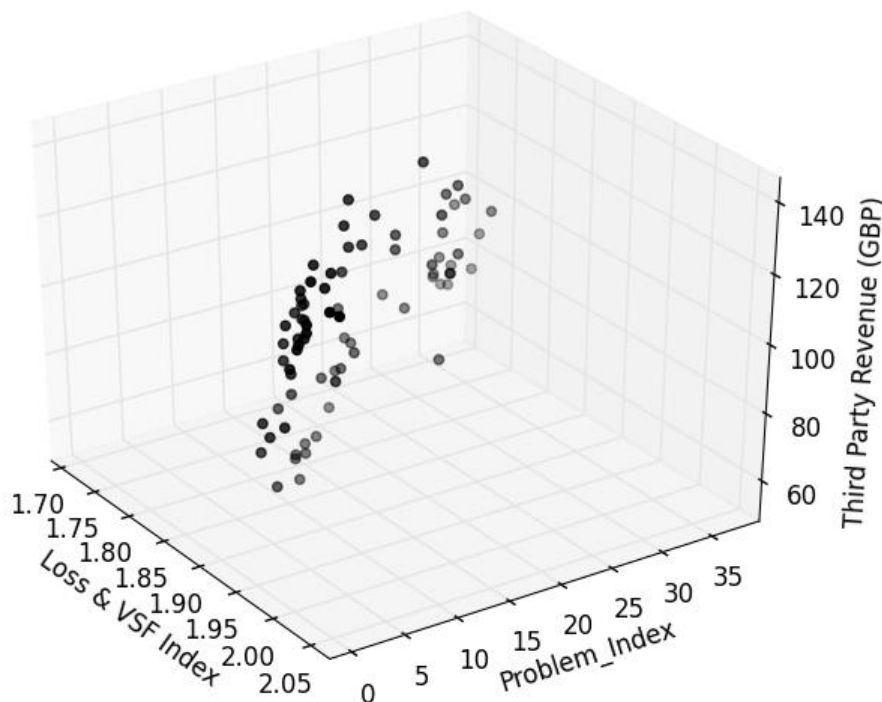

Figure 6-27: Pareto-optimal solutions scenario 2 case 1

Only 53% of the ESS capacity was used as illustrated in Figure 6-30 which shows the operating pattern of the ESS based on  $f_2$ . There is no reactive power used in this case as there is no voltage problem on the network.

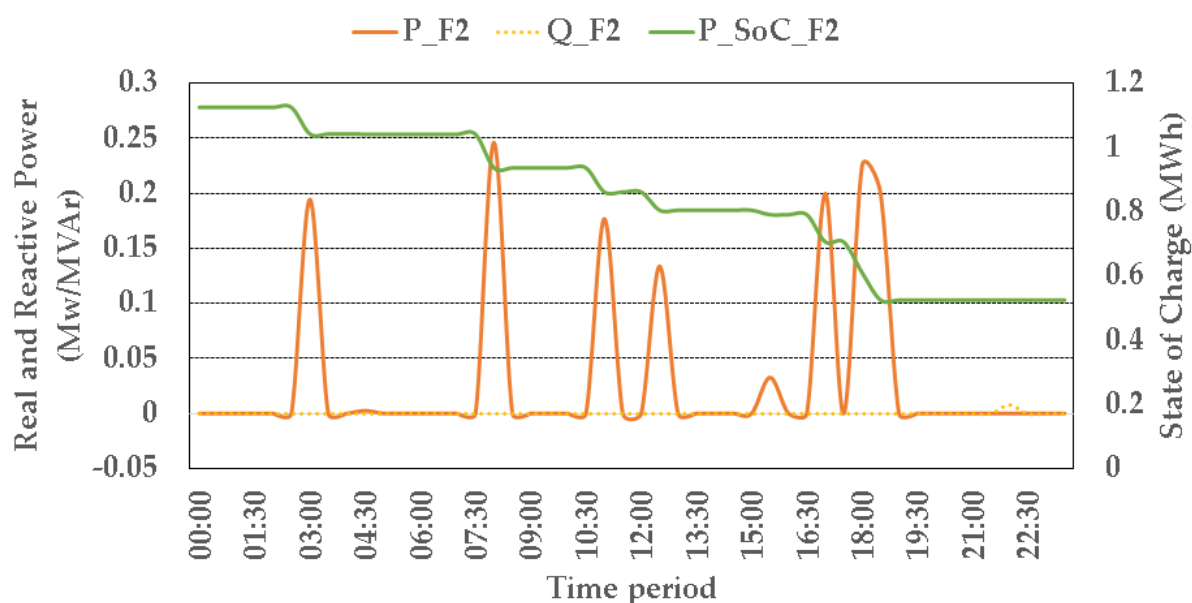

Figure 6-28: ESS real and reactive power output and state of charge over a day for the solution based on objectives 2 (Scenario 2 case 1 - thermal excursion case)

Case 2 (Winter) – Undervoltage

There was another extreme scenario in the winter as reported in Section 5.1 where there were 17 undervoltage events and 1 thermal overload event. The results from the ESS located at midpoint of the network (busbar 6) and at the remote end (busbar 22) both provided the same results in terms of best figures for  $f_1$  and  $f_2$ . For the commercial revenue,  $f_3$ , the ESS located at busbar 6 provided a much higher revenue and hence busbar 6 was selected here as the candidate location for the optimisation. Table 6-15 presents a breakdown of the optimal solution based on the individual objectives.

| Selection of Solution | $f_1$ | $f_2$ | $f_3$ (£) | Loss (MW) | VSF  | Events | Max Voltage (P.U) | Min Voltage (P.U) | % Thermal Utilisation |
|-----------------------|-------|-------|-----------|-----------|------|--------|-------------------|-------------------|-----------------------|
| $f_1$ - Loss and VSF  | 1.7   | 87.35 | 72        | 2.39      | 1715 | 1485   | 1.16              | 0.97              | 75                    |
| $f_2$ -               | 1.92  | 0     | 138       | 2.83      | 1577 | 0      | 1.06              | 0.95              | 75                    |

| Number of problems         |      |       |     |      |      |     |      |      |    |
|----------------------------|------|-------|-----|------|------|-----|------|------|----|
| $f_3$ - Commercial revenue | 1.81 | 38.41 | 144 | 2.57 | 1621 | 653 | 1.12 | 0.94 | 75 |

Table 6-15: Solution trade-off based on stakeholder requirements for scenario 2 case 2

Figure 6-29 provides a representation of the Pareto-optimal solutions for this case. A lower loss and higher VSF compared to the base-case ( $f_1$ ) leads to lower revenues and a higher number of problems. Solutions based on the minimum number of problems ( $f_2$ ) lead to only a 7% reduction in losses and a 1% improvement in the VSF compared to  $f_1$  and  $f_3$  which resulted in a 21% and 16% reduction in real power losses respectively and a 10% and 4% improvement in VSF. Solutions for  $f_1$  and  $f_3$  do however worsen the problems on the network. This is more apparent with  $f_1$  where the number of events increased to 1485. The thermal utilisation for all three solutions remains constant at approximately 75%.

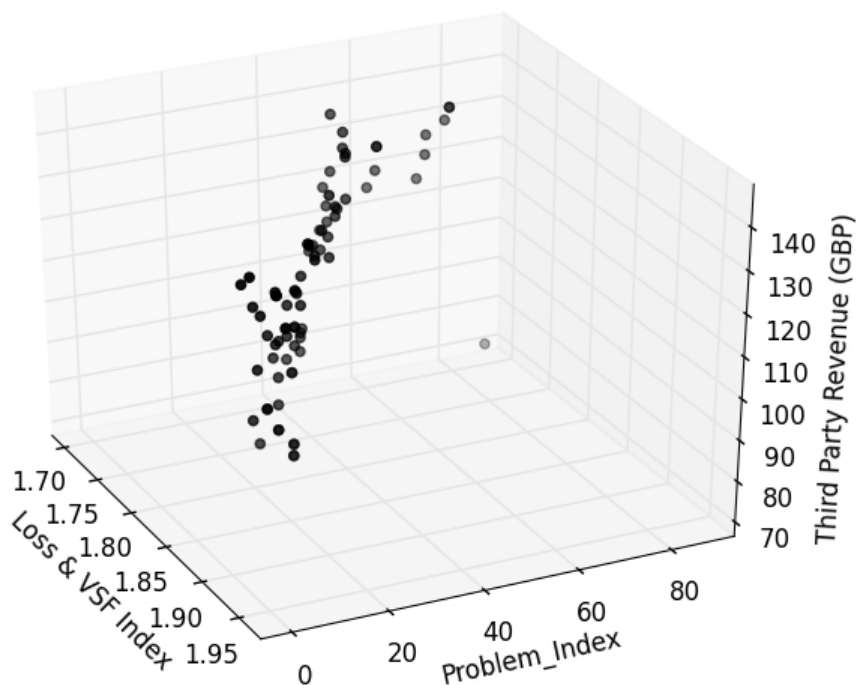

Figure 6-29: Pareto-optimal solutions scenario 1 case 2



The operating pattern for the ESS based on the  $f_2$  solution is illustrated in Figure 6-30. 88% of the ESS capacity was used and reactive power was provided in the morning during the off-peak period twice to the network and absorbed once to fix the voltage problems on the network.

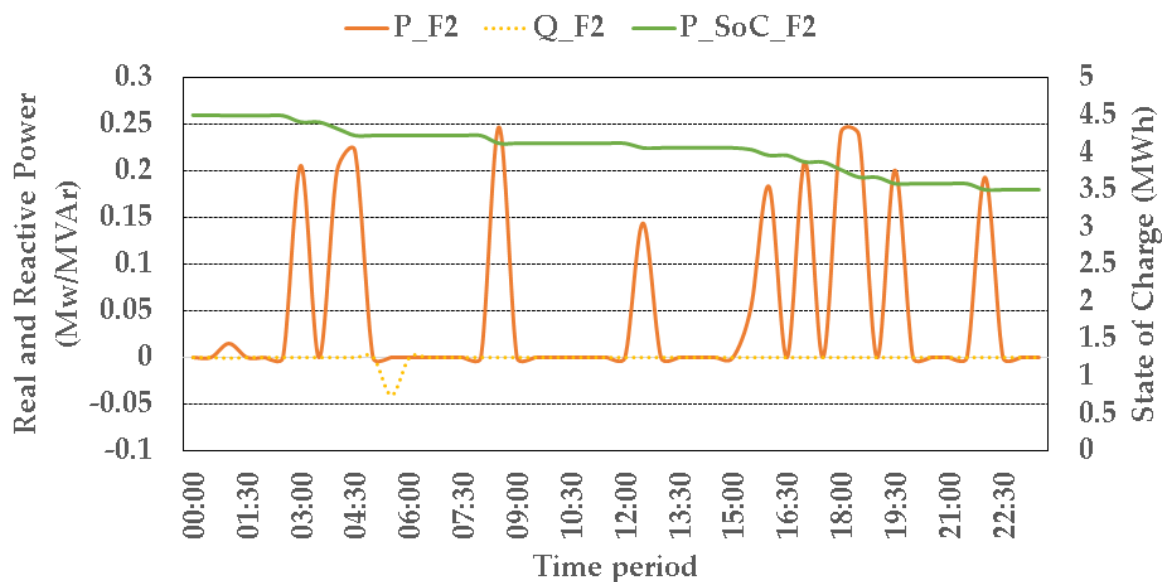

Figure 6-30: ESS real and reactive power output and state of charge over a day for the best solutions for objectives 2 in scenario 2 case 2 (winter voltage excursion case)

### 5.2.10 Case 2 (Summer) – Overvoltage

The ESS located at the midpoint (busbar 6) provided the best set of optimal solutions when considering losses and commercial revenue. The results for the ESS located at busbar 22 (remote end) and busbar 6 both had solutions with the problem index reduced to 0. The trade-off of solutions based on requirements for the DNO or third-party stakeholder is provided in Table 6-16. The lower loss (19%) and higher VSF (8%) compared to the base-case leads to an almost 5 times increase in voltage events and raises the maximum voltage on the network by 9%. For objective 3, the losses were reduced by 3% but the VSF and problems were worsened by 1% and 21% respectively. The feasible solution for a DNO based on the second objective leads to a 100% reduction in voltage events and keeps the voltages on the network within the range of 1.06 PU – 0.97 PU. Figure 6-31 depicts the pareto-optimal solutions for the problem.

| Selection of Solution     | $f1$ | $f2$ | $f3$ (£) | Loss (MW) | VSF  | Events | Max Voltage (P.U) | Min Voltage (P.U) | % Thermal Utilisation |
|---------------------------|------|------|----------|-----------|------|--------|-------------------|-------------------|-----------------------|
| Base-case                 |      |      |          |           |      |        |                   |                   |                       |
| $f1$ - Loss and VSF       | 1.73 | 5.77 | 49       | 0.49      | 1774 | 1419   | 1.18              | 0.97              | 38.5                  |
| $f2$ - Number of problems | 2    | 0    | 77       | 0.60      | 1609 | 0      | 1.06              | 0.97              | 38.4                  |
| $f3$ - Commercial revenue | 1.98 | 1.21 | 93       | 0.59      | 1628 | 297    | 1.12              | 0.97              | 38.5                  |

Table 6-16: Solution trade-off based on stakeholder requirements for scenario 2 case 2

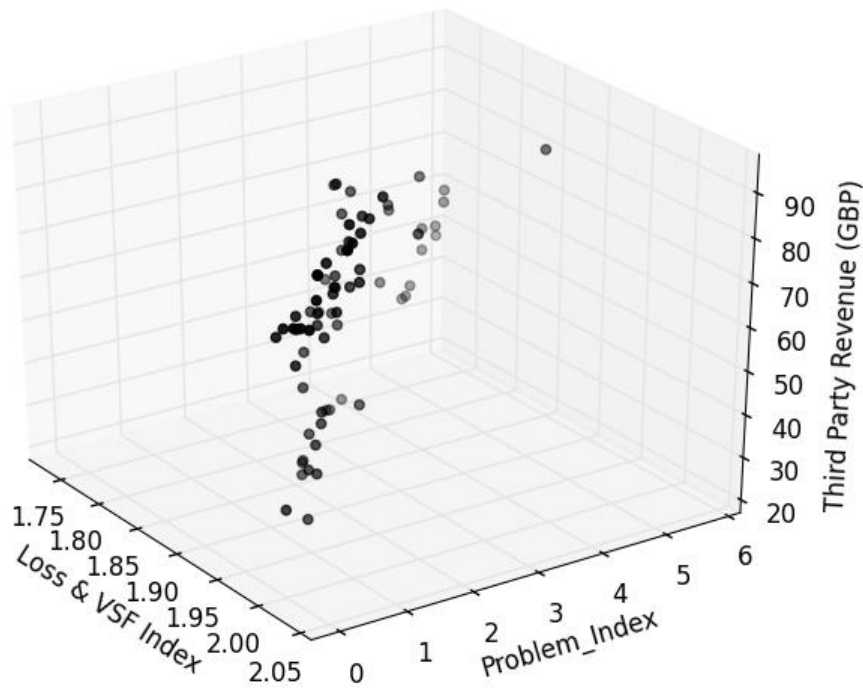

Figure 6-31: Pareto-optimal solutions scenario 1 case 2

The operating pattern of the ESS based on objective 2 is illustrated in Figure 6-32. A combination of real and reactive power was provided and absorbed (only reactive power) by the ESS to resolve the 256 voltage events. Over 78% capacity was used in this solution with real power discharged eight times through the day.

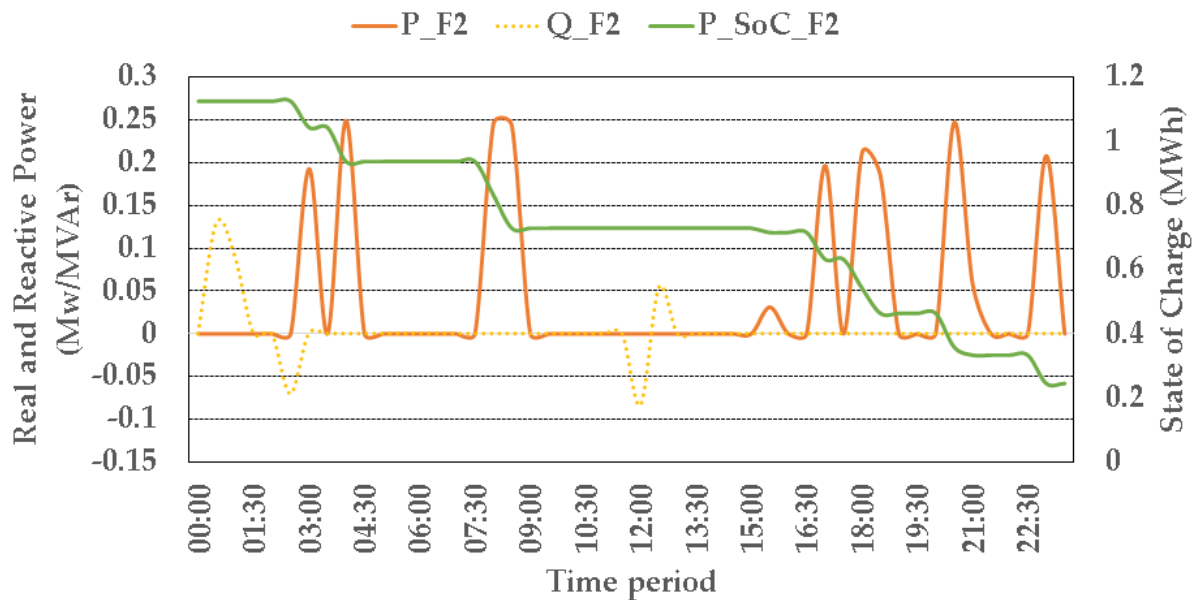

Figure 6-32: ESS real and reactive power output and state of charge over a day for the best solutions for objectives 2 in scenario 2 case 3 (summer voltage excursion case)

## 6 DISCUSSION AND CONCLUDING REMARKS

This chapter evaluates the worst-case impacts of different levels of LCTs on a distribution network when considering uncertainty of demand and generation, as well as the location of these LCTs. The suitability of using ESS was assessed by optimising the daily operation of an ESS to meet multiple objectives which are:

- Minimisation of network related losses and maximisation of VSF;
- Minimisation of network voltage and thermal problems; and
- Maximisation of commercial revenues from the electricity market and embedded benefits (TRIAD and DUoS).

The multiple objectives and contradicting operation requirements for DNO or third party stakeholders were discussed in previous chapters and in this chapter, the hypothesis is tested as to whether ESS can satisfy all stakeholder requirements. Different demand and generation profiles were developed based on a probabilistic study where 5000 MC simulations were carried out to uncover the worst-case network issues that could occur on a distribution network. These cases were then investigated with ESS installed and with the operation optimised using the NSGA-II

MOEA heuristic method to optimise the daily operating pattern of the ESS and OLTC. This optimisation does not take into account the cost of the ESS as it is scheduling the daily operation of ESS for different stakeholder benefits, assuming the ESS has already been installed as a solution.

The ESS located at the remote locations where thermal overload occurred was more effective in reducing the thermal excursions and the ESS located at the midpoint of the network was effective in resolving voltage excursions. The ESS optimised with the base-case scenario profile from the MC simulations provided a solution in the Pareto-front that was 75% successful in resolving the thermal excursion problems. Solutions based on losses and commercial revenue yielded higher revenues and lower losses but led to extreme thermal excursions. This confirms that operation of the ESS to reduce problems will not lead to higher revenues for a third party or lower losses and a higher VSF. Indeed, higher amounts of real and reactive power from the ESS will cause more losses on the network and a lower VSF but the operation can be optimised to provide a slight improvement on losses in the network.

The results from scenario 1 with 30% PV and 13% HP showed that a reduction in losses and improvement in VSF on the network was correlated with an increase in the number of problems on the network. For scenario 2 with 60% PV and 25% HP, the improvement in loss and VSF led to an increase in the number of problems and lower revenues. This leads to a conclusion that loss reduction and improving VSF on the network in the scenarios evaluated should be treated as secondary as long as the network is operating within regulatory defined constraints, for voltage and thermal constraints.

In all the cases investigated, optimising ESS purely based on commercial revenues for a third party as the primary requirement led to more problems on the network in most cases. The ESS was effective in fixing all voltage problems in scenario 1 and 2 and from its use in both scenarios, daily revenues were gained amounting to £250 for

scenario 1 in the summer and £138 and £77 for scenario 2 in winter and summer respectively. However, the thermal excursions were not all fully eliminated with the ESS only able to reduce the problems by 14% in case 1 (30% PV and 13% HP scenario) and 38% in case 2 (60% PV and 25% HP scenario). This suggests that the ESS on this network is not sized to mitigate the prevailing thermal overload issues brought about by dispersed and high levels of HP and PV concentrations on the case study network in the extreme cases studied. The ESS used in this extreme scenario will have to be combined with another solution both conventional (such as reconductoring) and new (such as real time thermal rating) to resolve the thermal overload problem.

The results obtained from assessing the optimised ESS operating patterns for each scenario showed that there are trade-offs with technical objectives and commercial objectives. This is what is required to be understood in order to get a common understanding between DNOs and third parties in planning for future distribution network expansion with ESS.

In the next chapter, the conclusions from the research carried out in this thesis are presented and the contributions to the research area are also pointed out. Finally, the future work that can be carried out to answer questions that have arisen as part of this work will be discussed

## Chapter Seven: Conclusions and Recommendations for Further Work

---

### 1 CONCLUSIONS

The central question asked in this thesis is whether distributed ESS can become a feasible alternative investment for DNOs as LCT grow on their networks. The effect that updates to the regulatory and electricity market structures would have on the realisation of multiple stakeholder benefits is evaluated because they affect ESS ownership types, use and cross-collaboration between T&D and third party owners. Large ESS has been proven to be feasible and is widely utilised worldwide, mostly in the form of pumped hydro storage (PHS). The geographical limitations of PHS siting and huge cost implications added with the fact that many LCTs are installed close to customers means that smaller distributed ESS located at the MV and LV side of the distribution networks are being considered. Distributed ESS has not been proven to be financially viable and has limitations due to the current regulatory and market conditions in deregulated and unbundled electricity systems, such as that of the UK. This means that ESS, which is an alternative and innovative investment has not been factored into short, medium and long term planning arrangements for DNOs. This thesis investigated the use of ESS in short and medium term planning for DNOs by considering LCT impacts on the distribution networks; the regulatory and electricity market frameworks (both current and proposed future changes); and financial aspects of investing in ESS under different ownership types and business models. This required a holistic approach to ensure the technical, financial and regulatory aspects are considered while remaining agnostic towards any particular ESS technology.

This chapter summarises what is covered in the six chapters in this thesis and brings together conclusions from the last three (4 – 6). Afterwards, the contributions of this thesis; limitations of the research and suggestions for future work; and final conclusions are presented.

## **1.1 SUMMARY OF CHAPTERS**

### **1.1.1 Chapter 1**

In Chapter 1, the first section discussed the UK's electricity system and the current challenges faced. This led on to the motivation behind the research carried out in this thesis, which is to establish the potential role and viability of distributed ESS in distribution networks. The objectives are set out as understanding LCT impacts; regulatory and market barriers; planning and operating strategies for ESS in short and medium term using analytical and heuristic methods; and evaluating the technical and financial benefits under different business and ownership models. The contributions of this thesis and list of publications that came out from the research were then presented.

The second section provided a background to the UK electricity sector and discussed the evolution of the UK power sector, government policies and the UK regulatory framework and electricity market which will be used as the basis for case studies carried out in latter chapters for short and medium term planning. A discussion of the challenges caused by LCTs and solutions that have been recognised in industry and academia are also discussed. An overview of ESS is presented including the technology types and the functions and benefits both economic and technical.

### **1.1.2 Chapter 2**

Chapter 2 provided a review into the literature on the valuation of ESS benefits used in power systems covering planning and operating ESS in distribution networks. The conflicts between benefits for different stakeholders and applications of ESS for technical and market operations were the key issues pointed out from the literature with a conclusion that multiple stakeholders need to be factored into DNO planning arrangements involving ESS, along with consideration for the changing regulatory and market environment. A need for methods and tools that enable successful deployment and operational planning was highlighted.

The review of planning methods for distribution networks showed the complexity of planning and the increase in difficulty when future technologies, such as ESS that have a temporal control requirement with a finite resource are included. Literature on the methods for planning and operating distributed energy resources and specifically ESS for different applications, technical and market based were reviewed.

### **1.1.3 Chapter 3**

Chapter 3 presented the two case study networks used in this thesis, one of which is a model of a real distribution network in the North West of England. The other network used was the IEEE 33 bus test network, which is widely used in research in this field. The software used in modelling the networks, creating the control algorithm for the ESS and coordinating the operation over a day to a year was discussed. A big part of studying ESS operation is dealing with the finite energy resource and the time variability of demand and generation on the network. The approaches to model the demand and generation and the sources of the datasets used were presented.

### **1.1.4 Chapter 4**

Chapter 4 presented a review into the regulatory and market frameworks that promote or limit the use of ESS in countries with high renewable proliferation and targets. It began by discussing regulation and electricity markets covering deregulation, liberalisation and unbundling of electricity systems and the regulatory and electricity market environments in a variety of countries with unbundled and vertically integrated electricity systems. The structure and operation of different electricity systems impacts the uptake of ESS differently. The worldwide deployments of ESS and the respective business models and ownership types that were used in the country's reviewed were discussed.

The major regulatory and electricity market barriers for implementing ESS were presented along with recommendations to encourage ESS deployment.



### *1.1.5 Chapter 5*

Chapter 5 began with a discussion on UK targets for LCTs and the associated problems they can lead to on the distribution network, and followed on from Chapter 2 to review the literature where ESS was evaluated and discussed as a solution to meeting the needs of the UK grid. The problems established from literature and industry on evaluating the financial viability of ESS were presented. This Chapter also described the commercial applications considered for using ESS, with commercial applications referring to non-distribution network services which are non-regulated services.

A medium term planning study was carried out that follows a 15 year period using the 6.6 kV real distribution network model. The problem description, broken down into the network model, commercial model, ESS model, was discussed. For the ESS model, an algorithm was developed for voltage and thermal constraint management that coordinated ESS operation with the on-load tap changer (OLTC) for efficient network operation. A control was added to the algorithm to enable the ESS to participate in the daily spot market, operating at half hour periods through a year. It can be specified whether to coordinate market and technical operations, or act purely for market or technical purposes. Market operation here is operation for arbitrage in the spot market and technical operation is the operation to meet network requirements. For the market operation, the balancing market was considered through the planning period and the short term operating reserves and fast frequency response services were considered in the final year only. The cost and revenue streams for ESS under different ownership and business models and performance both technically and commercially of the ESS was investigated. The result was used to assess if under a scenario of growing solar PV and heat pump proliferation on a distribution network, the adoption of ESS becomes viable by means of a net present value (NPV) analyses over the 15 year planning period

### **1.1.6 Chapter 6**

Chapter 6 looked at a shorter period for daily operational planning of ESS operated for commercial and technical purposes, which often have conflicting objectives. The stochasticity of demand and generation was taken into account by carrying out Monte Carlo simulations on statistical distributions of HP, PV and domestic demand which were obtained from live networks as part of the Customer Led Network Revolution Project [127].

The study was in two stages, firstly, there was the LCT impact assessment study where the Monte Carlo simulations were carried out on a test MV distribution network (the IEEE 33 bus network) and this was used to determine the worst impacts of increased LCT installations under different scenarios that follow the UK government's policies. An ESS was then installed on the test network in locations suffering from voltage and thermal excursions. Afterwards, the ESS was optimised using the NSGA-II multi-objective heuristic method to establish the potential of owning and operating ESS to resolve the technical impact and obtain commercial revenues in addition from market operations and embedded benefits. The embedded benefits are gained from the relieving stress, particularly during peak demand periods on the T&D networks. Asset upgrade deferral was not considered here as the ESS was specified to be lower than the cost of an equivalent upgrade. A secondary objective of the research in this chapter was to show how conflicting multi-objectives complicate the planning for ESS operation, and how regardless of the sometimes counterproductive nature of the ESS operation for third party and DNO requirements, a coordinated approach would mean that they both could profit from ESS implementation.

## **1.2 CONCLUSIONS FROM REVIEW INTO REGULATORY AND ELECTRICITY MARKET**

### **BARRIERS LIMITING ESS GROWTH**

ESS is seen as a useful tool for use in all areas of the grid from power generation down to utilisation by consumers at the distribution network level. If they are to compete against conventional solutions and practices, the regulatory and market

structures made around conventional technologies and practices will need to be updated. This review showed that there were common issues affecting most countries using ESS in various capacities with the problems split into regulatory and electricity market barriers. The regulatory issues include asset classification of ESS, which is seen as a generation asset. This affects T&D use of system charges in unbundled electricity networks and tax charges. There is also a lack of frameworks and incentives for storage on the networks, compared to LCTs. This is conflicting considering the fact that these LCTs give rise to the issues that will require expensive reinforcement and upgrade requirements as they continue to increase in concentrations on the network. Other barriers established include the difficulty in valuing ESS as a result of the different operating requirements and revenue streams for different stakeholders; the unwillingness of power system stakeholders, to change the status quo; the lack of common standards and practices as it is a non-conventional technology, and the lack of recovery of benefits from using ESS to control intermittent renewables.

In the electricity market, issues were established that included:

- Limits from requirements which were developed for conventional dispatchable generators;
- Lack of market liquidity causing a barrier for new entrants such as ESS owners who are unlikely to be generators, T&D owners or suppliers;
- Decline in spreads of electricity prices, particularly with the drop in oil and gas prices affecting wholesale prices;
- Unfair advantage provided to network monopolies if they own ESS as they can reduce competitiveness and influence market prices;
- Price control mechanisms;
- The impact of ESS on market prices, for example, if monopolies use them to distort prices between wholesale and retail;
- Low remuneration for ESS providing more superior ancillary services, for example faster response and ramp rate for frequency response; and

- Overall difficulties in long term value assessment for market operations, due to market uncertainty which can only be reduced by introducing schemes like those for renewables, such as the Feed-in-Tariffs and Contracts for Difference.

Key recommendations included aligning RES policies with that of ESS, for example allowing remuneration for RES schemes that include storage to control dispatch; creating a separate asset class for ESS; allowing network monopolies in unbundled power systems to own and operate ESS, while ensuring their commercial activities involving the use of the ESS are regulated. Other regulatory recommendations included standardising frameworks for evaluating ESS and procedures for connecting ESS to the grid, much like that of DG schemes; establishing a roadmap and target for ESS at the government level that will bolster investment and interest in ESS; and reusing EV batteries as they become plentiful, for grid storage applications. In the electricity market, the recommendations were updating the electricity market rules for ESS technologies to allow payment for high accuracy and responsiveness, simultaneous operation; different capacity requirements from that of conventional technologies; providing support mechanisms for ESS to compete against conventional technologies; consideration of flexible technologies such as ESS when implementing price caps; and implementation of a price for carbon which will promote the use of cleaner technologies, which will require the use of ESS.

If the said changes are made, ESS could become profitable for DNOs and third parties as the technical capability has already been demonstrated. Implementing the above recommendations would improve the feasibility of using ESS for those stakeholders who are considering ESS as an alternative to conventional reinforcements on the T&D networks.

### **1.3 CONCLUSIONS FROM THE MEDIUM TERM PLANNING FOR ESS ON A MV DISTRIBUTION NETWORK**

ESS used for purely technical or market operations is generally not feasible as observed in the literature review in Chapter 2. Assessing the true value of ESS is also

difficult due to limitations brought about by regulatory and electricity market structures. Evaluating different ownership and business models that could be possible if the regulatory and market rules are changed allowed for the feasibility assessment of using ESS under a more favourable regime. As were built to handle one way flow of power, increasing LCTs will affect the conventional operation and planning methods. The following were contributions from Chapter 6 to the ESS medium term planning problem for DNOs.

### ***1.3.1 Developed scenario of LCT increase on a case study network***

A 6.6 kV real MV network model was used as the test network for case studies that used a scenario developed from UK government LCT policies. A scenario was made with demand and generation LCT growth (including domestic demand growth) resulting in an 18% RES share on the network and an increase of 130% in RES export, and HP contributing 32% in network demand from less than 3% in the first year of the 15 year planning period. This resulted in 2245 undervoltage events and 389 overvoltage events over a year by the 15th year of the planning period. The greater prevalence of undervoltage was due to the high HP uptake. The network also reached a critical point by year 14 where there were 2 transformer overload issues, reaching 112 recorded events in year 15. In addition, there were 10 reverse power flow events. The results showed what could happen if government policies and targets are followed on a particular distribution network, if no interventions are made to accommodate high levels of solar PV and HP.

### ***1.3.2 Development of a centralised control algorithm for operating ESS for technical issues***

The default method to maintain the network voltage within the set limits is to use an on-load tap changer with a predetermined target voltage either at the primary substation or remote end using line drop compensation (LDC), with settings based on the DNOs understanding of historical demand on the network. The uptake of LCTs increases the uncertainty in demand and changes the demand patterns on the network, with issues like reverse power flow occurring and shifts in peak demand

periods. This will make OLTCs more difficult to configure and the settings will need to be regularly reviewed and updated. Furthermore, expensive network expansion or upgrades will be required to handle peak power flows. A voltage and power flow management algorithm that coordinates the operation of the operation of the ESS and OLTC was developed with the ESS handling small and more frequent voltage excursions that happen due to LCTs and the OLTC only operating for severe and less frequent violations that cannot be resolved with limited ESS resources. The ESS provides reactive power as a first alternative to fix the voltage excursion and if it reaches its rated limit, real power is provided to the network. This is coordinated with the power flow management to enable the ESS to sink reverse power flow and peak shave during periods of high power flows. The algorithm was successful in resolving all problems on the network with the use of two ESS devices (there was only one minor event with the voltage at the 1.06 P.U limit in year 15), with one located at the primary substation for peak shaving and another ESS located at a remote end for managing voltage excursions.

### ***1.3.3 Integrating centralised control algorithm with operating strategy for ESS technical and market operation***

The coordinated voltage control and power flow management algorithm was integrated with an algorithm which enables market operation for arbitrage in the power exchange market. The algorithm was developed to manage any constraints that arise as a result of market operation which at times is counterproductive to the normal operation of the network, it also carries out technical interventions that are not caused by market operations. This was shown in the results where there were higher number of constraint violations on the network than the base case without ESS when the ESS operation algorithm was specified purely for market operation. This algorithm and operating strategy was developed assuming that the DNOs and third party can collaborate together to provide maximum benefits, with the DNO providing network information via RTUs on the state of the network and forecasted

demand, and the third parties providing market intelligence on day ahead electricity prices.

#### ***1.3.4 Feasibility evaluation of ESS ownership under different business models***

Four business models were evaluated for the ESS under the third party and DNO ownership types. Under the third party ownership type, possible revenues from the spot and balancing market and ancillary services market, i.e. FFR and STOR (only in the final year of the planning study) were considered. The DNO ownership type considered network support services, i.e. purely technical operation and variants of business models where embedded distribution network (DUoS) and TRIAD benefits can be recovered. Services that included aggregated benefits from commercial and network support services were more profitable under the collaborative business model with the DNO and third party. The revenues from regulated network services provided the most revenue, which is also assured. This shows that the regulatory environment needs to be revised to enable DNOs to install ESS and to collaborate with third parties who will benefit from optimising the ESS operation for commercial benefits. Only then can the full value of ESS be derived and the payment for the high investment cost can also be offset. As ESS prices continue to drop and the technology improves, particularly around cycles to failure, the feasibility of using ESS increases, this was shown in this chapter where three ESS cost levels for power and energy capacity were evaluated as a sensitivity analysis.

### ***1.4 CONCLUSIONS FROM THE PLANNING FOR ESS USE ON A MV DISTRIBUTION***

#### ***NETWORK USING A STOCHASTIC AND MULTI-OBJECTIVE HEURISTIC METHOD***

A short term planning method was developed in this chapter that considered the stochastic nature of conventional domestic demand, and emerging demand and generation LCTs using Monte-Carlo simulations based on medium term developed scenarios for LCT proliferation on the network. This provided an understanding of the possible issues that could impact a distribution network, using the IEEE 33 bus test network for the case study. Scenarios for 2029/2030 were investigated for different levels of concentration of PV and HP customers on the network to explore

the full range of possible 48 half hour profiles for all the LV customers (busbars) on the network, with the most extreme profiles selected from the probabilistic load flow. The scenarios evaluated were a base case scenario of 2% PV and 1% HP installed on the network; 30% PV and 13% HP; and finally 60% PV and 25% HP; all possibilities for LCT uptake based on UK government policies.

A multi-objective optimisation algorithm was then developed that represented the problem as a dynamic optimal power flow problem with 48 half hour solutions for the ESS daily operation based on these three objectives for:

- loss reduction and voltage stability factor improvement;
- network problem count reduction (i.e. thermal and voltage excursions); and
- commercial revenues from the spot market and DUoS and TRIAD benefits based on 2029/2030 prices.

The solutions were represented as the ESS real and reactive power operation (either charging or discharging), the OLTC operation and revenues from the spot market, TRIAD and DUoS. From the profiles obtained from the Monte Carlo simulations, there were voltage excursion problems, with overvoltages occurring in the summer from high PV export and undervoltage in the winter from high HP and conventional domestic demand. The ESS was capable of fully resolving all the problems based on results from the optimal solutions. There were also thermal excursion problems in the winter, however the ESS was only able to reduce the number of problems by approximately 75% in the base case simulation with small amounts of PV and HP concentrations. The ESS was less effective in the other two scenarios of high PV and HP concentrations resolving only approximately 30% of thermal excursion problems on the network. This means on the case study network, reinforcement or alternative measures will still be required to resolve all thermal excursion issues. When considering commercial revenue potential from the set of optimal solutions over a day for each scenario, the ESS provided a discounted revenue that peaked at £250/day in scenario 1 and £138/day in scenario 2. This was based on limits of the



ESS tested on the network which was rated at 0.25 MW/1.125 MWh and the other at 1 MW/ 4.5 MWh, with the larger capacity and rated ESS providing the higher revenue.

The results show that ESS can play a part in resolving issues that arise from growing LCTs on a distribution network and furthermore, additional revenues can be obtained from commercial operations that can help offset the high investment cost of the ESS. There is however the need to clearly establish the objectives of all stakeholders involved and ensure that the ESS is optimised based on the requirements and compromises the stakeholders are willing to make.

## **2 CONTRIBUTIONS OF THESIS AND LIMITATIONS OF THE RESEARCH**

### **2.1 CONTRIBUTIONS OF THIS THESIS**

The contributions of the research are summarised as follows:

1. A comprehensive review of the regulatory and electricity market barriers to the deployment of ESS in the UK, EU and countries with high renewable levels and targets;
2. A coordinated OLTC and ESS voltage control algorithm, and a power flow management control algorithm for managing voltage and thermal network constraints caused by factors such as increase in demand or LCTs;
3. An algorithm that integrates the voltage and power flow management algorithm of the ESS with arbitrage operation in the electricity market;
4. A planning and evaluation approach that uses both a deterministic and stochastic method to assess LCT impacts on a distribution network, with the stochastic method developed equally in collaboration with Christian Barteczko-Hibbert a collaborator on a conference paper and on a journal paper (in preparation) where the method developed and dataset used in this thesis will also be presented;
5. A multi-objective optimisation method for daily ESS operation that also handles the OLTC control on a distribution network;

6. A method to quantify the multi-stakeholder benefits of implementing ESS in a distribution network based on different ownership types and business models;
7. Contributes to the ongoing discourse on ESS importance and feasibility on the grid by informing DNOs, policymakers and regulators on the investment decisions needed when implementing ESS in distribution networks.

## 2.2 *LIMITATIONS OF RESEARCH AND SUGGESTIONS FOR FURTHER RESEARCH*

The following are recommendations for further research that will strengthen the work carried out in this thesis:

1. Studies were carried out using half-hourly resolution, hence effects on voltages and thermal overload of LCTs and ESS operation that happen in sub half-hour periods were not captured. There is more variability in demand and generation as the resolution is reduced to minutes or even seconds. Further work would include dynamic studies carried out in minute resolutions to run in tandem with the half-hour resolution steady state analysis carried out in chapter 5 and 6 to assess the short term impact of LCTs and ESS.
2. This research did not consider different scenarios of HP and LCT uptake on different network topologies in different locations. Further research would look into this as the impacts will vary based on the network location and topology.
3. The ESS control developed for the medium term study in Chapter 5 did not consider network losses directly. As a result there was only a 0.2% reduction in losses over the 15 year period. Further studies should take loss reduction as part of the ESS operation into consideration in medium term planning studies.
4. Large ESS deployments can reduce the need for peaking power plants as more renewables are deployed on the grid. However, the lifecycle cost of ESS (from production to disposal) and the efficiency losses which will lead to the increases in GHG emissions (if the energy charged and discharged comes

from centralised baseload fossil fuel generators) needs to be investigated in future research to establish the full impact of a large scale ESS deployment on the grid.

5. Gas prices are linked to oil prices of which the former is intrinsically linked to the GB generation mix and impacts on the electricity prices. Oil prices were above \$100 a barrel from 2010 up until 2014, which meant that electricity market prices were higher and projected to increase as the years progressed, however, the high price of oil came to a crash at the end of 2014. This led to a depression in the electricity market prices which was not anticipated. Future work has to consider multiple scenarios of changes in wholesale prices in future and the impact this will have in ESS commercial revenue from the spot and balancing market.
6. Further work would investigate the impact of the increase in the value of ESS as renewable generation increases on the UK grid as the increase will affect spot, balancing and ancillary services market prices;
7. The assessment of FFR and STOR revenue was post processed from the ESS operation and only done in the final year of the 15 year long term planning study. Future research would investigate ESS control algorithms for ancillary services market operation with a dynamic model of the GB system to model the impact of growing renewables on the need for FFR and STOR ancillary services;
8. Although operating a single ESS of a small scale would not affect the overall market price due to its size (price-takers), growing amounts of distributed ESS on the GB grid will affect the wholesale market prices and price of other ancillary services. Further work will need to factor this by investigating future scenarios with large amounts of ESS deployments on the grid.

Furthermore, for the multi-objective optimisation the following are limitations and point to future work that could be done:

1. Dynamic parameter setting could be an option to be explored instead of static setting used in Chapter 6 for selecting parameters such as the probability of mutation, crossover probability, population size and number of generations. This will mean the parameters change as the solution set evolves. Further research would look at how this can improve on the MOEA heuristic developed in Chapter 6 in finding the global Pareto-optimal solutions.
2. The heuristic optimisation method only considers the operation of one ESS as opposed to the multiple ESS, for instance in Chapter 5, two ESS were installed and operated on the network. Depending on the issues on a network and budget of the DNO/third party, there is the possibility of installing multiple smaller sized ESS to provide multiple benefits on the network. The optimisation planning method here should be extended to consider multiple ESS operations.
3. Finally the optimisation method should be tested with different network topologies and sizes in future work.

### **3 CONCLUSION FROM THESIS**

This thesis established limits of current regulatory and electricity market frameworks to the deployment of ESS and developed an analytical ESS control algorithm which was used to evaluate the viability of ESS in distribution networks with increased levels of LCTs over a medium term planning period. A stochastic method was used to ascertain possible impacts of LCT growth in the medium term and a multi-objective optimisation method was used to control the ESS operation pattern over a day to mitigate the problem in a short-term planning problem. The optimisation provided a set of optimal solutions for objectives that considered technical and commercial benefits of the ESS on the network.

ESS will be a disruptive technology in the future. The work presented in this thesis shows that ESS is a useful solution that can aid in the transition towards a low carbon economy with electrification from heating and low carbon generation. For the grid to be able to host more LCTs, different forms of ESS with different capacities

and locations on the transmission and distribution networks will have to be deployed along with other flexible solutions such as demand response and interconnections. If the barriers limiting ESS from policy and regulation are addressed, an understanding of the needs of future networks is established, and there is collaboration between power system stakeholders investing in ESS, ESS can become a viable and crucial investment in distributions networks. The high cost of ESS and current government policies and regulations makes that investment in ESS risky and makes valuing the long term investment difficult. Therefore, a policy in place that reduces uncertainty in investment will aid a more thorough system wide technical and financial evaluation and will improve the viability of ESS, which has been shown from this thesis to be technically and financially viable to deploy in distribution networks under high LCT scenarios in the distribution networks. Chapter 4 provides a list of recommendations to enhance storage deployment. However, the following recommendations are deemed as the fundamental policy and regulatory update that should be considered for promoting the use of ESS:

1. **Active control and management of distributed resources in the distribution networks**: in countries where the distribution networks are unbundled and regulated, e.g. in the UK, it is very important the Distribution Network Operators (DNOs) are given the opportunity as part of their regulatory duties to actively manage their networks as a “Distribution System Operator” (DSO) with some grid balancing responsibilities transferred from the System Operators (SO) to the DNOs who will be facing high impact as a result of the growth in low carbon generation and demand (LCT-G and LCT-D) customers. In this case, the DNOs can actively manage multiple ESS and demand response resources for local ancillary services by procuring services from third parties or investing in ESS (if regulation is changed to allow this). In addition, the DNOs can gain additional revenue like SO’s from procuring and providing national ancillary system services from managing and directly or indirectly controlling the multiple distributed energy resources on their networks.

2. **Asset classification of ESS and standardisation of practices:** to aid the adoption of ESS, the classification of ESS will have to be different from that of a generator and/or consumer. Regulators should consider a separate asset classification for ESS which will eliminate the regulatory issues of ownership of storage by network monopolies as discussed in Chapter 4. A thorough analysis would be necessary to understand the competitive advantage it provides to network monopolies allowing for rules to be put in place to limit them. Once the distinction of ESS enacted by regulation, it would lead to standardising assessment frameworks, connection, and operational procedures for the deployment and use of ESS on the grid. This is very crucial to promoting investment and increase in ESS implementations, as was the case for distributed generation.
3. **Multiple uses of storage for regulated and non-regulated services:** if regulation allows for use of network resources for non-regulated services, this will allow network operators (who have a better visibility of short, medium and long term network issues) and third party private investors to collaborate for improved feasibility from optimised operations and multiple revenue streams. The regulatory and market structures in place will have to be amended to allow collaboration to take advantage of the multiple services that ESS will be able to offer.
4. **Target for ESS deployment:** targets being set for renewable electricity need to factor in requirements for flexibility from ESS both at the transmission and distribution level. It would be important in this case to have a nationwide and/or regional target for ESS based on a thorough evaluation by the system operator, transmission and distribution network owner on the levels required to provide services to manage constraints on the grid, for system balancing and to mitigate capacity problems. All of the above problems will persist as the levels of intermittent renewables, like wind turbines, increase; and more conventional baseload generation is shut down in shut down because of low carbon emissions targets.

5. **Battery capacity from vehicle to grid**: electric vehicles (EV) will become more prevalent as the cost of the battery technologies drop and the performance of batteries improves. Policies should facilitate investment in Vehicle to Grid (V2G) infrastructure and regulations should allow transmission and distribution network operators to exploit the EV battery resources when not in use for local and system wide grid applications. The battery resources from EVs can be used directly by the network operators who can bypass the lengthy evaluation and assessment required for the investment in ESS on their networks, which often deters its use. If the batteries are used for grid applications, their lifetime will be reduced because of the larger number of cycles from charging and discharging more frequently. A policy should also be in place to allow compensation for the used batteries from the EV users at the cost of a new replacement for the users. The used batteries can then be reused by the network operators and other third parties for other applications depending on their remaining life, and disposed or recycled subsequently.
6. **Dynamic pricing**: regulatory and electricity market changes that allow some form of dynamic pricing like the time-of-use tariffs at the retail electricity market level will promote investment in ESS by domestic, industrial and commercial customers who will want to take advantage of the varying prices to reduce their energy costs and gain additional revenues. It will also provide incentives for private sector investment in ESS on the networks with certainty of revenues. This will reduce the constraints on the network particularly during peak periods when prices will reflect the cost to procure electricity and/or balance the electricity system. The transmission and distribution network owners would be able to take advantage of the ESS resources for grid applications with the remuneration passed down to the ESS owners. Benefits were shown in this thesis from optimising the operation of ESS for the transmission and distribution use of system tariffs, which are dynamic based on the time of day, in the UK. The same approach can be

applied to consumer owned ESS allowing them to gain revenues from relieving the stress on the networks locally and nationally from the transmission and distribution use of system tariffs and from dynamic electricity prices.



## References

---

1. Domah, P. and M.G. Pollitt, *The restructuring and privatisation of the electricity distribution and supply businesses in England and Wales: a social cost-benefit analysis*. Fiscal Studies, 2001. **22**(1): p. 107-146.
2. Newbery, D.M., *Electricity liberalization in Britain: The quest for a satisfactory wholesale market design*. 2005.
3. Department of Energy and Climate Change, *The Carbon Plan: Delivering our low carbon future 2011*: UK.
4. Parliamentary Office of Science and Technology, *Future Electricity Networks*, U.P.O.o.S.a. Technology, Editor. 2011. p. 1 - 4.
5. Royal Academy of Engineering, *GB electricity capacity margin - A report by the Royal Academy of Engineering for the Council for Science and Technology*. 2013, Royal Academy of Engineering.
6. Bloomberg New Energy Finance, *White Paper - UK Power Forecasts*. 2012.
7. Bedford, M. *Briefing: Good news, bad news: the UK public spending review*. Proceedings of the ICE - Energy, 2011. **164**, 49-50.
8. UK Department of Energy and Climate Change, *Planning our electric future : technical update*. 2011. p. 1 - 56.
9. Department of Energy and Climate Change, *Planning our electric future: a White Paper for secure, affordable and low carbon electricity*. 2011: UK. p. 1 - 239.
10. Parliamentary Office of Science and Technology, *UK electricity networks*, U.P.O.o.S.a. Technology, Editor. 2001. p. 1-4.
11. Mackay, D.J.C., *Sustainable Energy-Without the Hot Air*. 2009, UIT Cambridge Ltd.
12. Stuart Young Consulting, *Analysis of UK Wind Power Generation - November 2008 to December 2010*. 2011.
13. Carbon Connect, *Distributed Generation - From cinderella to centre stage*. 2012.
14. Parliamentary Office of Science and Technology, *Electricity in the UK* U.P.O.o.S.a. Technology, Editor. 2007. p. 2-5.
15. Energy Networks Association, *UK and Ireland energy networks: Sustainable, secure and essential*. 2010: London.

16. Ofgem, *Electricity Distribution Annual Report for 2008-09 and 2009-10*. 2011, Ofgem. p. 1 - 66.
17. United Nations. *Kyoto Protocol*. 2014 [cited 2014 July 2014]; Available from: [http://unfccc.int/kyoto\\_protocol/items/2830.php](http://unfccc.int/kyoto_protocol/items/2830.php).
18. Department of Energy and Climate Change (DECC), *UK Renewable Energy Roadmap*. 2011.
19. Connor, P.M., et al., *Policy and regulation for smart grids in the United Kingdom*. Renewable and Sustainable Energy Reviews, 2014. **40**(0): p. 269-286.
20. Department of Energy and Climate Change (DECC). *2012 energy and emissions projections: projections of greenhouse gas emissions and energy demand 2012 to 2030*. 2012 October 2012 [cited 2014 19/08/2014]; Available from: <https://www.gov.uk/government/publications/2012-energy-and-emissions-projections>.
21. Wilson, I.A.G., P.G. McGregor, and P.J. Hall, *Energy storage in the UK electrical network: Estimation of the scale and review of technology options*. Energy Policy, 2010. **38**(8): p. 4099-4106.
22. Department of Energy and Climate Change (DECC). *Increasing the use of low-carbon technologies*. 2014 11 August 2014 [cited 2014 19/08/2014].
23. Committee on Climate Change, *Meeting Carbon Budgets - 2014 Progress Report to Parliament*. London.
24. Carbon Market Watch, *What's needed to fix the EU's carbon market - Recommendations for the Market Stability Reserve and future ETS reform proposals*, in *Carbon Market Watch Policy Briefing*. 2014.
25. European Commission, *The state of the European carbon market in 2012* 2012: Brussels.
26. Zahedi, A., *A review of drivers, benefits, and challenges in integrating renewable energy sources into electricity grid*. Renewable and Sustainable Energy Reviews, 2011. **15**(9): p. 4775-4779.
27. Viral, R. and D.K. Khatod, *Optimal planning of distributed generation systems in distribution system: A review*. Renewable and Sustainable Energy Reviews, 2012. **16**(7): p. 5146-5165.
28. Electricity North West, *Annex 23: Innovation Strategy*. 2014: Cheshire.

29. Pepermans, G., et al., *Distributed generation: definition, benefits and issues*. Energy Policy, 2005. **33**(6): p. 787-798.
30. Klessmann, C., C. Nabe, and K. Burges, *Pros and cons of exposing renewables to electricity market risks—A comparison of the market integration approaches in Germany, Spain, and the UK*. Energy Policy, 2008. **36**(10): p. 3646-3661.
31. Bayod-Rujula , A.A., *Future development of the electricity systems with distributed generation*. Journal of Energy, 2009. **34** (3): p. 377-383.
32. Passey, R., et al., *The potential impacts of grid-connected distributed generation and how to address them: A review of technical and non-technical factors*. Energy Policy, 2011. **39**(10): p. 6280-6290.
33. Guan, F.H., et al. *Research on distributed generation technologies and its impacts on power system*. in *Sustainable Power Generation and Supply, 2009. SUPERGEN '09. International Conference on*. 2009.
34. Pudjianto, D., et al., *Smart control for minimizing distribution network reinforcement cost due to electrification*. Energy Policy, 2013. **52**(0): p. 76-84.
35. Energy Research Partnership (ERP), *The future role for energy storage in the UK*. 2011. p. 1 - 48.
36. Dent, C., et al. *Capacity value of distributed generation for network capacity planning*. in *Electricity Distribution (CIRED 2013), 22nd International Conference and Exhibition on*. 2013.
37. House of Commons Trade and Industry Committee. *Trade and Industry Committee Publications - Chapter 3: Construction and Operating Standards*. 2014 [cited 2014 27 July]; Available from: <http://www.publications.parliament.uk/pa/cm200304/cmselect/cmtrdind/69/6906.htm>.
38. Strbac, G. and D. Porter, *Final Report: Review of Distribution Network Design and Performance Criteria 2007*, Imperial College, London and Kema Limited, .
39. Strbac, G., *Demand side management: Benefits and challenges*. Energy Policy, 2008. **36**(12): p. 4419-4426.
40. Department of Energy and Climate Change. *DUKES Chapter 5: Electricity 2011*; Available from:

<http://www.decc.gov.uk/assets/decc/11/stats/publications/dukes/2307-dukes-2011-chapter-5-electricity.pdf>.

41. Lehtonen, M. and S. Nye, *History of electricity network control and distributed generation in the UK and Western Denmark*. Energy Policy, 2009. **37**(6): p. 2338-2345.
42. Electricity Network Strategy Group, *A Smart Grid Vision: A smart Grid Vision*. 2009. p. 1 - 27.
43. Agrell, P.J., P. Bogetoft, and M. Mikkers, *Smart-grid investments, regulation and organization*. Energy Policy, 2013. **52**(0): p. 656-666.
44. European Commission, E., *Green Paper - Towards a European strategy for the security of energy supply*, . 2000, European Commission: Brussels.
45. Viljainen, S., et al., *Regulation of Electricity Distribution Business*, L.U.o. Technology, Editor. 2007 (b).
46. Viljainen, S.L.t.y., *Regulation design in the electricity distribution sector-theory and practice*. 2005, Lappeenranta University of Technology: Lappeenranta.
47. Christine Müller, *Advancing regulation with respect to smart grids: pioneering examples from the United Kingdom and Italy*, in *Fourth Annual Conference on Competition and Regulation in Network Industries*; . 2011: Brussels. p. 1-16.
48. Ofgem, *Regulating Energy Networks for the Future: RPI-X@20 in History of Energy Network Regulation*. 2009: UK.
49. National Audit Office, *The Electricity Generating Landscape in Great Britain*, in *National Audit Office Report to the House of Commons Energy and Climate Change*, H.o.C.E.a.C. Change, Editor. 2010. p. 2 - 23.
50. Wilson, I.A.G., et al., *Grid-connected renewables, storage and the UK electricity market*. Renewable Energy, 2011. **36**(8): p. 2166-2170.
51. National Grid *GB Seven Year Statement - Chapter 10*. 2009.
52. BSI Group, *Voltage characteristics of electricity supplied by public electricity networks 2010*, BSI.
53. Ofgem, *RIIO: A new way to regulate energy networks - Final decision*, O.o.G.a.E. Markets, Editor. 2010. p. 51.
54. The Electricity Advisory Committee, *2012 Storage Report: Progress and Prospects Recommendations for the U.S. Department of Energy*. 2012.

55. Poonpun, P. and W.T. Jewell, *Analysis of the Cost per Kilowatt Hour to Store Electricity*. Energy Conversion, IEEE Transactions on, 2008. **23**(2): p. 529-534.
56. Denholm, P., Ela, E., Kirby, B., Milligan, M. , *The Role of energy storage with renewable electricity generation*. 2010, National Renewable Energy Laboratory.
57. Manz, D., J. Keller, and N. Miller. *Value propositions for utility-scale energy storage*. in *Power Systems Conference and Exposition (PSCE), 2011 IEEE/PES*. 2011.
58. EPRI, *Energy Storage Technology Options: A White Paper Primer on Applications, Costs, and Benefits*. 2010, Electric Power Research Institute: Palo Alto, CA.
59. Taylor, P., Bolton, R., Stone, D., Zhang, X., Martin, C., Upham, P., Li, Y., Porter, R., Bonvallet, E.P., *Pathways for energy storage in the UK*. 2012, The Centre for Low Carbon Futures
60. Strbac, G. and et al, *Strategic Assessment of the Role and Value of Energy Storage Systems in the UK Low Carbon Energy Future - Report for the Carbon Trust*. 2012, Energy Futures Lab, Imperial College.
61. Anuta, O.H., et al., *An international review of the implications of regulatory and electricity market structures on the emergence of grid scale electricity storage*. Renewable and Sustainable Energy Reviews, 2014. **38**(0): p. 489-508.
62. Klockl, B., P. Stricker, and G. Koepfel. *On the properties of stochastic power sources in combination with local energy storage*. in *CIGRE Symposium on Power Systems with Dispersed Generation*. 2005. CIGRE.
63. Ibrahim, H., A. Ilinca, and J. Perron, *Energy Storage Systems - Characteristics and Comparisons*. Renewable and Sustainable Energy Reviews, 2008. **12**(5): p. 1221-1250.
64. Nourai, A., et al., *Load Leveling Reduces T & D Line Losses*. October, 2008. **23**(4): p. 2168-2173.
65. Gill, S., I. Kockar, and G.W. Ault, *Dynamic Optimal Power Flow for Active Distribution Networks*. Power Systems, IEEE Transactions on, 2014. **29**(1): p. 121-131.
66. DTI, *A Technical Review and Assessment of Active Network Management Infrastructures and Practices*. 2006, Department of Trade and Industry: London, U.K.
67. Chacra, F.A., et al., *Impact of Energy Storage Costs on Economical Performance in a Distribution Substation*. Power, 2005. **20**(2): p. 684-691.

68. Eyer, J., Corey, G., *Energy Storage for the Electricity Grid: Benefits and Market Potential Assessment Guide - A Study for the DOE Energy Storage Systems Program* 2010, Sandia National Laboratories: United States of America.
69. Grunewald, P.H., et al., *The socio-technical transition of distributed electricity storage into future networks-System value and stakeholder views*. *Energy Policy*, 2012. **50**: p. 449-457.
70. Klöckl, B., G. Papaefthymiou, and P. Pinson, *Probabilistic tools for planning and operating power systems with distributed energy storage*. *e & i Elektrotechnik und Informationstechnik*, 2008. **125**(12): p. 460-465.
71. Ofgem, *Price controls explained*, Ofgem, Editor. 2013: UK.
72. Strbac, G. and J. Mutale, *Framework and Methodology for Pricing of Distribution Networks with Distributed Generation - March 2005 a Report for Ofgem*. 2005.
73. Lang, P., et al., *State of Charge of GB*, in *Energy Storage Operators Forum*. 2013.
74. Fürsch, M., et al., *The role of grid extensions in a cost-efficient transformation of the European electricity system until 2050*. *Applied Energy*, 2013. **104**(0): p. 642-652.
75. Vasconcelos, J., Ruester, Sophia, He, Xian, Glachant, Jean-Michel *Electricity Storage: How to Facilitate its Deployment and Operation in the EU*. 2012, European University Institute.
76. UK Power Networks *Smarter Network Storage*. 2014 [cited 2014 December]; Available from: <http://innovation.ukpowernetworks.co.uk/innovation/en/Projects/tier-2-projects/Smarter-Network-Storage-%28SNS%29/>.
77. Garcia-Gonzalez, J. *Hedging strategies for wind renewable generation in electricity markets*. in *Power and Energy Society General Meeting - Conversion and Delivery of Electrical Energy in the 21st Century, 2008 IEEE*. 2008.
78. Korpaas, M., A.T. Holen, and R. Hildrum, *Operation and sizing of energy storage for wind power plants in a market system*. *International Journal of Electrical Power & Energy Systems*, 2003. **25**(8): p. 599-606.
79. Dicorato, M., et al., *Planning and Operating Combined Wind-Storage System in Electricity Market*. *Sustainable Energy, IEEE Transactions on*, 2012. **3**(2): p. 209-217.
80. Ohtaka, T. and S. Iwamoto. *Possibility of using NAS battery systems for dynamic control of line overloads*. in *Transmission and Distribution Conference and Exhibition 2002: Asia Pacific. IEEE/PES*. 2002.

81. Ippolito, M.G., et al., *Multi-objective optimized management of electrical energy storage systems in an islanded network with renewable energy sources under different design scenarios*. *Energy*, 2014. **64**(0): p. 648-662.
82. Sugihara, H., et al., *Economic and Efficient Voltage Management Using Customer-Owned Energy Storage Systems in a Distribution Network With High Penetration of Photovoltaic Systems*. *Power Systems, IEEE Transactions on*, 2013. **28**(1): p. 102-111.
83. Nick, M., et al. *Optimal location and sizing of distributed storage systems in active distribution networks*. in *PowerTech (POWERTECH), 2013 IEEE Grenoble*. 2013.
84. Chen, T.-H., et al., *Evaluation of advantages of an energy storage system using recycled EV batteries*. *International Journal of Electrical Power & Energy Systems*, 2013. **45**(1): p. 264-270.
85. Kazempour, S.J., et al., *Electric energy storage systems in a market-based economy: Comparison of emerging and traditional technologies*. *Renewable Energy*, 2009. **34**(12): p. 2630-2639.
86. ZUCKER, A., T. HINCHLIFFE, and A. SPISTO, *Assessing Storage Value in Electricity Markets - A literature review*. 2013, Joint Research Centre of the European Commission- Institute for Energy and Transport, .
87. Lakervi, E., E.J. Holmes, and E. Institution of Electrical, *Electricity Distribution Network Design*. 1995: P. Peregrinus.
88. Neimane, V., *On Development Planning of Electricity Distribution Networks*, in *Department of Electrical Engineering*. 2001, Royal Institute of Technology: Stockholm.
89. Grond, M.O.W., et al. *Multi-objective optimization techniques and applications in electric power systems*. in *Universities Power Engineering Conference (UPEC), 2012 47th International*. 2012.
90. Rivas-Davalos, F., et al. *Multiobjective Optimization Challenges in Power System: The Next Step Forward*. in *Electronics, Robotics and Automotive Mechanics Conference, 2007. CERMA 2007*. 2007 (b).
91. Rivas-Davalos, F., et al. *Evolutionary Multi-Objective Optimization in Power Systems: State-of-the-Art*. in *Power Tech, 2007 IEEE Lausanne*. 2007 (a).
92. Huang, Y., *Electricity Distribution Network Planning Considering Distributed Generation*. 2014, KTH Royal Institute of Technology: Stockholm.

93. Ameli, A., et al., *Distributed generation planning based on the distribution company's and the DG owner's profit maximization*. International Transactions on Electrical Energy Systems, 2013: p. n/a-n/a.
94. Shaaban, M.F. and E.F. El-Saadany, *Accommodating High Penetrations of PEVs and Renewable DG Considering Uncertainties in Distribution Systems*. Power Systems, IEEE Transactions on, 2014. **29**(1): p. 259-270.
95. Energy Networks Association (ENA), *Engineering Recommendation P2/6 - Security of Supply*. 2006.
96. Falaghi, H., et al., *DG integrated multistage distribution system expansion planning*. International Journal of Electrical Power & Energy Systems, 2011. **33**(8): p. 1489-1497.
97. El-khattam, W., Y.G. Hegazy, and M.M.A. Salama, *An integrated distributed generation optimization model for distribution system planning*. Power Systems, IEEE Transactions on, 2005. **20**(2): p. 1158-1165.
98. Gitizadeh, M., A.A. Vahed, and J. Aghaei, *Multistage distribution system expansion planning considering distributed generation using hybrid evolutionary algorithms*. Applied Energy, 2013. **101**(0): p. 655-666.
99. Borges, C.L.T. and V.F. Martins, *Multistage expansion planning for active distribution networks under demand and Distributed Generation uncertainties*. International Journal of Electrical Power & Energy Systems, 2012. **36**(1): p. 107-116.
100. Nara, K., et al., *Distribution systems expansion planning by multi-stage branch exchange*. Power Systems, IEEE Transactions on, 1992. **7**(1): p. 208-214.
101. Sedghi, M., M. Aliakbar-Golkar, and M.R. Haghifam, *Distribution network expansion considering distributed generation and storage units using modified PSO algorithm*. International Journal of Electrical Power & Energy Systems, 2013. **52**(0): p. 221-230.
102. Poudineh, R. and T. Jamasb, *Distributed generation, storage, demand response and energy efficiency as alternatives to grid capacity enhancement*. Energy Policy, 2014. **67**(0): p. 222-231.
103. Ben Aribia, H., N. Derbel, and H. Hadj Abdallah, *The active-reactive – Complete dispatch of an electrical network*. International Journal of Electrical Power & Energy Systems, 2013. **44**(1): p. 236-248.



104. Moradi, M.H. and M. Abedinie. *A combination of Genetic Algorithm and Particle Swarm Optimization for optimal DG location and sizing in distribution systems*. in *IPEC, 2010 Conference Proceedings*. 2010.
105. Khalesi, N., N. Rezaei, and M.R. Haghifam, *DG allocation with application of dynamic programming for loss reduction and reliability improvement*. *International Journal of Electrical Power & Energy Systems*, 2011. **33**(2): p. 288-295.
106. Oshiro, M., et al. *Optimal operation strategy by battery energy storage systems in distribution system*. in *IPEC, 2010 Conference Proceedings*. 2010.
107. Furusawa, K., et al., *A study of economic evaluation of demand-side energy storage system in consideration of market clearing price*. *Electrical Engineering in Japan*, 2007. **158**(1): p. 22-35.
108. Mori, H. and Y. Iimura. *An improved tabu search approach to distribution network expansion planning under new environment*. in *Power System Technology, 2004. PowerCon 2004. 2004 International Conference on*. 2004.
109. Alarcon-Rodriguez, A., G. Ault, and S. Galloway, *Multi-objective planning of distributed energy resources: A review of the state-of-the-art*. *Renewable and Sustainable Energy Reviews*, 2010. **14**(5): p. 1353-1366.
110. Miranda, et al., *Genetic algorithms in optimal multistage distribution network planning*. Vol. 9. 1994, New York, NY, ETATS-UNIS: Institute of Electrical and Electronics Engineers.
111. Yong-hua, S. and M.R. Irving, *Optimisation techniques for electrical power systems. II. Heuristic optimisation methods*. *Power Engineering Journal*, 2001. **15**(3): p. 151-160.
112. Roy, R. and S.P. Ghoshal, *A novel crazy swarm optimized economic load dispatch for various types of cost functions*. *International Journal of Electrical Power & Energy Systems*, 2008. **30**(4): p. 242-253.
113. Rivas-Davalos, F., et al. *Multiobjective Optimization Challenges in Power System: The Next Step Forward*. in *Electronics, Robotics and Automotive Mechanics Conference, 2007. CERMA 2007*. 2007.
114. Branke, J., et al., *Multiobjective Optimization: Interactive and Evolutionary Approaches*. 2008: Springer.

115. Radziukynas, V. and I. Radziukyniene, *Optimization Methods Application to Optimal Power Flow in Electric Power Systems*, in *Optimization in the Energy Industry*, J. Kallrath, et al., Editors. 2009, Springer Berlin Heidelberg. p. 409-436.
116. Geth, F., et al., *Integration of Energy Storage in Distribution Grids*. *Energy*, (1): p. 1-6.
117. Suazo-Martinez, C., et al., *Impacts of Energy Storage on Short Term Operation Planning Under Centralized Spot Markets*. *Smart Grid, IEEE Transactions on*, 2014. 5(2): p. 1110-1118.
118. Kahrobaee, S. and S. Asgarpoor. *Optimum planning and operation of compressed air energy storage with wind energy integration*. in *North American Power Symposium (NAPS), 2013*. 2013.
119. TNEI. *IPSA+ software website*. 2013 [cited 2013 18 December 2013]; Available from: [www.ipsa-power.com](http://www.ipsa-power.com).
120. Fortin, F.A., et al., *DEAP: Evolutionary Algorithms Made Easy*. *Journal of Machine Learning Research*, 2012. 13(2171-2175).
121. McQueen, D.H.O., P.R. Hyland, and S.J. Watson, *Monte Carlo simulation of residential electricity demand for forecasting maximum demand on distribution networks*. *Power Systems, IEEE Transactions on*, 2004. 19(3): p. 1685-1689.
122. Richardson, I., et al., *Domestic electricity use: A high-resolution energy demand model*. *Energy and Buildings*, 2010. 42(10): p. 1878-1887.
123. Gozel, T.N., A; Ochoa, L F,, *Deliverable 3.5 "Creation of aggregated profiles with and without new loads and DER based on monitored data"*. 2014, The University of Manchester.
124. Baran, M.E. and F.F. Wu, *Network reconfiguration in distribution systems for loss reduction and load balancing*. *Power Delivery, IEEE Transactions on*, 1989. 4(2): p. 1401-1407.
125. Boait, P. and A. Stafford, *Electrical load characteristics of domestic heat pumps and scope for demand side management*, in *21st International Conference on Electricity Distribution (CIRED)*. 2011: Frankfurt.
126. Centre for Sustainable Electricity and Distributed Generation (SEDG). *United Kingdom Generic Distribution Network (UKGDS)*. 2011 [cited 2011 September]; Available from: <http://monaco.eee.strath.ac.uk/ukgds/>.

127. Barteczko-Hibbert, C., Whitake, G., Slater, S., Groizard, J., *Insight Report: Baseline Domestic Profile - Test Cell 1a Customer Subgroup Analysis*. 2015, Customer Led Network Revolution, .
128. Anuta, O., C. Barteczko-Hibbert, and N. Wade, *Future low carbon technologies, impacts and energy storage solutions on UK distribution networks*, in *International Conference on Electricity Distribution*. 2014: Rome, Italy.
129. GROWDERS, *Grid Reliability and Operability with Distributed Generation using Transportable Storage*, in *D 9.4 – Report on European regulatory aspects for electricity storage*,. 2011.
130. Ritschel, A. and G.P. Smestad, *Energy subsidies in California's electricity market deregulation*. *Energy Policy*, 2003. **31**(13): p. 1379-1391.
131. Huneault, M., *Electricity Deregulation: Doubts Brought On by the California Debacle* IEEE Canadian Review, 2001(37 ).
132. Hall, D., Thomas, Stephen, Corral, Violeta, , *Global experience with electricity liberalisation*. 2009, Public Services International Research Unit (PSIRU): Jakarta.
133. Nagayama, H. and T. Kashiwagi, *Evaluating electricity sector reforms in Argentina: lessons for developing countries?* *Journal of Cleaner Production*, 2007. **15**(2): p. 115-130.
134. Regulatory Assistance Project (RAP), *China's Power Sector - A Backgrounder for International Regulators and Policy Advisors*. 2008.
135. European Parliament and Council, *Concerning common rules for the internal market in electricity and repealing Directive 96/92/EC*, in *Directive 2003/54/EG* 2003, Official Journal of the European Union. p. 37–56.
136. Jamasb, T. and M. Pollitt, *Incentive regulation of electricity distribution networks: Lessons of experience from Britain*. *Energy Policy*, 2007. **35**(12): p. 6163-6187.
137. International Energy Agency (IEA), *Lessons from Liberalised Electricity Markets*. 2005, OECD Publishing. p. 224.
138. Nordic Energy Regulators, *Economic regulation of electricity grids in Nordic countries*. 2011, Danish Energy Regulatory Authority.
139. US Department of Energy, *A Primer on Electric Utilities, Deregulation, and Restructuring of U.S. Electricity Markets*. 2002: Washington, D.C.
140. Barroso, L.A., et al. *Classification of electricity market models worldwide*. in *CIGRE/IEEE PES, 2005. International Symposium*; . 2005.

141. Pollitt, M.G., *Liberalisation and Regulation in Electricity Systems: How can we get the balance right?* 2007, Faculty of Economics, University of Cambridge, UK.
142. Zareipour, H., K. Bhattacharya, and C.A. Cañizares, *Electricity market price volatility: The case of Ontario*. *Energy Policy*, 2007. **35**(9): p. 4739-4748.
143. Stan, R., *The Relation between Futures and Spot Prices in the Nordic Electricity Market: The Theory of Storage*. 2012.
144. Ponsot-Jacquín, C. and J.-F. Bertrand, *Mass storage of energy*. 2012, IFP Energies nouvelles.
145. The Economist, *How to lose half a trillion euros - Europe's electricity providers face an existential threat*. 2013.
146. Pomper, D.E., *Watts the Future Holds: Structuring and Regulating Electricity Storage Markets to Benefit Ratepayers*. 2011, National Regulatory Research Institute.
147. Pike Research, *Energy Storage Tracker 2Q12 - Executive Summary*. 2012.
148. EWEA, *EU Energy Policy to 2050 - Achieving 80-95% emissions reduction*. 2011.
149. European Commission, *Materials Roadmap Enabling Low Carbon Energy Technologies*. 2011: Brussels; .
150. NREAP, *National Renewable Energy Action Plans of the European Member States database*. 2011.
151. European Commission, *The future role and challenges of Energy Storage*. 2013.
152. European Parliament, *Directive 2009/28/EC on the promotion of the use of energy from renewable sources and amending and subsequently repealing Directives 2001/77/EC and 2003/30/EC*. 2009b.
153. Beurskens, L.W.M., M. Hekkenberg, and P. Vethman, *Renewable Energy Projections as Published in the National Renewable Energy Action Plans of the European Member States - Summary Report*. 2011, Energy Research Centre of the Netherlands, ECN,.
154. Krajačić, G., et al., *Analysis of financial mechanisms in support to new pumped hydropower storage projects in Croatia*. *Applied Energy*, 2013. **101**(0): p. 161-171.
155. European Parliament, *Directive 2009/72/EC concerning common rules for the internal market in electricity and repealing Directive 2003/54/EC - The electricity directive*. 2009a.
156. Papapetrou, M., Maidonis, Thomas, Garde, Raquel, García, Gabriel,, *European Regulatory and Market Framework for Electricity Storage Infrastructure - Analysis*,

- stakeholder consultation outcomes and recommendations for the improvement of conditions (Draft Version)*. 2013.
157. UK Parliamentary office of Science and Technology, *Electricity Storage*. 2008.
  158. Energy Networks Association (ENA), *A Guide For Connecting Generation That Falls Under G59/2 To The Distribution Network*, in *Distributed Generation Connection Guide*. 2010.
  159. EA Technology, *Operating the Electricity Transmission Networks in 2020 - EA Technology's submission to National Grid's Consultation*. 2009.
  160. Energy Research Partnership (ERP), *Energy Research Partnership Technology Report - Electricity Infrastructure*. 2009, Energy Research Partnership.
  161. Andrews, S., M. Pooley, and J. Ward, *What Demand Side Services Does Distributed Generation Bring to the Electricity System?* 2013.
  162. Wirth, H., *Recent Facts about Photovoltaics in Germany*. 2015, Fraunhofer ISE,.
  163. KfW. *KfW and Federal Environment Ministry launch programme to promote use of energy storage in solar PV installations*. 2013 [cited 2013 20 May ]; Available from: [https://www.kfw.de/KfW-Group/Newsroom/Aktuelles/Pressemitteilungen/Pressemitteilungen-Details\\_107136.html](https://www.kfw.de/KfW-Group/Newsroom/Aktuelles/Pressemitteilungen/Pressemitteilungen-Details_107136.html).
  164. International Battery and Energy Storage Alliance *Bye Bye FIT hello selfconsumption*. *Energy Storage Journal*; , 2013. **1**.
  165. Federal Ministry of Economics and Technology (BMWi), *Energy Concept for an Environmentally Sound, Reliable and Affordable Energy Supply*. 2010.
  166. Steffen, B., *Prospects for pumped-hydro storage in Germany*. *Energy Policy*, 2012. **45**(0): p. 420-429.
  167. Frank, S., I. Steponavice, and S. Rebennack, *Optimal power flow: a bibliographic survey I*. *Energy Systems*, 2012. **3**(3): p. 221-258.
  168. Wasowicz, B., et al. *Evaluating regulatory and market frameworks for energy storage deployment in electricity grids with high renewable energy penetration*. in *European Energy Market (EEM), 2012 9th International Conference on the*. 2012.
  169. Lo Schiavo, L., et al., *Changing the regulation for regulating the change: Innovation-driven regulatory developments for smart grids, smart metering and e-mobility in Italy*. *Energy Policy*, 2013. **57**(0): p. 506-517.

170. Jones, R.S. and M. Kim, *Restructuring the Electricity Sector and Promoting Green Growth in Japan*. OECD Publishing.
171. Schwartz, D.L., *The Energy Regulation and Markets Review*. 2012, Law Business Research Ltd,.
172. Takatoshi Kojima, *How is 100% Renewable Energy Possible in Japan by 2020?* 2012, Global Energy Network Institute (GENI).
173. Roberts, B.P. and C. Sandberg, *The Role of Energy Storage in Development of Smart Grids*. Proceedings of the IEEE, 2011. **99**(6): p. 1139-1144.
174. The Lithium Review. *Japan's 20 Billion Yen Bet on Energy Storage*. 2013 [cited 2013 02 May]; Available from:  
<http://thelithiumreview.com/index.php/component/k2/item/48-japan-energy-storage>.
175. EnergyTrend. *Analysis on Energy Storage System: Lighter and more Family-Friendly*. 2012 20 June 2013]; Available from:  
[http://pv.energytrend.com/research/research\\_solar\\_20120706.html](http://pv.energytrend.com/research/research_solar_20120706.html).
176. METI, *Cool Earth – Innovative Energy Technology Program (Technology Development Roadmap)*, Ministry of Economy Trade and Industry, Editor. 2008 (a): Japan; .
177. *The Role of Grid-Scale Energy Storage in Meeting Our Energy and Climate Goals*, in US Senate Committee on Energy and Natural Resources. 2009, U.S. Government Printing Office: Washington.
178. Kintner-Meyer, M., et al., *National Assessment of Energy Storage for Grid Balancing and Arbitrage*. 2012, Pacific Northwest National Laboratory.
179. US Department of Energy, *Federal Regulatory Energy Storage Policy*. 2012.
180. Government, U., *Title 42 - THE PUBLIC HEALTH AND WELFARE*, in *United States Code*. 2010, U.S. Government Printing Office.
181. US Department of Energy, *Energy Storage Program Planning Document*, Office of Electricity Delivery and Energy Reliability, Editor. 2011.
182. Beacon Power. *Company FAQ*. [cited 2013 1st May]; Available from:  
<http://www.beaconpower.com/faq.asp>.
183. Kema, *Market Evaluation for Energy Storage in the United States* 2012: Fairfax, Virginia; .
184. Kema, *KEMA White Paper: Innovation in Competitive Electricity Markets*. 2011: Burlington, MA, .

185. Bhatnagar, D., and Loose, Verne,, *Evaluating Utility Procured Electric Energy Storage Systems: A Perspective for State Electric Utility Regulators* 2012: Albuquerque, New Mexico; .
186. Alexander, T.E. and S. Arora, *Energy Storage: The Road Ahead*. 2012.
187. Western Grid Development, *Order on Petition for Declaratory Order*, in 130 FERC ¶ 61,209; . 2010.
188. California Public Utility Commission, *Order Instituting Rulemaking Pursuant to Assembly Bill 2514 to Consider the Adoption of Procurement Targets for Viable and Cost Effective Energy Storage Systems*. 2010.
189. Andris Abele, E.E., Jessica Intrator, Byron Washom, et al., *2020 Strategic Analysis of Energy Storage in California*, California Energy Commission, Editor. 2011: California; .
190. United States of America Federal Energy Regulatory Commission, *Third Party Provision of Ancillary Services; Accounting and Financial Reporting for New Electric Storage Technologies*. 2013.
191. *Storage Technology for Renewable and Green Energy Act of 2011 (S 1845)*. 2011.
192. California Government, *California Assembly Bill 2514* 2011.
193. California Public Utilities Commission, *Descision Adopting Energy Storage Procurement Framework and Design Program, Agenda ID #12370 (Rev. 2)*. 2013.
194. Driesen, J., et al. *The development of power quality markets*. in *Power Engineering Society Winter Meeting, IEEE*. 2002.
195. Black, M. and G. Strbac, *Value of Bulk Energy Storage for Managing Wind Power Fluctuations*. *Energy Conversion, IEEE Transactions on*, 2007. **22**(1): p. 197-205.
196. Rangoni, B., *A contribution on electricity storage: The case of hydro-pumped storage appraisal and commissioning in Italy and Spain*. *Utilities Policy*, 2012. **23**(0): p. 31-39.
197. Ropenus, S., H.K. Jacobsen, and S.T. Schröder, *Network regulation and support schemes – How policy interactions affect the integration of distributed generation*. *Renewable Energy*, 2011. **36**(7): p. 1949-1956.
198. Department of Energy and Climate Change (DECC), *Energy Bill 2012 Impact Assessment: Liquidity Measures*. 2012.
199. International Energy Agency (IEA), *Distributed Generation in Liberalised Electricity Markets*. 2002.

200. Ropenus, S. and K. Skytte. *Regulatory review and barriers for the electricity supply system for distributed generation in EU-15*. in *International Conference on Future Power Systems*; . 2005.
201. Ferreira, H.L., et al., *Characterisation of electrical energy storage technologies*. *Energy*, 2013. **53**(0): p. 288-298.
202. Miller, N., et al. *Utility scale Battery Energy Storage Systems*. in *Power and Energy Society General Meeting, 2010 IEEE*. 2010.
203. Genoese, M., et al. *Price spreads in electricity markets: What are fundamental drivers?* in *Energy Market (EEM), 2010 7th International Conference on the European*. 2010.
204. Weare, C., *The California Electricity Crisis: Causes and Policy Options*, Public Policy Institute of California, Editor. 2003: San Francisco; .
205. Woo, C.-K., D. Lloyd, and A. Tishler, *Electricity market reform failures: UK, Norway, Alberta and California*. *Energy Policy*, 2003. **31**(11): p. 1103-1115.
206. Marchmont Hill Consulting, *Energy Storage in Australia - Commercial Opportunities, Barriers and Policy Options*. 2012.
207. Batlle, C., I.J. Pérez-Arriaga, and P. Zambrano-Barragán, *Regulatory Design for RES-E Support Mechanisms: Learning Curves, Market Structure, and Burden-Sharing* 2011, MIT Center for Energy and Environmental Policy Research.
208. Krajačić, G., et al., *Feed-in tariffs for promotion of energy storage technologies*. *Energy Policy*, 2011. **39**(3): p. 1410-1425.
209. Yilmaz, M. and P.T. Krein. *Review of benefits and challenges of vehicle-to-grid technology*. in *Energy Conversion Congress and Exposition (ECCE), 2012 IEEE*. 2012.
210. Patten, J., et al. *Electric vehicle battery &#x2014; Wind storage system*. in *Vehicle Power and Propulsion Conference (VPPC), 2011 IEEE*. 2011.
211. Cutter, E.A., S. Price, and L. Alagappan, *Impact of Market Rules on Energy Storage Economics*, in *32nd International Association for Energy Economics Conference*. 2009, Cleveland, Ohio.
212. Department of Energy and Climate Change, *Annex C: Capacity Market Design and Implementation Update* 2012.
213. Ares, E., *Carbon Price Floor*, in *Science and Environment*. 2013, House of Commons Library.



214. Technology, E., *Energy Networks Association on behalf of Smart Grid Forum Workstream 3: Assessing the Impact of Low Carbon Technologies on Great Britain's Power Distribution Network*. 2012.
215. Shaw, R., M. Attree, and T. Jackson, *Developing electricity distribution networks and their regulation to support sustainable energy*. *Energy Policy*. **38**(10): p. 5927-5937.
216. Veldman, E., et al., *Scenario-based modelling of future residential electricity demands and assessing their impact on distribution grids*. *Energy Policy*, 2013. **56**(0): p. 233-247.
217. Wade, N.S., et al., *Evaluating the benefits of an electrical energy storage system in a future smart grid*. *Energy Policy*, 2010. **38**(11): p. 7180-7188.
218. National Grid, *National Electricity Transmission System Security and Quality of Supply Standard: Version 2.2*. 2012.
219. Pearmine, R., et al., *Identification of a load-frequency characteristic for allocation of spinning reserves on the British electricity grid*. *Generation, Transmission and Distribution, IEE Proceedings*, 2006. **153**(6): p. 633-638.
220. Lockwood, M., *Energy networks and distributed energy resources in Great Britain*. 2014, University of Exeter, .
221. Ofgem, *Electricity Capacity Assessment Report 2013: Report to the Secretary of State*. 2013.
222. Ofgem, *Electricity Capacity Assessment Report 2014: Report to the Secretary of State*, E.M. Outlook, Editor. 2014.
223. Department of Energy & Climate Change (DECC). *Weekly solar PV installation & capacity based on registration date: Statistical data set*. 2014 [cited 2014 25 January]; Available from: <https://www.gov.uk/government/statistical-data-sets/weekly-solar-pv-installation-and-capacity-based-on-registration-date>.
224. renewableUK. *UK Wind Energy Database (UKWED)*. 2013 [cited 2013 24 October]; Available from: <http://www.renewableuk.com/en/renewable-energy/wind-energy/uk-wind-energy-database/index.cfm>.
225. UK Committee on Climate Change, *The Renewable Energy Review*. 2011.
226. Department of Energy & Climate Change (DECC), *The Future of Heating: Meeting the challenge*. 2013.
227. Department of Energy & Climate Change (DECC). *Energy production in 2012 from heat pumps in the UK*. 2013 [cited 2013 3 November]; Available from:

- [https://restats.decc.gov.uk/cms/assets/Uploads/Results\\_2012/ABSTRACT-energy-production-in-2012-from-heat-pumps-in-the-uk-16-July-2013.pdf](https://restats.decc.gov.uk/cms/assets/Uploads/Results_2012/ABSTRACT-energy-production-in-2012-from-heat-pumps-in-the-uk-16-July-2013.pdf).
228. Delta Energy and Environment, *Heat Pumps in Smart Grids*. 2014: United Kingdom.
229. Petit, R.F. and T.L. Collins, *Heat Pumps: Operation, Installation, Service*. 2011: ESCO PRESS.
230. Ochoa, L.F., A. Keane, and G.P. Harrison, *Minimizing the Reactive Support for Distributed Generation: Enhanced Passive Operation and Smart Distribution Networks*. Power Systems, IEEE Transactions on, 2011. **26**(4): p. 2134-2142.
231. Gaikwad, D. and S. Mehraeen. *Reactive Power Considerations in Reliability Analysis of Photovoltaic Systems*. in *Green Technologies Conference, 2012 IEEE*. 2012.
232. Fawcett, T. *The future role of heat pumps in the domestic sector*. in *Proceedings ECEEE 2011 Summer Study, Energy efficiency first: The foundation of a low-carbon society*. 2011.
233. Rebennack, S., et al., *Handbook of Power Systems II*. 2010: Springer Berlin Heidelberg.
234. Burger, M., et al., *A spot market model for pricing derivatives in electricity markets*. Quantitative Finance, 2004. **4**(1): p. 109-122.
235. Barbour, E., et al., *Towards an objective method to compare energy storage technologies: development and validation of a model to determine the upper boundary of revenue available from electrical price arbitrage*. Energy & Environmental Science, 2012. **5**(1): p. 5425-5436.
236. Elexon. *Market Index Price and Volume*. 2014 [cited 2014 20 January]; Available from: <https://www.elexonportal.co.uk/news/latest?cachebust=c00q7bso63>.
237. Department of Energy & Climate Change (DECC). *Energy and emissions projections*. 2013 [cited 2013 October]; Available from: <https://www.gov.uk/government/collections/energy-and-emissions-projections>.
238. Elexon. *Imbalance Pricing Guidance: A guide to electricity imbalance pricing in Great Britain*. 2014 [cited 2014 20 December]; Available from: [https://www.elexon.co.uk/wp-content/uploads/2014/11/imbalance\\_pricing\\_guidance\\_v8.0.pdf](https://www.elexon.co.uk/wp-content/uploads/2014/11/imbalance_pricing_guidance_v8.0.pdf).
239. National Grid. *National Grid - Firm Frequency Response (FFR)*. 2014 [cited 2014 12 March 2014]; Available from: <http://www2.nationalgrid.com/uk/services/balancing-services/frequency-response/firm-frequency-response/>.

240. National Grid. *Service reports for balancing services*. 2014 [cited 2014 September]; Available from: <http://www2.nationalgrid.com/UK/Industry-information/Electricity-transmission-operational-data/Report-explorer/Services-Reports/>.
241. National Grid. *Short Term Operating Reserve*. 2014 [cited 2014 September]; Available from: <http://www2.nationalgrid.com/uk/services/balancing-services/reserve-services/short-term-operating-reserve/>.
242. Flextricity. *Short Term Operating Reserve*. 2014 [cited 2014 October]; Available from: <http://www.flexitricity.com/core-services>.
243. National Grid, *Short Term Operating Reserve - Annual Market Report 2011/12*, in *STOR Review*. 2012.
244. National Grid, *Short Term Operating Reserve - Annual Market Report 2010/11*, in *STOR Review*. 2011.
245. National Grid, *Short Term Operating Reserve - Annual Market Report 2012/13*, in *STOR Review*. 2013.
246. National Grid, *The Statement of Use of System Charges Effective from 1 April 2014* 2014.
247. National Grid. *Historic Transmission Network Use of System Charges Tariffs 2005-06 to 2013-14*. 2014 [cited 2014 October]; Available from: <http://www2.nationalgrid.com/UK/Industry-information/System-charges/Electricity-transmission/Transmission-Network-Use-of-System-Charges/Tools-and-Data/>.
248. Electricity North West. *Use of System Charges*. 2014 [cited 2014 July]; Available from: <http://www.enwl.co.uk/our-services/use-of-system-charges>.
249. ENER-G, *How do Transmission and Distribution charges affect your energy bills?* 2014.
250. Saft, *Lithium-ion battery technical sheet*. 2014.
251. Lambert, T., P. Gilman, and P. Lilienthal, *Micropower System Modeling with Homer*, in *Integration of Alternative Sources of Energy*. 2006, John Wiley & Sons, Inc. p. 379-418.
252. Kayal, P. and C.K. Chanda, *Placement of wind and solar based DGs in distribution system for power loss minimization and voltage stability improvement*. *International Journal of Electrical Power & Energy Systems*, 2013. 53(0): p. 795-809.
253. Anuta, O., N. Wade, and J. McWilliam. *Coordinated operation of energy storage and on-load tap changer on a UK 11kV distribution network*. in *Electricity Distribution (CIRED 2013), 22nd International Conference and Exhibition on*. 2013.

254. Elexon. *Overview of System Sell and System Buy Prices*. 2003 [cited 2014 20 December]; Available from: [https://www.elexon.co.uk/wp-content/uploads/2014/11/imbalance\\_pricing\\_guidance\\_v8.0.pdf](https://www.elexon.co.uk/wp-content/uploads/2014/11/imbalance_pricing_guidance_v8.0.pdf).
255. National Grid. *Transmission Charges - Triad Data*. 2014 1st April [cited 2014 January]; Available from: <http://www2.nationalgrid.com/UK/Industry-information/System-charges/Electricity-transmission/Transmission-Network-Use-of-System-Charges/Transmission-Charges-Triad-Data/>.
256. Mullen, C., et al. *Use of standby generation for reduction of transmission network charges for half-hourly metered customers*. in *Power Engineering Conference (UPEC), 2014 49th International Universities*. 2014.
257. Warren, P., *A review of demand-side management policy in the UK*. *Renewable and Sustainable Energy Reviews*, 2014. **29**(0): p. 941-951.
258. Schoenung, S., *Energy Storage Systems Cost Update A Study for the DOE Energy Storage Systems Program*. 2011. p. 1 - 28.
259. Harrison, M., *Valuing the Future: the social discount rate in cost-benefit analysis*. 2010, Australian Government Productivity Commission.
260. Ward, J., M. Pooley, and G. Owen, *What Demand-Side Services Can Provide Value to the Electricity Sector ?*, in *GB Electricity Demand– realising the resourc*. 2013.
261. Pudjianto, D., et al., *Costs and benefits of DG connections to grid - studies on UK and Finnish systems*. 2006, DG-Grid (Intelligent Energy Europe).
262. Strickland, D., et al., *Estimation of Transportation Battery Second Life for Use in Electricity Grid Systems*. *Sustainable Energy, IEEE Transactions on*, 2014. **5**(3): p. 795-803.
263. Energy Networks Association, *Distributed Generation Connection Guide*. 2014.
264. Pearre, N.S. and L.G. Swan, *Technoeconomic feasibility of grid storage: Mapping electrical services and energy storage technologies*. *Applied Energy*, (0).
265. Leadbetter, J. and L.G. Swan, *Selection of battery technology to support grid-integrated renewable electricity*. *Journal of Power Sources*, 2012. **216**(0): p. 376-386.
266. Electricity North West. *Use of System Charging Statement FINAL NOTICE: Effective from 1st April 2014*. 2014 [cited 2014 July]; Available from: <http://www.enwl.co.uk/docs/default-source/charging/enwl-use-of-system-charging-statement---april-2014-%28finals%29-v1-07BC5F7882308.pdf?sfvrsn=2>.
267. National Grid, *Short Term Operating Reserve in Frequently Asked Questions*. 2013.

268. Bank of England. *Statistical Interactive Database - daily spot exchange rates against Sterling*. 2014 [cited 2014 August]; Available from: <http://www.bankofengland.co.uk/boeapps/iadb/Rates.asp?into=>.
269. Conti, S. and S. Raiti, *Probabilistic load flow using Monte Carlo techniques for distribution networks with photovoltaic generators*. *Solar Energy*, 2007. **81**(12): p. 1473-1481.
270. Vicente, W.B., R. Caire, and N. Hadjsaid, *Probabilistic load flow for voltage assessment in radial systems with wind power*. *International Journal of Electrical Power & Energy Systems*, 2012. **41**(1): p. 27-33.
271. Matej, et al., *Exploration and exploitation in evolutionary algorithms: A survey*. *ACM Comput. Surv.*, 2013. **45**(3): p. 1-33.
272. Vafae, F., et al. *Balancing the exploration and exploitation in an adaptive diversity guided genetic algorithm*. in *Evolutionary Computation (CEC), 2014 IEEE Congress on*. 2014.
273. Konak, A., D.W. Coit, and A.E. Smith, *Multi-objective optimization using genetic algorithms: A tutorial*. *Reliability Engineering & System Safety*, 2006. **91**(9): p. 992-1007.
274. Bakirtzis, A.G., et al., *Optimal power flow by enhanced genetic algorithm*. *Power Systems, IEEE Transactions on*, 2002. **17**(2): p. 229-236.
275. Tsoy, Y.R. *The influence of population size and search time limit on genetic algorithm*. in *Science and Technology, 2003. Proceedings KORUS 2003. The 7th Korea-Russia International Symposium on*. 2003.
276. Haupt, R.L. and S.E. Haupt, *Practical Genetic Algorithms*. 2004: Wiley.
277. Alarcon-Rodriguez, A.D., *A multi-objective planning framework for analysing the integration of distributed energy resources*. 2009, University of Strathclyde,: Glasgow.
278. Deb, K., *Multi-Objective Optimization Using Evolutionary Algorithms*. 2001: Wiley.
279. Chipperfield, A., et al., *Genetic Algorithm Toolbox - For Use with MATLAB*, in *User Guide Version 1.2*. 1994, University of Sheffield: UK.
280. Alves da Silva, A.P. and D.M. Falcão, *Fundamentals of Genetic Algorithms*, in *Modern Heuristic Optimization Techniques*. 2007, John Wiley & Sons, Inc. p. 25-42.
281. Deb, K., *An efficient constraint handling method for genetic algorithms*. *Computer Methods in Applied Mechanics and Engineering*, 2000. **186**(2-4): p. 311-338.
282. Gentle, J.E., W.K. Härdle, and Y. Mori, *Handbook of Computational Statistics: Concepts and Methods*. 2012: Springer Berlin Heidelberg.

283. Razali NM, G.J. *Genetic algorithm performance with different selection strategies in solving TSP*. in *Proceedings of the World Congress on Engineering*. 2011. London, U.K.
284. Kalyanmoy, D. and D. Debayan, *Analysing mutation schemes for real-parameter genetic algorithms*. *Int. J. Artif. Intell. Soft Comput.*, 2014. **4**(1): p. 1-28.
285. Ochoa, G., I. Harvey, and H. Buxton. *On recombination and optimal mutation rates*. in *Proceedings of the genetic and evolutionary computation conference*. 1999.
286. David, E.G., *Genetic Algorithms in Search, Optimization and Machine Learning*. 1989: Addison-Wesley Longman Publishing Co., Inc. 372.
287. Deb, K., et al., *A fast and elitist multiobjective genetic algorithm: NSGA-II*. *Trans. Evol. Comp*, 2002. **6**(2): p. 182-197.
288. Zielinski, K. and R. Laur, *Stopping Criteria for Differential Evolution in Constrained Single-Objective Optimization*, in *Advances in Differential Evolution*, U. Chakraborty, Editor. 2008, Springer Berlin Heidelberg. p. 111-138.
289. Georgilakis, P.S. and N.D. Hatziaargyriou, *A review of power distribution planning in the modern power systems era: Models, methods and future research*. *Electric Power Systems Research*, 2015. **121**: p. 89-100.
290. Cheng-Jin, Y. and H. Min-Xiang, *Multi-Objective Optimal Power Flow Considering Transient Stability Based on Parallel NSGA-II*. *Power Systems, IEEE Transactions on*, 2015. **30**(2): p. 857-866.
291. Hannon, M.J., *Raising the temperature of the UK heat pump market: Learning lessons from Finland*. *Energy Policy*, 2015. **85**: p. 369-375.
292. Committee on Climate Change, *Fourth Carbon Budget Review – Technical Report. Sectoral Analysis of the Cost-effective Path to the 2050 Target*. 2013.
293. (DECC), D.o.E.C.C., *Special feature – Seasonal variations in electricity demand*. 2014.
294. Castro, M., Elnor, L., Sprawson.,, *Impact of Policy that Drives Low Carbon Technologies on Distribution Networks*. 2014, EA Technology and Department of Energy and Climate Change.
295. Bhowmik, A.R. and A. Chakraborty, *Solution of optimal power flow using nondominated sorting multi objective gravitational search algorithm*. *International Journal of Electrical Power & Energy Systems*, 2014. **62**: p. 323-334.

296. Ballanti, A., et al. *Assessing the benefits of PV var absorption on the hosting capacity of LV feeders*. in *Innovative Smart Grid Technologies Europe (ISGT EUROPE), 2013 4th IEEE/PES*. 2013.
297. Ayyub, B.M. and R.H. McCuen, *Probability, Statistics, and Reliability for Engineers and Scientists, Third Edition*. 2011: Taylor & Francis.
298. Rainville, D., et al. *Deap: A python framework for evolutionary algorithms*. in *Proceedings of the 14th annual conference companion on Genetic and evolutionary computation*. 2012. ACM.
299. Hampshire County Council. *Monthly RPIs Figures 1974 - 2014 2013* [cited 2013 November]; Available from:  
<http://www3.hants.gov.uk/finance/retailpricesindexandconsumerpriceindex.htm>.
300. Jansen, T., *Analyzing Evolutionary Algorithms: The Computer Science Perspective*. 2013: Springer Berlin Heidelberg.

## Appendix One

---

### IEEE 33 bus network parameter

| Line Num | Send bus | Receive bus | Length (KM) | R (Ohms) | X (Ohms) | P base P(KW) | Q base Q(Kvar) |
|----------|----------|-------------|-------------|----------|----------|--------------|----------------|
| 1        | 1        | 2           | 2.8         | 0.0922   | 0.0477   | 100          | 60             |
| 2        | 2        | 3           | 2.5         | 0.4930   | 0.2511   | 90           | 40             |
| 3        | 3        | 4           | 1.6         | 0.3660   | 0.1864   | 120          | 80             |
| 4        | 4        | 5           | 0.9         | 0.3811   | 0.1941   | 60           | 30             |
| 5        | 5        | 6           | 1.6         | 0.8190   | 0.707    | 60           | 20             |
| 6        | 6        | 7           | 2.5         | 0.1872   | 0.6188   | 200          | 100            |
| 7        | 7        | 8           | 0.6         | 1.7114   | 1.2351   | 200          | 100            |
| 8        | 8        | 9           | 1.6         | 1.0300   | 0.74     | 60           | 20             |
| 9        | 9        | 10          | 0.75        | 1.0400   | 0.74     | 60           | 20             |
| 10       | 10       | 11          | 0.9         | 0.1966   | 0.065    | 45           | 30             |
| 11       | 11       | 12          | 3.2         | 0.3744   | 0.1238   | 60           | 35             |
| 12       | 12       | 13          | 2.8         | 1.4680   | 1.155    | 60           | 35             |
| 13       | 13       | 14          | 0.6         | 0.5416   | 0.7129   | 120          | 80             |
| 14       | 14       | 15          | 3.5         | 0.5910   | 0.526    | 60           | 10             |
| 15       | 15       | 16          | 1.6         | 0.7463   | 0.545    | 60           | 20             |
| 16       | 16       | 17          | 2.8         | 1.2890   | 1.721    | 60           | 20             |
| 17       | 17       | 18          | 3.2         | 0.7320   | 0.574    | 90           | 40             |
| 18       | 2        | 19          | 2.5         | 0.1640   | 0.1565   | 90           | 40             |
| 19       | 19       | 20          | 3.2         | 1.5042   | 1.3554   | 90           | 40             |
| 20       | 20       | 21          | 1.6         | 0.4095   | 0.4784   | 90           | 40             |
| 21       | 21       | 22          | 0.8         | 0.7089   | 0.9373   | 90           | 40             |
| 22       | 3        | 23          | 2.8         | 0.4512   | 0.3083   | 90           | 50             |
| 23       | 23       | 24          | 2.5         | 0.8980   | 0.7091   | 420          | 200            |
| 24       | 24       | 25          | 3.2         | 0.8960   | 0.7011   | 420          | 200            |
| 25       | 6        | 26          | 2.8         | 0.2030   | 0.1034   | 60           | 25             |
| 26       | 26       | 27          | 2.5         | 0.2842   | 0.1447   | 60           | 25             |
| 27       | 27       | 28          | 0.75        | 1.0590   | 0.9337   | 60           | 20             |
| 28       | 28       | 29          | 1.6         | 0.8042   | 0.7006   | 120          | 70             |
| 29       | 29       | 30          | 3.2         | 0.5075   | 0.2585   | 200          | 600            |
| 30       | 30       | 31          | 2.8         | 0.9744   | 0.963    | 150          | 70             |
| 31       | 31       | 32          | 3.2         | 0.3105   | 0.3619   | 210          | 100            |
| 32       | 32       | 33          | 1.4         | 0.3410   | 0.5302   | 60           | 40             |