



Wireless Sensor Network for Radiometric Detection and Assessment of Partial Discharge in HV Equipment

D. W. Upton⁽¹⁾, B. I. Saeed⁽¹⁾, U. Khan⁽¹⁾, A. Jaber⁽¹⁾, H. Mohamed⁽¹⁾, K. Mistry⁽¹⁾, P. J. Mather⁽¹⁾, P. Lazaridis⁽¹⁾, M. F. Q. Vieira⁽²⁾, R. Atkinson⁽³⁾, C. Tachtatzis⁽³⁾, E. Iorkyase⁽³⁾, M. Judd⁽⁴⁾, and I. A. Glover^{*(1)}

(1) Department of Engineering and Technology, University of Huddersfield, Huddersfield HD1 3DH, UK

(2) Departamento de Engenharia Eletrica, Universidade Federal de Campina Grande, 58429-900 Campina Grande, PB, Brazil

(3) Department of Electronic and Electrical Engineering, University of Strathclyde, Glasgow G1 1XW, UK

(4) High Frequency Diagnostics and Engineering Ltd., Glasgow G2 6HJ, UK

Abstract: Monitoring of partial discharge (PD) activity within high voltage electrical environments is frequently used for the assessment of insulation condition. Traditional measurement techniques employ technologies that require either offline installation or high power consumption and cost. A wireless sensor network is proposed that utilizes only received signal strength to locate partial discharge within a high-voltage electricity substation. The network comprises low-power and low-cost radiometric sensor nodes which receive the radiation propagated from a source of partial discharge. Results are reported from a test performed within a large indoor environment with a network of nine sensor nodes. An emulated PD source was placed at multiple locations within the network. Signal strength measured by the nodes is reported via WirelessHART to a data collection hub where it is processed using a location algorithm. The results obtained place the measured location within 2 m of the actual source location.

1. Introduction

Partial Discharge (PD) is a fault that occurs within the insulation of high voltage (HV) plant such as cables, switchgear and transformers. PD occurs due to the increased electric field when a void is present in the insulating material. The increased field causes a localized discharge across the void but does not span the conductors [1]. The intensity of PD allows the condition of HV plant to be assessed. It allows potential defects to be detected and located, and action to be taken before catastrophic failure occurs [2]. The detection and measurement of PD is a widely used technique for the assessment of HV plant [3] and many techniques have been developed utilizing both contact and wireless technologies.

This paper presents the progress made implementing a large scale wireless sensor network (WSN) intended to monitor HV plant within an electricity substation. The WSN utilizes received signal strength (RSS) of the electromagnetic wave radiated by a source of PD. A WSN provides benefits over traditional wired PD detection techniques such as installation without taking plant off-line, ease of reconfiguration and graceful system degradation in the event of node failure. In order for the

WSN to be a practical solution to PD monitoring the sensor nodes must be low cost, low power and able to detect PD radiation with intensity of engineering interest at a range of at least 10 m.

Traditional radiometric techniques for the detection and location of PD sources, such as time-of-arrival and time-difference-of-arrival [4, 5] employ technologies that require high-speed data acquisition and relatively large amounts of data processing. An RSS-only monitoring and location technology will be simpler and cheaper.

2. PD Wireless Sensor Network

The PD WSN is composed of an array of radiometric sensor nodes which all communicate to a central, data-collection, hub.

To avoid the measurements of PD intensity being inflated by communication signals, the measurement is limited to frequencies below 320 MHz, which the majority of PD activity occurs. Notch filters are also incorporated to remove narrowband interference (in particular broadcast signals) below this frequency.

Data is transmitted from sensor nodes to the data collection hub in the 2.4 GHz ISM band to avoid interfering with the measurement of PD activity. The WirelessHART transmission protocol is resilient to the harsh electromagnetic environment. It supports a mesh topology and features self-configuring, self-healing, functions.

3. Sensor Nodes

The sensor node, shown in Figure 1, comprises of four subsystems; an RF front-end, a signal conditioning unit, a microcontroller and a WirelessHART unit. A receiving antenna is connected to the RF front end, which contains a band-pass filter for the 30 – 320 MHz, a band-stop filter for the 75 – 255 MHz band, a low-noise amplifier (LNA), and an envelope detector. The filters remove interference, such as FM and digital radio, that may be present in the monitored band.

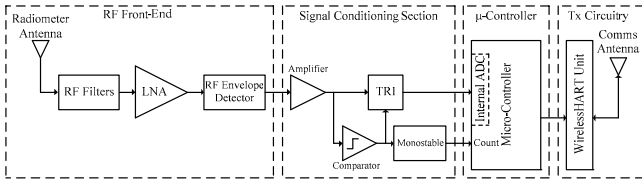

Figure 1: Wireless Sensor Node Block Diagram.

The envelope detected signal is applied to the signal conditioning circuit which provides further amplification before integrating it. The integration collapses the bandwidth of envelope signal. It provides an output which is a metric of accumulated partial discharge activity. The integrator is reset to zero when its output reaches a fixed threshold. The combined integration and reset circuit is the subsystem labelled TRI (transistor reset integrator) in Figure 1. A comparator is used to determine if a signal of sufficient size to be of PD interest is present and, if so, activate the integrator. This is to prevent envelope-detected noise from creating a constant rise in integrator output voltage. The comparator also counts the number of received (individual) PD events. Once the signal voltage drops below the threshold integration is stopped and the output of the TRI is thus held at a constant level. Figure 2(a) shows the outputs on an expanded timescale of the RF envelope detector and the TRI after a single emulated PD event is received. Figure 2(b) shows the output of the TRI for multiple events.

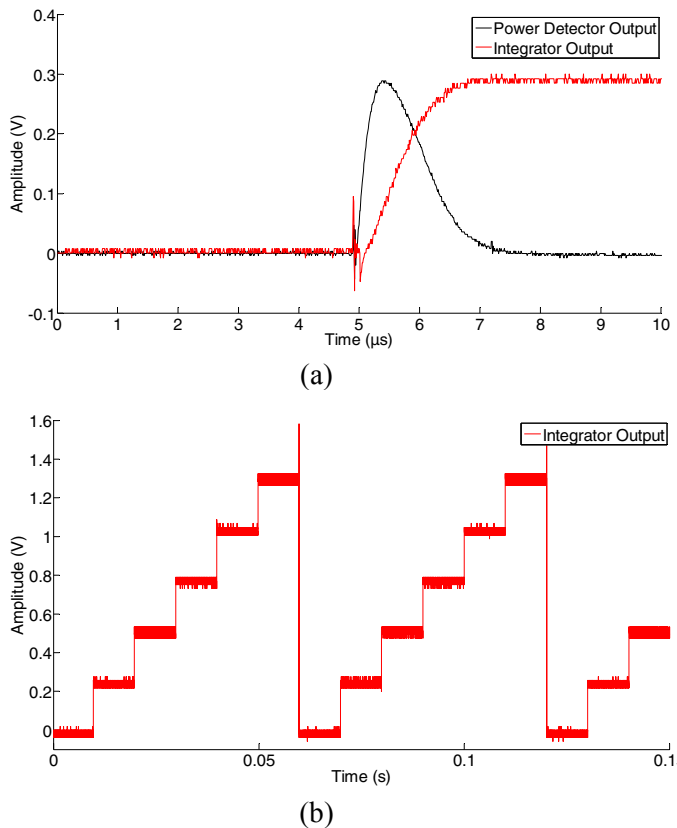

Figure 2: (a) RF Envelope Detector and TRI output for a single PD Event and (b) TRI output for multiple events.

The signal held at the output of the TRI is sampled by the internal analogue-to-digital converter (ADC) of a micro-controller when the signal from the comparator is applied to a digital ‘count’ input. The strength (i.e. integral) of each detected PD pulse is determined by taking the difference between the current and previous samples. The samples are then averaged by the microcontroller. Once the TRI output voltage reaches a preset threshold level the integrating capacitor is discharged, resetting the TRI. The average integrated signal and the count value are transmitted to the data-collection hub via the WirelessHART transceiver. The signals are then processed to locate the source of PD. The integrated signal step size is a measure of the received PD signal power at the terminals of the receiving antenna.

4. Sensor Node Calibration

An HVPD pC (picocoulomb) charge-injection pulse generator, Figure 3, was used to calibrate the sensor nodes. The device provides pulses from 1 pC to 100 nC (100,000 pC) with selectable pulse repetition rate (100, 120, 400 Hz). Figure 4 shows a 1 nC pulse generated by the calibrator.



Figure 3: HVPD pC calibrated charge pulse generator.

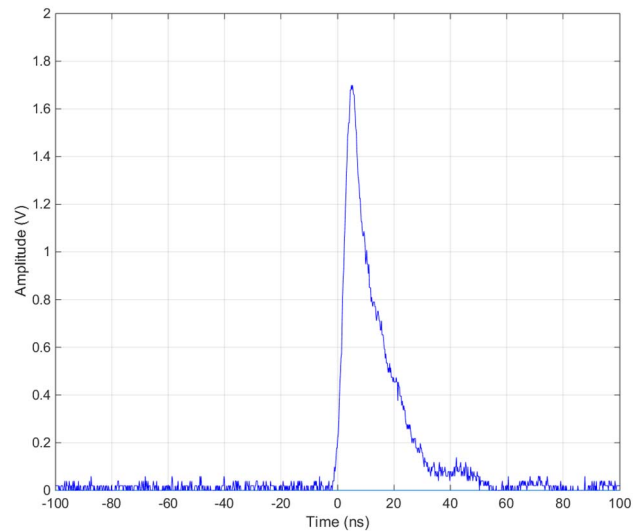

Figure 4: 1 nC pulse.

The calibrator was set to generate 1 nC pulses with a repetition rate of 100 Hz and connected via an attenuator to the front end of the sensor node. To present different power levels at the front end, the attenuator value was changed in discrete steps of 3 dB or 4 dB. With each

attenuator setting the signal peak power was measured at the front end and the output of the TRI was sampled and transferred to a PC to calculate the average step size. The relation between the signal peak power and the TRI average step size of one of the nodes is shown in Figure 5.

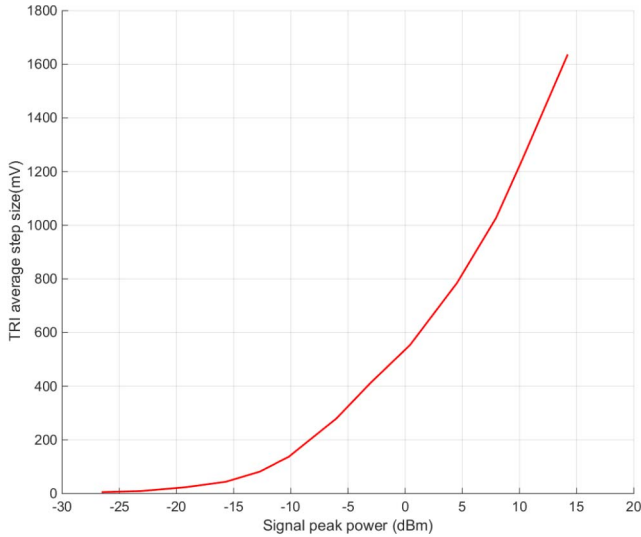

Figure 5: TRI average step size versus signal peak power.

5. Indoor test

A nine sensor-node network has been tested in large indoor space. The sensors were placed in a square grid with 9 m spacing, Figure 6 and Figure 7. The HVPD pC calibrator connected to Aaronia BicoLOG 20100E biconical antenna was used as a PD emulator to generate the signal to be located. The PD emulator was set to generate 10 nC pulses at a repetition rate of 100 Hz.

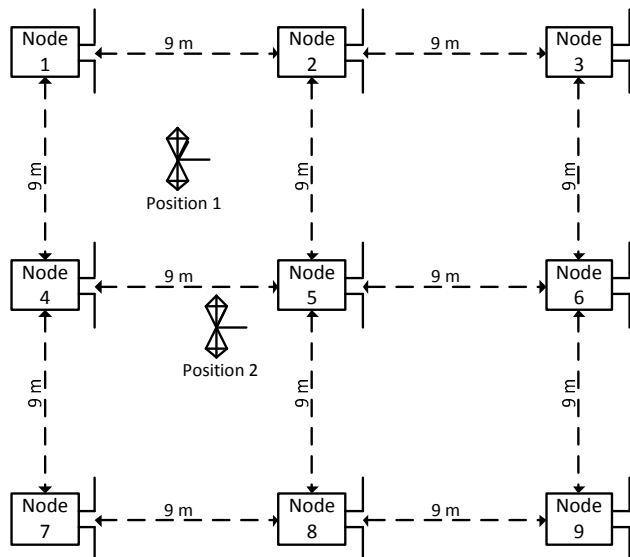
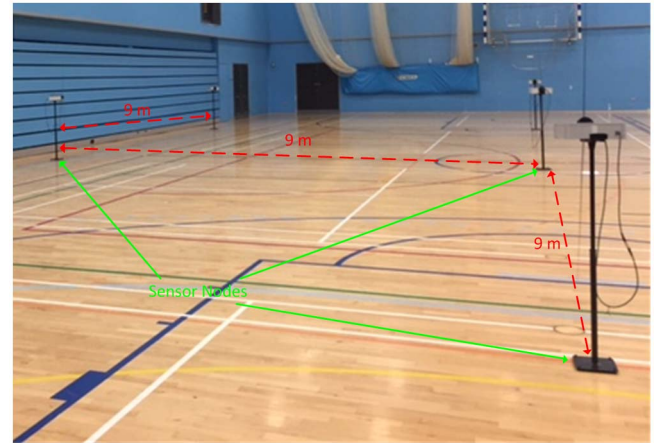

Figure 6: PD WSN layout.



(b)

Figure 7: Photograph of the test space.

The PD source was placed in two different locations (Position 1 and Position 2). The sensors were programmed to collect data for a duration of 1 second. For each location the test was repeated for several times. The received signal power by nodes is presented in Table 1. There is no data for node 2 since this malfunctioned during the test.

Table 1: Received signal power by nodes.

		Received signal power (dBm)								
PD source location										
	Node 1	Node 2	Node 3	Node 4	Node 5	Node 6	Node 7	Node 8	Node 9	
P1	-1.9	-	-12.2	-4.4	-7.1	-12.0	-13.4	-12.4	-17.5	
P2	-9.4	-	-13.2	-3.1	1.3	-9.8	-9.7	-9.0	-14.7	

PD source localisation is based on using a location algorithm that relies on received signal strength (RSS) [6]. As can be seen in Figure 8, the PD source locations were estimated approximately with an acceptable error range.

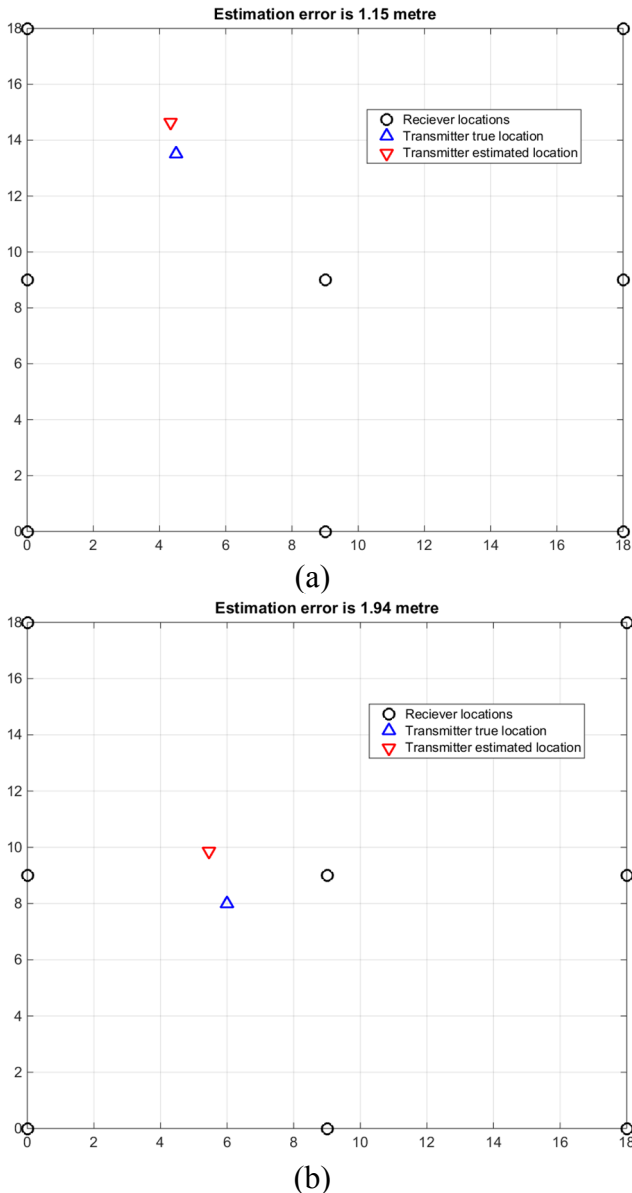

Figure 8: Estimated location of the PD source (a) Position 1 and (b) Position 2.

6. Conclusion

A real-time radiometric WSN system for monitoring and locating PD source has been designed, implemented and tested in an indoor environment and an RSS-based location algorithm has been demonstrated to successfully locate an emulated source of PD with useful accuracy.

The prototype system will shortly be deployed in an electricity substation to demonstrate successful operation in a more realistic environment.

7. Acknowledgements

This work was supported by the U.K. Engineering & Physical Sciences Research Council under Grant EP/J015873.

8. References

1. Y. Z. Arief, W. A. Izzati, Z. Adzis, "Modeling of Partial Discharge Mechanisms in Solid Dielectric Material," *International Journal of Engineering and Innovative Technology*, 1, 4, April 2012, pp. 315-320, ISSN: 2277-3754.
2. J. M. R. de Souza Neto, E. C. T. de Macedo, J. S. da Rocha Neto et al., "Plausibility of incoherent detection for radiometric monitoring of insulation integrity in HV substations," in *Proceedings of the Loughborough Antennas and Propagation Conference (LAPC '13)*, pp. 494-499, Loughborough, November 2013, doi: 978-1-4799-0091-6.
3. A. J. Reid, M. D. Judd, R. A. Fouracre, B. G. Stewart and D. M. Hepburn, "Simultaneous measurement of partial discharges using IEC60270 and radio-frequency techniques," in *IEEE Transactions on Dielectrics and Electrical Insulation*, vol. 18, no. 2, pp. 444-455, April 2011. doi: 10.1109/TDEI.2011.5739448
4. P. J. Moore, I. Portugues and I. A. Glover, "A nonintrusive partial discharge measurement system based on RF technology," *2003 IEEE Power Engineering Society General Meeting (IEEE Cat. No.03CH37491)*, 2003, pp. 633 Vol. 2. doi: 10.1109/PES.2003.1270372
5. M. D. Judd, "Radiometric partial discharge detection," *2008 International Conference on Condition Monitoring and Diagnosis*, Beijing, 2008, pp. 1025-1030. doi: 10.1109/CMD.2008.4580457
6. Y. Xu, J. Zhou and P. Zhang, "RSS-Based Source Localization When Path-Loss Model Parameters are Unknown," in *IEEE Communications Letters*, vol. 18, no. 6, pp. 1055-1058, June 2014. doi: 10.1109/LCOMM.2014.2318031.