

Spring 5-2011

The Cell Biology of Multi-nucleated Giant Cell Formation

Johnathan I. Bartee
Seton Hall University

Follow this and additional works at: <https://scholarship.shu.edu/theses>

 Part of the [Biology Commons](#), and the [Cell and Developmental Biology Commons](#)

Recommended Citation

Bartee, Johnathan I., "The Cell Biology of Multi-nucleated Giant Cell Formation" (2011). *Theses*. 199.
<https://scholarship.shu.edu/theses/199>

**The Cell Biology of
Multi-nucleated Giant Cell Formation**

**By
Johnathan Leonard Bartee**

**Submitted in partial fulfillment of the requirements for the
degree of Master of Science in Biology from the
Department of Biology of Seton Hall University
May 2011**

APPROVED BY



MENTOR
Dr. Allan Blake

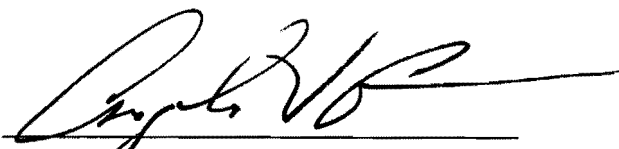

COMMITTEE MEMBER
Dr. Angela Klaus



COMMITTEE MEMBER
Dr. Heping Zhou

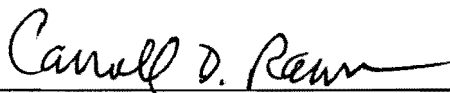

DIRECTOR OF GRADUATE STUDIES
Dr. Carroll Rawn



CHAIRPERSON, BIOLOGY DEPARTMENT
Dr. Carolyn Bentivegna

AKNOWLEDGEMENTS

I would like to write a few words of appreciation for the following people:

Dr. Allan Blake, my mentor, who is truly a brilliant man. I want to extend my sincerest words of appreciation and thanks for his continual dedication towards excellence in the lab and in the classroom. Dr. Blake, I thank you for allowing me to perform research and develop as a man of science in your lab. You have helped to motivate me and further extend my interests in the science field. I do not think my graduate career would have been the same without your presence. I truly thank you.

Dr. Angela Klaus for her wisdom, advice and willingness to be a member of my thesis committee, and aiding me in my understanding of all forms of microscopic techniques.

Dr. Heping Zhou for her willingness to be a member of my thesis committee and her help with the completion of my degree.

Dr. Carolyn Bentivegna the departmental chair for allowing me to perform research in Seton Hall's Biology Department.

Razwana Wahdat for being beyond supportive and sticking by my side as my laboratory partner throughout my years of studying at Seton Hall University.

The Biology Department faculty and staff for their continued support throughout my endeavors.

The Crohn's and Colitis Foundation of America for their financial support of this research project.

My colleagues for making my time at Seton Hall University memorable and for being ever supportive.

To my family; I cannot express my thanks enough for always being encouraging and supportive of me. Thank you!

TABLE OF CO/NTENTS

Introduction	Page 1
Materials and Methods	Page 8
Results	Page 17
Discussion	Page 38
Conclusions	Page 43
Literature Cited	Page 44

FIGURES

Figure 1	Page 5
Figure 2a,b	Page 19
Figure 3	Page 20
Figure 4	Page 22
Figure 5	Page 23
Figure 6a,b	Page 27
Figure 7a,b	Page 29
Figure 8	Page 31
Figure 9	Page 32
Figure 10	Page 34
Figure 11a,b	Page 35
Figure 12	Page 37

TABLES

Table 1

Page 25

ABSTRACT

Macrophages differentiate from circulating monocytes and perform critical roles in the innate and adaptive immune systems, including phagocytosis and foreign pathogen walling off. Macrophage cell fusion is a fundamental event underlying biological processes, such as bone remodeling and chronic inflammation. This thesis explores the molecular processes behind the macrophage formation of multinucleated giant cells (MGC). Using a homogenous, murine monocyte cell line, RAW 264.7, we examine the cellular response to bacterial endotoxins, crucial signaling molecules that activate macrophage pattern recognition receptors. RAW 264.7 mouse macrophages treated with lipopolysaccharide (LPS), a Gram negative bacterial endotoxin, or lipoteichoic acid (LTA), a Gram positive bacterial endotoxin, we observed cellular fusion and the formation of MGC. The time, cell density and concentration of endotoxin were quantified by phase contrast microscopy. Since LPS and LTA both elicit the release of Tumor Necrosis Factor Alpha (TNF- α) from macrophages, we examined the role of TNF- α in cellular fusion. TNF- α was shown to also induce cellular fusion. Taken together, our results show that a macrophage cell line provides a robust and reliable model for examining endotoxin-induced MGC formation.

INTRODUCTIO/N

Metazoans use cellular fusion and multinucleation in a number of well characterized fundamental biological processes, including bone remodeling, fertilization, placental development, and myoblast fusion (reviewed in Helming and Gordon, 2007).

For example, cell fusion is observed in bone remodeling where the fusion of osteoclasts is essential for renewing skeletal bone (Helming and Gordon, 2008). However, in recent years our understanding of cell fusion has expanded. For example, in the 1960's, osteoclasts were thought to derive from fusion of osteoblasts. Subsequent studies have shown conclusively that the osteoclast is hematopoietic in origin and therefore, unrelated to the stromal lineage (Vignery, 2005). Within the immune system, multinucleated giant cell (MGC) formation is critical to controlling invading pathogens and the resulting cell mediated inflammatory response, which is a tightly orchestrated multicellular response. By definition, a giant cell is a mass formed by the union of several distinct cells (usually macrophages) which undergo a defined set of intercellular interactions that ultimately result in a multinucleated cell with a single cytoplasmic compartment (Vignery, 2005). A foreign-body giant cell is a collection of fused macrophages which are generated in response to the presence of a large foreign body. This is particularly evident with parasitic infections, or implants that elicit a chronic

inflammation response such as a rejection of cosmetic implants or even body organs from donor to recipient.

Macrophages also exist at a critical juncture in the metazoan immune system, with involvement in both the innate and adaptive immune responses. Pattern recognition receptors on the macrophage cell surface detect foreign invaders, such as bacterial and viral antigens, and trigger the macrophage pro-inflammatory response. While short-term antigen exposure elicits an acute inflammatory response, a chronic inflammatory response develops if antigens persist. This chronic inflammatory event is poorly understood, but as macrophages replace neutrophils and T cells at the inflammation site, tissue macrophages surround and attempt to phagocytize the foreign body. If macrophages fail to engulf the invader, the macrophages isolate it from the surrounding tissue via MGC formation, or in the case of parasitic invasion, granuloma formation (Vignery, 2008). MGC is an evolutionarily conserved cellular response with the earliest observed response in fruit flies, yet the molecular mechanism involved remains unknown. *In vitro* isolated cells can be influenced to fuse and form multinucleated giant cells, showing that the fusion response is inherent in the macrophage

MGCs elicit a sustained immune response, which may ultimately prove beneficial to the host organism. This thesis research focuses on eliciting the cell fusion event in immortalized mammalian macrophages, quantifying the cell fusion event, as well as examining the roles of the bacterial endotoxins, the Gram negative bacterial endotoxin,

lipopolysaccharide (LPS), and the Gram positive bacterial endotoxin, lipoteichoic Acid (LTA), to stimulate macrophage multi-nucleated giant cell formation.

LPS, the major constituent of the outer membrane of all Gram-negative bacteria, both pathogens and mutualists, was independently discovered as a bacterial-associated substance called endotoxin that elicits septic shock in animals (Beutler and Rietschel, 2003). It is now known that LPS acts as a toxin by over-stimulating Toll-like receptor (TLR) innate immune signaling, which induces acute defensive inflammatory responses. An example of this is presented by mice deficient for Toll like Receptor 4 (TLR4), an integral membrane protein which serves as a pattern-recognition receptor protein (PRP) for LPS (Akira et al., 2006). Although multiple PRPs exist for a wide range of microbial components, TLR4 recognizes bacterial-derived for LPS, which, working in association with the intracellular MyD88 adaptor protein serves to initiate an intracellular protein kinase cascade (Figure 1; Akira et al., 2006). As shown in Figure 1, LPS acts as the prototypical bacterial endotoxin because it binds the CD14/TLR4/MD2 receptor complex, which promotes the transcription, translation and the secretion of pro-inflammatory cytokines in many immune cells, including macrophages. The short term release of pro-inflammatory cytokines serves to initiate an immune response to the detected pathogen.

Lipoteichoic acid (LTA), a cell wall component of Gram-positive bacteria is an amphiphilic, negatively charged glycolipid which interacts with a distinct set of cell surface PRPs, termed TLR2/TLR6 (Tang et al., 2010). LTA activation of the TLR2/6 pathway shares common features with the TLR4 pathway induced by LPS, but in

addition, LTA bound to targets can interact with circulating antibodies and activate the complement cascade to induce a passive immune kill phenomenon. LTA also triggers the immune cell release of reactive oxygen and nitrogen species, as well as acid hydrolases, highly cationic proteinases, bactericidal cationic peptides, growth factors, and cytotoxic cytokines, all of which may act in synergy to amplify cell damage. LTA shares many pathogenic similarities with LPS in cellular pathogen responses and therefore provides a starting point for examining two distinct microbial components on macrophage cell function (Figure 1).

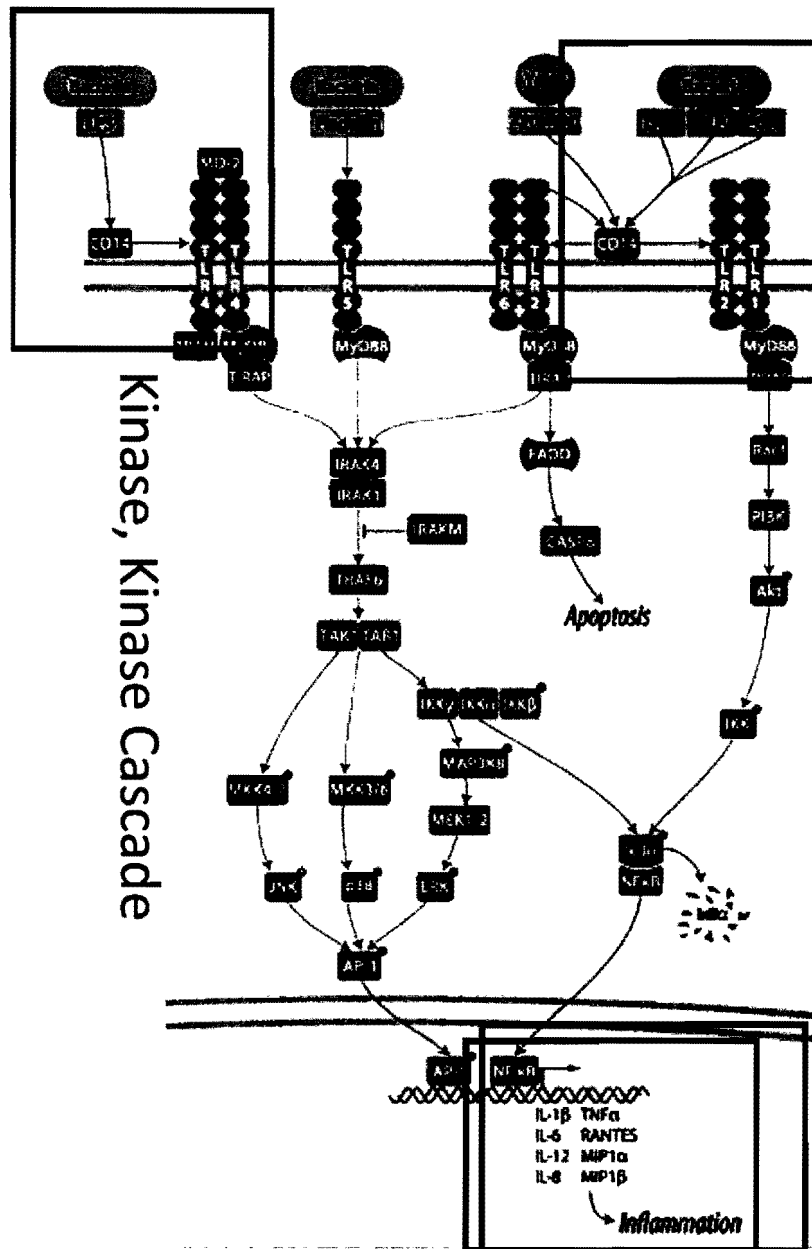

Toll-Like Receptor (TLR) Cartoon

Figure 1: This is an artistic depiction of the two pathways looked at in this research study. To the left there is LPS interacting with TLR-4 and to the right LTA interacts with TLR-2. A convergence point (NF-κB) can be seen towards the bottom.

We are interested in the convergence point and how this influences giant cell formations.

Modified and adapted from www.invitrogen.com.

In the events immediately following cell responses to microbial components, PRP activation elicits a tightly controlled release of pro-inflammatory cytokines (Akira et al., 2006). An early cytokine in the cellular response, Tumor Necrosis Factor α (TNF- α), is a key mediator of host immune responses. Acute release of TNF- α is an essential immune response to pathogens, while prolonged TNF- α is associated with an extended, and often inappropriate, inflammation response. Macrophages acutely respond to bacterial and viral pathogens by releasing TNF- α , which is beneficial; however, a sustained TNF- α release can have deleterious consequences for host tissues (Tak and Firestein, 2001).

An additional macrophage response to invading pathogens is an attempt to engulf foreign pathogens as a means to neutralize and isolate the threat (Cario, 2008). If engulfment is unsuccessful, a number of macrophages can surround the pathogen, and by fusing their cell plasma membranes, effectively creating a cellular barrier around the threat (Beutler and Rietschel, 2003). This cellular fusion is the basis for granuloma formation and multi-nucleated giant cell formations.

Despite the marked evolutionary conservation of the granuloma response, the molecular basis for granuloma formation and giant cell formation remains unknown. Although progress has been made in delineating molecular mediators involved in MGC formation, no clear macromolecular cohort has emerged (Helming and Gordon, 2009). This lack of defined macromolecular mediators may be due, in part, to the variety of macrophage populations studied and the differences in the fusion mediators employed (Helming and Gordon, 2009). To circumvent the heterogeneous nature of resident

monocytic cells in animals (Gordon and Taylor, 2005), it was chosen to examine the MGC formation in a defined rodent monocytic cell line, the RAW 264.7 cell. RAW 264.7 cells have been shown to undergo MGC formation in response to eliciting molecules, such as the bacterial endotoxin, LPS (Yangashita et al., 2005). Understanding the steps involved in MGC biogenesis could provide an important link between chronic pathogen recognition and macrophage responsiveness. This study proposes a straightforward model of pro-inflammatory cytokine-induced giant cell formation. Upon exposure to bacterial endotoxin, these cell line monocytes fuse together to form MGC. Since MGC formation can be studied in an isolated homogenous cell population, it should be possible to link the underlying intracellular biochemical events with the pronounced cell structure changes observed in cell fusion.

MGC formation represents a unique cellular response, which macrophages engage when challenged with bacterial endotoxins or large foreign bodies that cannot be ingested. The macrophage response to both cytokine exposure and bacterial components, such as endotoxins, is to increase phagocytosis. Despite the importance of the macrophage cell fusion response in a number of diseases, the molecular mechanism remains elusive. This study seeks to establish an assay for giant cell formation and determine the role of bacterial endotoxins in MGC development. In the current thesis, the goal is to examine the role of LPS and LTA on MGC formation.

MATERIALS AND METHODS

RAW 264.7 cell culture

The mouse macrophage cell line, RAW 264.7 (American Type Culture Collection, Manhasset, VA) was propagated in suspension culture as described (Dos Santos et al., 2007). Briefly, cell suspensions of the RAW 264.7 cells were maintained in 100 mm² culture dishes in Rosewell Park Memorial Institute (RPMI), medium with heat-inactivated, endotoxin tested, 5% fetal calf serum, and GlutaMAX™, high glucose, containing 1% streptomycin/penicillin, in a humidified atmosphere with 5% CO₂. All solutions and plastic ware used were certified cell culture grade, endotoxin free (Invitrogen; Carlsbad CA). Cells were routinely passaged at 70% confluence and split 1:5 (dish: dish ratio). Cells used in experiments were allowed to recover for 48 h before experiments. Cells were cultured in 6-well, 12-well, 24-well, or 48-well culture dishes purchased from Corning (Corning, NY) in RPMI, prior to experimentation.

Preliminary assays

RAW 264.7 cells monolayers were plated in 6-well, 12-well, 24-well, and 48-well tissue culture grade plastic dishes at varying seeding cell densities of 10,000 cells/well to 250,000 cells/well at different time intervals. After 48 hours in culture, the cells were rinsed with Dulbecco's phosphate-buffered saline, PBS, (Invitrogen; Carlsbad, CA) to remove growth medium and treated with Opti-MEM (Invitrogen; Carlsbad, CA), a serum-free medium alternative. Following O/N incubation, the monolayers were designated as control (no endotoxin treatment) or treated with increasing concentrations of lipopolysaccharide (LPS) (Invitrogen; Carlsbad, CA) over the range of 1 $\mu\text{g}/\text{mL}$ to 100 $\mu\text{g}/\text{mL}$. MGC formation was monitored every 12 hours by phase contrast light microscopy, at 100 X magnification, (Inverted, Phase-Contrast Leica® DMIL Microscope) and documented with a Leica® digital camera (Leica® DFC300FX CCD). All plates were also blindly observed and scored by an independent observer.

MGC formation morphological analysis and quantification

RAW 264.7 cells monolayers were plated in 12-well tissue culture grade plastic dishes at a seeding cell density of 100,000 cells/well and a total of 2 mL media per well. After 48 hours in culture, the cells were rinsed with PBS to remove growth medium and treated with Opti-MEM. Following O/N incubation, the monolayers were designated as control (no endotoxin treatment) or treated with 10 µg/mL LPS. Following 4 days incubation, morphological analysis of Multi-nucleated giant cell formation was viewed by phase contrast light microscopy (100 X magnification) and documented with a Leica® digital camera. Quantification was done by manually counting MGC formations. All quantifications were also blindly observed and scored by an independent observer.

Time-Course assay of giant cell formation

RAW 264.7 cells monolayers were plated in 24-well tissue culture grade plastic dishes at a seeding cell density of 100,000 cells/well and a total of 1 mL media per well. After 48 hours in culture, the cells were rinsed with PBS to remove growth medium and treated with Opti-MEM. Following O/N incubation, the monolayers were designated as control (no endotoxin treatment) or treated with 10 µg/mL LPS. Following each hour of incubation, phase contrast light microscopy (100 X magnification) was used to review 5 views of well treated with LPS so determine if giant cell formations had occurred. A “yes” or “no” designated was used based on the presence of absence of a formation respectively. All results were also observed and scored by an independent observer.

Cell viability assay

RAW 264.7 cells monolayers were plated in 24-well tissue culture grade plastic dishes at a seeding cell density of 100,000 cells/well and 1 mL media per well. After 48 hours in culture, the cells were rinsed with PBS to remove growth medium and treated with Opti-MEM. Following O/N incubation, the monolayers were designated as control (no endotoxin treatment) or treated with 10 µg/mL LPS. Calcein AM (485 nm/530 nm excitation/emission; Invitrogen; Carlsbad, CA) was prepared in a 1:100 ratio compared to well volume and diluted with Opti-MEM. After 96 hours incubation, each well was treated with 1 µM Calcein AM and incubated for 20 minutes. After 20 minutes, the Calcein AM solution was aspirated and the cell monolayers rinsed with PBS to remove residual Calcein AM. Opti-MEM was added to each well and the plates analyzed using an automated Cytofluor 4000 temperature-controlled fluorescence plate reader. Wells were also analyzed using epi-fluorescent microscopy (at 100 X magnification) and captured using a Leica® digital camera.

Endotoxin comparison assay

RAW 264.7 cells monolayers were plated in 12-well tissue culture grade plastic dishes at a seeding cell density of 100,000 cells/well and 1 mL media per well. After 48 hours in culture, the cells were rinsed with PBS to remove growth medium and treated with Opti-MEM. Following O/N incubation, wells were designated control (no treatment), LPS treated, and Lipoteichoic Acid, LTA, (Invitrogen; Carlsbad, CA), and treated accordingly. LTA treated wells were varied in concentration being 1 µg/mL, 10 µg/mL, or 100 µg/mL. Following 4 days incubation, giant cell formation was viewed by phase contrast light microscopy (100 X magnification) and documented with a Leica® digital camera. Quantification was done by manually counting MGC formations. All quantifications were also observed and scored by an independent observer.

TNF- α dependency assay

RAW 264.7 cells monolayers were plated in 24-well tissue culture grade plastic dishes at a seeding cell density of 100,000 cells/well and 1 mL media per well. After 48 hours in culture, the cells were rinsed with PBS to remove growth medium and treated with Opti-MEM. Following O/N incubation, plates were divided in three parts – negative control (no treatment), positive control (10 μ g/mL LPS treatment), or TNF- α removal. Once daily, for the entirety of the incubation duration, the media and hence the TNF- α build-up that was produced by the RAW 264.7 cells, was removed and replaced with a fresh milliliter of RPMI medium. Post 4 days incubation, and four TNF- α build-up removals, giant cell formation was viewed by phase contrast light microscopy (100 X magnification) and documented with a Leica® digital camera. Quantification was done by manually counting MGC formations. All quantifications were also observed and scored by an independent observer.

Soluble TNF- α treatment assay

RAW 264.7 cells monolayers were plated in 24-well tissue culture grade plastic dishes at a seeding cell density of 100,000 cells/well and 1 mL media per well. After 48 hours in culture, the cells were rinsed with PBS to remove growth medium and treated with Opti-MEM. Following O/N incubation, plates were divided into negative control (no treatment), positive control (10 μ g/mL LPS treatment), or 1 μ g/mL TNF- α (Invitrogen; Carlsbad, CA) treatment. Post 4 days incubation, and four TNF- α build-up removals, giant cell formation was viewed by phase contrast light microscopy (100 X magnification) and documented with a Leica® digital camera. Quantification was done by manually counting MGC formations. All quantifications were also blindly observed and scored by an independent observer.

Data analysis

All results from the different treatments and data groups were calculated and presented as the mean \pm SEM for each control or treatment (n = 3 or greater for the wells in each plate, with three plate replicates). Statistical comparisons between the means of different groups were performed by multiple ANOVA with a Neuman-Keuls multiple comparison post-test. Data was analyzed using GraphPad® Prism 4 and statistical significance was defined as $p < 0.05$.

RESULTS

Preliminary Cell Culture Assays

Cell monolayers of RAW 264.7 cells were plated in 6-well, 12-well, 24-well, and 48-well culture plates and treated with increasing concentrations of LPS. Cell plating concentrations included 10,000 cells/well, 25,000 cells/well, 50,000 cells/well, 100,000 cells/well, 150,000 cells/well, 200,000 cells/well, and 250,000 cells/well. Final LPS treatment concentrations were 1 $\mu\text{g/mL}$, 5 $\mu\text{g/mL}$, 10 $\mu\text{g/mL}$, 20 $\mu\text{g/mL}$, 50 $\mu\text{g/mL}$, and 100 $\mu\text{g/mL}$. The treated cells were incubated at 37°C for times intervals of 4 to 10 days. It was found that optimal conditions for the RAW 264.7 cell growth and maintenance included no more than a 5 day incubation period, plating of cells in a 24-well culture plate, a cell plating density of 100,000 cells/well, and a LPS treatment concentration of no more than 10 $\mu\text{g/mL}$. At an optimal LPS concentration, the maximum number of giant cell formations observed was $\sim 30\%$ of the total cell population (Figure 2a, 2b).

The time course results show that fusion of RAW 264.7 macrophages into MGCs is time dependent, concentration dependent, cell density dependent, and growth dependent. These findings expand on the work done by *Yanagishita, et al., 2007*, and

provide an experimental template for examining the factors involved in endotoxin-mediated RAW 264.7 cell fusion.

It was also observed that increasing the concentration of LPS treatment caused the cells to undergo apoptosis, which was evident at concentrations of 20 μg LPS treatment and above and appears to be related with LPS toxicity. However, despite the toxicity, even at the higher LPS concentrations MNC formation was still observed.

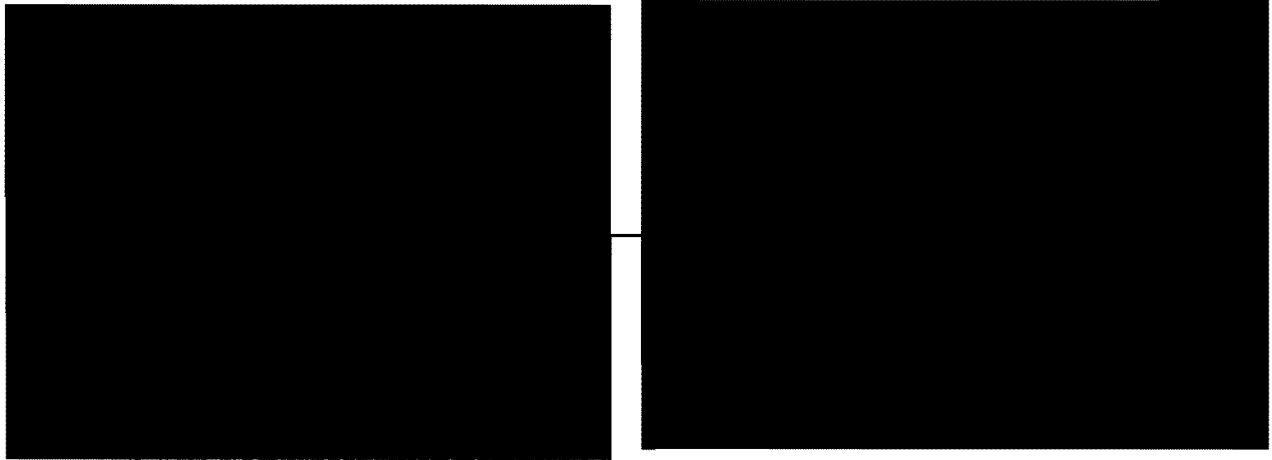

Treated RAW 264.7 cells post incubation.

RAW 264.7 cells were plated at 100k cells/well, treated, and incubated for 5 days.

Figure 2a: View of a control well. No MGC are observed. Six wells and a total of 5 views per well observed and formations averaged. (100 X magnification).

Figure 2b: View of a well with cells treated with 10 µg/mL LPS. MGC are indicated by arrows. Not all multi-nucleated giant cell formations are shown. Six wells and a total of 5 views per well observed and formations averaged. (100 X magnification).

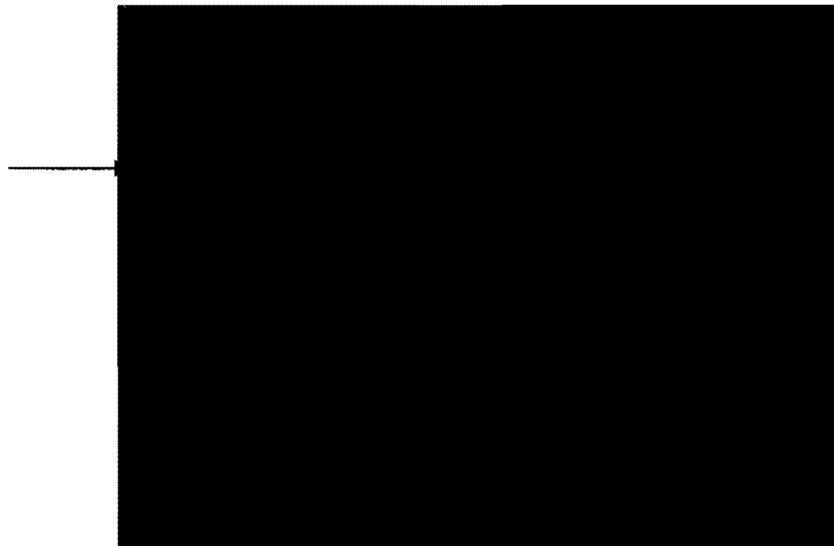

Potential toxicity of LPS.

RAW 264.7 cells were plated at 100k cells/well, treated, and incubated for 5 days.

Figure 3: View of a well with cells treated with 20 $\mu\text{g}/\text{mL}$ LPS. The observed result showed marked cell toxicity. The toxicity of LPS can be seen with increasing LPS concentrations. The cell mortality rate is approximately 75 %. Arrows indicate cell fusion. Not all formations are shown. (100 X magnification).

MGC: Morphological analysis and quantification

Defining the experimental parameters for MGC formation was a critical determinant for further experimentation. In order to document a giant cell formation, morphological analysis was done using phase-contrast microscopy with a final magnification 400 X. Figure 4 shows that multiple nuclei are present inside this individual giant cell formation.

Quantification of these giant cell formations was done in two independent experiments. Multiple views of each well were digitally captured using phase-contrast microscopy and Leica® digital camera. Each picture was then corroborated by an independent observer. As shown in Figure 5 the results show that at a 10 µg/mL LPS treatment, an increasing cell density yields a greater number of giant cell formations. As compared to the control groups, the treatment of RAW 264.7 cells with LPS caused a significant increase in MGC formations observed. These results indicate that the increasing cell density results in an increasing probability of cell fusion. It should be noted that an upper limit of cell density is determined by non-fusing cell overgrowth (Figure 4). At higher cell plating densities it becomes harder to count formations due to potential over growth in each well over time. (Data not shown)

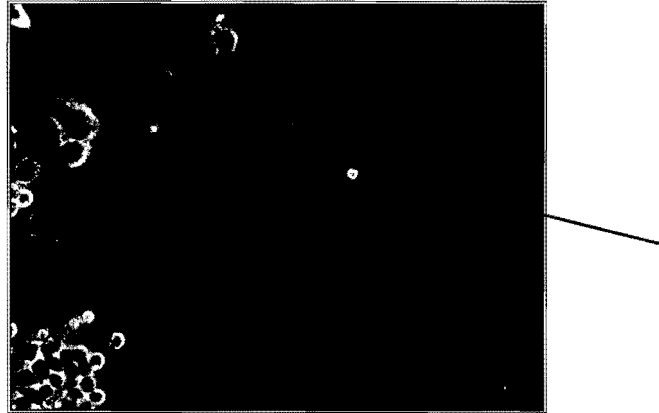

Close-up view of fused RAW 264.7 cells.

RAW 264.7 cells were plated at 100k cells/well, treated, and incubated for 96 hours.

Figure 4: A digital image of multi-nucleated giant cell formation in RAW 264.7 mouse cells treated with 10 $\mu\text{g}/\text{mL}$ LPS.

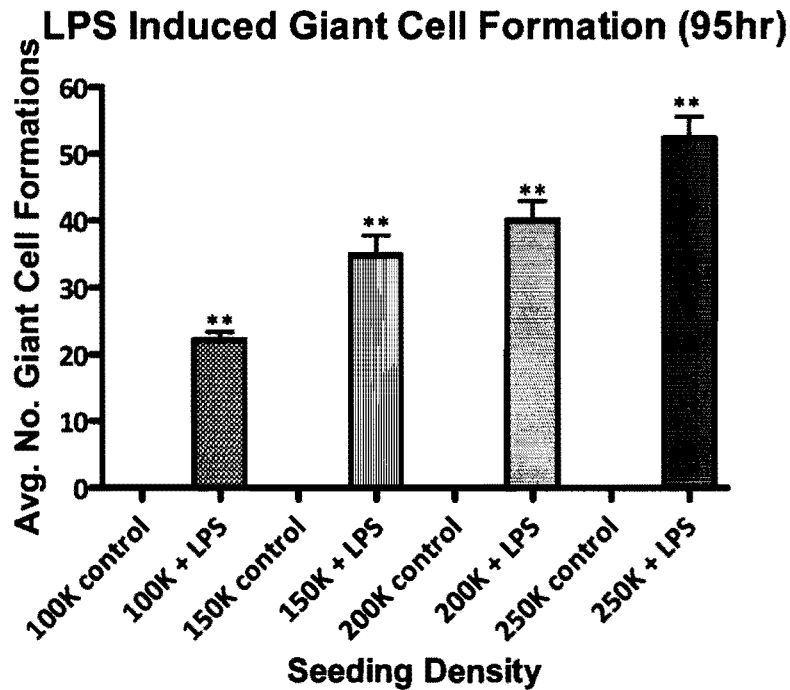

Giant cell formation analysis after 95 hours of incubation at 37°C with 5 % CO₂.

Figure 5: The concentration of LPS added was 10 µl of 10 µg/ml. The assay was carried out in 12 well plates with 2 ml of cell solution per well. The data shown is the average number of formations observed per random view per well. A total of five random views per well were taken for each seeding density with quantification done via manual techniques.

Data are means ±SEM from three independent experiments. Data were analyzed by multiple ANOVA with Newman-Keuls post hoc test. Using GraphPad® Prism statistical significance was defined as $p < 0.05$. ** $p < 0.001$

As compared to each densities' control group; LPS is shown to significantly increase the number of MGC formations observed with increasing cell number.

Time-course assay of MGC formation

To further investigate giant cell formations, we performed a time course for giant cell formation. Control and endotoxin treated RAW 264.7 cell cultures observed every hour for 24 consecutive hours, with 5 random views of each well documented by phase contrast microscopy and a “yes” or “no” result assigned based upon the observed MGC formation. Each view was cross-checked by an independent observer. The initial giant cell formation was seen to form within 24 hours, at the 22/23 hour time period. The experiment was repeated six times to verify the time course results.

Cells were also incubated until 10 days to reconfirm the appropriate length of incubation time. The optimal time of incubation was found to be approximately 4-5 days (a time point which avoided cell overcrowding in the control wells and minimized cell death in the treated wells). The four day time point is used in future experiments. .

Table 1: 100,000 cells/well											
Treated with 10 µg/mL LPS											
Hour 1	View 1	View 2	View 3	View 4	View 5	Hour 2	View 1	View 2	View 3	View 4	View 5
Well 1	No	No	No	No	No	Well 1	No	No	No	No	No
Well 2	No	No	No	No	No	Well 2	No	No	No	No	No
Well 3	No	No	No	No	No	Well 3	No	No	No	No	No
Well 4	No	No	No	No	No	Well 4	No	No	No	No	No
Hour 3	View 1	View 2	View 3	View 4	View 5	Hour 4	View 1	View 2	View 3	View 4	View 5
Well 1	No	No	No	No	No	Well 1	No	No	No	No	No
Well 2	No	No	No	No	No	Well 2	No	No	No	No	No
Well 3	No	No	No	No	No	Well 3	No	No	No	No	No
Well 4	No	No	No	No	No	Well 4	No	No	No	No	No
Hour 5	View 1	View 2	View 3	View 4	View 5	Hour 6	View 1	View 2	View 3	View 4	View 5
Well 1	No	No	No	No	No	Well 1	No	No	No	No	No
Well 2	No	No	No	No	No	Well 2	No	No	No	No	No
Well 3	No	No	No	No	No	Well 3	No	No	No	No	No
Well 4	No	No	No	No	No	Well 4	No	No	No	No	No
Hour 7	View 1	View 2	View 3	View 4	View 5	Hour 8	View 1	View 2	View 3	View 4	View 5
Well 1	No	No	No	No	No	Well 1	No	No	No	No	No
Well 2	No	No	No	No	No	Well 2	No	No	No	No	No
Well 3	No	No	No	No	No	Well 3	No	No	No	No	No
Well 4	No	No	No	No	No	Well 4	No	No	No	No	No
Hour 9	View 1	View 2	View 3	View 4	View 5	Hour 10	View 1	View 2	View 3	View 4	View 5
Well 1	No	No	No	No	No	Well 1	No	No	No	No	No
Well 2	No	No	No	No	No	Well 2	No	No	No	No	No
Well 3	No	No	No	No	No	Well 3	No	No	No	No	No
Well 4	No	No	No	No	No	Well 4	No	No	No	No	No
Hour 11	View 1	View 2	View 3	View 4	View 5	Hour 12	View 1	View 2	View 3	View 4	View 5
Well 1	No	No	No	No	No	Well 1	No	No	No	No	No
Well 2	No	No	No	No	No	Well 2	No	No	No	No	No
Well 3	No	No	No	No	No	Well 3	No	No	No	No	No
Well 4	No	No	No	No	No	Well 4	No	No	No	No	No
Hour 13	View 1	View 2	View 3	View 4	View 5	Hour 14	View 1	View 2	View 3	View 4	View 5
Well 1	No	No	No	No	No	Well 1	No	No	No	No	No
Well 2	No	No	No	No	No	Well 2	No	No	No	No	No
Well 3	No	No	No	No	No	Well 3	No	No	No	No	No
Well 4	No	No	No	No	No	Well 4	No	No	No	No	No

Hour 15	View 1	View 2	View 3	View 4	View 5	Hour 16	View 1	View 2	View 3	View 4	View 5
Well 1	No	No	No	No	No	Well 1	No	No	No	No	No
Well 2	No	No	No	No	No	Well 2	No	No	No	No	No
Well 3	No	No	No	No	No	Well 3	No	No	No	No	No
Well 4	No	No	No	No	No	Well 4	No	No	No	No	No
Hour 17	View 1	View 2	View 3	View 4	View 5	Hour 18	View 1	View 2	View 3	View 4	View 5
Well 1	No	No	No	No	No	Well 1	No	No	No	No	No
Well 2	No	No	No	No	No	Well 2	No	No	No	No	No
Well 3	No	No	No	No	No	Well 3	No	No	No	No	No
Well 4	No	No	No	No	No	Well 4	No	No	No	No	No
Hour 19	View 1	View 2	View 3	View 4	View 5	Hour 20	View 1	View 2	View 3	View 4	View 5
Well 1	No	No	No	No	No	Well 1	No	No	No	No	No
Well 2	No	No	No	No	No	Well 2	No	No	No	No	No
Well 3	No	No	No	No	No	Well 3	No	No	No	No	No
Well 4	No	No	No	No	No	Well 4	No	No	No	No	No
Hour 21	View 1	View 2	View 3	View 4	View 5	Hour 22	View 1	View 2	View 3	View 4	View 5
Well 1	No	No	No	No	No	Well 1	Yes	No	No	Yes	No
Well 2	No	No	No	No	No	Well 2	No	No	No	No	No
Well 3	No	No	No	No	No	Well 3	No	Yes	No	No	No
Well 4	No	No	No	No	No	Well 4	No	No	No	No	Yes
Hour 23	View 1	View 2	View 3	View 4	View 5	Hour 24	View 1	View 2	View 3	View 4	View 5
Well 1	Yes	Yes	No	Yes	No	Well 1	Yes	Yes	No	Yes	No
Well 2	No	No	No	No	No	Well 2	No	No	Yes	Yes	No
Well 3	No	Yes	No	No	No	Well 3	No	Yes	No	No	No
Well 4	No	No	No	Yes	Yes	Well 4	No	No	No	Yes	Yes

24-hour Time Course Analysis of Giant Cell Formations

Table 1: LPS added was at 10 µg/ml. Each view was checked hourly for MGC formations. Results were compared and condensed from the primary researcher and independent viewer. Results show that at the 22/23 hour time marks, the first MGC formation is observed.

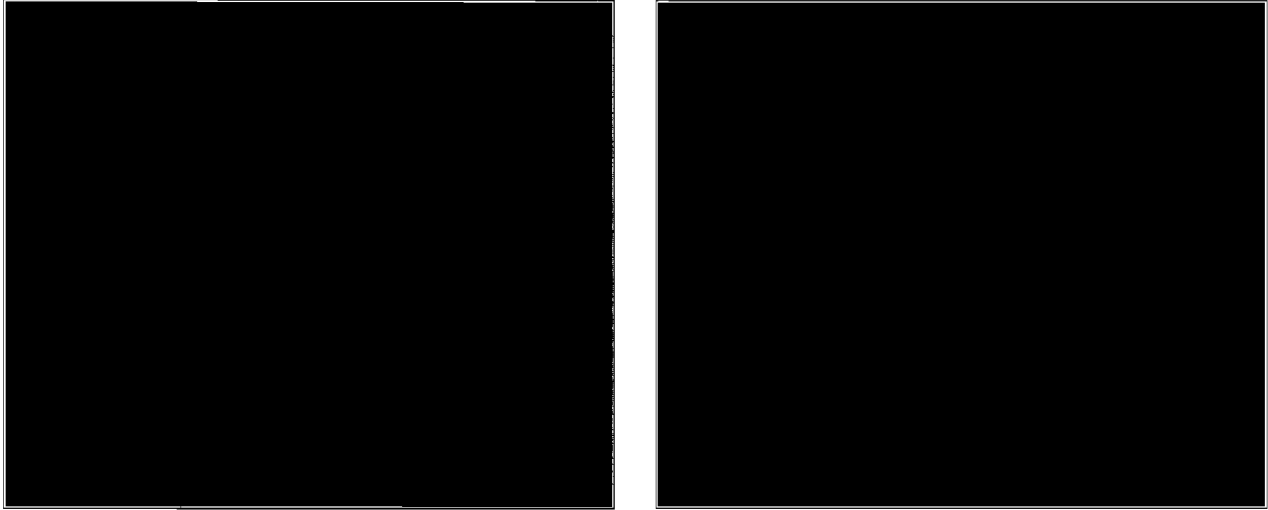

Comparison between treated and untreated RAW 264.7 cells.

Figure 6a: No giant cell formation was observed with untreated RAW 264.7 mouse macrophage cell line after 4 days of incubation plated at 100K seeding density. Four wells and a total of 5 views per well observed and formations averaged. (100 X magnification).

Figure 6b: Giant cell formation observed with LPS treated RAW 264.7 mouse macrophage cell line after 4 days of incubation. Some, not all formations are marked with an arrow. Four wells and a total of 5 views per well observed and formations averaged. Results indicate that 96 hours is the optimal time length of incubation. (100 X magnification).

Cell viability assay

To determine if the cells were still viable after treatment with the LPS endotoxin, Calcein AM was used. Being a fluorogenic esterase substrate, Calcein AM passively enters viable RAW 264.7 cells and is enzymatically cleaved by intracellular esterases. The newly formed negatively charged product is trapped in the intracellular compartment, and fluoresces (485 ex/ 530 em). Calcein AM product fluorescence indicates cell viability despite endotoxin treatment (Blake, 1994).

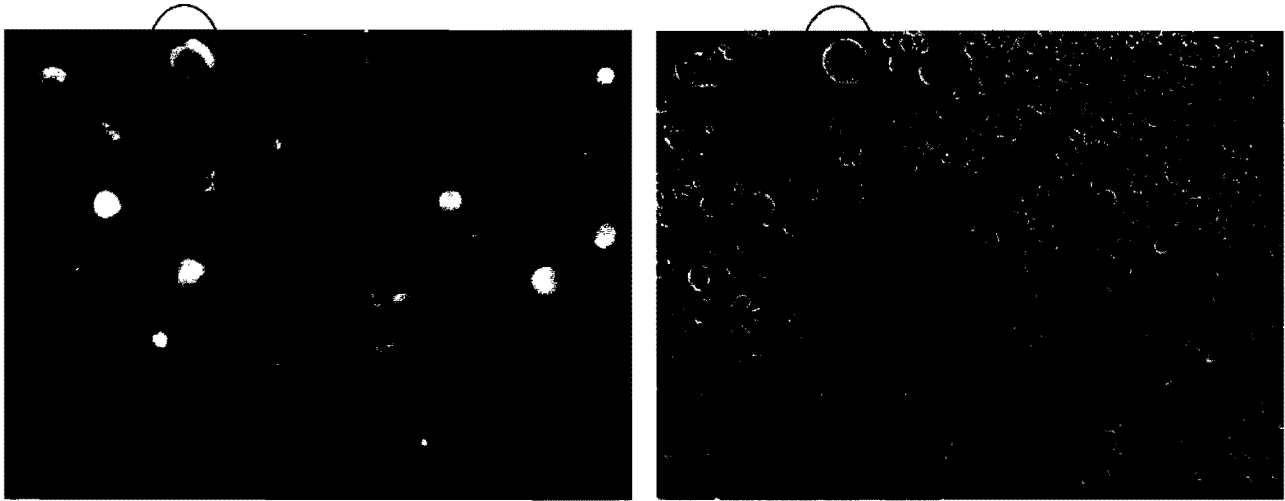

Calcein staining of RAW 264.7 cells.

Figure 7a: Epifluorescent digital image of Calcein AM stained RAW 264.7 MGC formation cells post 4 days incubation and treatment of 10 $\mu\text{g/ml}$ LPS. Seeding density being 100,000 cells/well.

Figure 7b: Corresponding phase-contrast image. The red circles show images of giant cell formation. This is limited to a few, as the picture has many formations. (100 X magnification).

Endotoxin comparison assay

Both Gram negative and Gram positive bacteria contain endotoxins that stimulate the innate immune system. In order to establish a comparison point between endotoxins and cell fusion, we compared treatment of RAW 264.7 cells with the gram-negative endotoxin LPS to the gram-positive endotoxin LTA. These distinct endotoxins activate distinct intracellular protein kinase signaling pathways with a convergence point at the level of pro-inflammatory transcriptional controlling the outcome of the pathway. We observed that both endotoxins elicited MGC formation, albeit at different effective concentrations. The concentration at which LTA causes a similar number of formations as LPS is 100 $\mu\text{g}/\text{mL}$. A ten-fold increase over the concentration of LPS was used. These results show that LPS elicits a greater MGC RAW 264.7 cells as compared to LTA (Figure 8).

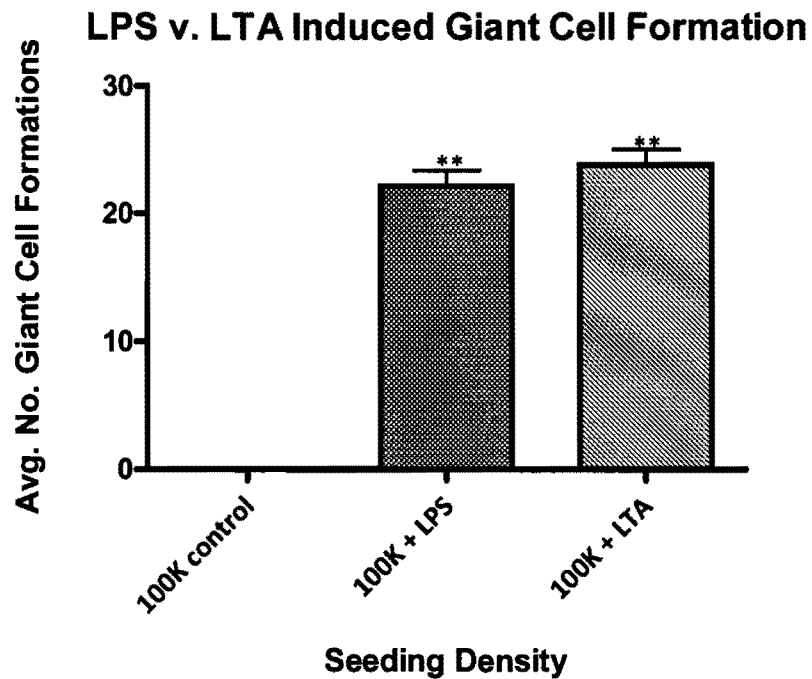

LPS and LTA elicit MGC formation in RAW 264.7 cell monolayers

Figure 8: The concentration of LPS added was at 10 μ l of 10 μ g/mL. The data shown is the average number of formations observed per random view (5) per well (4). LTA treated wells were at a concentration of 100 μ g/mL.

Data are means \pm SEM from three independent experiments. Data were analyzed by multiple ANOVA with Newman-Keuls post hoc test. Using GraphPad Prism statistical significance was defined as $p < 0.05$. ** $p < 0.001$ compared to untreated control cells

Using GraphPad Prism® and manual quantification techniques.

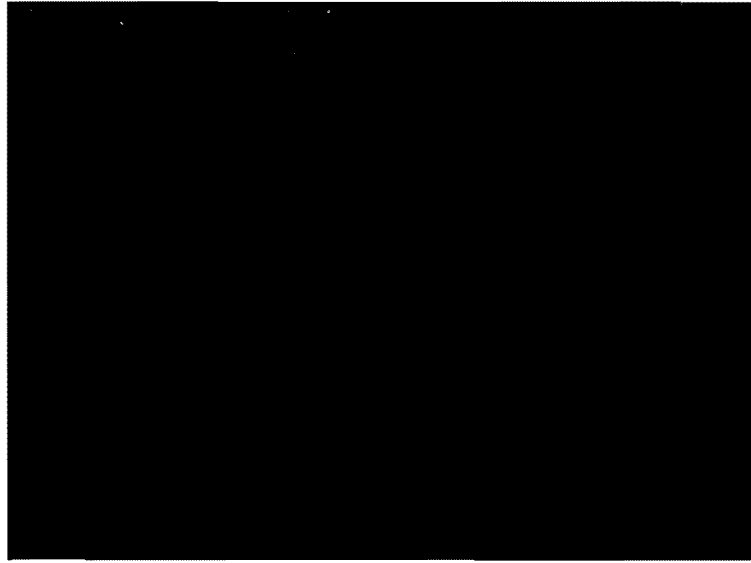

LTA induces MGC formation in RAW 264.7 cells.

Figure 9: View of a well with cells treated with 100 $\mu\text{g}/\text{mL}$ LTA. Representative MGC formations are marked with an arrow. Four wells and a total of five views per well observed and formations averaged. (100 X magnification).

TNF- α dependency assay

In order to establish the significance of endotoxin-stimulated TNF α cell fusion pathway, we removed the cell culture media which contained TNF- α every 24 hours for the entire incubation time. The experiment is designed to test the importance of endotoxin-stimulated TNF- α in stimulating MGC formation

The results shown in Figure 10 indicate that removal of the TNF- α decreases the total number of giant cell formations observed. There is an approximate 40 % decrease in MGC formations seen with daily removal of cell culture (Figure 10). These results suggest that TNF- α may be a significant factor in stimulating MGC formation in the RAW 264.7 cell model.

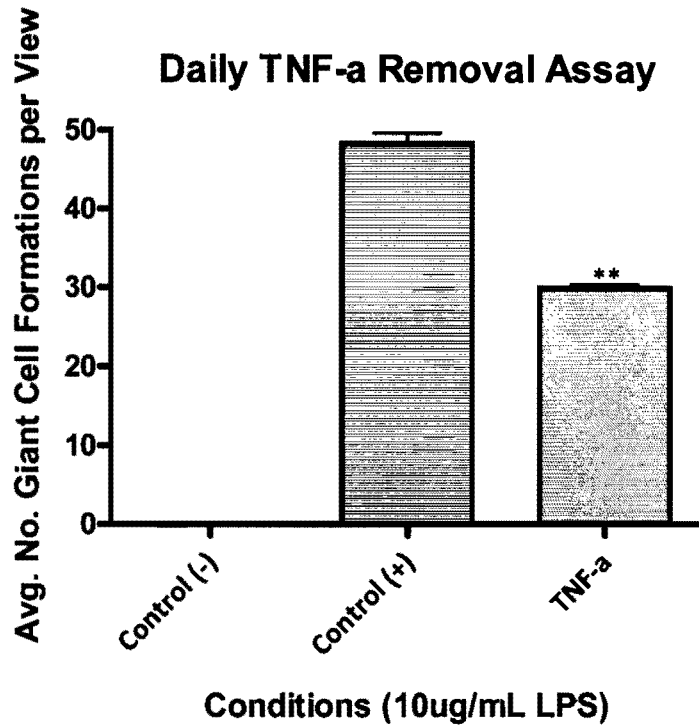

Giant cell formation analysis following daily media removal and after 96 hours of incubation at 37°C with 5 % CO₂.

Figure 10: The concentration of LPS added was 10 µg/ml. The assay was carried out in a 24 well plates. The data shown is the average number of formations observed per random view (5) per well (8).

Data are means ±SEM from three independent experiments. Data were analyzed by multiple ANOVA with Newman-Keuls post hoc test. Using GraphPad® Prism statistical significance was defined as $p < 0.05$. ** $p < 0.001$ (TNF- α media removed versus control with media present)

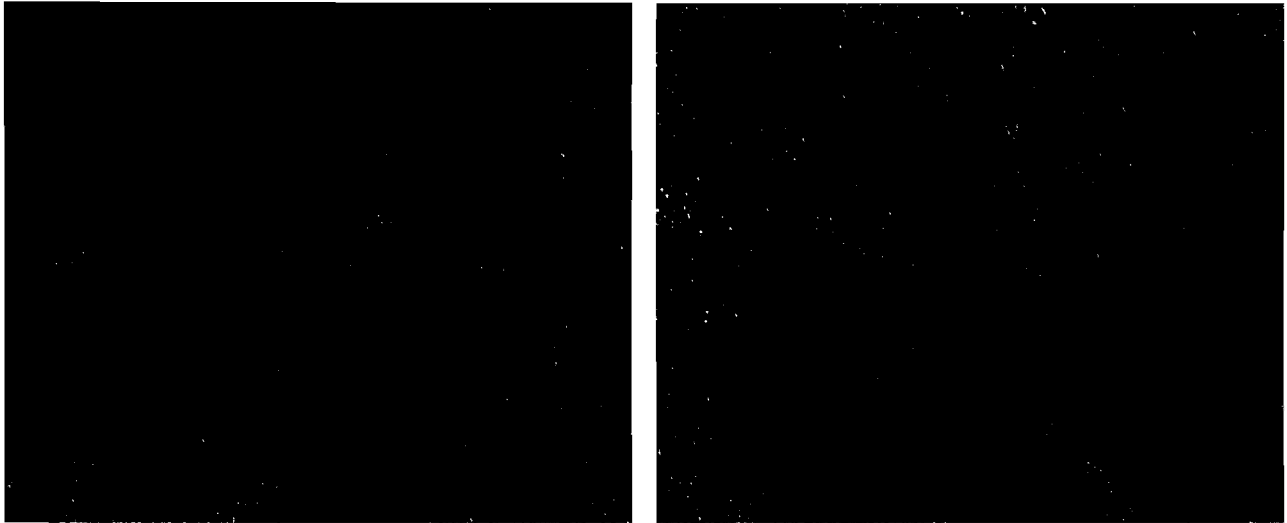

RAW 264.7 cells were plated (24-well culture plate used) at 100k cells/well, treated, and incubated for 96 hours.

Figure 11a: View of a well with cells treated with 10 µg/mL LPS. Representative MGC formations are indicated with an arrow. Eight wells and a total of 5 views per well observed and formations averaged. (100 X magnification).

Figure 11b: View of a well with cells treated with 10 µg/mL LPS and TNF- α removed daily. Representative MGC formations are indicated with an arrow. Eight wells and a total of 5 views per well observed and formations averaged. (100X magnification).

Soluble TNF- α Treatment Assay

In order to establish that TNF- α contributes to giant cell formations, RAW 264.7 monolayers were treated with commercially available, soluble TNF- α and compared these results with parallel cultures treated with LPS.

The results in Figure 12 show that the addition of exogenous, soluble TNF- α caused MGC formations. A treatment of 1 $\mu\text{g}/\text{mL}$ soluble TNF- α induced fusion at levels of approximately 33 percent of that of a LPS endotoxin treated well. As compared to the untreated cell group, the treatment of RAW 264.7 cells with soluble TNF- α caused a significant increase in MGC formations observed.

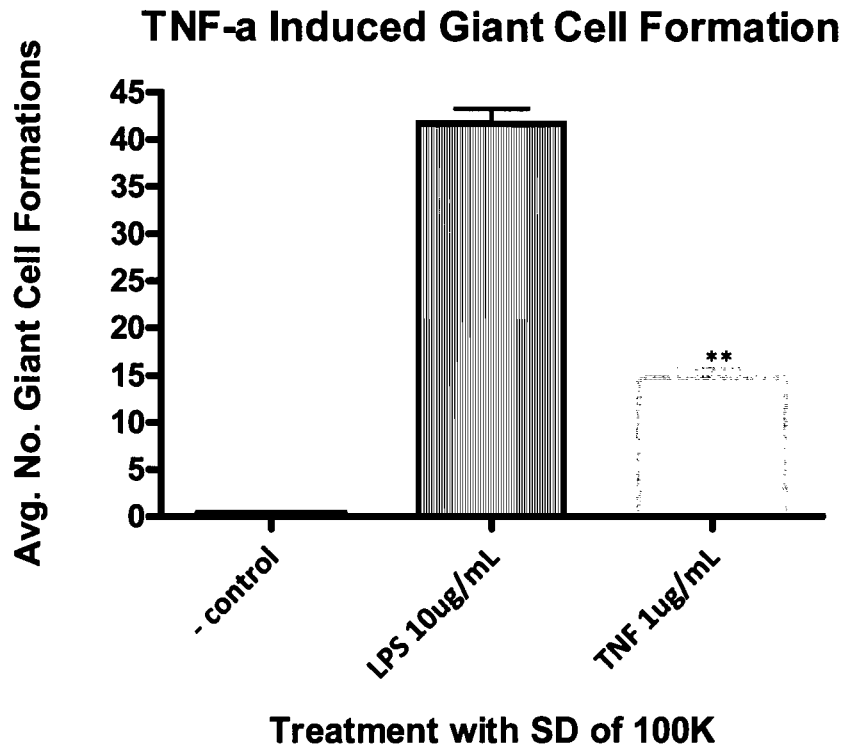

Giant cell formation analysis following soluble TNF- α treatment and after 96 hours of incubation at 37°C with 5 % CO₂.

Figure 12: The data shown is the average number of formations observed per random view (5) per well (8).

Data are means \pm SEM from three independent experiments. Data were analyzed by multiple ANOVA with Newman-Keuls post hoc test. Using GraphPad® Prism statistical significance was defined as $p < 0.05$. ** $p < 0.001$ (soluble TNF- α treatment versus LPS treatment)

As compared to the negative control group (untreated group); treatment of RAW 264.7 cells with soluble TNF- α is shown to significantly increase the number of MGC formations observed.

DISCUSSION

Macrophage fusion resulting in the formation of MGC or granuloma formation represents a unique cellular response, which macrophages engage when challenged with bacterial endotoxins or large foreign bodies. Macrophages have a pronounced cell fusion capacity when compared to other cells, making the macrophage an ideal model for examining the cell biology of MGC formation (Helming and Gordon, 2009). Despite the importance of the macrophage granuloma response in a number of diseases, including parasitic infections and chronic inflammatory diseases, such as rheumatoid arthritis, the molecular mechanisms involved remain elusive. However, cell cultured based approaches may provide unique insights to this process and provide a valuable model for identifying the molecular components involved (Helming and Gordon, 2008; Vignery, 2008).

In the current study, we establish the utility of an *in vitro* cell culture system to examine the roles of bacterial endotoxins in triggering cell fusion. RAW 264.7 cells are a mouse monocytic cell line that provides a renewal supply of monocytic cells, that when stimulated with bacterial endotoxins, respond by secreting pro-inflammatory mediators, as well as forming MGC formations (Yangashita et al., 2007). We have been able to trigger the formation of multi-nucleated giant cells, which resembles that of a

granuloma formation but without the walling off of a pathogen or invader, with the treatment of bacterial endotoxins LPS and LTA.

Yanagishita and colleagues (Yanagishita *et al.*, 2007) first established the ability of RAW 264.7 cells to fuse. The basic requirements were discovered to include plate size, incubation time, seeding cell density, and treatment concentration. LPS causes the RAW 264.7 macrophages to fuse in a linear fashion with regards to seeding cell density, suggesting a direct link between endotoxin-stimulated cellular events and the capacity for cell fusion. Our studies delineated the methodological requirements needed for endotoxin-mediated fusion with regard to optimizing the cell fusion assay conditions. Obstacles arise when using higher seeding densities because of the cell nutrient requirements, and cell overgrowth. Our results established that 100,000 cells/well is optimal for plating and allowing growth when using manual observation and quantification methods.

We discovered that the ideal LPS endotoxin concentration to elicit maximal macrophage fusions without causing cell death is 10 $\mu\text{g}/\text{mL}$. In order to check the cell viability per well, fluorescent microscopy is used in combination with Calcein AM, a fluorescent esterase substrate. The use of Calcein AM shows that the giant cell formations take in a great amount of the substrate and therefore has a higher intensity when being visualized with a fluorescent microscope (Figure 7a). Calcein use also showed that the cells were still viable after endotoxin treatment of 10 $\mu\text{g}/\text{mL}$, eliminating the thought that only cells that fused actually survived the treatment.

The plate used matters only with respect to the space distance between each cell in the well. At 100,000 cells/well, the larger the well, the less likely one cell is to be close enough for fusion to actually occur. The best spacing is provided with the use of 24-well plates (Figure 10, Figure 12) followed next by the use of 12-well plates (Figure 5, Figure 8). Our experiments were carried out on both 12 and 24 well plates. The larger the well (12 well plates), allow a greater amount of media to be inserted per well and hence the cells will have nutrients and growth factors for a longer period of time. The length of incubation found to work the best when trying to quantify giant cell formations was 4 days or 96 hours. At this point there was maximal giant cell formation with minimal stress on the cells and zero overgrowth of cells. Giant cells were seen to form at the 22/23 hours marks and not prior to these timestamps when doing a time course analysis (Table 1). Since giant cells in deed form within 24 hours, it can be assumed that the cause of the formations is at a post-transcriptional level.

Lipoteichoic acid (LTA) was shown to have a similar effect on RAW 264.7 macrophages over the same time course, with the same seeding density; however, with a 10-fold treatment concentration as compared to that of LPS treated cells (Figure 9). We have shown, through manual quantification methods and independent verifications that cells treated with LTA with a concentration of 100 µg/mL form a similar number of giant cell formations as cells treated with LPS with a concentration of 10µg/mL (Figure 8). Even though LTA and LPS have different kinase-kinase cascades, they have the same translational effect on RAW 264.7 cells. Both treatments elicit an immune response in

the cells causing them to fuse with their neighboring macrophages forming multinucleated giant cells. This can be attributed to the convergence point of both endotoxin treatments being NF- κ B. The transcription factor NF- κ B performs a seminal role in the TLR inflammation response, in particular with LPS activation of TLR4, as well as serving as a convergence point for TLRs that recognize other bacterial signals (Cario, 2008).

The transcription factor NF- κ B controls the dominant pro-inflammatory genes which are activated by LPS and LTA. Post activation of NF- κ B, there is a flow of TNF- α into the surrounding media from the activated cells. We hypothesized that this release of protein caused the cells to fuse and form multi-nucleated giant cells. To test said hypothesis, we removed the media daily for the whole incubation time and therefore removed the protein build-up. If the protein was responsible for fusion then it would make sense that a removal of this protein would in turn yield a lower number of giant cell formations. As shown in Figure 10, the removal of the TNF- α does yield a lower number of formations over the same incubation time, same seeding cell density, and treatment concentration. All variables were the same between the positive controls and the TNF- α wells except that the protein build-up was removed from the TNF- α wells. A removal of the media in turn yielded an approximate 40 percent decrease in the total number of giant cell formations observed. These results were verified by an independent viewer and by repeating it multiple times.

To confirm that it was in fact the TNF- α was a contributor to MGC formation; we treated monolayers of RAW 264.7 macrophages with soluble TNF- α and compared the results with LPS treated controls. Our results verified that TNF- α promotes MGC formation, a result which also was observed with the endotoxin, LTA. . LPS or LTA treatments ultimately result in the activation of the pro-inflammatory transcription factor, NF- κ B, It is clear that pro-inflammatory mediators , such as TNF α contribute to MGC formation, however, a number of other potential mediators have been identified (Helming and Gordon, 2009). Included among the permissive inducing factors are the cytokines Interleukin-4, myobacterial envelope glycoproteins, interferons, and several cytokines (Helming and Gordon, 2009). Although the present study does not directly address the potential role for these factors, the use of a defined, homogeneous cell population, in conjunction with defined bacterial endotoxins, clearly demonstrates that endotoxin exposure can stimulate a defined and readily quantifiable cell fusion event. By establishing a cell line macrophage model of MGC cell formation, we have set a precedent for examining the mediators of cell fusion in a homogenous cell population, devoid of the cellular heterogeneity seen in primary cell models derived from isolated tissues.

CONCLUSION

In this study, we reveal the cellular biology of multi-nucleated giant cell formation and tested theories behind the formations of giant cells. We have determined that giant cell formations are dependent on the treatment concentration, growth space allocation, available food source, original cell seeding density, and total incubation time. The main basis being that the cells have to be in an environment conducive for growth, while having neighboring cells in reach to allow fusion. We have also shown that different endotoxins (LPS and LTA), which have different kinase-kinase cascades, can yield the same result – stimulation of multi-nucleated giant cell formations. To better analyze the cell biology of giant cell formation we attempted to conclude what in fact is the cause of the formations. We used TNF- α removal assays to indicate said protein as the contributor to giant cell formations. Post verifying the need of TNF- α in giant cell formation, we treated monolayers with soluble TNF- α in an attempt to induce giant cell formations without the kinase-kinase cascade caused by endotoxin (LPS or LTA) treatment. Soluble TNF- α treatment also caused giant cell formations. We therefore conclude that TNF- α is a culprit that is responsible for multi-nucleated giant cell formations in RAW 264.7 cells.

LITERATURE CITED

Akira, S., Uematsu, S. and Takeuchi, O. Pathogen recognition and immunity. *Cell* 124: 783-801 (2006)

Blake, A.D. Dipyridamole protects cultures of rat embryonic cortical neurons from toxic insult. *Biochemical and Biophysical Research Communications* 314:501-504 (2004).

Borges, M, et. al., A two-colour fluorescence assay for the measurement of syncytial fusion between trophoblast-derived cell lines. *Placenta* 24:959-964 (2003).

Beutler, B., and Rietschel, E.T. Innate immune sensing and its roots: The story of endotoxin. *Nature Reviews Immunology* 3:169–176 (2003).

Cario, E. Therapeutic impact of Toll-like receptors on inflammatory bowel diseases: A multiple-edged sword. *Inflamm. Bowel Dis.* 14: 411-421 (2008)

Dos Santos, S., Delattre A-I., De Longueville, F., Bult, H. and Raes, M. Gene expression profiling of LPS-stimulated murine macrophages and role of NF-KB and PI3K/mTOR signaling pathways. *Ann. N.Y. Acad.Sci.* 1096:70-77 (2007).

Fanger, C.M, Hoth, M., Crabtree, G.R. and Lewis, R.S. Characterization of T Cell mutants with defects in capacitative calcium cell entry calcium cell entry: genetic evidence for the physiological roles of CRAC channels. *J. Cell Bio.* 131:655-667(1995).

Gordon J.N. and MacDonald T.T. Biological therapy in Crohn's disease. *Hosp Med.* 64:708-12 (2003).

Gordon, S. and Taylor, P.R. Monocyte and macrophage heterogeneity. *Nature Reviews Immunology* 5:953-964 (2005).

Helming, L. and Gordon, S. Macrophage fusion induced by IL-4 alternative activation is a multistage process involving multiple target molecules. *Eur. J. Immunol.* 37, 33-42 (2007).

Helming, L. and Gordan, S. The scavenger receptor CD36 plays a role in cytokine-induced macrophage fusion. J. of Cell Science. 2009;122(Pt 4): 453-9 (2009).

Kawai T, Adachi O, Ogawa T, Takeda K, Akira S. Unresponsiveness of MyD88-deficient mice to endotoxin. Immunity.11:115–122 (1999).

Tak, P.P. and Firestein, G.S. NF-KB: a key role in inflammatory disease. J. Clin. Invest. 107: 7-11 (2001).

Tang, C., Hsu, C., Yang, W., & Fong, Y. Lipoteichoic acid enhances IL-6 production in human synovial fibroblasts via TLR2 receptor, PKC δ and c-Src dependent pathways. Biochemical Pharmacology; 79.11:1648-1657 (2010).

Toll-Like Receptor (TLR)." Signaling Pathways. Web. Apr 28 2010.
<<http://www.invitrogen.com/site/us/en/home/Products-and-Services/Applications/Cell-and-Tissue-Analysis/Signaling-Pathways/Toll-like-Receptor-TLR.html>>.

Vignery, A. Macrophage fusion. Molecular mechanisms. In: Methods in Molecular Biology 475: Cell fusion: Overviews and Methods pp 149-161. Humana Press, Totowa, NJ (2008).

Vignery, Agnès . "Macrophage Fusion: The Making of Osteoclasts and Giant Cells ." J Exp Med 202.3: 337-340 (2005). <<http://jem.rupress.org/content/202/3/337.full>>.

Yanagashita, T., Watanabe, D., Akita, Y., Nakano, A., Ohshima, Y., Tamada, Y. and Matsumoto, Y. Construction of a novel in vitro epithelial cell granuloma model from a mouse macrophage cell line. Archives. Dermatological . Research. 299:399-403 (2007).