



**Michigan
Technological
University**

Michigan Technological University
Digital Commons @ Michigan Tech

Dissertations, Master's Theses and Master's Reports

2017

TIGHTENING THE LOOP ON THE CIRCULAR ECONOMY: DISTRIBUTED PLASTIC RECYCLING WITH AN OPEN SOURCE RECYCLEBOT

Shan Zhong

Michigan Technological University, szhong@mtu.edu

Copyright 2017 Shan Zhong

Recommended Citation

Zhong, Shan, "TIGHTENING THE LOOP ON THE CIRCULAR ECONOMY: DISTRIBUTED PLASTIC RECYCLING WITH AN OPEN SOURCE RECYCLEBOT", Open Access Master's Thesis, Michigan Technological University, 2017.

<https://digitalcommons.mtu.edu/etdr/397>

Follow this and additional works at: <https://digitalcommons.mtu.edu/etdr>



Part of the [Other Materials Science and Engineering Commons](#), and the [Polymer and Organic Materials Commons](#)

TIGHTENING THE LOOP ON THE CIRCULAR ECONOMY: DISTRIBUTED PLASTIC RECYCLING WITH
AN OPEN SOURCE RECYCLEBOT

By

Shan Zhong

A THESIS

Submitted in partial fulfillment of the requirements for the degree of

MASTER OF SCIENCE

In Materials Science and Engineering

MICHIGAN TECHNOLOGICAL UNIVERSITY

2017

© 2017 Shan Zhong

This thesis has been approved in partial fulfillment of the requirements for the Degree of
MASTER OF SCIENCE in Materials Science and Engineering.

Department of Materials Science and Engineering

Thesis Advisor: *Dr. Joshua A. Pearce*

Committee Member: *Dr. Stephen L. Kampe*

Committee Member: *Dr. Yun Hang Hu*

Department Chair: *Dr. Stephen L. Kampe*

Table of Contents

List of Figures	v
List of Tables	vii
Preface.....	ix
Acknowledgements.....	x
Abstract	xi
1. Introduction.....	1
1.1 Motivation	1
1.2 Thesis Outline	1
1.3 Reference.....	2
2. Energy Payback Time of Solar Photovoltaic Powered Waste Plastic Recyclebot System	4
2.1 Introduction	4
2.2 Methodology.....	6
2.2.1 Energy Payback Time	6
2.2.2 Embodied Energy	7
2.2.3 Filament production.....	10
2.3 Results	11
2.3.1 Embodied Energy of Recyclebot.....	11
2.3.2 Embodied Energy of Solar Photovoltaic System	13
2.3.3 PLA and ABS filament.....	14
2.4 Discussion	14
2.4.1 Energy Payback Time of Recyclebot	16
2.4.2 Energy Payback Time of Solar PV System	18
2.4.3 Energy Payback Time of Solar PV-Powered Recyclebot System.....	19
2.4.4 Applications in the Developing World.....	20
2.5 Conclusions	21
2.6 References	21
3. Tightening the Loop on the Circular Economy: Coupled Distributed Recycling and Manufacturing with Recyclebot and RepRap 3-D Printing.....	27
3.1 Introduction	27

3.2 Devices and methods.....	29
3.2.1 Material and energy measurements	29
3.2.2 Small-scale shredding of post-consumer plastic waste	30
3.2.3 Extruding filament.....	32
3.2.4 Printing Case Study Consumer Goods	33
3.2.5 Case Study Objects.....	34
3.3 Results.....	34
3.3.1 Shredding Post-Consumer Waste Plastic	34
3.3.2 Extruding Filament.....	37
3.3.3 Printing case study objects	38
3.4 Discussion	43
3.5 Conclusions.....	47
3.6 References	47
4. Conclusions and Recommendations/ Future Work.....	53
4.1 Overview	53
4.2 Conclusions Summary.....	53
4.2.1 Energy Payback Time of Solar Photovoltaic Powered Waste Plastic Recyclebot System:	53
4.2.2 Tightening the Loop on the Circular Economy: Coupled Distributed Recycling and Manufacturing with Recyclebot and RepRap 3-D Printing:.....	53
4.3 Future Work	54
4.4 References	55

List of Figures

Figure 1.1 The chemical structure for PLA [1].....	2
Figure 1.2 The chemical structure for ABS [2]	2
Figure 2.1 Verticle DC recyclebot. The white hopper is on the upper left and the black spooler is on the upper right. The motor in the upper middle drives and auger that feeds plastic into the hot zone (insulated in yellow). Filament is produced and looped through a light sensor to maintain loop length and thus filament diameter automatically. In this setup up the length and diameter can be measured continually.....	9
Figure 2.2 The percentage of the minimum embodied energy of each major component class in a recyclebot.	15
Figure 2.3 The percentage of the maximum embodied energy of each major component class in a recyclebot.	16
Figure 2.4 The general cost ranges for the recycled filament and commercial filament..	18
Figure 3.1 Post-consumer ABS stabilizing foot which is 92.36 g for each	30
Figure 3.2 Model of of open source granulator cutting chamber assembly.....	31
Figure 3.3 Comparison of filament quality from moist pellets and dried pellets	32
Figure 3.4 Recyclebot ac4.0 with labels	33
Figure 3.5 The post-consumer ABS plastic and crushed ABS pellets.....	35
Figure 3.6 A handful of crushed post-consumer ABS	36
Figure 3.7 Particle size distribution of a handful of ABS pellets	36
Figure 3.8 Total top side areas of different particle size ranges	36
Figure 3.9 The filament produced by recyclebot from crushed ABS pellets.....	37

Figure 3.10 The cross sections from different parts of recycled filament	38
Figure 3.11 The diameter distribution of recycled ABS filament	38
Figure 3.12 The camera bubble tripod printed a) components and b) assembled by the RepRap from recycled ABS filament	39
Figure 3.13 The SD card holder printed by the RepRap from recycled ABS filament	40
Figure 3.14 The camera hood printed a) with camera and b) with camera by the RepRap from recycled ABS filament	42
Figure 3.15 The energy consumption for producing a camera tripod, SD card holder and camera hood by traditional and distributed methods	44

List of Tables

Table 1.1 Some properties for PLA and ABS.....	2
Table 2.1 The embodied energy of materials needed in a recyclebot used in the input of the LCA.....	9
Table 2.2 Embodied energy for the barrel assembly of the recyclebot.	11
Table 2.3 Embodied energy for the frame assembly of the recyclebot.	11
Table 2.4 Embodied energy for the motor assembly of the recyclebot.	12
Table 2.5 Embodied energy for the electrical components and wiring part of recyclebot.	12
Table 2.6 Embodied energy for the feeder attachment and hopper part of recyclebot.....	13
Table 2.7 Embodied energy of single-crystal solar PV system [32].....	14
Table 3.1 Energy consumption, time consumption and filament consumption for printing a camera tripod.....	39
Table 3.2 Energy consumption and time consumption for producing a camera tripod from waste plastic	40
Table 3.3 Energy consumption, time consumption and filament consumption for printing a camera tripod.....	41
Table 3.4 Energy consumption and time consumption for producing a camera tripod from waste plastic	41
Table 3.5 Energy consumption, time consumption and filament consumption for printing a camera tripod.....	42

Table 3.6 Energy consumption and time consumption for producing a camera tripod from
waste plastic 42

Preface

This thesis is about distributed plastics recycling and composed of two submitted papers.

The contributions of authors are described hereafter.

Chapter two is under review. [Shan Zhong, Pratiksha Rakhe, Joshua M. Pearce, “Energy Payback Time of Solar Photovoltaic Powered Waste Plastic Recyclebot System”]. Shan Zhong was responsible for the literature review, experimental design, data collection, results analysis, figures, tables and writing the paper. Pratiksha Rakhe’s contribution in this project was on writing. J. M. Pearce contributed on the experimental design, writing, editing and consultation.

Chapter three is under review. [Shan Zhong, Joshua M. Pearce, “Tightening the Loop on the Circular Economy: Coupled Distributed Recycling and Manufacturing with Recyclebot and RepRap 3-D Printing”]. Shan Zhong’s contribution in this paper is on the literature review, experimental design, data collection, results analysis, figures, tables and writing the paper. J. M. Pearce contributed on the experimental design, writing, editing and consultation.

Acknowledgements

I would like to acknowledge the committee members: Dr. Stephen Kampe, Dr. Yun Hang Hu and particularly my advisor Dr. Joshua Pearce for all their professional guidance and assistance.

I would also like to thank Jerry Anzalone for the operation instruction and device maintenance.

Further thanks to my fellow graduate students, particularly, Handy Chandra, Adam Pringle, John Laureto, Siranee Nuchitprasitchai and Yuenyong Nilsiam.

A special thanks to my family for their unwavering support in this whole process.

Abstract

Following the goals of a circular economy, the growth of both plastic consumption and prosumer 3-D printing are driving an interest in producing 3-D printer filament from waste plastic. However, traditional recycling can have a significant environmental impact as it demands the collection and transportation of relatively low-density waste plastics to collection centers and reclamation facilities for separation and reconstruction. Compared to the traditional recycling, distributed recycling (where consumers directly recycle their own waste) has the potential to reduce energy consumption because it can save the energy for transportation needed in conventional recycling. A promising method of such distributed plastic recycling is to upcycle plastic waste into 3-D printing filament with a recyclebot, which is an open source waste plastic extruder.

In order to characterize the energy sustainability of this distributed recycling method, this study quantifies the embodied energy of a vertical DC solar-photovoltaic powered recyclebot based on life cycle energy analysis and compares it to horizontal AC recyclebot, conventional recycling and production of virgin 3-D printer filament. The energy payback time (EPBT) is calculated using the embodied energy of the materials making up the recyclebot itself and found to be about 5 days for extrusion of poly lactic acid (PLA) filament or 2.5 days for extrusion of acrylonitrile butadiene styrene (ABS) filament. The EPBT of a mono-crystalline silicon solar photovoltaic system is about 2.6 years alone. However, this can be reduced by over 96% if the solar photovoltaic system powers recyclebot to produce PLA filament from waste plastic (EPBT is only 0.10 year or about a month). Likewise, if ABS filament is produced from a recyclebot powered by

solar PV system, the energy saved is 90.6-99.9 MJ/kg and 26.33-29.43 kg of ABS filament needs to be produced in about half a month for the system to pay for itself. The results clearly show that the solar PV system powered recyclebot is already an excellent way to save energy for sustainable development.

If the recyclebot is combined with an open source self-replicating rapid prototyper (RepRap) 3-D printer, then the post-consumer plastics can be turned into useful and more valuable products directly. In order to analyze the impact of combining these two methods, this project also combines the distributed recycling method using a vertical recyclebot to make filament with distributed manufacturing using a delta RepRap to print useful products from post-consumer e-waste. Specifically, this study analyzes the recycling of ABS from computer waste into valuable consumer products pre-designed in the digital commons. The total electrical energy consumption for the combined process is monitored and an economic evaluation is completed. It is clear that using traditional recycling and manufacturing methods to produce an ABS product consumes more than double the energy compared to coupled distributed recycling and manufacturing method for complex products. Even more energy is saved for simple products. Simultaneously products valued in dollars can be made for pennies using the more environmentally-responsible combined processes. It is clear from the results that in the short-to-medium term, waste plastic from discarded e-waste can be significantly upcycled at the individual level using this commons-based approach. This tightening of the loop of the circular economy is a benefit of the environment and sustainability as well as the economic stability of consumers/prosumers.

1. Introduction

1.1 Motivation and Hypothesis

The object of this study is to follow the goals of circular economy, which is to decrease the energy and raw material consumption, reduce the cost of 3-D printing and increase the economic benefit of distributed recycling and manufacturing. The open source granulator and recyclebot are used to recycle thermoplastic and self-replicating rapid prototyper (RepRap) 3-D printer is used to produce products from recycled filament. Recycling plastics by recyclebot has the potential to save energy and raw materials, and the recyclebot powered by PV system can save energy further. Depending on the embodied energy of the plastic material, the energy payback time of PV combined recyclebot system varies slightly, but it is much less than the energy payback time of an individual PV system, which is already excellent for a commercial product (most never pay for themselves energetically).

The recycled filament from recyclebot can be used to print valuable products by RepRap, which can save energy from transportation and save materials by adjusting the fill density of products compared to traditional manufacturing method. 3-D printers allow for accurate fabrication and scale models as it can directly produce complex parts by building a component in layers from 3-D digital designs with essentially no material waste. The coupled distributed recycling and manufacturing method with recyclebot and RepRap tightens the recycling and production loops by decreasing the energy and materials consumptions, and generates great circular economic benefit for prosumers.

1.2 Thesis Outline

Chapter 2 investigates the embodied energy of recyclebot and a mono-crystalline silicon solar photovoltaic system, and estimates the energy payback time of an individual recyclebot and the PV powered recyclebot system based on the energy saved from plastics recycling of PLA. Chapter 3 describes a coupled distributed recycling and manufacturing method with recyclebot and RepRap. The post-consumer ABS plastic is recycled by the recyclebot, and RepRap uses the recycled filament to print valuable products. The energy consumption in the distributed recycling process and manufacturing process are compared to the traditional recycling method and manufacturing method. Finally, Chapter 4 discusses the experimental results in a broader perspective and draws recommendations for the future work.

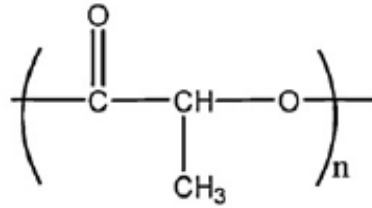

Figure 1.1 The chemical structure for PLA [1]

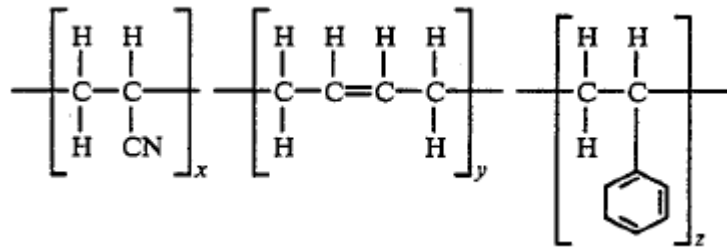

Figure 1.2 The chemical structure for ABS [2]

Table 1.1 Some properties for PLA and ABS

	PLA	ABS
Glass transition temperature (°C)	55-56 [3]	115.5 [4]
Degradation temperature (°C)	200 [5]	300-450 [6]
Tensile strength (MPa)	53 [3]	50 [7]
Elongation at yield (%)	1.7 [8]	7.5 [7]

1.3 Reference

1. Rasal, Rahul M., Amol V. Janorkar, and Douglas E. Hirt. Poly (lactic acid) modifications. Progress in polymer science 2010;35(3): 338-356.
2. Petiet, Thomas J. Halogenated bisphenol A ether flame retardant for ABS polymers. U.S. Patent 4,567,218, issued January 28, 1986.
3. Nampoothiri K. Madhavan, Nimisha Rajendran Nair, and Rojan Pappy John. An overview of the recent developments in polylactide (PLA) research. Bioresource technology 2010;101(22):8493-8501.
4. Li Yongjin, and Hiroshi Shimizu. Improvement in toughness of poly (l-lactide) (PLLA) through reactive blending with acrylonitrile-butadiene-styrene copolymer (ABS): morphology and properties. European Polymer Journal 2009;45(3):738-746.

5. Garlotta, Donald. A literature review of poly (lactic acid). *Journal of Polymers and the Environment* 2001;9(2):63-84.
6. Wang Shaofeng, Yuan Hu, Zhengzhou Wang, Tang Yong, Zuyao Chen, and Weicheng Fan. Synthesis and characterization of polycarbonate/ABS/montmorillonite nanocomposites. *Polymer Degradation and Stability* 2003;80(1):157-161.
7. Kim Jin Kuk, and Chang K. Kang. Basic studies on recycling of ABS resin. *Polymer-Plastics Technology and Engineering* 1995;34(6):875-890.
8. Jacobsen Sven, H. G. Fritz, Ph Degée, P. H. Dubois, and Robert Jérôme. Polylactide (PLA)—a new way of production. *Polymer Engineering & Science* 1999;39(7):1311-1319.

2. Energy Payback Time of Solar Photovoltaic Powered Waste Plastic Recyclebot System¹

2.1 Introduction

Global plastic production is growing 3.86% per year and is expected to increase to 850 million tons per year by 2050 [1, 2]. This growth aggravates the challenges of waste plastics disposal, especially in remote areas [3]. Landfill and incineration methods induce several negative environmental issues [4, 5, 6], and this linear model of resource consumption with a “take-make-dispose” pattern has increasingly significant economic limits [7]. To mitigate the contradiction between the rapid economic growth and the shortage of virgin materials and energy, the circular economy was first proposed in 1998 to build up the circular flow of materials and the use of resources and energy through multiple phases [8, 9]. Following the goals of a circular economy, recycling is becoming the mainstream method to dispose of waste plastics [10]. The conventional recycling method is to collect and transport waste plastic to a collection center and reclamation facility for separation and recycling [11]. This method usually consumes large amounts of energy for transportation [12], and needs considerable labor to separate the waste plastics [13]. In developing regions, this labor is provided by waste pickers, which collect post-consumer plastic in landfills [14].

Compared to conventional recycling methods, distributed recycling of plastic has the potential to conserve energy. For example, plastic air-filled bottles have been used as building units to replace traditional concrete blocks and have demonstrated superior thermal insulation [15]. This conserves energy used for the resultant building HVAC as well as the embodied energy of concrete and conventional recycling of waste plastic. Another example uses plastic containers converted into bio-gas digesters, which demonstrated higher gas yields in black-coated plastic containers than other materials [16]. Those studies indicate that distributed plastic recycling has potential to conserve energy for sustainable development. In this study, another distributed recycling method using a recyclebot is investigated in detail.

The recyclebot, an open source waste plastic extruder, offers a new approach to plastics recycling, which can be distributed and operated as a small business or even in the home [17]. The recyclebot contains a feeding zone, heating pipe and extrusion section. Plastic melts in the heating pipe and is extruded through a nozzle to form filament for 3-D printing [17]. This recycling method is not difficult to operate and is supported for many thermo-plastic products, which are identified with recycling codes [18]. The system is automated although the plastic containers must be cleaned and shredded before processing in the recyclebot. Using a recyclebot in the location that

¹ The material contained in this chapter is to be submitted to the journal.

plastic waste is generated not only saves the energy for transportation [19, 20], but can also increase personal income when the filament is sold [14]. As 3-D printing technology is developing to be of wide applicability for distributed manufacturing throughout the world [21, 22, 23], expensive commercial filament is one of remaining impediments to extended popularity of 3-D printing. The application of a recyclebot, which can produce filament for about 10 cents per kg of electricity [17], can further improve the economics of 3-D printing and extend distributed manufacturing [24].

The conventional recyclebot is powered by grid-provided electricity (referred to here as an AC recyclebot for clarity). For an AC recyclebot previous studies have shown that the embodied energy for shredding waste plastic is trivial, so the energy for producing filament is equivalent to the electricity consumption of the recyclebot alone [25]. The emissions from recycling waste plastic into 3-D printer filament are thus dependent on the greenhouse gas emissions of the electric grid that varies widely, from 0.00019 to 1.94 kg/kWh [26].

As a potential source of wide-scale renewable energy, solar electricity generation is increasing in popularity globally because of technical advances and reductions in costs [27]. Solar photovoltaic (PV) technology has been found to be particularly appropriate in the developing world [28,29, 30, 31, 32, 33]. Recent developments in the RepRap 3-D printer community [34] to make PV-powered 3-D printer designs [35, 36] can be directly transferred to direct current (DC)-based recyclebot technology [37]. These solar-powered recyclebots would have a double effect on energy and emissions savings. First, they offset grid electricity to make commercial 3-D printer filament and then again by reducing energy used and emissions with distributed recycling itself.

The solar-powered recyclebot has not been quantified previously and to do this a life cycle energy analysis is needed. Energy analysis is the process of determining the energy required directly and indirectly to allow a system to produce a specific good or service. Energy payback time (EPBT) is one metric adopted by several analysts in characterizing the energy sustainability of various technologies [38].

This paper quantifies the embodied energy of a vertical DC solar-powered recyclebot based on life cycle energy analysis and compares it to horizontal AC recyclebot, conventional recycling and production of virgin 3-D printer filament. The EPBT is calculated using the embodied energy of the materials making up the recyclebot itself. The mass of 3-D printer filament that the recyclebot must produce to offset the embodied energy for creating the recyclebot device is calculated. In addition, after combining a recyclebot and solar photovoltaic system, the amount of filament needed to pay for the whole system is also calculated, as well as the energy payback time. These results are compared to previous studies that investigated only the energy payback time for PV alone and discussed in the context of distributed recycling, energy conservation and GHG emissions mitigation.

2.2 Methodology

2.2.1 Energy Payback Time

The goal of this study is to investigate the energy payback time of solar photovoltaic powered vertical DC recyclebot, which consists of the PV module, a small battery system and all the parts for the thermo-mechanical system of the recyclebot. The EPBT can be mathematically determined by, first determining the energy saved by a system,

$$E_S = E_F - E_G \quad (2.1)$$

where E_S (MJ) is the energy saved by system, E_F (MJ) is the energy needed to form the system, E_G (MJ) is the energy generated or conserved by system.

The input energy E_F in the system can be classified as the respective embodied energies of each material present in the whole device. Embodied energy is the amount of energy required to produce the material in its product form [39].

EPBT for recyclebot alone will be calculated as:

$$EPBT_{recyclebot} = \frac{E_R}{(E_V - E_W) * v} \quad (\text{Unit: hour}) \quad (2.2)$$

where E_R (MJ) is the embodied energy of recyclebot, E_V (MJ/kg) is the energy for producing filament from virgin material, E_W (MJ/kg) is the energy for producing filament by recyclebot from waste plastic, and v (kg/h) is the extrusion rate.

EPBT of solar photovoltaic system powered recyclebot can be calculated as,

$$EPBT_{whole} = \frac{E_{whole}}{E_V * v} \quad (\text{Unit: hour}) \quad (2.3)$$

where E_{whole} (MJ) is the embodied energy of the whole system, which is the sum of the embodied energies of recyclebot and solar PV system.

The energy for producing recycled filament (E_R) and the filament extrusion rate (v) are obtained from the filament production experiment, and the detailed process is introduced in 2.2.3. The energy for producing commercial filament (E_V) is estimated with the plastic embodied energy, which is searched from the CES EduPack which provides a comprehensive database of materials and process information, powerful materials software tools, and a range of supporting resources [40, 41]. The embodied energy of recyclebot (E_R) is calculated by the sum of embodied energies of all components, but the manual energy (e.g. human labor) is not included, and the detailed process is introduced

in 2.2.2.2. The embodied energy of the solar PV system is estimated by the PV module area, and the energy consumption to produce the PV system in unit size is also determined from prior LCA studies, and the detailed information is in 2.2.2.1. A previous study investigating a horizontal AC-powered recyclebot found the energy for producing filament to be low (8.74 MJ to produce 1 kg HDPE filament) compared to production from virgin resin (76.7 MJ/kg) and waste HDPE processed in a conventional recycling center (48.9 MJ/kg) [25]. It should be noted that the energy required during the extrusion differs with thermoplastic materials and insulation used on a particular recyclebot machine.

The solar modules use solar insolation for the generation of electricity, which is stored in batteries. The power from the battery is then used to power the recyclebot for the extrusion of filament. The total energy used in the whole process from solar panels to extrusion can be calculated with the consumed energy during extrusion. These calculated energies can now be used in obtaining the EPBT of the whole system.

2.2.2 Embodied Energy

2.2.2.1 Solar Photovoltaic System

Solar PV is a clean, sustainable, renewable energy conversion technology that can help meet the energy demands of the world's growing population, while reducing the adverse anthropogenic impacts of fossil fuel use [42]. Solar photovoltaics growth has been rapid and by 2018, worldwide photovoltaic capacity is predicted to double to 430 GW [43]. As the AC recyclebot extrusion of HDPE filament requires 21.13W power, and initial heating need 0.06 kWh [25]. In this project, it was assumed that the DC recyclebot would use approximately the same power for initial heating, so two small monocrystalline silicon solar modules were used in the design of the system. Each module has an effective area of 0.2613 m² and produces 30W of power. According to energy requirement of initial heating, it requires a battery that has an output of 0.06 kW to finish within 1 hour. An identical small battery system for the off-grid 3-D printer [36] was used. The storage battery access makes the recyclebot work even in the absence of solar energy (e.g. during cloudy weather). PV modules need a support structure for the setup, but this can be improvised in the field from found materials as the system can be mobile. For example, PV modules can be propped against a wall or a rock in the field. The energy output of solar module depends on the radiation and the proper placement of the panels so as to receive maximum solar radiation for maximum efficiency. Insolation varies by location also affects the energy output of the system.

With the size of the solar PV system, its embodied energy can be estimated by the embodied energy of solar PV system in unit size which is found from the literature. In the solar PV system of this study, the energy consumptions for all the production processes and accessories are assumed to be scaled to the size of solar PV system.

2.2.2.2 Recyclebot (Recyclebot v4.0)

Both an AC powered and DC powered vertical recyclebots v4.0 [37] are used in this study. The devices consist of high power motor, feed tube, heating tube, frame, electrical components and wiring. All the components of the recyclebot are determined from the complete bill of materials and their corresponding mass is obtained. The embodied energies of all the materials used in the recyclebot are tabulated from the CES database [41]. Then the embodied energy of each component can be calculated by multiplying the mass by the corresponding material embodied energy. For example, the recyclebot requires a support structure, which consists of two 60.96 cm long, 1.6 kg weight strut channels made of steel whose embodied energy is 30.8-33.9 MJ/kg. According to the product of mass of the strut channels and embodied energy of steel, the embodied energy of strut channels is 98.56-108.48 MJ. The embodied energies of other components are calculated in the same way. Table 2.1 shows the embodied energy of materials used in a DC recyclebot v4.0. It should be noted that these values of embodied energy are just for materials and do not include energy for forming products. Hence the actual embodied energy might be about 26% larger than the value calculated in this project based on the comparison of energy between materials and forming products [43]. The motor is a 120W gear motor with 15 rpm combining with the heating tube and feed tube which helps in melting and extrusion of filament. The embodied energy of motor is obtained by the sum of embodied energy of its various components within it, which is 58.382-64.373 MJ. Except for the metallic parts, the recyclebot also consists of 3-D printed parts such as bearing house and feeder attachment, which are made of PLA. 3-D printed parts in this system were printed from the Rep-Rap 3D printer. The requirement and the dimensions of the object are analyzed. The respective material of every component is important as it decides the strength and efficiency of the system in whole.

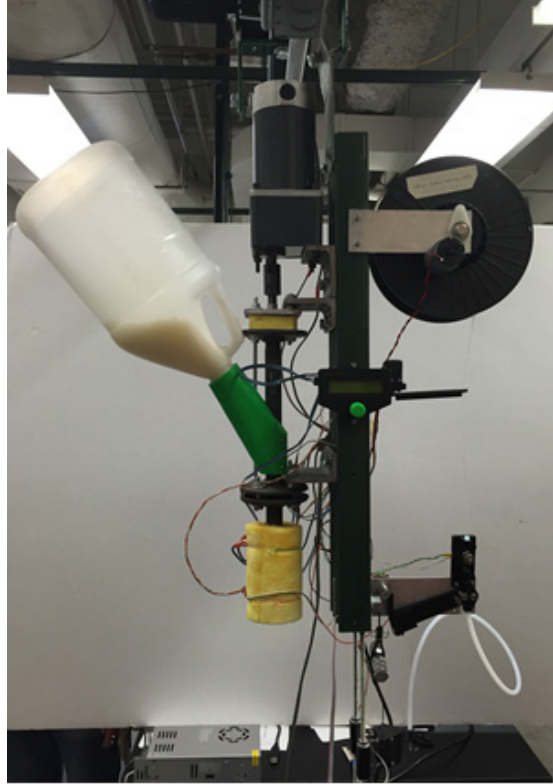

Figure 2.1 Verticle DC recyclebot. The white hopper is on the upper left and the black spooler is on the upper right. The motor in the upper middle drives and auger that feeds plastic into the hot zone (insulated in yellow). Filament is produced and looped through a light sensor to maintain loop length and thus filament diameter automatically. In this setup up the length and diameter can be measured continually.

Table 2.1 The embodied energy of materials needed in a recyclebot used in the input of the LCA (CES database [41])

Material	Embodied energy (MJ/kg)		CO ₂ footprint (kg/kg)
	Primary production	Recycling	
Steel	30.8-33.9	8.1-8.98	2.26-2.49
Galvanised steel	38.1-42	9.53-10.5	2.87-3.16
Brass	57.4-63.3	13-14.4	3.64-4.01
Stainless steel	50.4-55.6	11.8-13	3.63-4
Chromium steel	50.4-55.6	11.8-13	3.63-4
Copper	56.1-61.9	12.8-14.1	3.44-3.79
PVC	60.6-66.8	20.6-22.7	2.63-2.89
Silicon	1260-2240	-	94.5-168
Plastic	90.1-101	31.1-34.4	4.32-4.76

Lead	36.9-40.6	9.3-10.3	2.84-3.13
PC	109-120	36.9-40.8	7.03-7.75
HDPE	74.9-82.5	25.4-28.1	2.65-2.92
ABS	90.6-99.9	30.7-34	3.45-3.81
Ni	159-175	28.2-31.2	11.2-12.3
Pt	274000-302000	8140-8990	14000-15500
PLA	49.2-54.2	16.7-18.4	2.65-2.93
Nickle chromium	189-208	32.2-35.6	10.4-11.4
Lead-antimony	62-68.4	13.8-15.3	4.95-5.46
Epoxy	126-139	-	6.12-6.75
Ferrites(Fe_3O_4)	15.6-17.2	-	0.84-0.929
Aromatic polyimide	176-194	-	9.61-10.6

2.2.3 Filament production

PLA pellets and waste plastic ABS shards were used to produce filament with a DC recyclebot and an AC recyclebot respectively. Before the filament production, the temperature ranges of 150-180 °C and 158-190 °C with step of 2 °C were set to find out the best temperatures for PLA and ABS filament extrusion, respectively. The minimum temperature in the ranges were determined by the limit of the mobility of plastics for extrusion, and the temperatures increased until the plastic materials started to smoke (maximum temperature). These test experiments were performed under three auger rotation speeds, 6 r/min, 10 r/min and 15 r/min. It was found that the extrusion rate is largest and the melted plastic has rather higher plasticization properties when the auger rotation speed is 15 r/min. It was also found that the PLA filament extruded at 155 °C and the ABS filament extruded at 158 °C have rather higher surface gloss and mechanical properties.

In PLA filament production, the DC recyclebot heating tube temperature was set as 155 °C, and 17 minutes were needed in the initial heating phase of production. In ABS filament production, the AC recyclebot heating tube temperature was set as 158 °C, and 8 minutes were needed in the initial heating phase. As the temperature reached the set points, the respective motors were activated to rotate the augers. The rotation speed of the augers in both recyclebots was about 15 r/min. The initial 0.5 meters of filament was discarded because of poor mechanical properties as the feedback loop was established. Then the filament was collected in an auto spooler with the help of light sensor. The filament diameter in this study is 3.00 mm. A watt meter and timer were used to record power and time during the process.

2.3 Results

2.3.1 Embodied Energy of Recyclebot

The recyclebot can be separated into five key components by their function: barrel, frame, motor, electrical components and wiring, and feeder attachment and hopper. The detailed breakdown of the embodied energy about the five parts of recyclebot are presented in Tables 2.2, 2.3, 2.4, 2.5 and 2.6, respectively.

Table 2.2 Embodied energy for the barrel assembly of the recyclebot.

Part	Quantity	Material	Mass (kg)	Embodied energy	
				Min (MJ)	Max (MJ)
Heating tube	1	steel	0.30	9.24	10.17
Feed tube	1	steel	0.28	8.624	9.492
Feed screw	1	galvanised steel	0.15	5.715	6.3
Floor flange	3	steel	0.75	23.1	25.425
Brass nozzle	1	brass	0.15	8.61	9.495
Rod	4	galvanised steel	0.148	5.639	6.216
1½" bolt	2	galvanised steel	0.036	1.372	1.512
2 ¼" bolt	2	galvanised steel	0.044	1.676	1.848
Nut	16	galvanised steel	0.086	3.277	3.612
Washer	64	stainless steel	0.128	4.877	5.376
Kapton tape	1	aromatic polyimide	0.008	1.408	1.552
Nichrome wire	17 ft	nickle chromium	0.004	0.756	0.832
Bearing	1	chrome steel	0.13	6.552	7.228
Bearing house	1	PLA	0.03	1.476	1.626
Brass spacer	1	brass	0.12	6.888	7.596
Total				89.209	98.28

Table 2.3 Embodied energy for the frame assembly of the recyclebot.

Part	Quantity	Material	Mass (kg)	Embodied energy	
				Min (MJ)	Max (MJ)
Strut Channel	2	steel	3.2	98.56	108.48
Barrel Bracket	2	steel	0.8	24.64	27.12
Motor mount	2	steel	0.8	24.64	27.12
Strut Channel T-nut	6	galvanised steel	0.066	2.515	2.772
Socket head bolt	6	galvanised steel	0.132	5.029	5.544
M6 Bolt	2	galvanised steel	0.044	1.676	1.848
Split Washer	2	stainless steel	0.004	0.202	0.222

Flat washer	2	stainless steel	0.004	0.202	0.222
Deep well socket	1	galvanised steel	0.1	3.81	4.2
Total				161.273	177.529

Table 2.4 Embodied energy for the motor assembly of the recyclebot.

Part	Quantity	Material	Mass (kg)	Embodied energy	
				Min (MJ)	Max (MJ)
rotor	2	galvanized steel	0.56	21.336	23.52
ball bearing	2	chrome steel	0.26	13.104	14.456
shaft	1	galvanized steel	0.17	6.477	7.14
stator	1	steel	0.15	4.62	5.085
		copper	0.08	4.488	4.952
winding	1	copper	0.12	6.732	7.428
cable	1	copper	0.016	0.898	0.990
		PVC	0.012	0.727	0.802
Total				58.382	64.373

Table 2.5 Embodied energy for the electrical components and wiring part of recyclebot.

Part	Quantity	Material	Mass (g)	Embodied energy	
				Min (MJ)	Max (MJ)
Speed controller	1	silicon	0.2	0.252	0.448
		copper	29.5	1.655	1.826
		lead	6.0	0.221	0.244
		steel	150	4.62	5.085
		PVC	1.0	0.061	0.067
		epoxy	2.5	0.315	0.3475
		plastic	8.5	0.766	0.858
Temperature Controller	1	silicon	0.15	0.189	0.336
		copper	29.0	1.627	1.795
		lead	12.5	0.461	0.508
		platinum	0.005	1.37	1.51
		ferrites	2.5	0.039	0.043
		Lead-antimony	0.1	0.006	0.007
		PC	66.0	7.194	7.92
Solid state relay kit	1	epoxy	7.5	0.945	1.042
		silicon	0.06	0.076	0.134
		copper	17.0	0.9537	1.0523

		lead	6.0	0.221	0.244
		ferrites	2.5	0.039	0.043
		PC	12	1.308	1.44
		epoxy	2.5	0.315	0.348
Terminal strip	1	galvanised steel	10	0.381	0.42
		copper	6.0	0.337	0.371
		PC	12.0	1.308	1.44
K-type thermocouple	1	copper	45.0	2.524	2.786
		nickel	40.0	6.36	7.00
power cord and plug	1	copper	32.0	1.795	1.981
		PVC	36.0	2.182	2.405
Solderless connector	2	copper	6.0	0.337	0.371
		PVC	4.0	0.242	0.267
Insulated copper wire	10 ft	copper	16.0	0.898	0.990
		PVC	3.0	0.182	0.200
Kapton tape	1	aromatic polyimide	8.0	1.408	1.552
Hose clamp	1	stainless steel	22.7	1.144	1.262
Total				41.731	46.343

Table 2.6 Embodied energy for the feeder attachment and hopper part of recyclebot

Part	Quantity	Material	Mass (kg)	Embodied energy	
				Min (MJ)	Max (MJ)
Feeder attachment	1	PLA	0.045	2.214	2.439
Hopper	1	HDPE	0.015	1.124	1.238
Total				3.338	3.676

2.3.2 Embodied Energy of Solar Photovoltaic System

The energy needed for the small PV system to power the recyclebot can be divided in two parts: fabrication of PV module and its balance of system. The procedure for fabrication of solar PV module can be described in brief as purification and growing of crystal silicon, cell fabrication from a silicon wafer, and module assembly. The balance of system (BOS) for a PV system includes foundation, support structure, battery, inverter, electronic components, installation, wiring and cables [39]. In this study, the foundation and support structure is not necessary because it is just a temporarily positioned device and PV modules can be propped against a wall or a rock in the field. The detailed information about embodied energy of the single crystal solar PV system needed to power the recyclebot is showed in Table 2.7. It should be noted that the embodied energy in Table 2.7 all are scaled to the PV sizes used to power the recyclebot.

The area of PV modules used in this project is 0.5226m², so the embodied energy of this PV system is about 2276.44MJ or 632.34 kWh.

Table 2.7 Embodied energy of single-crystal solar PV system [39]

Process & item	Silicon purification and processing	Cell fabrication	Module assembly	Balance of system			Total
				Battery	Inverter	electronic components	
Embodied energy (MJ/m ²)	2397.6	432	684	165.6	118.8	558	4356

2.3.3 PLA and ABS filament

In PLA filament production, the DC recyclebot needed 17 minutes and 64.8 kJ for initial heating. During the extrusion process, the DC recyclebot consumes 0.01 kWh to extrude 22.6 grams of PLA filament. The energy for initial heating is inconsequential compared to the energy for whole day extrusion, so the average energy used for PLA filament production is 1.59 MJ/kg. The extrusion rate is not a constant, but the average extrusion rate is 0.19 kg/h. Thus it takes a little more than 5 hours to generate a kg of PLA filament from with a DC vertical recyclebot.

In ABS filament production, 8 minutes and 36.0 kJ were needed for initial heating by AC vertical recyclebot. The average energy used for ABS filament production is 1.24 MJ/kg, and its average extrusion rate is 0.22 kg/h.

2.4 Discussion

Based on the data in Tables 2.2-2.6, the embodied energy of the recyclebot is 353.933-390.201 MJ, which is equivalent to the energy for producing two coffee makers [44]. Figure 2.2 and Figure 2.3 are the pie charts showing the percentage of minimum embodied energy and maximum embodied energy of each core component in a recyclebot. From Figure 2.2-3, it is clear that there is not much difference between the minimum embodied energy percentage and maximum embodied energy percentage, and the frame part consumes nearly half of the total embodied energy. The strut channel of the frame has 98.56-108.48 MJ embodied energy, which is equivalent to the energy of a barrel part or double the energy of electrical components and the wiring part. The frame contains many heavy components made of metal, which is the cause of the high embodied energy. Thus to improve the sustainability of the device, this indicates design effort should focus on minimizing the use of metal in the frame. In electrical components

and wiring parts, there are several materials which contain very high embodied energy, such as electrical grade silicon in the speed controller and platinum in the temperature controller. These materials, however, have low masses in the components so they do not contribute much in the total embodied energy. There are some small components created by a 3-D printer, such as the bearing house and the feeder attachment. When the 3-D printer is powered by the solar photovoltaic system, the embodied energy of these printed components can be reduced further [29].

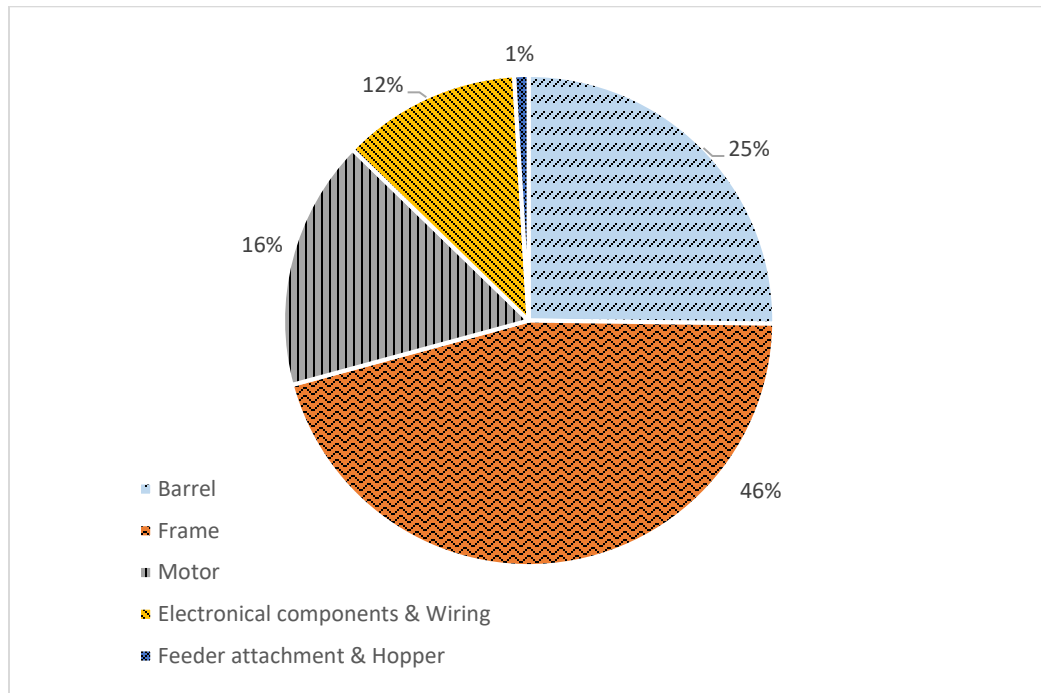

Figure 2.2 The percentage of the minimum embodied energy of each major component class in a recyclebot.

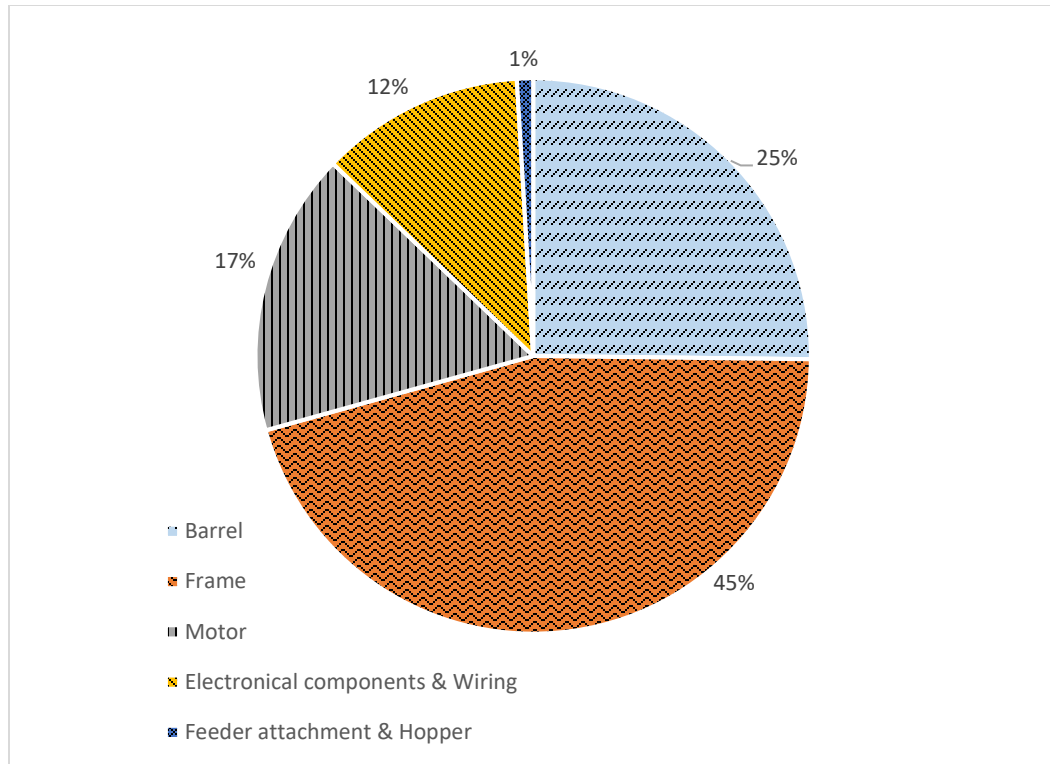

Figure 2.3 The percentage of the maximum embodied energy of each major component class in a recyclebot.

As can be seen by comparing Table 2.7 with Tables 2.2-2.6, the energy needed to make a solar PV system is 2,276 MJ, which 484-523% more than that of a recyclebot. The purification and growing crystal silicon process consumes half of the total energy. In the purification process, silicon dioxide is reduced to silicon with carbon and purified in the furnace repeatedly to metallurgical grade silicon, and then further purified to obtain solar-grade silicon, which needs a lot of energy [45]. An approach to reduce this embodied energy of the PV component in the future would be to use thin film PV [46]. In the balance of systems, the electrical components have the largest embodied energy in this case. If the solar powered recyclebot needs to be designed as a permanent device, the foundation and support structures are required. Then the support structure will consume the largest energy in the balance of systems, which is 1800 MJ/m² in the open field and 720 MJ/m² on the roof top [39]. However, it should be noted, there are low-mass racking systems that may be appropriate, which will reduce these values [47].

2.4.1 Energy Payback Time of Recyclebot

The EPBT of a recyclebot varies with the material of filament. In this project, it takes 1.59 MJ for a DC recyclebot to extrude 1 kg of PLA filament, while 1 kg of

commercial filament made from virgin PLA consumes 49.2-54.2 MJ. Thus, PLA filament produced by recyclebot from waste plastic can save 47.61-52.61 MJ/kg. Compared to the embodied energy of recyclebot which is 353.94-390.20 MJ, producing 6.73-8.20 kg of PLA filament from waste plastic can pay for a recyclebot in terms of energy. Given the extrusion rate of the DC recyclebot this could be accomplished conservatively in one week.

From this study on an AC recyclebot, the average energy used for ABS filament production from recyclebot is 1.24 MJ/kg. Compared to commercial filament made from virgin ABS, which needs 90.6-99.9 MJ/kg, the filament produced by the recyclebot from consumed ABS saves 89.36-98.66 MJ/kg of energy. Therefore, the recyclebot needs to produce 3.59-4.37 kg of ABS filament, and the energy saved from it will be equal to the energy for creating the recyclebot.

During the vertical DC recyclebot extrusion process, the average extrusion rate of PLA filament was found here to be 0.19 kg/h, while that of ABS filament was 0.22 kg/h on a vertical AC-based recyclebot. It is found that the recyclebot needs to work 35.42-43.16 hours with PLA filament or 16.32-19.86 hours with ABS filament to pay for itself. Here assuming that the recyclebot works 8 hours per day, the energy payback time can be obtained in only about 5 days based on PLA filament or about 2.5 days based on ABS filament. Clearly the potential to conserve energy with distributed waste plastic recycling is substantial.

2.4.2 Cost of Recyclebot-made filament

If labor and capital costs are excluded the cost to produce recycled waste plastic filament can be determined by the energy use of the recyclebot. In a single recyclebot system, the energy used in the extrusion process was provided from the electricity grid. The average electricity price in the U.S. is \$0.12/kWh or 3 cents/MJ. The energy consumptions to produce 1 kg of PLA and 1kg of ABS are 1.59 MJ and 1.24 MJ, respectively. With the average electricity price, the estimated cost for producing 1 kg of PLA and 1 kg of ABS can be calculated as 5 cents and 4 cents, respectively.

However, the electricity price varies from different locations. From the EIA database [48], the electricity prices in January 2017 vary from 1.74 cents/MJ to 7.04 cents/MJ in different states. The estimated costs for producing 1 kg of PLA and 1 kg of ABS can vary from 2.77 cents to 11.19 cents and 2.16 cents to 8.73 cents, respectively. Even though the device is operated in Hawaii which has the most expensive electricity price in U.S., the cost to produce 1 kg of PLA filament and 1 kg of ABS filament are still very inexpensive, just 11.19 cents and 8.73 cents. The price for 1 kg of PLA filament on Amazon ranges from \$14.95-89.99 and the price for 1 kg of ABS filament is from \$13.99-58.51 [49, 50, 51, 52]. Compared to the commercial filament, recycled filament

produced by the recyclebot can save significant amounts of money. Figure 2.3 is the comparison of the general cost ranges for producing recycled filament and buying commercial filament in market, and it can be seen that the cost for recycled filament is negligible.

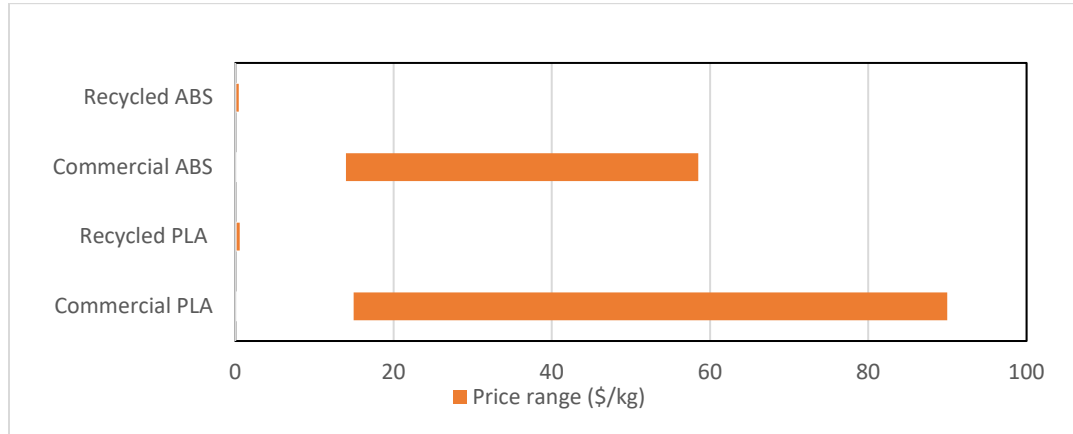

Figure 2.4 The general cost ranges for the recycled filament and commercial filament

2.4.3 Energy Payback Time of Solar PV System

The EPBT of solar PV system depends on materials of the module, the balance of systems, and the geographic location [43, 54]. Among them, the type of material determines energy conversion efficiency and geographical location determines solar flux, and the energy generated by solar PV system can be obtained by the product of solar flux and energy conversion efficiency. The EPBT can be calculated by the embodied energy dividing annual energy generated by the system [54]. In order to compare the effect of the solar powered recyclebot on saving energy, the general case of a monocrystalline silicon PV system is chosen for comparison, which has an energy conversion efficiency of 16.1% [55] and is located in a place which has global average solar flux of 8 kWh/m²/day. Then the annual average insolation is 2920 kWh/m²/year and energy generated by PV system in this project is 245.68 kWh/year. Thus, the EPBT of solar PV system used in this project, which has embodied energy of 632.34 kWh, is about 2.57 years. The fact that PV systems are an extremely favorable energy and emissions performer are well established. However, the results here show these values can be improved further when PV power is used for recycling.

2.4.4 Energy Payback Time of Solar PV-Powered Recyclebot System

Due to two monocrystalline solar panel being used the embodied energy of the solar photovoltaic system is 2,276.44 MJ and the embodied energy for the whole system is 2630.37-2666.64 MJ (i.e. the whole systems is the sum of the recyclebot and the solar PV system). When the recyclebot is powered by the solar PV system, the electricity used in producing filament from waste material also can be saved, which means energy saved is equal to the embodied energy of commercial filament. Thus, 48.53-54.2 kg PLA filament needs to be produced from consumed plastic to pay for the whole system in terms of energy. This means that the energy payback time of the whole system is 255.42-285.26 hours in terms of PLA, which is about 1 month, based on the assumption that the whole system works 8 hours per day. Comparing the EPBT of a single crystal solar PV system, whose EPBT is about 2.57 years, the EPBT of solar PV system combined with the recyclebot can be decreased at least by 96.20% if PLA filament is produced. Thus, the effect on saving energy of the whole system is clear. Likewise, if ABS filament is produced from a recyclebot powered by solar PV system, the energy saved is 90.6-99.9 MJ/kg. 26.33-29.43 kg of ABS filament needs to be produced from waste plastic to pay for the whole system. As the average extrusion rate of ABS filament is 0.22 kg /h, the EPBT of whole system based on ABS filament is 119.68-133.77 hours, which is about 0.04 years or about half a month.

The results clearly show that the solar PV system powered recyclebot is already an excellent way to save energy for sustainable development. Among PV modules, thin film modules have the lowest EPBT, which is 0.5 years, while considering balance of system, its EPBT is 1.5 years [46]. However, EPBT of single-crystal silicon photovoltaic system can decrease from 2.57 years to 0.09 years when it is combined with recyclebot, which produces PLA filament. Thus, single crystal silicon photovoltaic system combined with recyclebots, have about one thirtieth of the EPBT of thin film photovoltaic systems alone. However, the performance can be improved with the use of solar powered recyclebots consisting of low-embodied energy thin film PV.

Furthermore, the EPBT of solar PV system powered recyclebot can be further reduced with device improvements itself. In a recyclebot, the embodied energy of strut channel is a substantial fraction of the total energy of recyclebot. If the strut channel uses other materials which contain less embodied energy instead of steel, the total energy of the system will decrease. Properly designed ABS struts could offer a good choice because of the strength and impact resistance. The size of the individual components would need to be augmented to withstand the load when materials with longer strength are used similar to previous work on brackets for PV modules [24,47]. The ABS strut channel with a little larger size in this project could be strong enough to hold the recyclebot and motor. Future work is needed to optimize such a design. This would decrease embodied energy and accelerate EPBT as ABS has 95,300 MJ/m³ of embodied energy, while steel

has 285,400.5 MJ/m³ of embodied energy. In addition to the strut channel, the barrel bracket and motor mount also can be made from ABS, which also can reduce the total embodied energy.

2.4.5 Economic Payback Time of Solar Powered Recyclebot

Compared to the individual recyclebot, the energy for producing filament from waste plastics by the PV powered recyclebot can also be saved from the electricity grid, so the cost from the electricity grid can be saved by the whole system, which means the total cost saving by the whole system is equal to the price of commercial filament. The total cost for building the entire system is around \$1000 which is the cost sum of a recyclebot and a solar PV system. The normal price of 1 kg of PLA or ABS filament is \$20, so 50 kg of filament need to be produced by the whole system to pay for itself in terms of monetary cost. With the PLA and ABS filament extrusion rates, 263.16 hours and 227.27 hours are needed to produce 50 kg of PLA filament and 50 kg of ABS filament, respectively. Therefore, the monetary payback time of the whole system is 263.16 hours (32.9 days) with PLA filament production, or 227.27 hours (28.4 days) with ABS filament production.

2. 5 Applications in the Developing World

For those developing countries, whose energy access promotions have not met the requirement of sustainable development [56], the results of this study indicate that solar-powered recycling may be beneficial from an energy perspective. In addition, solar-powered recycling can help developing countries to reduce carbon emissions, which is necessary because the carbon emission from developing countries is more than from developed countries with the same unit of value-added [57]. Finally, it is well established that access to modern energy can increase income for families in developing countries [58]. This study has shown one application of modern energy using solar-powered recyclebot have potential to profitably produce filament, while avoiding the consumption of raw materials and grid electricity. This filament can be sold or higher value items can be printed to expand an entrepreneur's or community's income.

In addition, when a 3-D printer creates products, it needs energy to melt filament and form products. If a solar photovoltaic system not only powers the recyclebot, but also powers the 3-D printer to manufacture products further energy and emissions are saved. Moreover, if some small components used in recyclebot, such as barrel bracket, motor mount, bearing house and feeder attachment, are produced by 3-D printer powered by solar photovoltaic system, the embodied energy of recyclebot can be further reduced. Solar PV system powered recyclebot and 3-D printer systems are an excellent method to manufacture products from waste plastics by consumers anywhere in the world. This

method can turn waste plastics into useful high-value products, so it effectively decreases the expenditure from the cost of products and transportation. In conclusion, this method not only saves energy and money, but also reduces the emission of greenhouse gas, which is accord with sustainable development.

2.6 Conclusions

This study presented the embodied energy of DC vertical recyclebot powered with a mono-crystalline solar photovoltaic-battery system, and calculated the energy payback time of the recyclebot and the whole system. The results show that using a recyclebot to create 3-D printing filament from post-consumer plastics is an effective way to save energy, and the EPBT of recyclebot is 5 days based on PLA filament, or just 2.5 days based on ABS filament. When the recyclebot is powered by a solar photovoltaic system to produce filament, the energy can be further saved and equals to the energy for producing commercial filament from virgin materials. The EPBT of the whole system is just several weeks depending on the material used. When a solar powered recyclebot produces PLA filament from waste plastics, the EPBT of the whole system is about one month which decreased the EPBT of a single crystal photovoltaic system by over 96%. It is clear that solar photovoltaic powered recyclebots are an effective method to reduce energy use and protect the environment to meet the requirement of sustainable development.

2.6 References

1. Shen, Li, Juliane Haufe, and Martin K. Patel. Product overview and market projection of emerging bio-based plastics PRO-BIP 2009. Report for European Polysaccharide Network of Excellence (EPNOE) and European Bioplastics 2009; 243.
2. Plastics Europe. Production of plastics worldwide from 1950 to 2014 (in million metric tons). <http://www.statista.com/statistics/282732/global-production-of-plastics-since-1950>, March 16, 2016.
3. Barnes, David KA, Francois Galgani, Richard C. Thompson, and Morton Barlaz. Accumulation and fragmentation of plastic debris in global environments. *Philosophical Transactions of the Royal Society of London B: Biological Sciences* 2009;364(1526):1985-1998.
4. Zhang, J., Wang, X., Gong, J. and Gu, Z. A study on the biodegradability of polyethylene terephthalate fiber and diethylene glycol terephthalate. *Journal of Applied Polymer Science* 2004;93(3):1089-1096.

5. Astrup, T., Møller, J. and Fruergaard, T. Incineration and co-combustion of waste: accounting of greenhouse gases and global warming contributions. *Waste Management & Research* 2009;27(8):789-799.
6. Tansel, B. and Yildiz, B.S. Goal-based waste management strategy to reduce persistence of contaminants in leachate at municipal solid waste landfills. *Environment, development and sustainability* 2011;13(5):821-831.
7. MacArthur, E. Towards the circular economy. *Journal of Industrial Ecology* 2013.
8. Zhu D. J. Sustainable development calls for circular economy. *Science and Technology Journal* 1998;9:39-42.
9. Yuan, Z., Bi, J. and Moriguchi, Y. The circular economy: A new development strategy in China. *Journal of Industrial Ecology* 2006;10(1-2):4-8.
10. Bicket M., Guilcher S., Hestin M., Hudson C., Razzini P., Tan A., Ten Brink P., Van Dijn E., Vanner R. and Watkins E., 2014. Scoping study to identify potential circular economy actions, priority sectors, material flows and value chains. European Commission; 2014.
11. Alsema, E. A., P. Frankl, and K. Kato. Energy pay-back time of photovoltaic energy systems: present status and prospects. Utrecht University Repository; 2006.
12. Craighill, Amelia L., and Jane C. Powell. Lifecycle assessment and economic evaluation of recycling: a case study. *Resources, Conservation and Recycling* 1996;17(2):75-96.
13. Themelis, N. J., M. J. Castaldi, J. Bhatti, and L. Arsova. Energy and economic value of non-recycled plastics (NRP) and municipal solid wastes (MSW) that are currently landfilled in the fifty states. New York, NY: Columbia University; 2011.
14. Feeley Savanna R., Bas Wijnen, and Joshua M. Pearce. Evaluation of potential fair trade standards for an ethical 3-D printing filament. *Journal of Sustainable Development* 2014;7(5):1.
15. Mansour, Ashraf Mansour Habib, and Subhi A. Ali. Reusing waste plastic bottles as an alternative sustainable building material. *Energy for Sustainable Development* 2015;24:79-85.
16. Kumar, K. Vinoth, and R. Kasturi Bai. Plastic biodigesters—a systematic study. *Energy for Sustainable Development* 2005;9(4):40-49.
17. Baechler, Christian, Matthew DeVuono, and Joshua M. Pearce. Distributed recycling of waste polymer into RepRap feedstock. *Rapid Prototyping Journal* 2013;19(2):118-125.

18. Hunt, Emily J., Chenlong Zhang, Nick Anzalone, and Joshua M. Pearce. Polymer recycling codes for distributed manufacturing with 3-D printers. *Resources, Conservation and Recycling* 2015;97:24-30.
19. Arena, U., Mastellone, M.L. and Perugini, F.. Life cycle assessment of a plastic packaging recycling system. *The international journal of life cycle assessment* 2003,8(2):92-98.
20. Ross, S. and Evans, D.. The environmental effect of reusing and recycling a plastic-based packaging system. *Journal of Cleaner Production* 2003;11(5):561-571.
21. Pearce, Joshua M., C. Morris Blair, Kristen J. Laciak, Rob Andrews, Amir Nosrat, and Ivana Zelenika-Zovko. 3-D printing of open source appropriate technologies for self-directed sustainable development. *Journal of Sustainable Development* 2010;3(4):17.
22. Gwamuri, J., Wittbrodt, B.T., Anzalone, N.C. and Pearce, J.M.. Reversing the Trend of Large Scale and Centralization in Manufacturing: The Case of Distributed Manufacturing of Customizable 3-D-Printable Self-Adjustable Glasses. *Challenges in Sustainability* 2014;2(1):30-40.
23. Kietzmann, J., Pitt, L. and Berthon, P.. Disruptions, decisions, and destinations: Enter the age of 3-D printing and additive manufacturing. *Business Horizons* 2015;58(2):209-215.
24. Wittbrodt, B., Laureto, J., Tymrak, B. and Pearce, J.M.. Distributed manufacturing with 3-D printing: a case study of recreational vehicle solar photovoltaic mounting systems. *Journal of Frugal Innovation* 2015;1(1):1-7.
25. Kreiger, M. A., M. L. Mulder, A. G. Glover, and Joshua M. Pearce. Life cycle analysis of distributed recycling of post-consumer high density polyethylene for 3-D printing filament. *Journal of Cleaner Production* 2014;70:90-96.
26. Brander, M., A. Sood, C. Wylie, A. Haughton, and J. Lovell. Electricity-specific emission factors for grid electricity. *Ecometrica*. Edinburgh, United Kingdom; 2011.
27. Chaar El L., and N. El Zein. Review of photovoltaic technologies. *Renewable and Sustainable Energy Reviews* 2011;15(5):2165-2175.
28. Foley, G.. Rural electrification in the developing world. *Energy Policy* 1992;20(2):145-152.
29. Foley, G.. Photovoltaic applications in rural areas of the developing world. *World Bank Publications* 1995;304.
30. Acker, R.H. and Kammen, D.M.. The quiet (energy) revolution: analysing the dissemination of photovoltaic power systems in Kenya. *Energy Policy* 1996;24(1):81-111.

31. Chambouleyron, I. Photovoltaics in the developing world. *Energy* 1996;21(5):385-394.
32. Lorenzo, E.. Photovoltaic rural electrification. *Progress in Photovoltaics: Research and Applications* 1997;5(1):3-27.
33. Khoury, J., Mbayed, R., Salloum, G., Monmasson, E. and Guerrero, J., 2016. Review on the integration of photovoltaic renewable energy in developing countries—Special attention to the Lebanese case. *Renewable and Sustainable Energy Reviews* 2016;57:562-575.
34. Jones, R., Haufe, P., Sells, E., Iravani, P., Olliver, V., Palmer, C. and Bowyer, A.. RepRap—the replicating rapid prototyper. *Robotica* 2011;29(01):177-191.
35. King, D. L., Babasola, A., Rozario, J. and Pearce, J.M. Mobile Open-Source Solar-Powered 3-D Printers for Distributed Manufacturing in Off-Grid Communities. *Challenges in Sustainability* 2014;2(1):18-27.
36. Gwamuri, J., Franco, D., Khan, K.Y., Gauchia, L. and Pearce, J.M.. High-Efficiency Solar-Powered 3-D Printers for Sustainable Development. *Machines* 2016;4(1):3.
37. Appropedia. 2016. <http://www.appropedia.org/Recyclebot> (visited 9.14.2016)
38. Knapp, K., and T. Jester. Empirical investigation of the energy payback time for photovoltaic modules. *Solar Energy* 2001;71(3):165-172.
39. Nawaz, I., and G. N. Tiwari. Embodied energy analysis of photovoltaic (PV) system based on macro-and micro-level. *Energy Policy* 2006;34(17):3144-3152.
40. Appropedia. 2017. http://www.appropedia.org/How_to_get_embodied_energy_from_CES_database (visited 4.4.2017)
41. Edupack, C. E. S. Granta design limited. Cambridge, England, UK (2016).
42. Pearce, J.M.. Photovoltaics—a path to sustainable futures. *Futures* 2002;34(7):663-674.
43. EPIA-publications. European Photovoltaic Industry Association.
43. Lenzen, Manfred. Primary energy and greenhouse gases embodied in Australian final consumption: an input–output analysis. *Energy policy* 1998;26(6):495-506.
44. Ciceri, N. Duque, T. G. Gutowski, and M. Garetti. A tool to estimate materials and manufacturing energy for a product. In *Sustainable Systems and Technology (ISSST)*, 2010 IEEE International Symposium on: 1-6.

45. Sherwani, A. F., and J. A. Usmani. Life cycle assessment of solar PV based electricity generation systems: A review. *Renewable and Sustainable Energy Reviews* 2010;14(1):540-544.
46. Rauegi Marco, Silvia Bargigli, and Sergio Ulgiati. Life cycle assessment and energy pay-back time of advanced photovoltaic modules: CdTe and CIS compared to poly-Si. *Energy* 2007;32(8):1310-1318.
47. Wittbrodt, B.T. and Pearce, J.M.. Total US cost evaluation of low-weight tension-based photovoltaic flat-roof mounted racking. *Solar Energy* 2015;117:89-98.
48. EIA, US. Annual energy outlook 2016. US Energy Information Administration, Washington, DC 2017:60-62.
49. Amazon. 2016a. <https://www.amazon.com/Printing-Filament-Dimensional-Accuracy-0-03mm/dp/B01M2UHPPD/> (visited 3.31.2017)
50. Amazon. 2016b. <https://www.amazon.com/HATCHBOX-3D-PLA-1KG1-75-WHT-Filament-Dimensional/dp/B01NAZJ18C/> (visited 3.31.2017)
51. Amazon. 2016c. <https://www.amazon.com/TechOrbits-ABS-1KG1-75-Green-Filament-Dimensional-Accuracy/dp/B01FGCBV72/> (visited 3.31.2017)
52. Amazon. 2016d. <https://www.amazon.com/IC3D-Natural-1-75mm-Printer-Filament/dp/B0192EE9OC/> (visited 3.31.2017)
53. Fthenakis, V.. Solar Cells solar cell: Energy Payback Times photovoltaic (PV) energy payback time (EPBT) and Environmental Issues solar cell environmental issues. *Solar Energy* 2013:341-357.
54. Bhandari, Khagendra P., Jennifer M. Collier, Randy J. Ellingson, and Defne S. Apul. Energy payback time (EPBT) and energy return on energy invested (EROI) of solar photovoltaic systems: A systematic review and meta-analysis. *Renewable and Sustainable Energy Reviews* 2015;47:133-141.
55. Louwen, A., W. G. J. H. M. Sark, R. E. I. Schropp, W. C. Turkenburg, and A. P. C. Faaij. Life-cycle greenhouse gas emissions and energy payback time of current and prospective silicon heterojunction solar cell designs. *Progress in Photovoltaics: Research and Applications* 2015;23(10):1406-1428.
56. Bhattacharyya, Subhes C. Energy access programmes and sustainable development: A critical review and analysis. *Energy for Sustainable Development* 2012;16(3):260-271.
57. Jiang, Xuemei, and Yifang Liu. Global value chain, trade and carbon: Case of information and communication technology manufacturing sector. *Energy for Sustainable Development* 2015;25:1-7.

58. Sovacool, Benjamin K. The political economy of energy poverty: A review of key challenges. *Energy for Sustainable Development* 2012;16(3):272-282.

3. Tightening the Loop on the Circular Economy: Coupled Distributed Recycling and Manufacturing with Recyclebot and RepRap 3-D Printing²

3.1 Introduction

Over the last 50 years plastics have been used increasingly in a large range of products due to their versatility, low cost and durability [1, 2]. The global plastic production was 322 million tons in 2015, is growing 3.86% per annum, and is expected to increase to 850 million tons per year by 2050 [3, 4]. This aggressive plastic production growth aggravates the pressure for waste plastic disposal and generates many well-established environmental issues. Landfill, incineration and recycling are the three main methods to treat post-consumer plastics according to the principle of waste hierarchy in increasing order of environmental responsibility [5, 6]. Incineration of plastic has the capability for energy recovery in the form of heat [7], but large quantities of harmful compounds and greenhouse gases are emitted into the atmosphere during incineration [8, 9]. Plastics usually need more than 20 years to degrade in landfill conditions [10] and plastic debris in landfill is also a source of secondary environmental pollutants [8].

Incineration and landfill methods generate severe environmental issues, and this linear model of resource consumption that follows a “take-make-dispose” pattern has increasingly notable economic limits. High demand for resources leads to higher resource prices and supply disruptions, which exposes companies that follow the linear system to risks during heightened competition [11]. To reduce risk, the concept of circular economy was first proposed by a Chinese scholar in 1998 with the aim to mitigate the contradiction between rapid economic growth and the shortage of raw materials and energy [12]. This fundamentally new model of circular economy is required to separate economic growth from resource consumption growth [13]. A circular economy uses material symbiosis between different companies and production processes [14]. The core of the circular economy is the circular flow of materials and the use of resources and energy through multiple phases [15]. The circular economy is beneficial to society and economy as a whole by reducing the use of the natural environment as a sink for waste and reducing the use of virgin materials for economic activities [16].

Recycling, therefore, is the established best solution to treat post-consumer plastics following the goals of a circular economy [17]. However, traditional recycling can have a significant environmental impact as it demands the collection and transportation of relatively low-density waste plastics to collection centers and reclamation facilities for separation and reconstruction [18]. In centralized recycling systems, the transportation usually consumes large quantities of energy with the

² The material contained in this chapter is to be submitted to the journal.

concomitant emissions and environmental detriment [19] and needs considerable labor to classify those post-consumer plastics [20]. In developing regions, this labor is provided by waste pickers, which collect post-consumer plastic in landfills far below poverty-level wages [21, 22, 23, 24].

Compared to the traditional recycling, distributed recycling (where consumers directly recycle their own waste) has the potential to reduce energy consumption because it can save the energy for transportation needed in conventional recycling [25, 26]. A new promising method of such distributed plastic recycling is to upcycle plastic waste into 3-D printing filament with a recyclebot, which is an open source waste plastic extruder [27]. Waste plastic shards, powder or pellets are fed into the recyclebot through a hopper, and transported to the heating pipe by an auger, which is driven by a motor. The plastic is compressed and melted in this heating pipe and can be extruded through the nozzle to form filament for fused filament fabrication (FFF)-based 3-D printing. In general, plastic recycled for 3-D printing filament is of the same type, and the process is simplified if recycling codes are granular enough to identify different kinds of plastics [28]. After classifying the plastic, it is cleaned and shredded into small pieces to improve the filament's quality by maintaining the consistency of the feed rate. The recyclebot makes filament from post-consumer plastics instead of raw materials, which can decrease more than half of the embodied energy of the filament [29, 30]. In addition, the recyclebot provides the potential to recycle plastics at any location so that consumers in their own homes can save money by offsetting purchased filament. In addition, professional waste pickers can sell filament for a substantial high value per kg than they earn for only sorted plastic to increase their personal income [24].

If the recyclebot is combined with an open source self-replicating rapid prototyper (RepRap) 3-D printer [31, 32], then the post-consumer plastics can be turned into useful and more valuable products [33, 34]. Compared to the traditional plastic manufacturing methods, like plastic injection molding, additive manufacturing with a 3-D printer has two advantages. First, a 3-D printer allows for accurate fabrication and scale models as it can directly produce complex parts by building a component in layers from 3-D digital designs with essentially no material waste [35, 36]. Secondly, the 3-D printer can control the fill density of a product. By reducing the fill density of parts to the minimum necessary for mechanical functionality [37], 3-D print-based manufacture can save materials, reduce energy consumption and decrease greenhouse gas emissions all which contribute to sustainability [38, 39, 40]. The open source nature of the RepRap 3-D printer has resulted in rapid technical evolution and reductions in the cost; currently a basic polymer printing RepRap 3-D printer can be constructed for less than \$500 in parts [41]. Reducing the cost of 3-D printers has greatly expanded its popularity and enabled wide applicability for distributed manufacturing throughout the world for a wide range of products [42, 43, 44, 45, 46, 47, 48, 49].

In order to analyze the impact of combining these two trends, this paper combines the distributed recycling method using a vertical recyclebot to make filament with distributed manufacturing using a delta RepRap to print useful products from post-consumer waste. Specifically, this study recycles acrylonitrile butadiene styrene (ABS) from computer waste (approximately 20 weight percent of end of life electronics) into useful and valuable products. The total electrical energy consumption for the combined process is monitored and an economic evaluation is completed. These results are compared to the combination of traditional recycling and traditional manufacturing, and discussed in the context of the circular economy, energy conservation, greenhouse gas emission mitigation and economic benefit.

3.2 Devices and methods

3.2.1 Material and energy measurements

This project presents a distributed method to completely recycle thermoplastic into valuable consumer goods at the consumers residence. Post-consumer ABS, $-(C_8H_8 \cdot C_4H_6 \cdot C_3H_3N)-_n$, which is a versatile plastic used for a variety of durable goods, was chosen to test this method. Further all open source hardware-based equipment [50, 51] was used in all steps of the processing including an open source granulator [52], recyclebot ac4.0 [53], and delta-style RepRap [54]. Post-consumer ABS stabilizing feet (92.36 g/foot) for a 5G tower or smart UPS as seen in Figure 3.1 was shredded by the granulator. The crushed plastic was used to make 3-D printing filament with the recyclebot and then three case study consumer goods were manufactured including a camera tripod, an SD card holder and a camera hood by printing with a RepRap 3-D printer. In order to compare this method with the combination of traditional recycling and traditional manufacture in energy consumption, the electricity consumed at each step was recorded by a multimeter (± 0.01 kWh). To account for mass loss at each processing step, at each stage of processing the plastic was massed with a digital balance (± 0.01 g).

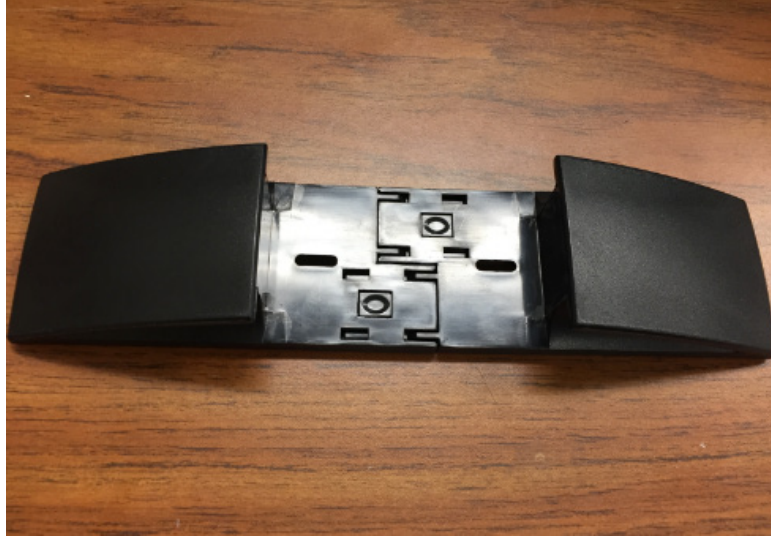

Figure 3.1 Post-consumer ABS stabilizing foot which is 92.36 g for each

3.2.2 Small-scale shredding of post-consumer plastic waste

Cleaning of the post-consumer plastic waste is necessary before the shredding step. Impurities not only degrade overall filament consistency, but also increase the clogging frequency in the nozzle of the 3-D printer. The post-consumer ABS source of stabilizing feet used here were relatively clean, but dust and dirt was mechanically removed from the plastic with a cloth. Next an open source plastic granulator/shredder [55] was used to shred the plastic. To be more accessible to small and medium sized enterprises (e.g. local companies, makerspaces, fablabs, hackerspaces or libraries) it was designed to operate on single phase power instead of three phase power, which is common for industrial tools available on the market. The hopper of the granulator is designed to maintain mechanical integrity of the granulator so the entrance is 200 cm² large to limit the size of the incoming plastic pieces. If the plastic particle is larger it will need to be manually cut or smashed before depositing in the hopper to be crushed in the granulator chamber by spinning fly knives. Three fly knives rotate about an axis and striking a bed knife that is stationary on the outside of the path the rotary blades follow (Figure 3.2). The shaft and fly knife mounts are made out of A36 steel. The fly knives and bed knife are made out of tool steel, and the sieve is made out of stainless steel. As the plastic is granulated, it is sorted by a sieve which has 1/8 inch holes in it because that is the acceptable granulated size for the recyclebot. The particle size distribution was determined by imaging and the use of the open source imageJ software [56].

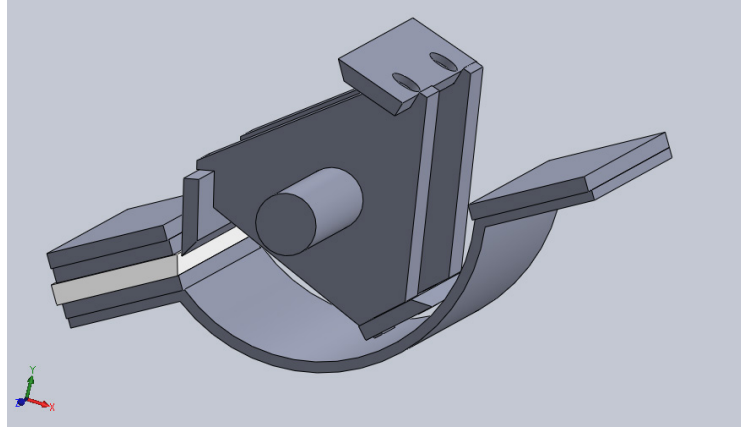

Figure 3.2 Model of of open source granulator cutting chamber assembly.

ImageJ was also used to get the areas and perimeters of these filament cross sections. Based on these areas (a), and perimeters (p), the circularity, C , of filament can be calculated by:

$$C = 4\pi\left(\frac{a}{p^2}\right) \quad (1)$$

The circularity is a number with the range of 0-1. $C=1$ indicates a perfect circle.

After shredding, the crushed plastic needs to be dried to maintain consistent quality by low temperature heating, or exposure to low-humidity environment by ambient, vacuum or desiccant. If this is not completed the moisture on the plastic vaporizes and form bubbles that roughen the filament surface. This can be seen in Figure 3, where the filament on the left was produce from moist pellets and the right one was from dried pellets. It is obvious that filament from dried particles has better quality.



Figure 3.3 Comparison of filament quality from moist pellets and dried pellets

3.2.3 Extruding filament

The two primary control parameters of the recyclebot are heating tube and extruder temperature and auger rotation speed. The temperature of heating tube should be above the glass transition temperature of the polymer being processed so that the polymer molecules have mobility, and also below the decomposition temperature to avoid breaking of molecule structures. The glass transition temperature and decomposition temperature of ABS are 115.5 °C and 300-450 °C respectively [57, 58]. While in this appropriate range, the molecule mobility would increase as temperature increases. The heating tube temperature was set as 180 °C here. The auger rotation speed determines the extrusion rate (kg/h) because the only plastic inputs into the tube is provided by the auger. It is better to set high rotation speed to get higher extrusion rates and avoid plastic staying in the heating tube for long time, which is important for filament quality. The auger rotation speed was set as 15 revolutions per min.

Filament diameter depends on the nozzle size and the tension on the filament after extruding. When the filament comes out through the nozzle, it swells slightly. Then as the tension increases, the filament diameter decreases. The recyclebot ac4.0 has a vertical geometry, as shown in Figure 4, so it uses gravity directly to provide tension on the filament after extruding. At the beginning of extruding, the filament descended gradually and then was pulled through the light sensor, diameter measurement, length measurement, guide tube and then wound on the spooler. In this collecting system, there are two modes to collect the filament, the auto mode and the manual mode. In auto mode, when the filament descends and passes through the light sensor, the spooler begins to

rotate and collect filament. If the rotation speed of spooler is too fast, the filament rises up and passed through the light sensor again, then the spooler slows and stops rotating. On manual mode, the rotation speed of spooler is adjusted manually by rotating a knob that controls the spooler speed on a panel. The manual mode is always used when the extrusion rate is not stable, such as the initial state of extrusion. To get a uniform size of filament, the filament should descend the same distance to keep the tension on the filament constant. To get the filament with 1.75 mm diameter, which was needed by the MOST delta-style RepRap, the nozzle size is 1.2 mm and the filament loop descended 30 cm.

During heating and extruding process, the electricity and time consumed were collected along with the mass to calculate the extrusion rate and energy consumption. The filament diameter distribution was determined by imaging and the use of the open source imageJ software [56].

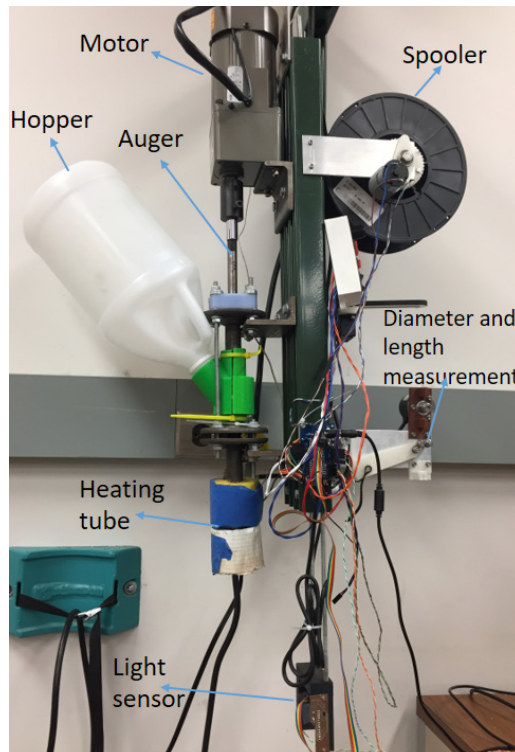

Figure 3.4 Recyclebot ac4.0 with labels

3.2.4 Printing Case Study Consumer Goods

The RepRap used in this project is the Athena 3-D printer which derived from the MOST delta RepRap 3-D printer. The Athena is easier to assemble and maintain and has better wire management and flexibility, which increases its applicability for households.

The basic RepRap printer was modified with a heated bed to ensure adhesion of ABS to the glass substrate (although other methods using compatible polymer beds can be used). It should be noted, however, that a heated printing surface is preferred, as ABS will contract when cooled leading to warped parts. During large prints with ABS without a printed bed warping can cause delamination in between printed layers. ABS printing temperature is in the range of 200-240 °C. If the temperature is too high, the extruder would leak between the separate parts and cause stringing. If the temperature is too cold, the plastic cannot stick well to the previous layer causing weak interlayer adhesion and under extrusion, which results in the printed part being easier to be pulled apart between layers.

3.2.5 Case Study Objects

The recycled ABS filament was used to test printing a camera tripod, SD card holder and camera hood. The camera bubble tripod consists of a tripod top, a tripod base, nine leg components and three tripod feet [59]. The SD card holder consists of a top side, bottom side, SD card container, micro-SD card container, card reader container and two multi-card containers [60]. The camera hood fits a Canon 18-135 STM lens [61].

The printing temperature was set as 220 °C except for the tripod feet. When the tripod feet were being printed, the printing temperature was set as 220 °C for first layer and 200 °C for other layers. The tripod foot has a relatively large sphere and one side always warped during printing, so decreasing the printing temperature was used to eliminate the issue. The heated bed temperature was set as 110 °C for all components. The printing speed was 60 mm/s, fan power at 80% and fill density was 100%.

3.3 Results

3.3.1 Shredding Post-Consumer Waste Plastic

The open source granulator was successfully used to shred post-consumer ABS as shown in Figure 3.5. The energy consumption for shredding 1 kg of ABS is 0.138 kWh and shredding rate is 4.358 kg/h. The shredded plastic was put into a vacuum chamber for half an hour. The vacuum chamber used in this study can contain about 1 kg of crushed plastic and it consumed 0.19 kWh for 33 minutes vacuuming. The vacuuming rate is 1.818 kg/h.



Figure 3.5 The post-consumer ABS plastic and crushed ABS pellets

The average particle size of the ABS pieces is 2.72 mm, which is based on Figure 3.6 and ImageJ analysis. Figure 3.6 is a picture of a handful of ABS particles, which was ran through ImageJ to get each particle's top side area assuming each particle is a sphere. It should be noted that using this method to estimate particle size always gets a larger number compared to the real size if the pellets are not perfect spheres. Figure 3.7 is the particle size distribution of that handful of pellets. It is found that most particles are within the particle size range of 0.08-1.06 mm. In order to get the plastic quantity distribution with respect to the particle size, the top side area was used to compare the relative mass of each pellet. Figure 3.8 is the total top side areas of different particle size ranges. It is obvious that though these tiny pellets are the greatest in number their contribution to the total mass is negligible. Most of post-consumer ABS were shredded into the pieces with the particle size of 2.04-5.96 mm, and the amount of the particles within this range is more than half of the total amount. However, there are a few particles which are larger than 8 mm and need to be removed manually or by a sieve to make sure these crushed ABS are small enough to be used as feedstock for the recyclebot.

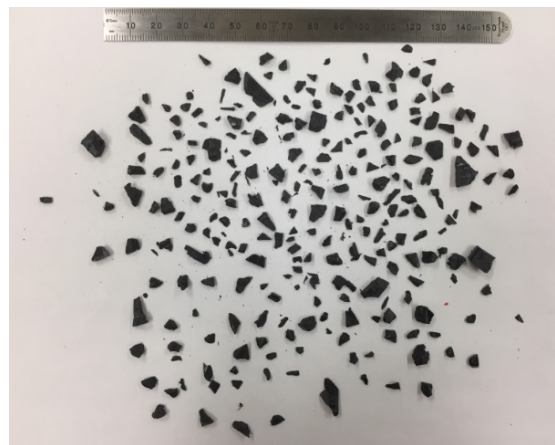

Figure 3.6 A handful of crushed post-consumer ABS

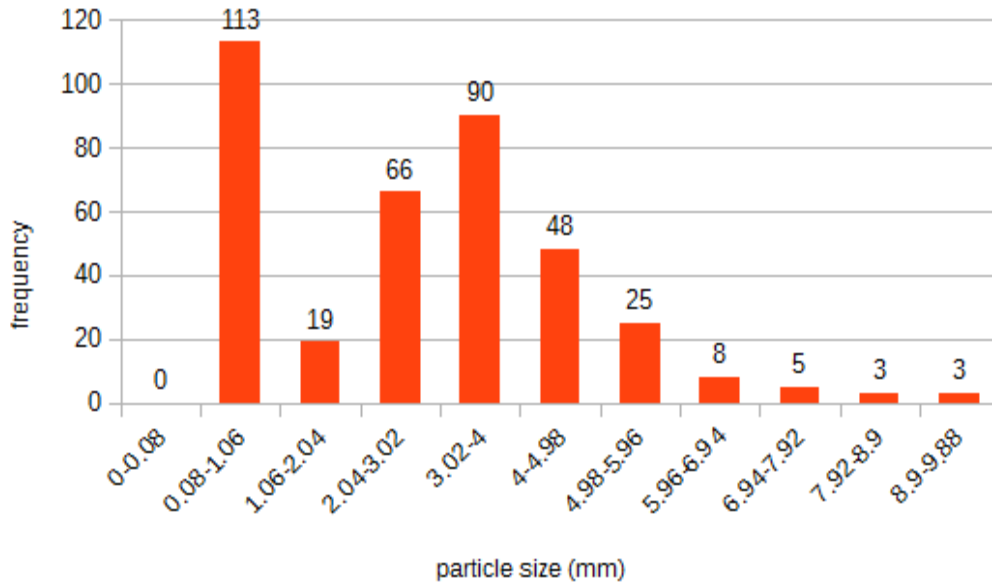

Figure 3.7 Particle size distribution of a handful of ABS pellets

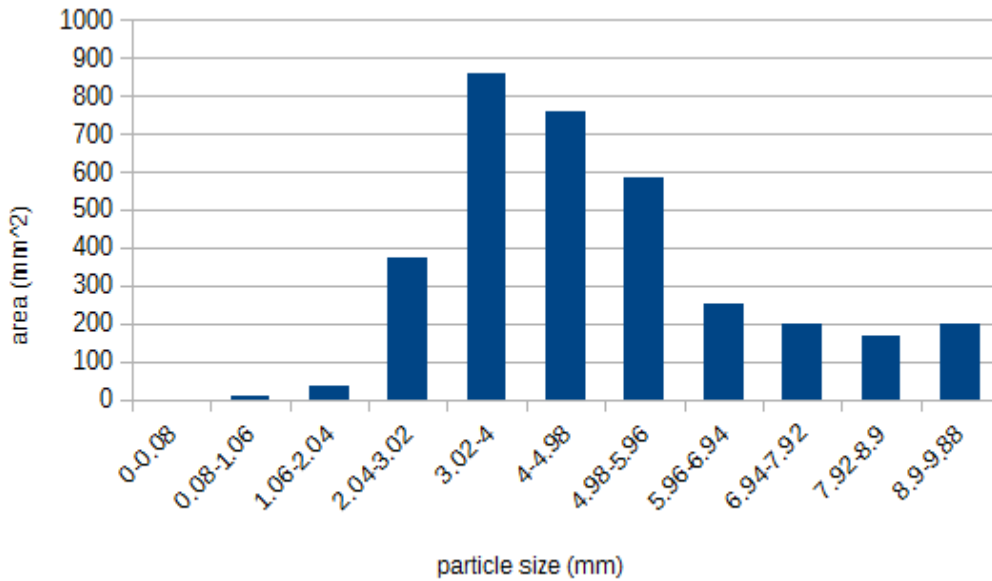

Figure 3.8 Total top side areas of different particle size ranges

In addition, not all of the plastic fed into the granulator can be shredded and collected in the collector. There is always some plastic leftover between the chamber bottom and blades which cannot be shredded and get through the sieve, which generates

the difference between the amount of post-consumer plastic and the amount of plastic particles. However, as more plastic waste is shredded, the influence of the difference is reduced.

3.3.2 Extruding Filament

The open source recyclebot ac4.0 was used to make filament from crushed ABS. Before the extrusion process, it took 7 minutes and 0.005 kWh for the heating tube to reach operation temperature. When the temperature rises up to the set point, the auger begins to rotate and filament is extruded. The initial 0.5 meters of filament was discarded because of inconsistency as the entire hot zone reached the set point temperature. The extrusion rate was 0.262 kg/h and energy consumption for extruding 1 kg of filament is 0.302 kWh. This results in a single vertical recyclebot capable of producing 6 kg of filament in a 24 hours day or a 1 kg spool in less than 4 hours. Figure 9 is a picture of recycled filament from the crushed ABS material. Compared to extrusion, the energy consumption for warming up the recyclebot is negligible if large quantities of filament are produced.



Figure 3.9 The filament produced by recyclebot from crushed ABS pellets

Figure 3.10 shows the filament cross sections from different parts of the spool. A knife was used to cut the filament perpendicular to its length in order to examine cross sections. ImageJ was used with Equation (1) to find that the circularity range of these cross sections is 0.81-0.89 and the average circularity is 0.87. This means the filament produced by recyclebot from crushed post-consumer ABS has good roundness and could be 3-D printed.

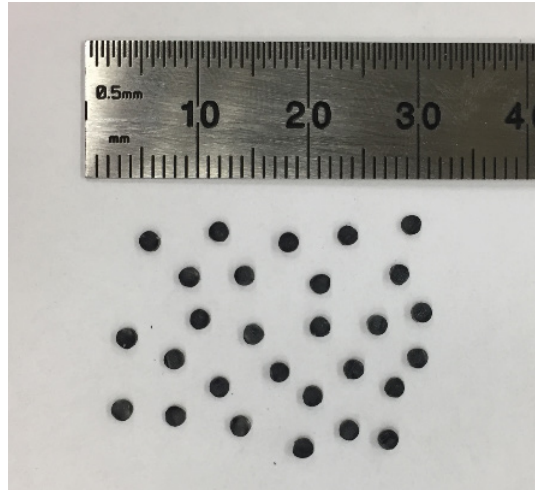

Figure 3.10 The cross sections from different parts of recycled filament

Figure 3.11 shows the distribution of filament diameters. The average diameter is 1.84 mm, which was calculated from cross section areas. It is clear that the tolerance of this filament is $+0.1/-0.04$ mm. The average diameter of commercial filament is 1.75 mm with tolerance of ± 0.05 mm. Compared to commercial filament, this recycled filament is slightly larger. Although the recyclebot settings good be tuned to more closely match commercial specifications, it is not necessary as the filament was well within the tolerances of the RepRap used for 3-D printing.

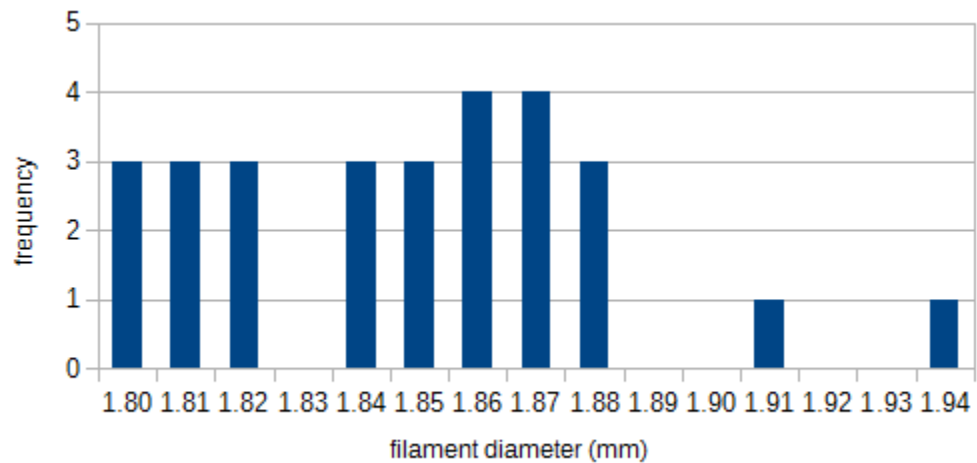

Figure 3.11 The diameter distribution of recycled ABS filament

3.3.3 Printing case study objects

The open source Athena RepRap was used to test print recycled ABS filament. It took 8 minutes and 0.03 kWh for the heated bed and nozzle to warm up. The components

were printed one by one and the printed camera tripod, SD card holder and camera hood are shown in Figures 3.12-3.14, respectively.

3.3.3.1 Camera tripod

The energy consumption, time consumption and filament consumption of printing a camera bubble tripod were shown in Table 3.1. Including the heating process, printing a camera tripod needs 1.56 kWh and 574 minutes (about 9.5 hours). During the whole printing process the energy consumption for initial heating is also small compared to the energy consumption for printing itself.

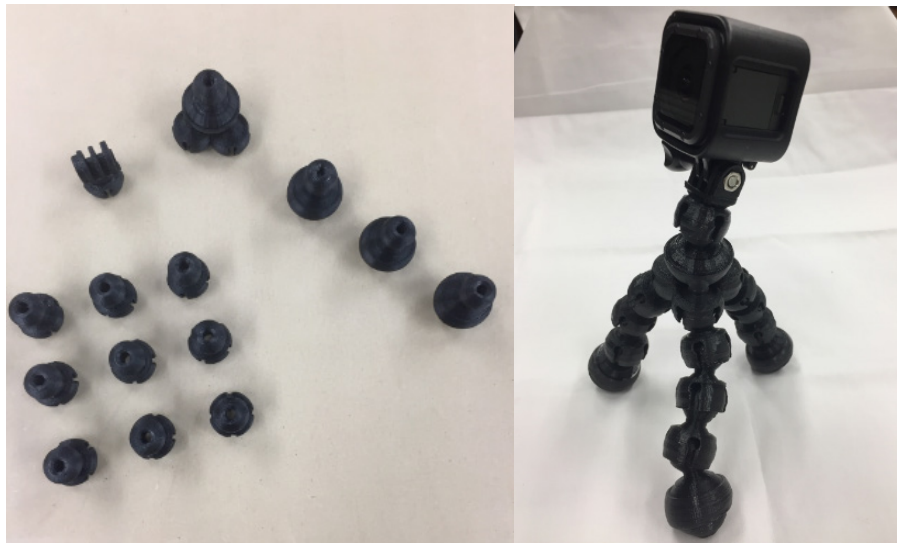

Figure 3.12 The camera bubble tripod printed a) components and b) assembled by the RepRap from recycled ABS filament

Table 3.1 Energy consumption, time consumption and filament consumption for printing a camera tripod

Item	Energy consumption (kWh)	Time consumption (min)	Filament consumption (g)
Tripod top (x1)	0.10	28	4.67
Tripod (x1)	0.23	94	14.90
Leg component (x9)	0.90	324	42.11
Tripod foot (x3)	0.30	120	27.08
Total	1.53	566	88.76

The total weight of 3-D printed camera tripod is 88.76 grams. The energy and time consumption for each step are summarized in Table 3.2. Based on the energy consumptions of 0.138 kWh/kg for shredding, 0.190 kWh/kg for vacuuming and 0.302 kWh/kg for filament extruding, 88.76 g of plastic requires 0.012 kWh for shredding, 0.017 kWh for vacuuming and 0.027 kWh for extruding filament. Based on the shredding rates of 4.358 kg/h, vacuuming rate of 1.818 kg/h and extrusion rate of 0.262 kg/h, it takes 0.020 hours to shred 0.121 kg of plastic, 0.049 hours to vacuum and 0.339 hours to extrude it. Therefore, to produce a camera bubble tripod from post-consumer ABS, 9.975 hours and 1.616 kWh were consumed in total.

Table 3.2 Energy consumption and time consumption for producing a camera tripod from waste plastic

Process	Energy consumption (kWh)	Time consumption (h)
Shredding	0.012	0.020
Vacuuming	0.017	0.049
Extruding filament	0.027	0.339
Printing	1.560	9.567
Total	1.616	9.975

3.3.3.2 SD card holder

The energy consumption, time consumption and filament consumption for 3-D printing a SD card holder are shown in Table 3.3. Including the heating process, printing a SD card holder needs 0.64 kWh and 289 minutes in total.



Figure 3.13 The SD card holder printed by the RepRap from recycled ABS filament

Table 3.3 Energy consumption, time consumption and filament consumption for printing a camera tripod

Item	Energy consumption (kWh)	Time consumption (min)	Filament consumption (g)
Top side	0.11	49	14.10
Bottom side	0.12	52	14.20
SD card container	0.07	33	7.99
Micro-SD card container	0.06	30	7.28
Card reader container	0.19	87	26.60
Multi-card container	0.06	30	7.43
Total	0.61	281	77.60

The total weight of 3-D printed SD card holder is 77.6 grams. Table 3.4 summarizes the energy and time consumption for each step. Based on the energy consumptions of 0.138 kWh/kg for shredding, 0.190 kWh/kg for vacuuming and 0.302 kWh/kg for filament extruding, 77.60 g of plastic requires 0.011 kWh for shredding, 0.015 kWh for vacuuming and 0.023 kWh for extruding filament. Based on the shredding rates of 4.358 kg/h, vacuuming rate of 1.818 kg/h and extrusion rate of 0.262 kg/h, it takes 0.018 hours to shred 77.60 g of plastic, 0.043 hours to vacuum and 0.296 hours to extrude it. Therefore, to produce a SD card holder from post-consumer ABS, 5.174 hours and 0.689 kWh were consumed in total.

Table 3.4 Energy consumption and time consumption for producing a camera tripod from waste plastic

Process	Energy consumption (kWh)	Time consumption (h)
Shredding	0.011	0.018
Vacuuming	0.015	0.043
Extruding filament	0.023	0.296
Printing	0.640	4.817
Total	0.689	5.174

3.3.3.3 Camera hood

To 3-D print the camera hood 0.18kWh of electricity was consumed over 72 minutes using 17.37g of recycled ABS filament. Including the heating process, printing a camera hood needs 0.21 kWh and 80 minutes in total.



Figure 3.14 The camera hood printed a) with camera and b) with camera by the RepRap from recycled ABS filament

Table 3.5 Energy consumption, time consumption and filament consumption for printing a camera tripod

Item	Energy consumption (kWh)	Time consumption (min)	Filament consumption (g)
Camera hood	0.18	72	17.37

The total weight of 3-D printed camera hood is 17.37 grams. Based on the energy consumptions of 0.138 kWh/kg for shredding, 0.190 kWh/kg for vacuuming and 0.302 kWh/kg for filament extruding, 17.37 g of plastic requires 0.002 kWh for shredding, 0.003 kWh for vacuuming and 0.005 kWh for extruding filament. Based on the shredding rates of 4.358 kg/h, vacuuming rate of 1.818 kg/h and extrusion rate of 0.262 kg/h, it takes 0.004 hours to shred 17.37 g of plastic, 0.010 hours to vacuum and 0.066 hours to extrude it. Therefore, to produce a camera hood from post-consumer ABS, 1.410 hours and 0.220 kWh were consumed in total.

Table 3.6 Energy consumption and time consumption for producing a camera tripod from waste plastic

Process	Energy consumption (kWh)	Time consumption (h)
Shredding	0.002	0.004
Vacuuming	0.003	0.010
Extruding filament	0.005	0.066

Printing	0.210	1.330
Total	0.220	1.410

3.4 Discussion

This distributed recycling and production method with a recyclebot and RepRap saves energy not only in recycling process, but also in manufacturing process. The energy consumption for ABS recycling in this project is 0.63 kWh/kg which is the sum of energy used in shredding, vacuuming and extruding filament process. The traditional plastic recycling method involves collecting and transporting post-consumer plastics to a collection center for separation, and then to reclamation facility for reconstruction. In a reclamation center, sorted plastic usually needs to be cleaned, dried, melted, extruded and then shredded into pellets for reuse [18]. This process is similar to the recycling process in this project, so it is assumed that their energy consumptions are nearly identical. This assumption is grounded in more detailed studies investigating recycling post-consumer HDPE, which found such results [38, 39]. But the traditional recycling method still requires large quantities of extra energy for transportation and sorting and compacting in the collection centers. The average energy consumption for transporting post-consumer plastics is 0.089 kWh/kg, for sorting is 0.075 kWh/kg, for compacting is 0.025 kWh/kg [25], which means the traditional recycling method consumes an extra 0.189 kWh/kg compared to the distributed recycling method introduced in this project. Besides, the energy consumption for transportation would increase as the distance increases. Collecting waste plastics in remote rural areas usually requires much more energy [38,39].

Figure 3.15 summarizes the energy consumption for producing the three case study products: a camera tripod, SD card holder and camera hood by traditional and distributed methods. The camera tripod, SD card holder and camera hood produced in the case study consumed 1.616 kWh, 0.689 kWh, 0.220 kWh and their mass are 88.76 g, 77.60 g, 17.37 g, respectively. The embodied energy of ABS is 36.667 kWh/kg which includes 13.500 kWh/kg feedstock energy [62, 63]. Except for the feedstock energy, 23.167 kWh is needed to complete mining, processing natural resources, manufacturing and delivery to get 1 kg of ABS product. Therefore, the traditional manufacture method needs to consume 2.056 kWh, 1.798 kWh and 0.402 kWh to produce a same camera tripod, SD card holder and camera hood, respectively based on their mass. If the feedstock energy is considered, extra raw material of 1.198 kWh, 1.048 kWh and 0.234 kWh are required to produce ABS products of 88.76 g, 77.60 g and 17.37 g respectively. The percent of energy saved by the distributed process depends on the complexity of the objects with the tripod being the most complex and the camera hood being the least complex. From Figure 3.15, it is clear that using traditional manufacturing method to produce an ABS product consumes more than double the energy compared to coupled

distributed recycling and manufacturing method. If the products of simple structures are produced, such as the case study products shown here, more energy can be conserved by this coupled distributed method.

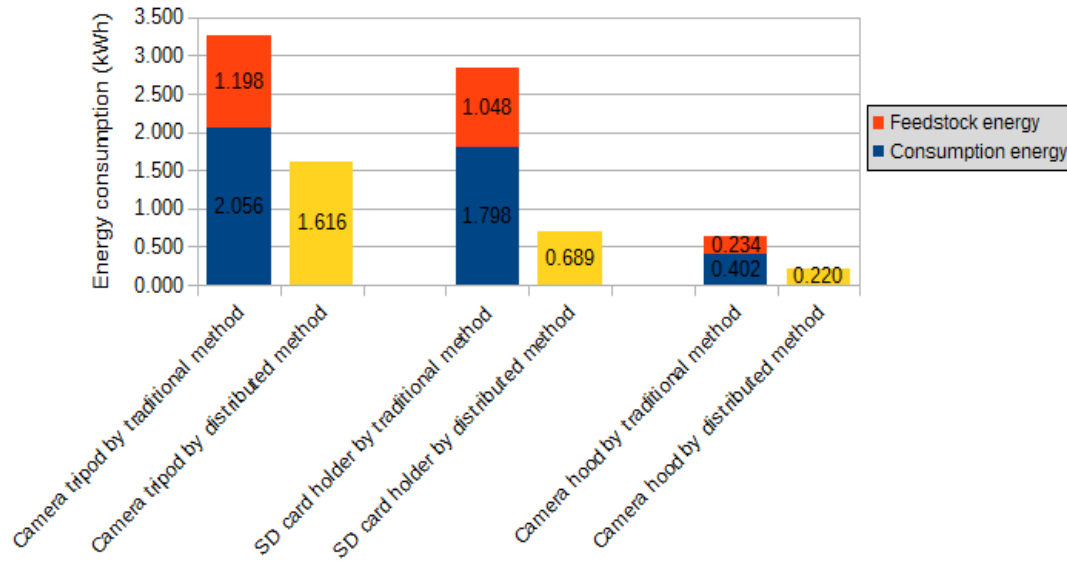

Figure 3.15 The energy consumption for producing a camera tripod, SD card holder and camera hood by traditional and distributed methods

As the energy consumption is less when prosumers (producing consumers) use distributed recycling and manufacturing methods, they can also reduce the greenhouse gas emissions to produce a product. The coupled distributed recycling and manufacturing method does not require post-consumer plastic transportation and product delivery, so it directly decreases carbon emissions from the combustion of transportation-related fuel. In addition, distributed recycling and manufacturing consumes less energy than the traditional recycling process and manufacturing process, so carbon emission decreases further from this conserved energy. According to the energy conservation and carbon emission mitigation, it is clear that this method has great benefit for environment and supports a growing body of evidence in this regard [64].

The total energy consumption for producing a camera bubble tripod, SD card holder and camera hood in this project is 1.616 kWh, 0.689 kWh and 0.220 kWh respectively, so their cost can be estimated as 19 cents, 8 cents and 3 cents based on the average electricity price in U.S. which is US \$0.12 /kWh. This represents substantial savings for consumer products. For example, the lowest-cost equivalent on Amazon for the similar camera bubble tripod costs US\$3.49 dollars [65] instead of 19 cents. Similarly, an equivalent camera lens hood costs US\$9.99 dollars [66] while the 3-D printed from recycled ABS waste costs only 3 cents. Thus, one could make 333 camera lens hoods for the same economic cost as purchasing a single one by conventional

distributors. Although the commons-based SD card holder design here is new and there is no identical commercial one, a similar one costs US\$5.98 [67] instead of 8 cents. The economic benefit of distributed recycling and manufacture method is obvious and even greater than those found earlier for creative commons designs coupled with commercial filament and 3-D printers [33]. This is for only simple products. Products with complex structures are always even relatively more expensive because of the restrictions in traditional manufacture methods. However, the complex structure does not make much difference in cost in the 3-D printing method, which is why for example sophisticated scientific equipment can be produced for 1% of the cost of those tools made by traditional methods [68, 69]. The other obvious advantage of 3-D printing is mass customization. 3-D printing facilitates can be used to individualize and customize products. The shape and size of the products can be easily modified in the 3-D digital models to meet the customer's requirements without significant extra cost. In addition, as using this method allows products to be produced at home and do not need the transportation and associated shipping costs the cost of the product can be reduced further.

The low cost and high quality are always the most important standards for people to evaluate a product. There is no doubt that coupled recycling and manufacturing method with large economic benefit is able to encourage people to recycle more plastic and produce products by themselves. When the 92.36 g stabilizing foot is either broken or not needed, it can be recycled by coupled distributed method and almost 5 camera lens hood can be produced from it, which means the value of approximately US\$50.00 is created from one stabilizing foot. The post-consumer plastic bottle recycle rate in America in 2013 is 30.9% [70], which results in about two thirds of plastic bottles being disposed by incineration and landfill. These recycled bottles are pure materials such as PET and HDPE and also be separated and recycled using the methods discussed here for ABS e-waste. However, those plastics that are used in electronic product, such as ABS, are always coupled to other materials so they usually have relatively lower recycle rates. With the stimulation for a circular economy created by the economic benefit, the post-consumer plastic recycle rate would potentially increase as the tools become more widely available for people to recycle more plastics in their homes or communities. In addition, in the future, more advanced polymers and composites [71] can be explored in this low-cost open source distributed upcycling case for a circular economy.

These results take the digital manufacturing optimization [72] and direct digital manufacturing [73] to the extreme case discussed by Kostakis et al. (2017). Kostakis et al. focus is on the model of designing globally, but manufacturing locally and builds on the conjunction of the digital commons of knowledge and design (e.g. the three commons-based designs used for case studies here) with desktop and bench-top manufacturing technologies (such as the open source 3-D printers used in this study). It is clear from the results of the study reported here that in the short-to-medium term waste

plastic from discarded e-waste can be significantly upcycled using this commons-based approach for the benefit of the environment as well as the economic stability of consumers. This coupled distributed recycling and manufacturing method helps to solve post-consumer plastic disposal issues and raw material shortage issues as it uses recycled plastic to produce products. This method closes the loop of plastic material flows, which not only assists the circular economy as a whole, but also the sustainability at the household level. When the 3-D printed part is no longer useful, it can be shredded and used to make filament and printed into new useful products. It is interesting to note that a broken stabilizer foot (the raw material used for this study) could be recycled using this method into a new stabilizing foot. Each foot weighs less than 93 g (and it could be printed with lower infill to weigh even less). In addition, the shipping weight of a single foot is 1 lb (453g), which is a factor of 4.87x due presumably to the mass of the packaging to ship one [74]. The stabilizing foot costs US\$9.99 on E-bay [75], which again shows considerable economic savings using the coupled distributed recycling-manufacturing process. However, more work is needed in this area to determine how many cycles are technically feasible. For example, the thermal properties would change and torsion strength would decrease as more recycled ABS is being mixed in the virgin ABS resin [76]. Future work is necessary to investigate the difference of thermal properties and physical properties between printed parts from recycled ABS filament and virgin ABS filament, and try to remedy the degradation influence of multiple cycles.

Lastly, the printing process consumed more than 90% of the whole energy for both processes. This is because printing with a heated bed consumes large quantities of energy to maintain the bed at 110 °C. Future work is necessary to improve the printing method to decrease the energy consumption with printing with ABS. Melted ABS cannot stick on the cold glass, but it can stick well on PLA thin layers. If the ABS is printed on the PLA thin layer instead of heated bed, more than half of the energy can be saved. Besides, if the whole system is powered by solar photovoltaic panels [45] instead of tradition electricity grid, the energy used can also be totally conserved.

A circular economy is an industrial economy that promotes greater resource productivity aiming to reduce waste and avoid pollution by design in which material flows of technical nutrients are recycled in the industrial system. This study has shown that the circle can be tightened by bringing the industrial system within in a single home, business, or community center. In this circle, the value can be generated continually as post-consumer products are being used to produce new products. In addition, when the materials flow in this circle, less energy is consumed and less greenhouse gas is emitted than would be otherwise to meet the same consumer desire. Therefore, this couple distributed recycling and manufacturing method fits well into the goal of circular economy and meets the requirement of sustainable development.

3.5 Conclusions

This study presents a distributed recycling and manufacturing method with the open source recyclebot and RepRap 3-D printer. Post-consumer ABS was recycled and then used as material to produce three case study products. The energy consumptions were recorded at each step. From the three case studies, it is clear that using traditional manufacturing method to produce an ABS product consumes more than double the energy compared to coupled distributed recycling and manufacturing method. In addition, by tightening the recycling and production loops the circular economy is supported as this method also decreases energy use, carbon emissions and has great economic benefit for prosumers.

3.6 References

1. Gu, L. and Ozbakkaloglu, T. Use of recycled plastics in concrete: A critical review. *Waste Management* 2016;51:19-42.
2. Passamonti, F. J., and Sedran, U. Recycling of waste plastics into fuels. LDPE conversion in FCC. *Applied Catalysis B: Environmental* 2012;125:499-506.
3. Shen, L., Haufe, J. and Patel, M.K. Product overview and market projection of emerging bio-based plastics PRO-BIP 2009. Report for European Polysaccharide Network of Excellence (EPNOE) and European Bioplastics 2009:243.
4. Plastics Europe. Global plastic production from 1950 to 2015 (in million metric tons). <https://www.statista.com/statistics/282732/global-production-of-plastics-since-1950/>, October, 2016.
5. Gertsakis, J., and Lewis, H. Sustainability and the waste management hierarchy. A discussion paper prepared for EcoRecycle Victoria, March 2003.
6. Webb, H.K., Arnott, J., Crawford, R.J. and Ivanova, E.P. Plastic degradation and its environmental implications with special reference to poly (ethylene terephthalate). *Polymers* 2012;5(1):1-18.
7. Sinha, V., Patel, M.R. and Patel, J.V. PET waste management by chemical recycling: a review. *Journal of Polymers and the Environment* 2010;18(1):8-25.
8. Zhang, J., Wang, X., Gong, J. and Gu, Z. A study on the biodegradability of polyethylene terephthalate fiber and diethylene glycol terephthalate. *Journal of Applied Polymer Science* 2004;93(3):1089-1096.
9. Astrup, T., Møller, J. and Fruergaard, T. Incineration and co-combustion of waste: accounting of greenhouse gases and global warming contributions. *Waste Management & Research* 2009;27(8):789-799.

10. Tansel, B. and Yildiz, B.S. Goal-based waste management strategy to reduce persistence of contaminants in leachate at municipal solid waste landfills. *Environment, development and sustainability* 2011;13(5):821-831.
11. MacArthur, E. Towards the circular economy. *Journal of Industrial Ecology* 2013.
12. Zhu D. J. Sustainable development calls for circular economy. *Science and Technology Journal* 1998;9:39-42.
13. Preston, F. A global redesign? Shaping the circular economy. *Energy, Environment and Resource Governance* 2012;2:1-20.
14. Jacobsen, N.B. Industrial symbiosis in Kalundborg, Denmark: a quantitative assessment of economic and environmental aspects. *Journal of Industrial Ecology* 2006;10(1-2):239-255.
15. Yuan, Z., Bi, J. and Moriguichi, Y. The circular economy: A new development strategy in China. *Journal of Industrial Ecology* 2006;10(1-2):4-8.
16. Andersen M.S. An introductory note on the environmental economics of the circular economy. *Sustainability Science* 2007;2(1):133-140.
17. Bicket M., Guilcher S., Hestin M., Hudson C., Razzini P., Tan A., Ten Brink P., Van Dijl E., Vanner R. and Watkins E., 2014. Scoping study to identify potential circular economy actions, priority sectors, material flows and value chains. European Commission; 2014.
18. Barton J. R., D. Dalley, and V. S. Patel. Life cycle assessment for waste management. *Waste management* 1996;16(1):35-50.
19. Craighill, A. L., and Powell, J.C. Lifecycle assessment and economic evaluation of recycling: a case study. *Resources, Conservation and Recycling* 1996;17(2):75-96.
20. Themelis N. J., M. J. Castaldi, J. Bhatti, and L. Arsova. Energy and economic value of non-recycled plastics (NRP) and municipal solid wastes (MSW) that are currently landfilled in the fifty states. New York, NY: Columbia University; 2011.
21. Hayami, Y., Dikshit, A.K. and Mishra, S.N. Waste pickers and collectors in Delhi: poverty and environment in an urban informal sector. *The Journal of Development Studies* 2006, 42(1):41-69.
22. Wilson, D.C., Velis, C. and Cheeseman, C., Role of informal sector recycling in waste management in developing countries. *Habitat International* 2006, 30(4):797-808.
23. Schenck, R. and Blaauw, P.F. The work and lives of street waste pickers in Pretoria—a case study of recycling in South Africa’s urban informal economy. In *Urban Forum* 2011, 22(4):411-430.

24. Feeley Savanna R., Bas Wijnen, and Joshua M. Pearce. Evaluation of potential fair trade standards for an ethical 3-D printing filament. *Journal of Sustainable Development* 2014;7(5):1.
25. Arena U., Mastellone M.L. and Perugini F. Life cycle assessment of a plastic packaging recycling system. *The international journal of life cycle assessment* 2003;8(2):92-98.
26. Ross, S. and Evans, D. The environmental effect of reusing and recycling a plastic-based packaging system. *Journal of Cleaner Production* 2003;11(5):561-571.
27. Baechler C., DeVuono M., and Pearce J.M. Distributed recycling of waste polymer into RepRap feedstock. *Rapid Prototyping Journal* 2013;19(2):118-125.
28. Hunt, E. J., Zhang C, Anzalone N, Pearce JM. Polymer recycling codes for distributed manufacturing with 3-D printers. *Resources, Conservation and Recycling* 2015;97:24-30.
29. Kreiger M., Gerald C. Anzalone, M. L. Mulder, A. Glover, and Joshua M. Pearce. Distributed recycling of post-consumer plastic waste in rural areas. In *MRS Proceedings*, 1492:91-96. Cambridge University Press; 2013.
30. Kreiger M. A., M. L. Mulder, A. G. Glover, and Joshua M. Pearce. Life cycle analysis of distributed recycling of post-consumer high density polyethylene for 3-D printing filament. *Journal of Cleaner Production* 2014;70:90-96.
31. Sells, E., Smith, Z., Bailard, S., Bowyer, A. and Olliver, V. RepRap: the replicating rapid prototyper: maximizing customizability by breeding the means of production. *Handbook of Research in Mass Customization and Personalization*, 2010.
32. Jones, R., Haufe, P., Sells, E., Irvani, P., Olliver, V., Palmer, C. and Bowyer, A. RepRap—the replicating rapid prototyper. *Robotica* 2011;29(1):177-191.
33. Wittbrodt B.T., Glover A.G., Laureto J., Anzalone G.C., Oppliger D., Irwin J.L. and Pearce J.M.. Life-cycle economic analysis of distributed manufacturing with open-source 3-D printers. *Mechatronics* 2013;23(6):713-726.
34. Redlich T. and Moritz M.. Bottom-up Economics. *Foundations of a Theory of Distributed and Open Value. The Decentralized and Networked Future of Value Creation: 3D Printing and its Implications for Society, Industry, and Sustainable Development* 2016:27.
35. Crane N. B., J. Tuckerman, and G. N. Nielson. Self-assembly in additive manufacturing: opportunities and obstacles. *Rapid Prototyping Journal* 2011;17(3):211-217.

36. Gebhardt, A., Schmidt, F.M., Hötter, J.S., Sokalla, W. and Sokalla, P. Additive manufacturing by selective laser melting the realizer desktop machine and its application for the dental industry. *Physics Procedia* 2010;5:543-549.
37. Baich, L., Manogharan, G., Marie, H., Study of infill print design on production cost-time of 3D printed ABS parts. *International Journal of Rapid Manufacturing* 2015; 5(3-4):308-319.
38. Kreiger, M., and Pearce, J.M. Environmental impacts of distributed manufacturing from 3-D printing of polymer components and products. In *MRS Proceedings*, 1492:85-90. Cambridge University Press; 2013.
39. Kreiger, M., and Pearce, J.M. Environmental life cycle analysis of distributed three-dimensional printing and conventional manufacturing of polymer products. *ACS Sustainable Chemistry & Engineering* 2013;1(12):1511-1519.
40. Ford, S. and Despeisse, M. Additive manufacturing and sustainability: an exploratory study of the advantages and challenges. *Journal of Cleaner Production* 2016;137: 1573–1587
41. Anzalone G.C., Wijnen, B. and Pearce, J.M. Multi-material additive and subtractive prosumer digital fabrication with a free and open-source convertible delta RepRap 3-D printer. *Rapid Prototyping Journal* 2015;21(5):506-519.
42. Pearce, J.M., Blair, C.M., Laciak, K.J., Andrews, R., Nosrat, A. and Zelenika-Zovko, I. 3-D printing of open source appropriate technologies for self-directed sustainable development. *Journal of Sustainable Development* 2010;3(4):17.
43. Mota C. The rise of personal fabrication. In *Proceedings of the 8th ACM conference on Creativity and cognition* 2011;279-288. ACM.
44. Richardson M. and Haylock B. Designer/maker: the rise of additive manufacturing, domestic-scale production and the possible implications for the automotive industry. *Computer-Aided Design & Applications PACE* 2012;2:33-48.
45. Gwamuri, J., Franco, D., Khan, K.Y., Gauchia, L. and Pearce, J.M. High-Efficiency Solar-Powered 3-D Printers for Sustainable Development. *Machines* 2016;4(1):3.
46. Kietzmann J., Pitt L. and Berthon P. Disruptions, decisions, and destinations: Enter the age of 3-D printing and additive manufacturing. *Business Horizons* 2015;58(2):209-215.
47. Pearce J.M.. Applications of open source 3-D printing on small farms. *Organic Farming* 2015;1(1):19-35.

48. Wittbrodt B., Laureto J., Tymrak B. and Pearce, J.M.. Distributed manufacturing with 3-D printing: a case study of recreational vehicle solar photovoltaic mounting systems. *Journal of Frugal Innovation* 2015;1(1):1-7.
49. Wittbrodt B.T. and Pearce J.M.. Total US cost evaluation of low-weight tension-based photovoltaic flat-roof mounted racking. *Solar Energy* 2015;117:89-98.
51. Gibb A. *Building open source hardware: DIY manufacturing for hackers and makers.* Pearson Education; 2014.
50. Ackerman J.R. Toward open source hardware. *U. Dayton L. Rev.* 2008;34:183.
52. Appropedia. Open Source Hardware Enterprise Plastic Granulator. 2016a. http://www.appropedia.org/Open_Source_Hardware_Enterprise_Plastic_Granulator (visited 12.8.2016)
53. Appropedia. Recyclebot 2016b. <http://www.appropedia.org/Recyclebot> (visited 9.8.2016)
54. Appropedia. Athena Build Overview. 2016c. http://www.appropedia.org/Athena_Build_Overview (visited 9.8.2016)
55. Gorechi P. Schaub A., Wilder L. Ford college community challenge: Plastic Granulator- Final report. *Open Source Hardware Enterprise*; 2016.
56. imageJ. 2016. <https://imagej.nih.gov/ij/> (visited Dec. 27, 2016).
57. Li Y. and Shimizu, H. Improvement in toughness of poly (l-lactide)(PLLA) through reactive blending with acrylonitrile-butadiene-styrene copolymer (ABS): Morphology and properties. *European Polymer Journal* 2009;45(3):738-746.
58. Wang, S., Hu, Y., Wang, Z., Yong, T., Chen, Z. and Fan, W. Synthesis and characterization of polycarbonate/ABS/montmorillonite nanocomposites. *Polymer Degradation and Stability* 2003;80(1):157-161.
59. Thingiverse.a. 2015. <http://www.thingiverse.com/thing:1201115> (visited 12.10.2016)
60. Thingiverse.b. 2015. <http://www.thingiverse.com/thing:633436> (visited 12.10.2016)
61. Thingiverse.c. 2012. <http://www.thingiverse.com/thing:38336/> (visited 12.10.2016)
62. Wötzel K., R. Wirth, and M. Flake. Life cycle studies on hemp fibre reinforced components and ABS for automotive parts. *Die Angewandte Makromolekulare Chemie* 1999;272(1):121-127.
63. Hammond, G., Jones, C., Lowrie F., and P. Tse. *Inventory of carbon & energy: ICE.* Bath: Sustainable Energy Research Team, Department of Mechanical Engineering, University of Bath; 2008.

64. Kohtala, C. Addressing sustainability in research on distributed production: an integrated literature review. *Journal of Cleaner Production* 2015; 106:654-668.
65. Amazon. 2016a. https://www.amazon.com/Flexible-Bendable-SSE-Microfiber-Cleaning/dp/B00K55IMS2/ref=sr_1_20 (visited 12.18.2016)
66. Amazon. 2016b. https://www.amazon.com/Replacement-Altura-Photo-18-135mm-3-5-5-6/dp/B0045FLMIA/ref=sr_1_1 (visited 12.18.2016)
67. Amazon. 2016c. https://www.amazon.com/Slots-Holder-Memory-Card-memory-Carrying/dp/B00CGTMXNK/ref=sr_1_6 (visited 12.18.2016)
68. Pearce, J.M. Building research equipment with free, open-source hardware. *Science* 2012;337(6100):1303-1304.
69. Pearce, J.M., 2013. Open-source lab: how to build your own hardware and reduce research costs. Elsevier.
70. Plastic American-Chemistry. 2013. United States national post-consumer plastics bottle recycling report. <https://plastics.americanchemistry.com/Education-Resources/Publications/2013-National-Post-Consumer-Plastics-Bottle-Recycling-Report.pdf>
71. Tian, X., Liu, T., Wang, Q., Dilmurat, A., Li, D. and Ziegmann, G. Recycling and remanufacturing of 3D printed continuous carbon fiber reinforced PLA composites. *Journal of Cleaner Production* 2017; 142(4):1609–1618.
72. Agustí-Juan, I. and Habert, G. Environmental design guidelines for digital fabrication. *Journal of Cleaner Production* 2017;142(4):2780–2791.
73. Chen, D., Heyer, S., Ibbotson, S., Salonitis, K., Steingrímsson, J.G. and Thiede, S. Direct digital manufacturing: definition, evolution, and sustainability implications. *Journal of Cleaner Production* 2015;107:615-625.
74. Amazon. 2016d. APC 0J-876-0011A PLASTIC STABILIZING FOOT 5G TOWER ROHS <https://www.amazon.com/0J-876-0011A-PLASTIC-STABILIZING-FOOT-TOWER/dp/B00DEMM7KM> (visited 12.26.2016).
75. E-bay. 2016. <http://www.ebay.com/itm/APC-0J-876-0011A-PLASTIC-STABILIZING-FOOT-5G-TOWER-or-SMART-UPS-/162291598475>(visited 12.19.2016).
76. Chen, S.C., Liao, W.H., Hsieh, M.W., Chien, R.D. and Lin, S.H. Influence of recycled ABS added to virgin polymers on the physical, mechanical properties and molding characteristics. *Polymer-Plastics Technology and Engineering* 2011; 50(3):306-311.

4. Conclusions and Recommendations/ Future Work

4.1 Overview

This study confirms the potential of recyclebot to reduce the energy and raw material consumptions, decrease the greenhouse gas emissions, increase the economic benefit and tighten the loop on the circular economy. In this project, the embodied energy of recyclebot and mono-crystalline silicon solar photovoltaic system are investigated. The energy payback time of an individual recyclebot and the PV powered recyclebot system are estimated based on the energy saved from plastics recycling. The recycled filament is used to print valuable products by RepRap. The energy consumptions of distributed recycling and manufacturing are compared to those of traditional recycling and manufacturing.

4.2 Conclusions Summary

Based on the studies undertaken in this project, the following conclusions are drawn:

4.2.1 Energy Payback Time of Solar Photovoltaic Powered Waste Plastic Recyclebot System:

- The EPBT of recyclebot is just a few days based on the energy saved from plastics recycling, so using a recyclebot to create 3-D printing filament from post-consumer plastics is an effective way to save energy.
- The PV powered recyclebot system can reduce energy consumption further. The EPBT of the whole system is about a month which decreases the EPBT of a single crystal photovoltaic system by over 96%.

4.2.2 Tightening the Loop on the Circular Economy: Coupled Distributed Recycling and Manufacturing with Recyclebot and RepRap 3-D Printing:

- Distributed recycling method with recyclebot saves energy from transporting, sorting, compacting plastics compared to traditional recycling method.
- Using traditional manufacturing method to produce an ABS product consumes more than double the energy compared to coupled distributed recycling and manufacturing method.
- The coupled distributed recycling and manufacturing method can produce valuable products from post-consumer plastics with cost of a few cents, which has potential to generate great economic benefit.

- The coupled distributed recycling and manufacturing method can reduce the raw material consumption and use the post-consumer plastics, which tightens the loop on the circular economy.

4.3 Future Work

There is a need to extend the applicability of recyclebot to fit more thermo-plastics. So far, PLA and ABS have been tested to be recycled by recyclebot and the recycled filament has showed good performance. It is necessary to make the recyclebot be able to recycle PET as the PET has become the most popular packing material for water and soft-drink bottles in the world [1].

PET is a kind of polymer that has high crystallinity because of the regular molecule structure. When the PET is extruded from the recyclebot, the filament tends to crystallize and becomes brittle, which makes the filament easy to break and difficult to collect. Therefore, it is necessary to set up a water-cooling system by the recyclebot nozzle to cool down the filament extruded. A water tank with two anti-rotating twin rollers inside can be set by the recyclebot nozzle. The PET filament extruded from the recyclebot can be pulled by the twin rollers, and then go through the cooling water and be collected by a rotating spooler. The PET filament cooled by water is not crystallized, so it is flexible and east to collect. A water tank with only a guide pipe was used to cool the PET filament, but the filament extruded was not under a uniform tension, which made the filament diameter varies significantly. Therefore, the two anti-rotating twin rollers is supposed to be a good method to keep uniform tension on the filament.

PET has a variety of degradative reactions when the temperature is near the melting point, especially the thermal degradation and hydrolytic degradation [2]. The loss of molecular weight leads to the decreases in the intrinsic viscosity and melt strength, which increases the difficulties for the forming process and affects the qualities of products [3]. From some tests of recycling PET pellets by recyclebot, it was difficult to pull the melted PET extruded from nozzle and make it form filament because of the low melt strength. The PET filament obtained was either too thin or discontinuous. Besides, high melting temperature always caused un-melted PET blocking the nozzle, which increases the residence time of other PET staying in the heating tube, so the color of extruded PET would turn to yellow even after momentary blocking. Therefore, vacuum drying the PET pellets before extrusion and setting up a gas-venting section in the heating tube of the recyclebot are good methods to prevent the hydrolytic degradation [4]. Using longer heating tube and setting up three heating sessions on it can improve PET's plasticization properties, meanwhile increasing the auger rotation speed to decrease the residence time, which is able to prevent the thermal degradation [4, 5, 6].

This study just considers energy consumption during the distributed recycling process. However, in the recycling process, large quantities of water is also required to clean the waste plastics at the beginning state, and this water consumption would probably become a restriction for the application of distributed recycling method in some locations. Therefore, the water consumption in the recycling process should also be investigated, and the cost for recycling should be estimated from both electricity and water consumptions in the future work.

4.4 References

1. Welle Frank. Twenty years of PET bottle to bottle recycling—an overview. *Resources, Conservation and Recycling* 2011;55(11):865-875.
2. Buxbaum L. H. The degradation of poly (ethylene terephthalate). *Angewandte Chemie International Edition in English* 1968;7(3):182-190.
3. Torres N., J. J. Robin, and B. Boutevin. Chemical modification of virgin and recycled poly (ethylene terephthalate) by adding of chain extenders during processing. *Journal of Applied Polymer Science* 2001;79(10):1816-1824.
4. Fredl Rüdiger. Method for recycling pet flakes. U.S. Patent 6,436,322, issued August 20, 2002.
5. Awaja Firas, Fugen Daver, and Edward Kosior. Recycled poly (ethylene terephthalate) chain extension by a reactive extrusion process. *Polymer Engineering & Science* 2004;44(8):1579-1587.
6. Oromiehie Abdulrasoul, and Alireza Mamizadeh. Recycling PET beverage bottles and improving properties. *Polymer international* 2004;53(6):728-732.