

## **In-house Report 128**

# **REVIEW OF DISABILITY ESTIMATES AND DEFINITIONS**

# **Review of Disability Estimates and Definitions**

**A study carried out on behalf of the Department for Work  
and Pensions**

**By**

**Madhavi Bajekal, Tim Harries, Rachel Breman and Kandy Woodfield  
National Centre for Social Research**

© Crown copyright 2004. Published with permission of the Department for Work and Pensions on behalf of the Controller of Her Majesty's Stationery Office.

The text in this report (excluding the Royal Arms and Departmental logos) may be reproduced free of charge in any format or medium provided that it is reproduced accurately and not used in a misleading context. The material must be acknowledged as Crown copyright and the title of the report specified. The DWP would appreciate receiving copies of any publication that includes material taken from this report.

Any queries relating to the content of this report and copies of publications that include material from this report should be sent to: Paul Noakes, Social Research Division, Room 4-26 Adelphi, 1-11 John Adam Street, London WC2N 6HT

For information about Crown copyright you should visit the Her Majesty's Stationery Office (HMSO) website at: [www.hmso.gov.uk](http://www.hmso.gov.uk)  
First Published 2004

ISBN 1 84388 244 2  
ISSN 1 368 244X

# Contents

SUMMARY.....	1
<b>1 INTRODUCTION .....</b>	<b>15</b>
1.1 BACKGROUND AND AIMS .....	15
1.2 OBJECTIVES OF THE REVIEW .....	16
1.3 CONCEPTUAL ISSUES: MODELS OF DISABILITY.....	17
1.4 RESEARCH METHODS .....	20
1.4.1 <i>The technical review</i> .....	20
1.4.2 <i>The consultation exercise</i> .....	21
1.5 SCOPE AND ORGANISATION OF THE REPORT.....	25
<b>2 DISABILITY AND DISABILITY-RELATED SURVEYS .....</b>	<b>27</b>
2.1 INTRODUCTION .....	27
2.2 IDENTIFICATION OF SURVEYS .....	27
2.3 TYPOLOGY OF DISABILITY SURVEYS.....	28
2.4 RELEVANCE OF DIMENSIONS OF THE GRID TO THE ASSESSMENT OF SURVEY QUALITY .....	28
2.4.1 <i>Non-measurement errors</i> .....	29
2.4.2 <i>Measurement errors</i> .....	31
2.5 ISSUES SPECIFIC TO MEASURING DISABILITY .....	34
2.6 CRITERIA FOR THE SELECTION OF SURVEYS FOR MORE DETAILED EXAMINATION.....	37
2.7 SUMMARY .....	38
<b>3 COMPARISON OF DISABILITY ESTIMATES ACROSS SURVEYS ....</b>	<b>39</b>
3.1 INTRODUCTION .....	39
3.2 GLOBAL DISABILITY ESTIMATES: EMPIRICAL COMPARISONS .....	41
3.3 ANALYSIS METHOD.....	42
3.4 RELIABILITY OF GLOBAL ESTIMATES .....	43
3.4.1 <i>Longstanding illness and limiting longstanding illness</i> .....	43
3.4.2 <i>Work-limiting disability</i> .....	50
3.4.3 <i>Current DDA disabled</i> .....	53
3.5 VALIDITY OF GLOBAL ESTIMATE .....	56
3.5.1 <i>DDA (current) and LLSI</i> .....	57
3.5.2 <i>DDA (current) and work-limiting disability</i> .....	60
3.5.3 <i>LLSI and work-limiting disability</i> .....	62
3.5.4 <i>Discussion</i> .....	63
3.6 ESTIMATES FROM DISABILITY SURVEYS: EMPIRICAL COMPARISONS .....	63
3.7 COMPARING KEY DISABILITY ESTIMATES .....	70
3.8 WEIGHTING AND GROSSING TO ESTIMATE ABSOLUTE COUNTS .....	75
3.9 SUMMARY .....	78
<b>4 UTILISING DISABILITY STATISTICS .....</b>	<b>81</b>
4.1 HOW DISABILITY ESTIMATES ARE USED BY DISABILITY ORGANISATIONS.....	81

4.2	THE USE OF ESTIMATES BY EXPERT USERS.....	82
4.3	TYPES AND CHARACTERISTICS OF ESTIMATES USED .....	84
4.3.1	<i>Overall estimates - of disabled people and people with particular types of disability</i> .....	84
4.3.2	<i>Disaggregations of the overall estimates</i> .....	86
4.3.3	<i>Access and dissemination</i> .....	87
4.4	CHOOSING THE MOST APPROPRIATE ESTIMATE .....	89
4.5	SUMMARY .....	97
<b>5</b>	<b>CONCLUSIONS AND SUGGESTIONS FOR THE FUTURE .....</b>	<b>99</b>
5.1	CONCLUSIONS.....	99
5.2	SUGGESTIONS FOR THE FUTURE .....	103
5.2.1	<i>Definitions of disability used and methods of data collection</i> .....	103
5.2.2	<i>Analysis of survey data</i> .....	106
5.2.3	<i>Dissemination of data</i> .....	106

## List of tables

Table 1.1	List of disability experts consulted.....	23
Table 1.2	List of disability organisations consulted .....	24
Table 3.1	National survey that include global disability questions.....	42
Table 3.2	Overall prevalence of LLSI (percent of population) across surveys, all adults aged 16 and over.....	45
Table 3.2	Work-limiting disability by sex (excluding proxies), LFS vs FRS .....	51
Table 3.3	DDA-current estimates, LFS01 vs Omnibus 2001.....	54
Table 3.4	Overall agreement between DDA (current) disabled and LLSI ( <i>Omnibus survey 2001</i> ).....	58
Table 3.5	Mean EQ5D scores by disability severity level and gender ( <i>Omnibus 2001</i> ) .....	59
Table 3.6	Overall agreement between DDA (current) disabled and WLD ( <i>Labour Force Survey 2001</i> ) .....	61
Table 3.7	Overall agreement between LLSI and WLD ( <i>Family Resources Survey 2000/01</i> ).....	63
Table 3.8	Main differences in design and content of disability surveys .....	65
Table 3.9	Comparison of age-specific prevalence rates and numbers of disabled people across key disability estimates.....	71
Table 3.10	Example of variation in population (absolute) count with differences in survey prevalence estimates .....	77
Table 4.2	Flow-chart for choosing the most appropriate estimate...94/159	
Table D.5.1	Proportion of adults with longstanding illness (LSI), including and excluding proxy interviews .....	136

## List of Figures

FIGURE S.1 COMPARING AGE-SPECIFIC PREVALENCE RATES OF KEY SURVEY ESTIMATES.....	6
FIGURE 3.1 LIMITING LONGSTANDING ILLNESS QUESTIONS.....	44
FIGURE 3.2 COMPARISON OF ADULT PREVALENCE RATES OF LLSI BETWEEN SURVEYS (EXCLUDING PROXIES), 2001, BY AGE GROUPS	46
FIGURE 3.3 COMPARISON OF LLSI RATES, CENSUS 2001, FRS AND GHS (WITH PROXIES), BY AGE GROUP .....	47
FIGURE 3.4 CHANGE IN RATES OF LIMITING LONGSTANDING ILLNESS, BY AGE GROUP (CENSUS 1991 VS CENSUS 2001).....	48
FIGURE 3.5 WORK-LIMITING DISABILITY QUESTIONS .....	50
FIGURE 3.6 WORK-LIMITED DISABILITY BY AGE GROUP, LFS VS FRS. ....	49
FIGURE 3.7 CURRENT DDA DISABLED (LFS, OMNIBUS).....	53
FIGURE 3.8 DDA CURRENT DISABLED BY AGE GROUP, LFS VS OMNIBUS .....	55
FIGURE 3.9 OVERLAP BETWEEN DDA AND LLSI DISABLED CATEGORIES: ALL ADULTS AGED 16 AND OVER ( <i>OMNIBUS SURVEY 2001</i> ) .....	57
FIGURE 3.10 MEAN EQ5D SCORES BY DISABILITY SEVERITY LEVEL AND AGE GROUP ( <i>OMNIBUS SURVEY 2001</i> ).....	60
FIGURE 3.11 OVERLAP BETWEEN DDA AND WLD CATEGORIES: WORKING AGE POPULATION( <i>LABOUR FORCE SURVEY 2001</i> ).....	61
FIGURE 3.12 OVERLAP BETWEEN WLD AND LLSI CATEGORIES: WORKING AGE POPULATION( <i>FAMILY RESOURCES SURVEY 2000/01</i> )	62
FIGURE 3.13 AGE-SPECIFIC PREVALENCE RATES IN THREE DISABILITY SURVEYS .....	67
FIGURE 3.14 OVERLAPS BETWEEN LLSI AND DISABILITY, BY AGE GROUP.....	69
FIGURE 3.15 COMPARISON OF AGE-SPECIFIC RATES OF DISABILITY ACROSS FIVE SURVEY ESTIMATES.....	72
FIGURE 3.16 COMPARISON OF OVERALL RATES OF DISABILITY AMONG THOSE OF WORKING AGE ACROSS KEY SURVEY ESTIMATES.. ..	68

FIGURE D.5.1 PROPORTION OF PROXY RESPONDENTS, BY AGE GROUP AND GENDER (FRS 2000/01)..... 135

FIGURE D.5.2 PERCENTAGE OF ADULTS WITH LONGSTANDING ILLNESS, BY AGE GROUP, INCLUDING/EXCLUDING PROXY RESPONSES (LFS 2001)..... 136



## **Acknowledgements**

We would like to thank, first of all, the representatives of disability organisations and experts we consulted for their valuable insights and knowledge of disability issues which inform the report throughout. We are particularly grateful to Claire Edwards (project manager, DWP), Grahame Whitfield (DWP), and Susan Purdon (*Natcen*) for their helpful advice and guidance at all stages of the project; to Howard Meltzer and Peter Noakes (members of the Steering Group); to Chris Tracey, Peter Matejic and Steve Ellerd-Elliott for explaining the intricacies of the Labour Force Survey and Family Resources Survey and making available the data from these at short notice; to Shaun Scholes for help with data extraction; and to Sue Johnson (*Natcen*) for her help with the literature search.

## **The Authors**

**Madhavi Bajekal** is a Research Director in the Survey Methods Unit at the National Centre for Social Research. Her main research interests are in health, disability and mortality, particularly in summary measures of population health (health expectancies) and in social, geographical and ethnic inequalities in health. She is a member of the International Centre for Health & Society, UCL, London and of REVES (International Network on Health Expectancy). She is seconded part-time to the Department of Health as a consultant on survey methods and secondary analysis of survey data.

**Rachel Breman** is a researcher in the Survey Methods Unit at *NatCen*. She has over four year's research experience in quantitative and qualitative studies, both in the public and private sectors. Over the past year, she has specialised in question testing methods and assists in the teaching of cognitive methods courses at *NatCen*. She recently worked on a study for DWP that compared strategies for collecting information on personal assets; 'An evaluation of the assets questions asked on the FRS and ENR survey' (2002).

**Tim Harries** is a Senior Researcher in the Qualitative Research Unit. He has recently worked on an evaluation of the extension of the New Deal for Disabled People and has a track record of disability-related research in the voluntary sector and the National Health Service. His other research interests include childcare provision and the transition to employment.

**Kandy Woodfield** is the Deputy Director of the Qualitative Research Unit. She has recently led two major studies exploring disability for the Department including '*Disabled for Life?*' (2002) and '*Diversity in Disability*' (forthcoming 2003). Her other research spans the spectrum of social policy issues including labour market participation, exclusion and disadvantage; social exclusion; discrimination; and socio-legal issues including the experiences of families in transition and victims' experiences of the legal system. She also co-ordinates teaching in qualitative methodology for *Natcen*.

## Abbreviations

CI	Confidence intervals for an estimate (expressed as an upper and lower limit, within which there is a 95 per cent probability that the true population estimate lies)
DDA	Disability Discrimination Act, 1995.
DS85	Disability Surveys of Great Britain (1985-88), OPCS
DS96/7	Disability in Great Britain: results from the 1996/7 disability follow-up of the Family Resources Survey, 1999
DWP	Department for Work and Pensions
EQ5D	EuroQol: 5 Dimensions
FRS	Family Resources Survey
GB	Great Britain
GHS	General Household Survey
HSE	Health Survey for England
ICF	International Classification of Functioning, Disability and Health (WHO, 2002)
ICIDH	International Classification of Impairments, Disabilities and Handicaps (WHO, 1980)
LFS	Labour Force Survey
LLSI	Limiting longstanding illness, disability or infirmity
LSI	Longstanding (or long-term) illness, disability or infirmity
SE	Standard error
UK	United Kingdom
WHO	World Health Organisation
WLD	Work-limiting disability

## Notes for Tables

- 1 The following conventions have been used in tables:
  - no observations (zero value)
  - 0 non-zero values of less than 0.5 per cent and thus rounded to zero
  - [ ] used to warn of small sample bases, if the unweighted base is less than 50. (If a group's unweighted base is less than 30, data are normally not shown for that group.)
  - NA The category is not applicable for the sub-group
- 2 Because of rounding, row or column percentages may not add exactly to 100 per cent.
- 3 A percentage may be quoted in the text for a single category that aggregates two or more of the percentages shown in a table. The percentage for the single category may, because of rounding, differ by one percentage point from the sum of the percentages in the table.
- 4 'Missing values' occur for several reasons, including refusal or inability to answer a particular question; refusal to co-operate in an entire section of the survey; and cases where the question is not applicable to the informant. In general, missing values have been omitted from all tables and analyses.
- 5 The population sub-group to whom each table refers is stated at the upper left corner of the table.
- 6 Sample bases are shown in each table. For surveys in which only a selected number of persons were selected for interview, the sample is weighted (selection probability weights) to compensate for limiting the number of interviews in the household. In such instances, the weighted bases are shown in the tables. The weighted bases have been scaled to the achieved (unweighted) sample size.
- 7 Where appropriate, data from adjacent years of a survey have been combined to increase the base size and thereby improve precision of the estimates (e.g. data from the Health Survey for England 2000 and 2001).
- 8 The term 'significant' refers to statistical significance (at the 95 per cent level) and is not intended to imply substantive importance.

## **SUMMARY**

This report reviews existing survey estimates of disability for Great Britain. It explores the definitions of disability used and the methodological validity of the disability questions. The report identifies the reasons why disability estimates vary from survey to survey and recommends appropriate estimates for use in a range of circumstances. The study was carried out by a research team of quantitative and qualitative researchers from the National Centre *for* Social Research between May and July 2003.

### **Background**

The study was commissioned by the Department for Work and Pensions (DWP). Its aim was to provide an independent technical review of the range of estimates of the number of disabled adults in Great Britain derived from survey data. From a policy perspective, it is important to be able to understand and disentangle the different sources of variation in order to provide consistent and reliable information and to monitor trends in the prevalence of disability.

Estimates of disability differ for three reasons: real changes over time in the numbers of people experiencing disability or long-term illness; differences in the ways that “disability” is defined; and methodological differences between surveys. This study aimed to shed some light on the methodological and definitional issues and to suggest ways in which variation between estimates could be minimised so that changes over time can be reliably monitored.

### **Methodology**

The aim of the review was to provide DWP with a comprehensive evaluation of different survey estimates of disability.

The review had three inter-related objectives, namely:

- to clarify the conceptual and operational differences in existing survey definitions of disability, evaluate the methodological reliability of estimates and provide a framework within which to assess their appropriateness for different purposes (the “technical review”)
- to consult with key stakeholders and users of disability estimates to find out which sources of national estimates they currently use, and elicit their views on measurement and definitional issues of disability (the “consultation”)

- to explore what might be done to ensure consistency over time of estimates and definitions of disability in Great Britain.

## Key findings

**There is no single ‘gold standard’ measure of disability.** The multi-dimensional and dynamic nature of disability makes it inherently difficult to measure. As a result, there are multiple reasons for the observed differences in survey estimates. Therefore, it is critical that users of disability estimates understand how certain differences are generated and what criteria they can use to judge which estimate is the most useful in meeting their objectives.

**A wide variation exists in survey estimates of the numbers of disabled adults in Great Britain.** Estimates range from 8.6 million (20 per cent) in the 1996/7 Disability Survey (Grundy et al, 1999) to 11 million (23 per cent) in more recent estimates of the number of adults covered by the Disability Discrimination Act (DDA) (Grewal I et al 2002).

Much of this variation arises from differences in the definitions of disability being used, the age range of the populations to which they apply (i.e. working age, all adults or total population), or differences in how definitions are operationalised in surveys (e.g. question wording, the order in which questions are asked and survey context).

**Despite these differences, age-specific disability rates for those of working age do not differ markedly.** Overall estimates of the proportion of the working age population who are disabled based on the DDA definition are similar to those based on other definitions (see Figures S.1). Estimates for those over working age (men aged 65 and over, women aged 60 and over), are sensitive to the definition of disability used and are more unstable between surveys even when the same definition is used.

**Figure S.1: Key survey estimates of the overall prevalence of disability among people of working age in Great Britain (2001)<sup>1</sup>**

<sup>1</sup> These estimates have been adjusted for differences in the age-distribution of respondents in the various survey being compared. The reference population used is the GB Census 2001 gender and age distribution (in 5-year age bands to age 85+). This graph is based on Figure 3.16 in the main text. Sources: LLSI (limiting longstanding illness), Family Resources Survey (FRS) 200/01; DDA (people with a currently existing condition covered by the Disability Discrimination Act, or a progressive health condition), Labour Force Survey (LFS), 2001; WLD (work-limiting disability), LFS 2001; longterm (long-term disabled defined as those with a WLD or covered by the DDA, or both), LFS 2001.

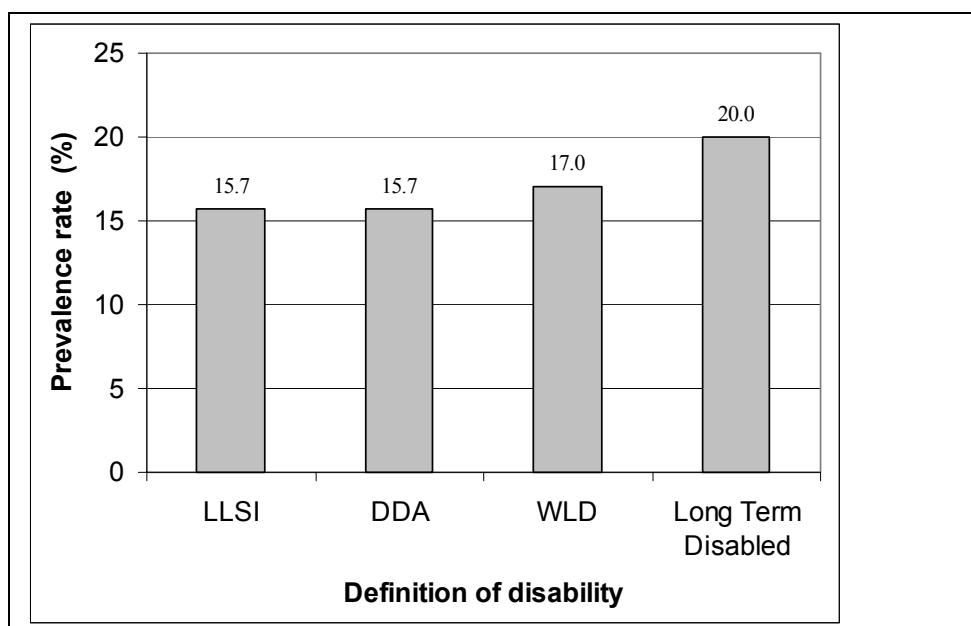

### **The different types of questions used to determine disability**

Few specialist disability surveys have been conducted in Great Britain. All of these have used detailed questionnaires measuring functional limitations in different domains of daily activities (such as mobility, communication and self-care). These specialist disability surveys are based on the **ICIDH** (International Classification of Impairments, Disabilities and Handicaps, WHO, 1980) concept of disability and are considered to provide an 'objective' measure of disability.

In contrast, non-specialist surveys in Great Britain (i.e. those that cover disability amongst other topics) generally use one single-item, *global*<sup>2</sup> question measuring self-assessed restriction in daily activities. These are considered to provide a more 'subjective' measure of disability.

<sup>2</sup> Global questions require the respondent to describe their overall functional ability by answering just one or two questions (such as the LLSI question). Such single-item questions encompass a number of dimensions which are not made explicit and the interpretation and/or comprehension of the question varies between respondents. Global questions are considered to be 'subjective' in that individuals report their *perception* of overall activity limitations. This approach acknowledges that individuals experience and react to activity limitations differently and that their perceptions are a valid assessment of the impact of functional limitations on daily life (such as the performance of social roles (e.g. work) and participation). Because of their brevity, global questions are more easily included in surveys whose prime focus is not the measurement of disability. As opposed to single-item global questions, disability-specific surveys ask a series of questions, covering several domains of activity (such as self-care, locomotion, seeing, hearing). Such surveys and questionnaire modules (or 'instruments') are considered to be more 'objective' in that they provide an explicit and common frame of reference for the assessment of disability. Thus, limitations due to growing older would be counted as disabilities in disability-specific surveys, but may not be captured by global questions as elderly respondents may discount limitations as a natural part of ageing.

Three main types of single-item disability questions are used in UK surveys:

- The most well known and widely used single-item survey instrument for assessing activity limitation is the **self-reported limiting longstanding illness or disability question (LLSI)**. Variants of this question intend to capture the perceived disabling effects of chronic ill-health (morbidity) and physical and sensory impairments.
- The second type of measure aims to assess **work-limiting disability (WLD)** as defined by the respondent's perception of restriction in her or his capacity for paid work, in either the kind or amount of work they could do, or both. At its core, the question is hypothetical in that it asks respondents to consider work they *might or could* do. Respondents are also asked to judge if their work capacity is causally connected to an underlying health problem (rather than to other sorts of factors such as environmental or attitudinal barriers) and to assess if this problem is enduring.
- The final type of measure seeks to identify whether respondents have a **disability covered by the 1995 Disability Discrimination Act (DDA)**. The DDA defines disability as a '*physical or mental impairment which has a substantial and long-term adverse effect on (a person's) ability to carry out normal day-to-day activities*'.

The Government's Public Service Agreement (PSA) target to increase the labour market participation of disabled people is based on the number of people who are **long-term disabled**. This includes people of working age covered by the DDA as well as those with a work-limiting disability (i.e. categories 2 and 3 above).

### **Difficulties with measuring disability**

In addition to the well-documented issues that can affect validity and reliability in any survey-based estimates, several specific issues complicate the measurement of disability:

- **Accessibility is known to affect the representation of disabled people in surveys.** Survey design can often prevent the participation of disabled people or particular groups of disabled people (for example, people with visual impairments may find it impossible to participate in self-completion surveys without assistance). **It is possible therefore that all estimates based on national surveys are understated.**
- **There is no single, accepted definition of what 'disability' means.** Theoretical and lay perceptions of disability differ, and previous research has demonstrated that public understanding of the concept is fraught with comprehension issues and that interpretations of question meaning vary widely. Research into attitudes towards and experiences of disability has

shown that disabled people vary in their response when asked to say whether or not they see themselves as 'disabled'. The reasons for why responses vary are multifaceted but include such things as: age effects (i.e. older people are more likely to associate limitations to their daily lives with the ageing process than being 'disabled'), issues relating to self-identity and fears about the social cost of identification as 'disabled'.

- **The specific nature of certain types of disability can pose obstacles to producing reliable estimates of prevalence and severity over time.** For example, certain forms of mental health problems are episodic in nature and severity levels can vary over time.
- **Measurements of the number and type of activity limitations that constitute 'disability' vary from survey to survey** as do the threshold levels of severity. This makes comparability difficult.
- **Other forms of variability in surveys include:** whether 'capacity to' undertake an activity or actual performance of that activity are measured in surveys (i.e. 'Are you able to walk without assistance?' versus 'Do you walk without assistance?'); variations in how people are asked to assess their capacity or performance (for example: some surveys ask people to discount the assistance of aids such as sticks or adaptations; others ask people to judge their capacity whilst using these forms of assistance); the reference period (six months or a year or more) that is taken to constitute a long-standing illness or disability can also vary between surveys and is sometimes not specified.

### **The reliability and validity of key disability estimates**

**The technical review analysed primary data to examine differences between estimates relating to validity** (i.e. *does the survey question measure what it set out to measure and does it do so without systematic errors and biases?*) **and reliability** (i.e. *over time or in different contexts, would the survey produce similar results?*).

- Detailed analysis of estimates from the main survey sources suggested that single-item questions on activity limitation (such as LLSI and DDA disabled) and work disability (WLD) produced **estimates that were sensitive to factors related to the instrument** (question wording and order); **to the mode of data collection; to decisions relating to survey process** (for example, the collection of data by proxy) **and the sponsorship of the survey** (or context effects).
- **Of the three types of global estimates, the DDA definition appeared the least robust, with large overall and within age differences between surveys.** This was mainly because the DDA definition is relatively new and is the least standardised in terms of how the question is asked in surveys (operational differences).



- **Estimates from specialist disability surveys are also highly sensitive to the survey process** (e.g. mode of contact and screening criteria). Thus, if surveys using the same instrument (e.g. Disability Surveys, 1985 and 1996/7) do not follow identical survey procedures, the interpretability of any evidence of change over time is seriously compromised.

### Comparing differences in prevalence rates between key estimates

Despite differences in the definition of disability used, when the best available figures of the different types of estimates were compared (see Figure S.2 below), several important findings emerged:

**Figure S.2 Comparing age-specific prevalence rates of key survey estimates<sup>3</sup>**

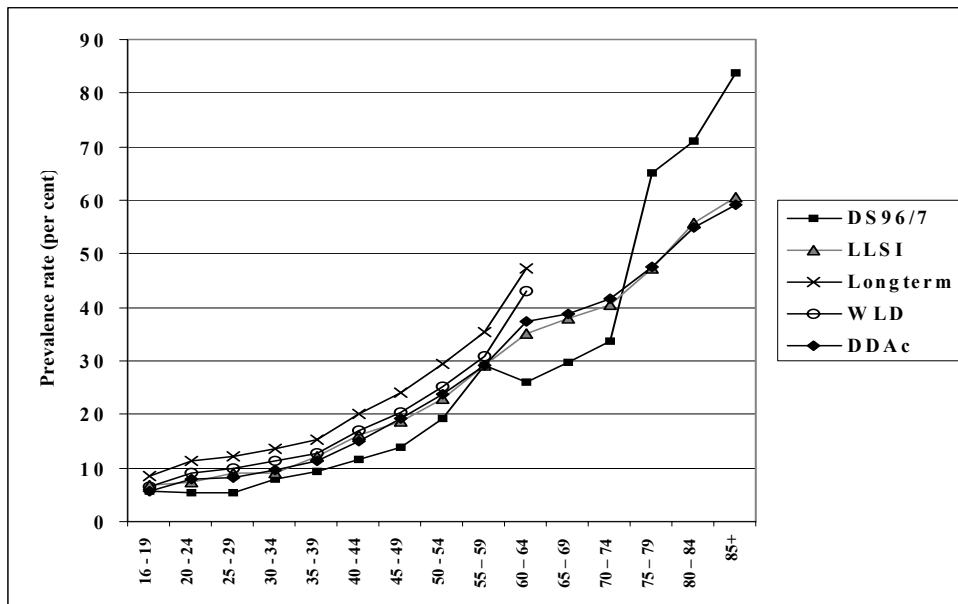

- All five estimates of disability prevalence rates were remarkably similar for all ages up to retirement age (at which point comparisons become more unstable). Overall, the (age-adjusted) differences between the estimates are relatively small (between two and three percentage points).
- The number of disabled people of working age is higher for the estimate that is based on the long-term disabled definition than it is for all other

<sup>3</sup> Sources: *DS96/7*: Disability Survey 1996/97 (FRS-follow up), (Grundy et al 1999); *LLSI* (limiting-longstanding illness or disability), derived from FRS 2000/01; *WLD* (Work-limiting disability), derived from LFS 2001; *DDAc* (people with a currently existing condition covered by the DDA, or a progressive health condition), derived from LFS 2001; *Longterm* (long term disabled defined as those with a WLD or a DDAc, or both), derived from LFS 2001.

global or disability-specific survey estimates. This is because long-term disabled includes people covered by the DDA as well as those reporting a WLD. Overall, the proportion of long-term disabled people of working age was about four percentage points higher than estimates produced using other definitions (see Figure S.1).

- Disability prevalence rates from more 'objective' disability measures (Disability Survey, 1996/7 (DS96/7) in figure S.2) were lower than for global questions for all age groups up to retirement age, and higher for those over retirement age.
- From a statistical point of view it is reassuring that the DDA current estimates are so similar to those derived from the question on longstanding illness or disability which limits activities (LLSI).
- For older people (of post-retirement age), estimates based on global questions were found to be unstable between different surveys that used the same question, and were more sensitive to the definition of disability used.
- There was less available evidence on which to test the reliability of disability specific surveys. Nevertheless, the advantage of using estimates that are based on disability-specific surveys is that they provide a more objective measure, because the specificity of the questions limits the likelihood that they will be understood very differently or that respondents will attempt to rationalise their own behaviour through their answers. Much of the variation in age-specific rates observed between the four disability-specific surveys was due to differences in survey operational features (such as in the use of different or no screening). As with global estimates, we find that for those of working age, the difference in age-specific prevalence rates was small compared to differences for those over retirement age.

**Both 'subjective' and 'objective' measures of disability appear to provide fairly reliable estimates for the working-age population**, albeit that the detailed sets of questions result in slightly lower estimates than do the broadly defined global questions.

### **Choosing an appropriate estimate**

Having established the variation between existing estimates and the explanations for that variation, the research team developed a flow-chart and table to assist users of the estimates in making their choice about which estimate was most appropriate. The table is reproduced in three sections below (Table S.1). The flow-chart is shown in Chapter Four and is also reproduced in larger scale at the end of this report.

**Table S.1 Choosing an appropriate estimate**

<i>I want an estimate of the disabled <b>adult population</b> (aged 16 and over) covered by the DDA...</i>					
<u>Survey</u>	<u>Prevalence / estimate*</u>	<u>Strengths</u>	<u>Weaknesses</u>	<u>Overall assessment of usability</u>	<u>Which survey should I use and why?</u>
LFS	<b>DDA disabled</b> 23 per cent, 11 million, 2002	Large sample size  Currently, is only continuous survey to include DDA definition  Trend data available from 1998 onwards	People over retirement age only asked DDA question at first interview  Estimates unstable between survey waves (e.g. mode effects between repeat interviews, large proportion of proxy responses)	Published estimates are only reliable for working age population  Published estimates updated every quarter. No annual estimates produced.	<p><i>It is anticipated that from 2003/04 the FRS will provide reliable, and more easily interpretable, annual estimates for all adults.</i></p> <p><i>LFS is presently the main source for estimating the number of disabled people covered by the DDA.</i></p> <p><i>The sample sizes of other surveys, such as the ad-hoc Omnibus Survey, are too small to provide robust estimates.</i></p>
FRS	<b>DDA disabled</b> Available from 2003/04 survey	Large sample size  Can be used to calculate annual cross-sectional estimates (unlike the quarterly estimates from LFS)	Weaknesses as yet unknown (data not yet available)  Published figures quote prevalence rates, not counts	Will provide annual estimates on a consistent basis for monitoring trends nationally, by region and broad socio-economic groups	
Omnibus survey 2001	<b>DDA disabled</b> (14 per cent)	Provides a quick, cost-effective way to obtain estimates for topics of immediate policy relevance, social attitudes etc.	Small sample size	Should not be used to provide a total population estimate	

- NB: Figures in brackets indicate estimates derived for this report and that are not available from published sources.

***I want an estimate of the disabled population of working age (men aged 16-64, women aged 16-59)...***

<u>Survey</u>	<u>Prevalence / estimate*</u>	<u>Strengths</u>	<u>Weaknesses</u>	<u>Overall assessment of usability</u>	<u>Which estimate should I use and why?</u>
LFS 2002	<p><b>DDA disabled</b> 15 per cent, 5.5 million</p> <p><b>Work limiting disability</b> 15 per cent, 5.4 million</p> <p><b>Long-term disabled</b> 19 per cent 6.9 million</p>	<p>Large sample size</p> <p>Detailed information on labour market participation</p> <p>Can also be linked to other attributes such as educational attainment, ethnicity. Regional and sub-national estimates possible.</p> <p>Long-term disabled definition combines DDA disabled and people with work disability and is used for defining the disabled population in the PSA</p>	<p>Quarterly estimates based on responses from different waves of the survey.</p> <p>Estimates unstable between survey waves (e.g. mode effects between repeat interviews, large proportion of proxy responses, specially young people)</p> <p>Annual estimates not published.</p>	<p>Currently, is the only available estimate of those of working age who have a long-term disability (DDA or WLD)</p>	<p><i>The LFS should be used to provide an estimate of those of working age covered by the DDA, with a work-limiting disability or long-term disabled because:</i></p> <ul style="list-style-type: none"> <li><i>It is currently the only survey source for estimates based on these three definitions.</i></li> <li><i>The Government's PSA target is based on an LFS-based estimate of the long-term disabled population</i></li> </ul>
FRS	<p><b>Work capacity</b></p> <p><b>DDA disabled</b> Available from 2003/04 survey</p>	<p>Large sample size</p> <p>Can be used to calculate annual cross-sectional estimates.</p> <p>Survey with most detailed information on income, welfare benefits and service use, carers of disabled people</p>	<p>Question on work capacity does not differentiate between people with short-term (non disabled) and long-term (disabled) limitation.</p> <p>Doesn't include people in institutions</p>	<p>Does not routinely derive an estimate of those of working age with a work-limiting disability.</p>	

\* NB: Figures in brackets indicate estimates derived for this report and that are not available from published sources.

Table S.1 continued...

<b><i>I want an (non-DDA) estimate of the disabled <u>adult population</u> ( LLSI or ICIDH)..</i></b>					
<u>Survey</u>	<u>Prevalence / estimate*</u>	<u>Strengths</u>	<u>Weaknesses</u>	<u>Overall assessment of usability</u>	<u>Which estimate should I use and why?</u>
<b>LLSI (limiting long-standing illness)</b>					
FRS	(22 per cent in 2000/01)	Large sample size  Estimate of LLSI using harmonised global question	No assessment of severity  No breakdown by type of activity limitation	Largest sample size, so most precise annual estimates of LLSI	<p><i>If estimates of disabled GB adult population needed by:</i></p> <p><i>a) type of disability – then use the Disability Surveys 1996/7 (ICIDH)</i></p> <p><i>b) localities – then use the Census 2001 (LLSI)</i></p> <p><i>c) trends over time – then use: GHS (LLSI) for long-term trends or FRS (LLSI) for the last decade</i></p> <p><i>d) ethnic minorities – then use the Census 2001 (LLSI)</i></p> <p><i>e) receipt of disability benefits – then use the FRS(LLSI).</i></p> <p><i>f) trends over time in type of disability – then HSE (ICIDH)</i></p>
GHS	(22 per cent in 2001)	Large sample size  Longest running time series data available from 1977 onwards	No assessment of severity  No breakdown by type of activity limitation (only ICD disease groups)	Most suited to analysis of long-term trends in LLSI	
Census 2001	21 per cent, 9.5 million	Gives total population coverage rather than estimates based on a sample  Accurate estimates for small areas (e.g. wards) and for population groups (ethnic minorities)	No assessment of severity  No breakdown by type of activity limitation  Uses non-harmonised version of LLSI question	Gives the most accurate available estimates for LLSI, but cannot be updated between censuses (every 10 years)	
<b>ICIDH (International Classification of Impairment, Disability and Handicap)</b>					
Disability Survey 1996/7	20 per cent, 8.6 million	Large sample of disabled people achieved through 'screening'  Uses a set of 'objective measures' to assess disability  Measures severity  Overall figures can be broken down by types of disabilities	A fair proportion of those over working age who were eligible were screened out  Was a one-off survey, so results can't be compared over time  Questionnaire too long  Severity scale based on expert judgement	Is a reliable estimate of the disabled population of working age and of those aged over 75, although is now somewhat dated  Understates disability prevalence in those aged 60-74.	

**Comment:** Page: 67  
I've changed "limitation" to "disability". Hope this is okay.

Health Survey for England 2001	(20 per cent in 2001)	<p>Relatively small sample of disabled people (no screening to boost sample)</p> <p>Uses a set of 'objective measures' and LLSI</p> <p>Measures severity</p> <p>Disability measured every five years (including among 65+ population in institutions)</p>	<p>Coverage limited to England</p> <p>Mental problems excluded</p> <p>Understates disability among older people (compared with DS96/7)</p>	<p>Currently, only survey using objective measures that can be used to assess trends over time (1995, 2001)</p> <p>Uses same questionnaire to measure disability among children aged 10-15.</p>	
--------------------------------	-----------------------	---	--	---	--

\* NB: Figures in brackets indicate estimates derived for this report and that are not available from published sources.

## **User perspectives on the current range of disability estimates**

The consultation exercise with disability organisations and expert users revealed some dissatisfaction with the inclusiveness of the overall estimates suggested some possible explanations for inconsistencies between estimates. It also highlighted the important role played by estimates in the policy process:

- Disability estimates play an important role in all stages of government policy processes. Good quality estimates enhance this process and the ability of disability organisations to contribute to it. They are also important for disability organisations' own service planning and development.
- There was a feeling amongst disability organisations and expert users that data were too seldom available that related estimates to regional or demographic factors (such as ethnicity) or to social outcomes (such as housing or educational achievement).
- Some disability organisations held the view that sampling strategies and the operationalisations of "disability" were not always sufficiently inclusive and that surveys therefore underestimated the numbers of disabled people.

## **The future of disability estimates?**

The technical review and the consultations with expert users and disability organisations led to a number of suggestions for the improvement of estimates and the extension of what was available in the future:

- Surveys that do not specialise in disability but that include a global question on disability should include a question on the level of difficulty rather than a simple 'yes/no' scale. Standard questions should be developed for use across different surveys, allowing greater harmonisation and more cross-survey analysis.
- Experts suggested that a large specialist survey that is dedicated to questions of disability should be conducted at regular intervals (every five years or so). This should have a large enough sample of disabled people to allow more fine-grained analysis of sub-groups (by disability, geography, social and demographic characteristics). Ideally, specialist surveys should also include the standard harmonised global question, so that the 'objective' and 'subjective' measures of disability can be calibrated at regular intervals against each other. This would improve interpretability of long-term trends in observed and self-perceived disability rates.
- Others also suggested that a longitudinal or panel survey was important for understanding the mechanisms behind flows into and out of disability and the long-run impact of social policy. This would also allow a greater

focus on methodological issues relating to the survey measurement of disability.

- Disability questions in surveys should be cognitively tested to find out how they are actually understood by respondents.
- Not all disability organisations have the resources to do their own statistical analysis. There was a call for government departments to do more analysis (within-survey and inter-survey) and to co-ordinate the approach and provision of statistics across departments.
- The dissemination of estimates and access to analyses should be improved. The onus should be on the sponsors of surveys to promote findings, facilitate access to findings, and give clear explanations of the meaning of different figures.





# 1 INTRODUCTION

## 1.1 Background and aims

The research project reported here was commissioned by the Department for Work and Pensions (DWP). Its aim was to provide an independent technical review of the range of estimates of the number of disabled people in Great Britain derived from survey data.

There exists a wide variation in survey estimates of the numbers of disabled adults in Great Britain, ranging from 6.2 million (14 per cent) in the 1985 OPCS Survey of Disability (Martin, Meltzer and Elliot 1988) to 11 million (23 per cent) in more recent estimates of the number of adults covered by the Disability Discrimination Act (Grewal I et al 2002).

Differences in estimates are attributable to two main sources: real differences over time and methodological differences in the collection of disability statistics. From a policy perspective, it is important to be able to disentangle these two sources of variation and provide consistent and reliable information to monitor trends in the prevalence of disability.

The collection of information on the number of disabled people in the population presents a particularly complex measurement issue. Different concepts of disability exist and, depending upon the concept used and the primary focus of the survey, questionnaire instruments may vary. Terms such as impairment, functional limitation, disability and activity restriction are often inconsistently used, resulting in conflicting estimates of prevalence. It is therefore often not possible to compare estimates from different surveys, as they draw on diverse definitions, use different thresholds of severity to decide whether someone is disabled (or not) and may also cover different time periods, geographical areas and age groups.

These measurement problems are further compounded when examining changes in the prevalence of disability over time. Increasingly, disability is viewed as a dynamic process that reflects the interaction between an individual with an impairment and the environmental context in which they live. Viewed as a dynamic concept, changes in reported disability result from an interaction between changes in individual functional status and changes in the physical, social and attitudinal environments that facilitate or act as barriers to participation. The recognition that disability is not a static phenomenon further complicates the assessment of the reliability of survey reports in separating out true change from measurement error (Mathiowetz 1999).

## 1.2 Objectives of the Review

The aim of the review was to provide DWP with a comprehensive evaluation of the range of survey estimates of disability and their strengths and weaknesses. More specifically, the review had three inter-related objectives, namely:

1. to clarify the conceptual and operational differences in existing survey definitions of disability, evaluate the methodological reliability of estimates and provide a framework within which to assess their appropriateness for different purposes (the “technical review”).
2. to consult with key stakeholders and users of disability estimates – such as national disability advocacy/campaign groups, expert users of disability statistics and survey methodologists – to find out which sources of national estimates they currently use and elicit their views on measurement and definitional issues of disability (the “consultation exercise”).
3. to explore what might be done to ensure consistency over time of estimates and definitions of disability in Great Britain.

These elements of the review are, in our view, intrinsically linked. We have therefore dealt with them concurrently, building one upon the other so as to provide an understanding of how estimates are derived and used and to help inform discussion of issues of cross-survey comparability and purpose. The review does not recommend a preferred or ‘best’ estimate but provides information to assess the strengths and weaknesses of different estimates and current estimates’ appropriateness for different purposes.

Administrative sources – for example the number of claimants of disability related benefits – provide a non-survey source of data on the number of disabled people. The main advantages of administrative sources are their ready availability, low cost and comprehensive coverage of all claimants (as opposed to sample based estimates). However, their main drawback is that the criteria used to assess benefit entitlement may not include everyone who is disabled under different definitions (for example people receiving Incapacity Benefit would not include all those covered by the Disability Discrimination Act). Equally, some people who would consider themselves disabled may not claim disability-related benefits. For these reasons, claimant counts tend to be considerably smaller than the number of disabled people estimated through general population surveys. For example, the recipiency rates in the UK were reported to be about six per cent (Grammenos S 2003) for adults aged 20 to 64, when survey prevalence rates were around 20 per cent. In this review, we do not examine administrative sources of disability estimates as these were outside the remit of the study.

### **1.3 Conceptual issues: models of disability**

The theoretical and philosophical debates surrounding the modelling of disability have particular significance for this review of disability estimates. In the survey context the language that is used is of the utmost importance and can heavily influence the way in which respondents reply to structured questions. Recent qualitative work with both disabled and non-disabled people has highlighted the complex, and sometimes conflicting, ways in which people define themselves either as 'disabled' or not (Grewal et al: 2001). This complexity in lay perceptions of disability and in the theoretical debates surrounding disability can lead to very different outcomes (and estimates) when it interacts with the survey process.

As a context to the later chapters, this section briefly reviews the dominant models of disability and some key findings relating to lay perceptions of disability. Our descriptions concentrate on the fundamental distinctions between the models.

#### ***The medical (or individual) model***

This model emerged from the approaches traditionally taken towards disabled people by professionals in the caring and welfare sectors. These were people empowered by society to 'cure' or 'care' for disabled people, often in institutions segregated from the rest of society. Variations of this model are found in the 'charity' or 'administrative' models. Like doctors, other health or social welfare practitioners have historically based their practices on the core assumptions set out in the medical model. The fundamental premise of this model locates the 'problem of disability' with disabled people rather than with society. As such, it implies that the way to overcome barriers to inclusion is to 'adjust' the individual disabled person in order to 'fit' society, rather than adjust society to accommodate disabled people. So, for example, the historical focus on rehabilitation and treatment for disabled people. In summary, the medical model of disability perceives that the restrictions and limitations in the lives of disabled people are a direct result of their impairments. This can be characterised as a 'functional' approach to disability. For example, a person who is blind is perceived as having a functional limitation (their loss of vision) which affects their ability to perform an activity (seeing) and causes their disability (blindness) which in turn accounts for other social impacts that limit or prevent the performance of a role considered 'normal' for that individual, e.g. labour market participation. Early efforts by the WHO (World Health Organisation) to standardise concepts and definitions resulted in the development of the International Classification of Impairments, Disabilities and Handicaps (ICIDH) in 1980.

#### ***The social model***

The social model challenges many of the assumptions set out in the medical model. It emerged in the 1960's as part of a wave of challenging discourses, which confronted established ideas about disability, race, gender, ethnicity and sexuality.

The continued denial of opportunity, restriction of choice and self-determination, and the lack of control over the support systems in disabled people's lives led to questioning of the central assumptions underlying the medical model. In contrast to the medical model, the social model begins with society, not with an individual's functional ability. The social model of disability focuses on how a person is 'disabled' by the barriers imposed upon them by society, for example "*The lecture theatre has no wheelchair access therefore I cannot attend the lecture*".

As with the medical model there is an acceptance that impairment means that a disabled person has a bodily function/organ/limb which acts differently. The critical difference is that in this model, a difference in a functional capacity is not assumed to imply a negative impact on ability or experience. Instead, *disability* is the disadvantage or restriction of activity caused by contemporary societies, which take little or no account of people who have physical or mental impairment and thus excludes them from participation in the mainstream of social activities.

### ***The biopsychosocial model***

The original ICIDH framework developed by the WHO (the 'medical model') focused on 'deficiencies' resulting from health conditions and impairments. The emphasis was entirely individual-based and on the negative. In response to the criticism levied against the ICIDH, WHO has developed a new system of classification, the ICF (International Classification of Functioning and Disability) (WHO 2002). The ICF attempts to bridge the gap between the medical and social models, demonstrated in its use of neutral terminology such as by the use of the term 'activity restriction' instead of disability and 'participation' instead of handicap.

The concept of participation in the ICF explicitly takes into account the social context- both the external environmental factors and personal characteristics of the individual. The latter range from relatively uncontroversial characteristics such as age and gender, to aspects such as social position, ethnicity, personality and coping behaviour, life styles and past and current experiences. Importantly, the concept of participation goes beyond the performance of social roles and deals with the wider issues of the effects of barriers and facilitators to overall participation in society. Barriers and facilitators to participation include discrimination, stigma, legislation, and access. Nevertheless, the focus of the revised model remains on locating the source of the disability with the individual (and their impairment).

Clearly, these three models present very different challenges for the survey researcher attempting to operationalise the concept of 'disability' for a survey question. The ICF survey questionnaire is currently being developed and we know of no survey measure of the social model. Existing survey estimates have generally used the ICIDH concept or legal definition, such as that based on the DDA. Chapter 2 will describe in more detail the different routes that have been taken in key surveys over recent years.

### **Lay perceptions of disability**

This challenge is further complicated by the fact that lay perceptions of disability have been found to be multifaceted and sometimes contradictory. Recent research (Grewal I et al 2001) with disabled and non-disabled demonstrated how complex perceptions of 'disability' are:

- There were four commonly held beliefs about what constitutes disability – physical impairment, visible '*difference*', something which causes incapacity, a permanent and unchanging state
- These beliefs were primarily informed by media portrayals of disabled people's lives, personal experience of disability, or the influence of family attitudes and beliefs
- In a national survey just under half of disabled participants (as defined by the survey) saw themselves as disabled (Grewal I et al 2002). The preceding qualitative research identified various reasons why people might not think of themselves as 'disabled', these included:
  - Believing that your impairment is not *severe* enough to count as a 'disability' (most usually related either to perceptions of the restrictions on daily activities, for example '*I can work so I'm not disabled*' or the pain/suffering associated with the impairment, i.e. '*I don't suffer like those people who have constant pain*' etc.).
  - Considering your impairment as a natural part of ageing process ('*I'm old not disabled*').
  - Considering your impairment as an '*illness*' not a disability.
  - Not including your impairment as a 'disability' because it is not a visible or immediately obvious impairment (for example, popular images of disability were typically those of wheelchair users, blind people or those missing a limb).
  - Not wishing to be stigmatised or '*lumped together*' with other 'disabled' people.

### **Our approach**

From the discussion above, the emerging view in the field of disability research is that 'disability' refers to the interaction between the individual (the person with a long-term impairment or health condition) and the environmental factors (physical, social and attitudinal) that facilitate or hinder their ability to perform social roles. However, with the exception of the measurement of work disability, the standard survey definition of disability is generally based on health-based aspects of disability (e.g. measuring impairments, functional

or activity limitations), but not society-based definitions (participation restrictions).

It is not the role of this report to address the debate about how disability ought to be defined and measured. However, we have not been able to altogether avoid using the words “disability” and “impairment” and have therefore had to choose to use them either in the way in which they are understood within the social model or in the way they are used within the medical model. The latter of these forms will probably be more familiar to most readers, so for the sake of clarity of meaning it is this form that we have adopted. Thus, we generally employ the term “disability” to mean *any health condition or physical/mental impairment that limits a person’s day-to-day activities* and do not use the term as it would be defined under the social model of disability. Taking this approach enables us to use terms such as “multiple-disability”, “impairment-specific” and “disability estimate” in their commonly understood sense, rather than having to re-define them on each occasion. We are keen to stress that the choice of this approach was made for purely pragmatic reasons and should not be taken to imply any ideological position on the part of the authors.

## **1.4 Research Methods**

The research for this study comprised two parallel parts: the technical review, which was an appraisal of existing survey sources and the empirical comparison of disability estimates derived from them; and a consultation exercise with key disability organisations and expert users of disability statistics.

### **1.4.1 The technical review**

The main focus of the technical review was a critical examination of existing survey estimates of the number of disabled people in Great Britain. The research process included the following:

1. A literature review to clarify concepts and definitions of disability. This provided a frame of reference to delineate formal definitions derived from the different conceptual models of disability and the extent to which these correspond with lay perceptions of disability. The latter were thought to be of particular interest as they were likely to influence responses to single-item or global questions which depend upon self-categorisation into disabled/non-disabled.
2. An overview of the main components of large-scale national surveys that include a measure of disability. This was presented in the form of a grid that highlighted key differences in features such as sample coverage, sample size, response rates etc. The grid included surveys with questions on long-term activity limitation in its broadest sense (*any* limitation); to those measuring *substantial* limitation, difficulty or incapacity with specific tasks; and those measuring participation restrictions (e.g. work-limiting

disability). The aim was not to make an exhaustive list of surveys, but to help define criteria and methodological standards for the selection of specific surveys for more detailed empirical investigation.

3. A range of estimates derived from the selected surveys were tabulated and compared. The aim of this empirical investigation was to provide evidence of the reliability and validity of the different survey questionnaire instruments and to assess the anticipated impact of the operational features of survey design on variability between surveys and over time.

### **1.4.2 The consultation exercise**

#### ***Aims and objectives***

The aim of this part of the study was two-fold:

1. To consult survey methodologists, research analysts and expert users of survey-based disability statistics in order to:
  - deepen our understanding of the issues related to survey measurement of disability;
  - inform our understanding of how survey estimates are derived and used;
  - elicit views on the adequacy or otherwise of existing disability statistics for informing policy development.
2. To consult national organisations that provide services for disabled people and / or campaign on disability issues in order to:
  - discover the source of any numerical estimates that are used
  - find out for what purposes these estimates are used
  - uncover any perceived gaps in the availability and quality of estimates,
  - find out about the consequences of any such gaps.

#### ***The method***

As qualitative research seeks to provide explanations of attitudes or behaviours rather than quantify their extent in the population, it requires a specific approach to sample design. It is neither necessary nor desirable for qualitative samples to be as large as survey samples or to be statistically representative. Instead, in order to provide robust explanations from which wider inferences can be drawn and to generate conceptual frameworks applicable to the broader population it is essential that qualitative samples are selected purposively to encompass the range and diversity present in the target population(s).

The consultative interviews were exploratory in nature. Participants were encouraged to discuss their views and experiences in an open way and introduce issues that they felt were important to the research question. The



questioning was responsive to the interviewees' own comments and situations. Questions were not pre-set, and the order in which issues were addressed and the amount of time spent on different themes varied between interviews.

A list of the organisations and experts consulted is included in Appendix A.

***The consultation with expert users of the surveys***

The sample of expert users included in the consultation exercise was limited to those with specialist knowledge of the methodological issues in the measurement of disability in surveys, and research analysts who had used such surveys in the development or evaluation of social policy. In addition to issues related to definitions and operational features of different surveys, experts were encouraged to consider the informational and analytical limitations of current estimates and to express views on 'ideal' future disability statistics provision.

**Table 1.1 List of disability experts consulted**

<b>Name</b>	<b>Expertise</b>	<b>Affiliation</b>
Roger Thomas	Survey methodologist	NatCen
Howard Meltzer	Survey methodologist (with a special interest in disability surveys)	ONS
Labour Force Survey team	Survey operation	ONS
Family Resources Survey team	Survey operation	NatCen
Omnibus survey (Grahame Whitfield)	Survey commissioner/reporting	DWP
Steve Ellerd-Elliott, Peter Matejic	Government analysts (FRS)	DWP
Chris Tracey	Government analyst (LFS)	DWP
Richard Berthoud	Employment outcomes, income maintenance policy, disability dynamics and transitions	IESR, Univ. of Essex
Tania Burchardt	Employment outcomes, disability dynamics and transitions, social participation, policy evaluation	CASE, London School of Economics
Emily Grundy	Trends in disability, older people, social and economic disadvantage	LSHTM, Univ. of London
Patricia Thornton, Michael Hirst	Policy evaluation, evaluation of interventions, disability follow-up studies	SPRU, Univ. of York

Table 1.1 lists the expert users who were consulted. Methodological specialists included individuals with experience of developing survey instruments as well as survey contractors with in-depth knowledge of the operational processes and the history, aims and development of both specialist and continuous surveys over time. We also interviewed analysts in government departments who had a role in commissioning surveys and who informed the policy development process. Our focus in this study was to understand the nature of *existing* estimates, and given the limited time frame of the study, we interviewed a small, targeted number of external (academic) researchers, and relied on published literature to gain a broader range of academic views. The academics consulted were specifically those who had made extensive use of survey data for secondary analysis. The interests of the latter group were mainly in exploring the impact of adult disability on outcomes (e.g. employment), income maintenance and the evaluation of social policy initiatives (rather than those with an interest in health or educational policy).

As the scope of interviews with different types of experts varied, the method of recording interviews was geared to what was most suitable in the circumstances: interviews were either taped (and later transcribed) or extensive notes taken, supplemented where necessary with email clarifications. For consistency and continuity, the same member of the research team conducted all interviews with expert users.

### ***The consultation with disability organisations***

The sample for the consultation exercise with disability organisations was purposively selected to represent the diversity of national organisations that specialised in the provision of services for disabled people or that campaigned on disability issues. For this reason, it was ensured that some pan-disability organisations were included as well as organisations focussed their activities on specific groups such as people with communication difficulties, learning difficulties and mental health problems. Additionally, care was taken to include organisations that were themselves run by disabled people. The resulting list of organisations that were consulted is shown in Table 1.2.

Interviews were conducted with one or more people on the staff of each organisation who were considered to be most appropriate because of their insight into or dealings with disability estimates. In practice the people interviewed varied between organisations. They included chief executives, a director of external relations, researchers, information officers, policy & campaigning staff, a marketing & communications officer and one person with a specialised technical/scientific training.

**Table 1.2 List of disability organisations consulted**

	<b>Pan-disability</b>	<b>Impairment-specific</b>
British Council of Disabled People	✓	
Disability Alliance	✓	
Disability Rights Commission	✓	
Mencap		✓
MIND		✓
Royal Association for Disability and Rehabilitation	✓	
Royal National Institute of the Blind		✓
Royal National Institute for Deaf People		✓
SCOPE <sup>4</sup>		✓
SKILL	✓	

All interviews were conducted with topic guides that had been designed in collaboration with DWP (Appendix B). These were used to signpost the

<sup>4</sup> SCOPE's principal focus has historically been people with cerebral palsy. However, their campaigning and service provision activities also cover people with other disabilities.

structure of the interview while nevertheless allowing the researcher to respond to participants' own accounts of their experiences and views. For the sake of consistency, all the consultation interviews were conducted by the same member of the research team – a qualitative researcher with extensive experience of depth interviewing. All the interviews were conducted in a confidential space at the office of the organisation concerned. To aid analysis and to allow the interviewer to give full concentration to exploratory questioning during the interview, all interviews were tape-recorded.

The interviews were then analysed from the tape using a modified version of the 'Framework' technique. 'Framework' is an analytic technique developed by the Qualitative Research Unit at the National Centre that involves ordering and synthesising verbatim data within a series of thematic charts. (The structure of the framework used for this study is shown in the Appendices). Further interpretative analysis was derived from these analytic charts. As the study was qualitative in design it is possible to describe the range and nature of views and practices amongst those who participated in the research. However, this research cannot provide any statistical data relating to prevalence of views or experiences; nor can it infer any general patterns relating to other types of disability organisations who were not included in the sample.

## **1.5 Scope and Organisation of the Report**

Chapter 2 of this report lists the main survey sources for disability statistics and presents an overview of survey processes that affect estimates in general, and potential sources of measurement error specific to the identification of disabled people. It also presents criteria that have been used to select a sub-set of surveys for detailed empirical investigation.

A range of disability estimates obtained from the surveys selected for detailed examination are then assessed and compared in Chapter 3. The main aim of this chapter is to provide empirical evidence of the reliability and validity of survey estimates of disability, and to assess the magnitude of the difference in estimates employing different definitions.

In Chapter 4 we discuss how disability estimates are currently used by disability organisations and expert users and their perceptions of the quality of these estimates and how well they serve the specific needs of different types of users.

Overall conclusions and suggestions arising from the review as well as from the consultative process are presented in Chapter 5.

Questionnaire listing, topic guide and technical aspects of the study are described in detail in the Appendices.



## 2 DISABILITY AND DISABILITY-RELATED SURVEYS

### 2.1 Introduction

This chapter identifies the main survey sources for disability estimates in Great Britain. In addition, it explores the range of survey processes that can affect estimates, as well as the potential sources of measurement error specific to the identification of disabled people. The end of this chapter presents the criteria that we have used to select a sub-set of surveys for the detailed empirical investigation that is described in Chapter 3.

The focus of this chapter is to discuss sources of measurement error in surveys that need to be taken into account when comparing different survey estimates. However, it should be emphasised right at the outset that surveys (and censuses) provide the best available estimates of the numbers of disabled people in the population compared with alternative data sources, such as administrative data. As discussed in Chapter 1, administrative sources and registration systems invariably understate the population prevalence of disability. Survey data also has the merit of including a much richer level of detail of the characteristics of disabled people than non-survey sources.

### 2.2 Identification of surveys

Appendix F<sup>5</sup> contains a grid that lists surveys that include disability as a component in Great Britain in recent years.

In order to identify the relevant surveys to be included in the grid, a comprehensive literature search was performed. This included searching databases (for example, Medline, Economic and Social Research Council Data Archive at the University of Essex) to gather published reports/articles relating to any measurement of disability and impairments. Furthermore, reports were gathered from previous work done by NatCen, Department for Work and Pensions and the Office for National Statistics as examples. The surveys included in the grid are dated from 1985 – 2002. Wherever possible, the most recent findings are reported (particularly for repeat/continuous surveys).

---

<sup>5</sup> The sequence of labelling of appendices in this report appears discontinuous, because to improve readability, appendices referenced early in the report but which contained information presented as large A3 pull-outs could only be affixed to the end of the report (hence the Grid is the last appendix – F).

### 2.3 Typology of disability surveys

Questions on self-reported long-standing illnesses, impairments, disabilities and infirmities have been included within several surveys of the general population in Great Britain.

Broadly speaking, three types of disability surveys were identified:

- surveys that include a subjective 'global'<sup>6</sup> measure of disability (for example, the limiting longstanding illness question), but that do not include information about disability type or severity
- surveys that include a module of questions that explores the association of disability with the prime focus of the survey (e.g. labour market participation in the Labour Force Survey)
- surveys for which the count of the number of disabled people is the prime focus. Such surveys provide details of the types of disability, their severity and their geographical distribution and range. They range from the highly detailed (e.g. Disability Surveys, 1985-88) to the less detailed (e.g. Health Survey for England).

### 2.4 Relevance of dimensions of the grid to the assessment of survey quality

As a means of systematically comparing the surveys identified through a literature search, a list of descriptors were applied to each of them. Descriptors are important because they provide an at-a-glance overview of the key components of a survey. Examples of characteristics covered by descriptors include population coverage (the type of people included in the survey – e.g. children, adults, people in Wales, people from across Great Britain), response rates and sample size. These act as markers of survey quality and precision and are important to consider when making judgements on the reliability and robustness of findings.

The sources of error that affect survey estimates have been well documented in the literature. Broadly speaking, these sources may be classified into two types – those relating to survey design and sampling (*non-measurement errors*) and those relating to the survey questionnaire and the process of data collection (*measurement errors*) (Fowler et al, 1990). The descriptors included in the grid (Appendix F) are mainly those related to non-measurement errors (e.g sample size, response rate etc) .

---

<sup>6</sup> see footnote 1, chapter 1 for definitions of subjective vs. objective measures, global questions vs questionnaire modules or instruments.

## **2.4.1 Non-measurement errors**

### **Population coverage**

The population coverage of a survey is an important consideration when determining how representative and generalisable findings are.

The definition of the survey population will impact on the inclusiveness of the disability estimate. For example, if the survey population only includes adults aged 18+ who live in private households, then children and those living in institutions are (automatically) excluded. If disability rates were higher among the latter group, then the resulting prevalence estimate would be lower than the prevalence rate for the total population.

Most general household surveys in Great Britain exclude people living in institutions. Residents in all types of communal establishments (e.g. boarding schools, residential and care homes and long-stay hospitals) constituted 1.35 per cent of the total population of England in the 1991 Census, with about three-fifths of them being aged 65 or over (OPCS Communal Establishments, 1993). The majority of residents in communal establishments were in residential and care home settings. This group was on average in poorer health than people of the same age in the general population. It can therefore be seen that by excluding the institutional population, survey estimates underestimate the population prevalence of disability.

### **Coverage error**

Coverage error is a term used to describe the failure to include on a sample frame all the different types of eligible individuals in a population. Individuals who fall into any categories that are *not* included on the sample frame will have zero chance of being selected as respondents.

For example, a telephone survey would preclude the participation of individuals who did not have a telephone, and this would be a form of bias. The characteristics of those with no telephone number might be different to those of people who do. This would mean that the survey estimates would be unreliable and would contain *systematic bias*.

### **Sample size and sampling error (precision)**

For most general surveys, the single most important factor that influences precision and that can also be manipulated is the sample size. The precision of an estimate relates to the sampling error and is indicated by the width of the confidence intervals around an estimate. It is this confidence interval (rather than the estimate itself) which is used to make statements about the likely 'true' value in the population: the narrower the confidence interval, the more precise the estimate of where the 'true' value lies.

For a simple random sample, precision increases in proportion to the square root of the sample size (i.e. the standard error is inversely proportional to the square root of the sample size.) This means that the gain in precision from increasing the sample size by a fixed amount diminishes as the total sample



size increases. Thus the precision gained from increasing a sample size from 500 to 1,000 is greater than the gain from increasing a sample from 10,000 to 10,500, even though the absolute increase is the same in both cases.<sup>7</sup>

Most government-sponsored general population surveys have a sample size that is large enough to permit fairly precise estimates of overall disability (however this may be defined) by broad age bands and gender. However, the sample sizes of general population surveys that are designed to provide overall prevalence estimates (or estimates by a limited number of breaks, such as by gender, broad age bands or region) are generally not large enough to provide precise estimates for specific types of disability ( e.g relatively rare disabilities such as severe disfigurement); or for sub-groups of the population (e.g. minority ethnic groups); or for local areas. To obtain precise estimates for rare conditions or small sub-groups of the population would require very large samples of the general population. Cost-effective approaches to address this issue are to use screening to identify the population of interest, 'boosting' the sample of particular groups (eg ethnic minorities, or residents of specific types of areas) or using follow-up methods to identify and survey the eligible population identified from a large general population survey (e.g. FRS follow-up Disability Survey 1996/7).

### **Response rate (*bias*)**

Response rates can have a direct impact on the reliability of survey estimates and can contribute to the variation in estimates across different surveys. Errors relating to non-response arise from a failure to collect information from the persons selected for measurement (unit non-response), or from a failure to obtain complete information from all respondents regarding a specific question (item non-response). There are three main reasons for unit non-response: (1) unwillingness to be interviewed (e.g. invasion of privacy), (2) interviewers inability to establish contact during the fieldwork period and (3) prevention of participation by language barriers or disability. Non-responders in each of these categories are likely to have different characteristics to those that do respond. Currently, the highest group of non-responders within social surveys in Great Britain is young adult males living in inner-city areas (Hudson 1995). Low response rates may be indicative of bias, which means that estimates derived from a study would not be generalisable to the population as a whole<sup>8</sup>.

What is important to note with regard to respondents and non-respondents is how similar (or different) the characteristics of these groups are. For example a low response rate in a survey of disability might produce estimates that were not representative of the true target population of disabled people. Unless information is known about non-responders, there is no way of knowing whether they share the same characteristics as respondents. The greater the

---

<sup>7</sup> This is because the change in the square root would be larger in the first example (in which the change would be 10) than it would be in the latter (in which the change would be 2.5).

<sup>8</sup> There is no magic rate of response that indicates freedom from bias. Any non-response in an initial random sample might cause response bias, and the higher the level of non-response the greater the risk of bias.

difference between responders and non-responders with respect to the attribute (e.g. disability) being measured, the greater the respondent bias will be (Groves & Couper 1998).

### **Proxy response**

The use of information obtained by proxy also has an effect on survey estimates (see Appendix D). Proxy reports involve asking individuals within the sampled household to provide information on behalf of other household members. This has several advantages, including that it:

- increases the sample size at a lower data-collection cost (the alternative would be to sample more households, which would cost more)
- provides information that may have been lost had the other household member been unwilling or unable to participate.

However, the use of proxy reporting is thought sometimes to lead to poor quality data compared with that collected with self response. For example, Lair (1987) found that proxy reporters for elderly respondents typically reported more and more severe activity limitations than did respondents themselves. This may partly be because older people are more likely to discount functional limitations that they consider to be a natural part of growing old. If the areas covered by questions are sensitive or the labels attached are considered stigmatising then self-reporting is also likely to lead to lower reported prevalences.

### **2.4.2 Measurement errors**

The sources of error that affect survey estimates have been well documented in the literature. Broadly speaking, these sources can be classified into two types – those relating to the survey questionnaire and the process of data collection (*measurement errors*); and those relating to survey design and sampling (*non-measurement errors*) (Fowler et al, 1990).

Measurement errors may develop from any of the components directly engaged in the measurement process (e.g. the *questionnaire*, the *respondent* or the *interviewer*), as well as from characteristics that define the measurement process (e.g. the mode and method of data collection).

#### ***The questionnaire as a source of measurement error***

Tourangeau and colleagues (1984) describe the survey question-and-answer as involving four steps:

- comprehension of the question
- retrieval of information from the memory
- assessment of the link between the retrieved information and the requested information
- communication of the response.

The first step, comprehension of the question, involves the respondent assigning an initial meaning to the question. Ideally, the question would convey the same meaning to each respondent as it did to the researcher. This is not always the case. Factors such as environment, language and structural considerations affect the interpretation of the question by the respondent (Mathiowetz 1999). These include the overall topic of the questionnaire, the particular wording of a question and the sequential order in which questions are presented. Furthermore, the interpretation put on a question also depends on whether the question is read by the respondent himself (self-administration) or read to the respondent by the interviewer.

Respondents' comprehension of survey questions is subject to wide variation due to differences in the perceived meaning of the question. The overall topic of the questionnaire, the sponsorship of the survey, and the order of the questions can all impact on how questions are interpreted.

### ***The respondent as a source of measurement error***

Once a respondent has interpreted a question they must then recall the required information from their memory, formulate a judgement as to whether the recalled information matches the required information of the question, and, finally communicate the response (Tourangeau et al 1984).

As a part of the response process, the respondent must establish whether or not they wish to disclose the information at all. Questions on personal or sensitive issues form a part of many surveys. The current literature suggests that questions on personal issues can lead to the under-reporting of socially undesirable behaviour and attitudes and to the over-reporting of socially *desirable* behaviour and attitudes (Mathiowetz 1999). Even if a respondent is able to retrieve the information, they may choose to edit it as a means of reducing the effort involved in providing a response.

### ***The interviewer as a source of measurement error***

Where questionnaires are administered by interviewers, interviewers themselves sometimes affect the survey measurement process.

Interviewers may sometimes read questions differently from how they are written. Furthermore, interviewers' ability to perform other tasks related with interviewing can vary (for example, their ability to probe appropriately and to record the information given by the respondent). Interviewer bias of this sort can affect the value of the final survey estimates.

### ***The effects of the mode of data collection***

In addition to errors concerned with survey measurement, other factors also affect survey estimates. More specifically, the *mode* of data collection (e.g. postal, telephone, face-to-face interviews) used within a survey can impact on the quality of data.

In the past 25 years, new computerised methods of data collection have given survey researchers new choices of method. In brief, the available methods now include:

- The “pen and paper” self-administered questionnaire
- Computer Assisted Telephone Interviewing (CATI) and Computer Assisted Personal Interviewing (CAPI). Both of these approaches use a computerised program that controls the order of the questions to be administered and carries out edit checks as answers are provided.
- Audio Computer-Assisted Self-administered Interviewing (ACASI). In this approach a computer program displays the questions on screen and simultaneously plays a digitised recording to the respondent, generally via earphones.
- Internet-based and web-based surveys.

While there is currently no ‘gold standard’ data collection method, each method has its own strengths and weaknesses. The pertinence of these in any survey depends upon the context of the survey and the information to be collected. For example, self-administered questionnaires have been shown to increase respondents’ willingness to disclose information on sensitive topics (e.g. sexual health and attitudes) and will obviously eliminate interviewer effects. However, disadvantages include the inability of respondents to clarify the meaning of questions and respondent errors in following the correct routing of questions. Furthermore, this method assumes that respondents are able to read and write, which will not always be the case – especially for people with cognitive/learning difficulties. Not only can this affect the quality of the data, but it can also impact on the overall response rate by preventing some respondents from taking part.

With methods such as CAPI or ACASI, the respondent is not required to read for themselves. This can be advantageous for populations with low rates of literacy, but questions need to be kept short. Long or complicated questions can decrease the ability of respondents to listen and respond bearing in mind all aspects of the question being asked. For example, it may be difficult for respondents to keep the response options in their minds unless show-cards are used as an aid.

Lastly, there are also differences in the mode of responding. For example, the methods of verbal communication, paper and pencil and computer mouse each impose different cognitive requirements on respondents. These cognitive requirements may be important considerations, especially for people with physical or mental impairments. Taken collectively, these differences relating to data collection methods, administration and mode of responding all have an affect on the response process and therefore, ultimately, also affect the quality of data that are collected.

## 2.5 Issues specific to measuring disability

The measurement of disability in national surveys is more challenging than the measurement of many other phenomena. Many conceptual and definitional problems continue to be a source of debate.

### **Coverage, access and participation**

Survey interviews place demands on both the physical and sensory resources of respondents. For example, a CAPI interview requires the respondent to hear the question, understand each of the question and response options, provide a verbal response, and all-the-while to maintain a cognitive focus.

Disabled people can be restricted in their ability to participate in the survey process, and the design of the data collection method can either help or hinder participation. For example, self-completion questionnaires restrict participation for those with visual impairments. A recent study of non-responders to a survey conducted in the US found relatively high rates of anxiety disorder among non-respondents who were willing to complete the non-response interview by telephone or in a public place, but were not willing to have the interviewer in their home for the initial face to face interview (Mathiowetz, 2003). This finding suggests that permitting flexible modes of data collection may be a more inclusive strategy to improve survey participation among disabled people (and indeed among non-disabled).

### **Cognition**

Many of the questions used to measure disabilities are fraught with comprehension issues and are ambiguous. People interpret phrases, concepts and terms to mean different things. Question testing methods may elicit where the question fails to achieve its intended purpose. The respondent may often be limited in the response they are asked to give (e.g. simplifying it down to a yes/no answer). This fails to capture both the complexity and spectrum of the enablement-disablement process.

Other than the standard piloting of questionnaire instruments in large national surveys, there has been little systematic cognitive testing of single-question instruments that measure disability. Thus a key goal should be to cognitively test single-item questions in order to check for misunderstandings, incomplete concept coverage, inconsistent interpretation, *satisficing*,<sup>9</sup> question order effects and so on.

### **Social cognition and self-concept**

Getting an individual to classify themselves with respect to disability is problematic. It is questionable as to whether clear, explicit and objective definitions are achievable when attempting to measure disability. Disability is a concept that is dynamic; and linked to complex individual and societal accommodations and barriers, behavioural and cultural norms and expectations. Theories derived from social cognition can help explain and

---

<sup>9</sup> The answering of questions in such a way as is thought will satisfy or please the interviewer

understand how individuals classify themselves in relation to social categories.

Specifically, two concepts are useful for consideration in relation to measuring disability. Firstly, the concept of the self; self conceptions involve three components (how an individual sees him/herself, how other people see the individual and how the individual perceives others to see them). The second concept involves the idea of social identity and social categories that individual members associate themselves as belonging to. Identifying or affiliating oneself within a group membership carries with it both a social stigma as well as a social cost – both of which are highly relevant to disabled people.

### ***Mental health and disability***

According to the WHO, the burden of mental illness is currently the leading cause of life years lost due to disability in countries such as the United States, Canada and the UK (Murray CJL et al 1996). Mental illness (including depression, bipolar disorder, and schizophrenia) accounts for 25 per cent of all disability across major industrialised countries. However, measuring mental illness as a form of disability can be problematic, given the episodic nature of the illness and the variability in severity within episodes.

### ***Number and type of activities measured***

Disability-specific surveys typically include a number of items related to activity limitations as a way of measuring the prevalence of various types of disability in the population. Modules on activity limitations range from a detailed list of activities of daily living (ADLS),<sup>10</sup> to fewer questions on instrumental activities of daily living (IADLs)<sup>11</sup> and limitations in work or social participation, to the use of a single question on (non-specific) activity limitations. The latter are more likely to be included in general social or health surveys and the more detailed questions on disability-specific surveys.

The number and type of activities included are not consistent across all major surveys and are likely to affect disability estimates. As a general rule, it has been found that the more activities that are measured, the greater the number of people being identified as disabled (Gudex, 2000).

### ***Capacity versus performance***

Most disability surveys uses a form of questions related to capacity or an individual's ability to execute a task or an action ('can you..'). This type of formulation aims to indicate the highest probable level of functioning that a person may reach. As it does not depend upon social setting, it can be used in a variety of environments (e.g. in a household or institutional survey) (Craig, 1996). Capacity questions are particularly suited to IADLs as respondents

---

<sup>10</sup> ADLs generally include self-care tasks such as washing, feeding and dressing, bed/chair transfer; mobility (e.g. climbing stairs, walk outdoors); and communication (the ability to hear, talk and speak).

<sup>11</sup> IADLs are a measure of dependency which is less extreme than those covered by ADLs (Bone M, 1995). IADLs include ability to handle finances, to cook, shop, do laundry etc.

are often capable of doing these activities (e.g. cooking or doing laundry), but may not perform them on a regular basis. Disability surveys in GB have all used a capacity measure.

An alternative form of wording, sometimes used in surveys, is 'do you..'. A performance questionnaire describes what an individual does in his or her current environment. Because the current environment includes a set of specific contexts (physical, social and attitudinal), performance can also be understood as role limitation or participation restrictions on people's lives. The performance question formulation is generally restricted to tasks that people absolutely need to do (such as self-care) or would prefer to do themselves.

The gap between capacity and performance measures provides a useful guide as to what can be done to the environment of the individual to improve performance (ICF, 2002). The current literature suggests that measuring limitation by capacity (rather than performance) may overestimate estimates of disability by 15 to 20 per cent (Gudex, 2000).

### ***Scales and qualifiers***

Response categories can range from a simple 'yes/no' answer to three or more point difficulty scales (e.g. 'no difficulty/ some difficulty/ severe difficulty or cannot do without help' used in the HSE module). Dichotomised response scales may appear to be simpler, but have two major drawbacks: first, they require the respondent to make a judgement that may not always be clear-cut (therefore introducing reporting bias), and second, it makes it impossible to use the data to analyse the nature of disadvantage experienced by individuals with varying degrees of limitations.

Ordinal response scales such as the 3-point scale (e.g. 'no problems', 'some problems', 'severe problems') used in the EuroQol instrument (Williams, 1991) are sometimes converted to interval scales using statistical methods combined with expert judgement. Where individuals place themselves on a scale, scale preference (for example always choosing the middle category or the most positive assessment) may also be influenced by cultural norms. This poses particular problems in international comparability of results even when harmonised forms of questions are used. Efforts to achieve response scale equivalence methods are being developed (van Buuren, 2001).

A number of disability instruments also use qualifiers in the assessment of ability. These take the form of asking respondents to assess capacity either taking into account special aids they might use (such as hearing aids, walking sticks, grab rails etc.) or not. The current practice in most surveys is to allow the use of common aids when asking people about their ability to do an activity or task. The DDA definition of disability is unique in asking people to ignore the effect of aids, medication or treatment when answering the question on activity limitation.

### **Reference period**

The reference period used to define (long-term) disability may affect survey estimates. At times, the reference period is unspecified. This may lead to a greater subjectivity in responses and an increase in reporting bias. In other instances, the reference period may be defined from when the symptoms were first noticed, or when a medical diagnosis was made, or (more commonly) whether the limitation has lasted, or is expected to last six months (e.g. as in the European LFS) or a year or more.

The nature of the disabling condition may also affect how individuals respond: for example people with intermittent or episodic conditions (such as multiple sclerosis or epilepsy) or with variable intensity within episodes may or may not regard their condition *at the time* as 'long-term', or its effects as limiting even though they may be severely disabled during such episodes (Meltzer, 2001).

## **2.6 Criteria for the selection of surveys for more detailed examination**

Despite there being numerous surveys that have (in some sense) encapsulated the measurement of disability or impairment, variations in estimates have resulted from the fact that these surveys have used different definitions of disability that are dependent upon the specific aims and priorities of the survey in question. Whilst the grid (Appendix F) includes all the main disability-related surveys in Great Britain, a set of criteria was selected to establish the boundaries relating to the kind and number of surveys for detailed empirical investigation in Chapter 3.

The following criteria were used to select surveys for more detailed examination:

- The main focus of the survey is the measurement of the population prevalence of disability, or
- Disability is an important domain relating to the primary purpose of the survey (e.g. LFS, GHS);
- The survey includes any of the following 'global' measures ; disability as defined by the DDA ; work limiting disability; or limitations in activities due to a longstanding illness or disability
- The survey covers Great Britain

Of particular importance for the empirical investigation are surveys such as the 2001 Omnibus Survey and the Health Survey for England. Although these surveys may not satisfy all of the criteria listed above, they provide valuable corroborative data or multiple measures for cross –comparison (see Chapter 3).



## 2.7 Summary

- Survey estimates of the number of disabled people vary, causing confusion amongst disability organisations, policy makers, researchers and other relevant groups
- There are many factors that contribute to the variation in all types of survey-based estimates, including measurement errors (involving questionnaire instrument, respondent/proxy reports and interviewer effects), and differences arising because of differences in survey design (sampling, population coverage, non-response, mode of data collection)
- The survey design can often exclude participation of persons with disabilities due to factors such as survey coverage and interview procedures but also because identifying oneself as disabled may be regarded as stigmatising and have a social cost. It is likely therefore that all estimates based on non-specialist, general purpose surveys are understated.
- Disability questionnaires are fraught with comprehension issues and are thought to be subject to wide interpretation in terms of question meaning. However, there is none or limited evidence of cognitive testing of instruments.
- Non-specialist surveys in GB have included a variety of single-item questions measuring functional limitations in activities. There have been fewer specialist disability surveys conducted.
- Even when disability is the main focus of a survey, the measurement of disability is inherently complex and there are a number of issues that affect estimates of the number of people disabled and the population prevalence of disability.
- Disability-specific survey estimates are thought to vary by parameters such as the conceptual model of disability that informs the questionnaire instrument, the types of disabilities included, the level of capacity or performance used to define the threshold between disabled and non-disabled, and whether the effects of any aids and treatment are taken into account.

### 3 COMPARISON OF DISABILITY ESTIMATES ACROSS SURVEYS

#### 3.1 Introduction

With the aim of empirically examining the reliability and validity of the estimates reported we assembled datasets from nationally representative general population surveys that contained one or more questions on disability. Such secondary analysis of existing survey data places severe limits on the range of comparisons that can be performed. It is rare for more than one type of disability measure – for example, the limiting longstanding illness question and the DDA disability question - to be included in a single survey at the same time. Furthermore, because we were limited to self-reported measures and were unable to look at objective measures based on examination or tests, we had to rely on comparing one set of self-reports against another. This circularity is impossible to avoid when using only general population survey data.

Much of the evidence presented here provides an opportunity for assessing the performance of the questions used, or survey *instruments*, relative to one another. Inferences drawn from the comparisons shed light on the reliability and validity of the measures, but fall short of the type of empirical evidence required to test the very specific and technical usage of the terms validity and reliability.

There are numerous labels for the different types of validity and reliability measures that can be used to evaluate the properties of questionnaire instruments. These are often used inconsistently, partly because the same terms are defined differently within survey research methodology than they are in the field of psychometric testing. In this study we have used the following broad definitions of these terms:

- **validity**: the survey instrument actually measures what it claims to (content/face, criterion and construct validity)<sup>12</sup> and there are no systematic

---

<sup>12</sup>Criterion, construct and content validity assess the extent to which an indicator measures the desired underlying concept. **Criterion** validity is the extent to which a measure corresponds with some other observation that measures accurately ('gold standard') the phenomenon of interest. Criterion validity can be of two types: *concurrent* validity, where the criterion measure is measured at the same time as the indicator and the two are highly correlated; and *predictive* validity, where the indicator predicts a future criterion value (for example, current academic test results predicting future employment status). Criterion validity is difficult to demonstrate for dynamic, multi-dimensional concepts such as 'health' or 'disability' for which there is no single 'gold standard' criterion measure. The validity of such social concepts is generally assessed by construct validation. **Construct** validity involves the empirical testing of the known association between the indicator and a conceptually-related measure. To demonstrate construct validity, a measure should both correlate with indicators of the same concept (*convergent* validity) as well as correlate better with a second measure accepted as more closely related to the underlying concept than it does to a third, more distantly related measure (*discriminant* validity). **Content** validity is the extent to which items in a questionnaire tap all the relevant dimensions of the

errors in drawing conclusions from the data generated (freedom from bias).

- **reliability:** a reliable measure is one which produces consistent results from the same subjects over time (test-retest), or when administered by different interviewers (inter-rater) or in different contexts (portability).

For example, if all respondents to a survey were to underreport their income by 10 per cent and consistently do so in response to repeated measurement, the measure would be reliable (because test-retest results would be consistent) but not valid (as it is not an *accurate* measure of income).

Population estimates based on such a question would therefore be biased (overall bias). However statistical methods (such as correlation coefficients) that examine the relationship between income and an objective, verifiable measure such as physical height for example, would not be biased, since all respondents err in the same direction and relative magnitude (i.e. all underreport their income, and by the same proportionate amount). Differential response error (for example the over-reporting of income by individuals with low income and over-reporting by those with a high income) will also produce biased estimates (bias between groups). Differential response bias can be prompted by factors such as the context of the survey (e.g. a survey about health is more likely to stimulate people to consider more fully their health and functioning than one focused on income which includes a few question on health status) or the mode of administration (self-completion versus face-to-face for example). In such instances, the measure would be both not valid and unreliable (because of survey context effects and lack of portability).

The data at our disposal permits an interesting, albeit partial, examination of the methodological robustness of the existing survey measures of disability. The approach we have taken is two-fold. For global questions we first compared if estimates based on the same question, but asked in different surveys, provided similar prevalence estimates (for the overall population, and by age and gender). This comparison gave some indication of the reliability of the measure across surveys. We then tested if differently worded questions which aim to measure the same underlying concept were strongly correlated (convergent validity), and conversely, if differences in question wording and emphasis between questions successfully tapped into different dimensions of the same concept (discriminant validity). Evidence of the latter kind is particularly important because questions that are too highly correlated may be measuring the same dimension and could therefore be dropped from a survey in the interest of parsimony.

For estimates based on data from specialist disability surveys, our aim was limited to assessing the plausibility of the evidence of change over time in disability prevalence in GB, and the potential impact of survey conditions (design and processes) on the measurement of change (section 3.6).

---

concept being measured. A measure with content validity will certainly exhibit 'face validity' in that it appears to users, in terms of the question wording, to focus on the relevant concept. For a technical discussion of various forms of validity also see Kaplan et al (1976), Bowling (1991), Cook and Campbell (1979), Sturgis et al (2000).

### **3.2 Global disability estimates: empirical comparisons**

For the single-item or global questions on disability we tested the following propositions:

#### **1. Do estimates based on an identical question, covering the same population and at the same point in time, differ between surveys?**

The analysis presented in section 3.4 examines if estimates for the same measure obtained from different surveys produce consistent results. By ensuring that the comparison is restricted to estimates based on responses to the same question, asked of a random sample of the same population over the same year, variation in survey-based estimates due to differences in question wording, population coverage and time period were in effect controlled for. If estimates were still found to vary significantly, then the evidence would suggest that the indicator is unreliable. These comparisons also provide evidence of the impact of survey conditions such as survey context, mode of administration, the use of proxy information and question order on reliability.

#### **2. Are responses by the same individual to questions measuring a similar underlying concept related?**

The aim of this analysis is to test convergent validity: that is, questions that measure the same underlying concept should be positively associated with one another. For example, it would be surprising if the majority of individuals who report that they have a disability covered by the DDA do not also report limitation in activities because of a longstanding illness or disability in response to the LLSI question. To address this question we first explore how the same individual responds to questions using different definitions of disability (e.g. DDA versus LLSI) in order to assess the extent of overlap in responses to questions that essentially tap into the same underlying concept. We then probe deeper to assess if some groups systematically differ in the way they classify themselves with respect to different question formulations (section 3.5).

#### **3. Do questions that are worded to imply different threshold levels of disability (e.g. “any limitation” versus “substantial limitation”) capture different sub-sets of the disabled population as intended?**

The analysis presented in section 3.5.1 estimates discriminant validity using a scaled health-related quality of life score. This is used to test the hypothesis that the level of disability severity, inferred from the way in which questions are worded, is reflected in the average scores of the different subsets of the population who respond positively to each question. The aim of the empirical investigation here is to test whether differences in emphasis and question wording of different global estimates, which are intended to capture different sub-sets of the disabled population, are performing in the way they are supposed to.

### 3.3 Analysis method

A tick-list of the global questions included in the five surveys and in the 1991 and 2001 censuses (Table 3.1) shows that while data from four of the five surveys can be used to check the reliability of the limiting longstanding illness or disability (LLSI) question, there are only two candidate surveys for the DDA-disabled and work-disabled questions. No survey provides coverage of all global questions. The latest Omnibus survey has included the largest set of global questions which, not surprisingly, means that it features heavily in providing answers to the questions (2 and 3) relating to validity.

**Table 3.1 National survey that include global disability questions**

Global question	LFS	FRS	GHS	HSE	Omnibus	Comments
Longstanding illness	✓	✓	✓	✓	✓	Used as filter for disability questions. LFS uses different version of question.
Limiting longstanding illness, disability or infirmity		✓	✓	✓	✓	
DDA disabled – current	✓				✓	
DDA disabled – past	✓				✓	
Work disabled	✓	✓				asked only of men aged 16-64 and women aged 16-59
EQ5D (EuroQol: health related quality of life measure – five questions summarised to global score)			✓	✓	✓	Disability dimensions include difficulty in usual activities, mobility and self-care

In order to compare like with like, we sought to minimise the variability between estimates that resulted from differences between surveys in the method of data collection, in population coverage or in the period over which the population was surveyed. Details of the issues and methods developed are described in Appendix D and are summarised below:

- All prevalence estimates relate to 2001, except those based on the FRS. We have used FRS data from the most recent year (2000/01), when the

harmonised<sup>13</sup> version of the limiting longstanding illness question was asked.

- Estimates are based on annual cross-sectional data, except those for the Omnibus survey (which are based on a four month fieldwork period).
- Proxy interviews are excluded in the calculation of age/sex-specific prevalence rates.
- The population coverage of the surveys included Great Britain, except the HSE which was limited to England. We have therefore restricted the use of HSE estimates to address specific reliability issues (such as context effects) and to interpret the quality of the disability-specific GB surveys conducted in 1985 and 1996/7.
- Survey weights to adjust for differences in the probability of selection of individuals have been applied as needed (to allow for differences between surveys in the method of sampling), but weighting for non-response and “grossing” have not been used in the calculations (see section 3.8).

### 3.4 Reliability of global estimates

#### 3.4.1 Longstanding illness and limiting longstanding illness

##### **Question wording**

In the UK, the most well known and widely used single-item survey instrument for assessing activity limitation is the *self-reported limiting longstanding illness or disability* question (LLSI). The harmonised version of the question is in fact a two-part question (Figure 3.1). The first part asks respondents to differentiate the conditions they currently have on the basis of actual or expected duration – dividing them into those they regard as ‘longstanding’ and those they consider to be temporary or short-term. This first part, generally referred to as the *longstanding illness* (LSI) question, is often used in surveys as a filter question that determines whether or not the second part of the question is asked; the purpose of the second part being to establish what, if any, limitations result from the condition/s. Positive responses to both parts of the question identifies individuals with LLSI.

Four of the five selected surveys ask the harmonised LSI question, with the LFS using a modified version that explicitly defines a longterm condition as a condition lasting for a year or more. Because only those respondents who

---

<sup>13</sup> Since the mid-1990s, ONS have led the UK harmonisation initiative to develop standard questions and survey operational procedures (e.g. interviewer instructions) in order to collect information on key concepts that need to be measured on all or virtually all major government social surveys such as tenure, occupational status, employment and educational qualifications. These are usually used for classificatory purposes or to establish the prevalence of key attributes (e.g. LLSI). The harmonisation project aims to make the interpretation, analysis and reporting of survey data easier, to help users plan surveys (e.g. at a local level) that can provide data comparable with national surveys, and provide a means of cross-referencing key concepts against the more detailed topic priorities of a particular survey. Harmonised questions do not, however, imply data equivalence in that using the same question does not standardise response across person, place or time (van Buuren 2001).

reply in the affirmative to the LSI question are selected to answer subsequent questions relating to disability, changes to the wording of the filter question (for example, by changing the definition of long-term duration) can affect the disability estimate between surveys. For example, the overall prevalence of LSI among adults aged 16 in GB derived from the LFS was higher (38 per cent, including responses by proxy and 42 per cent excluding proxies) than estimates derived from the FRS (35 per cent and 36 per cent, respectively) or GHS (34 per cent and 35 per cent, respectively) (see table D.5.1, Appendix D). This means that a larger sub-set of the population was filtered into the disability module in the LFS when the reference period was stated to be a year or more compared to surveys using the harmonised LSI question where the reference period of what constitutes 'long-standing' is unspecified.

**Figure 3.1: Limiting longstanding illness questions**

<p><b><u>Harmonised LLSI question (GHS, FRS, HSE)</u></b></p> <ul style="list-style-type: none"> <li>▪ Do you have any long-standing illness, disability or infirmity? By long-standing I mean anything that has troubled you over a period of time or is likely to affect you over a period of time? (Yes/No)</li> </ul> <p>If yes,</p> <ul style="list-style-type: none"> <li>▪ Does this illness or disability (do any of these illnesses or disability) limit your activities in any way? (Yes/No)</li> </ul>
<p><b><u>Census 1991</u></b></p> <ul style="list-style-type: none"> <li>▪ Do you have any long-term illness, health problem or <i>handicap</i> which limits your daily activities or the work you can do? Include problems which are due to old age. (Yes/No)</li> </ul>
<p><b><u>Census 2001</u></b></p> <ul style="list-style-type: none"> <li>▪ Do you have any long-term illness, health problem or <i>disability</i> which limits your daily activities or the work you can do? Include problems which are due to old age. (Yes/No)</li> </ul>
<p><b><u>Labour Force Survey longstanding illness question (LSI)</u></b></p> <ul style="list-style-type: none"> <li>▪ Do you have any health problems or disabilities that you expect will last for more than a year? (Yes/No)</li> </ul>

In some surveys, such as the GHS and the HSE, respondents who report a long-standing illness are sometimes also asked for details of the nature of their condition before the second question on limitations. Conditions are self-reported and non-explicit in terms of dimensions or the type of long-term condition. Analysis of responses mentioned in the HSE reveal a mixture of diagnosed medical conditions, symptoms, impairments and loss of function and respondents who simply mention 'old age'. The responses suggest that the two-part LLSI question broadly captures, as intended, the perceived

disabling effects of chronic ill-health (morbidity) and physical and sensory impairments.

A variant of the LLSI question has been included in both the 1991 and 2001 UK Censuses, with the substitution of the word ‘disability’ in 2001 for the word ‘handicap’ used in 1991 (see Figure 3.1). The census measure of LLSI is based on a single question that requires respondents to make multiple judgements without clear guidance on what each is intended to include or exclude: namely, whether the condition is long-term (without defining “long-term”); whether the condition limits (the *performance* of) daily activities and/or *capacity* for work (i.e. participation in a specific social role). Respondents are also asked not to disregard problems that they would consider a natural part of the ageing process. The census question differs from the harmonised LLSI question by placing greater emphasis on limitations in *daily* activities and work roles (rather than any limitations), and is therefore closer to the concept of disability than of chronic morbidity. The results of the Census Validation Survey carried out to test the 1991 version of the question found that this variable does function empirically as a measure of disability (Thomas and Purdon, 1994).

### **Variability in prevalence rates**

Estimates of the overall prevalence of LLSI among adults exhibit a high degree of stability across three of the GB-based surveys – the FRS, GHS and Omnibus – but are substantially higher for the HSE. Census-based LLSI prevalence rates were substantially lower than survey estimates in 1991, but were more similar to survey estimates in 2001 (Table 3.2). Both the observed and the age-standardised LLSI rate per 100 population are shown for estimates derived from the 1991 census. This enables an assessment of the magnitude of change in LLSI over the decade, after controlling for differences in the age structure of the population over the period.

**Table 3.2 Overall prevalence of LLSI (percent of population) across surveys, all adults aged 16 and over.**

Survey	Sample size ('000)	% proxy	LLSI: incl proxy	LLSI: no proxy	CI (+/-) of estimate
FRS00/01	41.8	15	23	24	0.4
GHS01	16.4	9	22	23	0.6
HSE01	15.6	NA		26	0.6
Omnibus	6.9	NA		23	1.0
<b>Census91</b> (residents in households, GB)					
- <i>observed</i>			15		
- <i>age standardised</i>			16		
<b>Census01</b> (residents in households, GB)			21		



We first compared differences in age-specific estimates between the three large-scale surveys – the FRS, GHS and HSE (Figure 3.2). This showed that the age-specific prevalence rates derived from the FRS and GHS were broadly similar up to age 64, and that HSE rates were higher. For persons aged 65 and older, the FRS rates were closer to HSE rates and the GHS age-specific prevalence rates were considerably lower. These variations in age-specific rates cast doubt about the portability of the question and the consistency of results across surveys. Given that all three surveys ask the identical question and have similar characteristics of non-response (younger adults, particularly young men, tend to be under-represented), it has been suggested that the higher rates reported in the HSE may be related to survey context effects (Sturgis et al 2000).

The overall pattern of between-survey variation in age-specific prevalence rates was similar to that observed for age-specific and gender-specific rates (figures not shown). In general, women were more likely to report higher rates of LLSI, particularly at older ages, and this gender difference was found across all surveys.

**Figure 3.2 Comparison of adult prevalence rates of LLSI between surveys (excluding proxies), 2001, by age groups**

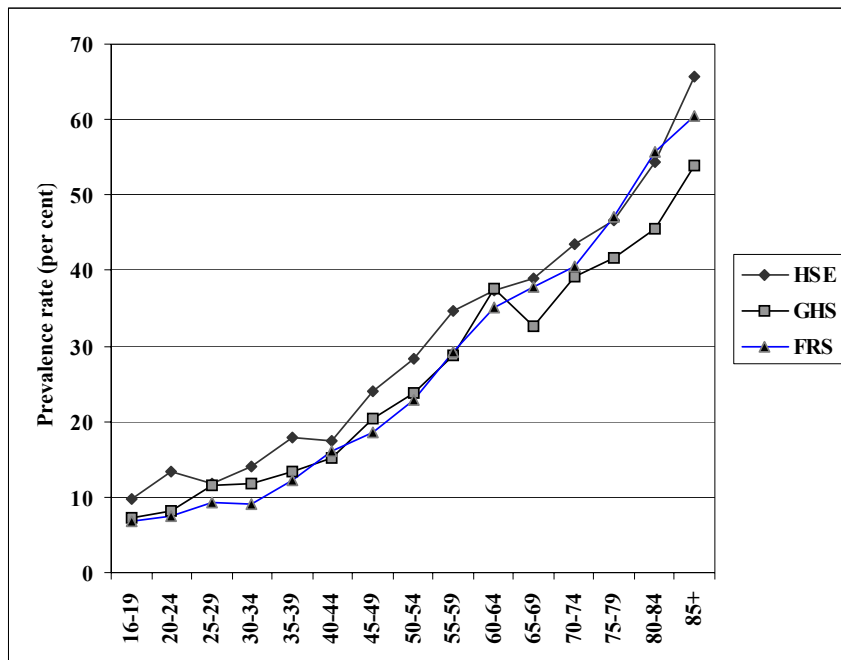

We also compared age-specific GB prevalence rates obtained from the FRS and GHS against estimates obtained from the Census 2001 (Figure 3.3). For this particular comparison, we included proxy responses in calculating the survey estimates because the census data is also likely to include proxy information. The Census information was collected by self-completion, usually by one member of the household filling in the form for the others.

There was a fairly smooth increase in LLSI with increasing age for rates derived from the Census 2001. Until the age of 64, rates across all three sources were similar, but survey estimates begin to dip lower than census estimates from about age 70 onwards for the FRS and from age 65 for the GHS. This finding indicates that including work limitation as an explicit activity limitation does not appear to have impacted significantly on prevalence rates that would have been obtained had the wording of the harmonised LLSI question been used in the census. This may in part be because those who perceive themselves to be work limited disabled would also consider themselves to be limited in terms of the broader criteria of 'any activity' (see section 3.5.3).

**Figure 3.3 Comparison of LLSI rates, Census 2001, FRS and GHS (with proxies), by age group**

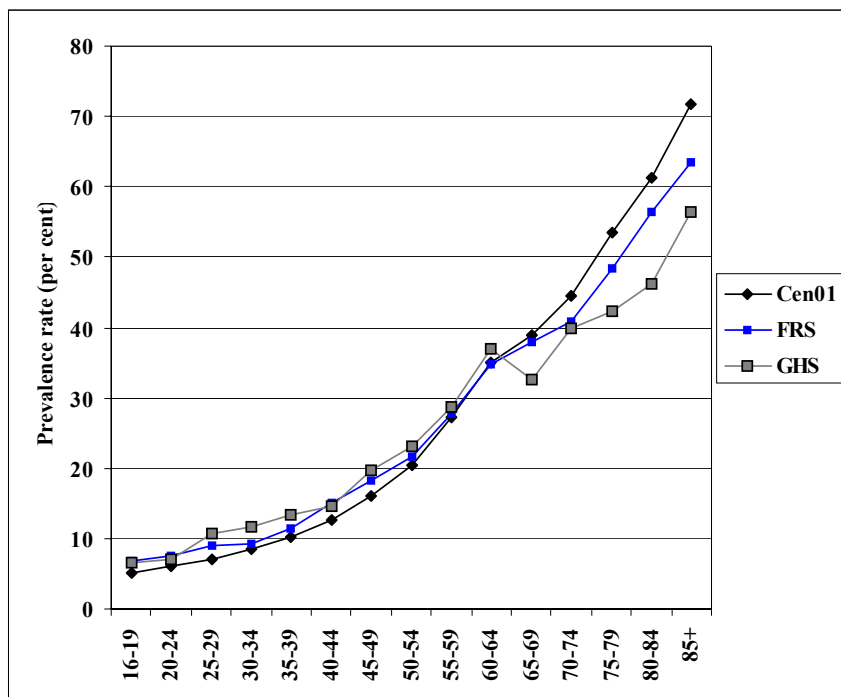

However, the increasing magnitude in the rate of difference between age-specific sample and census prevalence estimates at older ages suggests a differential response bias between estimates. Previous studies have shown that older respondents tend to discount conditions and disabilities that they regard as the inevitable consequence of old age (Sturgis et al 2000). In an experiment comparing responses to one question on self-assessed health 'compared to people your own age' with another question that lacked this instruction, respondents aged 65-75 were found to evaluate their health as better when asked to specifically compare themselves to their peer age group, while younger respondents did not (Brown-Epel et al 2001). The study suggested that the reference group for making comparative judgements for elderly people were people their own age, while for younger people, the reference point was their health at a former time. It is likely therefore that the

specific injunction in the census question to include conditions due to old age has the intended effect of stimulating more elderly people to report having a LLSI.

There was a substantial increase in census-based rates of LLSI among adults aged 16 and over in the general population – from 16 per cent (age-standardised rate) in 1991 to 21 per cent in 2001 (Table 3.1). Over the same period, equivalent population rates from the GHS drifted upwards, but the increase has been relatively modest - from around 21 per cent in 1991 to 22 per cent in 2001. Furthermore, the gap between the overall estimates obtained from the 2001 GHS and the 2001 Census (one per cent higher in GHS01) was substantially lower than that in 1991 (about six per cent higher in GHS91). Small changes in question wording are known to have an effect on response patterns and, given the evidence of trends from survey sources, it appears plausible that the substitution of the word ‘disability’ for ‘handicap’ in the most recent census has contributed to the increase in LLSI rates. Increase in LLSI rates was observed for all age-groups (Figure 3.4) and both sexes (figure not shown).

**Figure 3.4 Change in rates of limiting longstanding illness, by age group (Census 1991 vs Census 2001)**

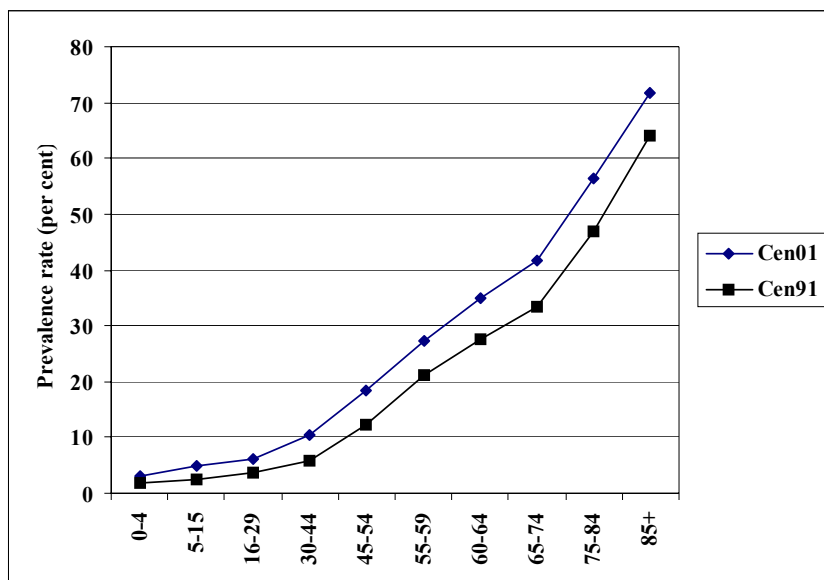

### **Discussion**

The LLSI question has the advantages of having face validity, being short and being easy to answer. It is expected that such a question, with a high degree of subjectivity, would not be reliable for identifying absolute numbers or overall prevalence rates and our analysis confirms this. However, if a measure of perceived activity limitation is required rather than an objective measure, then the inherent subjectivity of the LLSI measure is a strength.

Our comparisons of the statistical reliability of LLSI estimates have shown that:

- Other than the HSE01 (26 per cent), survey estimates of LLSI for the adult population of GB were very similar, ranging from 23 per cent (GHS01, Omnibus 2001) to 24 per cent (FRS00/01). Survey-based estimates were between two to five percentage points higher than those obtained from the 2001 Census (21 per cent) if proxy information was excluded in the calculation of overall prevalence rates. But if proxies were included, survey and Census 2001 estimates were broadly similar (23 per cent FRS00/01; 22 per cent GHS01 and 21 per cent Census 2001).
- Estimates of overall population prevalence vary between surveys, mainly because of the adoption of different strategies to taking information by proxy. Surveys that allow taking of proxy information (as opposed to those that restrict proxy information to specific groups (e.g. too ill)), reported lower population prevalence rates.. This is because proxy information is more likely to be taken for young people who are also less likely to have LLSI. In general, the higher the ratio of proxy data to self-report, the lower the overall estimated prevalence
- Within age-groups, estimates derived from different sources were broadly similar for those aged between 16-64, but were not for older age groups.
- Age-specific rates were higher when health was the focus of the survey (e.g. HSE) , indicating that the LLSI question may perform differently in different survey contexts
- Survey and census estimates were sensitive to differences in question wording.

### 3.4.2 Work-limiting disability

#### Question wording

**Figure 3.5 Work-limiting disability questions**

**Work-limiting Disability (LFS)**

- Do you have a long-term health problem or disability (*if yes*)
  - Does this health problem affect the KIND of work that you might do?
  - Does this health problem affect the AMOUNT of work that you might do?

**Work-limiting Disability (FRS)**

- Some people are restricted in the amount or type of work they can do, because of an injury, illness or disability. Which of these statements comes closest to your own position at the moment?
  - I am unable to work at the moment
  - I am restricted in the amount or type of work I can (could) do
  - I am not restricted in the amount or type of work I can (could) do

Both the LFS questions and the FRS questions aim to assess work-limiting disability (WLD) as defined by the respondent's perception of restriction in her or his capacity for paid work, in either the kind or amount of work they could do, or both. At its core, the question is hypothetical in that it asks respondents to consider work they *might or could* do. Respondents are also asked to judge if their work capacity is causally linked to an underlying health problem (rather than to other sorts of factors such as environmental or attitudinal barriers) and to assess if this problem is enduring. The complexity of the question contributes to problems of comprehension and high level of response variability.

By using the long-term illness or disability question as a filter to subsequent questions on limitations in work, the LFS aims to identify work disability due to an underlying condition that is expected to last for a year or more. The FRS question, on the other hand, does not attempt to differentiate between long-term limitation in work capacity and short-term illnesses or injuries that may result in temporary work restriction. Differences in question wording between the LFS and FRS questionnaires mean that respondents may interpret the questions differently. Other than the LFS and FRS, we found no large-scale survey that included questions on work disability.

In order to compare estimates between these two very different sources of work disability data, we calculated estimates in the following way:

- We restricted the analysis to adults of working age (i.e. under state pension age (SPA) – namely, men aged 16 to 64 and women aged 16 to

59). Estimates for older ages are not strictly comparable as only specific categories of people over SPA are asked the WLD questions in the LFS.

- We based prevalence rates on the total population of working age, rather than only the economically active population (as reported in the FRS 2000/2001, Table M7).
- We coded respondents to the FRS as having a work-limiting disability if they said that they were either unable to work or were restricted in type or amount of work they could do .
- We then calculated WLD rates from the FRS in two ways: first, including all those in the numerator who said they had a work restriction, regardless of whether they had a longstanding illness or not (FRS-1); and second, excluding from the numerator those who said they had a work disability but not a longstanding condition (FRS-2). The latter estimate was conceptually more similar to that defined in the LFS.

**Variability in prevalence estimates**

The three estimates of WLD – one from the LFS and two from the FRS (FRS-1 and FRS-2 defined as above) – have broadly similar overall rates (although the differences are statistically significant at the 95% level because of the small margin of error around the estimates owing to the large sample sizes of the surveys, see Chapter 2). Rates are higher for men than for women for all three types of estimates. Work-limiting disability rates from the LFS are the highest, and closer to estimates from the broader definition (FRS-1) than the more restrictive definition (FRS-2) obtained from the FRS (Table 3.2). Including proxies reduces the overall rates by about two per cent for all three estimates (figures not shown).

**Table 3.2 Work-limiting disability by sex (excluding proxies), LFS vs FRS**

Pop (16-59/64)	LFS01 (no proxies)			FRS00/01 (no proxies)			
	Sample (000s)	WLD	Error (+/-)	Sample (000s)	FRS-1	FRS-2	Error (+/-)
Men	33.2	20	0.4	16.3	18	16	0.6
Women	32.9	17	0.4	16.3	15	13	0.5
All	66.1	18	0.3	32.6	17	15	0.4

If the second definition of work limiting disability (FRS-2) is considered to be more like the LFS definition of work-limited disability, then the FRS estimates are significantly lower (15 per cent) than those from the LFS (18 per cent). If, on the other hand, respondents have interpreted the FRS question in a way that discounts short-term work restrictions in their responses, then the estimates obtained from the two surveys are remarkably similar in terms of overall prevalence and within age-groups (Figure 3.6). The fact that the differences between the two FRS estimates are proportionally higher in

younger age groups who are more likely to have sustained injuries that may restrict work capacity in the short-term, suggests that the more restrictive definition applied to the FRS data identifies work-limiting disability more accurately.

**Figure 3.6 Work-limited disability by age group, LFS vs FRS**

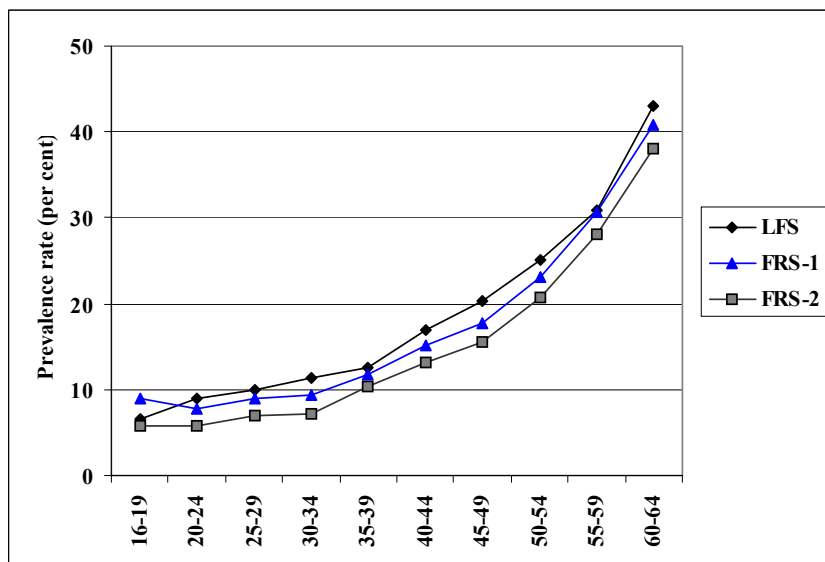

### Discussion

There is no single harmonised version of the survey question about work limiting disability. The LFS question sequence specifically identifies those with a long-term limitation in work capacity. Estimates derived by applying the LFS definition to FRS variables yield lower age-specific work-limiting disability rates. It is very likely that these differences are in part due to differences in question wording and order, but they may also be related to the survey content. The LFS, with its focus on labour market participation, may be expected to generate higher estimates of work limitation than a survey of household income and benefits.

Changes to question wording and sequence have been shown to have a dramatic effect on estimates. A change in the LFS questions in spring 1997 resulted in a reduction of 24 per cent in the number of people reporting a health problem lasting more than a year and affecting the kind of work they might do (Jenkins 1997). Question wording was changed so that the question was less hypothetical than before (from 'would affect any kind of paid work' to 'did it affect the kind of paid work'). More significantly, the sequence of questions was also changed, with respondents being asked if they had a long-term condition before they were asked about work limitations, rather than after. Analysis of the change in responses for the same people between the spring and the previous winter quarters showed that younger people were less likely to classify themselves as long-term work disabled. This is analogous to

the reduction in work disability estimates among young people obtained from the FRS before and after taking into account the presence of reported long-term conditions.

### 3.4.3 Current DDA disabled

#### Question wording

Since spring 1997, LFS respondents have been asked to identify whether they had a current disability covered by the 1995 Disability Discrimination Act (DDA). The DDA defines disability as a 'physical or mental impairment which has a substantial and long-term adverse effect on (a person's) ability to carry out normal day-to-day activities'. To count as disabling under this definition an impairment must:

- be physical or mental
- have a substantial adverse effect on day to day activities
- and be long-term.

The critical difference between the DDA definition and other disability definitions is that in the former the assessment of activity limitation should be made without regard to the effect of any medication, treatment or aids (other than spectacles). Such a specification can be expected to increase the percentage of people with a long-term activity limitation. The DDA definition also covers people who have a progressive illness from the moment that the condition has any impact on day-to-day activities. Those who have had a disability covered by the DDA definition in the past, and have since recovered, remain covered by the Act. Because the prevalence of past DDA disability is relatively small (about three per cent of adults), and responses may be subject to recall bias, we have not considered estimates of past DDA disability in this report.

#### Figure 3.7 Current DDA disabled (LFS, Omnibus)

- Do you have a long-term health problem or disability (*if yes*)
- Do these health problems or disabilities, when taken singly or together, substantially limit your ability to carry out normal day-to-day activities?  
*If you are receiving treatment, please consider what the situation would be without medication or treatment.*  
(Yes/No/Don't know)
  - {plus progressive medical conditions (e.g. cancer)}

The LFS is the only large government survey to include a question on DDA disability (Figure 3.7). The same question was also asked in the Omnibus survey 2001 and our analysis of consistency in estimates across surveys is based on a comparison of data from the LFS01 and the Omnibus.

The question on DDA disability requires individuals to interpret a series of (unspecified) statements, such as 'substantial limitation' and 'normal day-to-



*day* activities' and to also consider the impact of a hypothetical withdrawal of medication and/or treatment. This means that responses to the question will be more subject to reporting bias than responses to more specific questions on well-defined activity limitation. For example, the word substantial is not widely used amongst the general public and is therefore open to different interpretations. Furthermore, even where it is a familiar word, it is too non-specific to elicit consistent responses.

### **Variability in prevalence estimates**

**Table 3.3 DDA-current estimates, LFS01 vs Omnibus 2001**

		Sample (000s)	% proxies	DDA-C (incl proxies)	DDA-C (no proxies)	Error (+/-)
<b>Adults 16+</b>						
LFS	Men	41.2	37	20	25	0.4
	Women	46.1	25	23	25	0.4
	All	87.4	31	22	25	0.3
Omnibus	Men	3.1	NA	-	18	1.4
	Women	3.8	NA	-	19	1.3
	All	6.9	NA	-	19	1.0
<b>Working age</b>						
LFS	Men	33.2	42	15	17	0.4
	Women	32.9	28	15	16	0.4
	All	66.1	35	15	17	0.3
Omnibus	Men	2.6	NA	-	13	1.4
	Women	2.7	NA	-	14	1.3
	All	5.2	NA	-	14	1.0

Overall population estimates based on the Omnibus data are significantly lower than those based on the LFS – by about six per cent for the total adult population and three per cent for those of working ages (Table 3.3). This difference in magnitude between the two types of estimates holds across gender. Furthermore, the percentage of men classed as DDA current disabled was the same as that for women, irrespective of the overall level of disability recorded in either data source.

Omnibus-based estimates were substantially lower than those based on the LFS from about age 45 onwards and the differentials increased with advancing age to a difference of more than 10 percentage points for those aged 75 and over (Figure 3.8). One explanation may be that the DDA disability question in the LFS follows on from a preceding question about the type of the long-term health problem, using a checklist of symptoms, impairments and medical conditions. In the Omnibus, on the other hand, an

identical list of health problems is presented to respondents *after* the DDA disability question.

**Figure 3.8 DDA current disabled by age group, LFS vs Omnibus**

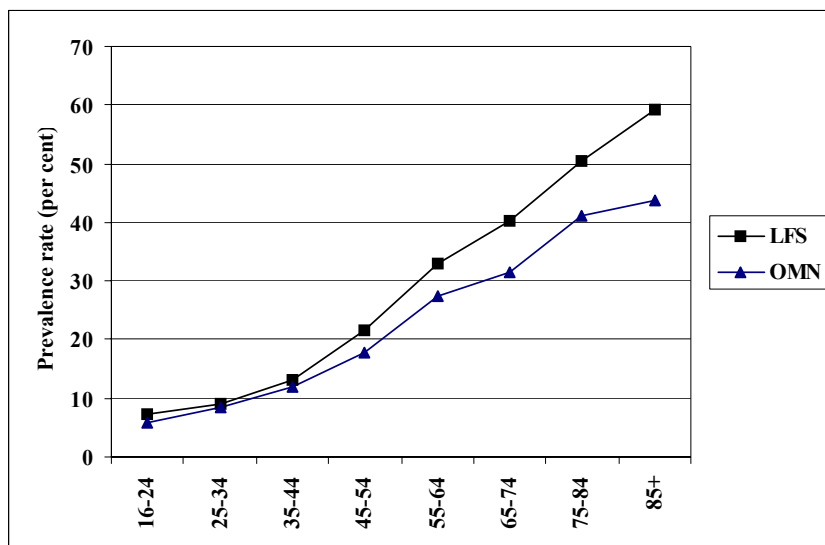

Using a checklist has the advantage of providing all respondents with a common frame of reference, but it is also known to increase overall reporting rates (Blaxter 1997, p.40). This increase in reporting can be substantial: the introduction of a checklist of common conditions in the 1977 GHS led to an increase in reported rates of 'chronic illness' from less than a third of the population before 1977 to 56 per cent of men and 70 percent of women reporting one or more conditions listed (Blaxter 1997).

### **Discussion**

Of the global estimates of disability analysed in this report, the DDA definition of current disability appears to be the least robust, with large overall and within-age differences in estimates, despite the question wording being the same in the two surveys compared. It is likely that this is mainly due to the differences in the positioning of the DDA question within the disability-related module of questions in the two surveys compared. The use of a check-list of conditions before the DDA question is asked may have stimulated reporting in the LFS compared to the Omnibus (where the check-list is presented after the DDA question). Further, given that the Omnibus survey has a relatively small sample and is not seasonally adjusted, this finding of the DDA estimates being the most inconsistent between surveys should be treated with caution. Given that the operationalisations of the DDA definition used in the two surveys is not standardised, more research is needed to assess the robustness of the DDA estimate.

In this study we have derived DDA current disability rates using the LFS data in a cross-sectional way (see Appendix D). Other studies that have analysed

repeated waves of the survey in a longitudinal way have highlighted other issues indicative of the reliability of the measure over time. Longitudinal analysis of wave-on-wave variation in the numbers *becoming* disabled from one quarter to the next shows that compared to wave one, rates of disability in the working-age population are overstated by about 1.4 percentage points in all subsequent (four) waves of the survey (Burchardt 2003). One possibility being investigated by ONS is that this may be due to differences in the mode of survey administration, with wave one interviews being face-to-face and subsequent interviews by telephone. There is some evidence from a formal test-retest study of self-reported functional limitations (albeit for an elderly population) that individuals are more likely to report being disabled when interviewed by telephone than in face to face interviews (Crawford et al 1997).

Longitudinal analysis of LFS data has also shown that about two in five (37 per cent) of those who became disabled no longer reported being disabled nine to twelve months later (Burchardt 2003). This evidence suggests that a substantial proportion of people who report themselves as current DDA disabled misjudge the period for which they are likely to be substantially limited (which in the LFS is 'a year or more' to qualify as long-term). Including them in the count of disabled people would therefore overstate disability rates. These are known as 'false positives'. Equally, there may be people in the sample who underestimate the future duration of their disability (false negatives), leading to underestimates. However, the scale of this type of error cannot be detected using the data available.

### **3.5 Validity of global estimate**

Given that all the global instruments under consideration are in some way or another measures of disability, we should expect them to show positive association with one another (convergent validity). For example, it would be surprising if the majority of individuals who report that they are DDA (current) disabled do not also report having an illness or disability that limits their activities in any way (i.e. LLSI). On the other hand, the global questions are not intended to be identical and, given differences in emphasis and question wording, we would expect different measures to include different sub-sets of the disabled population (discriminant validity). These two types of validation tests correspond to questions two and three, respectively, as set out in section 3.2.

As noted previously (section 3.1), we are limited in the range of comparative evidence that we can assemble from the data available to us. We have therefore compared three sets of instruments: DDA (current) and LLSI; DDA (current) and work-limiting disability, and work-limiting disability and LLSI. We first inspect the degree of overlap between the sets of measures and use statistical tests of measures of association (Cohen's kappa or  $\kappa$  statistic) to assess the strength of agreement between them. We then explore in more detail the characteristics of groups who report activity limitation for one type of global question but not another. With respect to discriminant validity, data

constraints have limited our analysis to a comparison of LSI, LLSI, DDA disabled (current and past) based on the Omnibus data.

### 3.5.1 DDA (current) and LLSI

#### Convergent validity

Based on the Omnibus survey data, 63 percent of adults aged 16 and over reported no longstanding illness (Figure 3.9). Of those who said they had a longstanding illness (37 per cent), seven in ten reported having some form of disability, with four in ten reporting having both LLSI and a current disability covered by the DDA, two in ten a LLSI only and one in ten a DDA disability only.

**Figure 3.9** Overlap between DDA and LLSI disabled categories: all adults aged 16 and over (*Omnibus survey 2001*)

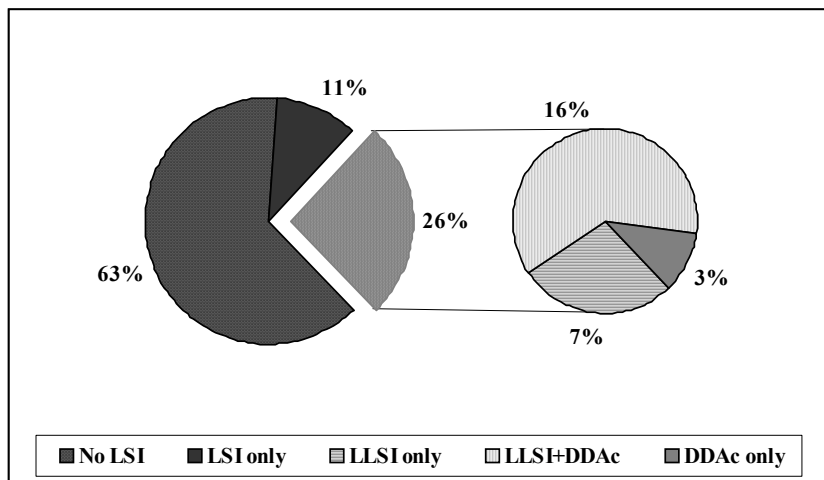

Looked at another way, Table 3.4 shows a 90 per cent exact agreement in self-ratings between the DDA and LLSI categories based on a simple calculation of observed proportions that lie on the diagonal. However, we would expect some agreement between instruments by chance alone. A more robust measure of the strength of the agreement in excess of that obtained by chance is provided by the kappa statistic (Altman 1991).<sup>14</sup> The kappa value overall is 0.70, indicating good agreement between the two measures. Age-group specific kappa values range from a low of 0.55 for age group 16-24 to the highest (0.82) for those aged 85 and over, with values for the intermediate age bands between 0.65 to 0.73. These figures indicate that

<sup>14</sup> A kappa value of one indicates perfect agreement and zero indicating no agreement better than chance. Indicative guidelines to interpret the strength of agreement for intermediate values between zero and one are as follows: very good (over 0.8); good (over 0.6); moderate (over 0.4), fair (over 0.2) and poor (0.2 or under).

the agreement between LLSI and DDA is good to very good for all age-groups except young adults.

**Table 3.4 Overall agreement between DDA (current) disabled and LLSI (Omnibus survey 2001)**

LLSI	DDA (current) disabled		Total
	Yes (%)	No (%)	
Yes (%)	<b>16</b>	7	23
No (%)	3	<b>74</b>	77
<b>Total</b>	19	81	100
<b>Kappa</b>	0.70		
<b>Base</b>	6886		

The mismatch between those reporting having a long-term limitation and those reporting a DDA defined disability appears plausible, given the higher qualifying threshold (in terms of severity, duration and type of activities) applied to the latter.

However, three per cent of respondents said that their condition did not limit their activities (no LLSI), but then reported having a substantial limitation (DDA disabled). On the face of it this appears inconsistent as the LLSI question asks about 'any limitations' and the DDA question about 'substantial limitations' in daily activities. A very small fraction of this group (15 of 187 respondents) have a progressive condition and are automatically included within the DDA disabled category even if they do not experience any limitations. It is also possible that some respondents classed themselves as DDA disabled after considering what their situation might be in the absence of any treatment or medication, as required by the DDA definition. Equally, it could be inferred that in part the discrepancy is indicative of differences in comprehension of questions between respondents. There was insufficient data to explore these alternative explanations in more detail.<sup>15</sup> It should be borne in mind that although the magnitude of the inconsistency appears relatively trivial (three per cent of the total sample), when grossed up into numbers of people nationally, this translates into a difference of about one and a half million people.

### **Discriminant validity**

To examine discriminant validity we explored the relationship between mean scores on an index of health-related quality of life (Euroqol or EQ5D) and the

<sup>15</sup> Additional information which could potentially have provided some insight into the relative contribution of different factors, such as questions on the duration since onset and the nature of the long-term condition (coded into 17 types of conditions), were only asked of those who said they currently had a limiting longstanding condition or had had a long-term condition in the past. Thus these variables were not available for the group who reported being DDA disabled but did not have LLSI because they were filtered out.

sub-sets of the sample reporting activity limitations along the continuum of severity of disability. If the various global questions were to perform as expected, we would predict population sub-sets with no longstanding health condition or disability to have the highest (self-rated) health-related quality of life on average. Correspondingly, the inferred gradient of increasing disability severity from LSI to LLSI to DDA (current) should be reflected in a stepped decline in average scores for population sub-sets who said they had a LSI but no activity limitations, compared to those who had LLSI but were not substantially limited, compared to those who reported a DDA (current) defined disability. Those reporting a past DDA disability that did not currently limit their activities would be expected to have better scores than those with current activity limitations.

The EQ5D is specifically designed to provide descriptions and valuations of 243 possible health states based on the combinations of responses to five dimensions of health. Each of these dimensions has three levels of functioning: no problems (1)/ some problems (2)/ severe problems(3). The five dimensions are mobility, self-care, usual activities (study, work, housework, family or leisure activities), pain/discomfort and anxiety/depression. Responses range between those with no problem in any dimension ('perfect health') with a score value of one, through to death (score set equal to zero) and states considered worse than being dead (with negative scores, for example being unconscious)). Utility (or 'relative desirability') tariffs for each health state have been derived for Great Britain, based on the time-trade-off method.<sup>16</sup> These have been converted using regression techniques into an overall score with interval scale properties (Williams 1995).

**Table 3.5 Mean EQ5D scores by disability severity level and gender (Omnibus 2001)**

	Men	Women	All	Base
No LSI	0.96	0.95	0.95	4355
LSI (only)	0.73	0.70	0.72	2532
LLSI (no DDA)	0.63	0.61	0.62	1592
DDA (current)	0.59	0.58	0.59	1280
DDA (past)	0.93	0.90	0.91	211
Overall score (HSE 96)	0.87	0.86	0.86	6923
	0.86	0.84	0.85	16047

<sup>16</sup> Time trade-off (TTO) is one of a range of techniques developed to assign values to a set of descriptions of health states (e.g. with varying degrees of pain, disability etc.) via judgements of panels. In the TTO method, panel members are asked to make a decision between two alternatives: either to remain in a specific health state (H1) for a set period of time (e.g. 20 years) followed by death, or to have perfect health for a shorter period of time (x), followed by death. The duration of x is varied until the subject is indifferent between the two alternatives. The utility value of the individual's preference for health state (H1) is given by the ratio x:20. With perfect health set to one, the scores for the other (poorer) health states essentially denote a life year adjusted to take account of the (decrements in the) quality of life in each health state.

Table 3.5 shows that the EQ5D mean scores differed between population sub-groups in predicted ways, with a clear (and significant) decline in mean scores as perceived levels of disability increase. Those who said they were DDA disabled in the past had higher mean scores (0.91) than those reporting a long-standing condition or disability (i.e. LSI, average score 0.72), implying that past disabilities did not impact significantly on respondents' valuation of their current health state. Those with LSI but *no* activity limitation had higher scores (0.72) than those with *any* limitation (i.e. LLSI, 0.62), who in turn had higher scores than those reporting *substantial* limitation (i.e. DDA current, 0.59). The close correspondence between overall population scores derived from the Omnibus survey (0.86) and those from the Health Survey for England (0.85) lends added weight to the robustness of our findings.

Although EQ5D scores gradually decline with advancing age, the relative position of scores between measures is maintained across age groups (Figure 3.10). This indicates that the overall differences in mean scores observed in Table 3.5 are not simply an artefact of age variation of the population sub-sets included in the various disability categories. The decline in health-related quality of life scores for all categories with age is also indicative of older people making a more positive assessment of their functional ability compared to a younger person with a similar level of problems in key dimensions of everyday life. For example, for the same average score value of about 0.7, younger respondents in the survey reported having a substantial limitation in daily activities while those aged 75 and over reported having no limitation (only a longstanding condition).

**Figure 3.10 Mean EQ5D scores by disability severity level and age group (Omnibus survey 2001)**

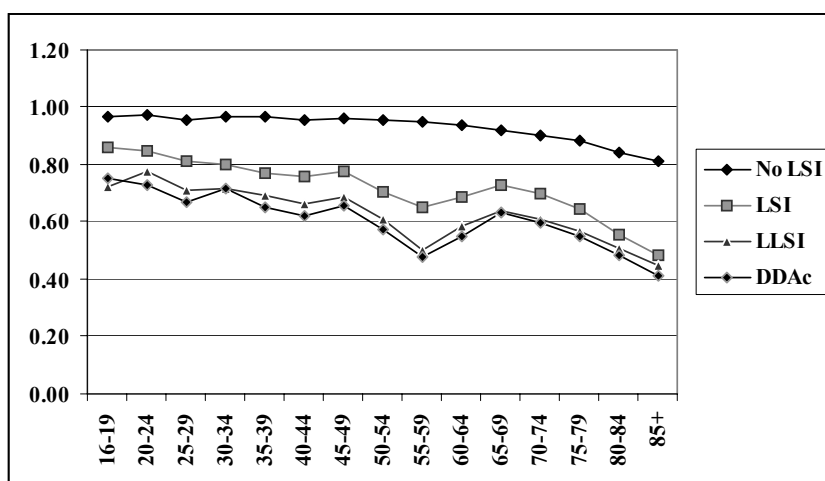

### 3.5.2 DDA (current) and work-limiting disability

Figure 3.11 is based on LFS 2001 data (excluding proxy interviews) for those of working age. Overall, 70 per cent of adults of working age reported no

long-term illness.<sup>17</sup> Just over a fifth (21 per cent) of the population reported having some form of disability, with two-thirds of these reporting both WLD and a current disability covered by the DDA. The proportion of the working age population claiming work-limiting disability alone (five per cent) was slightly higher than that for those DDA disabled but not work-limited (three per cent).

The exact agreement between the two measures (93 per cent) was higher for WLD against DDA than for LLSI against DDA. This is also reflected in the slightly higher kappa value of 0.73 (Table 3.6). Age specific kappa values ranged between 0.6 for the youngest age group (16-24) to 0.74 for the oldest age group (men aged 55-64 and women aged 55 to 59). Overall, the degree of agreement between the two sets of comparisons – DDA versus LLSI and DDA versus WLD - was very similar, suggesting the possibility of a large overlap between those reporting DDA, LLSI and WLD.

**Figure 3.11** Overlap between DDA and WLD categories: working age population (*Labour Force Survey 2001*)

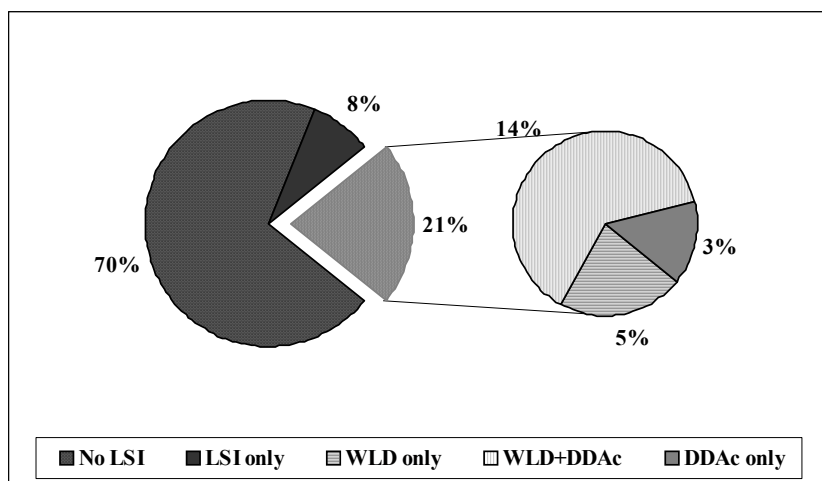

**Table 3.6** Overall agreement between DDA (current) disabled and WLD (*Labour Force Survey 2001*)

WLD	DDA (current) disabled		Total
	Yes (%)	No (%)	
Yes (%)	14	5	18
No (%)	3	79	82
<b>Total</b>	17	83	100
<b>Kappa</b>	0.73		
<b>Base</b>	42790		

<sup>17</sup> As mentioned previously, the LFS includes a modified version of the LSI question which appears to overstate the prevalence of longstanding illness amongst adults relative to estimates derived from the harmonised LSI question (see section 3.4.1).



### 3.5.3 LLSI and work-limiting disability

For the LLSI and work-limiting measures of disability we have used data from the FRS 2000/01 survey and limited ourselves to the working age population and excluding proxies – as in the previous set of comparisons. Note that even though the work-limiting disability question in the FRS is worded differently from the questions included in the LFS, they are similar enough to suggest that they are measuring the same construct. For the purpose of this comparison, we have used the WLD measure that is conceptually similar to that in the LFS – namely, long-term work-limiting disabled (FRS-2 as defined in section 3.4.2).

Figure 3.12 shows that the proportion of adults of working age who said they didn't have a longstanding illness is three percentage points higher in the FRS compared with figures from the LFS (Figure 3.11), resulting in a correspondingly lower prevalence of respondents of working age reporting some limitation (18 per cent vs 21 per cent, respectively). The level of overlap between the reporting of WLD and LLSI is higher than the overlap in any of the pairs of measures compared in the previous sections. More than seven out of ten respondents (13 per cent of 18 per cent) with some degree of disability said they experienced limitations in their activities and felt that they were restricted in the type or amount of work they can do. In fact respondents reporting WLD were almost entirely a sub-set of the population who said they had LLSI, with less than one in ten respondents (one per cent of 14 per cent) reporting WLD but not LLSI.

**Figure 3.12** Overlap between WLD and LLSI categories: working age population (Family Resources Survey 2000/01)

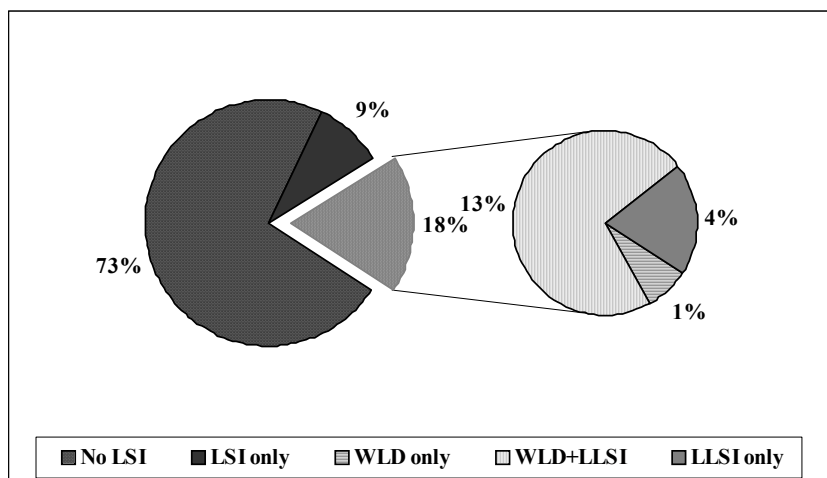

The strength of agreement between WLD and LLSI is mirrored in the 95 per cent exact match between the two instruments and the overall kappa value of 0.81 that denotes excellent agreement (Table 3.7). Age-group specific kappa

values show the familiar pattern of slightly lower agreement for young adults aged 16 to 24 (0.75) compared with older ages (0.79 – 0.82).

### 3.5.4 Discussion

The empirical examination of the validity of global disability instruments revealed that despite their brevity they performed in expected ways. The high degree of agreement between the different instruments (with kappa values ranging from 0.7 to 0.8) led us to conclude that the convergent validity of the measures examined is good to very good. In other words, despite the different definition of activity limitation used by each questionnaire instrument, they are all tapping into the same underlying construct. Estimates of LLSI and WLD were found to be more strongly associated than were rates of DDA disabled.

**Table 3.7 Overall agreement between LLSI and WLD (Family Resources Survey 2000/01)**

	LLSI		
WLD	Yes (%)	No (%)	Total
Yes (%)	<b>13</b>	1	15
No (%)	4	<b>82</b>	85
<b>Total</b>	17	83	100
<b>Kappa</b>	0.81		
<b>Base</b>	25762		

Differences between population sub-sets who said they have one or more (overlapping) types of activity limitation also appear to be systematic. We found that responses to questions with different threshold levels of severity of disability were correlated with scores derived from a health related quality of life instrument. Although all the measures reviewed, including the reference instrument (EQ5D) used for assessing discriminant validity are based on self-reports, the consistency of the relationship between declining health-related quality of life with increasing levels of disability supports the inference that the global disability questions are broadly understood in the way they were intended.

### 3.6 Estimates from disability surveys: empirical comparisons

Surveys that specifically set out to measure the population prevalence of disability are comparatively few in Great Britain. Estimates derived from disability surveys are widely regarded as more 'objective' than estimates based on global questions because they measure ability across a specified range of activities rather than relying on self-definition based on a simple dichotomy of disabled/non-disabled. Disability surveys also have the property of additive decomposition in that counts of the overall number of disabled people can be broken down by type of main disabling condition and/or by severity. In this section we present evidence on the variation in the overall prevalence of disability obtained from four disability surveys. We also critically

evaluate survey design features and measurement protocols that contribute to that variability. The main differences between the four surveys are shown in Table 3.8.

### ***Disability surveys: design and questionnaire instruments***

Between 1985-88 a series of disability surveys (DS85) were carried out by the Office of Population Censuses and Surveys (now ONS). These are widely regarded as *the* definitive surveys of disability in Great Britain (Martin et al, 1988). The DS85 surveys included the population resident in institutions ('communal establishments') as well as the general population in households, and included both children and adults. The study located disability within the ICIDH conceptual framework and defined it as a 'restriction or lack of ability to perform normal activities which has resulted from the impairment of a structure or function of the body or mind'. It recognised that there was a continuum of abilities and that a decision therefore needed to be made about the level of (dis)ability that constituted the threshold between disabled and non-disabled groups. It measured ability in a range of everyday activities as a capacity (*can* do) rather than performance (*do* do) measure that was largely independent of social setting – e.g. the instrument could be used for individuals resident in supported environments such as institutions or households. The study went on to develop severity scales (ranging from 1-10 (highest)) for 13 domains covering physical, mental and sensory functioning. A summary overall disability score on a scale of one to ten was derived by taking a weighted average of the individual's three most severe disabilities.

The DS85 disability instrument and the scoring method were used in a number of subsequent surveys, most notably in the 1996/7 Disability Survey (DS96/7 – which was also known as the FRS follow-up study (Grundy et al, 1999)). Although DS96/7 was not primarily intended to replicate DS85 and produce total population estimates of disability (Craig, 1996), it presented an opportunity to update prevalence estimates for a sub-set of the total population – namely, adults aged 16 and over resident in private households.

The main difference between these two surveys was the way in which the sample was selected. DS85 survey used a postal screening of the general household population (based on answers to 33 questions on long-term limitations or health conditions) to identify the eligible sample with sufficient indication of a limitation to justify an interview. Eligibility for the DS96/7 was determined from answers to questions in the FRS on benefits received, reported limiting long-standing illness or disability, age (all aged 75 and over) and restriction in work capacity (Grundy et al 1999).

The HSE series introduced a module of questions on disability in 1995 (Purdon, 1996), and this was repeated in 2000 (Hirani et al, 2001) and 2001 (Bajekal et al, 2002).<sup>18</sup> The disability module in the HSE was asked of all

---

<sup>18</sup> In this report, we have used the combined 2000 and 2001 HSE adult general population samples to improve the precision of estimates. In HSE2000, the general population sample was smaller than in other years because of a special boost of older people resident in care homes (Bajekal, 2001).

**Table 3.8 Main differences in design and content of disability surveys**

	DS85	DS96/7	HSE95	HSE00/01
Population Coverage	GB -households (all ages) -institutions (all ages)	GB -households (adults aged 16 and over)	England -households (aged 10 and over)	England -households (aged 10 and over) -institutions (aged 65 and over)
Sample recruitment	Postal screen of households, based on answers to 33 questions on long-term limitations or health conditions <i>-potential for misclassification (false negatives)</i> - 15% of population screened-in	Follow-up of FRS sample based on 6 criteria (long-term limitations, work restrictions, benefits receipt, age) <i>-potential for misclassification (false negatives)</i> - 25% of FRS sample screened-in	No sift criteria used	No sift criteria used
Proxy (adults)	restricted to those too ill	restricted to those too ill	no proxies	restricted to those too ill in institutions
Sample size	large (10,000 disabled adults)	medium (7,000 disabled adults)	small (3,000 disabled adults)	small (4,200 disabled adults)
Denominator population (to calculate prevalence rates)	external source (mid-year population estimates) <i>-potential for error -limited information on the socio-economic characteristics of the base (non-disabled) population</i>	FRS main survey sample (stage 1) <i>-two stages of non-response error</i>	Survey sample	Survey sample
Disability dimensions	13 domains: locomotion, personal care, seeing, hearing, communication, reaching and stretching, continence, dexterity, behaviour, intellectual functioning, consciousness		5 domains: locomotion, personal care, seeing, hearing, communication	
Severity score	Overall and domain-specific. Score range 1-10 (highest) (interval scale)		Overall and domain-specific. Score range: none, moderate, severe (ordinal scale)	
Prevalence estimate (all adults in households)	13.5% 14.3% <i>(standardised to 2001 age profile)</i>	19.8% 20.1% <i>(standardised to 2001 age profile)</i>	18.0% 18.0% <i>(standardised to 2001 age profile)</i>	17.8% 17.2% <i>(standardised to 2001 age profile)</i>

adults in the sample. Like DS85, the disability instrument used was an adapted version of the WHO recommended questionnaire based on the ICIDH framework (WHO-Europe, 1996). Unlike DS85, however, the HSE included fewer questions on each dimension of disability covered, and did not include certain types of disabilities and those that predominantly affect the elderly (Table 3.8). These exclusions are likely to lead to lower prevalence estimates in the HSE compared with DS85 – particularly at older ages. On the other hand, the postal screening questions used in the OPCS 1985 survey might have failed to identify those people with milder forms of disability who were included in the Health Survey. In addition, DS85 and DS96/7 included Wales and Scotland (which were both excluded from the Health Surveys), and in both these countries proportions of people with a disability were higher than in England.

### ***Variability in prevalence estimates***

The four disability surveys included in our review provide estimates of the prevalence of disability in different years and for different sub-sets of the population. We have therefore restricted our empirical analysis to adults aged 16 and over resident in households, and have presented both the reported overall rates and rates derived after adjusting for differences in the age structure of the population in different years (i.e. after standardising to 2001 census age and sex distribution).

**Figure 3.13 Age-specific prevalence rates in three disability surveys**

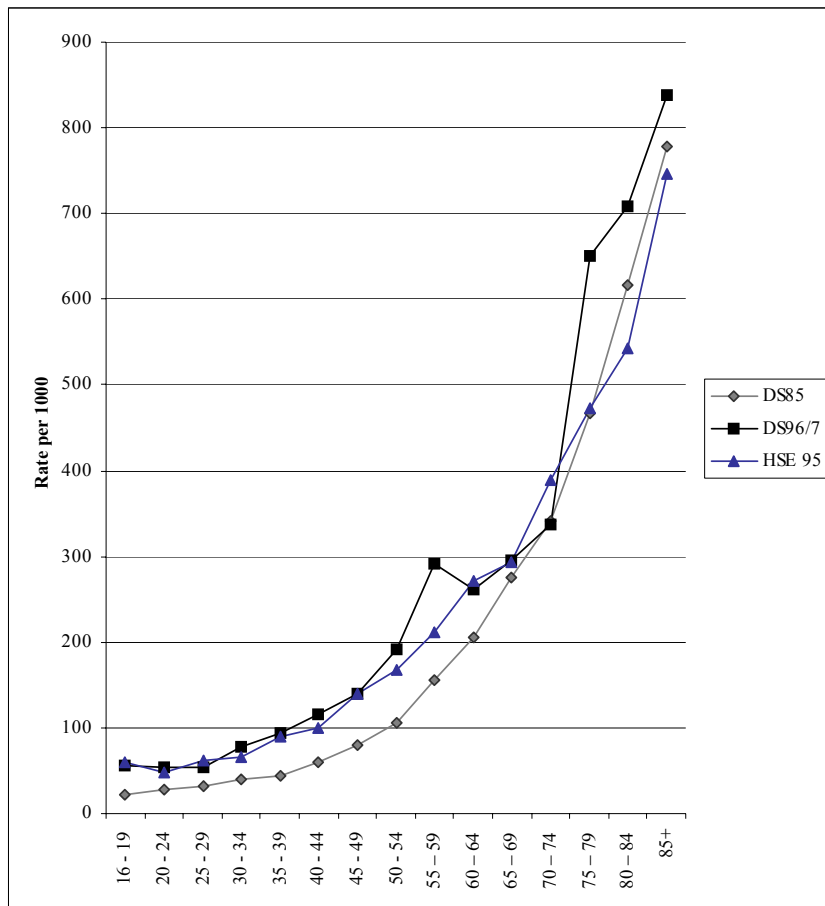

Age-adjusted overall prevalence rates were lowest for DS85 (14 per cent) and broadly similar for the other three surveys (18-20 per cent, see Table 3.8). Comparing disability prevalence estimates within age-bands we note the following (Figure 3.13)<sup>19</sup>:

- Estimates based on the same disability instrument and scales were considerably lower in DS85 than in DS96/7 for all ages, except those aged 60 to 74.
- HSE95 estimates were similar to DS96/7 upto age 49, and higher for all older age bands, except for those aged 60-74.

A detailed examination of the age-related differences in prevalence estimates between DS85 and DS96/7 suggested that the substantially higher rates in the latter were primarily due to methodological differences in the screening procedures used to identify disabled people in the two surveys, rather than wholly attributable to a 'real' increase in disability over the decade (Grundy et

<sup>19</sup> For clarity, HSE00/01 based rates have been omitted from the figure. These were found to be very similar to the HSE95 rates (Bajekal, 2002).

al, 1999). The use of a household postal screen in DS85 is thought likely to have resulted in more 'false negatives' – i.e. the form-filler in the household may have missed out members with mild forms of disability who were then assumed to be non-disabled (i.e. a form of proxy response). In DS96/7 on the other hand, although a different set of sift criteria was used to determine eligibility, they were all based on individual responses to questions in the main FRS survey. The close correspondence in the age-specific rates in DS96/7 and HSE95 for younger age groups also suggests that rates in DS85 were likely to have been understated than those in DS96/7.

However prevalence rates for those aged 60-74 in DS96/7 are substantially lower than expected (Figure 3.13). These rates are neither internally consistent – we would expect rates of disability to increase uniformly with advancing age, rather than suddenly dip at age 60 – nor conform with the age-related pattern of variation observed in other, external, sources of data such as the HSE95 or DS85. Grundy et al (p.28, 1999) suggests that the reason for this anomaly is the operation of the sift criteria used for different age groups in DS96/7. All those aged 75 and over were automatically entered, while those of working age were selected on the basis of responses to questions about work restriction, benefits receipt and the presence of a LLSI. Respondents aged between working age and 74 were entered into the follow-up survey only if they reported having a LLSI or were in receipt of one of the disability related benefits not restricted to people of working age (e.g. Attendance Allowance). Because older people tend to underreport functional limitations, it was thought likely that the sift criteria failed to include some people in the 60-74 age groups who would otherwise have been classified as disabled using the disability questionnaire.

The HSE00/01 allows us to empirically test this assumption. In the HSE all respondents were asked questions in the disability module, irrespective of their responses to previous questions on limiting longstanding illness or disability. Thus it is possible to calculate within each age group the proportion of people who responded positively to the LLSI question, and of these, those who fell below the disability threshold (LLSI only) and those who were also classified as disabled (LLSI + disabled); and additionally those who said no to having a LLSI but were classed as disabled (disabled only). It is the latter group that would be missed if the disability module were asked only of those reporting a LLSI as in the DS96/7. Note that respondents who were not disabled and did not report a LLSI ( 70 per cent of the total sample) have been excluded from the percentage distribution presented in Figure 3.14. Thus the sum of the bars (100 per cent) within each age group is based on the total number of respondents who were either classed as disabled or said they had a LLSI, or had both.

**Figure 3.14 Overlaps between LLSI and disability, by age group**

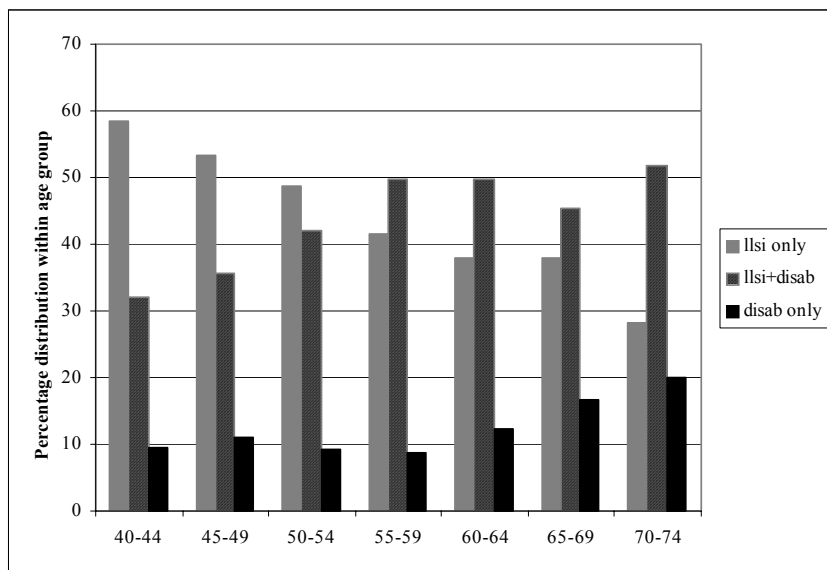

The analysis shows, as expected, that the proportion of those reporting a LLSI who are also disabled rises with age – in other words, the overlap between the sub-sets of the population reporting both LLSI and disability becomes stronger. But we also see that the proportion of respondents who are categorised as disabled but said they did not have a LLSI remains a fairly constant proportion until age 60 (under 10 per cent), and then gradually increases – doubling to 20 per cent of those aged 70-74. This finding shows that the use of LLSI as a sift criteria or filter question will lead to an underestimate of disability for all ages, and particularly for those aged 60 and over.

A general comparison of the age-related pattern of variation between rates obtained from the DS series and the HSE series reveals some interesting observations. As expected, the HSE underestimates disability rates for older ages because of the comparatively limited set of functional limitations it covers. However, the close correspondence in rates at ages below 60 between HSE95 and DS96/7 rather than between DS85 and DS96/7 appears to suggest that differences in survey procedures exert as large an effect on estimates as differences in measurement instruments. HSE95 and DS96/7 use different questionnaire instruments but follow more similar survey protocols to determine eligibility compared to the postal screen used in DS85.

### **Discussion**

As has been noted by various commentators, estimates of the prevalence of disability are highly sensitive to the measures used – for example, the types of disabilities included, the defining threshold of severity and whether difficulties are assessed with or without the use of assistive aids or treatment. Our



empirical analysis suggests that differences in the measurement properties of instruments undoubtedly do have an impact, but that differences in disability prevalence estimates are also highly sensitive to the survey process (e.g. mode of contact and selection criteria). Thus, if surveys using the same instrument (e.g. DS85, DS96/7) do not follow identical survey protocols, the interpretability of any evidence of change over time is seriously compromised.

Furthermore, because population sub-groups have been shown to differ in the way they report functional limitations (based on age or socio-economic circumstances for example), it would be particularly important in a future disability survey to include a sample of those who would class themselves as non-disabled. This would allow estimates to be adjusted for potential response bias due to factors such as discounting for age, the use of negative language and restrictive response categories.

### **3.7 Comparing key disability estimates**

As discussed in Chapter 2, there is no 'gold' standard measure of disability, and the multi-dimensional and dynamic nature of disability make it inherently difficult to measure. And, as we have shown, there are multiple reasons for differences in survey estimates: including for example, differences in the concept of disability used, the threshold criteria for classification between disabled and non-disabled, survey design and operational procedures, and variability in individual reporting behaviour. However, as our empirical comparisons in this chapter have shown, despite these differences, estimates based on alternative survey sources and different definitions appear, on the whole, to be broadly similar, though more so for the population of working age than for the post-retirement age groups.

In this section we compare the key survey estimates that are currently used by DWP to estimate the prevalence of disability and the numbers of disabled people in GB. In Table 3.9 and Figure 3.15 we compare five estimates, namely:

- LLSI (from the FRS survey)
- DDA (current) disability (from the LFS survey)
- work-limiting disability (from the LFS survey)
- long-term disability (WLD or DDAc)<sup>20</sup> (from the LFS survey), and
- estimates derived from a disability survey (DS96/7).

In each instance, where alternative survey sources exist for the same estimate (e.g. LLSI, WLD), we have selected the one that is either the most commonly used or provides the most precise rates (i.e. has the largest sample size).

---

<sup>20</sup> The term 'long-term disabled' was coined by the DRC's disability briefing. LFS respondents have been defined as having a long-term disability if they report having a current long-term disability covered by the DDA (including progressive illnesses not currently disabling or work-limiting) or a work-limiting disability, or both. Long-term disability thus defined is used by the DWP to monitor the Governments Public Service Agreement (PSA) target for increasing the employment rate of disabled people and is what DWP refers to as PSA disabled.

In addition to the age-specific rates, there are four additional overall estimates at the bottom of Table 3.9. The first gives the overall population prevalence rate based on the survey sample; the next adjusts the overall survey rate for age-related differences between survey samples (see section 3.8) using the Census 2001 as the common reference population; and counts in the third row provide an estimate of the number of disabled people to compare against the published counts (in the last row). It should be noted that the derived counts (penultimate row Table 3.9) illustrate the range of variation in the absolute count of the number of disabled people in the population, but do not correspond exactly to the published counts. This is because we have not applied the survey-specific weighting and grossing factors (see section 3.8) but have used a simple age-weighting method across all estimates to assess the scale of relative differences in absolute counts.

**Table 3.9 Comparison of age-specific prevalence rates and numbers of disabled people across key disability estimates**

Data source Measure	All ages, all persons			Working age, all persons			
	LFS DDAc	FRS LLSI	DS96/7 OPCS disability scale	LFS WLD	LFS DDAc	LFS Long- term disabled	FRS LLSI
16 - 19	5.5	6.8	5.6	6.6	5.5	8.6	6.8
20 - 24	7.9	7.4	5.3	9.0	7.9	11.4	7.4
25 - 29	8.1	9.2	5.3	9.9	8.1	12.0	9.2
30 - 34	9.6	9.1	7.8	11.4	9.6	13.5	9.1
35 - 39	11.5	12.2	9.4	12.6	11.5	15.3	12.2
40 - 44	15.1	16.1	11.5	17.0	15.1	20.0	16.1
45 - 49	19.3	18.7	14.0	20.3	19.3	23.9	18.7
50 - 54	23.9	22.9	19.2	25.2	23.9	29.4	22.9
55 - 59	29.2	29.2	29.1	30.9	29.2	35.4	29.2
60 - 64	37.2	35.2	26.1	43.0	37.2	47.4	41.1
65 - 69	38.7	37.9	29.6				
70 - 74	41.6	40.6	33.8				
75 - 79	47.6	47.1	65.0				
80 - 84	54.8	55.8	70.9				
85+	59.2	60.4	83.8				
Overall prevalence (%) (survey derived: no proxy)	24.8	23.9	20.2	18.3	16.7	21.4	16.7
<b>Age-adjusted prevalence (%)</b>	22.0	21.9	20.0	17.0	15.4	20.0	15.7
<b>Estimated Count (millions)</b>	8.4	8.4	7.7	5.1	4.6	6.0	4.7
Published	11.0	NA	8.6	5.4	5.9	6.9	NA

Figure 3.15 shows that age-specific rates of DDA current disability and LLSI were remarkably similar across all age groups, with work-limiting disability rates (for working age groups) marginally higher only for those aged 60-64. This is because in Figure 3.15 the DDA and LLSI estimates are based on combined rates for men and women aged 60-64, while only men are included in the WLD estimate and men report higher rates of WLD than women in all age groups. The disability-specific survey estimates exhibit a different patterning of age-specific rates: for those of working ages, rates were lower than for any of the global estimates; for those between retirement age and 74, they are substantially lower (because of problems with screening for this age group, see section 3.6); and they are substantially higher for those aged 75 and over.

**Figure 3.15 Comparison of age-specific rates of disability across five survey estimates**

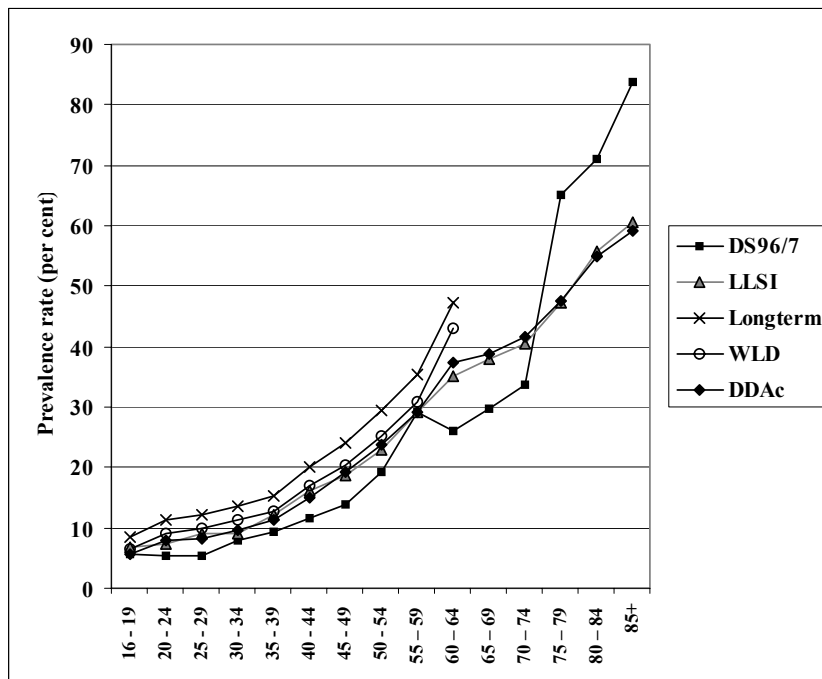

When the overall estimates for the working age population based on the four disability definitions derived from single-item questions are compared (see Figure 3.16), we find that LLSI and DDA are almost exactly the same, with WLD rates a little higher and long-term disability rates still higher. The latter is perhaps to be expected, as the measure includes all those covered by the DDA *and* those with a WLD. As we saw in section 3.5.2, although there is a great deal of overlap between the populations included in the two definitions

(92 per cent reported having both), about 8 per cent of respondents reported having only a WLD or only a DDA disability.

**Figure 3.16 Comparison of the overall rate of disability among those of working age across key survey estimates**

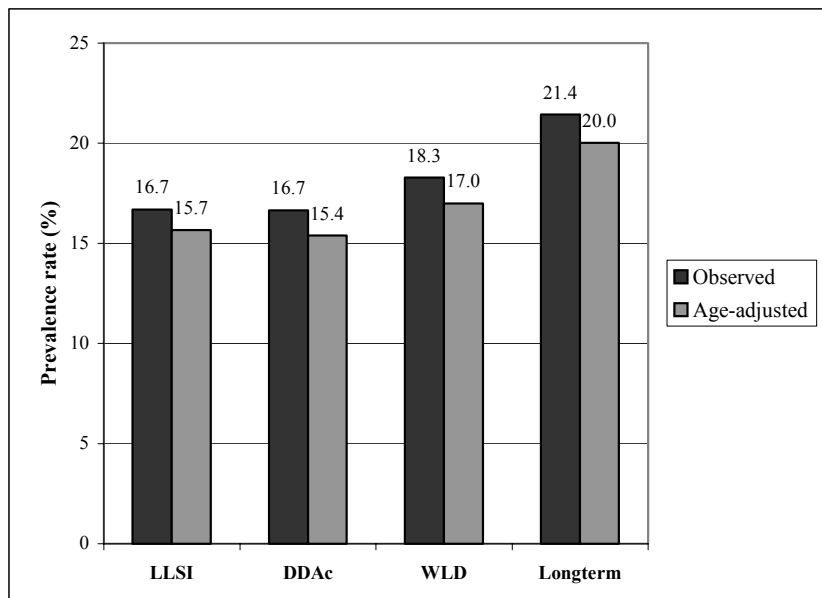

The differences in absolute counts of disabled adults mimics the differences observed in the age-specific rates (Table 3.9). For the total population, disability-specific survey estimates were the lowest (7.7 million in DS96/7, partly because disability among those age 65 to 74 was underestimated in this survey), with the DDA current and LLSI based counts being very similar (about 8.4 million). It should be noted that the derived counts of the number of people covered by the DDA are considerably lower than the published counts (11 million, Grewal I, 2002).<sup>21</sup>

For those of working age (men 16-64, women 16-59), we find that the age-adjusted absolute count was broadly similar (4.6 million DDA disabled and 4.7 million disabled people with LLSI). Both the prevalence rate and the count of disabled people of working age was higher for WLD than for DDA and LLSI (by about two per cent, or a difference of about half a million people). Thus, the combined measure of WLD and DDA – the long-term disabled – had the highest age-adjusted prevalence rate (20 per cent) and the highest estimated number of disabled people of working age (6 million, compared to the published estimate of 6.9 million).

<sup>21</sup> This is likely to be because of differences between the two studies in weighting and grossing methods as well as the way in which the LFS data was annualised for this study compared to the standard approach to deriving quarterly estimates in the LFS (see Appendix D).

## **Discussion**

From the evidence above, it is apparent that the number of disabled people of working age is higher with the estimate based on the long-term disabled definition than it is with all other global or disability-specific survey estimates. Long-term disabled is also the most inclusive definition, including those covered by the DDA and those with work-limiting disability as well as those with progressive conditions that may not currently limit capacity to work or cause substantial limitation in daily activities.

Estimates of long-term disability have remained fairly stable over time, but are potentially sensitive to societal influences in reporting behaviour (as are other global estimates). Studies have shown that self-reporting of work-limiting disability, for example, is influenced by factors such as labour-market success, changes in expectations and cultural norms (such as social acceptability of disability as a rationalisation for withdrawal from the labour market), and changes in welfare benefits provision (Grammenos S 2002). It is also possible that growing awareness of the DDA, as well as an expansion in the number of diagnosed medical conditions covered by the Act will stimulate increased reporting of DDA disability by respondents.

From a statistical point of view it seems reassuring that estimates based on the DDA (current) definition are so similar to those derived from the question on longstanding illness or disability that limits activities (LLSI question), as both questions aim to identify the population that have activity limitations. However, this similarity in rates is rather surprising given that the DDA definition expressly asks respondents to discount the impact of any medication, treatment or aids used in assessing adverse long-term impact on daily activities, which the LLSI question does not do. A study of the effects of the use of aids on reporting behaviour showed that 26 per cent of US adults aged 18 to 44 who were long-term users of assistive devices (such as wheelchairs, hearing aids etc.) reported no limitation in daily activities (Madan J et al, 2003). This suggests that it is possible that the instruction to consider the situation without the use of medication, treatment or aids in the DDA definition is being misunderstood or ignored by respondents, resulting in prevalence rates being understated. It also suggests that individuals using such aids would not be captured in surveys that define disability based on reported limitations and do not also include questions about the use of aids (this is specially important for the assessment of disability among the elderly, who form the largest group of users of assistive devices).

For people past retirement age, estimates based on global questions were found to be unstable between different surveys and sensitive to the definition of disability used.

Overall, our comparisons between self-reported global disability questions lead us to infer that for the working-age population, prevalence rates that are derived using different definitions of disability and based on different surveys are broadly consistent, ranging as they do from 15.4 per cent (DDAc) to 17 per cent (WLD) (the long-term disabled combines these two estimates to

produce a higher estimate of 20 per cent). As we would expect, aspects such as differences in question wording and sequence, the use of proxies, and survey context effects contribute to the variability of overall prevalence rates and counts between estimates.

In contrast to the number of surveys with one or more global questions, there were relatively few disability-specific surveys, making it hard to make an informed judgement on their stability vis-à-vis global estimates. The fact that these surveys are spaced across several years makes the task even more difficult, as part of the variation may be due to 'real' changes in the prevalence of disability. Although all four of the disability surveys included in this study were based on the ICIDH concept of disability, they used different questionnaires, severity thresholds and survey procedures.

The advantage of using estimates based on disability-specific surveys is that they provide a more objective measure. This is because the specificity of the questions makes it less likely that respondents comprehend questions very differently or attempt to rationalise their own behaviour through their answers.<sup>22</sup> Much of the variation in age-specific rates that was observed between the four disability-specific surveys was mainly due to differences in operational features (such as in the use of different forms of screening, or none at all). As for global estimates, we find that for those of working age, the difference in age-specific prevalence rates was small compared to what it was for those over retirement age. This was mainly because of differences in the types of disabilities counted in one set of surveys (those based on the OPCS scale) compared with the second set (based on HSE questionnaire). Unfortunately, none of the disability-specific surveys included any of the key global questions – such as DDA disability question or the long-term disabled or work-limiting disability questions. If they had, this would have allowed us to compare the correspondence between responses to the global questions and those obtained from the long set of objective questionnaires.

The choice of whether to use a disability estimate derived from a global question as opposed to one using a detailed questionnaire depends primarily on the intended purpose of the information (see section 4.4). Both measures appear to provide fairly reliable estimates for the working-age population, albeit with the detailed set of questions resulting in slightly lower estimates than did the broadly defined global questions.

### **3.8 Weighting and grossing to estimate absolute counts**

So far in this chapter, we have largely compared differences between surveys in age-specific *prevalence* rates of disability, usually expressed in terms of the percentage of the population (or sub-groups of the population, e.g. by age bands) with a disability. Often, results from large-scale surveys are 'grossed up' to convert information obtained from a sample into estimated *counts* of the number of disabled people in the population. Users of survey estimates are

---

<sup>22</sup> One study has shown, for example, that those not in work systematically over-report the effects of health conditions have on their ability to work (Grammenos 2002)

understandably confused when prevalence estimates from different surveys are broadly similar, but there appear to be relatively large differences in the absolute numbers (or counts) of disabled people derived from each survey.

In principle, the conversion of sample estimates into population counts can be considered a two-stage process. First, the sample is weighted to correct for differences in response rates among different types of population groups (non-response weighting). Second, the weighted sample is scaled up to the total population counts, so that survey sample equals the population total (grossing).

In its simplest form, non-response weighting involves comparing the sample distribution (for example, by age) with a reliable external source of the 'true' population distribution (also by age). Groups that are under-represented (or over-represented) in the sample are assigned a 'weight' equivalent to the ratio of the population size to the sample size in that group. For example, if it were found that the proportion of young men aged 16 to 24 was 10 per cent lower in the sample than in the general population, then all young men in the survey would be assigned a weight of 1.11 (i.e.  $100/90$ ) in order to achieve the 'correct' representation. In this way, lower response rates among young men would be compensated for by making the assumption that the characteristics of young men who didn't take part in the survey were similar to those who did. In practice, the methods used to adjust for non-response are more complex and also take account of stratification and other survey design features. However, it should be noted that all weighting methods involve making assumptions about non-respondents that may not be valid and that are subject to error.<sup>23</sup>

Once the sample has been weighted to be representative of the population, grossing up from sample estimates to population counts simply involves multiplying the weighted prevalence estimate with the population count ('scaling'). Often, the weighting and the scaling factors are combined into a single 'grossing up factor' (as in the GHS and LFS) that adjusts the unweighted or raw sample estimates simultaneously for differential non-response and scales up the sample counts to the population counts.

Surveys such as the LFS, FRS and GHS use slightly different non-response weighting methodologies. However, they all scale up to a common standard population – the mid-year estimate of the population resident in private households in GB. The overall (weighted or age-adjusted) prevalence estimate for the population can then be applied to the total population count to obtain an estimate of the number of individuals in the population with that characteristic. For example, a 20% estimate of disability prevalence for adults

---

<sup>23</sup> Several government surveys have undertaken studies to match sampled addresses with their Census returns in order to obtain a more detailed picture of the socio-demographic characteristics of residents in households that have refused to take part in the survey or could not be contacted. Such information plays a crucial role in identifying which characteristics are most significant in distinguishing between responding and non-responding households. This information is then used to improve non-response weighting (Living in Britain (GHS 2001)).

aged 16 and over would correspond to 7.7 million disabled people (based on 38.4 million adults in households in GB, Census 2001).

Based on the GB population in Census 2001, for every one percentage point difference in prevalence (irrespective of the actual *level*, i.e. any prevalence value between 1 per cent and 100 per cent ), the count of the number of disabled people would change by 384 thousand (or 192 thousand and 768 thousand for a difference of half a percentage points and two percentage points, respectively). The margin of error around the survey prevalence estimates, the upper and lower confidence intervals (see section 2.4) can also be converted into the upper and lower bounds of the estimated population count (Table 3.10).<sup>24</sup>

**Table 3.10 Example of variation in population (absolute) count with differences in survey prevalence estimates**

	Survey 1			Survey 2		
	Lower CI (%)	Overall (%)	Upper CI (%)	Lower CI (%)	Overall (%)	Upper CI (%)
Prevalence	19.7	20.0	20.3	20.1	20.5	20.9
Count (millions)	7.56	7.68	7.79	7.72	7.87	8.02

In the example above (Table 3.10), the estimated numbers of disabled people in the two surveys differ by about 200 thousand but, given the margins of error around each estimate, these differences are not statistically significant (at the 95% confidence level). From the range of figures in the example above, we can conclude that the 'true' population count of disabled people lies somewhere in the region of 7.5 million to 8 million people.

Often, users apply overall population prevalence rates estimated for an earlier time period (say, from a survey done five years ago) or for a different geographical area (say, a country with an older population profile) to obtain current counts. Even if it is assumed that age-specific prevalence rates have remained unchanged over time or place, such simple approximation methods can lead to misleading estimates.

This is because summary measures such as the overall proportion of the population disabled (population prevalence) or the number of disabled people (absolute count) are a function (summed product) of age-specific rates and age-specific population distribution. It is not possible therefore to update overall population proportions or absolute counts without explicitly taking into account changes in age-specific prevalence rates and the age distribution of the population. In the absence of up to date figures for either of these two parameters, the assumptions made about which rates and which population distribution has been used in the (revised) estimate should be explicitly stated.

<sup>24</sup> The calculations in Table 3.10 presented by way of example are based on surveys with large sample sizes like the LFS and the FRS which have small error margins (0.4 per cent and 0.3 per cent, respectively, for a prevalence rate of around 20 per cent of all adults).



### 3.9 Summary

- Survey estimates of disability are known to vary widely, ranging from 8.6 million (20 per cent) of the adult GB population (Disability Survey, 1996/7) to 11 million (23 per cent, LFS 2002 estimate of the number of adults covered by the DDA).
- The key question addressed in this chapter is: are differences in disability prevalence rates mainly due to differences in survey conditions (e.g. survey context, screening procedures, question-order etc.) or mainly due to differences in the definition of disability used, or due to both these factors? The empirical investigation in the chapter therefore addressed issues related to reliability and validity of both single-item global questions and specialist disability questionnaires to assess the impact of between-survey variability. It then compared commonly used estimates based on different definitions of disability in order to assess the similarities and differences in age-specific prevalence rates between measures.
- Reliability of overall and age-specific prevalence rates based on the same global question but derived from different surveys showed that rates were sensitive to factors related to the instrument (question wording and question order); to the mode of data collection; to decisions relating to survey process (for example, the collection of data by proxy) and to context effects. But, importantly, the magnitude of these differences was relatively small, particularly for those under retirement age.
- Of the three types of question whose performance was compared between surveys, overall population estimates of DDA-current disability were found to be the most inconsistent. This was mainly because of the way in which the DDA question was asked was the least standardised in the two surveys compared. Although the question wording was the same, in one of the surveys (LFS) respondents were presented with a check-list of conditions *before* the DDA question was asked. This has the advantage of giving all respondents a common frame of reference of the type of conditions to consider in their response to the DDA question that follows. But this is also known to stimulate reporting compared to the alternative format where the check-list of conditions is presented *after* the DDA question (as was done in the Omnibus survey).
- Within age-groups, between survey variation for the same question was found to be largest for older (post-retirement) age-groups. This finding indicates evidence of differential bias.
- By assessing the extent of overlap in answers given by respondents to different forms of disability questions, we tested the assumption that the global questions were all measuring the same underlying concept (convergent validity). There was good to very good agreement between estimates based on DDA-current, LLSI and work disability, and particularly the latter two. In other words, respondents who said that they were limited

in any of the activities covered in the LLSI definition were also likely to report limitation in work and substantial limitation in normal daily activities (DDA).

- These was a clear pattern of declining health-related quality of life with increasing levels of activity limitation measured by the different forms of global questions. Thus, respondents who said they had no long-term illnesses or disabilities had the highest (best) scores on average. The next highest scores were registered by those reporting a condition in the past from which they had recovered; the next highest scores were those with a current long-term condition, but no reported limitation; then came those with a current limitation, (in any activity and at any level), and lastly came those who reported a substantial limitation in daily activities. The relative ranking of scores for each reported level of disability (from none to substantial) was consistent for all age groups.
- Our findings suggest that while different global questions are tapping into the same underlying concept of functional limitation (and hence, are highly correlated), differences in question-wording and emphasis mean that in effect they have different severity cut-off points. This finding indicates that the different types of disability questions are valid in that they are being understood in expected ways by respondents.
- We then compared estimates derived from two pairs of disability-specific surveys. The instrument used in both sets was based on the same conceptual model of disability, but the surveys differed in sample selection, the types of limitations asked about and determination of the threshold level between disabled and not-disabled (namely, by judgement by an expert panel *versus* a self-reported severity scale). The comparison showed that although prevalence estimates were sensitive to the types of disabilities included in the survey (particularly for older age-groups), sample selection procedures (such as screening methods) had a bigger impact on variability between estimates.
- Lastly, we compared prevalence rates and age-adjusted overall disability-rates for five commonly used measures: DDA disabled, work limiting disability, long-term disabled, LLSI and the 'objective' estimate of disability from the 1996/7 Disability Survey. The five estimates were found to have similar age-specific rates for all age-groups through to (but not including) retirement age. Rates for older ages were less stable between different measures.
- For those of working age, overall (age-adjusted) differences between DDA, LLSI and WLD estimates were under two percentage points. The difference between these three estimate types and long-term disabled was higher (about four percentage points) because long-term disability includes those with a work disability or a DDA disability, or both. Rates from more 'objective' disability questionnaires were lower than for global questions for

all age groups up to retirement age, and higher for those over retirement age.

## 4 UTILISING DISABILITY STATISTICS

This chapter looks at how disability estimates are used by disability researchers and disability organisations, and what types of estimates they have need of. It also considers the manner in which they are accessed and disseminated, and the implications of the quality and availability of estimates for policy development, research and service development.

To begin this chapter we will consider the various purposes for which the disability organisations and expert users used disability estimates. In practice, for the disability organisations this involves considering the various stages of their policy-making process – throughout which, estimates were considered to have a potentially important role. Expert users had a different perspective and their views are discussed later in 4.2.

### 4.1 How disability estimates are used by disability organisations

Disability organisations participating in this study reported using disability estimates in all the stages of their decision-making process – from the identification of issues for consideration through to the implementation and evaluation of new policies and services. They used the estimates to influence the policy process of other organisations (central and local government, or employers for example) as well as to inform their own organisational policy processes.

#### *Identifying and prioritising issues for policy consideration*

Some respondents reported that disability estimates were one means by which policy issues were first drawn to their attention. They said that reflecting on the numbers of disabled people who accessed and did not access certain services, for example, might highlight for them policy areas that needed addressing, and that might otherwise have remained hidden.

Similarly, where numbers of different policy areas were competing for attention, estimates of the numbers of people affected would sometimes influence decisions about which one to prioritise.

#### *Getting issues on the agenda of others; and keeping them there*

Much of the work of the disability organisations involved getting issues onto the agenda of other organisations – especially government departments but also local government, employers and service providers. There was a strong belief amongst these respondents that numerical estimates helped draw attention to disability-related issues and get them onto policy agendas. Statistics, it was said, were attention-grabbing in a way that words were not, and enabled policy-makers and managers to more easily grasp the scale and

importance of issues. They felt, for example, that government departments were more likely to give time and attention to an issue if it could be shown that there were large numbers of individuals involved. And they felt that service providers, educational institutions and employers were likely to be more responsive to questions about DDA compliance when arguments were backed up by statistics on the prevalence of disability.

### ***Convincing others of the need to change practice***

Closely linked with the previous point was lobbying work around changes to practice, often in connection with the DDA. Respondents reported that managers of services affected by the Act sometimes underestimated the numbers of disabled people and that their enthusiasm for the Act and for implementing it in their own organisations increased when they appreciated the numbers of people that might benefit.

### ***Winning resources***

Once an issue was on the agenda, numerical estimates were considered helpful in winning money and time for its support. Numbers were said to lend weight to an appeal for resources, such that appeals that did not include convincing statistics were at a disadvantage. This was the case for disability organisations when they applied for grants from charitable trusts and other similar sources. They reported that awarding bodies invariably asked for statistical evidence of need or likely impact.

This point was emphasised by disability organisations, which described how important the ability to estimate the extent of the resource need was in the competition for resources. Policy-makers were said by some to need reassurance about the likely cost of policy ideas and to react more favourably to proposals that included estimates of cost implications that were based on reliable statistics. Similarly, disability organisations needed to be able to estimate the cost of their own programmes.

### ***Evaluating policy changes***

A final area in which disability estimates were used was in policy evaluation. This might involve using estimates of the total numbers of people potentially affected by an initiative to calculate the proportion that actually had benefited. It might also involve looking at segments of the target population to assess whether a policy had been effective across different types of disability or degrees of severity. In order to make valid evaluations of impact, the availability of at least two sets of figures was seen as necessary – one from before the introduction of a new policy (the baseline figure) and one from afterwards.

## **4.2 The use of estimates by expert users**

The experts consulted fall into two distinct types of users: - namely, analysts associated with the collection and reporting of specific surveys (e.g. LFS or

FRS) and researchers (usually academics), who used multiple sources but selected the one that best suited their specific research question.

The former group had in-depth knowledge of the disability measures included in 'their' survey, and focused on updating counts of the number of disabled people and prevalence estimates. Occasionally, they conducted cross-analysis with other information collected in the survey, such as in the study by Smith and colleagues, which used the LFS on labour market participation, income and socio-economic circumstances of disabled people (Smith et al 2002).

Government analysts similarly used specific survey collections to inform policy development in their Departments. For example, the DWP are responsible for the Disability Discrimination Act (DDA) and therefore need estimates based on the DDA definition of disability so that they can know how many people are covered by the Act's provisions and the likely implications of any proposed extensions to the Act. The DWP is also responsible for the Public Service Agreement target around employment rates of disabled people. In this case they use an overall estimate of long-term disabled derived from combining the work-limiting estimate and the DDA estimate from the LFS. Overall, government analysts are more likely to use survey estimates alongside administrative data, for example using econometric modelling to forecast demand for social care services or welfare benefit costs and to assess the impact of policy initiatives.

Researchers, on the other hand, reported using survey estimates and sources in a variety of ways. For example, when designing new studies (e.g. policy evaluation studies), existing survey prevalence estimates were used to guide sampling design decisions and in particular to identify target groups with certain disabilities or attributes (e.g. disabled people wanting work but not in paid employment). Occasionally, existing surveys were also used as a sampling frame for follow-up studies for the collection of additional information not included in the main survey. An example of this was the follow-up of disabled children from the DS85 survey to gather information on the contextual factors affecting transitions into adulthood.

Researchers mostly used surveys for secondary analysis. Both cross-sectional and longitudinal survey data were used, although to answer different sorts of research questions. Cross-sectional data were mainly used for in-depth examination of issues such as the correlates of disability or trends over time in disability and other outcomes. Where available, longitudinal survey data provided a rich source for exploring the dynamics of disability and causal pathways in the disabling process. The importance of such analysis lies in the fact that it suggests reasons why individuals with similar levels of disability may have different disability trajectories. Understanding the attributes of especially vulnerable groups or identifying break-points in the cycle of disadvantage helps to inform the development of better and more focused policy initiatives (Berthoud, 2003, Burchardt, 2003).

### **4.3 Types and characteristics of estimates used**

The types of estimates used by those disability organisations that were consulted can be divided into two broad groups: those that reflected the total numbers of people within organisations' constituencies, and those that broke these overall estimates down into sub-categories. The desired characteristics of each of these groups of estimates are described below, as are respondents' views on their current quality and availability.

#### ***4.3.1 Overall estimates - of disabled people and people with particular types of disability***

Overall estimates of the number of disabled people (or people with particular disabilities) were used by disability organisations to try to persuade external organisations to give priority to the needs of that group over other priorities. For this reason, the choice of which estimate to use was informed by the following factors:

- the consistency of the estimate – both with the estimates used by other organisations and with historical estimates
- the size of the estimate
- the authority of the source
- the appropriateness for the intended purpose.

Disability organisations' desire for consistency was based partly on the need to retain people's confidence in the validity of the estimates, but also on the perception that a well-known and well-remembered estimate would have more impact. A figure was believed to be more memorable if it was repeated over time and received from different sources. In addition to making an estimate memorable, this was also believed to lend it an air of authority. This encouraged a preference for well-known and established estimates and a certain reluctance to consider new and different ones.

Disability organisations usually considered it an advantage to have larger estimates of the numbers of people in their constituencies, as this was thought to bolster campaigning positions. This encouraged them to scrutinise available estimates and to check the way they operationalised their definitions of disability, the way the samples for the surveys were drawn and the resulting degrees of inclusiveness. Criticised features included screening procedures that supposedly missed out people with certain types of disability, and sampling frames that were said to exclude people living in supported accommodation or those over retirement age. In addition, the reliance of some surveys on self-definition was thought by some disability organisations to lead to the undercounting of people less likely to define themselves as disabled (e.g. older people or people who found the term "disabled" stigmatising).

Some disability organisations admitted that where there was any doubt over which estimate to use, they tended to opt for the larger one. Larger estimates were also assumed to generally be more inclusive. In practice this meant that

disability organisations sometimes obtained disability-specific estimates from more specialised sources. For example, one disability organisation used figures from a national epidemiological study, another used an estimate that was based on a number of small local surveys, and yet another derived its national disease-prevalence estimates from figures taken from the small number of localities that ran registers of children who developed the disease. Such sources were perceived to have the advantage of data-collection methods tailored to the characteristics of particular types of disability. This meant that people believed that these estimates were less likely to be exclusive. However, as these estimates tended to come from one-off studies or to be geographically specific, extrapolations were necessary for national, current figures. These extrapolations tended to be based on assumptions about the temporal and/or geographical consistency of prevalence rates, even though respondents were not always sure whether or not these assumptions were valid.

The authority of the estimate, meanwhile, was considered by disability organisations to lend credence to its use in support of a point. For one organisation, the ability to reference the Disability Rights Commission (DRC) as the source of a figure was considered an advantage. Considering the DRC as quasi-governmental, they felt that statistics taken from the DRC's own bulletin would carry more weight in the eyes of government policy-makers than if the organisation itself had chosen which figures to use. In fact, disability organisations usually sourced their overall estimates from DRC bulletins, partly for convenience but also perhaps for the reason just stated.

A final key factor mentioned by disability organisations was appropriateness to purpose. For example, where the application of the estimate was to be around compliance with the DDA, then the most useful number was one based on the DDA definition of disability. On the other hand, a wider definition might be more useful for other purposes, such as fundraising.

### ***Difficulties with overall estimates***

Although disability organisations believed that different types of estimate were needed for different contexts, some also acknowledged that there were problems associated with the existing range of estimates they were using.

One such problem was the confusion that resulted from the use of data from two different surveys. One of these surveys (the FRS follow-up) was preferred for the greater inclusiveness of its overall estimate, while the other (the LFS) was liked for its cross-referencing of disability with employment issues. Data from these two surveys was often presented side-by-side, even though the total estimate in the LFS was almost 2m lower than the total from the FRS follow-up<sup>25</sup>. This caused some confusion both amongst disability organisations themselves and also amongst the people to whom they passed on statistics.

---

<sup>25</sup> The LFS figure only covers people of working age, whereas the FRS follow-up also includes those aged over 65.



Another inconsistency mentioned by disability organisations was the fact that the total of all the impairment-specific estimates added up to far more than the overall estimate of the number of disabled people. One proffered explanation was that of double-counting – i.e. that some people with more than one impairment were being counted by more than one impairment-specific study. However, one of the impairment-specific estimates was by itself greater than either of those disseminated by the DRC, so this explanation cannot be sufficient. According to some respondents amongst the disability organisations, the answer lies in the definitions underlying the estimates. They explained that disability organisations' interests lay in knowing overall numbers of people with a particular type of disability, even if its impact on the person's life was relatively small. This inevitably captured a far larger number of people than would be captured if a threshold of severity were employed. Hence, the argument went, the total numbers would be much larger than the overall disability estimates from surveys such as the FRS follow-up or the LFS.

#### **4.3.2 Disaggregations of the overall estimates**

In general, the disability organisations consulted needed estimates at two levels: the overall estimates just discussed and also disaggregations (or breakdowns) of these overall estimates. For the pan-disability organisations this meant disaggregations of the estimates for all disabled people; for those with a impairment-specific remit it meant breakdowns of the estimates of numbers of people in their particular disability group (e.g. people with visual impairments or people with learning disabilities).

These disaggregations tended to be used in priority setting, service planning (and in trying to influence these two processes amongst other organisations), and also in policy evaluation. The sub-categories that were mentioned as useful are listed below, together with brief descriptions of ways in which they were said to be potentially useful:

- age-group – to give insights into the kind of life-stage dependent services that were likely to be needed
- ethnicity – to enable more culturally-targeted service development
- severity of disability – to allow an evaluation of the likely degree of support needs
- age of onset – for a better assessment of (among other things) people's attitudes to their disabilities, these sometimes being different amongst those impaired for longer or since birth
- impact of the disability on communication – for predicting the need for communication aids, the impact of discriminatory practice in this area and the potential of new communication technology such as the Internet
- use of technical aids – to help gauge the need for support services relating to those aids (for example, hearing-aid services)
- number of different disabilities – to give some idea of the numbers of people with multiple support needs

- number of disabled people in the household – to give some idea of the availability of support from other household members and their likely need to receive support themselves
- experience of discrimination / barriers – to distinguish between those whose who had support needs and those who did not.

Furthermore, to be really useful to organisations, estimates at these sub-levels needed to tie in with wider contextual factors affecting disabled peoples' lives relating to – for example – poverty, employment, educational achievement, access to higher education, access to communication facilities such as the Internet or access to services.

### ***Difficulties with disaggregated estimates***

Whereas some organisations had accessed these types of disaggregated figures from the DRC, disability organisations felt frustrated that they were not able to access more. Some felt that insufficient analysis was being done on existing data and that the analysis that was being done was not being made easily available. Others felt that the raw data itself was not being collected and that questions on disability were too often omitted from large government-sponsored general purpose surveys.

The absence of accessible data of this nature (described above) was seen as a hindrance to effective lobbying, fund-raising, policy evaluation and general scrutiny of public services locally and nationally. It was said to sometimes be the cause of embarrassment, with organisations feeling that they were expected to know more statistical facts about their constituency group than they did, and that their position as experts in their field was eroded as a result.

### ***4.3.3 Access and dissemination***

As well as the *existence* of estimates and their appropriateness to the needs of disability organisations, an equally important factor is the way in which estimates that do exist are made available: how they are disseminated and how accessible they are to the lay-user. Respondents in this study were not always aware of what disability estimates were available, where they could go to find them or – once they had found them – how to interpret them.

### ***Disability organisations***

The first point to note is the variation between the different organisations in the level of staff resources allocated to statistical information. For example, one disability organisation had a person trained in statistics who spent a significant proportion of their time on disability estimates, whereas in another the primary users of the estimates claimed little understanding of statistics and spent little time on them. This was reflected in differing levels of confidence around the search for salient statistics. Those with little specialist resource tended to look for figures that were easily understood and required little or no further analysis. In contrast, those with more expertise were sometimes able

to engage in secondary analysis themselves in order to produce the particular estimates that were most useful for them.

Another factor that affected how estimates were accessed was awareness of where to look for them. Unlike the expert users, disability organisations were not always aware of the full range of estimates that were in the public domain, and were sometimes hesitant about seeking new sources. Furthermore, they sometimes commented that unfamiliar information sources could be difficult to use.

One result of the difficulties experienced or perceived by potential users of estimates was that information on estimates tended to travel in a cascade, becoming more simplified at each stage of the cascade as it was assessed by people with less time to spend understanding statistics or less confidence or expertise in the area. By the time estimates reached their final users they had sometimes passed through numerous different channels. For example, numbers from one survey were initially produced by the research team but were then presented in a simplified format by another organisation before they were picked up by disability organisations who then passed them on to callers to their enquiry lines or visitors to their web pages (e.g. journalists, local disability organisations or members of the public). Although the facts of simplification and easier access were greatly appreciated by some of the recipients of the information, in each of these stages lay the potential for misunderstanding and misinterpretation of the original data.

A second consequence was that some disability organisations preferred to rely on a limited range of familiar sources for their disability estimates, rather than face the hurdles of looking at new figures. As a result, it is likely that organisations were not tapping into the full range of statistics that were available in the public domain. And a result of this, respondents said, was that their fundraising, lobbying and planning potential was diminished.

### ***Expert users***

Expert users of disability statistics felt that the range of published statistics available was limited, despite the relevant data being collected in surveys. There was little information or analysis of disability prevalence at sub-national levels (regions were considered too broad to be analytically useful). As decision-making and resource allocation become increasingly localised, it was felt to be important to understand variations in disability prevalence by geographical location, by area typologies (inner-city, mining etc) and by area deprivation. Similarly, there was little information or analysis by ethnicity and, considering the multiple disadvantage faced by minority groups, this was felt to be a serious gap in information.

They also felt that there was little attempt to reconcile the impairment-specific estimates with information obtained from epidemiological studies. The latter (for example studies of hearing and visual impairments) show higher prevalence rates than the rates reported using the LFS survey. Part of the explanation for this may be the fact that the LFS only reports the 'main'

disabling condition and not any other conditions. One suggestion was that figures for the latter should be routinely reported alongside the figures for 'main' conditions.

The general view of expert research users was that existing single-item 'global' questions in large-scale surveys were too focused on chronic health problems. This, they said, was reflected in various ways:

- in question wording (health condition generally mentioned before disability);
- in the use of check-lists of conditions in surveys, which were often interpreted as the reference frame;
- and in the 'filtering-out' of respondents who did not report long-term a health condition or disability.

Furthermore, the use of questions that conflated ill health and disability was said to make it difficult to distinguish between disadvantage associated with each concept.

#### **4.4 Choosing the most appropriate estimate**

In this section we concentrate on how to select the most appropriate estimate for the task in hand. Given the differences we have outlined between estimates it is understandable that disability organisations and government officials sometimes find it difficult to know which estimate to use for which purpose. The current absence of a single, agreed estimate means that users must select between different sources – and the choice is not always straightforward. In the following box (Figure 4.1), we provide an illustration of the types of questions that might be asked by users when they turn to the existing estimates.

**Figure 4.1 The types of questions asked of estimates**

- *What proportion of the population fall under the DDA legislation?*
- *How many people have communication difficulties?*
- *How many more disabled people are in employment now than were ten years ago?*
- *How many disabled voters are there?*
- *How many disabled children are there who could in the future need supported housing?*
- *How many people have a hearing impairment / visual impairment / mental health impairment (regardless of severity)?*
- *How many of the people with a hearing / visual / mental health impairment fall into each of X categories of severity?*
- *What proportion of people who have benefited from national policy X have a more severe disability?*
- *How many people suffer from discrimination as a result of their disability (i.e. are disabled as defined by the social model)?*
- *How many people would benefit from sub-titles / audio description etc?*
- *How many people use / would use lifting facilities in public toilets?*
- *What proportion of disabled people have more than one disability?*
- *Does onset in later life cause greater or lesser exclusion from the working world?*
- *How many disabled people think they have experienced discrimination in their daily life?*

As this shows, the questions asked of estimates are often very different. These differences lie across four main dimensions:

- Requirements for disaggregated data by type of disability|  
*versus*  
Requirements for overall estimates of numbers of disabled people
- Requirements for data that can be used to predict future needs/costs/ implications  
*versus*  
Requirements for data that presents the current picture
- Requirements for data that provides estimates of disabled people's attitudes  
*versus*  
Requirements for data about their experiences
- Requirements for data linking disability and (for example) employment  
*versus*  
Requirements for single estimates of the nature and prevalence of disabilities.

**Comment:** Page: 64  
I think this should be "impairment", as otherwise we would be referring here to different types of disabling outcomes.

It is difficult to choose an estimate that is ‘fit for purpose’ and that is able to answer the questions asked of it when there is such a range of competing estimates. No single survey provides data that is appropriate for all purposes. Hence, individuals seeking to choose which set of survey data to use must consider the advantages of each option. The approach we have adopted is to allow users to first select a suitable candidate survey/s from a flow-chart listing the options (Table 4.2), and then select the most appropriate survey based on the strengths and weaknesses of each survey (Table 4.3).

### ***A flowchart to help choose an appropriate data source***

The flow-chart can be approached in two ways, giving priority either to finding a survey that uses a preferred definition of disability, or to finding a survey that links disability to other types of attributes or outcome indicators (such as household income, employment, use of services etc.). A larger (A3) version of the flow chart is appended to the end of the report.

#### **Approach 1 - Prioritising the definition of disability over other survey characteristics**

To prioritise the definition of disability, start at the top of the flow-chart and track the chart in a downward direction. First choose the appropriate age-group (either working-age or over working age); next select the definition that you would prefer to be used in the survey (four different definitions are used by surveys of the working-age population; only two are used by surveys of people over working age). Each definition is used in a number of surveys (for example, the “work limiting” definition is used in the LFS and also in the FRS). You should consider the characteristics (shown between the dotted lines) of the surveys that use your chosen definition, and select the survey that most fits your needs.

For example, you might decide that you want an estimate of working-age adults that is based on the work-limiting definition of disability. Tracking down the flow-chart, gives you two options, the LFS and the FRS. The second most important criteria for your choice of survey might be the ability to link the disability data with information about labour market participation. By studying the fourth row of information for the LFS and the FRS, you would see that labour market information was only available for the LFS, which would therefore be your choice.

#### **Approach 2 - Prioritising the other survey characteristics over the definition of disability**

To prioritise the other survey characteristics over the definition of disability, start with the information contained between the dotted lines. In this area of the flow-chart, each column of data describes one survey. (The names of the surveys are given in the patterned boxes just above). Select the column whose characteristics most closely represents the characteristics that you want from the survey; then track up to find the name of the survey. (If you are looking for information about people over working age then check at the bottom of the page to ensure that this survey is shown here.) You may now

find that the survey you have chosen uses two different definitions (for example, the FRS uses both the work-limiting definition and the LLSI definition). If so, then you will need to choose the one that most suits your needs.

For example, you might feel that it is most important for you that the estimate you use enables you to link disability data with labour market participation. This would lead you to choose the column of information that relates to the LFS. You would then have a choice of three different LFS estimates – one based on the DDA definition, one based on a combination of the work-limiting definition and the DDA definition (i.e. long-term disabled) and one based only on the work-limiting definition. If your purpose for the estimate you were seeking was connected with the implementation of the DDA then you might choose the first definition. (The estimate of 6.8m that is often quoted consists of the second option, a combination of the people who qualify under the DDA definition or those who qualify under the work-limiting definition.)

Users wanting estimates for adults of all ages should first choose their survey on the top, working-age side of the chart but check that the survey is shown at the bottom of the page before making their final choice.

### ***A table to help choose the most appropriate estimate***

Having identified the suitable data source/s using the flow-chart, users can then narrow down the selection to the most appropriate survey based on the main strengths and weaknesses of each of the surveys (Table 4.3).

**Table 4.3 Choosing an appropriate estimate**

<i>I want an estimate of the disabled adult population (aged 16 and over) covered by the DDA...</i>					
<u>Survey</u>	<u>Prevalence / estimate*</u>	<u>Strengths</u>	<u>Weaknesses</u>	<u>Overall assessment of usability</u>	<u>Which survey should I use and why?</u>
LFS	<b>DDA disabled</b> 23 per cent, 11 million, 2002	Large sample size  Currently, is only continuous survey to include DDA definition  Trend data available from 1998 onwards	People over retirement age only asked DDA question at first interview  This estimate has not been updated since 2002  Estimates unstable between survey waves (e.g. mode effects between repeat interviews, large proportion of proxy responses)	Published estimates are only reliable for working age population  Published estimates updated every quarter. No annual estimates produced.	<i>It is anticipated that from 2003/04 the FRS will provide reliable, and more easily interpretable, annual estimates for all adults.</i>  <i>LFS is presently the main source for estimating the number of disabled people covered by the DDA.</i>  <i>The sample sizes of other surveys, such as the ad-hoc Omnibus Survey, are too small to provide robust estimates.</i>

FRS	<b>DDA disabled</b> Available from 2003/04 survey	Large sample size  Can be used to calculate annual cross-sectional estimates (unlike the quarterly estimates from LFS)	Weaknesses as yet unknown (data not yet available)  Published figures quote prevalence rates, not counts	Will provide annual estimates on a consistent basis for monitoring trends nationally, by region and broad socio-economic groups	
Omnibus survey 2001	<b>DDA disabled</b> (14 per cent)	Provides a quick, cost-effective way to obtain estimates for topics of immediate policy relevance, social attitudes etc.	Small sample size	Should not be used to provide a total population estimate	

***I want an estimate of the disabled population of working age (men aged 16-64, women aged 16-59)...***

<u>Survey</u>	<u>Prevalence / estimate*</u>	<u>Strengths</u>	<u>Weaknesses</u>	<u>Overall assessment of usability</u>	<u>Which estimate should I use and why?</u>
LFS 2002	<b>DDA disabled</b> 15 per cent, 5.5 million  <b>Work limiting disability</b> 15 per cent, 5.4 million  <b>Long-term disabled</b> 19 per cent 6.9 million	Large sample size  Detailed information on labour market participation  Can also be linked to other attributes such as educational attainment, ethnicity. Regional and sub-national estimates possible.  Long-term disabled definition combines DDA disabled and people with work disability and is used for defining the disabled population in the PSA	Quarterly estimates based on responses from different waves of the survey.  Estimates unstable between survey waves (e.g. mode effects between repeat interviews, large proportion of proxy responses, specially young people)  Annual estimates not published.	Currently, is the only available estimate of those of working age who have a long-term disability (DDA or WLD)	<i>The LFS should be used to provide an estimate of those of working age covered by the DDA, with a work-limiting disability or long-term disabled because:</i> <ul style="list-style-type: none"> <li><i>It is currently the only survey source for estimates based on these three definitions.</i></li> <li><i>The Government's PSA target is based on an LFS-based estimate of the long-term disabled population</i></li> </ul>
FRS	<b>Work capacity</b>  <b>DDA disabled</b> Available from 2003/04 survey	Large sample size  Can be used to calculate annual cross-sectional estimates.  Survey with most detailed information on income, welfare benefits and service use, carers of disabled people	Question on work capacity does not differentiate between people with short-term (non disabled) and long-term (disabled) limitation.	Does not routinely derive an estimate of those of working age with a work-limiting disability.	



Table 4.3 continued...

<b>I want an estimate of the disabled adult population (LLSI or ICIDH)</b>					
<u>Survey</u>	<u>Prevalence / estimate*</u>	<u>Strengths</u>	<u>Weaknesses</u>	<u>Overall assessment of usability</u>	<u>Which estimate should I use and why?</u>
<b>LLSI (limiting long-standing illness)</b>					
FRS	(22 per cent in 2000/01)	Large sample size  Estimate of LLSI using harmonised global question	No assessment of severity  No breakdown by type of activity limitation	Largest sample size, so most precise annual estimates of LLSI	<p><i>If estimates of disabled GB adult population needed by:</i></p> <p><i>a) type of disability – then use the Disability Surveys 1996/7 (ICIDH)</i></p> <p><i>b) localities – then use the Census 2001 (LLSI)</i></p> <p><i>c) trends over time – then use: GHS (LLSI) for long-term trends or FRS (LLSI) for the last decade</i></p> <p><i>d) ethnic minorities – then use the Census 2001 (LLSI)</i></p> <p><i>e) receipt of disability benefits – then use the FRS(LLSI).</i></p> <p><i>f) trends over time in type of disability – then HSE (ICIDH)</i></p>
GHS	(22 per cent in 2001)	Large sample size  Longest running time series data available from 1977 onwards	No assessment of severity  No breakdown by type of activity limitation (only ICD disease groups)	Most suited to analysis of long-term trends in LLSI	
Census 2001	21 per cent, 9.5 million	Gives total population coverage rather than estimates based on a sample  Accurate estimates for small areas (e.g. wards) and for population groups (ethnic minorities)	No assessment of severity  No breakdown by type of activity limitation  Uses non-harmonised version of LLSI question	Gives the most accurate available estimates for LLSI, but cannot be updated between censuses (every 10 years)	
<b>ICIDH (International Classification of Impairment, Disability and Handicap)</b>					
Disability Survey 1996/7	20 per cent, 8.6 million	Large sample of disabled people achieved through 'screening'  Uses a set of 'objective measures' to assess disability  Measures severity  Overall figures can be broken down by types of disabilities	A fair proportion of those over working age who were eligible were screened out  Was a one-off survey, so results can't be compared over time  Questionnaire too long  Severity scale based on expert judgement	Is a reliable estimate of the disabled population of working age and of those aged over 75, although is now somewhat dated  Understates disability prevalence in those aged 60-74.	

**Comment:** Page: 67  
I've changed "limitation" to "disability". Hope this is okay.

Health Survey for England 2001	(20 per cent in 2001)	<p>Relatively small sample of disabled people (no screening to boost sample)</p> <p>Uses a set of 'objective measures' and LLSI</p> <p>Measures severity</p> <p>Disability measured every five years (including among 65+ population in institutions)</p>	<p>Coverage limited to England</p> <p>Mental problems excluded</p> <p>Understates disability among older people (compared with DS96/7)</p>	<p>Currently, only survey using objective measures that can be used to assess trends over time</p> <p>Uses same questionnaire to measure disability among children aged 10-15.</p>	
--------------------------------	-----------------------	---	--	--	--

\* NB: Figures in brackets indicate estimates derived for this report and that are not available from published sources.

**Table 4.2 Flow-chart for choosing the most appropriate estimate**

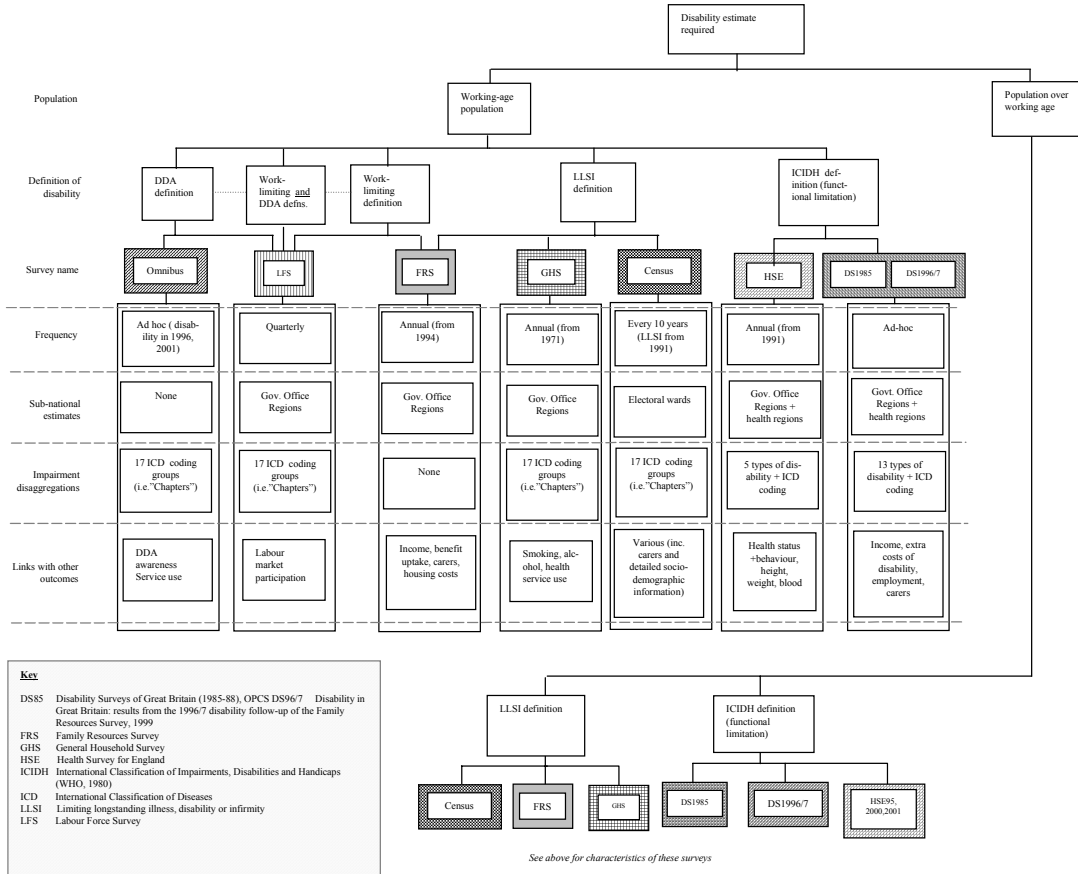

## 4.5 Summary

- Disability estimates are used by disability organisations to enhance their ability to influence policy development amongst local government, central government and service providers.
- They are also used by some of these organisations to inform their own priorities and programmes.
- Overall estimates of the numbers of disabled people are useful for disability organisations when they are engaged in broad-brush lobbying or decision-making, or in general fund-raising.
- Disability researchers and organisations expressed mixed views regarding the adequacy of the overall estimates that were available. However it was generally felt that sampling strategies and operationalisations of “disability” sometimes excluded certain groups – and that they should be made more inclusive.
- Impairment-specific estimates from impairment-specific studies tended to be larger than those derived from surveys measuring overall disability (such as LFS). Explanations given for this included the non-counting of “secondary” conditions by overall surveys and the counting of people with milder conditions in the impairment-specific studies. In addition, the reliability of the latter may sometimes have been affected by temporal and locational specificity.
- Some disability organisations and expert users felt that there was a paucity of information at the sub-national level, and that information that related disability data to ethnicity and other demographic dimensions was also inadequate.
- There was also a call from the disability experts and organisations for more published analysis of the relationship between disability and factors such as income, educational achievement and employment – such information being important for more policy-specific work.
- Expert users drew attention to the lack of longitudinal panel data for exploring flows into and out of disability, and to gain an understanding of the reasons why some individuals with similar levels of limitations were more disadvantaged than others.
- Some disability organisations felt that the lack of relevant statistical information undermined their ability to fund-raise or lobby effectively. They also said that it made it more difficult for them to identify where service

development or campaigning was needed and to gauge the level of that need.

- Some disability organisations acted as conduits for statistical information, passing it on to others via enquiry lines, web sites or printed bulletins.
- Some disability organisations felt that their status as experts in their fields depended on their ability to provide others with clear and appropriate statistics. Where they were unable to do so, they felt that this status was called into question.

## 5 CONCLUSIONS AND SUGGESTIONS FOR THE FUTURE

Survey estimates of the number of disabled people vary, causing confusion amongst disability organisations, policy makers, researchers and other users of disability statistics. Furthermore, disability statistics collected through government-sponsored national surveys for specific policy purposes do not fully meet the needs of disability organisations and researchers; nor are they always easily accessible.

This study has sought to systematically review existing survey sources and explore the reasons why prevalence estimates of disability from different sources vary. A purposive sample of disability organisations and expert users of statistics was also consulted to elicit views on the purposes for which disability estimates are needed, the adequacy of statistics currently available and views on 'ideal' statistics for the future.

### 5.1 Conclusions

A wide variation exists in survey estimates of the numbers of disabled adults in Great Britain. The variation ranges from 6.2 million (14 per cent) in the 1985 OPCS Survey of Disability (Martin, Meltzer and Elliot 1988) to 11 million (23 per cent) in more recent estimates of the number of adults covered by the Disability Discrimination Act (Grewal I et al 2002).

The consultation exercise with disability organisations and expert users revealed some dissatisfaction with the inclusiveness of the overall estimates and possible explanations for inconsistencies between estimates. It also highlighted the important role played by disability estimates in all stages of government policy processes. Good quality estimates enhance this process and the ability of disability organisations to contribute to it. They are also important for organisations' own service planning and development.

*The study has shown why it is important for users to recognise that:*

There is no single 'gold standard' measure of disability. The multi-dimensional and dynamic nature of disability makes it inherently difficult to measure. As a result, there are multiple reasons for the observed differences in survey estimates. Therefore, it is critical that users of disability estimates understand how certain differences are generated and what criteria they can use to judge which estimate is the most useful in meeting their objectives.

In addition to the well documented issues that can affect validity and reliability in all surveys there are several specific issues that complicate the statistical measurement of disability:

- Accessibility is known to affect the representation of disabled people in surveys. Survey design can often prevent the participation of disabled people or particular groups of disabled people (for example, people with visual impairments may find it impossible to participate in self-completion surveys without assistance). It is likely therefore that all estimates based on non-specialist, general purpose surveys are understated.
- There is no single, accepted definition of what 'disability' means. Theoretical and lay perceptions of disability differ and previous research has demonstrated that public understanding of the concept is fraught with comprehension issues and that the term is subject to wide interpretation in terms of meaning. Research into attitudes towards and experiences of disability has shown that disabled people vary in their response when asked to identify themselves as 'disabled'. The reasons why responses vary are multifaceted but include such things as: age effects (i.e. older people are more likely to associate limitations to their daily lives with the ageing process than being 'disabled'), issues relating to self-identity and fears about the social cost of identifying oneself as 'disabled'.
- The specific nature of certain types of disability can pose obstacles to producing reliable estimates of prevalence and severity over time. For example, certain forms of mental health problems are episodic in nature and severity levels can vary over time.
- Measurements of the number and type of activity limitations that constitute 'disability' vary from survey to survey as do the threshold levels of severity that make measurement and comparability difficult.
- Other forms of variability in surveys include: whether 'capacity to' undertake an activity or actual performance of that activity is measured in surveys (i.e. 'Are you able to walk without assistance?' versus 'Do you walk without assistance?'); variations in how people are asked to assess their capacity or performance, for example some surveys ask people to discount the assistance of aids such as sticks or adaptations, others ask people to judge their capacity whilst using these forms of assistance; the reference period that constitutes a long-standing illness or disability can also vary or be unspecified in different surveys.

The technical review explored surveys using global questions (whereby respondents describe themselves as disabled or not through answering, usually, a single question) and specialist disability surveys that identify a respondent as disabled or not based on their answers to a series of questions.

- Non-specialist surveys in GB have included a variety of single-item ('global') questions measuring functional limitations in activities. There have been fewer specialist disability surveys conducted. Nevertheless,

the advantage of using estimates based on disability surveys is that they provide a more objective measure in that the specificity of the questions limits the likelihood that respondents comprehend questions very differently or that respondents attempt to rationalise their own behaviour through their answers.

- Three main types of single-item 'global' disability questions are used in UK surveys:
  - The most well known and widely used single-item survey instrument for assessing activity limitation is the *self-reported limiting longstanding illness or disability* question (LLSI). Variants of this question intend to capture the perceived disabling effects of chronic ill-health (morbidity) and physical and sensory impairments.
  - The second type of measure aims to assess work-limiting disability (WLD) as defined by the respondent's perception of restriction in her or his capacity for paid work, in either the kind or amount of work they could do, or both. At its core, the question is hypothetical in that it asks respondents to consider work they *might or could* do. Respondents are also asked to judge if their work capacity is causally connected to an underlying health problem (rather than to other sorts of environmental or attitudinal barriers factors) and to assess if this problem is enduring.
  - The final type of measure seeks to identify whether respondents have a disability covered by the 1995 Disability Discrimination Act (DDA). The DDA defines disability as a '*physical or mental impairment which has a substantial and long-term adverse effect on (a person's) ability to carry out normal day-to-day activities*'.

#### *Exploring reliability and validity:*

The technical review sought to explore differences between estimates relating to validity (*does the survey question measure what it set out to measure and does it do so without systematic errors and biases?*) and reliability (*over time or in different contexts would the survey produce similar results?*).

Detailed analysis of estimates from the main survey sources suggested that single-item global questions on activity limitation (such as LLSI and DDA disabled) and work disability (WLD) produced estimates that were sensitive to factors related to the instrument (question wording and order); to the mode of data collection; to decisions relating to survey process (for example, the collection of data by proxy) and the sponsorship of the survey (or context effects). Of the three types the DDA definition appears the least consistent, with large overall and within-age differences across the two survey estimates compared. This can be attributed largely to the differences in the way that the DDA definition was operationalised in the two surveys. – with one format providing a check-list of conditions *before* the DDA disability question was



asked – which is known to stimulate reporting - and the other using the same check-list *after* respondents had answered the DDA disability question.

Estimates from specialist disability surveys were also found to be highly sensitive to the survey process (e.g. mode of contact and selection criteria). Much of the variation in age-specific rates observed between the four disability surveys was mainly owing to differences in operational features (such as in the use of different or no screening). Thus, if surveys using the same instrument (e.g. DS85, DS96/7) do not follow identical survey procedures, the interpretability of any evidence of change over time is seriously compromised.

#### *Key findings of the technical review of disability estimates*

Despite these apparent differences when the estimates produced by the different surveys were examined in comparison several important findings emerged:

- Disability rates are remarkably similar across all ages up to retirement age at which point comparisons become more unstable. This finding holds across five separate estimates derived using different definitions of disability and with some estimates based on responses to 'subjective' single-item or global questions and others based on 'objective' disability-specific questionnaires.
- Although the differences between the different survey estimates for the working age population are statistically relevant *they are small* and can be explained by various differences in survey design, conduct and sampling.
- Global questions and specialist disability questionnaires appear to provide fairly reliable estimates for the working age population, albeit that the specialist survey estimates are lower than the broadly defined global questions.
- It was apparent that the number of disabled people of working age is the highest for the estimate based on the long-term disabled definition, compared to all other global survey estimates.
- Estimates of long-term disabled have remained fairly stable over time, but are potentially sensitive to societal influences in reporting behaviour (as are other global estimates).
- From a statistical point of view it appears reassuring that the DDA current estimates are so similar to those derived from the question on longstanding illness or disability which limits activities (LLSI).
- For older people (of post-retirement age), estimates based on global questions and those based on specialist disability surveys were found

to be unstable between different surveys and more sensitive to the definition of disability used.

*Having established the scale of variation between existing estimates and explanations for that variation, the research team then developed a flow-chart and table to assist users of the estimates in choosing the most appropriate estimate (see Chapter 4).*

## **5.2 Suggestions for the future**

Towards the end of the interviews with disability organisations and expert users of the estimates, respondents were asked how they would suggest the provision of estimates be improved. Their ideas are discussed below.

### **5.2.1 Definitions of disability used and methods of data collection**

The general view of expert research users was that existing single-item 'global' questions in large-scale surveys were too focused on chronic health problems and that a greater focus should be given to disability.

One of the difficulties in designing questions for use in general population surveys is that the boundaries between (ill) health, impairment and disability are 'fuzzy' and may not map well onto lay perceptions. There was a general view that it would be helpful to cognitively test existing question modules to understand how the categories of ill-health and disability are understood by respondents.

Consistency and better clarity about what estimates refer to was clearly seen as important by both expert users and those from disability organisations.

Disability organisations felt there should be more liaison between teams working on different surveys, so as to ensure greater consistency of definitions and their operationalisation in questionnaires. Others wanted more consistency from government departments around their definitions of individual impairment types – regarding, for example, definitions of learning disability.

Some expert users held the view that although better versions of existing questions could be constructed, the merits of such a change needed to be balanced against the disadvantage of a discontinuity in long-run data series. A more pragmatic approach might be to add new questions, or if a change were essential, to have a 'bridging' year when both the old and new estimates could be calculated and a prospective or retrospective re-scaling performed. Two experts were of the firm view that while the longstanding illness question needed to be asked (to distinguish between short- and long-term limitations and to define the type of condition that are being asked about), the

subsequent sequence of questions on impairments/disability should not be conditional on a positive answer to the longstanding illness question. As our analysis of the 1996/7 Disability Survey (FRS follow-up) has shown, filtering on limiting longstanding condition question resulted in a significant understatement of disability prevalence in the post-working age group.

Amongst expert users of surveys that include one or more global questions on disability, there was a general consensus that the analysis potential of the data would be significantly improved by the addition of a question on *degree of activity restriction*. Existing global questions generally use a dichotomised yes/no response scale. This has at least two consequences. Firstly, where too broad a definition is used there is the risk of underestimating the true consequences of disability. Secondly, as analysis using the disability surveys has shown, there is as much variation in experience within the group classed as 'disabled' as there is between disabled and non-disabled people. Proponents of the social model of disability are especially critical of the severity scales developed by OPCS for the 1985 survey (Abberley, 1992), saying that the subjectivity involved in the method used represented a 'crude version of a cultural consensus'. The scale, with its associated battery of questions, is also so large as to make it impractical to include it in a general purpose survey. It is possible that a cruder, subjective scale of severity (as used in the Health Survey for instance) would be adequate for analytical purposes.

Some disability organisations had a slightly different perspective. They felt that in identifying people as disabled or not, surveys should try to take into account the impact of impairment (e.g. on their communication abilities or on their ability to live their lives in the way they would like to) as well as the diagnostic details of their impairment.

The DDA disability question was considered to be fit for what it was intended to measure – namely, operationalising a definition in law. But again, the issue of how respondents answer the question remains untested. Of particular interest is the instruction to discount treatment and/or the use of aids. It is thought likely that the effect of this instruction is to inflate estimates of disabled people. As awareness of the DDA increases and more conditions are covered by the provisions of the Act it is thought that this affect will increase steadily over time.

Some disability organisations felt that there should be one big survey that was dedicated to disability, and that this would be preferable to disability being included in surveys whose main focus was elsewhere. With the latter type of survey, it was argued, insufficient attention was given to the methodological issues around the operationalisation of definitions of disability. A second perceived problem was that the sample of disabled people in these surveys was not always sufficient for the drawing of meaningful conclusions. The dedicated disability survey, one organisation suggested, should be repeated at regular intervals so that trends could be monitored.

Expert users agreed with disability organisations that there was a need for disability surveys that were repeated at regular intervals (for example, once every five years). Such disability surveys needed to have a large enough sample size to allow sub-group analysis (e.g. by social position, ethnicity, sub-national estimates etc) and analysis by disability categories (e.g. by type of impairment and severity). From the outset, such surveys should consider development and design issues that would yield secondary gains, such as identifying a short set of questions for use in general purpose surveys or calibrating existing global questions. Ideally, instruments that are devised should also be multi-purpose (serve cross-government information needs); be usable alongside annual data to align long-term trends obtained from less objective, global measures; and map easily onto internationally accepted standard instruments, so as to allow cross-population comparability.

However, given the expense of disability surveys, it was felt to be vital to establish a clear link between data collection and policy outcomes, so as to guide decisions about the sort of data collected. Explicit linkages were felt not to have always informed the content and design of surveys and there was perceived to be a mis-match between what was being measured, what was relevant for policy formulation, and the outcomes of such exercises for disabled people.

Expert users perceived a continuing need for global disability questions in non-specialist surveys in order to monitor trends and to enable cross-sectional analysis of disability against outcome measures that comprise the primary purpose of non-specialist surveys (eg. LFS, FRS). The development of a validated, short-form instrument would improve harmonisation of disability measurement across surveys and allow a greater range of cross-analyses. It was felt to be important to test the performance of questions and to ensure that the instrument links with the disability concept being measured in the specialist survey. Similarly, a number of disability organisations felt that more of the major government surveys should include questions on disability. Examples that were given of surveys thought not currently to have questions on disability were Social Trends and The Crime Survey.

Some expert users and disability organisations felt that longitudinal data on disability was the best way forward to fully disentangle and understand complex issues such as causation and flows into and out of disability; the different trajectories of disability and disadvantage (or other consequences of disability) and the interactions between them; life-course effects; and long-run impact of social policy. Various analyses have shown that impacts of conditions that limit activities may be variable (the condition itself may be intermittent or episodic) and that individual circumstances and/or social contexts in which people live might change. Longitudinal surveys also provide the opportunity for methodological validation of instruments (for example, the assessment of what proportion of flows into/out of disability is the result of measurement error or inconsistent reporting and what proportion is 'true'). Such issues undermine the interpretability of cross-sectional estimates and panel surveys provide one way to assess their magnitude.

Some of the current longitudinal surveys include a measure (albeit crude) of disability. However they have a number of limitations. For example the British Household Panel Survey has too small a sample and lacks a measure of severity. The LFS panels, on the other hand, only provide information for a limited follow-up period. Surveys such as the Family and Children Survey (FACS) and the English Longitudinal Survey of Ageing (ELSA) will in future fill some of these gaps in information. However, these surveys together do not cover the total population and have very different methodologies and content.

### **5.2.2 Analysis of survey data**

Expert users do not face the same methodological barriers to accessing existing estimates as were faced by some of the disability organisations that were consulted (especially those without a dedicated and specialist in-house research function). These latter organisations made suggestions for ways in which existing surveys could be made more user-friendly. First, there was a call for government departments to undertake more analysis of existing surveys. Namely that the data from all surveys that include a disability question should be analysed to show how the experiences and circumstances of disabled people compared with those of others. Second, there was a request that the data from different government departments (e.g. DWP and the Department of Health) be compared in cross-sectional analyses, to provide more useful and relevant estimates.

### **5.2.3 Dissemination of data**

Similarly, disability organisations had a number of suggestions to make about how the dissemination of data could be improved. A number of respondents spoke positively about the "Disability Briefing" bulletin of disability estimates published by the DRC. However there was also a feeling that the DRC was not sufficiently resourced to be the main means of dissemination of disability statistics and that this role should be taken on by the government itself.

There was a feeling amongst the disability organisations that there should generally be more promotion of disability estimates and it was suggested that users of disability statistics should be alerted when new findings become available. Another view was that it should be an obligation on the part of government departments to disseminate their own disability statistics. There was also a proposal for the creation of a web page to provide a single point of access to disability statistics from all government departments. This web page, it was thought, might also list all the major surveys that include disability questions and of whom analyses them. And it was suggested that statistics that are made available on the Web should be easier to access, with respondents from one organisation mentioning the difficulty they had in viewing or printing-off data stored in PDF format. Finally, one organisation felt that access to information about disability from general surveys was restricted by the fact of its not usually being published. They suggested that disability analyses should as a matter of course be published with other findings.

## **APPENDIX A ORGANISATIONS AND EXPERTS CONSULTED**

### **Disability experts consulted**

Roger Thomas  
Howard Meltzer  
Labour Force Survey team (Annette Walling)  
Family Resources Survey team (Rory Fitzgerald)  
Omnibus survey (Grahame Whitfield)  
Steve Ellerd-Elliott, Peter Matejic  
Chris Tracey  
Richard Berthoud  
Tania Burchardt  
Emily Grundy  
Patricia Thornton  
Michael Hirst

### **Disability organisations consulted**

British Council of Disabled People  
Disability Alliance  
Disability Rights Commission  
Mencap  
MIND  
Royal Association for Disability and Rehabilitation  
Royal National Institute of the Blind  
Royal National Institute for Deaf People  
SCOPE  
SKILL



## P6076 - Review of Disability Estimates and Definitions

TOPIC GUIDE - Interviews with disability organisations May 2003

### Key objectives:

- Find out how organisations derive their disability statistics and how they use them
- Find out what definitions of disability / impairment they use and in what circumstances
- Explore future strategies and needs with regard to disability statistics

- Remind about the study and its aims  
(*emphasise that aim is not to come up with new estimates or definitions*)
- Confirm independence of NatCen from the DWP
- Remind topics to be covered
- Remind about confidentiality, and how material will be used
- Invite questions
- Explain tape recorder, length of interview.

### 1. BACKGROUND

- **Personal details**
  - Job title
  - Role in organisation and responsibilities
  - Length of time in current position
  - Professional background
- **Organisational details**
  - Key aims of organisation
  - Description of the organisation's client-group is (e.g. all disabled people in the UK; hearing impaired people in England and Wales)
  - Role of client group in determining org's strategy (e.g. membership / election of trustees)
  - No of employees
  - Position in organisation of research / statistical functions

## 2. DEFINITIONS OF DISABILITY / IMPAIRMENT

- **Categorisations and definitions used**

*for nos. of all disabilities as well as for specific disability groups*

- Description of categories of disability used by the organisation (e.g. by time of onset / severity / cause of impairment / numbers of different impairments / age)
- Generation/source of categories/definitions (inc. definition of “disability” itself - if relevant)
- *If more than one definition used...* preferred definition and factors accounting for preference
- Reasons for using specific definitions (e.g. taken from DDA, used as registration criteria etc)
- Changes over time (experienced) in relation to definitions used/preferred
- Consistencies / inconsistencies between definitions used
- Predictions for the future in relation to definitions used/preferred

- **Use/usefulness of different categories/definitions**

- In planning service delivery (marketing)
- In fund-raising
- In lobbying
- In public information service
- In other ways

- **Adequacy of and access to different categories/definitions**

- Fit between definitions/categories used and purpose used for
- Evaluation of access to estimates derived using different definitions
- Improvements / suggestions re. definitions

## 3. NUMERICAL ESTIMATES OF DISABILITY

*Probe for each of the categories mentioned by the respondent in section 2  
Include estimates of specific groups and of disabled ppl overall.*

- **Sizes of estimates**

- Figures currently used, factors accounting for why these estimates are used
- Changes to estimates over time – and reasons
- Predicted future changes to estimates
- Current / future impact of external influences (e.g. disability rights agenda)



- **Sources of estimates**
  - Data from Govt surveys
  - Data from own surveys (refer to *topic guide for expert users* if conduct own survey work)
  - Data from other surveys
  - Secondary analysis
    - who does it
    - what they do
    - strengths / weaknesses of this approach
  
- **Influences, if any, of surveys from outside the UK**
  
- *If not covered in Section 2. Purposes for which data used – and views about use/usefulness of different estimates in:*
  - planning service delivery (marketing)
  - fund-raising
  - lobbying
  - public information service
  - other ways
  
- **Adequacy and access**
  - How well available figures suit their needs
  - Accessibility of Govt statistics
  - Improvements / suggestions
  
- 4. The Future**
  - Predictions of future statistical needs (and how could be provided)
  - How they would like to be able to access statistics in the future
  - Views about 'ideal' disability statistics provision

## APPENDIX C SURVEY QUESTIONNAIRES

### ***C.1 General Household Survey 2001: health and disability***

**Ask this section of all adults (except proxy informants)**

**Ask if there is a child / there are children under 16 in household (not asked of proxy informants)**

1. Genhlth [\*]<sup>26</sup>Over the last twelve months would you say your health has on the whole been good, fairly good, or not good?

Good ..... 1  
Fairly Good ..... 2  
Not Good ..... 3

2. Illness [\*]Do you have any long-standing illness, disability or infirmity?  
By long-standing, I mean anything that has troubled you over a period of time or that is likely to affect you over a period of time?

Yes ..... 1  
No ..... 2

Ask if has a long-standing illness  
**(Illness = 1)**

3. Lmatter [\*]What is the matter with you?  
(Max SIX)

**For each illness mentioned above**

5. LMat WHAT IS THE MATTER WITH RESPONDENT?

ENTER THE (FIRST/SECOND/etc.)  
CONDITION/SYMPTOM RESPONDENT MENTIONED  
ENTER TEXT OF AT MOST 40 CHARACTERS

6. ICD CODE FOR COMPLAINT AT LMAT

7. LimitAct Does this illness or disability (Do any of these illnesses or disabilities) limit your activities in any way?

Yes ..... 1

---

<sup>26</sup> {\*} indicates that the question is an opinion question. Interviewers are instructed to repeat the question if asked for clarification.

No ..... 2

**Ask all**

8. CutDown [\*]

Now I'd like you to think about the 2 weeks ending yesterday. During those 2 weeks, did you have to cut down on any of the things you usually do (about the house/at work or in your free time) because of (answers at Lmatter) or some other illness or injury?

Yes ..... 1

No ..... 2

Ask if had to cut down on normal activities because of illness or injury  
**(CutDown = 1)**

9. NDysCutD How many days was this in all during these 2 weeks, including

Saturdays and Sundays?

1..14

10. Cmatter [\*]What was the matter with you?  
ENTER TEXT OF AT MOST 40 CHARACTERS

## **C.2 Labour Force Survey 2001 – health problems or disabilities**

### **Current health problems or disabilities**

#### **1. HPRMB**

*I should now like to ask you a few questions about your health. These questions will help us estimate the number of people in the country who have health problems.*

ENTER 1 TO CONTINUE

- 1 Continue
- 2 Too ill / distressed to answer: Visible problem
- 3 Too ill / distressed to answer: Other

**APPLIES IF AGE>74**

#### **2. LNGLIM**

*Do you have any health problems or disabilities that you expect will last for more than a year?*

- 1 yes
- 2 no

**APPLIES IF (AGE =16-59 OR (SEX=1 AND AGE=16-64)) (not State pension age)  
OR (AGE<75 AND FIRST CONTACT) (under 75 years and first contact)  
OR (AGE>=75 AND HPRMB=2) (not too ill/distressed to continue)**

#### **3. LIMITK**

*Does this health problem affect the KIND of paid work that you might do?*

- 1 yes
- 2 no

**APPLIES IF (LNGLIM=1 (long term health problem) (long term health problems)  
AND AGE =16-59 OR (SEX=1 AND AGE=16-64)  
OR ((AGE=>64 OR (SEX=2 AND AGE>59)) AND (WRKING=1 OR  
RELBUS=1 OR OWNBUS=1 OR JBAWAY=1 OR LOOK4=1 OR  
LIKEWK=1)) (in paid work / away from job/business / unpaid work for own  
or relatives business)**

**APPLIES TO THOSE WITH HEALTH PROBLEMS AND OF WORKING AGE OR PENSIONERS  
LOOKING FOR WORK OR WANTING WORK**

#### **4. LIMITA**

*...or the AMOUNT of paid work that you might do?*

- 1      yes
- 2      no

**APPLIES TO THOSE WITH HEALTH PROBLEMS AND OF WORKING AGE OR PENSIONERS  
LOOKING FOR WORK OR WANTING WORK**

5. **HEAL**

*Do you have...*

- 1      problems or disabilities (including arthritis or rheumatism)  
connected with your arms or hands?
- 2      ...legs or feet?
- 3      ...back or neck?
- 4      do you have difficulty in seeing (while wearing spectacles or  
contact lenses)?
- 5      difficulty in hearing?
- 6      a speech impediment
- 7      severe disfigurement, skin conditions, allergies?
- 8      chest or breathing problems, asthma, bronchitis?
- 9      heart, blood pressure or blood circulation problems?
- 10     stomach, liver, kidney or digestive problems?
- 11     diabetes?
- 12     depression, bad nerves or anxiety?
- 13     epilepsy?
- 14     severe or specific learning difficulties (mental handicap)
- 15     mental illness or suffer from phobias, panics or other nervous  
disorders?
- 16     progressive illness not included elsewhere (e.g. cancer not  
included elsewhere, multiple sclerosis, symptomatic HIV,  
Parkinson's disease, muscular dystrophy)?
- 17     other health problems or disabilities?

**APPLIES IF LNGLIM=1 (has long term health problem)**

6. **HEALTH**

*Which of these is your main health problem/disability?*

- 1 problems or disabilities (including arthritis or rheumatism) connected with your arms or hands?
- 2 ...legs or feet?
- 3 ...back or neck?
- 4 do you have difficulty in seeing (while wearing spectacles or contact lenses)?
- 5 difficulty in hearing?
- 6 a speech impediment
- 7 severe disfigurement, skin conditions, allergies?
- 8 chest or breathing problems, asthma, bronchitis?
- 9 heart, blood pressure or blood circulation problems?
- 10 stomach, liver, kidney or digestive problems?
- 11 diabetes?
- 12 depression, bad nerves or anxiety?
- 13 epilepsy?
- 14 severe or specific learning difficulties (mental handicap)
- 15 mental illness or suffer from phobias, panics or other nervous disorders?
- 16 progressive illness not included elsewhere (e.g. cancer not included elsewhere, multiple sclerosis, symptomatic HIV, Parkinson's disease, muscular dystrophy)?
- 17 other health problems or disabilities?

**APPLIES IF HEAL>1 (more than one long term health problem)**

7. **HEALIM**

*Do these health problems or disabilities, when taken singly or together, substantially limit your ability to carry out normal day to day activities? If you are receiving medication or treatment, please consider what the situation would be without the medication or treatment.*

- 1 yes
- 2 no
- 3 don't know

**APPLIES IF LNGLIM=1 (has long term health problem)**

PAST HEALTH PROBLEMS/DISABILITIES

8. **HEALYR**

*Have you EVER had any health problems or disabilities (apart from those you have already told me about) that have lasted for longer than one year?*

- 1     yes
- 2     no

**HEALPB**

*...and what were those health problems or disabilities?*

PROBE ALL HEALTH PROBS/DISABS THAT AFFECTED  
RESPONDENT IN PAST

*Which of these is your main health problem/disability?*

- 1     problems or disabilities (including arthritis or rheumatism)  
connected with your arms or hands?
- 2     ...legs or feet?
- 3     ...back or neck?
- 4     do you have difficulty in seeing (while wearing spectacles or  
contact lenses)?
- 5     difficulty in hearing?
- 6     a speech impediment
- 7     severe disfigurement, skin conditions, allergies?
- 8     chest or breathing problems, asthma, bronchitis?
- 9     heart, blood pressure or blood circulation problems?
- 10    stomach, liver, kidney or digestive problems?
- 11    diabetes?
- 12    depression, bad nerves or anxiety?
- 13    epilepsy?
- 14    severe or specific learning difficulties (mental handicap)
- 15    mental illness or suffer from phobias, panics or other nervous  
disorders?
- 16    progressive illness not included elsewhere (e.g. cancer not  
included elsewhere, multiple sclerosis, symptomatic HIV,  
Parkinson's disease, muscular dystrophy)?
- 17    other health problems or disabilities?

**APPLIES IF HEALYR=1 (long term health problem/disability  
in the past)**

9. **HEALYL**

*Did these health problems or disabilities, when taken singly or together  
substantially limit your ability to carry out normal day to day activities?*

*If you were receiving medication or treatment, please consider what the  
situation would be without the medication or treatment.*

- 1     yes
- 2     no
- 3     don't know

**C.3 OPCS survey of disability in Great Britain: Screening questionnaire**

**1. Does anyone in your household have the following difficulties due to long-term health problems or disabilities, either physical or mental?**

- (a) Difficulty walking for quarter of a mile on the level
- (b) Great difficulty walking up or down steps or stairs
- (c) Difficulty bending down and straightening up, **even** when holding on to something
- (d) Falling or having great difficulty keeping balance
- (e) Difficulty using arms to reach and stretch for things
- (f) Great difficulty holding, gripping or turning things
- (g) Difficulty recognising a friend across the road, **even** if glasses or contact lenses are worn
- (h) Difficulty reading ordinary newspaper print, **even** if glasses or contact lenses are worn
- (i) Difficulty hearing someone talking in a quiet room
- (j) Severe suffering from noises in the head or ears
- (k) Difficulty going outside the house or garden without help
- (l) Great difficulty following a conversation if there is background noise, for example, a TV, radio or children playing

**2. *Is there anyone in your household who is affected by the following health problems or disabilities?***

- (a) *Severe and frequent bouts of breathlessness, wheezing or coughing which limit daily activities*
- (b) *Severe difficulties with eating, drinking or digestion which limit daily activities*
- (c) *Severe pain or irritation which limits daily activities*
- (d) *A scar, blemish or deformity which limits daily activities*
- (e) *Lack of control of bladder at least once a day or night*
- (f) *Lack of control of bowels at least once a month*



**3. Does anyone in your household have the following long term health problems or disabilities?**

- (a) A fit or convulsion in the past two years
- (b) Difficulty being understood by other people
- (c) Difficulty understanding what others say or what they mean
- (d) Frequently getting confused or disoriented
- (e) Severe depression or anxiety
- (f) Difficulty getting on with people, so that family life, work or leisure is severely affected
- (g) Mental handicap or other severe learning difficulty
- (h) Mental illness or phobias which limit daily activities

**4. In the last twelve months has anyone in your household seen a psychiatrist or other specialist because of a mental, nervous or emotional problem?**

**5. In the last twelve months has anyone in your household attended a day centre, taken sheltered work or lived in sheltered housing because of a health problem or disability?**

**6. Has anyone in your household attended a special school because of a long term health problem or disability?**

**7. Is there anyone in your household who, because of a long term health problem or disability....**

- (a) Would find it difficult to live alone without help?
- (b) Is dependent on life-sustaining equipment?
- (c) Is limited in the type or amount of paid work they can do?

**These questions are about all children under 16 (including babies and toddlers) in your household. If there are no children go on to question 12.**

**8. Is there any child in your household**

- (a) who is unable to do things which most children of the same age can do, because of a health, development or behaviour problem?

- (b) who needs more help than usual for children of the same age with feeding, dressing, toileting, going up and down stairs or other daily activities?*
- (c) who attends a special school, or remedial unit of an ordinary school, because of health or behaviour problems, disabilities or learning difficulties?*
- (d) who attends an ordinary school but is limited in taking part in school activities because of health or behaviour problems or disabilities?*
- (e) whose health, behaviour or development causes worry that he or she may have a long term health problem, physical or mental disability or handicap?*

**9. Does anyone (including any child) in your household have other difficulties with daily activities because of disabilities or long term health or behaviour problems not mentioned so far?  
IF yes, PLEASE DESCRIBE.**

**C.4 Health Survey for England 2001: Disability module**

**ASK ALL AGED 10+**

**DisIntA**

SHOW CARD F.

Do any of the things on this card apply to you? Please read all the things on the card before telling me.

INTERVIEWER: DO NOT INCLUDE TEMPORARY DISABILITIES, IE PROBLEMS EXPECTED TO LAST LESS THAN ONE YEAR.

- 1 Yes
- 2 No

**IF (DisIntA = Yes) THEN**

**DisAbA**

Which ones apply to you? Just tell me the numbers.

CODE ALL THAT APPLY.

- 1 Cannot walk 200 yards or more on own without stopping or discomfort (WITH WALKING AID IF NORMALLY USED)
- 2 Cannot walk up and down a flight of 12 stairs without resting
- 3 Cannot follow a TV programme at a volume others find acceptable (WITH HEARING AID IF NORMALLY WORN)
- 4 Cannot see well enough to recognise a friend across a road (four yards away) (WITH GLASSES OR CONTACT LENSES IF NORMALLY WORN)
- 5 Cannot speak without difficulty

**IF (Hear IN DisAbA) THEN**

**NoVol**

Can you follow a TV programme with the volume turned up?

WITH HEARING AID IF NORMALLY WORN.

- 1 Yes
- 2 No

**ASK ALL AGED 10+**

**HearAid**

Can I check, do you wear a hearing aid most of the time?

- 1 Yes
- 2 No

**IF NOT(Hear IN DisAbA) AND (HearAid = Yes) THEN**

**NoHrAid**

Can you hear well enough to follow a TV programme at a volume others find acceptable **without your hearing aid**?

- 1 Yes
- 2 No

**IF (Sight IN DisAbA) THEN**

**NoArmSee**

Can you see well enough to recognise a friend one yard away (at arm's length)?

WITH GLASSES OR CONTACT LENSES IF NORMALLY WORN.

- 1 Yes
- 2 No

**ASK ALL AGED 10+**

**Glasses**

Can I check, do you wear glasses or contact lenses most of the time?

- 1 Yes
- 2 No

**IF NOT(Sight IN DisAbA) AND (Glasses=Yes) THEN**

**NoGlas**

Can you see well enough to recognise a friend across the road (four yards away) **without glasses or contact lenses**?

- 1 Yes
- 2 No

**IF (Walk IN DisAbA) THEN**

**HowFar**

What is the furthest you can walk on your own without stopping or discomfort WITH WALKING AID IF NORMALLY USED ...READ OUT...

- 1 .... only a few steps
- 2 or more than a few steps but less than 200 yards?
- 3 CODE IF APPLIES: Cannot walk at all

**IF Age >= 10 AND (HowFar <> NoWalk) THEN**

**WikAid**

Can I check, do you use a walking stick or other walking aid most of the time when walking?

- 1 Yes
- 2 No

**IF NOT(Walk IN DisAbA) AND (WikAid=Yes) THEN**

**NoWikAd**

Can you walk 200 yards or more on your own without stopping or discomfort **without the walking stick or aid**?

- 1 Yes
- 2 No

**IF (Stair IN DisAbA) AND (HowFar <> NoWalk) THEN**

**TkRest**

Can you walk up and down a flight of 12 stairs if you hold on and take rests?

- 1 Yes
- 2 No

**ASK ALL AGED 10+****DisIntB**

SHOW CARD G.

Do any of the things on this card apply to you? Please read all the things on the card before telling me.

INTERVIEWER: DO NOT INCLUDE TEMPORARY DISABILITIES, I.E. PROBLEMS EXPECTED TO LAST LESS THAN ONE YEAR.

- 1 Yes
- 2 No

**IF (DisIntB = Yes) THEN****DisAbB**

Which ones apply to (you)? Just tell me the numbers.

CODE ALL THAT APPLY.

- 1 Cannot get in and out of bed on own without difficulty
- 2 Cannot get in and out of a chair without difficulty
- 3 Cannot bend down and pick up a shoe from the floor when standing
- 4 Cannot dress and undress without difficulty
- 5 Cannot wash hands and face without difficulty
- 6 Cannot feed, including cutting up food without difficulty
- 7 Cannot get to and use toilet on own without difficulty
- 8 Have problem communicating with other people - that is, have problem understanding them or being understood by them

**IF (Bed IN DisAbB) THEN****BedDif**

Can you get in and out of bed on your own ...READ OUT...

- 1 with some difficulty, or
- 2 can you only get in or out of bed with someone to help you?
- 3 CODE IF APPLIES: Confined to bed

**IF (Chair IN DisAbB)****ChrDif**

Can you get in and out of a chair on your own ...READ OUT...

- 1 with some difficulty, or
- 2 can you only get in or out of a chair with someone to help you?
- 3 CODE IF APPLIES: Chair-bound

**IF (Dress IN DisAbB) THEN****DrsDif**

Can you dress and undress yourself on your own ...READ OUT...

- 1 with some difficulty, or
- 2 can you only dress and undress with someone to help you?

**IF (Wash IN DisAbB) THEN**

**WashDif**

Can you wash your hands and face on your own ...READ OUT...

- 1 with some difficulty, or
- 2 can you only wash your hands and face with someone to help you?

**IF (Feed IN DisAbB) THEN**

**FeedDif**

Can you feed yourself, including cutting up food ...READ OUT...

- 1 with some difficulty, or
- 2 can you only feed yourself with someone to help you

**IF (Toilet IN DisAbB) THEN**

**ToiDif**

Can you get to and use the toilet on your own ...READ OUT...

- 1 with some difficulty, or
- 2 can you only get to and use the toilet with someone to help you?

**IF (Commun IN DisAbB) THEN**

**ComFam**

Do you have any problems communicating with **close members of your family**, that is, problems with understanding members of your close family or making them understand you?

- 1 Yes
- 2 No

**ComSpch**

Are your communication problems to do with your speech?

- 1 Yes
- 2 No

**ComHear**

Are your communication problems to do with your hearing?

- 1 Yes
- 2 No

**ComVis**

Are your communication problems to do with your vision?

- 1 Yes
- 2 No

**IF (DisIntA = Yes) OR (DisIntB = Yes) THEN**

**Problem**

You have told me you have a (*Problem/number of problems*).

What health condition has caused (*this /these*) problem (s)?

PROBE FOR FULL DETAILS, INCLUDING: 'Was it caused by anything else?/' 'What does the doctor call this condition?/' 'What does the doctor say causes this problem?'

Open answer: up to 150 characters

**IF (DisAbA = Yes) OR (DisAbB = Yes) THEN**

**TrigAcc**

(*Is/Are any of your*) problem(s) the result of an accident?

1 Yes

2 No

**IF (TrigAcc = No) OR (NumProb > 1) THEN**

**TrigIll**

(*Is/Are any of your*) problem(s) the result of an illness or disease?

1 Yes

2 No

**IF (TrigIll = Yes) THEN**

**ProbChk**

INTERVIEWER CHECK: Have you recorded name of disease or illness at 'Problem'?

1 Yes

2 No

**IF (ProbChk = No) THEN**

**ProbChkO**

INTERVIEWER: RECORD FULL DETAILS OF DISEASE OR ILLNESS.

Open answer: up to 150 characters

**C.5 Family Resources Survey 2000/01: health problems or disabilities**

**Block Qhealth – Health & Ability to Work 2002**

Asked of all respondents (proxy information from parents on behalf of children):

**Health**

NOW THERE ARE SOME QUESTIONS ABOUT HEALTH

**Do you have any long-standing illness, disability or infirmity? By 'longstanding' I mean anything that has troubled you over a period of time or that is likely to affect you over a period of time?**

.....Yes  
.....No

If 'yes' to **Health**....

*Hprob*

***Does this illness or disability (Do any of these illnesses or disabilities) limit your activities in any way?***

.....Yes  
.....No

*In the Section of the questionnaire covering work*

**Rstrct**

**SHOW CARD O**

**Some people are restricted in the amount or type of work they can do, because they have an injury, illness or disability. Which of these statements comes closest to your own position at the moment?**

**CODE FIRST THAT APPLIES. INTERVIEWER: THIS IS A QUESTION OF OPINION.**

**BECAUSE OF INJURY, ILLNESS, DISABILITY ...**

**1: I am unable to work at the moment.**

**2: I am restricted in the amount or type of work I can (could) do.**

**3: I am not restricted in the amount or type of work I can (could) do.**



If unable to work:

**Injlong**      **How long have you been unable to work because of this injury/ illness/disability**  
**1: 28 weeks or less**  
**2: Over 28 weeks, up to 1 year**  
**3: More than 1 year**

If more than 1 year:

**IncDur**      **Can I check, in which year did you stop working because of this injury/ illness/ disability?**  
**INTERVIEWER: PROBE TO CLASSIFY**  
**1: 1995 or later**  
**2: Stopped work in 1994**  
**3: Stopped work in 1993**  
**4: Stopped work in 1992**  
**5: Before 1992**  
**6: Has never worked**

Even if they have occasionally returned to work AFTER becoming ill or disabled, code the FIRST time they stopped work for this reason.

DSS statisticians need to know which year, in order to help forecasting of the 'Transitional Protection' of benefits relating to incapacity.

If restricted in the amount or type of work:

**InjWk**      **How many hours a week (could you/are you able to) work?**  
**1: Less than 16 hours a week**  
**2: 16 but less than 24 hours a week**  
**3: 24 but less than 30 hours a week**  
**4: 30 hours a week or more**

## **C.6 Omnibus Survey 2001: health and disability**

*Adults aged 16 and over (no proxy responses, one person selected for interview in each household)*

**ASK ALWAYS:**

### **Intro271**

The next set of questions are about the experience of illness and disability and the effects these have on daily life.

(1) PRESS ENTER TO CONTINUE

**ASK ALWAYS:**

M271\_1

Please look at this card and for each topic say which statement best describes your own health state today..

Mobility

- (1) I have no problems walking about
- (2) I have some problems in walking about
- (3) I am confined to bed

**ASK ALWAYS:**

M271\_2

Self-Care

- (1) I have no problems with self-care
- (2) I have some problems washing or dressing myself
- (3) I am unable to wash or dress myself

**ASK ALWAYS:**

M271\_3

Usual Activities

- (1) I have no problems with performing my usual activities (eg. work, study, housework, family or leisure activities)
- (2) I have some problems with performing my usual activities
- (3) I am unable to perform my usual activities

**ASK ALWAYS:**

M271\_4

Pain/Discomfort

- (1) I have no pain or discomfort
- (2) I have moderate pain or discomfort
- (3) I have extreme pain or discomfort

**ASK ALWAYS:**

M271\_5

Anxiety/depression

- (1) I am not anxious or depressed
- (2) I am moderately anxious or depressed
- (3) I am extremely anxious or depressed

**ASK ALWAYS:**

M271\_6

To help people say how good or bad their health is, we have drawn a scale (rather like a thermometer) on which the best state of health you can imagine is marked by 100 and the worst state of health you can imagine is marked by 0.

We would like you to indicate on this scale how good or bad your own health is today, in your opinion. Please do this by showing me the point on the scale which indicates how good or bad your current health is.

RECORD POINT ON SCALE IN THE BOX AS 0-100 E.G IF MIDWAY BETWEEN 50 AND 60 = 55

INTERVIEWER - IF THE RESPONDENT HAS A VISUAL IMPAIRMENT PLEASE USE THE QUESTION FORM BELOW AND DO NOT USE THE SHOWCARD - ASK

On a scale from 0 - the worst state of health you can imagine - to 100 the best state of health you can imagine - how good or bad would you say your own health is today?

0..100

**ASK ALWAYS:**

M271\_7

Compared to my general level of health over the last 12 months, my general health today is....

RUNNING PROMPT

- (1) Better
- (2) much the same
- (3) or worse?

**ASK ALWAYS:**

M271\_8

Over the last 12 months would you say your health has on the whole been....

RUNNING PROMPT

- (1) Good
- (2) fairly good
- (3) or not good?

**ASK ALWAYS:**

M271\_9

[\*] Do you have any long-standing illness, disability or infirmity? By long-standing, I mean anything that has troubled you over a period of time or that is likely to affect you over a period of time.

LONG-TERM MEANS A YEAR OR MORE.

- (1) Yes
- (2) No

**ASK IF:** Has long-standing illness, disability or infirmity

M271\_10

[\*] Does this illness or disability (Do any of these illnesses or disabilities) limit your activities in any way?

- (1) Yes
- (2) No

**ASK IF:** Has long-standing illness, disability or infirmity

M271\_11

[\*]May I just check? Do these health problems or disabilities, when taken singly or together, substantially limit your ability to carry out normal day-to-day activities? If you are receiving medication or treatment, please consider what the situation would be without medication or treatment.

INTERVIEWER NOTE - LEAVE IT TO THE INFORMANT TO DECIDE WHAT IS SUBSTANTIAL

- (1) Yes
- (2) No

**ASK IF:** Has long-standing illness, disability or infirmity

**AND:** Illness or disability limits respondent's activity

M271\_12

When did this/these illness or disability start to limit your activities in any way?

Was it...

RUNNING PROMPT

- (1) Up to 6 months ago
- (2) Over 6 months up to a year ago
- (3) Over a year up to 2 years ago
- (4) Over 2 years up to 5 years ago
- (5) Over 5 years ago

**ASK IF:** No current long-standing illness

M271\_13

Have you ever had a long-term illness that affected your activities?

LONG-TERM MEANS A YEAR OR MORE.

- (1) Yes
- (2) No

**ASK IF:** No current long-standing illness

**AND:** M271\_13 = Yes

M271\_14

[\*] May I just check? Did these health problems, when taken singly or together, substantially limit your ability to carry out normal day-to-day activities? If you were receiving medication or treatment, please consider what the situation would have been without medication or treatment.

- (1) Yes
- (2) No
- (3) Don't know

**Ask IF:** Has long-standing illness, disability or infirmity and illness or disability limits respondent's activity OR had long-term illness in the past

M271\_15

What is/was the matter with you?

PROBE FOR LIMITING LONG-STANDING ILLNESS AND DISABILITIES

INTERVIEWER: PLEASE BE SENSITIVE TO THE NATURE OF THIS QUESTIONING

STRING[250]

**Ask IF:** Has long-standing illness, disability or infirmity and illness or disability limits respondent's activity OR had long-term illness in the past

M271\_16M

The respondent said their problem / disability was .....

(Conditions recorded at M271\_15).

INTERVIEWER PLEASE CODE ALL THAT APPLY

The respondent has...

SET [17] OF

- (1) problems or disabilities (including arthritis or rheumatism) connected with his/her arms or hands?
- (2) ...legs or feet?
- (3) ...back or neck?
- (4) difficulty in seeing (while wearing spectacles or contact lenses)?
- (5) difficulty in hearing?
- (6) a speech impediment?
- (7) severe disfigurement, skin conditions, allergies?
- (8) chest or breathing problems, asthma, bronchitis?
- (9) heart, blood pressure or blood circulation problems?
- (10) stomach, liver, kidney or digestive problems?
- (11) diabetes?
- (12) depression, bad nerves or anxiety?
- (13) epilepsy?
- (14) severe or specific learning difficulties (mental handicap)?

(15) mental illness or suffer from phobias, panics or other nervous disorders?

(16) progressive illness not included elsewhere (e.g. cancer not included elsewhere, multiple sclerosis, symptomatic HIV, Parkinson's disease, muscular dystrophy)?

(17) other health problems or disabilities?

**ASK IF:** Has long-standing illness, disability or infirmity and illness or disability limits respondent's activity

M271\_17

INTERVIEWER PLEASE CHECK

DOES THE RESPONDENT HAVE MORE THAN ONE LIMITING LONG-STANDING ILLNESS OR DISABILITY?

(1) Yes

(2) No

**ASK IF:** Has long-standing illness, disability or infirmity and illness or disability limits respondent's activity

**AND:** More than one disability

M271\_18a

Which illness or disability most limits your activities?

STRING[200]

**ASK IF:** Has long-standing illness, disability or infirmity and illness or disability limits respondent's activity

**AND:** More than one disability

M271\_18b

The respondent said that their most limiting illness or disability was.....(condition recorded at M271\_18a)

INTERVIEWER PLEASE CODE MAIN ILLNESS OR DISABILITY

SET [17] (AS AT M271\_16M)

(1) problems or disabilities (including arthritis or rheumatism) connected with his/her arms or hands?

...etc.

## **APPENDIX D ANALYTIC APPROACH TO EMPIRICAL COMPARISONS**

In order to compare like with like, our aim was to minimise as far as was possible the variability between estimates arising from differences between surveys in the method of data collection, in population coverage or the period over which the population was surveyed.

The five surveys included in the empirical examination were the Family Resources Survey (FRS), the Labour Force Survey (LFS), the General Household Survey (GHS), the Health Survey for England (HSE) and the Omnibus survey.

### ***D.1 Selection of comparison year***

Of the five surveys included in our short-list for detailed investigation, four are continuous surveys (conducted every year), except the disability module included in the Omnibus survey, which was most recently included in the first quarter of 2001. We decided to compare estimates for 2001, because this was the most recent year for which data were available for all five surveys and also because selecting the year when the national census was conducted offered additional advantages. The 2001 Census included a question on limiting longstanding illness (although a different version to that in the surveys); and it also provided an accurate demographic distribution of the population to adjust for sampling variation between surveys in the age and gender distribution of respondents. Where necessary, estimates were age-standardised<sup>27</sup> using the Census 2001 for Great Britain (GB) as the reference population.

The FRS had used a different form of the limiting longstanding question in both the 2001/02 and 2002/03 rounds of the survey. The harmonised question was used in all years until 2000/01 and as this was closest to our target year of 2001, we have used the 2000/01 FRS data for this study.

### ***D.2 Population coverage***

All the five surveys are based on random probability sampling of the non-institutional population resident in households (or the 'general population') aged 16 and over. The GHS and HSE also include a sample of children, with the former including all children in the household and the latter selecting a maximum of two children per household.

While four of our surveys sampled a representative population of Great Britain, the Health Survey for England (HSE) was limited to the general population resident in England. Previous studies have shown that Scotland

---

<sup>27</sup> Age standardisation is a statistical procedure whereby differences in survey estimates arising because of differences in the age profiles of the population from which the samples are drawn are adjusted for. This is particularly important to do when comparing estimates separated by intervals of five to ten years (such as that between the disability-specific surveys).



and Wales have higher overall rates of self-reported disability for all age groups (Martin et al 1988, Census 2001). While we felt that the restricted coverage of the HSE was unlikely to have a significant impact on age and gender specific estimates as the population of England accounts for over 85 per cent of GB population (Census 2001), we have restricted the use of HSE estimates in the analysis of global questions to provide an additional external source to interpret the quality of the four GB-based surveys.

The advantage of including the HSE in our comparative framework is that in three previous rounds of the survey (first introduced in 1995 and repeated in 2000 and 2001), a special disability module based on the ICIDH definition was included in the survey. These data provide the only other source with which to compare the estimates based on the dedicated specialist disability surveys – the OPCS Disability Survey 1985 (DS85) and the FRS follow-up Disability Survey 1996/7 (DS96/7). We have therefore used the HSE to gain additional insight into the possible reasons for the large reported differences in age/sex prevalence obtained from DS85 and DS96/7.

### ***D.3 Calculating annual cross-sectional estimates***

Unlike the other surveys included in this study, the LFS and Omnibus surveys are not geared to routinely provide annual cross-sectional estimates. The LFS samples a fresh panel every quarter, and respondents are then interviewed in five successive quarters (or waves). Thus in any one quarter, one panel will be receiving their first interview, one their second, and so on, with one panel receiving their final (fifth wave) interview. Estimates from the LFS are published quarterly (not annually) and include the sample interviewed in each quarter (i.e. responses obtained in waves 1 to 5). Wave 1 interviews in the LFS are face-to-face, while subsequent waves are mainly conducted by telephone. There is some evidence to indicate that the change in the mode of interview increases the prevalence of disability in waves 2-5 compared to wave 1 (Burchardt, 2003). On the other hand, face-to-face interviews are the norm in the other four surveys. Hence, for the LFS, we calculated estimates based on data relating only to wave 1 interviews of the four new panels interviewed each quarter in 2001. This procedure ensured that across all five surveys, annual cross-sectional estimates based on face-to-face interviews were being compared.

The Omnibus survey differs from other surveys in that for each month of fieldwork, different organisations commission questions which run for however many months they are required. Fieldwork for the health and disability module included in the 2001 survey was conducted over a four month period rather than throughout the year. Estimates based on the Omnibus data therefore include seasonal effects and are not intended to provide reliable annual estimates. Further, compared with the other surveys in our set, the Omnibus has a substantially lower sample size, affecting the precision of estimates ( i.e. larger standard errors or confidence limits around the sample estimate). Hence, estimates derived from the Omnibus survey have been used in this study in instances where it was the only other source of

information for an estimate of interest (e.g. disabled as defined by the Disability Discrimination Act (DDA)).

#### D.4 Proxy interviews

The collection of information by proxy presents a dilemma: it permits the recording of information about household members that would otherwise not be available, thereby increasing sample size (and reducing the sampling error) at a lower marginal cost than increasing the number of households, yet the literature suggests that the information obtained may not be valid or reliable. Threats to validity are posed particularly by questions on attitudes, opinions, past events or which are highly subjective – e.g. pain, depression and affective disorders. Recent investigations comparing self and proxy reports suggest that for older people, proxies tend to overestimate functional limitations and underestimate health related quality of life (refs..). However, it remains unclear whether the discrepancy is a function of over-reporting on the part of the proxy informants or under-reporting on the part of respondents, or both.

The LFS incorporates proxy interviewing as an explicit survey design decision, while in the other surveys it is generally restricted to certain population groups, such as parents answering on behalf of children or people who are too ill or unable to answer on their own behalf. The HSE and Omnibus surveys, on the other hand, do not permit proxy responses, except in the special case of children. The proportion of adult proxy respondents ranges from nine percent in the GHS, to 15 percent in the FRS and 31 per cent in the LFS in the year selected for this study.

**Figure D.5.1 Proportion of proxy respondents, by agegroup and gender (FRS 2000/01)**

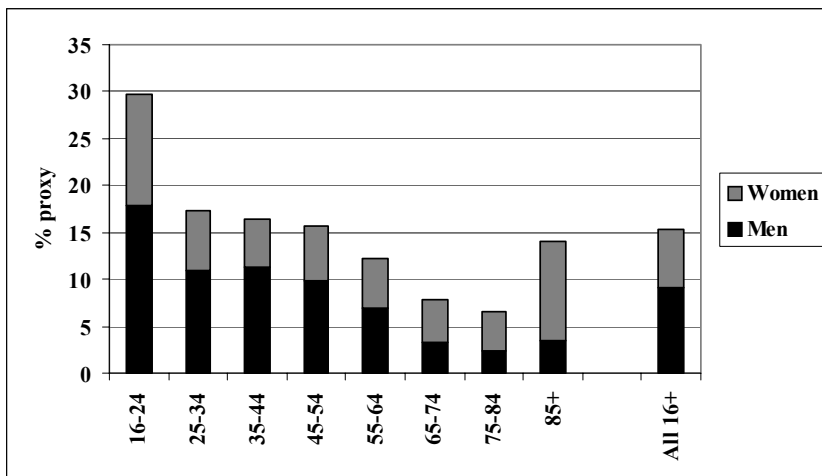

The percentage of proxy respondents in each age group followed a similar pattern in all three surveys: the proportion was highest for the age group 16-24, falling sharply in the next higher age group (25-34) and then more gradually to its lowest level in age band 75-84 followed by an increase among the oldest old, aged 85 and over. Overall, the proportion of proxy responses to self-reports was higher for men than for women, except in the older age groups (see Figure D.5.1).

Given the younger age distribution of proxy respondents, including them in the calculation of overall disability rates results in rates that are lower than if proxies were excluded. Further, the higher the proportion of proxy interviews the larger the magnitude of the difference between these two types of estimates as shown in Table D.5.1, using the percentage of adults reporting longstanding illness as an example

**Table D.5.1 Proportion of adults with longstanding illness (LSI), including and excluding proxy interviews**

Survey	Sample size ('000s)	Percent proxy response	LSI: with proxy (%)	LSI: without proxy (%)	Absolute difference (without – with)
LFS 2001	87.6	30.7	37.6	41.5	3.9*
FRS 2000/1	41.8	15.2	34.6	36.2	1.6*
GHS 2001	16.4	8.9	36.0	37.1	1.1
HSE 2001	15.6	NA	NA	45.7	NA
Omnibus 2001	6.9	NA	NA	36.7	NA

\*Differences significant at the 95% level.

**Figure D.5.2 Percentage of adults with longstanding illness, by age group, including/excluding proxy responses (LFS 2001)**

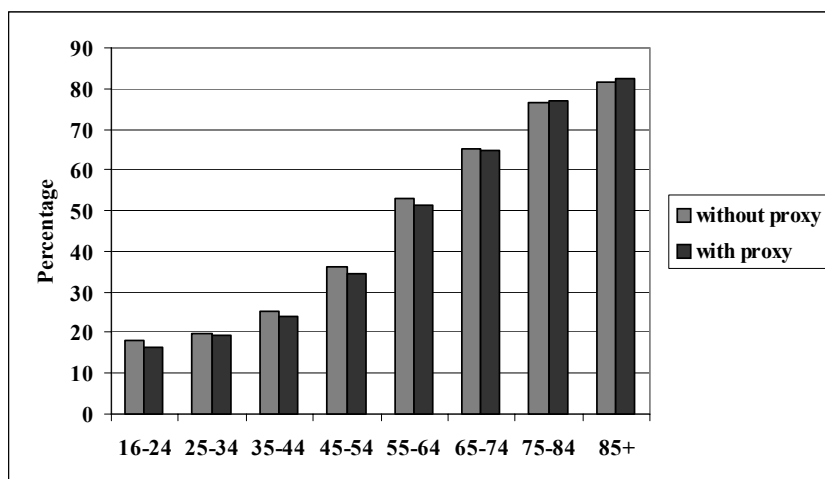

Despite the large differences in the overall estimates derived by including and excluding proxy interviews (and which are statistically significant for the FRS and LFS surveys), age-specific rates of disability for these two types were very similar (see Figure D.5.2).

Exploratory logistic regression using the LFS of proxy/self-report (dependent or Y variable) against age (banded in 10-year age groups), sex and reported longstanding illness (as this is the filter question for asking subsequent questions about activity limitation or disability) showed that adults who answer on their own behalf are significantly more likely (odds ratio: 1.21 (95 % CI: 1.17 -1.26) to report a longstanding illness, after allowing for age and sex (results not shown). Odds of reporting a disability covered by the DDA was also found to be higher among adults who were personally interviewed (1.22, 95% CI 1.17-1.27). This finding indicates that information obtained by proxy was systematically biased towards a lower rate of ill-health or disability than self-reports, after taking into account demographic differences between proxy interview respondents and personal interview respondents.

More methodological work is called for to ascertain if the health and disability related estimates obtained from surveys such as the LFS and FRS are improved by including proxy responses, as opposed to excluding them (Review of the LFS ONS 2002). The approach we have taken in this study is that whenever we report overall estimates, we report both sets of figures – i.e. overall estimates including and excluding proxy interviews – as the former correspond to the published figures in survey reports and, arguably, are closer to the true population value. But when we compare age/sex rates, these are based on personal interview data only. Hence, discussion of between-survey reliability is based solely on estimates excluding proxy interviews.

### ***D.5 Using survey weights***

Many of the surveys included in our selection use complex weights to adjust for survey design effects (such as clustering) and for non-response, and often additional weights are applied to “gross-up” results in order to provide estimates of the total number of people in the population who have a particular characteristic. The methods used to calculate these separate weights vary between surveys. As our comparative approach in this study is based on the analysis of percentages or proportions, rather than exact counts of people, we have not applied any survey weights to the datasets. The only survey weights we have used in the analysis are to correct for differential selection probabilities. In surveys such as the Omnibus where only one adult member of the household is selected for interview the achieved sample is unbalanced as the chances of selection for interview are zero for residents other than the one selected in multiple occupancy households while every person in a single-person household is selected. Unequal selection probability weights are therefore necessary to ensure that the sample remains representative of the population as a whole. Thus only estimates based on the Omnibus adult population sample and the HSE sample of children (maximum of two selected per household) have been weighted.

#### ***D.6 Standard errors and Confidence Intervals***

We have calculated approximate standard errors (SE) for proportions based on simple random sampling. Surveys such as the FRS and HSE, which use a clustered design to select the sample, will have larger SEs when design factors such as clustering of individuals within households and of addresses within postcode sectors are taken into account. It should be noted therefore that the approximate SEs reported in this study are smaller than the true SEs and therefore, the 95% confidence intervals ( $CI=SE * 1.96$ ) will also be narrower. This should be borne in mind when interpreting whether differences are significant or non-significant. Generally, the large sample sizes of surveys such as the FRS and LFS result in very tight SEs (about 0.2-0.4) and differences of over one percent (for an attribute with a prevalence of 50 percent) in estimates for the total adult population are likely to be significant at the 95% level.

## **APPENDIX E ANALYTICAL FRAMEWORK FOR CONSULTATION WITH DISABILITY ORGANISATIONS**

Verbatim transcripts of the interviews with disability organisations were analysed by ordering and synthesising data from the interviews under a series of headings. These headings are shown here.

### **Chart 1 – Background and use of estimates**

- Personal details of the respondent
- Details of the organisation
- Definitions of disability used by the organisation – with reasons
- Uses of disability estimates
- Sources of estimates

### **Chart 2 – Critiques, unmet needs and suggestions**

- Critiques of different definitions of disability
- Critiques of different estimates and their sources
- Other related statistical needs
- Implications of the quality and availability of estimates
- Disaggregations of overall estimates that would be useful
- Suggestions for the how the provision of disability estimates could be improved

**APPENDIX F GRID SUMMARISING MAJOR DISABILITY AND  
DISABILITY-RELATED SURVEYS**

(see A3 pull out at end of report)

## REFERENCES

- Abberly, P. (1992). Handicapped by Numbers: A critique of the OPCS Disability Surveys. *Sociology* (9)
- Altman, D.G. (1991). *Practical Statistics for Medical Research*. Chapman & Hall: London.
- Bajekal, M. (2002). Care homes and their residents, *Health Survey for England 2000*. The Department of Health, London: The Stationary Office.
- Bajekal, M., & Prescott, A. (2003). Disability. *Health Survey for England 2001*. The Department of Health, London: The Stationary Office
- Belson, W.A. (1981). *The Design and Understanding of Survey*. Aldershot, England:Gower.
- Berthoud, R. (2003). Disabled People and Jobs. Institute for Social and Economic Research, University of Essex.
- Berthoud, R., Lakey, J., and McKay, S. (1993). *The Economics of Disabled People*. Policy Studies Institute, London.
- Blaxter, M. (1990). *Health and Lifestyles*. London:Routledge.
- Bone, M. (1995). *Trends in dependency among older people in England*. Office of Population Censuses and Surveys, Social Survey Division, London.
- Bowling, A. (1991). *Measuring Health: a review of quality of life measurement scales*. Open University Press.
- Brown, O. (2001). General subjective health status or age-related subjective health status. *Social Science and Medicine*, 1373-81.
- Burchardt, T. (2000). *The Dynamics of Being Disabled*. CASE paper, London School of Economics, London.
- Burchardt, T. (2003), *Employment Retention and the Onset of Sickness or Disability: Evidence from the Labour Force Survey Longitudinal Datasets*. In-house report, 109. Department for Work and Pensions, London.
- Charlton, J & Wallace, M. (1994). Long-term Illness: Results from the 1991 Census. *Population Trends*, (75), pp.18-25.
- Clark, H. H., & Schober, M. F. (1992). Asking Questions and Influencing Answers. In J. M. Tanur (ed.), *Questions About Questions: Inquiries into the Cognitive Basis of Surveys*, New York: Russell Sage Foundation.
- Cousins, C., Jenkins, J. & Laux, R. (1998). Disability data from the LFS: Comparing 1997-98 with the past. *Labour Market Trends*. June, 1998:pp.321-29.
- Craig, P. (1996). *Disability follow-up to the Family Resources Survey – Aims, methods and coverage*. In-house Report 19. Department of Social Security, London.
- Crawford, S., Jette, A., & Tennstedt, S. (1997). Test-retest reliability of self-reported disability measures in older adults. *Journal of the American Geriatrics Society*, 45:338-41.
- Department for Work and Pensions (2002). The Family Resources Survey. Crown Copyright, London. <http://www.dwp.gov.uk/asd/frs>
- Devore, D. (1998). 1996 Disability Survey: Follow-up to the Family Resources Survey, *Technical report*. Office for National Statistics, London.



- Evans, O. & Lader, D. (2003). *Disability and the Disability Discrimination Act. A report of a survey module in the National Statistics Omnibus Survey 2001*. In-house report 114. Department for Work and Pensions, London.
- Grammenos S. (2003) *Illness, Disability and Social Inclusion*. European Foundation for the Improvement of Living and Working Conditions. (<http://www.eurofound.eu.int/publications/files/EF0335EN.pdf>)
- Grewel, I., Joy, S., Lewis, J., Swales, K., & Woodfield, K. (2002). *'Disabled for life?' Attitudes towards, and experiences of, disability in Great Britain*. Research Report 173. Department for Work and Pensions, London.
- Groves, R.M & Couper, M.P. (1998). *Non-response in Household Interview Surveys*, Canada: John Wiley & Sons Inc.
- Grundy, E., Ahlburg, D., Ali, M., Breeze, E., & Sloggett, A. (1999). *Disability in Great Britain*. Research Report 94. Department of Social Security, London.
- Gudex, C., & Lafortune, G. (2000). *An inventory of health and disability related surveys in OECD countries*. Joint ECE/WHO Expert Meeting on Health Statistic Measurements, Ottawa, Canada. Working paper No. 6.
- Fowler Jr. F.J., Mangione, T.W. (1990) *Standardized Survey Interviewing: Minimising interviewer-related error*. Applied Social Research Methods Series: 18. Newbury Park, CA: Sage.
- Hudson, C. (1995). *Tacking survey non-response*. Quality Issues in Social Surveys (QUISS) Seminar London: in *Survey Methodology Bulletin*, 37, National Centre for Social Research.
- Hultsch, D.F., Hammer, M., & Small, B.J. (1993). Age differences in cognitive performance in later life: relationships to self-reported health and activity life-style. *Journal of Gerontology*, 48:111.
- Jenkins, J. (1997). Assessment of the quality of data from the Spring 1997 LFS disability module. *Labour Market Trends*, December 1997, p.494-95.
- Kuh, D.J.L, Wadsworth, M.E.J., and Yusuf, E.J. (1993). Burden of disability in a post war birth cohort in the UK. *Journal of Epidemiology and Community Health* (48):262-69.
- Krosnick, J. A. (1991). Response strategies for coping with the cognitive demands of attitude measures in surveys. *Applied Cognitive Psychology*, (5) p33.
- Krosnick, J.A., and Schuman, H. (1987). Attitude intensity, importance, certainty and susceptibility to response effects. *Journal of Personality and Social Psychology*, (54), pp940-52.
- Madans J., Rasch B., Altman B. (2002). Exploring the impact of assistive device use on disability measurement. Presentation to the First Meeting of the Washington City Group on Disability Statistics, Washington DC. (<http://www.cdc.gov/nchs/citygroup.htm>).
- Martin, J., Meltzer, H., & Elliot, D. (1998). The prevalence of disability among adults. Office of Population Censuses and Surveys, Social Survey Division, *Report 1*. London: Her Majesty's Stationary Office.
- Mathiowetz, N.A. (2000). Methodological issues in the measurement of work disability. Chapter 3 in N. Mathiowetz and G. Wunderlich (eds), *Survey Measurement of Work Disability: Summary of a Workshop*. Washington, D.C: National Academy Press.
- Melzer, H. (2001). Identifying disabled people in national surveys in Great Britain. Paper presented at the INED Conference, Paris.
- Murray, C., Lopez, A.D. (editors) (1996). The global burden of disease. GBD Vol. 1. Harvard University Press, Cambridge.
- McDowell, I, & Newell, C. (1996). *Measuring Health: a guide to rating scales and questionnaires*. New York/Oxford: Oxford University Press.

Office for National Statistics (2002). *Living in Britain: Results from the 2001 General Household Survey*. Crown Copyright, London.

Office of Population Censuses and Surveys (1993). *Census 1991 Communal Establishments, volume 1*. HMSO: London.

Oliver, M. (1996). Defining impairment and disability: Issues at stake. In *Exploring the Divide*, Barnes, C., & Mercer, G. (eds). The Disability Press: Leeds.

Prescott-Clarke, P. (1990). *Employment and Handicap*. Social & Community Planning Research, London.

Purdon, S. (1996). Disability. In Prescott-Clarke, P., & Primateta, P. (eds) *Health Survey for England, 1995*.

Smith, A. & Twomey, B. (2002). Labour market experiences of people with disabilities. *Labour Market Trends*, August 2002, pp.415-427.

Sturgis, P., Thomas, R., Purdon, S., Bridgwood, A., & Dodd, T. (2001). *Comparative review and assessment of key health state measures of the general population*. Department of Health, London. <http://www.doh.gov.uk/public/healthreport>

Thomas, R. (1989). Testing questions on disability and long-term ill-health for the 1991 Census. *Survey Method Bulletin*, (24) p.56. Office of Population Censuses and Surveys, London.

Thomas, R., & Dobbs, J. *Survey measurement of disability and identification of disabled persons in the private household population* (monograph), Survey Methods Centre, National Centre for Social Research.

Thomas, R. & Purdon, S. (1994). Using the results of the 1991 Census Question on limiting long-term illness. *Survey Methods Centre Newsletter*, National Centre for Social Research (14) 2:7-14.

Tourangeau, R. (1984). Cognitive Sciences and Survey Methods. In T. Jabine, M. Straf, J. Tanur, and R. Tourangeau (eds.), *Cognitive Aspects of Survey Methodology: Building a Bridge Between Disciplines*. p73. Washington, DC:National Academy Press.

Tourangeau, R., Lance, J., and Rasinski, K. (2000). The Psychology of Survey Response. *Respondents Understanding of Survey Questions*. Cambridge University Press.

van Buuren, S., Eysers, S., Tennant, A Hopman-Rock, M. (2001). Response conversion: A new technology for comparing existing health information. *TNO Prevention and Health Report*. (2001.97). ([http://www.iph.fgov.be/epidemiology/disab/EDM2002\\_08.pdf](http://www.iph.fgov.be/epidemiology/disab/EDM2002_08.pdf)).

Williams, A. (1995). *The Measurement and valuation of health: A Chronicle*. Centre for Health Economics, Discussion Paper, 136, University of York.

World Health Organisation (2001). *World Health report 2002*. [http://www.who.int/health\\_topics/mental\\_health](http://www.who.int/health_topics/mental_health)

World Health Organisation (1980). *International classification of functioning, disability and health*. <http://www.who.int/classification/icf>

APPENDIX F: GRID SUMMARISING MAJOR DISABILITY AND DISABILITY-RELATED SURVEYS											
Survey Name (Most recent year available)	Sponsor	Population Coverage	Sample size	Response rates	Proxy interviews	Selection	Mode	Frequency	Module	Published estimates	Other
OPCS Disability Surveys 1985/88	Former DHSS (Department of Health and Social Security)	GB. All ages 0+, institutional population included	10,000 adults, 2000 children (with one or more disabilities from a sample of about 133,000 households)	93% full interview in private households. 96% full co-operation from establishments	Proxy interviews permitted if respondent was too ill. This was usually done by the carer.	Private households, communal establishments and institutions	Face-to-face. Pen and paper (PAPI)	Ad-hoc survey comprising series of four linked surveys, each including different population sub-groups, conducted between 1985-88.	Specialist disability surveys examining population prevalence, severity, socio-economic characteristics, employment, finances and use of services	14% total population, estimated 6.2 million .	Only one adult aged over 60 randomly selected in households with 2 or more eligible persons over 60.

Disability Survey 1996/7 (FRS follow-up)	DWP (Department for Work and Pensions)	GB. Adults aged 16+, institutional population excluded.	7,000 disabled adults aged 16+ (from base sample of 33,897 base sample in FRS96/7)	83% of those found eligible	Not stated	Follow-up of representative adult sample of household population	Face-to face (CAPI).	Ad-hoc annual cross-sectional survey	Specialist disability surveys examining population prevalence, severity, socio-economic characteristics, employment, finances and use of services	20% of the adult population estimated 8.6 million	Questionnaire instrument and scoring method identical to the 1985 Disability Surveys.
Labour Force Survey (2001)	Office for National Statistics, Department of Finance and Personnel (Northern Ireland).	UK. Adults aged 16+, institutions excluded.	60,000 households in 5 waves (approx. 85,000 adults)	N/A	Yes	Private households and some communal establishments (e.g. nurses homes)	Face-to-face first interview (CAPI); telephone interviews subsequent waves (CATI).	New cross section of households selected every quarter (wave 1) and all adults in household re-interviewed in next 4 quarters (waves 2-5).	Limitations on type or amount of work can do + DDA definition of disability	15% (5.4 million people - work limiting disabled), 15% (5.5 million - DDA current-disabled), 19% (6.8 million - All long term disabled) Figures taken from LFS data, Summer 2002. All estimates are for the working age population.	Estimates for each quarter based on respondents in different waves (1 through 5) of the interview cycle. LFS based on a sample of households rather than individuals, therefore re-interviews include new movers into household and leavers not followed up.
Family Resources Survey (2001/02)	Department of Social Security (now DWP)	GB. Adults 18+ (16-17 if not in full time education). Institutions excluded.	39,000 adults	66% overall (2001/02)	Yes - partner of household permitted to answer on behalf of the other.	Private households. Each adult member of the household is interviewed and members grouped into benefit units (cohabitating, married or single couples and their dependent children, not single sex couples)	Face-to-face (CAPI).	Annual cross-sectional estimates; continuous survey	Until 2000/01, LLSI harmonised question, changed to Census 2001 version in 2001/02. Registered disability. Limitations on type or amount of work that can be done. Special disability follow up on 1996-97. LLSI Question changed to harmonised version from 2003/04.	22% adults reporting LLSI (aged 16 and over)	Scottish Highlands and Islands excluded.
General Household Survey 2001	Various including Office for National Statistics, Department of Health, DWP, Health Development Agency	GB. Adults aged 16+, institutions excluded.	9000 households (approximately 20,000 individuals)	72% in total	Restricted proxies to household members too ill or in hospital. Parents answer on behalf of children aged under 16. Proxies not allowed for questions on health, smoking, drinking, income and qualifications.	Household questionnaire completed by the householder or spouse, and an individual questionnaire by all adults 16 yrs + within the household	Face-to-face CAPI interview (1994 onwards) and some self-completion. Telephone interview for follow up.	Annual cross-sectional estimates; continuous survey	LLSI question asked since 1977. Main source for long-term trend data on LLSI.	19% adults disabled.	Special follow-up surveys of people aged 65 and over covering disability and dependency (ADL's and IADL's for the elderly only)
Health Survey for England (2001)	Department of Health	England. All ages. Institutions not covered (except those aged 65 and over in 2000)	15,647 adults (16+) and 3,993 children.	67% adults 16+ (based on numbers in cooperating and non-cooperating (estimated) households)	Not permitted for adults. Parents answer on behalf of children under 13.	At each household contacted, all adults 16+ and a maximum of two children were eligible for inclusion.	Face-to-face CAPI interview, physical measurements, blood and saliva samples	Annual cross-sectional estimates; continuous survey	LLSI question introduced in 1996. Extended coverage of general health and disability in 1996, including SF-36, EQ5D. Disability module repeated in 2000 and 2001.	26 % adults (LLSI); 18% of adults with one or more disabilities	Disability module limited to 5 domains and does not include mental health.

APPENDIX F: GRID SUMMARISING MAJOR DISABILITY AND DISABILITY-RELATED SURVEYS

Survey Name (Most recent year available)	Sponsor	Population Coverage	Sample size	Response rates	Proxy interviews	Selection	Mode	Frequency	Module	Published estimates	Other
Scottish Health Survey (1998)	Scottish Health Department	Scotland. all adults aged, all ages, institutions excluded.	8000 adults	76% interviewed, 63% saw the nurse.	Household member able to answer for other household members by proxy.	Private households (1 adult and 2 children per household unit)	Face-to-face CAPI interview, physical measurements, blood and saliva samples	Cross sectional , repated every 5 years	Varies year to year but includes GHS LLSI questions each round	LLSI:adults (under 65) 22% men 25% women	Some regions under-represented. Weighting adjustments for age and sex.
Welsh Health Survey (1998)	Welsh Office	Wales. all adults aged 18+, institutions excluded.	30,000 adults	59% (61% if adjusted for oversampling)	Yes	Private households	Self completion postal survey	Annual cross-section, repeated intermittently.	SF-36 health questions, LLSI	LLSI:adults (under 65) 25% men 24% women	Reported bias in morbidity in those that chose to take part in the survey
British Household Panel Survey	Economic and Social Research Council	GB. Adults aged 16+, institutions excluded.	5,500 households per year	89%	Proxies permitted to answer on behalf of other household members absent at the time of interview. Proxy informant must be over 16 years old.	Panel study of individuals in private households. New panel members added to study as members of households reach age 16, or new adults join household. Panel members followed if original member moves to different household.	Face -to-face, CAPI, short self completion questionnaire	Panel reinterviewed annually	GHS LLSI questions. Registered disability. Limitations on type or amount of work that can be done.		Longitudinal survey which began in September 1990.
Families and Children Study 1999-2000 Wave 2	Department for Work and Pensions	GB. Lone parent and couple families with children, institutions excluded.	4,252 families	83% (panel sample 2001)	Partner proxy interviews allowed	Private households - Sample taken from Child Benefits records and formed part of a panel (since 1999). Mother figure was preference to be selected for the interview.	Face-to-face CAPI interview and self completion questionnaires	Panel study - wave 1 in 1999, wave 2 in 2000 and wave 3 in 2001. Repeated annually.	Module of health questions (including LSI, type of illness/disability, whether this limits daily activities, duration of illness/disability and whether it affects work capacity). Asked of the main respondent and any dependent children	LLSI adults 28%	Longitudinal survey with a follow-up every year. Started in 1999.
Health Education Monitoring Survey (1998)	Health Education Authority (now Health Development Agency)	England. all adults aged. 16+, institutions excluded.	5,800 adults	71%	No proxy interviews allowed	Private households	Face-to-face CAPI interview and self completion questionnaires	Annually . Stopped in 1998.	Questions on social support and activities of daily living (ADL) for older people included for the first time in 1998.	N/A	
Survey of English Housing (2001)	Office of the Deputy Prime Minister	England. Adults aged 16+, institutions excluded.	20,000 adults	80%	Where the head of household or spouse/partner not available, proxy interviews were permitted with another responsible adult (2% of all cases)	Private households (Head of household and partner/spouse)	Face-to-face CAPI interview	Annual cross-sectional estimates, continuous survey	Series of questions in disability module that have been included since 1999 and are a permanent part of the survey. Additional disability questions relating to wheelchair use were included in 2003/2004 (data not yet available)	N/A	Children were over-represented, but compensated by grossing
Omnibus Survey 1995	Formerly sponsored by the Department of Social Security.	GB. Adults aged 16+, institutions excluded.	5,797 adults	72% over 3 waves	No proxy interviews allowed.	Private households.	Face-to-face CAPI interview	Omnibus Survey is carried out monthly - sample taken over 3 months	Module of questions on disability were asked of respondents who had/or currently suffers from LLTI, disability or infirmity.	20% total population (covered by DDA definition)	
Omnibus Survey 2001	Department for Education and Employment/ Disability Rights Commission	UK. Adults aged. 16+, institutions excluded.	6,992 adults	63% overall	No proxy interviews allowed.	One household member is interviewed at each selected household (random selection if 2 or more people present)	Face-to-face CAPI interviews	Omnibus Survey is carried out monthly - sample taken over 4 months	Module of questions on disability were asked of respondents who had/or currently suffers from LLTI, disability or infirmity.	23% in total (Long standing health problem that limited activities). Adults aged 16-25 = 19%	

APPENDIX F: GRID SUMMARISING MAJOR DISABILITY AND DISABILITY-RELATED SURVEYS											
Survey Name (Most recent year available)	Sponsor	Population Coverage	Sample size	Response rates	Proxy interviews	Selection	Mode	Frequency	Module	Published estimates	Other
Employment of Disabled People: Assessing the Extent of Participation (1996)	Department for Education and Employment	GB and six areas of Northern Ireland. Males (16-64 years) and females (16-59 years).	2,890 disabled adults	70%	In the minority of cases, proxy interviews allowed with the disabled persons carer, or with the carer and disabled person together	Private households with a disabled member	Initial screening followed by face-to-face interview (CAPI)	Ad-hoc annual cross-sectional survey	Coverage of disability and dependency, OCPS severity scale questions, other questions relating to support, benefits, employment, perceptions, work location and mobility, nature of health problems and disability (DDA and non-DDA definitions)	N/A	Undersampling of economically inactive respondents and oversampling of economically active respondents
Employment and Handicapp (Prescott-Clarke) 1990	Employment Service, SCPR (now NatCen)	GB. Adults 16-64 years for males, 16-59 years for females, institutions excluded.	1,713 adults	71% overall	Proxy interviews allowed for those who were not available at the time of the interview	Private households.	Face-to-face pen and paper interview	Ad-hoc annual cross-sectional survey	Module of questions on disability were asked of respondents who had/or currently suffers from LLTI, disability or infirmity. Questions in the context of health, and employment.	N/A	
Census 1991	Office for National Statistics	UK. All ages, institutions included	Entire population in UK	98% estimated		Private households, communal and institutional dwellings	Self completion (form collected by Census enumerator)	Every 10 years	LLSI question	13.3% total population LLSI (7.2 million people)	Underenumeration of residents in inner city areas and young men.
Census 2001	Office for National Statistics	UK. All ages, institutions included	Entire population in UK	96% estimated		Private households, communal and institutional dwellings	Self completion postal return of form	Every 10 years	LLSI question and a new question on carers	18.2% (estimated 9.5 million people) LLSI	Underenumeration of residents in inner city areas.

**Table 4.2 Flow-chart for choosing the most appropriate estimate**

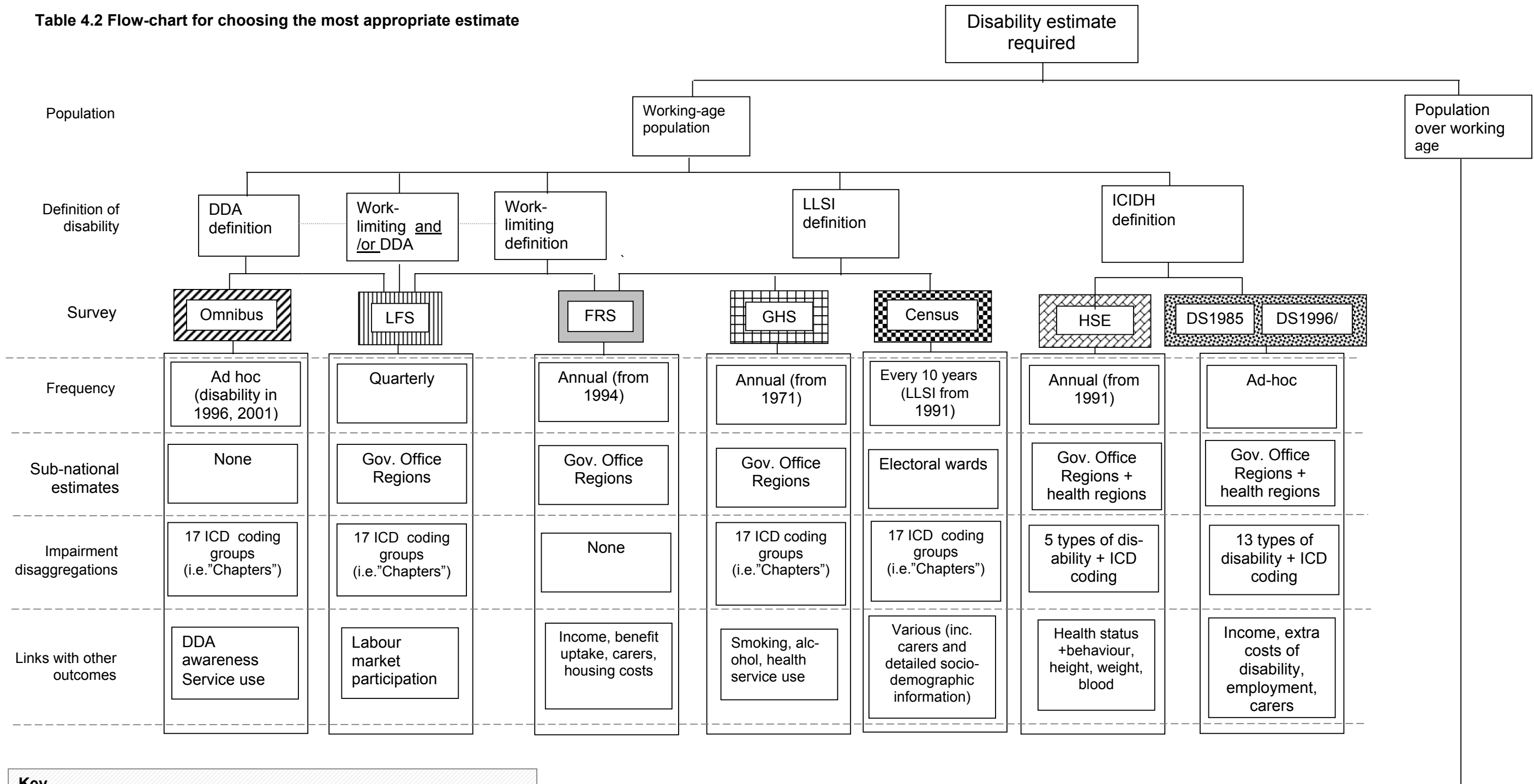

**Key**  
 DS85 Disability Surveys of Great Britain (1985-88), OPCS  
 DS96/7 Disability in Great Britain: results from the 1996/7 disability follow-up of the Family Resources Survey  
 FRS Family Resources Survey  
 GHS General Household Survey  
 HSE Health Survey for England  
 ICIDH International Classification of Impairments, Disabilities and Handicaps (WHO, 1980)  
 ICD International Classification of Diseases  
 LLSI Limiting longstanding illness, disability or infirmity  
 LFS Labour Force Survey

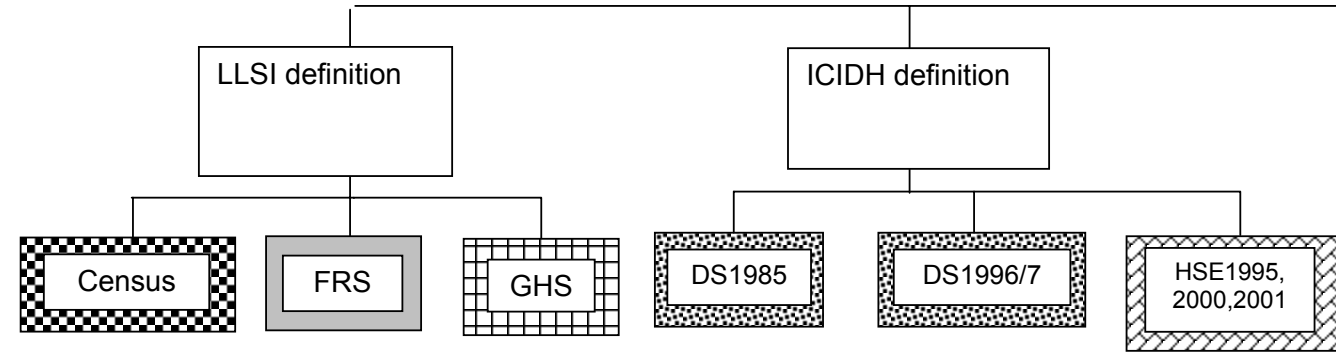

See above for characteristics of these surveys

...