

A Single Amino Acid Substitution in the Pleckstrin Homology Domain of Phospholipase C δ 1 Enhances the Rate of Substrate Hydrolysis*

(Received for publication, December 9, 1996, and in revised form, April 18, 1997)

Paul A. Bromann, Evan E. Boetticher, and Jon W. Lomasney‡

From the Feinberg Cardiovascular Research Institute, Departments of Pathology and Pharmacology, Northwestern University Medical School, and Northwestern University Institute for Neuroscience, Chicago, Illinois 60611

The pleckstrin homology (PH) domain has been postulated to serve as an anchor for enzymes that operate at a lipid/water interface. To understand further the relationship between the PH domain and enzyme activity, a phospholipase C (PLC) δ 1/PH domain enhancement-of-activity mutant was generated. A lysine residue was substituted for glutamic acid in the PH domain of PLC δ 1 at position 54 (E54K). Purified native and mutant enzymes were characterized using a phosphatidylinositol 4,5-bisphosphate (PI(4,5)P₂)/dodecyl maltoside mixed micelle assay and kinetics measured according to the dual phospholipid model of Dennis and co-workers (Hendrickson, H. S., and Dennis, E. A. (1984) *J. Biol. Chem.* 259, 5734–5739; Carmen, G. M., Deems, R. A., and Dennis, E. A. (1995) *J. Biol. Chem.* 270, 18711–18714). Our results show that both PLC δ 1 and E54K bind phosphatidylinositol bisphosphate cooperatively (Hill coefficients, $n = 2.2 \pm 0.2$ and 2.0 ± 0.1 , respectively). However, E54K shows a dramatically increased rate of PI(4,5)P₂-stimulated PI(4,5)P₂ hydrolysis (interfacial V_{\max} for PLC δ 1 = 4.9 ± 0.3 $\mu\text{mol}/\text{min}/\text{mg}$ and for E54K = 31 ± 3 $\mu\text{mol}/\text{min}/\text{mg}$) as well as PI hydrolysis (V_{\max} for PLC δ 1 = 27 ± 3.4 $\text{nmol}/\text{min}/\text{mg}$ and for E54K = 95 ± 12 $\text{nmol}/\text{min}/\text{mg}$). In the absence of PI(4,5)P₂ both native and mutant enzyme hydrolyze PI at similar rates. E54K also has a higher affinity for micellar substrate (equilibrium dissociation constant, $K_s = 85 \pm 36$ μM for E54K and 210 ± 48 μM for PLC δ 1). Centrifugation binding assays using large unilamellar phospholipid vesicles confirm that E54K binds PI(4,5)P₂ with higher affinity than native enzyme. E54K is more active even though the interfacial Michaelis constant (K_m) for E54K (0.034 ± 0.01 mol fraction PI(4,5)P₂) is higher than the K_m for native enzyme (0.012 ± 0.002 mol fraction PI(4,5)P₂). D-Inositol trisphosphate is less potent at inhibiting E54K PI(4,5)P₂ hydrolysis compared with native enzyme. These results demonstrate that a single amino acid substitution in the PH domain of PLC δ 1 can dramatically enhance enzyme activity. Additionally, the marked increase in V_{\max} for E54K argues for a direct role of PH domains in regulating catalysis by allosteric modulation of enzyme structure.

In many cell types, ligand binding to integral membrane

* This work was supported by National Institutes of Health Grant HL55591 (to J. W. L.) and National Research Service Award MH11219 (to P. A. B.). The costs of publication of this article were defrayed in part by the payment of page charges. This article must therefore be hereby marked "advertisement" in accordance with 18 U.S.C. Section 1734 solely to indicate this fact.

‡ To whom correspondence should be addressed. Tel.: 312-503-0450; Fax: 312-503-0137; E-mail: jlomas@merle.acns.nwu.edu.

receptors leads to an increase in the intracellular second messengers, inositol 1,4,5-trisphosphate (IP₃)¹ and diacylglycerol. This increase results largely from activation of a family of phosphoinositide-specific phospholipase C (PLC) enzymes that hydrolyze polyphosphoinositides such as phosphatidylinositol 4,5-bisphosphate (PI(4,5)P₂) (3). IP₃ releases intracellular Ca²⁺ from the endoplasmic reticulum via interaction with a specific receptor located on the surface of the endoplasmic reticulum (3, 4). Diacylglycerol, as well as increased intracellular Ca²⁺, activates protein kinase C (PKC) (5). Recent studies suggest that PLC δ 1 can be stimulated both by a p122-Rho-GTPase-activating protein (6) and also by G_h (transglutaminase II) (7). Recent genetic studies in spontaneously hypertensive rats suggest that activity of this effector enzyme plays an important role in the control of blood pressure (5, 8), and light and electron microscopic studies of PLC δ in neurofibrillary tangles suggest a role in Alzheimer's disease (9).

PLC δ 1 hydrolyzes substrate at a lipid/water interface. Kinetic analyses developed by Dennis and co-workers (1, 2) are used to describe this type of enzymatic activity. According to this dual phospholipid binding model, a soluble enzyme must first associate with lipid (either specifically or nonspecifically) to anchor the enzyme to the lipid/water interface. Enzyme bound to the interface can then subsequently bind its substrate (within the interface) at the catalytic site where substrate hydrolysis occurs. For enzymes operating in the "scooting" or processive mode, multiple catalytic cycles can occur before the enzyme detaches from the interface (10, 11). The pleckstrin homology (PH) domain of PLC δ 1 lies within the NH₂-terminal region of the enzyme. Both this NH₂-terminal region (12, 13) and the PH domain specifically (14) bind to PI(4,5)P₂ with high affinity. Further, this binding is important for processive catalysis to occur (13, 14).

This study seeks to determine the mechanisms of PH domain-mediated activation of PLC δ 1. A mutant PLC δ 1 (E54K) was constructed to generate a PH domain enhancement-of-function mutant. This single amino acid substitution at position 54 of PLC δ 1 dramatically increases the activity of this enzyme. Using kinetic analyses we show that changes in both the equilibrium binding constant (K_s) and V_{\max} contribute to the increased rate of processive hydrolysis, whereas the interfacial binding constant (K_m) does not contribute. The position of this substitution within the PH domain of PLC δ 1 uniquely demonstrates the functional importance of this domain. Further, the increase in V_{\max} for E54K suggests a new role for PH

¹ The abbreviations used are: IP₃, inositol 1,4,5-trisphosphate; PLC, phospholipase C; PI(4,5)P₂, phosphatidylinositol 4,5-bisphosphate; PKC, protein kinase C; PH domain, pleckstrin homology domain; PI, phosphatidylinositol; PE, phosphatidylethanolamine; LUV, large unilamellar vesicle; D-IP₃, D-myoinositol 1,4,5-trisphosphate; PC, phosphatidylcholine; PS, phosphatidylserine.

domains as allosteric regulatory sites. We show that this PH domain-mediated change in K_s and V_{\max} is a mechanism for PLC $\delta 1$ activation and propose that this may be a general mechanism for mutant enzymes in which overactivation leads to human disease.

EXPERIMENTAL PROCEDURES

Materials—Phosphatidylinositol (PI) and phosphatidylethanolamine (PE) were from Avanti Polar Lipids. Radiolabeled phospholipids were purchased from DuPont NEN. PI(4,5)P₂ was from Calbiochem. PLC $\delta 1$ monoclonal antibodies were a gift from Dr. Steven Roffler, Academia Sinica, Taiwan. All other reagents were purchased from Sigma and were of the highest grade possible.

Mutagenesis of Human PLC $\delta 1$ —Replacement of the single glutamic acid residue at position number 54 with lysine in human PLC $\delta 1$ (E54K) was performed using the polymerase chain reaction described previously using the bacterial expression plasmid pRSETAplc (15). The mutant, E54K, was subsequently confirmed by DNA sequence analysis.

Expression and Purification of PLC $\delta 1$ —BL21(DE3) *Escherichia coli* (Novagen) were transformed with mutant as well as with wild-type PLC $\delta 1$ pRSETA constructs. At appropriate times, the culture was induced with 10 mM isopropyl-1-thio- β -D-galactopyranoside at 18 °C for about 8 h. The cells were collected by centrifugation and frozen at -20 °C. The remaining purification protocol was performed according to Cheng *et al.* (15). Briefly, cell pellets were ground to a paste in liquid nitrogen using a mortar and pestle. All subsequent steps were performed at 4 °C using prechilled buffers. The resulting powder was resuspended in 50 ml of sonication buffer (50 mM sodium phosphate, pH 8.0, 0.1 M KCl, 1 mM EGTA, 1 mM EDTA, and 0.1% Tween-20), and sonicated. This suspension was centrifuged at 17,000 rpm at 4 °C for 45 min. The supernatant was applied to 5 ml of Ni²⁺-nitrilotriacetic acid-agarose (Qiagen) in batch mode. The resin was washed 5 times with 250 ml of equilibration buffer and then five more times with 250 ml of equilibration buffer plus 15 mM imidazole. PLC was eluted with equilibration buffer plus 100 mM imidazole. Active fractions were identified using a PI hydrolysis assay and immunoblot. Active fractions were concentrated with Millipore 30,000 NMWL filters and then dialyzed against 1 liter of sonication buffer plus 10 μ M phenylmethylsulfonyl fluoride (added fresh) and 1 mM dithiothreitol using Pierce dialysis cassettes. For purification to homogeneity, samples were applied to 0.5 ml of heparin-Sepharose (Pharmacia Biotech Inc.) equilibrated with sonication buffer. Columns were washed and eluted using a 150 ml of linear salt gradient from 0.1 to 0.5 M KCl in sonication buffer. Active fractions were identified using a PI hydrolysis assay and Coomassie gel staining.

Assay of PLC $\delta 1$ Activity—Measurement of PLC $\delta 1$ catalytic activity was performed according to the method of Cifuentes *et al.* (13). Briefly, PI(4,5)P₂ and ³[H]PI(4,5)P₂ (4.6 Ci/mmol) or PI and ³[H]PI (11.0 Ci/mmol) in chloroform/methanol (2:1) were dried in Argon using an N-TEVAF AF automatic thin film drier (Organomation). Final concentrations of PI(4,5)P₂ were 1–325 μ M, and the concentration of ³[H]-PI(4,5)P₂ was 0.033 μ M in a final reaction volume of 30 μ l. Final concentrations of PI were 10–150 μ M, and ³[H]PI was 0.2 μ M. Dried lipids were solubilized in a solution of dodecyl maltoside (ranging from at least 200 μ M to 10 mM), 100 mM NaCl, and 20 mM HEPES, pH 7.0. The mixtures were sonicated, and the free Ca²⁺ was buffered using EGTA (stability constant for calcium/EGTA of $6.8 \times 10^6 \text{ M}^{-1}$). Reactions were initiated by the addition of enzyme (0.888–566 ng) and carried out in a 30- μ l volume containing mixed micelle substrate, enzyme, 10 μ M or 1 mM free Ca²⁺, 100 mM NaCl, 5 mM dithiothreitol, 0.1% gelatin, and 20 mM HEPES, pH 7.0, at 30 °C. Reactions were stopped by the addition of 250 μ l of 10% trichloroacetic acid and 25 μ l of 20% Triton X-100. Samples were vortexed briefly and kept on ice for 10 min. Precipitates were sedimented at 10,000 $\times g$ at 4 °C for 1 min. Supernatants (280 μ l each) were extracted with 1 ml of chloroform/methanol (2:1), and the aqueous phase (535 μ l each), containing the ³[H]IP₃ or ³[H]IP product, was transferred to a scintillation vial and counted for 5 min. PLC $\delta 1$ activity was also determined using PI/deoxycholate mixed micelles. 50–90 ng of enzyme was added to a 50- μ l assay buffer containing 300 μ M PI, 25,000 cpm ³[H]PI, 0.1% sodium deoxycholate, 50 mM HEPES, pH 7.0, 100 mM NaCl, 0.5 mg/ml bovine serum albumin, 3 mM Ca²⁺, and 1 mM EGTA. The reaction was terminated by adding 2 volumes of CHCl₃/methanol/concentrated HCl (100:100:0.6 v/v/v) followed by 1 volume of 1 N HCl containing 5 mM EDTA. After vortexing and centrifugation at 10,000 $\times g$ for 5 min, the aqueous phase was removed and counted.

Protein-Lipid Vesicle Binding Assay—20 μ g of PI(4,5)P₂ and 400 μ g of PE were mixed and dried down to a thin film under N₂. PE at 400

μ g/ml (520 μ M) had previously shown no detectable protein binding. Lipid mixtures were lyophilized for >4 h and stored at -80 °C. Before use, 1 ml of 180 mM sucrose was added to the lipid mixtures and bubbled with N₂ for 5 min. One ml of 2 \times binding buffer (100 mM HEPES, pH 7, 200 mM KCl, 10 mM EGTA, 10 mM EDTA) was added. The lipid mixture was centrifuged for 30 min at 2,000 $\times g$ at 4 °C. The pellet was redissolved in 1 ml of 50 mM HEPES, 100 mM KCl, 5 mM EGTA, 5 mM EDTA, and 200 μ g/ml bovine serum albumin. This 1 \times PI(4,5)P₂/PE lipid vesicle solution was serially diluted into solution concentrations of 0.07–18 μ M PI(4,5)P₂ and 2.0–260 μ M PE (constant mol fractions). Enzyme was added to 190 μ l of the PI(4,5)P₂/PE mixture and allowed to incubate at room temperature for 10 min. Enzyme/lipid mixtures were centrifuged at 4 °C, at 400,000 $\times g$ for 40 min. Supernatants were removed, and the pellet was redissolved in sodium dodecyl sulfate-protein buffer and run in a 15% acrylamide gel. The proteins were then immunoblotted.

Analysis of Kinetic Data—The kinetics for the native and mutant enzyme were fit to the dual phospholipid binding model originally used to describe the kinetics of phospholipase A₂ (1, 2) (Reaction 1).

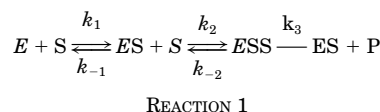

According to this model, enzyme first associates (via interaction between a noncatalytic site and lipid moiety) with the lipid/detergent mixed micelle to form an enzyme-mixed micelle complex. This interfacial binding is a function of the bulk lipid concentration in the mixed micelle. Thus, to determine the equilibrium dissociation constant for interfacial binding (denoted here as K_s), we measured substrate hydrolysis as a function of bulk substrate concentration while keeping the mol fraction of substrate constant (case I). Once the enzyme-mixed micelle complex forms substrate hydrolysis can then proceed at the catalytic site. In contrast to interfacial binding, interfacial catalysis is not dependent on bulk concentration of substrate but rather is dependent on the mol fraction of substrate in the lipid/mixed micelle. Therefore, to assay substrate binding to the catalytic site as well as the maximum rate of interfacial catalysis, both the interfacial Michaelis constant (denoted here as K_m) and interfacial V_{\max} were determined by measuring substrate hydrolysis with increasing mol fractions of substrate while keeping the bulk concentration of substrate constant (case II). Covarying bulk lipid concentration and mol fraction yielded a sigmoidal rate *versus* [substrate] curve indicative of cooperativity (case III).

Data from all cases were fit to the Hill equation (16) (Equation 1) using the program PRISM (Graphpad).

$$v = \frac{V_{\max} \cdot [S]^n}{K' + [S]^n} \quad (\text{Eq. 1})$$

v = rate, V_{\max} = maximum rate, $[S]$ = initial substrate concentration, n = Hill coefficient, and K' is a complex association factor.

Determination of K_s —For case I data, Equation 1 reduces to the Henri Michaelis-Menten equation or simple rectangular hyperbola with slope, n , equal to 1. Data were fit to Equation 2 from which values of the equilibrium dissociation constant (K_s) were obtained.

$$v = \frac{V_{\max} \cdot [S]}{K_s + [S]} \quad (\text{Eq. 2})$$

Determination of K_m and V_{\max} —For case II data, a sigmoidal curve fit better than a rectangular hyperbola with slope equal to 1. Therefore, data were fit to Equation 3 using the Hill coefficient derived from case III data (16) and K_m as well as V_{\max} determined.

$$v = \frac{V_{\max} \cdot [X]_{\text{case III}}^n}{K_m + [X]_{\text{case III}}^n} \quad (\text{Eq. 3})$$

K_m is the interfacial Michaelis-Menten constant, V_{\max} is the interfacial V_{\max} at a constant PI(4,5)P₂ concentration of 100 μ M, X is the mol fraction of substrate, and $n_{\text{case III}}$ is the Hill coefficient derived from case III. Data from case III were fit to a sigmoidal curve according to Equation 1 where K' in this case is defined by the intrinsic association factors of different lipid binding sites with the Hill coefficient, n , equal to the total number of binding sites.

RESULTS

Mutagenesis of PLC $\delta 1$ —The cDNA for human PLC $\delta 1$ was mutated to substitute a lysine for glutamic acid at residue

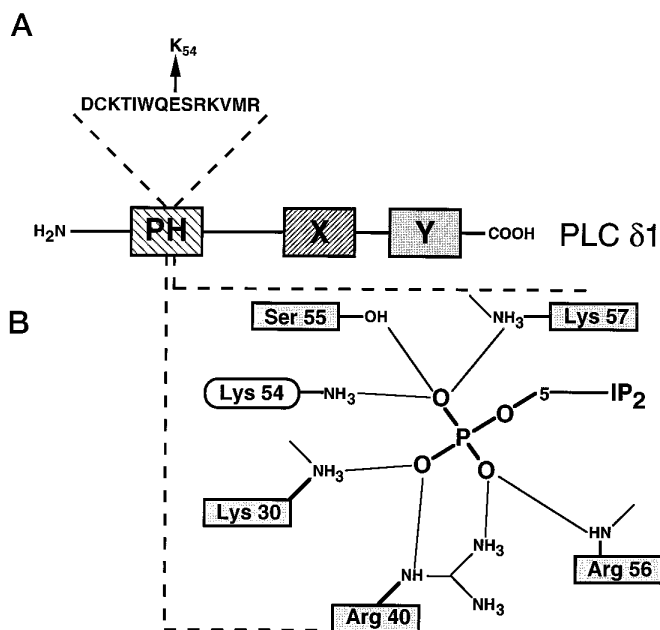

FIG. 1. Schematic representation of PLC $\delta 1$ and proposed interaction between K54 and IP₃. Panel A, PLC $\delta 1$ is schematically represented showing locations of X, Y, and PH domains. The glutamic acid residue at position 54 was replaced by a basic lysine residue. Position 54 is within the PH domain (amino acids 16–124). Panel B, the diagram of the PH domain/d-IP₃ binding site is based on the crystal structure of PLC $\delta 1$ PH domain complexed with IP₃ (17). The substituted lysine residue at position 54 is proposed to interact with an oxygen at the 5 phosphate position of the substrate inositol head group.

position 54 (Fig. 1A). This residue lies in the $\beta 3/\beta 4$ loop of the PH domain of PLC $\delta 1$ (17). The backbone carbonyl of Glu-54 interacts with the 5 position of the inositol headgroup via a water-mediated hydrogen bond (17). We hypothesized that lysine substitution at this position would enhance affinity for phosphoinositides. This might occur because lysine is a fully charged species at physiological pH, and this ionic interaction would lead not only to displacement of a water molecule but also to enhanced bonding of the positively charged lysine with the negatively charged oxygen at the 5 phosphate of the inositol head group (Fig. 1B). Purified proteins were assayed for their ability to hydrolyze PI in a sodium deoxycholate/PI mixed micelle assay. Both native and mutant enzyme showed a very similar specific activity toward hydrolysis of PI, 0.95 $\mu\text{mol}/\text{min}/\text{mg}$ for PLC $\delta 1$ and 1.2 $\mu\text{mol}/\text{min}/\text{mg}$ for E54K, ensuring that the substitution E54K has not globally affected enzyme structure or activity.

Mutant PLC $\delta 1$ E54K Has Increased Hydrolytic Activity—PI(4,5)P₂ hydrolysis was assayed according to case III conditions as described under “Experimental Procedures.” Substrate hydrolysis was measured simultaneously varying the bulk concentration and mol fraction of PI(4,5)P₂. This was accomplished using multiple assays where the concentration of dodecyl maltoside was kept constant at 200 μM (to ensure that [detergent] was greater than the critical micellar concentration) and the PI(4,5)P₂ concentration increased from 1 to 75 μM . With dodecyl maltoside as diluent, rates of substrate hydrolysis are linear over 4 min, with r^2 values ranging from 0.95 to 0.99. When solid lines were fit to both sets of data using Equation 1 from “Experimental Procedures,” the Hill coefficient of PLC $\delta 1$ was calculated to be 2.2 ± 0.2 and for E54K was calculated to be 2.0 ± 0.1 (Table I). Further, Fig. 2 shows that E54K has a dramatically enhanced rate of catalysis. Thus, the single substitution in the PH domain of this PLC $\delta 1$ dramatically enhances its rate of hydrolysis but does not change the inherent

TABLE I
Comparison of PLC $\delta 1$ and E54K kinetic constants derived from activity assays according to case I, II, and III

PLC $\delta 1$ and E54K catalytic hydrolysis of PI(4,5)P₂/dodecyl maltoside mixed micelles was carried out in 10 μM Ca²⁺ (buffered with EGTA), 100 mM NaCl, 5 mM dithiothreitol, 0.1% gelatin, and 20 mM HEPES, pH 7.0. Kinetic constants were according to case I, II, or III as described under “Experimental Procedures.” The Hill coefficients (n) were calculated by fitting case III data to Equation 1. Both the interfacial Michaelis-Menten constant (K_m) as well as the interfacial V_{max} were calculated by fitting case II data to Equation 3. The equilibrium dissociation constants (K_s) were calculated by fitting case I data to Equation 2. Data are means \pm S.E.

	Hill coefficient n case III	Interfacial K_m case II	K_s case I	V_{max} case II
			μM	$\mu\text{mol}/\text{min}/\text{mg}$
PLC $\delta 1$	2.2 ± 0.2	0.012 ± 0.002	210 ± 48	4.9 ± 0.3
E54K	2.0 ± 0.1	0.034 ± 0.01	85 ± 36	31 ± 3

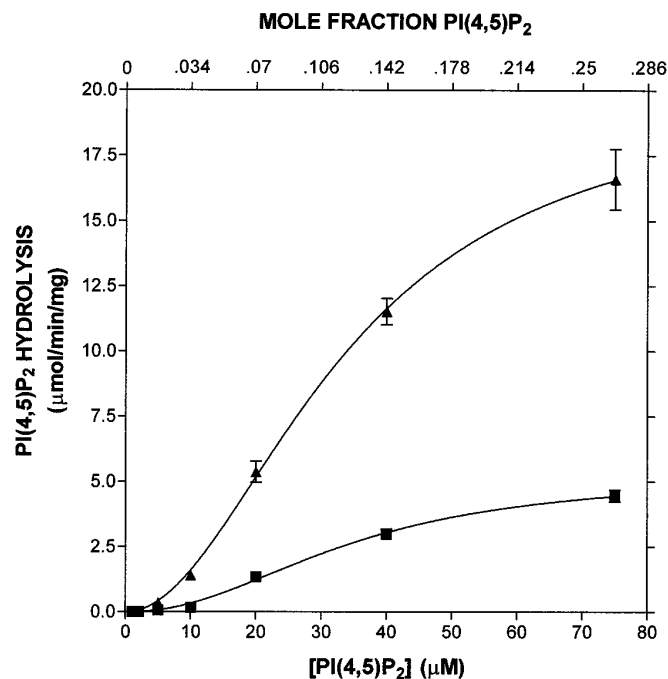

FIG. 2. PLC $\delta 1$ and E54K show the same degree of catalytic cooperativity, but E54K has a higher initial rate of PI(4,5)P₂ hydrolysis. Initial rates of substrate hydrolysis are shown for native (■) and mutant (▲) enzyme as a function of both bulk PI(4,5)P₂ concentration and mol fraction of substrate (case III). Activity toward PI(4,5)P₂/dodecyl maltoside mixed micelles was assayed according to case III conditions as stated under “Experimental Procedures” with the concentration of dodecyl maltoside fixed at 200 μM and the concentration of PI(4,5)P₂ varied. Solid lines were fit to raw data using Equation 1 from which Hill coefficients were obtained (Table I). Error bars represent the S.E. ($n = 2$) and are shown when larger than the symbol.

cooperativity in enzyme activity.

Determination of K_m —The effect of the mutation E54K on secondary binding within the interface (K_m) was determined by assaying native and mutant activity according to case II conditions as described under “Experimental Procedures.” Multiple measurements of enzyme activity were made at a constant bulk concentration of PI(4,5)P₂ (100 μM was chosen as this value is similar to the calculated K_s for E54K (Table I)) and varying mol fractions of substrate (0.01–0.25 mol fraction PI(4,5)P₂) using dodecyl maltoside as diluent (Fig. 3). The mol fraction of PI(4,5)P₂ was not increased above 0.25 because the kinetics of PI(4,5)P₂ hydrolysis deviated from linearity above 0.25 (data not shown) as has been observed by other investigators (16). Solid lines were fit to the data using Equation 3

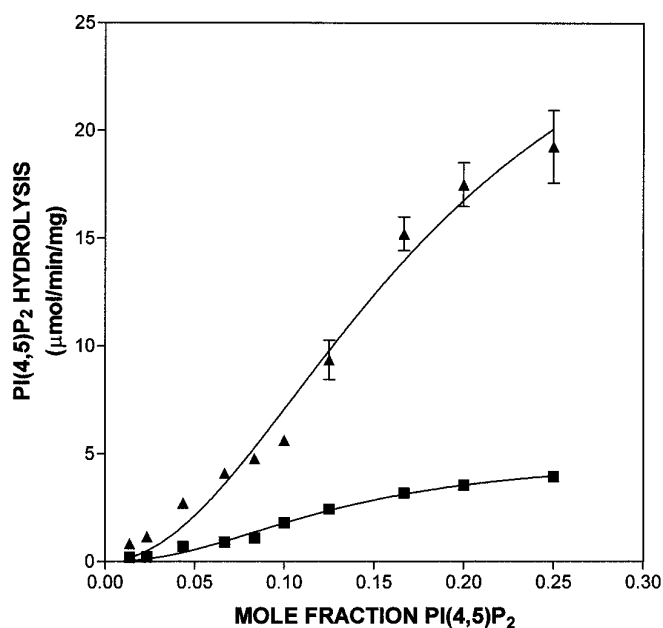

FIG. 3. PLC $\delta 1$ and E54K have similar K_m values though E54K has a higher V_{max} for PI(4,5) P_2 hydrolysis. Initial rates of substrate hydrolysis are shown for native (■) and mutant (▲) enzyme as a function of PI(4,5) P_2 surface concentration or PI(4,5) P_2 mol fraction (case II). Activity toward PI(4,5) P_2 /dodecyl maltoside mixed micelles was assayed for case II conditions according to "Experimental Procedures." The dodecyl maltoside concentration was varied to vary the PI(4,5) P_2 mol fraction, and the PI(4,5) P_2 concentration was fixed at 100 μM . Solid lines were fit to raw data using Equation 3 from which values of K_m and V_{max} were obtained (Table I). Error bars represent the S.E. ($n = 2$) and are shown when larger than the symbol.

("Experimental Procedures") which describes case II activity. The data fit a sigmoidal curve better than a hyperbolic one. This result has also been noted when measuring case II activity of PLC β (16) and phospholipase A_2 (1). For PLC $\delta 1$, $K_m = 0.012 \pm 0.002$, and for E54K $K_m = 0.034 \pm 0.01$ (Table I). V_{max} for PLC $\delta 1$ was 4.9 ± 0.3 $\mu mol/min/mg$ and 31 ± 3 $\mu mol/min/mg$ for E54K (Table I).

Determination of K_s —The effect of E54K on initial binding to the interface was determined by assaying enzyme activity according to case I conditions as described under "Experimental Procedures." Multiple assays were performed with varying bulk concentrations of PI(4,5) P_2 (10–325 μM) yet keeping the mol fraction of PI(4,5) P_2 constant. This was achieved by increasing the bulk concentration of PI(4,5) P_2 (adding more lipid) while simultaneously increasing the concentration of dodecyl maltoside thus ensuring that the PI(4,5) P_2 mol fraction was kept constant at 0.04. This value was chosen as it approximates the K_m for E54K. Solid lines were fit to the data using Equation 2 which simply describes a rectangular hyperbola with slope equal to 1 from which values of K_s were determined. E54K was much more active than native enzyme even at relatively low substrate concentrations (Fig. 4). The K_s for PLC $\delta 1$ was calculated to be 210 ± 48 μM , whereas the K_s for E54K was only 85 ± 36 μM (Table I). These values were within the range of constants determined previously for PLC β (16), PLC γ (18, 19), and PLC $\delta 1$ (13, 14).

In addition to the kinetic analysis, a thermodynamic equilibrium centrifugation binding assay was done to examine further initial binding to substrate. This assay was not used quantitatively since the kinetic data were more reliable, and the equilibrium association constant K_a (or $\frac{1}{K_s}$) has not always provided good agreement with affinity constants determined kinetically (13, 16). However, it was used qualitatively as an

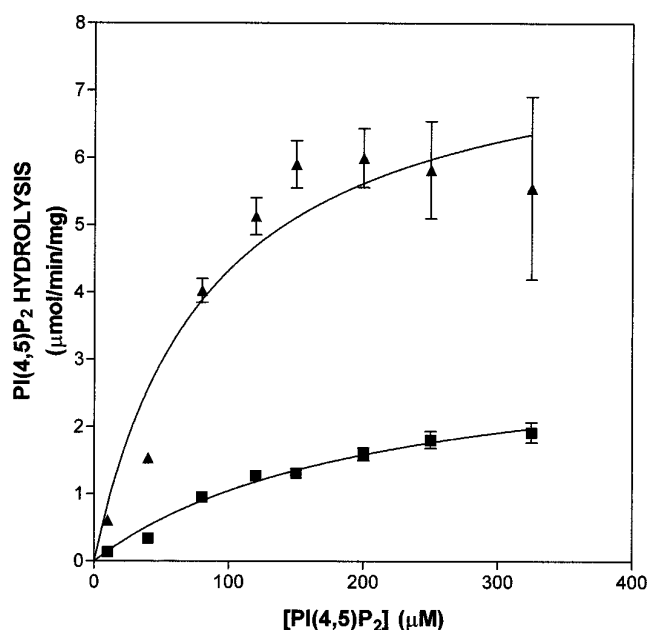

FIG. 4. E54K has both a lower K_s value than PLC $\delta 1$ as well as a higher initial rate of PI(4,5) P_2 hydrolysis. Initial rates of substrate hydrolysis are shown for native (■) and mutant (▲) enzyme as a function of bulk PI(4,5) P_2 concentration (case I). Activity toward PI(4,5) P_2 /dodecyl maltoside mixed micelles was assayed for case I conditions according to "Experimental Procedures." PI(4,5) P_2 concentration and dodecyl maltoside were covaried while keeping the PI(4,5) P_2 mol fraction constant at 0.04. Solid lines were fit to raw data using Equation 2 from which values of K_s were obtained (Table I). Error bars represent the S.E. ($n = 2$) and are shown when larger than the symbol.

other independent measure of the relative affinities of native and mutant enzyme for PI(4,5) P_2 /PE LUVs. E54K was associated with LUVs at much lower concentrations of PI(4,5) P_2 than is the case for PLC $\delta 1$ (Fig. 5). At about 1.1 μM PI(4,5) P_2 PLC $\delta 1$ was no longer associated with LUVs, suggesting that it no longer bound to PI(4,5) P_2 at this concentration. However, even at concentrations as low as 0.07 μM PI(4,5) P_2 E54K still associated with the LUVs. Neither enzyme bound to PE LUVs alone over the range of PE concentrations used in this assay (data not shown).

PI(4,5) P_2 Enhances the Rate of PI Hydrolysis for Both PLC $\delta 1$ and E54K—PI hydrolysis was assayed according to case III conditions described under "Experimental Procedures." The concentration of dodecyl maltoside was kept constant at 200 μM , and the PI concentration increased from 10 to 150 μM . When solid lines were fit to both sets of data using Equation 1 from "Experimental Procedures," the Hill coefficient of PLC $\delta 1$ was calculated to be 1.9 ± 0.2 and for E54K was calculated to be 2.0 ± 0.4 (Fig. 6). Fig. 6 shows that both PLC $\delta 1$ and E54K have similar rates of catalysis for PI in the absence of PI(4,5) P_2 (V_{max} for PLC $\delta 1 = 15 \pm 2$ nmol/min/mg and V_{max} for E54K = 18 ± 2 nmol/min/mg). Assays were also performed in the presence of 50 μM PI(4,5) P_2 . Hydrolysis of substrate under these conditions was still cooperative with Hill coefficients of 1.5 ± 0.3 for PLC $\delta 1$ and 1.6 ± 0.6 for E54K. In the presence of PI(4,5) P_2 (Fig. 6), PLC $\delta 1$ activity was enhanced 2-fold ($V_{max} = 27 \pm 3$ nmol/min/mg), but E54K activity was enhanced more than 5-fold ($V_{max} = 95 \pm 10$ nmol/min/mg).

D-IP $_3$ Inhibits PLC $\delta 1$ and E54K—D-IP $_3$ inhibited PI(4,5) P_2 hydrolysis for both native and mutant enzyme. Dodecyl maltoside/PI(4,5) P_2 mixed micelles were assayed according to "Experimental Procedures" with constant PI(4,5) P_2 (1 μM) and dodecyl maltoside (200 μM) concentrations. D-IP $_3$ (0 to 25 μM) was added to each assay prior to addition of enzyme. Both enzymes were inhibited by D-IP $_3$ in a dose-dependent manner

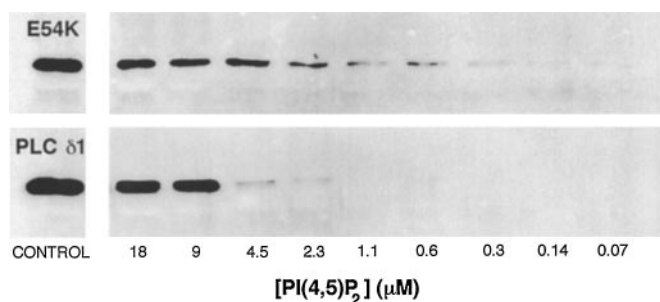

FIG. 5. E54K has a higher affinity for PI(4,5)P₂ in LUVs than native PLC $\delta 1$. Native and mutant enzyme were incubated with sucrose-loaded LUVs (20:1 PE/PI(4,5)P₂) with a range of PI(4,5)P₂ concentrations (0.07–18 μ M). This was followed by ultracentrifugation as described under “Experimental Procedures.” PLC $\delta 1$ and E54K protein remaining in the pellet were quantitated using sodium dodecyl sulfate-polyacrylamide gel electrophoresis and Western blot and were compared with controls. PLC $\delta 1$ bound to LUVs with PI(4,5)P₂ concentrations as low as 1.1 μ M. E54K also bound to LUVs but bound at PI(4,5)P₂ concentrations below 1.1 μ M even down to 0.07 μ M, suggesting that E54K has a much higher affinity for PI(4,5)P₂ in sucrose-loaded LUVs. The experiment shown is representative of multiple experiments that gave relatively similar results within each assay (E54K bound better than PLC $\delta 1$), but variability among assays precludes determination of rigorous binding constants.

(Fig. 7). The shift in the dose-response curve to the right for E54K was consistent with data demonstrating higher interfacial binding but might also suggest that this mutant bound D-IP₃ less well than native enzyme.

DISCUSSION

The dual phospholipid model (1, 2) is used extensively to characterize the activity of a number of enzymes that operate processively at a lipid/water interface (1, 16, 19). According to this model, enzymes must first associate with an interface that contains substrate to form an enzyme-interface complex (Reaction 1). Enzyme attachment to the interface has been shown to occur via protein/lipid interactions (13, 14, 16, 20) but could also occur via protein/protein interactions. Interface binding can be due to specific or nonspecific recognition of anchoring ligand, which may or may not be a true substrate for the enzyme. The model necessitates two distinct binding sites: an anchoring and catalytic site. For PLC $\delta 1$, these two sites exist in a single molecule (13–15). Interface binding is mediated through an NH₂-terminal PH domain (13, 14). This domain has been shown in PLC $\delta 1$ to bind polyphosphoinositides with high affinity and specificity (13, 14, 17, 21). Secondary binding of substrate occurs at the catalytic domain with a lower affinity (100 μ M) (13, 14, 17, 21, 22).

The tertiary structure of the PLC $\delta 1$ PH domain complexed to IP₃ was recently solved by x-ray crystallography at a resolution of 1.9 Å (17). IP₃ binds to the PH domain of PLC $\delta 1$ with very high affinity ($K_d = 210$ nM) (17). Other investigators functionally demonstrate a high affinity interaction among IP₃, PLC $\delta 1$ (23), and its PH domain (21). Several residues in the PLC $\delta 1$ PH domain interact directly with the phosphates of the inositol headgroup. These include basic residues Lys-30, Lys-32, and Lys-57 as well as a Van der Waals interaction between Trp-36 and the inositol ring (17). In fact, our laboratory has shown the functional importance of many of these residues. Substitution of Lys-30, Lys-32, and Trp-36 with glycine greatly attenuates substrate binding and hydrolysis (14). The glutamic acid residue at position 54 interacts with the 5 phosphate through a water-mediated hydrogen bond (17). The lysine substitution at this position (Fig. 1A) changes the charge state from -1 to $+1$, providing a positively charged species that may enhance binding to a negatively charged phosphate of the inositol head group for IP₃ as well as other phosphoinositides (Fig.

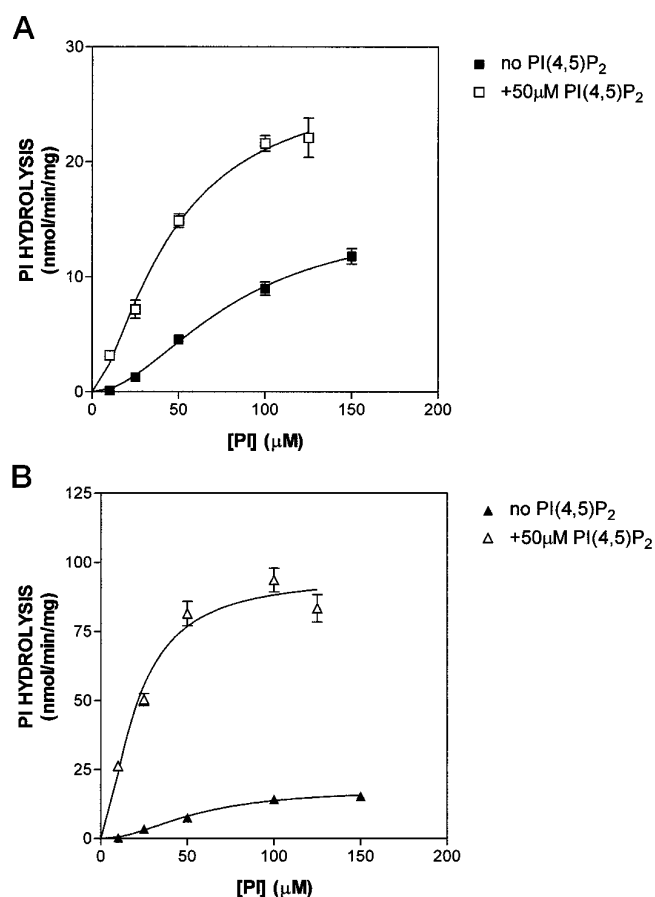

FIG. 6. PI(4,5)P₂ enhances PI hydrolysis for PLC $\delta 1$ and E54K, but E54K is enhanced more than PLC $\delta 1$. Panel A, native enzyme initial rates of substrate hydrolysis are shown as a function of both bulk PI concentration and mol fraction of substrate (case III). Activity toward PI/dodecyl maltoside mixed micelles was assayed according to case III conditions as stated under “Experimental Procedures” with the dodecyl maltoside concentration fixed at 200 μ M, calcium concentration fixed at 1 mM, and PI concentration varied. *Solid symbols* indicate activity in the absence of any PI(4,5)P₂. *Open symbols* indicate activity in the presence of 50 μ M PI(4,5)P₂. Panel B, mutant enzyme was assayed equivalently. *Solid lines* were fit to raw data using Equation 1 from which V_{max} and Hill coefficients were obtained. *Error bars* represent the S.E. ($n = 2$) and are shown when larger than the symbol.

1B) (17). We propose that the tighter binding of PI(4,5)P₂ to E54K is because of stronger direct ionic interactions with the lysine and elimination of potentially unfavorable interactions between the negatively charged native glutamic acid and PI(4,5)P₂.

PI hydrolysis in PI/sodium deoxycholate mixed micelles was used to assess PLC $\delta 1$ activity during and following purification. Both native (0.95 μ mol/min/mg) and mutant (1.2 μ mol/min/mg) enzyme have a similar specific activity toward hydrolysis of PI in PI/deoxycholate micelles, indicating that the tertiary structure of E54K has not been adversely affected by the amino acid substitution. A PI(4,5)P₂/dodecyl maltoside mixed micelle assay was used to characterize the kinetics of enzyme activity. This system has been used to characterize PLC $\beta 1$, PLC $\beta 2$, turkey erythrocyte PLC (16), and PLC $\delta 1$ (13). The main advantage in using dodecyl maltoside is that it is an inherently neutral diluent of PI(4,5)P₂. Increasing mol fractions of detergent are not inhibitory toward PLC activity (16). As reported by other groups (13, 14, 16), we find that so-called neutral diluents such as phosphatidylcholine (PC) and phosphatidylserine (PS) can affect PLC activity with PC being inhibitory and PS being stimulatory (data not shown). This makes these lipids less desirable as diluents of substrate since

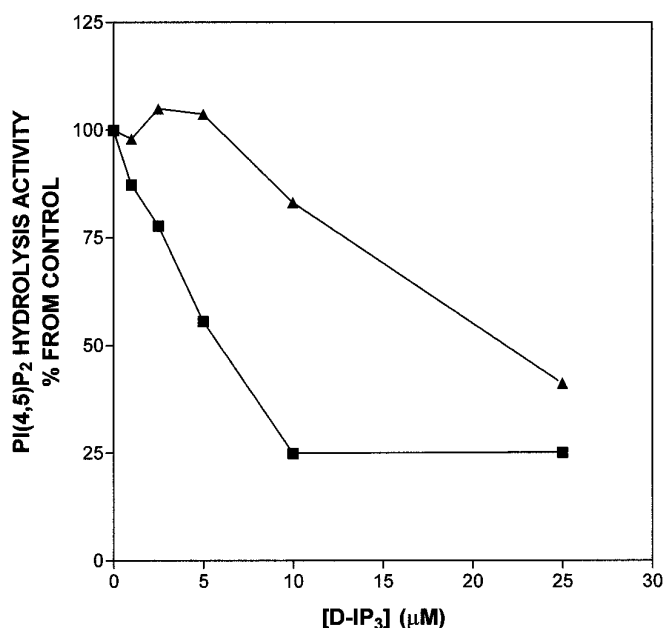

FIG. 7. D-IP₃ inhibits both PLC $\delta 1$ and E54K. Initial rates of substrate hydrolysis for native (■) and mutant (▲) enzyme were measured in the absence or presence of varying concentrations of D-IP₃. Activity toward PI(4,5)P₂/dodecyl maltoside mixed micelles was assayed using 0.033 μ M [³H]PI(4,5)P₂, 1 μ M PI(4,5)P₂, and 200 μ M dodecyl maltoside \pm 0–25 μ M D-IP₃ as described under "Experimental Procedures." Both enzymes are inhibited by low concentrations of D-IP₃. PLC $\delta 1$ is inhibited by as little as 1 μ M D-IP₃, and maximum inhibition is observed by 10 μ M inhibitor. In contrast, E54K is also inhibited by D-IP₃ but not to the same extent as native enzyme. Error bars represent the S.E. ($n = 2$) and are shown when larger than the symbol.

they are not true neutral diluents, and observed effects on PI(4,5)P₂ hydrolysis might be attributed to various complex diluent effects instead of substrate effects.

In agreement with several investigators (13, 14, 24), PLC $\delta 1$ hydrolysis of PI(4,5)P₂ and PI is processive and cooperative. The Hill coefficients for native and mutant enzyme for hydrolysis of substrates PI(4,5)P₂ and PI range from 1.5 to 2.2 (Table I). This suggests that at least 2 mol of substrate bind per mol of both PLC $\delta 1$ and E54K. Further, the similarity among Hill coefficients for native and mutant enzyme for both PI(4,5)P₂ and PI substrate suggests that the E54K mutation has not affected the inherent processivity of PLC $\delta 1$. A likely model for this processivity is that one molecule of substrate must bind to the catalytic site with the second molecule of PI(4,5)P₂ binding to the PH domain (13, 14, 16, 25) which serves as an anchor or site of allosteric modulation. Clearly, the PH domain is not solely responsible for processivity even among PLC enzymes. The PI-PLC from *Bacillus cereus* also hydrolyzes PI processively even though this enzyme contains no PH domain (26). In addition, human PLC $\delta 1$ that has 70 amino acids deleted from the PH domain can hydrolyze PI processively (14).

To understand fully the mechanisms of activation of enzymes that act at a lipid/water interface, it is necessary to determine the contribution of interfacial binding and catalysis in overall enzyme activation. Hendrickson and Dennis (20) demonstrate that didecanoyl-PC activation of secretory phospholipase A₂ substrate (thio-PE) hydrolysis is dependent on the surface concentration of didecanoyl-PC rather than on the bulk concentration of this activator. Further, they find that didecanoyl-PC activation of thio-PE substrate results not from an increase in secondary binding within the interface (no change in K_m) but by increasing the catalytic rate or efficiency of the enzyme (by increasing the V_{max}). Studies with the phospholipase A₂ inhibitor manoalide also show that interface binding is not crucial

for PC stimulation of PE hydrolysis (27).

Previous studies with PLC enzymes indicate that changes in K_s , K_m , and V_{max} mediate enzyme activation. Wahl *et al.* (19) find that epidermal growth factor-activated enzyme has a 4-fold lower K_m for PI(4,5)P₂ hydrolysis as well as a 7.5-fold lower K_s . This demonstrates that both interfacial binding as well as secondary substrate binding within the interface mediate the epidermal growth factor stimulation of PLC $\gamma 1$ PI(4,5)P₂ hydrolysis. The V_{max} values for activated and inactivated enzymes are equivalent, suggesting that activation does not affect catalytic efficiency. Work from our laboratory (14) shows that PI(4,5)P₂-mediated stimulation of PLC $\delta 1$ PI hydrolysis results from decreases in both K_s and K_m , although the largest magnitude change is in K_s . Again, V_{max} values for activated and unactivated enzymes are equivalent. Jones and Carpenter (18) report that phosphatidic acid enhances PI(4,5)P₂ hydrolysis not by increasing the affinity of PLC $\gamma 1$ for substrate micelles but by decreasing the K_m of the activated enzyme 10-fold and increasing the V_{max} 4-fold. These data suggest that phosphatidic acid activation of PLC $\gamma 1$ occurs not by affecting the affinity of enzyme for initial binding to substrate but by affecting secondary binding within the substrate interface or by affecting interfacial catalytic efficiency. $\beta\gamma$ subunits of heterotrimeric G-proteins activate the PLC $\beta 2$ enzyme (28, 29). Romoser *et al.* (28) find that at activating concentrations of $\beta\gamma$ subunits, PLC $\beta 2$ does not show any increased affinity for PI(4,5)P₂/lipid vesicles (28). Although the authors do not demonstrate the mechanism of activation, their data suggest that interfacial binding does not play a role in activation by $\beta\gamma$ subunits.

The results reported here demonstrate that catalytic efficiency (V_{max}) and interfacial binding (K_s) are the primary determinants of PLC $\delta 1$ enhanced activity. The PH domain mutant E54K has markedly enhanced catalytic activity (Fig. 3). Kinetic analyses show that E54K has a much higher V_{max} (31 μ mol/min/mg) than does PLC $\delta 1$ (4.9 μ mol/min/mg) (Table I). However, the K_m for E54K is actually a bit higher (0.034 mol fraction PI(4,5)P₂) than for PLC $\delta 1$ (0.012 mol fraction PI(4,5)P₂) (Table I). These data suggest that the affinity for PI(4,5)P₂ binding within the interface at the catalytic site is unchanged or even lower so that, all things equal, E54K and native enzyme should have the same rates of substrate hydrolysis, or E54K should hydrolyze substrate less well. Therefore, increased catalytic efficiency (V_{max}) is likely a determining factor in the observed enhanced activity of E54K.

E54K shows a reduction of approximately 2.5-fold in the K_s (85.0 μ M) compared with native enzyme (211.5 μ M) (Fig. 4 and Table I). These data suggest that the increased activity of E54K is partially a result of enhanced initial binding to the interface. A centrifugation binding assay with LUVs confirms the enhanced interface binding of E54K. E54K is able to bind to lower concentrations of PI(4,5)P₂ in LUVs than PLC $\delta 1$. These data are not examined quantitatively in part because the kinetic constants are more rigorous, and the equilibrium association constant K_a (or $\frac{1}{K_s}$) has not always provided good agreement with affinity constants determined kinetically (13, 16). The poor agreement between K_s and K_a may be the result of different lipid interfaces differentially affecting enzyme vesicle binding affinity (14, 16). In addition, the assumption of 1:1 stoichiometry between PI(4,5)P₂ and enzyme might be violated given that results for case II data are sigmoidal, indicating cooperativity of binding within the interface. Among other things this may indicate the presence of another PI(4,5)P₂ binding site within the interface. Some likely structural candidates might be the C2 domain (30) or the gelsolin-like PI binding domain

(31), both of which are found in PLC $\delta 1$.

The E54K mutation has not generated a constitutively active PLC $\delta 1$ since rates of PI hydrolysis for native and mutant enzymes are equivalent in the absence of PI(4,5)P₂ (Fig. 6). PI hydrolysis is cooperative similar to PI(4,5)P₂ hydrolysis, suggesting that both substrates serve as PH domain ligands. 50 μ M PI(4,5)P₂ enhances the rates of PI hydrolysis for both enzymes, which shows that PI(4,5)P₂ is specifically required for enhanced activity (Fig. 6). These results agree with previous data showing that PI(4,5)P₂ increases the rate of PI hydrolysis by wild-type enzyme in phospholipid vesicles (14). The kinetic data support a mechanism where PI(4,5)P₂ specifically binds to the PH domain and allosterically modulates the active site of the enzyme increasing catalytic efficiency. A mechanism of allosteric modulation of catalysis by phospholipid binding has also been proposed for PKC (32, 33). PS cooperatively enhances the activity of PKC in PS/Triton X-100 mixed micelles with a high degree of specificity (33). Further, PS binding to PKC enhances proteolysis at a specific site of the enzyme, suggesting that PS binding induces an allosteric modulation of PKC structure (34).

Both native and E54K enzyme can be inhibited by low concentrations of D-IP₃ (Fig. 7). Interestingly, the data show that D-IP₃ is less potent at E54K than native PLC $\delta 1$ (Fig. 7). Although the mechanism for this difference is unclear, it might be because of E54K increased affinity for PI(4,5)P₂. These data are somewhat surprising given that D-IP₃ and PI(4,5)P₂ have been shown to have similar high affinities for the PLC $\delta 1$ PH domain (21, 35), which suggests that the structural determinants mediating a high affinity interaction between PH domain and the phosphoinositides are in the polar head group (17). The mechanisms of this differential inhibition will be explored in the future.

In summary, we have found that a single amino acid substitution of PLC $\delta 1$ leads to enzyme activation. The mutation is a lysine for glutamic acid substitution at position 54 within the PH domain. The native and mutant enzymes were characterized using the dual phospholipid binding model of Hendrickson and Dennis (1). The data show that both native and mutant enzymes operate in the same processive mode of hydrolysis, both binding to 2 mol of PI(4,5)P₂/mol of enzyme. The interfacial V_{\max} for E54K is about 6-fold greater than that for native PLC $\delta 1$. The data also show that E54K shows no increase in substrate binding within the PI(4,5)P₂/dodecyl maltoside micelle interface (K_m). However, in both kinetic and thermodynamic assays, E54K has an increased affinity for initial substrate binding. In fact, the K_s for E54K is approximately 2.5-fold lower than that of native enzyme. PI(4,5)P₂ also enhances PI hydrolysis for PLC $\delta 1$ by almost 2-fold but more than 5-fold for E54K. Thus, both increased interfacial binding and increased catalytic efficiency enhance enzyme activity. The PH domain mediates these effects in PLC $\delta 1$. It is interesting to speculate that this same mechanism of activation may operate for other enzymes as well. The small nonreceptor tyrosine kinase, Bruton's tyrosine kinase, also has a PH domain. In fact, when the conserved mutation E54K is made in this enzyme (E41K), the result is a 100-fold increase in cell growth in NIH-3T3 cells and enhanced Bruton's tyrosine kinase membrane association (36). Although the mechanism for this gain of function is not clear, recent evidence shows that Bruton's tyrosine kinase PH domain containing the E41K mutation binds to inositol 1,2,3,4,5,6-hexakisphosphate 2-fold better than native Bruton's tyrosine kinase PH domain (37). Given that the PH

domain is the structural determinant mediating PLC $\delta 1$ membrane translocation (38) and enzyme activation (14), it is possible that the *in vivo* transformation and membrane localization seen in the mutant Bruton's tyrosine kinase follow the mechanism we have proposed for E54K/PLC $\delta 1$. There is already ample evidence demonstrating that the PH domain of various enzymes mediates enzyme translocation to membranes (14, 36, 38, 39). Our data show the importance of membrane association and allosteric modulation in mediating enzyme activation *in vitro*.

Acknowledgments—We thank Dr. Klim King for critical discussions and for assistance with protein/lipid binding assays. We thank Dr. Steven Roffler for providing PLC $\delta 1$ monoclonal antibodies.

REFERENCES

- Hendrickson, H. S., and Dennis, E. A. (1984) *J. Biol. Chem.* **259**, 5734–5739
- Carman, G. M., Deems, R. A., and Dennis, E. A. (1995) *J. Biol. Chem.* **270**, 18711–18714
- Berridge, M. J., and Irvine, R. F. (1989) *Nature* **341**, 197–205
- Berridge, M. J., and Irvine, R. F. (1984) *Nature* **312**, 315–321
- Yagisawa, H., Tanase, H., and Nojima, H. (1991) *J. Hypertens.* **9**, 997–1004
- Homma, Y., and Emori, Y. (1995) *EMBO J.* **14**, 286–291
- Feng, J.-F., Rhee, S. G., and Im, M.-J. (1996) *J. Biol. Chem.* **271**, 16451–16454
- Kato, H., Fukami, K., Shibasaki, F., Homma, Y., and Takenawa, T. (1992) *J. Biol. Chem.* **267**, 6483–6487
- Shimohama, S., Perry, G., Richey, P., Praprotnik, D., Takenawa, T., Fukami, K., Whitehouse, P. J., and Kimura, J. (1995) *Brain Res.* **669**, 217–224
- Berg, O. G., Yu, B. Z., Rogers, J., and Jain, M. K. (1991) *Biochemistry* **30**, 7283–7297
- Jain, M. K., Ranadive, G., Yu, B. Z., and Verheij, H. M. (1991) *Biochemistry* **30**, 7330–7340
- Rebecchi, M., Peterson, A., and McLaughlin, S. (1992) *Biochemistry* **31**, 12742–12747
- Cifuentes, M. E., Honkanen, L., and Rebecchi, M. J. (1993) *J. Biol. Chem.* **268**, 11586–11593
- Lomasney, J. W., Cheng, H.-F., Wang, L.-P., Kuan, Y.-S., Liu, S.-M., Fesik, S. W., and King, K. (1996) *J. Biol. Chem.* **271**, 25316–25326
- Cheng, H.-F., Jiang, M.-J., Chen, C.-L., Liu, S.-M., Wong, L.-P., Lomasney, J. W., and King, K. (1995) *J. Biol. Chem.* **270**, 5495–5505
- James, S. R., Paterson, A., Harden, T. K., and Downes, C. P. (1995) *J. Biol. Chem.* **270**, 11872–11881
- Ferguson, K. M., Lemmon, M. A., Schlessinger, J., and Sigler, P. B. (1995) *Cell* **83**, 1037–1046
- Jones, G. A., and Carpenter, G. (1993) *J. Biol. Chem.* **268**, 20845–20850
- Wahl, M. I., Jones, G. A., Nishibe, S., Rhee, S. G., and Carpenter, G. (1992) *J. Biol. Chem.* **267**, 10447–10456
- Hendrickson, H. S., and Dennis, E. A. (1984) *J. Biol. Chem.* **259**, 5740–5744
- Lemmon, M. A., Ferguson, K. M., Obrien, R., Sigler, P. B., and Schlessinger, J. (1995) *Proc. Natl. Acad. Sci. U. S. A.* **92**, 10472–10476
- Rebecchi, M., Boguslavsky, V., Boguslavsky, L., and McLaughlin, S. (1992) *Biochemistry* **31**, 12748–12753
- Cifuentes, M. E., Delaney, T., and Rebecchi, M. J. (1994) *J. Biol. Chem.* **269**, 1945–1948
- Pawson, T. (1995) *Nature* **373**, 573–580
- Boguslavsky, V., Rebecchi, M., Morris, A. J., Jhon, D. Y., Rhee, S. G., and McLaughlin, S. (1994) *Biochemistry* **33**, 3032–3037
- Hendrickson, H. S., Johnson, E. K., Khan, T. H., and Chial, H. J. (1992) *Biochemistry* **31**, 12169–12172
- Bianco, I. D., Kelley, M. J., Crowl, R. M., and Dennis, E. A. (1995) *Biochim. Biophys. Acta* **1250**, 197–203
- Romoser, V., Ball, R., and Smrcka, A. V. (1996) *J. Biol. Chem.* **271**, 25071–25078
- Smrcka, A. V., and Sternweis, P. C. (1993) *J. Biol. Chem.* **268**, 9667–9674
- Davletov, B. A., and Sudhof, T. C. (1993) *J. Biol. Chem.* **35**, 26386–26390
- Yu, F.-X., Sun, H.-Q., Janmey, P. A., and Yin, H. L. (1992) *J. Biol. Chem.* **267**, 14616–14621
- Orr, J. W., and Newton, A. C. (1992) *Biochemistry* **31**, 4667–4673
- Orr, J. W., and Newton, A. C. (1992) *Biochemistry* **31**, 4661–4667
- Orr, J. W., Keranen, L. M., and Newton, A. C. (1992) *J. Biol. Chem.* **267**, 15263–15266
- Garcia, P., Gupta, R., Shaw, S., Morris, A. J., Rudge, S. A., Scarlata, S., Petrova, V., McLaughlin, S., and Rebecchi, M. J. (1995) *Biochemistry* **34**, 16228–16234
- Li, T. J., Tsukada, S., Satterthwaite, A., Havlik, M. H., Park, H., Takatsu, K., and Witte, O. N. (1995) *Immunity* **2**, 451–460
- Fukuda, M., Kojima, T., Kabayama, H., and Mikoshiba, K. (1996) *J. Biol. Chem.* **271**, 30303–30306
- Paterson, H. F., Savopoulos, J. W., Perisic, O., Cheung, R., Ellis, M. V., Williams, R. L., and Katan, M. (1995) *Biochem. J.* **312**, 661–666
- Pitcher, J. A., Touhara, K., Payne, E. S., and Lefkowitz, R. J. (1995) *J. Biol. Chem.* **270**, 11707–11710