



Contents lists available at ScienceDirect

Science of the Total Environment

journal homepage: [www.elsevier.com/locate/scitotenv](http://www.elsevier.com/locate/scitotenv)

## Developing strategies to reduce spray drift in pneumatic spraying in vineyards: Assessment of the parameters affecting droplet size in pneumatic spraying

A. Miranda-Fuentes<sup>a,\*</sup>, P. Marucco<sup>b</sup>, E.J. González-Sánchez<sup>a</sup>, E. Gil<sup>c</sup>, M. Grella<sup>b</sup>, P. Balsari<sup>b</sup>

<sup>a</sup> Department of Rural Engineering, University of Córdoba, Ctra. Nacional IV, km 396, Campus de Rabanales, Córdoba 14014, Spain

<sup>b</sup> Department of Agricultural, Forest and Food Sciences (DiSAFA), University of Turin (UNITO), Largo Paolo Braccini 2, 10095 Grugliasco, TO, Italy

<sup>c</sup> Department of Agri Food Engineering and Biotechnology (DEAB), Universitat Politècnica de Catalunya (UPC), Esteve Terradas 8, Campus del Baix Llobregat D4, 08860 Castelldefels, Barcelona, Spain

### HIGHLIGHTS

- Pneumatic sprayers produce very fine droplets that are very likely to be drifted.
- Pneumatic nozzle's air spout diameter had a strong influence on the droplet size.
- Airflow rate and liquid flow rate are strongly related to droplet size.
- Droplet size can be accurately predicted with the aforementioned parameters.
- Drift risk can be reduced by modifying the spout characteristics.

### GRAPHICAL ABSTRACT

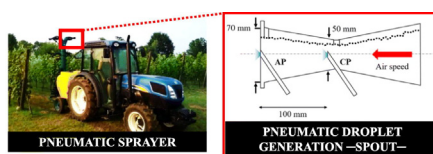

Droplet spectra measurements using laser spray diffraction system.

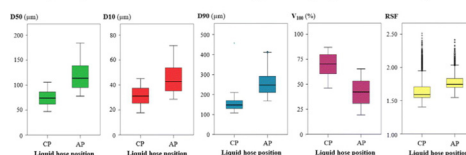

### ARTICLE INFO

#### Article history:

Received 18 July 2017

Received in revised form 23 October 2017

Accepted 23 October 2017

Available online xxx

Editor: E. Capri

#### Keywords:

Pneumatic spraying

Droplet size

Spray drift

Spray technology

Droplet homogeneity

### ABSTRACT

Pneumatic sprayers are widely used in vineyards due to their very fine droplet size, which makes the drift risk to become an important problem to be considered. The aim of this study was to assess the effect of the spout diameter at the release point on the spray droplet size and uniformity achieved for different liquid flow rates (LFR) and air flow rates (AFR).

A test bench was developed to simulate a real pneumatic sprayer under laboratory conditions, and it was empirically adjusted to match the air pressure conditions as closely as possible to real working conditions. Two positions of insertion of the liquid hose, the conventional position (CP) and an alternative position (AP), were tested for three LFRs, 1.00, 1.64, and 2.67 L min<sup>-1</sup>, and four AFRs, 0.280, 0.312, 0.345, and 0.376 m<sup>3</sup> s<sup>-1</sup>. The air speed decrease between the two insertion points of the liquid hose was measured. A Malvern SprayTec® instrument was used to measure the droplet size, and the D50, D10, and D90 parameter values were obtained. The relative SPAN factor (RSF) was also calculated. A model to predict variations in D50 was fitted using the aforementioned parameters.

The results show that variations in the diameter of the spout significantly change the droplet size, producing a mean increase of 59.45% in D50 and similar increases in D10 and D90. The model developed to predict variations in D50 has a very high degree of accuracy ( $R^2 = 0.945$ ). The relative decrease in the air speed along the spout did not present significant differences for the different airflow rates tested. The results of the study show that the

\* Corresponding author.

E-mail address: [antonio.miranda@uco.es](mailto:antonio.miranda@uco.es) (A. Miranda-Fuentes).

droplet size produced in pneumatic spraying can be modified easily by varying the air spout dimensions. This should be taken into account by manufacturers from a design point of view.

© 2017 Elsevier B.V. All rights reserved.

## 1. Introduction

Plant protection product (PPP) applications have changed substantially in recent years due to the new European legal framework, beginning with the European Directive for Sustainable Use of Pesticides 2009/128/EC (EC, 2009), which focuses on increasing spray application efficiency, supporting strategies for integrated control, and spray dose reduction. This new paradigm has its origin in concern about the various factors that contribute to the risk of PPP pollution, which is related mainly to field run-off and spray drift (TOPPS-Prowadis, 2014).

This risk is attracting increased attention from the general population and, of course, from the scientific community. This social concern is justified by the fact that spray drift affects not only water pollution and the environment but also adjacent sensitive areas, such as schools and natural parks, and also bystanders (Butler Ellis et al., 2014).

According to ISO22866:2005 (ISO, 2005), drift is defined as 'the quantity of plant protection product that is carried out of the sprayed area (treated) by the action of air currents during the application process'. In any orchard, this includes droplets that move horizontally through the orchard canopy and beyond the orchard, as well as droplets that move upward above the canopy (via direct spraying into the air or upward diffusion from the sprayed canopy). For this reason, spray drift generated during spray applications to bush/tree crops is complex and difficult to control (Delele et al., 2007; Llorens et al., 2016; van de Zande et al., 2008). Some authors have quantified that, during an orchard spray application, 30 to 50% of the total applied PPP spray mixture can be lost to the air from the targeted site to a non-target receptor site (Van den Berg et al., 1999). In addition to the more localised movement of agrochemical residues in turbulent air masses downwind of the application, residues can also become concentrated in inversions or stable air masses and be transported long distances (Felsot et al., 2011). Thus, during and immediately after spray application, non-target receptors, including water (Dabrowski and Schulz, 2003), plants (Marrs et al., 1993), and animals (Davis and Williams, 1990; Ernst et al., 1991; Lahr et al., 2000) can be acutely exposed and may therefore face the risk of adverse effects. Thus, drift may cause damage to non-target plants, contaminate water courses, generate illegal residues in food and feed commodities (Benbrook and Baker, 2014), and cause adverse exposure to animals and humans (Felsot et al., 2011; Butler Ellis et al., 2010).

According to Hofman and Solseng (2001) the factors affecting pesticide emissions to the air during the application process can be divided into technical and environmental factors.

Among the technical factors that affect spray drift, the size of the particles has a large impact on the off-target drift (Take et al., 1996), as this parameter has been found to be more important than the environmental wind speed during the spray drift generation process (Bird et al., 1996; Combellack, 1982; Frost and Ware, 1970; Grella et al., 2017). Thus, producing a fine spray tends to increase the drift risk (Bode et al., 1976). Likewise, in bush/tree crop spray applications, the air flow of the sprayer's fan plays a crucial role in ensuring the biological efficacy of treatments and reducing the drift risk. Correct adjustment of the air jet for the canopy size, leaf density, and row distance reduces spray drift by increasing spray deposition (Dekeyser et al., 2014; Doruchowski et al., 2002; Duga et al., 2015; Marucco et al., 2008).

Thus, for many years, the main efforts to prevent spray drift have been focused on generating larger droplets. Nozzle type (Nuyttens et al., 2007a) and nozzle size (Guler et al., 2007) have the greatest effects on droplet size and velocity spectra. With hydraulic nozzles, the main strategy for reducing spray drift is the use of air induction (AI) nozzles (Felsot et al., 2011; TOPPS-Prowadis, 2014), which have been proven

to reduce spray drift substantially, compared to conventional nozzles, by maintaining similar deposition values (Derksen et al., 2007; Ganzelmeier and Rautmann, 2000) and thus ensuring consistency in the biological efficacy of treatments (Doruchowski et al., 2017; Garcerá et al., 2017).

Among the various parameters used in characterising the range of droplet sizes in a spray, the most commonly used is the volumetric median diameter (VMD or D50). Other useful parameters include the tenth- and ninetieth-percentile diameters (D10 and D90) and the percentage of the volume composed of droplets with diameters < 100  $\mu\text{m}$  ( $V_{100}$ ). In characterising the relationship between spray drift and droplet size, many researchers have considered droplets smaller than 75  $\mu\text{m}$  (Hobson et al., 1990; Hobson et al., 1993; Miller and Hadfield, 1989), 100  $\mu\text{m}$  (Bode, 1984; Byass and Lake, 1977; Gil et al., 2014; Grover et al., 1978), 150  $\mu\text{m}$  (Combellack et al., 1996; Yates et al., 1985), or 200  $\mu\text{m}$  (Bouse et al., 1990) to be the ones most prone to drift. Zhu et al. (1994) found that spray particles < 50  $\mu\text{m}$  in diameter remain suspended in the air indefinitely or until they evaporate. Although there is no specific droplet size range that is likely to drift under all conditions, droplets with diameters < 100  $\mu\text{m}$  are generally accepted to be highly driftable. The  $V_{100}$  parameter is therefore often used as an indicator of the drift risk potential associated with a nozzle or application technology (van de Zande et al., 2008). Many authors have found significant relationships between drift and  $V_{100}$  (Arvidsson et al., 2011; Baetens et al., 2008; Bode, 1984; Bouse et al., 1990; Combellack et al., 1996; Gil et al., 2015; Nuyttens et al., 2007a, 2010, 2011).

Pneumatic sprayers are very popular and are widely used in the most important vineyard areas all around the world. Their suitability for low to very low volume application rates, the large working capacity of the sprayers, and the importance of generating good and uniform coverage together with precise penetration into the canopy make this type of spray technology an interesting option, mainly for large farms. Pneumatic sprayers represent approximately 25% of the total market for sprayers for bush/tree crops, with very widespread use in vineyards in southern Europe. However, few advances have been made in this technology with respect to the droplet size and the collateral risk of drift.

The pneumatic diffusers that are typically mounted on vineyard sprayers consist of spouts in which spray droplets are generated by the action of a high-speed, high-pressure air stream on a liquid conveyed at low pressure (maximum of 0.15 MPa) inside the spout (Balsari and Scienza, 2003). The Venturi effect created at the internal part of the spouts generates very fine droplets. Although there have been very few studies of droplet size spectra produced by pneumatic sprayers (Balsari et al., 2016), the diameters of the droplets are known to be typically < 100  $\mu\text{m}$ , which is the threshold below which droplets become very driftable. This driftability increases when droplets are blown away by pneumatic cannons mounted on the top part of the sprayer. These cannons disperse the spray to nearby rows with high air speeds and flight distances, which increases the time during which the spray is exposed to wind and consequently increases the drift risk.

With hydraulic nozzles, the main factors affecting the characteristics of the droplet spectra are the nozzle type and size, and the working pressure. In contrast, with pneumatic sprayer spouts, the main parameters affecting the droplet size spectra are the variations in the air speed and liquid flow rate, which depend on the physical characteristics of the spouts and the characteristics of the elements that release the liquid into the air stream, including their positions inside the spouts. The air flow speed is inversely correlated to the droplet size: higher air speeds produce finer droplets. The opposite is true of the relation between

the droplet size and the liquid flow rate: higher liquid flow rates produce larger droplets (Márquez, 2007). However, there is little reliable information available about the quantitative relations between these two parameters and droplet size.

The main objective of this work was to assess quantitatively the influence of the working parameters, i.e., the air flow rate and liquid flow rate, on the size of the droplets generated in a pneumatic cannon similar to the ones commonly used in vineyard sprayers. Another objective was to assess the influence of the spout diameter at the release point of the liquid on the droplet size. Droplet uniformity and its relationship to the risk of drift during vineyard spraying using pneumatic sprayers were also examined in this study.

## 2. Materials and methods

### Abbreviations

AFR	Air flow rate
AP	Alternative insertion position of the liquid hose in the pneumatic nozzle
CP	Conventional insertion position of the liquid hose in the pneumatic nozzle
D10	Diameter for which a volume fraction of 10% is made up of drops with diameters smaller than this value (expressed in $\mu\text{m}$ )
D50	Volume median diameter of diameter for which a volume fraction of 50% is made up of drops with diameters smaller than this value (expressed in $\mu\text{m}$ )
D90	Diameter for which a volume fraction of 90% is made up of drops with diameters smaller than this value (expressed in $\mu\text{m}$ )
HP	Hose position of the liquid hose in the pneumatic nozzle
LFR	Liquid flow rate in the spraying circuit
RSF	Relative SPAN factor, a measure of the droplet homogeneity in the spray population
SD	Spout diameter of the pneumatic nozzle
V <sub>100</sub>	Portion of the sprayed volume composed of droplets finer than 100 $\mu\text{m}$ .
VMD	Volumetric mean diameter, equivalent to D50

### 2.1. Test bench setup

Trials were carried out in the laboratory of the Department of Agricultural, Forest, and Food Sciences (DiSAFA) of the University of Torino (Grugliasco, Torino, Italy). A prototype of a test bench was mounted using three different spaces (Fig. 1).

The test bench was mounted using three different spaces, i.e., three different rooms, to separate the spraying elements (A in Fig. 1) from the measurement area (B in Fig. 1) and from the data acquisition and analysis area (C in Fig. 1). Spaces A and B were connected through a window through which the air spout was placed.

The spraying circuit (Fig. 2) was powered by a membrane pump (AR 202, Anнови Reverberi S.P.A., Modena, Italy), with a maximum pressure of 2.0 MPa and a maximum flow rate of 23.2 L min<sup>-1</sup>. A manometer with a measurement resolution of  $\pm 0.01$  MPa was used to adjust the working pressure and thereby control the liquid flow rate (Fig. 2). The pump was driven by an asynchronous 230-V, 15.3-A electrical engine (model 100 L<sub>2</sub>, Ravel Srl, Bomperto, Italy) and fed by a water tank with a 50-L capacity.

The pneumatic system consisted of a centrifugal fan (CIMA SpA, Pavia, Italy) controlled by a 230-V, 15.9-A electrical engine (LEX-LEN 200 L-8, Euromotori Srl, Macherio, Italy) and a flexible tube 2.5 m in length and 150 mm in diameter that conducted the air towards the air spout. The fan rotary speed was remotely controlled using a dial positioned in the fan control box (Fig. 1). This control device allowed for a

working resolution of  $\pm 1$  rpm. The actual fan rotary speed was checked using an optical tachometer (Photo tachometer, Lutron Electronic Enterprise Co, Ltd., Taipei, Taiwan).

### 2.2. Pneumatic nozzle description

To assess the effect of the spout diameter at the release point on the size of the generated droplets, two insertion positions for the liquid hose (hose positions, HP) were tested: the conventional position (CP) and an alternative position (AP) (Fig. 3), corresponding to spout diameters of 50 mm and 70 mm, respectively. Because the AP location was farther from the air flow inlet than the CP, a reduction in the air speed (AS) was expected for a constant air flow rate. Consequently, as the droplet diameter is inversely proportional to the air speed in pneumatic spraying (Di Prinzio et al., 2010), a decrease in the AS was expected when using this AP. The reason, therefore, for choosing the more external position of the spout as AP was that, in this position, the maximum decrease in air speed was expected to be achieved.

The resulting droplet sizes produced for the two positions were determined using a commercial pneumatic nozzle (model TC·SAV2C, CIMA SpA, Pavia, Italy) of the type that is usually mounted on the top part of a vineyard pneumatic sprayer to spray adjacent rows. The spout had a conical shape with a fixed insertion position where the liquid pipe was inserted.

Alongside the holes made in the spout to insert the liquid hose, a curved implement was inserted into the spout to measure the pressure along the longitudinal axis and perpendicular to the air current lines.

### 2.3. Adjustment of the fan rotary speed to match the air pressure to real conditions

The stationary fan was calibrated using a real pneumatic sprayer (model TC·SAV2C, CIMA SpA, Pavia, Italy) equipped with two upper outlets (cannons) (spray-head model Savoy, CIMA SpA). The sprayer was attached to a tractor (T4, New Holland Inc., Torino, Italy). The calibration procedure consisted of determining the relationship between the rotary speeds of the test bench's fan and the real sprayer's fan to maintain similar working conditions. The purpose of this was to ensure that the air pressures measured at a specific point in the air spout would be the same in both cases.

The air pressure in the sprayer's spout was measured at a point on its mid plane (Fig. 4a). An implement was used to measure the air flow pressure at the centre of the spout and in the direction of the air speed vector, and a manometer with a measurement resolution of  $\pm 1$  mm H<sub>2</sub>O was used to measure, in terms of water height, the air pressure of the sprayer when its fan was rotating at 300, 350, 400, 450, 500, and 550 rpm. The fan rotation speeds were measured with an optical tachometer (Photo tachometer, Lutron Electronic Enterprise Co, Ltd.).

The measurements performed using the test bench's fan and the sprayer's fan were taken using the same procedures and sampling positions (Fig. 4b). In addition, the same fan rotary speeds used in the real sprayer were measured.

Once the relationship between fan rotary speed and air pressure was obtained, the operating speed of the test bench fan was calculated according to the regression curve for each fan rotary speed tested (Fig. 7). The air pressure measurements were repeated at the calculated speed values and empirically corrected to be equal to those obtained for the sprayer fan for the corresponding fan rotary speed values. This ensured that the pressure was exactly the same in both systems.

### 2.4. Air speed reduction along the spout longitudinal axis

The variation in the air speed along the longitudinal axis of the spout was checked and found to be proportional to the air flow rate. The air speed values were measured along the longitudinal axis of the spout between the two intended positions of insertion of the liquid hose. The

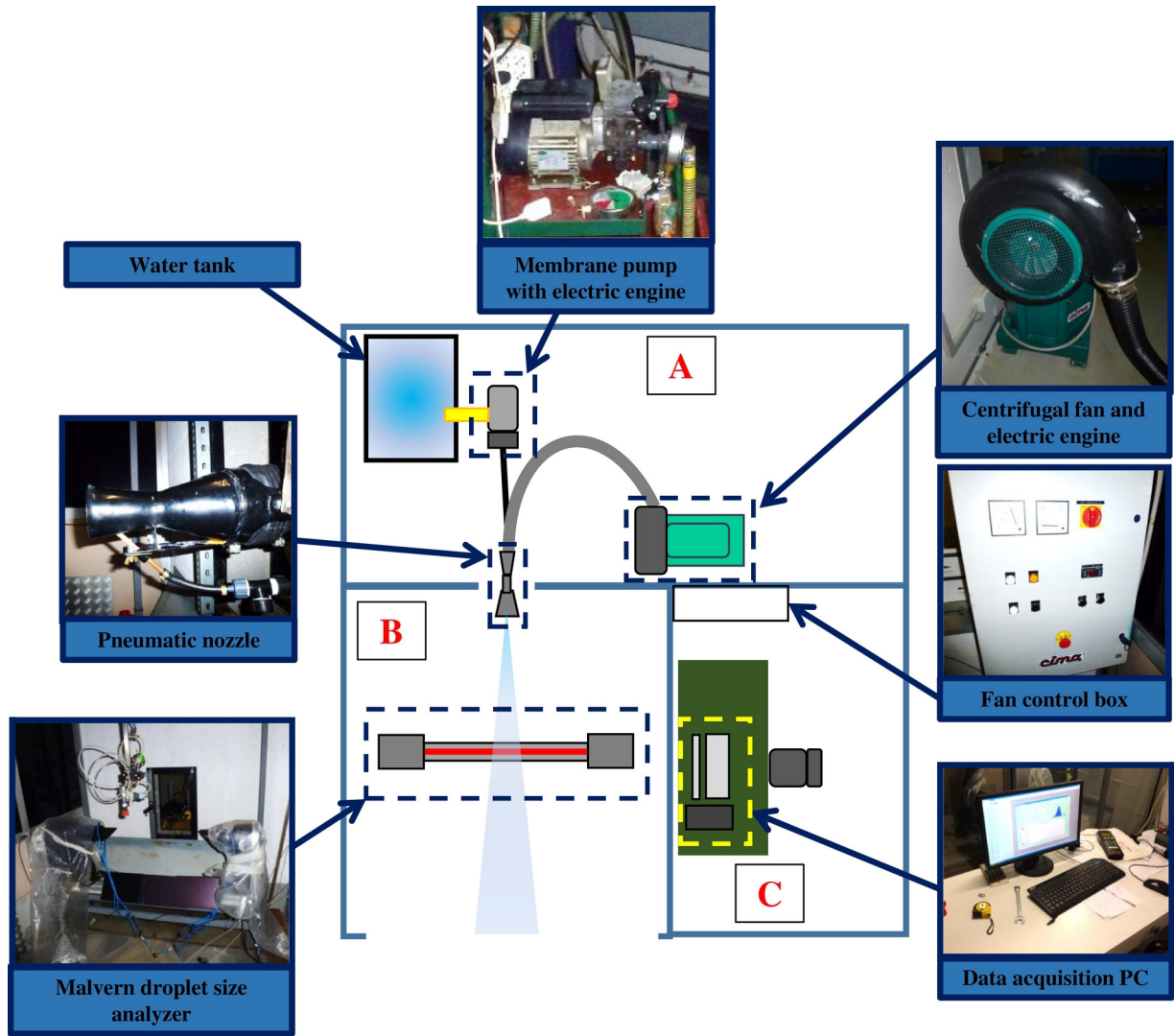

Fig. 1. Laboratory setup for the test bench and difference spaces: A. Spraying equipment, B. Spray droplet measurement instruments, and C. Trial control and data acquisition elements.

starting position was coincident with the original insertion point of the liquid hose (CP), and the final point was coincident with the air spout outlet (AP).

The air speeds were measured with a Pitot-tube-based anemometer (Testo 400, Testo Inc., Lenzkirch, Germany) with a measurement resolution of  $\pm 0.01$  hPa, a differential pressure of  $1.28 \text{ m s}^{-1}$ , and a

measurement range of up to  $+2000 \text{ hPa}$  ( $571.43 \text{ m s}^{-1}$ ). Speeds were measured at a frequency of 1 Hz over a time period of 20 s, and the average value was automatically calculated by the device.

An implement was developed and fixed to the air spout to position the Pitot tube precisely in the centre of the spout (Fig. 5). The two extreme positions and the central one were tested.

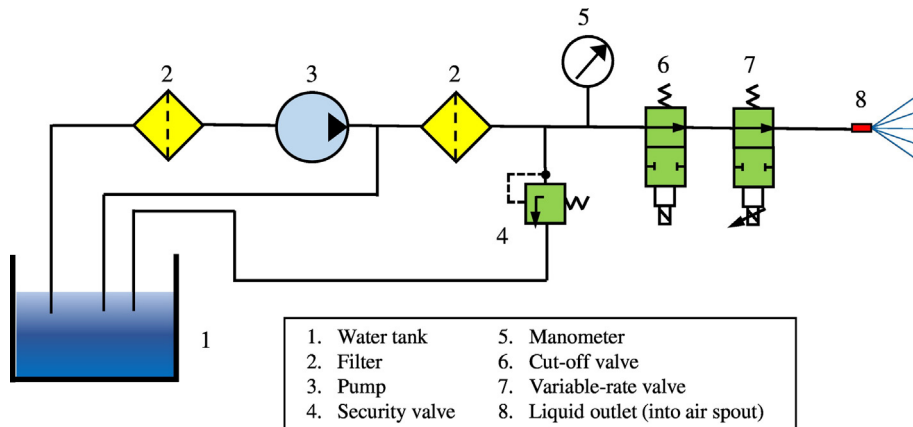

Fig. 2. Spraying circuit used in the test bench.

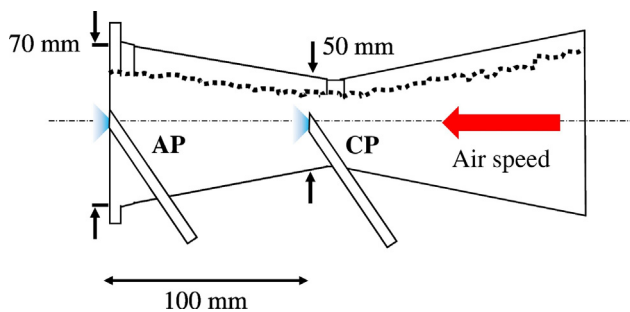

Fig. 3. Conventional (CP) and alternative (AP) positions of insertion of the liquid hose in the air spout.

A series of eight air flow rates (AFRs) (those generated by the fan at 350, 400, 450, 500, 550, 600, 650, and 700 rpm) were tested. The four calibrated rotary speed corresponding to 350, 400, 450, and 550 rpm were also tested using the conventional pneumatic sprayer. Three replicates, each obtained over a 20-s acquisition period of time, were performed for each air flow rate tested.

### 2.5. Droplet size measurement

The droplet sizes produced were measured using a Malvern Spraytec® laser diffraction system (STP5342, Malvern Instruments Ltd., Worcestershire, UK) (Fig. 6). The instrument has a maximum measurement frequency of 10 kHz and a measurement range of 0 to 2000  $\mu\text{m}$ . As pneumatic sprayers generate very small droplets, a 300-mm lens was used to get more resolution and work in a more appropriate scale. The instrument includes software (SprayTec Software v3.30, Malvern) for managing the data acquisition and charting.

The laser device was placed inside the designated chamber (B - Fig. 1) to avoid possible disturbance to the air flow and thus to the measurement process. An air current, settled as a curtain that flowed next to the instrument, was used to prevent the coalescence of droplets on the surface of the lens cover. The instrument was covered properly to protect it from the spray liquid. All of the tests were conducted with the nozzle positioned orthogonally at a distance of 50 cm from the laser beam emitted by the instrument. This distance was adjusted in previous tests to ensure that representative droplet sizes were obtained.

The data were acquired for 60 s at a 1-Hz frequency. The 10th percentile diameter (D10), 50th percentile or volumetric median diameter (D50), 90th-percentile diameter (D90), and percentage volume composed of droplets finer than 100  $\mu\text{m}$  in diameter ( $V_{100}$ ) were



Fig. 5. Implement for measuring the air speed in the centre of the air spout.

determined for each configuration tested. The frequencies of a series of pre-established droplet size intervals, distributed on a logarithmic scale, were also measured. Three replications were carried out for each configuration. A replication was considered to be complete when 60 values had been obtained for each combination of parameters.

### 2.6. Experimental design

The experiment was designed to consider two different hose positions (HP) were tested (CP and AP, Fig. 3), three liquid flow rate (LFR) levels, and four air flow rate (AFR) levels (Table 1). The LFR and AFR levels used are shown in Table 1.

For each configuration of the aforementioned parameters, D10, D50, D90,  $V_{100}$ , and the SPAN factor (calculated as RSF, which reflects the droplet uniformity) were measured or calculated. The RSF calculation is expressed in Eq. (1).

$$\text{RSF} = \frac{D90 - D10}{D50} \quad (1)$$

The experimental design was a completely randomised factorial and three replications for each configuration. A total of 24 different combinations were tested (Table 1), by combining the HP (two positions), the LFR (three levels), and the AFR (four levels) parameters. When the measurements for all of the air flow rate levels had been obtained, one

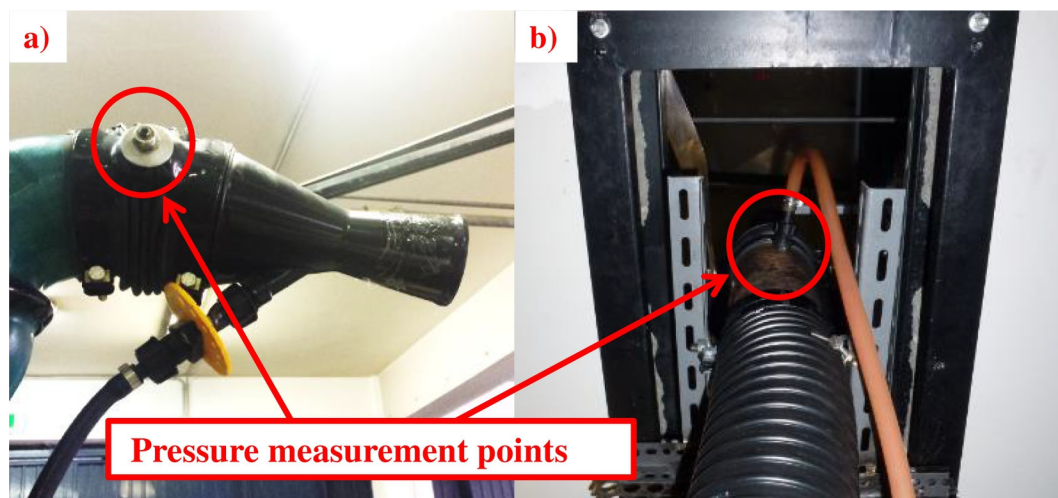

Fig. 4. Air pressure sampling position in: a) the real sprayer, and b) the prototype.



Fig. 6. Malvern SprayTec® droplet size analyser.

replication of the trial was considered to have been completed. This cycle was repeated three times.

The values chosen for the different parameters (Table 1) were selected according to the specifications of the manufacturer and the working ranges commonly used by farmers in the area. The spraying liquid pressure was kept constant at 0.1 MPa.

### 2.7. Statistical data analysis

An analysis of covariance (ANCOVA,  $\alpha = 0.05$ ) was conducted to detect differences in air speed reduction along the longitudinal axis of the spout for the different AFR levels, using the distance to the original position as a covariate. Normality and homoscedasticity were assessed using Shapiro-Wilk and Levène tests ( $\alpha = 0.05$ ), respectively.

Differences in droplet size were assessed using the R-software to import all of the individual data files into a general matrix. A preliminary analysis was performed using this software to plot the results and perform a Shapiro-Wilk test ( $\alpha = 0.05$ ) of the normality of the data and a Levène test ( $\alpha = 0.05$ ) of the homogeneity of the variances. The matrix with all of the data was then exported for statistical analysis. SPSS v20 (IBM, Armonk, NY, USA) was used to perform the analysis of variance (ANOVA) and develop the linear model.

A three-way ANOVA was performed to assess the influences of the different test parameters on the droplet size parameters and the droplet uniformity. In addition, the significance of the effects of interactions between the factors was checked.

Linear regression models were obtained to express the effects of the liquid and air flow rates on the calculated D50 and RSF values for both the CP and AP. A linear model (Eq. (2)) was fitted to predict VMD as a function of LFR and AFR.

$$D50 = \beta_0 + \beta_1 \times SD + \beta_2 \times LFR + \beta_3 \times AFR + \varepsilon \quad (2)$$

In this equation,  $\beta_0$  is the constant term of the regression corresponding to the D50 value when the predictive parameters are zero;  $\beta_1$ ,  $\beta_2$ , and  $\beta_3$  are the magnitudes of the effects of SD, LFR and AFR, respectively, on D50; and  $\varepsilon$  is the residual error of the model. Prior to

the model development, the normality and homoscedasticity of the residuals were checked (Hair et al., 1999).

## 3. Results and discussion

### 3.1. Adjustment of the test bench to simulate a real sprayer

Fig. 7 show the air pressure values for the commercial sprayer and the spraying prototype.

Fig. 7 shows that the air pressure is directly correlated to the air flow rate in both systems. Nevertheless, the prototype generated a lower air pressure than the commercial equipment. The fan air flow pressure values for the test bench were almost half those of the sprayer over the entire range of fan rotary speeds investigated, as indicated by the different slopes in both curves (Fig. 7). The measured values were very consistent, with no significant differences in the air pressure detected among the different replications of the measurements (coefficient of variation CV < 5%). This has remarkable practical importance, as the test bench can be configured easily to match any rotary speed of the real sprayer. This makes it possible to produce target air flow rates for droplet size measurements (Table 1). The results of the manual adjustment are shown in Table 2, along with the corresponding rotary speed values of the real sprayer and the calculated theoretical values.

Differences were detected between the calculated and adjusted rotary speed values. These differences may have been due to errors in the adjustment of the rotary speed of the prototype by the control box and the adjustment of the rotary speed of the sprayer's fan with the optical tachometer.

### 3.2. Air speed reduction along the spout longitudinal axis

The air speed reductions for the three measured positions along the spout's longitudinal axis for the different air flow rates are shown in Fig. 8 and Table 3.

The ANCOVA revealed significant differences ( $p = 0.0349$ ) in the speed decreases associated with the different air flow rates. This indicates that AFR significantly affects the air speed change along the spout and thus the absolute difference in air speed between the two liquid hose insertion positions. Table 3 shows the absolute and relative air speed drops between sampling points 0 and 10.

As Table 3 shows, there was a constant relative air speed drop along the spout, with a CV among the measured values of 3.31%. This means that for any value of the air flow rate, a constant air speed drop should be expected, and therefore, a change in the insertion point of the spout will have the same effect for a constant speed decrease. This is logical, considering that the AFR is calculated as the air speed multiplied by the cross-sectional area of the spout. Therefore, the higher the AFR is, the higher the absolute speed drop will be, while the percentage decrease remains the same. This is important because it can be confirmed that the working principle of the droplet size change works under real measured conditions and consequently can be applied to check the differences.

### 3.3. Droplet size

The results of the ANOVA for all of the dependent variables revealed that every test parameter considered and their interactions (double and

**Table 1**  
Studied variables with adjustable parameters and selected levels for each one.

Studied parameter	Air spout diameter (SD)	Liquid flow rate (LFR)	Air flow rate (AFR)
Studied levels	50/70 mm	1.00/1.64/2.67 L min <sup>-1</sup>	0.280/0.312/0.348/0.376 m <sup>3</sup> s <sup>-1</sup>
Regulation based on	Position of the liquid hose	Position of the regulatory disc	Rotary speed of the fan
Positions tested	Conventional/Alternative	Positions 3/5/7	541/598/663/720 rpm

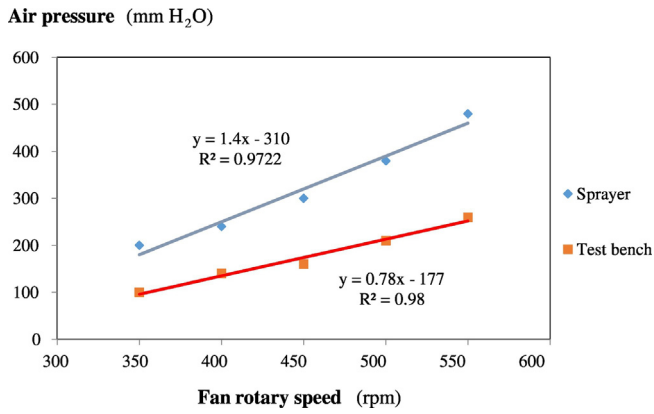

Fig. 7. Air pressure versus rotary speed for the sprayer and the test bench.

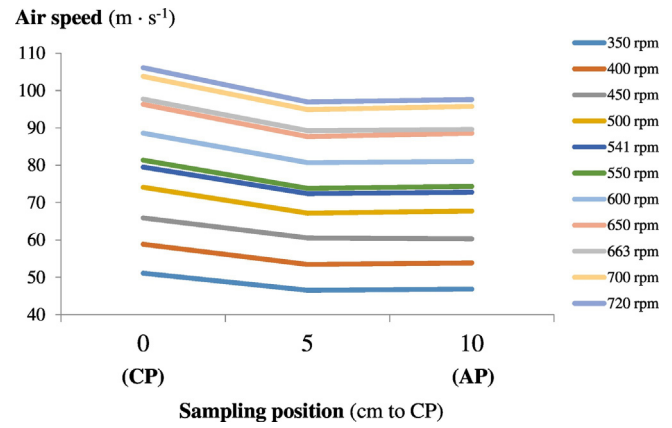

Fig. 8. Air speed values along the longitudinal axis of the air spout.

triple) were highly significant in all cases for D50, D10, D90, V100, and RSF ( $p < 10^{-4}$  in every case).

The droplet size parameters D50, D10, and D90, along with  $V_{100}$  and RSF for both positions of the liquid hose, for all possible combinations of cases, are shown in Fig. 9. The differences in the parameters are clearly evident for both parameters and thus confirm the ANOVA results. The high variability observed for each parameter is the result of the inclusion of all of the combinations and the presentation together of very different results.

As Fig. 9 shows, D50, D10, and D90 were considerably higher for the AP in all cases, as was the variability in the results. In the particular case of D50, the median value rose from 74.25  $\mu\text{m}$  to 118.39  $\mu\text{m}$ . This is a 59.45% mean increase in the D50 parameter between the two tested positions, reflecting larger droplet sizes overall. According to the ASAE S-572 droplet size classification (Southcombe et al., 1997), which is used to assess the spray drift of droplets of different sizes, the use of the AP can change the droplet sizes from the very fine (VF) category to the fine (F) category, the limit between the two being 100  $\mu\text{m}$ .

The AP also increased the median values of the D10 and D90 parameters, from 31.19  $\mu\text{m}$  to 45.28  $\mu\text{m}$  and from 151.92  $\mu\text{m}$  to 254.82  $\mu\text{m}$ , respectively. These are increases of 45.17% for D10 and 67.73% for D90. Note that the increases in the median values are proportional to the droplet sizes, with the minimum and maximum increases corresponding to the D10 and D90 parameters, respectively.

The D50 mean values ( $\mu\text{m}$ ) for each combination and the standard errors for each position of the liquid hose are shown in Fig. 10.

The values were very stable, with a very small standard error for each combination. Given that each bar reflects 180 values, this indicates that the instrument was very accurate in measuring the droplet size and that the values obtained are highly reliable.

For both positions of the liquid hose, D50 increases with LFR and decreases with AFR. These results are consistent with the results obtained by Manhani et al. (2013), who found that an increase in the air flow rate produced a decrease in the VMD. These results are also consistent with the findings of Di Prinzio et al. (2010), who reported that the droplet size achieved in pneumatic spraying can be changed by changing the ratio between the liquid and air flow rates.

The mean values for the inner position of the liquid hose were below the 100  $\mu\text{m}$ , with the maximum mean value for the highest LFR

**Table 2**  
Results of the adjustment of the rotary speed values to make the pressure match in both systems. Calculated test bench speed values were obtained from the general regression, while the adjusted ones were obtained experimentally on the bench.

Parameter		Values			
Sprayer rotary speed	(rpm)	350	400	450	500
Measured air pressure	(mm <sub>H2O</sub> )	180	240	300	380
Calculated test bench rotary speed	(rpm)	462	552	642	732
Adjusted test bench rotary speed	(rpm)	541	598	663	720

corresponding to the lowest AFR (D50 = 99.99  $\mu\text{m}$ ) and the minimum mean value for the lowest LFR corresponding to the highest AFR (D50 = 49.46  $\mu\text{m}$ ). The effect of LFR in this case is not very remarkable, resulting in a mean VMD increase of 23.56% from the minimum to the maximum AFR.

The values for the AP of the liquid hose were, in general, greater than or equal to 100  $\mu\text{m}$ , except for the highest AFR values at the lowest LFR positions. With this configuration, the maximum D50 was obtained with the highest LFR and the lowest AFR and occurred with the CP (D50 = 173.61  $\mu\text{m}$ ). The minimum value was obtained in the opposite case (D50 = 80.12  $\mu\text{m}$ ). An increase in droplet size is very important because it is the most important parameter affecting spray drift (Combella, 1982; Grella et al., 2017), with droplets smaller than 100  $\mu\text{m}$  very likely to drift as a result of wind action (van De Zande et al., 2008).

The VMD values for the AP of the liquid hose were higher than those for the CP for all combinations of the test parameters. A mean D50 increase of 58.62% was obtained using AP. Fig. 11 shows the mean relative differences in D50 between the two liquid hose positions for the different combinations of AFR and LFR.

The mean relative differences ranged from 48.29% to 73.63%, and as Fig. 11 shows, there was not a clear trend in the differences. The largest differences are concentrated in the lower right-hand corner of the graph, which corresponds to the highest LFR and the lowest AFR. This combination produces the coarsest droplets for both positions, which means that the largest differences arise under the most favourable conditions for producing larger droplets. However, the smallest differences are not concentrated in the opposite corner of the graph, which means that the differences remain constant up to a point for the combination

**Table 3**  
Mean air speeds for sampling positions 0, 5, and 10 along the longitudinal axis of the air spout and absolute and relative air speed drops.

Prototype	Air speed (m s <sup>-1</sup> )			$\Delta\text{speed}$ (m s <sup>-1</sup> )	$\Delta\text{speed}$ (%)
	Sampling position				
rpm	0	5	10		
350	51.80	46.51	46.84	4.23	8.29
400	58.83	53.44	53.85	4.98	8.47
450	65.90	60.54	60.30	5.60	8.50
500	74.10	67.16	67.75	6.35	8.57
541	79.51	72.39	72.76	6.74	8.48
550	81.36	73.81	74.36	6.99	8.60
600	88.58	80.69	81.02	7.56	8.53
650	96.31	87.68	88.56	7.75	8.04
663	97.70	89.26	89.60	8.11	8.30
700	103.78	94.92	95.76	8.02	7.73
				Mean	8.35
				Std. dev.	0.28
				CV (%)	3.31

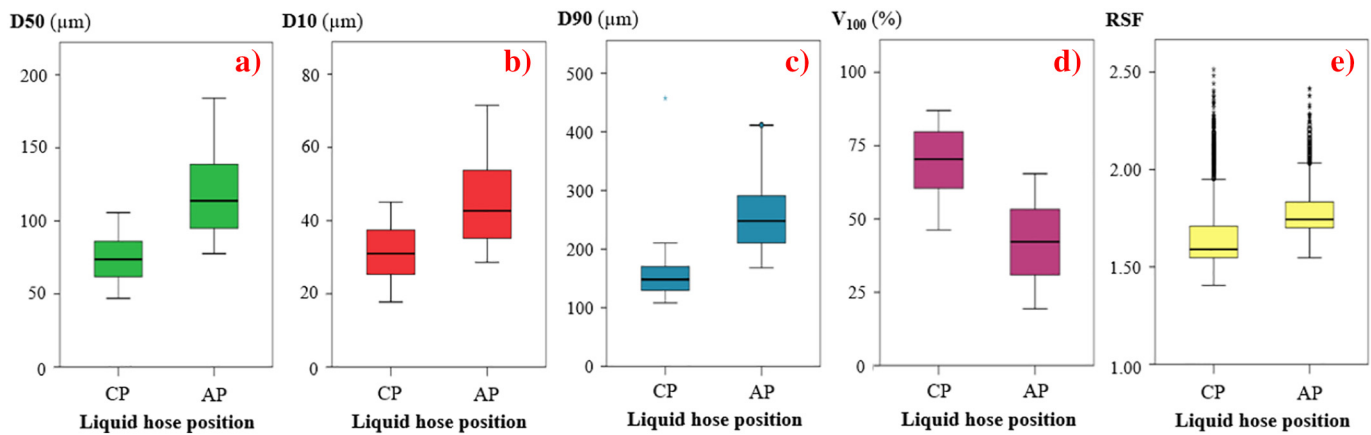

Fig. 9. Boxplots for the variables D50 (a), D10 (b), D90 (c),  $V_{100}$  (d), and RSF (e). The boxplots include all of the combinations of AFR and LFR considered.

of both parameters, beyond which point it increases. This finding could be important in terms of recommendations given to farmers and applicators concerning how to maximise differences in droplet size.

A linear model was developed to predict D50 as a function of the spout diameter at the release point (SD), LFR and AFR (Eq. (3)).

$$D50 = 121.145 + 2.207 \times SD + 11.900 \times LFR - 543.460 \times AFR \quad (3)$$

In this equation, D50 is expressed in μm, SD in mm, LFR in  $L \text{ min}^{-1}$ , and AFR in  $m^3 \text{ s}^{-1}$ .

All the variables considered were found to be highly significant ( $p < 10^{-4}$ ), and the model has a coefficient of determination  $R^2 = 0.945$ . This means that the three variables explain most of the differences observed in D50 and that the behaviour of the tested spout can be almost completely explained by these parameters. Note that SD coefficient in this equation is 2.2, which means that a small increase in SD can produce a large increase in D50. This can also be seen by comparing the relative air speed difference along the spout (Table 3) and the relative increase in the droplet diameter (Fig. 11). The mean air speed decrease was 8.35%, and the mean D50 increase was >50%. This is a very important finding because it shows that the air spout diameter at the point of spray generation can be varied to vary the droplet size generated. Design criteria that reflect this fact can be provided by sprayer manufacturers to help farmers reduce the drift risk in their applications,

especially when spraying at long distances from the target canopy, where this risk is higher.

### 3.4. Droplet driftability

Droplet driftability is significantly related to the  $V_{100}$  parameter (Hilz and Vermeer, 2013; Nuyttens et al., 2007b; van de Zande et al., 2008). The  $V_{100}$  results for every combination of the independent variables considered in this study are shown in Fig. 12.

The high  $V_{100}$  values obtained for the CP represent a very high drift risk, as these two parameters are positively correlated (Gil et al., 2014). With this HP, most mean values are above 50%, and some configurations lead to mean values of nearly 90%. A comparison of this top value with one obtained using a conventional hollow-cone nozzle ( $V_{100}$  value of 23.1% for an Albuz ATR Lilac) and used as a reference by other authors (van de Zande et al., 2008) shows that use of the pneumatic cannon increases the value of this parameter by a factor of nearly four (an increase of 290%). On the other hand, for the AP, the  $V_{100}$  values were significantly reduced to below 75% in every case. It is also noteworthy that it is possible to have, in the most favourable case,  $V_{100}$  values of 24%, which are similar to those obtained with the aforementioned reference nozzle. Pneumatic spraying is known to produce very fine droplets, but for the AP of the liquid hose and the lowest AFR, the driftable spray fraction is similar to that obtained with a hydraulic nozzle. This finding has useful implications for high wind speed conditions

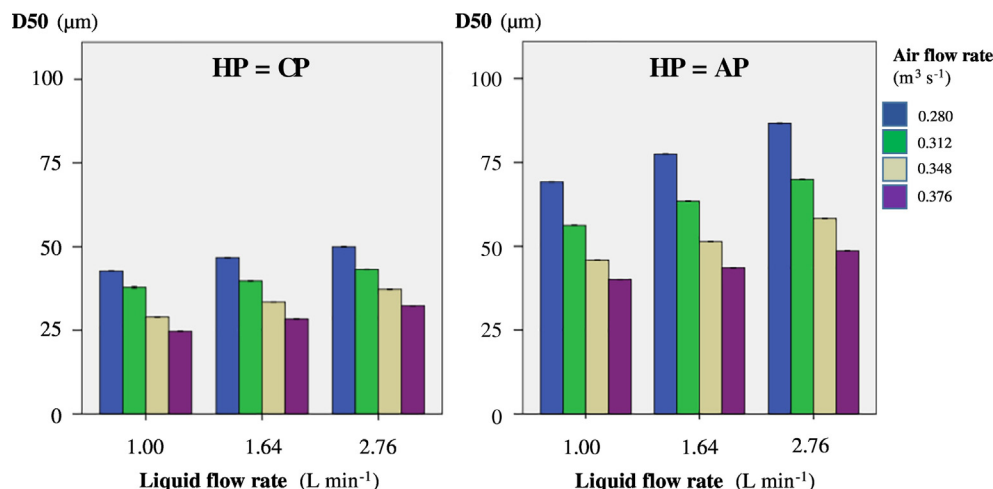

Fig. 10. D50 values for different combinations of variables for the two positions of the liquid hose. The error bars indicate the standard errors.



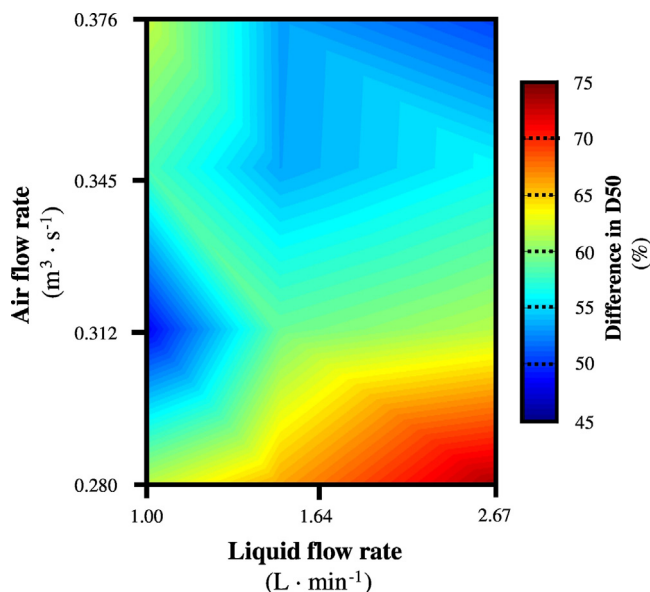

Fig. 11. Mean relative differences in D50 between the two liquid hose positions for every combination of AFR and LFR.

and for cases in which it is absolutely necessary to continue a spraying process even in adverse conditions. Nevertheless, a mean reduction of 27.18% in  $V_{100}$  can be achieved just by modifying the hose position in the cannon. This reduction would be associated with a drift risk reduction of 60.80% according to the formula for spray drift reduction potential based on  $V_{100}$  proposed by van de Zande et al. (2008), in which the reference  $V_{100}$  value is the mean of the values obtained with the CP. This reduction is similar to some reductions achieved using low-drift nozzles rather than conventional hollow-cone nozzles, according to these authors.

### 3.5. Droplet spectra uniformity

Significant differences in the droplet spectra uniformity, as measured by the RSF, were detected for all of the studied variables and their interactions ( $p < 10^{-4}$  in every case). This means that the hose AP does not achieve the uniformity of the CP, and therefore, the new configuration alters the uniformity of the droplet population. This occurs because of the influence of the studied variables on the D10 and D90 parameters. As Fig. 9 shows, the percentage increase was higher

for D90 and, therefore, the range in the spray volume between these two limits is higher for the AP of the liquid hose.

Nevertheless, and as Fig. 13 shows, the RSF increase was much smaller than the increases in the droplet size parameters, with an absolute increase of 0.124% from the median value of 1.654% obtained with the CP to 1.778% for the AP. This corresponds to a relative increase of 7.50%.

Fig. 13 shows the mean RSF values obtained for every combination of AFR and LFR considered for the two positions of the liquid hose.

The variation in RSF within each combination was still low, even with the errors associated with the three measured parameters combined. The differences in RSF did not seem to follow any particular trend with respect to the LFR or AFR values and was very stable except for the lowest LFR and the CP of the liquid hose. However, the ANOVA test revealed that significant differences existed ( $p < 10^{-4}$ ) for each parameter and their interaction. A Tukey test ( $\alpha = 0.05$ ) detected three homogeneous groups corresponding to the three tested LFRs, with mean values of 1.76% for an LFR of  $1.00 \text{ L min}^{-1}$  (position 3 of the regulatory disc), 1.72% for an LFR of  $2.67 \text{ L min}^{-1}$  (position 7), and 1.70% for an LFR of  $1.64 \text{ L min}^{-1}$  (position 5). These results indicate that RSF did not increase with LFR; rather, RSF was lowest for the intermediate LFR value. Nevertheless, the relative differences were very low, so an important influence on the spray was not expected.

Three homogeneous groups corresponding to the tested AFRs were detected using a Tukey test, and RSF was found to increase with increasing AFR. The mean RSF results for AFR levels of  $0.280 \text{ m}^3 \text{ s}^{-1}$  and  $0.312 \text{ m}^3 \text{ s}^{-1}$  (541 rpm and 598 rpm of the fan) were not significantly different (1.63% and 1.64%, respectively). Differences were detected between these two groups and each of the others, and between the other two, with mean values of 1.74% for the AFR of  $0.348 \text{ m}^3 \text{ s}^{-1}$  (663 rpm) and 1.85% for the AFR of  $0.376 \text{ m}^3 \text{ s}^{-1}$  (720 rpm). Again, the differences were small, so important effects are not expected.

As Fig. 13 shows, an increase in RSF with AFR occurred for some positions of the LFR disc. This trend is very notable for position 3 of the regulatory disc (the lowest LFR, Table 1) for CP and is evident, albeit to a much lesser extent, for some other cases, such as position 5 (Table 1) for CP and position 3 for AP. In general, a small increase in RSF can be observed for the different LFR values, but the Tukey test results did not indicate that the increase was statistically significant.

These results indicate that a change in the liquid hose position does not greatly alter the homogeneity of the droplet population generated, even though this homogeneity was slightly lower for the AP. It is a very important finding that the increase in the droplet size is remarkable but the uniformity loss is not. This finding has practical implications for the design of pneumatic sprayers to reduce spray drift in cannon-type spouts. Nevertheless, more research is needed to assess the effect

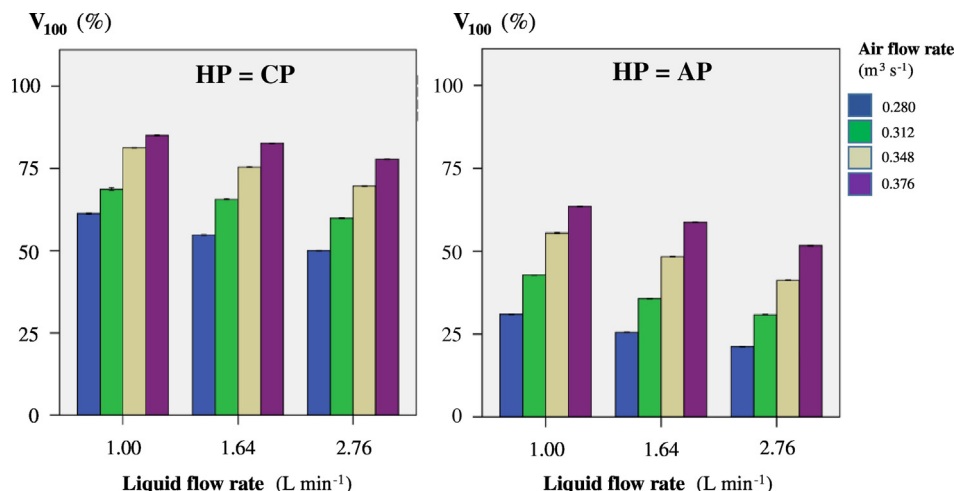

Fig. 12.  $V_{100}$  for different combinations of variables for the two positions of the liquid hose. The error bars indicate the standard errors.

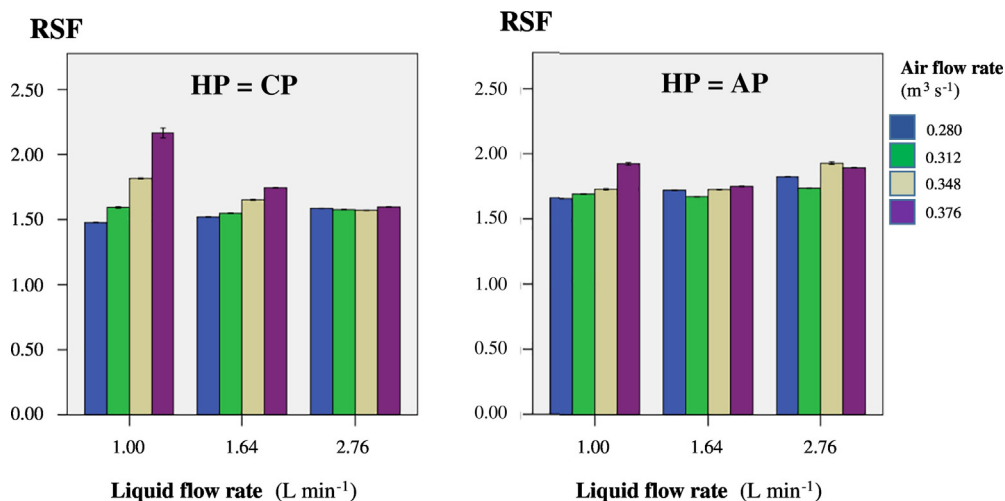

Fig. 13. Mean relative SPAN factor (RSF) for every tested combination of LFR and AFR for the two tested positions of the liquid hose. The error bars indicate the standard errors.

of this variable on spray deposition, coverage, and homogeneity in a real canopy.

#### 4. Conclusions

Droplet size and uniformity were measured for two different positions of the liquid hose in the air spout of a pneumatic nozzle in a test bench empirically adjusted to properly simulate a real pneumatic sprayer. Three LFRs and four AFRs were tested, and their influences on droplet size and uniformity were assessed. The following conclusions can be drawn from the study.

Changes in the position of the liquid hose inside the air spout significantly increased the droplet size of the generated spray plume, with a mean increase in D50 of 59.45% observed. The spout diameter at the release point, liquid flow rate, and air flow rate all produced significant variations in the evaluated droplet size parameters. The spray drift potential can be reduced substantially by changing the liquid hose position from the conventional position to the alternative position. This can reduce spray drift dramatically in applications performed with pneumatic sprayers and thereby contribute to meeting the requirements for the sustainable use of pesticides. The ability to predict the spray droplet size for different combinations of parameters could help farmers increase the safety of their treatments, reduce pollution of the environment, and ensure the sustainability of pneumatic applications in vineyards and compliance with the requirements of the current regulatory framework.

#### Acknowledgements

The authors thank CIMA for the use of their spraying equipment. The first author acknowledges a National Training Program of University Lecturers (FPU) scholarship received from the Spanish Ministry of Education, Culture, and Sport. This work was partially financed by the AgVANCE project (AGL2013-48297-C2-1-R) under the Spanish Ministry of Economy and Competitiveness (MINECO).

#### References

Arvidsson, T., Bergström, L., Kreuger, J., 2011. Spray drift as influenced by meteorological and technical factors. *Pest Manag. Sci.* 67, 586–598.

Baetens, K., Ho, Q.T., Nuyttens, D., de Schampheleire, M., Endalew, A., Hertog, M., Nicolai, B., Ramon, H., Verboven, P., 2008. Development of a 2-D-diffusion advection model for fast prediction of field drift. *Atmos. Environ.* 43, 1674–1682.

Balsari, P., Scienza, A., 2003. Forme di allevamento della vite e modalità di distribuzione dei fitofarmaci. *Ed. Informatore Agrario S.p.a.* p. 352.

Balsari, P., Tamagnone, M., Marucco, P., Matta, F., 2016. How air liquid parameters affect droplet size: experiences with different pneumatic nozzles. *Asp. Appl. Biol. Int. Adv. Pestic.* 132, 265–271.

Benbrook, C.M., Baker, B.P., 2014. Perspective on dietary risk assessment of pesticide residues in organic food. *Sustainability* 6, 3552–3570.

Bird, S.L., Esterly, D.M., Perry, S.G., 1996. Atmospheric pollutants and trace gases. Off-target deposition of pesticides from agricultural aerial spray applications. *J. Environ. Qual.* 25, 1095–1104.

Bode, L.E., 1984. Downwind drift deposits by ground applications. *Proceedings Pesticide Drift Management Symposium*, p. 50.

Bode, L.E., Butler, B.J., Goering, C.E., 1976. Spray drift and recovery as affected by spray thickener, nozzle type, and nozzle pressure. *Trans. ASAE* 19 (2), 213–218.

Bouse, L.F., Kirk, I.W., Bode, L.E., 1990. Effect of spray mixture on droplet size. *Trans. ASAE* 33 (3), 783–788.

Butler Ellis, M.C., Lane, A.G., O'Sullivan, C.M., Miller, P.C.H., Glass, C.R., 2010. Bystander exposure to pesticide spray drift: new data for model development and validation. *Biosyst. Eng.* 107, 162–168.

Butler Ellis, M.C., Lane, A.G., O'Sullivan, C.M., Alanis, R., Harris, A., Stallinga, H., van de Zande, J.C., 2014. Bystander and resident exposure to spray drift from orchard applications: field measurements, including a comparison of spray drift collectors. *Asp. Appl. Biol. Int. Adv. Pestic.* 122, 187–194.

Byass, J.B., Lake, J.R., 1977. Spray drift from a tractor-powered field sprayer. *Pestic. Sci.* 8, 117–126.

Combellack, J.H., 1982. Loss of herbicides from ground sprayers. *Weed Res.* 22, 193–204.

Combellack, J.H., Western, N.M., Richardson, R.G., 1996. A comparison of the drift potential of a novel twin fluid nozzle with conventional low volume flat fan nozzles when using a range of adjuvants. *Crop. Prot.* 15 (2), 147–152.

Dabrowski, J.M., Schulz, R., 2003. Predicted and measured levels of azinphosmethyl in the Lourens River, South Africa. Comparison of runoff and spray drift. *Environ. Toxicol. Chem.* 22, 494–500.

Davis, B.N.K., Williams, C.T., 1990. Buffer zone widths for honeybees from ground and aerial spraying of insecticides. *Environ. Pollut.* 63, 247–259.

Dekeyser, D., Foqué, D., Duga, A.T., Verboven, P., Hendrickx, N., Nuyttens, D., 2014. Spray deposition assessment using different application techniques in artificial orchard trees. *Crop. Prot.* 64, 187–197.

Delele, M.A., Jaeken, P., Debaer, C., Baetens, K., Endalew, A.M., Ramon, H., Nicolai, B.M., Verboven, P., 2007. CFD prototyping of an air-assisted orchard sprayer aimed at drift reduction. *Comput. Electron. Agric.* 55, 16–27.

Derksen, R.C., Zhu, H., Fox, R.D., Braze, R.D., Krause, C.R., 2007. Coverage and drift produced by air induction and conventional hydraulic nozzles used for orchard applications. *Trans. ASABE* 50, 1493–1501.

Di Prinzio, A., Behmer, S., Magdalena, J.C., 2010. Equipos pulverizadores terrestres. *Tecnología de aplicación de agroquímicos. Argentina: Área de comunicaciones del INTA Alto Valle. cap. 9, pp. 107–120 (In Spanish).*

Doruchowski, G., Labanowska, B., Goszczynski, W., Godyń, A., Holownicki, R., 2002. Spray deposit, spray loss and biological efficacy of chemicals applied with different spraying techniques in black currants. *EJPAU* 5(2), #01. (Available Online). <http://www.ejpau.media.pl/volume5/issue2/engineering/art-01.html>.

Doruchowski, G., Świechowski, W., Masny, S., Maciesiak, A., Tartanus, M., Bryk, H., Holownicki, R., 2017. Low-drift nozzles vs. standard nozzles for pesticide application in the biological efficacy trials of pesticides in apple pest and disease control. *Sci. Total Environ.* 575, 1239–1246.

Duga, A.T., Ruysen, K., Dekeyser, D., Nuyttens, D., Bylemans, D., Nicolai, B.M., Verboven, P., 2015. Spray deposition profiles in pome fruit trees: effects of sprayer design, training system and tree canopy characteristics. *Crop. Prot.* 67, 200–213.

Ernst, W.R., Jonah, P., Doe, K., Julien, G., Hennigar, P., 1991. Toxicity to aquatic organisms of off-target deposition of endosulfan applied by aircraft. *Environ. Toxicol. Chem.* 10, 103–114.

- European Community, 2009. Directive 2009/128/EC of the European parliament and the council of 21 October 2009 establishing a framework for community action to achieve the sustainable use of pesticides. Off. J. Eur. Union L 309, 71–86.
- Felsot, A.S., Unsworth, J.B., Linders, J.B.H.J., Roberts, G., 2011. Agrochemical spray drift: assessment and mitigation—a review. *J. Environ. Sci. Health B* 46, 1–23.
- Frost, K.R., Ware, G.W., 1970. Pesticide drift from aerial and ground applications. *Agric. Eng.* 51 (8), 460–464.
- Ganzelmeier, H., Rautmann, D., 2000. Drift, drift reducing sprayers and sprayer testing. *Asp. Appl. Biol. Int. Adv. Pestic.* 57, 1–10.
- Garcerá, C., Román, C., Moltó, E., Abad, R., Insa, J.A., Torrent, X., Planas, S., Chueca, P., 2017. Comparison between standard and drift reducing nozzles for pesticide application in citrus: Part II. Effects on canopy spray distribution, control efficacy of *Aonidiella aurantii* (Maskell), beneficial parasitoids and pesticide residues on fruit. *Crop. Prot.* 94, 83–96.
- Gil, E., Balsari, P., Gallart, M., Llorens, J., Marucco, P., Andersen, P.G., Fàbregas, X., Llop, J., 2014. Determination of drift potential of different flat fan nozzles on a boom sprayer using a test bench. *Crop. Prot.* 56, 58–68.
- Gil, E., Gallart, M., Balsari, P., Marucco, P., Almajano, M.P., Llop, J., 2015. Influence of wind velocity and wind direction on measurements of spray drift potential of boom sprayers using drift test bench. *Agric. For. Meteorol.* 202, 94–101.
- Grella, M., Gallart, M., Marucco, P., Balsari, P., Gil, E., 2017. Ground deposition and airborne spray drift assessment in vineyard and orchard: the influence of environmental variables and sprayer settings. *Sustainability* 9 (5), 728.
- Grover, R., Kerr, L.A., Maybank, J., Yoshidja, K., 1978. Field measurement of droplet drift from ground sprayers. I. Sampling, analytical and data integration techniques. *Can. J. Plant Sci.* 58 (3), 611–622.
- Guler, H., Zhu, H., Ozkan, H.E., Derksen, R.C., Yu, Y., Krause, C.R., 2007. Spray characteristics and drift reduction potential with air induction and conventional flat fan nozzles. *Trans. ASABE* 50 (3), 745–754.
- Hair, J.F., Anderson, R.E., Tatham, R.L., Black, W.C., 1999. *Multivariate Data Analysis*. 7th edition. Prentice Hall.
- Hilz, E., Vermeer, A.W.P., 2013. Spray drift review: the extent to which a formulation can contribute to spray drift reduction. *Crop. Prot.* 44, 75–83.
- Hobson, P.A., Miller, P.C.H., Walklate, P.J., Tuck, C.R., Western, N.M., 1990. Spray drift from hydraulic spray nozzles: the use of a computer simulation model to examine factors influencing drift. *Conference Proceedings AgEng 1990*, Berlin, pp. 1–11.
- Hobson, P.A., Miller, P.C.H., Walklate, P.J., Tuck, C.R., Western, N.M., 1993. Spray drift from hydraulic spray nozzles: the use of a computer simulation model to examine factors influencing drift. *J. Agric. Eng. Res.* 54, 293–305.
- Hofman, V., Solseng, E., 2001. Reducing spray drift. North Dakota State University NDSU Extension Service AE-1210. ND, Fargo.
- ISO, 2005. ISO 22866:2005: equipment for Crop Protection—Methods for Field Measurements of Spray Drift. International Organization for Standardization, Geneva, Switzerland.
- Lahr, J., Gadjji, B., Dia, D., 2000. Predicted buffer zones to protect temporary pond invertebrates from groundbased insecticide applications against desert locusts. *Crop. Prot.* 19, 489–500.
- Llorens, J., Gallart, M., Llop, J., Miranda-Fuentes, A., Gil, E., 2016. Difficulties to apply ISO 22866 requirements for drift measurements. A particular case of traditional olive tree plantations. *Asp. Appl. Biol.* 132, 31–38.
- Manhani, G.G., Teixeira, M.M., Fernandes, H.C., Zolnier, S., Sasaki, R.S., 2013. Developing a system to control the air flow of a pneumatic sprayer. *Biosci. J.* 29, 667–675.
- Márquez, L., 2007. Pulverización y pulverizadores neumáticos. *Agrotécnica 2* (2007), 34–41 (in Spanish).
- Marrs, R.H., Frost, A.J., Plant, R.A., Lunnis, P., 1993. Determination of buffer zones to protect seedlings of non-target plants from the effects of glyphosate spray drift. *Agric. Ecosyst. Environ.* 45, 283–293.
- Marucco, P., Tamagnone, M., Balsari, P., 2008. Study of Air Velocity Adjustment to Maximize Spray Deposition in Peach Orchards. *Agric. Eng. Int. CIGR J.* X 1–13.
- Miller, P.C.H., Hadfield, D.J., 1989. A simulation model of the spray drift from hydraulic nozzles. *J. Agric. Eng. Res.* 42, 135–147.
- Nuyttens, D., Baetens, K., De Schampheleire, M., Sonck, B., 2007a. Effect of nozzle type, size and pressure on spray droplet characteristics. *Biosyst. Eng.* 97 (3), 333–345.
- Nuyttens, D., De Schampheleire, M., Baetens, K., Sonck, B., 2007b. The Influence of Operator-controlled Variables on Spray Drift From Field Crop Sprayers. 50 pp. 1129–1140.
- Nuyttens, D., De Schampheleire, M., Verboven, P., Sonck, B., 2010. Comparison between indirect and direct spray drift assessment methods. *Biosyst. Eng.* 105 (1), 2–12.
- Nuyttens, D., De Schampheleire, M., Baetens, K., Brusselman, E., Dekeyser, D., Verboven, P., 2011. Drift from field crop sprayers using an integrated approach: results of a 5-year study. *Trans. ASABE* 54 (2), 403–408.
- Southcombe, E.E.S., Miller, P.C.H., Ganzelmeier, H., Van De Zande, J., Miralles, A., Hewitt, A.J., 1997. The international (BCPC) spray classification system including a drift potential factor. *Proceedings of the Brighton Crop Protection Conference - Weeds*, pp. 371–380.
- Take, M.E., Barry, J.W., Richardson, B., 1996. An FSCBG Sensitivity Study for Decision Support Systems, Paper No. 961037, ASAE Annual Meeting: Phoenix, AZ.
- TOPPS-Prowadis Project, 2014. Best management practices to reduce spray drift. (Available online at). <http://www.topps-life.org/>. Accessed date: 1 January 2017.
- van de Zande, J.C., Holterman, H.J., Wenneker, M., 2008. Nozzle classification for drift reduction in orchard spraying: identification of drift reduction class threshold nozzles. *Agric. Eng. Int. CIGR Ej. X* 1–12.
- Van den Berg, F., Kubiak, R., Benjey, W.G., Majewski, M.S., Yates, S.R., Reeves, G.L., Smelt, J.H., Linden, A.M.A.V.D., 1999. Emission of pesticides into the air. *Water Air Soil Pollut.* 115, 195–218.
- Yates, W.E., Cowden, R.E., Akesson, N.B., 1985. Drop size spectra from nozzles in high-speed airstream. *Trans. ASAE* 28 (2), 405–410.
- Zhu, H., Reichard, D.L., Fox, R.D., Brazee, R.D., Ozkan, H.E., 1994. Simulation of drift of discrete sizes of water droplets from field sprayers. *Trans. ASAE* 37 (5), 1401–1407.